

# Official Bulletin of the Industrial Property

Inventions

Utility Models

Designs

Trademarks

Geographical Indications



საქართველოს ინტელექტუალური  
საკუთრების ეროვნული ცენტრი

**საქპატენტი**

**SAKPATENTI**

NATIONAL INTELLECTUAL PROPERTY  
CENTER OF GEORGIA

[www.sakpatenti.gov.ge](http://www.sakpatenti.gov.ge)

Date of Publication – 2022 06 10

**11(590)**

# INID CODES FOR IDENTIFICATION OF BIBLIOGRAPHIC DATA

## INVENTIONS, UTILITY MODELS

- (10) Number of publication for application, which has been examined
- (11) Number of patent and kind of document
- (21) Serial number of application
- (22) Date of filing of the application
- (23) Date of exhibition or the date of the earlier filing and the number of application, if any
- (24) Date from which patent may have effect
- (31) Number of priority application
- (32) Date of filing of priority application
- (33) Code of the country or regional organization allotting priority application number
- (44) Date of publication of application not granted, but examined and number of bulletin
- (45) Date of publication of registered document
- (51) International Patent Classification Index

- (54) Title of the invention
- (57) Abstract
- (60) Number of examined patent document granted by foreign patent office, date from which patent has effect and country code
- (62) Number of the earlier application and in case of divided application, date of filing an application
- (71) Name, surname and address of applicant (country code)
- (72) Name, surname of inventor (country code)
- (73) Name, surname and address of patent owner (country code)
- (74) Name, surname of representative or patent attorney
- (85) Date of commencement of the national phase of International Application
- (86) Number and date of filing of international application
- (87) Number and date of publication of international application
- (94) Calculated date of expiry of the SPC or the duration of the SPC

## DESIGNS

- (10) Number of publication for application
- (11) Number of patent and kind of document or number of registration
- (15) Date of registration/Date of patent renewal
- (18) Expected expiration date of patent or registration
- (21) Serial number of application
- (22) Date of filing of the application
- (23) Date of exhibition or the date of the earlier filing and the number of application, if any
- (24) Date from which patent may have effect
- (28) Number of designs included in the application
- (30) Data relating to priority (number of application, date of filing of application, two-letter code identifying the authority with whom the priority application was made)
- (31) Number of priority application
- (32) Date of filing of priority application
- (33) Code of the country or regional organization allotting priority application number
- (34) Two-letter code according to WIPO St.3 identifying the authority with which the priority application was made
- (44) Date of publication of design and number of bulletin (the first publication)
- (45) Date of publication of design registered by WIPO and number of bulletin

- (51) International Classification for designs (class and subclass of the Locarno Classification)
- (54) Title of the invention
- (55) Reproduction of the design
- (57) Description of characteristic features of the design including indication of colors
- (58) Date of recording of any kind of amendment in the Register
- (62) Number of the earlier application, registration and document number and if available the date of filing an application in case of divided application
- (71) Name, surname and address of applicant (country code)
- (72) Name, surname of creator (country code)
- (73) Name, surname and address of patent owner (country code)
- (74) Name, surname of representative or patent attorney
- (81) Contracting states concerned  
II designated contracting states according to the 1960 Act  
III designated contracting states according to the 1999 Act
- (85) Owner's permanent address
- (86) Owner's nationality
- (87) Owner's residence
- (88) State in which the owner has a real and effective industrial or commercial establishment

## TRADEMARKS

- (111) - Number of registration
- (151) - Date of registration
- (156) - Date of the renewal
- (181) - Expected expiration date of registration
- (186) - Renewal expiration date of registration
- (141) - Date of cancel of duration of the mark
- (210) - Serial number of application
- (220) - Date of filing of the application
- (230) - Data concerning exhibition
- (260) - Number of application, for which favorable decision of examination about registration has been taken (publication number)
- (310) - Number of the first application
- (320) - Date of filing of the first application
- (330) - Code, identifying national or regional Office where the first application was made
- (511) - International Classification of Goods and Services for the purposes of registration of trade marks and/or list of goods and/or services classified according thereto
- (526) - Disclaimer
- (531) - Description of figurative elements of Trade Marks according to the International Classification of the Figurative Elements of Marks

- (540) - Reproduction of Trade Mark
- (550) - Nature and kind of Trade Mark
- (551) - Indication to the effect that the mark is a collective mark, a certification mark or a guarantee mark
- (554) - Three-dimensional mark
- (580) - Date of recording of any kind changes in respect of applications or registrations
- (591) - Information concerning colors claimed
- (731) - Name and address of the applicant
- (732) - Name and address of the holder of the registration
- (740) - Name and address of the representative
- (750) - Addreses for correspondence
- (770) - Name and address of the previous applicant or holder in case of change in ownership
- (771) - Previous name and address of the applicant or holder in case of change in ownership
- (791) - Name and address of the licensee
- (793) - Indication of conditions and/or restrictions under the license (Type of license, number of license agreement, data of license, data of validity of license)
- (800) - Certain data relating to the international registration of Trade Marks under the Protocol Relating to Madrid Agreement (International registration number)
- (852) - Partial cancellation of the list of goods and services
- (891) - Date of subsequent designation

## CODES FOR PUBLICATION IN BULLETIN

- (21) AP 0000 000000 - serial number of application for invention
- (10) AP 0000 0000 A - number of published application for invention (first publication)
- (11) P 0000 0000 B - number of patent for invention (second publication)
- (21) API 0000 000000 - number of application for imported patent
- (11) PI 0000 0000 A - number of imported patent (first publication)
- (21) AU 0000 000000 - serial number of application for utility model
- (10) AU 0000 000 U - number of published application for utility model (first publication)
- (11) U 0000 000 Y - number of patent for utility model (second publication)
- (21) AD 0000 000000 - serial number of application for design
- (10) AD 0000 000 S - number of published application for design (first publication)
- (11) D 0000 000 S - registered design

## INTERNATIONAL PATENT CLASSIFICATION FOR INVENTIONS AND UTILITY MODELS

- SECTION A - HUMAN NECESSITIES
- SECTION B - PERFORMING OPERATIONS; TRANSPORTING
- SECTION C - CHEMISTRY; METALLURGY
- SECTION D - TEXTILES; PAPER
- SECTION E - FIXED CONSTRUCTIONS
- SECTION F - MECHANICAL ENGINEERING; LIGHTING; HEATING; WEAPONS; BLASTING
- SECTION G - PHYSICS
- SECTION H - ELECTRICITY

- 
- M - Trade Mark
  - (210) AM 0000 000000 - Serial number of application;
  - (260) AAM 0000 00000 A - Publication number of application;
  - (111) M 0000 00000 R - Number of registration;
  - (111) MMM0000 00000 Rn - Number of renewals, in which n=1,2,3;
  - (111) M 0000 00000 R(P) - Number of registration under partial assignment of rights
-

# Official Bulletin of the Industrial Property

Inventions

Utility Models

Designs

Trademarks

Geographical Indications

# CONTENT

<b>PUBLISHED TITLES OF PROTECTION</b> .....	3
<b>INVENTIONS</b>	
▪ APPLICATIONS APPROVED FOR GRANTING PATENT .....	4
▪ PATENTED INVENTIONS .....	6
<b>UTILITY MODELS</b>	
PATENTED UTILITY MODELS .....	8
<b>DESIGNS</b>	
▪ REGISTERED DESIGN .....	9
▪ DESIGNS, WHICH HAVE BEEN REGISTERED WITH THE INTERNATIONAL BUREAU CLAIMING PRIORITY ON THE TERRITORY OF GEORGIA .....	10
<b>TRADEMARKS</b>	
▪ APPLICATIONS FILED UNDER THE NATIONAL PROCEDURE APPROVED FOR REGISTRATION .....	32
▪ REGISTERED TRADEMARKS .....	41
▪ TRADEMARKS REGISTERED ACCORDING TO THE ACCELERATED PROCEDURE .....	47
▪ INTERNATIONAL TRADEMARKS FOR WHICH A DECISION ON GRANTING PROTECTION IS TAKEN .....	50
▪ INTERNATIONAL TRADEMARKS PROTECTED IN GEORGIA .....	95
<b>GEOGRAPHICAL INDICATIONS</b>	
▪ AJIKA .....	105
▪ TKEMALI .....	108
<b>OFFICIAL NOTIFICATIONS</b>	
<b>INVENTIONS</b>	
▪ RESTORATION OF PATENT .....	111
▪ ABOLITION OF PATENTS WITH THE RIGHT TO RESTORE .....	111
▪ EXPIRATION OF TERMS OF RESTORATION OF PATENTS .....	112
▪ EXPIRATION OF TERMS OF PATENTS .....	114
▪ CHANGES OF NAMES AND/OR ADDRESSES OF PATENTOWNERS .....	114
<b>UTILITY MODELS</b>	
▪ RESTORATION OF PATENT .....	115
▪ EXPIRATION OF TERMS OF RESTORATION OF PATENTS .....	115
<b>DESIGNS</b>	
▪ EXTENSION OF TERMS OF INTERNATIONAL DESIGNS REGISTRATION .....	116
▪ CANCELLATION OF INTERNATIONAL DESIGNS REGISTRATION .....	119
<b>TRADEMARKS</b>	
▪ EXTENSION OF TERMS OF TRADEMARKS REGISTRATION .....	121
▪ COMPLETE TRANSFER OF RIGHTS .....	125
▪ CHANGES OF NAMES AND/OR ADDRESSES OF TRADEMARKS OWNERS .....	127
▪ CANCELLATION OF TRADEMARKS REGISTRATION .....	129
<b>CLASSIFICATION INDEXES</b>	
INVENTIONS .....	131
UTILITY MODELS .....	132
DESIGNS .....	133
TRADEMARKS .....	134

## **PUBLISHED TITLES OF PROTECTION**

### **INVENTIONS**

- **APPLICATIONS APPROVED FOR GRANTING PATENT:**  
15479; 15382; 15554; 15536
- **PATENTED INVENTIONS:**  
7386-7389

### **UTILITY MODELS**

- **PATENTED UTILITY MODELS:**  
2116-2118

### **DESIGNS**

- **REGISTERED DESIGN:**  
936
- **DESIGNS, WHICH HAVE BEEN REGISTERED WITH THE INTERNATIONAL BUREAU CLAIMING PRIORITY ON THE TERRITORY OF GEORGIA:**  
217297; 216596; 216936; 220134; 217073; 220131; 217006

### **TRADEMARKS**

- **APPLICATIONS FILED UNDER THE NATIONAL PROCEDURE APPROVED FOR REGISTRATION:**  
99510, 99511; 114921, 114922; 114926; 115003; 115006-115008; 115099; 115124, 115125; 115206; 115210; 115220, 115221; 115326; 115330; 115333, 115334; 115337; 115339; 115345; 115347, 115348; 115399; 115404; 115407; 115409; 115413; 115417; 115424, 115425; 115427; 115429; 115431; 115434-115437; 115507; 115513; 115515, 115516; 115519-115522; 115527, 115528; 115532, 115533; 115535-115537; 115539; 115597
- **REGISTERED TRADEMARKS:**  
35485-35510; 35515-35554
- **TRADEMARKS REGISTERED ACCORDING TO THE ACCELERATED PROCEDURE:**  
35478-35484; 35511-35514; 35555
- **INTERNATIONAL TRADEMARKS FOR WHICH A DECISION ON GRANTING PROTECTIONS IS TAKEN:**  
114301-114305; 114366-114370; 114376-114381; 114391, 114392; 114432; 114434-114436; 114446-114451; 114458-114461; 114477; 114483-114487; 114493; 114495, 114496; 114499-114502; 114550; 114552, 114553; 114555-114559; 114570-114572; 114645; 114668, 114669; 114701; 114707; 114717; 114789-114793; 114819-114821; 114834, 114835; 114837, 114838; 114881; 114894-114899; 114928; 114940-114948; 114959-114963; 114965-114968; 115076; 115078; 115081; 115083; 115132-115136; 115138; 115140; 115151-115154; 115189, 115190; 115277; 115293
- **INTERNATIONAL TRADEMARKS PROTECTED IN GEORGIA:**  
109171; 109313; 109714; 110103; 110357; 111777; 111780; 112463; 112516; 112533; 112535; 112563; 112573; 112629; 112758; 112798; 112801; 112826-112830; 112853; 112855-112858; 112872; 112874-112876; 112880-112883; 112885-112888; 112946-112949; 112951-112953; 112955, 112956; 112958; 112963, 112964; 112966; 112972, 112973; 112983; 112987, 112988; 112990-112992; 113005; 113052; 113061; 113063-113066; 113080-113085; 113089-113091; 113153-113157; 113159-113163; 113174; 113176; 113288-113290; 113294-13297; 113302, 113303; 113305-113313; 113438; 113440, 113441; 113443; 113454-113457; 113481; 113530, 113531; 113563; 113565; 113567; 113570-113575; 113673-113675; 113715; 113731; 113743

### **GEOGRAPHICAL INDICATIONS**

3509/7; 3511/7

# INVENTIONS

## APPLICATIONS APPROVED FOR GRANTING PATENT

The decision can be appealed at the Chamber of Appeal of Sakpatenti within 3 months from the publication or at the Mtskheta District Court Administrative Cases Board (Address: №17, Samkhedro St., Mtskheta), within 1 month following the publication.

### PART A

#### A 61

(10) AP 2022 15479 A (51) Int. Cl. (2006)  
A 61 K 31/4192  
A 61 K 31/4146  
A 61 K 31/41

(21) AP 2019 15479 (22) 2019 05 14

(31) 62/671,985

(32) 2018 05 15

(33) US

(71) H. Lundbeck A/S (DK)

Ottiliavej 9, Valby, DK-2500, Denmark (DK)

(72) GRICE, Cheryl A. (US);

BUZARD, Daniel J. (US);

SHAGHAFI, Michael B. (US)

(74) Tamaz Shilakadze

(85) 2020 10 29

(86) PCT/US2019/032289, 2019 05 14

(54) MAGL INHIBITORS

(57) Compound of formula (I)

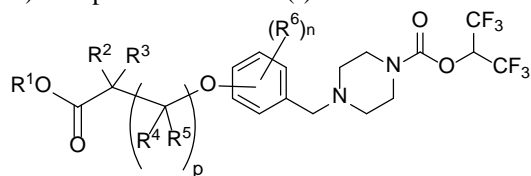

(I)

pharmaceutical compositions on the basis thereof,  
and usage therefor the treatment of pain.

Claims: 4 independents

19 dependents

(10) AP 2022 15382 A (51) Int. Cl. (2006)  
A 61 K 39/09  
A 61 K 39/385  
A 61 K 39/00  
A 61 P 31/04

(21) AP 2018 15382 (22) 2018 12 04

(31) 62/595,388

(32) 2017 12 06

(33) US

(71) Merck Sharp & Dohme Corp. (US)

126 East Lincoln Ave., Rahway, NJ 07065-0907,  
USA (US)

(72) SMITH, William, J. (US);

MCHUGH, Patrick (US);

WINTERS, Michael Albert (US);

SKINNER, Julie, M. (US);

HE, Jian (US);

MUSEY, Luwy (US);

ABEYGUNAWARDANA, Chitrananda (US);

CUI, Yadong Adam (US);

KOSINSKI, Michael, J. (US)

(74) Shalva Gvaramadze

(85) 2020 07 01

(86) PCT/US2018/063709, 2018 12 04

(54) COMPOSITIONS COMPRISING STREPTO-  
COCCUS PNEUMONIAE POLYSACCHA-  
RIDE-PROTEIN CONJUGATES AND  
METHODS OF USE THEREOF

(57) An invention relates to multivalent immuno-  
genic compositions comprising 21 various *S. pneu-*  
*pneumoniae* polysaccharide protein conjugates, whe-  
rein each therefrom comprises *S. pneumoni-*  
*ae* serotype conjugated to carrier protein. In some  
embodiments, at least one of polysaccharide pro-  
tein conjugates is formed by conjugation reaction  
wherein aprotic solvent is used.

Claims: 18 independents

31 dependents

Fig.: 52

(10) AP 2022 15554 A (51) Int. Cl. (2006)  
A 61 K 39/395  
A 61 K 39/00  
C 07 K 16/00

(21) AP 2016 15554 (22) 2016 07 28

(62) AP 2016 14712 2016 07 28

(31) 62/198,867; 62/239,559; 62/255,140; 62/322,974

(32) 2015 07 30; 2015 10 09; 2015 11 13; 2016 04 15

(33) US; US; US; US

(71) Macrogenics Inc. (US)

9704 Medical Center Drive, Rockville,  
MD 20850, USA (US)

(72) SHAH, Kalpana (US);

SMITH, Douglas, H. (US);

LA MOTTE-MOHS, Ross (US);

JOHNSON, Leslie, S. (US);

MOORE, Paul, A. (US);

BONVINI, Ezio (US);

KOENIG, Scott (US)

(74) Shalva Gvaramadze

(85) 2021 02 09

(86) PCT/US2016/044430, 2016 07 28

(54) PD-1-BINDING MOLECULES AND METHODS OF USE THEREOF

(57) Present invention is directed to selected anti-PD-1 antibodies capable of binding to human PD-1 and second epitope at the same time, and said second epitope is an epitope of molecule involved in regulating an immune check point present on the surface of an immune cells. Present invention also pertains to methods of using molecules that bind PD-1 for stimulating immune responses, as well as methods of detecting PD-1.

Claims: 8 independents

26 dependents

Fig.: 38

## PART F

### F 16

(10) AP 2022 15536 A (51) Int. Cl. (2006)  
F 16 L 55/132

(21) AP 2019 15536 (22) 2019 06 21

(31) 62/688,875; 62/689,527

(32) 2018 06 22; 2018 06 25

(33) US; US

(71) TDW DELAWARE, INC. (US)

Suite 780 1100 Market Street Wilmington,  
DE 19801, USA (US)

(72) MCKONE, Thomas H. (US);

PARSLEY, Cody A. (US);

PREWETT, Keelan J. (US)

(74) Tamar Kochlamazashvili

(85) 2021 01 17

(86) PCT/US2019/038523, 2019 06 21

(54) ISOLATION PLUG WITH ENERGIZED SEAL

(57) A device includes at least one plugging head (20) having a seal (30) to sealably engage a pipe wall; a fluid-activated cylinder (64) located on one side of the seal and moveable in an axial direction; metal support segments (40) located on another side of the seal and moveable in a transverse direction radially outward and inward; the metal segments including a concave portion (45), a portion (35) of the seal residing within the concave portion when unset and set. When in a seal unset position a portion (33) of the seal is covered by adjacent metal support segments.

Claims: 2 independents

13 dependents

Fig.: 17

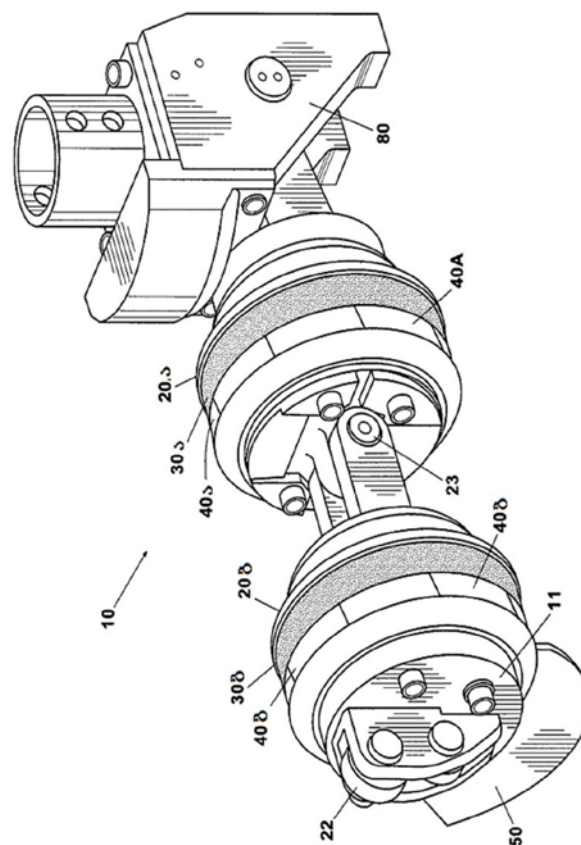

Fig. 1

## PATENTED IVENTIONS

### PART A

#### A 01

- (11) P 2022 7389 B (51) Int. Cl. (2006)  
A 01 N 43/78  
C 07 D 277/56  
C 07 D 417/12
- (10) AP 2022 15378 A (44) 2(581)/2022  
(21) AP 2018 15378  
(22) 2018 11 27  
(24) 2018 11 27  
(31) 17204474.5  
(32) 2017 11 29  
(33) EP  
(86) PCT/EP2018/082711, 2018 11 27  
(73) Syngenta Participations AG (CH)  
Rosentalstrasse 67, Basel, 4058,  
Switzerland (CH)  
(72) POULIOT, Martin (CH);  
RENDINE, Stefano (CH)  
(74) Tamar Kochlamazashvili  
(54) MICROBIOCIDAL THIAZOLE  
DERIVATIVES

#### A 61

- (11) P 2022 7387 B (51) Int. Cl. (2006)  
A 61 K 31/137  
A 61 K 31/42  
A 61 K 31/506  
A 61 K 31/551  
A 61 K 31/7008  
A 61 K 45/06
- (10) AP 2021 15226 A (44) 23(579)/2021  
(21) AP 2018 15226  
(22) 2018 04 26  
(24) 2018 04 26  
(31) 62/491,504; 62/558,814  
(32) 2017 04 28; 2017 09 14  
(33) US; US  
(86) PCT/US2018/029518, 2018 04 26  
(73) The Brigham And Women's Hospital, Inc. (US)  
75 Francis St. Boston, MA 02115, USA (US)  
(72) WELLMAN, D. Andrew (US);  
TARANTO-MONTEMURRO, Luigi (US)  
(74) Giorgi Kartvelishvili  
(54) METHODS AND COMPOSITIONS FOR  
TREATING SLEEP APNEA

- (11) P 2022 7388 B (51) Int. Cl. (2006)  
A 61 K 9/00  
A 61 K 31/4365  
A 61 K 31/4184  
A 61 P 7/02  
A 61 P 1/04
- (10) AP 2022 15592 A (44) 4(583)/2022  
(21) AP 2019 15592  
(22) 2019 08 27  
(24) 2019 08 27  
(31) 10-2018-0101047  
(32) 2018 08 28  
(33) KR  
(86) PCT/KR2019/010891, 2019 08 27  
(73) HK INNO.N Corporation (KR)  
6F, 7F, 8F, 100, Eulji-ro, Jung-Gu Seoul,  
04551, Korea (KR)  
(72) CHO, Tae Keun (KR);  
CHO, Young Dae (KR);  
KWON, Eunji (KR);  
SHIN, Myung Jin (KR)  
(74) Shalva Gvaramadze  
(54) PHARMACEUTICAL COMPOSITION  
COMPRISING ANTIPLATELET AGENT  
AND GASTRIC ACID SECRETION  
INHIBITOR

- (11) P 2022 7386 B (51) Int. Cl. (2006)  
A 61 K 39/00  
A 61 K 39/05
- (10) AP 2021 15276 A (44) 23(579)/2021  
(21) AP 2018 15276  
(22) 2018 07 13  
(24) 2018 07 13  
(31) 201721025513  
(32) 2017 07 18  
(33) IN  
(86) PCT/IB2018/055180, 2018 07 13  
(73) Serum Institute Of India Pvt LTD (IN)  
212/2, Off Soli Poonawalla Rd., Hadapsar,  
Pune, Maharashtra, 411028, India (IN)  
(72) SHITOLE, Anil Vyankatrao (IN);  
RAKESH, Kumar (IN);  
SHARMA, Inder Jit (IN);  
DODDAPANENI, Manohar (IN);  
SHARMA, Hitt Jyoti (IN)  
(74) Giorgi Ghvinjilia  
(54) IMMUNOGENIC COMPOSITION HAVING  
IMPROVED STABILITY, ENHANCED  
IMMUNOGENICITY AND REDUCED  
REACTOGENICITY AND PROCESS  
FOR PREPARATION THEREOF



---

# UTILITY MODELS

## PATENTED UTILITY MODELS

### PART A

#### A 01

- (11) U 2022 2117 Y (51) Int. Cl. (2006)  
A 01 C 9/06  
(10) AU 2022 15775 U (44) 3(582)/2022  
(21) AU 2021 15775  
(22) 2021 10 28  
(24) 2021 10 28  
(73) Omar Marsagishvili (GE)  
Krtsanisi St. 3, bld. b, app. 2, 0114, Tbilisi,  
Georgia (GE)  
(72) Omar Marsagishvili (GE)  
(54) DEVICE FOR KHINKALI FORMATION
- 

### PART G

#### G 09

- (11) U 2022 2116 Y (51) Int. Cl. (2006)  
G 09 F 19/00  
(10) AU 2022 15550 U (44) 3(582)/2022  
(21) AU 2021 15550  
(22) 2021 02 03  
(24) 2021 02 03  
(73) Shota Chedia (GE)  
Bagebi, bld. 3, app. 62, 0162, Tbilisi,  
Georgia (GE)  
(72) Shota Chedia (GE)  
(74) Shalva Gvaramadze  
(54) MOBILE ADVERTISING SYSTEM
- 

### PART C

#### C 12

- (11) U 2022 2118 Y (51) Int. Cl. (2006)  
C 12 G 1/06  
(10) AU 2022 15602 U (44) 4(583)/2022  
(21) AU 2021 15602  
(22) 2021 04 13  
(24) 2021 04 13  
(73) Teimuraz Lomsadze (GE)  
Sairme St. 5, app. 27, 0194, Tbilisi,  
Georgia (GE)  
(72) Teimuraz Lomsadze (GE)  
(74) Shalva Gvaramadze  
(54) METHOD FOR SPARKLING WINE  
PRODUCTION
-

---

## DESIGNS REGISTERED DESIGN

(11) D 2022 936 S      (51) 02-02  
(10) AD 2022 1240 S    (44) 2022 02 25 №4  
(21) AD 2021 1240  
(22) 2021 10 04  
(24) 2021 10 04  
(28) 2  
(18) 2026 10 04  
(73) Teimuraz Murvanidze (GE)  
    S. Virsaladze St. 2/4, 0108, Tbilisi,  
    Georgia (GE)  
(72) Teimuraz Murvanidze (GE)  
(74) Shalva Gvaramadze (GE)  
(54) 1.-2. COMBINED COSTUME

---

**DESIGNS, WHICH HAVE BEEN REGISTERED WITH THE INTERNATIONAL  
BUREAU CLAIMING PRIORITY ON THE TERRITORY OF GEORGIA**

The decision can be appealed at the Chamber of Appeal of Sakpatenti within 3 months from the publication or at the Mtskheta District Court Administrative Cases Board (Address: №17, Samkhedro St., Mtskheta), within 1 month following the publication.

- (11) DM/217 297                   (51) 26-04  
 (15) 2021 09 14               (44) 11/2022 (2022 03 18)  
 (22) 2021 09 14  
 (28) 6  
 (73) Ideal Industries Lighting LLC  
       9201 Washington Avenue, 53406 Racine, WI (US)  
 (85) –  
 (86) US  
 (87) US  
 (88) US  
 (89) US  
 (81) III. EG, EM, GB, GE, US  
 (72) Bin Hou  
       1685 Lederer Circle, 95131, San Jose , CA (US)  
 (74) Withrow & Terranova, PLLC  
       106 Pinedale Springs Way, 27511 Cary, NC (US)  
 (54) 1.-6. LED lens  
 (55)

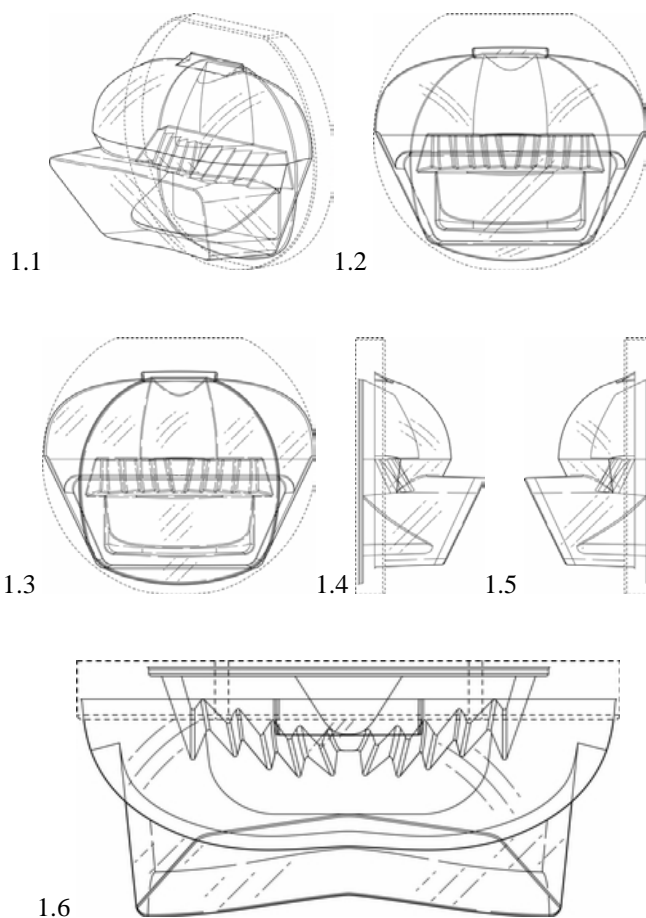

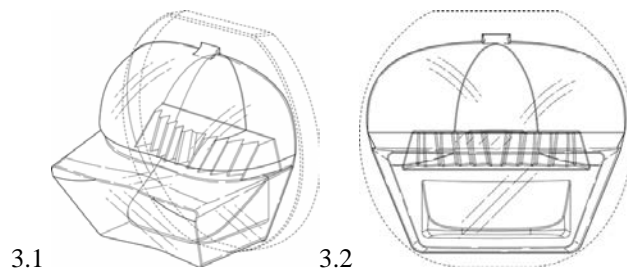
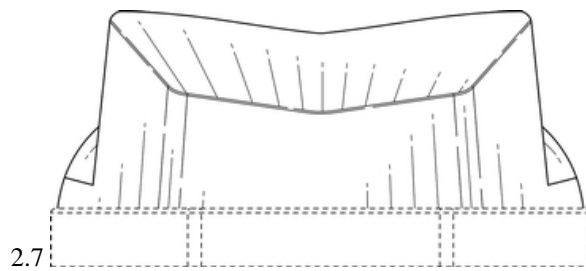
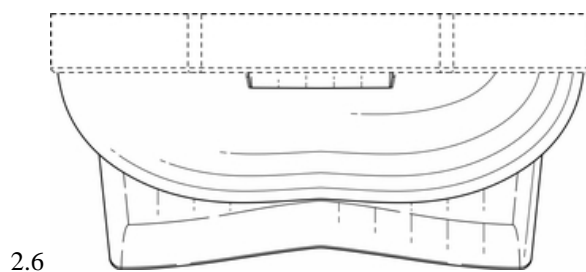
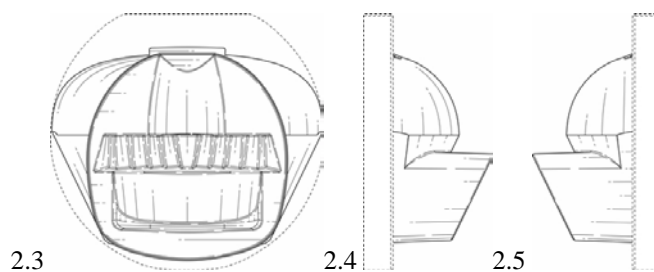
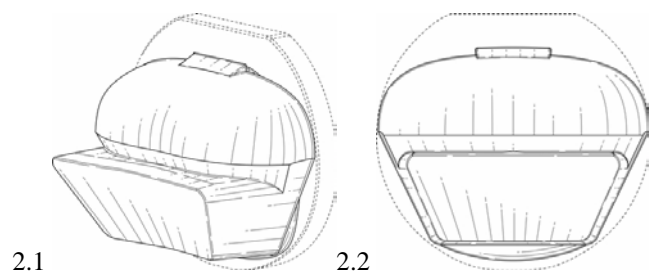
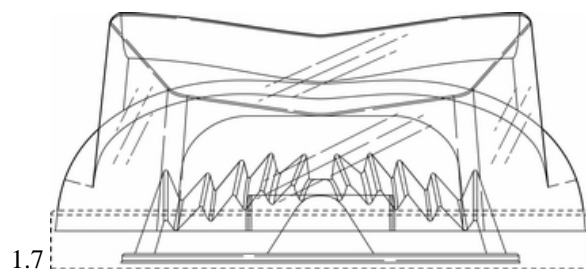

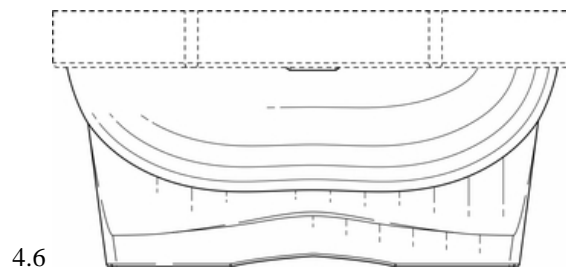
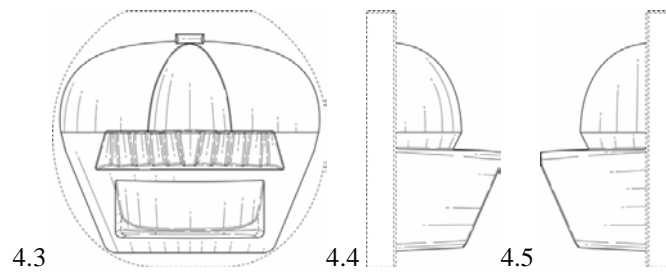
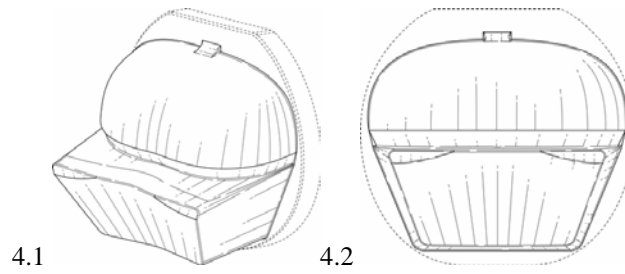
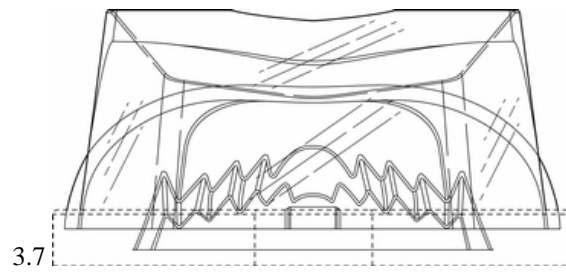
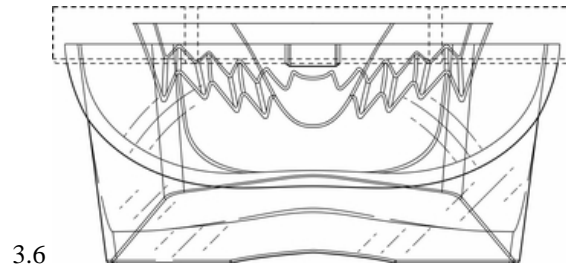
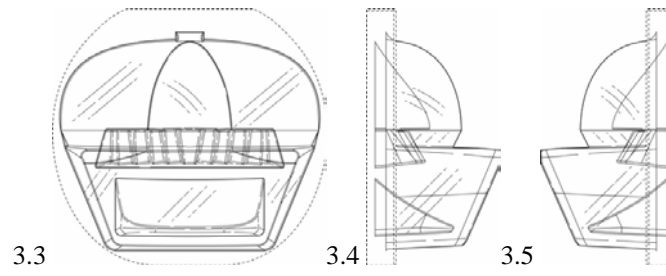

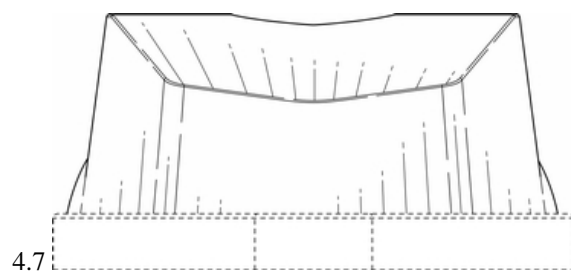

4.7

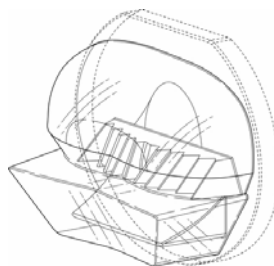

5.1



5.2

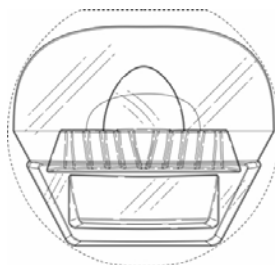

5.3

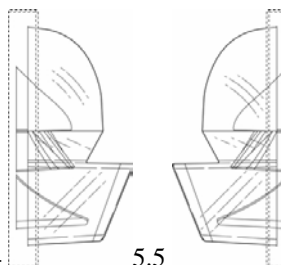

5.4

5.5

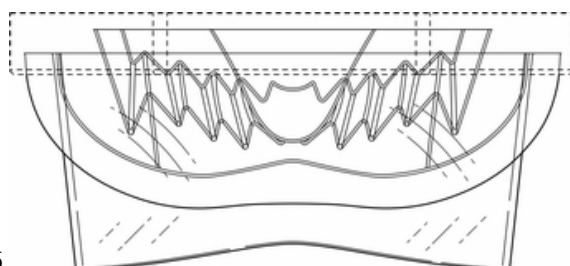

5.6

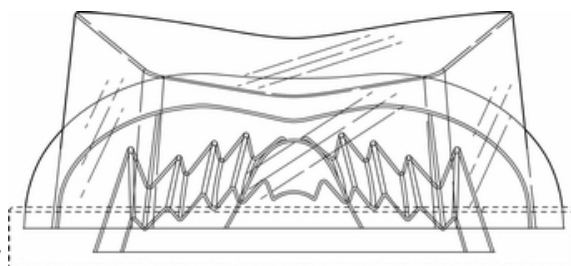

5.7

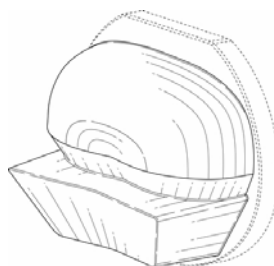

6.1



6.2

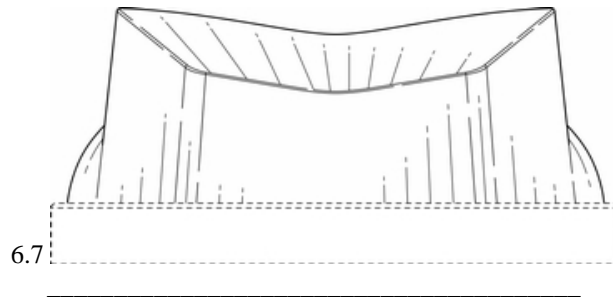
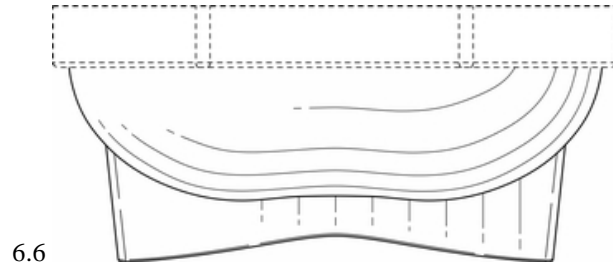
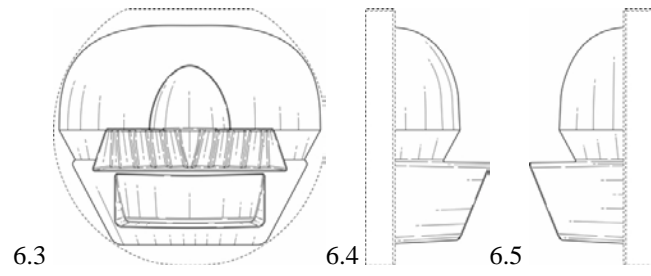

- (11) DM/216 596 (51) 11-01  
 (15) 2021 09 20 (44) 12/2022 (2022 03 25)  
 (22) 2021 09 20  
 (28) 5  
 (73) HARRY WINSTON SA  
 Chemin Du Tourbillon 8, 1228 Plan-les-Ouates (CH)  
 (85) CH  
 (86) CH  
 (87) CH  
 (88) CH  
 (89) CH  
 (81) II. MA III. AL, AM, AZ, BA, BZ, CA, CH, EM, GB, GE, KG, LI, MC, MD, ME, MK, MN, NO, OM, SG, TN, TR, UA  
 (72) 1-2; 4 Rie YATSUGI-KANG  
 C/o Harry Winston Inc. 718 Fifth Avenue, 10019, New York (US);  
 3. Delphine ABDOURAHIM  
 C/o Harry Winston Inc. 718 Fifth Avenue, 10019, New York (US);  
 5. Dominique RIVIERE  
 C/o Harry Winston Inc. 718 Fifth Avenue, 10019, New York (US)  
 (74) The Swatch Group AG (The Swatch Group SA) (The Swatch Group Ltd.)  
 Faubourg Du Lac 6, 2501 Biel/Bienne (CH)  
 (54) 1. Finger ring, 2. Necklace, 3. Pair of earrings, 4. Pair of earrings, 5. Brooch  
 (55)



1.1



1.2



1.3



1.4



1.5



1.6



1.7



1.8



2.1



2.2





2.3



2.4



2.5



2.6



2.7

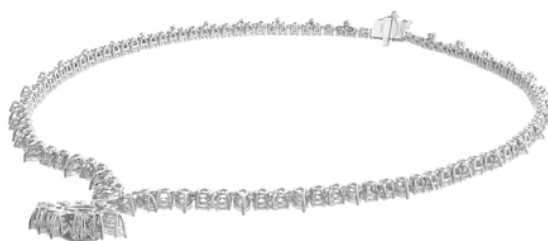

2.8



3.1



3.2



3.3



3.4





3.5



3.6



3.7



3.8



4.1



4.2



4.3



4.4



4.5



4.6



4.7



4.8

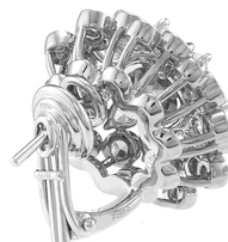

5.1



5.2



5.3



5.4



5.5



5.6



5.7



5.8

- (11) DM/216 936 (51) 10-02  
 (15) 2021 09 28 (44) 13/2022 (2022 04 01)  
 (22) 2021 09 28  
 (28) 1  
 (73) RADO UHREN AG (RADO WATCH CO. LTD.) (MONTRES RADO SA)  
 Bielstrasse 45, 2543 Lengnau (CH)  
 (85) –  
 (86) CH  
 (87) CH  
 (88) –  
 (89) CH  
 (81) II. MA III. BA, CH, EM, GB, GE, NO, OM, SG, TN, TR, UA, VN  
 (72) Renato Scarinzi  
 Les Plans Dessous 183a, 2534, Les Prés D'Orvin (CH);  
 Marco Scarinzi  
 Chemin Du Cledar 1, 2502, Bienne (CH)  
 (74) The Swatch Group AG  
 Faubourg Du Lac 6, 2501 Biel (CH)  
 (54) 1. Watch  
 (55)

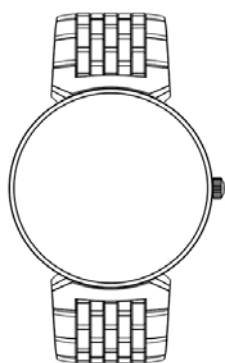

1.1

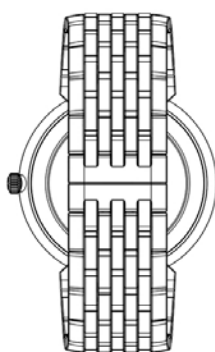

1.2



1.3

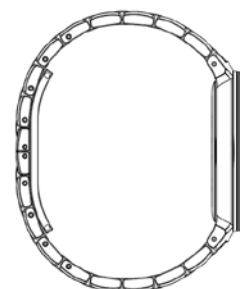

1.4

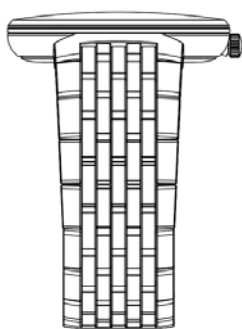

1.5

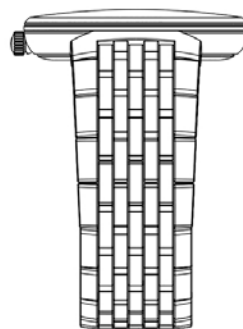

1.6



1.7

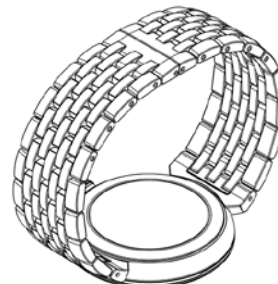

1.8

- (11) DM/220 134 (51) 02-04  
(15) 2022 04 08 (44) 16/2022 (2022 04 22)  
(22) 2022 04 08  
(28) 4  
(73) Valentino S.p.A.  
Via Turati 16/18, I-20121 Milano, MI (IT)  
(85) –  
(86) EM, IT  
(87) EM, IT  
(88) EM, IT  
(89) EM  
(81) III. AZ, EM, GB, GE, JP, KG, KR, RU, TJ, TR, UA  
(72) Pierpaolo PICCIOLI  
C/o VALENTINO S.p.A., Via Turati, 16/18, I-20121, Milano, MI (IT)  
(74) Jacobacci & Partners / Matteo Mozzi  
Via Senato, 8, I-20121 Milano, MI (IT)  
(46) 2022 04 22  
(54) 1.-4. Shoe  
(55)



1.1



1.2



1.3



1.4



1.5



1.6



1.7



1.8

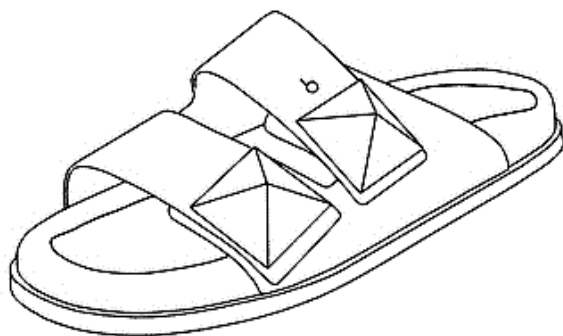

2.1



2.2

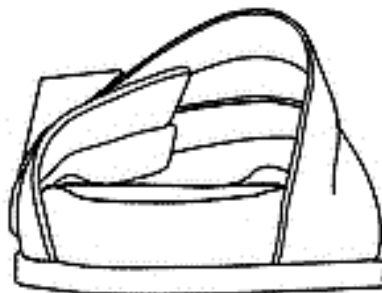

2.3

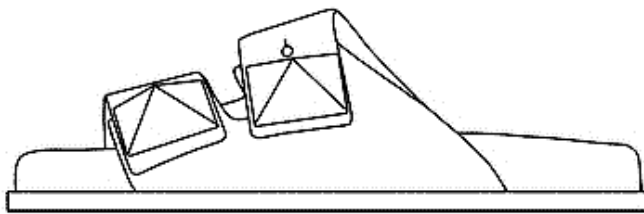

2.4

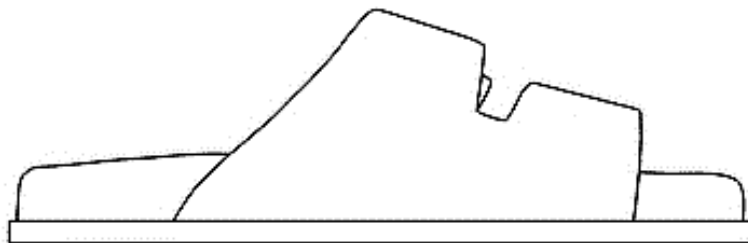

2.5

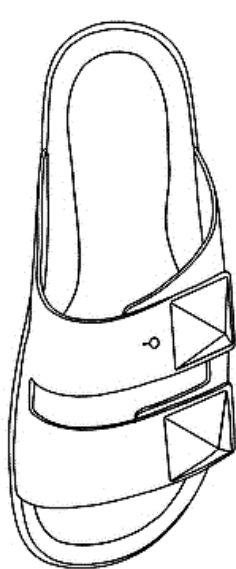

2.6

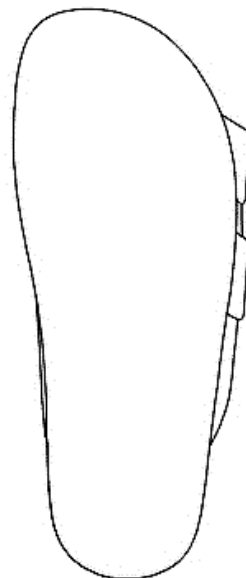

2.7

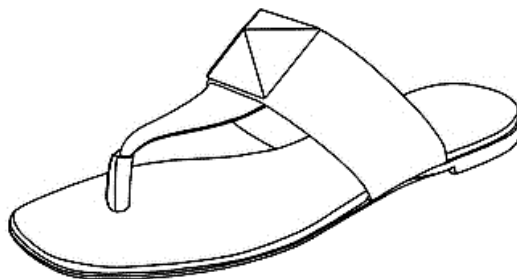

3.1

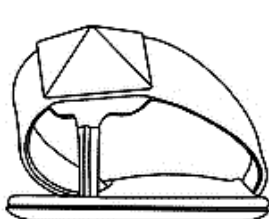

3.2

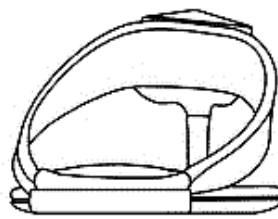

3.3

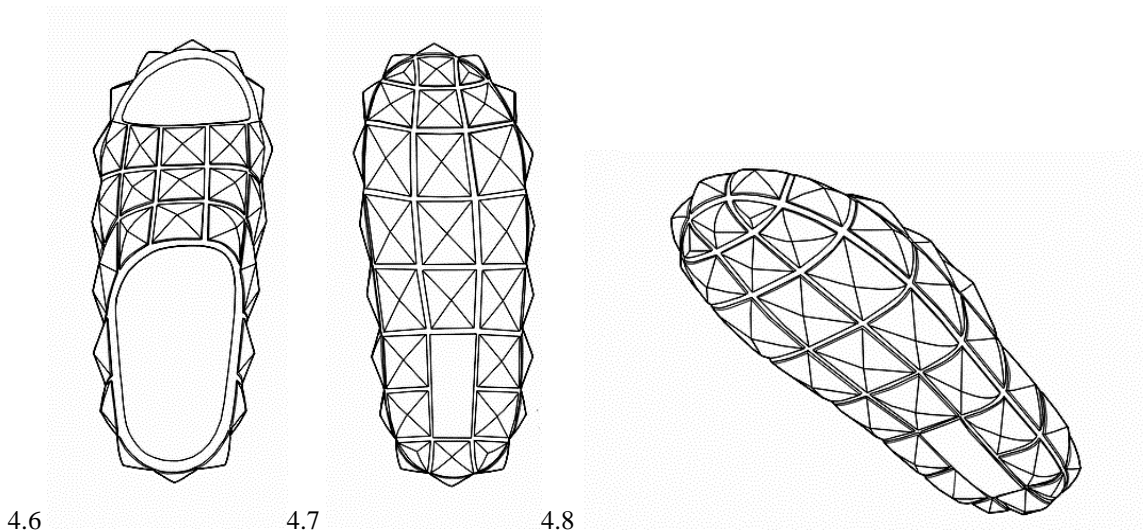
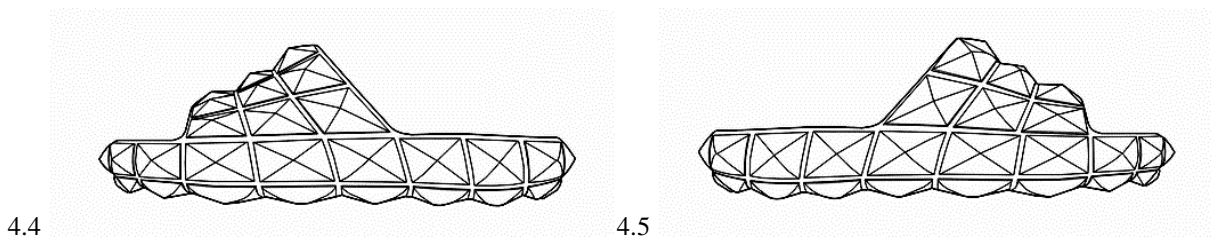
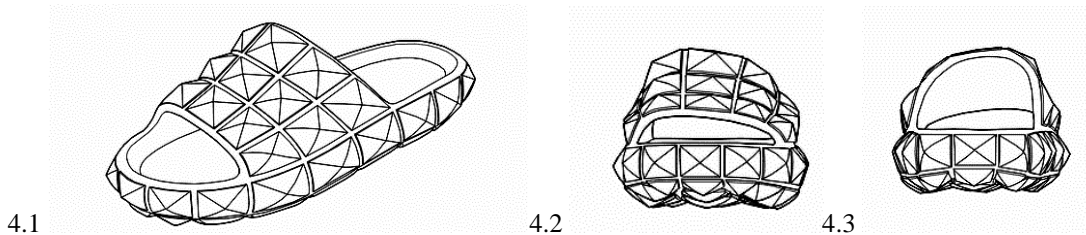
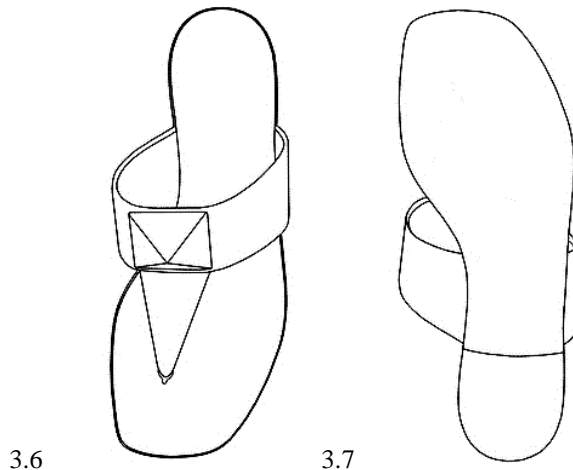
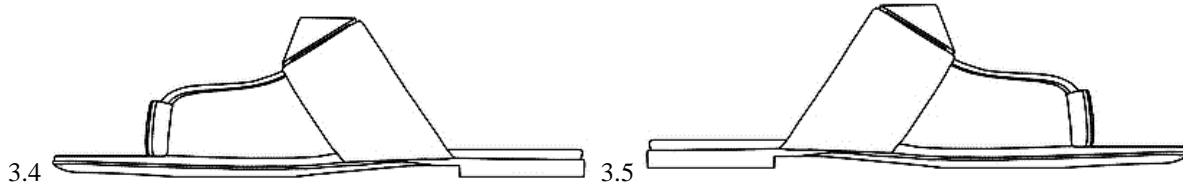



- (11) DM/217 073 (51) 02-07  
 (15) 2021 12 20 (44) 16/2022 (2022 04 22)  
 (22) 2021 12 20  
 (28) 1  
 (73) HARRY WINSTON SA  
 Chemin Du Tourbillon 8, 1228 Plan-les-Ouates (CH)  
 (85) CH  
 (86) CH  
 (87) CH  
 (88) CH  
 (89) CH  
 (81) II. MA III. AL, AM, AZ, BA, BZ, CA, CH, EM, GB, GE, KG, LI, MC, MD, ME, MK, MN, NO, OM, RU,  
 SG, TN, TR, UA  
 (72) Nina PIKOVA  
 C/o Harry Winston SA, Chemin Du Tourbillon 8, 1228, Plan-les-Ouates (CH)  
 (74) The Swatch Group AG (The Swatch Group SA) (The Swatch Group Ltd.)  
 Faubourg Du Lac 6, 2501 Biel/Bienne (CH)  
 (54) 1. Pair of cufflinks  
 (55)

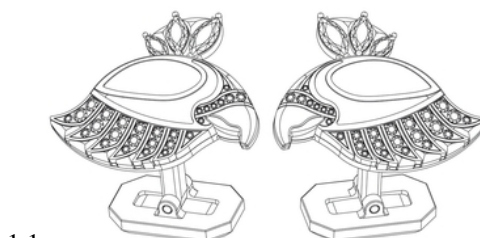

1.1

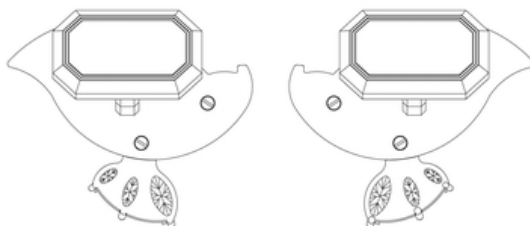

1.2

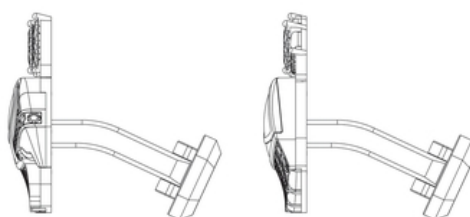

1.3

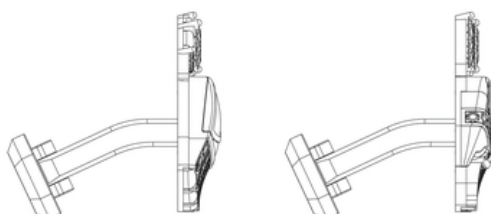

1.4

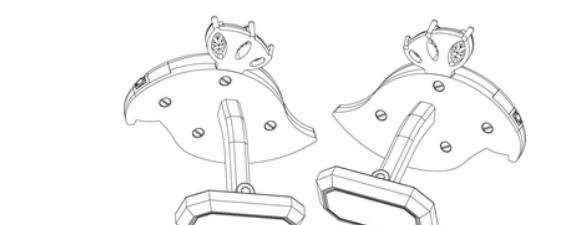
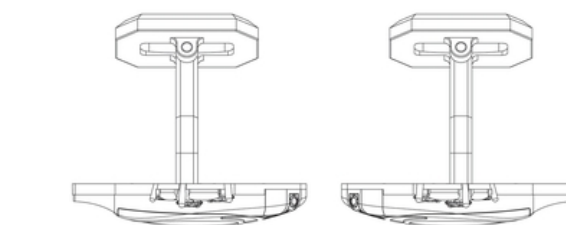
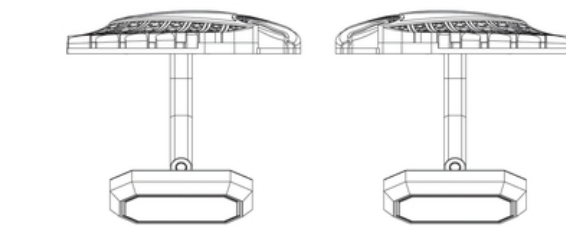

- (11) DM/220 131 (51) 03-01  
(15) 2022 04 04 (44) 16/2022 (2022 04 22)  
(22) 2022 04 04  
(28) 2  
(73) Valentino S.p.A.  
Via Turati 16/18, I-20121 Milano, MI (IT)  
(85) –  
(86) EM, IT  
(87) EM, IT  
(88) EM, IT  
(89) EM  
(81) III. AZ, EM, GB, GE, JP, KG, KR, RU, TJ, TR, UA  
(72) Pierpaolo PICCIOLI  
C/o VALENTINO S.p.A., Via Turati, 16/18, I-20121, Milano, MI (IT)  
(74) Jacobacci & Partners / Matteo Mozzi  
Via Senato, 8, I-20121 Milano, MI (IT)  
(46) 2022-04-22  
(54) 1.-2. Bag  
(55)

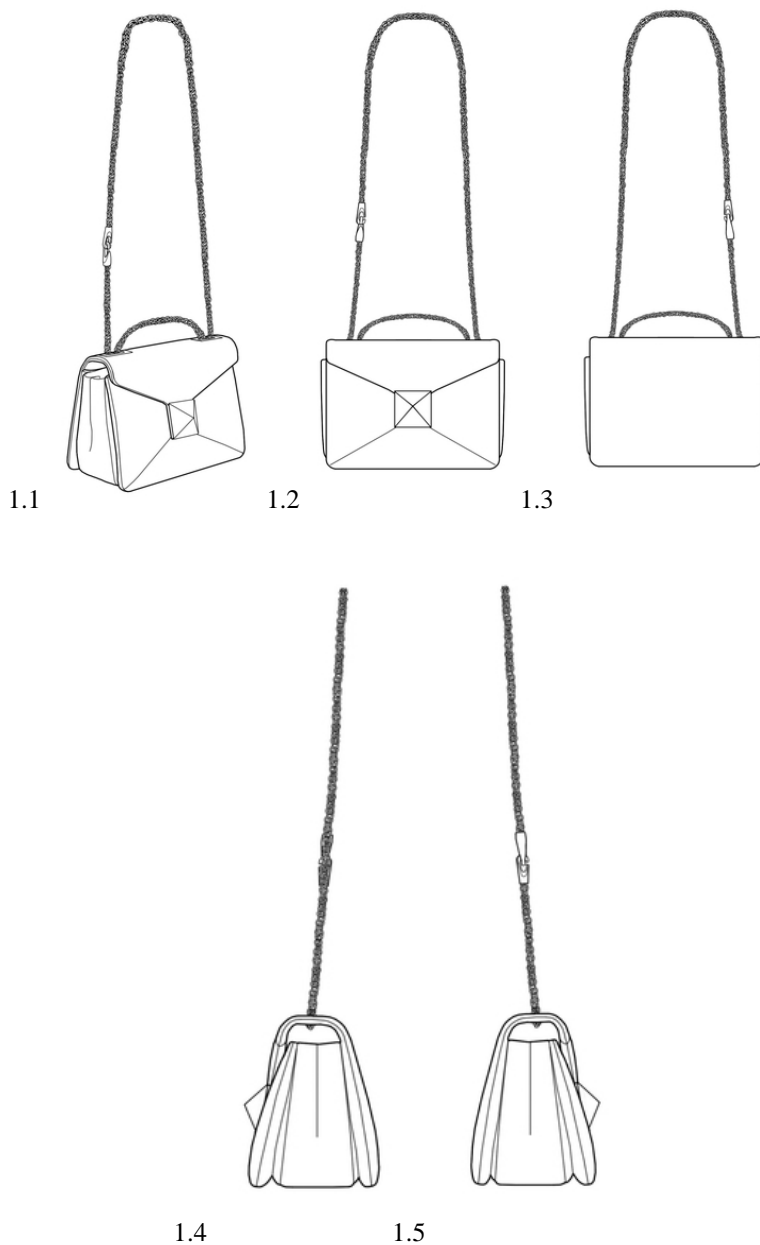

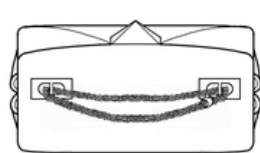

1.6



1.7

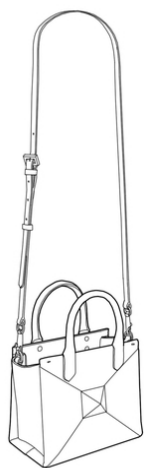

2.1



2.2



2.3

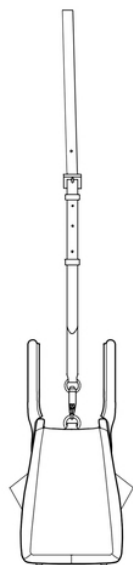

2.4

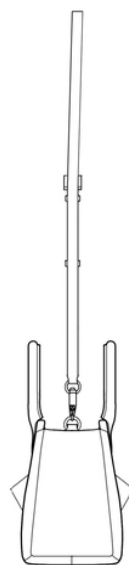

2.5

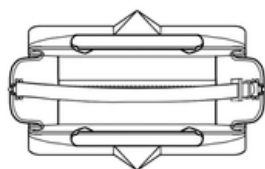

2.6

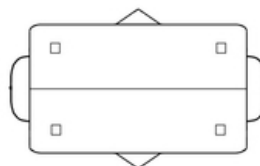

2.7

- (11) DM/217 006 (51) 10-02  
 (15) 2021 10 19 (44) 16/2022 (2022 04 22)  
 (22) 2021 10 19  
 (28) 7  
 (73) OMEGA SA (OMEGA AG) (OMEGA LTD.)  
 Jakob-Stämpfli-Strasse 96, 2502 Biel/Bienne (CH)  
 (85) CH  
 (86) CH  
 (87) CH  
 (88) CH  
 (89) CH  
 (81) II. MA III. AL, AM, AZ, BA, BZ, CH, EM, GB, GE, KG, LI, MC, MD, ME, MK, MN, NO, OM, SG, TN,  
 TR, UA  
 (72) Jean-Claude Monachon  
 C/o OMEGA SA (OMEGA AG) (OMEGA LTD.) Jakob-Stämpfli-Strasse 96, 2502, Biel/Bienne (CH)  
 (74) The Swatch Group AG (The Swatch Group SA) (The Swatch Group Ltd.)  
 6, Faubourg Du Lac, 2501 BIEL/BIENNE (CH)  
 (54) 1. Watch, 2. Watch case, 3. Watch dial, 4. Watch, 5. Watch case, 6. Watch dial, 7. Watch movement  
 (55)

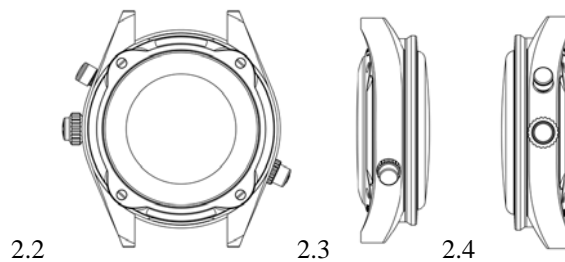
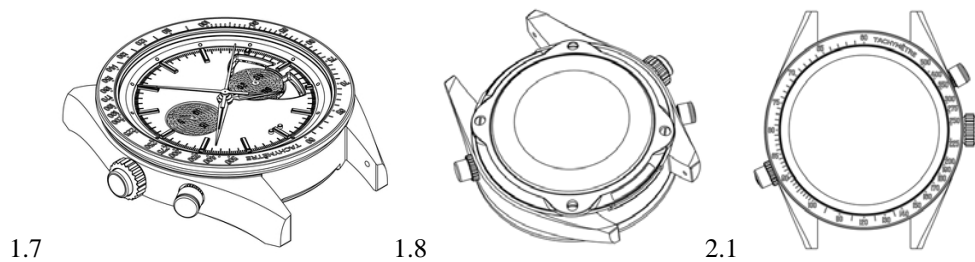
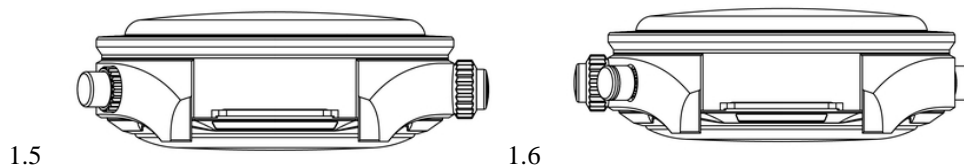
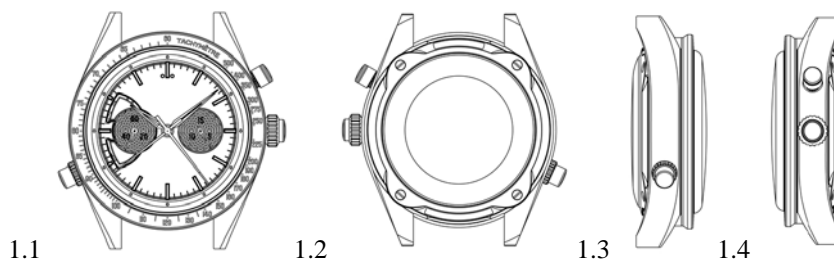

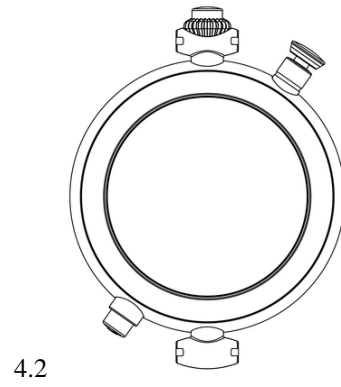
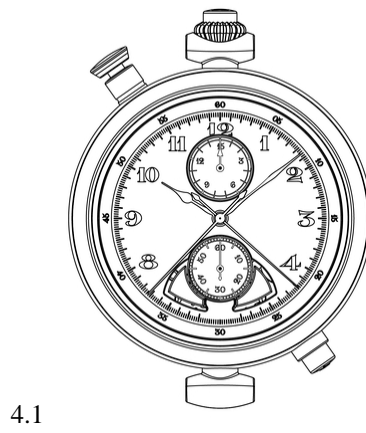
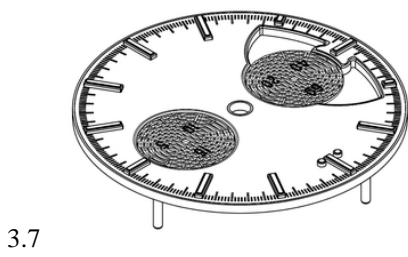
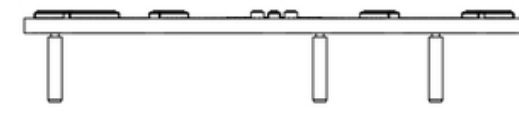
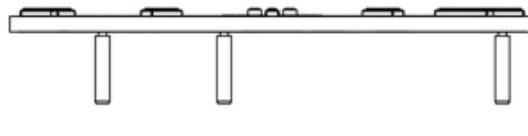
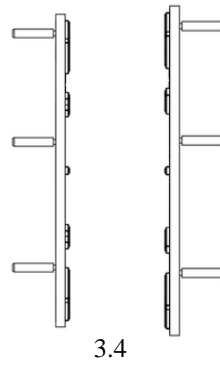
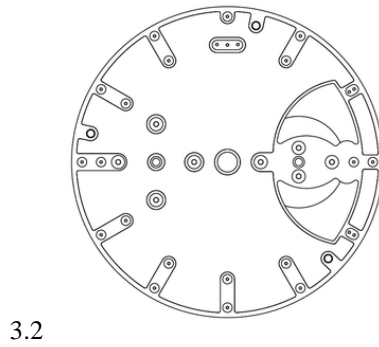
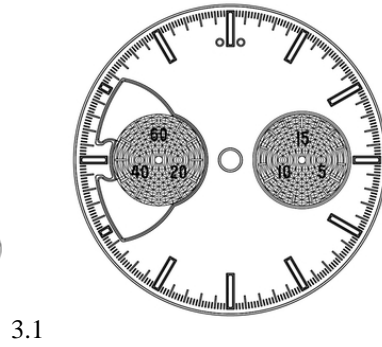
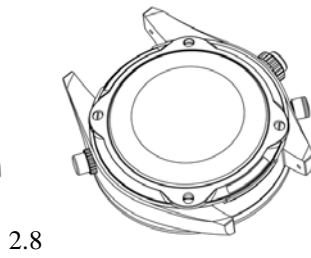
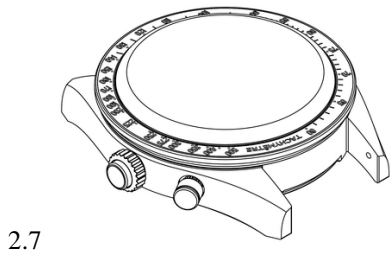
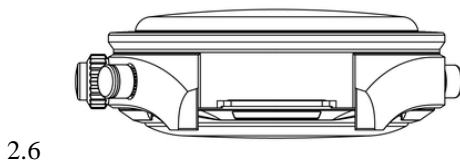
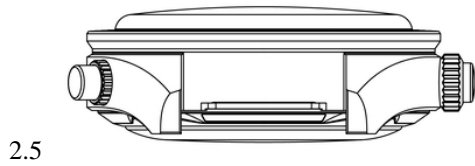

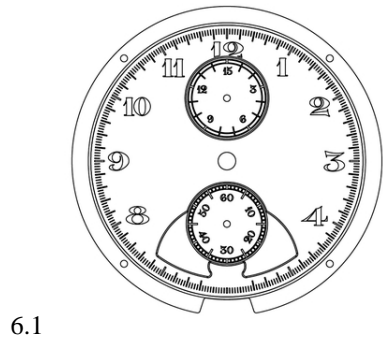
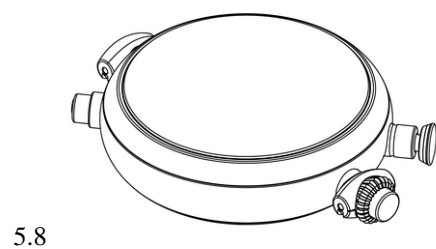
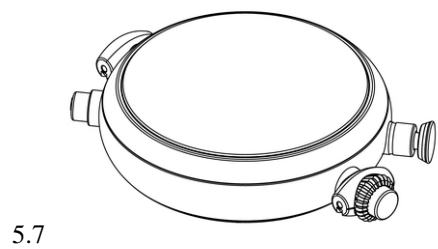
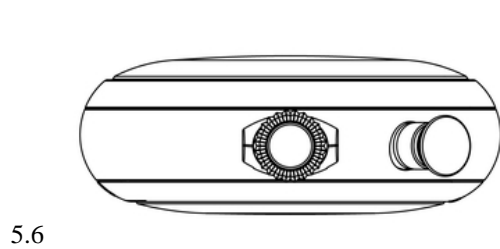
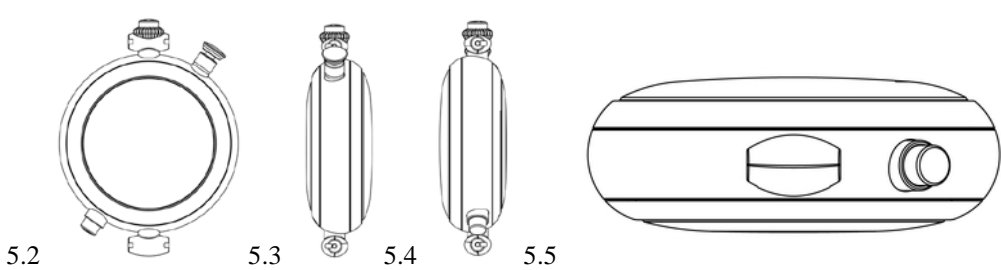
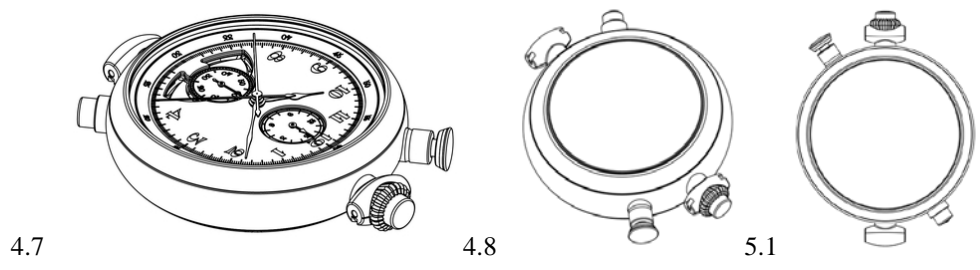
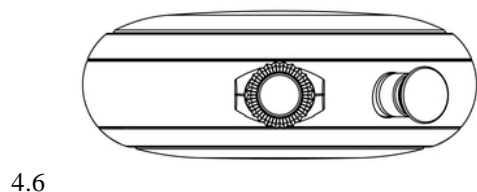
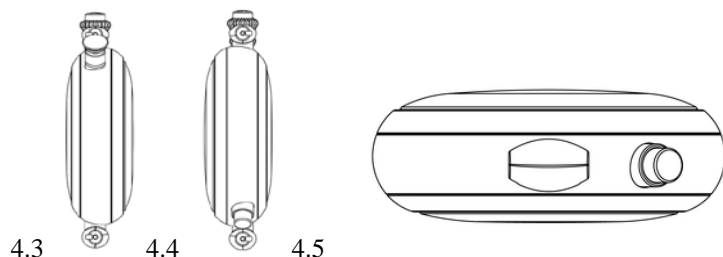

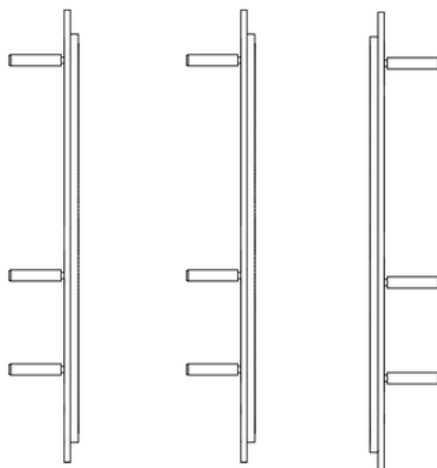

6.2

6.3

6.4

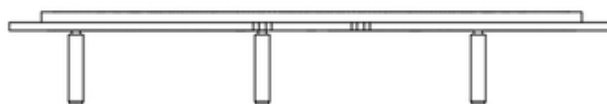

6.5



6.6

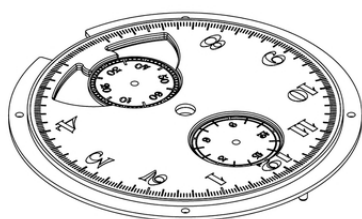

6.7

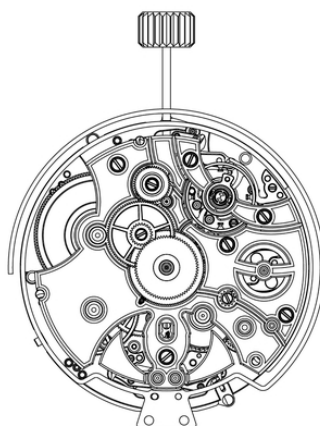

7.1



7.2

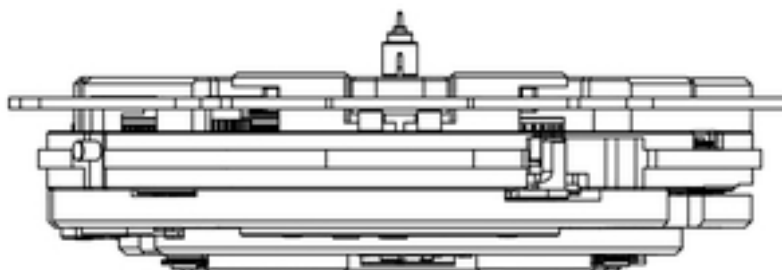

7.3



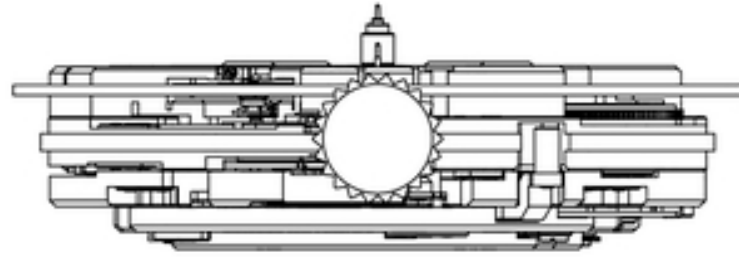

7.4

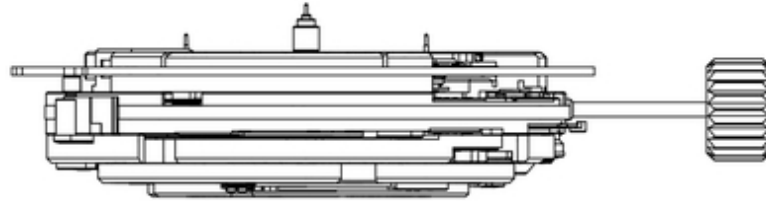

7.5

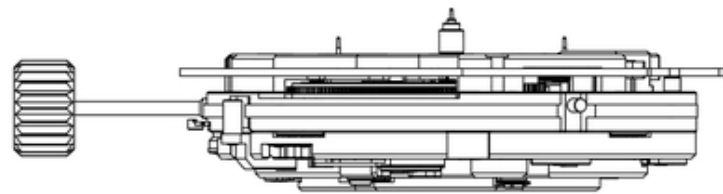

7.6

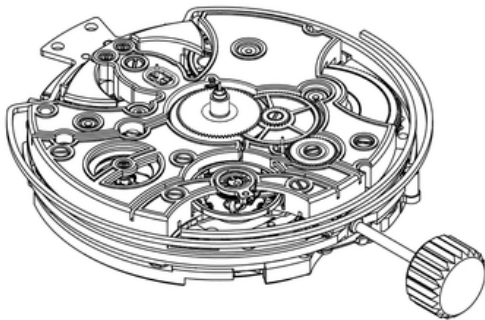

7.7

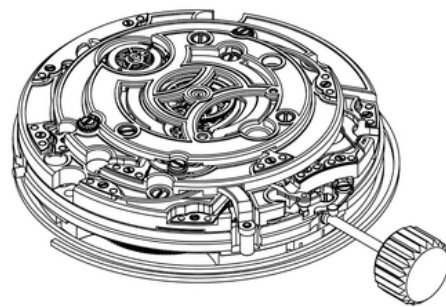

7.8

# TRADEMARKS

## APPLICATIONS FILED UNDER THE NATIONAL PROCEDURE APPROVED FOR REGISTRATION

The decision can be appealed at the Chamber of Appeal of Sakpatenti within 3 months from the publication or at the Mtskheta District Court Administrative Cases Board (Address: №17, Samkhedro St., Mtskheta), within 1 month following the publication.

(260) AM 2022 99510 A

(210) AM 99510

(220) 2018 09 25

(731) LTD "Zhorzholiani Trading"

Nutsubidze Plateau, II mcr., I qu., bld. 6,  
app. 6, 0183, Tbilisi, Georgia

(740) Davit Zhorzholiani

(540)



(591) White, red, golden

(531) 19.09.02; 24.01.10; 24.01.15; 24.09.01;  
25.01.05; 27.05.10; 27.05.24; 28.19; 29.01.15

(526) GEORGIA

(511) 20, 21, 29, 30, 33, 35, 43

(260) AM 2022 99511 A

(210) AM 99511

(220) 2018 09 25

(731) LTD "Zhorzholiani Trading"

Nutsubidze Plateau, II mcr., I qu., bld. 6,  
app. 6, 0183, Tbilisi, Georgia

(740) Davit Zhorzholiani

(540)



(591) White, red, golden

(531) 05.07.10; 19.09.02; 24.01.10; 24.01.15;  
24.09.01; 25.01.05; 27.05.10; 27.05.24;  
28.19; 29.01.15

(511) 29, 30, 32, 35, 43

(260) AM 2022 114921 A

(210) AM 114921

(220) 2021 10 13

(731) LTD "Agronom"

B. Kvernadze Str. 35, Entrance 2, floor 3,  
0171, Tbilisi, Georgia

(540)



(591) Black, green, blue

(531) 27.05.01; 27.05.09; 27.05.10; 27.05.17;  
28.03; 29.01.13

(511) 5

(260) AM 2022 114922 A

(210) AM 114922

(220) 2021 10 13

(731) LTD "Agronom"

B. Kvernadze Str. 35, Entrance 2, floor 3,  
0171, Tbilisi, Georgia

(540)



(591) Black, white, red, blue

(531) 26.04.04; 26.04.09; 26.04.24; 26.11.01;  
26.11.05; 26.11.06; 27.05.01; 27.05.24;  
29.01.14

(511) 5

(260) AM 2022 114926 A

(210) AM 114926

(220) 2021 10 13

(731) LTD "Agronom"

B. Kvernadze Str. 35, Entrance 2, floor 3,  
0171, Tbilisi, Georgia

(540)



(591) Black, orange, green, blue  
 (531) 01.03.01; 05.03.13; 05.03.15; 26.01.13;  
 26.01.15; 27.05.01; 27.05.10; 27.05.17;  
 29.01.15

(511) 5

(260) AM 2022 115003 A  
 (210) AM 115003  
 (220) 2021 10 19  
 (731) LTD "Glokal"  
 Budapest Str. 13a, app. 7, Vake-Saburtalo  
 District, Tbilisi, Georgia  
 (740) Nino Bakhtadze  
 (540)



(591) White, blue  
 (531) 26.02.07; 26.11.12; 27.05.01; 29.01.04  
 (511) 4, 7, 8, 9, 12

(260) AM 2022 115006 A  
 (210) AM 115006  
 (220) 2021 10 19  
 (731) LTD "Linus & Co"  
 Madneuli Str. 10, 1103, Daba Kazreti,  
 Bolnisi, Georgia  
 (540)

## ADDRUN

(591) Black-white  
 (511) 1, 5, 31

(260) AM 2022 115007 A  
 (210) AM 115007  
 (220) 2021 10 19  
 (731) LTD "Linus & Co"  
 Madneuli Str. 10, 1103, Daba Kazreti,  
 Bolnisi, Georgia  
 (540)

## TOTALRUN

(591) Black-white  
 (511) 1, 5, 31

(260) AM 2022 115008 A  
 (210) AM 115008  
 (220) 2021 10 19  
 (731) LTD "Linus & Co"  
 Madneuli Str. 10, 1103, Daba Kazreti,  
 Bolnisi, Georgia

(540)

## INSRUN

(591) Black-white  
 (511) 1, 5, 31

(260) AM 2022 115099 A  
 (210) AM 115099  
 (220) 2021 10 22  
 (731) LTD "3G – Georgian Global Group "  
 Mukhiani, I mcr., bld. 13, app. 25, Tbilisi,  
 Georgia  
 (740) Vakhtang Torotadze  
 (540)



(591) EE2A2C red, 0066B1 blue, FFFFFFF white  
 (531) 26.04.02; 26.04.05; 26.04.22; 26.04.24;  
 27.05.01; 27.05.02; 27.05.24; 29.01.13  
 (511) 29, 30, 31, 32, 33

(260) AM 2022 115124 A  
 (210) AM 115124  
 (220) 2021 10 27  
 (731) Syngenta Participations AG  
 Rosentalstrasse 67, 4058 Basel, Switzerland  
 (740) Pavle Meipariani  
 (540)

## ADVION

(591) Black-white  
 (511) 1, 5

(260) AM 2022 115125 A  
 (210) AM 115125  
 (220) 2021 10 27  
 (731) Syngenta Limited  
 Syngenta Jealott's Hill International Research  
 Centre, Bracknell, Berkshire RG42 6EY,  
 United Kingdom  
 (740) Pavle Meipariani

(540)

**DEMAND**(591) Black-white  
(511) 1, 5

(260) AM 2022 115206 A

(210) AM 115206

(220) 2021 10 29

(731) Gaba International Holding GmbH  
Grabetsmattweg, Therwil 4106, Switzerland

(740) Tamaz Shilakadze

(540)

**ANYTIME  
ANYWHERE**(591) Black-white  
(511) 3

(260) AM 2022 115210 A

(210) AM 115210

(220) 2021 11 01

(310) 083745

(320) 2021 07 08

(330) JM

(731) British American Tobacco (Brands) Inc.  
(a Delaware corporation)  
251 Little Falls Drive, Suite 100,  
Wilmington, Delaware, 19808-1674, USA

(740) Tamar Kotchlamazashvili

(540)

**Z P R O J E C T**(591) Black-white  
(531) 27.05.10  
(511) 34

(260) AM 2022 115220 A

(210) AM 115220

(220) 2021 11 02

(731) LTD "Legal Group"  
Iosebidge Str. 49, 0160, Saburtalo District,  
Tbilisi, Georgia

(540)

(591) 1E32C9 dark blue  
(531) 07.01.01; 07.01.24; 24.01.01; 24.01.05;  
24.01.11; 28.19; 29.01.04  
(511) 45

(260) AM 2022 115221 A

(210) AM 115221

(220) 2021 11 02

(731) LG Electronics Inc.  
128, Yeoui-daero, Yeongdeungpo-gu, Seoul,  
07336, Republic of Korea

(740) Shalva Gvaramadze

(540)

**I Wave**

(591) Black-white

(511) 7, 11

(260) AM 2022 115326 A

(210) AM 115326

(220) 2021 11 08

(731) LLC "Royal Home Luxury"  
Rustavi Highway 19, bld 3, Storeroom,  
floor 1, Krtsanisi District, Tbilisi, Georgia

(540)



(591) 000000 black, FFFFFFF white

(531) 01.15.11; 03.01.15; 05.05.01; 27.03.11

(511) 24, 35

(260) AM 2022 115330 A

(210) AM 115330

(220) 2021 11 08

(731) Brands for Less (BFL) FZCO  
P.O. Box 80794, Jebel Ali, Dubai, United  
Arab Emirates

(740) Giorgi Kartvelishvili

(540)

**Brands For Less**

(591) Yellow, white, black

(531) 10.03.10; 10.03.11; 27.05.01; 29.01.12

(511) 35

(260) AM 2022 115333 A

(210) AM 115333

(220) 2021 11 09

(731) Ekaterine Nebulishvili  
Shatberashvili Str. 31, Tbilisi, Georgia

(540)

**WINEBO**

(591) Black-white  
(511) 33

(260) AM 2022 115334 A  
(210) AM 115334  
(220) 2021 11 09  
(731) Hankook & Company Co., LTD  
286, Pangyo-ro, Bundang-gu, Seongnam-si,  
Gyeonggi-do, Republic of Korea  
(740) Tamaz Shilakadze  
(540)

 **hankook SMART LINE**

(591) Black-white  
(531) 03.07.16; 03.07.17; 18.01.21; 26.13.25;  
27.05.01; 27.05.10; 28.05  
(511) 12

(260) AM 2022 115337 A  
(210) AM 115337  
(220) 2021 11 10  
(731) Mastercard International Incorporated  
2000 Purchase Street, Purchase, New York,  
10577, USA  
(740) Tamar Kotchlamazashvili  
(540)



(591) Silver, golden, orange, light yellow, yellow,  
lilac, purple, light pink, pink, light green,  
green, sky-blue, dark blue, blue, white, black,  
morengo, grey, light grey  
(531) 26.01.01; 26.01.06; 27.05.01; 29.01.15  
(511) 9, 35, 36

(260) AM 2022 115339 A  
(210) AM 115339  
(220) 2021 11 10  
(731) Novartis AG  
4002 Basel, Switzerland  
(740) Shalva Gvaramadze  
(540)

 **ЗОЛГЕНСМА**

(591) Black-white  
(531) 01.13.15; 14.11.01; 28.05  
(511) 5

(260) AM 2022 115345 A  
(210) AM 115345  
(220) 2021 11 11  
(731) Novartis AG  
4002 Basel, Switzerland  
(740) Shalva Gvaramadze  
(540)

 **ЗОЛГЕНСМА**

(591) Different tones of lilac, green, white  
(531) 01.13.15; 14.11.01; 28.05; 29.01.13  
(511) 5

(260) AM 2022 115347 A  
(210) AM 115347  
(220) 2021 11 11  
(731) Pfizer Inc.  
235 East 42nd Street, New York, NY  
10017, USA  
(740) Natela Otariidze  
(540)

**PAXLOVID**

(591) Black-white  
(511) 5

(260) AM 2022 115348 A  
(210) AM 115348  
(220) 2021 11 11  
(731) LTD "Linus & Co"  
Madneuli Str. 10, 1103, Daba Kazreti,  
Bolnisi, Georgia  
(540)

 **KELPIE**

(591) Black-white  
(531) 03.01.08; 27.05.01; 27.05.17  
(511) 1, 5, 31

(260) AM 2022 115399 A  
(210) AM 115399  
(220) 2021 11 12  
(731) Six Continents Limited  
Broadwater Park, Denham, Buckinghamshire,  
UB9 5HR, United Kingdom  
(740) Tamar Kotchlamazashvili

(540)

**NIGNETTE**

(591) Black-white

(531) 27.05.01

(511) 43

(260) AM 2022 115404 A

(210) AM 115404

(220) 2021 11 15

(731) LTD "Barnabeli"

Geguti Str. 2, 0101, Tbilisi, Georgia

(540)



(591) D3AC67 golden

(531) 27.05.01; 27.05.11; 27.05.21

(511) 32, 33

(260) AM 2022 115407 A

(210) AM 115407

(220) 2021 11 15

(731) Sanovel Ilaj Sanaii Ve Tijaret A. S.

Istinye Mahallesi, Balabandere Caddesi No:14

TR-34460 Sariyer, Istanbul, Turkey

(740) Merab Kvimsadze

(540)

**AYRA**

(591) Black-white

(531) 27.05.02

(511) 5

(260) AM 2022 115409 A

(210) AM 115409

(220) 2021 11 15

(731) Sanovel Ilaj Sanaii Ve Tijaret A. S.

Istinye Mahallesi, Balabandere Caddesi No:14

TR-34460 Sariyer, Istanbul, Turkey

(740) Merab Kvimsadze

(540)

**AYRA PLUS**

(591) Black-white

(531) 27.05.01

(511) 5

(260) AM 2022 115413 A

(210) AM 115413

(220) 2021 11 15

(731) Sanovel Ilaj Sanaii Ve Tijaret A. S.

Istinye Mahallesi, Balabandere Caddesi No:14

TR-34460 Sariyer, Istanbul, Turkey

(740) Merab Kvimsadze

(540)

**RILACE**

(591) Black-white

(531) 27.05.01

(511) 5

(260) AM 2022 115417 A

(210) AM 115417

(220) 2021 11 15

(731) Toyota Jidosha Kabushiki Kaisha

(also trading as Toyota Motor Corporation)

1, Toyota-cho, Toyota-shi, Aichi-ken, Japan

(740) Tamar Kotchlamazashvili

(540)



(591) Black, grey, blue

(531) 27.05.01; 27.05.02; 27.05.19; 29.01.13

(511) 12

(260) AM 2022 115424 A

(210) AM 115424

(220) 2021 11 16

(731) LTD "IG Development Georgia"

Vazha-Pshavela Ave. 70, 0186, Tbilisi,

Georgia

(540)



(591) Black, light grey, morengo

(531) 20.05.16; 25.07.07; 26.04.02; 26.04.04;

26.04.05

(511) 9

(260) AM 2022 115425 A  
 (210) AM 115425  
 (220) 2021 11 16  
 (731) LTD "IG Development Georgia"  
 Vazha-Pshavela Ave. 70, 0186, Tbilisi,  
 Georgia  
 (540)



(591) Grey, black, white  
 (531) 20.05.16; 24.15.01; 26.03.23  
 (511) 9

(260) AM 2022 115427 A  
 (210) AM 115427  
 (220) 2021 11 16  
 (731) LTD "IG Development Georgia"  
 Vazha-Pshavela Ave. 70, 0186, Tbilisi,  
 Georgia  
 (540)

სოთი ქულა  
 СИТИ КУЛА  
 CITY QULA

(591) Black-white  
 (511) 36, 41, 43

(260) AM 2022 115429 A  
 (210) AM 115429  
 (220) 2021 11 16  
 (731) The Lubrizol Corporation  
 29400 Lakeland Blvd., Wickliffe, Ohio  
 44092-2298, USA  
 (740) Merab Kvimsadze  
 (540)

COMPUZOL

(591) Black-white  
 (531) 27.05.01  
 (511) 4

(260) AM 2022 115431 A  
 (210) AM 115431  
 (220) 2021 11 17  
 (731) JSC "Corporation Kindzmarauli"  
 Iia Chavchavadze Str. 55, 4800, Kvareli,  
 Georgia

(540)

ბედობა  
 Бедоба  
 Bedoba

(591) Black-white  
 (511) 33

(260) AM 2022 115434 A  
 (210) AM 115434  
 (220) 2021 11 17  
 (731) BMJ Industries FZ-LLC  
 Al-Hamra Industrial Zone-FZ, Ras Al  
 Khaimah, United Arab Emirates  
 (740) Pavle Meipariani  
 (540)

SERENA

(591) Black-white  
 (511) 34

(260) AM 2022 115435 A  
 (210) AM 115435  
 (220) 2021 11 18  
 (731) General Motors LLC  
 300 Renaissance Center, City of Detroit, State  
 of Michigan 48265-3000, USA  
 (740) Giorgi Taktakishvili  
 (540)

VISTIQ

(591) Black-white  
 (511) 12

(260) AM 2022 115436 A  
 (210) AM 115436  
 (220) 2021 11 18  
 (731) General Motors LLC  
 300 Renaissance Center, City of Detroit, State  
 of Michigan 48265-3000, USA  
 (740) Giorgi Taktakishvili  
 (540)

ESCALADE IQL

(591) Black-white  
 (511) 12

(260) AM 2022 115437 A  
 (210) AM 115437  
 (220) 2021 11 18  
 (731) General Motors LLC  
 300 Renaissance Center, City of Detroit, State  
 of Michigan 48265-3000, USA  
 (740) Giorgi Taktakishvili



(540)

## LUMISTIQ

(591) Black-white  
(511) 12

(260) AM 2022 115507 A

(210) AM 115507

(220) 2021 11 22

(731) KT & G Corporation

71, Beotkkot-gil, Daedeok-gu, Daejeon,  
Republic of Korea

(740) Giorgi Taktakishvili

(540)

## Fiit SPRING

(591) Black-white  
(511) 34

(260) AM 2022 115513 A

(210) AM 115513

(220) 2021 11 22

(731) LLC "TR Real Estate"

Irakli Abashidze Str. 65-67, app. 15, Tbilisi,  
Vake District, Georgia

(540)

## ფუტკრის სტუდია

(591) Black-white  
(511) 35

(260) AM 2022 115515 A

(210) AM 115515

(220) 2021 11 22

(731) Mixuebingcheng Co., LTD

Room 16004, Block A, Hanhaibeijin Business  
Center, North 3rd Ring Wenhua Road, Jinshui  
District, Zhengzhou City, Henan Province,  
People's Republic of China

(740) Khatuna Imnadze

(540)



(591) Black-white

(531) 02.01.23; 02.01.27; 04.05.05; 08.01.18

(511) 29, 30, 32, 35, 43

(260) AM 2022 115516 A

(210) AM 115516

(220) 2021 11 22

(731) Mixuebingcheng Co., LTD

Room 16004, Block A, Hanhaibeijin Business  
Center, North 3rd Ring Wenhua Road, Jinshui  
District, Zhengzhou City, Henan Province,  
People's Republic of China

(740) Khatuna Imnadze

(540)

## MIXUE

(591) Black-white

(531) 27.05.01

(511) 29, 30, 32, 35, 43

(260) AM 2022 115519 A

(210) AM 115519

(220) 2021 11 24

(731) General Motors LLC

300 Renaissance Center, City of Detroit, State  
of Michigan 48265-3000, USA

(740) Giorgi Taktakishvili

(540)

## ESCALADE IQ

(591) Black-white

(511) 12

(260) AM 2022 115520 A

(210) AM 115520

(220) 2021 11 24

(731) General Motors LLC

300 Renaissance Center, City of Detroit,  
State of Michigan 48265-3000, USA

(740) Giorgi Taktakishvili

(540)

## ASCENDIQ

(591) Black-white

(511) 12

(260) AM 2022 115521 A

(210) AM 115521

(220) 2021 11 24

(731) General Motors LLC

300 Renaissance Center, City of Detroit, State  
of Michigan 48265-3000, USA

(740) Giorgi Taktakishvili

(540)

## SUBURBAN

(591) Black-white

(511) 12



(260) AM 2022 115522 A  
 (210) AM 115522  
 (220) 2021 11 24  
 (731) Mastercard International Incorporated  
 2000 Purchase Street, Purchase, New York,  
 10577, USA  
 (740) Tamar Kotchlamazashvili  
 (540)

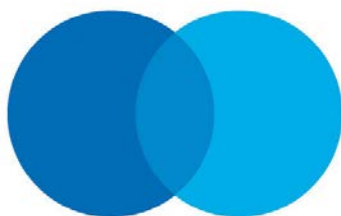

(591) Blue, dark blue, light blue  
 (531) 26.01.06; 29.01.04  
 (511) 9, 36

(260) AM 2022 115527 A  
 (210) AM 115527  
 (220) 2021 11 24  
 (731) LLC "Geopharms"  
 Dighomi Educational Experimental Economic  
 Unit, 0156, Tbilisi, Georgia  
 (540)



(591) Grey, orange, white  
 (531) 26.02.07; 27.05.01; 27.05.10; 29.01.12  
 (511) 29, 30, 31, 32

(260) AM 2022 115528 A  
 (210) AM 115528  
 (220) 2021 11 24  
 (731) Luka Alliance Limited  
 Akara Bild. 24 De Kastro Striti, Uikhems  
 Kei 1, Roud-tauni, Tortola, Virgin Islands  
 (British)  
 (740) Rima Lomauri  
 (540)



(591) Green, white  
 (531) 05.03.15; 05.03.20; 27.05.01; 28.19; 29.01.03  
 (511) 29, 30, 31, 43

(260) AM 2022 115532 A  
 (210) AM 115532  
 (220) 2021 11 25  
 (731) British American Tobacco (Brands) Limited  
 Globe House, 4 Temple Place, London,  
 WC2R 2PG, United Kingdom  
 (740) Tamar Kotchlamazashvili (540)



(591) Black-white  
 (531) 27.05.01  
 (511) 34

(260) AM 2022 115533 A  
 (210) AM 115533  
 (220) 2021 11 25  
 (731) Tp-Link Corporation Limited  
 Room 901, 9/F, New East Ocean Centre,  
 9 Science Museum Road, Tsim Sha Tsui,  
 Kowloon, Hong Kong  
 (740) Liliana Darakhvelidze  
 (540)



(591) Black-white  
 (531) 27.05.19  
 (511) 9

(260) AM 2022 115535 A  
 (210) AM 115535  
 (220) 2021 11 25  
 (731) Tp-Link Corporation Limited  
 Room 901, 9/F, New East Ocean Centre,  
 9 Science Museum Road, Tsim Sha Tsui,  
 Kowloon, Hong Kong  
 (740) Liliana Darakhvelidze  
 (540)



**HomeCare**

(591) Black-white  
 (531) 02.09.01; 24.01.08; 27.05.01  
 (511) 9

(260) AM 2022 115536 A  
(210) AM 115536  
(220) 2021 11 25  
(731) Tp-Link Corporation Limited  
Room 901, 9/F, New East Ocean Centre,  
9 Science Museum Road, Tsim Sha Tsui,  
Kowloon, Hong Kong  
(740) Liliana Darakhvelidze  
(540)

**Omada**

(591) Black-white  
(531) 26.11.12; 26.11.22; 27.05.01  
(511) 9

---

(260) AM 2022 115537 A  
(210) AM 115537  
(220) 2021 11 25  
(731) Janssen Pharmaceutica NV  
Turnhoutseweg 30, Beerse B-2340, Belgium  
(740) Giorgi Taktakishvili  
(540)

**ნებილეტი**

(591) Black-white  
(511) 5

---

(260) AM 2022 115539 A  
(210) AM 115539  
(220) 2021 11 26  
(731) JSC "TBC Bank"  
Marjanishvili Str. 7, 0102, Tbilisi, Georgia  
(740) Mariam Usenashvili  
(540)



**თიბისი ნეტი**  
**TBC NET**

(591) 00AEEF azure, 63666A morengo  
(531) 26.03.03; 26.03.04; 26.03.24; 27.05.01;  
29.01.13  
(511) 35, 36, 39, 41, 42,

---

(260) AM 2022 115597 A  
(210) AM 115597  
(220) 2021 11 30  
(731) LLC "Jolio"  
D. Gulia Str. 4, 0114, Tbilisi, Georgia  
(540)



(591) Black, yellow, light grey  
(531) 05.03.16; 05.05.20; 26.04.03; 26.13.25;  
29.01.12  
(511) 29

---

## REGISTERED TRADEMARKS

(111) M 2022 35485 R  
 (151) 2022 05 30  
 (181) 2032 05 30  
 (260) AM 2021 112264 A  
 (220) 2021 03 21

(732) LTD "Dugladze Wine Company"  
 Orkhevi, Akhvlediani St., Lane 8, 0109,  
 Samgori District, Tbilisi, Georgia

(111) M 2022 35486 R  
 (151) 2022 05 30  
 (181) 2032 05 30  
 (260) AM 2021 113118 A  
 (220) 2021 05 24

(732) LLC "INI Group"  
 M. Kostava Str. 76, app. 9a, 0171, Tbilisi,  
 Georgia

(111) M 2022 35487 R  
 (151) 2022 05 30  
 (181) 2032 05 30  
 (260) AM 2021 113233 A  
 (220) 2021 05 31

(732) Ketevan Chkhikvishvili  
 Sarajishvili Str. 7, III Line, Tbilisi, Georgia

(111) M 2022 35488 R  
 (151) 2022 05 30  
 (181) 2032 05 30  
 (260) AM 2021 113263 A  
 (220) 2021 06 02

(732) Miranda Kiria  
 Tskhemi Str. 16, 0108, Mtatsminda District,  
 Tbilisi, Georgia

(111) M 2022 35489 R  
 (151) 2022 05 30  
 (181) 2032 05 30  
 (260) AM 2021 113281 A  
 (220) 2021 06 03

(732) LTD "Minia"  
 Ilia Chavchavadze Str. 17, app. 9, 6000,  
 Batumi, Georgia

(111) M 2022 35490 R  
 (151) 2022 05 30  
 (181) 2032 05 30  
 (260) AM 2021 113399 A  
 (220) 2021 06 08

(732) JSC "Kotekhi-Gurjaani Winery"  
 K. Koroghlishvili Str. 38, 1500, Gurjaani,  
 Georgia

(111) M 2022 35491 R  
 (151) 2022 05 30  
 (181) 2032 05 30  
 (260) AM 2021 113423 A  
 (220) 2021 06 09

(732) LTD "Joy Mail"  
 Grigol Lortkipanidze Str. 6, app. 140, 6000,  
 Batumi, Georgia

(111) M 2022 35492 R  
 (151) 2022 05 30  
 (181) 2032 05 30  
 (260) AM 2021 113485 A  
 (220) 2021 06 11

(732) LTD "Teleimedi"  
 Ak. Tsereteli Ave. 140, Didube District,  
 Tbilisi, Georgia

(111) M 2022 35493 R  
 (151) 2022 05 30  
 (181) 2032 05 30  
 (260) AM 2021 113504 A  
 (220) 2021 06 16

(732) LTD "Eurosteell"  
 Ilo Mosashvili Str. 14-16, app. 13, Tbilisi,  
 Georgia

(111) M 2022 35494 R  
 (151) 2022 05 30  
 (181) 2032 05 30  
 (260) AM 2021 113684 A  
 (220) 2021 06 25

(732) Naked Wolfe Footwear PTY. LTD  
 C/Abound Business Solutions, Level 4,  
 114 William Str. Melbourne VIC 3000,  
 Australia

(111) M 2022 35495 R  
 (151) 2022 05 30  
 (181) 2032 05 30  
 (260) AM 2021 113685 A  
 (220) 2021 06 25

(732) Naked Wolfe Footwear PTY. LTD  
 C/Abound Business Solutions, Level 4,

---

114 William Str. Melbourne VIC 3000, Australia	Ingorokva Str. 19, ent. 3, app. 30, 0108, Tbilisi, Georgia
(111) M 2022 35496 R (151) 2022 05 30 (181) 2032 05 30 (260) AM 2021 113697 A (220) 2021 06 29 (732) LTD "Crosty Global" N. Zhvania Str. 12, fl. 10, app. 39, (Block II), Old Tbilisi District, Tbilisi, Georgia	(111) M 2022 35502 R (151) 2022 05 30 (181) 2032 05 30 (260) AM 2021 113853 A (220) 2021 07 12 (732) Vivo Mobile Communication Co., LTD №168 Jinghai East Rd., Chang'an, Dongguan, Guangdong, People's Republic of China
(111) M 2022 35497 R (151) 2022 05 30 (181) 2032 05 30 (260) AM 2021 113698 A (220) 2021 06 29 (732) LTD "Crosty Global" N. Zhvania Str. 12, fl. 10, app. 39, (Block II), Old Tbilisi District, Tbilisi, Georgia	(111) M 2022 35503 R (151) 2022 05 30 (181) 2032 05 30 (260) AM 2021 113864 A (220) 2021 07 14 (732) Mirone Pangani Vill. Agaraki, Vake District, Tbilisi, Georgia
(111) M 2022 35498 R (151) 2022 05 30 (181) 2032 05 30 (260) AM 2021 113704 A (220) 2021 06 30 (732) LLC "Tifliski Vini Pogreb" Yumashev Str. 27, 0198, Tbilisi, Georgia	(111) M 2022 35504 R (151) 2022 05 30 (181) 2032 05 30 (260) AM 2021 114027 A (220) 2021 07 23 (732) LTD "Incredible Caucasus" H. Tumanyan Str. 22/Kote Apkhazi Str. 55, Tbilisi, Georgia
(111) M 2022 35499 R (151) 2022 05 30 (181) 2032 05 30 (260) AM 2021 113709 A (220) 2021 07 01 (732) LTD "Aversi-Pharma" Davit Aghmashenebeli Ave. 148, 0112, Tbilisi, Georgia	(111) M 2022 35505 R (151) 2022 05 30 (181) 2032 05 30 (260) AM 2022 116829 A (220) 2022 02 25 (732) COLGATE-PALMOLIVE COMPANY, Delaware corporation 300 Park Avenue, New York, New York 10022, USA
(111) M 2022 35500 R (151) 2022 05 30 (181) 2032 05 30 (260) AM 2021 113710 A (220) 2021 07 01 (732) LTD "Aversi-Pharma" Davit Aghmashenebeli Ave. 148, 0112, Tbilisi, Georgia	(111) M 2022 35506 R (151) 2022 05 30 (181) 2032 05 30 (260) AM 2021 113498 A (220) 2021 06 15 (732) Maxeon Solar Pte. LTD 8 Marina Boulevard №05-02 Marina Bay Financial Centre, 018981, Singapore
(111) M 2022 35501 R (151) 2022 05 30 (181) 2032 05 30 (260) AM 2021 113762 A (220) 2021 07 02 (732) LTD "NB Legal"	(111) M 2022 35507 R (151) 2022 05 30 (181) 2032 05 30 (260) AM 2021 113594 A (220) 2021 06 21

---

(732) Davit Pirvelashvili  
Medea Chakhava Str. 4, app. 11, 0179, Tbilisi,  
Georgia;  
Levan Sgarangia  
Otar Lortkipanidze Str. 6, app. 10, 0114,  
Tbilisi, Georgia

(111) M 2022 35517 R  
(151) 2022 06 02  
(181) 2032 06 02  
(260) AM 2021 111836 A  
(220) 2021 02 19  
(732) LLC "Alcoholic Beverages Factory"  
Vill. Martkopi, Vaziani Settlement 1320,  
Gardabani, Georgia

(111) M 2022 35508 R  
(151) 2022 05 30  
(181) 2032 05 30  
(260) AM 2021 113595 A  
(220) 2021 06 21  
(732) Davit Pirvelashvili  
Medea Chakhava Str. 4, app. 11, 0179, Tbilisi,  
Georgia;  
Levan Sgarangia  
Otar Lortkipanidze Str. 6, app. 10, 0114,  
Tbilisi, Georgia

(111) M 2022 35518 R  
(151) 2022 06 02  
(181) 2032 06 02  
(260) AM 2021 112188 A  
(220) 2021 03 17  
(732) LLC "Alcoholic Beverages Factory"  
Vill. Martkopi, Vaziani Settlement 1320,  
Gardabani, Georgia

(111) M 2022 35509 R  
(151) 2022 05 30  
(181) 2032 05 30  
(260) AM 2021 113600 A  
(220) 2021 06 22  
(732) Rivian IP Holdings LLC  
13250 N. Haggerty Road, Plymouth,  
Michigan 48170, USA

(111) M 2022 35519 R  
(151) 2022 06 02  
(181) 2032 06 02  
(260) AM 2021 112475 A  
(220) 2021 07 28  
(732) Gocha Darakhvelidze  
Zaza Bendeliani Str. 3/48, Tbilisi, Georgia

(111) M 2022 35510 R  
(151) 2022 05 30  
(181) 2032 05 30  
(260) AM 2021 113601 A  
(220) 2021 06 22  
(732) Rivian IP Holdings LLC  
13250 N. Haggerty Road, Plymouth,  
Michigan 48170, USA

(111) M 2022 35520 R  
(151) 2022 06 02  
(181) 2032 06 02  
(260) AM 2021 112672 A  
(220) 2021 04 16  
(732) LTD "Imuno"  
Zugdidi Str. 36, Chkhorotsku, Georgia

(111) M 2022 35515 R  
(151) 2022 06 02  
(181) 2032 06 02  
(260) AM 2021 111424 A  
(220) 2021 01 26  
(732) LLC "Mister Georgia Emer. Georgia"  
Agaraki Str. 30, 4100, Senaki, Georgia

(111) M 2022 35521 R  
(151) 2022 06 02  
(181) 2032 06 02  
(260) AM 2021 112678 A  
(220) 2021 04 19  
(732) The Procter & Gamble Company  
One Procter & Gamble Plaza, Cincinnati,  
Ohio 45202, USA

(111) M 2022 35516 R  
(151) 2022 06 02  
(181) 2032 06 02  
(260) AM 2021 111835 A  
(220) 2021 02 19  
(732) LLC "Alcoholic Beverages Factory"  
Vill. Martkopi, Vaziani Settlement 1320,  
Gardabani, Georgia

(111) M 2022 35522 R  
(151) 2022 06 02  
(181) 2032 06 02  
(260) AM 2021 112680 A  
(220) 2021 05 28  
(732) Swiss Pharma International AG  
Lindenstrasse 22, 8008 Zurich, Switzerland

(111) M 2022 35523 R  
(151) 2022 06 02  
(181) 2032 06 02  
(260) AM 2021 112709 A  
(220) 2021 04 23  
(732) LTD "Barambo"  
Vill. Natakhtari, 3308, Mtskheta, Georgia

(111) M 2022 35529 R  
(151) 2022 06 02  
(181) 2032 06 02  
(260) AM 2021 113105 A  
(220) 2021 05 23  
(732) Jadran-Galenski Laboratorij d.d. Svilno 20,  
51000 Rijeka, Croatia

(111) M 2022 35524 R  
(151) 2022 06 02  
(181) 2032 06 02  
(260) AM 2021 113011 A  
(220) 2021 05 14  
(732) The Procter & Gamble Company  
One Procter & Gamble Plaza, Cincinnati,  
Ohio 45202, USA

(111) M 2022 35530 R  
(151) 2022 06 02  
(181) 2032 06 02  
(260) AM 2021 113106 A  
(220) 2021 05 23  
(732) Jadran - Galenski Laboratorij d.d. Svilno 20,  
51000 Rijeka, Croatia

(111) M 2022 35525 R  
(151) 2022 06 02  
(181) 2032 06 02  
(260) AM 2021 113043 A  
(220) 2021 05 20  
(732) Philip Morris Brands Sàrl  
Quai Jeanrenaud 3, 2000 Neuchâtel,  
Switzerland

(111) M 2022 35531 R  
(151) 2022 06 02  
(181) 2032 06 02  
(260) AM 2021 113119 A  
(220) 2021 05 25  
(732) Obshchestvo s Ogranichennoy Otvetstvennostyu  
"Avtograph"  
Ul. Butlerova, D. 17b, E. 2, Pom. XI, K. 69,  
Of. 137, Moscow, 117342, Russian Federation

(111) M 2022 35526 R  
(151) 2022 06 02  
(181) 2032 06 02  
(260) AM 2021 113044 A  
(220) 2021 05 20  
(732) Philip Morris Brands Sàrl  
Quai Jeanrenaud 3, 2000 Neuchâtel,  
Switzerland

(111) M 2022 35532 R  
(151) 2022 06 02  
(181) 2032 06 02  
(260) AM 2021 113188 A  
(220) 2021 05 28  
(732) Full Fortune Intellectual Limited  
Rm 503 Wilson Hse 19-27 Wyndham St  
Central Hong Kong, Hong Kong

(111) M 2022 35527 R  
(151) 2022 06 02  
(181) 2032 06 02  
(260) AM 2021 113050 A  
(220) 2021 05 20  
(732) The Procter & Gamble Company  
One Procter & Gamble Plaza, Cincinnati,  
Ohio 45202, USA

(111) M 2022 35533 R  
(151) 2022 06 02  
(181) 2032 06 02  
(260) AM 2021 113223 A  
(220) 2021 05 31  
(732) LTD "Biopolus"  
Noneshvili Str. 65, 6000, Batumi, Georgia

(111) M 2022 35528 R  
(151) 2022 06 02  
(181) 2032 06 02  
(260) AM 2021 113051 A  
(220) 2021 05 20  
(732) KUA YUE Express Group Co., Ltd  
1st-8th Floor, Building A, Lufthansa Park,  
Shenzhen Airport Terminal 4th Road, Hourui  
Community, Hangcheng Street, Baoan District,  
Shenzhen City, Guangdong Province, China

(111) M 2022 35534 R  
(151) 2022 06 02  
(181) 2032 06 02  
(260) AM 2021 113400 A  
(220) 2021 06 09  
(732) LTD "Geo Holding"  
Giorgi Saakadze descent 6, floor 5,  
Commercial Space 13, 0160, Saburtalo  
District, Tbilisi, Georgia

(111) M 2022 35535 R  
(151) 2022 06 02  
(181) 2032 06 02  
(260) AM 2021 113407 A  
(220) 2021 06 09  
(732) KT & G Corporation  
71, Beotkkot-gil, Daedeok-gu, Daejeon,  
Republic of Korea

---

(111) M 2022 35536 R  
(151) 2022 06 02  
(181) 2032 06 02  
(260) AM 2021 113409 A  
(220) 2021 06 09  
(732) KT & G Corporation  
71, Beotkkot-gil, Daedeok-gu, Daejeon,  
Republic of Korea

---

(111) M 2022 35537 R  
(151) 2022 06 02  
(181) 2032 06 02  
(260) AM 2021 113413 A  
(220) 2021 06 09  
(732) KT & G Corporation  
71, Beotkkot-gil, Daedeok-gu, Daejeon,  
Republic of Korea

---

(111) M 2022 35538 R  
(151) 2022 06 02  
(181) 2032 06 02  
(260) AM 2021 113589 A  
(220) 2021 06 21  
(732) Obschestvo s Ogranitchennoy Otvetstven-  
nostiu "WDS"  
Kulakova Str. 20, bldg. 1G, 123592 Moscow,  
Russian Federation

---

(111) M 2022 35539 R  
(151) 2022 06 02  
(181) 2032 06 02  
(260) AM 2021 113687 A  
(220) 2021 06 28  
(732) LTD "Biopolus"  
Noneshvili Str. 65, 6000, Batumi, Georgia

---

(111) M 2022 35540 R  
(151) 2022 06 02  
(181) 2032 06 02  
(260) AM 2021 113778 A  
(220) 2021 07 07  
(732) David Arevazov  
Parnavaz Mepe Ave. 18, entrance 2, app. 87,  
0131, Tbilisi, Georgia

---

(111) M 2022 35541 R  
(151) 2022 06 02  
(181) 2032 06 02  
(260) AM 2021 113791 A  
(220) 2021 07 08  
(732) British American Tobacco (Brands) Inc.  
(a Delaware corporation)  
251 Little Falls Drive, Suite 100, Wilmington,  
Delaware, 19808-1674, USA

---

(111) M 2022 35542 R  
(151) 2022 06 02  
(181) 2032 06 02  
(260) AM 2021 113846 A  
(220) 2021 07 09  
(732) LTD "Nalan Chamashir"  
mcr. XVI, LTD "Unity" negotiable area/mcr.  
XVI, Surrounding Area (Leonidze Str. 15), 3700,  
Rustavi, Georgia

---

(111) M 2022 35543 R  
(151) 2022 06 02  
(181) 2032 06 02  
(260) AM 2021 113868 A  
(220) 2021 07 14  
(732) LTD "New Light"  
Al. Kazbegi Ave. 25a, Tbilisi, Georgia

---

(111) M 2022 35544 R  
(151) 2022 06 02  
(181) 2032 06 02  
(260) AM 2021 113869 A  
(220) 2021 07 14  
(732) LTD "New Light"  
Al. Kazbegi Ave. 25a, Tbilisi, Georgia

---

(111) M 2022 35545 R  
(151) 2022 06 02  
(181) 2032 06 02  
(260) AM 2021 113870 A  
(220) 2021 07 14  
(732) LTD "New Light"  
Al. Kazbegi Ave. 25a, Tbilisi, Georgia

---

(111) M 2022 35546 R  
(151) 2022 06 02  
(181) 2032 06 02  
(260) AM 2021 113889 A  
(220) 2021 07 15  
(732) British American Tobacco (Brands) Inc.  
(a Delaware corporation)  
251 Little Falls Drive, Suite 100, Wilmington  
Delaware, Delaware, 19808-1674, USA

---

(111) M 2022 35547 R  
(151) 2022 06 02  
(181) 2032 06 02  
(260) AM 2021 114038 A  
(220) 2021 07 26

(732) Zakrytoe Aktionernoje Obshestvo  
"Pharmfirm "Sotex"  
Selskoe Poselenie Berezhnyakovskoe,  
Pos. Belikovo, dom 11, Sergeevo-Posadsky  
Municipal region, 141345, Moskovskaya  
oblast, Russian Federation

---

(111) M 2022 35548 R  
(151) 2022 06 02  
(181) 2032 06 02  
(260) AM 2021 114063 A  
(220) 2021 07 29

(732) LTD "Black Tomatoes"  
M. and A. Balanchivadze Str. 40, app. 40a,  
Saburtalo District, Tbilisi, Georgia

---

(111) M 2022 35549 R  
(151) 2022 06 02  
(181) 2032 06 02  
(260) AM 2021 114135 A  
(220) 2021 08 02

(732) FMC Agro Singapore Pte Ltd  
77 Robinson Road #13-00, Robinson 77,  
Singapore 068896, Singapore;  
FMC Corporation  
2929 Walnut Street Philadelphia, Pennsylvania  
19104, USA

---

(111) M 2022 35550 R  
(151) 2022 06 02  
(181) 2032 06 02  
(260) AM 2021 114136 A  
(220) 2021 08 02

(732) FMC Agro Singapore Pte Ltd  
77 Robinson Road #13-00, Robinson 77,  
Singapore 068896, Singapore;  
FMC Corporation  
2929 Walnut Street Philadelphia, Pennsylvania  
19104, USA

---

(111) M 2022 35551 R  
(151) 2022 06 02  
(181) 2032 06 02  
(260) AM 2021 114146 A  
(220) 2021 08 03

(732) LTD "Idea Development"  
Pekin Ave. 2, app. 59, Saburtalo District,  
Tbilisi, Georgia

---

(111) M 2022 35552 R  
(151) 2022 06 02  
(181) 2032 06 02  
(260) AM 2021 114234 A  
(220) 2021 08 12

(732) Levan Tsanava  
O. Chkheidze Str. 12, app. 6, 0186, Tbilisi,  
Georgia

---

(111) M 2022 35553 R  
(151) 2022 06 02  
(181) 2032 06 02  
(260) AM 2021 114238 A  
(220) 2021 08 12

(732) LTD "Tsaghveri"  
Borrow Tsaghveri, 1212, Borjomi, Georgia

---

(111) M 2022 35554 R  
(151) 2022 06 02  
(181) 2032 06 02  
(260) AM 2021 114309 A  
(220) 2021 08 13

(732) LTD "Kartuli Tema"  
Irakli Gamrekeli Str. 35v, 0186, Tbilisi, Georgia

---



## TRADEMARKS REGISTERED ACCORDING TO THE ACCELERATED PROCEDURE

The decision can be appealed at the Chamber of Appeal of Sakpatenti within 3 months from the publication.

(111) M 2022 35478 R  
(151) 2022 05 23  
(181) 2032 05 23  
(210) AM 117648  
(220) 2022 04 29  
(732) LTD "Thermoindustry"  
Bokhua Str. 1, 0159, Tbilisi, Georgia  
(740) Lasha Maisuradze  
(540)



(591) Black-white  
(531) 24.13.09; 26.01.05; 26.11.03; 26.11.05;  
26.11.07; 26.11.08; 26.11.13; 27.05.01;  
27.05.15; 28.19  
(511) 11

(111) M 2022 35479 R  
(151) 2022 05 25  
(181) 2032 05 25  
(210) AM 117815  
(220) 2022 05 16  
(732) LTD "Jakarta"  
David Aghmashenebeli Ave. 179,  
app. 39, Tbilisi, Georgia  
(540)



(591) Sky-blue, white, grey, morengo, black, red  
(531) 03.01.14; 03.01.20; 06.01.01; 06.01.02;  
19.07.01; 19.07.12; 27.05.01; 27.05.02;  
27.05.03; 29.01.15  
(511) 33

(111) M 2022 35480 R  
(151) 2022 05 25  
(181) 2032 05 25  
(210) AM 117816  
(220) 2022 05 16  
(732) LLC "Ionfash Georgia"  
Libani Str. 4g, Tbilisi, Georgia  
(540)



(591) White, grey, blue  
(531) 26.04.02; 26.04.05; 26.04.22; 27.05.01;  
29.01.13  
(511) 19, 35

(111) M 2022 35481 R  
(151) 2022 05 27  
(181) 2032 05 27  
(210) AM 117725  
(220) 2022 05 10  
(732) Zviad Rekvava  
Ilia Chavchavadze Ave. 75, app. 56,  
Tbilisi, Georgia  
(540)

(591) Black, white, sky-blue, yellow, pink, green,  
emerald green  
(531) 17.02.13; 26.04.02; 26.04.09; 27.05.01;  
27.05.10; 29.01.15  
(511) 44

(111) M 2022 35482 R  
(151) 2022 05 27  
(181) 2032 05 27  
(210) AM 117813  
(220) 2022 05 16  
(732) Nobel Ilac Sanayii Ve Ticaret Anonim Sirketi  
Representation in Georgia  
4 Liberty Square, 0105, Tbilisi, Georgia  
(740) Tinatin Tskhvediani  
(540)

**ertinob**  
**ერთინობი**

(591) Black-white  
(511) 5, 35

(111) M 2022 35483 R  
 (151) 2022 05 27  
 (181) 2032 05 27  
 (210) AM 117734  
 (220) 2022 05 10  
 (732) LTD "Gurman"  
 Akaki Tsereteli Str. 163/165, 6400, Kutaisi,  
 Georgia

(540)



(591) White, red  
 (531) 09.07.01; 09.07.19; 11.01.01; 11.01.03;  
 11.01.04; 26.01.02; 28.19; 29.01.12  
 (511) 29, 30

(111) M 2022 35484 R  
 (151) 2022 05 30  
 (181) 2032 05 30  
 (210) AM 117722  
 (220) 2022 05 08  
 (732) LTD "Company Orbita"  
 Akaki Tsereteli Ave. 126, 0119, Didube  
 district, Tbilisi, Georgia

(740) Ioane Irajuli;  
 Lia Shikhiashvili;  
 Zurab Bezhashvili

(540)

**Naturella**

(591) White, green  
 (531) 05.03.13; 05.03.15; 27.05.01; 27.05.08;  
 29.01.03  
 (511) 30, 32

(111) M 2022 35511 R  
 (151) 2022 05 30  
 (181) 2032 05 30  
 (210) AM 117911  
 (220) 2022 05 23  
 (732) Badri Bagatelia  
 Irakli Abashidze Str., 70, app. 76, 0179,  
 Tbilisi, Georgia

(540)

**გემო, რომელიც მიყვარს**

(591) Black-white  
 (511) 43

(111) M 2022 35512 R  
 (151) 2022 05 30  
 (181) 2032 05 30  
 (210) AM 117655  
 (220) 2022 05 02  
 (732) Joint Stock Company "Lomisi"  
 Vill. Natakhtari, 3308, Mtskheta, Georgia

(540)



(591) Black, yellow, blue, ivory  
 (531) 01.03.01; 01.03.02; 01.05.06; 01.05.24;  
 01.05.25; 01.15.24; 02.09.15; 02.09.17;  
 02.09.18; 02.09.25; 03.09.01; 03.09.04;  
 03.09.06; 05.11.17; 05.11.19; 10.03.01;  
 12.01.09; 12.01.10; 12.01.16; 16.01.13;  
 16.01.14; 16.01.15; 16.01.25; 16.03.13;  
 18.01.01; 18.01.07; 18.01.08; 18.05.03;  
 18.05.10; 24.17.12; 28.19; 29.01.15

(511) 32

(111) M 2022 35513 R  
 (151) 2022 05 31  
 (181) 2032 05 31  
 (210) AM 117829  
 (220) 2022 05 17  
 (732) Nikoloz Kiknadze  
 Varketili 3, III mcr., bld. 312, app. 20, Tbilisi,  
 Georgia

(540)



(591) white, green, light green  
 (531) 05.03.13; 27.05.01; 28.19; 29.01.03  
 (511) 31

(111) M 2022 35514 R  
 (151) 2022 05 31  
 (181) 2032 05 31  
 (210) AM 117740  
 (220) 2022 05 11

(732) LLC "Wine Sector"  
Vill. Matsimi, 2700, Lagodekhi, Lagodekhi  
Region, Georgia

(540)



(591) Red, yellow, white

(531) 05.03.04; 05.03.19; 05.07.10; 11.03.02;  
24.09.02; 24.09.03; 24.09.05; 24.09.24;  
24.09.25; 27.05.01; 29.01.13

(511) 33

---

(111) M 2022 35555 R

(151) 2022 06 03

(181) 2032 06 03

(210) AM 118000

(220) 2022 05 30

(732) LTD "Ori Nabiji"

Navtlughi Str. 39-41, 0113, Isani District,  
Tbilisi, Georgia

(540)

**icola**

(591) Black-white

(511) 32

## INTERNATIONAL TRADEMARKS FOR WHICH A DECISION ON GRANTING PROTECTIONS IS TAKEN

The decision can be appealed at the Chamber of Appeal of Sakpatenti within 3 months from the publication or at the Mtskheta District Court Administrative Cases Board (Address: №17, Samkhedro St., Mtskheta), within 1 month following the publication.

(260) AM 2022 114301 A  
 (800) 936432  
 (151) 2007 04 20  
 (891) 2021 02 10  
 (731) BAUSCH & LOMB INCORPORATED  
 One Bausch & Lomb Place, Rochester,  
 New York 14604, USA  
 (540)

### ENVISTA

(591) Black, white  
 (511)  
 10 – Surgical, medical, dental and veterinary apparatus and instruments; artificial limbs, eyes and teeth; ophthalmic, ocular and eye-related implants, apparatus and instruments; intraocular lenses; intraocular lens inserters; intraocular lens implants; intraocular implants; holders for intraocular lenses; lenses (intraocular prostheses) for surgical implantation; medical, surgical and microsurgical apparatus, instrumentation and devices for use in ophthalmic, ocular, and eye-related procedures; ophthalmic, ocular, and eye-related surgical instruments, apparatus and devices; medical and surgical apparatus, instruments, and devices used in diagnosing eye conditions and performing ophthalmic, ocular and eye-related surgical procedures, and component parts thereof; surgical apparatus, instruments and devices used to inject intraocular lenses; medical, surgical, ophthalmic, ocular, refractive, and eye-related lasers (for medical and surgical use), aberrometers, corneal topographers, microkeratomes, keratomes and blades, phacoemulsification devices, handheld ophthalmic surgical instruments, endoscopes, tonometers and corneal shields; implantable medical devices; knives and cutters for surgical use and purposes; surgical, ophthalmic, and ocular instruments, apparatus, and devices for use in eye surgery; apparatus and instruments for non-invasive surgery; corneal shields and splints for medical or surgical use; artificial lenses for implantation in the eye.

(260) AM 2022 114302 A  
 (800) 1045766  
 (151) 2010 02 11  
 (891) 2021 07 06  
 (731) Cinnabon Franchisor SPV LLC  
 5620 Glenridge Drvie NE, Atlanta GE 30342,  
 USA

(540)

### CINNABON

(591) Black, white  
 (511)  
 30 – Bakery goods for consumption on or off the premises.  
 35 – Retail bakery store services.

(260) AM 2022 114303 A  
 (800) 1321404  
 (151) 2016 10 26  
 (891) 2021 07 27  
 (731) BIOFARMA  
 50 rue Carnot, F-92284 Suresnes CEDEX,  
 France  
 (540)

### TIBSOVO

(591) Black, white  
 (511)  
 5 – Anti-cancer preparations, pharmaceutical products for the prevention and treatment of cancer, biological preparations for the treatment of cancer.

(260) AM 2022 114304 A  
 (800) 1384452  
 (151) 2017 09 18  
 (891) 2021 05 10  
 (731) BMC OTOMOTIV SANAYI VE TICARET ANONIM SIRKETI  
 Oruc Reis Mahallesi Tekstil Kent Caddesi, Koza Plaza A Blok K. 4. D. 13-14-15-16, Esenler, Istanbul, Turkey  
 (540)

### BMC NEOCITY

(591) Black, white  
 (511)  
 12 – Vehicles for locomotion by land namely, automobiles, buses, trucks, tractors, refrigerated vehicles, ambulances, concrete mixing vehicles, dust carts, vehicles for cleaning/washing streets; vehicles for emptying gullies, sports cars, golf carts, forklifts, military vehicles for transport and parts thereof (included in this class); motors and engines for land vehicles and parts thereof (included in this class), chassis for vehicles and automobiles, axles, axle-journals for ve-

hicles, connecting rods (other than parts of motors and engines), gearboxes, reduction gears for land vehicles, clutches, clutch discs, cylinders and cylinder liners, land vehicle turbines, transmission chains for land vehicles, gearing, vehicle wheels, rims for vehicle wheels, balance weights for vehicle wheels; vehicle bodies, tipping bodies for trucks, trailers for tractors, refrigerated bodies for vehicles; tipping and lifting apparatus for trucks and wagons (part of vehicles); shock absorbers for automobiles, suspension shock absorbers and shock absorbing springs for vehicles, vehicle suspension springs; repair outfits for brakes, breaking devices and parts, brakes, brake linings, brake shoes, brake segments for vehicles; vehicles seats, head-rests for vehicle seats, safety seats for children; direction signals for vehicles; tyres, inner tubes and tubeless tyres for vehicles; repair outfits for inner tubes, patches for repairing inner tubes; valves for vehicle tyres; windows for vehicles; windscreen wipers; petrol tanks for vehicles; anti-skid chains; luggage carriers for vehicles, cycle and ski carriers for vehicles; air pumps (vehicle parts); anti-theft alarms, horns for vehicles; safety belts for vehicle seats, air bags; seat covers for vehicles, vehicle covers, sun shields and visors for automobiles; trailer hitches for vehicles; rearview mirrors; vehicles for locomotion by air namely telpher trains, chairlifts; vehicles for locomotion by rail namely locomotives, trains, tramcars, waggons; vehicles for locomotion by water and parts thereof namely boats, ships, yachts, ferry boats, rudders, screw-propellers, hulls, spars for ships, davits for boats, steering gears for ships.

(260) AM 2022 114305 A

(800) 1431459

(151) 2018 09 17

(891) 2021 06 24

(731) Astrocast SA

Chemin des Ramiers 20, Chavannes-près-Renens, CH-1022, Switzerland

(540)

## ASTRONODE

(591) Black, white

(511)

9 – Satellite receivers; satellite signal receivers; satellite reception and transmission apparatus and instruments; apparatus and instruments for satellite transmission reception and decoding; satellite transmitters; satellite transmitters; software for satellite navigation systems.

38 – Data transmission and telecommunication services; telecommunication services; telecommunications; satellite transmission; data transmission via satellite; satellite communication services; communication by satellite; satellite transmission services.

(260) AM 2022 114366 A

(800) 1608342

(151) 2021 04 05

(891) 2021 04 05

(731) VISTA PHYTOLAB Inc.

111 Cherrytree Drive, Brampton ON L6Y 3N5, Canada

(540)

## Аллер-Нол-ODS

(591) Black, white

(531) 28.05

(511)

5 – Acaricides; aconitine; alkaloids for medical purposes; alginates for pharmaceutical purposes; algicides; aldehydes for pharmaceutical purposes; dental amalgams of gold; dental amalgams; amino acids for veterinary purposes; amino acids for medical purposes; analgesics; anaesthetics; antibiotics; antiseptics; medicine cases, portable, filled; first-aid boxes, filled; aluminium acetate for pharmaceutical purposes; acetates for pharmaceutical purposes; germicides; balms for medical purposes; bandages for dressings; diagnostic biomarker reagents for medical purposes; biocides; bromine for pharmaceutical purposes; paper for mustard plasters; fly catching paper; reagent paper for veterinary purposes; reagent paper for medical purposes; mothproofing paper; petroleum jelly for medical purposes; vaccines; oxygen baths; antiseptic cotton; aseptic cotton; absorbent cotton; wadding for medical purposes; cotton for medical purposes; dietetic substances adapted for medical use; radiological contrast substances for medical purposes; nutritive substances for microorganisms; radioactive substances for medical purposes; melissa water for pharmaceutical purposes; seawater for medicinal bathing; mineral waters for medical purposes; thermal water; dietary fibre; moulding wax for dentists; gases for medical purposes; guaiacol for pharmaceutical purposes; sexual stimulant gels; haematogen; haemoglobin; hydrastine; hydrastinine; glycerine for medical purposes; glycerophosphates; glucose for medical purposes; gentian for pharmaceutical purposes; hormones for medical purposes; mustard for pharmaceutical purposes; mustard plasters; mud for baths; medicinal mud; gamboge for medical purposes; gurgun balsam for medical purposes; air deodorizing preparations; deodorants, other than for human beings or for animals; deodorants for clothing and textiles; diastase for medical purposes; digitalin; vitamin supplement patches; mineral food supplements; nutritional supplements; albumin dietary supplements; dietary supplements for animals; yeast dietary supplements; alginate dietary supplements; glucose dietary supplements; casein dietary supplements; lecithin dietary supplements; linseed oil dietary supplements; propolis dietary supplements; protein dietary supplements; protein supplements for animals; royal jelly dietary supplements; pollen dietary supplements; wheat germ dietary supplements; linseed dieta-

ry supplements; acai powder dietary supplements; dietary supplements with a cosmetic effect; enzyme dietary supplements; yeast for pharmaceutical purposes; gelatine for medical purposes; cod liver oil; isotopes for medical purposes; immunostimulants; insecticides; iodine for pharmaceutical purposes; iodides for pharmaceutical purposes; alkaline iodides for pharmaceutical purposes; iodoform; calomel [fungicide]; tartar for pharmaceutical purposes; camphor for medical purposes; capsules for medicines; cachets for pharmaceutical purposes; haemostatic pencils; wart pencils; caustic pencils; carbolineum [parasiticide]; caustics for pharmaceutical purposes; cachou for pharmaceutical purposes; quassia for medical purposes; quebracho for medical purposes; oxygen for medical purposes; gallic acid for pharmaceutical purposes; acids for pharmaceutical purposes; adhesives for dentures; surgical glues; stem cells for veterinary purposes; stem cells for medical purposes; cocaine; collagen for medical purposes; collodion for pharmaceutical purposes; corn rings for the feet; medicated sweets; barks for pharmaceutical purposes; cedar wood for use as an insect repellent; croton bark; mangrove bark for pharmaceutical purposes; myrobalan bark for pharmaceutical purposes; quinquina for medical purposes; medicated animal feed; medicinal roots; rhubarb roots for pharmaceutical purposes; lint for medical purposes; starch for dietetic or pharmaceutical purposes; creosote for pharmaceutical purposes; blood for medical purposes; cultures of microorganisms for medical or veterinary use; curare; dental lacquer; liquorice for pharmaceutical purposes; milk sugar for pharmaceutical purposes; medicinal drops; adhesive plasters; medicines for alleviating constipation; adhesive tapes for medical purposes; lecithin for medical purposes; lotions for veterinary purposes; medicated hair lotions; lotions for pharmaceutical purposes; medicated after-shave lotions; personal sexual lubricants; lupulin for pharmaceutical purposes; magnesia for pharmaceutical purposes; liniments; ointments for pharmaceutical purposes; sunburn ointments; mercurial ointments; frostbite salve for pharmaceutical purposes; gauze for dressings; medicinal oils; mustard oil for medical purposes; camphor oil for medical purposes; castor oil for medical purposes; oil of turpentine for pharmaceutical purposes; dill oil for medical purposes; dental mastics; dental abrasives; dental impression materials; teeth filling material; dressings, medical; surgical dressings; drugs for medical purposes; medicines for veterinary purposes; serotherapeutic medicines; medicines for human purposes; medicines for dental purposes; menthol; medicinal drinks; moleskin for medical purposes; almond milk for pharmaceutical purposes; powdered milk for babies; royal jelly for pharmaceutical purposes; milk ferments for pharmaceutical purposes; Irish moss for medical purposes; flour for pharmaceutical purposes; linseed meal for pharmaceutical purposes; fish meal for pharmaceutical purposes; fly glue; antibacterial soap; disinfectant

soap; medicated soap; freeze-dried meat adapted for medical purposes; mint for pharmaceutical purposes; dietetic beverages adapted for medical purposes; malted milk beverages for medical purposes; narcotics; medicinal infusions; tincture of iodine; eucalyptol for pharmaceutical purposes; tinctures for medical purposes; opium; opodeldoc; decoctions for pharmaceutical purposes; antiparasitic collars for animals; stick liquorice for pharmaceutical purposes; sulfur sticks [disinfectants]; pastilles for pharmaceutical purposes; medicated toothpaste; pectin for pharmaceutical purposes; pepsins for pharmaceutical purposes; peptones for pharmaceutical purposes; hydrogen peroxide for medical purposes; pesticides; food for babies; leeches for medical purposes; blood plasma; nicotine patches for use as aids to stop smoking; eyepatches for medical purposes; poultices; compresses; scapulars for surgical purposes; babies' diapers; diapers for pets; diapers for incontinence; bunion pads; breast-nursing pads; pomades for medical purposes; powder of cantharides; pyrethrum powder; anti-uric preparations; bacterial preparations for medical and veterinary use; bacteriological preparations for medical and veterinary use; balsamic preparations for medical purposes; albuminous preparations for medical purposes; biological preparations for veterinary purposes; biological preparations for medical purposes; veterinary preparations; bismuth preparations for pharmaceutical purposes; vitamin preparations; diagnostic preparations for veterinary purposes; diagnostic preparations for medical purposes; bath preparations for medical purposes; therapeutic preparations for the bath; haemorrhoid preparations; preparations for callouses; lice treatment preparations [pediculicides]; acne treatment preparations; preparations to facilitate teething; preparations for the treatment of burns; fumigation preparations for medical purposes; opotherapy preparations; air purifying preparations; bronchodilating preparations; preparations for reducing sexual activity; sterilizing preparations; soil-sterilizing preparations; corn remedies; pharmaceutical preparations for treating dandruff; preparations for destroying noxious animals; herbicides; preparations for destroying dry rot fungus; larvae exterminating preparations; fly destroying preparations; preparations for destroying mice; slug exterminating preparations; vermin destroying preparations; pharmaceutical preparations for skin care; contact lens cleaning preparations; preparations of microorganisms for medical or veterinary use; lime-based pharmaceutical preparations; hemostatic preparations; medicated eye-washes; medicinal hair growth preparations; nutraceutical preparations for therapeutic or medical purposes; opiates; anticryptogamic preparations; aloe vera preparations for pharmaceutical purposes; bismuth subnitrate for pharmaceutical purposes; disinfectants; cream of tartar for pharmaceutical purposes; angostura bark for medical purposes; condurango bark for medical purposes; cotton swabs for medical purposes; styptic pencils; preparations of trace elements

for human and animal use; sulfonamides [medicines]; pharmaceutical preparations; pharmaceutical preparations for treating sunburn; enzyme preparations for veterinary purposes; enzyme preparations for medical purposes; phytotherapy preparations for medical purposes; chemico-pharmaceutical preparations; chemical preparations for veterinary purposes; chemical preparations for the diagnosis of pregnancy; chemical preparations for medical purposes; chemical preparations for treating wheat blight; chemical preparations for treating diseases affecting vine plants; chemical preparations for treating mildew; chemical preparations for treating phyloxera; chemical preparations for pharmaceutical purposes; chilblain preparations; mothproofing preparations; collyrium; lead water; chemical conductors for electrocardiograph electrodes; albuminous foodstuffs for medical purposes; dietetic foods adapted for medical purposes; by-products of the processing of cereals for dietetic or medical purposes; homogenized food adapted for medical purposes; freeze-dried food adapted for medical purposes; pharmaceuticals; sanitary towels; panty liners [sanitary]; propolis for pharmaceutical purposes; pearl powder for medical purposes; radium for medical purposes; hydrated chloral for pharmaceutical purposes; solvents for removing adhesive plasters; vaginal washes for medical purposes; solutions for contact lenses; chemical reagents for medical or veterinary purposes; gum for medical purposes; rubber for dental purposes; chewing gum for medical purposes; nicotine gum for use as an aid to stop smoking; insect repellents; insect repellent incense; repellents for dogs; tissues impregnated with pharmaceutical lotions; sarsaparilla for medical purposes; sugar for medical purposes; asthmatic tea; fumigating sticks; massage candles for therapeutic purposes; linseed for pharmaceutical purposes; tobacco-free cigarettes for medical purposes; siccatives [drying agents] for medical purposes; syrups for pharmaceutical purposes; turpentine for pharmaceutical purposes; greases for veterinary purposes; greases for medical purposes; lacteal flour for babies; infant formula; soporifics; bicarbonate of soda for pharmaceutical purposes; bath salts for medical purposes; salts for mineral water baths; salts for medical purposes; potassium salts for medical purposes; sodium salts for medical purposes; smelling salts; mineral water salts; malt for pharmaceutical purposes; semen for artificial insemination; alcohol for pharmaceutical purposes; medicinal alcohol; alloys of precious metals for dental purposes; ergot for pharmaceutical purposes; cooling sprays for medical purposes; antibacterial handwashes; adjuvants for medical purposes; astringents for medical purposes; vermifuges; disinfectants for hygiene purposes; disinfectants for chemical toilets; appetite suppressants for medical purposes; medical preparations for slimming purposes; parasiticides; mouthwashes for medical purposes; febrifuges; depuratives; animal washes [insecticides]; detergents for medical purposes; cattle washes [insecticides]; dog

washes [insecticides]; insecticidal veterinary washes; vesicants; purgatives; remedies for perspiration; remedies for foot perspiration; chemical contraceptives; antiparasitic preparations; laxatives; tonics [medicines]; medicated toiletry preparations; digestives for pharmaceutical purposes; nervines; bouillons for bacteriological cultures; steroids; strychnine; serums; tanning pills; appetite suppressant pills; slimming pills; antioxidant pills; sanitary tampons; vulnery sponges; thymol for pharmaceutical purposes; biological tissue cultures for veterinary purposes; biological tissue cultures for medical purposes; smoking herbs for medical purposes; medicinal herbs; implants [living tissues]; surgical implants comprised of living tissues; pants, absorbent, for incontinence; sanitary panties; babies' diaper-pants; charcoal for pharmaceutical purposes; porcelain for dental prostheses; phenol for pharmaceutical purposes; enzymes for veterinary purposes; enzymes for medical purposes; ferments for pharmaceutical purposes; formic aldehyde for pharmaceutical purposes; phosphates for pharmaceutical purposes; fungicides; quinine for medical purposes; chinoline for medical purposes; diabetic bread adapted for medical use; chloroform; flowers of sulfur for pharmaceutical purposes; cement for animal hooves; bone cement for surgical and orthopaedic purposes; dental cements; medicinal tea; herbal teas for medicinal purposes; insecticidal animal shampoos; medicated shampoos; medicated shampoos for pets; pediculicidal shampoos; medicated dry shampoos; pre-filled syringes for medical purposes; eucalyptus for pharmaceutical purposes; herbal extracts for medical purposes; plant extracts for pharmaceutical purposes; tobacco extracts [insecticides]; extracts of hops for pharmaceutical purposes; elixirs [pharmaceutical preparations]; ethers for pharmaceutical purposes; esters for pharmaceutical purposes; cellulose esters for pharmaceutical purposes; rat poison; poisons; bacterial poisons; jalap; capsules made of dendrimer-based polymers, for pharmaceuticals; chemical preparations for treating diseases affecting cereal plants; injectable dermal fillers; bracelets impregnated with insect repellent; suppositories; milking grease; douching preparations for medical purposes; sedatives; jujube, medicated; fennel for medical purposes; cellulose ethers for pharmaceutical purposes.

(260) AM 2022 114367 A  
 (800) 1608402  
 (151) 2021 06 16  
 (891) 2021 06 16  
 (731) Specialty Food Group, L.L.C.  
 9835 NW 14 Street, Doral FL 33172,  
 USA  
 (540)

**POPFULLY**

(591) Black, white

(511)

29 – Snack mix consisting of dehydrated fruit and processed nuts; snack mix consisting of processed seeds; snack mix consisting of wasabi peas, processed nuts, dehydrated fruit and/or raisins; snack mix consisting primarily of dehydrated fruits, processed nuts and also including sesame sticks; snack mix consisting primarily of processed fruits, processed nuts and/or raisins; snack mix consisting primarily of processed nuts and salted squash seeds and also including toasted corn; snack mix consisting primarily of processed nuts, seeds, dried fruit and also including chocolate.

30 – Popcorn; snack mix consisting primarily of crackers, pretzels and/or popped popcorn; candy-coated popcorn; caramel popcorn; caramel-coated popcorn; chocolate covered popcorn; flavor-coated popped popcorn; gift baskets containing popcorn; glazed popcorn; microwave popcorn; popped popcorn; processed popcorn; processed unpopped popcorn; seasoned popcorn; unpopped popcorn.

(260) AM 2022 114368 A

(800) 1608439

(151) 2021 06 02

(891) 2021 06 02

(731) TINE SA

Postboks 7 Kalbakken, N-0901 OSLO, Norway

(540)



(591) Black, white

(531) 25.01.25; 27.05.01; 27.05.04

(511)

29 – Meat; hamburgers; sausages; sausages containing cheese; minced meats containing cheese; fish, poultry and game; cheese nuggets; meat extracts; vegetarian substitutes for meat, fish, poultry and game; preserved, frozen, dried and cooked fruits and vegetables; jellies, jams, marmalades, compotes; eggs; dairy products; milk, butter, yogurt and yogurt drinks, dairy-based beverages and other milk products; cheese; cheese products; specialty cheeses; cream cheese; fromage frais; mold-ripened cheese; cheese spreads; smoked cheese; hard cheese; processed cheese; grilling cheese; rennet; cheese powder; curd; blended cheese; cheese substitutes; ripened cheeses; fresh unripened cheeses; cottage cheese; goat's milk cheese; cheese fondue; dessert cheese; wraps made of cheese; vegetarian/plant-based milk substitutes, including oat milk,

rice milk, soy milk, almond milk, coconut milk and products consisting primarily of these products; desserts made from milk products; powdered milk; whey; whey powder; edible oils and fats; cheese dips; sticks, poppers and nuggets made of cheese; omelettes; cheese soufflés; creamed potatoes; prepared meals consisting primarily of meat, fish, poultry, fruit or vegetables; prepared meals consisting primarily of vegetarian substitutes for meat, fish, poultry, fruit or vegetables; nuts, processed; snack mixes consisting of processed nuts and cheese and processed fruits.

(260) AM 2022 114369 A

(800) 1608477

(151) 2021 07 13

(891) 2021 07 13

(731) PARK CAPITAL VENTURES, LLC

4000 Ponce De Leon Blvd, Suite 470,  
Coral Gables FL 33146, USA

(540)

**LUV**

(591) Black, white

(511)

35 – Providing incentive award programs for customers through issuance and processing of loyalty points for purchase of a company's goods and services.

(260) AM 2022 114370 A

(800) 1608480

(151) 2021 04 30

(891) 2021 04 30

(731) BETTY BLUE S.P.A.

Via Viadagola 30, Fraz. Quarto Inferiore,  
I-40057 GRANAROLO DELL'EMILIA (BO),  
Italy

(540)

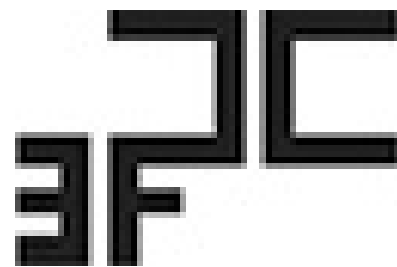

(591) Black, white

(531) 26.11.02; 26.11.06; 26.11.11; 27.05.01;  
27.05.08; 27.05.15

(511)

14 – Amulets [jewellery]; rings [jewelry]; hat jewellery; shoe jewellery; bracelets [jewelry]; bracelets made of embroidered textile; jewelry chains; clasps for jewellery; jewellery charms; necklaces [jewellery]; cuff links; medals; lockets; earrings; pins being jewelry; ornamental pins; brooches being jewelry; watch bands; wristwatches; works of art of precious metal; figurines of precious metal; split rings of precious me-



tal for keys; charms for key rings; boxes of precious metal; key rings; key rings comprised of split rings with decorative fobs or trinkets.

18 – Umbrellas; key cases; trunks [luggage]; leather bags; beach bags; bags for sports; purses; handbags; briefcases; business card cases; credit card cases; pocket wallets; haversacks; valises; rucksacks; faux fur; imitation leather; clothing for pets; collars for animals; leather leashes.

25 – Berets; skull caps; hats; fake fur hats; hoods [clothing]; muffs; headbands; waterproof jackets and pants; clothing of imitations of leather; clothing of leather; clothing for gymnastics; dresses; suits; bath robes; bandanas; stockings; breeches for wear; shirts; tank tops; casual jackets; stuff jackets [clothing]; tights; belts [clothing]; collars; bathing suits; neckties; scarves; jackets [clothing]; skirts; gloves; leggings [leg warmers]; sweaters; trousers; ear muffs; parkas; pelisses; ponchos; shawls; neck scarves [mufflers]; overcoats; tee-shirts; combinations [clothing article]; underwear; pyjamas; brassieres; dressing gowns; slippers; sandals; shoes; sneakers; half-boots; boots; wooden shoes [footwear].

(260) AM 2022 114376 A

(800) 1608801

(151) 2021 05 11

(891) 2021 05 11

(731) Vingroup Joint Stock Company

No. 7, Bang Lang 1 Street, Vinhomes Riverside Ecological Urban Area, Viet Hung Ward, Long Bien District, Hanoi City, Viet Nam

(540)

## Vinfast VF e35

(591) Black, white

(531) 27.05.01; 27.07.11

(511)

12 – Automobiles; electric cars; off road light sports utility vehicles; motorcycles; electric motorcycles; motor scooters; mopeds; bicycles; electric bicycles; electric assist bicycles; all-terrain vehicles; golf cars; engines for land vehicles; sports cars; electrically-powered motor vehicles; side cars; structural parts and component parts for land vehicles, namely air bags [safety devices for automobiles], anti-glare devices, anti-skid chains, automobile bodies, automobile chains, vehicle chassis, hoods for vehicles, brakes for vehicles, axles for vehicles, torsion bars for vehicles, bicycle frames, motorcycle frames, bicycle pedals, bicycle saddles, vehicle bumpers, clutches for land vehicles, doors for vehicles, driving motors for land vehicles, rearview mirrors, side view mirror, reduction gears for land vehicles, vehicle wheels, rims for vehicle wheels, safety belts for vehicle seats, vehicle seats, shock absorbers for vehicles, tires for vehicle

wheels, windows for vehicles, windscreen wipers, windscreen.

(260) AM 2022 114377 A

(800) 1608810

(151) 2021 05 11

(891) 2021 05 11

(731) Vingroup Joint Stock Company

No. 7, Bang Lang 1 Street, Vinhomes Riverside Ecological Urban Area, Viet Hung Ward, Long Bien District, Hanoi City, Viet Nam

(540)

## Vinfast VF e33

(591) Black, white

(531) 27.05.01; 27.07.11

(511)

12 – Automobiles; electric cars; off road light sports utility vehicles; motorcycles; electric motorcycles; motor scooters; mopeds; bicycles; electric bicycles; electric assist bicycles; all-terrain vehicles; golf cars; engines for land vehicles; sports cars; electrically-powered motor vehicles; side cars; structural parts and component parts for land vehicles, namely air bags [safety devices for automobiles], anti-glare devices, anti-skid chains, automobile bodies, automobile chains, vehicle chassis, hoods for vehicles, brakes for vehicles, axles for vehicles, torsion bars for vehicles, bicycle frames, motorcycle frames, bicycle pedals, bicycle saddles, vehicle bumpers, clutches for land vehicles, doors for vehicles, driving motors for land vehicles, rearview mirrors, side view mirror, reduction gears for land vehicles, vehicle wheels, rims for vehicle wheels, safety belts for vehicle seats, vehicle seats, shock absorbers for vehicles, tires for vehicle wheels, windows for vehicles, windscreen wipers, windscreen.

(260) AM 2022 114378 A

(800) 1608863

(151) 2021 04 30

(891) 2021 04 30

(731) BETTY BLUE S.P.A.

Via Viadagola 30, Fraz. Quarto Inferiore, I-40057 GRANAROLO DELL'EMILIA (BO), Italy

(540)



(591) Black, white

(531) 26.11.02; 26.11.06; 26.11.11; 27.05.01;  
27.05.02; 27.05.02; 27.05.08; 27.05.15;  
27.05.22

(511)

14 – Amulets [jewellery]; rings [jewelry]; hat jewellery; shoe jewellery; bracelets [jewelry]; bracelets made of embroidered textile; jewelry chains; clasps for jewellery; jewellery charms; necklaces [jewellery]; cuff links; medals; lockets; earrings; pins being jewelry; ornamental pins; brooches being jewelry; watch bands; wristwatches; works of art of precious metal; figurines of precious metal; split rings of precious metal for keys; charms for key rings; boxes of precious metal; key rings; key rings comprised of split rings with decorative fobs or trinkets.

18 – Umbrellas; key cases; trunks [luggage]; leather bags; beach bags; bags for sports; purses; handbags; briefcases; business card cases; credit card cases; pocket wallets; haversacks; valises; rucksacks; faux fur; imitation leather; clothing for pets; collars for animals; leather leashes.

25 – Berets; skull caps; hats; fake fur hats; hoods [clothing]; muffs; headbands; waterproof jackets and pants; clothing of imitations of leather; clothing of leather; clothing for gymnastics; dresses; suits; bath robes; bandanas; stockings; breeches for wear; shirts; tank tops; casual jackets; stuff jackets [clothing]; tights; belts [clothing]; collars; bathing suits; neckties; scarves; jackets [clothing]; skirts; gloves; leggings [leg warmers]; sweaters; trousers; ear muffs; parkas; pelisses; ponchos; shawls; neck scarves [mufflers]; overcoats; tee-shirts; combinations [clothing article]; underwear; pyjamas; brassieres; dressing gowns; slippers; sandals; shoes; sneakers; half-boots; boots; wooden shoes [footwear].

(260) AM 2022 114379 A

(800) 1608870

(151) 2021 03 02

(891) 2021 03 02

(731) Otkrytoe aktsionernoe obshchestvo  
"Beryozastroymaterialy"  
ul. Komsomolskaya, d. 25, 225210 Beryoza,  
Brestskaya obl., Belarus

(540)



(591) Green and black

(531) 26.04.04; 26.04.05; 26.04.16; 26.04.24;  
26.11.01; 26.11.12; 27.05.01; 29.01.13

(511)

19 – Clay; potters' clay; earth for bricks; bricks; firebricks; roofing, not of metal; building materials, not of metal; refractory construction materials, not of me-

tal; ceramic granite; mosaics for building; wall claddings, not of metal, for building; coatings [building materials]; building panels, not of metal; wall tiles, not of metal; floor tiles, not of metal; tiles, not of metal, for building; slabs, not of metal, for building; tile floorings, not of metal; terra-cotta [building material]; pantiles, not of metal; roofing tiles, not of metal; cladding, not of metal, for building; linings, not of metal, for building; roof coverings, not of metal; works of stonemasonry; works of art of stone, concrete or marble.

35 – Sales promotion for others; advertising; retail and wholesale services, also on-line, of the clay, potters' clay, earth for bricks, bricks, firebricks, roofing, building materials, not of metal, refractory construction materials, not of metal, ceramic granite, mosaics for building, wall claddings, not of metal, for building, coatings [building materials], building panels, not of metal, wall tiles, not of metal, floor tiles, not of metal, tiles, not of metal, for building, slabs, not of metal, for building, tile floorings, not of metal, terra-cotta [building material], pantiles, not of metal, roofing tiles, not of metal, cladding, not of metal, for building, linings, not of metal, for building, roof coverings, not of metal, works of stonemasonry, works of art of stone, concrete or marble.

(260) AM 2022 114380 A

(800) 1608889

(151) 2021 05 11

(891) 2021 05 11

(731) Vingroup Joint Stock Company

No. 7, Bang Lang 1 Street, Vinhomes Riverside  
Ecological Urban Area, Viet Hung Ward, Long  
Bien District, Hanoi City, Viet Nam

(540)

# Vinfast VF e36

(591) Black, white

(531) 27.05.01

(511)

12 – Automobiles; electric cars; off road light sports utility vehicles; motorcycles; electric motorcycles; motor scooters; mopeds; bicycles; electric bicycles; electric assist bicycles; all-terrain vehicles; golf cars; engines for land vehicles; sports cars; electrically-powered motor vehicles; side cars; structural parts and component parts for land vehicles, namely air bags [safety devices for automobiles], anti-glare devices, anti-skid chains, automobile bodies, automobile chains, vehicle chassis, hoods for vehicles, brakes for vehicles, axles for vehicles, torsion bars for vehicles, bicycle frames, motorcycle frames, bicycle pedals, bicycle saddles, vehicle bumpers, clutches for land vehicles, doors for vehicles, driving motors for land vehicles, rearview mirrors, side view mirror, reduction gears for land vehicles, vehicle wheels, rims for ve-

hicle wheels, safety belts for vehicle seats, vehicle seats, shock absorbers for vehicles, tires for vehicle wheels, windows for vehicles, windscreen wipers, windscreen.

(260) AM 2022 114381 A

(800) 1608897

(151) 2021 03 23

(891) 2021 03 23

(731) ZoodPay SA

Rue Caroline 15A, c/o Mehrzad Khoi,  
CH-1003 Lausanne, Switzerland

(540)

**ZOODPAY**

(591) Black, white

(511)

9 – Software; e-commerce software; application software; downloadable applications software for e-commerce; downloadable mobile applications software for online purchase of a variety of goods enabling a deferred payment without additional fees; communication software to enable customers to access their bank account information and to process bank transactions; apparatus for processing electronic payments; microchip cards; chip cards; encoded cards.

35 – Advertising; promotional services; commercial business management; business administrative assistance; office functions; advice with respect to company management and strategy; accounting; providing commercial information and provision of commercial advice in connection with e-commerce; procurement services for others (purchasing goods and services for other businesses); provision of sales areas online for sellers and buyers of goods and services; systemization of data in computer databases; computerized database management; data processing services; online retail sales services in the field of personal care products, cosmetics, clothing and footwear, furnishing, interior design, food products, electronic articles, sports articles and toys, watches and pocket clocks, household appliances, computers, cameras [photography] and video equipment and items of jewelry; the bringing together for the benefit of others of a variety of goods excluding the transport thereof enabling customers to conveniently view and purchase those goods; administrative processing of purchase orders placed by telephone or computer.

36 – Financial services; factoring; online deferred debit payment services enabling the consumer to purchase goods on an online trading platform and pay the bill through multiple payments without additional fees; secure payment processing services for commercial transactions; processing and management of mobile payments and contactless transactions with merchants via wearable devices; payment authorization, verification and processing services for transactions; electronic transfer of funds by telecommunication;

transfer of funds for the purchase of goods and services via electronic communications networks; automated payment services; payment services provided via wireless telecommunication apparatus and devices; payment services for e-commerce; carrying out cashless payment transactions; online banking services; bank transfer services; processing of bank transfers; financial services provided by telephone; computerized financial services; on-line bill payment services; payment and credit services.

(260) AM 2022 114391 A

(800) 1395098

(151) 2018 01 31

(891) 2021 07 13

(731) NOVARTIS AG

CH-4002 Basel, Switzerland

(540)

**EMZELBI**

(591) Black, white

(511)

5 – Pharmaceutical preparations.

(260) AM 2022 114392 A

(800) 1577096

(151) 2020 12 04

(891) 2021 07 29

(731) Chugan Electronic Commerce Co., Ltd.  
Room 302, Unit 6, Building 5, Duyuan  
Community, Houzhai Street, Yiwu City,  
322000 Zhejiang Province, China

(540)

**FINETOO**

(591) Black, white

(531) 27.05.09

(511)

25 – Brassieres; corselets; sports singlets; underwear; layettes [clothing]; vests.

(260) AM 2022 114432 A

(800) 1609279

(151) 2021 06 08

(891) 2021 06 08

(731) Shenzhen Jasic Technology Co., Ltd.

No.3, Qinglan 1st Road, Pingshan District,  
Shenzhen, China

(540)

**M MOSDAR**

(591) Black, white

(531) 01.01.02; 01.01.14; 27.05.08; 27.05.09;  
27.05.17

(511)  
7 – Glass cutting machines; soldering irons, gas-operated; welding machines, electric; electric arc welding apparatus; soldering apparatus, electric; electric arc cutting apparatus; electrodes for welding machines; soldering blow pipes, gas-operated; soldering apparatus, gas-operated; cutters [machines]; electric arc welders.

(260) AM 2022 114434 A  
(800) 1609340  
(151) 2021 04 08  
(891) 2021 04 08  
(731) Egis Gyógyszergyár Zrt.  
Keresztúri út 30-38., H-1106 Budapest,  
Hungary

(540)

## CURESOLUTE

(591) Black, white  
(511)  
3 – Cosmetics and cosmetic preparations.  
5 – Human pharmaceutical preparations; dietetic substances adapted for medical use; dietary supplements; medicinal ointments; medicated skin creams; plasters, materials for dressings.

(260) AM 2022 114435 A  
(800) 1609346  
(151) 2021 04 08  
(891) 2021 04 08  
(731) Egis Gyógyszergyár Zrt.  
Keresztúri út 30-38., H-1106 Budapest,  
Hungary

(540)

## PURASOLUTE

(591) Black, white  
(511)  
3 – Cosmetics and cosmetic preparations.  
5 – Human pharmaceutical preparations; dietetic substances adapted for medical use; dietary supplements; medicinal ointments; medicated skin creams; plasters, materials for dressings.

(260) AM 2022 114436 A  
(800) 1609417  
(151) 2021 06 03  
(891) 2021 06 03  
(731) LABORATOIRES GOEMAR  
Parc Technopolitain Atalante, CS 41908,  
F-35435 SAINT-MALO CEDEX, France

(540)



(591) Blue, green, white  
(531) 01.13.01; 01.13.15; 26.01.01; 26.01.16;  
26.13.25; 27.05.02; 27.05.19; 29.01.13

(511)

1 – Chemical products for use in agriculture, horticulture and forestry; soil fertilizers; chemical substances for preserving foodstuffs; sea water for industrial use; fertilizing products; biostimulants (chemicals used in agriculture, horticulture and forestry); physiological activators (chemicals used in agriculture, horticulture and forestry); fertilizers for plant nutrition; activators for nutrition and plant, tree, vine, cereal, fruit and vegetable growth regulation; physiological activators for plant growth; algae (fertilizers).

(260) AM 2022 114446 A  
(800) 1609830  
(151) 2021 05 25  
(891) 2021 05 25  
(731) Paragon Vision Sciences, Inc.  
2120 W. Guadalupe Road, Suite 112,  
Gilbert AZ 85233, USA

(540)

## PARAGON CRT DUAL AXIS

(591) Black, white  
(511)  
9 – Contact lenses.

(260) AM 2022 114447 A  
(800) 1609873  
(151) 2021 05 12  
(891) 2021 05 12  
(731) Gevorgyan David Smbatovich  
Rozhdestveno village, household 2,  
apt. 4, Volokolamsk district, RU-143600  
Moscow region, Russian Federation

(540)



(591) Blue, dark lilac, lilac, light lilac  
(531) 26.01.01; 26.01.06; 29.01.04

(511)

11 – Urinals being sanitary fixtures; pipes [parts of sanitary installations]; wash-hand basins [parts of sanitary installations]; bath installations; bath tubs; bath tubs for sitz baths; heaters for baths; hydromassage bath apparatus; spa baths [vessels]; microbubble generators for baths; bath fittings; sinks; mixer taps for water pipes; shower cubicles; coils [parts of distilling, heating or cooling installations]; heat accumulators; steam accumulators; disinfectant apparatus; air deodorizing apparatus; ionization apparatus for the treatment of air or water; tanning apparatus [sun beds]; hand drying apparatus for washrooms; water purifying apparatus and machines; underfloor heating apparatus and installations; water heaters; water flushing installations; showers; taps; taps for pipes and pipelines; immersion heaters; sauna bath installations; water intake apparatus; deodorizing apparatus, not for personal use; water filtering apparatus; air purifying apparatus and machines; sanitary apparatus and installations; cooking rings; steam facial apparatus [saunas]; toilet seats; hydroponic growing systems; air dryers; water sterilizers; air sterilizers; laundry dryers, electric; hair dryers; toilets, portable; toilets [water-closets]; humidifiers; humidifiers for central heating radiators; toilet bowls; water conduits installations; desalination plants; cooling installations for water; cooling installations for liquids; purification installations for sewage; swimming pool chlorinating apparatus; water softening apparatus and installations; heating installations; heating installations [water]; water supply installations; filters for drinking water.

20 – Bathtub grab bars, not of metal; bath seats for babies; bathroom vanities [furniture]; towel stands [furniture]; racks [furniture]; furniture shelves; showcases [furniture]; doors for furniture; flower-stands [furniture]; index cabinets [furniture]; console tables; furniture of metal; inflatable furniture; office furniture; school furniture; legs for furniture; head-rests [furniture]; trestles [furniture]; benches [furniture]; trolleys [furniture]; screens [furniture]; coatstands; indoor window blinds [furniture]; furniture casters, not of metal; edgings of plastic for furniture; brackets, not of metal, for furniture; feet for furniture; furniture partitions of wood; freestanding partitions [furniture]; trolleys for computers [furniture]; washstands [furniture]; saw benches [furniture]; dinner wagons [furniture]; screens for fireplaces [furniture]; mirrors [looking glasses]; hand-held mirrors [toilet mirrors]; mirror tiles; silvered glass [mirrors]; mats, removable, for sinks; shells; door closers, not of metal, non-electric; indoor window blinds of paper; indoor window blinds of woven wood; indoor window blinds of textile; baskets, not of metal; chests of drawers; curtain rails; shelves for storage.

(260) AM 2022 114448 A

(800) 1609882

(151) 2021 05 05

(891) 2021 05 05

(731) RIMOWA GmbH

Richard-Byrd-Strasse 13, 50829 Köln, Germany

(540)

## NEVER STILL

(591) Black, white

(511)

3 – Perfumery; soaps; cosmetics; scented oils; scented wax for polishing; leather cream.

4 – Candles; scented candles.

18 – Traveling trunks; valises; holdalls; bags; brief-bags; vanity cases, not fitted; travelling sets [leatherware]; rucksacks; hipsacks; shoe bags for travel; gym bags; garment bags for travel; bags [envelopes, pouches] of leather, for packaging; bags for sports; handbags; clutch bags; luggage tags; labels of leather; fitted protective covers for luggage; shopping bags; umbrellas; parasols; casual bags; cosmetic bags sold empty; cosmetic purses; toiletry bags; tote bags; back packs; duffel bags; clear plastic bags for travel; clear cosmetic bags.

24 – Textile material; linings [textile]; labels of textile; blankets; towels of textile; beach towels.

25 – Clothing; headgear; footwear; tee-shirts; sweaters; knitwear [clothing]; sports jerseys; shirts; stockings; pullovers; polo shirts; bandanas [neckerchiefs]; scarves; neck scarves [mufflers]; sashes for wear; rainwear; caps [headwear]; baseball caps; sleep masks; community masks.

(260) AM 2022 114449 A

(800) 1609884

(151) 2021 06 03

(891) 2021 06 03

(731) Limited liability company "Supermash"

30 A Verhniy Val str., Kyiv 04071, Ukraine

(540)

## FLOREX

(591) Black, white

(531) 27.05.17

(511)

3 – Cosmetics, namely hair dyes.

(260) AM 2022 114450 A

(800) 1609941

(151) 2021 06 03

(891) 2021 06 03

(731) Limited liability company "Supermash"

30 A Verhniy Val str., Kyiv 04071, Ukraine

(540)



(591) Blue, white, yellow and black

(531) 26.04.02; 26.04.05; 26.04.12; 26.04.18;  
26.05.24; 27.05.03; 27.05.09; 27.05.24;  
29.01.13

(511)

3 – Bleaching preparations and other substances for laundry use; cleaning, polishing, degreasing and abrasive preparations; soap; perfumes; essential oils; cosmetics; hair lotions; tooth powders; toothpastes.

(260) AM 2022 114451 A

(800) 1609964

(151) 2021 04 27

(891) 2021 04 27

(731) PULATHANELİLER GIDA PAZARLAMA  
SAN. VE TİC. A.Ş.  
Eyüp Sultan Mah. İbni Sina Cad. No: 22,  
Samandira, Turkey

(540)



(591) Gold, black and white

(531) 05.03.13; 17.02.01; 17.02.02; 26.15.25;  
27.05.01; 27.05.17; 29.01.13

(511)

29 – Processed olives, olive paste, olive oil, edible oils; prepared nuts and dried fruits as snacks, walnuts, almonds, figs, hazelnuts, nuts, peanuts; all dried and processed nuts and fruits.

(260) AM 2022 114458 A

(800) 1545894

(151) 2020 07 14

(891) 2021 07 09

(731) NOVARTIS AG  
CH-4002 Basel, Switzerland

(540)

**XIPTIBA**

(591) Black, white

(511)

5 – Pharmaceutical preparations.

(260) AM 2022 114459 A

(800) 1575724

(151) 2020 07 14

(891) 2021 07 09

(731) NOVARTIS AG  
CH-4002 Basel, Switzerland

(540)

**ZACTILBI**

(591) Black, white

(511)

5 – Pharmaceutical preparations.

(260) AM 2022 114460 A

(800) 1588116

(151) 2021 03 15

(891) 2021 07 08

(731) WordDive Oy  
Verstaankatu 1, FI-33100 Tampere, Finland

(540)



(591) Blue, brown, white

(531) 26.03.06; 26.04.12; 29.01.13

(511)

9 – Downloadable software for mobile phones and computers, for use in language instruction.

41 – Educational services, namely, conducting on-line programs in the field of language instruction, namely, english; providing online classes for learning foreign languages, namely, english; providing courses of instruction, namely, english-language courses, including providing teacher-student conferencing.

42 – Software as a service (SaaS) services featuring software for learning foreign languages.

(260) AM 2022 114461 A

(800) 1590509

(151) 2021 02 25

(891) 2021 07 28

(731) Dart Industries Inc.  
14901 S. Orange Blossom Trail,  
Orlando FL 32837, USA

(540)

**SUPERSONIC**

(591) Black, white

(511)

8 – Hand-operated food processor; hand-operated kitchen utensil, namely, hand-operated kitchen appliance for dicing, slicing, chopping and cutting food.

(260) AM 2022 114477 A  
 (800) 1610107  
 (151) 2021 03 22  
 (891) 2021 03 22  
 (731) ITF Licensing (UK) Ltd  
 Bank Lane, Roehampton, London SW15 5XZ,  
 United Kingdom

(540)

## DAVIS CUP

(591) Black, white

(511)

16 – Printed matter and printed publications; stationery; periodical publications, books, magazines, brochures, programmes, book marks, pens, pencils, crayons, posters, photographs, diaries, calendars, stickers, maps, stamps, postcards, greeting cards, paper shopping bags, plastic bags for wrapping and packaging, desk accessories; instructional and teaching material; photographs; advertising materials.

25 – Clothing, footwear, headgear.

41 – Entertainment services, sporting and cultural services; producing, organising, conducting and staging sports competitions, tournaments and events, arranging and conducting of sporting events for radio, film and television, provision of recreational facilities.

(260) AM 2022 114483 A  
 (800) 1610332  
 (151) 2021 06 23  
 (891) 2021 06 23  
 (731) DOLCE & GABBANA TRADEMARKS S.r.l.  
 VIA GOLDONI 10, I-20129 MILANO (IT),  
 Italy

(540)



(591) Black, white

(531) 24.09.02; 24.09.12; 27.05.07; 27.05.10;  
 27.05.17

(511)

3 – Cosmetics; perfumes; perfumes in solid form; deodorant for personal use; soap; liquid soap; cakes of toilet soap; bath foam; dentifrices; shampoos; essential oils; hair lotions; permanent waving and curling preparations; cosmetics in the form of gels; hair dyes; face creams for cosmetic purposes; mascara; eyeliner; eyeshadow; make-up pencils; sun bronzers; lipsticks;

foundation; cosmetic body creams; nail varnish; preparations for reinforcing the nails; nail varnish removers; cosmetic oils; suntan creams.

(260) AM 2022 114484 A

(800) 1610449

(151) 2021 06 22

(891) 2021 06 22

(731) Apple Inc.

One Apple Park Way, Cupertino CA 95014,  
 USA

(540)

## APPLE FIND MY

(591) Black, white

(511)

9 – Telecommunications apparatus and instruments in the nature of wireless receivers; wireless communication devices for the transmission of data; network communication apparatus in the nature of wireless receivers; computer hardware; computer hardware for use in finding, tracking, displaying, and sharing the geographic location of individuals and consumer goods, sending notifications on the geographic location of individuals, locating lost or missing consumer goods, and preventing unauthorized access to consumer goods; wearable computer hardware; computer peripheral devices; peripheral devices for computers, mobile telephones, mobile electronic devices, wearable electronic devices, and earphones; wearable peripherals for use with computers, mobile telephones, mobile electronic devices; audio speakers; earphones; electronic tags for goods.

(260) AM 2022 114485 A

(800) 1610525

(151) 2021 05 04

(891) 2021 05 04

(731) BGH Edelstahlwerke GmbH

Am Stahlwerk 1, 01705 Freital, Germany

(540)



(591) Black, white

(531) 26.07.03; 26.13.25; 27.05.17; 27.05.23

(511)

6 – Common metals and their alloys; non-electric cables and wires of common metal; pipes and tubes of metal; poles of metal; sheet metal; beams of metal; steel in bar form; bright steel tubes; bright steel bars; metal forgings.



(260) AM 2022 114486 A  
 (800) 1610529  
 (151) 2021 07 21  
 (891) 2021 07 21  
 (731) The Australian National University, a body established under the Australian National University Act 1991 (Cth)  
 L6, 121 Marcus Clarke St., Building X-005,  
 ACTON ACT 2601, Australia

(540)

**ANU**

(591) Black, white

(511)

41 – Conducting of educational conferences; design of educational courses, examinations and qualifications; dissemination of educational material; higher education services; organisation of exhibitions for cultural or educational purposes; provision of education services via an online forum; provision of educational courses; provision of educational examinations; provision of facilities for education; provision of information relating to education; publication of educational materials; vocational education; consultancy services relating to education; education services; providing information, including online, about education, training, entertainment, sporting and cultural activities; sporting activities.

42 – Advisory services relating to scientific research; advisory services relating to technological research; computer research services; engineering research; laboratory research; laboratory services (scientific research or analysis); management of scientific research projects; preparation of reports relating to scientific research; preparation of reports relating to technical research; preparation of technical reports and analyses of technical data for scientific research; providing information, including online, about industrial analysis and research services; providing information, including online, about scientific and technological services and research and design relating thereto; product research and development services (for others); scientific research services; research, engineering and technical consultancy for industry; scientific research; scientific research services in the field of social sciences; technical research; technological research.

(260) AM 2022 114487 A

(800) 1610584

(151) 2021 03 02

(891) 2021 03 02

(731) FM World Sp. z o.o.  
 ul. Żmigrodzka 247, PL-51-129 Wrocław,  
 Poland

(540)

**FEDERICO MAHORA**

**PURE**

(591) Black, white

(531) 27.05.01

(511)

3 – Perfumes; extracts of flowers [perfumes]; fumigation preparations [perfumes]; perfumed toilet waters; fragrance preparations; scented sachets; air fragrance reed diffusers; scented oils; room scenting sprays (terms linguistically incorrect in the opinion of the International Bureau – Rule 13 (2) (b) of the Regulations); sachets for perfuming linen; air fragrancing preparations; scented fabric refresher sprays; perfumery and fragrances.

4 – Perfumed candles; aromatherapy fragrance candles.

5 – Air freshener sprays (terms too vague in the opinion of the International Bureau – Rule 13 (2) (b) of the Regulations).

35 – Advertising; banner advertising; outdoor advertising; advertising and marketing; promotion [advertising] of business; electronic billboard advertising; advertising of business web sites; online advertising on a computer network; advertising by transmission of on-line publicity for third parties through electronic communications networks; brand creation services; brand creation services (advertising and promotion).

(260) AM 2022 114493 A

(800) 1610733

(151) 2021 04 29

(891) 2021 04 29

(731) TRINA SOLAR Co., LTD

No. 2 Trina Road, Trina PV Park, Xinbei,  
 Changzhou, 213031 Jiangsu, China

(540)

**TrinaStorage**

(591) Black, white

(531) 27.05.01; 27.05.09

(526) Storage

(511)

9 – Batteries, electric; inverters [electricity]; battery boxes; battery charge devices; data processing apparatus; power controllers; electrical power distribution blocks; electric control devices for energy management; lithium ion batteries; electrical transformers; converters, electric; photovoltaic apparatus and installations for generating solar electricity; accumulator jars.



(260) AM 2022 114495 A

(800) 1610842

(151) 2021 04 22

(891) 2021 04 22

(731) AstraZeneca UK Limited

1 Francis Crick Avenue, Cambridge Biomedical  
Campus, Cambridge CB2 0AA, United  
Kingdom

(540)



(591) Black, white

(531) 26.03.23; 26.11.06; 26.11.09; 26.13.25

(511)

5 – Pharmaceutical preparations and substances.

(260) AM 2022 114496 A

(800) 1610844

(151) 2021 05 07

(891) 2021 05 07

(731) İLKAS SAĞLIK ÜRÜNLERİ SANAYİ VE  
TİCARET LİMİTED ŞİRKETİ

3.Organize Sanayi Bölgesi 83525 Nolu,  
Cadde No:5, Şehitkamil, Gaziantep, Turkey

(540)

littles baby

(591) Black, white

(531) 27.05.01

(511)

5 – Dietary supplements for pharmaceutical and veterinary purposes; dietary supplements; nutritional supplements; medical preparations for slimming purposes; food for babies; herbs and herbal beverages adapted for medicinal purposes; sanitary preparations for medical use; hygienic pads; hygienic tampons; plasters; materials for dressings; diapers made of paper and textiles for babies, adults and pets; deodorants, other than for human beings or for animals; air purifying preparations; air deodorising preparations.

(260) AM 2022 114499 A

(800) 1610891

(151) 2021 03 25

(891) 2021 03 25

(731) Ivoclar Vivadent AG

Bendererstrasse 2, FL-9494 Schaan,  
Liechtenstein

(540)

VivaScan

(591) Black, white

(511)

5 – Materials for use in dentistry; materials for the manufacture of dental impressions, models, crowns, bridges, inlays, prostheses, artificial teeth; materials for the characterization of teeth; materials for polishing teeth; dental waxes; dental filling materials; dental adhesive agents; root filling materials; core build-up materials for use in dentistry; luting materials for use in dentistry; materials for pulp protection and root treatment; materials for cavity treatment; materials for dentin wound and pulp treatment; materials used in acid etching and for preventing caries; adhesive agents for dental purposes; protective varnishes for teeth; drying and degreasing materials for use in dentistry; materials used for cosmetic restoration of damaged teeth; diagnostic substances for medical use; dental materials for the bleaching of teeth; dental composites; dental cements; salivary diagnostic preparation; disinfectants; preparations for the hygiene of teeth and oral cavity; medical mouthwash; dental materials for treating caries and periodontitis; colour stains for use in dentistry; precious metal alloys and non-precious metal alloys for dental technology; precious metals and non-precious metals for dental technology; investment materials for use in dentistry; dental adhesives; materials for repairing damaged teeth; opaque materials for dental use; metal primers for dental purposes; fiber reinforced resin for the manufacture of crowns, bridges and pontics; fissure sealants for dental use; mixing capsules for dental materials; materials for the proof of plaque; ceramic layering.

9 – Scanners; apparatus for the processing of images and devices for CAD-CAM-processing.

10 – Apparatus, devices, tools, and instruments for dental use; impression devices for dental use; registration devices for dental use; articulators for dental use; mixing devices for dental use; blasting devices for dental use; dosing instruments and apparatus for dental use; milling, grinding, and drilling instruments for dental use; artificial teeth; dental plates; dental crowns and bridges; syringes; shade guides; dental matrices; dental strips; apparatus and instruments for the caries prophylaxis and for the treatment of periodontitis; polishing instruments; ceramiac mixing plates for dental use; tooth pins for medical use; ingots made of synthetic materials, metal, or ceramic for the manufacture of dental crowns, bridges, inlays, prostheses, artificial teeth; dental applicators; prefabricated parts for crowns, bridges, and pontics; scanners for dental use, and parts thereof.

(260) AM 2022 114500 A  
 (800) 1611012  
 (151) 2021 06 02  
 (891) 2021 06 02  
 (731) TINE SA  
 Postboks 7 Kalbakken, N-0901 OSLO, Norway  
 (540)



(591) Blue, yellow and red  
 (531) 25.01.25; 26.01.16; 26.01.18; 27.05.01;  
 29.01.13

(511)  
 29 – Meat; hamburgers; sausages; sausages containing cheese; minced meats containing cheese; fish, poultry and game; cheese nuggets; meat extracts; vegetarian substitutes for meat, fish, poultry and game; preserved, frozen, dried and cooked fruits and vegetables; jellies, jams, marmalades, compotes; eggs; dairy products; milk, butter, yogurt and yogurt drinks, dairy-based beverages and other milk products; cheese; cheese products; specialty cheeses; cream cheese; fromage frais; mold-ripened cheese; cheese spreads; smoked cheese; hard cheese; processed cheese; grilling cheese; rennet; cheese powder; curd; blended cheese; cheese substitutes; ripened cheeses; fresh unripened cheeses; cottage cheese; goat's milk cheese; cheese fondue; dessert cheese; wraps made of cheese; vegetarian/plant-based milk substitutes, including oat milk, rice milk, soy milk, almond milk, coconut milk and products consisting primarily of these products; desserts made from milk products; powdered milk; whey; whey powder; edible oils and fats; cheese dips; sticks, poppers and nuggets made of cheese; omelettes; cheese soufflés; creamed potatoes; prepared meals consisting primarily of meat, fish, poultry, fruit or vegetables; prepared meals consisting primarily of vegetarian substitutes for meat, fish, poultry, fruit or vegetables; nuts, processed; snack mixes consisting of processed nuts and cheese and processed fruits.

(260) AM 2022 114501 A  
 (800) 1611055  
 (151) 2021 04 01  
 (891) 2021 04 01  
 (731) WORLD MEDICINE İLAÇ SAN. VE TİC.  
 A.Ş.  
 15 TEMMUZ MAH., CAMİ YOLU CAD.  
 No:50, Bağcılar, İstanbul, Turkey

(540)  
**МЕДАОХ–МЕДАОКС**

(591) Black, white  
 (531) 28.05  
 (511)  
 5 – Pharmaceutical and veterinary preparations for medical purposes, chemical preparations for medical purposes, dietary supplements, including those adapted for medical purposes, dietary supplements for slimming purposes, food for babies, herbs and herbal beverages adapted for medicinal purposes, dental preparations and articles, sanitary preparations for medical use, hygienic pads, hygienic tampons, plasters, materials for dressings, diapers, including those made of paper and textiles, preparations for destroying vermin, fungicides, herbicides, deodorants, other than for human beings or for animals, air deodorising preparations, disinfectants, antiseptics, detergents for medical purposes.

(260) AM 2022 114502 A  
 (800) 1611063  
 (151) 2021 07 05  
 (891) 2021 07 05  
 (731) AFTERSHOKZ, LLC  
 1801 Burnet Avenue, Suite 102, Syracuse  
 NY 13206, USA  
 (540)

**openjoy**

(591) Black, white  
 (511)  
 9 – Batteries; battery chargers; chargers for batteries; earphones; electronic memory devices; headphones; horns for loudspeakers; lithium ion batteries; megaphones; memory expansion modules; microphones; smartglasses; spectacles; virtual reality headsets; wireless speakers; MP3 players; bone conduction earphones.

(260) AM 2022 114550 A  
 (800) 1611603  
 (151) 2021 06 04  
 (891) 2021 06 04  
 (731) Andronnik Limited Liability Company  
 Sacco and Vanzetti street, building 77, floor 5,  
 RU-630008 Novosibirsk, Russian Federation  
 (540)



(591) Black, pink, white  
 (531) 02.09.01; 03.01.06; 03.01.16; 29.01.13  
 (511)  
 3 – Amber [perfume]; aromatics [essential oils]; air fragrancing preparations; breath freshening sprays; canned pressurized air for cleaning and dusting purposes; balms, other than for medical purposes; basma [cosmetic dye]; lip glosses; nail glitter; petroleum jelly for cosmetic purposes; shoe polish; cotton wool for cosmetic purposes; sachets for perfuming linen; adhesives for cosmetic purposes; scented water; Javelle water; lavender water; toilet water; depilatory wax; moustache wax; creams for leather; shoemakers' wax; massage gels, other than for medical purposes; dental bleaching gels; make-up; deodorants for pets; deodorants for human beings or for animals; depilatory preparations; air fragrance reed diffusers; scented wood; perfumes; non-slipping liquids for floors; windscreen cleaning liquids; greases for cosmetic purposes; perfumery; decorative transfers for cosmetic purposes; ionone [perfumery]; eyebrow pencils; cosmetic pencils; adhesives for affixing false eyelashes; adhesives for affixing false hair; hair conditioners; quillaia bark for washing; beard dyes; cosmetic dyes; shoe cream; cosmetic creams; skin whitening creams; hair spray; nail varnish; hair lotions; lotions for cosmetic purposes; after-shave lotions; beauty masks; oils for cleaning purposes; oils for perfumes and scents; oils for cosmetic purposes; oils for toilet purposes; essential oils; essential oils of cedarwood; essential oils of lemon; essential oils of citron; bergamot oil; gaultheria oil; jasmine oil; lavender oil; almond oil; rose oil; oil of turpentine for degreasing; almond milk for cosmetic purposes; cleansing milk for toilet purposes; musk [perfumery]; soap; deodorant soap; shaving soap; cakes of toilet soap; antiperspirant soap; soap for foot perspiration; almond soap; mint for perfumery; cosmetic kits; gel eye patches for cosmetic purposes; nail art stickers; false nails; eau de Cologne; bases for flower perfumes; dentifrices; pumice stone; lipstick cases; hydrogen peroxide for cosmetic purposes; breath freshening strips; teeth whitening strips; sandcloth; glass cloth [abrasive cloth]; lipsticks; pomades for cosmetic purposes; breath freshening preparations for personal hygiene; shaving preparations; bath preparations, not for medical purposes; cosmetic preparations for baths; hair straightening preparations; hair waving preparations; leather bleaching preparations; mouthwashes, not for medical purposes; cosmetic preparations for slimming purposes; eye-washes, not for medical purposes; make-up removing preparations; nail care preparations; cleaning preparations; chemical cleaning preparations for household purposes; collagen preparations for cosmetic purposes; aloe vera preparations for cosmetic purposes; sunscreen preparations; make-up powder; nail varnish removers; scouring solutions; false eyelashes; pre-moistened cosmetic wipes; tissues impregnated with cosmetic lotions; tissues impregnated with make-up removing

preparations; baby wipes impregnated with cleaning preparations; massage candles for cosmetic purposes; potpourris [fragrances]; fumigation preparations [perfumes]; leather preservatives [polishes]; astringents for cosmetic purposes; eyebrow cosmetics; make-up preparations; sun-tanning preparations [cosmetics]; hair dyes; neutralizers for permanent waving; cosmetic preparations for eyelashes; cosmetic preparations for skin care; shoe wax; cosmetics; cosmetics for children; cosmetics for animals; mascara; detergents, other than for use in manufacturing operations and for medical purposes; douching preparations for personal sanitary or deodorant purposes [toiletries]; degreasers, other than for use in manufacturing processes; bleaching preparations [decolorants] for cosmetic purposes; toiletry preparations; antiperspirants [toiletries]; phytocosmetic preparations; removable tattoos for cosmetic purposes; cloths impregnated with a detergent for cleaning; shampoos; shampoos for animals [non-medicated grooming preparations]; shampoos for pets [non-medicated grooming preparations]; dry shampoos; herbal extracts for cosmetic purposes; extracts of flowers [perfumes]; ethereal essences; badian essence; mint essence [essential oil].

(260) AM 2022 114552 A  
 (800) 1611622  
 (151) 2021 07 02  
 (891) 2021 07 02  
 (731) AFTERSHOKZ, LLC  
 1801 Burnet Avenue, Suite 102, Syracuse  
 NY 13206, USA  
 (540)

## opensnow

(591) Black, white  
 (511)  
 9 – Batteries; battery chargers; chargers for batteries; earphones; electronic memory devices; headphones; horns for loudspeakers; lithium ion batteries; megaphones; memory expansion modules; microphones; smartglasses; spectacles; virtual reality headsets; wireless speakers; MP3 players; bone conduction earphones.

(260) AM 2022 114553 A  
 (800) 1611633  
 (151) 2021 06 04  
 (891) 2021 06 04  
 (731) CANPACK S.A.  
 Jasnogórska 1, PL-31-358 Kraków, Poland  
 (540)

## CREATE THAT FEELING

(591) Black, white  
 (511)  
 6 – Beverage cans of metal; metal cans, sold empty; closures of metal; cap closures of metal; closures of

metal for containers; tin cans [empty]; containers made of metal for use in the storage of gases; containers of metal [storage, transport]; metal aerosol containers [empty]; metal aerosol containers sold empty; screw caps of metal; sealing caps of metal; bottle closures of metal; tinfoil; foils of metal for covering; foils of metal for cooking; aluminium; sheet metal; aluminium foil; alloys of metal; aluminium and its alloys; packaging, wrapping and bundling articles, of metal; metallic capsules [containers]; storage containers of metal; cans of metal for alcoholic beverages; metal oil cans [empty]; boxes of common metal; steel for tins.

21 – Soap dispensers; hand soap dispensers; dispensers for liquid soap; dispensers for cosmetics; shower gel dispensers; shampoo dispensers; body cleanser dispensers; bottles; containers for household or kitchen use.

42 – Advisory services relating to industrial engineering; advisory services relating to design engineering; engineering design and consultancy; engineering design; engineering services relating to computer programming; engineering services relating to metal forming systems; engineering consultancy services; computer assisted engineering design services; consultancy services relating to product engineering; engineering consultancy relating to design; consultancy relating to the design of packaging; technical assessments relating to design; product development for others; product development; professional consultancy relating to industrial design; product research and development; research to develop new products; design and testing of new products; design and development of new products; design and testing for new product development; packaging design for others; designing of packaging and wrapping materials; new product design; design of specialist machinery; design of industrial products; consumer product design; design of ornamental layouts; provision of information relating to industrial design; styling [industrial design]; design sketching of packaging, containers, dinnerware and table utensils; engineering services for the design of machinery; engineering and computer-aided engineering services; advisory services relating to industrial design; design services relating to metal-working presses; design services relating to metal-working tools; industrial and graphic art design; industrial art design; product design and development; computer-aided industrial design.

(260) AM 2022 114555 A

(800) 1611688

(151) 2021 04 12

(891) 2021 04 12

(731) Hetsen & Klaver B.V.

De Dieze 2, NL-8253 PS Dronten, Netherlands

(540)

**HKliving**

(591) Black, white

(511)

4 – Candles; scented candles.

11 – Lighting, lamps, incandescent light bulbs, lamp glasses, chandeliers, lampshade holders, lampshades, fixtures for lamps, floor lamps, pendant lamps, table lamps, fairy lights for festive decoration, lanterns; lampshades; lighting devices and installations.

20 – Furniture, living room furniture, kitchen furniture, bathroom furniture, garden furniture and bedroom furniture; office furniture; furniture, including chairs, stools, seats, armchairs, hanging chairs, sofas, couches, couchettes, settees, divans, tables, coffee tables, side tables, beds, bed bases, drawers, bookcases, wardrobes, clothes racks, credenzas; mirrors, frames and picture frames of wood, cork, cane, reed, wicker, horn, bone, ivory, baleen, tortoiseshell, amber, mother of pearl, meerschaum, plastic and substitutes for all of these materials, included in this class; wall decorations, including art objects of materials such as wood, wax, plaster, plastic, unless included in other classes; wine racks; book stands; magazine racks; umbrella stands; coat racks, mattresses, cushions; seat or decorative pillows; baskets, not of metal; room screens.

21 – Household or kitchen utensils and containers; raw or semi-manufactured glass (except glass used for building purposes); glass, porcelain and earthenware; bakeware; baking moulds; tableware of glass or porcelain; mugs, cups, glasses; plates, bowls, dishes, jugs; cake domes and cake stands; candle holders, tealight holders; trays; earthenware; statues, figurines, plaques and works of art of porcelain, terracotta, glass, ceramics and earthenware; wall decorations, including art of porcelain, earthenware, terracotta, glass, ceramics and plexiglas; vases; trays for serving; cutlery trays; knife blocks; cutting boards; wine coolers; carafes; plant and flower pots; insulated food cover domes; boxes of glass, ceramic, earthenware and porcelain; bottles of glass, ceramic, earthenware and porcelain; teapots; thermos flasks; mugs; salt and pepper mills; spice holders; pans and woks; plastic ice cube molds; bottles; beverage can holders; dustbins; non-electric percolators; bottle openers; non-electric coffee makers; thermally insulated containers for food and drink; coolers [non-electric] and jugs [drinking utensils] of both rigid material and fabrics for use at home or at picnics; fully equipped picnic baskets; lunch boxes; cool bags and boxes; cosmetic and toilet utensils; cosmetic and cleaning brushes; toilet brushes; soap dispensers; toothbrush holders; bath sponges; picnic baskets (empty).

24 – Textile products and substitutes therefor; linen; bed clothes and blankets; quilt covers, bed sheets, sheets, blankets, bedspreads, pillowcases; towels, tea towels; bath towels; washcloths; curtains of textile or plastic; plaids; tablecloths; runners [tablecloths]; wall

decorations of textile; wall hangings of textile; picnic blankets; mosquito nets.

27 – Carpets and rugs, whether or not handmade; bath mats; wall hangings, not of textile.

35 – Retail and wholesale services, as well as import and export of items for home and office furnishings, including lighting, furniture, household or kitchen utensils and containers, glass, ceramic, porcelain and earthenware, linen, bed clothes and blankets, curtains, wall decorations, objects of art, carpets, cutlery, scented sticks, fragrances for interiors and rooms, posters and printed art and other interior items, lifestyle products and artifacts, whether or not provided online; the bringing together, for the benefit of others (excluding transport), of lighting, furniture, household or kitchen utensils and containers, glass, ceramic, porcelain and earthenware, linen, bed clothes and blankets, curtains, wall decorations, objects of art, carpets, cutlery, scented sticks, fragrances for interiors and rooms, posters and printed art and other interior items, lifestyle products and artifacts, with the aim of enabling third parties to see and buy them, arranging exhibitions and demonstrations relating to the aforementioned goods; commercial-business intermediary services to assist in establishing business contacts between consumers and manufacturers of lighting, furniture, household or kitchen utensils and containers, glass, ceramic, porcelain and earthenware, linen, bed clothes and blankets, curtains, wall decorations, objects of art, carpets, cutlery, scented sticks, fragrances for interiors and rooms, posters and printed art and other interior items, lifestyle products and artifacts; the aforementioned services also in the context of franchising for the operation of retail and wholesale companies in the areas of lighting, furniture, household or kitchen utensils and containers, glass, ceramic, porcelain and earthenware, linen, bed clothes and blankets, curtains, wall decorations, objects of art, carpets, cutlery, scented sticks, fragrances for interiors and rooms, posters and printed art and other interior items, lifestyle products and artifacts; sales promotion; shop window dressing; organizing events, exhibitions and exchanges for commercial and/or publicity purposes; information and advice on the aforesaid services; all of the aforementioned services whether or not be provided by electronic means, including the Internet.

(260) AM 2022 114556 A

(800) 1611697

(151) 2021 06 23

(891) 2021 06 23

(731) QINGDAO UNI-POWER TYRE CO., LTD  
Room 209-031(A), 2nd Floor, Beijing Road  
No.43, Qianwan Free Trade Port, Qingdao  
Area, China (Shandong) Pilot Free Trade Zone,  
Qingdao City, 266000 Shandong, China

(540)

**ATLANDER**

(591) Black, white

(531) 26.11.02; 26.11.09; 27.05.01; 29.01.12

(511)

12 – Inner tubes for pneumatic tyres; spikes for tires; tyres for vehicle wheels; casings for pneumatic tyres; patches for repairing inner tubes; solid tyres for vehicle wheels; pneumatic tyres; adhesive rubber patches for repairing inner tubes; automobile tyres; inner tubes for bicycle tyres.

(260) AM 2022 114557 A

(800) 1611785

(151) 2021 07 01

(891) 2021 07 01

(731) AFTERSHOKZ, LLC

1801 Burnet Avenue, Suite 102, Syracuse  
NY 13206, USA

(540)

**OPENZ**

(591) Black, white

(511)

9 – Batteries; battery chargers; chargers for batteries; earphones; electronic memory devices; headphones; horns for loudspeakers; lithium ion batteries; megaphones; memory expansion modules; microphones; smartglasses; spectacles; virtual reality headsets; wireless speakers; mp3 players; bone conduction earphones.

(260) AM 2022 114558 A

(800) 1611790

(151) 2021 07 01

(891) 2021 07 01

(731) AFTERSHOKZ, LLC

1801 Burnet Avenue, Suite 102, Syracuse  
NY 13206, USA

(540)

**openspeed**

(591) Black, white

(511)

9 – Batteries; battery chargers; chargers for batteries; earphones; electronic memory devices; headphones; horns for loudspeakers; lithium ion batteries; megaphones; memory expansion modules; microphones; smartglasses; spectacles; virtual reality headsets; wireless speakers; mp3 players; bone conduction earphones.

(260) AM 2022 114559 A  
 (800) 1611802  
 (151) 2021 05 07  
 (891) 2021 05 07  
 (731) Tom Tailor GmbH

Garsteder Weg 14, 22453 Hamburg, Germany

(540)



(591) Black, white

(531) 24.01.15; 27.05.01; 27.05.17; 27.05.21;  
 27.05.24

(511)

18 – Briefcases, briefcases [leather goods]; pocket wallets; attache cases; boxes of leather or leatherboard; net bags for shopping; shopping bags; collars for animals; skins; purses; handbags; suitcases; handbag frames; skins; hat boxes of leather; card wallet; boxes made of leather or leatherboard; chain mesh purses; child carrier bags; garment bags for travel; vanity cases, not fitted; credit card cases; leathercloth; imitation leather; leather leashes; leatherboard; leather straps; leather strips; music cases; travelling trunks; rucksacks; bags for climbers; boxes of leather or leather board; umbrella covers; key cases; school backpacks; school bags; shoulder strap; walking stick seats; bags for sports; parasols; walking sticks; bags with wheels; kit bags; satchel; tool bags made of leather, empty; bags [envelopes, pouches] of leather, for packaging; umbrellas; traveling sets; travelling bags; leather, partly raw or worked; leather cord.

25 – Suits; evening gowns; armpit shirts; workwear; ball gowns; bikinis; brassieres; bathing trunks; clothing; bathing suits; berets; boxer shorts; bath robes; camisoles; women's blouses; dresses; mittens; leisure wear; waist belts [clothing]; clothing; clothing for gymnastics; galoshes; gaiters; jeans; jackets [clothing]; gloves; scarves; shirts; trousers; shirt blouses; half-boots; ankle boots; slippers; braces for clothing [suspenders]; girdles; hot pants; hats; headwear; corsets; neckties; hoods [clothing]; carnival costumes; Mardi Gras costumes; children's clothing; knee-high stockings; underwear; bibs, not of paper; dressing gowns; coats; caps being headwear; cap peaks; nightgowns; raincoats; footwear; socks; shawls; scarves; veil; head veil; breast veil; sweaters; underpants; polo shirts; parkas; pelerines; peep toe sandals; sweaters; slippers; combinations [clothing]; outdoor clothing; skirts; stockings; pyjamas; sports shoes; loafers; aprons; shoes; lace boots; boots; boot uppers; sandals; garters; tuxedos; spaghetti strap tops; ski clothing; ski boots; clothing for sports; tights; knitwear; slipper; tee-shirts; togas; jerseys; jersey clothing; tracksuits;

theatrical costumes; uniforms; underwear; underwear; underpants; overcoat; waistcoats; lingerie; calf stockings; thong sandals.

(260) AM 2022 114570 A

(800) 1612075

(151) 2021 06 18

(891) 2021 06 18

(731) Zhejiang Wuyi Haoyu Bailian Industry and Trade Co., Ltd.

(Autonomous declare), (Zhejiang Wuyi Haoyu Bailian, Industry and Trade Co., Ltd. Inside), Tongqin Hardware Machinery Industrial Park, Wuyi County, 321000 Jinhua City, China

(540)

STOHF

(591) Black, white

(531) 27.05.01

(511)

7 – Agricultural machines; electric hammers; transmission chains, other than for land vehicles; hand-held tools, other than hand-operated; lawnmowers [machines]; saws [machines]; saw blades [parts of machines]; chain saws; woodworking machines.

(260) AM 2022 114571 A

(800) 1612115

(151) 2021 06 28

(891) 2021 06 28

(731) Junhua WANG

No. 91, Building 23, No. 128 Yard, Changjiang Middle Road, Erqi District, Zhengzhou, Henan, China

(540)

BUBU

(591) Black, white

(531) 27.05.01

(511)

5 – Babies' diapers; babies' diaper-pants; preparations to facilitate teething.

(260) AM 2022 114572 A

(800) 1612123

(151) 2021 06 28

(891) 2021 06 28

(731) SIMONELLI GROUP S.P.A.

Via Emilio Betti 1, I-62020 BELFORTE DEL CHIANTI (MC), Italy

(540)

**Mythos**

(591) Black, white

(531) 26.05.01; 26.05.18; 26.05.24; 27.05.01;  
27.05.10; 27.05.24

(511)

7 – Coffee grinders, electric; power-operated coffee grinders; electrical appliances used in kitchen for milling; pepper mills other than hand-operated; electric spice grinders; food processors, electric; electric kitchen appliances for chopping, mixing, pressing; kitchen machines, electric; electric kitchen tools; electric coffee frothers; electric milk frothers; beverage making machines; electric mixers for household purposes; food preparation machines, electromechanical; food whisks (electric -); electric food blenders; grinders, electric; vending machines.

(260) AM 2022 114645 A

(800) 1613698

(151) 2021 06 02

(891) 2021 06 02

(731) ROLEX SA

Rue François-Dussaud 3-5-7, CH-1211  
Genève 26, Switzerland

(540)

**MICROSTELLA**

(591) Black, white

(511)

6 – Nuts of metal.

8 – Hand-operated hand tools and implements; nut wrench.

14 – Components of timepieces and accessories for timepieces not included in other classes.

(260) AM 2022 114668 A

(800) 1608043

(151) 2021 05 27

(891) 2021 08 10

(731) SANOFI

54 rue La Boétie, F-75008 Paris, France

(540)

**KORJAYA**

(591) Black, white

(511)

5 – Pharmaceutical product.

(260) AM 2022 114669 A

(800) 1608226

(151) 2021 05 27

(891) 2021 08 10

(731) SANOFI

54 rue La Boétie, F-75008 Paris, France

(540)

**AMZEZMA**

(591) Black, white

(511)

5 – Pharmaceutical product.

(260) AM 2022 114701 A

(800) 1614225

(151) 2021 04 06

(891) 2021 04 06

(731) LIMITED LIABILITY COMPANY "MAIN SOLUTIONS"

Municipal district, Lefortovo intra-city area,  
the 2nd Sinichkina Street, house 9A, building 4,  
floor 3, premise I, room 4, office B5U,  
RU-111020 Moscow, Russian Federation

(540)

**LEWERT***established 1893*

(591) Black, white, red

(531) 26.04.04; 26.04.05; 26.04.18; 26.04.24;  
27.05.01; 27.05.09; 27.05.10; 27.05.24;  
29.01.13

(526) Established 1893.

(511)

7 – 3D printers; vending machines; welding machines, electric; soldering apparatus, gas-operated; high pressure washers; apparatus for drawing up beer under pressure; apparatus for aerating water; apparatus for aerating beverages; electrical apparatus for sealing plastics [packaging]; electric arc cutting apparatus; electric arc welding apparatus; electric welding apparatus; inking apparatus for printing machines; soldering apparatus, electric; expansion tanks [parts of machines]; drums [parts of machines]; reels, mechanical, for flexible hoses; valves [parts of machines]; fans for motors and engines; bearings [parts of machines]; water heaters being parts of machines; bellows [parts of machines]; agitators; lawnmowers [machines]; nail extractors, electric; raking machines; stalk separators [machines]; turf removing ploughs; electric hand drills; crushers for kitchen use, electric; shredders [machines] for industrial use; kitchen grinders, electric; incubators for eggs; tools [parts of machines]; hand-held tools, other than hand-operated; agricultural implements, other than hand-operated; air condensers; ditchers [ploughs]; tin openers, electric; compressors for refrigerators; aerocondensers; diggers [machines];



harvesting machines; coffee grinders, other than hand-operated; cultivators [machines]; soldering lamps; churns; shearing machines for animals; blowing machines; ironing machines; bottle sealing machines; waste disposal units; earth moving machines; butter machines; sausage making machines; grinding machines; bottle washing machines; dishwashers; bottle filling machines; dairy machines; peeling machines; brewing machines; pasta making machines; machines for the production of sugar; weeding machines; sifting machines; cinder sifters [machines]; bread cutting machines; packaging machines; waste compacting machines; machines and apparatus for cleaning, electric; machines and apparatus for carpet shampooing, electric; machines and apparatus for polishing [electric]; kitchen machines, electric; rinsing machines; flour mill machines; grating machines for vegetables; wringing machines for laundry; cutting machines; steam engines; tilling machines for agricultural purposes; cutters [machines]; agricultural machines; mixing machines; washing machines [laundry]; coin-operated washing machines; clippers [machines]; spin dryers [not heated]; packing machines; filtering machines; mills [machines]; mills for household purposes, other than hand-operated; pepper mills, other than hand-operated; mixers [machines]; blenders, electric, for household purposes; vacuum cleaner bags; threshing machines; motorized cultivators; meat choppers [machines]; suction nozzles for vacuum cleaners; vacuum cleaner attachments for disseminating perfumes and disinfectants; beer pumps; lubricating pumps; knives for mowing machines; chaff cutter blades; knives, electric; scissors, electric; vegetable spiralizers, electric; pulverisers [machines]; soldering irons, gas-operated; soldering irons, electric; saws [machines]; chain saws; ploughs; wine presses; basket presses; fruit presses, electric, for household purposes; fodder presses; cleaning appliances utilizing steam; food processors, electric; vacuum cleaners; cutting blow pipes, gas-operated; robots [machines]; 3D printing pens; snow ploughs; juice extractors, electric; straw [chaff] cutters; machines for the mineralization of drinking water; air suction machines; washing apparatus; beverage preparation machines, electromechanical; food preparation machines, electromechanical; shoe polishers, electric; vacuum cleaner hoses; screwdrivers, electric; brushes for vacuum cleaners; parquet wax-polishers, electric.

9 – 3D spectacles; DVD players; answering machines; electrical adapters; batteries for electronic cigarettes; accumulators, electric; batteries, electric, for vehicles; aerials; remote control apparatus; monitoring apparatus, other than for medical purposes; sound recording apparatus; Global Positioning System [GPS] apparatus; air analysis apparatus; sound transmitting apparatus; electric apparatus for commutation; intercommunication apparatus; projection apparatus; blueprint apparatus; telephone apparatus; facsimile machines; phototelegraphy apparatus; battery jars; anode batteries; galvanic batteries; ignition batteries; solar ba-

ttaries; solar panels for the production of electricity; batteries, electric; balances [steelyards]; binoculars; biochips; connected bracelets [measuring instruments]; scales; baby scales; bathroom scales; scales with body mass analysers; camcorders; video baby monitors; video cassettes; video telephones; video screens; viewfinders, photographic; electric plugs; electric sockets; couplings, electric; hands-free kits for telephones; speakers; joysticks for use with computers, other than for video games; transparencies [photography]; dictating machines; floppy disks; phonograph records; disks, magnetic; optical discs; disk drives for computers; juke boxes for computers; wearable video display monitors; electronic numeric displays; electronic interactive whiteboards; electronic notice boards; audio interfaces; measures; pressure indicators; temperature indicators; measuring instruments; ionization apparatus not for the treatment of air or water; calorimeters; calculating machines; pocket calculators; rearview cameras for vehicles; cinematographic cameras; thermal imaging cameras; electronic pens [visual display units]; video game cartridges; toner cartridges, unfilled, for printers and photocopiers; memory cards for video game machines; encoded magnetic cards; computer keyboards; thin client computers; encoded key cards; electronic book readers; electronic agendas; mouse pads; magnetic encoders; compact discs [audio-video]; compact discs [read-only memory]; computers; laptop computers; tablet computers; notebook computers; wearable computers; lasers, not for medical purposes; flashlights [photography]; mouse [computer peripheral]; megaphones; portable media players; coin-operated mechanisms for television sets; microprocessors; microphones; audio mixers; modems; monitors [computer hardware]; monitors [computer programs]; selfie sticks [hand-held monopods]; headphones; sound recording carriers; magnetic data media; optical data media; computer software, recorded; weighing machines; computer hardware; selfie lenses; egg-candlers; ozonisers [ozonators]; radio pagers; electronic pocket translators; transmitters [telecommunication]; telephone transmitters; computer software platforms, recorded or downloadable; compact disc players; cassette players; protective films adapted for computer screens; protective films adapted for smartphones; sound recording strips; personal digital assistants [PDAs]; measuring glassware; diagnostic apparatus, not for medical purposes; weighing apparatus and instruments; audio- and video-receivers; computer software applications, downloadable; printers for use with computers; computer programs, recorded; computer game software, recorded; computer programs [downloadable software]; computer operating programs, recorded; computer screen saver software, recorded or downloadable; record players; processors [central processing units]; electronic publications, downloadable; distribution consoles [electricity]; control panels [electricity]; baby monitors; masts for wireless aerials;



transmitting sets [telecommunication]; radios; vehicle radios; frames for photographic transparencies; walkie-talkies; respirators for filtering air; security surveillance robots; teaching robots; humanoid robots with artificial intelligence; subwoofers; scanners [data processing equipment]; hand-held electronic dictionaries; integrated circuit cards [smart cards]; smartglasses; smartphones; smartwatches; audiovisual teaching apparatus; charging stations for electric vehicles; radiotelegraphy sets; radiotelephony sets; personal stereos; stereoscopes; stands for photographic apparatus; bags adapted for laptops; egg timers [sandglasses]; television apparatus; telegraphs [apparatus]; telescopes; teleprompters; teleprinters; mobile phones; cell phones; cordless telephones; thermometers, not for medical purposes; transistors [electronic]; telephone receivers; amplifiers; electric installations for the remote control of industrial operations; video recorders; sound reproduction apparatus; invoicing machines; tape recorders; data processing apparatus; battery chargers; chargers for electric accumulators; chargers for electronic cigarettes; wearable activity trackers; computer peripheral devices; photocopiers [photographic, electrostatic, thermic]; bar code readers; downloadable ring tones for mobile phones; downloadable image files; downloadable music files; USB flash drives; cameras [photography]; digital photo frames; enlarging apparatus [photography]; cases for smartphones; cases especially made for photographic apparatus and instruments; spectacle chains; time clocks [time recording devices]; sleeves for laptops; covers for personal digital assistants [PDAs]; covers for tablet computers; covers for smartphones; pedometers; virtual reality headsets; cell phone straps; spectacle cords; equalizers [audio apparatus]; projection screens; fluorescent screens; downloadable graphics for mobile phones; epidiascopes; ergometers.

11 – Distillation apparatus; desiccating apparatus; disinfectant apparatus; air deodorizing apparatus; ionization apparatus for the treatment of air or water; coffee roasters; beverage cooling apparatus; hand drying apparatus for washrooms; fruit roasters; water purifying apparatus and machines; refrigerating apparatus and machines; drying apparatus and installations; freezers; heating and cooling apparatus for dispensing hot and cold beverages; drying apparatus; boilers, other than parts of machines; spa baths [vessels]; waffle irons, electric; fans [air-conditioning]; fans [parts of air-conditioning installations]; electric fans for personal use; roasting spits; refrigerating display cabinets; heated display cabinets; water heaters; air reheaters; extractor hoods for kitchens; gas cooking ovens for household purposes; gas cooking ovens; cooking stoves; gas burners; hot water bottles; footwarmers, electric or non-electric; bed warmers; pocket warmers; warming pans; roasting apparatus; stills; showers; refrigerating containers; gas lighters; lighters; friction lighters for igniting gas; evaporators; shower cubicles; heating apparatus; cool boxes, electric; refrigerating

chambers; fireplaces, domestic; electrically heated carpets; distillation columns; ventilation hoods; air-conditioning apparatus; air conditioners for vehicles; gas boilers; heating boilers; coffee machines, electric; curling lamps; nail lamps; germicidal lamps for purifying air; ultraviolet ray lamps, not for medical purposes; electric lamps; barbecues; bread baking machines; watering machines for agricultural purposes; ice-cream making machines; pounded rice cake making machines, electric, for household purposes; multicookers; footmuffs, electrically heated; heaters for baths; heaters for heating irons; immersion heaters; brackets for gas burners; socks, electrically heated; refrigerating appliances and installations; bath fittings; blankets, electric, not for medical purposes; fabric steamers; hearths; electric cooktops; food steamers, electric; steam boilers, other than parts of machines; pasteurisers; coffee percolators, electric; stoves [heating apparatus]; bakers' ovens; hot air ovens; kitchen ranges [ovens]; microwave ovens [cooking apparatus]; microwave ovens for industrial purposes; furnaces, other than for laboratory use; heating plates; hot plates; wine cellars, electric; heaters, electric, for feeding bottles; heating cushions, electric, not for medical purposes; tortilla presses, electric; apparatus for dehydrating food waste; fumigation apparatus, not for medical purposes; water filtering apparatus; air purifying apparatus and machines; ice machines and apparatus; cooling appliances and installations; cooking apparatus and installations; lighting apparatus and installations; sanitary apparatus and installations; cooking rings; light-emitting diodes [LED] lighting apparatus; heating apparatus for solid, liquid or gaseous fuels; heating apparatus, electric; hot air apparatus; steam facial apparatus [saunas]; safety accessories for water or gas apparatus and pipes; regulating and safety accessories for gas apparatus; regulating accessories for water or gas apparatus and pipes; regulating and safety accessories for water apparatus; regulating and safety accessories for gas pipes; roasting jacks; plate warmers; electric appliances for making yogurt; rotisseries; searchlights; radiators [heating]; central heating radiators; radiators, electric; sinks; roasters; lamps; floor lamps; ceiling lights; electric pressure cookers; autoclaves, electric, for cooking; gas scrubbers [parts of gas installations]; sterilizers; water sterilizers; air sterilizers; air dryers; laundry dryers, electric; hair dryers; malt roasters; tobacco roasters; bread toasters; humidifiers for central heating radiators; air-conditioning installations; cooling installations for liquids; milk cooling installations; cooling installations for tobacco; water purification installations; purification installations for sewage; steam generating installations; water distribution installations; air filtering installations; ventilation [air-conditioning] installations and apparatus; ventilation [air-conditioning] installations for vehicles; water softening apparatus and installations; cooling installations and machines; heating installations; heaters for vehicles; heating ins-

tallations [water]; air cooling apparatus; cooking utensils, electric; filters for air conditioning; filters for drinking water; chocolate fountains, electric; air fryers; deep fryers, electric; fittings, shaped, for furnaces; bread-making machines; refrigerators; kettles, electric; book sterilization apparatus; refrigerating cabinets; heating elements.

(260) AM 2022 114707 A

(800) 1614489

(151) 2021 06 04

(891) 2021 06 04

(731) CANPACK S.A.

Jasnogórska 1, PL-31-358 Kraków, Poland

(540)



(591) Black

(531) 25.07.17; 27.05.01; 27.05.10; 27.05.14

(511)

6 – Beverage cans of metal; metal cans, sold empty; closures of metal; cap closures of metal; closures of metal for containers; tin cans [empty]; containers made of metal for use in the storage of gases; containers of metal [storage, transport]; metal aerosol containers [empty]; metal aerosol containers sold empty; screw caps of metal; sealing caps of metal; bottle closures of metal; tinfoil; foils of metal for covering; foils of metal for cooking; aluminium; sheet metal; aluminium foil; alloys of metal; aluminium and its alloys; packaging, wrapping and bundling articles, of metal; metallic capsules [containers]; storage containers of metal; cans of metal for alcoholic beverages; metal oil cans [empty]; boxes of common metal; steel for tins.

21 – Soap dispensers; hand soap dispensers; dispensers for liquid soap; dispensers for cosmetics; shower gel dispensers; shampoo dispensers; body cleanser dispensers; bottles; containers for household or kitchen use.

42 – Advisory services relating to industrial engineering; advisory services relating to design engineering; engineering design and consultancy; engineering design; engineering services relating to computer programming; engineering services relating to metal forming systems; engineering consultancy services; computer assisted engineering design services; consultancy services relating to product engineering; engineering consultancy relating to design; consultancy relating to the design of packaging; technical assessments

relating to design; product development for others; product development; professional consultancy relating to industrial design; product research and development; research to develop new products; design and testing of new products; design and development of new products; design and testing for new product development; packaging design for others; designing of packaging and wrapping materials; new product design; design of specialist machinery; design of industrial products; consumer product design; design of ornamental layouts; provision of information relating to industrial design; styling [industrial design]; design sketching of packaging, containers, dinnerware and table utensils; engineering services for the design of machinery; engineering and computer-aided engineering services; advisory services relating to industrial design; design services relating to metal-working presses; design services relating to metal-working tools; industrial and graphic art design; industrial art design; product design and development; computer-aided industrial design.

(260) AM 2022 114717 A

(800) 1615009

(151) 2021 05 20

(891) 2021 05 20

(731) Ivoclar Vivadent AG

Bendererstrasse 2, FL-9494 Schaan,  
Liechtenstein

(540)

## Ivoclar

(591) Black, white

(511)

3 – Dentifrices; bleaching preparations for dental use; dental materials for the bleaching of teeth; materials for polishing teeth.

5 – Materials for use in dentistry; materials and auxiliary materials for the manufacture of dental impressions, models, crowns, bridges, inlays, prostheses, artificial teeth; materials for the characterization of teeth; dental waxes; dental filling materials; materials for relining teeth; materials for root canal filling; core build-up materials for use in dentistry; dental luting materials; materials for pulp protection and root treatment, materials for cavity treatment; materials for dentin wound and pulp treatment; materials used for acid etching and for the caries prophylaxis, dental adhesive agents; protective varnishes for teeth; drying and degreasing materials for the use in dentistry; materials for cosmetic restoration of damaged teeth; diagnostic substances for medical use; dental composites; dental cements; salivary diagnostic preparation; preparations and substances for medical use; disinfectants; preparations for the hygiene of teeth and oral cavity for medical purposes; medical mouthwash; dental materials for the treatment of caries and periodontitis; color stains for use in dentistry; dental alloys;

precious metal alloys and non-precious metal alloys for dental use; precious metals and non-precious metals for dental use; investment materials for dental use; dental adhesives; materials for repairing damaged teeth; opaque materials for dental use; metal primers for dental purposes; fiber-reinforced synthetic materials for the manufacture of crowns, bridges and pontics; fissure sealants for dental use; mixing capsules for dental materials; materials for the detection of plaque; dental ceramic layering; healthcare preparations; preparations for health care; veneers; ingots made of resin, metal or ceramic for the manufacture of dental crowns, bridges, inlays, prostheses, artificial teeth.

7 – 3D printers for dental use and parts thereof; accessories for 3D printers for dental use included in this class; 3D printers for dental use and parts thereof; accessories for 3D printers for dental use, included in this class.

9 – Software for dental use; scanners; apparatus for the processing of images and devices for CAD-CAM-processing.

10 – Apparatus, devices, tools and instruments for dental use; impression devices for dental use; registration devices for dental use; articulators for dental use; mixing devices for dental use; blasting devices for dental use; dosing instruments and apparatus for dental use; milling, grinding and drilling instruments for dental use; artificial teeth; dental plates; dental crowns and bridges; syringes; shade guides for dental use; dental matrices; dental strips; apparatus and instruments for the caries prophylaxis and for the treatment of periodontitis; polishing instruments namely tooth polishing appliances for use by dentists; ceramic mixing plates for dental use; tooth pins for medical use; dental applicators; milling machines and grinding machines for dental use for the treatment of ceramics, metal and plastic materials and parts thereof; polymerization apparatus for dental use; ultrasonic cleaning instruments for dental use; prefabricated parts for crowns, bridges and pontics; milling machines and grinding machines for dental use for the treatment of ceramics, metal and plastic materials and parts thereof; milling and grinding tools for dental use as machine tools and parts thereof; holding devices for machine tools and piece holders for milling and grinding machines for dental use.

11 – Dental furnaces.

38 – Providing access to databases.

41 – Organization of seminars, educational courses and trainings relating to dentistry.

42 – Cloud computing services.

(260) AM 2022 114789 A

(800) 1517462

(151) 2019 10 07

(891) 2021 09 10

(731) MSC MEDITERRANEAN SHIPPING  
COMPANY HOLDING SA  
Chemin Rieu 12-14, CH-1208 Genève,  
Switzerland

(540)



(591) Black, white

(531) 26.11.01; 26.11.13; 27.05.08; 27.05.10;  
27.05.15; 27.05.17

(511)

39 – Transport; marine transport; shipbrokerage; transport of merchandise by river, railway, ferryboat, car, truck and ship; freight (transport of merchandise); freight forwarding services; international sea freight shipping services; freight forwarding agency services; freight brokerage; transport brokerage; transport of freight by ship, airplane, train, motor vehicle and truck; transport of passengers by river, railway, ferryboat, car and ship; transport of freight containers by ship; transport of freight containers by rail; transport of freight containers by truck; packaging and storage of merchandise and parcels; packaging of merchandise in transit; storage of merchandise in transit; advisory services relating to the tracking of merchandise in transit (transport information); warehouse storage services; storage of merchandise in warehouses; collection, delivery and storage of personal goods; provision of information with respect to the rental of storage space in warehouses; Handling of loads; freight handling services; loading of freight containers onto ships; loading of freight containers onto trucks; loading of freight containers onto rail vehicles; loading, packing, storage, transport and unloading of freight; loading, packing, storage, transport and unloading of cargo; ship unloading services; harbor crane unloading; boat rental; rental of loading containers; rental of transport and storage containers; rental of containers for the marine transport industry; rental of stationary and mobile storage containers for commercial and domestic users; rental of warehouses; provision of information relating to merchandise transport and storage; provision of information online in the field of merchandise transport, packaging and storage; pleasure boat cruises; provision of cruise ships for travel; arranging of travel, excursions and cruises; travel reservations; provision of transportation advice; advisory services relating to the storage and transport of goods, freight or cargo; tracking and tracing of ship-

ments (transport information); computerized tracking and tracing of packages in transit (information relating to transport); tracking of freight vehicles by computer or via global positioning systems (transport information); logistics services relating to transport; logistics services consisting in merchandise transport, packaging and storage services; supply chain logistics and reverse logistics services comprising storage, transport and delivery of goods for third parties by plane, railway, ship or truck; transport and storage services relating to storage logistics, distribution logistics and returns logistics.

(260) AM 2022 114790 A

(800) 1541824

(151) 2020 06 03

(891) 2021 09 09

(731) F. Hoffmann-La Roche AG

Grenzacherstrasse 124, CH-4070 Basel,  
Switzerland

(540)

**LITUMBIA**

(591) Black, white

(511)

5 – Pharmaceutical preparations.

(260) AM 2022 114791 A

(800) 1543715

(151) 2020 02 18

(891) 2021 06 28

(731) ERKAYA TEKSTİL İTHALAT İHRACAT  
DIŞ TİCARET LİMİTED ŞİRKETİ

Kemalpaşa Mahallesi Çukur Çeşme, Sokak  
No: 30 Fatih, İstanbul, Turkey

(540)



GIOTELLI

(591) Black, white

(531) 26.13.25; 27.05.09; 27.05.22

(511)

25 – Clothing, including underwear and outer clothing, other than special purpose protective clothing; socks, mufflers [clothing], shawls, bandanas, scarves, belts [clothing]; footwear, shoes, slippers, sandals; headgear, hats, caps with visors, berets, caps [headwear], skull caps.

35 – Advertising, marketing and public relations; organization of exhibitions and trade fairs for commer-

cial or advertising purposes; office functions; secretarial services; arranging newspaper subscriptions for others; compilation of statistics; rental of office machines; systemization of information into computer databases; telephone answering for unavailable subscribers; business management, business administration and business consultancy; accounting; commercial consultancy services; personnel recruitment, personnel placement, employment agencies, import-export agencies; temporary personnel placement services; business appraisals; auctioneering; the bringing together, for the benefit of others, of a variety of goods, namely, bleaching and cleaning preparations, perfumery, cosmetics, fragrances, deodorants for personal use and animals, soaps, dental care preparations, abrasive preparations, emery cloth, sandpaper, pumice stone, abrasive pastes, polishing preparations for leather, vinyl, metal, wood, eyeglasses, sunglasses, optical lenses and cases, containers, parts and components thereof, jewellery, imitation jewellery, gold, precious stones and jewellery made thereof, cufflinks, tie pins, statuettes and figurines of precious metal, clocks, watches and chronometrical instruments, chronometers and their parts, watch straps, goods made of leather, imitations of leather or other materials, designed for carrying items, bags, boxes and trunks made of leather or stout leather, key cases, clothing, including underwear and outer clothing, other than special purpose protective clothing, socks, footwear, headgear, enabling customers to conveniently view and purchase those goods, such services may be provided by retail stores, wholesale outlets, by means of electronic media or through mail order catalogues.

(260) AM 2022 114792 A

(800) 1583854

(151) 2020 10 28

(891) 2021 03 31

(731) ADELBEL S.R.L.

Via Lecce, Zona Industriale Km 2 S.N.,  
I-73048 Nardò (LE), Italy

(540)



ETEROTICA

(591) Black, white

(531) 26.13.25; 27.05.01

(511)

24 – Fabrics and textile material for textile use and for the production of clothing, underwear, underclothes and lingerie, bags and footwear; household textiles and household textile goods and linens including kitchen linen and table linens, bath linen, bed linen, beach towels and sheets; fabrics for furnishing and interior decoration including curtains and drapes, wall

fabrics and wallpaper, pillow shams, covers and loose covers for furniture.

25 – Articles of underwear, underclothes and lingerie for women, men and children including slips (underclothing), underpants, boxer shorts and slips (underclothing), bras, tops (clothing), tank tops and vest tops, undershirts, T-shirts, bodies (clothing), baby doll pajamas, chemises, dressing gowns, nightgowns, overalls, pyjamas, combinations [clothing], unitards, leggings [leg warmers], bustiers, waist cinchers, girdles, garters, stocking suspenders, tights, stockings, socks, slipper socks, shapewear, disposable underwear, thermal underwear, sweat-absorbent underwear, nightwear, maternity underwear and lingerie, babies' undergarments, babies' pants [underwear]; clothing for men, women and children including undershirts, T-shirts, polo shirts, blouses, shirts, jerseys (clothing) and sweaters, pullovers, cardigans, sweatshirts, gilets, hosiery, shorts, bermudas, jeans, leggings, skirts, men's suits, ceremonial dresses for women, tailleurs, coats, raincoats, jackets [clothing], wind-resistant jackets, down jackets, blousons, trench coats, parkas, overcoat mantles, outerwear, clothing for sports, tracksuits, combinations [clothing], jumper suit, one-piece coveralls, bathing suits, beach clothes, sundresses, bath robes, bathing caps, neckties, ascots, bow ties, braces for clothing [suspenders], neckerchiefs, scarfs, shawls, stoles, shoulder wraps [clothing], gloves [clothing], fingerless gloves (clothing), muffs [clothing], waistbands [parts of clothing], leather belts [clothing], textile belts [clothing]; footwear for men, women and children including shoes, gymnastic shoes, boots, half-boots, mountaineering boots, sandals, flip-flops, clogs, espadrilles, slippers, mules, shoe covers (not for medical purposes), soles for footwear, shoe uppers; headwear for men, women and children including hats, caps, berets, headwear, visors and bandanas.

26 – Accessories for clothing, underwear, underclothes, headwear and footwear, sewing articles and decorative textile articles including brooches [clothing accessories], ornamental novelty badges [buttons], top-knots [pompoms], sequins, spangles for decoration, not of precious metal, feathers [clothing accessories], arrangements of artificial flowers, intertwined cords for clothing, bracelets and expanding bands for holding sleeves [clothing accessories], shoulder pads for clothing, skirt flounces, hat decorations; accessories for clothing, underwear, underclothes, lingerie, headwear and footwear, sewing articles and decorative textile articles including ornaments for shoes [not of precious metal], shoe laces, buttons, clasps, belt clasps, clasps for clothing, metal fasteners for footwear, buckles [clothing accessories], buckles for belts, shoe fasteners, zip fasteners, fastenings for clothing, fastenings for suspenders, snap rings [fasteners], scarf clips not being jewellery; accessories for clothing, underwear, underclothes, lingerie, headwear and footwe-

ar, sewing articles and decorative textile articles including appliques [haberdashery], artificial blossoms for attachment to clothing, bindings for hemming clothing, lace, tapes, reinforcing tapes for clothing, beads for trimming, embroidery lace, embroidery for garments, ornamental cloth patches, decorative articles for the hair including hair elastics, hair bands, hair barrettes, hair weaves, charms (other than for jewellery, key rings or key chains) including decorative charms for eyewear, decorative charms for mobile telephones.

35 – Wholesale and retail store services for the benefit of others, also by mail order catalogues and by means of electronic media including the Internet in relation to templates and patterns for dressmaking and for making clothes, underwear, underclothes and lingerie including templates and patterns for marking and for embroidery, templates and patterns for design, templates and printed templates for suits, models and dressmaking stencils for designing, three dimensional templates for educational purposes, fabrics and textile material for textile use and for the production of clothing, underwear, underclothes and lingerie, bags and, footwear, household textiles and household textile goods and linens including kitchen linen and table linens, bath linen, bed linen, beach towels and sheets, fabrics for furnishing and interior decoration including curtains and drapes, wall fabrics and wallpaper, pillow shams, covers and loose covers for furniture, articles of underwear, underclothes and lingerie for women, men and children including slips (underclothing), underpants, boxer shorts and slips (underclothing), bras, tops (clothing), tank tops and vest tops, undershirts, T-shirts, bodies (clothing), baby doll pajamas, chemises, dressing gowns, nightgowns; wholesale and retail store services for the benefit of others, also by mail order catalogues and by means of electronic media including the Internet in relation to overalls, pyjamas, combinations [clothing], unitards, leggings [leg warmers], bustiers, waist cinchers, girdles, garters, stocking suspenders, tights, stockings, socks, slipper socks, shapewear, disposable underwear, thermal underwear, sweat-absorbent underwear, nightwear, maternity underwear and lingerie, babies' undergarments, babies' pants [underwear], clothing for men, women and children including undershirts, T-shirts, polo shirts, blouses, shirts, jerseys (clothing) and sweaters, pullovers, cardigans, sweatshirts, gilets, hosiery, shorts, bermudas, jeans, leggings, skirts, men's suits, ceremonial dresses for women, tailleurs, coats, raincoats, jackets [clothing], wind-resistant jackets, down jackets, blousons, trench coats, parkas, overcoat mantles, outerwear, clothing for sports, tracksuits, combinations [clothing], jumper suit, one-piece coveralls, bathing suits, beach clothes, sundresses, bath robes, bathing caps, neckties, ascots, bow ties, braces for clothing [suspenders], neckerchiefs, scarfs, shawls, stoles, shoulder wraps [clothing], gloves [clothing], fingerless gloves (clothing), muffs [clothing], waist-

bands [parts of clothing], leather belts [clothing], textile belts [clothing], footwear for men, women and children including shoes, gymnastic shoes, boots, half-boots, mountaineering boots, sandals, flip-flops, clogs, espadrilles, slippers, mules, shoe covers (not for medical purposes), soles for footwear, shoe uppers, headwear for men, women and children including hats, caps, berets, headwear, visors and bandanas, accessories for clothing, underwear, underclothes, headwear and footwear; wholesale and retail store services for the benefit of others, also by mail order catalogues and by means of electronic media including the Internet in relation to sewing articles and decorative textile articles including brooches [clothing accessories], ornamental novelty badges [buttons], top-knots [pompoms], sequins, spangles for decoration, not of precious metal, feathers [clothing accessories], arrangements of artificial flowers, intertwined cords for clothing, bracelets and expanding bands for holding sleeves [clothing accessories], shoulder pads for clothing, skirt flounces, hat decorations, accessories for clothing, underwear, underclothes, lingerie, headwear and footwear, sewing articles and decorative textile articles including ornaments for shoes [not of precious metal], shoe laces, buttons, clasps, belt clasps, clasps for clothing, metal fasteners for footwear, buckles [clothing accessories], buckles for belts, shoe fasteners, zip fasteners, fastenings for clothing, fastenings for suspenders, snap rings [fasteners], scarf clips not being jewellery, accessories for clothing, underwear, underclothes, lingerie, headwear and footwear, sewing articles and decorative textile articles including appliques [haberdashery], artificial blossoms for attachment to clothing, bindings for hemming clothing, lace, tapes, reinforcing tapes for clothing, beads for trimming, embroidery lace, embroidery for garments, ornamental cloth patches, decorative articles for the hair including hair elastics, hair bands, hair barrettes, hair weaves, charms (other than for jewellery, key rings or key chains) including decorative charms for eyewear, decorative charms for mobile telephones; business advisory services relating to franchising namely business management assistance in the establishment and running of franchised outlets relating to clothing, underwear, underclothes, lingerie, footwear and headwear; business advice and information services relating to organization and business management of franchised outlets and related advertising and promotion in relation to clothing, underwear, underclothes, lingerie, headwear and footwear; sales promotion services; sales promotion services in relation to clothing, underwear, underclothes, lingerie, headwear and footwear; presentation of goods on communication media, for retail purposes; presentation of goods on communication media, for retail purposes in relation to clothing, underwear, underclothes, lingerie, headwear and footwear; arranging of commercial exhibitions, arranging and organizing of trade fairs for commercial and advertising purposes; import-export

agency services; procurement services for others [purchasing goods and services for other businesses]; procurement services for others [purchasing goods and services for other businesses] in relation to clothing, underwear, underclothes, lingerie, headwear and footwear; provision of an online marketplace for buyers and sellers of goods and services in relation to advertising, marketing and promotion services; advertising, marketing and promotion services; advertising, marketing and promotion services in relation to clothing, underwear, underclothes, lingerie, headwear and footwear; marketing services; marketing services in relation to clothing, underwear, underclothes, lingerie, headwear and footwear; sponsorship search, market surveys; rental of sales stands; providing commercial information and advice for consumers in the choice of products and services; providing commercial information and advice for consumers in the choice of products and services in relation to clothing, underwear, underclothes, lingerie, headwear and footwear; business information; business information services in relation to clothing, underwear, underclothes, lingerie, headwear and footwear; commercial intermediation services, administrative services for the relocation of businesses; commercial administration of the licensing of the goods and services of others; commercial administration of the licensing of the goods and services of others in relation to clothing, underwear, underclothes, lingerie, headwear and footwear; organization of fashion shows for commercial purposes, organization of fashion shows for promotional purposes.

40 – Tailoring or dressmaking of clothing, underwear, underclothes and lingerie; tailoring [custom manufacture]; clothing, underwear, underclothes and lingerie alteration [custom manufacture].

41 – Education and training services relating to fashion and design; education and training services for dressmaking; organisation of training courses, teaching activities, workshops, seminars and conventions relating to fashion and design; organisation of fashion shows, fashion and design events and competitions; organizing and presenting displays of entertainment relating to style and fashion.

42 – Dress designing including the design of clothing, underwear, underclothes and lingerie, footwear and headwear, textile design, design of templates, design of fashion accessories; fashion design consulting services; providing information about fashion design services; dress designing; research and industrial and technological development regarding materials, printing, sewing and washing techniques in the clothing sector.

(260) AM 2022 114793 A

(800) 1592442

(151) 2021 03 29

(891) 2021 09 09

(731) Shperov Pavel

103 Carson Dr Ste 913781 Bear, DE19701,  
Bear DE 19701, USA

(540)

**SOAK**

(591) Black, white

(531) 27.05.01

(511)

34 – Electronic cigarettes.

(260) AM 2022 114819 A

(800) 1616279

(151) 2021 04 21

(891) 2021 04 21

(731) "Unilactis" Limited Liability Partnership

482 Zhansugurov Street, 050014 Zhetysu  
district, Almaty city, Kazakhstan

(540)



(591) Blue, white and red

(531) 01.15.15; 25.05.02; 26.04.06; 26.04.07;

26.04.18; 26.04.24; 27.05.02; 27.05.17;

27.05.19; 27.05.24; 29.01.13

(526) ®

(511)

29 – Meat, fish, poultry and game; meat extracts; preserved, frozen, dried and cooked fruits and vegetables; jellies, jams, compotes; eggs, milk and milk products, oils and fats for food.

30 – Coffee; tea; cocoa; sugar; rice; tapioca; sago; artificial coffee; flour and preparations made from cereals; bread, pastries and confectionery; ice cream; honey; treacle; yeast; baking-powder; salt; mustard; vinegar; sauces [condiments]; spices; edible ices.

35 – Import-export agency services; commercial or industrial management assistance; organization of exhibitions for commercial and advertising purposes; advertising; production of advertising materials; retail and wholesale services through intermediaries; retail and wholesale services.

42 – Packaging design.

43 – Buffet services; snack-bar services; café services; cafeteria services; food services.

(260) AM 2022 114820 A

(800) 1616303

(151) 2021 07 27

(891) 2021 07 27

(731) Japan Tobacco Inc.

1-1, Toranomom 4-chome, Minato-ku,  
Tokyo, Japan

(540)



(591) Gray, blue, yellow and orange

(531) 03.02.13; 05.01.12; 07.05.01; 24.15.01;

27.01.01; 27.05.02; 29.01.14

(511)

34 – Tobacco, raw or manufactured; smoking tobacco, pipe tobacco, rolling tobacco, chewing tobacco, snus; cigarettes, electronic cigarettes, cigars, cigarettos; snuff; smokers' articles included in this class; cigarette paper, cigarette tubes and matches.

(260) AM 2022 114821 A

(800) 1616305

(151) 2021 07 27

(891) 2021 07 27

(731) Japan Tobacco Inc.

1-1, Toranomom 4-chome, Minato-ku,  
Tokyo, Japan

(540)



(591) Gray, yellow and orange

(531) 03.02.13; 05.01.12; 07.05.01; 24.15.01;

27.01.01; 27.05.02; 29.01.13

(511)

34 – Tobacco, raw or manufactured; smoking tobacco, pipe tobacco, rolling tobacco, chewing tobacco, snus; cigarettes, electronic cigarettes, cigars, cigari-

llos; snuff; smokers' articles included in this class; cigarette paper, cigarette tubes and matches.

(260) AM 2022 114834 A

(800) 1616766

(151) 2021 05 03

(891) 2021 05 03

(731) Harry Winston SA

Chemin du Tourbillon 8, CH-1228 Plan-les-Ouates, Switzerland

(540)

## JEWELS THAT TELL TIME

(591) Black, white

(511)

14 – Precious metals and their alloys and goods made of these materials or coated therewith included in this class, namely figurines, trophies; jewelry, namely rings, earrings, cuff links, charms, brooches, chains, necklaces, tie pins, tie clips, jewelry caskets (cases), cases; precious stones, semi-precious stones (gemstones).

(260) AM 2022 114835 A

(800) 1616816

(151) 2021 05 17

(891) 2021 05 17

(731) Egis Gyógyszergyár Zrt.

Keresztúri út 30-38., H-1106 Budapest, Hungary

(540)

## PROSOLUTE

(591) Black, white

(511)

3 – Cosmetics and cosmetic preparations.

5 – Human pharmaceutical preparations; dietetic substances adapted for medical use; dietary supplements; medicinal ointments; medicated skin creams; plasters, materials for dressings.

(260) AM 2022 114837 A

(800) 1616848

(151) 2021 07 06

(891) 2021 07 06

(731) Beats Electronics, LLC

8600 Hayden Place, Culver City CA 90232, USA

(540)

## Beats Studio Buds

(591) Black, white

(526) buds

(511)

9 – Earphones; electric charging cables for use with headphones and earphones; carrying case for earphones; protective case for earphones.

(260) AM 2022 114838 A

(800) 1616853

(151) 2021 06 17

(891) 2021 06 17

(731) Limited Liability Company "Scientific and production enterprise Rogneda"

Dorozhnaya str., 4B, Staraya Kupavna, the city of Noginsk, RU-142450 Moscow region, Russian Federation

(540)

## АНТИЖУК

(591) Black, white

(531) 28.05

(511)

1 – Antistatic preparations, other than for household purposes; size for finishing and priming; gurjun balsam for use in the manufacture of varnish; agglutinants for concrete; preparations for the separation of greases; tanning substances; gums [adhesives] for industrial purposes; concrete-aeration chemicals; chemicals for the manufacture of paints; starch-liquifying chemicals [ungluing agents]; flower preservatives; seed preserving substances; hydrates; ceramic glazings; detergents for use in manufacturing processes; defoliants; chemical additives for oils; grafting wax for trees; tree cavity fillers [forestry]; glaziers' putty; casein for industrial purposes; adhesives for billposting; leather glues; adhesives for wall tiles; adhesives for paperhanging; cement for mending broken articles; gluten [glue], other than for stationery or household purposes; adhesives for industrial purposes; flocculants; starch paste [adhesive], other than for stationery or household purposes; grafting mastic for trees; mastic for leather; mastic for tyres; oil cement [putty]; synthetic materials for absorbing oil; filtering materials of vegetable substances; filtering materials of chemical substances; rubber preservatives; brickwork preservatives, except paints and oils; cement preservatives, except paints and oils; preservatives for tiles, except paints and oils; bacterial preparations for industrial use; opacifiers for enamel or glass; separating and unsticking [ungluing] preparations; cement-waterproofing chemicals, except paints; wallpaper removing preparations; decolorants for industrial purposes; chemical substances for analyses in laboratories, other than for medical or veterinary purposes; chemical preparations for scientific purposes; solvents for varnishes; soot for industrial or agricultural purposes; synthetic resins, unprocessed; fire extinguishing compositions; glutinous tree-grafting preparations; fireproofing preparations; cement for footwear;



concrete preservatives, except paints and oils; water glass [soluble glass]; activated carbon; chemicals for use in forestry, except fungicides, herbicides, insecticides and parasiticides; enamel-staining chemicals; glass-staining chemicals; water-purifying chemicals; oil-purifying chemicals; anti-tarnishing chemicals for windows; horticultural chemicals, except fungicides, herbicides, insecticides and parasiticides; agricultural chemicals, except fungicides, herbicides, insecticides and parasiticides; chimney cleaners, chemical; colour-brightening chemicals for industrial purposes; emulsifiers; cellulose ether derivatives.

2 – Whites [colorants or paints]; primers; fixatives for dyestuffs; alizarine dyes; aniline dyes; ink for leather; shoe dyes; asbestos paints; distempers; fireproof paints; enamels for painting; bactericidal paints; anti-fouling paints; ceramic paints; printing ink; lacquers; anti-rust oils; lime wash; thickeners for paints; coatings for roofing felt [paints]; undercoating for vehicle chassis; varnishes; agglutinants for paints; anti-corrosive preparations; protective preparations for metals; stains for leather; thinners for paints; thinners for lacquers; whitewash; siccatives [drying agents] for paints; badigeon; anti-tarnishing preparations for metals; anti-rust preparations; blacks [colorants or paints].

(260) AM 2022 114881 A  
(800) 1114705  
(151) 2012 03 28  
(891) 2021 08 26  
(731) Public Joint Stock Company Acron  
"Acron", RU-173012 Veliky Novgorod,  
Russian Federation  
(540)



(591) Dark -green (Pantone 329C): bright red  
(Pantone 192C).  
(531) 26.01.06; 27.05.08; 29.01.12  
(511)

1 – Chemicals used in science and photography, as well as in agriculture, horticulture and forestry, but none of the aforesaid to be used in relation to seed treatment; unprocessed artificial resins, unprocessed plastics; fire extinguishing compositions; tempering and soldering preparations; chemical substances for preserving foodstuffs; tanning substances.

(260) AM 2022 114894 A  
(800) 1526407  
(151) 2020 02 26  
(891) 2021 08 23  
(731) A&D Company, Limited  
23-14, Higashi Ikebukuro 3-chome,  
Toshima-ku, Tokyo 170-0013, Japan  
(540)



(591) Black, white  
(531) 27.05.01; 27.05.10; 27.05.17; 27.05.22  
(511)  
10 – Sphygmomanometers; clinical thermometers; inhalers; body fat monitors; medical apparatus and instruments.

(260) AM 2022 114895 A  
(800) 1537794  
(151) 2020 05 20  
(891) 2021 09 10  
(731) F. Hoffmann-La Roche AG  
Grenzacherstrasse 124, CH-4070 Basel,  
Switzerland  
(540)

**SUNLUMIO**

(591) Black, white  
(511)  
5 – Pharmaceutical preparations.

(260) AM 2022 114896 A  
(800) 1557963  
(151) 2020 07 27  
(891) 2021 08 19  
(731) GARMONIA, Ltd.  
Kamennoostrovsky prospect, 37, litera A,  
pom. 7-N No538, RU-197022 Saint Petersburg,  
Russian Federation  
(540)

**CRYSTAGEN**

(591) Black, white  
(511)  
5 – Amino acids for veterinary purposes; amino acids for medical purposes; dietetic substances adapted for medical use; dietary supplements; nutritional supplements; dietary supplements for animals; medicated sweets; medicated animal feed; dietetic beverages adapted for medical purposes; pastilles for pharmaceutical purposes; dietetic foods adapted for medical purposes; pharmaceuticals.

(260) AM 2022 114897 A

(800) 1563893

(151) 2020 10 06

(891) 2021 08 24

(731) GARMONIA, Ltd.

Kamennooostrovsky prospect, 37, litera A,  
pom. 7-N No538, RU-197022 Saint Petersburg,  
Russian Federation

(540)



(591) Gray and blue

(531) 26.04.05; 26.04.18; 27.05.22; 29.01.12

(511)

3 – Cosmetics.

5 – Nutritional supplements; dietary supplements;  
veterinary preparations; pharmaceutical preparations;  
dietetic foods adapted for medical purposes.

(260) AM 2022 114898 A

(800) 1579828

(151) 2020 11 02

(891) 2021 09 17

(731) ETNIA BARCELONA, S.L.

Enric Morera 42-44, E-08950 ESPLUGUES DE  
LLOBREGAT, Spain

(540)

# ALLPOETS

(591) Black, white

(531) 27.05.17

(511)

9 – Spectacles; spectacle lenses; sunglasses; spectacle  
frames; goggles for sports; spectacle cases.

(260) AM 2022 114899 A

(800) 1613629

(151) 2021 07 28

(891) 2021 09 14

(731) Nathan Stuart Jackson

26 Savannah Corner, Nickol WA 6714,  
Australia

(540)

# MOONPLAYER

(591) Black, white

(511)

25 – Arm warmers (clothing); articles of water-resis-  
tant clothing; articles of waterproof clothing; articles  
of weatherproof clothing; athletic clothing; beach  
clothing; belts (clothing); braces for clothing (suspen-  
ders); casual clothing; children's clothing; clothes;  
clothing; clothing for sports; clothing for swimming;  
clothing incorporating digital components; clothing  
incorporating electronic sensors; clothing incorpora-  
ting leds; clothing, not being protective clothing, in-  
corporating reflective or fluorescent elements or mate-  
rial; denims (clothing); drawers (clothing); ear muffs  
(clothing); embroidered clothing; gloves (clothing);  
headbands (clothing); hoods (clothing); interlinings  
for clothing; jackets (clothing); jerseys (clothing);  
knitwear (clothing); leather belts (clothing); money  
belts (clothing); motorcyclists' clothing (other than for  
protection against accident or injury); motorists' clot-  
hing; muffs (clothing); occupational clothing (other  
than for protection against accident or injury); pants  
(clothing); ready-made clothing; smart clothing (clot-  
hing which incorporates digital components); smart  
clothing with built-in digital components; smart gar-  
ments (clothing which incorporates digital compo-  
nents); sports clothing (other than golf gloves); stuff  
jackets (clothing); thermal clothing; thermally insula-  
ted clothing (not specifically adapted for protection  
against accident or injury); thongs (clothing); water-  
resistant clothing; waterproof clothing; weather resis-  
tant outer clothing; weatherproof clothing (not specifi-  
cally adapted for protection against accident or inju-  
ry); wristbands (clothing); wristlets (clothing); athle-  
tics footwear; casual footwear; footwear; footwear  
parts; footwear uppers; inserts for footwear (other  
than orthopaedic); non-slipping devices for footwear;  
parts of footwear; sporting footwear; sports footwear;  
thongs (footwear); trainers (footwear); headwear; he-  
adwear incorporating electronic sensors; peaked head-  
wear; sun visors (headwear); thermal headwear; visors  
being headwear; apparel (clothing, footwear, headge-  
ar); interlinings for headgear; sports headgear (other  
than helmets); waterproof headgear; underwear;  
swimwear; t-shirts; printed t-shirts; caps being head-  
wear; sports caps; socks.

35 – Hypermarket retailing; management of a retail  
enterprise for others; presentation of goods on com-  
munication media, for retail purposes; retail clothing  
shop services; retail of gift baskets; retail of gift sets;  
retail of hampers; retail of sample packs; retail ser-  
vices; retailing of goods (by any means); wholesaling  
of goods (by any means); administration relating to  
sales methods; rental of sales stands; marketing and  
sales channel management; administration relating to  
marketing; advice relating to marketing management;  
business consultancy services relating to the marke-  
ting of fund raising campaigns; direct marketing; mar-  
ket campaigns; marketing; planning of marketing stra-  
tegies; product marketing; production of sound recor-  
dings for marketing purposes; production of video re-

cordings for marketing purposes; search engine optimisation services (marketing services); targeted marketing; advertising; arranging exhibitions for advertising purposes; demonstration of goods for advertising purposes; development of advertising concepts; direct market advertising; dissemination of advertising material; organising of prize draws for advertising purposes; production of advertising material; production of visual advertising matter; distribution of advertising material; distribution of goods for advertising purposes; distribution of samples; arranging and conducting promotional and marketing events; consultancy relating to sales promotions; discount services (retail, wholesale, or sales promotion services); modelling for advertising or sales promotion; organisation and management of incentive and sales promotion programmes (frequent buyer programmes); production, organisation and presentation of fashion shows for advertising or promotional purposes; promotion (advertising) of business; promotional advertising services; promotional marketing; sales promotion (for others); sales promotion services; sales promotions at point of purchase or sale (for others); sales promotions by issuing redeemable coupons (for others); search engine optimisation for sales promotion; sponsorship (promotion and marketing services); promotion of goods and services through sponsorship of sports events; promotional services; promotional studies; online advertising on a computer network; online retail services; providing information, including online, about advertising, business management and administration and office functions; provision of an online marketplace for buyers and sellers of goods and services; advertising services provided over the internet; compilation of advertisements for use as web pages on the internet; compilation of directories for publishing on the internet; rental of advertising space on the internet; advisory services relating to customer service management; sales promotion through customer loyalty programmes (for others); organisation and management of customer loyalty programmes; organisation, operation and supervision of customer loyalty schemes; sales promotions through customer loyalty programmes (for others); the bringing together, for the benefit of others, a variety of goods (excluding the transport thereof), enabling customers to conveniently view and purchase the goods; bartering services for others to facilitate the trade exchange of goods and services; conducting of trade shows; organisation of trade expositions or shows for commercial or advertising purposes; organising of trade competitions; organising of trade shows; provision of trade information; trade promotional services; intermediary business services relating to the commercialising of goods (wholesaling); intermediary business services relating to the commercialisation of goods.

(260) AM 2022 114928 A

(800) 1618202

(151) 2021 03 02

(891) 2021 03 02

(731) FM World Sp. z o.o.

ul. Zmigrodzka 247, PL-51-129 Wrocław,  
Poland

(540)

UTIQUE



(591) Gold

(531) 25.01.25; 27.05.01; 29.01.02

(511)

3 – Aloe vera preparations for cosmetic purposes; antiperspirants [toiletries]; anti-perspirants in the form of sprays; deodorants and antiperspirants; antiperspirants for personal use; aromatics; aromatic oils; lotions for cosmetic purposes; balms, other than for medical purposes; flower perfumes (bases for -); lip gloss; nail glitter; amber [perfume]; tissues impregnated with cosmetic lotions; tissues impregnated with cosmetics; facial wipes impregnated with cosmetics; moist wipes impregnated with a cosmetic lotion; wipes impregnated with a skin cleanser; tissues impregnated with make-up removing preparations; tissues impregnated with essential oils, for cosmetic use; essential oils of lemon; deodorants for human beings; deodorants for human beings or for animals; air fragrance reed diffusers; extracts of flowers [perfumes]; herbal extracts for cosmetic purposes; sunscreen preparations; hair dye; incense; joss sticks; cosmetics; make-up preparations; natural cosmetics; cosmetics for eyelashes; eyebrow cosmetics; make-up preparations; cosmetics for children; cosmetics for personal use; skincare cosmetics; skin care creams [cosmetic]; cosmetic creams; skin whitening creams; hair spray; nail polish; cosmetic masks; potpourris [fragrances]; mint for perfumery; almond milk for cosmetic purposes; facial cleansing milk; cleansing milk for toilet purposes; soaps; perfumed soaps; perfumed soaps; antiperspirant soap; toilet soap; cosmetic soaps; soaps and gels; liquid bath soaps; soaps for body care; soap for foot perspiration; deodorant soap; shaving soap; almond soap; nail art stickers; hair nourishers; conditioning preparations for the hair; hair conditioners for babies; jasmine oil; lavender oil; gaultheria oil; almond oil; bergamot oil; rose oil; oils for hair conditioning; peppermint oil [perfumery]; cuticle oil; hair fixing oil; oils for cosmetic purposes; oils for perfumes and scents; oils for perfumes and scents; essential

oils; essential oils for personal use; oils for cosmetic purposes; cedarwood (essential oils of -); oils for toilet purposes; cosmetic pencils; breath freshening strips; teeth whitening strips; shoe polish; musk [perfumery]; eye-washes, not for medical purposes; liquid latex body paint for cosmetic purposes; hair lotion; mouthwashes, not for medical purposes; mouthwashes, not for medical purposes; vaginal washes for personal sanitary or deodorant purposes; after-shave preparations; lipstick; pomades for cosmetic purposes; dentures (preparations for cleaning -); make-up removing preparations; eye make-up remover; depilatory preparations; hair removal and shaving preparations; douching preparations for personal sanitary or deodorant purposes [toiletries]; bath preparations; baths (cosmetic preparations for -); bath preparations, not for medical purposes; hair waving preparations; shining preparations [polish]; fumigation preparations [perfumes]; nail care preparations; skin, eye and nail care preparations; refurbishing preparations (terms too vague in the opinion of the International Bureau – Rule 13 (2) (b) of the Common Regulations); denture polishes; hair straightening preparations; sun blocking preparations [cosmetics]; tanning preparations; phyto-cosmetic preparations; collagen preparations for cosmetic purposes; cosmetic preparations for bath and shower; cosmetic preparations for slimming purposes; breath freshening preparations for personal hygiene; astringents for cosmetic purposes; toiletries; perfumed lotions [toilet preparations]; non-medicated cosmetics and toiletry preparations; perfumed body lotions [toilet preparations]; perfumery; perfumery, essential oils; face powder; eyelashes (false -); bath salts, not for medical purposes; shampoo; dry shampoos; body shampoos; shampoos for pets [non-medicated grooming preparations]; baby shampoo; shampoo bars; shampoos for personal use; false nails; artificial nails for cosmetic purposes; cleansers for intimate personal hygiene purposes, non medicated; dentifrices; dentifrices and mouthwashes; air fragrancing preparations; massage candles for cosmetic purposes; talcum powder, for toilet use; mascara; long lash mascaras; petroleum jelly for cosmetic purposes; toilet water; cologne impregnated disposable wipes; lavender water; perfume water; toilet water; floral water; micellar water; javelle water; hydrogen peroxide for cosmetic purposes; moustache wax; cosmetic kits; nail varnish removers; nail varnish remover [cosmetics]; nail polish remover pens; hair gel; shaving gel; make-up removing gels; styling gels; dental bleaching gels; gels for cosmetic use; gels for fixing hair; massage gels, other than for medical purposes; gel eye patches for cosmetic purposes.

4 – Candles for lighting; perfumed candles.

(260) AM 2022 114940 A

(800) 1618700

(151) 2021 05 20

(891) 2021 05 20

(731) TOUCHBEAUTY BEAUTY & HEALTH (SHENZHEN) CO., LTD

(Settled in Shenzhen Qianhai, Commercial Secretary Co., Ltd.), Room 201, Block A, No.1 Qianwan Road, Shenzhen-Hongkong Cooperation, Shenzhen, Guangdong, China

(540)

**TOUCHBeauty**

(591) Black, white

(531) 27.05.10

(511)

8 – Eyelash curlers; fingernail polishers, electric or non-electric; razors, electric or non-electric; nail files, electric; beard clippers; hair clippers for personal use, electric and non-electric; depilation appliances, electric and non-electric; curling tongs; hand implements for hair curling (non-electric); goffering irons.

10 – Tongue scrapers; vibromassage apparatus; dental picks for use in dental treatment; mirrors for dentists; physiotherapy apparatus; feeding bottles; artificial breasts; abdominal corsets; orthopaedic footwear; ear picks.

11 – Nail lamps; curing lamps, not for medical purposes; fumigation apparatus, not for medical purposes; steam facial apparatus [saunas].

20 – Dressing tables; beauty cabinet (furniture); massage tables; mirrors [looking glasses]; photograph frames; photo frame bracket; mirror tiles; hand-held mirrors [toilet mirrors]; figurines of wood, wax, plaster or plastic; pillows.

21 – Cosmetic utensils; fitted vanity cases; toilet cases; toilet sponges; perfume sprayers; powder puffs; combs; electric combs; brushes; toothbrushes, electric.

(260) AM 2022 114941 A

(800) 1618739

(151) 2021 07 22

(891) 2021 07 22

(731) BESIX Group, société anonyme

Avenue des Communautés 100, B-1200  
Bruxelles, Belgium

(540)

**BESIX**

(591) Black, white

(511)

35 – Administrative advice on laws, regulations and permit requests in matters relating to respect for the environment, and compliance with security standards;

administrative management of non-compliance following site hand-over.

36 – Organization of collections, fund raising, charitable fund raising; financial sponsorship (sponsoring) of charity; financial assistance to development; sponsorship services; real estate broking.

37 – Construction; repair; installation service; construction information; building construction supervision; construction consultancy.

40 – Treatment of materials; water treatment.

42 – Scientific and technological services and research and design relating thereto; industrial analysis and research services; services provided by engineers, advice on civil engineering; architectural consultation; supervision, monitoring and quality control of site work and of their compliance with norms, laws, rules, practices and standards, both national and international, on the environment and building safety.

(260) AM 2022 114942 A

(800) 1618741

(151) 2021 07 22

(891) 2021 07 22

(731) BESIX Group, société anonyme  
Avenue des Communautés 100, B-1200  
Bruxelles, Belgium

(540)



(591) Red, white and various shades of blue

(531) 26.03.04; 26.03.24; 26.04.04; 26.04.06;  
26.04.09; 26.04.24; 26.07.15; 29.01.13

(511)

35 – Administrative advice on laws, regulations and permit requests in matters relating to respect for the environment, and compliance with security standards; administrative management of non-compliance following site hand-over.

36 – Organization of collections, fund raising, charitable fund raising; financial sponsorship (sponsoring) of charity; financial assistance to development; sponsorship services; real estate broking.

37 – Construction; repair; installation service; construction information; building construction supervision; construction consultancy.

40 – Treatment of materials; water treatment.

42 – Scientific and technological services and research and design relating thereto; industrial analysis and research services; services provided by engineers, advice on civil engineering; architectural consultation; supervision, monitoring and quality control of site work and of their compliance with norms, laws, rules, practices and standards, both national and international, on the environment and building safety.

(260) AM 2022 114943 A

(800) 1618743

(151) 2021 07 06

(891) 2021 07 06

(731) Publichne aktsionerne tovarystvo "MOTOR  
SICH"  
15 Motorobudivnykiv Av, Shevchenkivsky  
district, Zaporizhia, Zaporizhia region 69068,  
Ukraine

(540)

# MSB

(591) Black, white

(511)

12 – Aircraft, in particular helicopters; air vehicles.

(260) AM 2022 114944 A

(800) 1618744

(151) 2021 07 16

(891) 2021 07 16

(731) Gottfried Stiller GmbH  
Bonner Wall 29, 50677 Köln, Germany

(540)

# STEINKAMP

(591) Black, white

(531) 27.05.01; 27.05.17; 27.05.19

(511)

6 – Building and construction materials and elements of metal; floor drains of metal; metal hardware; parts and accessories for all the aforesaid goods, included in this class.

11 – Sanitary installations, water supply and sanitation equipment; sanitary and bathroom installations and plumbing fixtures; steam baths, saunas and spas; bathtubs; shower pans; sink units; taps [faucets]; parts and accessories for all the aforesaid goods, included in this class.

20 – Furniture and non-metallic furniture fittings; bathroom furniture; bathroom cupboards; bathroom washstands; seating furniture; racks; mirrors (silvered glass); mirrored cabinets; fasteners, fastener connecting parts and fastening holders, not of metal; door fittings, not of metal; non-metal hooks; shower



seats; shower seats; towel stands [furniture]; freestanding towel racks; front plate knobs (non-metallic -); non-metallic hooks for furniture; parts and accessories for all the aforesaid goods, included in this class.

21 – Cosmetic and toilet utensils; towel racks; toilet roll holders; parts and accessories for all the aforesaid goods, included in this class.

(260) AM 2022 114945 A

(800) 1618819

(151) 2021 06 29

(891) 2021 06 29

(731) KiwiKo B.V.

Marconistraat 80, NL-3029 AK Rotterdam,  
Netherlands

(540)



(591) Different shades of green, yellow and red

(531) 05.03.13; 05.03.15; 27.05.07; 27.05.10;  
27.05.11; 29.01.15

(511)

31 – Seedlings; cuttings (plant -); seeds (plant -); plants; fresh fruits.

(260) AM 2022 114946 A

(800) 1619013

(151) 2021 08 18

(891) 2021 08 18

(731) KENISSI MANUFACTURE SA

Rue de France 65, CH-2400 Le Locle,  
Switzerland

(540)

**KENISSI**

(591) Black, white

(511)

14 – Timepieces, namely watches, wristwatches, components parts of timepieces and accessories for parts of timepieces not included in other classes; clocks and other chronometric instruments; chronometers; chronographs (timepieces); watch bands; dials (timepieces); boxes and presentation cases for timepieces; movements for watches, chronometers and clocks and parts thereof; precious metals and their alloys.

35 – Presentation of watches and clocks and component parts of timepieces on all communication media for retailing; online advertising; making available information and provision of advice to consumers concerning watches and clocks and component parts of timepieces for online sale; retail services featuring timepieces and component parts of timepieces, via glo-

bal computer networks, by catalog, by mail and by other electronic means.

42 – Technical project study; research and development of new products (for others); technical, scientific and industrial research; product design, technical design; conducting of technical project studies; products quality control.

(260) AM 2022 114947 A

(800) 1619064

(151) 2021 05 20

(891) 2021 05 20

(731) VERWOOD TRADING LIMITED

Archiepiskopou Makariou III, 155 PROTEAS  
HOUSE, 5th floor, CY-3026 Limassol, Cyprus

(540)

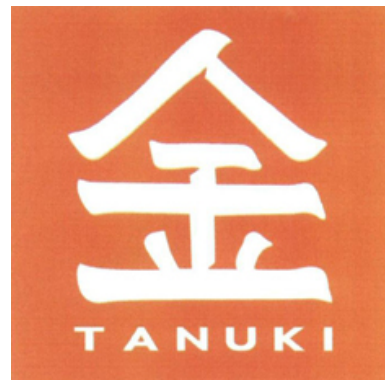

(591) Orange and white

(531) 27.05.24; 28.03; 29.01.12

(511)

35 – Market studies; marketing research; import-export agency services; commercial information agency services; demonstration of goods; organization of trade fairs for commercial or advertising purposes.

41 – Providing recreation facilities; presentation of variety shows; gambling services; providing casino facilities [gambling]; providing amusement arcade services; club services [entertainment or education]; party planning [entertainment].

43 – Services for providing food and drink; food and drink catering; canteen services.

(260) AM 2022 114948 A

(800) 1619097

(151) 2021 08 06

(891) 2021 08 06

(731) ECOMMERCE TECHNOLOGIES LTD

Cambridge House, 16 High Street, Saffron  
Walden, Essex CB10 1AX, United Kingdom

(540)

 The logo for PayDo features a stylized blue eye icon with motion lines to its left, followed by the word "PayDo" in a bold, blue, sans-serif font.

(591) Dark blue and light blue

(531) 26.02.01; 26.11.21; 27.05.10; 27.05.11;  
29.01.04

(511)

36 – Financial services, namely, electronic funds transfer; financial trading services; electronic payment services; processing of electronic payments; transfer of funds; money transfer services; e-wallet payment services; international commodity trading and exchanges services for others.

(260) AM 2022 114959 A

(800) 1619513

(151) 2021 05 24

(891) 2021 05 24

(731) Yiwu jihong electric appliance co. LTD.  
dongyuan characteristic, industrial community,  
jiangdong street, yiwu, zhejiang, China

(540)

 The logo for lenroad consists of the word "lenroad" in a bold, black, lowercase, sans-serif font.

(591) Black, white

(531) 27.05.01

(511)

7 – Dumpling making machine; ironing machines; sewing machines; kitchen machines, electric; grinding mill, electric; grinders, electric, for household purposes; electric meat cutter, for household purposes; electric vegetable cutter, for household purposes; whisks, electric, for household purposes; blenders, electric, for household purposes; fruit presses, electric, for household purposes; mills for household purposes, other than hand-operated; dishwashers; juice machines, electric; dry cleaning machine; washing machines [laundry]; vacuum cleaners.

8 – Electric shaver; electric razors; electric hair clipper; electric nasal hair trimmers; hand tools, hand-operated; trowels [gardening]; manual sprayer for insecticide; garden tools, hand-operated; beard clippers; razor cases; razor blade; curling tongs; cuticle tweezers; hair-removing tweezers; pedicure sets, electric; crimping irons; hand implements for hair curling; electric or non-electric hair clippers; razor blades; nail files; electric and safety razor; nail clipper; nail files, electric; nail files (electric or non-electric).

(260) AM 2022 114960 A

(800) 1619567

(151) 2021 06 04

(891) 2021 06 04

(731) BYD COMPANY LIMITED

No.1, Yan'an Road, Kuichong Street, Dapeng  
New District, Shenzhen, Guangdong, China

(540)

 The logo for BUILD YOUR DREAMS features the words "BUILD YOUR DREAMS" in a bold, black, uppercase, sans-serif font.

(591) Black, white

(531) 27.05.01

(511)

12 – Motor coaches; automobile chassis; electric vehicles; motor cars; automobile bodies; steering wheels for vehicles; rolling stock for railways; forklift trucks; motorcycles; brake pads for automobiles.

(260) AM 2022 114961 A

(800) 1619616A

(151) 2021 07 27

(891) 2021 07 27

(731) Amazon Europe Core S.à.r.l.

38, avenue John F. Kennedy, L-1855  
Luxembourg, Luxembourg

(540)

 The logo for PRIME DAY features the words "PRIME DAY" in a bold, black, uppercase, sans-serif font.

(591) Black, white

(511)

35 – Retail store services and online retail store services featuring a wide array of consumer goods of others; retail store services; sales promotion for others; providing online markets for buyers and sellers of goods and services; advertising and marketing; commercial information; wholesale store services; sales promotion; administration of consumer loyalty programs; administration of loyalty programs involving discounts, rewards, or incentives; customer loyalty program services featuring rewards in the form of discounted shipping services and access to retail discounts and offers.

(260) AM 2022 114962 A

(800) 1619623

(151) 2021 08 03

(891) 2021 08 03

(731) Apple Inc.

One Apple Park Way, Cupertino CA 95014,  
USA

(540)

 The logo for UP NEXT KIT features the words "UP NEXT KIT" in a bold, black, uppercase, sans-serif font.

(591) Black, white

(531) 26.03.04; 27.05.01

(511)  
38 – Streaming of data; streaming of audio and video material on the Internet featuring performances, documentaries, music, and interviews featuring musical artists; streaming of audio and visual content featuring musical artists; audio and video broadcasting services over the Internet featuring performances, documentaries, music, and interviews featuring musical artists; audio broadcasting and video broadcasting featuring musical artists; delivery of digital music by electronic transmission.

(260) AM 2022 114963 A  
(800) 1619645  
(151) 2021 08 11  
(891) 2021 08 11  
(731) FERRERO TRADING LUX S.A.  
Route de Trèves 16, L-2633 Senningerberg,  
Luxembourg  
(540)



(591) White light blue blue grey fawn beige  
(531) 01.15.17; 01.15.19; 03.06.25; 27.03.03;  
27.05.02; 27.05.03; 27.05.04; 27.05.08;  
27.05.09; 27.05.17; 29.01.15  
(511)  
28 – Games; toys; video game apparatus; gymnastic and sporting articles; decorations for christmas trees, except lighting articles and sweets; figurines (toys); poseable toy figures [toys]; animal shaped toys.

30 – Pastry and confectionery; chocolate and chocolate-based products.

(260) AM 2022 114965 A  
(800) 1619728  
(151) 2021 08 31  
(891) 2021 08 31  
(731) Impulse (Qingdao) Health Tech Co., Ltd.  
No. 369 Huashan 2nd Road, Jimo City,  
Qingdao City, Shandong Province, China  
(540)



(591) Black, white  
(531) 27.05.01

(511)  
28 – Fishing tackle; knee guards [sports articles]; chess; ice skates; christmas tree ornaments, except illumination articles and confectionery; archery implements; body rehabilitation apparatus; machines for physical exercises; swimming pools [play articles]; plastic race tracks [toys]; balls for games; games; toys.

(260) AM 2022 114966 A  
(800) 1619818  
(151) 2021 07 08  
(891) 2021 07 08  
(731) VEGA RENOVABLES Y MARCAS SLU  
Calle Ciudad Real, 3, Pol. Ind Camporosso,  
E-02520 CHINCHILLA DE  
MONTEARAGÓN, Spain  
(540)



(591) Black, white  
(531) 03.04.01; 03.04.11; 08.03.12; 25.01.06;  
26.01.15  
(511)  
29 – Cheese.

(260) AM 2022 114967 A  
(800) 1619820  
(151) 2021 07 08  
(891) 2021 07 08  
(731) VEGA RENOVABLES Y MARCAS SLU  
Calle Ciudad Real, 3,, Pol. Ind Camporosso,  
E-02520 CHINCHILLA DE  
MONTEARAGÓN, Spain  
(540)

## VEGA GOURMET

(591) Black, white  
(511)  
29 – Cheese.



(260) AM 2022 114968 A  
 (800) 1619853  
 (151) 2021 09 02  
 (891) 2021 09 02  
 (731) Bayer Consumer Care AG  
 Peter-Merian-Str. 84, CH-4052 Basel,  
 Switzerland

(540)



(591) Green, purple, gray-blue and gray  
 (531) 05.03.13; 26.01.06; 26.01.24; 26.07.04;  
 9.01.15

(511)

5 – Pharmaceutical preparations; food and dietetic supplements; hygienic products for medical use; dietetic foods for medical use; dietetic substances for medical use; dietary fibers; formulations with probiotic bacteria for medicinal purposes; dietetic food supplements; nutritional supplements.

(260) AM 2022 115076 A  
 (800) 1621365  
 (151) 2021 02 02  
 (891) 2021 02 02  
 (731) LIMITED LIABILITY MANUFACTURING  
 AND TRADING COMPANY "ACME"  
 5 Promyslova Str., Ukrainka, Obukhivsky r-n,  
 Kyivska obl. 08720, Ukraine

(540)



(591) Black, white  
 (531) 26.01.05; 26.04.04; 26.04.05; 26.04.16;  
 26.04.24; 27.05.01

(511)

3 – Toiletry preparations.

5 – Pharmaceutical preparations; sanitary preparations for medical purposes.

(260) AM 2022 115078 A  
 (800) 1621383  
 (151) 2021 02 20  
 (891) 2021 02 20  
 (731) MATRIZE Handels-GmbH  
 Alter Fischmarkt 11, 20457 Hamburg, Germany

(540)

## DENZEL

(591) Black, white

(511)

8 – Tool belts [holders]; waistcoats for holding hand tools and instruments; cases for hand tools and instruments; belts for hand instruments bags; belts for hand instrument cases; wall mounted holders for hand tools and instruments; covers for hand tools and instruments.

12 – Luggage nets for vehicles; luggage elastic rubber cords for vehicles; luggage straps for vehicles; trunk organizers (vehicle organizers); mechanics' creepers.

18 – Bags; tool bags, empty; shopping bags; wheeled shopping bags; backpacks; business cases.

22 – Braces, not of metal, for handling loads; straps, not of metal, for handling loads; slings, not of metal, for handling loads; strapping for securing loads; cables, not of metal; tie-down straps, not of metal; cord; ropes; string.

25 – Footwear for household, building or repair purposes, including boots, high boots, sandals, galoshes; clothing for household, building or repair purposes, including combinations, jackets, trousers, gloves, waistcoats.

(260) AM 2022 115081 A  
 (800) 1621706  
 (151) 2021 09 08  
 (891) 2021 09 08  
 (731) HAGEN Deutschland GmbH & Co. KG  
 Lehmweg 99 – 105, 25488 Holm/Krs.  
 Pinneberg, Germany

(540)

## CATIT

(591) Black, white

(511)

20 – Scratching posts for cats, cat houses, beds for cats, cat flaps, not being of metal or masonry, cat baskets, animal carriers in the form of boxes.

21 – Cat litter pans, fur brushes for animals, feed dispensers, drinking troughs for animals.

28 – Toys for cats.

31 – Foodstuffs for cats, cat litter, catnip, beverages for pets, cat treats [edible].

(260) AM 2022 115083 A  
 (800) 1621794  
 (151) 2021 06 11  
 (891) 2021 06 11  
 (731) Myovant Sciences GmbH  
 Viaduktstrasse 8, CH-4051 Basel, Switzerland

(540)



(591) Black, white  
(531) 26.11.12; 27.05.01  
(511)

5 – Pharmaceutical preparations for human use; biological preparations for medical or therapeutic use; pharmaceutical preparations for human use for the treatment of oncological diseases, disorders and conditions, and prostate cancer; biological preparations for medical or therapeutic use for the treatment of oncological diseases, disorders and conditions, and prostate cancer.

44 – Provision of health information and medical information; provision of information concerning the diagnostic, prophylactic and therapeutic properties of pharmaceutical and biological preparations for prevention and treatment of diseases, disorders and conditions; patient assistance services, namely, provision of information in the field of healthcare and pharmaceuticals via a website; patient assistance services, namely, provision of health information and medical information, pharmaceutical advice, treatment and disease management, and patient assistance programs via a website or telecommunication networks.

(260) AM 2022 115132 A  
(800) 1621866  
(151) 2021 07 23  
(891) 2021 07 23  
(731) Obschestvo s ogranichennoi otvetstvennostyu "VSK"  
113, ul. 50 let Oktyabrya, g. Dimitrovgrad,  
RU-433502 Ulyanovskaya oblast, Russian  
Federation

(540)



(591) Black, white  
(531) 28.05  
(511)

32 – Aperitifs, non-alcoholic; seltzer water; soda water; waters [beverages]; mineral water [beverages]; carbonated water; table waters; kvass; cocktails, non-alcoholic; beer-based cocktails; lemonades; non-alcoholic beverages; isotonic beverages; non-alcoholic honey-based beverages; rice-based beverages, other than milk substitutes; soya-based beverages, other than milk substitutes; whey beverages; protein-enriched sports beverages; soft drinks; non-alcoholic beverages flavoured with tea; non-alcoholic fruit juice beverages; fruit nectars, non-alcoholic; beer; ginger beer; malt beer; sarsaparilla [non-alcoholic beverage]; syr-

ups for lemonade; syrups for beverages; smoothies; vegetable juices [beverages]; fruit juices; preparations for making carbonated water; non-alcoholic preparations for making beverages; must; grape must, unfermented; beer wort; malt wort; sherbets [beverages]; non-alcoholic fruit extracts; extracts of hops for making beer; non-alcoholic essences for making beverages.

(260) AM 2022 115133 A  
(800) 1621884  
(151) 2021 08 12  
(891) 2021 08 12  
(731) Limited Liability Company "Elfa laboratory"  
vul. Simi Sosninykh, 9, Kyiv 03148, Ukraine  
(540)



(591) Black, white  
(531) 27.05.01  
(511)

3 – Bleaching preparations for household needs; bleaching salts; dishes care products; dishwashing detergents; dishwashing detergents in dishwashing machines, including: dishwashing gels, dishwashing tablets, dishwashing detergents; dishwashing machines care products, including dishwashing machines cleaners; quillaia bark for washing; drying agents for dishwashing machines; cleaning preparations, including cleaners for dishwashing machines; scouring solutions, including cleaning solutions for dishwashing machines; preparations for shining dishes.

(260) AM 2022 115134 A  
(800) 1621905  
(151) 2021 08 24  
(891) 2021 08 24  
(731) Gevorgyan David Smbatovich  
Rozhdestveno village, household 2, apt. 4,  
Volokolamsk district, RU-143600 Moscow  
region, Russian Federation  
(540)



(591) Blue  
(531) 05.13.25; 28.05; 29.01.04  
(511)

11 – Steam accumulators; heat accumulators; hydro-massage bath apparatus; disinfectant apparatus; air deodorizing apparatus; hand drying apparatus for washrooms; flushing tanks; bidets; bath tubs; spa baths [vessels]; bath tubs for sitz baths; water heaters; water flushing installations; microbubble generators for baths; showers; shower cubicles; Turkish bath ca-

binets, portable; taps; mixer taps for water pipes; taps for pipes and pipelines; heaters for baths; heaters for heating irons; immersion heaters; anti-splash tap nozzles; hot air bath fittings; bath fittings; steam boilers, other than parts of machines; urinals being sanitary fixtures; water intake apparatus; sanitary apparatus and installations; regulating and safety accessories for water apparatus; washers for water taps; sinks; disinfectant dispensers for toilets; toilet seats; air dryers; laundry dryers, electric; pipes [parts of sanitary installations]; toilets [water-closets]; toilets, portable; wash-hand basins [parts of sanitary installations]; toilet bowls; water conduits installations; bath installations; steam generating installations; water distribution installations; water supply installations; heating elements.

(260) AM 2022 115135 A

(800) 1621953

(151) 2021 05 17

(891) 2021 05 17

(731) Closed Joint Stock Company "Starodvorskie kolbasy"

ul. Poliny Osipenko, d. 41, of. 210, RU-600009  
g. Vladimir, Russian Federation

(540)

# Баварушки

(591) Black, white

(531) 28.05

(511)

29 – Preserved peppers; aloe vera prepared for human consumption; alginates for culinary purposes; anchovy, not live; peanuts, prepared; artichokes, preserved; albumen for culinary purposes; white of eggs; beans, preserved; soya beans, preserved, for food; broth; ginger jam; ham; fatty substances for the manufacture of edible fats; toasted laver; edible birds' nests; sea-cucumbers, not live; peas, preserved; mushrooms, preserved; guacamole; game, not live; gelatine; meat jellies; jellies for food; fruit jellies; yolk of eggs; coconut fat; bone oil for food; lard; suet for food; edible fats; curd; fruit-based snack food; milk substitutes; charcuterie; raisins; caviar; eggplant paste; vegetable marrow paste; fish roe, prepared; yogurt; galbi [grilled meat dish]; sauerkraut; kefir; kimchi; isinglass for food; clams, not live; potato-based dumplings; milk shakes; black pudding; onion rings; arrangements of processed fruit; compotes; meat, canned; vegetables, canned; fish, canned; fruits, canned; broth concentrates; corn dogs; gherkins; rissoles; frozen rissoles; shrimps, not live; prawns, not live; buttercream; croquettes; silkworm chrysalis for human consumption; sweet corn, processed; kumys; chicken wings; spiny lobsters, not live; lecithin for culinary purposes; salmon, not live; onions, preserved; margarine; marmalade; oils for fo-

od; peanut butter; cocoa butter for food; coconut oil for food; coconut butter; corn oil for food; sesame oil for food; linseed oil for food; extra virgin olive oil for food; olive oil for food; palm oil for food; palm kernel oil for food; sunflower oil for food; rape oil for food; butter; soya bean oil for food; mussels, not live; almonds, ground; animal marrow for food; mollusks, not live; milk; peanut milk; peanut milk for culinary purposes; coconut milk; coconut milk for culinary purposes; almond milk; almond milk for culinary purposes; oat milk; rice milk; rice milk for culinary purposes; protein milk; condensed milk; soya milk; powdered milk; fish meal for human consumption; vegetable mousses; fish mousses; fruit pulp; meat; meat, preserved; freeze-dried meat; chicken nuggets; milk beverages, milk predominating; peanut milk-based beverages; coconut milk-based beverages; almond milk-based beverages; edible insects, not live; sausage casings, natural or artificial; vegetables, preserved; freeze-dried vegetables; vegetables, dried; vegetables, cooked; potato fritters; olives, preserved; lobsters, not live; flavored nuts; candied nuts; coconut, desiccated; nuts, prepared; tomato paste; liver pâté; pectin for culinary purposes; liver; pickles; jams; powdered eggs; milk products; fish-based foodstuffs; soured milk; poultry, not live; pieces of chicken in batter; bulgogi; pollen prepared as foodstuff; cranberry compote; tomato purée; apple purée; crayfish, not live; crustaceans, not live; fish, preserved; fish, not live; salted fish; fermented baked milk; vegetable salads; fruit salads; bacon; sardelki [sausages]; sardines, not live; pork; herrings, not live; seeds, prepared; sunflower seeds, prepared; cream [dairy products]; whipped cream; vegetable-based cream; fat-containing mixtures for bread slices; smetana; lemon juice for culinary purposes; tomato juice for cooking; vegetable juices for cooking; salted meats; sausages; sausages in batter; hot dog sausages; preparations for making bouillon; preparations for making soup; nut-based spreads; tripe; soups; vegetable soup preparations; whey; cheese; tahini; tofu; truffles, preserved; tuna, not live; oysters, not live; falafel; milk ferments for culinary purposes; rennet; fish fillets; dates; frosted fruits; frozen fruits; fruit, preserved; fruit preserved in alcohol; fruit, stewed; hazelnuts, prepared; potato flakes; hummus; fruit peel; preserved garlic; lentils, preserved; potato chips; low-fat potato chips; fruit chips; shpikachki [sausages]; non-alcoholic eggnog; seaweed extracts for food; meat extracts; edible ant larvae, prepared; berries, preserved; snail eggs for consumption; eggs; yakitori.

(260) AM 2022 115136 A  
 (800) 1621955  
 (151) 2021 05 20  
 (891) 2021 05 20  
 (731) Carl Freudenberg KG  
 Höhnerweg 2-4, 69469 Weinheim, Germany  
 (540)



(591) Red, white, green and blue  
 (531) 05.03.11; 05.03.13; 05.03.15; 26.04.02;  
 26.04.05; 26.04.18; 27.05.07; 29.01.15  
 (511)  
 7 – Machines, namely electric floor cleaning apparatus and cleaning robots and parts therefor, electric floor cleaning brushes (parts of machines), electric window cleaning apparatus and parts therefor, electric cleaning machines and apparatus for carpets and carpeted flooring, electric vacuum cleaners, electric window vacuum cleaners.  
 21 – Articles for cleaning purposes, especially household cloths, window cloths made of leather and artificial leather, dust cloths, cloths for washing dishes, cloths for cleaning surfaces, dusters, scouring cloths, multi-purpose cloths, floor-cloths, microfiber cloths, sponge cloths, cloths made of nonwovens, cloths made of woven or knitted fabrics, dry disposable cloths, scouring pads made of nonwoven material with and without sponge section; cloths, sponges or spongecloths made wholly or principally of generated cellulose, especially for household cleaning purposes or as draining mats; steel-wool for cleaning, especially steel-wool cleaners with and without handles, made of foamed plastic, steel-wool pads with soap; sponges for household purposes, especially plastic-coated scouring sponges, cleaning sponges made of viscose or plastic; household or kitchen utensils, especially manually operated, non-electrical cleaning instruments, especially brooms, brushes, dustpans, mops, devices for wringing out mops, toilet brushes, holders for toilet brushes, window-cleaning devices, water wipers, household gloves made of latex or plastic; disposable gloves for household or gardening purposes; gardening gloves and wiping gloves; drying devices for laundry (not heat, not electrical), drying racks for clothes and laundry, rotary clothes dryers for clothes and laundry, drying mounts for clothes and laundry, clothes-pegs, ironing boards, sleeve boards, ironing board supports, ironing cloths, iron cleaning cloths; containers for household or kitchen, especially water buckets, pedal-bins, waste-bins, sorting containers of

plastic for laundry; laundry baskets of plastic; components, not of metal, for hand-operated, non-electrical cleaning instruments included in this class, in particular arms, handles, connecting parts, links, couplings, not of metal, being fitted goods.

(260) AM 2022 115138 A  
 (800) 1621973  
 (151) 2021 07 08  
 (891) 2021 07 08  
 (731) KRYOLAN GmbH Chemische Fabrik  
 Papierstraße 10, 13409 Berlin, Germany  
 (540)

## DIGITAL COMPLEXION

(591) Black, white  
 (511)  
 3 – Beauty care preparations and toiletries; cosmetics; make-up.

(260) AM 2022 115140 A  
 (800) 1622021  
 (151) 2021 08 11  
 (891) 2021 08 11  
 (731) Open-Type Joint Stock Company "TAKF"  
 ul. Oktyabrskaya, d. 22, Tambov,  
 RU-392000 Tambovskaya oblast, Russian  
 Federation  
 (540)

## Bite&Go Bite'n'go

(591) Black, white  
 (511)  
 30 – Pancakes; buns; waffles; sweets; cocoa; coffee; cinnamon [spice]; biscuits; capers; seasonings; caramels [sweets]; cereal preparations; fondants [confectionery]; cake powder; mint for confectionery; pastries; gingerbread; chewing gum; ice, natural or artificial; chips [cereal products]; corn flakes; pies; groats for human food; cocoa beverages with milk; pastilles [confectionery]; coffee beverages with milk; chocolate beverages with milk; pralines; sago; molasses for food; chocolate; marzipan; condiments; crackers; halvah; hominy grits; chocolate mousses; chocolate-based spreads; chocolate spreads containing nuts; mints for breath freshening.

(260) AM 2022 115151 A  
 (800) 1622345  
 (151) 2021 08 11  
 (891) 2021 08 11  
 (731) Public Joint Stock Company "Krasnyj Ocyabr"  
 ul. Malaya Krasnoselskaya, d. 7, str. 24,  
 RU-107140 Moscow, Russian Federation

(540)

**EINEM**

(591) Black, yellow, gray and white

(531) 26.04.03; 26.04.05; 26.04.18; 26.04.24;  
26.13.01; 27.05.01; 27.05.09; 27.05.10;  
27.05.24; 29.01.14

(511)

30 – Star aniseed; pancakes; buns; waffles; sweets; cocoa; coffee; cinnamon [spice]; biscuits; capers; seasonings; caramels [sweets]; cereal preparations; fondants [confectionery]; cake powder; mint for confectionery; gingerbread; chewing gum; ice, natural or artificial; chips [cereal products]; corn flakes; pies; groats for human food; cocoa beverages with milk; pastilles [confectionery]; coffee beverages with milk; chocolate beverages with milk; pralines; sago; molasses for food; chocolate; marzipan; condiments; crackers; halvah; hominy grits; chocolate mousses; chocolate-based spreads; chocolate spreads containing nuts; mints for breath freshening.

(260) AM 2022 115152 A

(800) 1622346

(151) 2021 08 11

(891) 2021 08 11

(731) Public Joint Stock Company "Krasnyj Ocyabr"  
ul. Malaya Krasnoselskaya, d. 7, str. 24,  
RU-107140 Moscow, Russian Federation

(540)



(591) Black, yellow, gray and white

(531) 26.04.03; 26.04.05; 26.04.18; 26.04.24;  
26.13.01; 27.05.01; 27.05.21; 27.05.24;  
29.01.14

(511)

30 – Star aniseed; pancakes; buns; waffles; sweets; cocoa; coffee; cinnamon [spice]; biscuits; capers; seasonings; caramels [sweets]; cereal preparations; fon-

dants [confectionery]; cake powder; mint for confectionery; gingerbread; chewing gum; ice, natural or artificial; chips [cereal products]; corn flakes; pies; groats for human food; cocoa beverages with milk; pastilles [confectionery]; coffee beverages with milk; chocolate beverages with milk; pralines; sago; molasses for food; chocolate; marzipan; condiments; crackers; halvah; hominy grits; chocolate mousses; chocolate-based spreads; chocolate spreads containing nuts; mints for breath freshening.

(260) AM 2022 115153 A

(800) 1622356

(151) 2021 07 16

(891) 2021 07 16

(731) "Lex Tobacco Company" LLC

Kurghinyan street lane 13, apt. 2, Malatia-  
Sebastia, 0068 Yerevan, Armenia

(540)



(591) Black, white

(531) 24.01.03; 24.01.15; 27.05.01

(526) TOBACCO COMPANY

(511)

34 – Matches; tips of yellow amber for cigar and cigarette holders; gas containers for cigar lighters; tobacco pipes; books of cigarette papers; absorbent paper for tobacco pipes; chewing tobacco; cigars; cigar cutters; cigar cases; cigarette cases; cigar holders; cigarettes containing tobacco substitutes, not for medical purposes; cigarettes; pocket machines for rolling cigarettes; cigarette holders; mouthpieces for cigarette holders; cigarette paper; cigarillos; pipe cleaners for tobacco pipes; firestones; herbs for smoking; pipe racks for tobacco pipes; match holders; tobacco jars; snuff; snuff boxes; match boxes; ashtrays for smokers; spittoons for tobacco users; humidors; electronic cigarettes; liquid solutions for use in electronic cigarettes; oral vaporizers for smokers; flavorings, other than essential oils, for tobacco; flavorings, other than essential oils, for use in electronic cigarettes; wicks adapted for cigarette lighters.



(260) AM 2022 115154 A

(800) 1622384

(151) 2021 06 25

(891) 2021 06 25

(731) "WELLCORM" Limited Liability Company  
 Centralnaya street, 46, office 205, Murino,  
 Vsevolozhsky district; RU-188669 Leningrad  
 region, Russian Federation

(540)

# PROXBOCT

(591) Black, white

(531) 28.05

(511)

5 – Nutritional supplements for animal foodstuffs; animal feed supplements for veterinary purposes; flavoring and aromatic supplements for animals; dietary supplements for animals; protein supplements for animals; medicated animal feed; dietetic animal foodstuffs for medical purposes; antiparasitic collars for animals; bacterial preparations for medical and veterinary use; bacteriological preparations for medical and veterinary use; biological preparations for veterinary purposes; veterinary preparations; preparations of trace elements for human and animal use; enzyme preparations for veterinary purposes; chemical preparations for veterinary purposes; enzymes for veterinary purposes.

31 – Dog biscuits; animal foodstuffs; pet food; strengthening animal forage; pet treats, edible; beverages for pets; aromatic sand [litter] for pets; litter for animals; animal fattening preparations; sanded paper [litter] for pets; cat litter, including cat litters of wood, silica gel.

35 – Import-export agency services; demonstration of goods; presentation of goods on communication media, for retail purposes; sales promotions at point of purchase or sale, for others; dissemination of advertising matter and advertisements; advertising; procurement services for others [purchasing goods and services for other businesses]; retail and wholesale services; retail and wholesale services for fodder for animals; retail services provided by television stores or via websites; administrative processing of purchase orders; on-line ordering services.

(260) AM 2022 115189 A

(800) 1336243

(151) 2016 11 04

(891) 2021 09 30

(731) MBE WORLDWIDE S.p.A.  
 Viale Lunigiana, 357, I-20125 MILANO (MI),  
 Italy

(540)

# PEOPLEPOSSIBLE

(591) Black, white

(511)

16 – Cards, packaging materials, packaging paper, packaging cardboard, cardboard packaging, packaging containers of paper, packaging materials of paper and recycled paper, boxes of paper and cardboard, cartons of cardboard for packaging, foldable packaging boxes of cardboard, rigid packaging boxes of cardboard, bags (envelopes, pouches) of paper for packaging; paper, cardboard, printed matter; bookbinding material; photographs; stationery; adhesives for stationery or household purposes; artists' materials; paint brushes; typewriters and office requisites (except furniture); instructional and teaching material (except apparatus); plastic materials for packaging (not included in other classes); printers' type; printing blocks.

35 – Presentation of goods on communication media, for retail purposes; electronic commerce services, namely, providing information about products via telecommunication networks for advertising and sales purposes; retailing and wholesaling, for others, including online and via mail order, of foodstuffs, beverages, clothing and accessories, footwear, bags, suitcases, umbrellas, sporting articles, sports equipment, furnishings, textiles, household and furnishing articles, household, bed and bathroom linen, furniture, electronic goods, optical goods, photographic, it and telecommunications goods, computer software; retailing and wholesaling, for others, including online and via mail order, of computer hardware, cosmetics, perfumery, detergents, beauty products and toiletries, goldsmithery, imitation jewellery, clocks and watches, household utensils, crockery, bathroom articles, household electric appliances, DIY articles, hardware goods, goods for animals, gardening and leisure articles; retailing and wholesaling, for others, including online, including by mail order, of cards, packaging materials, packaging paper, packaging cardboard, cardboard packaging, packaging containers of paper, packaging materials of paper and recycled paper, boxes of paper and cardboard, cartons of cardboard for packaging, foldable packaging boxes of cardboard, rigid packaging boxes of cardboard; retailing and wholesaling, for others, including online, including by mail order, of bags (envelopes, pouches) of paper for packaging, paper and cardboard, printed matter, bookbinding material, photographs, stationery, adhesives for stationery or household purposes, artists' materials, paintbrushes, typewriters and office requisites (except furniture); retailing and wholesaling, for others, including online, including by mail order, of instructional and teaching material (except apparatus), plastic materials for packaging (not included in other classes), printers' type, printing blocks; retailing and wholesaling, for others, including online, including by mail order, of games and playthings, vehicles, motorcycles, bicycles, motors, engines and spare parts, musical instruments; providing information regarding products from searchable indexes and databases of information, including text, electronic documents, databases, graphics

and audio visual information, on computer and communication networks; electronic business services, in particular providing information on products and services via telecommunication networks for advertising and sales purposes; promoting the goods and services of others through discount offers via an online electronic communications networks; promoting the goods and services of others by providing a website featuring coupons, rebates, price-comparison information, product reviews, links to the retail websites of others, and discount information; commercial information and advice for consumers; price comparison services; sales promotion for others; dissemination of advertising for others via an online communications network; providing a searchable database in the fields of business information; providing a searchable online advertising guide featuring the goods and services of other online and offline vendors; promoting the goods and services of others through limited availability discount offers via an on-line electronic communications network; product reviews (sales promotion and testing); marketing services; advertising; business management; business administration; office functions (services for others).

38 – Signal transmission for electronic commerce via telecommunication systems and data communication systems; providing an online, interactive bulletin board for the transmission of messages among computer users concerning hobbies, collectibles, trading, and the sale of goods and services via a global communications network; telecommunications (services on behalf of third parties).

39 – Forwarding of goods and freight [shipping of goods]; shipment and delivery of goods ordered via mail order; courier services; transport; packaging and storage of goods; travel arrangement (services for others).

(260) AM 2022 115190 A

(800) 1337723

(151) 2016 11 04

(891) 2021 09 30

(731) MBE WORLDWIDE S.p.A.

Viale Lunigiana, 357, I-20125 MILANO (MI), Italy

(540)

## **MBE PEOPLEPOSSIBLE**

(591) Black, white

(511)

16 – Cards, packaging materials, packaging paper, packaging cardboard, cardboard packaging, packaging containers of paper, packaging materials of paper and recycled paper, boxes of paper and cardboard, cartons of cardboard for packaging, foldable packaging boxes of cardboard, rigid packaging boxes of cardboard, bags (envelopes, pouches) of paper for packaging; paper, cardboard, printed matter; bookbinding material;

photographs; stationery; adhesives for stationery or household purposes; artists' materials; paint brushes; typewriters and office requisites (except furniture); instructional and teaching material (except apparatus); plastic materials for packaging (not included in other classes); printers' type; printing blocks.

35 – Presentation of goods on communication media, for retail purposes; electronic commerce services, namely, providing information about products via telecommunication networks for advertising and sales purposes; retailing and wholesaling, for others, including online and via mail order, of foodstuffs, beverages, clothing and accessories, footwear, bags, suitcases, umbrellas, sporting articles, sports equipment, furnishings, textiles, household and furnishing articles, household, bed and bathroom linen, furniture, electronic goods, optical goods, photographic, it and telecommunications goods, computer software; retailing and wholesaling, for others, including online and via mail order, of computer hardware, cosmetics, perfumery, detergents, beauty products and toiletries, goldsmithery, imitation jewellery, clocks and watches, household utensils, crockery, bathroom articles, household electric appliances, DIY articles, hardware goods, goods for animals, gardening and leisure articles; retailing and wholesaling, for others, including online, including by mail order, of cards, packaging materials, packaging paper, packaging cardboard, cardboard packaging, packaging containers of paper, packaging materials of paper and recycled paper, boxes of paper and cardboard, cartons of cardboard for packaging, foldable packaging boxes of cardboard, rigid packaging boxes of cardboard; retailing and wholesaling, for others, including online, including by mail order, of bags (envelopes, pouches) of paper for packaging, paper and cardboard, printed matter, bookbinding material, photographs, stationery, adhesives for stationery or household purposes, artists' materials, paintbrushes, typewriters and office requisites (except furniture); retailing and wholesaling, for others, including online, including by mail order, of instructional and teaching material (except apparatus), plastic materials for packaging (not included in other classes), printers' type, printing blocks; retailing and wholesaling, for others, including online, including by mail order, of games and playthings, vehicles, motorcycles, bicycles, motors, engines and spare parts, musical instruments; providing information regarding products from searchable indexes and databases of information, including text, electronic documents, databases, graphics and audio visual information, on computer and communication networks; electronic business services, in particular providing information on products and services via telecommunication networks for advertising and sales purposes; promoting the goods and services of others through discount offers via an online electronic communications networks; promoting the goods and services of others by providing a website featuring coupons, rebates, price-comparison informa-

tion, product reviews, links to the retail websites of others, and discount information; commercial information and advice for consumers; price comparison services; sales promotion for others; dissemination of advertising for others via an online communications network; providing a searchable database in the fields of business information; providing a searchable online advertising guide featuring the goods and services of other online and offline vendors; promoting the goods and services of others through limited availability discount offers via an on-line electronic communications network; product reviews (sales promotion and testing); marketing services; advertising; business management; business administration; office functions (services for others).

38 – Signal transmission for electronic commerce via telecommunication systems and data communication systems; providing an online, interactive bulletin board for the transmission of messages among computer users concerning hobbies, collectibles, trading, and the sale of goods and services via a global communications network; telecommunications (services on behalf of third parties).

39 – Forwarding of goods and freight [shipping of goods]; shipment and delivery of goods ordered via mail order; courier services; transport; packaging and storage of goods; travel arrangement (services for others).

(260) AM 2022 115277 A  
 (800) 1624288  
 (151) 2021 10 05  
 (891) 2021 10 05  
 (731) Société des Produits Nestlé S.A.  
 CH-1800 Vevey, Switzerland  
 (540)

## PRENAN

(591) Black, white  
 (511)

5 – Food and food substances for babies; food preparations for infants; lacteal flour for babies; powdered milk for babies; foodstuffs and food substances for medical use for children and patients; nutritional supplements; vitamin preparations, mineral-based preparations.

29 – Milk and dairy products; powdered milk; milk-based beverages and preparations; milk substitutes.

(260) AM 2022 115293 A  
 (800) 1339334  
 (151) 2017 01 10  
 (891) 2021 10 20  
 (731) SOREMARTEC S.A.  
 16, Route de Trèves, L-2633 Senningerberg,  
 Luxembourg

(540)



(591) Red, different shades of brown, different shades of green, orange, beige, white and black

(531) 02.09.01; 05.07.02; 05.07.03; 05.07.06; 05.07. 11; 05.07.13; 05.07.22; 05.07.24; 08.01.10; 09.01.09; 11.03.01; 11.03.04; 25.05.02; 26.01.03; 26.01.18; 27.05.04; 27.05.17; 27.05.19; 27.05.21; 27.05.24; 29.01.15

(511)

30 – Pastry and confectionery; biscuits, cookies, cakes, cereal-based snack food, chocolate and chocolate-based products.



---

**INTERNATIONAL TRADEMARKS PROTECTED IN GEORGIA**

(260) AM 2022 109171 A  
(800) 1541878  
(151) 2019 12 16  
(181) 2029 12 16  
(891) 2019 12 16  
(511) 01, 05, 31, 35, 41, 44

---

(260) AM 2022 109313 A  
(800) 1543920  
(151) 2020 07 06  
(181) 2030 07 06  
(891) 2020 07 06  
(511) 11

---

(260) AM 2022 109714 A  
(800) 1549661  
(151) 2019 08 23  
(181) 2029 08 23  
(891) 2019 08 23  
(511) 09

---

(260) AM 2022 110103 A  
(800) 967714  
(151) 2008 05 09  
(181) 2028 05 09  
(891) 2020 09 22  
(511) 05, 29, 30, 32

---

(260) AM 2022 110357 A  
(800) 1549467  
(151) 2020 07 20  
(181) 2030 07 20  
(891) 2020 09 03  
(511) 07

---

(260) AM 2022 111777 A  
(800) 1575778  
(151) 2020 09 14  
(181) 2030 09 14  
(891) 2020 09 14  
(511) 03, 05

---

(260) AM 2022 111780 A  
(800) 1575887  
(151) 2020 12 11  
(181) 2030 12 11  
(891) 2020 12 11  
(511) 41, 45

---

(260) AM 2022 112463 A  
(800) 1331788  
(151) 2016 07 27  
(181) 2026 07 27  
(891) 2021 02 26  
(511) 03, 04, 14, 24, 25, 27, 30

---

(260) AM 2022 112516 A  
(800) 1584680  
(151) 2020 08 31  
(181) 2030 08 31  
(891) 2020 08 31  
(511) 05, 29, 32

---

(260) AM 2022 112533 A  
(800) 1585151  
(151) 2020 02 21  
(181) 2030 02 21  
(891) 2020 02 21

---

(260) AM 2022 112535 A  
(800) 1585176  
(151) 2020 08 31  
(181) 2030 08 31  
(891) 2020 08 31  
(511) 01, 05

---

(260) AM 2022 112563 A  
(800) 695587  
(151) 1998 03 23  
(181) 2028 03 23  
(891) 2020 11 30  
(511) 03, 26

---

(260) AM 2022 112573 A  
(800) 1581032  
(151) 2021 01 27  
(181) 2031 01 27  
(891) 2021 03 22  
(511) 12, 27, 28

---

(260) AM 2022 112629 A  
(800) 1585868  
(151) 2020 08 31  
(181) 2030 08 31  
(891) 2020 08 31  
(511) 01, 03

---

(260) AM 2022 112758 A  
(800) 1587662  
(151) 2020 01 30  
(181) 2030 01 30  
(891) 2020 01 30  
(511) 18

---

(260) AM 2022 112830 A  
(800) 1472367  
(151) 2019 02 20  
(181) 2029 02 20  
(891) 2021 03 08  
(511) 06

---

(260) AM 2022 112798 A  
(800) 1588221  
(151) 2020 12 08  
(181) 2030 12 08  
(891) 2020 12 08  
(511) 27, 28

---

(260) AM 2022 112853 A  
(800) 1589143  
(151) 2021 03 15  
(181) 2031 03 15  
(891) 2021 03 15  
(511) 07

---

(260) AM 2022 112801 A  
(800) 1588272  
(151) 2020 12 09  
(181) 2030 12 09  
(891) 2020 12 09  
(511) 28

---

(260) AM 2022 112855 A  
(800) 1589203  
(151) 2021 03 01  
(181) 2031 03 01  
(891) 2021 03 01  
(511) 29, 30, 41

---

(260) AM 2022 112826 A  
(800) 1292222  
(151) 2016 02 15  
(181) 2026 02 15  
(891) 2021 04 13  
(511) 02

---

(260) AM 2022 112856 A  
(800) 1589210  
(151) 2021 02 19  
(181) 2031 02 19  
(891) 2021 02 19  
(511) 05

---

(260) AM 2022 112827 A  
(800) 1382773  
(151) 2017 10 31  
(181) 2027 10 31  
(891) 2021 03 09  
(511) 11

---

(260) AM 2022 112857 A  
(800) 1589212  
(151) 2021 02 19  
(181) 2031 02 19  
(891) 2021 02 19  
(511) 05

---

(260) AM 2022 112828 A  
(800) 1383484  
(151) 2017 11 21  
(181) 2027 11 21  
(891) 2021 04 12  
(511) 09, 36, 42

---

(260) AM 2022 112858 A  
(800) 1589218  
(151) 2021 03 17  
(181) 2031 03 17  
(891) 2021 03 17  
(511) 01

---

(260) AM 2022 112829 A  
(800) 1402882  
(151) 2017 09 13  
(181) 2027 09 13  
(891) 2021 03 29  
(511) 03, 05, 29, 32, 35

---

(260) AM 2022 112872 A  
(800) 1589710  
(151) 2021 01 05  
(181) 2031 01 05  
(891) 2021 01 05  
(511) 12, 37

---

(260) AM 2022 112874 A  
(800) 1589743  
(151) 2021 02 18  
(181) 2031 02 18  
(891) 2021 02 18  
(511) 29, 30, 41

---

(260) AM 2022 112885 A  
(800) 1590081  
(151) 2021 03 25  
(181) 2031 03 25  
(891) 2021 03 25  
(511) 03, 29, 30, 32, 35

---

(260) AM 2022 112875 A  
(800) 1589775  
(151) 2020 11 05  
(181) 2030 11 05  
(891) 2020 11 05  
(511) 19

---

(260) AM 2022 112886 A  
(800) 1590091  
(151) 2021 01 27  
(181) 2031 01 27  
(891) 2021 01 27  
(511) 29, 31, 32

---

(260) AM 2022 112876 A  
(800) 1589809  
(151) 2020 11 20  
(181) 2030 11 20  
(891) 2020 11 20  
(511) 09, 28, 41

---

(260) AM 2022 112887 A  
(800) 368772  
(151) 1970 07 01  
(181) 2030 07 01  
(891) 2021 02 22  
(511) 01, 16

---

(260) AM 2022 112880 A  
(800) 1589939  
(151) 2021 03 16  
(181) 2031 03 16  
(891) 2021 03 16  
(511) 16, 18

---

(260) AM 2022 112888 A  
(800) 415593  
(151) 1975 05 26  
(181) 2025 05 26  
(891) 2021 03 11  
(511) 05

---

(260) AM 2022 112881 A  
(800) 1589957  
(151) 2020 12 07  
(181) 2030 12 07  
(891) 2020 12 07  
(511) 07, 09, 12, 38, 42

---

(260) AM 2022 112946 A  
(800) 1590314  
(151) 2021 01 12  
(181) 2031 01 12  
(891) 2021 01 12  
(511) 11, 18

---

(260) AM 2022 112882 A  
(800) 1590019  
(151) 2021 01 08  
(181) 2031 01 08  
(891) 2021 01 08  
(511) 12, 35, 36, 37, 39, 41

---

(260) AM 2022 112947 A  
(800) 1590327  
(151) 2021 03 05  
(181) 2031 03 05  
(891) 2021 03 05  
(511) 42

---

(260) AM 2022 112883 A  
(800) 1590068  
(151) 2021 02 09  
(181) 2031 02 09  
(891) 2021 02 09  
(511) 03, 05

---

(260) AM 2022 112948 A  
(800) 1590331  
(151) 2021 02 25  
(181) 2031 02 25  
(891) 2021 02 25  
(511) 18

---

(260) AM 2022 112949 A  
(800) 1590352  
(151) 2021 02 09  
(181) 2031 02 09  
(891) 2021 02 09  
(511) 03

---

(260) AM 2022 112963 A  
(800) 1590680  
(151) 2020 11 19  
(181) 2030 11 19  
(891) 2020 11 19  
(511) 29, 30, 43

---

(260) AM 2022 112951 A  
(800) 1590375  
(151) 2021 03 03  
(181) 2031 03 03  
(891) 2021 03 03  
(511) 05

---

(260) AM 2022 112964 A  
(800) 1590708  
(151) 2020 12 16  
(181) 2030 12 16  
(891) 2020 12 16  
(511) 06, 11, 40

---

(260) AM 2022 112952 A  
(800) 1590395  
(151) 2021 03 03  
(181) 2031 03 03  
(891) 2021 03 03  
(511) 09

---

(260) AM 2022 112966 A  
(800) 1590745  
(151) 2021 02 07  
(181) 2031 02 07  
(891) 2021 02 07  
(511) 06

---

(260) AM 2022 112953 A  
(800) 1590399  
(151) 2020 11 19  
(181) 2030 11 19  
(891) 2020 11 19  
(511) 29, 30, 43

---

(260) AM 2022 112972 A  
(800) 1590854  
(151) 2021 01 26  
(181) 2031 01 26  
(891) 2021 01 26  
(511) 03, 05

---

(260) AM 2022 112955 A  
(800) 1590541  
(151) 2020 11 10  
(181) 2030 11 10  
(891) 2020 11 10  
(511) 09, 15, 16, 36, 37, 38, 41

---

(260) AM 2022 112973 A  
(800) 1590856  
(151) 2021 04 09  
(181) 2031 04 09  
(891) 2021 04 09  
(511) 03

---

(260) AM 2022 112956 A  
(800) 1590553  
(151) 2021 01 15  
(181) 2031 01 15  
(891) 2021 01 15  
(511) 04

---

(260) AM 2022 112983 A  
(800) 1591088  
(151) 2021 03 29  
(181) 2031 03 29  
(891) 2021 03 29  
(511) 31

---

(260) AM 2022 112958 A  
(800) 1590587  
(151) 2020 11 13  
(181) 2030 11 13  
(891) 2020 11 13  
(511) 03

---

(260) AM 2022 112987 A  
(800) 1591241  
(151) 2021 03 08  
(181) 2031 03 08  
(891) 2021 03 08  
(511) 25

---

(260) AM 2022 112988 A  
(800) 1591255  
(151) 2021 02 11  
(181) 2031 02 11  
(891) 2021 02 11  
(511) 01, 02, 16, 17

---

(260) AM 2022 113063 A  
(800) 1591990  
(151) 2020 12 07  
(181) 2030 12 07  
(891) 2020 12 07  
(511) 12

---

(260) AM 2022 112990 A  
(800) 1591290  
(151) 2020 10 10  
(181) 2030 10 10  
(891) 2020 10 10  
(511) 03, 05, 16, 35, 39

---

(260) AM 2022 113064 A  
(800) 1592010  
(151) 2020 12 15  
(181) 2030 12 15  
(891) 2020 12 15  
(511) 38, 41, 42

---

(260) AM 2022 112991 A  
(800) 1591381  
(151) 2021 03 15  
(181) 2031 03 15  
(891) 2021 03 15  
(511) 01, 02, 19, 37

---

(260) AM 2022 113065 A  
(800) 1592019  
(151) 2021 03 27  
(181) 2031 03 27  
(891) 2021 03 27  
(511) 39

---

(260) AM 2022 112992 A  
(800) 1591477  
(151) 2021 02 10  
(181) 2031 02 10  
(891) 2021 02 10  
(511) 30

---

(260) AM 2022 113066 A  
(800) 1592031  
(151) 2021 03 05  
(181) 2031 03 05  
(891) 2021 03 05  
(511) 42

---

(260) AM 2022 113005 A  
(800) 1544237  
(151) 2020 06 24  
(181) 2030 06 24  
(891) 2021 04 07  
(511) 05

---

(260) AM 2022 113080 A  
(800) 1592521  
(151) 2021 03 10  
(181) 2031 03 10  
(891) 2021 03 10  
(511) 09

---

(260) AM 2022 113052 A  
(800) 1591590  
(151) 2020 12 30  
(181) 2030 12 30  
(891) 2020 12 30  
(511) 09, 16, 35, 36, 37, 41, 42

---

(260) AM 2022 113081 A  
(800) 1592579  
(151) 2021 02 26  
(181) 2031 02 26  
(891) 2021 02 26  
(511) 35

---

(260) AM 2022 113061 A  
(800) 1591973  
(151) 2020 12 21  
(181) 2030 12 21  
(891) 2020 12 21  
(511) 03, 04, 35

---

(260) AM 2022 113082 A  
(800) 1592613  
(151) 2021 03 24  
(181) 2031 03 24  
(891) 2021 03 24  
(511) 01

---

(260) AM 2022 113083 A  
(800) 1592632  
(151) 2021 02 10  
(181) 2031 02 10  
(891) 2021 02 10  
(511) 05, 38, 42, 44

---

(260) AM 2022 113154 A  
(800) 1593075  
(151) 2021 03 19  
(181) 2031 03 19  
(891) 2021 03 19  
(511) 25

---

(260) AM 2022 113084 A  
(800) 1592648  
(151) 2021 03 17  
(181) 2031 03 17  
(891) 2021 03 17  
(511) 05

---

(260) AM 2022 113155 A  
(800) 1593107  
(151) 2021 03 19  
(181) 2031 03 19  
(891) 2021 03 19  
(511) 25

---

(260) AM 2022 113085 A  
(800) 1592697  
(151) 2021 01 14  
(181) 2031 01 14  
(891) 2021 01 14  
(511) 05, 31

---

(260) AM 2022 113156 A  
(800) 1593119  
(151) 2020 07 01  
(181) 2030 07 01  
(891) 2020 07 01  
(511) 05, 09, 10, 41, 44

---

(260) AM 2022 113089 A  
(800) 1592747  
(151) 2021 03 23  
(181) 2031 03 23  
(891) 2021 03 23  
(511) 05

---

(260) AM 2022 113157 A  
(800) 1593164  
(151) 2020 11 19  
(181) 2030 11 19  
(891) 2020 11 19  
(511) 18

---

(260) AM 2022 113090 A  
(800) 1592809  
(151) 2021 03 16  
(181) 2031 03 16  
(891) 2021 03 16  
(511) 05

---

(260) AM 2022 113159 A  
(800) 1593369  
(151) 2020 07 01  
(181) 2030 07 01  
(891) 2020 07 01  
(511) 05, 09, 10, 41, 44

---

(260) AM 2022 113091 A  
(800) 1059251  
(151) 2010 09 22  
(181) 2030 09 22  
(891) 2021 04 29  
(511) 03, 05, 29

---

(260) AM 2022 113160 A  
(800) 1593373  
(151) 2020 07 01  
(181) 2030 07 01  
(891) 2020 07 01  
(511) 05, 09, 10, 41, 44

---

(260) AM 2022 113153 A  
(800) 1592960  
(151) 2021 03 25  
(181) 2031 03 25  
(891) 2021 03 25  
(511) 05

---

(260) AM 2022 113161 A  
(800) 1593415  
(151) 2020 07 01  
(181) 2030 07 01  
(891) 2020 07 01  
(511) 05, 09, 10, 41, 44

---

---

(260) AM 2022 113162 A  
(800) 1593518  
(151) 2021 03 05  
(181) 2031 03 05  
(891) 2021 03 05  
(511) 09

---

---

(260) AM 2022 113294 A  
(800) 1594253  
(151) 2021 04 08  
(181) 2031 04 08  
(891) 2021 04 08  
(511) 01, 17

---

---

(260) AM 2022 113163 A  
(800) 1593534  
(151) 2021 04 05  
(181) 2031 04 05  
(891) 2021 04 05  
(511) 45

---

---

(260) AM 2022 113295 A  
(800) 1594455  
(151) 2020 12 03  
(181) 2030 12 03  
(891) 2020 12 03  
(511) 09, 16, 35, 36, 37, 38, 41, 42

---

---

(260) AM 2022 113174 A  
(800) 1286641  
(151) 2016 01 04  
(181) 2026 01 04  
(891) 2020 11 11  
(511) 28

---

---

(260) AM 2022 113296 A  
(800) 1594466  
(151) 2021 03 12  
(181) 2031 03 12  
(891) 2021 03 12  
(511) 35, 36

---

---

(260) AM 2022 113176 A  
(800) 1320188  
(151) 2016 09 12  
(181) 2026 09 12  
(891) 2021 05 11  
(511) 03, 05, 30

---

---

(260) AM 2022 113297 A  
(800) 1594479  
(151) 2021 01 28  
(181) 2031 01 28  
(891) 2021 01 28  
(511) 05, 31

---

---

(260) AM 2022 113288 A  
(800) 1593993  
(151) 2020 09 29  
(181) 2030 09 29  
(891) 2020 09 29  
(511) 05, 09, 10

---

---

(260) AM 2022 113302 A  
(800) 1594568  
(151) 2021 04 07  
(181) 2031 04 07  
(891) 2021 04 07  
(511) 05

---

---

(260) AM 2022 113289 A  
(800) 1594014  
(151) 2020 12 18  
(181) 2030 12 18  
(891) 2020 12 18  
(511) 19, 20, 21

---

---

(260) AM 2022 113303 A  
(800) 1594577  
(151) 2021 04 05  
(181) 2031 04 05  
(891) 2021 04 05  
(511) 05

---

---

(260) AM 2022 113290 A  
(800) 1594086  
(151) 2021 03 04  
(181) 2031 03 04  
(891) 2021 03 04  
(511) 09, 41

---

---

(260) AM 2022 113305 A  
(800) 1594613  
(151) 2021 04 07  
(181) 2031 04 07  
(891) 2021 04 07  
(511) 07, 09, 10, 11, 21

---

(260) AM 2022 113306 A  
(800) 1594614  
(151) 2021 04 05  
(181) 2031 04 05  
(891) 2021 04 05  
(511) 05

---

(260) AM 2022 113313 A  
(800) 1594750  
(151) 2021 03 25  
(181) 2031 03 25  
(891) 2021 03 25  
(511) 05

---

(260) AM 2022 113307 A  
(800) 1594639  
(151) 2020 07 15  
(181) 2030 07 15  
(891) 2020 07 15  
(511) 05

---

(260) AM 2022 113438 A  
(800) 1595303  
(151) 2021 04 21  
(181) 2031 04 21  
(891) 2021 04 21  
(511) 33

---

(260) AM 2022 113308 A  
(800) 1594669  
(151) 2021 02 19  
(181) 2031 02 19  
(891) 2021 02 19  
(511) 30

---

(260) AM 2022 113440 A  
(800) 1595371  
(151) 2021 04 05  
(181) 2031 04 05  
(891) 2021 04 05  
(511) 05

---

(260) AM 2022 113309 A  
(800) 1594683  
(151) 2021 04 08  
(181) 2031 04 08  
(891) 2021 04 08  
(511) 05

---

(260) AM 2022 113441 A  
(800) 1595392  
(151) 2021 01 26  
(181) 2031 01 26  
(891) 2021 01 26  
(511) 35, 41, 44

---

(260) AM 2022 113310 A  
(800) 1594688  
(151) 2021 02 04  
(181) 2031 02 04  
(891) 2021 02 04  
(511) 02

---

(260) AM 2022 113443 A  
(800) 1595420  
(151) 2021 04 09  
(181) 2031 04 09  
(891) 2021 04 09  
(511) 09

---

(260) AM 2022 113311 A  
(800) 1594702  
(151) 2021 02 05  
(181) 2031 02 05  
(891) 2021 02 05  
(511) 09, 28, 41

---

(260) AM 2022 113454 A  
(800) 1595761  
(151) 2020 11 27  
(181) 2030 11 27  
(891) 2020 11 27  
(511) 18, 25, 35

---

(260) AM 2022 113312 A  
(800) 1594744  
(151) 2021 02 05  
(181) 2031 02 05  
(891) 2021 02 05  
(511) 09, 28, 41

---

(260) AM 2022 113455 A  
(800) 1595766  
(151) 2021 04 02  
(181) 2031 04 02  
(891) 2021 04 02  
(511) 05

---



(260) AM 2022 113456 A  
(800) 1595790  
(151) 2021 01 26  
(181) 2031 01 26  
(891) 2021 01 26  
(511) 03, 05

---

(260) AM 2022 113567 A  
(800) 695736  
(151) 1998 06 17  
(181) 2028 06 17  
(891) 2021 01 14  
(511) 03

---

(260) AM 2022 113457 A  
(800) 1595869  
(151) 2021 04 07  
(181) 2031 04 07  
(891) 2021 04 07  
(511) 29

---

(260) AM 2022 113570 A  
(800) 1227975  
(151) 2014 07 25  
(181) 2024 07 25  
(891) 2021 04 14  
(511) 25

---

(260) AM 2022 113481 A  
(800) 1578267  
(151) 2021 01 29  
(181) 2031 01 29  
(891) 2021 04 26  
(511) 09

---

(260) AM 2022 113571 A  
(800) 1247362  
(151) 2015 03 31  
(181) 2025 03 31  
(891) 2021 05 19  
(511) 03

---

(260) AM 2022 113530 A  
(800) 1596502  
(151) 2020 12 10  
(181) 2030 12 10  
(891) 2020 12 10  
(511) 21

---

(260) AM 2022 113572 A  
(800) 1365502  
(151) 2017 06 02  
(181) 2027 06 02  
(891) 2021 05 18  
(511) 44

---

(260) AM 2022 113531 A  
(800) 1596534  
(151) 2021 03 18  
(181) 2031 03 18  
(891) 2021 03 18  
(511) 05

---

(260) AM 2022 113573 A  
(800) 1503204  
(151) 2019 11 07  
(181) 2029 11 07  
(891) 2021 06 01  
(511) 09

---

(260) AM 2022 113563 A  
(800) 1597361  
(151) 2020 12 30  
(181) 2030 12 30  
(891) 2020 12 30  
(511) 03, 05, 10, 44

---

(260) AM 2022 113574 A  
(800) 1543882  
(151) 2020 07 01  
(181) 2030 07 01  
(891) 2021 05 28  
(511) 05

---

(260) AM 2022 113565 A  
(800) 1597380  
(151) 2021 02 18  
(181) 2031 02 18  
(891) 2021 02 18  
(511) 07, 09, 10, 12, 20, 28

---

(260) AM 2022 113575 A  
(800) 1546175  
(151) 2020 07 01  
(181) 2030 07 01  
(891) 2021 05 28  
(511) 05

---

(260) AM 2022 113673 A  
(800) 1006010  
(151) 2009 02 24  
(181) 2029 02 24  
(891) 2021 04 22  
(511) 05

---

(260) AM 2022 113674 A  
(800) 1023697  
(151) 2009 10 05  
(181) 2029 10 05  
(891) 2021 06 03  
(511) 29, 30

---

(260) AM 2022 113675 A  
(800) 1226748  
(151) 2014 10 06  
(181) 2024 10 06  
(891) 2021 06 07  
(511) 05, 10

---

(260) AM 2022 113715 A  
(800) 1599180  
(151) 2021 04 21  
(181) 2031 04 21  
(891) 2021 04 21  
(511) 09

---

(260) AM 2022 113731 A  
(800) 1599723  
(151) 2021 03 15  
(181) 2031 03 15  
(891) 2021 03 15  
(511) 35, 36, 39

---

(260) AM 2022 113743 A  
(800) 1600161  
(151) 2021 04 21  
(181) 2031 04 21  
(891) 2021 04 21  
(511) 05

---

---

# GEOGRAPHICAL INDICATIONS

In accordance with the Article 8.4 of the Law on Appellations of Origin and Geographical Indications, the LEPL National Intellectual Property Centre of Georgia – SAKPATENTI publishes the materials on Geographical Indications "Ajika" and "Tkemali" represented by the Ministry of Environmental Protection and Agriculture of Georgia.

If no additional information will be arrived to SAKPATENTI within 3 months after publication, the information shall be submitted into the State Register of Appellations of Origin and Geographical Indications, and published in the Official Bulletin of Industrial Property of Georgia.

If, within 3 months after the publication of application materials, additional information regarding these materials is submitted to SAKPATENTI, it shall be sent to the Ministry of Environmental Protection and Agriculture of Georgia for the review.

## AJIKA SPECIFICATION

**APPLICATION №** 3509/7

**DATE OF APPLICATION:** 25/08/2021

**GEOGRAPHICAL INDICATION:** AJIKA

**NAME OF PRODUCT FOR WHICH THE REGISTRATION IS REQUIRED:** Ajika (Condiment)

**NAME AND ADDRESS OF APPLICANT:** The Ministry of Environmental Protection and Agriculture of Georgia: Marshal Gelovani Ave. 6, 0159 Tbilisi, Georgia

### 1. NAME: AJIKA

### 2. ADDITIONAL SIGNS

"Ajika" is a spice/condiment having pasty consistency. It is widely used in both in the preparation of dishes and independently, as a spice on the table.

"Ajika" has been prepared in Georgia during many centuries, primarily based on slightly different recipes in Abkhazia and Samegrelo.<sup>1</sup> Currently, "Ajika" production, in its variations, is already widespread throughout Georgia and is very popular among the population.

Recipes for "Ajika" preparation were passed down orally or in writing form from generation to generation. According to the recipe used, "Ajika" is characterized with different levels of spiciness and aroma.

According to these recipes, the necessary ingredients of the product are: red hot pepper, salt, garlic, dried spices and blue melilot. According to the recipes, it is also allowed to add grinded or crushed walnuts, nuts, sunflower seeds and various herbs (dried and fresh). In order to reduce the spiciness, it is possible to replace the hot pepper with Bulgarian pepper (Lat. *Capsicum annum* L) partially, as well.

Diligent preparation makes "Ajika" – homogeneous, thickened spicy mass having dark red or reddish-brown color.

Fresh green pepper can be used instead of red pepper for "Ajika" preparation. In this case "Ajika" already has greenish tinge.

---

<sup>1</sup> Wikipedia –<https://ka.wikipedia.org/wiki/%E1%83%90%E1%83%AF%E1%83%98%E1%83%99%E1%83%90>

Rich and unique aroma of "Ajika" finished product should be emphasized, which is due to diligent processing of ingredients and, as a result, intensive separation of ethers from fresh materials.

The uniqueness of flavor, among other features, is due to the fact that the herbs grown and spices prepared in Georgia, usually distinguished with taste and aroma are used at product preparation.

### **3. METHOD OF PREPARATION:**

- Dried red pepper is washed, peeled, moistened, and dried in hang position;
- Dried red pepper is grinded in meat grinder. In the case of Ajika preparation with less spiciness, pepper is pre-cleaned from the seeds;
- The pepper is ground first coarsely, then finely;
- Pre-chopped garlic and condiments are added therein, and received mass is grinded several times in a grid;
- Received mass is salted, boiled cooled water is added therein, and it is stirred vigorously until obtaining of thick homogeneous mass;
- Then, according of taste, other ingredients are added.

The mass previously grinded in meat grinder is used in the case of "Ajika" preparation with green pepper.

### **4. GEOGRAPHICAL AREA**

Pepper, garlic, fresh herbs and dried spices used as finished product for "Ajika" preparation shall be produced only in the territory of Georgia. Ingredients such as walnuts, nuts, sunflower seeds and salt can be of non-Georgian origin too.

### **5. LINK WITH GEOGRAPHICAL AREA**

It should be noted that "Ajika" is uniquely of Abkhazian<sup>2</sup> origin, which is confirmed by its original name "Apirpil-Jika" (in Abkhazian language pepper salt). The area of further distribution of this product under the name "Ajika" became Samegrelo, later – Western Georgia and Georgia in whole.

According to one of legends,<sup>3</sup> the origin of "Apirpil-Jika" is related to Abkhazian shepherds stayed for long time in the mountains, on alpine pastures, to herd sheep. In order to diversify the meager ration consisting of only lamb and sheep milk, the shepherds added a mixture of herbs and salt to their meal.

Salt was obtained from the stock provided by cattle owners to feed the sheep (salt awakens the appetite of cattle, therefore, they consume more water and more food increasing their weight). Since salt was very expensive product at the time, hired shepherds stole it for their own consumption.

To prevent theft, the owners threw hot peppers on sheep food. However, salt with pepper turned out to be more interesting for shepherds. Moreover, further mixing of salt with pepper, spices and herbs further improved its taste characteristics.

Because like other products imported from America to Europe, the pepper spread in Georgia in the 15th century, we must assume that the origin of "Apirpil-Jika" is also related to this period.

Traditionally, in Abkhazia the pepper was sown in March. It was harvested when even the lowest fruit was reddened. After that, the tied pepper was hung and dried in "apatskha" – spinning hut (same "patskha" – a farm house or dwelling).

Abkhazian "Apirpil-Jika" was prepared in special vessel, flat stone, so called – "akhakia", having small depression in the middle. On the surface of second stone ("apkhniga") the ingredients of "Apirpil-Jika" were rubbed with two hands for a long time, until obtaining homogeneous mass. If desired, pepper was cleaned from the seeds to alleviate the bitterness, spiciness.

---

<sup>2</sup> <https://ka.wikipedia.org/wiki/%E1%83%90%E1%83%A4%E1%83%AE%E1%83%90%E1%83%96%E1%83%94%E1%83%97%E1%83%98>

<sup>3</sup> <https://imedinews.ge/ge/kultura/86432/ajikas-aramaterialuri-kulturuli-memkvidreobis-dzeglis-statusi-mienicha>

As mentioned, the original recipe underwent a number of changes. If in the old times the pepper was smoked for "Apirpil-Jika" preparation. Now less people use this method, and the pepper is dried without the use of smoke. In addition, instead of "akhakia", the families use more convenient tool for crushing pepper – "kvasanaki" – the mortar with pestle or meat grinder, while the enterprises use relatively high-performance technical equipment for this purpose.

Only a few ingredients were used for classic Abkhazian "Apirpil-Jika" preparation: red hot pepper, salt, garlic and dried coriander.

Currently, walnut, various spices and herbs added with taste are considered as traditional ingredients for "Ajika" preparation.

It is especially important to note that by the order 202/67 of November 19, 2018, of the Director General of the National Agency for Cultural Heritage Preservation of Georgia, the status of monument of intangible cultural heritage was granted to the technology of preparation of Abkhazian "Apirpil-Jika" and Megrelian "Ajika",<sup>4</sup> that is a clear confirmation of the indigenous origin and high reputation of this product.

Today in the Georgian market exist different varieties of "Ajika", prepared in the family and industrially, as well. "Ajika" is one of the most important attributes of national dishes and Georgian table as a whole, which, along with other spices, has an honorable place in the menu of local restaurants.

## 6. CONFIRMATION OF ORIGIN

The control of production process in Georgia is ensured by the use of labeling of each individual batch of products on the market and the traceability marks on packaging of individual products, as well as records of purchases, products and sales prepared by manufacturers.

## 7. LABELING

The name shall appear on product label as follows:

With Georgian characters – დაცული გეოგრაფიული აღნიშვნა „აჯიკა“

With Abkhazian characters – Ихъчоу Агеографиаџ Дырга "АЦЪЫКА"

With Lathin characters – **Protected Geographical Indication and/or PGI "AJIKA"**

With Cyrillic characters – **Охраняемое Географическое Указание "АДЖИКА"**

It is also advisable to indicate the ingredients that are different from the main, taste-enhancing ingredients on the label, which shall be marked with lower case letters than the letters used for geographical indication.

## 8. CONTROL BODY

State control for observance of production specification shall be carried out by LEPL – National Food Agency.

<sup>4</sup> Register of Intangible Monuments; Abkhazian Salt "Apropiljika" and Megrelian "Ajika" Preparation Technology; reg. №44. [https://www. heritagesites.ge/uploads/files/60b68d3b8fbb4.pdf](https://www.heritagesites.ge/uploads/files/60b68d3b8fbb4.pdf)

# TKEMALI

## SPECIFICATION

**APPLICATION №** 3511/7

**DATE OF APPLICATION:** 03/09/2021

**GEOGRAPHICAL INDICATION:** TKEMALI

**NAME OF PRODUCT FOR WHICH THE REGISTRATION IS REQUIRED:** Tkemali (Sauce)

**NAME AND ADDRESS OF APPLICANT:** The Ministry of Environmental Protection and Agriculture of Georgia: Marshal Gelovani Ave. 6, 0159 Tbilisi, Georgia

### 1. NAME: TKEMALI

### 2. ADDITIONAL SIGNS

"Tkemali" – cherry plum sauce is a Georgian sauce having thick consistency, prepared on the basis of traditional recipes, and its varieties are widely spread throughout Georgia.

Main fresh material of this sauce is the fruit of cherry plum (Lat. *Prúnus cerasiféra*). By color it can be yellow, red and purple. Currently found wild as cultivated varieties. Varieties distinguished accordingly zones in Georgia are: Guldedava, Gazapkhulis Mertskali, Tsiteli Drosha, Kutaisi, Rioni, Khvaviani, etc. Wild as cultivated varieties of plant can be used to make cherry plum sauces "Tkemali".

Except cherry plum, the main ingredients of the finished product are: garlic, pennyroyal, coriander, fennel, dill (or spices prepared from herbs), pepper, salt and sugar (with taste). Important in the recipe of "Tkemali" is pennyroyal (Lat. *Mentha pulegium*), which gives cherry plum sauce a distinctive and unique aroma, with which this sauce is so famous.

In accordance to cherry plum color used to make sauce "Tkemali", it can be green, dark reddish, brown or yellow.

Instead of cherry plum, the alucha (Lat. *Prunus Vachushtii*) is used as fresh material of sauce and damson (Lat. *Prunus insititia*), as well. Depending on the taste, it is also allowed to use other fruits or their mixtures as ingredients so that the amount of added fruit does not exceed 15% of the total amount.

"Tkemali" is characterized by variety of aromas and has pleasant taste that evokes balanced spiciness and sourness, which is due to the herbs used in Georgia and spices prepared from them, which are distinguished by their taste characteristics and aromas.

"Tkemali" is rich with organic acids, hydrocarbons, microelements, pectins and vitamins C, B<sub>1</sub>, B<sub>2</sub>, PP and E.

### 3. METHOD FOR PREPARATION

The fresh materials for sauce preparation shall be healthy and undamaged. Fruit picking should be done manually, however, the use of mechanized means is also allowed. Ripe as immature cherry plum is harvested.

According to the ingredients used, ratio and preparation methods, there are basically two types of "Tkemali": fresh, green, usually prepared in the spring or beginning of summer, with still green, unripe cherry plum and/or alucha, and prepared for winter with ripe fruit.

### **3.1. METHOD FOR FRESH GREEN TKEMALI PREPARATION**

Selected and washed unripe green cherry plum and/or alucha is boiled over low heat in water until completely softened. In the case of alucha, the relatively small amount of water is needed, because at high temperatures it excretes its own juice abundantly;

After cooling and draining the broth, the fruit softened mass is gently rubbed until the its complete peeling and separating from stones;

If necessary, to obtain the consistency of sauce, the soft mass is sprinkled with cherry plum broth;

The spices for "Tkemali" are first finely shredded, and then, diligently crushed or grinded in meat grinder.

It should be noted that when herbs and garlic come in touch with metal, the taste properties are reduced, as aroma and the fresh color. Therefore, to get particularly high quality sauce, preference is given to spices crushed into the mortar with pestle.

### **3.2. METHOD FOR WINTER TKEMALI PREPARATION**

Selected and washed ripe cherry plum (or damson) is boiled like fresh unripe green cherry plum except that after mixing with spices, it needs to be boiled over a low heat for some time;

Unlike thereof, dried herbs are mostly used to keep "Tkemali" in winter;

To give the final commodity to "Tkemali" sauce, it is sterilized in a glass container that is hermetically sealed.

According to the recipe used, Tkemali" is characterized with different levels of sourness, spiciness and aroma.

## **4. GEOGRAPHICAL AREA**

Cherry plum (alucha, damson, etc. and fruit added with flavor), garlic, pepper, fresh herbs and spices used to make "Tkemali" sauces shall be produced only in Georgia.

## **5. LINK WITH GEOGRAPHICAL AREA**

Cherry plum culture is widespread in Georgia and thrives well at 1600-1800 m altitude above sea level. It does not depend on soil, is resistant to diseases, drought and frost-resistant fruit. It occupies 21-22% of total number of orchards, and 10% among stone fruits. Cherry plum plants are mainly located in Western Georgia, where about 20% of total area of orchards are occupied by cherry plum, however, it is very popular in Eastern Georgia, as well.

Cherry plum is high yielding plant. One adult tree yields 60-80 kg on average, and in some cases 300 kg or more can be harvested therefrom.

"Tkemali" is called visit card of Georgian table. It is recognized as first in Georgia, and there is no Georgian table without it. This sauce was often admired by the guests arrived in Georgia. It should be noted that the quality of "Tkemali" sauce is significantly determined with its special taste properties and distinctive aroma of locally grown cherry plum, as well as blending herbs and spices. The quality thereof is also greatly determined by the experience and craftsmanship of mixing therewith spices.

Today, "Tkemali" is prepared in all regions of Georgia, but Western Georgia is considered as motherland of it. Boiling of "Tkemali" here is special ritual, the performance whereof is honor of experienced housewives.

The rules and recipes for "Tkemali" preparation were passed down orally or in writing form from generation to generation. The earliest recipe can be found in the culinary book compiled by Barbara

Jorjadze in the XIX century: "Georgian Cuisine and Family Household Notes", published in 1874. Information about the procedure of "Tkemali" sauce preparation and its constituent ingredients is also given in other Georgian culinary literature published later, as well.

## 6. CONFIRMATION OF ORIGIN

The control of production process in Georgia is ensured by the use of labeling of each individual batch of products on the market and the traceability marks on packaging of individual products, as well as records of purchases, products and sales prepared by manufacturers.

## 7. LABELING

The name shall appear on product label as follows:

With Georgian characters – დაცული გეოგრაფიული აღნიშვნა „ტყემალი“

With Latin characters – **Protected Geographical Indication and/or PGI "TKEMALI"**

With Cyrillic characters – **Охраняемое Географическое Указание "ТКЕМАЛИ"**

However, if alucha or damson is used as main fresh material in "Tkemali" sauce preparation the name of main fresh material used should be indicated on the label, which shall be marked with lower case letters than the letters used for geographical indication.

## 8. CONTROL BODY

State control for observance of production specification shall be carried out by LEPL – National Food Agency.

## LITERATURE:

- T. Salukvadze, "Food for Healthy and Sick Person", Georgian SSR Medical Publishing, Tbilisi, 1954, p. 399-400;
- N. Khoperia, "Family Book", Publishing House "Soviet Georgia", Tbilisi, 1965, p. 115;
- Markozashvili, "Storage and Preservation of Fruits, Berries and Vegetables in Domestic Conditions", Publishing House "Soviet Georgia", Tbilisi, 1974, p. 138;
- Sh. Mumladze, " Rational Technology Processing for Obtaining Pectins Having Different Complex-Producing Properties from Industrial Cherry Plum Varieties", Publishing House "Meridiani", Tbilisi, 2011, p. 31;
- B. Jorjadze, "Complete Kitchen", Bakur Sulakauri Publishing House, Tbilisi, 2017, p. 177.



---

**OFFICIAL NOTIFICATIONS  
INVENTIONS  
RESTORATION OF PATENT**

(21) AP 2019 15052  
(11) P 2021 7209 B  
(73) Nugzar Abzhandadze  
(54) DEVICE FOR DANCING FOUNTAIN JETS CONTROL  
DATE OF PATENT CANCELLATION: 2022 04 19  
DATE OF PATENT RESTORATION: 2022 06 10

---

**ABOLITION OF PATENTS WITH THE RIGHT TO RESTORE**

(21) AP 2006 10433  
(11) P 2010 5055 B  
(73) Interdigital Technology Corporation  
(54) METHOD AND APPARATUS FOR POWER CONTROL IN A MULTIPLE ANTENNA SYSTEM  
DATE OF PATENT CANCELLATION: 2022 05 16  
LIMITED DATE OF PATENT RESTORATION: 2023 05 16

---

(21) AP 2012 12708  
(11) P 2014 6185 B  
(73) Miner Enterprises Inc.  
(54) RAILROAD FREIGHT CAR DRAFT GEAR  
DATE OF PATENT CANCELLATION: 2022 05 10  
LIMITED DATE OF PATENT RESTORATION: 2023 05 10

---

(21) AP 2012 13325  
(11) P 2017 6715 B  
(73) Takeda AS  
(54) ROLLED COLLAGEN CARRIER  
DATE OF PATENT CANCELLATION: 2022 05 24  
LIMITED DATE OF PATENT RESTORATION: 2023 05 24

---

(21) AP 2018 14792  
(11) P 2019 7023 B  
(73) Giorgi Loladze  
(54) METHOD FOR MAKING HEATEFFICIENT CONSTRUCTION COMPONENT  
DATE OF PATENT CANCELLATION: 2022 05 22  
LIMITED DATE OF PATENT RESTORATION: 2023 05 22

---

(21) AP 2018 15219  
(11) P 2021 7318 B  
(73) H. Lundbeck A/S  
(54) PYRAZOLE MAGL INHIBITORS  
DATE OF PATENT CANCELLATION: 2022 05 22  
LIMITED DATE OF PATENT RESTORATION: 2023 05 22

---

(21) AP 2004 8200  
(11) P 2006 3744 B  
(73) Giorgi Kakhiani  
(54) METHOD FOR PRODUCTION OF VACCINE AGAINST ANTHRAX  
DATE OF PATENT CANCELLATION: 2022 05 10  
LIMITED DATE OF PATENT RESTORATION: 2023 05 10

---

(21) AP 2005 9784  
(11) P 2009 4681 B  
(73) Takeda AS  
(54) AGGLOMERATION OF CALCIUM-CONTAINING COMPOUND OBTAINED BY ROLLER  
COMPACTION  
DATE OF PATENT CANCELLATION: 2022 05 24  
LIMITED DATE OF PATENT RESTORATION: 2023 05 24

---

(21) AP 2005 9802  
(11) P 2010 4896 B  
(73) Takeda AS  
(54) CHEWABLE, SUCKABLE AND SWALLOWABLE TABLET CONTAINING A CALCIUM-  
CONTAINING COMPOUND AS AN ACTIVE SUBSTANCE  
DATE OF PATENT CANCELLATION: 2022 05 24  
LIMITED DATE OF PATENT RESTORATION: 2023 05 24

---

## EXPIRATION OF TERMS OF RESTORATION OF PATENTS

(21) AP 2009 11256  
(11) P 2011 5286 B  
(73) Devi Vasadze  
(54) NOTIFICATION SYSTEM OF AIR-RAID PRECAUTIONS  
DATE OF PATENT CANCELLATION: 2021 05 15  
DATE OF PATENT RESTORATION VALIDITY HAS EXPIRED: 2022 05 15

---

(21) AP 2009 12035  
(11) P 2013 5857 B  
(73) Pierre Fabre Dermo-Cosmetique  
(54) EMOLLIENT COMPOSITION FOR ATOPIC DERMATITIS PREVENTIVE TREATMENT  
DATE OF PATENT CANCELLATION: 2021 05 18  
DATE OF PATENT RESTORATION VALIDITY HAS EXPIRED: 2022 05 18

---

(21) AP 2009 12036  
(11) P 2013 5900 B  
(73) Pierre Fabre Dermo-Cosmetique  
(54) EMOLLIENT COMPOSITION  
DATE OF PATENT CANCELLATION: 2021 05 18  
DATE OF PATENT RESTORATION VALIDITY HAS EXPIRED: 2022 05 18

---

(21) AP 2010 12453  
(11) P 2013 5965 B  
(73) Pierre Fabre Dermo-Cosmetique  
(54) USAGE OF DELTA-TOCOPHERYL- CARBOHYDRATE AS DEPIGMENTING AGENT  
DATE OF PATENT CANCELLATION: 2021 05 12  
DATE OF PATENT RESTORATION VALIDITY HAS EXPIRED: 2022 05 12

---

(21) AP 2010 12505  
(11) P 2015 6328 B  
(73) Millennium Pharmaceuticals, Inc.  
(54) SOLID PHARMACEUTICAL COMPOSITIONS AND PROCESSES FOR THEIR PRODUCTION  
DATE OF PATENT CANCELLATION: 2021 05 14  
DATE OF PATENT RESTORATION VALIDITY HAS EXPIRED: 2022 05 14

---

(21) AP 2012 13310  
(11) P 2015 6397 B  
(73) EGIS Gyógyszergyár Nyilvánosan Működő Részvénytársaság  
(54) PROCESS FOR THE PREPARATION OF A RIVAROXABAN AND INTERMEDIATES FORMED IN SAID PROCESS  
DATE OF PATENT CANCELLATION: 2021 05 04  
DATE OF PATENT RESTORATION VALIDITY HAS EXPIRED: 2022 05 04

---

(21) AP 2013 13659  
(11) P 2017 6754 B  
(73) Western University of Health Sciences;  
Tesorx Pharma LLC  
(54) PROLIPOSOMAL TESTOSTERONE FORMULATIONS  
DATE OF PATENT CANCELLATION: 2021 05 09  
DATE OF PATENT RESTORATION VALIDITY HAS EXPIRED: 2022 05 09

---

(21) AP 2016 14141  
(11) P 2019 7031 B  
(73) Perdinand Tavadze Institute of Metallurgy and Materials Studies  
(54) SEMICONDUCTOR ELECTRICAL MATERIAL, RADIATION-RESISTANT TO HARD EXPOSURE  
DATE OF PATENT CANCELLATION: 2021 05 11  
DATE OF PATENT RESTORATION VALIDITY HAS EXPIRED: 2022 05 11

---

(21) AP 2016 14142  
(11) P 2019 6986 B  
(73) Perdinand Tavadze Institute of Metallurgy and Materials Studies  
(54) METHOD FOR OBTAINING VOLUME CRYSTALS InAs-CaAs FROM HARD SOLUTIONS  
DATE OF PATENT CANCELLATION: 2021 05 11  
DATE OF PATENT RESTORATION VALIDITY HAS EXPIRED: 2022 05 11

---

(21) AP 2015 14335  
(11) P 2018 6888 B  
(73) JSC "OLAINPHARM"  
(54) PHARMACEUTICAL COMPOSITION FOR THE PREVENTION AND TREATMENT OF DISEASES ASSOCIATED WITH ELEVATED INDUCIBLE NITRIC OXIDE SYNTHASE  
DATE OF PATENT CANCELLATION: 2021 05 14  
DATE OF PATENT RESTORATION VALIDITY HAS EXPIRED: 2022 05 14

---

(21) AP 2018 14777  
(11) P 2020 7077 B  
(73) Akaki Tsereteli State University;  
Merab Shalamberidze  
(54) POLYMERIC COMPOSITION FOR ORTHOPAEDIC SUPINATORS PRODUCTION  
DATE OF PATENT CANCELLATION: 2021 05 10  
DATE OF PATENT RESTORATION VALIDITY HAS EXPIRED: 2022 05 10

---

(21) AP 2005 9737  
(11) P 2012 5462 B  
(73) Interdigital Technology Corporation  
(54) მოწყობილობა და ხერხი საგანგებო გამომახვებების ხელშეწყობისათვის უსადენო  
ლოკალურ ქსელში  
DATE OF PATENT CANCELLATION: 2021 05 09  
DATE OF PATENT RESTORATION VALIDITY HAS EXPIRED: 2022 05 09

---

## EXPIRATION OF TERMS OF PATENTS

(21) AP 2002 7200  
(11) P 2006 3784 B  
(73) Pfizer Product Inc.  
(54) OPTICAL RESOLUTION OF (1-BENZYL-4-METHYLPYPERIDIN-3-YL) -METHYLAMINE  
ENANTIOMERS AND USE THEREOF FOR PREPARATION OF PYRROLO 2,3-PYRIMIDINE  
DERIVATIVES AS PROTEIN KINASES INHIBITORS  
DATE OF PATENT EXPIRATION: 29 05 2022

---

(21) AP 2002 7204  
(11) P 2006 3810 B  
(73) BRF S.A..  
(54) ALIMENTARY COMPOSITION COMPRISING DIETARY FIBRES, AS WELL AS USE THEREOF IN  
PREPARATION OF ALIMENTARY PRODUCTS  
DATE OF PATENT EXPIRATION: 29 05 2022

---

## CHANGES OF NAME AND/OR ADDRESSES OF PATENTOWNERS

(21) AP 2014 14132  
(11) P 2021 7330 B  
(54) LABELED INHIBITORS OF PROSTATE SPECIFIC MEMBRANE ANTIGEN (PSMA), THEIR USE AS  
IMAGING AGENTS AND PHARMACEUTICAL AGENTS FOR THE TREATMENT OF PROSTATE  
CANCER

NEW NAME AND NEW ADDRESS:	Deutsches Krebsforschungszentrum (DE) Im Neuenheimer Feld 280, 69120 Heidelberg, Germany (DE); Ruprecht-Karls-Universität Heidelberg (DE) Grabengasse 1, 69117 Heidelberg, Germany (DE)
FORMER NAME AND FORMER ADDRESS:	Deutsches Krebsforschungszentrum (DE) Im Neuenheimer Feld 280, 69120 Heidelberg, Germany (DE); Ruprecht-Karls-Universität Heidelberg (DE) Grabengasse 1, 69117 Heidelberg, Germany (DE)
DATE OF REGISTRATION: 2022 03 29	2022 05 25

---

(21) AP 2016 14600  
(11) P 2021 7282 B  
(54)  $\beta$ -D-2'-DEOXY-2' $\alpha$ -FLUORO-2'- $\beta$ -C-SUBSTITUTED-2-MODIFIED-N6-SUBSTITUTED  
PURINE NUCLEOTIDES FOR HCV TREATMENT  
NEW NAME AND NEW ADDRESS: Atea Pharmaceuticals Inc. (US)  
125 Summer Street Boston, MA 02110, USA (US)  
FORMER NAME AND FORMER ADDRESS: Atea Pharmaceuticals Inc. (US)  
125 Summer Street Boston, MA 02110, USA (US)  
DATE OF REGISTRATION: 2022 03 29 2022 06 02

---

## UTILITY MODELS RESTORATION OF PATENT

(21) AU 2018 14765  
(11) U 2019 2013 Y  
(73) Lali Ghurtchumelia  
(54) FIRE EXTINGUISHING POWDER  
DATE OF PATENT CANCELLATION: 2022 04 24  
DATE OF PATENT RESTORATION: 2022 06 10

---

## EXPIRATION OF TERMS OF RESTORATION OF PATENTS

(21) AU 2013 13085  
(11) U 2014 1803 Y  
(73) Zviad Gugava  
(54) SPICERY  
DATE OF PATENT CANCELLATION: 2021 05 10  
DATE OF PATENT RESTORATION VALIDITY HAS EXPIRED: 2022 05 10

---

(21) AU 2014 13472  
(11) U 2015 1875 Y  
(73) Gocha Chakhaia;  
Zurab Varazashvili;  
Levan Tsulukidze  
(54) FIRE EXTINGUISHING POWDER  
DATE OF PATENT CANCELLATION: 2021 05 16  
DATE OF PATENT RESTORATION VALIDITY HAS EXPIRED: 2022 05 16

---

(21) AU 2018 14779  
(11) U 2019 2016 Y  
(73) Revaz Sikharulidze  
(54) ARMATURE FRAMEWORK FOR HEAT-INSULATING CEILING PLATE  
DATE OF PATENT CANCELLATION: 2021 05 11  
DATE OF PATENT RESTORATION VALIDITY HAS EXPIRED: 2022 05 11

---

## DESIGNS

### EXTENSION OF TERMS OF INTERNATIONAL DESIGNS REGISTRATION

(11) DM/66915

(73) MAKEL ELEKTRİK MALZEMELERİ SANAYİ VE TİCARET LIMITED SİRKETİ

Fevzi Cakmak Cd. Muhacir Mh. No: 51 Kirac Mevkii Buyukcekmece, Istanbul (TR)

(15) 2005 08 17

(24) 2005 08 17

(18) 2025 08 17

(28) 16

(28') 16

(54) 1., 5., 9., 13. Electric switches; 2., 6., 10., 14. Commutators; 3., 7., 11., 15. Electric sockets; 4., 8., 12., 16. Ground electric sockets

---

(11) DM/68891

(73) SWATCH AG (SWATCH SA) (SWATCH LTD.)

Jakob-Stämpfli-Strasse 94, CH-2502 Biel/Bienne (CH)

(15) 2007 05 04

(24) 2007 05 04

(18) 2027 05 04

(28) 2

(28') 2

(54) Wristwatches

---

(11) DM/68895

(73) SWATCH AG (SWATCH SA) (SWATCH LTD.)

Jakob-Stämpfli-Strasse 94, CH-2502 Biel/Bienne (CH)

(15) 2007 05 04

(24) 2007 05 04

(18) 2027 05 04

(28) 1

(28') 1

(54) Wristwatch

---

(11) DM/68896

(73) SWATCH AG (SWATCH SA) (SWATCH LTD.)

Jakob-Stämpfli-Strasse 94, CH-2502 Biel/Bienne (CH)

(15) 2007 05 04

(24) 2007 05 04

(18) 2027 05 04

(28) 6

(28') 6

(54) Wristwatches

---

(11) DM/68957

(73) SWATCH AG (SWATCH SA) (SWATCH LTD.)

94, Rue Jakob Stämpfli, CH-2502 BIENNE (CH)

(15) 2007 05 16

(24) 2007 05 16

(18) 2027 05 16

(28) 2

(28') 2  
(54) Wristwatches

---

(11) DM/68971  
(73) I DIVISION ELECTRICA  
S.A., Polígono Industrial Villanueva de Gallego, Sector 2, Parcela H. Villanueva de Gallego,  
E-50830 Zaragoza (ES)  
(15) 2007 05 16  
(24) 2007 05 16  
(18) 2027 05 16  
(28) 2  
(28') 2  
(54) Electric cupboards

---

(11) DM/78197  
(73) RICHARD YU  
13 Glenrose House 2 Benhill Wood Road Sutton, Surrey SM 1 4HT (EM)  
(15) 2012 04 02  
(24) 2012 04 02  
(18) 2027 04 02  
(28) 1  
(28') 1  
(54) Hot water bottle

---

(11) DM/78612  
(73) RENATA AG (RENATA SA)  
Kreuzenstrasse 30, CH-4452 Itingen (CH)  
(15) 2012 05 16  
(24) 2012 05 16  
(18) 2027 05 16  
(28) 7  
(28') 7  
(54) Blister pack, Packaging card with ornamental design, Packaging with ornamental design

---

(11) DM/78705  
(73) LABORATOIRES LA PRAIRIE SA  
Industriestrasse 8, CH-8604 Volketswil (CH)  
(15) 2012 04 24  
(24) 2012 04 24  
(18) 2027 04 24  
(28) 1  
(28') 1  
(54) Container

---

(11) DM/78883  
(73) FA LOTUSGRILL GMBH  
Rheingönheimer Weg 3-5, 67117 Limburgerhof (DE)  
(15) 2012 05 15  
(24) 2012 05 15  
(18) 2027 05 15  
(28) 1  
(28') 1  
(54) Barbecue toolsets

---

(11) DM/87800  
(73) ASH-D ICECEK GIDA OTOMOTIV TEMIZLIK SANAYI VE TICARET A.S.  
Maslak Ahi Evren Cad. Ata Center No:1 Kat:1 Sisli, Istanbul (TR)  
(15) 2015 09 25  
(24) 2015 09 25  
(28) 1  
(28') 1  
(18) 2025 09 25  
(54) Bottle

---

(11) DM/92167  
(73) CHEN NACHUM  
101 Weissman st, 4342135 Raanana (IL)  
(15) 2016 08 05  
(24) 2016 08 05  
(18) 2026 08 05  
(28) 2  
(28') 2  
(54) Appliance for electrical nerve stimulation,Medical electrodes

---

(11) DM/95346  
(73) TISSOT SA (TISSOT AG) (TISSOT LTD)  
Chemin des Tourelles 17, CH-2400 Le Locle (CH)  
(15) 2017 03 16  
(24) 2017 03 16  
(18) 2027 03 16  
(28) 11  
(28') 11  
(54) 11. Watch bracelet, 1.-4. Watch cases, 5. Watch bracelet, 6.-8. Watch dials, 9.-10. Watch cases

---

(11) DM/95413  
(73) HARRY WINSTON SA  
Chemin du Tourbillon 8, CH-1228 Plan-les-Ouates (CH)  
(15) 2017 03 07  
(24) 2017 03 07  
(18) 2027 03 07  
(28) 1  
(28') 1  
(54) Opera glasses with handle and integrated watch

---

(11) DM/95949  
(73) MEMBRAN SAFETY SOLUTIONS LLC  
c/o Hertz Lichtenstein & Young, 1800 Century Park East, 10th floor, Los Angeles 90067 (US)  
(15) 2017 04 28  
(24) 2017 04 28  
(18) 2027 04 28  
(28) 10  
(28') 10  
(54) Crash helmets

---

(11) DM/96085  
(73) UNION UHRENFABRIK GMBH  
Frühlingsweg 5, 01768 Glashütte (DE)  
(15) 2017 05 15

---



(24) 2017 05 15  
(18) 2027 05 15  
(28) 1  
(28') 1  
(54) Watch dial with watch hands

---

(11) DM/96831  
(73) GÜHRING KG  
Herderstrasse 50-54, 72458 Albstadt (DE)  
(15) 2017 05 29  
(24) 2017 05 29  
(18) 2027 05 29  
(28) 2  
(28') 2  
(54) Tool cabinets

---

## CANCELLATION OF INTERNATIONAL DESIGNS REGISTRATION

(11) DM/68170  
(73) ÇIGIR KIMYA SANAYI VE TICARET ANONIM SIRKETI  
Bakir Ve Pirinç Sanayi Sitesi Açelya Caddesi No: 45 D Blok, TR-34900 Büyükçekmece-Istanbul (TR)  
CANCELLATION DATE OF REGISTRATION: 2021 08 28  
(58) 2022 05 24

---

(11) DM/76573  
(73) THE SWATCH GROUP MANAGEMENT SERVICES AG  
(THE SWATCH GROUP MANAGEMENT SERVICES SA)  
(THE SWATCH GROUP MANAGEMENT SERVICES LTD)  
Seevorstadt 6, CH-2502 Biel/Bienne (CH)  
CANCELLATION DATE OF REGISTRATION: 2021 08 15  
(58) 2022 05 24

---

(11) DM/76607  
(73) THE SWATCH GROUP MANAGEMENT SERVICES AG  
(THE SWATCH GROUP MANAGEMENT SERVICES SA)  
(THE SWATCH GROUP MANAGEMENT SERVICES LTD)  
Seevorstadt 6, CH-2502 Biel/Bienne (CH)  
CANCELLATION DATE OF REGISTRATION: 2021 08 22  
(58) 2022 05 24

---

(11) DM/76626  
(73) THE SWATCH GROUP MANAGEMENT SERVICES AG  
(THE SWATCH GROUP MANAGEMENT SERVICES SA)  
(THE SWATCH GROUP MANAGEMENT SERVICES LTD)  
Seevorstadt 6, CH-2501 Biel/Bienne (CH)  
CANCELLATION DATE OF REGISTRATION: 2021 08 10  
(58) 2022 05 24

---

(11) DM/92062  
(73) HIDETOSHI NISHIO  
3-3, Honcho 3-chome, Chuo-ku, Chiba-shi, Chiba 2600012 (JP)  
CANCELLATION DATE OF REGISTRATION: 2021 08 06  
(58) 2022 05 24

---

(11) DM/92346  
(73) SAVOLA GIDA SANAYI VE TICARET ANONIM SIRKETI  
Mete Plaza, Icerenkoy Mah. Bahcelerarasi Sok. K:23 No:43 Atasehir, Istanbul (TR)  
CANCELLATION DATE OF REGISTRATION: 2021 08 26  
(58) 2022 05 24

---

(11) DM/93365  
(73) MARLENKA INTERNATIONAL S.R.O. (LTD.)  
Valčířská 434, CZ-738 01 Lískovec, Frydek-Místek (CZ)  
CANCELLATION DATE OF REGISTRATION: 2021 08 15  
(58) 2022 05 24

---

(11) DM/93807  
(73) VALTER TARQUINI  
Via Carlo Galeffi, 46, I-00128 Rome (IT)  
CANCELLATION DATE OF REGISTRATION: 2021 08 24  
(58) 2022 05 24

---

## TRADEMARKS

### EXTENSION OF TERMS OF TRADEMARKS REGISTRATION

(111) M 2002 14440 R2

(156) 2002 05 01

(186) 2032 05 01

(732) Hyundai Motor Company  
140-2, Kye-Dong, Jongro-ku, Seoul,  
Republic of Korea

(111) M 2002 14772 R2

(156) 2002 10 29

(186) 2032 10 29

(732) IP Holdings Unltd LLC  
1450 Broadway, New York, New York 10018,  
USA

(111) M 2002 14486 R2

(156) 2002 05 24

(186) 2032 05 24

(732) Geonet LLC  
Nucubidze Str. 171, 0186, Tbilisi, Georgia

(111) M 2002 14776 R2

(156) 2002 10 29

(186) 2032 10 29

(732) IP Holdings Unltd LLC  
1450 Broadway, New York, New York 10018,  
USA

(111) M 2002 14537 R2

(156) 2002 06 27

(186) 2032 06 27

(732) General Motors LLC  
300 Renaissance Center, City of Detroit,  
State of Michigan 48265-3000, USA

(111) M 2002 14727 R2

(156) 2002 10 15

(186) 2032 10 15

(732) ZY Holdings LLC  
1450 Broadway, New York, New York 10018,  
USA

(111) M 2002 14485 R2

(156) 2002 05 24

(186) 2032 05 24

(732) Viacom International Inc.  
1515 Broadway, New York, NY 10036,  
USA

(111) M 2002 14765 R2

(156) 2002 10 15

(186) 2032 10 15

(732) Hyundai Motor Company  
231, Yangjae-Dong, Seocho-Gu, Seoul,  
137-938, Republic of Korea

(111) M 2002 14661 R2

(156) 2002 09 13

(186) 2032 09 13

(732) Ford Motor Company  
One American Road, Dearborn,  
Michigan 48126, USA

(111) M 2012 22929 R1

(156) 2012 09 24

(186) 2032 09 24

(732) RB Hygiene Home Switzerland AG  
Richtistrasse 5, 8304 Wallisellen, Switzerland

(111) M 2002 14662 R2

(156) 2002 09 13

(186) 2032 09 13

(732) Ford Motor Company  
One American Road, Dearborn,  
Michigan 48126, USA

(111) M 2011 21973 R1

(156) 2011 11 17

(186) 2031 11 17

(732) LTD "Bravo Record"  
Merab Kostava Str. 68, bld. 2, 0171, Tbilisi,  
Georgia

(111) M 2002 14672 R2

(156) 2002 09 13

(186) 2032 09 13

(732) Zippo Manufacturing Company  
33 Barber Street, Bradford, Pennsylvania  
16701, USA

(111) M 2012 22760 R1

(156) 2012 07 13

(186) 2032 07 13

(732) Teijin Limited  
2-4, Nakanoshima 3-chome, Kita-ku, Osaka,  
Japan

(111) M 2012 22598 R1  
 (156) 2012 05 16  
 (186) 2032 05 16  
 (732) LRD "Ballis"  
 Davit Aghmashenebeli Str. 15-d, 0170,  
 Akhalkalaki, Georgia

---

(111) M 2012 22599 R1  
 (156) 2012 05 16  
 (186) 2032 05 16  
 (732) Johnson & Johnson (corporation  
 organized and existing under the laws of the  
 State of New Jersey)  
 One Johnson & Johnson Plaza, New  
 Brunswick, New Jersey 08933, USA

---

(111) M 2012 22669 R1  
 (156) 2012 06 07  
 (186) 2032 06 07  
 (732) JSC "Galichpharm"  
 Ul. Oprishkovskaya 6/8, Lviv, 79024,  
 Ukraine

---

(111) M 2012 22625 R1  
 (156) 2012 05 16  
 (186) 2032 05 16  
 (732) Vanguard Trademark Holdings USA LLC  
 600 Corporate Park Drive, Str. Louis, Missouri  
 63105, USA

---

(111) M 2012 22630 R1  
 (156) 2012 05 16  
 (186) 2032 05 16  
 (732) Groupe Lactalis  
 10 rue Adolphe Beck 53000 Laval, France

---

(111) M 2012 22632 R1  
 (156) 2012 05 16  
 (186) 2032 05 16  
 (732) Hongta Tobacco (Group) CO., LTD  
 N118, Hongta Avenue, Hongta District,  
 Yuxi, Yunnan, China

---

(111) M 2012 22638 R1  
 (156) 2012 05 16  
 (186) 2032 05 16  
 (732) Holland & Barrett Retail Limited  
 Samuel Ryder House, Barling Way,  
 Eliot Park, Nuneaton, Warwickshire,  
 CV10 7 RH, United Kingdom

---

(111) M 2012 22676 R1  
 (156) 2012 06 07  
 (186) 2032 06 07  
 (732) LTD "Radio Imedi"  
 Aleksidze Str. 3, 0193, Tbilisi, Georgia

---

(111) M 2012 22737 R1  
 (156) 2012 07 02  
 (186) 2032 07 02  
 (732) Reckitt & Colman (Overseas) Health Limited  
 103-105 Bath Road, Slough, Berkshire,  
 SL1 3UH, United Kingdom

---

(111) M 2012 22738 R1  
 (156) 2012 07 02  
 (186) 2032 07 02  
 (732) Reckitt & Colman (Overseas) Health Limited  
 103-105 Bath Road, Slough, Berkshire,  
 SL1 3UH, United Kingdom

---

(111) M 2012 22966 R1  
 (156) 2012 09 24  
 (186) 2032 09 24  
 (732) Toyota Jidosha Kabushiki Kaisha  
 (also trading as Toyota Motor Corporation)  
 1, Toyota-Cho, Toyota-Shi, Aichi-Ken, Japan

---

(111) M 2012 22834 R1  
 (156) 2012 07 30  
 (186) 2032 07 30  
 (732) Banana Republic (ITM) Inc.  
 2 Folsom Street, San Francisco, California  
 94105, USA

---

(111) M 2012 22835 R1  
 (156) 2012 07 30  
 (186) 2032 07 30  
 (732) Banana Republic (ITM) Inc.  
 2 Folsom Street, San Francisco, California  
 94105, USA

---

(111) M 2012 22836 R1  
 (156) 2012 07 30  
 (186) 2032 07 30  
 (732) Banana Republic (ITM) Inc.  
 2 Folsom Street, San Francisco, California  
 94105, USA

---

(111) M 2012 22837 R1  
(156) 2012 07 30  
(186) 2032 07 30  
(732) Banana Republic (ITM) Inc.  
2 Folsom Street, San Francisco, California  
94105, USA

---

(111) M 2012 22838 R1  
(156) 2012 07 30  
(186) 2032 07 30  
(732) Banana Republic (ITM) Inc.  
2 Folsom Street, San Francisco, California  
94105, USA

---

(111) M 2012 22839 R1  
(156) 2012 07 30  
(186) 2032 07 30  
(732) Banana Republic (ITM) Inc.  
2 Folsom Street, San Francisco, California  
94105, USA

---

(111) M 2012 22840 R1  
(156) 2012 07 30  
(186) 2032 07 30  
(732) Banana Republic (ITM) Inc.  
2 Folsom Street, San Francisco, California  
94105, USA

---

(111) M 2012 22841 R1  
(156) 2012 07 30  
(186) 2032 07 30  
(732) Banana Republic (ITM) Inc.  
2 Folsom Street, San Francisco, California  
94105, USA

---

(111) M 2012 22842 R1  
(156) 2012 07 30  
(186) 2032 07 30  
(732) Banana Republic (ITM) Inc.  
2 Folsom Street, San Francisco, California  
94105, USA

---

(111) M 2012 22843 R1  
(156) 2012 07 30  
(186) 2032 07 30  
(732) Banana Republic (ITM) Inc.  
2 Folsom Street, San Francisco, California  
94105, USA

---

(111) M 2012 22844 R1  
(156) 2012 07 30  
(186) 2032 07 30  
(732) Banana Republic (ITM) Inc.  
2 Folsom Street, San Francisco, California  
94105, USA

---

(111) M 2012 22845 R1  
(156) 2012 07 30  
(186) 2032 07 30  
(732) Banana Republic (ITM) Inc.  
2 Folsom Street, San Francisco, California  
94105, USA

---

(111) M 2012 22846 R1  
(156) 2012 07 30  
(186) 2032 07 30  
(732) Banana Republic (ITM) Inc.  
2 Folsom Street, San Francisco, California  
94105, USA

---

(111) M 2012 22847 R1  
(156) 2012 07 30  
(186) 2032 07 30  
(732) Banana Republic (ITM) Inc.  
2 Folsom Street, San Francisco, California  
94105, USA

---

(111) M 2012 22848 R1  
(156) 2012 07 30  
(186) 2032 07 30  
(732) Banana Republic (ITM) Inc.  
2 Folsom Street, San Francisco, California  
94105, USA

---

(111) M 2012 22849 R1  
(156) 2012 07 30  
(186) 2032 07 30  
(732) Banana Republic (ITM) Inc.  
2 Folsom Street, San Francisco, California  
94105, USA

---

(111) M 2012 22850 R1  
(156) 2012 07 30  
(186) 2032 07 30  
(732) Banana Republic (ITM) Inc.  
2 Folsom Street, San Francisco, California  
94105, USA

---

(111) M 2012 23014 R1  
(156) 2012 10 09  
(186) 2032 10 09  
(732) Toyota Jidosha Kabushiki Kaisha  
(also trading as Toyota Motor Corporation)  
1, Toyota-Cho, Toyota-Shi, Aichi-Ken, Japan

---

(111) M 2013 23655 R1  
(156) 2013 05 13  
(186) 2033 05 13  
(732) LTD "Dani 2012"  
Cabadze Str. 2, 0112, Tbilisi, Georgia

---

(111) M 2012 23078 R1  
(156) 2012 11 12  
(186) 2032 11 12  
(732) Forbes LLC  
499 Washington Boulevard, Jersey City,  
New Jersey 07310, USA

---

(111) M 2013 23306 R1  
(156) 2013 01 25  
(186) 2033 01 25  
(732) Gogita Sozashvili  
Simon Tchiqovani Str. 35, app. 7, 0171,  
Tbilisi, Georgia

---

(111) M 2013 23699 R1  
(156) 2013 05 17  
(186) 2033 05 17  
(732) JSC "Telavi Wine Cellar"  
Vill. Kurdghelauri, 2200, Telavi, Georgia

---

(111) M 2012 22499 R1  
(156) 2012 04 19  
(186) 2032 04 19  
(732) LTD "Champions 111"  
Ilia Chavchavadze Ave. 29, fl. 5, 0179,  
Tbilisi, Georgia

---

(111) M 2012 22580 R1  
(156) 2012 05 03  
(186) 2032 05 03  
(732) LTD "Champions 111"  
Ilia Chavchavadze Ave. 29, fl. 5, 0179,  
Tbilisi, Georgia

---

(111) M 2013 23599 R1  
(156) 2013 04 12  
(186) 2033 04 12  
(732) LTD "Dani 2012"  
Cabadze Str. 2, 0112, Tbilisi, Georgia

---

## COMPLETE TRANSFER OF RIGHTS

(111) M 2019 31546 R  
(732) Armenuhi Saakyan  
T. Abuladze Str. 32, app. 17, 0162, Tbilisi,  
Georgia  
(770) LTD "SAH & Co"  
T. Abuladze Str. 32, app. 17, 0162, Tbilisi  
Georgia  
(580) 2022 05 24

---

(111) M 2019 31547 R  
(732) Armenuhi Saakyan  
T. Abuladze Str. 32, app. 17, 0162, Tbilisi,  
Georgia  
(770) LTD "SAH & Co"  
T. Abuladze Str. 32, app. 17, 0162, Tbilisi  
Georgia  
(580) 2022 05 24

---

(111) M 2019 31964 R  
(732) JSC "Eqimo"  
Akaki Tsereteli Ave. 123, Tbilisi, Georgia  
(770) JSC Vabako  
Botchorishvili Str. 37, app. 221, 0186,  
Tbilisi, Georgia  
(580) 2022 05 20

---

(111) M 2020 33346 R  
(732) LTD "Zoomisol"  
Shalva Nutsubidze Str. 193, app. 1, Tbilisi,  
Georgia;  
LTD "Villa Mosavali"  
Shalva Nutsubidze Str. 193, app. 1, Tbilisi,  
Georgia  
(770) LTD "Villa Mosavali"  
Shalva Nutsubidze Str. 193, app. 1, Tbilisi,  
Georgia  
(580) 2022 05 11

---

(111) M 2021 34351 R  
(732) Armenuhi Saakyan  
T. Abuladze Str. 32, app. 17, 0162, Tbilisi,  
Georgia  
(770) LTD "SAH & Co"  
T. Abuladze Str. 32, app. 17, 0162, Tbilisi  
Georgia  
(580) 2022 05 24

---

(111) M 2011 21946 R  
(732) Zippy – Comércio e Distribuição, S.A.  
Rua João Mendonça, no. 529, Oporto district,  
Matosinhos municipality, São Mamede de  
Infesta and Senhora da Hora parish, 4464-503  
Senhora da Hora, Matosinhos, Portugal  
(770) Fashion Division, S.A.  
Lugar do Espido, Via Norte, 4470-177 Maia,  
Portugal  
(580) 2022 05 23

---

(111) M 2011 21947 R  
(732) Zippy – Comércio e Distribuição, S.A.  
Rua João Mendonça, no. 529, Oporto district,  
Matosinhos municipality, São Mamede de  
Infesta and Senhora da Hora parish, 4464-503  
Senhora da Hora, Matosinhos, Portugal  
(770) Fashion Division, S.A.  
Lugar do Espido, Via Norte, 4470-177 Maia,  
Portugal  
(580) 2022 05 23

---

(111) M 2015 25825 R  
(732) Theramex HQ UK Limited  
Sloane Square House, 1 Holbein Place,  
Belgravia, London SW1W 8NS,  
United Kingdom  
(770) Teva Pharmaceuticals International GmbH  
Schlüsselstrasse 12, CH-8645 Jona,  
Switzerland  
(580) 2022 05 11

---

(111) M 2015 25825 R  
(732) Teva Pharmaceuticals International GmbH  
Schlüsselstrasse 12, CH-8645 Jona,  
Switzerland  
(770) Laboratoire Théramex S.A.M.  
6, Avenue Albert II, 98000, Monaco  
(580) 2022 05 11

---

(111) M 2015 25948 R  
(732) Armenuhi Saakyan  
T. Abuladze Str. 32, app. 17, 0162, Tbilisi,  
Georgia  
(770) LTD "SAH & Co"  
T. Abuladze Str. 32, app. 17, 0162, Tbilisi  
Georgia  
(580) 2022 05 24

---

(111) M 1998 8458 R  
(732) RoC Opco LLC  
c/o Gryphon Investors, One Maritime Plaza,  
Suite 2300, San Francisco, California 94111,  
USA  
(770) Roc International S.A.R.L.  
5, rue C.M. Spoo, Grand-Duche de  
Luxembourg, Luxembourg  
(580) 2022 05 19

---

(111) M 2015 25743 R  
(732) Armenuhi Saakyan  
T. Abuladze Str. 32, app. 17, 0162, Tbilisi,  
Georgia  
(770) LTD "SAH & Co"  
T. Abuladze Str. 32, app. 17, 0162, Tbilisi  
Georgia  
(580) 2022 05 24

---

(111) M 1997 7456 R  
(732) Moncler S.p.A.  
Via Stendhal 47, 20144 Milano, Italy  
(770) Sportswear Company S.P.A.  
Galleria Cavour 4, 40124 Bologna, Italy  
(580) 2022 05 04

---

(111) M 2017 28494 R  
(732) Armenuhi Saakyan  
T. Abuladze Str. 32, app. 17, 0162, Tbilisi,  
Georgia  
(770) LTD "SAH & Co"  
T. Abuladze Str. 32, app. 17, 0162, Tbilisi  
Georgia  
(580) 2022 05 24

---

(111) M 2017 28822 R  
(732) Armenuhi Saakyan  
T. Abuladze Str. 32, app. 17, 0162, Tbilisi,  
Georgia  
(770) LTD "SAH & Co"  
T. Abuladze Str. 32, app. 17, 0162, Tbilisi  
Georgia  
(580) 2022 05 24

---

(111) M 2017 28821 R  
(732) Armenuhi Saakyan  
T. Abuladze Str. 32, app. 17, 0162, Tbilisi,  
Georgia  
(770) LTD "SAH & Co"  
T. Abuladze Str. 32, app. 17, 0162, Tbilisi  
Georgia  
(580) 2022 05 24

---

(111) M 2018 29567 R  
(732) Armenuhi Saakyan  
T. Abuladze Str. 32, app. 17, 0162, Tbilisi,  
Georgia  
(770) LTD "SAH & Co"  
T. Abuladze Str. 32, app. 17, 0162, Tbilisi  
Georgia  
(580) 2022 05 24

---

(111) M 2018 29898 R  
(732) LTD "Aviator"  
I. Gogebashvili Str. 46b, app.7, 0179, Tbilisi,  
Georgia  
(770) LTD "City Loft"  
May 26, named after the Square, 0171, Tbilisi,  
Georgia  
(580) 2022 05 20

---

(111) M 2018 29999 R  
(732) Armenuhi Saakyan  
T. Abuladze Str. 32, app. 17, 0162, Tbilisi,  
Georgia  
(770) LTD "SAH & Co"  
T. Abuladze Str. 32, app. 17, 0162, Tbilisi  
Georgia  
(580) 2022 05 24

---

(111) M 2018 30089 R  
(732) LTD "Aviator"  
I. Gogebashvili Str. 46b, app.7, 0179, Tbilisi,  
Georgia  
(770) LTD "City Loft"  
May 26, named after the Square, 0171, Tbilisi,  
Georgia  
(580) 2022 05 20

---

(111) M 2018 30380 R  
(732) LTD "Aviator"  
I. Gogebashvili Str. 46b, app.7, 0179, Tbilisi,  
Georgia  
(770) LTD "City Loft"  
May 26, named after the Square, 0171, Tbilisi,  
Georgia  
(580) 2022 05 20

---

(111) M 2018 30381 R  
(732) LTD "Aviator"  
I. Gogebashvili Str. 46b, app.7, 0179, Tbilisi,  
Georgia  
(770) LTD "City Loft"  
May 26, named after the Square, 0171, Tbilisi,  
Georgia  
(580) 2022 05 23

---



(111) M 2018 30198 R  
(732) Armenuhi Saakyan  
T. Abuladze Str. 32, app. 17, 0162, Tbilisi,  
Georgia  
(770) LTD "SAH & Co"  
T. Abuladze Str. 32, app. 17, 0162, Tbilisi  
Georgia  
(580) 2022 05 24

---

## CHANGES OF NAMES AND/OR ADDRESSES OF TRADEMARKS

(111) M 1998 9237 R  
(732) Sega Corporation  
Sumitomo Fudosan Osaki Garden Tower,  
1-1-1 Nishi-Shinagawa, Shinagawa-ku, Tokyo,  
Japan  
(770) Sega Games Co., Ltd.  
Sumitomo Fudosan Osaki Garden Tower,  
1-1-1 Nishi-Shinagawa, Shinagawa-ku, Tokyo,  
Japan  
(580) 2022 05 29

---

(111) M 1998 9238 R  
(732) Sega Corporation  
Sumitomo Fudosan Osaki Garden Tower,  
1-1-1 Nishi-Shinagawa, Shinagawa-ku, Tokyo,  
Japan  
(770) Sega Games Co., Ltd.  
Sumitomo Fudosan Osaki Garden Tower,  
1-1-1 Nishi-Shinagawa, Shinagawa-ku, Tokyo,  
Japan  
(580) 2022 05 29

---

(111) M 1998 9240 R  
(732) Sega Corporation  
Sumitomo Fudosan Osaki Garden Tower,  
1-1-1 Nishi-Shinagawa, Shinagawa-ku, Tokyo,  
Japan  
(770) Sega Games Co., Ltd.  
Sumitomo Fudosan Osaki Garden Tower,  
1-1-1 Nishi-Shinagawa, Shinagawa-ku, Tokyo,  
Japan  
(580) 2022 05 29

---

(111) M 1998 9242 R  
(732) Sega Corporation  
Sumitomo Fudosan Osaki Garden Tower,  
1-1-1 Nishi-Shinagawa, Shinagawa-ku, Tokyo,  
Japan

(770) Sega Games Co., LTD  
Sumitomo Fudosan Osaki Garden Tower,  
1-1-1 Nishi-Shinagawa, Shinagawa-ku, Tokyo,  
Japan  
(580) 2022 05 29

---

(111) M 1998 9244 R  
(732) Sega Corporation  
Sumitomo Fudosan Osaki Garden Tower,  
1-1-1 Nishi-Shinagawa, Shinagawa-ku, Tokyo,  
Japan  
(770) Sega Games Co., LTD  
Sumitomo Fudosan Osaki Garden Tower,  
1-1-1 Nishi-Shinagawa, Shinagawa-ku, Tokyo,  
Japan  
(580) 2022 05 29

---

(111) M 1999 12574 R  
(732) Sega Corporation  
Sumitomo Fudosan Osaki Garden Tower,  
1-1-1 Nishi-Shinagawa, Shinagawa-ku, Tokyo,  
Japan  
(770) Sega Games Co., LTD  
Sumitomo Fudosan Osaki Garden Tower,  
1-1-1 Nishi-Shinagawa, Shinagawa-ku, Tokyo,  
Japan  
(580) 2022 05 29

---

(111) M 2000 13189 R  
(732) Sega Corporation  
Sumitomo Fudosan Osaki Garden Tower,  
1-1-1 Nishi-Shinagawa, Shinagawa-ku, Tokyo,  
Japan  
(770) Sega Games Co., LTD  
Sumitomo Fudosan Osaki Garden Tower,  
1-1-1 Nishi-Shinagawa, Shinagawa-ku, Tokyo,  
Japan

(580) 2022 05 29

---

(111) M 2000 13190 R

(732) Sega Corporation

Sumitomo Fudosan Osaki Garden Tower,  
1-1-1 Nishi-Shinagawa, Shinagawa-ku, Tokyo,  
Japan

(770) Sega Games Co., LTD

Sumitomo Fudosan Osaki Garden Tower,  
1-1-1 Nishi-Shinagawa, Shinagawa-ku, Tokyo,  
Japan

(580) 2022 05 29

---

(111) M 2002 14661 R

(732) Ford Motor Company

One American Road, Dearborn, Michigan  
48126, USA

(770) Ford Motor Company

The American Road, Dearborn, Michigan  
48121, USA

(580) 2022 05 25

---

(111) M 2002 14662 R

(732) Ford Motor Company

One American Road, Dearborn, Michigan  
48126, USA

(770) Ford Motor Company

The American Road, Dearborn, Michigan  
48121, USA

(580) 2022 05 25

---

(111) M 2012 22669 R

(732) JSC "Galichpharm"

Ul. Oprishkovskaya 6/8, Lviv, 79024, Ukraine

(770) Aktsionernoe Obshchestvo Otkritogo Tipa  
"Galichpharm"

Ul. Oprishkovskaya 6/8, Lviv, 79024, Ukraine

(580) 2022 05 12

---

(111) M 2012 22563 R

(732) Vertiv IT Systems Inc.

3414 Governors Drive SW, Suite 100,  
Huntsville, Alabama 35805, USA

(770) Vertiv IT Systems Inc.

1209 Orange Street, Wilmington, Delaware  
19801, USA

(580) 2022 05 16

---

(111) M 2012 22499 R

(732) LTD "Champions 111"

Ilia Chavchavadze Ave. 29, fl. 5, 0179,  
Tbilisi, Georgia

(770) LTD "Champions 111"

April Str. 9 15, 4200, Sighnaghi, Georgia

(580) 2022 04 05

---

(111) M 2012 22580 R

(732) LTD "Champions 111"

Ilia Chavchavadze Ave. 29, fl. 5, 0179,  
Tbilisi, Georgia

(770) LTD "Champions 111"

April Str. 9 15, 4200, Sighnaghi, Georgia

(580) 2022 04 04

---

(111) M 1996 2349 R

(732) Albemarle Corporation

4250 Congress Street, Suite 900, Charlotte,  
NC 28209, USA

(770) Albemarle Corporation

451 Florida Street, Baton Rouge, Louisiana,  
70801, USA

(580) 2022 05 23

---

## CANCELLATION OF TRADEMARKS REGISTRATION

(111) M 2001 14132 R  
(151) 2001 11 19  
(732) Intel Corporation  
2200 Mission College Boulevard, Santa Clara,  
California 95052-8119, USA  
(141) 2022 05 27

---

(111) M 2001 14138 R  
(151) 2001 11 19  
(732) Eastman Kodak Company  
343, State Street, Rochester, New York  
04650-0205, USA  
(141) 2022 05 27

---

(111) M 2001 14142 R  
(151) 2001 11 19  
(732) Merck & CO., Inc.,  
a New Jersey Corporation  
One Merck Drive, P.O. Box 100, Whitehouse  
Station, New Jersey 08889-0100, USA  
(141) 2022 05 27

---

(111) M 2001 14137 R  
(151) 2001 11 19  
(732) Obshchestvo s Ogranichennoy Otvetstven-  
nostyu "KZI Pharmaceuticals"  
Lesnaya Str., bld. 43, 127055 Moscow,  
Russian Federation  
(141) 2022 05 27

---

(111) M 2001 14146 R  
(151) 2001 11 19  
(732) Live Nation Entertainment Inc.  
9348 Civic Center Drive, Beverly Hills,  
California 90210, USA  
(141) 2022 05 27

---

(111) M 2001 14147 R  
(151) 2001 11 19  
(732) Ucha Abzianidze  
Tskneti Str. 1, app. 118, 0162, Tbilisi, Georgia;  
Venera Stefanishvili  
Tskneti Str. 1, app. 118, 0162, Tbilisi, Georgia  
(141) 2022 05 27

---

(111) M 2001 14153 R  
(151) 2001 11 19  
(732) Imperial Tobacco Ukraine  
Ul. Akademika Zabolotnogo 35, Kieve 0326,  
Ukraine

(141) 2022 05 27

---

(111) M 2011 21966 R  
(151) 2011 11 16  
(732) Nemiroff Intellectual Property Establishment  
Haus Rechsteiner, P.O. Box 634/Stadtle 31,  
LI-9490 Vaduz, Liechtenstein  
(141) 2022 05 24

---

(111) M 2011 21985 R  
(151) 2011 11 18  
(732) Obshchestvo s Sgranichennoi otvetstven-  
nostiu "Koordinirujshchiy Raspreditelni  
Tsentr "Efko-Kaskad"  
Ul. Frunze, dom 4, Alekseevka, RU-309850,  
Belgorodskaya oblast, Russian Federation  
(141) 2022 05 27

---

(111) M 2011 21986 R  
(151) 2011 11 18  
(732) Obshchestvo s Sgranichennoi otvetstven-  
nostiu "Koordinirujshchiy Raspreditelni  
Tsentr "Efko-Kaskad"  
Ul. Frunze, dom 4, Alekseevka, RU-309850,  
Belgorodskaya oblast, Russian Federation  
(141) 2022 05 27

---

(111) M 2011 21988 R  
(151) 2011 11 18  
(732) LTD "G-P-C"  
Marjanishvili Str. 26, 0102, Tbilisi, Georgia  
(141) 2022 05 27

---

(111) M 2011 21990 R  
(151) 2011 11 18  
(732) LTD "Shavka"  
Mtckheta Str. 29, app. 9, 0179, Tbilisi,  
Georgia  
(141) 2022 05 27

---

(111) M 2011 21971 R  
(151) 2011 11 17  
(732) RB Health (US) LLC  
399 Interpace Parkway, Parsippany, New  
Jersey 07054, USA  
(141) 2022 05 27

---

(111) M 2011 21972 R  
(151) 2011 11 17  
(732) Kayla Foods Int'l (Barbados) Inc.  
a Barbados Corporation  
27 Pine Road, Belleville, Str. Michael,  
BB11113, W.I., Barbados  
(141) 2022 05 27

---

(111) M 2011 21984 R  
(151) 2011 11 17  
(732) Alcon Inc.  
Rue Louis-d'Affry 6, CH-1701 Fribourg,  
Switzerland  
(141) 2022 05 25

---

(111) M 2011 21991 R  
(151) 2011 11 21  
(732) LTD "Georgian Reilway Transconteiner"  
Tamar Mepe Ave. 15, 0112, Tbilisi,  
Georgia  
(141) 2022 05 30

---

(111) M 2011 21992 R  
(151) 2011 11 21  
(732) Koba Shavgulidze  
Shartava Str. 49, 0160, Tbilisi, Georgia  
(141) 2022 05 30

---

---

# CLASSIFICATION INDEXES

## INVENTIONS

### CONCORDANCE TABLE OF INTERNATIONAL CLASSIFICATION INDEX AND PUBLICATION NUMBERS

INTERNATIONAL CLASSIFICATION INDEXES (51)	NUMBER OF PUBLISHED APPLICATION (10)
A 61 K 31/4192; A 61 K 31/4146; A 61 K 31/41	AP 2022 15479 A
A 61 K 39/09; A 61 K 39/385; A 61 K 39/00; A 61 P 31/04	AP 2022 15382 A
A 61 K 39/395; A 61 K 39/00; C 07 K 16/00	AP 2022 15554 A
F 16 L 55/132	AP 2022 15536 A

### CONCORDANCE TABLE OF PUBLICATION NUMBERS AND INTERNATIONAL CLASSIFICATION INDEX

NUMBER OF PUBLISHED APPLICATION (10)	INTERNATIONAL CLASSIFICATION INDEXES (51)
AP 2022 15382 A	A 61 K 39/09; A 61 K 39/385; A 61 K 39/00; A 61 P 31/04
AP 2022 15479 A	A 61 K 31/4192; A 61 K 31/4146; A 61 K 31/41
AP 2022 15536 A	F 16 L 55/132
AP 2022 15554 A	A 61 K 39/395; A 61 K 39/00; C 07 K 16/00

### CONCORDANCE TABLE OF INTERNATIONAL CLASSIFICATION INDEX, PATENT NUMBERS AND PUBLICATION NUMBERS

INTERNATIONAL CLASSIFICATION INDEX (51)	NUMBER OF PATENT (11)	NUMBER OF PUBLISHED APPLICATION (10)
A 01 N 43/78; C 07 D 277/56; C 07 D 417/12	P 2022 7389 B	AP 2022 15378 A
A 61 K 31/137; A 61 K 31/42; A 61 K 31/506; A 61 K 31/551; A 61 K 31/7008; A 61 K 45/06	P 2022 7387 B	AP 2021 15226 A
A 61 K 9/00; A 61 K 31/4365; A 61 K 31/4184; A 61 P 7/02; A 61 P 1/04	P 2022 7388 B	AP 2022 15592 A
A 61 K 39/00; A 61 K 39/05	P 2022 7386 B	AP 2021 15276 A

### CONCORDANCE TABLE OF PATENT NUMBERS, PUBLICATION NUMBERS AND INTERNATIONAL CLASSIFICATION INDEX

NUMBER OF PATENT (11)	NUMBER OF PUBLISHED APPLICATION (10)	INTERNATIONAL CLASSIFICATION INDEX (51)
P 2022 7386 B	AP 2021 15276 A	A 61 K 39/00; A 61 K 39/05
P 2022 7387 B	AP 2021 15226 A	A 61 K 31/137; A 61 K 31/42; A 61 K 31/506; A 61 K 31/551; A 61 K 31/7008; A 61 K 45/06
P 2022 7388 B	AP 2022 15592 A	A 61 K 9/00; A 61 K 31/4365; A 61 K 31/4184; A 61 P 7/02; A 61 P 1/04
P 2022 7389 B	AP 2022 15378 A	A 01 N 43/78; C 07 D 277/56; C 07 D 417/12

**CONCORDANCE TABLE OF APPLICATION NUMBERS,  
PUBLICATION NUMBERS AND PATENTS**

NUMBER OF APPLICATION (21)	NUMBER OF PUBLISHED APPLICATION (10)	NUMBER OF PATENT (11)
AP 2018 15226	AP 2021 15226 A	P 2022 7387 B
AP 2018 15276	AP 2021 15276 A	P 2022 7386 B
AP 2018 15378	AP 2022 15378 A	P 2022 7389 B
AP 2019 15592	AP 2022 15592 A	P 2022 7388 B

## UTILITY MODELS

**CONCORDANCE TABLE OF INTERNATIONAL CLASSIFICATION INDEX,  
PATENT NUMBERS AND PUBLICATION NUMBERS**

INTERNATIONAL CLASSIFICATION INDEX (51)	NUMBER OF PATENT (11)	NUMBER OF PUBLISHED APPLICATION (10)
A 01 C 9/06	U 2022 2117 Y	AU 2022 15775 U
C 12 G 1/06	U 2022 2118 Y	AU 2022 15602 U
G 09 F 19/00	U 2022 2116 Y	AU 2022 15550 U

**CONCORDANCE TABLE OF PATENT NUMBERS,  
PUBLICATION NUMBERS AND INTERNATIONAL CLASSIFICATION INDEX**

NUMBER OF PATENT (11)	NUMBER OF PUBLISHED APPLICATION (10)	INTERNATIONAL CLASSIFICATION INDEX (51)
U 2022 2116 Y	AU 2022 15550 U	G 09 F 19/00
U 2022 2117 Y	AU 2022 15775 U	A 01 C 9/06
U 2022 2118 Y	AU 2022 15602 U	C 12 G 1/06

**CONCORDANCE TABLE OF APPLICATION NUMBERS,  
PUBLICATION NUMBERS AND PATENTS**

NUMBER OF APPLICATION (21)	NUMBER OF PUBLISHED APPLICATION (10)	NUMBER OF PATENT (11)
AU 2021 15550	AU 2022 15550 U	U 2022 2116 Y
AU 2021 15602	AU 2022 15602 U	U 2022 2118 Y
AU 2021 15775	AU 2022 15775 U	U 2022 2117 Y

**DESIGNS****CONCORDANCE TABLE OF INTERNATIONAL CLASSIFICATION INDEX,  
NUMBERS OF REGISTRATION AND PUBLICATION NUMBERS**

INTERNATIONAL CLASSIFICATION INDEX (51)	NUMBER OF REGISTRATION (11)	NUMBER OF PUBLISHED APPLICATION (10)
02-02	D 2022 936 S	AD 2022 1240 S

**CONCORDANCE TABLE OF NUMBERS OF REGISTRATION,  
PUBLICATION NUMBERS AND INTERNATIONAL CLASSIFICATION INDEX**

NUMBER OF REGISTRATION (11)	NUMBER OF PUBLISHED APPLICATION (10)	INTERNATIONAL CLASSIFICATION INDEX (51)
D 2022 936 S	AD 2022 1240 S	02-02

**CONCORDANCE TABLE OF APPLICATION NUMBERS,  
PUBLICATION NUMBERS AND NUMBERS OF REGISTRATION**

NUMBER OF APPLICATION (21)	NUMBER OF PUBLISHED APPLICATION (10)	NUMBER OF REGISTRATION (11)
AD 2021 1240	AD 2022 1240 S	D 2022 936 S

## TRADEMARKS

### CONCORDANCE TABLE OF REGISTRATION NUMBERS, APPLICATION NUMBERS, PUBLICATION NUMBERS AND BULLETIN NUMBERS

NUMBER OF REGISTRATION (111)	NUMBER OF APPLICATIONS (210)	NUMBER OF PUBLISHED APPLICATIONS (260)	NUMBER OF BULLETIN
1	2	3	4
M 2022 35478 R	AM 117648	–	11(590)2022
M 2022 35479 R	AM 117815	–	11(590)2022
M 2022 35480 R	AM 117816	–	11(590)2022
M 2022 35481 R	AM 117725	–	11(590)2022
M 2022 35482 R	AM 117813	–	11(590)2022
M 2022 35483 R	AM 117734	–	11(590)2022
M 2022 35484 R	AM 117722	–	11(590)2022
M 2022 35485 R	AM 112264	AM 2022 112264 A	3(582)2022
M 2022 35486 R	AM 113118	AM 2021 113118 A	23(579)2021
M 2022 35487 R	AM 113233	AM 2021 113233 A	23(579)2021
M 2022 35488 R	AM 113263	AM 2021 113263 A	23(579)2021
M 2022 35489 R	AM 113281	AM 2022 113281 A	3(582)2022
M 2022 35490 R	AM 113399	AM 2022 113399 A	3(582)2022
M 2022 35491 R	AM 113423	AM 2022 113423 A	3(582)2022
M 2022 35492 R	AM 113485	AM 2022 113485 A	3(582)2022
M 2022 35493 R	AM 113504	AM 2022 113504 A	3(582)2022
M 2022 35494 R	AM 113684	AM 2022 113684 A	2(581)2022
M 2022 35495 R	AM 113685	AM 2022 113685 A	2(581)2022
M 2022 35496 R	AM 113697	AM 2022 113697 A	3(582)2022
M 2022 35497 R	AM 113698	AM 2022 113698 A	3(582)2022
M 2022 35498 R	AM 113704	AM 2022 113704 A	3(582)2022
M 2022 35499 R	AM 113709	AM 2022 113709 A	3(582)2022
M 2022 35500 R	AM 113710	AM 2022 113710 A	3(582)2022
M 2022 35501 R	AM 113762	AM 2022 113762 A	3(582)2022
M 2022 35502 R	AM 113853	AM 2022 113853 A	2(581)2022
M 2022 35503 R	AM 113864	AM 2022 113864 A	3(582)2022
M 2022 35504 R	AM 114027	AM 2022 114027 A	3(582)2022
M 2022 35506 R	AM 113498	AM 2022 113498 A	3(582)2022
M 2022 35507 R	AM 113594	AM 2022 113594 A	3(582)2022
M 2022 35508 R	AM 113595	AM 2022 113595 A	3(582)2022
M 2022 35509 R	AM 113600	AM 2022 113600 A	3(582)2022
M 2022 35510 R	AM 113601	AM 2022 113601 A	3(582)2022
M 2022 35511 R	AM 117911	–	11(590)2022
M 2022 35512 R	AM 117655	–	11(590)2022
M 2022 35513 R	AM 117829	–	11(590)2022
M 2022 35514 R	AM 117740	–	11(590)2022
M 2022 35515 R	AM 111424	AM 2021 111424 A	21(577)2021
M 2022 35516 R	AM 111835	AM 2021 111835 A	21(577)2021
M 2022 35517 R	AM 111836	AM 2021 111836 A	21(577)2021
M 2022 35518 R	AM 112188	AM 2021 112188 A	21(577)2021
M 2022 35519 R	AM 112475	AM 2022 112475 A	3(582)2022
M 2022 35520 R	AM 112672	AM 2021 112672 A	21(577)2021
M 2022 35521 R	AM 112678	AM 2021 112678 A	22(578)2021
M 2022 35522 R	AM 112680	AM 2021 112680 A	23(579)2021
M 2022 35523 R	AM 112709	AM 2021 112709 A	22(578)2021



1	2	3	4
M 2022 35524 R	AM 113011	AM 2022 113011 A	1(580)2022
M 2022 35525 R	AM 113043	AM 2021 113043 A	22(578)2021
M 2022 35526 R	AM 113044	AM 2021 113044 A	22(578)2021
M 2022 35527 R	AM 113050	AM 2022 113050 A	1(580)2022
M 2022 35528 R	AM 113051	AM 2021 113051 A	23(579)2021
M 2022 35529 R	AM 113105	AM 2021 113105 A	22(578)2021
M 2022 35530 R	AM 113106	AM 2021 113106 A	22(578)2021
M 2022 35531 R	AM 113119	AM 2021 113119 A	22(578)2021
M 2022 35532 R	AM 113188	AM 2021 113188 A	22(578)2021
M 2022 35533 R	AM 113223	AM 2022 113223 A	2(581)2022
M 2022 35534 R	AM 113400	AM 2022 113400 A	3(582)2022
M 2022 35535 R	AM 113407	AM 2021 113407 A	23(579)2021
M 2022 35536 R	AM 113409	AM 2021 113409 A	23(579)2021
M 2022 35537 R	AM 113413	AM 2021 113413 A	23(579)2021
M 2022 35538 R	AM 113589	AM 2022 113589 A	3(582)2022
M 2022 35539 R	AM 113687	AM 2022 113687 A	2(581)2022
M 2022 35540 R	AM 113778	AM 2022 113778 A	4(583)2022
M 2022 35541 R	AM 113791	AM 2022 113791 A	4(583)2022
M 2022 35542 R	AM 113846	AM 2022 113846 A	4(583)2022
M 2022 35543 R	AM 113868	AM 2022 113868 A	4(583)2022
M 2022 35544 R	AM 113869	AM 2022 113869 A	4(583)2022
M 2022 35545 R	AM 113870	AM 2022 113870 A	4(583)2022
M 2022 35546 R	AM 113889	AM 2022 113889 A	4(583)2022
M 2022 35547 R	AM 114038	AM 2022 114038 A	4(583)2022
M 2022 35548 R	AM 114063	AM 2022 114063 A	4(583)2022
M 2022 35549 R	AM 114135	AM 2022 114135 A	4(583)2022
M 2022 35550 R	AM 114136	AM 2022 114136 A	4(583)2022
M 2022 35551 R	AM 114146	AM 2022 114146 A	4(583)2022
M 2022 35552 R	AM 114234	AM 2022 114234 A	4(583)2022
M 2022 35553 R	AM 114238	AM 2022 114238 A	4(583)2022
M 2022 35554 R	AM 114309	AM 2022 114309 A	4(583)2022
M 2022 35555 R	AM 118000	-	11(590)2022

**CONCORDANCE TABLE OF PUBLICATION NUMBERS  
AND APPLICATION NUMBERS**

NUMBER OF PUBLISHED APPLICATION (260)	NUMBER OF APPLICATION (210)	1	2
1	2	AM 2022 115404 A	AM 115404
AM 2022 99510 A	AM 99510	AM 2022 115407 A	AM 115407
AM 2022 99511 A	AM 99511	AM 2022 115409 A	AM 115409
AM 2022 114921 A	AM 114921	AM 2022 115413 A	AM 115413
AM 2022 114922 A	AM 114922	AM 2022 115417 A	AM 115417
AM 2022 114926 A	AM 114926	AM 2022 115424 A	AM 115424
AM 2022 115003 A	AM 115003	AM 2022 115425 A	AM 115425
AM 2022 115006 A	AM 115006	AM 2022 115427 A	AM 115427
AM 2022 115007 A	AM 115007	AM 2022 115429 A	AM 115429
AM 2022 115008 A	AM 115008	AM 2022 115431 A	AM 115431
AM 2022 115099 A	AM 115099	AM 2022 115434 A	AM 115434
AM 2022 115124 A	AM 115124	AM 2022 115435 A	AM 115435
AM 2022 115125 A	AM 115125	AM 2022 115436 A	AM 115436
AM 2022 115206 A	AM 115206	AM 2022 115437 A	AM 115437
AM 2022 115210 A	AM 115210	AM 2022 115507 A	AM 115507
AM 2022 115220 A	AM 115220	AM 2022 115513 A	AM 115513
AM 2022 115221 A	AM 115221	AM 2022 115515 A	AM 115515
AM 2022 115326 A	AM 115326	AM 2022 115516 A	AM 115516
AM 2022 115330 A	AM 115330	AM 2022 115519 A	AM 115519
AM 2022 115333 A	AM 115333	AM 2022 115520 A	AM 115520
AM 2022 115334 A	AM 115334	AM 2022 115521 A	AM 115521
AM 2022 115337 A	AM 115337	AM 2022 115522 A	AM 115522
AM 2022 115339 A	AM 115339	AM 2022 115527 A	AM 115527
AM 2022 115345 A	AM 115345	AM 2022 115528 A	AM 115528
AM 2022 115347 A	AM 115347	AM 2022 115532 A	AM 115532
AM 2022 115348 A	AM 115348	AM 2022 115533 A	AM 115533
AM 2022 115399 A	AM 115399	AM 2022 115535 A	AM 115535
		AM 2022 115536 A	AM 115536
		AM 2022 115537 A	AM 115537
		AM 2022 115539 A	AM 115539
		AM 2022 115597 A	AM 115597

CONCORDANCE TABLE OF INDEX OF GOODS AND/OR SERVICES  
AND APPLICATION NUMBERS

INDEX OF GOODS AND/OR SERVICES (511)	NUMBER OF PUBLISHED APPLICATIONS (260)	1	2
1	2	24	AM 2022 115326 A
1	AM 2022 115006 A	29	AM 2022 115099 A
1	AM 2022 115007 A	29	AM 2022 115515 A
1	AM 2022 115008 A	29	AM 2022 115516 A
1	AM 2022 115124 A	29	AM 2022 115527 A
1	AM 2022 115125 A	29	AM 2022 115528 A
1	AM 2022 115348 A	29	AM 2022 115597 A
3	AM 2022 115206 A	29	AM 2022 99510 A
4	AM 2022 115003 A	29	AM 2022 99511 A
4	AM 2022 115429 A	30	AM 2022 115099 A
5	AM 2022 114921 A	30	AM 2022 115515 A
5	AM 2022 114922 A	30	AM 2022 115516 A
5	AM 2022 114926 A	30	AM 2022 115527 A
5	AM 2022 115006 A	30	AM 2022 115528 A
5	AM 2022 115007 A	30	AM 2022 99510 A
5	AM 2022 115008 A	30	AM 2022 99511 A
5	AM 2022 115124 A	30	AM 2022 99511 A
5	AM 2022 115125 A	30	AM 2022 99511 A
5	AM 2022 115339 A	30	AM 2022 99511 A
5	AM 2022 115345 A	30	AM 2022 99511 A
5	AM 2022 115347 A	31	AM 2022 115006 A
5	AM 2022 115348 A	31	AM 2022 115007 A
5	AM 2022 115407 A	31	AM 2022 115008 A
5	AM 2022 115409 A	31	AM 2022 115099 A
5	AM 2022 115413 A	31	AM 2022 115348 A
5	AM 2022 115537 A	31	AM 2022 115527 A
7	AM 2022 115003 A	31	AM 2022 115528 A
7	AM 2022 115221 A	32	AM 2022 115099 A
8	AM 2022 115003 A	32	AM 2022 115099 A
9	AM 2022 115003 A	32	AM 2022 115404 A
9	AM 2022 115337 A	32	AM 2022 115515 A
9	AM 2022 115424 A	32	AM 2022 115516 A
9	AM 2022 115425 A	32	AM 2022 115527 A
9	AM 2022 115522 A	32	AM 2022 99511 A
9	AM 2022 115533 A	32	AM 2022 99511 A
9	AM 2022 115535 A	33	AM 2022 115099 A
9	AM 2022 115536 A	33	AM 2022 115333 A
11	AM 2022 115221 A	33	AM 2022 115404 A
12	AM 2022 115003 A	33	AM 2022 115431 A
12	AM 2022 115334 A	33	AM 2022 99510 A
12	AM 2022 115417 A	33	AM 2022 99510 A
12	AM 2022 115435 A	34	AM 2022 115210 A
12	AM 2022 115436 A	34	AM 2022 115434 A
12	AM 2022 115437 A	34	AM 2022 115507 A
12	AM 2022 115519 A	34	AM 2022 115532 A
12	AM 2022 115520 A	35	AM 2022 115326 A
12	AM 2022 115521 A	35	AM 2022 115330 A
20	AM 2022 99510 A	35	AM 2022 115337 A
21	AM 2022 99510 A	35	AM 2022 115513 A
		35	AM 2022 115515 A
		35	AM 2022 115516 A
		35	AM 2022 115539 A
		35	AM 2022 99510 A
		35	AM 2022 99511 A
		36	AM 2022 115337 A
		36	AM 2022 115427 A
		36	AM 2022 115522 A
		36	AM 2022 115539 A
		39	AM 2022 115539 A

1	2
41	AM 2022 115427 A
41	AM 2022 115539 A
42	AM 2022 115539 A
43	AM 2022 115399 A
43	AM 2022 115427 A
43	AM 2022 115515 A

1	2
43	AM 2022 115516 A
43	AM 2022 115528 A
43	AM 2022 99510 A
43	AM 2022 99511 A
45	AM 2022 115220 A

CONCORDANCE TABLE OF INDEX OF GOODS AND/OR SERVICES  
AND NUMBERS OF TRADEMARKS REGISTERED ACCORDING  
TO THE ACCELERATED PROCEDURE

INDEX OF GOODS AND/OR SERVICES (511)	NUMBERS OF REGISTERED ACCORDING TO THE ACCELERATED PROCEDURE (111)
M 2022 35482 R	5
M 2022 35478 R	11
M 2022 35480 R	19
M 2022 35483 R	29
M 2022 35483 R	30
M 2022 35484 R	30
M 2022 35513 R	31
M 2022 35484 R	32
M 2022 35512 R	32
M 2022 35555 R	32
M 2022 35479 R	33
M 2022 35514 R	33
M 2022 35480 R	35
M 2022 35482 R	35
M 2022 35511 R	43
M 2022 35481 R	44

# OFFICIAL BULLETIN OF THE INDUSTRIAL PROPERTY

**INVENTIONS**  
**UTILITY MODELS**  
**DESIGNS**  
**TRADEMARKS**  
**GEOGRAPHICAL INDICATIONS**

## **11(590)**

EDITOR-IN-CHIEF: N. Bebrishvili

EDITOR-TRANSLATOR: E. Gabunia

PROOFREADER: A. Shikhashvili

COMPUTER LAYOUT: M. Ordenidze  
K. Svanidze

[info@sakpatenti.gov.ge](mailto:info@sakpatenti.gov.ge)  
[www.sakpatenti.gov.ge](http://www.sakpatenti.gov.ge)