

# Official Bulletin of the Industrial Property

Inventions

Utility Models

Designs

Trademarks



საქართველოს ინტელექტუალური  
საკუთრების ეროვნული ცენტრი

**საკპატი**

**SAKPATENTI**

NATIONAL INTELLECTUAL PROPERTY  
CENTER OF GEORGIA

[www.sakpatenti.gov.ge](http://www.sakpatenti.gov.ge)

Date of Publication – 2022 06 27

**12(591)**

# INID CODES FOR IDENTIFICATION OF BIBLIOGRAPHIC DATA

## INVENTIONS, UTILITY MODELS

- (10) Number of publication for application, which has been examined
- (11) Number of patent and kind of document
- (21) Serial number of application
- (22) Date of filing of the application
- (23) Date of exhibition or the date of the earlier filing and the number of application, if any
- (24) Date from which patent may have effect
- (31) Number of priority application
- (32) Date of filing of priority application
- (33) Code of the country or regional organization allotting priority application number
- (44) Date of publication of application not granted, but examined and number of bulletin
- (45) Date of publication of registered document
- (51) International Patent Classification Index

- (54) Title of the invention
- (57) Abstract
- (60) Number of examined patent document granted by foreign patent office, date from which patent has effect and country code
- (62) Number of the earlier application and in case of divided application, date of filing an application
- (71) Name, surname and address of applicant (country code)
- (72) Name, surname of inventor (country code)
- (73) Name, surname and address of patent owner (country code)
- (74) Name, surname of representative or patent attorney
- (85) Date of commencement of the national phase of International Application
- (86) Number and date of filing of international application
- (87) Number and date of publication of international application
- (94) Calculated date of expiry of the SPC or the duration of the SPC

## DESIGNS

- (10) Number of publication for application
- (11) Number of patent and kind of document or number of registration
- (15) Date of registration/Date of patent renewal
- (18) Expected expiration date of patent or registration
- (21) Serial number of application
- (22) Date of filing of the application
- (23) Date of exhibition or the date of the earlier filing and the number of application, if any
- (24) Date from which patent may have effect
- (28) Number of designs included in the application
- (30) Data relating to priority (number of application, date of filing of application, two-letter code identifying the authority with whom the priority application was made)
- (31) Number of priority application
- (32) Date of filing of priority application
- (33) Code of the country or regional organization allotting priority application number
- (34) Two-letter code according to WIPO St.3 identifying the authority with which the priority application was made
- (44) Date of publication of design and number of bulletin (the first publication)
- (45) Date of publication of design registered by WIPO and number of bulletin

- (51) International Classification for designs (class and subclass of the Locarno Classification)
- (54) Title of the invention
- (55) Reproduction of the design
- (57) Description of characteristic features of the design including indication of colors
- (58) Date of recording of any kind of amendment in the Register
- (62) Number of the earlier application, registration and document number and if available the date of filing an application in case of divided application
- (71) Name, surname and address of applicant (country code)
- (72) Name, surname of creator (country code)
- (73) Name, surname and address of patent owner (country code)
- (74) Name, surname of representative or patent attorney
- (81) Contracting states concerned
  - II designated contracting states according to the 1960 Act
  - III designated contracting states according to the 1999 Act
- (85) Owner's permanent address
- (86) Owner's nationality
- (87) Owner's residence
- (88) State in which the owner has a real and effective industrial or commercial establishment

## TRADEMARKS

- (111) - Number of registration
- (151) - Date of registration
- (156) - Date of the renewal
- (181) - Expected expiration date of registration
- (186) - Renewal expiration date of registration
- (141) - Date of cancel of duration of the mark
- (210) - Serial number of application
- (220) - Date of filing of the application
- (230) - Data concerning exhibition
- (260) - Number of application, for which favorable decision of examination about registration has been taken (publication number)
- (310) - Number of the first application
- (320) - Date of filing of the first application
- (330) - Code, identifying national or regional Office where the first application was made
- (511) - International Classification of Goods and Services for the purposes of registration of trade marks and/or list of goods and/or services classified according thereto
- (526) - Disclaimer
- (531) - Description of figurative elements of Trade Marks according to the International Classification of the Figurative Elements of Marks

- (540) - Reproduction of Trade Mark
- (550) - Nature and kind of Trade Mark
- (551) - Indication to the effect that the mark is a collective mark, a certification mark or a guarantee mark
- (554) - Three-dimensional mark
- (580) - Date of recording of any kind changes in respect of applications or registrations
- (591) - Information concerning colors claimed
- (731) - Name and address of the applicant
- (732) - Name and address of the holder of the registration
- (740) - Name and address of the representative
- (750) - Addreses for correspondence
- (770) - Name and address of the previous applicant or holder in case of change in ownership
- (771) - Previous name and address of the applicant or holder in case of change in ownership
- (791) - Name and address of the licensee
- (793) - Indication of conditions and/or restrictions under the license (Type of license, number of license agreement, data of license, data of validity of license)
- (800) - Certain data relating to the international registration of Trade Marks under the Protocol Relating to Madrid Agreement (International registration number
- (852) - Partial cancellation of the list of goods and services
- (891) - Date of subsequent designation

## CODES FOR PUBLICATION IN BULLETIN

- (21) AP 0000 000000 - serial number of application for invention
- (10) AP 0000 0000 A - number of published application for invention (first publication)
- (11) P 0000 0000 B - number of patent for invention (second publication)
- (21) API 0000 000000 - number of application for imported patent
- (11) PI 0000 0000 A - number of imported patent (first publication)
- (21) AU 0000 000000 - serial number of application for utility model
- (10) AU 0000 000 U - number of published application for utility model (first publication)
- (11) U 0000 000 Y - number of patent for utility model (second publication)
- (21) AD 0000 000000 - serial number of application for design
- (10) AD 0000 000 S - number of published application for design (first publication)
- (11) D 0000 000 S - registered design

## INTERNATIONAL PATENT CLASSIFICATION FOR INVENTIONS AND UTILITY MODELS

- SECTION A - HUMAN NECESSITIES
- SECTION B - PERFORMING OPERATIONS; TRANSPORTING
- SECTION C - CHEMISTRY; METALLURGY
- SECTION D - TEXTILES; PAPER
- SECTION E - FIXED CONSTRUCTIONS
- SECTION F - MECHANICAL ENGINEERING; LIGHTING; HEATING; WEAPONS; BLASTING
- SECTION G - PHYSICS
- SECTION H - ELECTRICITY

- 
- M - Trade Mark
  - (210) AM 0000 000000 - Serial number of application;
  - (260) AAM 0000 00000 A - Publication number of application;
  - (111) M 0000 00000 R - Number of registration;
  - (111) MMM0000 00000 Rn - Number of renewals, in which n=1,2,3;
  - (111) M 0000 00000 R(P) - Number of registration under partial assignment of rights
-

# Official Bulletin of the Industrial Property

Inventions

Utility Models

Designs

Trademarks

# CONTENT

<b>PUBLISHED TITLES OF PROTECTION</b> .....	3
<b>INVENTIONS</b>	
▪ APPLICATIONS APPROVED FOR GRANTING PATENT .....	4
▪ PATENTED INVENTIONS .....	10
<b>UTILITY MODELS</b>	
▪ APPLICATIONS APPROVED FOR GRANTING PATENT .....	12
▪ PATENTED UTILITY MODELS .....	13
<b>DESIGNS</b>	
▪ APPLICATIONS APPROVED FOR REGISTRATION .....	14
▪ REGISTERED DESIGN .....	21
▪ DESIGNS, WHICH HAVE BEEN REGISTERED WITH THE INTERNATIONAL BUREAU CLAIMING PRIORITY ON THE TERRITORY OF GEORGIA .....	22
<b>TRADEMARKS</b>	
▪ APPLICATIONS FILED UNDER THE NATIONAL PROCEDURE APPROVED FOR REGISTRATION .....	34
▪ REGISTERED TRADEMARKS .....	40
▪ TRADEMARKS REGISTERED ACCORDING TO THE ACCELERATED PROCEDURE .....	45
▪ INTERNATIONAL TRADEMARKS FOR WHICH A DECISION ON GRANTING PROTECTION IS TAKEN .....	49
▪ INTERNATIONAL TRADEMARKS PROTECTED IN GEORGIA .....	187
<b>OFFICIAL NOTIFICATIONS</b>	
<b>INVENTIONS</b>	
▪ RESTORATION OF PATENTS .....	194
▪ ABOLITION OF PATENTS WITH THE RIGHT TO RESTORE .....	195
▪ EXPIRATION OF TERMS OF RESTORATION OF PATENT .....	196
▪ TRANSFER OF RIGHTS .....	197
<b>UTILITY MODELS</b>	
▪ ABOLITION OF PATENTS WITH THE RIGHT TO RESTORE .....	199
▪ EXPIRATION OF TERMS OF RESTORATION OF PATENT .....	199
<b>DESIGNS</b>	
▪ CANCELLATION OF DESIGN REGISTRATION .....	200
▪ CANCELLATION OF INTERNATIONAL DESIGNS REGISTRATION .....	200
<b>TRADEMARKS</b>	
▪ EXTENSION OF TERMS OF TRADEMARKS REGISTRATION .....	207
▪ COMPLETE TRANSFER OF RIGHTS .....	209
▪ CHANGES OF NAMES AND/OR ADDRESSES OF TRADEMARKS OWNERS .....	210
▪ CANCELLATION OF TRADEMARKS REGISTRATION .....	211
▪ REGISTRATION OF LICENSE AGREEMENTS .....	213
▪ INTERNATIONAL LICENSE AGREEMENTS .....	214
<b>CLASSIFICATION INDEXES</b>	
INVENTIONS .....	215
UTILITY MODELS .....	217
DESIGNS .....	218
TRADEMARKS .....	219

## **PUBLISHED TITLES OF PROTECTION**

### **INVENTIONS**

- **APPLICATIONS APPROVED FOR GRANTING PATENT:**  
15671; 15792; 15769; 14903; 15586; 15630; 15489; 15442; 15650; 15657; 15513; 15369; 15678; 15722
- **PATENTED INVENTIONS:**  
7390-7393

### **UTILITY MODELS**

- **APPLICATIONS APPROVED FOR GRANTING PATENT:**  
15433; 15099
- **PATENTED UTILITY MODELS:**  
2119, 2120

### **DESIGNS**

- **APPLICATIONS APPROVED FOR REGISTRATION:**  
1258; 1263; 1257
- **REGISTERED DESIGN:**  
937
- **DESIGNS, WHICH HAVE BEEN REGISTERED WITH THE INTERNATIONAL BUREAU CLAIMING PRIORITY ON THE TERRITORY OF GEORGIA:**  
220135; 217126; 217124; 220291; 220293; 218688; 217266

### **TRADEMARKS**

- **APPLICATIONS FILED UNDER THE NATIONAL PROCEDURE APPROVED FOR REGISTRATION:**  
108680\*; 112702\*; 115325; 115405, 115406; 115408; 115410-115412; 115414-115416; 115418-115420; 115433; 115510-115512; 115514; 115518; 115585-115587; 115596; 115599, 115600; 115605; 115670; 115675-115677; 115679; 115683; 115686, 115687; 115691, 115692; 115744
- **REGISTERED TRADEMARKS:**  
35575-35626
- **TRADEMARKS REGISTERED ACCORDING TO THE ACCELERATED PROCEDURE:**  
35556-35574
- **INTERNATIONAL TRADEMARKS FOR WHICH A DECISION ON GRANTING PROTECTIONS IS TAKEN:**  
108937; 112211; 112651; 112977; 114374; 114424; 114426; 114433; 114452-114456; 114488-114492; 114494; 114497; 114503-114506; 114508, 114509; 114511, 114512; 114518-114522; 114560-114569; 114574-114577; 114579; 114585-114587; 114622, 114623; 114630; 114638; 114650-114654; 114665-114667; 114702; 114706; 114708, 114709; 114715, 114716; 114718; 114720-114728; 114730-114734; 114763-114768; 114770-114772; 114783; 114840-114842; 114845-114854; 114863-114867; 114871; 114873-114876; 114969-114971; 115029-115033; 115036; 115038, 115039; 115077; 115079, 115080; 115082; 115084, 115085; 115139; 115156; 115162-115165; 115168-115171; 115174; 115179; 115191; 115249, 115250; 115252; 115254-115258; 115269; 115271-115276; 115278; 115289, 115290; 115292; 115296-115298; 115300; 115302; 115361; 115449-115456; 115469-115472; 115476; 115479, 115480; 115482, 115483; 115499-115502; 115541, 115542; 115544, 115545; 115641-115649; 115661-115669
- **INTERNATIONAL TRADEMARKS PROTECTED IN GEORGIA:**  
110618; 111805; 112869; 112871; 112968-112971; 112993-112996; 112998-113004; 113006, 113007; 113053, 113054; 113056, 113057; 113059; 113074; 113076, 113077; 113079; 113087, 113088; 113152; 113164-113167; 113169-113171; 113173; 113177; 113180; 113299-113301; 113330; 113442; 113465; 113467; 113469, 113470; 113480; 113525-113527; 113532, 113533; 113535; 113551-113555; 113568, 113569; 113744; 113755-113759; 113761; 113845; 113890-113893; 113939-113941; 113943; 114021; 114119-114121

# INVENTIONS

## APPLICATIONS APPROVED FOR GRANTING PATENT

The decision can be appealed at the Chamber of Appeal of Sakpatenti within 3 months from the publication or at the Mtskheta District Court Administrative Cases Board (Address: №17, Samkhedro St., Mtskheta), within 1 month following the publication.

### PART A

#### A 01

- (10) AP 2022 15671 A (51) Int. Cl. (2006)  
A 01 N 43/78  
C 07 D 277/56  
C 07 D 411/12
- (21) AP 2019 15671 (22) 2019 11 28  
(31) 18209591.9  
(32) 2018 11 30  
(33) EP  
(71) SYNGENTA PARTICIPATIONS AG (CH)  
Rosentalstrasse 67, Basel, 4058, Switzerland (CH)
- (72) BLUM, Mathias (CH);  
EDMUNDS, Andrew (CH);  
MONACO, Mattia, Riccardo (CH);  
BURNS, David (GB);  
LAMBERTH, Clemens (CH);  
RENDINE, Stefano (CH)
- (74) Tamar Kochlamazashvili  
(85) 2021 06 25  
(86) PCT/EP 2019/082975, 2019 11 28  
(54) MICROBIOCIDAL THIAZOLE DERIVATIVES  
(57) Invention relates to thiyasol-4-carboxamide compounds of formula (I),

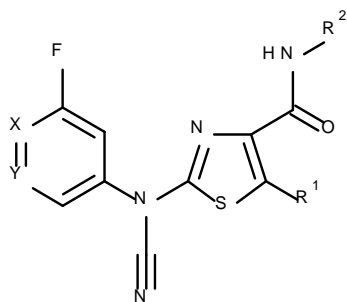

agrochemical compounds comprising thereof, and their usage as fungicides.

Claims: 4 independents  
11 dependents

#### A 23

- (10) AP 2022 15792 A (51) Int. Cl. (2006)  
A 23 F 3/00
- (21) AP 2021 15792 (22) 2021 11 09  
(71) Bakhva Dolidze (GE)  
I. Shemokmedeli Str. 32, 3500, Ozurgeti, Georgia (GE);  
Temur Revishvili (GE)  
University Str. 9, app. 13, Ozurgeti, Georgia (GE);  
Zurab Andghuladze (GE)  
Ilia Chavchavadze Str. 10, app. 2, Ozurgeti, Georgia (GE);  
Alu Gamakharia (GE)  
Tavisupleba St., IV lane 33, Kutaisi, Georgia (GE);  
Zaza Papidze (GE)  
Sulkhan-Saba Ave. 19/21, Kutaisi, Georgia (GE);  
Davit Rokva (GE)  
Metsniereba St.14/24, Ozurgeti, Georgia (GE);  
Mamuka Tskhvaradze (GE)  
Ilia Chavchavadze Str. 7/37, Kutaisi, Georgia (GE)
- (72) Bakhva Dolidze (GE);  
Temur Revishvili (GE);  
Zurab Andghuladze (GE);  
Alu Gamakharia (GE);  
Zaza Papidze (GE);  
Davit Rokva (GE);  
Mamuka Tskhvaradze (GE)
- (54) DEVICE FOR TEA LEAF ROASTING  
(57) A device includes cylindrical case 3 for tea leaf roasting placed in heat-insulating casing 2 having tea leaf receiver, lid, drying zones, screw conveyor 6 placed therein, and mixing and circulating blades 7 in said zones between the coils. Tea leaf supply device – screw conveyor-type hopper-dispenser is connected to said casing in tea leaf receiving zone, and screw conveyor-type transporter 5 and screw conveyor placed in cylindrical case are kinematically connected to each other and have common drive 11. Copper tube 9 is spirally wound on casing of tea leaf supply and placed in heat-insulating casing 10. The device has cylindrical case surface heating means – inventory heater, onto the energypower 12 whereof the power unit 13 is switched, which is copper tube spirally wound around cylindrical case. Furthermore, the unit is equipped with circulation system with cooling

liquid moving in spiral-coiled copper tube in inventory heater and on the casing of tea leaf supply device, which is executed as a valve 15 and a pump 16 connected therewith the pipes 14.

Claims: 1 independent

Fig.: 1

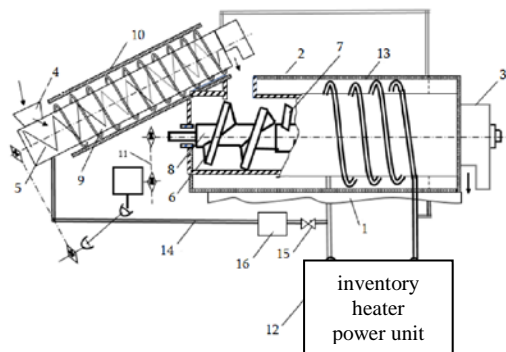

Fig. 1

## A 61

(10) AP 2022 15769 A (51) Int. Cl. (2006)

A 61 K 8/73  
A 61 K 8/891  
A 61 K 8/19  
A 61 K 8/67  
A 61 K 8/92  
A 61 K 8/34  
A 61 K 8/27  
A 61 K 8/37  
A 61 Q 15/00

(21) AP 2020 15769 (22) 2020 05 04

(31) 102019000006907

(32) 2019 05 16

(33) IT

(71) HULKA S.R.L. (IT)

Viale della Scienza 26, Rovigo, 45100, Italy (IT)

(72) PANIN, Giorgio (IT)

(74) Nugzar Ksovreli

(85) 2021 10 25

(86) PCT/EP2020/062259, 2020 05 04

(54) DEODORANT COMPOSITION

(57) Cosmetic formulation includes vitamin E or an ester thereof, starch, sodium bicarbonate, zinc oxide and cosmetically acceptable carrier.

Claims: 1 independent

16 dependents

(10) AP 2022 14903 A (51) Int. Cl. (2006)

A 61 K 9/16  
A 61 K 47/02  
A 61 K 9/06  
A 61 K 47/42  
A 61 K 33/26

(21) AP 2017 14903 (22) 2017 03 15

(31) 16160539.9

(32) 2016 03 15

(33) EP

(71) Solvotrin Therapeutics LTD (IE)

Inchera Little Island Cork, Co Cork, Ireland (IE)

(72) WHELEHAN, Michael (IE);

GABOR, Radics (IE);

LEDWIDGE, Mark (IE);

O'FLYNN, Pat (IE);

WANG, Jun (IE);

GILMER, John (IE)

(74) Tamaz Shilakadze

(85) 2018 10 15

(86) PCT/EP2017/056134, 2017 03 15

(54) COMPOSITIONS AND METHODS FOR

INCREASING IRON INTAKE IN MAMMAL

(57) Compositions contains iron, buffering agent, and carrier containing denatured protein.

Claims: 7 independents

41 dependents

Fig.: 6

(10) AP 2022 15586 A (51) Int. Cl. (2006)

A 61 K 31/19

A 61 K 9/00

A 61 K 31/191

A 61 K 31/185

A 61 K 47/38

A 61 K 9/06

(21) AP 2019 15586 (22) 2019 08 28

(31) 18191289.0

(32) 2018 08 28

(33) EP

(71) Selo Medical GmbH (AT)

Moosham 29, 5585 Untertrenberg, Austria (AT)

(72) Norbert Fuchs (AT)

(74) Shalva Gvaramadze

(85) 2021 03 15

(86) PCT/EP2019/072926, 2019 08 28

(54) THERAPY OF HIGH-RISK HUMAN  
PAPILLOMAVIRUS INFECTIONS

(57) Pharmaceutical composition containing selenite-containing compound, and pharmaceutically acceptable acid, is used in the prevention or treatment of infection of internal reproductive organ of female patient with human papillomavirus (HPV); at that, the composition is applied intravaginally.

Claims: 1 independent

14 dependents

Fig.: 2

(10) AP 2022 15630 A (51) Int. Cl. (2006)

A 61 K 31/4196

A 61 K 31/444

A 61 K 31/437

A 61 P 35/00

C 07 D 471/04

- (21) AP 2019 15630 (22) 2019 11 12  
 (31) 62/767,602; 62/909,970  
 (32) 2018 11 15; 2019 10 03  
 (33) US; US  
 (71) PFIZER INC (US)  
 235 East 42<sup>nd</sup> Street, New-York, NY 10017,  
 USA (US)  
 (72) AHMAD, Omar Khaled (US);  
 DEL BEL, Matthew L. (US);  
 GALLEGO, Rebecca Anne (US);  
 HE, Mingying (US);  
 JALAIE, Mehran (US);  
 JOHNSON, Ted William (US);  
 KANIA, Robert Steven (US);  
 MCTIGUE, Michele Ann (US);  
 NAIR, Sajiv Krishnan (US);  
 SCHMITT, Anne-Marie Dechert (US);  
 TUTTLE, Jamison Bryce (US);  
 ZHOU, Ru (US);  
 ZHOU, Dahui (US)  
 (74) Shalva Gvaramadze  
 (85) 2021 05 14  
 (86) PCT/IB2019/059702, 2019 11 12  
 (54) 2,3-DIHYDRO-1H-PYRROLO[3,4-C]PYRIDIN-  
 1-ONE DERIVATIVES AS HPK1 INHIBI-  
 TORS FOR THE TREATMENT OF CANCER  
 (57) Present invention relates to 2,3-dihydro-1H-  
 pyrrolo[3,4-c]pyridin-1-one derivatives of general  
 Formula (I),

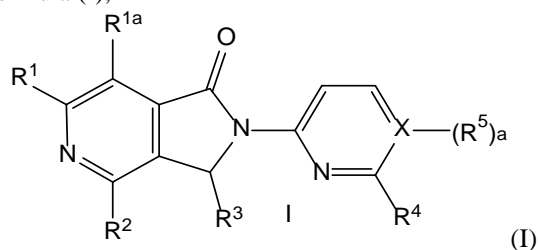

and pharmaceutically acceptable salts thereof,  
 pharmaceutical compositions, and usage therefor  
 abnormal cell growth, particularly, cancer treatment.

Claims: 5 independents  
 71 dependents

## PART B

### B 22

- (10) AP 2022 15489 A (51) Int. Cl. (2006)  
 B 22 B 3/08  
 B 22 B 47/00  
 C 22 C 1/06  
 (21) AP 2020 15489 (22) 2020 11 10  
 (71) Tinatin Lezhava (GE)  
 Nutsubidze Plateau, II mcr., III qu., bld. 3,  
 app. 35, 0183, Tbilisi, Georgia (GE);  
 Jemal Shengelia (GE)  
 Nutsubidze Str. 2, app. 9, 0177, Tbilisi,  
 Georgia (GE);  
 Gigla Tsurtsunia (GE)  
 Didi Dighomi, Ioane Petritsi Str. 8a, app. 2,  
 0131, Tbilisi, Georgia (GE);  
 Nana Koiava (GE)  
 Kartoziya Str. 10, bld. "b", Ent. 4, app. 386, 0177,  
 Tbilisi, Georgia (GE);  
 Davit Gogoli (GE)  
 Politkovskaya Str. 8, Ent. 2, app. 29, 0186,  
 Tbilisi, Georgia (GE);  
 Levan Beriashvili (GE)  
 Vazisubani, Tsulukidze St., Lane 3, bld. 9,  
 app. 24, 0190, Tbilisi, Georgia (GE);  
 Giorgi Gorelishvili (GE)  
 Beri Gabriel Salosi Ave., Lane 6, bld. 5, app. 37,  
 0121, Tbilisi, Georgia (GE);  
 Vazha Chagelishvili (GE)  
 Darialis Str., Lane 6, 0162, Tbilisi,  
 Georgia (GE);  
 Zviad Kurtanidze (GE)  
 Lubliana Str. 11, bld. "i", app. 82, Tbilisi,  
 Georgia (GE)  
 TSU "R. Agladze Institute of Inorganic Chemistry  
 and Electrochemistry" (GE)  
 Mindeli Str. 11, 0186, Tbilisi, Georgia (GE);  
 LEPL "Shota Rustaveli National Science Foun-  
 dation of Georgia" (GE)  
 M. Aleksidze Str. 1, Tbilisi, Georgia (GE)  
 (72) Tinatin Lezhava (GE);  
 Jemal Shengelia (GE);  
 Gigla Tsurtsunia (GE);  
 Nana Koiava (GE);  
 Davit Gogoli (GE);  
 Levan Beriashvili (GE);  
 Giorgi Gorelishvili (GE);  
 Vazha Chagelishvili (GE);  
 Zviad Kurtanidze (GE)  
 (54) METHOD FOR ELECTROCHEMICAL  
 ENRICHMENT OF LOW QUALITY  
 RAW MANGANESE  
 (57) A method for electrochemical enrichment of low  
 quality raw manganese provides electrochemical  
 discharge of raw material by electrolysis with indirect  
 electrochemical reduction of raw MnO<sub>2</sub> and parallel



reduction of  $Fe_{3+}$  to  $Fe_{2+}$  ions in the electrolyzer by electrolytic manganese diode at the anode – electro-synthesis; in addition, usage of large electrolyzer, and the electrode passing through the carbon cage is taken as a cathode. The concentration of iron ions in the solution is 1.5-2.5 g/l, and the solution passed through the cathode is delivered from the electrolyzer to the accumulation of raw manganese, and the solution obtained by leaching into the mass is returned to the anodic area of electrolyzer without filtering.

Claims: 1 independent

Table: 2

### B 30

(10) AP 2022 15442 A (51) Int. Cl. (2006)

B 30 B 9/02

(21) AP 2020 15442 (22) 2020 09 15

(71) Davit Tvaltvadze (GE)

Varlamishvili Str. 34, 4600, Kutaisi, Georgia (GE);

Iuri Gabelia (GE)

Varlamishvili Str. 34, 4600, Kutaisi, Georgia (GE)

(72) Davit Tvaltvadze (GE);

Iuri Gabelia (GE)

(74) Archil Geguchadze

(54) MECHANICAL GRAPE PRESSURE

(57) A pressure includes perforated raw material hopper 2, handle screw pressing 6-10, and juice receiving capacity 3 mounted on common bottom 1; at that, raw material hopper is removable and fixed with componentry to be placed on the receiving plane. Screw pressing is attached to rotating frame 5 attached to base shafts 4. The pressure is equipped with grape-pressing device 12, 13 additional rotating frame 11, and receiving plane thereof is disposed perpendicular relative to the plane of screw pressing attachment onto rotating frame, and istalled capable to be: placed above the hopper and open.

Claims: 1 independent

3 dependents

Fig.: 4

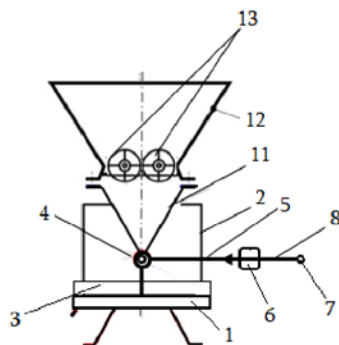

Fig. 1

### B 66

(10) AP 2022 15650 A (51) Int. Cl. (2006)

B 66 D 5/26

(21) AP 2021 15650 (22) 2021 06 04

(71) Simon Bitsadze (GE)

Pekini Ave. 31g, app. 29, 0160, Tbilisi, Georgia

(GE);

Rusudan Bitsadze (GE)

Pekini Ave. 31g, app. 29, 0160, Tbilisi, Georgia

(GE)

(72) Simon Bitsadze (GE);

Rusudan Bitsadze (GE)

(54) MAGNETIC HYDRAULIC PUSHER

(57) A pusher includes a case 1 executed as interconnected hydrocylinders 3 and 6 of different diameters with the pistons 4 and 6 placed therein; at that, small diameter hydrocylinder piston rod 8 is executed capable to be connected to execution mechanism, and big diameter hydrocylinder piston is current power electromagnetic anchor 4 placed into big diameter hydrocylinder 3 disposed in electromagnetic rod 2; at that, small diameter piston upper area is connected to anchor-piston lower area with a pipe 12 and regulating valve 13, and anchor-piston upper area is connected to small diameter piston lower area with one-way valve 10; furthermore, anchor-piston upper area is additionally connected to working liquid tank with pressure regulating valve 11.

Claims: 1 independent

Fig.: 1

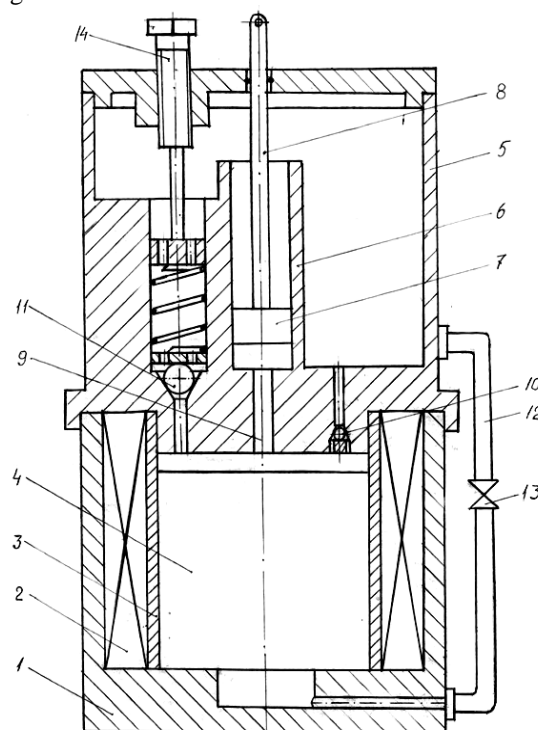

Fig. 1

**PART C****C 12**

- (10) AP 2022 15657 A (51) Int. Cl. (2006)  
C 12 M 1/34
- (21) AP 2021 15657 (22) 2021 06 09
- (71) Lali Chakhvashvili (GE)  
Mukhiani II mcr., bld. 7, app. 40, 0172, Tbilisi,  
Georgia (GE);  
Tamar Berberashvili (GE)  
Al. Kazbegi Ave. 47, app. 31, 0177, Tbilisi,  
Georgia (GE);  
Paata Kervalishvili (GE)  
Panaskertel-Tsitsishvili Str. bld. 6, app. 30, 0194,  
Tbilisi, Georgia (GE);  
Tamar Bzhalava (GE)  
Sulkhan Tsintsadze Str. 42, app. 10, 0160,  
Tbilisi, Georgia (GE)
- (72) Lali Chakhvashvili (GE);  
Tamar Berberashvili (GE);  
Paata Kervalishvili (GE);  
Tamar Bzhalava (GE)
- (54) METHOD FOR VIRUSES VIBRATIONAL FREQUENCY DETERMINATION
- (57) A method for viruses vibrational frequency determination is disclosed. The method provides determination of oscillating spectra based on the signal scattered by a virion (viral nanostructure) irradiated with electromagnetic wave. To determine the significance of virus viral frequency, first of all the dielectric and magnetic permeability, geometrical dimensions, and structural uniformity parameters thereof are measured, and then an algorithm for calculating the scatter of signal scattering wavelengths, and the wavelength of resonant scattering wave by the system is construed.
- Claims: 1 independent  
1 dependent
- Fig.: 2

**C 22**

- (10) AP 2022 15513 A (51) Int. Cl. (2006)  
C 22 C 33/04
- (21) AP 2020 15513 (22) 2020 12 09
- (71) Nugzar Tsereteli (GE)  
Varketili Array, Upper Plateau, II mcr., bld. 21,  
app. 62, Tbilisi, Georgia (GE);  
Ketevan Tsereteli (GE)  
Varketili Array, Upper Plateau, II mcr., bld. 21,  
app. 62, Tbilisi, Georgia (GE)
- (72) Nugzar Tsereteli (GE);  
Ketevan Tsereteli (GE)
- (54) METHOD FOR OBTAINING SILICOMANGANESE
- (57) A method provides large fractional manganese-containing material, reducing agent, quartzite, low-

phosphorus slag and flux, and continues supply with pre-mixed fine-fractional manganese-containing material melting in low-phosphorus liquid slag with a ratio 1:1-1:3, after cooling, batch melting, and obtaining metal and slag periodical release; at that, additionally, low-phosphorus slag is mixed with fine-grained carbonaceous material in such a way that weight ratio of carbon therein, and of manganese in fine-grained material is 0.08-0.16.

Claims: 1 independent

Table: 1

**PART G****G 01**

- (10) AP 2022 15369 A (51) Int. Cl. (2006)  
G 01 N 27/12  
G 08 B 21/16
- (21) AP 2020 15369 (22) 2020 06 16
- (71) Georgian Technical University (GE)  
M. Kostava Str. 77, 0175, Tbilisi, Georgia (GE)
- (72) Archil Prangishvili (GE);  
Nugzar Iashvili (GE);  
Iuri Khutashvili (GE)
- (74) Givi Sibashvili
- (54) NATURAL GAS LEAK CONTROL, ALARM AND MANAGEMENT DEVICE
- (57) Natural gas leak control device includes measurement circuit with: methane semiconductor converter containing heating component, information processing circuit having signal amplifier, analog switch, analog-to-digital converter, memory and control equipments, information board, and power pack. The device is executed capable to switch its outlet electromagnetic shut-off valve to the inlet, and additionally it contains electromagnetic valve circuit integrity sound and light indicators.
- Claims: 1 independent  
1 dependent
- Fig.: 1

**PART H****H 01**

- (10) AP 2022 15678 A (51) Int. Cl. (2006)  
H 01 L 29/66
- (21) AP 2021 15678 (22) 2021 07 03
- (71) Zakaria Taliashvili (GE)  
Batumi Str. 27, app. 28, 0154, Tbilisi,  
Georgia (GE);  
Avtandil Tavkheldze (GE)

Mtskheta Str. 18, app. 11, 0179, Tbilisi,  
Georgia (GE)

(72) Zakaria Taliashvili (GE);  
Avtandil Tavkheldze (GE)

(74) Khatuna Imnadze

(54) SEMICONDUCTOR LIGHT-ABSORBING  
NANOSTRUCTURAL SURFACE

(57) Light-absorbing nanostructure is formed on semiconductor material surface, and contains U-shaped cavities, the depth whereof is chosen so that the beams of lights reflected from cavity top and from bottom overlap each other, when they are in the opposite phase. Said cavities are disposed so that create aperiodic nanostructure. A method for nanostructure making is disclosed, as well.

Claims: 2 independents

1 dependent

Fig.: 3

---

## H 02

(10) AP 2022 15722 A (51) Int. Cl. (2006)  
H 02 K 19/00

(21) AP 2021 15722 (22) 2021 08 23

(71) JSC "Zago Technology" (GE)

Besiki Str. 4, Business Center in Besiki,  
Office 203, 0108, Tbilisi, Georgia (GE)

(72) Vyacheslav Zagoruichenko (GE)

(54) MULTI-DISC INDUCTION GENERATOR  
WITH POWER REGULATION IN  
EXCITATION WINDING

(57) Represented multi-disc induction generator contains magnetic conductors, and switched thereto the cores with installed thereon the excitation and working windings, shafts and stator and rotor discs arranged in sections, and it is made of dielectric material with radial cuts wherein the segments made of magnetic material are embedded. Stator and rotor discs are arranged in two sections, with the stator discs shifted in 180 degrees in different sections, corresponding to half of disc magnetic and non-magnetic sectors, and inductor generator excitation windings are switched to each other in sequence. The generator additionally contains the windings switched in sequence.

Claims: 1 independent

2 dependents

Fig.: 5

## PATENTED INVENTIONS

### PART A

#### A 01

- (11) P 2022 7391 B (51) Int. Cl. (2006)  
 A 01 N 25/02  
 A 01 N 25/04  
 A 01 N 25/16  
 A 01 N 53/00  
 A 01 P 7/04
- (10) AP 2022 14391 A (44) 4(583)/2022  
 (21) AP 2015 14391  
 (22) 2015 06 24  
 (24) 2015 06 24  
 (31) 62/016,242  
 (32) 2014 06 24  
 (33) US  
 (86) PCT/US2015/037327, 2015 06 24  
 (73) FMC Corporation (US)  
 2929 Walnut Street, Philadelphia,  
 PA 19104 (US)  
 (72) BIRD, David (US);  
 MARTIN, Timothy, M. (US);  
 YAN, Laibin, B. (US)  
 (74) Tamaz Shilakadze  
 (54) FOAM FORMULATIONS AND  
 EMULSIFIABLE CONCENTRATES

### PART B

#### B 07

- (11) P 2022 7390 B (51) Int. Cl. (2006)  
 B 07 B 1/28  
 B 07 B 1/42  
 B 07 B 1/46
- (10) AP 2022 15368 A (44) 4(583)/2022  
 (21) AP 2020 15368  
 (22) 2020 06 16  
 (24) 2020 06 16  
 (73) Viktor Zviadauri (GE)  
 Vazha-Pshavela Ave., V qu., bld. 4, app. 79,  
 Tbilisi, Georgia (GE);  
 Tengiz Nadiradze (GE)  
 Bakhtrioni St. 7a, app. 33, Tbilisi,  
 Georgia (GE);  
 Giorgi Tumanishvili (GE)  
 Didi Dighomi, III mcr., bld. 4, app. 65, 0131,  
 Tbilisi, Georgia (GE);

- Tamaz Natriashvili (GE)  
 Panaskerteli St. 17, app. 4, 0194, Tbilisi,  
 Georgia (GE);  
 Davit Sakhvadze (GE)  
 Saiatnova St. 1, Tbilisi, Georgia (GE)
- (72) Viktor Zviadauri (GE);  
 Tengiz Nadiradze (GE);  
 Giorgi Tumanishvili (GE);  
 Tamaz Natriashvili (GE);  
 Davit Sakhvadze (GE)
- (54) DEVICE FOR POWDERED BINDING  
 MATERIAL DOSAGE SUPPLEMENT  
 FROM HOPPER, TRANSPORTATION  
 AND SCREENING THEREOF

#### B 64

- (11) P 2022 7393 B (51) Int. Cl. (2006)  
 B 64 D 27/10  
 F 02 K 3/77
- (10) AP 2022 15579 A (44) 5(584)/ 2022  
 (21) AP 2021 15579  
 (22) 2021 03 05  
 (24) 2021 03 05  
 (73) LLC "Georgian Aviation University" (GE)  
 Ketevan Dedopali Ave. 16, Tbilisi,  
 Georgia (GE)  
 (72) Giorgi Mushkudiani (GE);  
 Sergo Tepnadze (GE);  
 Andro Maisuradze (GE)  
 (74) Andro Maisuradze  
 (54) TWO-CONTOUR TURBOJET DRIVE  
 HAVING COMBINED DEVICE  
 PROTECTING THEREFROM  
 INFLUENCE OF FOREIGN  
 BODIES

### PART C

#### C 07

- (11) P 2022 7392 B (51) Int. Cl. (2006)  
 C 07 K 16/18  
 C 07 K 16/44
- (10) AP 2022 15170 A (44) 3(582)/2022  
 (21) AP 2018 15170  
 (22) 2018 02 27  
 (24) 2018 02 27  
 (31) JP 2017-035594  
 (32) 2017 02 27  
 (33) JP

- 
- (86) PCT/IB2018/000249, 2018 02 27
- (73) Teijin Pharma Limited (JP)  
2-1, Kasumugaseki 3-chome, Chiyoda-ku,  
Tokyo, 100-0013, Japan (JP);  
Merck Sharp & Dohme Corp. (US)  
126 East Lincoln Avenue, Rahway, NJ  
07065, USA (US)
- (72) MALASHOCK, Daniel, Stephen (US);  
JABLONSKI, Angela, Marie (US);  
PARMENTIER BATTEUR, Sophie (US);  
BAKER, Jeanne, E. (US);  
TANOKURA, Akira (JP);  
MURAKAMI, Takashi (JP);  
RAGHUNATHAN, Gopalan (raghu) (US);  
NAMIKI, Naoko (JP);  
MIECZKOWSKI, Carl (US);  
EGUCHI, Hiroshi (JP)
- (74) Shalva Gvaramadze
- (54) HUMANIZED ANTIBODY FOR TREATING  
OR PREVENTING COGNITIVE DISOR-  
DERS, PROCESS FOR PRODUCING THE  
SAME, AND AGENT FOR TREATING OR  
PREVENTING COGNITIVE DISORDERS  
USING THE SAME
-

---

# UTILITY MODELS

## APPLICATIONS APPROVED FOR GRANTING PATENT

The decision can be appealed at the Chamber of Appeal of Sakpatenti within 3 months from the publication or at the Mtskheta District Court Administrative Cases Board (Address: №17, Samkhedro St., Mtskheta), within 1 month following the publication.

### PART B

#### B 22

(10) AU 2022 15433 U (51) Int. Cl. (2006)  
B 22 F 3/11  
B 22 F 3/23  
C 22 C 1/08

(21) AU 2020 15433 (22) 2020 09 02

(71) Vitali Bakhtadze (GE)  
VIII mcr., bld. 12, app. 56, 3700, Rustavi,  
Georgia (GE);  
LEPL "Shota Rustaveli National Science  
Foundation Of Georgia" (GE)  
M. Aleksidze St. 1, Tbilisi, Georgia (GE);  
LEPL "Ivane Javakhishvili Tbilisi State  
University" (GE)  
I. Chavchavadze Ave. 1, Tbilisi, Georgia (GE)

(72) Vitali Bakhtadze (GE);  
Vazha Mosidze (GE)

(54) GAS PURIFICATION CATALYST OF AIRS  
EXHAUSTED FROM INTERNAL COMBUS-  
TION ENGINES

(57) Gas purification catalyst of airs exhausted from  
internal combustion engines includes aluminosilicate  
block and a layer preferably containing thermally  
resistant oxide, with manganese (III, IV) oxide being  
used as secondary layer, and cobalt (II, III) oxide  
being catalytically active phase with the following  
ratio of components in mass%:

manganese (III, IV) oxide – 4,0-8,0

cobalt (II, III) oxide – 4,0-8,0

the rest – up to 100.

Claims: 1 independent

Table: 4

---

(57) Elevator start system includes elevator start  
control device located on one of walls of elevator  
coupe having safe-type body mounted in a way to be  
capable to hang on it. Control device contains coin  
feeder and perception means thereof. Perception  
means is executed in the form of spring-loaded or  
rigid component, a lever or spring-loaded button, and  
contains comparison block containing comparator  
electronic signal source and electronic scale with a  
power supply attached thereto. Coin supplier is  
executed with refundable of discarded coins. The  
system also includes plastic card terminal and finger-  
print scanner.

Claims: 1 independent

12 dependents

Fig.: 21

---

#### B 66

(10) AU 2022 15099 U (51) Int. Cl. (2006)  
B 66 B 9/00

(21) AU 2019 15099 (22) 2019 05 21

(71) Teimuraz Sharashenidze (GE)  
Gldani Array, VII mcr., 2<sup>nd</sup> km, Penitentiary  
Institution №8, Tbilisi, Georgia (GE)

(72) Teimuraz Sharashenidze (GE)

(54) ELEVATOR START SYSTEM

---

---

# PATENTED UTILITY MODELS

## PART A

### A 61

- (11) U 2022 2120 Y (51) Int. Cl. (2006)  
A 61 L 2/16  
(10) AU 2022 15637 U (44) 5(584)/2022  
(21) AU 2021 15637  
(22) 2021 05 24  
(24) 2021 05 24  
(73) LLC "Eco Bohemia" (GE)  
Vill. Tserovani, 3318, Mtskheta, Georgia (GE)  
(72) Koba Gachechiladze (GE)  
(54) DISINFECTANT ANTIBACT
- 

## PART F

### F 01

- (11) U 2022 2119 Y (51) Int. Cl. (2006)  
F 01 K 23/10  
(10) AU 2022 15699 U (44) 5(584)/2022  
(21) AU 2021 15699  
(22) 2021 07 19  
(24) 2021 07 19  
(73) Revaz Giorganashvili (GE)  
Didi Dighomi, Demetre Tavidadbuli St. 6,  
app. 40, 0131, Tbilisi, Georgia (GE);  
Zezva Jaiani (GE)  
Tskneti St. 4a, app. 32, 0162, Tbilisi,  
Georgia (GE)  
(72) Revaz Giorganashvili (GE);  
Zezva Jaiani (GE)  
(74) Khatuna Imnadze  
(54) VEHICLE INTERNAL COMBUSTION  
ENGINE EXHAUST GASES DISPOSAL  
DEVICE
-

---

# DESIGNS

## APPLICATIONS APPROVED FOR REGISTRATION

The decision can be appealed at the Chamber of Appeal of Sakpatenti within 3 months from the publication or at the Mtskheta District Court Administrative Cases Board (Address: №17, Samkhedro str., Mtskheta), within 1 month following the publication.

- (10) AD 2022 1258 S (51) 11-01  
(21) AD 2022 1258 (22) 2022 01 25  
(28) 1  
(71) LTD "Zarapkhana" (GE)  
Lublina St. 15, 0159, Tbilisi, Georgia (GE)  
(72) Tea Tetradze (GE)  
(54) KNIFE  
(55)



1.1



1.2

---



- (10) AD 2022 1263 S (51) 19-08  
 (21) AD 2022 1263 (22) 2022 03 29  
 (28) 10  
 (71) LLC "Kvareli Cellar" (GE)  
 Vill. Chikaani, 4814, Kvareli, Georgia (GE)  
 (72) Meri Tsitsishvili (GE)  
 (74) Khatuna Imnadze (GE)  
 (54) 1.-10 LABEL  
 (55)

**AVANI**



e 750ml | ALC.10,5-13,0%  
 PRODUCED BY KVARELI CELLAR

1.1

**AVANI**



e 750ml | ALC.10,5-13,0%  
 PRODUCED BY KVARELI CELLAR

2.1

**AVANI**



რძგ  
 e 750ml | ALC.10,5-13,0%  
 PRODUCED BY KVARELI CELLAR

3.1

**VS** Brandy

**Ortus**

0.5L/ ALC: 40%

**KVARELI  
 CELLAR**  
 PRODUCED IN GEORGIA

4.1

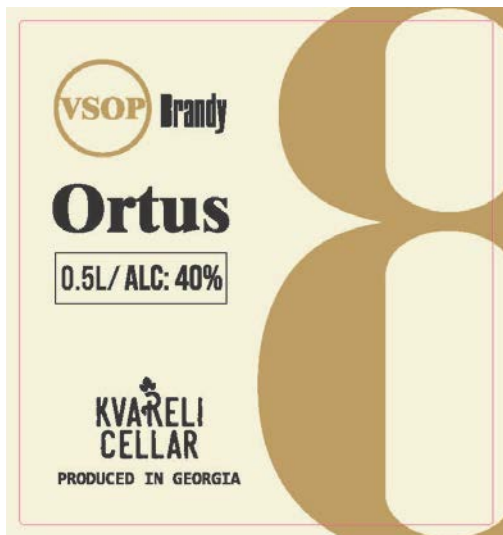

5.1



6.1

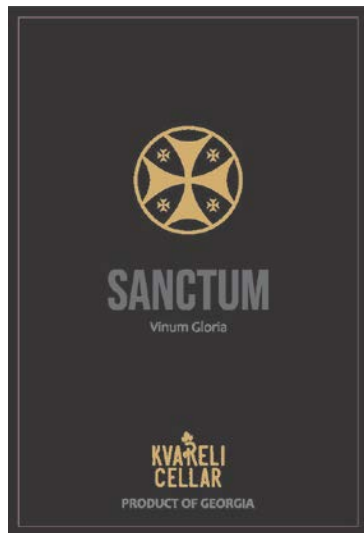

7.1



8.1

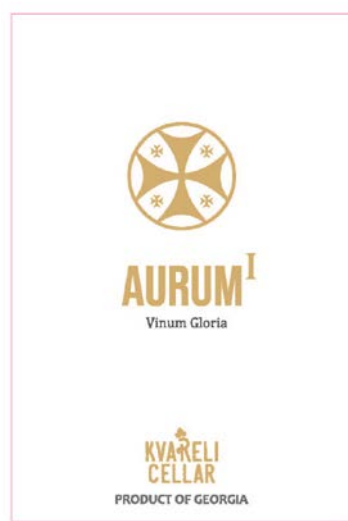

9.1



10.1

(10) AD 2022 1257 S (51) 21-01  
(21) AD 2022 1257 (22) 2022 01 25  
(28) 13  
(71) LTD "Zarapkhana" (GE)  
Lublina St. 15, 0159, Tbilisi, Georgia (GE)  
(72) Mikheil Datjania (GE)  
(54) 1.-12. CHESS FIGURES; 13. CHESS SET  
(55)



1.1



2.1



3.1



4.1



5.1



6.1



7.1



8.1



9.1



10.1



11.1



12.1



13.1



13.2



13.3



13.4

## REGISTERED DESIGN

- (11) D 2022 937 S      (51) 01-01  
(10) AD 2022 1248 S    (44) 2022 03 10 №5  
(21) AD 2021 1248  
(22) 2021 11 03  
(24) 2021 11 03  
(28) 1  
(18) 2026 11 03  
(73) Ketevan Meshveliani (GE)  
    Davit Aghmashebeli Ave. 147, 0112, Tbilisi,  
    Georgia (GE)  
(72) Ketevan Meshveliani (GE)  
(74) Nikoloz Gogilidze (GE)  
(54) CHOCOLATE
-

## DESIGNS, WHICH HAVE BEEN REGISTERED WITH THE INTERNATIONAL BUREAU CLAIMING PRIORITY ON THE TERRITORY OF GEORGIA

The decision can be appealed at the Chamber of Appeal of Sakpatenti within 3 months from the publication or at the Mtskheta District Court Administrative Cases Board (Address: №17, Samkhedro St., Mtskheta), within 1 month following the publication.

- (11) DM/220 135 (51) 19-08  
 (15) 2022 04 06 (44) 16/2022 (2022 04 22)  
 (22) 2022 04 06  
 (28) 5  
 (73) Elite Construction Kft.  
 Déri Miksa U. 8C., 2142 Nagytarcsa (HU)  
 (85) HU  
 (86) HU  
 (87) HU  
 (88) HU  
 (89) HU  
 (81) III. AZ, EM, GE, MD, MN, TJ, TM, UA  
 (72) Oleg Beloshytskyy  
 Déri Miksa Utca 8C., 2142, Nagytarcsa (HU)  
 (74) Danubia Patent & Law Office LLC  
 Bajcsy-Zsilinszky Út 16., 1051 Budapest (HU)  
 (46) 2022 04 22  
 (54) 1.-5. Label  
 (55)

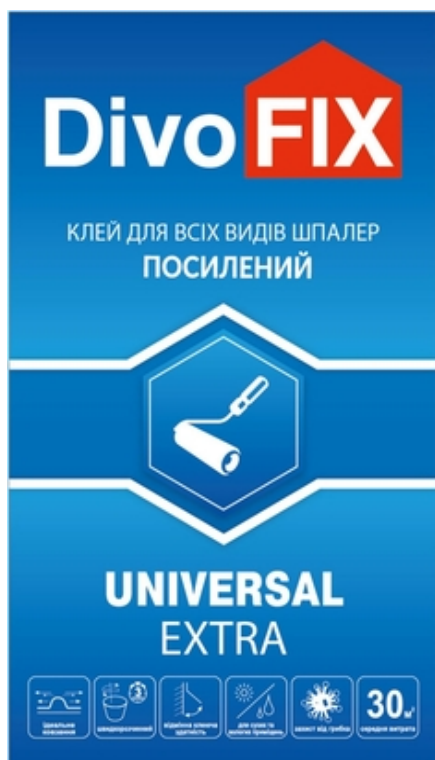

1.1



2.1



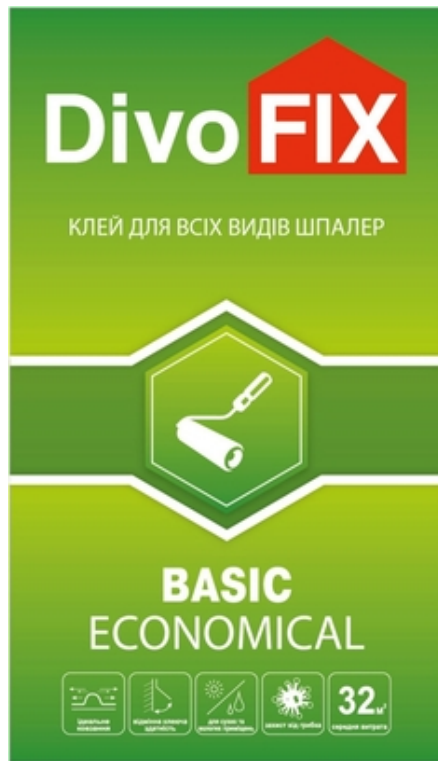

3.1



4.1



5.1

- (11) DM/217 126 (51) 10-07  
 (15) 2021 10 29 (44) 17/2022 (2022 04 29)  
 (22) 2021 10 29  
 (28) 1  
 (73) OMEGA SA (OMEGA AG) (OMEGA LTD.)  
 Jakob-Stämpfli-Strasse 96, 2502 Biel/Bienne (CH)  
 (85) CH  
 (86) CH  
 (87) CH  
 (88) CH  
 (89) CH  
 (81) II. MA III. AL, AM, AZ, BA, BZ, CH, EM, GB, GE, KG, LI, MC, MD, ME, MK, MN, NO, OM, RU, SG,  
 TN, TR, UA  
 (72) Jean-Claude Monachon  
 C/o OMEGA SA (OMEGA AG) (OMEGA LTD.) Jakob-Stämpfli-Strasse 96, 2502, Biel/Bienne (CH)  
 (74) The Swatch Group AG (The Swatch Group SA) (The Swatch Group Ltd.)  
 6, Faubourg Du Lac, 2501 BIEL/BIENNE (CH)  
 (54) 1. Watch case  
 (55)

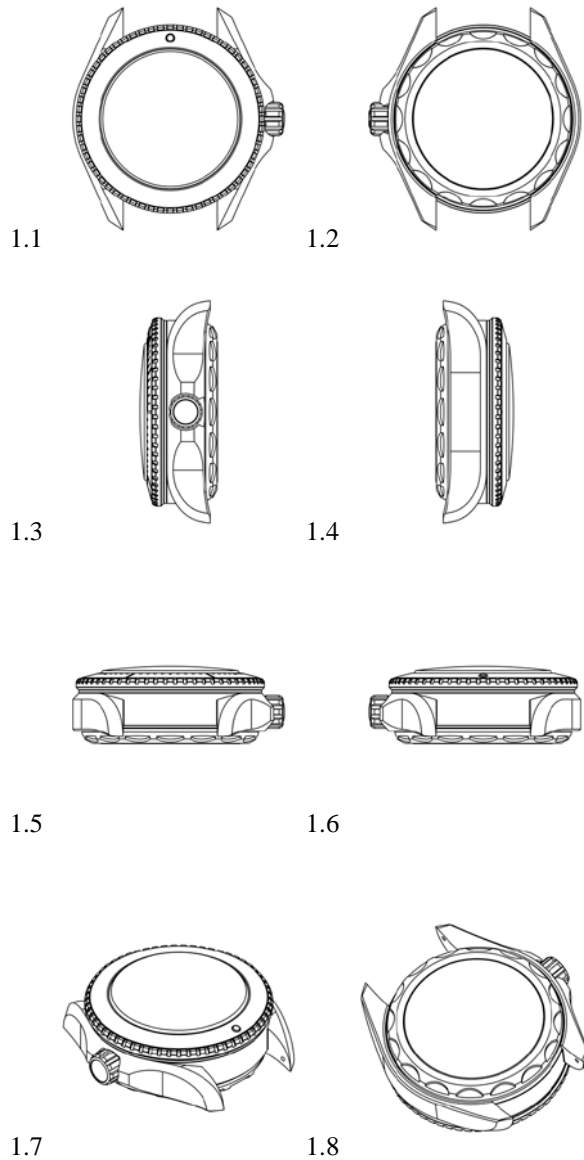

- (11) DM/217 124 (51) 11-01  
 (15) 2021 10 28 (44) 17/2022 (2022 04 29)  
 (22) 2021 10 28  
 (28) 3  
 (73) HARRY WINSTON SA  
 Chemin Du Tourbillon 8, 1228 Plan-les-Ouates (CH)  
 (85) CH  
 (86) CH  
 (87) CH  
 (88) CH  
 (89) CH  
 (81) II. MA III. AL, AM, AZ, BA, BZ, CA, CH, EM, GB, GE, KG, LI, MC, MD, ME, MK, MN, NO, OM, SG,  
 TN, TR, UA  
 (72) 1-2 Rie YATSUGI-KANG  
 C/o Harry Winston Inc. 718 Fifth Avenue, 10019, New York (US)  
 3 Tobias WUEST  
 C/o Harry Winston Inc. 718 Fifth Avenue, 10019, New York (US)  
 (74) The Swatch Group AG (The Swatch Group SA) (The Swatch Group Ltd.)  
 Faubourg Du Lac 6, 2501 Biel/Bienne (CH)  
 (54) 1. Necklace, 2. Bracelet, 3. Pair of earrings  
 (55)

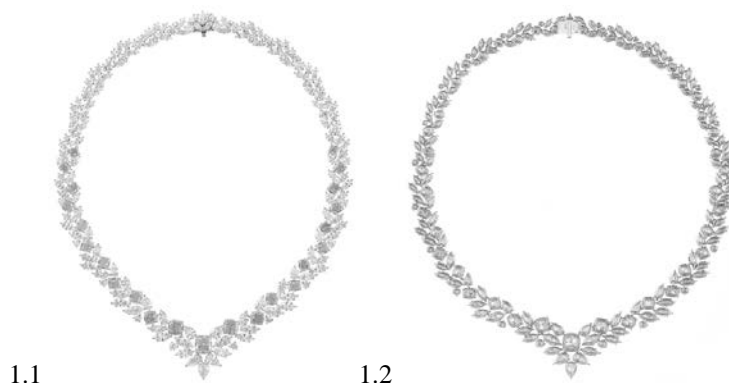

1.7



1.8



2.1



2.2



2.3



2.4



2.5



2.6



2.7



2.8



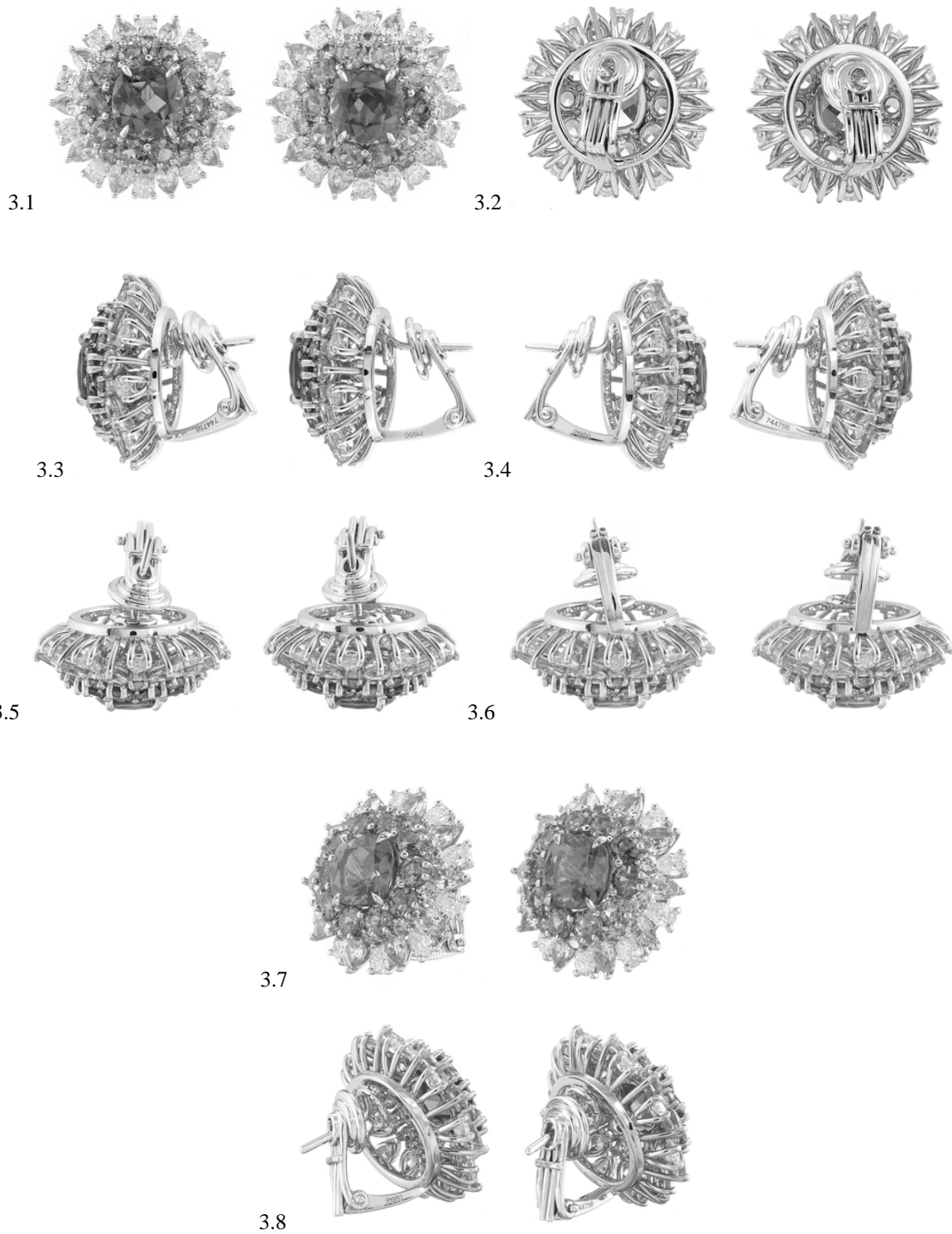

- (11) DM/220 291 (51) 12-07  
(15) 2022 01 12 (44) 17/2022 (2022 04 29)  
(22) 2022 01 12  
(28) 1  
(30) No1: 19.07.2021; 2021503627; RU  
(73) JOINT STOCK COMPANY AVIATION HOLDING COMPANY SUKHOI  
Russia, Moscow, Ul. Polikarpova, 23b, 125284 Moscow (RU)  
(85) –  
(86) RU  
(87) RU  
(88) –  
(89) RU  
(81) III. AM, AZ, BY, DE, EG, EM, FR, GB, GE, IL, JP, KP, KR, MN, NA, RS, SY, TM, TR, UA, US, VN  
(72) Denis Yuryevich ARDEEV  
Zelenograd City (Moscow), Building 1535, Apartment 223, 124683, Moscow (RU);  
Mikhail Yuryevich STRELETS  
Moscow Region, Reutov City, Ubileiny Prospect 9, Apartment 123, 543965, Moscow (RU);  
Aleksy Sergeevich BULATOV  
Moscow, Novokurkinskoe Sh. 31, Apartment 59, 125466, Moscow (RU);  
Vasiliy Sergeevich EROFEEV  
Moscow, Vrachebny Proezd 10, Building 1, Apartment 150, 125367, Moscow (RU);  
Andrey Borisovich ALENIN  
Moscow Region, Khimki City, Druzhby Str. 8a, Apartment 104, 141400, Moscow (RU);  
Mikhail Sergeevich MINKOV  
Moscow, Kliazmynskaya Str. 8B, Apartment 95, 125412, Moscow (RU)  
(74) JSC "Reestr-Consulting"/ DMITRY MARKIN  
Russia, Moscow, B. Balkansky Per, Constr 20-1. , 129090 Moscow (RU)  
(46) 2022 04 29  
(54) 1. Stealth supersonic single-engine unmanned aerial vehicle  
(55)

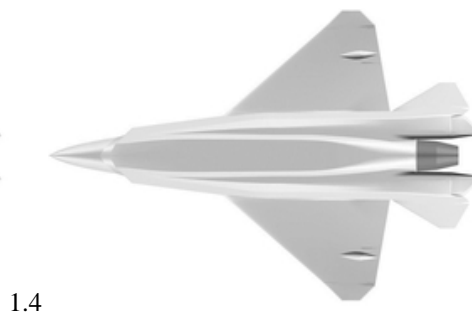



1.5



1.6



1.7

---

- (11) DM/220 293                   (51) 12-07
- (15) 2022 01 12                 (44) 17/2022 (2022 04 29)
- (22) 2022 01 12
- (28) 1
- (30) No1: 19.07.2021; 2021503628; RU
- (73) JOINT STOCK COMPANY AVIATION HOLDING COMPANY SUKHOI  
Russia, Moscow, Ul. Polikarpova, 23b, 125284 Moscow (RU)
- (85) –
- (86) –
- (87) RU
- (88) –
- (89) –
- (81) III. AM, AZ, BY, DE, EG, EM, FR, GB, GE, IL, JP, KP, KR, MN, NA, RS, SY, TM, TR, UA, US, VN
- (72) Mikhail Yuryevich STRELETS  
Ubileiny Prospect 9, Apartment 123, 543965, Reutov, Moscow Region (RU);  
Aleksey Sergeevich BULATOV  
Novokurkinskoe Sh. 31, Apartment 59, 125466, Moscow (RU);  
Vasiliy Sergeevich EROFEEV  
Vrachebny Proezd 10, Building 1, Apartment 150, 125367, Moscow (RU);  
Artem Alekseevich NIZHENKO  
Akademica Pavlova Str. 27 Building4, Apartment 68, 121359, Moscow (RU);  
Denis Yuryevich ARDEEV  
Building 1535, Apartment 223, 124683, Zelenograd City, Moscow (RU);  
Natalia Borisovna POLYAKOVA  
Maloye Sareevo Village, Building 19a, 143033, Odintsovsky District, Moscow Region (RU)
- (74) JSC "Reestr-Consulting"/ DMITRY MARKIN  
Russia, Moscow, B. Balkansky Per, Constr 20-1. JSC "Reestr-Consulting", 129090 Moscow (RU)
- (46) 2022 04 29
- (54) 1. Stealth supersonic single-engine two-seat aircraft
- (55)

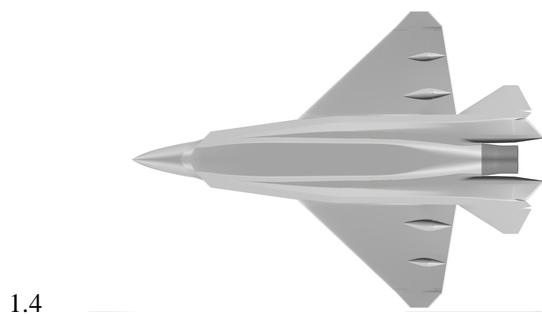
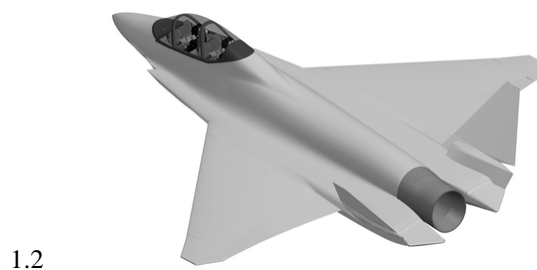
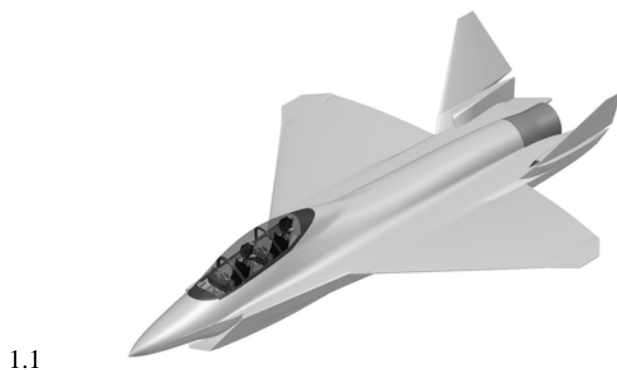





1.5



1.6



1.7

---

- (11) DM/218 688
- (15) 2024 10 25
- (22) 2021 10 25
- (28) 1
- (30) No1: 28.04.2021; No. 1: 28.04.2021; 008521595-001; EMNo. 1: 28.04.2021; 6134016; GB
- (73) William Maxwell Preston  
The Inn At Kingsbarns 5 Main Street, KY16 8TA Kingsbarns (GB)
- (85) GB
- (86) GB
- (87) GB
- (88) GB
- (89) GB
- (81) III. AL, AM, AZ, BA, BN, BW, BY, BZ, CH, EG, GE, GH, IL, IS, KG, KH, KP, LI, MC, MD, ME, MK, MN, MX, NA, NO, OA, OM, RS, RU, RW, SG, SM, SR, ST, SY, TJ, TM, TN, TR, UA, US, VN, WS
- (72) William Maxwell Preston  
The Inn At Kingsbarns 5 Main Street, KY16 8TA Kingsbarns (GB)
- (74) Marks & Clerk LLP  
40 Torphichen Street, EH3 8JB Edinburgh (GB)
- (46) 2022 04 29
- (54) 1. Graphic design (two-dimensional)
- (55)

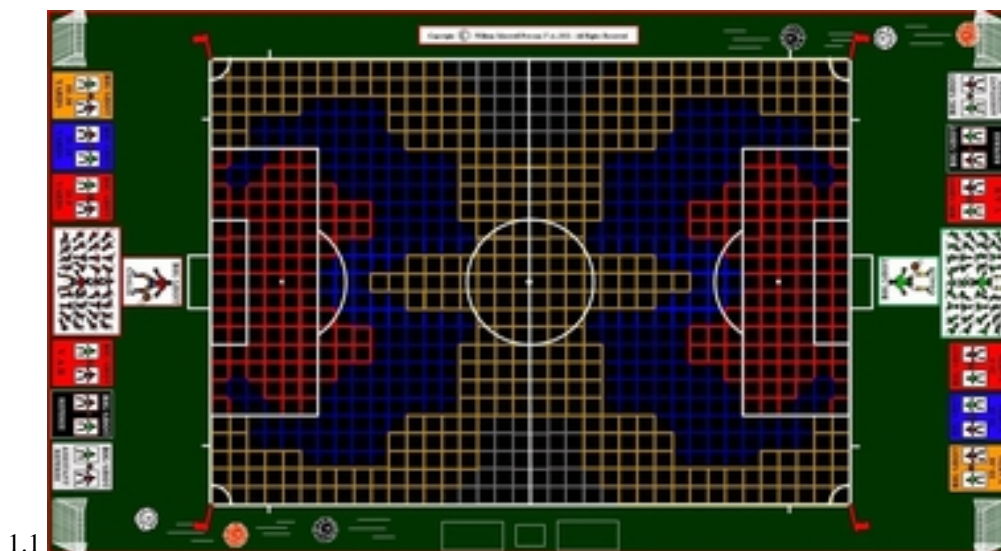

- (11) DM/217 266 (51) 10-07  
 (15) 2021 11 02 (44) 18/2022 (2022 05 06)  
 (22) 2021 11 02  
 (28) 1  
 (73) HARRY WINSTON SA  
 Chemin Du Tourbillon 8, 1228 Plan-les-Ouates (CH)  
 (85) CH  
 (86) CH  
 (87) CH  
 (88) CH  
 (89) CH  
 (81) II. MA III. AL, AM, AZ, BA, BZ, CA, CH, EM, GB, GE, KG, LI, MC, MD, ME, MK, MN, NO, OM, RU,  
 SG, TN, TR, UA  
 (72) Nina PIKOVA  
 C/o Harry Winston SA Chemin Du Tourbillon 8, 1228, Plan-les-Ouates (CH)  
 (74) The Swatch Group AG (The Swatch Group SA) (The Swatch Group Ltd.)  
 Faubourg Du Lac 6, 2501 Biel/Bienne (CH)  
 (54) 1. Watch case with bracelet  
 (55)

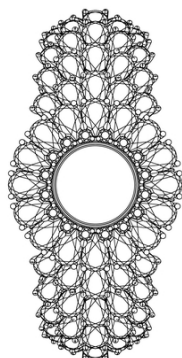

1.1

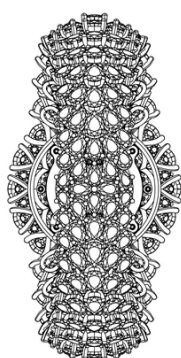

1.2



1.3



1.4

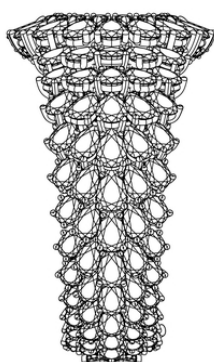

1.5

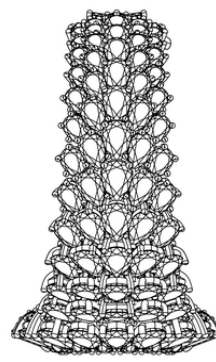

1.6

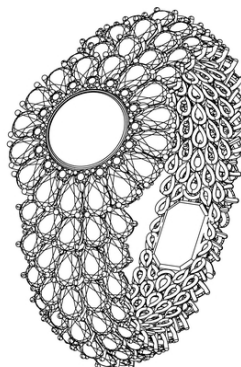

1.7

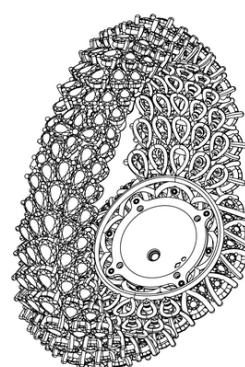

1.8

---

# TRADEMARKS

## APPLICATIONS FILED UNDER THE NATIONAL PROCEDURE APPROVED FOR REGISTRATION

The decision can be appealed at the Chamber of Appeal of Sakpatenti within 3 months from the publication or at the Mtskheta District Court Administrative Cases Board (Address: №17, Samkhedro St., Mtskheta), within 1 month following the publication.

(260) AM 2022 108680 A\*  
(210) AM 108680  
(220) 2020 06 17  
(731) LTD "Kartveli"  
Kakheti Highway, 110a, 0151, Isani-Samgori  
District, Tbilisi, Georgia  
(740) Davit Dzamukashvili  
(540)



(591) Black, golden, white  
(531) 04.03.01; 05.13.06; 24.01.05; 24.01.13;  
24.01.17; 24.13.01; 24.13.09; 24.13.24;  
25.01.19; 27.05.01; 27.05.10; 27.05.11;  
27.05.24; 29.01.13  
(511) 33

---

(260) AM 2022 112702 A\*  
(210) AM 112702  
(220) 2021 04 21  
(731) The Hut.com Limited  
5th Floor, Voyager House, Chicago Avenue,  
Manchester Airport, Manchester M90 3DQ,  
United Kingdom  
(740) Giorgi Taktakishvili  
(540)

### MYPROTEIN

(591) Black-white  
(511) 5, 29, 30, 32

---

(260) AM 2022 115325 A  
(210) AM 115325  
(220) 2021 11 08  
(731) LTD "Royal Dent"  
Kipshidze Str. 2, 0162, Tbilisi, Georgia  
(540)

როიალ დენტი  
**Royal Dent**

(591) Black-white  
(511) 44

---

(260) AM 2022 115405 A  
(210) AM 115405  
(220) 2021 11 15  
(731) LLC "TR Real Estate"  
I. Abashidze Str. 65-67, app. 15, Vake District,  
Tbilisi, Georgia  
(540)

ბი სტუდო  
**Bee Studio**

(591) Black-white  
(511) 35

---

(260) AM 2022 115406 A  
(210) AM 115406  
(220) 2021 11 15  
(731) LLC "TR Real Estate"  
I. Abashidze Str. 65-67, app. 15, Vake District,  
Tbilisi, Georgia  
(540)

ქოფი სტუდო  
**Coffee Studio**

(591) Black-white  
(511) 30, 35, 43

---

(260) AM 2022 115408 A  
(210) AM 115408  
(220) 2021 11 15  
(731) LLC "TR Georgia Project 2"

Chitadze Str. 3 / Niaghvari Str. 4, app. 11,  
Mtatsminda District, Tbilisi, Georgia

(540)

**დიზაინ სტუდიო**  
**Design Studio**

(591) Black-white

(511) 20, 35

(260) AM 2022 115410 A

(210) AM 115410

(220) 2021 11 15

(731) LLC "TR Georgia Project 2"

Chitadze Str. 3 / Niaghvari Str. 4, app. 11,  
Mtatsminda District, Tbilisi, Georgia

(540)

**იორი ველი**  
**Iori Valley**

(591) Black-white

(511) 35

(260) AM 2022 115411 A

(210) AM 115411

(220) 2021 11 15

(731) LLC "TR Georgia Project 2"

Chitadze Str. 3 / Niaghvari Str. 4, app. 11,  
Mtatsminda District, Tbilisi, Georgia

(540)

**იორი ესთეიტი**  
**Iori Estate**

(591) Black-white

(511) 35

(260) AM 2022 115412 A

(210) AM 115412

(220) 2021 11 15

(731) LLC "TR Georgia Project 2"

Chitadze Str. 3 / Niaghvari Str. 4, app. 11,  
Mtatsminda District, Tbilisi, Georgia

(540)

**ი-ორი ველი**  
**Y-ori Valley**

(591) Black-white

(511) 35

(260) AM 2022 115414 A

(210) AM 115414

(220) 2021 11 15

(731) LLC "TR Georgia Project 2"

Chitadze Str. 3 / Niaghvari Str. 4, app. 11,  
Mtatsminda District, Tbilisi, Georgia

(540)

**ი-ორი ესთეიტი**  
**Y-ori Estate**

(591) Black-white

(511) 35

(260) AM 2022 115415 A

(210) AM 115415

(220) 2021 11 15

(731) LLC "TR Georgia Project 2"

Chitadze Str. 3 / Niaghvari Str. 4, app. 11,  
Mtatsminda District, Tbilisi, Georgia

(540)

**ი-ორი ველი**  
**I-ori Valley**

(591) Black-white

(511) 35

(260) AM 2022 115416 A

(210) AM 115416

(220) 2021 11 15

(731) LLC "TR Georgia Project 2"

Chitadze Str. 3 / Niaghvari Str. 4, app. 11,  
Mtatsminda District, Tbilisi, Georgia

(540)

**ი-ორი ესთეიტი**  
**I-ori Estate**

(591) Black-white

(511) 35

(260) AM 2022 115418 A

(210) AM 115418

(220) 2021 11 15

(731) LLC "TR Georgia Project 2"

Chitadze Str. 3 / Niaghvari Str. 4, app. 11,  
Mtatsminda District, Tbilisi, Georgia

(540)

**იორი ველი**  
**Iory Valley**

(591) Black-white

(511) 35

(260) AM 2022 115419 A

(210) AM 115419

(220) 2021 11 15

(731) Sanovel Ilaj Sanaii Ve Tijaret A. S.

Istinye Mahallesi, Balabandere Caddesi No:14  
 TR-34460 Sariyer, Istanbul, Turkey  
 (740) Merab Kvimsadze  
 (540)

**NOTTA**

(591) Black-white  
 (511) 5

(260) AM 2022 115420 A  
 (210) AM 115420  
 (220) 2021 11 15  
 (731) LLC "TR Georgia Project 2"  
 Chitadze Str. 3 / Niaghvari Str. 4, app. 11,  
 Mtatsminda District, Tbilisi, Georgia  
 (540)

**იორი ისთეიტი**

**Iory Estate**

(591) Black-white  
 (511) 35

(260) AM 2022 115433 A  
 (210) AM 115433  
 (220) 2021 11 17  
 (731) Viron Therapeutics LLC  
 1 Boston Place, Suite 2603, Boston,  
 MA 02108, USA  
 (540)

**VIRON**

(591) Black-white  
 (511) 42

(260) AM 2022 115510 A  
 (210) AM 115510  
 (220) 2021 11 22  
 (310) 20211160  
 (320) 2021 05 24  
 (330) BY  
 (731) Monster Energy Company a Delaware  
 Corporation  
 1 Monster Way, Corona, California 92879,  
 USA  
 (740) Natela Otariidze  
 (540)



(591) Black, white, golden  
 (531) 03.01.01; 03.01.16; 27.05.01; 27.05.02;  
 29.01.13  
 (511) 32

(260) AM 2022 115511 A  
 (210) AM 115511  
 (220) 2021 11 22  
 (731) LLC "TR Georgia Project 2"  
 Chitadze Str. 3 / Niaghvari Str. 4, app. 11,  
 Mtatsminda District, Tbilisi, Georgia  
 (540)

**იორის მამული**

(591) Black-white  
 (511) 35

(260) AM 2022 115512 A  
 (210) AM 115512  
 (220) 2021 11 22  
 (731) LLC "TR Georgia Project 2"  
 Chitadze Str. 3 / Niaghvari Str. 4, app. 11,  
 Mtatsminda District, Tbilisi, Georgia  
 (540)

**იორის ხეობა**

(591) Black-white  
 (511) 35

(260) AM 2022 115514 A  
 (210) AM 115514  
 (220) 2021 11 22  
 (731) LLC "TR Real Estate"  
 I. Abashidze Str. 65-67, app. 15, Vake District,  
 Tbilisi, Georgia  
 (540)

**ყავის სტუდია**

(591) Black-white  
 (511) 30, 35, 43

(260) AM 2022 115518 A  
 (210) AM 115518  
 (220) 2021 11 23  
 (731) Dunhill Tobacco of London Limited  
 Globe House, 4 Temple Place, London, WC2R  
 2PG, United Kingdom  
 (740) Tamar Kochlamazashvili

(540)

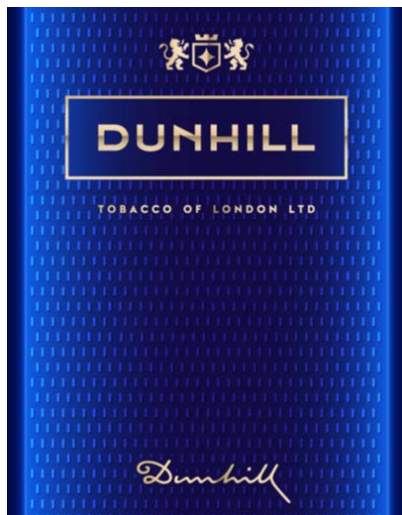

(591) Grey, white, sky-blue, dark bkue, blue  
 (531) 24.01.03; 25.01.01; 25.01.13; 25.07.01;  
 25.07.08; 25.07.15; 25.07.20; 25.07.21;  
 26.04.02; 26.04.22; 26.04.24; 27.05.01;  
 27.05.10; 27.05.24; 29.01.12  
 (511) 34

(260) AM 2022 115585 A  
 (210) AM 115585  
 (220) 2021 11 26  
 (731) LTD "Wine Company Shumi"  
 Lionidze Str. 33, Telavi, Georgia  
 (740) Shalva Gvaramadze  
 (540)

**IGRIKA**  
**იგრიკა**  
**ИГРИКА**

(591) Black-white  
 (511) 33

(260) AM 2022 115586 A  
 (210) AM 115586  
 (220) 2021 11 26  
 (731) LTD "Wine Company Shumi"  
 Lionidze Str. 33, Telavi, Georgia  
 (740) Shalva Gvaramadze  
 (540)

**BARBOLI**  
**ბარბოლი**  
**БАРБОЛИ**

(591) Black-white  
 (511) 33

(260) AM 2022 115587 A  
 (210) AM 115587  
 (220) 2021 11 26  
 (731) LTD "Wine Company Shumi"  
 Lionidze Str. 33, Telavi, Georgia  
 (740) Shalva Gvaramadze  
 (540)

**MARIALI**  
**მარიალი**  
**МАРИАЛИ**

(591) Black-white  
 (511) 33

(260) AM 2022 115596 A  
 (210) AM 115596  
 (220) 2021 11 30  
 (310) 018501958  
 (320) 2021 06 28  
 (330) EUIPO  
 (731) The Procter & Gamble Company  
 One Procter & Gamble Plaza  
 Cincinnati, Ohio 45202, USA  
 (540)



(591) Green, white  
 (531) 24.15.02; 24.15.13; 26.04.02; 26.04.05;  
 26.04.22; 26.04.24; 27.03.01; 27.03.15;  
 27.05.01; 27.05.24; 29.01.12  
 (511) 3, 5, 16

(260) AM 2022 115599 A  
 (210) AM 115599  
 (220) 2021 11 30  
 (731) Yanwen Hu  
 1206RM, C/26 Building, GuiFangYuan BuJi  
 Street, LongGang Dist, Shenzhen, People  
 Republic of China  
 (740) Khatuna Imnadze  
 (540)

**MARSHYDRO**

(591) Black-white  
 (531) 01.13.01; 01.13.05; 01.13.10; 27.01.06;  
 27.01.11; 27.05.01; 27.05.19  
 (511) 11, 22

(260) AM 2022 115600 A  
 (210) AM 115600  
 (220) 2021 11 30  
 (731) Venhua Hu

No. 28, Group 3, Fuxing Village Wubao Town,  
Gongjing Dist Zigong, Sichuan, People  
Republic of China  
(740) Khatuna Imnadze  
(540)

**SPIDER FARMER**

(591) Black-white  
(531) 03.13.02; 27.05.01  
(511) 11, 22

(260) AM 2022 115605 A  
(210) AM 115605  
(220) 2021 12 01  
(731) Tp-Link Corporation Limited  
Room 901, 9/F, New East Ocean Centre, 9  
Science Museum Road, Tsim Sha Tsui,  
Kowloon, Hong Kong  
(740) Liliana Darakhvelidze  
(540)

**Tapo**

(591) Black-white  
(531) 27.05.01; 28.05  
(511) 9, 11

(260) AM 2022 115670 A  
(210) AM 115670  
(220) 2021 12 03  
(731) The Procter & Gamble Company  
One Procter & Gamble Plaza  
Cincinnati, Ohio 45202, USA  
(540)

**ALWAYS INFINITY FLEXPROTECT**

(591) Black-white  
(531) 27.05.01  
(511) 5

(260) AM 2022 115675 A  
(210) AM 115675  
(220) 2021 12 06  
(731) "Folipharm" GmbH  
Regensburger Str. 28C, Berlin, 10777, Germany  
(740) Varlami Burjanadze  
(540)

**FOLIADIN**

(591) 2A8C7E dark green, 00A695 light green, white  
(531) 05.03.14; 27.05.01; 27.05.08; 29.01.03  
(511) 5

(260) AM 2022 115676 A  
(210) AM 115676  
(220) 2021 12 06  
(731) Shenzhen City Heng Zhi He Technology Co. Ltd  
4F4006, Shenzhen computer building, Madame  
Curie Avenue, wankecheng community,  
Bantian street, Longgang District, Shenzhen,  
People Republic of China  
(740) Giorgi Kartvelishvili  
(540)



(591) Black-white  
(531) 03.01.01  
(511) 12

(260) AM 2022 115677 A  
(210) AM 115677  
(220) 2021 12 07  
(731) LTD "TM Group"  
S. Tsintsadze Str. 59, app. 39, Tbilisi,  
Georgia  
(540)

**NATTURA**

**ნატურა**

(591) Black-white  
(511) 43

(260) AM 2022 115679 A  
(210) AM 115679  
(220) 2021 12 07  
(731) LTD "TM Group"  
S. Tsintsadze Str. 59, app. 39, Tbilisi,  
Georgia  
(540)

**LENS HOTEL**

(591) Black-white  
(511) 43

(260) AM 2022 115683 A  
(210) AM 115683  
(220) 2021 12 07  
(731) LTD "Termo Center"  
Sh. Gogidze Str. 6, 0159, Tbilisi,  
Georgia



(540)



(591) Yellow, black

(531) 01.15.15; 12.03.01; 12.03.11; 15.01.13;  
15.01.21; 15.01.23; 15.01.25; 26.11.05;  
26.11.08; 28.19; 29.01.12

(511) 11

(260) AM 2022 115686 A

(210) AM 115686

(220) 2021 12 08

(731) LTD "LJ Group"

Merab Kostava Str. 72, app. 8, Tbilisi, Georgia

(540)

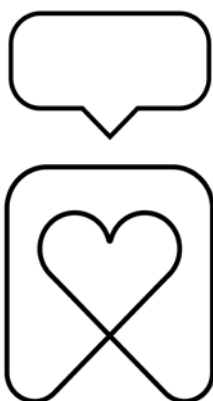

(591) Black-white

(531) 02.09.01; 26.04.04; 26.04.06; 26.04.14;  
26.13.25

(511) 9, 35, 42

(260) AM 2022 115687 A

(210) AM 115687

(220) 2021 12 08

(731) LTD "LJ Group"

Merab Kostava Str. 72, app. 8, Tbilisi, Georgia

(540)

**Like Notes**

(591) Lilac, yellow, white, black

(531) 02.09.01; 26.04.14; 27.05.01; 27.05.17

(511) 9, 16, 25, 35, 42

(260) AM 2022 115691 A

(210) AM 115691

(220) 2021 12 09

(731) Jelly Belly Candy Company

One Jelly Belly Lane, Fairfield, California  
94533, USA

(740) Giorgi Taktakishvili

(540)

**BEAN BOOZLED**

(591) Black-white

(511) 30

(260) AM 2022 115692 A

(210) AM 115692

(220) 2021 12 09

(731) Jelly Belly Candy Company

One Jelly Belly Lane, Fairfield, California  
94533, USA

(740) Giorgi Taktakishvili

(540)



(591) Black-white

(531) 25.03.01; 25.03.03; 25.03.11; 25.03.13;  
25.03.15; 26.01.01; 26.01.19; 26.01.22;  
26.01.24; 27.05.01; 27.05.19; 27.05.24

(511) 30

(260) AM 2022 115744 A

(210) AM 115744

(220) 2021 12 10

(310) 83586

(320) 2021 06 21

(330) JM

(731) Amazon Technology Inc.

410 Teri Ave N, Sietli, Vashingtoni,  
98109, USA

(740) Tamaz Shilakadze

(540)

**BUGBUST**

(591) Black-white

(511) 41, 42

**REGISTERED TRADEMARKS**

(111) M 2022 35575 R  
(151) 2022 06 16  
(181) 2032 06 16  
(260) AM 2020 111082 A  
(220) 2020 12 29

(732) N(N)LE "Foundation Atinati"  
Irakli Abashidze Str. 28, app. 6, 0109, Tbilisi,  
Vake District, Georgia

(111) M 2022 35581 R  
(151) 2022 06 16  
(181) 2032 06 16  
(260) AM 2021 113024 A  
(220) 2021 05 17

(732) Joint Stock Company "Yantar"  
Moscow Prospect, House 1A, Voronezh,  
Russian Federation

(111) M 2022 35576 R  
(151) 2022 06 16  
(181) 2032 06 16  
(260) AM 2021 112666 A  
(220) 2021 04 16

(732) LLC "Bolero & Company"  
Kuchishvili Str. 12-14-16, 0179, Tbilisi, Georgia

(111) M 2022 35582 R  
(151) 2022 06 16  
(181) 2032 06 16  
(260) AM 2021 113115 A  
(220) 2021 05 24

(732) LLC "TV and Producers School Prime  
Tv Prime Line"  
Vazisubani Settlement, I mcr. bld.3, app. 87,  
Isani-Samgori District, Tbilisi Georgia

(111) M 2022 35577 R  
(151) 2022 06 16  
(181) 2032 06 16  
(260) AM 2021 112667 A  
(220) 2021 04 16

(732) LLC "Bolero & Company"  
Kuchishvili Str. 12-14-16, 0179, Tbilisi, Georgia

(111) M 2022 35583 R  
(151) 2022 06 16  
(181) 2032 06 16  
(260) AM 2021 113134 A  
(220) 2021 05 26

(732) Idai Nature S.L.  
Es/mosku, 10. Pol. Mas De Tous 46185  
La Pobra De Valbona (Valencia), Spain

(111) M 2022 35578 R  
(151) 2022 06 16  
(181) 2032 06 16  
(260) AM 2021 112670 A  
(220) 2021 04 16

(732) LLC "Bolero & Company"  
Kuchishvili Str. 12-14-16, 0179, Tbilisi, Georgia

(111) M 2022 35584 R  
(151) 2022 06 16  
(181) 2032 06 16  
(260) AM 2021 113218 A  
(220) 2021 05 31

(732) Irine Khundadze  
Z. Paliashvili Str. 5, app. 16, 0179, Tbilisi,  
Georgia

(111) M 2022 35579 R  
(151) 2022 06 16  
(181) 2032 06 16  
(260) AM 2021 112671 A  
(220) 2021 04 16

(732) LLC "Bolero & Company"  
Kuchishvili Str. 12-14-16, 0179, Tbilisi, Georgia

(111) M 2022 35585 R  
(151) 2022 06 16  
(181) 2032 06 16  
(260) AM 2021 113269 A  
(220) 2021 06 02

(732) LLC "ACT"  
John (Malkhaz) Shalikhvili Str. 8, 0159,  
Vake-Saburtalo District, Tbilisi, Georgia

(111) M 2022 35580 R  
(151) 2022 06 16  
(181) 2032 06 16  
(260) AM 2021 112732 A  
(220) 2021 04 29

(732) Gaba International Holding Gmbh  
Grabetsmattweg, Therwil 4106, Switzerland

(111) M 2022 35586 R  
(151) 2022 06 16  
(181) 2032 06 16  
(260) AM 2021 113270 A  
(220) 2021 06 02

(732) LLC "ACT"  
John (Malkhaz) Shalikashvili Str. 8, 0159,  
Vake-Saburtalo District, Tbilisi, Georgia

Zh. Shartava Str. 18, app. 15, 0160, Tbilisi,  
Georgia

(111) M 2022 35587 R  
(151) 2022 06 16  
(181) 2032 06 16  
(260) AM 2021 113271 A  
(220) 2021 06 02  
(732) LLC "ACT"  
John (Malkhaz) Shalikashvili Str. 8, 0159,  
Vake-Saburtalo District, Tbilisi, Georgia

(111) M 2022 35593 R  
(151) 2022 06 16  
(181) 2032 06 16  
(260) AM 2021 113373 A  
(220) 2021 06 06  
(732) LTD "Kerki"  
Gorgasali St./Khimshiashvili Str. 111/13 (15)  
/S. Khimshiashvili Str. 15, app. 5, 6000, Batumi,  
Georgia

(111) M 2022 35588 R  
(151) 2022 06 16  
(181) 2032 06 16  
(260) AM 2021 113272 A  
(220) 2021 06 02  
(732) LLC "ACT"  
John (Malkhaz) Shalikashvili Str. 8, 0159,  
Vake-Saburtalo District, Tbilisi, Georgia

(111) M 2022 35594 R  
(151) 2022 06 16  
(181) 2032 06 16  
(260) AM 2021 113392 A  
(220) 2021 06 08  
(732) Jordan River Tobacco Manufacturing Co.  
Victor Nadim Victor Barakat Building,  
Al-Taybeh, Main Street / Ramallah, The West  
Bank, Palestine

(111) M 2022 35589 R  
(151) 2022 06 16  
(181) 2032 06 16  
(260) AM 2021 113274 A  
(220) 2021 06 02  
(732) Philip Morris Products S.A.  
Quai Jeanrenaud 3, Neuchâtel, 2000, Switzerland

(111) M 2022 35595 R  
(151) 2022 06 16  
(181) 2032 06 16  
(260) AM 2021 113422 A  
(220) 2021 06 09  
(732) LTD "Joy Mail"  
Grigol Lortkipanidze Str. 6, app. 140, 6000,  
Batumi, Georgia

(111) M 2022 35590 R  
(151) 2022 06 16  
(181) 2032 06 16  
(260) AM 2021 113345 A  
(220) 2021 06 04  
(732) Karen Akopyan  
M. Kostava Str. 5/12, 0700, Akhaltsikhe,  
Georgia

(111) M 2022 35596 R  
(151) 2022 06 16  
(181) 2032 06 16  
(260) AM 2021 113430 A  
(220) 2021 06 10  
(732) Advanced Bio-Technologies Inc.  
4830 West Kennedy Blvd., Suite 600, Tampa,  
Florida 33609, USA

(111) M 2022 35591 R  
(151) 2022 06 16  
(181) 2032 06 16  
(260) AM 2021 113346 A  
(220) 2021 06 04  
(732) Mamuka Khuroshvili  
Gamarjveba Str. 7, Mtskheta, Georgia

(111) M 2022 35597 R  
(151) 2022 06 16  
(181) 2032 06 16  
(260) AM 2021 113516 A  
(220) 2021 06 17  
(732) Philip Morris Brands Sàrl  
Quai Jeanrenaud 3, 2000 Neuchâtel, Switzerland

(111) M 2022 35592 R  
(151) 2022 06 16  
(181) 2032 06 16  
(260) AM 2021 113365 A  
(220) 2021 06 05  
(732) Nino Bakhtadze

(111) M 2022 35598 R  
(151) 2022 06 16  
(181) 2032 06 16  
(260) AM 2021 113517 A

---

(220) 2021 06 17 (732) Philip Morris Brands Sàrl Quai Jeanrenaud 3, 2000 Neuchâtel, Switzerland	Quai Jeanrenaud 3, 2000 Neuchâtel, Switzerland
(111) M 2022 35599 R (151) 2022 06 16 (181) 2032 06 16 (260) AM 2021 113608 A (220) 2021 06 23 (732) LTD "Fripsy" Vazha-Pshavela Ave., V quar., bld. 1, app. 165, Tbilisi, Georgia	(111) M 2022 35605 R (151) 2022 06 16 (181) 2032 06 16 (260) AM 2021 113790 A (220) 2021 07 08 (732) Colgate-Palmolive Company Delaware Corporation 300 Park Avenue, New York, New York 10022, USA
(111) M 2022 35600 R (151) 2022 06 16 (181) 2032 06 16 (260) AM 2021 113619 A (220) 2021 06 24 (732) LTD "Global Products" Zeda Ghele Str. 14, 6010, Batumi, Georgia	(111) M 2022 35606 R (151) 2022 06 16 (181) 2032 06 16 (260) AM 2021 113793 A (220) 2021 07 09 (732) Essity Hygiene and Health Aktiebolag SE-405 03 Göteborg, Sweden
(111) M 2022 35601 R (151) 2022 06 16 (181) 2032 06 16 (260) AM 2021 113703 A (220) 2021 06 30 (732) LTD "Tifliski Vini Pogreb" Yumashev Str. 27, 0198, Tbilisi, Georgia	(111) M 2022 35607 R (151) 2022 06 16 (181) 2032 06 16 (260) AM 2021 113876 A (220) 2021 07 15 (732) LTD "Kau Tivi" Ramaz Chkhikvadze Str. 6, app. 14, 0183, Tbilisi, Georgia
(111) M 2022 35602 R (151) 2022 06 16 (181) 2032 06 16 (260) AM 2021 113764 A (220) 2021 07 02 (732) LTD "Best Group" M. Kostava Str. N47/57, Tbilisi, Saburtalo District, Georgia	(111) M 2022 35608 R (151) 2022 06 16 (181) 2032 06 16 (260) AM 2021 113971 A (220) 2021 07 16 (732) Eczacıbasi Holding Anonim Sirketi Kanyon Ofis Buyukdere Cad. №185 34394 Levent Istanbul, Turkey
(111) M 2022 35603 R (151) 2022 06 16 (181) 2032 06 16 (260) AM 2021 113774 A (220) 2021 07 06 (732) Kimberly-Clark Worldwide Inc. Neenah, WI 54956, USA	(111) M 2022 35609 R (151) 2022 06 16 (181) 2032 06 16 (260) AM 2021 113973 A (220) 2021 07 16 (732) Guangdong Oppo Mobile Telecommunications Corp., LTD No.18 Haibin Road, Wusha, Chang'an, Dongguan, Guangdong, China
(111) M 2022 35604 R (151) 2022 06 16 (181) 2032 06 16 (260) AM 2021 113787 A (220) 2021 07 07 (732) Philip Morris Brands Sàrl	(111) M 2022 35610 R (151) 2022 06 16 (181) 2032 06 16 (260) AM 2021 113979 A

---

(220) 2021 07 19  
 (732) LTD "Erti Kava Coffe Room"  
 Aleksandre Griboedov Str. 6 / Mitropane  
 Laghidze Str. 8, 0108, Mtatsminda District,  
 Tbilisi, Georgia

(732) Yongkang Pengcheng Grinding Apparatus &  
 Abrasive Co., LTD  
 Building 2, No.398 Jinqian North Road,  
 Xiangzhu Village 4, Xiangzhu Town,  
 Yongkang City, Jinhua City, Zhejiang  
 Province, People's Republic of China

(111) M 2022 35611 R  
 (151) 2022 06 16  
 (181) 2032 06 16  
 (260) AM 2021 113981 A  
 (220) 2021 07 19  
 (732) LTD "TCA"  
 Arboshiki Str. 2, 0144, Isani District, Tbilisi,  
 Georgia

(111) M 2022 35617 R  
 (151) 2022 06 16  
 (181) 2032 06 16  
 (260) AM 2021 114060 A  
 (220) 2021 07 28  
 (732) Philip Morris Products S.A.  
 Quai Jeanrenaud 3, 2000 Neuchâtel, Switzerland

(111) M 2022 35612 R  
 (151) 2022 06 16  
 (181) 2032 06 16  
 (260) AM 2021 114034 A  
 (220) 2021 07 23  
 (732) Philip Morris Products S.A.  
 Quai Jeanrenaud 3, 2000 Neuchâtel, Switzerland

(111) M 2022 35618 R  
 (151) 2022 06 16  
 (181) 2032 06 16  
 (260) AM 2021 114140 A  
 (220) 2021 08 02  
 (732) LTD "Impexpharm"  
 Giorgi Saakadze's II exit 17, 0160, Saburtalo  
 District, Tbilisi, Georgia

(111) M 2022 35613 R  
 (151) 2022 06 16  
 (181) 2032 06 16  
 (260) AM 2021 114035 A  
 (220) 2021 07 23  
 (732) Philip Morris Products S.A.  
 Quai Jeanrenaud 3, 2000 Neuchâtel, Switzerland

(111) M 2022 35619 R  
 (151) 2022 06 16  
 (181) 2032 06 16  
 (260) AM 2021 114327 A  
 (220) 2021 08 17  
 (732) LTD "Pi"  
 St. Nikoloz Str. 12/16, 0102, Tbilisi, Georgia

(111) M 2022 35614 R  
 (151) 2022 06 16  
 (181) 2032 06 16  
 (260) AM 2021 114040 A  
 (220) 2021 07 26  
 (732) LTD "Nimqear"  
 Al. Kazbegi Ave. 24a, app. 18, Saburtalo  
 District, 6010, Tbilisi, Georgia

(111) M 2022 35620 R  
 (151) 2022 06 16  
 (181) 2032 06 16  
 (260) AM 2021 114332 A  
 (220) 2021 08 18  
 (732) JSC "Georgian Film"  
 Akhmeteli Str. 10a, 0159, Tbilisi, Georgia

(111) M 2022 35615 R  
 (151) 2022 06 16  
 (181) 2032 06 16  
 (260) AM 2021 114042 A  
 (220) 2021 07 26  
 (732) Philip Morris Products S.A.  
 Quai Jeanrenaud 3, 2000 Neuchâtel, Switzerland

(111) M 2022 35621 R  
 (151) 2022 06 16  
 (181) 2032 06 16  
 (260) AM 2021 114336 A  
 (220) 2021 08 18  
 (732) LTD "Gorgeous Georgian Paradise"  
 Budapest Str. 11, ent. 2, 0160, Tbilisi, Georgia

(111) M 2022 35616 R  
 (151) 2022 06 16  
 (181) 2032 06 16  
 (260) AM 2021 114044 A  
 (220) 2021 07 27

(111) M 2022 35622 R  
 (151) 2022 06 16  
 (181) 2032 06 16  
 (260) AM 2020 110746 A  
 (220) 2020 12 05

(732) Philip Morris Brands Sàrl  
Quai Jeanrenaud 3, 2000 Neuchâtel, Switzerland

---

(111) M 2022 35623 R  
(151) 2022 06 16  
(181) 2032 06 16  
(260) AM 2021 113507 A  
(220) 2021 06 16  
(732) ) LTD "Paradice 18"  
Tsothe Dadiani Str. 30, Tbilisi, Georgia

---

(111) M 2022 35624 R  
(151) 2022 06 16  
(181) 2032 06 16  
(260) AM 2021 114045 A  
(220) 2021 07 27  
(732) Marks and Spencer PLC  
Waterside House, 35 North Wharf Road,  
London W2 1NW, United Kingdom

---

(111) M 2022 35625 R  
(151) 2022 06 16  
(181) 2032 06 16  
(260) AM 2021 114046 A  
(220) 2021 07 27  
(732) Marks and Spencer PLC  
Waterside House, 35 North Wharf Road,  
London W2 1NW, United Kingdom

---

(111) M 2022 35626 R  
(151) 2022 06 16  
(181) 2032 06 16  
(260) AM 2021 114047 A  
(220) 2021 07 27  
(732) Marks and Spencer PLC  
Waterside House, 35 North Wharf Road,  
London W2 1NW, United Kingdom

---

## TRADEMARKS REGISTERED ACCORDING TO THE ACCELERATED PROCEDURE

The decision can be appealed at the Chamber of Appeal of Sakpatenti within 3 months from the publication.

(111) M 2022 35556 R

(151) 2022 06 03

(181) 2032 06 03

(210) AM 118003

(220) 2022 05 31

(732) LLC "MetatronX"

Vazisubani Settlement, III mcr., II qu., bld. 5,  
appt. 34, Isani-Samgori District, Tbilisi,  
Georgia

(540)

**ANIMATRON** 

(591) Morengo, orange

(531) 23.01.01; 27.01.01; 27.01.25; 27.03.15;  
27.05.01; 29.01.12

(511) 28, 42

(111) M 2022 35557 R

(151) 2022 06 07

(181) 2032 06 07

(210) AM 117746

(220) 2022 05 11

(732) LTD "Veon Georgia"

Bambis Rigi (Cotton Row) 8, 0105, Tbilisi,  
Georgia

(740) Levan Nanobashvili

(540)

**Aicell**  
**აიჯელი**

(591) Black-white

(511) 9, 16, 18, 25, 35, 36, 37, 38, 41, 42, 44

(111) M 2022 35558 R

(151) 2022 06 07

(181) 2032 06 07

(210) AM 117838

(220) 2022 05 18

(732) LLC "Neues Leben"

Perdinand Tavadze Str. 3, bld. 5, 0177, Tbilisi,  
Georgia

(540)

**J**

RAINER

(591) Black-white

(531) 23.01.01; 27.05.01; 27.05.21

(511) 33

(111) M 2022 35559 R

(151) 2022 06 08

(181) 2032 06 08

(210) AM 118062

(220) 2022 06 03

(732) LLC "Champions 111"

Ilia Chavchavadze Ave. 29, fl. 5, 0179, Tbilisi,  
Georgia

(540)



(591) FCFCFC white, F15A22 orange, 231F20 black

(531) 26.01.03; 26.01.24; 26.04.10; 26.04.22;  
26.04.24; 27.05.01; 27.05.24; 29.01.13

(511) 38

(111) M 2022 35560 R

(151) 2022 06 08

(181) 2032 06 08

(210) AM 118063

(220) 2022 06 03

(732) LLC "Champions 111"

Ilia Chavchavadze Ave. 29, fl. 5, 0179, Tbilisi,  
Georgia

(540)



(591) 231F20 black, F15A22 orange, FCFCFC white

(531) 26.01.01; 26.01.03; 26.01.18; 26.01.24;  
26.04.02; 26.04.10; 26.04.22; 26.04.24;  
27.05.01; 27.05.17; 27.05.24; 29.01.13

(511) 38

(111) M 2022 35561 R

(151) 2022 06 08

(181) 2032 06 08

(210) AM 117742

(220) 2022 05 11

(732) LTD "Veon Georgia"  
Bambis Rigi (Cotton Row) 8, 0105, Tbilisi,  
Georgia

(740) Levan Nanobashvili  
(540)

**GeOn**  
**ჯონ**

(591) Black-white  
(511) 9, 16, 18, 25, 35, 36, 37, 38, 41, 42, 44

(111) M 2022 35562 R

(151) 2022 06 08

(181) 2032 06 08

(210) AM 117744

(220) 2022 05 11

(732) LTD "Veon Georgia"  
Bambis Rigi (Cotton Row) 8, 0105, Tbilisi,  
Georgia

(740) Levan Nanobashvili  
(540)

**Cellfie**  
**სელფი**

(591) Black-white  
(511) 9, 18, 25, 35, 36, 37, 38, 41, 42, 44

(111) M 2022 35563 R

(151) 2022 06 08

(181) 2032 06 08

(210) AM 117745

(220) 2022 05 11

(732) LTD "Veon Georgia"  
Bambis Rigi (Cotton Row) 8, 0105, Tbilisi,  
Georgia

(740) Levan Nanobashvili  
(540)

**Cellfie Mobile**  
**სელფი მობაილ**

(591) Black-white  
(511) 9, 18, 25, 35, 36, 37, 38, 41, 42, 44

(111) M 2022 35564 R

(151) 2022 06 09

(181) 2032 06 09

(210) AM 117919

(220) 2022 05 24

(732) LTD "Leotom"  
Sokhumi Str., bld. 19/3, app. 16, 5223, Jvari,  
Tsalenjikha Region, Georgia

(540)



(591) Dark blue, white, black, blue, sky-blue,  
turquoise

(531) 10.01.01; 19.03.24; 29.01.12

(511) 34

(111) M 2022 35565 R

(151) 2022 06 09

(181) 2032 06 09

(210) AM 118018

(220) 2022 06 02

(732) LLC "Georgian Wines and Spirits Company"  
Achinebuli, 2200, Telavi, Georgia

(540)

**ელფერი**

(591) Black-white

(511) 33

(111) M 2022 35566 R

(151) 2022 06 09

(181) 2032 06 09

(210) AM 118019

(220) 2022 06 02

(732) LLC "Georgian Wines and Spirits Company"  
Achinebuli, 2200, Telavi, Georgia

(540)

**გონიერი**

(591) Black-white

(511) 33



(111) M 2022 35567 R  
 (151) 2022 06 10  
 (181) 2032 06 10  
 (210) AM 118083  
 (220) 2022 06 09  
 (732) İlke İçgiyim Tekstil Sanayi Ve Ticaret Limited  
 Şirketi  
 Sururi Mh., Inci S. Mektebi Inci Han.  
 No: 28/00, 034, Istanbul, Turkey  
 (740) Einar Iliazov  
 (540)



(591) Yellow, black, white  
 (531) 26.01.04; 26.01.20; 26.01.24; 26.04.10;  
 26.04.24; 29.01.13  
 (511) 25

(111) M 2022 35568 R  
 (151) 2022 06 10  
 (181) 2032 06 10  
 (210) AM 117923  
 (220) 2022 05 25  
 (732) Philip Morris Brands Sàrl  
 Quai Jeanrenaud 3, 2000 Neuchâtel,  
 Switzerland  
 (740) Pavle Meipariani  
 (540)

## PARLIAMENT SLIMS

(591) Black-white  
 (511) 34

(111) M 2022 35569 R  
 (151) 2022 06 10  
 (181) 2032 06 10  
 (210) AM 117931  
 (220) 2022 05 25  
 (732) Philip Morris Brands Sàrl  
 Quai Jeanrenaud 3, 2000 Neuchâtel,  
 Switzerland  
 (740) Pavle Meipariani  
 (540)

## MARLBORO SUMMER ZEST

(591) Black-white  
 (511) 34

(111) M 2022 35570 R  
 (151) 2022 06 14  
 (181) 2032 06 14  
 (210) AM 117804  
 (220) 2022 05 13

(732) Limited Liability Society "Trade House "A-Icra"  
 Fioletova Str. 8, Room 9, Office 7, 414000,  
 Astrakhan, Russian Federation  
 (740) Irakli Gvilia  
 (540)



(591) Black-white  
 (531) 27.05.02; 27.05.15  
 (511) 29

(111) M 2022 35571 R  
 (151) 2022 06 14  
 (181) 2032 06 14  
 (210) AM 118075  
 (220) 2022 06 08  
 (732) Nobel Ilac Sanayii Ve Ticaret Anonim Sirketi  
 Representation in Georgia  
 4 Liberty Square, Tbilisi, 0105, Georgia  
 (740) Tinatin Tskhvediani  
 (540)

## Memistin XR

მემისტინ იქს არო

(591) Black-white  
 (511) 5, 35

(111) M 2022 35572 R  
 (151) 2022 06 14  
 (181) 2032 06 14  
 (210) AM 118076  
 (220) 2022 06 08  
 (732) Nobel Ilac Sanayii Ve Ticaret Anonim Sirketi  
 Representation in Georgia  
 4 Liberty Square, Tbilisi, 0105, Georgia  
 (740) Tinatin Tskhvediani  
 (540)

## Senodop

სენოდოპი

(591) Black-white  
 (511) 5, 35

(111) M 2022 35573 R  
 (151) 2022 06 14  
 (181) 2032 06 14  
 (210) AM 117985  
 (220) 2022 05 27  
 (732) LTD "Bolero & Company"  
 Kuchishvili Str. 12-14-16, fl. 6, 0179, Tbilisi,  
 Georgia  
 (540)

## Bee Joe Be Joe

(591) Black-white  
(511) 33

---

(111) M 2022 35574 R  
(151) 2022 06 14  
(181) 2032 06 14  
(210) AM 118139  
(220) 2022 06 13  
(732) LLC "Champions 111"  
Ilia Chavchavadze Ave. 29, fl. 5, 0179, Tbilisi,  
Georgia

(540)



(591) FCFCFC white, F15A22 orange, 231F20 black  
(531) 26.01.18; 26.01.24; 26.04.10; 26.04.22;  
26.04.24; 27.05.01; 27.05.24; 29.01.13  
(511) 35

---

## INTERNATIONAL TRADEMARKS FOR WHICH A DECISION ON GRANTING PROTECTIONS IS TAKEN

The decision can be appealed at the Chamber of Appeal of Sakpatenti within 3 months from the publication or at the Mtskheta District Court Administrative Cases Board (Address: №17, Samkhedro St., Mtskheta), within 1 month following the publication.

(260) AM 2022 108937 A

(800) 563242

(151) 1990 06 11

(891) 2020 05 12

(731) Spiess-Urania Chemicals GmbH

Frankenstrasse 18 b, 20097 Hamburg, Germany

(540)

# Cuprozin

(591) Black, white

(531) 27.05.01; 27.05.17

(511)

1 – Industrial chemicals, except those intended for treating metals and for science; chemicals, including chemicals containing biological raw materials, for agricultural, horticultural and forestry purposes as well as products used during landscaping and constructing sports fields, namely soil treatment products, soil additives, soil improving products, particularly those for soil stability and hoeing products for spreading insecticides, treating soil, retaining soil, plant protection products and products for stopping cuts [in bark], products to conserve and keep fresh feed and flowers, leaf lustering products, seed treatment products and seed denaturing products; unfreezing agents; fertilizing substances, including manure, plant strengthening products, compost and peat; plant growth regulating preparations.

5 – Chemicals containing biological primary materials for treating diseases in plants caused by deficiencies; disinfectants; products for destroying weeds and vermin as well as chemicals, including chemicals containing biological primary materials, for plant protection, namely agents for combating weeds and vermin, fungi and microbes; insect repellents for animals and insects, substances to attract animals and insects, insect decomposing products and sanitary products for household use against insects and vermin.

(260) AM 2022 112211 A

(800) 1581239

(151) 2020 12 29

(891) 2020 12 29

(731) Limited liability company "Internet Solutions"

Presnenskaya nab., 10, Pomeschenie I, et. 41, komn. 6, RU-123112 Moscow, Russian Federation

(540)

# OZON

(591) Blue

(531) 27.05.09; 29.01.04

(511)

9 – Scientific, nautical, surveying, photographic, cinematographic, optical, weighing, measuring, signaling, checking [supervision], life-saving and teaching apparatus and instruments; apparatus and instruments for conducting, switching, transforming, accumulating, regulating or controlling electricity; apparatus for recording, transmission or reproduction of sound or images; magnetic data carriers, recording discs; compact discs, DVDs and other digital recording media; mechanisms for coin-operated apparatus; cash registers, calculating machines, data processing equipment, computers; software; DVD players; antennas; high-frequency apparatus; remote control apparatus; monitoring apparatus, other than for medical purposes; global positioning system [GPS] apparatus; intercommunication apparatus; projection apparatus; telephone apparatus; facsimile machines; computer memory devices; scales; camcorders; video telephones; telephone apparatus, including mobile telephones; video screens; hands-free kits for telephones; holograms; transparencies [photography]; diaphragms [photography]; dictating machines; electronic notice boards; calculating machines, including pocket calculators; cinematographic cameras; electronic pens [visual display units]; video game cartridges; encoded magnetic cards; carriers for dark plates [photography]; computer keyboards; electronic book readers; electronic agendas; mouse pads; compact discs [audio-video]; compact discs [read-only memory]; laptop computers; tablet computers; notebook computers; head cleaning tapes [recording]; magnetic tapes; videotapes; mouse [computer peripheral]; microprocessors; microphones; modems; monitors [computer hardware]; headphones; computer software, recorded; wrist rests for use with computers; radio pagers; electronic pocket translators; transmitters [telecommunication]; compact disc players; cassette players; sound recording strips; time recording apparatus; satellite navigational apparatus; printers for use with computers; cleaning apparatus for sound recording discs; record players; computer programs, recorded; computer game software, recorded; computer programs, downloadable; processors

[central processing units]; electronic publications, downloadable; radios; vehicle radios; walkie-talkies; scanners [data processing equipment]; smartphones; integrated circuit cards [smart cards]; audiovisual teaching apparatus; bags adapted for laptops; integrated circuits; television apparatus; telescopes; teleprompters; teleprinters; detectors; transistors [electronic]; amplifiers; baby monitors; computer peripheral devices; demagnetizing apparatus for magnetic tapes; photocopiers [photographic, electrostatic, thermic]; computer software applications, downloadable; downloadable music files; cameras [photography]; glazing apparatus for photographic prints; darkrooms [photography]; digital photo frames; sleeves for laptops; tripods for cameras; screens [photography].

10 – Surgical, medical, dental and veterinary apparatus and instruments; orthopedic articles; suture materials; therapeutic and assistive devices adapted for persons with disabilities; massage apparatus; apparatus, devices and articles for nursing infants.

14 – Precious metals and their alloys; jewelry, precious and semi-precious stones; horological and chronometric instruments; works of art of precious metal; jewelry boxes.

15 – Musical instruments.

16 – Printed matter; adhesives [glues] for stationery or household purposes; instructional and teaching material [except apparatus]; fountain pens; albums; almanacs; atlases; posters; announcement cards [stationery]; note books; pads [stationery]; drawing pads; spiral notebooks; pamphlets; booklets; newsletters; newspapers; engravings; punches [office requisites]; magazines [periodicals]; periodicals; printed publications; calendars; pencils; pencil lead holders; pictures; paintbrushes; books; postage stamps; writing cases [stationery]; musical greeting cards; greeting cards; postcards; writing materials; writing instruments; school supplies [stationery]; prospectuses; rubber erasers; graphic reproductions; marking pens [stationery]; staples for offices; writing or drawing books; manuals [handbooks]; flags of paper; photo-engravings; labels, not of textile.

28 – Games and playthings; gymnastic and sporting articles; toy vehicles; swimming pools [play articles]; trampolines; novelty toys for parties; scratch cards for playing lottery games; dolls' feeding bottles; creels [fishing traps]; shuttlecocks; spinning tops [toys]; jigsaw puzzles; punching bags; bite sensors [fishing tackle]; discs for sports; dolls' houses; dominoes; swimming kickboards; spring boards [sports articles]; chessboards; checkerboards; darts; Christmas trees of synthetic material; swimming jackets; kites; toys for pets; stuffed toys; plush toys; toy mobiles; novelty toys for playing jokes; parlor games; table-top games; building games; kaleidoscopes; bladders of balls for games; bingo cards; playing cards; reels for fishing; rocking horses; swings; skittles; skittles [games]; golf

clubs; hockey sticks; bells for Christmas trees; dolls' rooms; controllers for game consoles; confetti; Christmas crackers [party novelties]; ice skates; roller skates; in-line roller skates; dice; dolls' beds; dolls; flippers for swimming; fishing lines; bows for archery; mah-jong; puppets; carnival masks; teddy bears; scale model vehicles; balls for games; artificial fishing bait; knee guards [sports articles]; elbow guards [sports articles]; backgammon games; dolls' clothes; baseball gloves; boxing gloves; golf gloves; gloves for games; toy pistols; toy air pistols; percussion caps [toys]; caps for pistols [toys]; rattles [playthings]; candle holders for Christmas trees; Christmas tree stands; floats for fishing; portable games with liquid crystal displays; swimming belts; archery implements; soap bubbles [toys]; rackets; weight lifting belts [sports articles]; sling shots [sports articles]; scooters [toys]; sleds [sports articles]; nets for sports; tennis nets; bite indicators [fishing tackle]; fishing tackle; artificial snow for Christmas trees; strings for rackets; machines for physical exercises; fishing tackle, including Creels [fishing traps]; fish hooks; water wings; landing nets for anglers; rods for fishing; ornaments for Christmas trees, except lights, candles and confectionery; apparatus for games; marbles for games; billiard balls; playing balls; party balloons; chess games; checkers [games]; paper party hats; shin guards [sports articles]; chest expanders [exercisers].

29 – Prepared meals consisting primarily of meat, fish, poultry or vegetables; frozen meals consisting primarily of meat, fish, poultry or vegetables; mushrooms, processed; mushrooms, dried; jellies, jams, compotes; fruit-based snack food; nut and seed-based snack bars; charcuterie; caviar; preserved, dried, cooked, frozen vegetables, fruits, berries; canned meat, fish, vegetables and fruits; soup concentrates; oils and fats for food; milk and milk products; seafood, processed; meat, fish, poultry and game, including meat, fish, poultry and game, processed; nuts, prepared; vegetable pastes [purees]; meat pâté; liver pâté; fish-based foodstuffs; vegetable salads; fruit salads; bacon; edible seeds, processed; fat-containing mixtures for bread slices; snack mixes consisting of processed fruits, processed nuts or raisins; sausages; preparations for making soup; tripe; cheese; vegetable chips; fruit chips; eggs.

30 – Cereal bars; muesli bars; mustard; yeast; cereal-based snack food; artificial coffee; sugar substitutes; pastries; pasta; instant porridge; coffee; starch for food; groats for human food; honey; flour and preparations made from cereals; biscuits; pies; pizzas; popcorn; mustard meal; condiments; gingerbread; spices; ravioli; sugar; pancake mixes, pastry mixes; salt; sauces [condiments]; dough; vinegar, sauces [condiments]; bread; bread, pastries and confectionery; chips [cereal products]; hot dog sandwiches; tea; herbal teas, other than for medicinal use; cheeseburgers [sandwiches]; grain-based chips.

31 – Fresh fruits, vegetables, berries; natural plants and flowers; bulbs, seedlings and seeds for planting; food and beverages for pets; nuts, unprocessed; crustaceans and seafood, live.

36 – Financial affairs; monetary affairs; real estate affairs; rental of real estate; financial analysis; lease-purchase financing; issuance of credit cards; capital investment; providing financial information; financial consultancy; business liquidation services, financial; financial management; processing of debit card payments; processing of credit card payments; online banking; organization of monetary collections; antique appraisal; jewelry appraisal; stamp appraisal; numismatic appraisal; art appraisal; financial evaluation [banking, real estate]; electronic funds transfer; surety services; loans [financing]; financial sponsorship; installment loans; financing services; fiscal valuation; brokerage; securities brokerage; stock brokerage services; real estate brokerage.

37 – Installation, maintenance and repair of computer hardware; interference suppression in electrical apparatus.

38 – Telecommunications routing and junction services; communications, including communications by fiber optic networks, communications by computer terminals, satellite transmission; providing telecommunications connections to a global computer network; electronic bulletin board services [telecommunications services]; rental of telecommunication equipment; providing user access to global computer networks; teleconferencing services; message sending; computer aided transmission of messages and images; providing access to databases; providing telecommunication channels for teleshopping services.

39 – Transport; packaging and storage of goods; parking place rental; rental of warehouses; message delivery; parcel delivery; delivery of goods; delivery of goods by mail order; providing traffic information; providing transportation information; warehousing information; transportation logistics; hauling; transport and storage of trash; car transport; portering; providing driving directions for travel purposes; courier services [messages or merchandise]; physical storage of electronically stored data or documents; storage; freight forwarding.

41 – Game services provided online from a computer network; providing online electronic publications, not downloadable; organization of lotteries; electronic desktop publishing; publication of texts, other than publicity texts; translation; providing online videos, not downloadable; providing online music, not downloadable; online publication of electronic books and journals; digital imaging services [photography].

42 – Design and development of computer hardware and software; computer system analysis; recovery of computer data; computer virus protection services; en-

gineering; installation of computer software; web site design consultancy; information technology [IT] consultancy; consultancy in the design and development of computer hardware; computer software consultancy; quality control; updating of computer software; monitoring of computer systems by remote access; software as a service [SaaS]; maintenance of computer software; conversion of data or documents from physical to electronic media; providing information relating to computer technology and programming via a web site; providing search engines for the internet; platform as a service [PaaS]; conversion of computer programs and data, other than physical conversion; computer system design; rental of web servers; computer rental; rental of computer software; hosting computer sites [web sites]; server hosting; creating and designing website-based indexes of information for others [information technology services]; creating and maintaining web sites for others; computer programming; copying of computer programs; off-site data backup; computer technology consultancy; electronic data storage; surveying; electronic monitoring of credit card activity to detect fraud via the internet; electronic monitoring of personally identifying information to detect identity theft via the internet.

43 – Services for providing food and drink; snack-bar services; café services; cafeteria services; rental of cooking apparatus; rental of tents; rental of transportable buildings; rental of drinking water dispensers; restaurant services; self-service restaurant services; canteen services; bar services; food and drink catering; washoku restaurant services; udon and soba restaurant services.

---

(260) AM 2022 112651 A  
 (800) 1586739  
 (151) 2021 03 05  
 (891) 2021 03 05  
 (731) Albemarle Corporation  
 4250 Congress Street, Suite 900, Charlotte  
 NC 28209, USA

(540)

## SAYTEX ALERO

(591) Black, white

(511)

1 – Flame retardants for incorporation in synthetic compositions.

---

(260) AM 2022 112977 A  
 (800) 1590958  
 (151) 2021 03 20  
 (891) 2021 03 20  
 (731) Max Rohr, Inc.  
 103 Foulk Road, Suite 253, Wilmington  
 DE 19803, USA

(540)



(591) Black, white

(531) 27.01.12; 27.05.01; 27.05.02; 27.05.10

(511)

34 – Cigarillos; cigars.

(260) AM 2022 114374 A

(800) 1608606

(151) 2021 06 17

(891) 2021 06 17

(731) Limited Liability Company "Marvel CT"

Preobrajenskaya pl., 8, fl.27, room LXXXVI,

RU-107061 Moscow, ( Federation), Russian

Federation

(540)

(591) Blue, white

(531) 27.05.01; 29.01.04

(511)

9 – Scientific, research, navigation, surveying, photographic, cinematographic, audiovisual, optical, weighing, measuring, signalling, detecting, testing, inspecting, life-saving and teaching apparatus and instruments; apparatus and instruments for conducting, switching, transforming, accumulating, regulating or controlling the distribution or use of electricity; apparatus and instruments for recording, transmitting, reproducing or processing sound, images or data; recorded or downloadable media, computer software, blank digital or analogue recording and storage media; mechanisms for coin-operated apparatus; cash registers, calculating devices; computers and computer peripheral devices; diving suits, divers' masks, ear plugs for divers, nose clips for divers and swimmers, gloves for divers, breathing apparatus for underwater swimming; fire extinguishing apparatus; ticket dispensers; 3D spectacles; DVD players; juke boxes, musical; fire engines; answering machines; electrical adapters; batteries for electronic cigarettes; accumulators, electric; batteries, electric, for vehicles; accelerometers; actinometers; alidades; altimeters; ear pads for headphones; ammeters; nanoparticle size analysers; anemometers; anodes; aerials; anticathodes; apertometers [optics]; high-frequency apparatus; testing apparatus not for medical purposes; electro-dynamic apparatus for the remote control of railway points; electro-dynamic apparatus for the remote control of signals; remote control apparatus; monitoring apparatus, other than for medical purposes; sound recording apparatus; Glo-

bal Positioning System [GPS] apparatus; distillation apparatus for scientific purposes; diffraction apparatus [microscopy]; air analysis apparatus; apparatus to check franking; sound transmitting apparatus; apparatus for fermentation [laboratory apparatus]; breathing apparatus, except for artificial respiration; apparatus and installations for the production of X-rays, not for medical purposes; electric apparatus for commutation; magnetic resonance imaging [MRI] apparatus, not for medical purposes; intercommunication apparatus; stills for laboratory experiments; projection apparatus; radiological apparatus for industrial purposes; X-ray apparatus not for medical purposes; blueprint apparatus; flashing lights [luminous signals]; stereoscopic apparatus; telephone apparatus; facsimile machines; phototelegraphy apparatus; igniting apparatus, electric, for igniting at a distance; acid hydrometers; Salinometers; acidimeters for batteries; aerometers; beacons, luminous; battery jars; automated teller machines [ATM]; barometers; anode batteries; galvanic batteries; ignition batteries; solar batteries; solar panels for the production of electricity; batteries, electric; balances [steelyards]; betatrons; binoculars; biochips; electronic tags for goods; lens hoods; magnetic tape units for computers; computer memory devices; fire hose nozzles; encoded identification bracelets, magnetic; connected bracelets [measuring instruments]; safety tarpaulins; electronic key fobs being remote control apparatus; bullet-proof clothing; signalling buoys; life buoys; marking buoys; directional compasses; vacuum gauges; electrolyzers; variometers; verniers; scales; baby scales; bathroom scales; letter scales; weighbridges; precision balances; scales with body mass analysers; levelling staffs [surveying instruments]; camcorders; video baby monitors; video cassettes; video projectors; video telephones; video screens; viewfinders, photographic; electric plugs; micrometer screws for optical instruments; viscosimeters; circuit closers; wavemeters; voltmeters; mechanical signs; signs, luminous; switchboxes [electricity]; current rectifiers; gas testing instruments; gasometers [measuring instruments]; galvanometers; hands-free kits for telephones; heliographic apparatus; hygrometers; hydrometers; weights; peepholes [magnifying lenses] for doors; hairdressing training heads [teaching apparatus]; holograms; plotters; loudspeakers; sounding leads; plumb bobs; range finders; parking sensors for vehicles; piezoelectric sensors; densimeters; densitometers; detectors; smoke detectors; infrared detectors; counterfeit coin detectors; joysticks for use with computers, other than for video games; transparencies [photography]; slide projectors; diaphragms [photography]; dictating machines; dynamometers; light-emitting diodes [LED]; quantum dot light-emitting diodes [QLED]; organic light-emitting diodes [OLED]; floppy disks; phonograph records; disks, magnetic; optical discs; circular slide rules; disk drives for computers; juke boxes for computers; wearable video display monitors; electronic numeric displa-

ys; DNA chips; electronic interactive whiteboards; electronic notice boards; electric wire harnesses for automobiles; bullet-proof vests; life jackets; reflective safety vests; identification threads for electric wires; nose clips for divers and swimmers; padlocks, electronic; locks, electric; bells [warning devices]; alarm bells, electric; electric door bells; signal bells; acoustic conduits; mirrors for inspecting work; road signs, luminous or mechanical; downloadable emoticons for mobile phones; marine depth finders; probes for scientific purposes; buzzers; needles for surveying compasses; needles for record players; eyewear; reflective articles for wear, for the prevention of accidents; measures; pressure measuring apparatus; simulators for the steering and control of vehicles; inverters [electricity]; pressure indicators; automatic indicators of low pressure in vehicle tyres; temperature indicators; incubators for bacteria culture; measuring instruments; cosmographic instruments; mathematical instruments; levelling instruments; instruments containing eyepieces; surveying instruments; azimuth instruments; interfaces for computers; audio interfaces; ionization apparatus not for the treatment of air or water; satellite finder meters; spark-guards; coaxial cables; fibre optic cables; cables, electric; calipers; slide calipers; screw-tapping gauges; calorimeters; calculating machines; pocket calculators; decompression chambers; rearview cameras for vehicles; cinematographic cameras; thermal imaging cameras; mouth guards for sports; life-saving capsules for natural disasters; electronic pens [visual display units]; holders for electric coils; biometric identity cards; identity cards, magnetic; video game cartridges; toner cartridges, unfilled, for printers and photocopiers; ink cartridges, unfilled, for printers and photocopiers; memory cards for video game machines; encoded magnetic cards; riding helmets; protective helmets; carriers for dark plates [photography]; cathodes; spools [photography]; choking coils [impedance]; coils, electric; electromagnetic coils; cinematographic film, exposed; computer keyboards; solenoid valves [electromagnetic switches]; wire connectors [electricity]; thin client computers; downloadable cryptographic keys for receiving and spending cryptocurrency; encoded key cards; electronic book readers; electronic agendas; push buttons for bells; mouse pads; magnetic encoders; visors for helmets; collectors, electric; calibrating rings; smart rings; ring sizers; protective suits for aviators; commutators; compact discs [audio-video]; compact discs [read-only memory]; comparators; marine compasses; laptop computers; tablet computers; notebook computers; wearable computers; condensers [capacitors]; contacts, electric; wind socks for indicating wind direction; traffic cones; branch boxes [electricity]; distribution boxes [electricity]; junction boxes [electricity]; connectors [electricity]; battery boxes; cabinets for loudspeakers; diving suits; downloadable e-wallets; galena crystals [detectors]; covers for electric outlets; logs [measuring instruments]; lasers, not for medical

purposes; lactodensimeters; lactometers; vacuum tubes [radio]; darkroom lamps [photography]; thermionic valves; amplifying tubes; flashlights [photography]; head cleaning tapes [recording]; magnetic tapes; videotapes; surveying chains; fire escapes; rulers [measuring instruments]; square rulers for measuring; slide-rules; contact lenses; correcting lenses [optics]; close-up lenses; optical lenses; optical condensers; sounding lines; electricity conduits; measuring spoons; magnifying glasses [optics]; thread counters; magnets; decorative magnets; crash test dummies; resuscitation mannequins [teaching apparatus]; mouse [computer peripheral]; trackballs [computer peripherals]; pressure gauges; security tokens [encryption devices]; divers' masks; solderers' helmets; protective masks; respiratory masks, other than for artificial respiration; materials for electricity mains [wires, cables]; voting machines; money counting and sorting machines; material testing instruments and machines; furniture especially made for laboratories; megaphones; portable media players; diaphragms [acoustics]; diaphragms for scientific apparatus; metal detectors for industrial or military purposes; digital weather stations; metronomes; rules [measuring instruments]; carpenters' rules; dressmakers' measures; mechanisms for counter-operated apparatus; coin-operated mechanisms for television sets; shutter releases [photography]; micrometers; microprocessors; microscopes; microtomes; microphones; audio mixers; modems; lightning conductors; monitors [computer hardware]; monitors [computer programs]; selfie sticks [hand-held monopods]; terminals [electricity]; junction sleeves for electric cables; teeth protectors; temperature indicator labels, not for medical purposes; knee-pads for workers; headphones; earpieces for remote communication; surveyors' levels; sound recording carriers; magnetic data media; optical data media; electronic sheet music, downloadable; computer game software, recorded; computer software, recorded; sheaths for electric cables; identification sheaths for electric wires; weighing machines; computer hardware; punched card machines for offices; life-saving apparatus and equipment; shoes for protection against accidents, irradiation and fire; objectives [lenses] [optics]; lenses for astrophotography; selfie lenses; egg-candlers; fire extinguishers; rescue laser signalling flares; electrified fences; limiters [electricity]; clothing for protection against accidents, irradiation and fire; clothing for protection against fire; asbestos clothing for protection against fire; clothing especially made for laboratories; survival blankets; ozonisers [ozonators]; octants; eyepieces; ohmmeters; wrist rests for use with computers; spectacle frames; oscillographs; plumb lines; mirrors [optics]; spectacles; sunglasses; goggles for sports; electronic collars to train animals; finger sizers; signalling panels, luminous or mechanical; biometric passports; wah-wah pedals; radio pagers; pince-nez; electronic pocket translators; transmitters [telecommunication]; telephone transmitters; transmitters of electr-

onic signals; switches, electric; periscopes; data gloves; gloves for divers; gloves for protection against accidents; gloves for protection against X-rays for industrial purposes; asbestos gloves for protection against accidents; furnaces for laboratory use; droppers for measuring, other than for medical or household purposes; laboratory pipettes; pyrometers; planimeters; plane tables [surveying instruments]; plates for batteries; computer software platforms, recorded or downloadable; wafers for integrated circuits; printed circuit boards; compact disc players; cassette players; protective films adapted for computer screens; protective films adapted for smartphones; sound recording strips; X-ray films, exposed; films, exposed; life-saving rafts; animal signalling rattles for directing livestock; laboratory trays; digital signs; stands adapted for laptops; semi-conductors; polarimeters; personal digital assistants [PDAs]; fire pumps; measuring glassware; weight belts for divers; life belts; fuses; circuit breakers; converters, electric; telerupters; food analysis apparatus; diagnostic apparatus, not for medical purposes; distance recording apparatus; distance measuring apparatus; speed measuring apparatus [photography]; appliances for measuring the thickness of leather; apparatus for measuring the thickness of skins; speed checking apparatus for vehicles; time recording apparatus; apparatus and instruments for astronomy; nautical apparatus and instruments; apparatus and instruments for physics; chemistry apparatus and instruments; measuring apparatus; measuring devices, electric; boiler control instruments; meteorological instruments; naval signalling apparatus; observation instruments; navigation apparatus for vehicles [on-board computers]; satellite navigational apparatus; regulating apparatus, electric; telecommunication apparatus in the form of jewellery; precision measuring apparatus; audio- and video-receivers; prisms [optics]; computer software applications, downloadable; ticket printers; printers for use with computers; hemline markers; retorts' stands; apparatus for changing record player needles; drainers for use in photography; cleaning apparatus for phonograph records; fire beaters; sighting telescopes for firearms; telescopic sights for artillery; test tubes; pressure indicator plugs for valves; magnetic wires; telegraph wires; telephone wires; wires, electric; conductors, electric; copper wire, insulated; fuse wire; computer programs, recorded; computer game software, downloadable; computer programs, downloadable; computer operating programs, recorded; computer screen saver software, recorded or downloadable; record players; processors [central processing units]; rods for water diviners; electronic publications, downloadable; distribution consoles [electricity]; control panels [electricity]; radar apparatus; baby monitors; masts for wireless aerials; transmitting sets [telecommunication]; radios; vehicle radios; sprinkler systems for fire protection; frames for photographic transparencies; screens for photoengraving; flowmeters; walkie-talkies; voltage surge protectors;

voltage regulators for vehicles; stage lighting regulators; light dimmers [regulators], electric; light regulators [dimmers], electric; speed regulators for record players; cell switches [electricity]; washing trays [photography]; marking gauges [joinery]; T-squares for measuring; time switches, automatic; relays, electric; safety restraints, other than for vehicle seats and sports equipment; body harnesses for support when lifting loads; X-ray photographs, other than for medical purposes; rheostats; respirators for filtering air; retorts; refractometers; refractors; grids for batteries; security surveillance robots; laboratory robots; teaching robots; telepresence robots; humanoid robots with artificial intelligence; electric sockets; height measuring instruments; speaking tubes; horns for loudspeakers; subwoofers; saccharometers; optical fibres [light conducting filaments]; traffic-light apparatus [signalling devices]; dog whistles; signalling whistles; sports whistles; sextants; inductors [electricity]; safety nets; nets for protection against accidents; fire alarms; signals, luminous or mechanical; rescue flares, non-explosive and non-pyrotechnic; sirens; electronic access control systems for interlocking doors; scanners [data processing equipment]; hand-held electronic dictionaries; integrated circuit cards [smart cards]; smartglasses; smartphones; smartwatches; connections for electric lines; couplings, electric; sonars; sound locating instruments; lighting ballasts; resistances, electric; spectrograph apparatus; spectrometers; speed indicators; alcoholmeters; satellites for scientific purposes; protection devices for personal use against accidents; audiovisual teaching apparatus; charging stations for electric vehicles; radiotelegraphy sets; radiotelephony sets; spectacle lenses; anti-glare glasses; optical glass; personal stereos; stereoscopes; stands for photographic apparatus; stroboscopes; fire boats; sulfimeters; bags adapted for laptops; drying racks [photography]; spherometers; integrated circuits; printed circuits; counters; parking meters; mileage recorders for vehicles; revolution counters; abacuses; egg timers [sandglasses]; taximeters; ear plugs for divers; tachometers; television apparatus; telegraphs [apparatus]; telescopes; teleprompters; teleprinters; mobile telephones; cordless telephones; theodolites; credit card terminals; interactive touch screen terminals; thermo-hygrometers; thermometers, not for medical purposes; thermostats; thermostats for vehicles; climate control digital thermostats; crucibles [laboratory]; tone arms for record players; totalizers; transistors [electronic]; transponders; protractors [measuring instruments]; transformers [electricity]; step-up transformers; resuscitation training simulators; vehicle breakdown warning triangles; triodes; starter cables for motors; discharge tubes, electric, other than for lighting; capillary tubes; neon signs; Pitot tubes; X-ray tubes not for medical purposes; telephone receivers; headgear being protective helmets; squares for measuring; gauges; quantity indicators; petrol gauges; water level indicators; electric loss in-



dicators; light-emitting electronic pointers; slope indicators; levels [instruments for determining the horizontal]; mercury levels; spirit levels; urinometers; amplifiers; particle accelerators; electric installations for the remote control of industrial operations; steering apparatus, automatic, for vehicles; balancing apparatus; video recorders; sound reproduction apparatus; invoicing machines; tape recorders; protection devices against X-rays, not for medical purposes; railway traffic safety appliances; data processing apparatus; oxygen transvasing apparatus; theft prevention installations, electric; devices for the projection of virtual keyboards; film cutting apparatus; drying apparatus for photographic prints; optical character readers; centering apparatus for photographic transparencies; dosage dispensers; battery chargers; chargers for electric accumulators; chargers for electronic cigarettes; acoustic alarms; sounding apparatus and machines; apparatus for editing cinematographic film; cathodic anti-corrosion apparatus; couplers [data processing equipment]; wearable activity trackers; anti-theft warning apparatus; computer peripheral devices; anti-interference devices [electricity]; demagnetizing apparatus for magnetic tapes; acoustic couplers; alarms; fog signals, non-explosive; whistle alarms; adding machines; readers [data processing equipment]; heat regulating apparatus; photocopiers [photographic, electrostatic, thermic]; electric and electronic effects units for musical instruments; bar code readers; downloadable ring tones for mobile phones; downloadable image files; downloadable music files; animated cartoons; filters for respiratory masks; filters for ultraviolet rays, for photography; filters for use in photography; USB flash drives; magic lanterns; optical lanterns; signal lanterns; cameras [photography]; glazing apparatus for photographic prints; shutters [photography]; darkrooms [photography]; photometers; flash-bulbs [photography]; digital photo frames; enlarging apparatus [photography]; photovoltaic cells; containers for contact lenses; spectacle cases; containers for microscope slides; cases for smartphones; cases especially made for photographic apparatus and instruments; chromatography apparatus for laboratory use; chronographs [time recording apparatus]; laboratory centrifuges; spectacle chains; cyclotrons; compasses for measuring; frequency meters; time clocks [time recording devices]; Petri dishes; sleeves for laptops; covers for personal digital assistants [PDAs]; covers for tablet computers; covers for smartphones; fire blankets; chips [integrated circuits]; jigs [measuring instruments]; pedometers; meteorological balloons; electrified rails for mounting spot lights; asbestos screens for firemen; fire hose; virtual reality headsets; protective helmets for sports; head guards for sports; lifeboats; snorkels; cell phone straps; spectacle cords; tripods for cameras; switchboards; distribution boards [electricity]; equalizers [audio apparatus]; screens [photography]; workmen's protective face-shields; projection screens; radiology screens for industrial

purposes; fluorescent screens; exposure meters [light meters]; ducts [electricity]; galvanic cells; downloadable graphics for mobile phones; epidiascopes; ergometers; armatures [electricity]; black boxes [data recorders].

35 – Business management, organization and administration; office functions; arranging subscriptions to telecommunication services for others; import-export agency services; commercial information agency services; advertising agency services; cost price analysis; rental of office equipment in co-working facilities; rental of advertising space; business auditing; financial auditing; business intermediary services relating to the matching of potential private investors with entrepreneurs needing funding; employment agency services; computerized file management; book-keeping; invoicing; demonstration of goods; transcription of communications [office functions]; opinion polling; market studies; business investigations; business research; marketing research; personnel recruitment; business management and organization consultancy; business organization consultancy; business management consultancy; personnel management consultancy; professional business consultancy; consultancy regarding advertising communication strategies; consultancy regarding public relations communication strategies; layout services for advertising purposes; marketing; marketing in the framework of software publishing; targeted marketing; business management of performing artists; business management of sports people; writing of curriculum vitae for others; scriptwriting for advertising purposes; news clipping services; updating and maintenance of information in registries; updating and maintenance of data in computer databases; updating of advertising material; word processing; online retail services for downloadable and pre-recorded music and movies; online retail services for downloadable ring tones; online retail services for downloadable digital music; organization of exhibitions for commercial or advertising purposes; arranging newspaper subscriptions for others; organization of fashion shows for promotional purposes; organization of trade fairs; shop window dressing; business appraisals; payroll preparation; data search in computer files for others; sponsorship search; administrative assistance in responding to calls for tenders; business management assistance; commercial or industrial management assistance; commercial intermediation services; providing business information; providing business information via a website; providing commercial and business contact information; providing commercial information and advice for consumers in the choice of products and services; provision of an online marketplace for buyers and sellers of goods and services; providing user reviews for commercial or advertising purposes; web indexing for commercial or advertising purposes; providing user rankings for commercial or advertising purposes; presentation of goods on communication media, for retail purposes; media

relations services; economic forecasting; auctioneering; wholesale services for pharmaceutical, veterinary and sanitary preparations and medical supplies; retail services for works of art provided by art galleries; retail services for pharmaceutical, veterinary and sanitary preparations and medical supplies; sales promotion for others; promotion of goods and services through sponsorship of sports events; production of tele-shopping programmes; production of advertising films; office machines and equipment rental; rental of advertising time on communication media; publicity material rental; rental of billboards [advertising boards]; rental of vending machines; rental of sales stands; rental of photocopying machines; consumer profiling for commercial or marketing purposes; publication of publicity texts; radio advertising; development of advertising concepts; bill-posting; distribution of samples; dissemination of advertising matter; direct mail advertising; registration of written communications and data; writing of publicity texts; advertising; online advertising on a computer network; advertising by mail order; television advertising; compilation of statistics; compilation of information into computer databases; business inquiries; systemization of information into computer databases; administrative services for medical referrals; advisory services for business management; corporate communications services; negotiation of business contracts for others; negotiation and conclusion of commercial transactions for third parties; compiling indexes of information for commercial or advertising purposes; tax preparation; drawing up of statements of accounts; telemarketing services; psychological testing for the selection of personnel; interim business management; outsourced administrative management for companies; business management of hotels; business management for freelance service providers; business project management services for construction projects; commercial administration of the licensing of the goods and services of others; business management of reimbursement programmes for others; administration of consumer loyalty programs; administration of frequent flyer programs; administrative processing of purchase orders; administrative services for the relocation of businesses; public relations; commercial lobbying services; competitive intelligence services; modelling for advertising or sales promotion; typing; market intelligence services; appointment reminder services [office functions]; website traffic optimization; appointment scheduling services [office functions]; tax filing services; search engine optimization for sales promotion; retail services relating to bakery products; gift registry services; price comparison services; pay per click advertising; secretarial services; procurement services for others [purchasing goods and services for other businesses]; shorthand; outsourcing services [business assistance]; telephone answering for unavailable subscribers; telephone switchboard services; photocopying services; business efficiency expert services; retail or

wholesale services.

36 – Insurance services; credit bureau services; debt collection agency services; financial analysis; rental of apartments; rental of offices for co-working; rental of real estate; rental of offices [real estate]; rental of farms; hire-purchase financing; savings bank services; accommodation bureau services [apartments]; rent collection; issuance of travellers' cheques; issuance of credit cards; issuance of tokens of value; capital investment; financial research; clearing, financial; insurance consultancy; financial consultancy; debt advisory services; stock exchange quotations; crowdfunding; lending against security; business liquidation services, financial; brokerage; financial management; exchanging money; online banking; processing of debit card payments; processing of credit card payments; financial exchange of virtual currency; real estate affairs; factoring; organization of monetary collections; arranging finance for construction projects; antique appraisal; jewellery appraisal; financial evaluation of standing timber; stamp appraisal; real estate appraisal; numismatic appraisal; art appraisal; financial evaluation of development costs relating to the oil, gas and mining industries; financial valuation of intellectual property assets; financial evaluation of wool; financial evaluation [insurance, banking, real estate]; financial appraisals in responding to calls for tenders; repair costs evaluation [financial appraisal]; electronic funds transfer; surety services; securities brokerage; real estate brokerage; brokerage of carbon credits; insurance brokerage; providing insurance information; providing rebates at participating establishments of others through use of a membership card; loans [financing]; pawnbrokerage; providing financial information; providing financial information via a website; cheque verification; investment of funds; charitable fund raising; stocks and bonds brokerage; financial sponsorship; mortgage banking; instalment loans; insurance underwriting; life insurance underwriting; health insurance underwriting; accident insurance underwriting; marine insurance underwriting; fire insurance underwriting; apartment house management; real estate management; financial management of reimbursement payments for others; real estate agency services; actuarial services; banking; stock brokerage services; e-wallet payment services; retirement payment services; bail-bonding; preparation of quotes for cost estimation purposes; electronic transfer of virtual currencies; trusteeship; provident fund services; financial customs brokerage services; mutual funds; financing services; safe deposit services; deposits of valuables; fiscal valuation.

37 – Construction; installation and repair services; mining extraction, oil and gas drilling; asphaltting; drilling of deep oil or gas wells; drilling of wells; rebuilding engines that have been worn or partially destroyed; rebuilding machines that have been worn or partially destroyed; renovation of clothing; retreading of

tyres; vulcanization of tyres [repair]; building sealing; linen ironing; pressing of clothing; disinfecting; mining extraction; vehicle battery charging; charging of electric vehicles; knife sharpening; building insulating; bricklaying; riveting; construction consultancy; varnishing; re-tinning; installation of utilities in construction sites; scaffolding; road paving; window cleaning; vehicle washing; building construction supervision; tuning of musical instruments; upholstering; rustproofing; anti-rust treatment for vehicles; sanding; pumicing; strong-room maintenance and repair; vehicle maintenance; paper hanging; painting or repair of signs; cleaning of buildings [exterior surface]; vehicle polishing; vehicle breakdown repair services; providing information relating to repairs; providing construction information; rental of bulldozers; rental of drainage pumps; rental of dish drying machines; rental of road sweeping machines; rental of cleaning machines; rental of cranes [construction equipment]; rental of dishwashing machines; rental of laundry washing machines; rental of construction equipment; rental of excavators; laying of cable; plumbing; masonry; roofing services; painting, interior and exterior; carpentry services; underwater repair; plastering; quarrying services; repair of security locks; umbrella repair; parasol repair; motor vehicle maintenance and repair; burner maintenance and repair; film projector repair and maintenance; airplane maintenance and repair; safe maintenance and repair; clock and watch repair; repair of power lines; pump repair; upholstery repair; shoe repair; clothing repair; photographic apparatus repair; furniture restoration; restoration of musical instruments; restoration of works of art; vehicle greasing; demolition of buildings; warehouse construction and repair; vehicle service stations [refuelling and maintenance]; sterilization of medical instruments; washing; washing of linen; pier breakwater building; pipeline construction and maintenance; underwater construction; harbour construction; factory construction; building of fair stalls and shops; shipbuilding; cleaning of buildings [interior]; snow removal; street cleaning; vermin exterminating, other than for agriculture, aquaculture, horticulture and forestry; housekeeping services [cleaning services]; tyre balancing; pest control services, other than for agriculture, aquaculture, horticulture and forestry; hydraulic fracturing services; refilling of toner cartridges; refilling of ink cartridges; cell phone battery charging services; artificial snow-making services; laundering; services of electricians; installation of doors and windows; irrigation devices installation and repair; elevator installation and repair; installation and repair of flood protection equipment; heating equipment installation and repair; burglar alarm installation and repair; furnace installation and repair; telephone installation and repair; installation and repair of air-conditioning apparatus; fire alarm installation and repair; freezing equipment installation and repair; electric appliance installation and repair; kitchen equipment installation;

installation, maintenance and repair of computer hardware; machinery installation, maintenance and repair; office machines and equipment installation, maintenance and repair; interference suppression in electrical apparatus; swimming-pool maintenance; furniture maintenance; chimney sweeping; boiler cleaning and repair; cleaning of clothing; dry cleaning; vehicle cleaning; diaper cleaning; leather care, cleaning and repair; fur care, cleaning and repair.

39 – Transport; packaging and storage of goods; organization of tours; air transport; motor coach rental; boat rental; garage rental; rental of vehicle roof racks; aircraft rental; parking place rental; rental of electric wine cellars; rental of warehouses; rental of tractors; booking of seats for travel; travel reservation; transport reservation; towing; vehicle breakdown towing services; bottling services; water distribution; water supplying; delivery of newspapers; message delivery; parcel delivery; delivery of goods; delivery of goods by mail order; flower delivery; replenishment of vending machines; launching of satellites for others; transportation logistics; rescue operations [transport]; arranging of cruises; arranging of passenger transportation services for others via an online application; arranging of transportation for travel tours; arranging for travel visas and travel documents for persons travelling abroad; armoured-car transport; hauling; carting; transport and storage of waste; transporting furniture; lighterage services; ferry-boat transport; removal services; transport of travellers; guarded transport of valuables; bus transport; car transport; barge transport; boat transport; railway transport; marine transport; passenger transport; river transport; ambulance transport; tram transport; portering; piloting of civilian drones; refloating of ships; cash replenishment of automated teller machines; shipbrokerage; transport brokerage; freight brokerage [forwarding (Am.)]; providing driving directions for travel purposes; providing traffic information; providing information relating to storage services; providing transportation information; car rental; railway truck rental; rental of diving bells; rental of diving suits; rental of motor racing cars; rental of aircraft engines; railway coach rental; rental of storage containers; rental of wheelchairs; horse rental; rental of freezers; rental of navigational systems; refrigerator rental; vehicle rental; stevedoring; unloading cargo; electricity distribution; distribution of energy; packaging of goods; collection of recyclable goods [transport]; carpooling services; ice-breaking; piloting; escorting of travellers; transport by pipeline; operating canal locks; car parking; chauffeur services; pleasure boat transport; car sharing services; courier services [messages or merchandise]; salvaging; salvage of ships; gift wrapping; underwater salvage; taxi transport; transport services for sightseeing tours; luggage storage; franking of mail; freight [shipping of goods]; freighting; physical storage of electronically stored data or documents; boat storage; storage; freight forwarding.

41 – Teaching; education; entertainment services; sporting and cultural activities; modelling for artists; academies [education]; rental of indoor aquaria; rental of artwork; rental of sports grounds; rental of tennis courts; mobile library services; lending library services; booking of seats for shows; videotaping; physical education; production of music; discotheque services; animal training; dubbing; publication of books; film distribution; movie studio services; health club services [health and fitness training]; nightclub services [entertainment]; layout services, other than for advertising purposes; microfilming; videotape editing; production of radio and television programmes; screenplay writing; religious education; aikido instruction; gymnastic instruction; judo instruction; correspondence courses; practical training [demonstration]; training services provided via simulators; organization of balls; organization of exhibitions for cultural or educational purposes; providing recreation facilities; arranging and conducting of colloquiums; arranging and conducting of congresses; arranging and conducting of conferences; arranging and conducting of concerts; arranging and conducting of workshops [training]; arranging and conducting of in-person educational forums; arranging and conducting of seminars; arranging and conducting of symposiums; organization of competitions [education or entertainment]; arranging of beauty contests; organization of cosplay entertainment events; organization of lotteries; organization of fashion shows for entertainment purposes; organization of shows [impresario services]; organization of sports competitions; vocational guidance [education or training advice]; amusement park services; sign language interpretation; language interpretation; know-how transfer [training]; television entertainment; vocational retraining; providing online videos, not downloadable; providing information in the field of education; providing information relating to recreational activities; providing information in the field of entertainment; providing online music, not downloadable; providing television programmes, not downloadable, via video-on-demand services; providing films, not downloadable, via video-on-demand services; providing user reviews for entertainment or cultural purposes; providing golf facilities; providing user rankings for entertainment or cultural purposes; providing sports facilities; providing amusement arcade services; cinema presentations; providing online electronic publications, not downloadable; presentation of circus performances; presentation of variety shows; presentation of live performances; theatre productions; conducting guided climbing tours; conducting fitness classes; educational examination; film production, other than advertising films; rental of audio equipment; rental of video cameras; rental of video cassette recorders; rental of videotapes; rental of show scenery; rental of sound recordings; toy rental; rental of cinematographic apparatus; rental of motion pictures; games equipment rental; rental of stadium faci-

lities; rental of lighting apparatus for theatrical sets or television studios; rental of radio and television sets; rental of skin diving equipment; rental of sports equipment, except vehicles; rental of stage scenery; rental of training simulators; electronic desktop publishing; online publication of electronic books and journals; publication of texts, other than publicity texts; radio entertainment; writing of texts; sado instruction [tea ceremony instruction]; zoological garden services; news reporters services; film directing, other than advertising films; party planning [entertainment]; music composition services; subtitling; tutoring; entertainer services; holiday camp services [entertainment]; gambling services; video editing services for events; conducting guided tours; disc jockey services; sound engineering services for events; game services provided online from a computer network; personal trainer services [fitness training]; providing casino facilities [gambling]; calligraphy services; karaoke services; club services [entertainment or education]; songwriting; cultural, educational or entertainment services provided by art galleries; providing museum facilities [presentation, exhibitions]; educational services provided by special needs assistants; educational services provided by schools; orchestra services; translation; scriptwriting, other than for advertising purposes; physical fitness assessment services for training purposes; face painting; ticket agency services [entertainment]; educational examination for users to qualify to pilot drones; coaching [training]; lighting technician services for events; sport camp services; recording studio services; nursery schools; photography; photographic reporting; timing of sports events; boarding school education; production of shows.

42 – Scientific and technological services and research and design relating thereto; industrial analysis, industrial research and industrial design services; quality control and authentication services; design and development of computer hardware and software; water analysis; computer system analysis; handwriting analysis [graphology]; chemical analysis; rental of meters for the recording of energy consumption; energy auditing; recovery of computer data; business card design; graphic design of promotional materials; interior design; industrial design; graphic arts design; computer virus protection services; oil-field surveys; geological surveys; engineering; installation of computer software; meteorological information; clinical trials; material testing; textile testing; bacteriological research; biological research; geological research; research in the field of environmental protection; cosmetic research; mechanical research; research in the field of welding; research in the field of building construction; research in the field of telecommunications technology; research in the field of physics; chemical research; research and development of new products for others; medical research; scientific and technological research relating to patent mapping; scientific and technological research in the field of natural di-

sasters; scientific research; analysis for oil-field exploitation; underwater exploration; technological research; calibration [measuring]; website design consultancy; computer security consultancy; information technology [IT] consultancy; computer technology consultancy; consultancy in the design and development of computer hardware; architectural consultancy; internet security consultancy; computer software consultancy; data security consultancy; technological consultancy; oil-well testing; quality control; vehicle roadworthiness testing; land surveying; dress designing; updating of computer software; monitoring of computer systems to detect breakdowns; monitoring of computer systems for detecting unauthorized access or data breach; monitoring of computer systems by remote access; electronic monitoring of credit card activity to detect fraud via the internet; electronic monitoring of personally identifying information to detect identity theft via the internet; software as a service [SaaS]; maintenance of computer software; authenticating works of art; design of interior decor; quality evaluation of standing timber; quality evaluation of wool; digitization of documents [scanning]; conversion of data or documents from physical to electronic media; urban planning; providing information relating to computer technology and programming via a website; providing scientific information, advice and consultancy relating to carbon offsetting; providing search engines for the internet; platform as a service [PaaS]; conversion of computer programs and data, other than physical conversion; conducting technical project studies; computer system design; rental of web servers; computer rental; rental of computer software; unlocking of mobile phones; geological prospecting; oil prospecting; hosting computer sites [web sites]; server hosting; development of computer platforms; construction drafting; software development in the framework of software publishing; cloud seeding; consultancy in the field of energy-saving; creating and designing website-based indexes of information for others [information technology services]; creating and maintaining websites for others; computer programming; technical writing; copying of computer programs; cloud computing; architectural services; information technology services provided on an outsourcing basis; chemistry services; packaging design; off-site data backup; telecommunications technology consultancy; scientific laboratory services; user authentication services using single sign-on technology for online software applications; user authentication services using technology for e-commerce transactions; weather forecasting; styling [industrial design]; cartography services; exploration services in the field of the oil, gas and mining industries; data encryption services; electronic data storage; surveying.

(260) AM 2022 114424 A

(800) 1608942

(151) 2021 06 22

(891) 2021 06 22

(731) Apple Inc.

One Apple Park Way, Cupertino CA 95014,  
USA

(540)

## APPLE FIND MY

(591) Black, white

(511)

42 – Design and development of computer hardware, software, and peripherals; computer programming; electronic data storage; cloud computing services; providing virtual computer systems and virtual computer environments through cloud computing; providing online non-downloadable software; providing computer hardware or software information online.

(260) AM 2022 114426 A

(800) 1608997

(151) 2021 04 01

(891) 2021 04 01

(731) Limited liability company "Proizvodstvennaya, kompaniya Sibiryak"  
ul. Prudskaya 10, selo Bolshepanyushevo,  
RU-658101 Aleyskiy rayon, Altayskiy kray,  
Russian Federation

(540)



(591) White, black, brown, green

(531) 05.03.13; 05.03.15; 05.07.01; 26.13.25;  
27.05.21; 29.01.14

(511)

30 – Groats for human food.

35 – Demonstration of goods; distribution of samples; market studies; organization of exhibitions for commercial or advertising purposes; sales promotion for others; procurement services for others [purchasing goods and services for other businesses]; presentation of goods on communication media, for retail purposes; commercial information and advice for consumers; rental of sales stands; commercial intermediation services; negotiation and conclusion of commercial transactions for third parties.

(260) AM 2022 114433 A  
 (800) 1609312  
 (151) 2021 06 01  
 (891) 2021 06 01  
 (731) SIMVALIN HOLDINGS LIMITED  
 Kritis, 32 Papachristoforou Build., 4th floor,  
 CY-3087 Limassol, Cyprus  
 (540)

## PROALLERGY

(591) Black, white  
 (511)  
 5 – Food for babies; lacteal flour for babies.

(260) AM 2022 114452 A  
 (800) 878434  
 (151) 2006 01 20  
 (891) 2021 08 10  
 (731) Coolike-Regnery GmbH  
 Lilienthalstr. 2-4, 64625 Bensheim, Germany  
 (540)

## VIBASEPT

(591) Black, white  
 (511)  
 3 – Cleaning agents for tools and equipment, for use in the sanitary field and for hygiene; antiseptic soaps.  
 5 – Disinfecting agents for tools and equipment for use in the sanitary field; disinfectants for human and veterinary use; fungicides, herbicides.  
 37 – Cleaning and disinfection of rooms and buildings as well as of objects of all kinds.

(260) AM 2022 114453 A  
 (800) 994574  
 (151) 2008 11 25  
 (891) 2021 08 09  
 (731) CSP International Fashion Group S.p.A.  
 Via Piubega, 5/C, I-46040 Ceresara (MN), Italy  
 (540)

## LEPEL

(591) Black, white  
 (511)  
 25 – Clothing, footwear and headgear.

(260) AM 2022 114454 A  
 (800) 1138545  
 (151) 2012 08 09  
 (891) 2021 07 16  
 (731) CERTUSS Dampfautomaten GmbH & Co. KG  
 Hafenstr a e 65, 47809 Krefeld, Germany  
 (540)

## CERTUSS

(591) Black, white

(511)  
 9 – Weighing, measuring, signalling, electrical display, electrical control, electrical monitoring and checking (supervision) apparatus and instruments for steam installations, including as systems.

11 – Automatic steam machines; installations for processing water for automatic steam machines and for supplying automatic steam machines.

(260) AM 2022 114455 A  
 (800) 1170291  
 (151) 2013 03 08  
 (891) 2021 07 23  
 (731) GROUPE ADEO  
 Rue Sadi Carnot, CS 00001, F-59790  
 RONCHIN, France  
 (540)

## NATERIAL

(591) Black, white  
 (511)  
 6 – Metal garden sheds; swimming pools (metal structures); swimming pool covers of metal; metal fences, gratings and grilles; gates of metal; outdoor blinds of metal; metal slabs and paving blocks; common metals and alloys thereof; building materials of metal; transportable buildings of metal; materials of metal for railway tracks; non-electric cables and wires of metal; non-electric locks of metal; hardware of metal; metal screws, nails, nuts and bolts; pipes of metal; safes; ores; boxes, chests and containers of metal; letter boxes (of metal); buildings of metal; verandas of metal; pergolas of metal; metal carports; screening panels of metal; scaffolding of metal; metal railings and balusters; works of art, statues or figurines (statuettes) of common metals; chimneys of metal and spare parts of metal for chimneys.

8 – Non-electric cutlery; forks and particularly barbecue forks; tongs and particularly barbecue tongs.

11 – Lighting fixtures; indoor and outdoor Christmas lights; barbecues; toasters and grills for barbecues; lighter chimneys for barbecues; roasting spits; gas-fueled terrace heaters; apparatus for lighting, heating, steam generating, cooking, refrigerating, drying, ventilating, water distribution and sanitary installations; air or water purifying apparatus and machines; air-conditioning apparatus or installations; valves and fittings (excluding parts of machines, engines or motors and barrel taps); sinks; barbecue covers.

18 – Parasols; leather and imitations of leather; trunks and suitcases; backpacks; bags or small bags (envelopes, pouches) for packaging (made of leather); umbrellas and walking sticks; covers for parasols.

19 – Non-metallic garden sheds; children's playhouses; swimming pools (non-metal structures); swimming pool covers not of metal; non-metallic fences,

gratings and grilles; gates not of metal; outdoor blinds not of metal and not of textile; non-metallic paving stones and slabs; floors not of metal; duckboards and floors of wood for terraces; buildings, not of metal; verandas not of metal; pergolas not of metal; carports not of metal; arbors (building); non-metallic railings and balusters; construction materials not of metal; screening panels not of metal; natural or synthetic screens; outdoor blinds not of metal and not of textile; sand (excluding foundry sand); gravel; stone; asphalt; pitch and bitumen; concrete; cement; plaster; coatings (building materials); binding agents for making briquettes; floors not of metal.

20 – Furniture and particularly garden furniture; cupboards; cupboards; doors and shelves for furniture; fittings for furniture (not of metal); seat cushions; cushions; flower-pot pedestals; wardrobes; wooden furniture partitions; furniture casters (not of metal); show-cases (furniture); clothes hooks, not of metal; coat stands (not of metal); shelves; shelves for storage; holders for hammocks; cases, boxes, chests, bins and containers made of wood or plastic; wickerwork; mirrors (looking glasses); frames; bedding (excluding bed linen); works of art made of wood, wax, plaster, cork, reed, cane, wicker, horn, bone, ivory, whalebone, shell, amber, mother-of-pearl, meerschaum, substitutes for all these materials or of plastic; outdoor blinds of textile for terraces, verandas and pergolas.

21 – Pottery; flower pots and tubs; candle jars (lamps); cleaning material; brushes (except paintbrushes) and particularly barbecue brushes; kitchen containers and utensils; spatulas (kitchen utensils).

22 – Tents; tarpaulins; hammocks; shading canopies.

---

(260) AM 2022 114456 A

(800) 1337939

(151) 2017 01 17

(891) 2021 07 20

(731) Astrocast SA

Chemin des Ramiers 20, Chavannes-près-Renens, CH-1022, Switzerland

(540)

## ASTROCAST

(591) Black, white

(511)

9 – Satellite receivers; satellite signal receivers; satellite reception and transmission apparatus and instruments; apparatus and instruments for satellite transmission reception and decoding; satellite transmitters; satellite transmitters; software for satellite navigation systems.

38 – Data transmission and telecommunication services; telecommunication services; telecommunications; satellite transmission; data transmission via satellite; satellite communication services; communication by satellite; satellite transmission services.

---

(260) AM 2022 114488 A

(800) 1610594

(151) 2021 06 24

(891) 2021 06 24

(731) Foursquare Labs, Inc.

50 West 23rd Street, 8th Floor, New York  
NY 10010, USA

(540)

## FOURSQUARE

(591) Black, white

(511)

9 – Downloadable software in the nature of a mobile application for displaying and sharing a user's location and finding, locating, and interacting with other users and places.

41 – Entertainment services, namely, providing on-line computer games.

42 – Providing on-line non-downloadable software for displaying and sharing a user's location and finding, locating, and interacting with other users and places.

45 – On-line social networking services.

---

(260) AM 2022 114489 A

(800) 1610614

(151) 2021 05 25

(891) 2021 05 25

(731) Paragon Vision Sciences, Inc.

2120 W. Guadalupe Road, Suite 112,  
Gilbert AZ 85233, USA

(540)

## PARAGON CRT

(591) Black, white

(511)

9 – Contact lenses.

---

(260) AM 2022 114490 A

(800) 1610640

(151) 2021 05 20

(891) 2021 05 20

(731) FIDIA FARMACEUTICI S.p.A.

Via Ponte della Fabbrica, 3/A, I-35031 ABANO  
TERME (PD), Italy

(540)

## HYALASTINE

(591) Black, white

(511)

1 – Chemicals for use in industry and science; biological preparations for use in industry and science; active chemical ingredients for use in the manufacture of pharmaceuticals, cosmetics, medicines, dietetic substances, foodstuffs and sanitary preparations.

3 – Non-medicated cosmetics and toiletry preparations; non-medicated toothpastes; perfumery, essential

---

oils; skin care creams, not for medical use; topical sprays for cosmetic purposes; dermatological cosmetic preparations, not for medical purposes; cosmetic preparations for body care and beauty; soaps; shampoo; cosmetic preparations for hair care and beauty; hair lotions; mouth washes not for medical use; oral hygiene preparations; cosmetic preparations, namely, sun-tanning, sun-protecting and after sun creams, ointments, conditioners, lotions, oils and sprays.

5 – Pharmaceutical preparations; medical and veterinary preparations; sanitary preparations for medical purposes; foodstuffs and dietetic substances for medical or veterinary purposes; dietary supplements for humans and animals; plasters, materials for dressings; disinfectants; fungicides; parapharmaceutical preparations; medicines; chemical preparations for medical and pharmaceutical purposes; active pharmaceutical ingredients for the production of pharmaceutical preparations (active principles), namely chemical and biological preparations for pharmaceutical purposes; pre-filled syringes for medical purposes; medicated food supplements; dietary and nutritional supplements; vitamins; solutions for contact lenses; ophthalmologic preparations; eye drops; ophthalmic preparations for use in ocular surgery; ophthalmic eye drops and artificial tears; medicated creams or gels for the contour of the eyes.

(260) AM 2022 114491 A  
(800) 1610644  
(151) 2021 05 21  
(891) 2021 05 21  
(731) WR International AG  
c/o RA Landtwing, Baarerstrasse 11,  
CH-6300 Zug, Switzerland

(540)

## Smart Kid

(591) Black, white  
(511)  
5 – Foodstuffs for babies and children; food supplements for human beings, food supplements as supplements to a normal diet or as a health-boosting supplements; meal replacements and dietetic foods and beverages for medical use; nutritional supplements and vitamins; food supplements containing algae extracts; food supplements containing fruit extracts; vitamins and nutritional supplements used for increasing endurance, muscle work capacity and muscle mass and body functions.

(260) AM 2022 114492 A  
(800) 1610660  
(151) 2021 06 09  
(891) 2021 06 09  
(731) Shenzhen NJY Technology Co., Ltd.  
201, Block B, Jiada R&D Building,

No. 5 Songpingshan Road, Songpingshan  
Community, Xili Street, Nanshan District,  
518000 Shenzhen, China

(540)

## Microwear 微穿戴

(591) Black, white  
(531) 27.05.01; 28.03

(511)

9 – Smartwatches; humanoid robots with artificial intelligence; chargers for electric accumulators; headphones; mobile telephones; computers; batteries, electric; data processing apparatus; radios; integrated circuits.

(260) AM 2022 114494 A

(800) 1610754

(151) 2021 03 22

(891) 2021 03 22

(731) Zhejiang Hiland Technology Co., Ltd  
Liangshan Hi-tech Industrial Park, Anji  
Economic Development Zone, Dipu Subdistrict,  
Huzhou City, Zhejiang Province, China

(540)

# Hiland

(591) Black, white

(531) 26.01.03; 26.01.24; 27.05.01; 27.05.07;  
27.05.17

(511)

07 – Loading ramps; handling apparatus for loading and unloading; filter presses; curtain drawing devices, electrically operated.

(260) AM 2022 114497 A

(800) 1610858

(151) 2021 02 04

(891) 2021 02 04

(731) Soft Construct Limited  
Clinch's House, Lord Street, Douglas Isle of  
Man IM99 1RZ, United Kingdom

(540)

## CreedRoomz

(591) Black, white

(511)

9 – Optical, weighing, measuring, signalling, checking (supervision), apparatus and instruments; apparatus and instruments for conducting, switching, transforming, accumulating, regulating or controlling electricity; apparatus for recording, transmission or reproduction of sound or images; application software; calculating machines, data processing equipment and computers; apparatus and instruments for recording,



transmission or reproduction of sound, data and/or images; application software relating to and for playing casino games, gambling and betting; computer and electronic games software; computer software for playing games; computer hardware for use in gaming equipment; computer software for digital lotteries and casinos; computer hardware for use in digital lotteries; computer hardware for use in casinos; computer software for gaming, gambling and betting; computer lottery games; computer lottery games downloadable from the Internet; computer software; computer software applications, downloadable; computer software distributed via the Internet; computer software downloadable from the Internet; computer software and programs for use on computer networks including the Internet; computer software platforms for social networking; computer software to enable uploading, posting, showing, displaying, tagging, blogging, sharing or otherwise providing electronic media or information in the fields of virtual communities, electronic gaming, entertainment, and general interest via the Internet or other communications networks with third parties; computer software platforms for computer software programs running on, or in connection with, mobile devices; computer software for the provision and management of on-line games and competitions; computer software for use on computer networks, including the Internet for gaming, gambling and betting; computer software relating to and for playing casino games, gambling and betting; computer software for use on computer networks, including the Internet for gaming, gambling and betting; computer programs and application software for use on telephones and handheld mobile devices; computer programs relating to and for playing casino games, gambling and betting; downloadable electronic publications; electronic number generators; electronic publications; games and competitions in electronic and computer software form; games, gaming, and gambling related software; interactive computer systems; interactive computer and mobile device systems; interactive software; interactive games, gaming and gambling software; online games, gaming and gambling related software; software for use with games, entertainment, recreational, amusement, gaming and video game terminals, machines and apparatus; software for interactive scratch cards and scratch card games; software and software packages for the registration and operation of betting related to sports; software for processing bets including through the Internet; sound and video recordings; video screens; virtual reality computer and gaming hardware and software; augmented reality computer and gaming hardware and software; mixed reality computer and gaming hardware and software; extended reality computer and gaming hardware and software; wagering systems; parts and fittings for all the aforesaid goods.

28 – Games, toys, playthings and novelties; apparatus for games; appliances, equipment and accessories for

bingo; articles and apparatus for use in games, in lottery games and in playing games and lottery games; automatic gaming machines; automatic slot machines; bags specially adapted for handheld games; bags specially adapted for handheld video games; bingo game playing apparatus; bingo cards; bingo markers; board games; card games; cards (games); casino games, equipment and accessories therefor; chips and dice [gaming equipment]; chips, counters, discs and tokens for gambling; action skill games; coin fed gaming machines; coin-operated amusement gaming machines; coin-operated gambling and betting machines; coin-operated games; coin-operated gaming equipment; counters, discs and pawns for games; darts, quoits; dart games; dice and cases therefor; dice games; electronic board games; free standing games apparatus; free standing video games apparatus; free standing gaming and gambling apparatus; game boards; game cards; gaming apparatus; gaming and amusement machines and parts and fittings therefor; gaming chips; gaming equipment; gaming machines; gaming tables; gambling machines; hand held computer games; lottery balls; mahjong; parlour games, devices, equipment and accessories therefor; pinball games; playing cards; poker chips; puzzles; question sets for games, gaming and gambling; quiz games; roulette sets, chips, wheels, tables, equipment and accessories therefor; scratch cards; scratch card games; slot machines (gaming devices); sports games; amusement apparatus and accessories for games; amusement apparatus and accessories for games, adapted for use with televisions; betting terminals; betting terminals with internet connections; electric, electronic or mechanical gaming apparatus for betting; electrical and electronic gaming apparatus for use in on-line betting; electronic game equipment; slot machines; gaming machines; parts and fittings for all the aforesaid goods.

35 – Advertising; business management; business administration; office functions; business management; business administration; business services related to establishing and providing sales, brokerage and collection points for betting; office functions; on-line advertising on a computer network; on-line data processing services; retail services in relation to games, apparatus and devices for betting, games, gaming, gambling, casinos and wagering; retail services in relation to software and software packages for the registration and operation of betting related to sports; sponsoring in the form of advertising (term considered too vague by the International Bureau – rule 13 (2) (b) of the Regulations); systematic ordering of data in computer databases; business organization consultancy with regard to providing of betting; television advertising; wholesale services in relation to games, gaming and gambling equipment, games and books relating to gambling, and betting materials, devices and equipment; business services related to establishing of sports betting offices; information con-

cerning the services mentioned before; services mentioned before through or not through the Internet; advisory and consultancy services in relation to the aforesaid.

38 – Telecommunication access services; telecommunications services, namely, electronic transmission of streamed and downloadable audio and video files via computer and other communications networks; web casting services; delivery of message by electronic transmission; telecommunication services namely, electronic transmission of streamed and downloaded audio and video and multimedia content files via computer and other communications networks; audio broadcasting of spoken word, music, concerts, and radio programs; wireless broadband communications services in the fields of gaming, gambling and casino services, including card games; electronic transmission of information and data; audio broadcasting and transmission of educational and entertainment digital media; telecommunications services, namely, transmission of text, images, audio, and video, and data via telecommunications networks, wireless communications networks, and the internet; providing access to databases; providing telecommunication connectivity services for the transfer of images, messages, audio, visual, audiovisual and multimedia works among e-readers, mobile phones, smartphones, portable electronic devices, portable digital devices, tablets or computers; streaming of audio, visual and audiovisual material via the internet or other computer or communications network; telecommunications services; providing video on-demand transmission of computer games; electronic and wireless transmission and streaming of digital media content for others via global computer networks to handheld computers, laptops, and mobile electronic devices; provision of information, consultancy and advisory services in the field of telecommunications.

41 – Education (training); entertainment services; sporting and cultural activities; entertainment by or relating to games, competitions, quizzes and audience participation events; amusement arcades; amusement arcade gaming machine rental services; amusement parks; arranging and conducting of contests and competitions, including offline and online by way of a computer database or the Internet; arranging, organizing, providing, presenting, management and administration of a lottery, of competitions, games, quizzes, fun events and audience participation events, and of gaming and gambling services; assuring equipment for gambling in casinos (rental); betting; betting, gaming, games, gambling, book-making, bingo, poker and casino services; betting and pools services; betting services for receiving, recording and conducting bets and paying out betting winnings; betting and bookmaking services provided by means of the internet; betting offices and sports betting terminals; betting shop services provided through retail betting

shops; casino, gaming and gambling services; conducting lotteries; electronic betting, gambling and gaming services; entertainment; entertainment services in the nature of on-line gaming and gambling; entertainment services, namely, providing virtual environments in which users can interact through social games for recreational, leisure or entertainment purposes; entertainment in the form of services providing an Internet platform for downloading software for electronic games, electronic games downloadable from the Internet; electronic games of skill, electronic gambling games and electronic card games downloadable from the Internet; skill games, electronic games and software for fixed odds betting programs, horse racing betting, instant lotteries, pools; entertainment and sporting services provided on-line from a computer database or the Internet; operating of sports betting offices; gambling, gaming, betting and wagering services; gambling services provided by means of the Internet; horses (betting on-); interactive entertainment; interactive lottery, gambling, gaming, betting and pools services; Internet lottery, gambling, gaming, betting and pools services; lottery services; lottery, gambling, gaming, betting and pools services; on-line betting, gambling and gaming services; on-line spread betting, gaming, betting, gambling bookmaking and wagering services; organization, production, presentation and conducting of betting events and forums, competitions, contests, games and quizzes; organisation and holding of contests and competitions, including on-line by way of a computer database or the Internet; organisation of on-line betting; organisation of card games and tournaments; organisation of television games and on-line games in the global computer network; prize draws; providing interactive multi-player computer games via the Internet and electronic communication networks; providing temporary use of non-downloadable interactive, multiplayer and single player games; providing online computer and electronic games by means of a web-based system; provision of betting and gaming services by means of a computer based system; provision of non-downloadable internet games; provision of information on-line via the Internet or from a computer network or database relating to entertainment, lottery, gaming, betting and gambling services; providing casino facilities (gambling); providing casino and gaming services by means of a website and a global computer network; providing online information about casinos, gambling and general news about the gaming industry; providing on-line computer games; providing information regarding on-line games; providing information on-line from a computer database or electronic network, including the Internet, relating to entertainment and sporting events; provision of information relating to sporting events; publication of electronic books or periodicals on-line; providing gaming house facilities; provision of information about gambling and games; on-line gaming services; provision of on-line publications about

gambling; rental of gaming and gambling machines and equipment; receiving and conducting of betting, in particular sports betting; running lotteries, exchange rate betting, pools, jackpot systems, tipping competitions and games, running online games, keeping gambling houses, keeping casinos; services in the field of racing, wagers and betting, games of chance, entertainment, bingo halls, casinos, contests, gaming, gambling, games of chance, electronic games, media games, tournaments for poker and other card games, action skill games and lotteries, including online via a computer database, telecommunications and the Internet; services of a sports bookmaker; spread betting, gaming, betting, gambling, bookmaking and wagering services; betting, games, gaming and gambling machine rental services; provision of the aforesaid services in electronic or computer form, via the television, radio or other means of broadcasting; provision of the aforesaid services on-line via the Internet or from a computer network or database; consultancy, information and advisory services relating to all the aforesaid services.

42 – Scientific and technological services and research and design relating thereto design and development of computer hardware and software; application service provider (ASP); application service provider (ASP) featuring software to enable or facilitate the uploading, downloading, streaming, posting, displaying, blogging, linking, sharing or otherwise providing electronic media or information over communication networks; computer game design; creation, hosting, updating and maintaining Internet sites; design and development of software in the form of services relating to the development and creation of software for use in relation to electronic games downloadable from the Internet, electronic puzzles downloadable from the Internet, electronic board games downloadable from the Internet, electronic games of skill, electronic gambling games and electronic card games downloadable from the Internet, skill games, electronic games and software for fixed odds betting programs, spread betting programs, horse racing betting, instant lotteries, and pools; design and development services in relation to gaming and gambling machines, apparatus and accessories; design and development services in relation to interactive entertainment products; design of scratch cards and electronic scratch cards and scratch card games; design services relating to the production of computer games and interactive entertainment products; design of graphics, visuals, virtual and interactive images, and of special effects for games, audiovisual, multimedia productions and for Internet gaming and gambling website pages; development of computer software applications solutions; providing temporary use of non-downloadable software for use in connection with interactive, multiplayer and single player games, gaming and gambling; providing a web hosting platform for use of non-downloadable software in connection with interactive, multiplayer and single

player games, gaming and gambling for third parties; providing and licensing multiple user access to information and news information over the Internet and other global networks; technical management with regard to providing of betting; consultancy, information and advisory services relating to all the aforesaid services.

---

(260) AM 2022 114503 A  
 (800) 1611073  
 (151) 2021 04 01  
 (891) 2021 04 01  
 (731) WORLD MEDICINE İLAÇ SAN. VE TİC.  
 A.Ş.  
 15 TEMMUZ MAH., CAMİ YOLU CAD.  
 NO:50, Bağcılar, İstanbul, Turkey

(540)  
**C-MUN – C-MYH**

(591) Black, white

(531) 28.05

(511)

5 – dietary supplements, including those adapted for medical purposes, dietary supplements for slimming purposes, food for babies, herbs and herbal beverages adapted for medicinal purposes, dental preparations and articles, sanitary preparations for medical use, hygienic pads, hygienic tampons, plasters, materials for dressings, diapers, including those made of paper and textiles, preparations for destroying vermin, fungicides, herbicides, deodorants, other than for human beings or for animals, air deodorising preparations, disinfectants, antiseptics, detergents for medical purposes.

---

(260) AM 2022 114504 A  
 (800) 1611077  
 (151) 2021 07 15  
 (891) 2021 07 15  
 (731) Beijing Dajia Internet Information Technology Co., Ltd.  
 Room 101D1-7, 1st Floor, Building 1, No. 6,  
 Shangdi West Road, Haidian District, Beijing,  
 China

(540)

**KUAISHOU**

(591) Black, white

(511)

9 – Downloadable software applications for smartphones; computer software, recorded; computer programs, downloadable; computer game software, recorded; computer game software, downloadable; downloadable e-wallets; global positioning system [GPS] apparatus; camcorders; cameras [photography]; batteries, electric; measuring apparatus; fluorescent screens; variometers; remote control apparatus; semi-

conductors; integrated circuits; optical fibers [light conducting filaments]; animated cartoons.

35 – Advertising; publicity; advertising agency services; online advertising on a computer network; pay per click advertising; providing commercial information and advice for consumers in the choice of products and services; consumer profiling for commercial or marketing purposes; administration of consumer loyalty programs; providing user rankings for commercial or advertising purposes; provision of an online marketplace for buyers and sellers of goods and services; sales promotion for others; business management for freelance service providers; website traffic optimization; sponsorship search; import-export agency services.

36 – Insurance brokerage; providing insurance information; processing of credit card payments; processing of debit card payments; electronic funds transfer; e-wallet payment services; charitable fund raising; real estate management; trusteeship; lending against security; surety services.

38 – Message sending; providing online forums; computer aided transmission of messages and images; communications by computer terminals; videoconferencing services; providing internet chatrooms; streaming of data; video-on-demand transmission; transmission of podcasts; television broadcasting.

41 – Educational services; instruction services; arranging and conducting of conferences; providing online electronic publications, not downloadable; production of shows; production of music; providing online videos, not downloadable; providing online music, not downloadable; entertainment services; providing information in the field of entertainment; health club services [health and fitness training]; organization of lotteries.

42 – Technological research; quality control; computer software design; computer system design; software as a service [SaaS]; electronic data storage; user authentication services using technology for e-commerce transactions; user authentication services using single sign-on technology for online software applications; graphic arts design; graphic design of promotional materials; research and development of new products for others.

45 – Dating services; online social networking services; leasing of internet domain names; copyright management; licensing of intellectual property; licensing of computer software [legal services]; registration of domain names [legal services]; licensing [legal services] in the framework of software publishing; escorting in society [chaperoning]; conducting funeral ceremonies.

(260) AM 2022 114505 A  
(800) 1611102  
(151) 2021 06 28  
(891) 2021 06 28  
(731) AFTERSHOKZ, LLC  
1801 Burnet Avenue, Suite 102, Syracuse  
NY 13206, USA

(540)

## OPENHEAR

(591) Black, white  
(511)  
10 – Ear plugs [ear protection devices]; ear trumpets; hearing aids; hearing aids for the deaf; hearing protectors without the ability to reproduce or transmit sound; audiometers; surgical implants comprised of artificial materials.

(260) AM 2022 114506 A  
(800) 1611154  
(151) 2021 06 29  
(891) 2021 06 29  
(731) AFTERSHOKZ, LLC  
1801 Burnet Avenue, Suite 102, Syracuse  
NY 13206, USA

(540)

## OPENS SAFE

(591) Black, white  
(511)  
10 – Ear plugs [ear protection devices]; ear trumpets; hearing aids; hearing aids for the deaf; hearing protectors without the ability to reproduce or transmit sound; audiometers; surgical implants comprised of artificial materials.

(260) AM 2022 114508 A  
(800) 1611237  
(151) 2021 06 10  
(891) 2021 06 10  
(731) HE QI HONG  
No. 041, Paihe Road, Shangpai Town,  
Feixi County, 231200 Anhui Province,  
China

(540)



**LADIES CAPRICE**

(591) Black, white  
(531) 05.05.01; 26.04.03; 26.11.08; 27.03.11;  
27.05.04

(511)  
25 – Clothing; underwear; brassieres; underpants; layettes [clothing]; bathing suits; waterproof clothing; hosiery; hats; scarves.

(260) AM 2022 114509 A  
(800) 1611248  
(151) 2021 07 05  
(891) 2021 07 05  
(731) SHOKZ HOLDING LIMITED  
Rm 2603A 26/F Tower 1 Lippo Ctr 89,  
Queensway Admiralty, Hong Kong, China

(540)

## openjog

(591) Black, white  
(511)  
9 – Batteries; battery chargers; chargers for batteries; earphones; electronic memory devices; headphones; horns for loudspeakers; lithium ion batteries; megaphones; memory expansion modules; microphones; smartglasses; spectacles; virtual reality headsets; wireless speakers; MP3 players; bone conduction earphones.

(260) AM 2022 114511 A  
(800) 1611345  
(151) 2021 06 09  
(891) 2021 06 09  
(731) ZHUHAI AKON TECHNOLOGY CO., LTD  
NO.2 BULIDING, NO.2 DINGWAN NINE  
ROAD, SANZAO TOWN, JINWAN  
DISTRICT, ZHUHAI CITY, 519090  
GUANGDONG PROVINCE, China

(540)



(591) Black, white  
(531) 27.05.01; 27.05.09  
(511)  
9 – Accumulators, electric; optical lanterns; surveying apparatus and instruments; speed measuring apparatus [photography]; precision balances; photocopiers [photographic, electrostatic, thermic].

(260) AM 2022 114512 A  
(800) 1611347  
(151) 2021 04 06  
(891) 2021 04 06  
(731) Limited liability company "Skillbox"  
Bolshoy bulvar, d. 42, stroenie 1, etazh 0,  
pom.150, rab. 3, Territoriya innovatsionnogo  
tsentra, Skolkovo, RU-121205 Moskva,  
Russian Federation

(540)

## Skillbox

(591) Black, white  
(511)  
9 – Computer software, recorded; computer software applications, downloadable.

35 – Computerized file management; opinion polling; market studies; business investigations; marketing research; business management and organization consultancy; personnel management consultancy; business management consultancy; business organization consultancy; marketing; business management of performing artists; updating and maintenance of data in computer databases; provision of an online marketplace for buyers and sellers of goods and services; presentation of goods on communication media, for retail purposes; compilation of information into computer databases; systemization of information into computer databases; telemarketing services; search engine optimization for sales promotion; personnel recruitment consultancy; information services relating to jobs and career opportunities; commercial intermediation services.

38 – Providing user access to global computer networks; providing access to databases; providing telecommunications connections to a global computer network; computer aided transmission of messages and images; transmission of digital files; videoconferencing services.

41 – Correspondence courses; practical training [demonstration]; training services provided via simulators; publication of books; academies [education]; organization of exhibitions for cultural or educational purposes; providing recreation facilities; arranging and conducting of colloquiums; arranging and conducting of congresses; arranging and conducting of conferences; arranging and conducting of concerts; arranging and conducting of workshops [training]; arranging and conducting of in-person educational forums; arranging and conducting of seminars; arranging and conducting of symposiums; organization of competitions [education or entertainment]; vocational guidance [education or training advice]; providing information in the field of education; educational examination; providing online electronic publications, not downloadable; publication of texts, other than publicity texts; tutoring; teaching; educational services provided by schools; coaching [training]; nursery schools.

42 – Computer software consultancy; software as a service [SaaS]; maintenance of computer software; computer system design; hosting computer sites [web sites]; computer software design; computer programming; technical writing; cloud computing; data encryption services.

(260) AM 2022 114518 A  
 (800) 929205  
 (151) 2007 05 09  
 (891) 2021 08 13  
 (731) Christine Reck  
 Vorarlbergerstraße 44, 88400 Biberach,  
 Germany

(540)

## MOTOMED

(591) Black, white  
 (511)  
 10 – Medical apparatus for physiotherapy, movement  
 trainers with motor-driven cranks, ergometers for me-  
 dical purposes; rehabilitation apparatus.

28 – Sports equipment, exercise machines.

(260) AM 2022 114519 A  
 (800) 996561A  
 (151) 2009 03 06  
 (891) 2021 08 19  
 (731) Adama Makhteshim LTD.  
 Hebron Road, Industrial Zone, 8410001  
 Beer Sheva, Israel

(540)

## EMBRELIA

(591) Black, white  
 (511)  
 5 – Preparations for destroying vermin; fungicides,  
 herbicides.

(260) AM 2022 114520 A  
 (800) 1047891  
 (151) 2010 03 11  
 (891) 2021 07 16  
 (731) Publichne aktsionerne tovarystvo "Motor Sich"  
 Prosp. Motorobudivnykhiv, 15,  
 m., Zaporizhzhia 69068, Ukraine

(540)



(591) Black, white  
 (531) 01.05.08; 03.07.01; 03.07.24; 26.01.02;  
 26.01.04; 26.01.13; 26.01.15; 26.01.24;  
 27.01.12; 28.05

(511)  
 7 – Wind-driven power stations; gas compressor  
 units; motors for boats; engines for boats; engines, ot-  
 her than for land vehicles; chain saws; aeroplane en-  
 gines; cream and milk separators; superchargers; mo-  
 bile electric power stations; aeronautical engines; jet  
 engines other than for land vehicles; separators; heat  
 exchangers (parts of machines); turbines other than  
 for land vehicles; turbo expander power plants; tur-  
 bocompressors.

12 – Jet engines for land vehicles; driving motors for  
 land vehicles; tractors; vehicles for locomotion by  
 land, air, water or rail.

(260) AM 2022 114521 A  
 (800) 1404943  
 (151) 2018 02 06  
 (891) 2021 07 27  
 (731) MAYTEKS ÖRME SANAYİ VE TİCARET  
 ANONİM ŞİRKETİ  
 10007 Sokak No:20 A.O.S.B., TR-35620 Çiğli  
 İZMİR, Turkey

(540)

# antebies

(591) Black, white  
 (531) 02.09.01; 27.05.08  
 (511)  
 25 – Clothing, footwear, headgear.

(260) AM 2022 114522 A  
 (800) 1437927  
 (151) 2018 09 04  
 (891) 2021 06 17  
 (731) QingLing Motors Co., Ltd.  
 #1 Xiexingcun, Zhongliangshan, Jiulongpo  
 District, Chongqing, China

(540)



(591) Black, white  
 (531) 26.01.02; 26.01.18; 26.01.24; 27.05.24  
 (511)  
 12 – Locomotives; engines for land vehicles; motor  
 coaches; cars; automobile tires; gear boxes for land  
 vehicles; upholstery for automobiles; aircraft.

(260) AM 2022 114560 A  
 (800) 1611840  
 (151) 2021 08 12  
 (891) 2021 08 12  
 (731) Liu, Chao

Room 666, No.73 Futian Road, Zhangcun  
 Town, Huancui District, Weihai City, 264200  
 Shandong Province, China

(540)



(591) Black, white  
 (531) 26.03.01; 26.11.11; 26.11.25; 26.13.25  
 (511)  
 28 – Rods for fishing; archery implements; fishing tackle; fishing lines; toys; balls for games.

(260) AM 2022 114561 A  
 (800) 1611863  
 (151) 2021 06 04  
 (891) 2021 06 04  
 (731) UCB Biopharma SRL

Allée de la Recherche 60, B-1070 Bruxelles,  
 Belgium

(540)

**VALIGGO**

(591) Black, white  
 (511)  
 5 – Pharmaceutical preparations and substances.

(260) AM 2022 114562 A  
 (800) 1611869  
 (151) 2021 06 04  
 (891) 2021 06 04  
 (731) UCB Biopharma SRL

Allée de la Recherche 60, B-1070 Bruxelles,  
 Belgium

(540)

**LUMAROZA**

(591) Black, white  
 (511)  
 5 – Pharmaceutical preparations and substances.

(260) AM 2022 114563 A  
 (800) 1611880  
 (151) 2021 07 22  
 (891) 2021 07 22  
 (731) MARKEVICH NIKOLAI IVANOVICH

ul. Profsoyusnaya, 93, korp.4, kv.326,  
 RU-117279 Moscow, Russian Federation

(540)

*Sammy  
 Beauty*

(591) Black, white

(531) 27.05.01

(511)

3 – Non-medicated cosmetics and toiletry preparations; non-medicated dentifrices; perfumery, essential oils; bleaching preparations and other substances for laundry use; cleaning, polishing, scouring and abrasive preparations; abrasives; amber [perfume]; descaling preparations for household purposes; antistatic preparations for household purposes; aromatics [essential oils]; air fragrancing preparations; cake flavourings [essential oils]; flavourings for beverages [essential oils]; food flavourings [essential oils]; breath freshening sprays; canned pressurized air for cleaning and dusting purposes; balms, other than for medical purposes; basma [cosmetic dye]; lip glosses; nail glitter; polishing stones; abrasive paper; emery paper; polishing paper; petroleum jelly for cosmetic purposes; shoe polish; cobblers' wax; cotton wool for cosmetic purposes; cotton wool impregnated with make-up removing preparations; sachets for perfuming linen; drying agents for dishwashing machines; adhesives for cosmetic purposes; scented water; Javelle water; lavender water; micellar water; toilet water; wax for parquet floors; floor wax; non-slipping wax for floors; depilatory wax; moustache wax; tailors' wax; creams for leather; polish for furniture and flooring; shoemakers' wax; polishing wax; massage gels, other than for medical purposes; heliotropine; dental bleaching gels; geraniol; make-up; deodorants for pets; deodorants for human beings or for animals; depilatory preparations; air fragrance reed diffusers; scented wood; perfumes; non-slipping liquids for floors; windscreen cleaning liquids; greases for cosmetic purposes; volcanic ash for cleaning; perfumery; decorative transfers for cosmetic purposes; ionone [perfumery]; shaving stones [astringents]; smoothing stones; eyebrow pencils; cosmetic pencils; silicon carbide [abrasive]; carbides of metal [abrasives]; alum stones [astringents]; tripoli stone for polishing; adhesives for affixing false eyelashes; adhesives for affixing false hair; hair conditioners; quillaia bark for washing; corundum [abrasive]; beard dyes; colorants for toilet purposes; cosmetic dyes; body paint for cosmetic purposes; starch for laundry purposes; laundry glaze; shoe cream; polishing creams; cosmetic creams; skin whitening creams; polishing rouge; incense; hair spray; nail varnish; liquid latex body paint for cosmetic purposes; hair lotions; lotions for cosmetic purposes; after-shave lotions; beauty masks; oils for perfumes and scents; oils for cosmetic purposes; oils for toilet purposes; essential

oils of cedarwood; essential oils of lemon; essential oils of citron; oils for cleaning purposes; bergamot oil; gaultheria oil; jasmine oil; lavender oil; almond oil; rose oil; oil of turpentine for degreasing; whitening; cleaning chalk; almond milk for cosmetic purposes; cleansing milk for toilet purposes; musk [perfumery]; deodorant soap; shaving soap; soap for brightening textile; cakes of toilet soap; antiperspirant soap; soap for foot perspiration; soap; almond soap; mint for perfumery; cosmetic kits; emery; gel eye patches for cosmetic purposes; nail art stickers; false nails; eau de Cologne; bases for flower perfumes; joss sticks; pastes for razor strops; toothpaste; pumice stone; lipstick cases; hydrogen peroxide for cosmetic purposes; breath freshening strips; teeth whitening strips; sand-cloth; glass cloth [abrasive cloth]; lipsticks; pomades for cosmetic purposes; shaving preparations; cosmetic preparations for baths; bath preparations, not for medical purposes; hair straightening preparations; hair waving preparations; laundry soaking preparations; grinding preparations; smoothing preparations [starching]; colour-removing preparations; leather bleaching preparations; denture polishes; mouthwashes, not for medical purposes; cosmetic preparations for slimming purposes; starch glaze for laundry purposes; preparations to make the leaves of plants shiny; eye-washes, not for medical purposes; fabric softeners for laundry use; laundry bleach; dry-cleaning preparations; paint stripping preparations; lacquer-removing preparations; make-up removing preparations; floor wax removers [scouring preparations]; varnish-removing preparations; rust removing preparations; nail care preparations; preparations for cleaning dentures; wall-paper cleaning preparations; preparations for unblocking drain pipes; chemical cleaning preparations for household purposes; collagen preparations for cosmetic purposes; bleaching preparations [decolorants] for household purposes; laundry preparations; aloe vera preparations for cosmetic purposes; sunscreen preparations; colour-brightening chemicals for household purposes [laundry]; breath freshening preparations for personal hygiene; shining preparations [polish]; make-up powder; diamantine [abrasive]; stain removers; nail varnish removers; vaginal washes for personal sanitary or deodorant purposes; scouring solutions; false eyelashes; antistatic dryer sheets; baby wipes impregnated with cleaning preparations; colour run prevention laundry sheets; tissues impregnated with cosmetic lotions; tissues impregnated with make-up removing preparations; safrol; massage candles for cosmetic purposes; laundry blueing; turpentine for degreasing; potpourris [fragrances]; bleaching soda; washing soda, for cleaning; bath salts, not for medical purposes; bleaching salts; fumigation preparations [perfumes]; leather preservatives [polishes]; ammonia [volatile alkali] [detergent]; astringents for cosmetic purposes; eyebrow cosmetics; make-up preparations; sun-tanning preparations [cosmetics]; hair dyes; neutralizers for permanent waving; cosmetic preparations for eye-

lashes; cosmetic preparations for skin care; shoe wax; dentifrices; cosmetics; cosmetics for children; cosmetics for animals; mascara; cleansers for intimate personal hygiene purposes, non medicated; douching preparations for personal sanitary or deodorant purposes [toiletries]; detergents, other than for use in manufacturing operations and for medical purposes; degreasers, other than for use in manufacturing processes; bleaching preparations [decolorants] for cosmetic purposes; antiperspirants [toiletries]; toiletry preparations; phytocosmetic preparations; talcum powder, for toilet use; cotton swabs for cosmetic purposes; terpenes [essential oils]; emery cloth; cloths impregnated with a detergent for cleaning; henna [cosmetic dye]; shampoos for animals [non-medicated grooming preparations]; shampoos for pets [non-medicated grooming preparations]; dry shampoos; shampoos; sandpaper; soda lye; herbal extracts for cosmetic purposes; extracts of flowers [perfumes]; ethereal essences; badian essence; mint essence [essential oil].

5 – Pharmaceuticals, medical and veterinary preparations; sanitary preparations for medical purposes; dietetic food and substances adapted for medical or veterinary use, food for babies; dietary supplements for human beings and animals; plasters, materials for dressings; material for dental fillings and dental impressions; disinfectants; preparations for destroying noxious animals; fungicides, herbicides; acaricides; aconitine; alkaloids for medical purposes; alginates for pharmaceutical purposes; algicides; aldehydes for pharmaceutical purposes; dental amalgams of gold; dental amalgams; amino acids for veterinary purposes; amino acids for medical purposes; analgesics; anaesthetics; antibiotics; antiseptics; medicine cases, portable, filled; first-aid boxes, filled; aluminium acetate for pharmaceutical purposes; acetates for pharmaceutical purposes; germicides; oxygen cylinders, filled, for medical purposes; balms for medical purposes; bandages for dressings; diagnostic biomarker reagents for medical purposes; biocides; bracelets impregnated with insect repellent; bromine for pharmaceutical purposes; paper for mustard plasters; fly catching paper; reagent paper for veterinary purposes; reagent paper for medical purposes; mothproofing paper; petroleum jelly for medical purposes; vaccines; oxygen baths; antiseptic cotton; aseptic cotton; absorbent cotton; wadding for medical purposes; cotton for medical purposes; dietetic substances adapted for medical use; radiological contrast substances for medical purposes; nutritive substances for microorganisms; radioactive substances for medical purposes; bismuth subnitrate for pharmaceutical purposes; melissa water for pharmaceutical purposes; seawater for medicinal bathing; mineral waters for medical purposes; thermal water; dietary fibre; moulding wax for dentists; gases for medical purposes; guaiacol for pharmaceutical purposes; massage gels for medical purposes; sexual stimulant gels; haematogen; haemoglobin; hydrastine; hydrastinine; glycerine for medical purposes; glyce-



rophosphates; glucose for medical purposes; gentian for pharmaceutical purposes; hormones for medical purposes; mustard for pharmaceutical purposes; mustard plasters; mud for baths; medicinal mud; contraceptive sponges; gamboge for medical purposes; gurjun balsam for medical purposes; air deodorizing preparations; deodorants, other than for human beings or for animals; deodorants for clothing and textiles; diastase for medical purposes; digitalin; vitamin supplement patches; mineral food supplements; nutritional supplements; albumin dietary supplements; dietary supplements for animals; yeast dietary supplements; alginate dietary supplements; glucose dietary supplements; casein dietary supplements; lecithin dietary supplements; linseed oil dietary supplements; propolis dietary supplements; protein dietary supplements; protein supplements for animals; royal jelly dietary supplements; pollen dietary supplements; wheat germ dietary supplements; linseed dietary supplements; acai powder dietary supplements; dietary supplements with a cosmetic effect; enzyme dietary supplements; yeast for pharmaceutical purposes; gelatine for medical purposes; cod liver oil; isotopes for medical purposes; immunostimulants; insecticides; iodine for pharmaceutical purposes; iodides for pharmaceutical purposes; alkaline iodides for pharmaceutical purposes; iodoform; calomel [fungicide]; cream of tartar for pharmaceutical purposes; tartar for pharmaceutical purposes; camphor for medical purposes; capsules for medicines; cachets for pharmaceutical purposes; capsules made of dendrimer-based polymers, for pharmaceuticals; haemostatic pencils; wart pencils; caustic pencils; carbolineum [parasiticide]; caustics for pharmaceutical purposes; cachou for pharmaceutical purposes; quassia for medical purposes; quebracho for medical purposes; oxygen for medical purposes; gallic acid for pharmaceutical purposes; acids for pharmaceutical purposes; adhesives for dentures; surgical glues; stem cells for veterinary purposes; stem cells for medical purposes; cocaine; collagen for medical purposes; collodion for pharmaceutical purposes; corn rings for the feet; cannabis for medical purposes; medicated sweets; angostura bark for medical purposes; barks for pharmaceutical purposes; cedar wood for use as an insect repellent; condurango bark for medical purposes; croton bark; mangrove bark for pharmaceutical purposes; myrobalan bark for pharmaceutical purposes; quinquina for medical purposes; medicated animal feed; medicinal roots; rhubarb roots for pharmaceutical purposes; lint for medical purposes; starch for dietetic or pharmaceutical purposes; creosote for pharmaceutical purposes; blood for medical purposes; cultures of microorganisms for medical or veterinary use; curare; dental lacquer; liquorice for pharmaceutical purposes; milk sugar for pharmaceutical purposes; adhesive plasters; medicines for alleviating constipation; adhesive tapes for medical purposes; lecithin for medical purposes; lotions for veterinary purposes; medicated hair lotions; lotions for pharmaceutical purposes;

medicated after-shave lotions; personal sexual lubricants; lupulin for pharmaceutical purposes; magnesia for pharmaceutical purposes; liniments; ointments for pharmaceutical purposes; sunburn ointments; mercurial ointments; frostbite salve for pharmaceutical purposes; gauze for dressings; medicinal oils; mustard oil for medical purposes; camphor oil for medical purposes; castor oil for medical purposes; oil of turpentine for pharmaceutical purposes; dill oil for medical purposes; dental mastics; dental abrasives; dental impression materials; dressings, medical; surgical dressings; drugs for medical purposes; medicines for veterinary purposes; serotherapeutic medicines; medicines for human purposes; medicines for dental purposes; menthol; medicinal drinks; moleskin for medical purposes; almond milk for pharmaceutical purposes; powdered milk for babies; royal jelly for pharmaceutical purposes; milk ferments for pharmaceutical purposes; Irish moss for medical purposes; flour for pharmaceutical purposes; linseed meal for pharmaceutical purposes; fish meal for pharmaceutical purposes; fly glue; antibacterial soap; disinfectant soap; medicated soap; freeze-dried meat adapted for medical purposes; mint for pharmaceutical purposes; dietetic beverages adapted for medical purposes; malted milk beverages for medical purposes; injectable dermal fillers; bone void fillers comprised of living tissues; narcotics; medicinal infusions; tincture of iodine; eucalyptol for pharmaceutical purposes; tinctures for medical purposes; opium; opodeldoc; decoctions for pharmaceutical purposes; antiparasitic collars for animals; cotton sticks for medical purposes; cotton swabs for medical purposes; stick liquorice for pharmaceutical purposes; sulfur sticks [disinfectants]; pastilles for pharmaceutical purposes; medicated toothpaste; pectin for pharmaceutical purposes; pepsins for pharmaceutical purposes; peptones for pharmaceutical purposes; hydrogen peroxide for medical purposes; pesticides; food for babies; leeches for medical purposes; blood plasma; nicotine patches for use as aids to stop smoking; eyepatches for medical purposes; poultices; compresses; scapulars for surgical purposes; babies' diapers; diapers for pets; swim diapers, reusable, for babies; swim diapers, disposable, for babies; diapers for incontinence; diaper changing mats, disposable, for babies; bunion pads; breast-nursing pads; pomades for medical purposes; powder of cantharides; pyrethrum powder; anti-uric preparations; bacterial preparations for medical and veterinary use; bacteriological preparations for medical and veterinary use; balsamic preparations for medical purposes; albuminous preparations for medical purposes; biological preparations for veterinary purposes; biological preparations for medical purposes; bismuth preparations for pharmaceutical purposes; vitamin preparations; diagnostic preparations for veterinary purposes; diagnostic preparations for medical purposes; douching preparations for medical purposes; bath preparations for medical purposes; therapeutic pre-

parations for the bath; haemorrhoid preparations; preparations for callouses; lice treatment preparations [pediculicides]; acne treatment preparations; preparations to facilitate teething; preparations for the treatment of burns; fumigation preparations for medical purposes; ootherapy preparations; air purifying preparations; bronchodilating preparations; preparations for reducing sexual activity; sterilizing preparations; soil-sterilizing preparations; corn remedies; pharmaceutical preparations for treating dandruff; herbicides; preparations for destroying dry rot fungus; larvae exterminating preparations; fly destroying preparations; preparations for destroying mice; slug exterminating preparations; vermin destroying preparations; pharmaceutical preparations for skin care; contact lens cleaning preparations; preparations of microorganisms for medical or veterinary use; lime-based pharmaceutical preparations; styptic preparations; medicated eye-washes; medicinal hair growth preparations; nutraceutical preparations for therapeutic or medical purposes; opiates; anticryptogamic preparations; aloe vera preparations for pharmaceutical purposes; preparations of trace elements for human and animal use; sulfonamides [medicines]; pharmaceutical preparations for treating sunburn; enzyme preparations for veterinary purposes; enzyme preparations for medical purposes; phytotherapy preparations for medical purposes; chemico-pharmaceutical preparations; chemical preparations for veterinary purposes; chemical preparations for the diagnosis of pregnancy; chemical preparations for medical purposes; chemical preparations for treating diseases affecting cereal plants; chemical preparations for treating wheat blight; chemical preparations for treating diseases affecting vine plants; chemical preparations for treating mildew; chemical preparations for treating phyloxera; chemical preparations for pharmaceutical purposes; chilblain preparations; mothproofing preparations; collyrium; lead water; chemical conductors for electrocardiograph electrodes; albuminous foodstuffs for medical purposes; dietetic foods adapted for medical purposes; by-products of the processing of cereals for dietetic or medical purposes; homogenized food adapted for medical purposes; freeze-dried food adapted for medical purposes; pharmaceuticals; sanitary towels; panty liners [sanitary]; propolis for pharmaceutical purposes; pearl powder for medical purposes; radium for medical purposes; hydrated chloral for pharmaceutical purposes; solvents for removing adhesive plasters; vaginal washes for medical purposes; solutions for contact lenses; chemical reagents for medical or veterinary purposes; gum for medical purposes; rubber for dental purposes; chewing gum for medical purposes; nicotine gum for use as an aid to stop smoking; insect repellents; insect repellent incense; repellents for dogs; tissues impregnated with pharmaceutical lotions; sarsaparilla for medical purposes; sugar for medical purposes; crystallized rock sugar for medical purposes; asthmatic tea; fumigating sticks; massage candles for therapeutic purpo-

ses; suppositories; linseed for pharmaceutical purposes; tobacco-free cigarettes for medical purposes; siccatives [drying agents] for medical purposes; syrups for pharmaceutical purposes; turpentine for pharmaceutical purposes; milking grease; greases for veterinary purposes; greases for medical purposes; lacteal flour for babies; infant formula; soporifics; bicarbonate of soda for pharmaceutical purposes; bath salts for medical purposes; salts for mineral water baths; salts for medical purposes; potassium salts for medical purposes; sodium salts for medical purposes; smelling salts; mineral water salts; malt for pharmaceutical purposes; semen for artificial insemination; alcohol for pharmaceutical purposes; medicinal alcohol; alloys of precious metals for dental purposes; ergot for pharmaceutical purposes; cooling sprays for medical purposes; antibacterial handwashes; adjuvants for medical purposes; astringents for medical purposes; vermifuges; disinfectants for hygiene purposes; disinfectants for chemical toilets; appetite suppressants for medical purposes; medical preparations for slimming purposes; parasiticides; mouthwashes for medical purposes; medicated dentifrices; febrifuges; depuratives; animal washes [insecticides]; detergents for medical purposes; cattle washes [insecticides]; dog washes [insecticides]; insecticidal veterinary washes; vesicants; purgatives; remedies for perspiration; remedies for foot perspiration; chemical contraceptives; antiparasitic preparations; sedatives; laxatives; tonics [medicines]; medicated toiletry preparations; digestives for pharmaceutical purposes; nervines; bouillons for bacteriological cultures; steroids; headache relief sticks; strychnine; serums; tanning pills; appetite suppressant pills; slimming pills; jujube, medicated; antioxidant pills; sanitary tampons; vulnerary sponges; thymol for pharmaceutical purposes; biological tissue cultures for veterinary purposes; biological tissue cultures for medical purposes; smoking herbs for medical purposes; medicinal herbs; transplants [living tissues]; surgical implants comprised of living tissues; pants, absorbent, for incontinence; sanitary panties; babies' diaper-pants; charcoal for pharmaceutical purposes; fennel for medical purposes; porcelain for dental prostheses; phenol for pharmaceutical purposes; enzymes for veterinary purposes; enzymes for medical purposes; ferments for pharmaceutical purposes; formic aldehyde for pharmaceutical purposes; phosphates for pharmaceutical purposes; quinine for medical purposes; chinoline for medical purposes; diabetic bread adapted for medical use; chloroform; flowers of sulfur for pharmaceutical purposes; cement for animal hooves; bone cement for surgical and orthopaedic purposes; dental cements; medicinal tea; herbal teas for medicinal purposes; insecticidal animal shampoos; medicated shampoos; medicated shampoos for pets; pediculicidal shampoos; medicated dry shampoos; pre-filled syringes for medical purposes; eucalyptus for pharmaceutical purposes; herbal extracts for medical purposes; plant extracts for pharmaceutical purposes; tobac-

co extracts [insecticides]; extracts of hops for pharmaceutical purposes; elixirs [pharmaceutical preparations]; ethers for pharmaceutical purposes; esters for pharmaceutical purposes; cellulose esters for pharmaceutical purposes; cellulose ethers for pharmaceutical purposes; rat poison; poisons; bacterial poisons; jalap.

14 – Precious metals and their alloys; jewellery, precious and semi-precious stones; horological and chronometric instruments; agates; diamonds; amulets [jewellery]; anchors [clock- and watchmaking]; barrels [clock- and watchmaking]; bracelets [jewellery]; bracelets made of embroidered textile [jewellery]; watch bands; charms for key rings; jewellery charms; brooches [jewellery]; alarm clocks; pins [jewellery]; ornamental pins; tie pins; jewellery hat pins; beads for making jewellery; pearls made of ambroid [pressed amber]; busts of precious metal; jewellery rolls; jet, unwrought or semi-wrought; jewellery findings; key rings [split rings with trinket or decorative fob]; retractable key rings; pearls [jewellery]; copper tokens; tie clips; cuff links; clasps for jewellery; badges of precious metal; gold, unwrought or beaten; cloisonné jewellery; works of art of precious metal; ivory jewellery; jewellery of yellow amber; iridium; cabochons; spun silver [silver wire]; necklaces [jewellery]; split rings of precious metal for keys; rings [jewellery]; boxes of precious metal; presentation boxes for jewellery; watch cases [parts of watches]; clock cases; pendulums [clock- and watchmaking]; medals; lockets [jewellery]; precious metals, unwrought or semi-wrought; movements for clocks and watches; clock-works; misbaha [prayer beads]; coins; gold thread [jewellery]; threads of precious metal [jewellery]; silver thread [jewellery]; olivine [gems]; osmium; palladium; platinum [metal]; watch springs; crucifixes of precious metal, other than jewellery; crucifixes as jewellery; rhodium; ruthenium; stopwatches; silver, unwrought or beaten; earrings; ingots of precious metals; alloys of precious metal; statues of precious metal; figurines of precious metal; statuettes of precious metal; watch glasses; paste jewellery; watch hands; clock hands; ornaments of jet; shoe jewellery; hat jewellery; presentation boxes for watches; chronographs [watches]; chronometers; chronoscopes; chains [jewellery]; watch chains; dials [clock- and watchmaking]; atomic clocks; watches; sundials; clocks and watches, electric; control clocks [master clocks]; clocks; wristwatches; rosaries; jewellery boxes; spinel [precious stones].

18 – Leather and imitations of leather; animal skins; luggage and carrying bags; umbrellas and parasols; walking sticks; whips, harness and saddlery; collars, leashes and clothing for animals; mountaineering sticks; slings for carrying infants; luggage tags; pocket wallets; saddlecloths for horses; business card cases; reins; reins for guiding children; sling bags for carrying infants; harness fittings; credit card cases [wallets]; parts of rubber for stirrups; chamois leather,

other than for cleaning purposes; umbrellas; parasols; saddlery; frames for umbrellas or parasols; handbag frames; card cases [notecases]; cases of leather or leatherboard; valves of leather; imitation leather; leather, unworked or semi-worked; leatherboard; casings, of leather, for springs; umbrella rings; hat boxes of leather; boxes of leather or leatherboard; boxes of vulcanized fibre; purses; chain mesh purses; fastenings for saddles; butts [parts of hides]; saddle trees; bags [envelopes, pouches] of leather, for packaging; moleskin [imitation of leather]; travelling sets [leatherware]; knee-pads for horses; muzzles; halters; vanity cases, not fitted; furniture coverings of leather; clothing for pets; covers for animals; trimmings of leather for furniture; collars for animals; hiking sticks; conference folders; music cases; goldbeaters' skin; cat o' nine tails; leather leashes; pads for horse saddles; horseshoes; girths of leather; leathercloth; horse blankets; garment bags for travel; shoulder belts [straps] of leather; briefcases; traces [harness]; fur; randsels [Japanese school satchels]; haversacks; leather straps; straps for soldiers' equipment; harness straps; straps for skates; straps of leather [saddlery]; chin straps, of leather; stirrup leathers; umbrella handles; walking stick handles; suitcase handles; grips for holding shopping bags; rucksacks; travelling bags; riding saddles; net bags for shopping; umbrella or parasol ribs; stirrups; bags for climbers; tool bags, empty; handbags; beach bags; saddlebags; compression cubes adapted for luggage; bags for sports; bags for campers; shopping bags; wheeled shopping bags; school bags; bags; pouch baby carriers; travelling trunks; trunks [luggage]; nose bags [feed bags]; bridoons; umbrella sticks; walking stick seats; tefillin [phylacteries]; bits for animals [harness]; bridles [harness]; harnesses for animals; key cases; horse collars; suitcases; motorized suitcases; suitcases with wheels; valises; attaché cases; covers for horse saddles; umbrella covers; kid; curried skins; cattle skins; leather cord; blinkers [harness]; labels of leather; game bags [hunting accessories].

24 – Textiles and substitutes for textiles; frieze [cloth]; banners of textile or plastic; velvet; household linen; diapered linen; bath linen, except clothing; bed linen; table linen, not of paper; cot bumpers [bed linen]; buckram; fustian; sleeping bag liners; felt; bunting of textile or plastic; gauze [cloth]; damask; jersey [fabric]; table runners, not of paper; drugget; shower curtains of textile or plastic; curtains of textile or plastic; net curtains; zephyr [cloth]; canvas for tapestry or embroidery; bolting cloth; baby buntings; crepe [fabric]; crepon; marabouts [cloth]; furniture coverings of textile; fabrics for textile use; filtering materials of textile; wall hangings of textile; non-woven textile fabrics; plastic material [substitute for fabrics]; textile material; tablemats of textile; bivouac sacks being covers for sleeping bags; sleeping bags; sleeping bags for babies; moleskin [fabric]; muslin fabric; pillowcases; mattress covers; bed blankets; blankets for hou-

sehold pets; brocades; diaper changing cloths for babies; handkerchiefs of textile; picnic blankets; travelling rugs [lap robes]; coasters of textile; bed valances; linings [textile]; hat linings, of textile, in the piece; curtain holders of textile material; bed covers; bed covers of paper; furniture coverings of plastic; towels of textile; hemp cloth; gummed cloth, other than for stationery purposes; printers' blankets of textile; cloth; door curtains; sheets [textile]; eiderdowns [down coverlets]; bath mitts; shrouds; glass cloths [towels]; cloths for removing make-up; face towels of textile; place mats of textile; table napkins of textile; mosquito nets; calico; oilcloth for use as tablecloths; tablecloths, not of paper; billiard cloth; taffeta [cloth]; ticks [mattress covers]; tick [linen]; lingerie fabric; fabric, impervious to gases, for aeronautical balloons; jute fabric; fabric for footwear; ramie fabric; esparto fabric; rayon fabric; fibreglass fabrics for textile use; adhesive fabric for application by heat; linen cloth; upholstery fabrics; hemp fabric; lining fabric for footwear; traced cloths for embroidery; chenille fabric; printed calico cloth; knitted fabric; cotton fabrics; silk fabrics for printing patterns; woollen cloth; elastic woven material; fabric; fabric imitating animal skins; haircloth [sackcloth]; cheese cloth; tulle; flags of textile or plastic; flannel [fabric]; trellis [cloth]; covers for cushions; fitted toilet lid covers of fabric; covers [loose] for furniture; pillow shams; cheviots [cloth]; silk [cloth]; labels of textile.

25 – Clothing, footwear, headgear; wimples; bandanas [neckerchiefs]; underwear; sweat-absorbent underwear; berets; overalls; boas [necklets]; teddies [underclothing]; boxer shorts; ankle boots; ski boots; boots for sports; breeches for wear; trousers; football shoes; brassieres; adhesive bras; valenki [felted boots]; mittens; collars [clothing]; detachable collars; shirt yokes; veils [clothing]; gabardines [clothing]; galoshes; neckties; ascots; leggings [leg warmers]; gaiters; boot uppers; corselets; jerseys [clothing]; waistcoats; sports jerseys; hosiery; heels; hoods [clothing]; hat frames [skeletons]; pockets for clothing; scarves; caps being headwear; kimonos; cap peaks; visors being headwear; tights; slips [underclothing]; combinations [clothing]; wet suits for water-skiing; bodices [lingerie]; corsets [underclothing]; suits; bathing suits; masquerade costumes; beach clothes; headscarves; leotards; jackets [clothing]; stuff jackets [clothing]; fishing vests; leggings [trousers]; liveries; camisoles; sports singlets; cuffs; short-sleeve shirts; mantillas; coats; sleep masks; furs [clothing]; hand warmers [fingerless gloves]; fingerless gloves; mitres [hats]; muffs [clothing]; footmuffs, not electrically heated; bibs, not of paper; bibs, sleeved, not of paper; fur stoles; hairdressing capes; heel protectors for shoes; ear muffs [clothing]; socks; sweat-absorbent socks; beach shoes; sports shoes; paper clothing; outerclothing; embroidered clothing; ready-made clothing; motorists' clothing; cyclists' clothing; clothing for gymnastics; clothing of imitations of leather; latex clothing; clothing of leat-

her; waterproof clothing; clothing incorporating LEDs; uniforms; clothing containing slimming substances; fittings of metal for footwear; maniples; overcoats; knickers; parkas; pelerines; gloves [clothing]; ski gloves; pyjamas; bathing trunks; shirt fronts; pocket squares; dresses; headbands [clothing]; garters; sock suspenders; stocking suspenders; ready-made linings [parts of clothing]; dress shields; soles for footwear; heelpieces for footwear; braces for clothing [suspenders]; half-boots; lace boots; ponchos; girdles; belts [clothing]; sashes for wear; money belts [clothing]; layettes [clothing]; non-slipping devices for footwear; sweaters; heelpieces for stockings; welts for footwear; chasubles; shirts; wooden shoes; sandals; bath sandals; boots; jumper dresses; saris; sarongs; footwear uppers; inner soles; albs; bath slippers; togas; knitwear [clothing]; underpants; gymnastic shoes; slippers; shoes; skull caps; turbans; aprons [clothing]; judo uniforms; karate uniforms; tee-shirts; rash guards; dressing gowns; bath robes; top hats; tips for footwear; stockings; sweat-absorbent stockings; shawls; paper hats [clothing]; shower caps; bathing caps; neck tube scarves; studs for football boots; hats; babies' pants [underwear]; gaiter straps; pelisses; esparto shoes or sandals; skirts; petticoats; skorts.

26 – Lace, braid and embroidery, and haberdashery ribbons and bows; buttons, hooks and eyes, pins and needles; artificial flowers; hair ornaments; false hair; appliqués [haberdashery]; haberdashery bows; fringes; mica spangles; shoe eyelets; false beards; charms, other than for jewellery, key rings or key chains; brooches [clothing accessories]; hat pins, other than jewellery; entomological pins; pins, other than jewellery; beads, other than for making jewellery; wreaths of artificial flowers; artificial Christmas wreaths; artificial Christmas wreaths incorporating lights; human hair; lace for edgings; artificial garlands; artificial Christmas garlands; artificial Christmas garlands incorporating lights; darning lasts; expanding bands for holding sleeves; frills [lacework]; trouser clips for cyclists; hair grips; hair barrettes; heat adhesive patches for repairing textile articles; blouse fasteners; shoe fasteners; fastenings for clothing; fastenings for suspenders; belt clasps; hook and pile fastening tapes; zip fasteners; zippers for bags; badges for wear, not of precious metal; competitors' numbers; embroidery needles; needles for wool combing machines; binding needles; saddlers' needles; shoemakers' needles; sewing needles; darning needles; needles; boxes for needles; lace trimmings; haberdashery [dressmakers' articles], except thread; decorative articles for the hair; heat adhesive patches for decoration of textile articles [haberdashery]; edgings for clothing; braids; gold embroidery; silver embroidery; bobbins for retaining embroidery floss or wool [not parts of machines]; tassels [haberdashery]; snap fasteners; sewing boxes; plaited hair; false hems; hooks [haberdashery]; crochet hooks; rug hooks; hooks for corsets; shoe hooks; haberdashery ribbons; ribbons for the hair;

ribbons and bows, not of paper, for gift wrapping; lingerie tapes; breast lift tapes; prize ribbons; hatbands; elastic ribbons; letters for marking linen; numerals for marking linen; monogram tabs for marking linen; sewing kits; toupees; sewing thimbles; needle-threaders; skirt flounces; bows for the hair; spangles for clothing; hair curling papers; wigs; feathers [clothing accessories]; birds' feathers [clothing accessories]; ostrich feathers [clothing accessories]; eyelets for clothing; picot [lace]; corset busks; hair bands; brassards; tapes for curtain headings; shoulder pads for clothing; pin cushions; needle cushions; top-knots [pompoms]; hair curlers, electric and non-electric, other than hand implements; buckles [clothing accessories]; shoe buckles; ornamental novelty badges [buttons]; artificial plants, other than Christmas trees; rosettes [haberdashery]; frills for clothing; hair nets; chenille [passementerie]; knitting needles; cords for trimming; shoe trimmings; trimmings for clothing; hat trimmings; false moustaches; festoons [embroidery]; artificial fruit; needle cases; shuttles for making fishing nets; hair colouring caps; bodkins; hair extensions; shoe laces; cords for clothing; woollen laces; hair pins; hair curling pins; collar supports.

(260) AM 2022 114564 A

(800) 1611895

(151) 2021 03 22

(891) 2021 03 22

(731) "DANI I NIKOL PLOVDIV" OOD  
"Sevastopol" str. 17, floor 1, BG-4002 Plovdiv,  
Bulgaria

(540)



(591) White, red, yellow, light green and dark green

(531) 26.13.25; 27.05.02; 29.01.15

(511)

30 – Ready-to-bake pastry products; frozen confectionery; frozen pastry crusts; frozen waffles; frozen pastry products stuffed with meat and vegetables; frozen dough; frozen confectionery (non-medicated); dried pasta products; snacks foods consisting mainly of pasta products; pastry products including wholemeal pastry products; stuffed pastry products; filo dough; bakery products; food products made from dough.

35 – Administrative processing of purchase orders made by telephone or computer; online advertising via computer communication networks, organization of presentation of new products; provision of an online marketplace for buyers and sellers of goods and services; providing business and commercial informa-

tion; product demonstrations and product presentation; promotion of goods, publication of advertising materials and texts; dissemination of advertising, marketing and promotional matter, dissemination of publicity and advertising matter, in particular flyer, brochures, leaflets and samples; distribution of advertisements via the Internet; online distribution of advertising materials; advertising, including on-line advertising on a computer network.

(260) AM 2022 114565 A

(800) 1611908

(151) 2021 05 28

(891) 2021 05 28

(731) Andronnik Limited Liability Company  
Sacco and Vanzetti street, building 77, floor 5,  
RU-630008 Novosibirsk, Russian Federation

(540)



(591) Black, white

(531) 03.01.06; 03.01.16; 03.01.24

(511)

3 – Amber [perfume]; aromatics [essential oils]; air fragrancing preparations; breath freshening sprays; canned pressurized air for cleaning and dusting purposes; balms, other than for medical purposes; basma [cosmetic dye]; lip glosses; nail glitter; petroleum jelly for cosmetic purposes; shoe polish; cotton wool for cosmetic purposes; sachets for perfuming linen; adhesives for cosmetic purposes; scented water; Javelle water; lavender water; toilet water; depilatory wax; moustache wax; creams for leather; shoemakers' wax; massage gels, other than for medical purposes; dental bleaching gels; make-up; deodorants for pets; deodorants for human beings or for animals; depilatory preparations; air fragrance reed diffusers; scented wood; perfumes; non-slipping liquids for floors; windscreen cleaning liquids; greases for cosmetic purposes; perfumery; decorative transfers for cosmetic purposes; ionone [perfumery]; eyebrow pencils; cosmetic pencils; adhesives for affixing false eyelashes; adhesives for affixing false hair; hair conditioners; quillaia bark for washing; beard dyes; cosmetic dyes; shoe cream; cosmetic creams; skin whitening creams; hair spray; nail varnish; hair lotions; lotions for cosmetic purposes; after-shave lotions; beauty masks; oils for cleaning purposes; oils for perfumes and scents; oils for cosmetic purposes; oils for toilet purposes; essential oils; essential oils of cedarwood; essential oils of lemon; essential oils of citron; bergamot oil; gaulthe-

ria oil; jasmine oil; lavender oil; almond oil; rose oil; oil of turpentine for degreasing; almond milk for cosmetic purposes; cleansing milk for toilet purposes; musk [perfumery]; soap; deodorant soap; shaving soap; cakes of toilet soap; antiperspirant soap; soap for foot perspiration; almond soap; mint for perfumery; cosmetic kits; gel eye patches for cosmetic purposes; nail art stickers; false nails; eau de Cologne; bases for flower perfumes; dentifrices; pumice stone; lipstick cases; hydrogen peroxide for cosmetic purposes; breath freshening strips; teeth whitening strips; sand-cloth; glass cloth [abrasive cloth]; lipsticks; pomades for cosmetic purposes; breath freshening preparations for personal hygiene; shaving preparations; bath preparations, not for medical purposes; cosmetic preparations for baths; hair straightening preparations; hair waving preparations; leather bleaching preparations; mouthwashes, not for medical purposes; cosmetic preparations for slimming purposes; eye-washes, not for medical purposes; make-up removing preparations; nail care preparations; cleaning preparations; chemical cleaning preparations for household purposes; collagen preparations for cosmetic purposes; aloe vera preparations for cosmetic purposes; sunscreen preparations; make-up powder; nail varnish removers; scouring solutions; false eyelashes; pre-moistened cosmetic wipes; tissues impregnated with cosmetic lotions; tissues impregnated with make-up removing preparations; baby wipes impregnated with cleaning preparations; massage candles for cosmetic purposes; potpourris [fragrances]; fumigation preparations [perfumes]; leather preservatives [polishes]; astringents for cosmetic purposes; eyebrow cosmetics; make-up preparations; sun-tanning preparations [cosmetics]; hair dyes; neutralizers for permanent waving; cosmetic preparations for eyelashes; cosmetic preparations for skin care; shoe wax; cosmetics; cosmetics for children; cosmetics for animals; mascara; detergents, other than for use in manufacturing operations and for medical purposes; douching preparations for personal sanitary or deodorant purposes [toiletries]; degreasers, other than for use in manufacturing processes; bleaching preparations [decolorants] for cosmetic purposes; toiletry preparations; antiperspirants [toiletries]; phytocosmetic preparations; removable tattoos for cosmetic purposes; cloths impregnated with a detergent for cleaning; shampoos; shampoos for animals [non-medicated grooming preparations]; shampoos for pets [non-medicated grooming preparations]; dry shampoos; herbal extracts for cosmetic purposes; extracts of flowers [perfumes]; ethereal essences; badian essence; mint essence [essential oil].

5 – Antiseptics; medicine cases, portable, filled; first-aid boxes, filled; balms for medical purposes; antiseptic cotton; aseptic cotton; absorbent cotton; wadding for medical purposes; cotton for medical purposes; dietetic substances adapted for medical use; nutritive substances for microorganisms; melissa water for pharmaceutical purposes; seawater for medicinal bat-

hing; mineral waters for medical purposes; thermal water; dietary fibre; haematogen; disinfectants; deodorants, other than for human beings or for animals; air deodorizing preparations; deodorants for clothing and textiles; vitamin supplement patches; mineral food supplements; nutritional supplements; albumin dietary supplements; dietary supplements for animals; yeast dietary supplements; alginate dietary supplements; glucose dietary supplements; casein dietary supplements; lecithin dietary supplements; linseed oil dietary supplements; propolis dietary supplements; protein dietary supplements; protein supplements for animals; royal jelly dietary supplements; pollen dietary supplements; wheat germ dietary supplements; linseed dietary supplements; acai powder dietary supplements; dietary supplements with a cosmetic effect; enzyme dietary supplements; yeast for pharmaceutical purposes; gelatine for medical purposes; cod liver oil; capsules for medicines; cachets for pharmaceutical purposes; collagen for medical purposes; medicated sweets; angostura bark for medical purposes; barks for pharmaceutical purposes; cedar wood for use as an insect repellent; condurango bark for medical purposes; croton bark; mangrove bark for pharmaceutical purposes; myrobalan bark for pharmaceutical purposes; quinquina for medical purposes; medicated animal feed; medicinal roots; rhubarb roots for pharmaceutical purposes; lint for medical purposes; starch for dietetic or pharmaceutical purposes; cultures of microorganisms for medical or veterinary use; dental lacquer; medicated candies; adhesive plasters; medicated hair lotions; lotions for pharmaceutical purposes; medicated after-shave lotions; liniments; frostbite salve for pharmaceutical purposes; ointments for pharmaceutical purposes; sunburn ointments; mercurial ointments; gauze for dressings; medicinal oils; mustard oil for medical purposes; camphor oil for medical purposes; castor oil for medical purposes; oil of turpentine for pharmaceutical purposes; dill oil for medical purposes; drugs for medical purposes; almond milk for pharmaceutical purposes; powdered milk for babies; antibacterial soap; disinfectant soap; medicated soap; freeze-dried meat adapted for medical purposes; mint for pharmaceutical purposes; dietetic beverages adapted for medical purposes; malted milk beverages for medical purposes; injectable dermal fillers; medicinal infusions; tincture of iodine; eucalyptol for pharmaceutical purposes; tinctures for medical purposes; decoctions for pharmaceutical purposes; cotton swabs for medical purposes; stick liquorice for pharmaceutical purposes; pastilles for pharmaceutical purposes; medicated toothpaste; food for babies; eyepatches for medical purposes; poultices; compresses; pomades for medical purposes; bacterial preparations for medical and veterinary use; bacteriological preparations for medical and veterinary use; balsamic preparations for medical purposes; albuminous preparations for medical purposes; biological preparations for veterinary purposes; biological preparations for medical purpo-

ses; diagnostic preparations for medical purposes; air purifying preparations; pharmaceutical preparations for treating dandruff; pharmaceutical preparations for skin care; contact lens cleaning preparations; medicated eye-washes; medicinal hair growth preparations; aloe vera preparations for pharmaceutical purposes; preparations of trace elements for human and animal use; pharmaceutical preparations; pharmaceutical preparations for treating sunburn; enzyme preparations for medical purposes; phytotherapy preparations for medical purposes; chemico-pharmaceutical preparations; chemical preparations for veterinary purposes; chemical preparations for medical purposes; collyrium; dietetic foods adapted for medical purposes; by-products of the processing of cereals for dietetic or medical purposes; homogenized food adapted for medical purposes; freeze-dried food adapted for medical purposes; pharmaceuticals; pearl powder for medical purposes; solutions for contact lenses; chewing gum for medical purposes; nicotine gum for use as an aid to stop smoking; sanitizing wipes; tissues impregnated with pharmaceutical lotions; massage candles for therapeutic purposes; syrups for pharmaceutical purposes; lacteal flour for babies; infant formula; antibacterial sprays; digestives for pharmaceutical purposes; antibacterial handwashes; adjuvants for medical purposes; astringents for medical purposes; disinfectants for hygiene purposes; medical preparations for slimming purposes; mouthwashes for medical purposes; febrifuges; detergents for medical purposes; serums; antioxidant pills; tanning pills; appetite suppressant pills; slimming pills; jujube, medicated; enzymes for medical purposes; ferments for pharmaceutical purposes; medicinal tea; herbal teas for medicinal purposes; insecticidal animal shampoos; medicated shampoos; medicated shampoos for pets; medicated dry shampoos; eucalyptus for pharmaceutical purposes; herbal extracts for medical purposes; plant extracts for pharmaceutical purposes; extracts of hops for pharmaceutical purposes; elixirs [pharmaceutical preparations].

9 – Accumulators, electric; 3D spectacles; ear pads for headphones; apertometers [optics]; remote control apparatus; monitoring apparatus, other than for medical purposes; sound recording apparatus; global positioning system [GPS] apparatus; diffraction apparatus [microscopy]; stereoscopic apparatus; binoculars; biochips; electronic tags for goods; lens hoods; magnetic tape units for computers; computer memory devices; encoded identification bracelets, magnetic; connected bracelets [measuring instruments]; camcorders; video baby monitors; video cassettes; video telephones; video screens; mechanical signs; signs, luminous; hands-free kits for telephones; peepholes [magnifying lenses] for doors; joysticks for use with computers, other than for video games; transparencies [photography]; slide projectors; diaphragms [photography]; dictating machines; phonograph records; disks, magnetic; optical discs; disk drives for computers; juke boxes for computers; electric door bells; signal bells; audio

interfaces; acoustic conduits; mirrors for inspecting work; road signs, luminous or mechanical; downloadable emoticons for mobile phones; eyewear; instruments containing eyepieces; interfaces for computers; calculating machines; pocket calculators; decompression chambers; rearview cameras for vehicles; cinematographic cameras; thermal imaging cameras; electronic pens [visual display units]; identity cards, magnetic; video game cartridges; toner cartridges, unfilled, for printers and photocopiers; ink cartridges, unfilled, for printers and photocopiers; memory cards for video game machines; encoded magnetic cards; computer keyboards; encoded key cards; electronic book readers; electronic agendas; push buttons for bells; mouse pads; magnetic encoders; compact discs [audio-video]; compact discs [read-only memory]; computers; wearable computers; laptop computers; tablet computers; notebook computers; contacts, electric; lasers, not for medical purposes; flashlights [photography]; vacuum tubes [radio]; darkroom lamps [photography]; magnetic tapes; videotapes; optical condensers; contact lenses; correcting lenses [optics]; close-up lenses; optical lenses; magnifying glasses [optics]; thread counters; magnets; decorative magnets; mouse [computer peripheral]; trackballs [computer peripherals]; pressure gauges; security tokens [encryption devices]; protective masks; material testing instruments and machines; furniture especially made for laboratories; megaphones; portable media players; diaphragms [acoustics]; diaphragms for scientific apparatus; shutter releases [photography]; micrometers; microprocessors; microscopes; microphones; audio mixers; modems; lightning conductors; monitors [computer hardware]; monitors [computer programs]; selfie sticks [hand-held monopods]; terminals [electricity]; surveyors' levels; sound recording carriers; magnetic data media; optical data media; computer software, recorded; sheaths for electric cables; identification sheaths for electric wires; weighing machines; computer hardware; punched card machines for offices; objectives [lenses] [optics]; lenses for astrophotography; selfie lenses; eyepieces; spectacle frames; mirrors [optics]; spectacles; sunglasses; goggles for sports; electronic pocket translators; telephone transmitters; computer software platforms, recorded or downloadable; wafers for integrated circuits; printed circuit boards; compact disc players; cassette players; protective films adapted for computer screens; protective films adapted for smartphones; sound recording strips; digital signs; stands adapted for laptops; semi-conductors; personal digital assistants [PDAs]; optical apparatus and instruments; computer software applications, downloadable; printers for use with computers; computer screen saver software, recorded or downloadable; computer programs, recorded; computer game software, downloadable; computer game software, recorded; computer programs, downloadable; computer operating programs, recorded; record players; processors [central processing units]; electronic publications,

downloadable; distribution consoles [electricity]; control panels [electricity]; radar apparatus; baby monitors; masts for wireless aerials; transmitting sets [telecommunication]; radios; vehicle radios; sprinkler systems for fire protection; frames for photographic transparencies; screens for photoengraving; stage lighting regulators; light dimmers [regulators], electric; speed regulators for record players; cell switches [electricity]; washing trays [photography]; laboratory robots; teaching robots; humanoid robots with artificial intelligence; subwoofers; optical fibres [light conducting filaments]; traffic-light apparatus [signalling devices]; signalling whistles; sports whistles; electronic access control systems for interlocking doors; scanners [data processing equipment]; hand-held electronic dictionaries; integrated circuit cards [smart cards]; smartglasses; smartwatches; smartphones; connections for electric lines; couplings, electric; audio-visual teaching apparatus; spectacle lenses; anti-glare glasses; optical glass; stands for photographic apparatus; bags adapted for laptops; drying racks [photography]; integrated circuits; printed circuits; telescopes; mobile telephones; cordless telephones; interactive touch screen terminals; bar code readers; video recorders; sound reproduction apparatus; devices for the projection of virtual keyboards; drying apparatus for photographic prints; optical character readers; battery chargers; chargers for electric accumulators; chargers for electronic cigarettes; acoustic alarms; apparatus for editing cinematographic film; computer peripheral devices; downloadable ring tones for mobile phones; downloadable image files; downloadable music files; animated cartoons; filters for use in photography; filters for ultraviolet rays, for photography; USB flash drives; magic lanterns; signal lanterns; optical lanterns; cameras [photography]; glazing apparatus for photographic prints; shutters [photography]; darkrooms [photography]; photometers; flash-bulbs [photography]; digital photo frames; enlarging apparatus [photography]; photovoltaic cells; containers for contact lenses; spectacle cases; containers for microscope slides; cases for smartphones; cases especially made for photographic apparatus and instruments; spectacle chains; time clocks [time recording devices]; sleeves for laptops; covers for personal digital assistants [PDAs]; covers for tablet computers; covers for smartphones; fire blankets; chips [integrated circuits]; jigs [measuring instruments]; pedometers; virtual reality headsets; protective helmets for sports; head guards for sports; cell phone straps; spectacle cords; tripods for cameras; screens [photography]; workmen's protective face-shields; projection screens; downloadable graphics for mobile phones.

35 – Arranging subscriptions to telecommunication services for others; import-export agency services; commercial information agency services; advertising agency services; cost price analysis; rental of office equipment in co-working facilities; rental of advertising space; business auditing; financial auditing; busi-

ness intermediary services relating to the matching of potential private investors with entrepreneurs needing funding; employment agency services; computerized file management; book-keeping; invoicing; demonstration of goods; transcription of communications [office functions]; opinion polling; market studies; providing business information; providing commercial information and advice for consumers in the choice of products and services; business investigations; business research; marketing research; personnel recruitment; consultancy regarding advertising communication strategies; consultancy regarding public relations communication strategies; business management and organization consultancy; business organization consultancy; business management consultancy; personnel management consultancy; professional business consultancy; layout services for advertising purposes; marketing; marketing in the framework of software publishing; targeted marketing; business management of performing artists; writing of curriculum vitae for others; scriptwriting for advertising purposes; news clipping services; updating and maintenance of information in registries; updating and maintenance of data in computer databases; updating of advertising material; word processing; organization of exhibitions for commercial or advertising purposes; organization of fashion shows for promotional purposes; organization of trade fairs for commercial or advertising purposes; shop window dressing; development of advertising concepts; business appraisals; payroll preparation; data search in computer files for others; sponsorship search; administrative assistance in responding to calls for tenders; business management assistance; commercial or industrial management assistance; commercial intermediation services; providing business information via a website; providing commercial and business contact information; provision of an online marketplace for buyers and sellers of goods and services; web indexing for commercial or advertising purposes; presentation of goods on communication media, for retail purposes; media relations services; economic forecasting; auctioneering; wholesale services for pharmaceutical, veterinary and sanitary preparations and medical supplies; retail services for pharmaceutical, veterinary and sanitary preparations and medical supplies; sales promotion for others; wholesale services for cosmetics, solutions for contact lenses, contact lenses, optical lenses, spectacles, containers for contact lenses, spectacle cases; retail services for cosmetics, solutions for contact lenses, contact lenses, optical lenses, spectacles, containers for contact lenses, spectacle cases; promotion of goods and services through sponsorship of sports events; production of teleshopping programmes; production of advertising films; office machines and equipment rental; rental of advertising time on communication media; publicity material rental; rental of billboards [advertising boards]; rental of vending machines; rental of sales stands; rental of photocopying machines;



publication of publicity texts; radio advertising; bill-posting; distribution of samples; dissemination of advertising matter; direct mail advertising; registration of written communications and data; writing of publicity texts; advertising; online advertising on a computer network; advertising by mail order; television advertising; document reproduction; compilation of information into computer databases; compilation of statistics; business inquiries; systemization of information into computer databases; advisory services for business management; corporate communications services; negotiation of business contracts for others; negotiation and conclusion of commercial transactions for third parties; compiling indexes of information for commercial or advertising purposes; tax preparation; drawing up of statements of accounts; telemarketing services; interim business management; outsourced administrative management for companies; business management for freelance service providers; commercial administration of the licensing of the goods and services of others; business management of reimbursement programmes for others; administration of consumer loyalty programs; administration of frequent flyer programs; administrative processing of purchase orders; public relations; commercial lobbying services; competitive intelligence services; modelling for advertising or sales promotion; typing; market intelligence services; appointment reminder services [office functions]; website traffic optimization; tax filing services; search engine optimization for sales promotion; appointment scheduling services [office functions]; gift registry services; price comparison services; pay per click advertising; secretarial services; procurement services for others [purchasing goods and services for other businesses]; shorthand; outsourcing services [business assistance]; telephone answering for unavailable subscribers; photocopying services; business efficiency expert services.

(260) AM 2022 114566 A  
 (800) 1611910  
 (151) 2021 04 22  
 (891) 2021 04 22  
 (731) 3M Company  
 3M Center, 2501 Hudson Road St. Paul  
 MN 55144, USA

(540)



(591) Black, white  
 (531) 20.05.15; 26.04.09; 27.05.17

(511)  
 16 – Stationery notes containing adhesive on one side for attachment to surfaces; index tabs, filing tabs, stationery tabs; easel paper and easel pads; page markers containing adhesive on one side for attachment to surfaces; adhesive tape for stationery or office use; labeling tape for stationery or office use; adhesive tape flags for stationery or office use; paper notebooks; display and message boards of paper or cardboard; dry erase writing boards and writing surfaces; holders for stationery notes; holders for adhesive tape flags for stationery or office use; dispensers for stationery notes and adhesive tape flags for stationery or office use; desktop organizers; pens and highlighter pens; adhesive paper labels.

(260) AM 2022 114567 A  
 (800) 1611942  
 (151) 2021 06 18  
 (891) 2021 06 18  
 (731) Zhejiang Wuyi Haoyu Bailian Industry and Trade Co., Ltd.  
 (Autonomous declare), (Zhejiang Wuyi Haoyu Bailian, Industry and Trade Co., Ltd. Inside), Tongqin Hardware Machinery Industrial Park, Wuyi County, 321000 Jinhua City, China

(540)



(591) Black, white  
 (531) 24.17.09; 26.11.08; 27.05.01; 27.05.11;  
 27.05.17

(511)  
 7 – Pumps [machines]; hand-held tools, other than hand-operated; handling machines, automatic [manipulators]; sewing machines; driving motors, other than for land vehicles; food preparation machines, electromechanical; kitchen machines, electric; machines and apparatus for carpet shampooing, electric.

(260) AM 2022 114568 A  
 (800) 1612047  
 (151) 2021 05 07  
 (891) 2021 05 07  
 (731) Avon Products, Inc.  
 1 Avon Place, Suffern NY 10901, USA

(540)

**AVON ADAPT**

(591) Black, white  
 (511)  
 3 – Skin care preparations; skin moisturizers; skin toners; body and beauty care preparations; powders,

cleansers, creams and lotions, all being cosmetic preparations for the face, hands and body; exfoliating scrubs for cosmetic purposes; cosmetic suntan preparations; sunscreen oils and lotions; soaps; shower and bath preparations; bath gel, bath oils, bath salts, bath beads, and effervescent bath preparations; beauty masks; talcum powder; eye cream; eye gels; eye lotions; eye make-up remover.

(260) AM 2022 114569 A

(800) 1612052

(151) 2021 04 28

(891) 2021 04 28

(731) Panasonic Life Solutions Elektrik San. ve Tic.

A. Ş.

Abdurrahmangazi Mah., Ebubekir Cad. No: 44,

TR-34887 Sancaktepe İstanbul, Turkey

(540)

**V:KO touchless**

(591) Black, light blue

(531) 01.01.02; 01.01.09; 26.01.06; 26.01.24;

26.11.02; 26.11.22; 27.05.01; 27.05.07;

27.05.09; 27.05.10; 29.01.13

(511)

9 – Apparatus and instruments for conducting, switching, transforming, accumulating, regulating, or controlling electricity: electric plugs, junction boxes [electricity], electric switches, circuit breakers, fuses, lighting ballasts, battery starter cables, electrical circuit boards, electric resistances, electric sockets, transformers [electricity], electrical adapters, battery chargers, electric and electronic cables, batteries, electric accumulators, solar panels for production of electricity.

(260) AM 2022 114574 A

(800) 1612201

(151) 2021 03 12

(891) 2021 03 12

(731) Krolk GmbH

Schleifmuehle 1, Cadolzburg, 90556 Bavaria,

Germany

(540)

**SOLK**

(591) Black, white

(511)

1 – Compost; composts; compost [fertilizer].

25 – Shoes; clothing; footwear; headgear.

(260) AM 2022 114575 A

(800) 1612304

(151) 2021 05 16

(891) 2021 05 16

(731) KRKA, tovarna zdravil, d.d., Novo mesto

Šmarješka cesta 6, SI-8000 Novo mesto,

Slovenia

(540)

**TIGALANT**

(591) Black, white

(511)

5 – Pharmaceutical preparations.

(260) AM 2022 114576 A

(800) 1612312

(151) 2021 06 23

(891) 2021 06 23

(731) Beijing Dajia Internet Information Technology Co., Ltd.

Room 101D1-7, 1st Floor, Building 1, No. 6,

Shangdi West Road, Haidian District, Beijing,

China

(540)

**快手**

(591) Black, white

(531) 28.03

(511)

9 – Electronic publications, downloadable; computer programs, downloadable; network communication equipment; cameras [photography]; computer peripheral devices; downloadable application software for cell phones; spectacles; headphones; batteries, electric; animated cartoons.

35 – Import-export agency services; marketing; provision of an online marketplace for buyers and sellers of goods and services; presentation of goods on communication media, for retail purposes; business management of performing artists; systemization of information into computer databases; business management and organization consultancy; sales promotion for others; website traffic optimization; sponsorship search.

36 – Financial management; art appraisal; credit sale for land vehicles [lease-purchase financing]; brokerage; charitable fund raising; lending against security; insurance information; rental of real estate; surety services; trusteeship.

38 – Providing internet chatrooms; transmission of greeting cards online; voice mail services; transmission of digital files; videoconferencing services; wireless broadcasting; computer aided transmission of messages and images; providing online forums; message sending; providing access to databases.

41 – Mobile library services; publication of texts, other than publicity texts; providing online electronic publications, not downloadable; teaching; providing on-line music, not downloadable; organization of shows [impresario services]; providing television programs, not downloadable, via video-on-demand transmission services; production of radio and television programmes; modelling for artists; entertainment services.

42 – Technological research; providing search engines for the internet; creating and designing website-based indexes of information for others [information technology services]; monitoring of computer systems by remote access; updating of computer software; information technology [IT] consultancy; conversion of data or documents from physical to electronic media; computer software design; graphic arts design.

45 – Dating services; online social networking services; personal background investigations; registration of domain names [legal services]; copyright management; licensing of intellectual property; licensing of computer software [legal services]; chaperoning; clothing rental; marriage agency services.

---

(260) AM 2022 114577 A  
 (800) 1612368  
 (151) 2021 06 03  
 (891) 2021 06 03  
 (731) Avon Products, Inc.  
 1 Avon Place, Suffern NY 10901, USA  
 (540)

## DISTILLERY

(591) Black, white  
 (511)  
 3 – Non-medicated toilet preparations; toiletries; skin care preparations; skin moisturizers; skin toners; body and beauty care preparations; powders, cleansers, creams and lotions, all for the face, hands and body; exfoliating scrubs for cosmetic purposes; cosmetic suntan preparations; sunscreen oils and lotions; soaps; shower and bath preparations; bath gel, bath oils, bath salts, bath beads, and effervescent bath preparations; beauty masks; talcum powder; nail polish; nail polish remover; false nails; adhesives for cosmetic purposes; cosmetics; eye cream; eye gels; eye lotions; eye make-up remover; eye shadow; eye liner; eyebrow cosmetics; mascara; lipstick; lip liner; lip-gloss; lip balm; make-up foundation; facial concealer; blusher; tissues impregnated with cosmetic lotions; powdered cosmetic tissues; cotton sticks for cosmetic purposes; cotton wool for cosmetic purposes; pumice stone; preparations for cleaning, moisturising, colouring and styling the hair; shampoos, conditioners, finishing spray, and gels, all for the hair; preparations for cleaning the teeth; shaving and aftershave preparations; perfumes; fragrances; toilet waters; cologne; room fragrances; incense sticks; deodorants for human beings; anti-per-

spirants for personal use (toiletries); essential oils (cosmetic); oils for perfumes and scents; potpourri; cosmetic kits.

---

(260) AM 2022 114579 A  
 (800) 1612463  
 (151) 2021 05 14  
 (891) 2021 05 14  
 (731) WindStar Medical GmbH  
 Bessie-Coleman-Straße 13, 60549 Frankfurt,  
 Germany  
 (540)

## Naturbell

(591) Black, white  
 (511)  
 3 – Soaps; perfumery, essential oils, cosmetics, hair lotions; cosmetics, make-up preparations, dentifrices.

5 – Pharmaceutical and sanitary preparations for health care, mineral food supplements, food supplements based on amino acids, food supplements based on minerals, food supplements based on trace elements, food supplements for medical purposes, vitamin preparations, all included in this class, in the form of effervescent tablets; dietetic substances adapted for medical purposes, feed additives for medical purposes; veterinary preparations, veterinary dietetics; food supplements for non-medical purposes on the basis of proteins, fats, fatty acids, with added vitamins, minerals, trace elements, either singly or in combination; food supplements for non-medical purposes on the basis of carbohydrates, dietary fiber, with added vitamins, minerals, trace elements, either singly or in combination.

30 – Dietetic food for non-medical purposes on the basis of carbohydrates, dietary fiber, with added vitamins, minerals, trace elements, either singly or in combination, included in this class; coffee, tea, cocoa, sugar, rice, coffee substitutes; flour and preparations made from cereals; bread, pastry; honey, spices.

---

(260) AM 2022 114585 A  
 (800) 1510256  
 (151) 2019 11 26  
 (891) 2021 07 30  
 (731) TOS s.r.l.  
 Largo Maurizio Vitale 1, I-10152 Turin, Italy  
 (540)

## SEBAGO

(591) Black, white  
 (511)  
 18 – Leather and imitations of leather; bags; rucksacks; school bags; sport bags; haversacks; travelling bags; trunks (luggage); suitcases; wallets; hiking sticks; key cases of leather and skins; vanity cases (not fitted); umbrellas; collars for animals; leashes for animals; slings for carrying infants.

25 – Clothing; footwear; headgear; men, women and children's articles of clothing; sportswear; casual wear; waterproof clothing; tracksuits; suits for sports activities; articles of clothing for sports activities; underwear; belts [clothing]; bathing suits; gloves [clothing]; hat and caps; bandanas [neckerchiefs]; scarves; stockings; socks; wrist band [clothing]; footwear for sports activities.

(260) AM 2022 114586 A

(800) 1526038

(151) 2019 12 02

(891) 2021 08 12

(731) FLO MAĞAZACILIK VE PAZARLAMA

ANONİM ŞİRKETİ

Merkez Mah. Taşocağı Cad., No:24 Kat:3

Mahmutbey, Bağcılar İstanbul, Turkey

(540)



(591) Black, red

(531) 27.05.01; 29.01.12

(511)

25 – Clothing, including underwear and outer clothing, other than special purpose protective clothing, socks, footwear, headwear.

35 – Advertising, marketing and public relations, including organization of exhibitions and trade fairs for commercial or advertising purposes; office functions; secretarial services, arranging newspaper subscriptions for others, compilation of statistics, rental of office machines, systemization of information into computer databases, telephone answering for unavailable subscribers; business management, business administration and business consultancy, accounting, commercial consultancy services, personnel recruitment, personnel placement, employment agencies, import-export agencies; trade marketing and trade promotional services; auctioneering; the bringing together, for the benefit of others, of a variety of goods, namely, unworked or semi-worked leather and animal skins, imitations of leather, stout leather, leather used for linings, goods made of leather, imitations of leather or other materials, designed for carrying items, including, bags, boxes and trunks made of leather or stout leather, keycases, umbrellas, parasols, sun umbrellas, walking sticks, whips, harness, saddlery, stirrups, straps of leather, saddlery, stirrups, straps of leather, saddlery, clothing, including underwear and outer clothing, other than special purpose protective clothing, socks, footwear, headwear, enabling customers to conveniently view and purchase those goods, such services may be provided by retail stores, wholesale outlets, by means of electronic media or through mail order catalogues.

(260) AM 2022 114587 A

(800) 1537324

(151) 2020 02 14

(891) 2021 06 02

(731) Lashmanova Iryna Volodymyrivna

bulv. Lidersonovskiyi, 5, kv. 66, Odesa 65014,

Ukraine

(540)



(591) Black, white

(531) 18.01.19; 27.03.15

(511)

12 – Luggage carriers for bicycles; tubeless tires for bicycles; safety seats for children, for vehicles; bicycles; bicycle brakes; bicycle motors; bicycle bells; bicycle cranks; bicycle chains; bicycle wheel hubs; pumps for bicycle tires; bicycle kickstands; bicycle frames; bicycle saddles; bicycle tires; bicycle wheel spokes; cycle mudguards; oars; rear-view mirrors; baby carriages; motors, electric, for land vehicles; dress guards for bicycles; warning horns for bicycles, motorcycles; horns for vehicles; repair outfits for inner tubes; inner tubes for bicycle tires; inner tubes for pneumatic tires; stroller hoods; bicycle handlebars; steering wheels for vehicles; bicycle wheels; vehicle wheels; baskets adapted for bicycles; vehicle seats; bodies for vehicles; adhesive rubber patches for repairing inner tubes; pneumatic tires; stroller covers; kick sledges; rims for bicycle wheels; rims for vehicle wheels; axles for vehicles; safety belts for vehicle seats; bicycle pedals; direction indicators for bicycles; direction indicators for land vehicles; security harness for vehicle seats; mudguards; shock absorbing springs for vehicles; reduction gear for land vehicles; push scooters [vehicles]; sleighs [vehicles]; reversing alarms for vehicles; bicycle saddles; motorcycle saddles; saddlebags adapted for bicycles; electric vehicles; vehicles for locomotion by land, air, water and rail; tricycles; saddle covers for motorcycles; saddle covers for bicycles; bicycle gears; tires for wheels of vehicles; vehicle wheel spokes.

20 – High chairs for babies; fans for personal use, non-electric; bassinets; bedsteads of wood; mats for infant playpens; bed casters, not of metal; furniture casters, not of metal; baskets, not of metal; armchairs; chairs [seats]; beds; playpens for babies; mattresses; waterbeds, not for medical purposes; baby changing mats; furniture; furniture of metal; air mattresses, not for medical purposes; inflatable furniture; air pillows, not for medical purposes; air cushions, not for medical purposes; bed bases; reeds [plaiting materials]; wickerwork; bedding, except linen; hand-held mirrors [toilet mirrors]; toilet mirrors; chests for toys; seats of metal; tables; wall-mounted baby changing platforms; tables of metal; figurines of wood, wax, plaster or

plastic; infant walkers; deck chairs; school furniture; boxes of wood or plastic; bins, not of metal.

28 – Swimming pools [play articles]; trampolines; billiard cues; billiard balls; billiard markers; billiard tables; bodyboards; boxing gloves; rattles [playthings]; building blocks [toys]; teddy bears; badminton shuttlecocks; swings; jigsaw puzzles; parlor games; bells for Christmas trees; spinning tops [toys]; discs for sports; dominoes; swimming kickboards; chess boards; checkerboards; darts; electronic targets; novelty toys for parties; ski bindings; kites; toys; novelty toys for playing jokes; stuffed toys; toy vehicles; toy models; toy pistols; toy figures; games; ring games; playing cards; playing balls; play balloons; kaleidoscopes; bladders of balls for games; paper party hats; carnival masks; bingo cards; skittles; mah-jong; quoits; ice skates; rocking horses; building games; confetti; dice; counters [discs] for games; balls for games; swimming jackets; flippers for swimming; flying discs [toys]; skis; bows for archery; dolls; dolls' clothes; dolls' rooms; dolls' beds; dolls' houses; puppets; masks [playthings]; soap bubbles [toys]; targets; clay pigeons [targets]; scale model vehicles; scale models kits [toys]; plush toys; balls for games; swimming pool air floats; water wings; knee guards [sports articles]; elbow guards [sports articles]; board games; in-line roller skates; swimming belts; punching bags; detonating caps [toys]; caps for pistols [toys]; dolls' feeding bottles; toy air pistols; portable games with liquid crystal displays; ornaments for Christmas trees, except lights, candles and confectionery; archery implements; apparatus for games; remote-controlled toy vehicles; racquets; sling shots [sports articles]; rollers for stationary exercise bicycles; skateboards; roller skates; gloves for games; baseball gloves; scooters [toys]; sleds [sports articles]; nets for sports; snowboards; tables for table tennis; foosball tables; theatrical masks; tennis nets; slides [playthings]; machines for physical exercises; body-training apparatus; backgammon games; batting gloves [accessories for games]; paintball guns [sports apparatus]; paintballs [ammunition for paintball guns] [sports apparatus]; chips for gambling; Christmas crackers [party novelties]; hockey sticks; cups for dice; skating boots with skates attached; chess games; checkers [games]; Christmas trees of synthetic material.

35 – Organization of exhibitions for commercial or advertising purposes; organization of trade fairs; demonstration of goods; import-export agency services; online advertising on a computer network; layout services for advertising purposes; marketing; procurement services for others [purchasing goods and services for other businesses]; presentation of goods on communication media, for retail purposes; publication of publicity texts; radio advertising; advertising by mail order; advertising agency services; advertising; pay per click advertising; bill-postings; distribution of samples; dissemination of advertising matter; direct

mail advertising; production of advertising films; television advertising; telemarketing services; systemization of information into computer databases.

(260) AM 2022 114622 A

(800) 1612539

(151) 2021 04 06

(891) 2021 04 06

(731) Limited liability company "Geekbrains"  
Leningradskij pr-kt, d. 39, str. 79, etazh  
pomeschenie, chast komnaty 23, XXXIV, 1,  
Vnutrigorodskaya territoriya; municipalnyj  
okrug Horoshevskij, Moskva, Russian  
Federation

(540)



(591) Black, white

(531) 02.09.25; 26.13.25; 27.05.01

(511)

9 – Computer software, recorded; computer software applications, downloadable; computer programs, recorded; computer game software; computer programs, downloadable; computer operating programs, recorded; downloadable image files; animated cartoons.

35 – Employment agency services; marketing research; personnel recruitment; marketing; psychological testing for the selection of personnel; website traffic optimization.

38 – Providing internet chatrooms; video-on-demand transmission; message sending; computer aided transmission of messages and images; transmission of digital files; videoconferencing services; providing online forums; teleconferencing services.

41 – Academies [education]; publication of books; providing information in the field of education; correspondence courses; practical training [demonstration]; arranging and conducting of conferences; arranging and conducting of congresses; arranging and conducting of workshops [training]; arranging and conducting of in-person educational forums; arranging and conducting of seminars; organization of competitions [education or entertainment]; vocational guidance [education or training advice]; vocational retraining; providing online videos, not downloadable; online publication of electronic books and journals; publication of texts, other than publicity texts; tutoring; teaching; coaching [training]; educational services provided by schools.

42 – Recovery of computer data; installation of computer software; website design consultancy; computer security consultancy; information technology [IT] consultancy; consultancy in the design and development of computer hardware; computer software consultancy; technological consultancy; updating of com-

puter software; monitoring of computer systems by remote access; software as a service [SaaS]; maintenance of computer software; providing information relating to computer technology and programming via a website; computer system design; computer software design; creating and maintaining websites for others; computer programming; technical writing; telecommunications technology consultancy.

(260) AM 2022 114623 A

(800) 1612619

(151) 2021 05 24

(891) 2021 05 24

(731) OBSHCHESTVO S OGRANICHENNOY,  
OTVETSTVENNOSTYU "NPO Petrovaks  
Farm"  
yl. Sosnovaya, d. 1, s. Pokrov, g. Podolsk,  
RU-142143 Moscow region, Russian  
Federation

(540)

## Artneo

(591) Black, white

(511)

5 – Acaricides; aconitine; alkaloids for medical purposes; alginates for pharmaceutical purposes; algicides; aldehydes for pharmaceutical purposes; dental amalgams of gold; dental amalgams; amino acids for veterinary purposes; amino acids for medical purposes; analgesics; anaesthetics; antibiotics; antiseptics; medicine cases, portable, filled; first-aid boxes, filled; aluminium acetate for pharmaceutical purposes; acetates for pharmaceutical purposes; germicides; balms for medical purposes; bandages for dressings; diagnostic biomarker reagents for medical purposes; biocides; bracelets impregnated with insect repellent; bromine for pharmaceutical purposes; paper for mustard plasters; fly catching paper; reagent paper for veterinary purposes; reagent paper for medical purposes; mothproofing paper; petroleum jelly for medical purposes; vaccines; oxygen baths; antiseptic cotton; aseptic cotton; absorbent cotton; wadding for medical purposes; cotton for medical purposes; dietetic substances adapted for medical use; radiological contrast substances for medical purposes; nutritive substances for microorganisms; radioactive substances for medical purposes; melissa water for pharmaceutical purposes; seawater for medicinal bathing; mineral waters for medical purposes; thermal water; dietary fibre; moulding wax for dentists; gases for medical purposes; guaiacol for pharmaceutical purposes; sexual stimulant gels; haematogen; haemoglobin; hydrastine; hydrastinine; glycerine for medical purposes; glycerophosphates; glucose for medical purposes; gentian for pharmaceutical purposes; hormones for medical purposes; mustard for pharmaceutical purposes; mustard plasters; mud for baths; medicinal mud; gamboge for medical purposes; gurjun balsam for medical purposes; air deodorizing preparations; deodorants, other

than for human beings or for animals; deodorants for clothing and textiles; diastase for medical purposes; digitalin; vitamin supplement patches; mineral food supplements; nutritional supplements; albumin dietary supplements; dietary supplements for animals; yeast dietary supplements; alginate dietary supplements; glucose dietary supplements; casein dietary supplements; lecithin dietary supplements; linseed oil dietary supplements; propolis dietary supplements; protein dietary supplements; protein supplements for animals; royal jelly dietary supplements; pollen dietary supplements; wheat germ dietary supplements; linseed dietary supplements; acai powder dietary supplements; dietary supplements with a cosmetic effect; enzyme dietary supplements; yeast for pharmaceutical purposes; gelatine for medical purposes; cod liver oil; isotopes for medical purposes; immunostimulants; insecticides; iodine for pharmaceutical purposes; iodides for pharmaceutical purposes; alkaline iodides for pharmaceutical purposes; iodoform; calomel [fungicide]; tartar for pharmaceutical purposes; camphor for medical purposes; capsules for medicines; cachets for pharmaceutical purposes; capsules made of dendrimer-based polymers, for pharmaceuticals; haemostatic pencils; wart pencils; caustic pencils; carbolineum [parasiticide]; caustics for pharmaceutical purposes; cachou for pharmaceutical purposes; quassia for medical purposes; quebracho for medical purposes; oxygen for medical purposes; gallic acid for pharmaceutical purposes; acids for pharmaceutical purposes; adhesives for dentures; surgical glues; stem cells for veterinary purposes; stem cells for medical purposes; cocaine; collagen for medical purposes; collodion for pharmaceutical purposes; corn rings for the feet; medicated sweets; barks for pharmaceutical purposes; cedar wood for use as an insect repellent; croton bark; mangrove bark for pharmaceutical purposes; myrobalan bark for pharmaceutical purposes; quinquina for medical purposes; medicated animal feed; medicinal roots; rhubarb roots for pharmaceutical purposes; lint for medical purposes; starch for dietetic or pharmaceutical purposes; creosote for pharmaceutical purposes; blood for medical purposes; cultures of microorganisms for medical or veterinary use; curare; dental lacquer; liquorice for pharmaceutical purposes; milk sugar for pharmaceutical purposes; medicated candies; adhesive plasters; medicines for alleviating constipation; lecithin for medical purposes; lotions for veterinary purposes; medicated hair lotions; lotions for pharmaceutical purposes; medicated after-shave lotions; personal sexual lubricants; lupulin for pharmaceutical purposes; magnesia for pharmaceutical purposes; liniments; ointments for pharmaceutical purposes; sunburn ointments; mercurial ointments; frostbite salve for pharmaceutical purposes; gauze for dressings; medicinal oils; mustard oil for medical purposes; camphor oil for medical purposes; castor oil for medical purposes; oil of turpentine for pharmaceutical purposes; dill oil for medical purposes; dental mastics; dental abrasives;

dental impression materials; teeth filling material; dressings, medical; surgical dressings; drugs for medical purposes; medicines for veterinary purposes; serotherapeutic medicines; medicines for human purposes; medicines for dental purposes; menthol; medicinal drinks; moleskin for medical purposes; almond milk for pharmaceutical purposes; powdered milk for babies; royal jelly for pharmaceutical purposes; milk ferments for pharmaceutical purposes; Irish moss for medical purposes; flour for pharmaceutical purposes; linseed meal for pharmaceutical purposes; fish meal for pharmaceutical purposes; fly glue; antibacterial soap; disinfectant soap; medicated soap; freeze-dried meat adapted for medical purposes; mint for pharmaceutical purposes; dietetic beverages adapted for medical purposes; malted milk beverages for medical purposes; narcotics; medicinal infusions; tincture of iodine; eucalyptol for pharmaceutical purposes; tinctures for medical purposes; opium; opodeldoc; decoctions for pharmaceutical purposes; antiparasitic collars for animals; stick liquorice for pharmaceutical purposes; sulfur sticks [disinfectants]; pastilles for pharmaceutical purposes; medicated toothpaste; pectin for pharmaceutical purposes; pepsins for pharmaceutical purposes; peptones for pharmaceutical purposes; hydrogen peroxide for medical purposes; pesticides; food for babies; leeches for medical purposes; blood plasma; nicotine patches for use as aids to stop smoking; eyepatches for medical purposes; poultices; compresses; scapulars for surgical purposes; babies' diapers; diapers for pets; diapers for incontinence; bunion pads; breast-nursing pads; pomades for medical purposes; powder of cantharides; pyrethrum powder; anti-uric preparations; bacterial preparations for medical and veterinary use; bacteriological preparations for medical and veterinary use; balsamic preparations for medical purposes; albuminous preparations for medical purposes; biological preparations for veterinary purposes; biological preparations for medical purposes; veterinary preparations; bismuth preparations for pharmaceutical purposes; vitamin preparations; diagnostic preparations for medical purposes; bath preparations for medical purposes; therapeutic preparations for the bath; haemorrhoid preparations; preparations for callouses; lice treatment preparations [pediculicides]; acne treatment preparations; preparations to facilitate teething; preparations for the treatment of burns; fumigation preparations for medical purposes; opotherapy preparations; air purifying preparations; bronchodilating preparations; preparations for reducing sexual activity; sterilizing preparations; soil-sterilizing preparations; corn remedies; pharmaceutical preparations for treating dandruff; preparations for destroying noxious animals; herbicides; preparations for destroying dry rot fungus; larvae exterminating preparations; fly destroying preparations; preparations for destroying mice; slug exterminating preparations; vermin destroying preparations; pharmaceutical preparations for skin care; contact lens cleaning preparations; pre-

parations of microorganisms for medical or veterinary use; lime-based pharmaceutical preparations; hemostatics for medical purposes; medicated eye-washes; medicinal hair growth preparations; nutraceutical preparations for therapeutic or medical purposes; opiates; anticryptogamic preparations; aloe vera preparations for pharmaceutical purposes; preparations of trace elements for human and animal use; sulfonamides [medicines]; pharmaceutical preparations; pharmaceutical preparations for treating sunburn; enzyme preparations for veterinary purposes; enzyme preparations for medical purposes; phytotherapy preparations for medical purposes; chemico-pharmaceutical preparations; chemical preparations for veterinary purposes; chemical preparations for the diagnosis of pregnancy; chemical preparations for medical purposes; chemical preparations for treating diseases affecting cereal plants; chemical preparations for treating wheat blight; chemical preparations for treating diseases affecting vine plants; chemical preparations for treating mildew; chemical preparations for treating phylloxera; chemical preparations for pharmaceutical purposes; chilblain preparations; mothproofing preparations; collyrium; lead water; chemical conductors for electrocardiograph electrodes; albuminous foodstuffs for medical purposes; dietetic foods adapted for medical purposes; by-products of the processing of cereals for dietetic or medical purposes; homogenized food adapted for medical purposes; freeze-dried food adapted for medical purposes; pharmaceuticals; sanitary towels; panty liners [sanitary]; propolis for pharmaceutical purposes; pearl powder for medical purposes; radium for medical purposes; hydrated chloral for pharmaceutical purposes; solvents for removing adhesive plasters; vaginal washes for medical purposes; solutions for contact lenses; chemical reagents for medical or veterinary purposes; gum for medical purposes; rubber for dental purposes; chewing gum for medical purposes; nicotine gum for use as an aid to stop smoking; insect repellents; insect repellent incense; repellents for dogs; tissues impregnated with pharmaceutical lotions; sarsaparilla for medical purposes; sugar for medical purposes; asthmatic tea; fumigating sticks; massage candles for therapeutic purposes; suppositories; linseed for pharmaceutical purposes; tobacco-free cigarettes for medical purposes; siccatives [drying agents] for medical purposes; syrups for pharmaceutical purposes; turpentine for pharmaceutical purposes; greases for veterinary purposes; greases for medical purposes; lacteal flour for babies; infant formula; soporifics; bicarbonate of soda for pharmaceutical purposes; bath salts for medical purposes; salts for mineral water baths; salts for medical purposes; potassium salts for medical purposes; sodium salts for medical purposes; smelling salts; mineral water salts; malt for pharmaceutical purposes; semen for artificial insemination; alcohol for pharmaceutical purposes; medicinal alcohol; alloys of precious metals for dental purposes; ergot for pharmaceutical purpo-

ses; cooling sprays for medical purposes; antibacterial handwashes; adjuvants for medical purposes; astringents for medical purposes; vermifuges; disinfectants; disinfectants for hygiene purposes; disinfectants for chemical toilets; appetite suppressants for medical purposes; medical preparations for slimming purposes; parasiticides; mouthwashes for medical purposes; febrifuges; depuratives; animal washes [insecticides]; detergents for medical purposes; cattle washes [insecticides]; dog washes [insecticides]; insecticidal veterinary washes; vesicants; purgatives; remedies for perspiration; remedies for foot perspiration; chemical contraceptives; antiparasitic preparations; sedatives; laxatives; tonics [medicines]; medicated toiletry preparations; digestives for pharmaceutical purposes; nervines; bouillons for bacteriological cultures; steroids; strychnine; serums; tanning pills; appetite suppressant pills; slimming pills; jujube, medicated; antioxidant pills; sanitary tampons; vulnery sponges; thymol for pharmaceutical purposes; biological tissue cultures for veterinary purposes; biological tissue cultures for medical purposes; smoking herbs for medical purposes; medicinal herbs; surgical implants comprised of living tissues; pants, absorbent, for incontinence; sanitary panties; babies' diaper-pants; charcoal for pharmaceutical purposes; porcelain for dental prostheses; phenol for pharmaceutical purposes; enzymes for veterinary purposes; enzymes for medical purposes; ferments for pharmaceutical purposes; formic aldehyde for pharmaceutical purposes; phosphates for pharmaceutical purposes; fungicides; quinine for medical purposes; chinoline for medical purposes; diabetic bread adapted for medical use; chloroform; flowers of sulfur for pharmaceutical purposes; cement for animal hooves; bone cement for surgical and orthopaedic purposes; dental cements; medicinal tea; herbal teas for medicinal purposes; insecticidal animal shampoos; medicated shampoos; medicated shampoos for pets; pediculicidal shampoos; medicated dry shampoos; pre-filled syringes for medical purposes; eucalyptus for pharmaceutical purposes; herbal extracts for medical purposes; plant extracts for pharmaceutical purposes; tobacco extracts [insecticides]; extracts of hops for pharmaceutical purposes; elixirs [pharmaceutical preparations]; ethers for pharmaceutical purposes; esters for pharmaceutical purposes; cellulose esters for pharmaceutical purposes; rat poison; poisons; bacterial poisons; jalap; bismuth subnitrate for pharmaceutical purposes; cream of tartar for pharmaceutical purposes; condurango bark for medical purposes; angostura bark for medical purposes; adhesive tapes for medical purposes; injectable dermal fillers; cotton swabs for medical purposes; diagnostic preparations for veterinary purposes; douching preparations for medical purposes; milking grease; transplants [living tissues]; fennel for medical purposes; cellulose ethers for pharmaceutical purposes.

(260) AM 2022 114630 A

(800) 1613054

(151) 2021 06 03

(891) 2021 06 03

(731) Limited Liability Company "Delfast"

104 Chumatskyi Shliakh St., Hostmotel Irpin,  
Kyiv region 08290, Ukraine

(540)

# Delfast

(591) Black, white

(531) 27.05.01

(511)

12 – Vehicles; apparatus for locomotion by land; suspension shock absorbers for vehicles; luggage carriers for vehicles; tires for vehicle wheels; bands for wheel hubs; safety seats for children, for vehicles; bicycles; electric bicycles; bicycle kickstands; bicycle brakes; bicycle motors; bicycle bells; dress guards for bicycles; bicycle handlebars; bicycle wheels; bicycle chains; bicycle pedals; bicycle frames; bicycle saddles; bicycle cranks; gears for bicycles; bicycle tires; tubeless tires for bicycles; bicycle mudguards; lug nuts for vehicle wheels; brakes for vehicles; shock absorbing springs for vehicles; rearview mirrors; motors, electric, for land vehicles; inner tubes for bicycle tires; inner tubes for pneumatic tires; rudders; steering wheels for vehicles; valves for vehicle tires; vehicle wheels; baskets adapted for bicycles; vehicle seats; wheelchairs; adhesive rubber patches for repairing inner tubes; bicycle wheel hubs; vehicle wheel hubs; self-balancing electric unicycles; mopeds; motor scooters; motorcycle frames; motorcycle saddles; motorcycles; bicycle wheel rims; vehicle wheel rims; axles for vehicles; axle journals; gearing for land vehicles; vehicle suspension springs; air pumps [vehicle accessories]; signal arms for vehicles; casings for pneumatic tires; bicycle trailers; trailers for transporting bicycles; anti-theft devices for vehicles; anti-theft alarms for vehicles; luggage nets for vehicles; bicycle wheel spokes; vehicle wheel spokes; spoilers for vehicles; panniers adapted for bicycles; saddlebags adapted for bicycles; panniers adapted for motorcycles; electric vehicles; tricycles; carrier tricycles; covers for vehicle steering wheels; saddle covers for bicycles; saddle covers for motorcycles; vehicle covers [shaped]; pneumatic tires; solid tires for vehicle wheels; spikes for tires.

(260) AM 2022 114638 A

(800) 1613460

(151) 2021 06 04

(891) 2021 06 04

(731) PHERECYDES PHARMA

NANTES BIOTECH, 22 boulevard Benoni  
Goullin, F-44200 Nantes, France



(540)

**PHERECYDES**

(591) Black, white

(511)

5 – Pharmaceutical and veterinary products; pharmaceutical preparations for the treatment or prevention of bacterial diseases; antibacterial substances for medical use; diagnostic agents for medical use; drug delivery agents; antibodies for medical or veterinary use; hygienic products for medicine; chemical preparations for medical or pharmaceutical use; bacterial and bacteriological preparations for medical or veterinary use; bactericides; fungicides; germicides; virucides; biocides; sporicides; levuricides; mycobactericides; media for bacteriological cultures; microbicides; preparations of microorganisms for medical and veterinary use.

10 – Analysis devices for identification of bacteria for medical use; surgical, medical, dental and veterinary apparatus and instruments; bacteria sampling apparatus; apparatus used for the study of bacterial disorders; applicators for anti-bacterial preparations.

42 – Medical and pharmacological research services; scientific research in bacteriology; chemical and microbiological laboratory services; research and development in the field of chemistry, microbiology, air flows, agri-foodstuffs, biology, bacteriology; consultancy with respect to pharmaceutical research and development; consultancy with respect to bacteriology research; clinical trials; carrying out clinical trials; auditing relating to air, water and surface hygiene, relating to sanitary risks and chemical or microbiological contamination; surveying [engineering work]; consultancy with respect to bacteriology; research and testing services in the fields of bacteriology and virology; scientific and technological services and research work, particularly for identifying and characterizing active materials for infectious disease treatment; development of pharmaceutical treatment products; conducting and scientific support of preclinical or clinical studies.

(260) AM 2022 114650 A

(800) 1613815

(151) 2021 01 20

(891) 2021 01 20

(731) GRATIS İÇ VE DIŞ TİCARET ANONİM ŞİRKETİ

Levent Mah.Yapı Kredi Plaza, C Blok Cömert Sok 1C Kat.5, Beşiktaş, İstanbul, Turkey

(540)



(591) Black, white

(531) 05.03.13; 05.03.14; 26.01.03; 26.01.15; 27.05.01

(511)

3 – Soaps.

5 – Pharmaceutical and veterinary preparations for medical purposes; chemical preparations for medical and veterinary purposes, chemical reagents for pharmaceutical and veterinary purposes; medicated cosmetics; dietary supplements for pharmaceutical and veterinary purposes; dietary supplements; nutritional supplements; medical preparations for slimming purposes; food for babies; herbs and herbal beverages adapted for medicinal purposes; dental preparations and articles; teeth filling material, dental impression material, dental adhesives and material for repairing teeth; sanitary preparations for medical use; hygienic pads; hygienic tampons; plasters; materials for dressings; diapers made of paper and textiles for babies, adults and pets; preparations for destroying vermin; herbicides, fungicides, preparations for destroying rodents; deodorants, other than for human beings or for animals; air purifying preparations; air deodorising preparations; disinfectants; antiseptics; detergents for medical purposes; medicated soaps; disinfectant soaps; antibacterial hand lotions.

35 – Advertising, marketing and public relations; organization of exhibitions and trade fairs for commercial or advertising purposes; development of advertising concepts; provision of an online marketplace for buyers and sellers of goods and services; office functions; secretarial services; arranging newspaper subscriptions for others; compilation of statistics; rental of office machines; systemization of information into computer databases; telephone answering for unavailable subscribers; business management, business administration and business consultancy; accounting; commercial consultancy services; personnel recruitment, personnel placement, employment agencies, import-export agencies; temporary personnel placement services; auctioneering; the bringing together, for the benefit of others, of bleaching and cleaning preparations, detergents other than for use in manufacturing operations and for medical purposes, laundry bleach, fabric softeners for laundry use, stain removers, dishwasher detergents, perfumery, non-medicated cosmetics, fragrances, deodorants for personal use and animals, soaps, dental care preparations, dentifrices, denture polishes, tooth whitening preparations, mouth washes, not for medical purposes, abrasive preparations, emery cloth, sandpaper, pumice stone, abrasive pastes, polishing preparations for leather, vinyl, metal and wood, polishes and creams for leather, vinyl, metal and wood, wax for polishing, pharmaceutical and veterinary preparations for medical purposes, chemical preparations for medical and veterinary purposes, chemical reagents for pharmaceutical and veterinary purposes, medicated cosmetics, dietary supplements

for pharmaceutical and veterinary purposes, dietary supplements, nutritional supplements, medical preparations for slimming purposes, food for babies, herbs and herbal beverages adapted for medicinal purposes, dental preparations and articles, teeth filling material, dental impression material, dental adhesives and material for repairing teeth, sanitary preparations for medical use, hygienic pads, hygienic tampons, plasters, materials for dressings, diapers made of paper and textiles for babies, adults and pets, preparations for destroying vermin, herbicides, fungicides, preparations for destroying rodents, deodorants, other than for human beings or for animals, air purifying preparations, air deodorising preparations, disinfectants, antiseptics, detergents for medical purposes, medicated soaps, disinfectant soaps, antibacterial hand lotions, meat, fish, poultry and game, processed meat products, dried pulses, soups, bouillon, processed olives, olive paste, milks of animal origin, milks of herbal origin, milk products, butter, edible oils, dried, preserved, frozen, cooked, smoked or salted fruits and vegetables, tomato paste, prepared nuts and dried fruits as snacks, hazelnut spreads and peanut butter, tahini (sesame seed paste), eggs and powdered eggs, potato chips, coffee, cocoa, coffee or cocoa based beverages, chocolate based beverages, pasta, stuffed dumplings, noodles, pastries and bakery products based on flour, desserts based on flour and chocolate, bread, simit [Turkish ring-shaped bagel covered with sesame seeds], poğaça [Turkish bagel], pita, sandwiches, katmer [Turkish pastry], pies, cakes, baklava [Turkish dessert based on dough coated with syrup], kadayif [Turkish dessert based on dough], desserts based on dough coated with syrup, puddings, custard, kazandibi [Turkish pudding], rice pudding, keşkül [Turkish pudding], honey, bee glue for human consumption, propolis for food purposes, condiments for foodstuff, vanilla (flavoring), spices, sauces (condiments), tomato sauce, yeast, baking powder, flour, semolina, starch for food, sugar, cube sugar, powdered sugar, tea, ice tea, confectionery, chocolate, biscuits, crackers, wafers, chewing gums, ice-cream, edible ices, salt, cerealbased snack food, popcorn, crushed oats, corn chips, breakfast cereals, processed wheat for human consumption, crushed barley for human consumption, processed oats for human consumption, processed rye for human consumption, rice, molasses for food, beers, preparations for making beer, mineral water, spring water, table water, soda water, fruit and vegetable juices, fruit and vegetable concentrates and extracts for making beverages, non-alcoholic soft drinks, energy drinks, protein-enriched sports beverages, enabling customers to conveniently view and purchase those goods, such services may be provided by retail stores, wholesale outlets, by means of electronic media or through mail order catalogues.

(260) AM 2022 114651 A

(800) 1613838

(151) 2021 04 22

(891) 2021 04 22

(731) LOCATELLI S.P.A.

VIA DELLA RESISTENZA 5/A, ALMENNO  
SAN BARTOLOMEO (BG), Italy

(540)



(591) Black, white

(531) 26.11.02; 26.11.06; 26.11.09; 27.05.01;  
27.05.21

(511)

9 – Helmets for motorcyclists; bicycle helmets; protective helmets for sports; face masks for protective helmets; face shields for protective helmets; goggles for motorcyclists; protective eyewear; side shields for eyeglasses; articles of protective clothing for wear by motorcyclists for protection against accident or injury; clothing for protection against accidents; shoes for protection against accidents, irradiation and fire; insulated clothing for protection against accidents or injury; protection devices for personal use against accidents; gloves for protection against accidents; clothing, footwear and headwear for protection against accidents, irradiation and fire; scientific, research, navigation, surveying, photographic, cinematographic, audiovisual, optical, weighing, measuring, signalling, detecting, testing, inspecting, life-saving and teaching apparatus and instruments; apparatus and instruments for conducting, switching, transforming, accumulating, regulating or controlling the distribution or use of electricity; apparatus and instruments for recording, transmitting, reproducing or processing sound, images or data; recorded and downloadable media, computer software, blank digital or analogue recording and storage media; mechanisms for coin-operated apparatus; cash registers, calculating devices; computers and computer peripheral devices; diving suits, divers' masks, ear plugs for divers, nose clips for divers and swimmers, gloves for divers, breathing apparatus for underwater swimming; fire-extinguishing apparatus.

25 – Jackets for motorcyclists; gloves for motorcyclists; waterproof suits for motorcyclists; boots for motorcyclists; clothing, not being protective clothing, incorporating reflective or fluorescent elements or material; clothing for sports; clothing of leather or imitations of leather; jackets [clothing]; leather jackets; rain jackets; wind jackets; padded jackets; waterproof jackets; light-reflecting jackets; sports jackets; wind-resistant jackets; rain pants; sweatpants; leather

trousers; waterproof jackets and pants; moisture-wicking sports pants; padded pants for athletic use; boots; bandanas [neckerchiefs]; neck tube scarves; gloves [clothing]; clothing, footwear, headwear.

(260) AM 2022 114652 A  
 (800) 1613951  
 (151) 2021 07 06  
 (891) 2021 07 06  
 (731) Cinnabon Franchisor SPV LLC  
 5620 Glenridge Drive NE, Atlanta GA 30342,  
 USA  
 (540)



(591) The colors blue, white, and light blue are claimed as a feature of the mark

(531) 25.03.01; 25.03.11; 27.05.01; 27.05.24; 29.01.12

(511)  
 30 – Ice cream; bakery goods; cakes; pastries; cinnamon rolls; buns; coffee and coffee-based beverages; iced coffee; cappuccino; coffee capsules containing coffee for brewing; cocoa-based beverages; breakfast cereals; refrigerated dough; mixes for bakery goods; muffins, donuts, donut holes, Danish bread, bagels.

43 – Restaurant services; take-out restaurant services; services for providing food and drink.

(260) AM 2022 114653 A  
 (800) 1613974  
 (151) 2021 07 02  
 (891) 2021 07 02  
 (731) Individual entrepreneur Adushkin Roman Evgenievich  
 Verhnie polya, house 10, apt 49, RU-109341  
 Moscow, Russian Federation  
 (540)



(591) Black, white  
 (531) 26.04.01; 26.04.05; 26.04.18; 26.04.24; 27.05.01; 27.05.24

(526) ®

(511)  
 9 – Accumulators, electric; batteries, electric, for vehicles; solar batteries; solar panels for the production of electricity.

(260) AM 2022 114654 A  
 (800) 1613990  
 (151) 2021 07 23  
 (891) 2021 07 23  
 (731) Anteris Technologies Corporation  
 860 Blue Gentian Road, Suite 340, Eagan MN  
 55121, USA  
 (540)

## ComASUR

(591) Black, white  
 (511)  
 10 – Medical apparatus and instruments for treating cardiovascular disease; medical devices, namely, heart valve delivery catheters; transcatheter delivery systems for prosthetic heart valves; catheter delivery systems for minimally invasive implantation of artificial heart valves; catheters; balloon catheters.

(260) AM 2022 114665 A  
 (800) 1596443  
 (151) 2020 10 27  
 (891) 2021 08 16  
 (731) FLO MAĞAZACILIK VE PAZARLAMA ANONİM ŞİRKETİ  
 Merkez Mah. Taşocağı Cad. No:24 Kat:3,  
 Mahmutbey Bağcılar, İstanbul, Turkey  
 (540)



(591) Black, orange  
 (531) 27.05.10; 29.01.12  
 (511)  
 25 – Clothing, including underwear and outer clothing, other than special purpose protective clothing; socks, mufflers [clothing], shawls, bandanas, scarves, belts [clothing], footwear, shoes, slippers, sandals, headgear, hats, caps with visors, berets, caps [headwear], skull caps.

35 – Advertising, marketing and public relations; organization of exhibitions and trade fairs for commercial or advertising purposes; development of advertising concepts; provision of an online marketplace for buyers and sellers of goods and services; office functions; secretarial services; arranging newspaper subscriptions for others; compilation of statistics; rental of office machines; systemization of information into computer databases; telephone answering for unavailable subscribers; business management, business administration and business consultancy; accounting; commercial consultancy services; personnel rec-

ruitment, personnel placement, employment agencies, import-export agencies; temporary personnel placement services; auctioneering; the bringing together, for the benefit of others, of a variety of goods, namely, unworked or semi-worked leather and animal skins, imitations of leather, stout leather, leather used for linings, goods made of leather, imitations of leather or other materials, designed for carrying items, including, bags, wallets, boxes and trunks made of leather or stout leather, keycases, trunks [luggage], suitcases, umbrellas, parasols, sun umbrellas, walking sticks, whips, harness, saddlery, stirrups, straps of leather (saddlery), clothing, including underwear and outerclothing, other than special purpose protective clothing, socks, mufflers [clothing], shawls, bandanas, scarves, belts [clothing], footwear, shoes, slippers, sandals, headgear, hats, caps with visors, berets, caps [headwear], skull caps, enabling customers to conveniently view and purchase those goods, such services may be provided by retail stores, wholesale outlets, by means of electronic media or through mail order catalogues.

(260) AM 2022 114666 A  
 (800) 1608034  
 (151) 2021 05 27  
 (891) 2021 08 10  
 (731) SANOFI  
 54 rue La Boétie, F-75008 Paris, France  
 (540)

## AMTRUMEERA

(591) Black, white  
 (511)  
 5 – Pharmaceutical product.

(260) AM 2022 114667 A  
 (800) 1608037  
 (151) 2021 05 27  
 (891) 2021 08 17  
 (731) SANOFI  
 54 rue La Boétie, F-75008 Paris, France  
 (540)

## AMJOURNA

(591) Black, white  
 (511)  
 5 – Pharmaceutical product.

(260) AM 2022 114702 A  
 (800) 1614305  
 (151) 2021 08 12  
 (891) 2021 08 12  
 (731) LABORATORIO PHFORMULA  
 INTERNACIONAL, S.L.  
 C. Comerç, 27, E-08003 BARCELONA,  
 Spain

(540)

## ARTOLOGIST

(591) Black, white  
 (511)

41 – Teaching and training services; training relating to health and wellbeing; training and education in the field of medicine; conducting educational events; organization of presentations for educational purposes; organization and conducting of award ceremonies; organization and conducting of competitions; organization and conducting of congresses; organization and conducting of seminars; organization and conducting of training workshops; publication of educational material; publication services (including electronic publishing services).

44 – Consultancy regarding body and beauty care; consultancy and advisory services relating to beauty services; beautician services; hygiene and beauty services; medical services; services for skin care; beauty treatment.

(260) AM 2022 114706 A  
 (800) 1614451  
 (151) 2021 04 19  
 (891) 2021 04 19  
 (731) HUGO BOSS Trade Mark Management GmbH  
 & Co. KG  
 Dieselstraße 12, 72555 Metzingen, Germany  
 (540)



(591) Black and white  
 (531) 26.04.02; 26.04.05; 26.04.18; 26.04.24;  
 27.05.17; 27.05.24

(511)  
 9 – Spectacles and parts therefor; spectacle cases; cell phone cases; laptop cases; smartwatches and software; mobile apps; wearable activity trackers; electronic pens; ear phones; ear plugs; alarm bells; films; downloadable image files; electronic magazines; downloadable music files; podcasts; usb web keys; communications headsets; microphones for communication devices; mobile data receivers; digital optical transmission apparatus; cd storage wallets; digital notepads; electronic memories; labels with integrated rfid chips; labels carrying magnetically recorded or encoded information; labels with machine-readable codes; cases for music storage devices; memory sticks; headsets for virtual reality games; electronic book reader covers; smart speakers; mp4 players; headphones; wireless headphones; in-ear headphones; headphones for

smart phones; cases for headphones; noise cancelling headphones; wireless headsets for smartphones; telephone headsets; headphone-microphone combinations; loudspeakers; cabinets for loudspeakers; wireless speakers; portable speaker docks.

14 – Precious metals and their alloys and goods of precious metals or coated therewith (included in this class); jewellery; clocks and watches; jewellery boxes and watch boxes; alarm clocks; cuff links.

16 – Paper, cardboard and goods made from these materials (included in this class); hangtags; printed matter; bookbinding material; photographs [printed]; office requisites, except furniture; pencil sharpeners, electric or non-electric; drawing rulers; punches [office requisites]; rubber erasers; stamp pads; pads [stationery]; bags [envelopes, pouches] of paper or plastics, for packaging; packing [cushioning, stuffing] materials of paper or cardboard; packing paper; containers of plastic, paper or cardboard for packaging; money clips; stickers.

18 – Leather and imitations of leather, and goods made of these materials (included in this class), in particular small leather goods; trunks and travelling bags; bags; umbrellas and parasols; luggage, bags, wallets and carrying bags.

24 – Woven fabrics and textile goods, included in this class, in particular handkerchiefs and hand towels; bed and table linen; wall hangings of textile; bed blankets and curtains of textile materials.

25 – Clothing for men, women and children; stockings; headgear; underwear; nightwear; swimwear; bathrobes; belts; shawls; accessories, in particular headscarves, neck scarves, shawls, dress handkerchiefs [pocket squares]; ties; gloves; shoes; belts of leather.

35 – Business management; sales consultancy; wholesale and retail services in relation to clothing, footwear, headgear and clocks and watches, spectacles, fashion accessories, cosmetics and perfumery, goods of leather, bags, bed linen, home textiles, household articles, stationery, luggage, sporting articles and smoking articles; marketing services; market research and market analysis; advertising; sales promotion; rental of advertising space; distribution of goods and advertising material for advertising purposes, including via electronic media and via the internet; presentation of goods, in particular shop and shop window dressing; organization of exhibitions for commercial or advertising purposes; promotion of business relationships by providing of commercial and business contacts; advice and advisory services for consumers; business consultancy and administration; business organization consulting; professional business consulting; fashion consultancy; organization of fashion shows for commercial, industrial and advertising purposes; management of retail stores in relation to clothing, footwear, headgear and clocks and watches,

spectacles, fashion accessories, cosmetics and perfumery, goods of leather, bags, bed linen, home textiles, household articles, stationery, luggage, sporting articles and smoking articles; online wholesale and retail services and online ordering services in relation to clothing, footwear, headgear and clocks and watches, spectacles, fashion accessories, cosmetics and perfumery, goods of leather, bags, bed linen, home textiles, household articles, stationery, luggage, sporting articles and smoking articles; mail ordering services and computerized online-ordering services in relation to clothing, footwear, headgear and clocks and watches, spectacles, fashion accessories, cosmetics and perfumery, goods of leather, bags, bed linen, home textiles, household articles, stationery, luggage, sporting articles and smoking articles.

(260) AM 2022 114708 A

(800) 1614530

(151) 2021 07 14

(891) 2021 07 14

(731) Apple Inc.

One Apple Park Way, Cupertino CA 95014,  
USA

(540)



(591) Black, white

(531) 24.15.21; 26.04.04; 26.04.16; 26.04.18;  
26.11.22

(511)

42 – Design and development of computer hardware, software, and peripherals; computer programming; electronic data storage; cloud computing services; providing virtual computer systems and virtual computer environments through cloud computing; providing online non-downloadable software; providing computer hardware or software information online.

(260) AM 2022 114709 A

(800) 1614602

(151) 2021 06 07

(891) 2021 06 07

(731) Obshchestvo s ogranichennoy otvetstvennostyu  
"KRAUN"

Novokosinskaya street, 20, 2, pom. IB/1,  
RU-111672 Moscow, Russian Federation

(540)

**SAPPHIRE CROWN**

(591) Black, white

(511)  
34 – Hookah tobacco; tobacco mixtures for hookahs; hookahs accessories included in this class; flavourings, other than essential oils, for tobacco.

(260) AM 2022 114715 A

(800) 1614942  
(151) 2021 07 22  
(891) 2021 07 22

(731) SHENZHEN WIZMAKER TECHNOLOGY CO., LTD  
401, 4F of Ahoke Nebula Industrial Park,  
No.38 Huaxing Rd, Henglang Community,  
Dalang St., Longhua Dist, Shenzhen,  
Guangdong, China

(540)

**WIZMAKER**

(591) Black, white

(531) 27.05.01

(511)

7 – 3d printers; 3d printing pens; proofing machine; food processors, electric; metalworking machines; machines for processing plastics; engraving machines; cutting machines; machines for the electronic industry.

(260) AM 2022 114716 A

(800) 1614957  
(151) 2021 07 06  
(891) 2021 07 06

(731) SHENZHEN TRANSSION TECHNOLOGY LIMITED  
Room 03, 23/F, Unit B Building, No 9,  
Shenzhen Bay Eco-Technology Park, Yuehai  
Street, Nanshan District, 518000 Shenzhen  
City, China

(540)

**Transsion**

(591) Black, white

(531) 26.11.08; 27.05.11

(511)

9 – Tablet computers; headphones; measuring instruments; video screens; alarms; computers; computer memory devices; telephone apparatus; hands-free kits for telephones; radiotelephony sets; cell phones; smartphones; electric apparatus for commutation; electrolyzers; fire extinguishers; measures; selfie sticks [hand-held monopods]; electronic collars to train animals; phototelegraphy apparatus; weighing apparatus and instruments; electronic notice boards; radiological apparatus for industrial purposes; transparencies [photography]; pedometers; materials for electricity mains [wires, cables]; battery chargers; batteries, electric.

(260) AM 2022 114718 A

(800) 1615037  
(151) 2021 06 22  
(891) 2021 06 22

(731) KYUNG DONG NAVIEN CO., LTD.

95, Suworam-gil, Seotan-myeon, Pyeongtaek-si  
Gyeonggi-do, Republic of Korea

(540)

**NAVIEN**

(591) Black, white

(511)

9 – Headset for mobile communication; humanoid robot with artificial intelligence; clothing for protection against accidents, irradiation and fire; home network controller; digital cameras for door; DNA chips; electronic collars to train animals; abacuses; protective shoes; locks, electric; carpenters' rules; physical and chemical laboratory apparatus and instruments; optical apparatus and instruments except for glasses and photographic apparatus; photographic apparatus and instruments; precision measuring apparatus; spectacles [optics]; time recording apparatus; coin change dispensers; life jackets; automatic fire extinguishing apparatus; fire engines; alarms; instruments for monitoring traffic; aqualungs; electrified fences; egg-candlers; ionization apparatus not for the treatment of air or water; electrical controlling devices; solar modules; neon signs; electric batteries; electricity measuring apparatus and instruments; cables, electric; electric door bells; electric audio and visual apparatus and instruments; software for controlling heating and cooling equipment; computer hardware and computer peripheral devices; electronic circuit boards; electric plugs; video game cartridges; mouth guards for boxing; gloves for protection against accidents; protection masks; electronic media featuring music performance; metronomes; encoded smart cards; downloadable tickets; photographic film [exposed]; downloadable electronic manuals; thermal controls [thermostats]; electronic remote control apparatus; automatic combustion control apparatus; electricity distribution/control apparatus and instruments; electronic controllers; communications controllers; server for home network system; electronic security system for home network; air analysis apparatus; measuring and control devices for air-conditioning technology; automatic controlling devices for the temperature of boilers; interphones; thermostats; video door phone system; video telephones; processed glass for non-construction; fire boats; wireless earphone (Bluetooth); telecommunication equipment.

11 – Heating and cooling systems for aircrafts; heating and cooling systems for railway vehicles; heating and cooling systems for motor cars, not being parts of engines or motors; heat guns; sterilizers for household purposes; air purifying apparatus; beverage cooling apparatus; heater for drying furnace; cooling installations for tobacco; gas regulators; electric lighting

apparatus; electric space cooling apparatus; hand-held electric hair dryers; gas lighters; apparatus for heating/ventilating and air conditioning; ventilation devices and installations; heat pumps; heat exchangers, other than parts of machines; cool boxes, electric; gas ranges; sink units; luminous house numbers; aquarium filtration apparatus; toilet bowls; heaters for heating irons; air conditioners for household purposes; bath tubs; beds for sauna; pocket warmers; dental ovens; medical sterilizer; gas grills; lighting equipment for bicycles; agricultural drying equipment; apparatus for dehydrating food waste; electric hot water boiler mats for household purposes; water heaters for household purposes; electric heating water mats for household purposes; domestic boilers; ventilating installations; non-electric lighting apparatus and devices; washers for water faucets; drainage treatment apparatus for household purposes; toilets, portable; heating apparatus and devices for laboratory use; cooling apparatus for ships; non-electric water purifiers for household purposes; non-electric water purifier filters for household purposes; electric water purifiers for household purposes; electric water purification filters for household purposes; water purifiers for household purposes; water purifier filters for industrial purpose; water purifier for commercial purpose; micro filters for water treatment; water treatment apparatus; sewage treatment devices.

35 – Price comparison services; retail store services featuring gas leak alarms; retail store services featuring electric heating water mats for household purposes; retail store services featuring household air cleaners; retail store services featuring domestic boilers; retail store services featuring water heaters for household purposes; retail store services featuring air circulation equipment; retail store services featuring air purifiers; retail store services featuring filters for air purifiers; retail store services featuring air conditioning units; retail store services featuring filters for air conditioning unit; retail store services featuring filters for household air cleaners; advertising and business management consultancy; advertising and commercial information services; retail store services featuring apparatus for heating/ventilating and air conditioning; retail store services featuring closed circuit television cameras for doors; retail store services featuring automatic controlling devices for the temperature of boilers; retail store services featuring video telephones; providing business and marketing information; providing commercial information and advice for consumers in the choice of products and services; providing information for other sales of goods; accountancy advice relating to taxation; import and export agencies; retail store services featuring smart remote controllers; retail store services featuring application software for smartphones; retail store services featuring temperature control apparatus [electric switches]; auctioneering provided on the internet; retail store services featuring remote multi switches; promoting the

goods and services of others by means of operating an on-line comprehensive shopping mall; retail store services featuring interphones; retail store services featuring electrical heating apparatus; retail store services featuring electric entrance access control systems; business intermediary services relating to mail order by telecommunications; telephone order taking services for others; compilation of information into computer databases; personnel recruitment services and employment agencies; computerized on-line ordering services; retail store services featuring home network devices; retail store services featuring fire alarms.

37 – Repair and maintenance of gas ranges; cleaning of household air cleaners; repair and maintenance of electric ovens for household purposes; installation of household air cleaners; repair of household air cleaners; repair and maintenance of drainage treatment apparatus for household purposes; installation of household heating boilers; repair of household heating boilers; cleaning of household heating boilers; repair and maintenance of non-electric water purifiers for household purposes; repair and maintenance of electric bidets for household purposes; repair and maintenance of ventilating fans for household use; installation of air circulation equipment; repair of air circulation equipment; cleaning of air circulation equipment; repair and installation of air purifiers; repair of air purifiers; cleaning of air purifiers; repair of filters for air purifiers; installation of filters for air purifiers; cleaning of filters for air purifiers; repair and maintenance of air purifying apparatus; repair of air conditioning apparatus; installation of air conditioning apparatus; air conditioning apparatus cleaning services; installation of filters for air conditioning unit; repair of filters for air conditioning unit; cleaning of filters for air conditioning unit; repair of filter for household air cleaners; installation of filters for household air cleaners; cleaning of filters for household air cleaners; repair and maintenance of filters for air extractor hoods; construction services relating to the installation of heating, ventilating and air conditioning systems; repair of apparatus for heating, ventilating and air conditioning; installation of apparatus for heating, ventilating and air conditioning; repair and maintenance of apparatus for heating, ventilating and air conditioning; cleaning of apparatus for heating, ventilating and air conditioning; repair and maintenance of refrigerating appliances and installations; repair and maintenance of cooking apparatus and installations; repair and maintenance of beverage-cooling apparatus; repair and maintenance of apparatus for dehydrating food waste; repair and maintenance of disposable pocket warmers; repair and maintenance of electric air purifiers; repair and maintenance of ventilating installations; repair and maintenance of installations for ventilation; general construction; construction of gas storage tanks; installation, maintenance and repair of temperature control apparatus; installation, maintenance and repair of CCTV camera for doors; insta-

llation, maintenance and repair of fire alarms; retail services for home networking apparatus; installation, maintenance and repair of video phones; installation, maintenance and repair of smart remote controllers; installation, maintenance and repair of remotely controlled multi-function switches; installation, maintenance and repair of intercoms; installation, maintenance and repair of electric entrance access control device.

(260) AM 2022 114720 A  
 (800) 723488  
 (151) 1999 05 12  
 (891) 2021 08 23  
 (731) Till Juan BOADELLA  
 Benzenrüti 6, CH-9410 Heiden, Switzerland  
 (540)



**BIOSYNTHESIS**

(591) Blue, green, red, violet, black  
 (531) 01.15.09; 26.04.01; 27.05.01; 29.01.01;  
 29.01.03; 29.01.04; 29.01.06  
 (511)  
 16 – Instructional and teaching materials (excluding apparatus); printed matter, particularly magazines and books.  
 41 – Educational and training services.  
 42 – Hygienic care; services of a psychologist, particularly psychotherapy, body-psychotherapeutics, vital psychological advice, psychosocial and spiritual character development, psychological advice on communication.

(260) AM 2022 114721 A  
 (800) 863055  
 (151) 2005 07 08  
 (891) 2021 08 05  
 (731) MANI, Inc.  
 8-3 Kiyohara Industrial Park, Utsunomiya,  
 Tochigi 321-3231, Japan  
 (540)



(591) Black, white  
 (531) 27.05.01  
 (511)  
 10 – Acupuncture needles; apparatus for use in medical analysis; arterial blood pressure measuring

apparatus; apparatus for artificial respiration; artificial skin for surgical purposes; artificial teeth; sets of artificial teeth; blood testing apparatus; appliances for washing body cavities; dental burs; cannulae; cases, fitted for medical instruments; cases, fitted for use by surgeons and doctors; castrating pincers; catgut; catheters; obstetric apparatus for cattle; clips (surgical); corn knives; cutlery (surgical); defibrillators; dental apparatus; dental apparatus, electric; dentures; diagnostic apparatus for medical purposes; dialyzers; drainage tubes for medical purposes, electric acupuncture instruments; electrocardiographs; electrodes for medical use; enema apparatus for medical purposes; fleams; forceps; galvanic belts for medical purposes; galvanic therapeutic appliances; gastroscopes; heart pacemakers; heating cushions (pads), electric, for medical purposes; hematimeters; hot air therapeutic apparatus; hot air vibrators for medical purposes; hypodermic syringes, inhalers; injectors for medical purposes; instrument cases for use by surgeons and doctors; artificial jaws; knives for surgical purposes; lancets; lasers for medical purposes; lenses (intraocular prostheses) for surgical implantation; medical apparatus and instruments; medical guidewires, spoons for administering medicines; mirrors for dentists; mirrors for surgeons; needles for medical purposes; obstetric apparatus; ophthalmometers; ophthalmoscopes; orthodontic appliances; orthopaedic articles; pins for artificial teeth; saws for surgical purposes; scalpels; scissors for surgery; tongue scrapers; surgical apparatus and instruments; surgical implants (artificial materials); suture materials; suture needles; syringes for injections; syringes for medical purposes; thread (surgical); traction apparatus for medical purposes; trocars; armchairs for medical or dental purposes; brushes for cleaning body cavities; clothing especially for operating rooms; apparatus for the treatment of deafness; dentists' armchairs; gloves for medical purposes; operating tables; urological apparatus and instruments; veterinary apparatus and instruments.

(260) AM 2022 114722 A  
 (800) 930211  
 (151) 2007 06 21  
 (891) 2021 08 24  
 (731) Harvia Finland Oy  
 Teollisuustie 1-3, FI-40950 Muurame, Finland  
 (540)



(591) Black, white  
 (531) 27.05.01  
 (511)  
 9 – Electric checking, supervision and regulating apparatuses, thermometers (not for medical purposes).  
 11 – Apparatus for heating, steam generating and cooking.



19 – Non-metallic building materials, prefabricated building elements (non-metallic), ready made buildings (non-metallic).

(260) AM 2022 114723 A

(800) 1251930

(151) 2015 04 22

(891) 2021 08 06

(731) DUCKSTONE LTD

22 Brondesbury Park, London NW6 7DL,  
United Kingdom

(540)

## MORELLI

(591) Black, white

(511)

6 – Buckles of common metal [hardware]; locks of metal, other than electric; latches of metal; works of art of common metal; doors of metal; door bolts of metal; furniture casters of metal; door fittings of metal; door casings of metal; buildings, transportable, of metal; door knockers of metal; door bells of metal, non-electric; keys; lintels of metal; partitions of metal; strap-hinges of metal; door panels of metal; sills of metal; door closers, non-electric; door openers, non-electric; runners of metal for sliding doors; door handles of metal; door stops of metal; fittings of metal for furniture; hooks of metal for clothes rails.

9 – Peepholes [magnifying lenses] for doors.

11 – Bath fittings; bath installations.

19 – Doors, not of metal; folding doors, not of metal; door panels, not of metal; sills, not of metal; buildings, transportable, not of metal; partitions, not of metal; lintels, not of metal; works of art of stone, concrete or marble.

20 – Furniture; furniture of metal; office furniture; school furniture; coatstands; furniture fittings, not of metal; door fittings, not of metal; locks, other than electric, not of metal; door bolts, not of metal; latches, not of metal; furniture casters, not of metal; door handles, not of metal; mirrors [looking glasses]; hand-held mirrors [toilet mirrors]; washstands [furniture]; racks [furniture]; shelves for storage; towel closets [furniture]; towel dispensers, fixed, not of metal; screens [furniture]; boxes of wood or plastic; works of art of wood, wax, plaster or plastic; curtain rods; clothes hooks, not of metal.

21 – Towel rails and rings; soap holders; napkin holders; shaving brush stands; toilet paper holders; soap dispensers; soap boxes; ceramics for household purposes; works of art of porcelain, ceramic, earthenware or glass; toilet cases; toilet utensils; cosmetic utensils; toilet paper dispensers; utensils for household purposes; boxes of metal, for dispensing paper towels; garbage cans; brushes; aerosol dispensers, not for medical purposes.

35 – Retail or wholesale services for locking hardware; retail or wholesale services for doors and door fittings; retail or wholesale services for furniture and furniture fittings; procurement services for others [purchasing goods and services for other businesses].

(260) AM 2022 114724 A

(800) 1254033

(151) 2015 04 22

(891) 2021 08 06

(731) DUCKSTONE LTD

22 Brondesbury Park, London NW6 7DL,  
United Kingdom

(540)

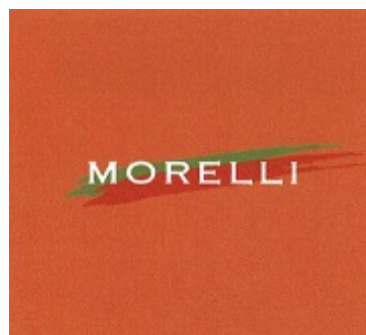

(591) Orange, white, red and green

(531) 26.13.01; 27.05.24; 29.01.13

(511)

6 – Buckles of common metal [hardware]; locks of metal, other than electric; latches of metal; works of art of common metal; doors of metal; door bolts of metal; furniture casters of metal; door fittings of metal; door casings of metal; buildings, transportable, of metal; door knockers of metal; door bells of metal, non-electric; keys; lintels of metal; partitions of metal; strap-hinges of metal; door panels of metal; sills of metal; door closers, non-electric; door openers, non-electric; runners of metal for sliding doors; door handles of metal; door stops of metal; fittings of metal for furniture; hooks of metal for clothes rails.

9 – Peepholes [magnifying lenses] for doors.

11 – Bath fittings; bath installations.

19 – Doors, not of metal; folding doors, not of metal; door panels, not of metal; sills, not of metal; buildings, transportable, not of metal; partitions, not of metal; lintels, not of metal; works of art of stone, concrete or marble.

20 – Furniture; furniture of metal; office furniture; school furniture; coatstands; furniture fittings, not of metal; door fittings, not of metal; locks, other than electric, not of metal; door bolts, not of metal; latches, not of metal; furniture casters, not of metal; door handles, not of metal; mirrors [looking glasses]; hand-held mirrors [toilet mirrors]; washstands [furniture]; racks [furniture]; shelves for storage; towel closets

[furniture]; towel dispensers, fixed, not of metal; screens [furniture]; boxes of wood or plastic; works of art of wood, wax, plaster or plastic; curtain rods; clothes hooks, not of metal.

21 – Towel rails and rings; soap holders; napkin holders; shaving brush stands; toilet paper holders; soap dispensers; soap boxes; ceramics for household purposes; works of art of porcelain, ceramic, earthenware or glass; toilet cases; toilet utensils; cosmetic utensils; toilet paper dispensers; utensils for household purposes; boxes of metal, for dispensing paper towels; garbage cans; brushes; aerosol dispensers, not for medical purposes.

35 – Retail or wholesale services for locking hardware; retail or wholesale services for doors and door fittings; retail or wholesale services for furniture and furniture fittings; procurement services for others [purchasing goods and services for other businesses].

(260) AM 2022 114725 A

(800) 1288429

(151) 2015 10 22

(891) 2021 09 03

(731) CERERIA TRENZI EVELINO S.R.L.

Via dei Faggi, 101, I-47082 SAN GIOVANNI  
IN MARIGNANO (RN), Italy

(540)



(591) Black, white

(531) 27.05.10; 27.07.23

(511)

3 – Abrasives; eau de cologne; lavender water; toilet water; scented water; nail art stickers; adhesives for cosmetic purposes; adhesives for affixing false hair; adhesives for affixing false eyelashes; scouring solutions; ammonia [volatile alkali] [detergent]; amber [perfume]; starch glaze for laundry purposes; fabric softeners for laundry use; canned pressurized air for cleaning and dusting purposes; aromatics [essential oils]; flavorings [flavourings] for beverages [essential oils]; cake flavorings [essential oils]; astringents for cosmetic purposes; lipstick cases; balms other than for medical purposes; hair conditioners; bases for flower perfumes; joss sticks; cotton sticks for cosmetic purposes; whitening; laundry blueing; javelle water; carbides of metal [abrasives]; silicon carbide [abrasive]; polishing paper; emery paper; sandpaper; abrasive

paper; volcanic ash for cleaning; non-slipping wax for floors; shoemakers' wax; depilatory wax; mustache wax; laundry wax; polishing wax; parquet floor wax; tailors' wax; shoe wax; polish for furniture and flooring; false eyelashes; make-up powder; mouthwashes, not for medical purposes; hair dyes; colorants for toilet purposes; corundum [abrasive]; quillaia bark for washing; cosmetics; cosmetics for animals; cosmetic preparations for eyelashes; eyebrow cosmetics; cosmetic creams; shoe cream; creams for leather; polishing creams; skin whitening creams; washing soda, for cleaning; bleaching preparations [decolorants] for cosmetic purposes; dentifrices; deodorants for pets; deodorants for human beings or for animals; detergents other than for use in manufacturing operations and for medical purposes; diamantine [abrasive]; heliotropine; badian essence; mint essence [essential oil]; oil of turpentine for degreasing; bergamot oil; ethereal essences; drying agents for dishwashing machines; extracts of flowers [perfumes]; petroleum jelly for cosmetic purposes; massage gels other than for medical purposes; dental bleaching gels; geraniol; cleaning chalk; greases for cosmetic purposes; henna [cosmetic dye]; incense; ionone [perfumery]; hair spray; almond milk for cosmetic purposes; cleansing milk for toilet purposes; scented wood; non-slipping liquids for floors; windshield cleaning liquids; soda lye; after-shave lotions; hair lotions; lip glosses; lotions for cosmetic purposes; shoe polish; mascara; beauty masks; eyebrow pencils; cosmetic pencils; mint for perfumery; decorative transfers for cosmetic purposes; musk [perfumery]; cosmetic kits; neutralizers for permanent waving; oils for toilet purposes; essential oils; essential oils of cedarwood; essential oils of lemon; essential oils of citron; jasmine oil; lavender oil; almond oil; rose oil; oils for perfumes and scents; oils for cleaning purposes; oils for cosmetic purposes; cotton wool for cosmetic purposes; pastes for razor strops; cobblers' wax; hydrogen peroxide for cosmetic purposes; smoothing stones; polishing stones; pumice stone; shaving stones [astringents]; alum stones [astringents]; pomades for cosmetic purposes; potpourris [fragrances]; sun-tanning preparations [cosmetics]; cosmetic preparations for baths; aloe vera preparations for cosmetic purposes; douching preparations for personal sanitary or deodorant purposes [toilettries]; bath preparations, not for medical purposes; laundry glaze; preparations for cleaning dentures; hair straightening preparations; polishing preparations; hair waving preparations; denture polishes; sunscreen preparations; preparations for unblocking drain pipes; scale removing preparations for household purposes; cosmetic preparations for slimming purposes; colour-color-brightening chemicals for household purposes [laundry]; antistatic preparations for household purposes; cosmetic preparations for skin care; depilatory preparations; perfumery; laundry preparations; anti-perspirants [toilettries]; grinding preparations; preparations to make the leaves of plants shiny; fumigation

preparations [perfumes]; laundry bleach; dry-cleaning preparations; make-up preparations; preservatives for leather [polishes]; nail care preparations; cleaning preparations; shaving preparations; toiletries; smoothing preparations [starching]; shining preparations [polish]; laundry soaking preparations; sachets for perfuming linen; wallpaper cleaning preparations; rust removing preparations; leather bleaching preparations; degreasers other than for use in manufacturing processes; make-up removing preparations; paint stripping preparations; lacquer-removing preparations; color-removing preparations; varnish-removing preparations; perfumes; lipsticks; air fragrancing preparations; polishing rouge; safrol; laundry starch; bath salts, not for medical purposes; bleaching salts; tissues impregnated with make-up removing preparations; almond soap; shaving soap; cakes of toilet soap; soap; soap for foot perspiration; antiperspirant soap; deodorant soap; disinfectant soap; medicated soap; soap for brightening textile; shampoos; shampoos for pets; dry shampoos; stain removers; nail polish; emery; bleaching soda; refurbishing preparations; breath freshening sprays; breath freshening strips; cloths impregnated with a detergent for cleaning; floor wax removers [scouring preparations]; talcum powder, for toilet use; abrasive cloth; emery cloth; glass cloth; terpenes [essential oils]; cosmetic dyes; beard dyes; tissues impregnated with cosmetic lotions; turpentine, for degreasing; tripoli stone for polishing; make-up; false nails; fragrances and perfumery; fragrances; eau de cologne; after-shave lotions; cosmetics; incense.

4 – Firelighters; additives, non-chemical, to motor-fuel; dust laying compositions; alcohol [fuel]; non-slipping preparations for belts; anthracite; benzene; benzine; benzol; candles; christmas tree candles; perfumed candles; coal; charcoal [fuel]; carburants; beeswax; carnauba wax; belting wax; illuminating wax; wax [raw material]; industrial wax; ceresine; kerosene; coke; fuel; fuel with an alcoholic base; mineral fuel; dust binding compositions for sweeping; dust absorbing compositions; electrical energy; tinder; petrol; ethanol [fuel]; petroleum ether; fuel gas; gas for lighting; oil-gas; gasoline; diesel oil; producer gas; solidified gases [fuel]; petroleum jelly for industrial purposes; lubricating graphite; industrial grease; lubricating grease; grease for leather; illuminating grease; grease for footwear; lanolin; grease for arms [weapons]; grease for belts; firewood; lignite; ligroin; lubricants; nightlights [candles]; lighting fuel; combustible briquettes; wood briquettes; peat briquettes [fuel]; vaporized fuel mixtures; naphtha; mazut; oleine; fuel oil; lubricating oil; rape oil for industrial purposes; industrial oil; moistening oil; textile oil; oil for the preservation of leather; oil for the preservation of masonry; oils for paints; oils for releasing form work [building]; cutting fluids; coal naphtha; coal tar oil; sunflower oil for industrial purposes; bone oil for industrial purposes; fish oil, not edible; castor oil for industrial purposes; motor oil; coal briquettes; ozocerite [ozokerite];

paraffin; petroleum, raw or refined; coal dust [fuel]; soya bean oil preparations for non-stick treatment of cooking utensils; preservatives for leather [oils and greases]; dust removing preparations; tallow; methylated spirit; stearine; wicks for candles; lamp wicks; paper spills for lighting; peat [fuel]; wood spills for lighting; xylene; xylol; aromatherapy fragrance candles; tealight candles; candles for lighting.

(260) AM 2022 114726 A

(800) 1358292

(151) 2017 05 24

(891) 2021 08 27

(731) Divico Pty Ltd

116 Thomas St, Hampton VIC 3188, Australia

(540)

 The logo for 'life-space' features a stylized leaf icon to the left of the brand name. The word 'life' is in a bold, lowercase sans-serif font, and 'space' is in a regular weight of the same font.

(591) Black, white

(531) 05.03.15

(511)

5 – Beverages adapted for medicinal purposes; dietary food supplements; dietary nutritional supplements; dietary preparations for slimming purposes (medical); dietary protein supplements; dietary supplements; energy drinks (dietary supplements); enzyme dietary supplements; glucose dietary supplements; herbal dietary supplements; mineral dietary supplements for humans; protein dietary supplements; dietetic foods for use in clinical nutrition; food supplements for medical purposes; mineral food supplements; nutritional supplement energy bars; nutritional supplements; protein supplements for humans; vitamin supplements; food for babies; nutritional meal replacement powders; nutritional meal replacements; mineral additives; probiotic bacterial formulations for medical use; probiotic bacterial preparations; vitamins; dietetic substances adapted for medical use.

(260) AM 2022 114727 A

(800) 1512027

(151) 2019 11 29

(891) 2021 09 08

(731) Zhejiang Shichuang Optics Film Manufacturing Co., Ltd.

No. 68 Fangjiadai Road, Economic

Development Zone, Haiyan Town, Jiaxing City,

Zhejiang, China

(540)

 The logo for 'GSWF' consists of the letters G, S, W, and F in a bold, stylized, blocky font. The letters are interconnected and have a slightly irregular, hand-drawn appearance.

(591) Black, white

(531) 27.05.17

(511)  
17 – Anti-dazzle films for windows [tinted films]; weatherstripping; waterproof packings; insulating materials; electrically operated transparent plastic film; plastic film, other than for wrapping; self-adhesive tapes, other than stationery and not for medical or household purposes; compositions to prevent the radiation of heat; gaskets; shock-absorbing buffers of rubber.

(260) AM 2022 114728 A

(800) 1533151

(151) 2020 04 09

(891) 2021 08 19

(731) GARMONIA, Ltd.

Kamennoostrovsky prospect, 37, litera A,  
pom. 7-N No.538, RU-197022 Saint Petersburg,  
Russian Federation

(540)

## SVETINORM

(591) Black, white

(511)

5 – Amino acids for veterinary purposes; amino acids for medical purposes; dietetic substances adapted for medical use; dietary supplements; nutritional supplements; dietary supplements for animals; medicated sweets; medicated animal feed; dietetic beverages adapted for medical purposes; pastilles for pharmaceutical purposes; dietetic foods adapted for medical purposes; pharmaceuticals.

(260) AM 2022 114730 A

(800) 1552654

(151) 2020 07 27

(891) 2021 08 18

(731) GARMONIA, Ltd.

Kamennoostrovsky prospect, 37, litera A,  
pom. 7-N No.538, RU-197022 Saint Petersburg,  
Russian Federation

(540)

## VISULINGUAL

(591) Black, white

(511)

5 – Dietetic substances adapted for medical use; dietary supplements; nutritional supplements; dietetic beverages adapted for medical purposes; veterinary preparations; dietetic foods adapted for medical purposes.

(260) AM 2022 114731 A

(800) 1557571

(151) 2020 07 27

(891) 2021 08 19

(731) GARMONIA, Ltd.

Kamennoostrovsky prospect, 37, litera A,  
pom. 7-N, No538, RU-197022 Saint Petersburg,  
Russian Federation

(540)

## VESUGEN

(591) Black, white

(511)

5 – Amino acids for veterinary purposes; amino acids for medical purposes; dietetic substances adapted for medical use; dietary supplements; nutritional supplements; dietary supplements for animals; medicated sweets; medicated animal feed; dietetic beverages adapted for medical purposes; pastilles for pharmaceutical purposes; dietetic foods adapted for medical purposes; pharmaceuticals.

(260) AM 2022 114732 A

(800) 1557937

(151) 2020 07 27

(891) 2021 08 19

(731) GARMONIA, Ltd.

Kamennoostrovsky prospect, 37, litera A,  
pom. 7-N No538, RU-197022 Saint Petersburg,  
Russian Federation

(540)

## CARTALAX

(591) Black, white

(511)

5 – Amino acids for veterinary purposes; amino acids for medical purposes; dietetic substances adapted for medical use; dietary supplements; nutritional supplements; dietary supplements for animals; medicated sweets; medicated animal feed; dietetic beverages adapted for medical purposes; pastilles for pharmaceutical purposes; dietetic foods adapted for medical purposes; pharmaceuticals.

(260) AM 2022 114733 A

(800) 1577912

(151) 2021 01 15

(891) 2021 09 09

(731) COLAVITA S.p.A.

Via Laurentina Km 23,00, I-00071 Pomezia  
(RM), Italy

(540)

## COLAVITA

(591) Black, white

(511)

29 – Olive oil for food; oils and fats for food; spiced oils; margarine; butter; animal fats for food; pickles; vegetables preserved in oil; pickled vegetables; vegetables, tinned; mixes for making soup; potato-based dumplings; vegetable-based spreads; tomato purée; peeled tomatoes; jams; marmalade.

30 – Pasta; dried pasta; fresh pasta; flour and preparations made from cereals; rice; polenta; semolina;

couscous; flour-based gnocchi; bread; biscuits; tarts; cakes; pastries; baking powder; vinegar; condiments; dressings for salad; pasta sauce; pesto; meat gravies; tomato sauce.

(260) AM 2022 114734 A

(800) 1611620

(151) 2021 06 13

(891) 2021 07 16

(731) Saxo Bank A/S

Philip Heymans Allé 15, DK-2900 Hellerup,  
Denmark

(540)



(591) Blue and white

(531) 25.05.02; 26.04.02; 26.04.07; 26.04.24;  
27.05.01; 29.01.12

(511)

36 – Finance services; monetary affairs; banking; electronic funds transfer; financial management; financial information; financial consultancy; clearing, financial; financing services; financial evaluations [banking]; trusteeship of money; home banking; debt collection; capital investment; mutual funds; factoring; stocks and bonds brokerage; stock exchange quotations; consulting and information concerning insurance; insurance consultancy; business liquidation services, financial; debit card services; issuance of credit cards; payment card services; credit bureau services; hire-purchase financing; loans [financing]; lending against securities; fiscal valuation; cheque verification; safe deposit services; currency trading and exchange services; deposits of valuables; investment banking services.

(260) AM 2022 114763 A

(800) 1615210

(151) 2021 07 07

(891) 2021 07 07

(731) TRINA SOLAR Co., LTD

No. 2 Trina Road, Trina PV Park, Xinbei,  
Changzhou, 213031 Jiangsu, China

(540)

(591) Black, white

(531) 27.05.01; 27.05.10; 27.05.17

(526) Tracker

(511)

6 – Roofing of metal, incorporating photovoltaic cells; poles of metal; buildings, transportable, of metal; reinforcing materials of metal for building; roof coverings of metal; props of metal; frames of metal for building; ironmongery; cantilevered brackets of metal.

(260) AM 2022 114764 A

(800) 1615283

(151) 2021 08 04

(891) 2021 08 04

(731) ZHEJIANG AKKO STAR ELECTRONIC  
TECHNOLOGY CO., LTD

4th floor, 399 Yin Hai Road, Futian street,  
Yiwu City, Zhejiang Province, China

(540)

(591) Black, white

(531) 01.15.03; 27.05.01; 27.05.08; 27.05.17

(511)

11 – Top light; miner's lamp; lamp; fluorescent lamp; led light; electric furnace; air purification devices and machines; drinking water filter; fan (air conditioning); water purification device; water purification equipment and machinery; electric heater; light bulb; searchlight; lantern for lighting; exhaust fan; colorful lamps for festival decoration; flashlight; lighting devices for vehicles.

(260) AM 2022 114765 A

(800) 1615296

(151) 2021 06 11

(891) 2021 06 11

(731) Limited liability company "Stroitel'nye

Noveyshie Energoberegayushchie tehnologii"  
vладение 27, street 9 Maya, RU-398017 city  
Lipetsk, region Lipetsk, Russian Federation

(540)



(591) Yellow, orange, red and black

(531) 07.01.09; 07.01.24; 07.03.20; 27.05.03;  
27.05.11; 29.01.12

(511)

11 – Lampshades; steam accumulators; heat accumulators; defrosters for vehicles; distillation apparatus; desiccating apparatus; hydromassage bath apparatus; disinfectant apparatus; air deodorizing apparatus; tanning apparatus [sun beds]; ionization apparatus for the treatment of air or water; coffee roasters; hand drying apparatus for washrooms; fruit roasters; water purifying apparatus and machines; drying apparatus and installations; drying apparatus; expansion tanks for

central heating installations; flushing tanks; refining towers for distillation; bidets; boilers, other than parts of machines; bath tubs; spa baths [vessels]; bath tubs for sitz baths; waffle irons, electric; roasting spits; water heaters; water flushing installations; air reheaters; extractor hoods for kitchens; acetylene generators; hydrants; burners; acetylene burners; gas burners; burners for lamps; germicidal burners; incandescent burners; oxyhydrogen burners; laboratory burners; oil burners; alcohol burners; hot water bottles; footwarmers, electric or non-electric; bed warmers; pocket warmers; warming pans; roasting apparatus; lampshade holders; stills; showers; gas lighters; lighters; friction lighters for igniting gas; chimney blowers; furnace ash boxes; evaporators; shower cubicles; Turkish bath cabinets, portable; heating apparatus; fireplaces, domestic; chimney flues; air valves for steam heating installations; level controlling valves in tanks; thermostatic valves [parts of heating installations]; electrically heated carpets; light bulbs; light bulbs, electric; solar thermal collectors [heating]; distillation columns; furnace grates; ventilation hoods; ventilation hoods for laboratories; lamp globes; air-conditioning apparatus; air conditioners for vehicles; gas boilers; laundry room boilers; heating boilers; coffee machines, electric; taps; mixer taps for water pipes; forges, portable; lava rocks for use in barbecue grills; lights, electric, for Christmas trees; acetylene flares; safety lamps; gas lamps; curling lamps; germicidal lamps for purifying air; light bulbs for directional signals for vehicles; arc lamps; laboratory lamps; oil lamps; ultraviolet ray lamps, not for medical purposes; miners' lamps; electric lamps; chandeliers; barbecues; watering machines for agricultural purposes; footmuffs, electrically heated; heaters for baths; heaters for heating irons; immersion heaters; brackets for gas burners; anti-splash tap nozzles; heat pumps; filaments for electric lamps; magnesium filaments for lighting; heating filaments, electric; luminous house numbers; heating apparatus for defrosting vehicle windows; hot air bath fittings; bath fittings; loading apparatus for furnaces; kiln furniture [supports]; sauna bath installations; fabric steamers; lamp reflectors; vehicle reflectors; hearths; steam boilers, other than parts of machines; pasteurisers; lamp mantles; sockets for electric lights; coffee percolators, electric; stoves [heating apparatus]; bakers' ovens; hot air ovens; kitchen ranges [ovens]; microwave ovens [cooking apparatus]; microwave ovens for industrial purposes; incinerators; kilns; solar furnaces; dental ovens; furnaces, other than for laboratory use; feeding apparatus for heating boilers; heating plates; cooking stoves; hot plates; heaters, electric, for feeding bottles; aquarium heaters; aquarium lights; clean chambers [sanitary installations]; water intake apparatus; deodorizing apparatus, not for personal use; apparatus for dehydrating food waste; fumigation apparatus, not for medical purposes; gas scrubbing apparatus; oil-scrubbing apparatus; glue-heating appliances; drying apparatus for fodder and forage; water

filtering apparatus; air purifying apparatus and machines; cooking apparatus and installations; lighting apparatus and installations; sanitary apparatus and installations; cooking rings; lighting apparatus for vehicles; light-emitting diodes [LED] lighting apparatus; heating apparatus for solid, liquid or gaseous fuels; heating apparatus, electric; hot air apparatus; steam facial apparatus [saunas]; safety accessories for water or gas apparatus and pipes; regulating and safety accessories for gas apparatus; regulating accessories for water or gas apparatus and pipes; regulating and safety accessories for water apparatus; regulating and safety accessories for gas pipes; roasting jacks; plate warmers; anti-glare devices for vehicles [lamp fittings]; rotisseries; radiator caps; diving lights; washers for water taps; radiators [heating]; central heating radiators; radiators, electric; sinks; disinfectant dispensers for toilets; drip irrigation emitters [irrigation fittings]; light diffusers; nuclear reactors; heat regenerators; pressure water tanks; roasters; lamps; ceiling lights; toilet seats; lighting installations for air vehicles; autoclaves, electric, for cooking; gas scrubbers [parts of gas installations]; lamp glasses; sterilizers; water sterilizers; air sterilizers; air dryers; laundry dryers, electric; hair dryers; malt roasters; tobacco roasters; bread toasters; discharge tubes, electric, for lighting; lamp chimneys; luminous tubes for lighting; pipes [parts of sanitary installations]; flues for heating boilers; boiler pipes [tubes] for heating installations; toilets [water-closets]; toilets, portable; humidifiers for central heating radiators; wash-hand basins [parts of sanitary installations]; toilet bowls; water conduits installations; air-conditioning installations; desalination plants; installations for processing nuclear fuel and nuclear moderating material; watering installations, automatic; water purification installations; purification installations for sewage; steam generating installations; water distribution installations; air filtering installations; swimming pool chlorinating apparatus; water softening apparatus and installations; heating installations; heaters for vehicles; heating installations [water]; polymerisation installations; water supply installations; flare stacks for use in the oil industry; ash conveyor installations, automatic; whirlpool-jet apparatus; aquarium filtration apparatus; cooking utensils, electric; flaming torches; headlights for automobiles; vehicle headlights; filters for air conditioning; filters for drinking water; lights for automobiles; bicycle lights; motorcycle lights; lights for vehicles; electric torches; lanterns for lighting; Chinese lanterns; fountains; ornamental fountains; deep fryers, electric; fittings, shaped, for furnaces; oven fittings made of fireclay; bread-making machines; chromatography apparatus for industrial purposes; kettles, electric; dampers [heating]; carbon for arc lamps; heating elements.

---

(260) AM 2022 114766 A

(800) 1615298

(151) 2021 06 18

(891) 2021 06 18

(731) NOXON S.P.A.

STRADA MOLINO MAGI, 66, 47892

ACQUAVIVA – GUALDICCILOLO,

San Marino

(540)



(591) Black, white

(531) 26.11.02; 26.11.09; 27.05.01

(511)

7 – Packing machines; canning machines; stretch-wrapping machines for applying plastics film to palletised loads; cartoning machines; machines for filling packaging containers; winding machines; industrial robots; lacing machines; bundling machines; machines for manufacturing packaging materials; bottling machines; wrapping machines; taping [tying] machines other than for office use; strapping machines; rolling surfaces [machines] for packages; semi-automatic stretchwrapping machines.

(260) AM 2022 114767 A

(800) 1615326

(151) 2021 08 03

(891) 2021 08 03

(731) SHARP CONSUMER ELECTRONICS,

POLAND SP. Z O.O.

Ostaszewo 57B; PL-87-148 Łysomice, Poland

(540)



(591) Red and black

(531) 26.01.03; 26.01.24; 27.05.01; 27.05.08;

27.05.09; 29.01.12

(511)

9 – Loudspeaker units; battery packs; chargers; cables, electric; electronic cables; audio cable; microphones; audio devices and radio receivers; body harnesses for support when lifting loads; protective and safety equipment; loudspeaker stands [adapted for]; speaker mounting brackets; cabinets for loudspeakers.

(260) AM 2022 114768 A

(800) 1615383

(151) 2021 02 19

(891) 2021 02 19

(731) IŞIK PLASTİK SANAYİ VE DIŞ TİCARET

PAZARLAMA ANONİM ŞİRKETİ

Gebze Organize Sanayi Bölgesi, İhsan Dede

Caddesi 100. Sokak, Gebze, Kocaeli, Turkey

(540)



(591) Red and white

(531) 26.04.09; 26.13.25; 27.05.01; 29.01.12

(511)

17 – Rubber, gutta-percha, gum, asbestos, mica and semi-finished synthetic goods made from these materials in the form of powder, bars, panels and foils included in this class, insulation, stopping and sealing materials: insulation paints, insulation fabrics, insulating tape and band, insulation covers for industrial machinery, joint sealant compounds for joints, gaskets, O-rings for sealing purposes (other than gaskets for motors, cylinders and washer for water taps), flexible pipes made from rubber and plastic; hoses made of plastic and rubber, including those used for vehicles; junctions for pipes of plastic and rubber; pipe jackets of plastic and rubber; hoses of textile material; junctions for pipes, not of metal; pipe jackets, not of metal; connecting hose for vehicle radiators.

(260) AM 2022 114770 A

(800) 1615401

(151) 2021 04 30

(891) 2021 04 30

(731) LAW FIRM "GORODISSKY &amp; PARTNERS"

LTD.

B. Spasskaya Str., 25, bldg. 3, RU-129090

Moscow, Russian Federation

(540)



(591) Light-blue and black

(531) 26.11.08; 28.05; 29.01.12

(511)

9 – Electronic publications, downloadable; electronic publications in the nature of training materials, manuals, reference books, downloadable; magnetic and optical media recorded, including with pre-recorded training materials, manuals and reference books; computer software applications, downloadable; computer software applications for mobile phones, downloadable.

16 – Fountain pens; posters; forms, printed; note books; pads [stationery]; spiral notebooks; wristbands for the retention of writing instruments; pamphlets;

booklets; newsletters; document holders [stationery]; printed publications; calendars; pencils; pencil lead holders; books; envelopes [stationery]; bags [envelopes, pouches] of paper or plastics, for packaging; folders for papers; printed matter; prospectuses.

35 – Business information; business management and organization consultancy; professional business consultancy; news clipping services; organization of exhibitions for commercial or advertising purposes; compilation of information into computer databases; systemization of information into computer databases; information, consultation and advice regarding all of the above services.

36 – Financial valuation of intellectual property assets; consultancy relating to the financial valuation of intellectual property assets; information, consultation and advice regarding all of the above services; financial valuation of intellectual property, including patents, trademarks, utility models, industrial designs, know-how, works of literature and art.

41 – Providing online electronic publications, not downloadable; organization of exhibitions for cultural or educational purposes; arranging and conducting of colloquiums; arranging and conducting of congresses; arranging and conducting of conferences; arranging and conducting of seminars; arranging and conducting of symposiums; organization of competitions [education or entertainment], including competitions in the field of trademarks; electronic desktop publishing; online publication of electronic books and journals; publication of texts, other than publicity texts; translation; information, consultation and advice regarding all of the above services.

45 – Legal services, including notary services; legal audit; legal research; intellectual property consultancy; licensing of intellectual property; licensing of computer software [legal services]; monitoring of intellectual property; legal searches; representation of interests in court and administrative authorities; registration of domain names [legal services]; services of patent attorneys in the field of intellectual property, including inventions, trademarks, appellations of origin, geographical indications, utility models, industrial designs, plant varieties and breeders rights, topology of integrated circuits, technology transfer, copyright, domains, know-how; copyright management; legal advocacy services; alternative dispute resolution services; mediation; monitoring intellectual property rights for legal advisory purposes; legal services, namely legal valuation of intellectual property, including patents, trademarks, utility models, industrial designs, know-how, works of literature and art; information, consultation and advice regarding all of the above services.

---

(260) AM 2022 114771 A  
(800) 1615513  
(151) 2021 06 25  
(891) 2021 06 25  
(731) INDUSTRIA DE DISEÑO TEXTIL, S.A.,  
(INDITEX, S.A.)  
Avenida de la Diputación, Edificio Inditex,  
Arteixo, E-15143 A CORUÑA, Spain  
(540)

## CONFORTLUX

(591) Black, white  
(511)  
25 – Clothing, footwear, headwear; clothing for motorists and cyclists; bibs not of paper; headbands (clothing); bath robes; bathing suits; bathing caps and sandals; boas (clothing); scarves; sports shoes and beach shoes; hoods (clothing); shawls; belts (clothing); money belts (clothing); wet suits for water-skiing; neckties; girdles [corsets]; fur stoles; foulards; caps [headwear]; caps; gloves (clothing); raincoats; girdles (underwear); body linen [garments]; mantillas; stockings; socks; neckerchiefs; furs (clothing); pajamas; soles (for footwear); heels; veils [clothing]; suspenders; layettes (clothing); shoulder wraps; sports jerseys; mittens; ear muffs (clothing); inner soles; wristbands (clothing); dress shields; beach wear; dressing gowns; pockets for clothing; sock suspenders; stocking suspenders; petticoats; tights; aprons (clothing); masquerade costumes; uniforms; cap peaks; wooden shoes; caps; coats; esparto shoes or sandals; non-slip devices for footwear; bath slippers; caps (headwear); blouses; bodysuits (clothing); berets; footmuffs, not electrically heated; lace boots; boots; boot uppers; studs for football boots; half-boots; fittings of metal for footwear; tips for footwear; heelpieces for footwear; shirts; shirt yokes; shirt fronts; T-shirts; short-sleeved tee-shirts; bodices [lingerie]; vests; jackets; fishing vests; stuff jackets; slippers (underwear); ready-made clothing; detachable collars and collars; clothing of leather; clothing of imitation leather; shower caps; slippers; skirts; trousers; ready-made linings (parts of clothing); overcoats (coats); trench coats (clothing); gymnastic shoes; jerseys (clothing); pullovers; sweaters; liveries; muffs (clothing); footwear uppers; pocket squares; parkas; pelerines; pelisses; spats; leggings; knitwear [clothing]; clothing for gymnastics; underwear; sandals; saris; underpants; hats; wimples (clothing); togas; trouser straps; suits; turbans; clothing; slippers; shoes; footwear for sports.

---

(260) AM 2022 114772 A  
(800) 1615561  
(151) 2021 09 01  
(891) 2021 09 01  
(731) Pro Vape  
Tēraudlietuves iela 22, LV-1026 Riga, Latvia



(540)



(591) Black, white

(531) 27.05.01; 27.05.09; 27.05.17

(511)

34 – Liquids for electronic cigarettes; liquid for electronic cigarettes; electronic cigarette liquid [e-liquid] comprised of propylene glycol; electronic cigarette liquid [e-liquid] comprised of vegetable glycerin; liquid nicotine solutions for use in electronic cigarettes; liquid nicotine solutions for electronic cigarettes; liquid solutions for use in electronic cigarettes.

(260) AM 2022 114783 A

(800) 1616035

(151) 2021 03 24

(891) 2021 03 24

(731) THERMOWAY TERMİK CİHAZLAR VE MAK. SAN. TİC. A.Ş.  
ÖMERLİ MAH. ATATÜRK SANAYİ SİTESİ,  
BÖLGESİ PROF. MEHMET BOZKURT,  
CAD. NO:50 HADIMKÖY ARNAVUTKÖY,  
İSTANBUL, Turkey

(540)



(591) Blue, brown, gray, white

(531) 27.05.01; 27.05.09; 27.05.10; 27.05.22;  
29.01.13

(511)

11 – Heating installations using solid, liquid or gas fuels or electricity, central heating boilers, boilers for heating installations, radiators [heating], heat exchangers, not parts of machines, stoves, kitchen stoves, solar thermal collectors [heating]; steam, gas and fog generators, steam boilers, other than parts of machines, acetylene generators, oxygen generators, nitrogen generators; installations for air-conditioning and ventilating; cooling installations and freezers; sanitary installations, taps [faucets], shower installations, toilets [water-closets], shower and bathing cubicles, bath tubs, toilet seats, sinks, wash-hand basins [parts of sanitary installations], washers for water taps; water softening apparatus; water purification apparatus; water purification installations; waste water purification installations; filters for aquariums and aquarium filtration apparatus; industrial type installations for cooking, drying and cooling purposes; pasteurizers and sterilizers.

(260) AM 2022 114840 A

(800) 1616955

(151) 2021 06 18

(891) 2021 06 18

(731) SYNGENTA CROP PROTECTION AG  
Rosentalstrasse 67, CH-4058 Basel, Switzerland

(540)

## ZEREVIDA

(591) Black, white

(511)

5 – Preparations for destroying vermin; insecticides; termiticides; anti-parasitic products; pest control products, namely, pesticides.

(260) AM 2022 114841 A

(800) 1616995

(151) 2021 08 27

(891) 2021 08 27

(731) ISU ABXIS CO., LTD.  
C-5F, 22, Daewangpangyo-ro 712beon-gil,  
Bundang-gu, Seongnam-si, Gyeonggi-do,  
Republic of Korea

(540)

## Fabagal

(591) Black, white

(511)

5 – Vaccines against flu; immunomodulators; vaccines; crude drugs; cardiovascular pharmaceutical preparations; enzymes for medical purposes; enzyme preparations for medical purposes; diagnostic agents for medicinal purposes; medicines for human purposes; pharmaceutical preparations for the treatment of tumours; pharmaceutical preparations for treating Fabry disease; antihypertensives; anti-diabetic pharmaceuticals; antibiotic preparations; antibiotics; anti-cancer preparations; antineoplastics; vasoconstrictors.

(260) AM 2022 114842 A

(800) 1617000

(151) 2021 07 15

(891) 2021 07 15

(731) ETNIA EYEWEAR CULTURE, S.L.  
Enric Morera 42-44, E-08950 ESPLUGUES  
DE LLOBREGAT, Spain

(540)

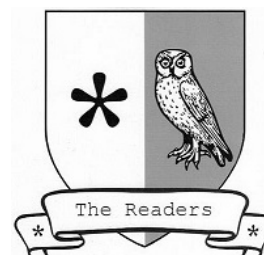

(591) Black, white  
(531) 03.07.05; 03.07.24; 05.05.19; 05.05.20;  
24.01.09; 24.01.10; 24.01.20; 24.17.03;  
25.01.06; 27.05.01

(511)  
9 – Eyewear, namely, eyeglasses, spectacles and sunglasses; alidades; lenses for eyeglasses, spectacles and sunglasses; cases for eyeglasses, spectacles and sunglasses; frames for eyeglasses, spectacles and sunglasses; eyewear instruments, namely, chains for eyeglasses and chains for sunglasses; goggles for sports.

---

(260) AM 2022 114845 A  
(800) 1617077  
(151) 2021 09 08  
(891) 2021 09 08  
(731) Perfetti Van Melle Benelux B.V.  
Zoete Inval 20, NL-4815 HK Breda,  
Netherlands  
(540)

## FRUITTELLA

(591) Black, white  
(511)  
5 – Food supplements; vitamin drops; gummy vitamins; vitamin tablets.

---

(260) AM 2022 114846 A  
(800) 1617114  
(151) 2021 04 27  
(891) 2021 04 27  
(731) SUNTORY HOLDINGS LIMITED  
1-40, Dojimahama 2-chome, Kita -Ku,  
Osaka-Shi, Osaka, Japan  
(540)

## YAMAZAKI

(591) Black, white  
(511)  
33 – Alcoholic beverages (except beers).

---

(260) AM 2022 114847 A  
(800) 1617132  
(151) 2021 09 09  
(891) 2021 09 09  
(731) Park Fragrance LLC  
70 West 36th Street, Suite 4B, New York  
NY 10018, USA  
(540)

## MIND GAMES

(591) Black, white  
(511)  
3 – Fragrances; perfumes.

---

(260) AM 2022 114848 A  
(800) 1617149  
(151) 2021 06 11  
(891) 2021 06 11  
(731) NEXANS  
4 Allée de l'Arche, F-92400 COURBEVOIE,  
France  
(540)

## NEXANS ELECTRIFY THE FUTURE

(591) Black, white  
(511)  
4 – Electrical energy.

9 – Apparatus and instruments for conducting, switching, transforming, accumulating, regulating or controlling the distribution or use of electricity; software for conducting, switching, transforming, accumulating, regulating or controlling the distribution or use of electricity.

37 – Construction, repair, maintenance and installation services in the fields of infrastructure for transport of electrical energy, electric networks; consultation services relating to construction, repair, maintenance and installation of infrastructure for transport of electrical energy, electric networks.

39 – Storage, distribution, transport, shipping and delivery of equipment and cables for transport and distribution of electrical energy, for electric networks; consultation and advisory services in the fields of transport and distribution of electric energy, electric networks; storage, distribution, transport of electrical energy.

42 – Engineering services in the fields of conducting, switching, transforming, accumulating, regulating or controlling the distribution or use of electricity; design of software in the fields of conducting, switching, transforming, accumulating, regulating or controlling the distribution or use of electricity.

---

(260) AM 2022 114849 A  
(800) 1617180  
(151) 2021 05 04  
(891) 2021 05 04  
(731) Apple Inc.  
One Apple Park Way, Cupertino CA 95014, USA  
(540)

## PAGES

(591) Black, white  
(511)  
42 – Providing temporary use of on-line non-downloadable software for creating, editing, and printing documents comprised of text and graphics and utility programs for use therewith.

---

(260) AM 2022 114850 A

(800) 1617218

(151) 2021 06 29

(891) 2021 06 29

(731) Brodetskiy Oleg Vladimirovich

sh. Entuziastov, 11a, korp. 4, kv. 173,

RU-111024 Moscow, Russian Federation

(540)



(591) Blue and red

(531) 27.05.01; 29.01.12

(511)

8 – Forks and spoons; carving forks; table forks; spoons; table knives, forks and spoons for babies; cheese slicers, non-electric; fruit segmenters; egg slicers, non-electric; vegetable knives; pizza cutters, non-electric; scaling knives; fruit corers; tin openers, non-electric; carving knives; vegetable slicers, hand-operated; kitchen mandolines; vegetable peelers, hand-operated; table cutlery [knives, forks and spoons]; vegetable choppers; vegetable spiralizers, hand-operated.

21 – Household or kitchen utensils; cookware and tableware, except forks, knives and spoons; autoclaves, non-electric, for cooking; buckets; cookie jars; whisks, non-electric, for household purposes; funnels; cruets; decanters; toothpick holders; table napkin holders; tea bag rests; cutting boards for the kitchen; bread boards; crushers for kitchen use, non-electric; strainers for household purposes; containers for household or kitchen use; kitchen containers; glass jars [carboys]; heat-insulated containers; heat-insulated containers for beverages; thermally insulated containers for food; glass flasks [containers]; frying pans; closures for pot lids; ceramics for household purposes; works of art made of ceramic; kitchen grinders, non-electric; cleaning instruments, hand-operated; cabarets [trays]; stew-pans; couscous cooking pots, non-electric; baking mats; ladles for serving wine; serving ladles; hot pots, not electrically heated; napkin rings; bread baskets for household purposes; baskets for household purposes; lunch boxes; tea caddies; cauldrons; coffee percolators, non-electric; coffeepots, non-electric; coffee grinders, hand-operated; butter-dish covers; dish covers; cheese-dish covers; reusable silicone food covers; jugs; ice cream scoops; mixing spoons [kitchen utensils]; basting spoons [cooking utensils]; pie servers; spatulas for kitchen use; butter dishes; pepper mills, hand-operated; mills for household purposes, hand-operated; confectioners' decorating bags [pastry bags]; stew pot sets; cake decorating tips and tubes; cookie [biscuit] cutters; pastry cutters; chopsticks; cocktail stirrers; food steamers, non-electric; pepper pots; pestles for kitchen use; droppers for household purposes; dripping pans; trays for household purposes; lazy susans; trivets [table utensils]; coasters, not of paper or textile; grill supports; menu card holders; knife rests for the table; egg cups; pots; cooking pots;

cruet sets for oil and vinegar; spice sets; potholders; grills [cooking utensils]; sifters [household utensils]; salad bowls; beverage urns, non-electric; sugar bowls; beaters, non-electric; egg separators, non-electric, for household purposes; cooking mesh bags, other than for microwaves; sieves [household utensils]; tea strainers; rolling pins, domestic; blenders, non-electric, for household purposes; fruit presses, non-electric, for household purposes; salt cellars; drinking vessels; vessels of metal for making ices and iced drinks; refrigerating bottles; bulb basters; mortars for kitchen use; portable cool boxes, non-electric; soup bowls; tajines, non-electric; graters for kitchen use; insulating flasks; utensils for household purposes; kitchen utensils; cooking utensils, non-electric; coffee filters, non-electric; egg poachers; cake moulds; ice cube moulds; cookery moulds; moulds [kitchen utensils]; bread bins; teapots; kettles, non-electric; garlic presses [kitchen utensils]; corkscrews, electric and non-electric; nutcrackers; ice tongs; salad tongs; sugar tongs; boxes for dispensing paper towels.

(260) AM 2022 114851 A

(800) 1617416

(151) 2021 07 26

(891) 2021 07 26

(731) BEAUTE RESORT

21 rue Le Sueur, F-75116 PARIS, France

(540)



(591) Black, white

(531) 27.05.01; 27.05.17

(511)

3 – Perfuming and cleaning preparations; toiletries; essential oils; aromatic extracts; perfumery products; perfumes; beauty care and body cleaning preparations; preparations for oral hygiene; cosmetics; soaps; hair lotions; dentifrices; make-up removing products; lipstick; beauty masks; shaving products; body deodorants; oils for cosmetic use; hair beauty products; make-up products; nail polish.

(260) AM 2022 114852 A

(800) 1617476

(151) 2021 09 08

(891) 2021 09 08

(731) DR Automobili S.r.l.

Zona Industriale di Macchia di Isernia snc,  
I-86070 Macchia di Isernia (IS), Italy

(540)



(591) Black, white

(531) 05.05.02; 05.05.20; 05.05.22; 15.07.01;  
24.01.03; 24.01.05; 24.01.25; 24.03.07;  
24.13.01

(511)

12 – Vehicles for use on land; transmission shafts for land vehicles; suspension systems for land vehicles; suspension shock absorbers for vehicles; gear boxes for land vehicles; clutches for land vehicles; differential transmissions for land vehicles; gearing for land vehicles; framing for land vehicles; bodies for land vehicles; engines for land vehicles; cardan shafts for vehicles; parts and fittings for land vehicles.

(260) AM 2022 114853 A

(800) 1617492

(151) 2021 03 01

(891) 2021 03 01

(731) PENOPLEX SPb LTD

Saperniy lane, 1, lit. A; RU-191014  
St. Petersburg, Russian Federation

(540)

## ПЕНОПЛЭКС КРОВЛЯ

(591) Black, white

(531) 28.05

(511)

17 – Insulating paper; lute; insulating paints; insulating varnish; latex [rubber]; insulating tapes; asbestos sheets; soundproofing materials; insulating materials; insulating refractory materials; non-conducting materials for retaining heat; insulating plaster; substances for insulating buildings against moisture; chemical compositions for repairing leaks; glass wool for insulation; fiberglass for insulation; insulating fabrics; waterproof packings; foils of metal for insulating; asbestos slate; slag wool [insulator].

19 – Roofing, not of metal; duckboards, not of metal; laths, not of metal; bituminous coatings for roofing; roof coverings, not of metal; roofing tiles, not of metal; slate; roofing slates.

(260) AM 2022 114854 A

(800) 1617628

(151) 2021 08 13

(891) 2021 08 13

(731) SHENZHEN ZHONGFUNENG ELECTRIC  
EQUIPMENT CO., LTD.

4/F,1/F, NO.9 ZHANGBEI AVENUE,  
ZHANGBEI VILLAGE, AILIAN  
COMMUNITY, LONGCHENG STREET,  
LONGGANG DISTRICT, SHENZHEN,  
GUANGDONG, China

(540)

## WISDOM

(591) Black, white

(531) 27.05.01; 27.05.17

(511)

11 – Searchlights; lampshades; lanterns for lighting; safety lamps; lamps; electric lamps; portable head-lamps; diving lights; light-emitting diodes [LED] lighting apparatus; gas lamps; aquarium lights; electric flashlights; lampshades; lighting apparatus and installations; miners' lamps.

(260) AM 2022 114863 A

(800) 1617894

(151) 2021 02 25

(891) 2021 02 25

(731) DEFACTO PERAKENDE TİCARET  
ANONİM ŞİRKETİ

Defacto Plaza Basın Ekspres, Yolu Atatürk  
Mah. Bahariye Cad. No:31, Küçükçekmece  
Küçükçekmece, İstanbul, Turkey

(540)

## DeFacto COOOL

(591) Black, white

(531) 27.05.01

(511)

35 – Advertising; business management; business administration; office functions; the bringing together, for the benefit of others, of a variety of goods including non-medicated cosmetics and toiletry preparations, non-medicated dentifrices, perfumery, essential oils, bleaching preparations and other substances for laundry use, cleaning, polishing, scouring and abrasive preparations, leather and imitations of leather, animal skins and hides, luggage and carrying bags, umbrellas and parasols, walking sticks, whips, harness and saddlery, collars, leashes and clothing for animals, clothing, footwear, headwear enabling customers to conveniently view and purchase those goods, such services may be provided by retail stores, wholesale outlets, by means of electronic media or through mail order catalogues.

(260) AM 2022 114864 A

(800) 1617895

(151) 2021 02 25

(891) 2021 02 25

(731) DEFACTO PERAKENDE TİCARET

ANONİM ŞİRKETİ

Defacto Plaza Basın Ekspres, Yolu Atatürk

Mah. Bahariye Cad. No:31, Küçükçekmece

Küçükçekmece, İstanbul, Turkey

(540)

# DeFacto LIFE

(591) Black, white

(531) 27.05.01

(511)

35 – Advertising; business management; business administration; office functions; the bringing together, for the benefit of others, of a variety of goods including non-medicated cosmetics and toiletry preparations, non-medicated dentifrices, perfumery, essential oils, bleaching preparations and other substances for laundry use, cleaning, polishing, scouring and abrasive preparations, leather and imitations of leather, animal skins and hides, luggage and carrying bags, umbrellas and parasols, walking sticks, whips, harness and saddlery, collars, leashes and clothing for animals, clothing, footwear, headwear enabling customers to conveniently view and purchase those goods, such services may be provided by retail stores, wholesale outlets, by means of electronic media or through mail order catalogues.

(260) AM 2022 114865 A

(800) 1617897

(151) 2021 02 25

(891) 2021 02 25

(731) DEFACTO PERAKENDE TİCARET

ANONİM ŞİRKETİ

Defacto Plaza Basın Ekspres, Yolu Atatürk

Mah. Bahariye Cad. No:31, Küçükçekmece

Küçükçekmece, İstanbul, Turkey

(540)

# DeFacto STUDIO

(591) Black, white

(531) 27.05.01

(511)

35 – Advertising; business management; business administration; office functions; the bringing together, for the benefit of others, of a variety of goods including non-medicated cosmetics and toiletry preparations, non-medicated dentifrices, perfumery, essential oils, bleaching preparations and other substances for laundry use, cleaning, polishing, scouring and abrasive preparations, leather and imitations of leather, animal skins and hides, luggage and carrying bags, umbrellas and parasols, walking sticks, whips, harness

and saddlery, collars, leashes and clothing for animals, clothing, footwear, headwear enabling customers to conveniently view and purchase those goods, such services may be provided by retail stores, wholesale outlets, by means of electronic media or through mail order catalogues.

(260) AM 2022 114866 A

(800) 1617898

(151) 2021 02 25

(891) 2021 02 25

(731) DEFACTO PERAKENDE TİCARET

ANONİM ŞİRKETİ

Defacto Plaza Basın Ekspres, Yolu Atatürk

Mah. Bahariye Cad. No:31, Küçükçekmece

Küçükçekmece, İstanbul, Turkey

(540)

# DeFacto FIT

(591) Black, white

(531) 27.05.01

(511)

35 – Advertising; business management; business administration; office functions; the bringing together, for the benefit of others, of a variety of goods including non-medicated cosmetics and toiletry preparations, non-medicated dentifrices, perfumery, essential oils, bleaching preparations and other substances for laundry use, cleaning, polishing, scouring and abrasive preparations, leather and imitations of leather, animal skins and hides, luggage and carrying bags, umbrellas and parasols, walking sticks, whips, harness and saddlery, collars, leashes and clothing for animals, clothing, footwear, headwear enabling customers to conveniently view and purchase those goods, such services may be provided by retail stores, wholesale outlets, by means of electronic media or through mail order catalogues.

(260) AM 2022 114867 A

(800) 1617899

(151) 2021 02 25

(891) 2021 02 25

(731) DEFACTO PERAKENDE, TİCARET

ANONİM ŞİRKETİ

Defacto Plaza Basın Ekspres, Yolu Atatürk

Mah. Bahariye Cad. No:31; Küçükçekmece

Küçükçekmece; İstanbul, Turkey

(540)

# DeFacto MODEST

(591) Black, white

(531) 27.05.01

(511)

35 – Advertising; business management; business administration; office functions; the bringing together,

for the benefit of others, of a variety of goods including non-medicated cosmetics and toiletry preparations, non-medicated dentifrices, perfumery, essential oils, bleaching preparations and other substances for laundry use, cleaning, polishing, scouring and abrasive preparations, leather and imitations of leather, animal skins and hides, luggage and carrying bags, umbrellas and parasols, walking sticks, whips, harness and saddlery, collars, leashes and clothing for animals, clothing, footwear, headwear enabling customers to conveniently view and purchase those goods, such services may be provided by retail stores, wholesale outlets, by means of electronic media or through mail order catalogues.

(260) AM 2022 114871 A  
 (800) 1617970  
 (151) 2021 06 18  
 (891) 2021 06 18  
 (731) MATRIZE Handels-GmbH  
 Alter Fischmarkt 11, 20457 Hamburg,  
 Germany

(540)



(591) Red, black, white and grey  
 (531) 26.04.02; 26.04.08; 26.04.09; 26.04.12;  
 26.04.18; 26.04.24; 26.11.08; 26.11.12;  
 27.05.17; 27.05.24; 29.01.15

(511)

8 – Tool belts [holders]; waistcoats for holding hand tools and instruments; cases for hand tools and instruments; belts for hand instruments bags; belts for hand instrument cases; wall mounted holders for hand tools and instruments; covers for hand tools and instruments.

12 – Luggage elastic rubber cords for vehicles; luggage straps for vehicles; trunk organizers (vehicle organizers).

18 – Bags; tool bags, empty; shopping bags; wheeled shopping bags; backpacks; business cases.

22 – Braces, not of metal, for handling loads; straps, not of metal, for handling loads; slings, not of metal, for handling loads; strapping for securing loads; cables, not of metal; tie-down straps, not of metal; ropes; cord; string; car towing ropes.

25 – Boots; high boots; sandals; galoshes; footwear for household, building or repair purposes; clothing

for household, building or repair purposes, including combinations, jackets, trousers, waistcoats.

(260) AM 2022 114873 A  
 (800) 1618043  
 (151) 2021 08 03  
 (891) 2021 08 03  
 (731) Apple Inc.  
 One Apple Park Way, Cupertino CA 95014,  
 USA

(540)

## CENTER STAGE

(591) Black, white

(511)

9 – Downloadable computer software for use in videoconferencing and video calls; downloadable computer software used to control and adjust a video camera during videoconferences and video calls.

(260) AM 2022 114874 A  
 (800) 1618119  
 (151) 2021 07 07  
 (891) 2021 07 07  
 (731) Zhejiang Yinlong Vehicle Parts Co., Ltd.  
 No. 51-55, Fenghuang West Road, Tangxia  
 Town, Rui'an City, Wenzhou City, Zhejiang  
 Province, China

(540)



(591) Black, white

(531) 26.01.02; 26.01.04; 26.01.12; 26.07.25;  
 27.05.01

(511)

7 – Carburetors; igniting magnetos; carburetters; internal combustion motors [other than for land vehicles]; gasoline engines not for land vehicles; carburetter feeders; igniting devices for internal combustion engines.

(260) AM 2022 114875 A  
 (800) 1618120  
 (151) 2021 07 16  
 (891) 2021 07 16  
 (731) JOEONE CO., LTD.  
 Qingmengyuan Zone, Quanzhou Economy &  
 Technology, Development Area, Fujian  
 Province, China

(540)

# 九牧王裤王

(591) Black, white

(531) 28.03

(511)

25 – Footwear; hats; hosiery; gloves [clothing]; neckties; belts made of leather; wedding dresses; clothing; layettes [clothing]; bathing suits.

(260) AM 2022 114876 A

(800) 1618157

(151) 2021 07 09

(891) 2021 07 09

(731) Pougacheva Alla Borisovna

Filippovskiy per. 8, str. 1, apt. 49, RU-119019  
Moscou, Russian Federation

(540)

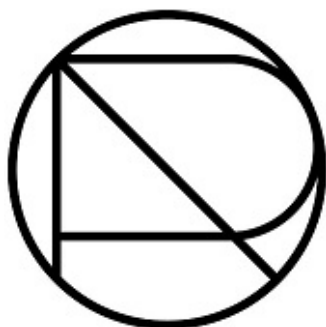

(591) Black, white

(531) 26.01.03; 26.01.12; 26.01.18; 26.11.09;  
26.11.12; 27.05.22

(511)

2 – Dyes for footwear.

3 – Bleaching preparations and other substances for laundry use; cleaning, polishing, scouring and abrasive preparations; soaps; perfumery, essential oils, cosmetics, hair lotions; non-medicated dentifrices; perfumes; eaux de toilette; eau de Cologne; deodorants [perfumery]; hygiene preparations being cosmetics; wipes impregnated with cosmetic preparations; shoemakers' wax; sprays, shoe cream; shoe black [shoe polish]; shoe polish and creams; wipes impregnated with shoe polish and cream; shoe polish applicators containing shoe polish; footwear polish.

4 – Candles and wicks for lighting; decorative candles.

5 – Deodorizers for footwear; deodorants for clothing or textile materials.

9 – Magnetic and optical data storage media; sound recording disks; discs containing video recordings; downloadable electronic publications; downloadable digital content in the nature of electronic publications of periodicals, printed matter; spectacles [optics]; binoculars; spectacle frames; spectacle chains; spectacle

cases; bags designed for notebook computers; notebook computer carrying cases; sleeves for laptops; covers for photographic apparatus; plastic pouches for compact discs; mobile phones including mobile phone covers including batteries for mobile phones, wireless headsets for mobile phones, hands-free holders for cellular phones, mobile phone holders for vehicles, screens for mobile phones; cases for mobile telephones; covers for portable telephones; mobile phone cases made of leather; decorative magnets.

10 – Orthopedic footwear; arch supports for footwear articles; arch supports for boots or shoes; boots for medical use; arch supports for footwear; orthopedic soles.

14 – Imitation jewelry; timepieces and chronometric instruments; medals; boxes for timepieces; watch chains; watch bands; watch bands made of metal, leather or plastic; jewelry charms; amulets [jewelry]; jewelry boxes; jewelry articles; pearls [jewelry]; semi-precious stones; precious stones; shoe ornaments of precious metal.

16 – Printed matter; paper and cardboard; bookbinding material; photographs [printed]; stationery; plastic materials for packaging; fonts; printing blocks; plastic bags for packaging; tissue paper; school supplies; pen cases; pencil cases; boxes of paper; cardboard cartons [boxes]; bags [envelopes, pouches] of paper or plastics, for merchandise packaging; gift boxes of paper; collapsible cardboard boxes; gift boxes of cardboard.

18 – Leather and imitations of leather; traveling trunks; suitcases; umbrellas and parasols; walking sticks; whips, harness and saddlery; collars for animals; suits for animals; business card cases; wallets; bags; traveling bags; haversacks; backpacks; purses; vanity cases, not fitted; hat boxes of leather; boxes of leather or leatherboard; travel sets [leatherware]; pouch baby carriers; garment bags for travel; beach bags; sports bags; bags for campers; key cases; umbrella covers; document cases; travel boot bags; dog shoes; baggage tags of paper.

21 – Household or kitchen utensils and containers; combs and sponges; brushes, except paintbrushes; shoe horns; shoe stretchers of wood; button hooks; shoe shine gloves; shoe shine cloths; wax-polishing appliances, non-electric, for shoes; brushes for polishing footwear; make-up sponges; cleaning sponges; toilet sponges; abrasive sponges for scrubbing the skin; household sponges; spectacle wiping cloths; sponges and cloths for polishing shoes; serving trays; trays for household use; trays for household use of precious metal; trays for domestic use, of metal; trays for domestic use, not of metal; serving trays of precious metals; vases; fruit cups; flower vases; ceramic vases; floor vases; vases of precious metal.

24 – Textiles and substitutes thereof; household linen; curtains of textile or plastic materials; fabrics for

changing babies; picnic blankets; traveling rugs [lap robes]; knit quilts; bed covers; bed blankets; pillow-cases; towels of textile materials; door curtains; tablecloths not of paper; diapered linen; bath linen except clothing; table linen not of paper; cot bumpers [bed linen]; baby bunting [snuggle suits]; sleeping bags; sleeping bag liners; face towels of textile; handkerchiefs of textile; place mats made of textile materials; table napkins of textile; glass cloths; lace table mats not made of paper; pennants of textile materials or plastic materials; table runners not of paper; table mats of textile materials; canvas for tapestry or embroidery.

25 – Clothing; footwear; headwear; underwear; headbands [clothing]; belts [clothing]; masks for sleeping; money belts [clothing]; scarves; shawls; ponchos; sports shoes; wooden shoes [footwear]; galoshes; stockings; socks; stocking suspenders; tights; gaiters; leg warmers; gloves [clothing]; suspenders; shower caps; bathing caps; dressing gowns; ear muffs [clothing]; muffs [clothing]; metal fittings for footwear; soles for footwear; non-slip devices for footwear; tips for footwear; leisure wear; housecoats; flat shoes; pajamas; wool socks with soles; footwear uppers; heelpieces for footwear; heel protectors for footwear.

26 – Lace and embroidery, ribbons and braid; buttons, hooks and eyes, pins and needles; artificial flowers; badges (for wear) not of precious metal; competitors' numbers; decorative articles for the hair; bows for the hair; hair barrettes; Hair ornaments; hair grips; hair pins; heat adhesive patches for decoration of textile articles [haberdashery]; trimmings for clothing; trimmings for headgear; trimmings for footwear; shoe fasteners; zip fasteners; zip fasteners for bags; edgings for clothing; sewing boxes; shoe hooks; shoe laces; metal fasteners for footwear; haberdashery ribbons; numerals or letters for marking linen; bows of textile materials for gift wrapping; charms other than for jewelry and key rings; brooches [clothing accessories]; embroidery for garments; decorative items made of fabric.

28 – Games, toys; gymnastic and sporting articles; cricket bags; golf bags, with or without wheels; golf bag carts; bags especially designed for skis; bags adapted for use with sporting equipment; toy buildings; dolls' houses.

35 – Advertising; online advertising on a computer network; radio advertising; television advertising; company management services; commercial business administration; sales promotion services at point of purchase or sale, for others; promoting the goods and services of others over the Internet; business management of wholesale outlets; wholesale and retail sale store services; online retail sale services in relation to cosmetics; wholesale services for clothing; retail services for clothing; wholesale services for footwear articles; retail sale of footwear; wholesale services for

jewels; retail services for jewelry; organizing and conducting trade shows; organization of exhibitions for commercial or advertising purposes; publication of advertising texts; demonstration of goods; administrative processing of purchase orders; procurement services for others [purchasing goods and services for other businesses]; compilation and systematization of information into computer databases.

(260) AM 2022 114969 A

(800) 1274475

(151) 2015 04 27

(891) 2021 09 21

(731) EASY LIFE S.r.l.

Via Fornaci 4/A-B, I-25040 Monticelli Brusati (BS), Italy

(540)



(591) Black, white

(531) 02.09.01; 11.03.04; 27.05.08

(511)

8 – Hand tools and implements (hand-operated); cutlery, forks and spoons.

21 – Household or kitchen utensils and containers; unworked or partially worked glass; glassware, porcelain and earthenware not included in other classes; coasters of cork.

(260) AM 2022 114970 A

(800) 1417066

(151) 2018 05 14

(891) 2021 09 22

(731) LIUZHOU OVM MACHINERY CO., LTD

No. 1 Yanghui Road, Liuzhou City, GuangXi, China

(540)



(591) Black, white

(531) 26.03.01; 26.03.05; 26.03.24; 27.05.17;

27.05.23

(511)

6 – Reinforcing materials of metal for building; fittings of metal for building; reinforcing materials, of metal, for concrete; rope thimbles of metal; building materials of metal; non-electric cables and wires of common metal; works of art of common metal.



7 – Jacks [machines]; pumps [machines]; cranes [lifting and hoisting apparatus]; elevating apparatus; embossing machines; metal working machines.

17 – Rubber, raw or semi-worked; padding materials of rubber or plastics; washers of rubber; shock-absorbing buffers of rubber; washers of rubber or vulcanized fiber [fibre]; pipe muffers, not of metal; insulating materials; expansion joint fillers; junctions, not of metal, for pipes.

19 – Building materials, not of metal; building stone; reinforcing materials, not of metal, for building; tiles, not of metal, for building; refractory construction materials, not of metal; buildings, not of metal; coatings [building materials]; props, not of metal.

37 – Building construction supervision; construction; upholstering; rustproofing; repair or maintenance of elevators [lifts]; machinery installation, maintenance and repair; harbour construction; heating equipment installation and repair.

(260) AM 2022 114971 A

(800) 1591056

(151) 2021 03 23

(891) 2021 08 31

(731) Abela Pharm d.o.o.

Viline vode bb, Slobodna zona Beograd,

11000 Beograd, Serbia

(540)

## BULAREN

(591) Black, white

(511)

5 – Medicines for human medicine; medicines for veterinary use; drugs for medical purposes.

(260) AM 2022 115029 A

(800) 1619866

(151) 2021 06 08

(891) 2021 06 08

(731) Fresenius Kabi AG

Else-Kröner-Str. 1, 61352 Bad Homburg,

Germany

(540)

## PRODAPT

(591) Black, white

(511)

5 – Pharmaceutical preparations in medical containers with the exception of oncological pharmaceutical products; pharmaceutical additive solutions for medical use with the exception of oncological pharmaceutical products.

10 – Medical containers for the administration of pharmaceutical preparations; instruments, apparatus, adapter, connecting parts for the delivery, administration of pharmaceutical preparations.

(260) AM 2022 115030 A

(800) 1619871

(151) 2021 09 14

(891) 2021 09 14

(731) Aktsionernoe Obschestvo "Nizhegorodsky khimiko-farmatsevtichesky zavod"

Salganskaya St., 7, RU-603950 Nizhny

Novgorod, Russian Federation

(540)

## ФУНГОДЕРИЛ

(591) Black, white

(531) 28.05

(511)

5 – Dietetic substances adapted for medical use; mineral food supplements; nutritional supplements; albumin dietary supplements; capsules for medicines; cachets for pharmaceutical purposes; liniments; ointments for pharmaceutical purposes; drugs for medical purposes; medicines for human purposes; albuminous preparations for medical purposes; biological preparations for medical purposes; vitamin preparations; preparations of trace elements for human and animal use; pharmaceutical preparations; chemico-pharmaceutical preparations; chemical preparations for medical purposes; chemical preparations for pharmaceutical purposes; albuminous foodstuffs for medical purposes; dietetic foods adapted for medical purposes; suppositories.

(260) AM 2022 115031 A

(800) 1619873

(151) 2021 08 30

(891) 2021 08 30

(731) Obschestvo s ogranichennoi otvetstvennostyu

"Nauchno-proisvodstvennaja company "SKiFF"

Nauchnyj proezd, d.20, str.3, floor 2, pom.204,

RU-117246 Moscow, Russian Federation

(540)

## ПРАЗИТЕЛ

(591) Black, white

(531) 28.05

(511)

5 – Vermin destroying preparations; parasiticides; antiparasitic preparations; veterinary preparations; biological preparations for veterinary purposes; chemical preparations for veterinary purposes; chemical reagents for medical or veterinary purposes; drugs for medical purposes; medicines for veterinary purposes; medicines for human purposes; medicinal drinks; pharmaceutical preparations.

(260) AM 2022 115032 A  
 (800) 1619893  
 (151) 2021 08 24  
 (891) 2021 08 24  
 (731) Ningbo Longjia Motorcycle Co., Ltd.  
 Zonghan Industrial Zone, Cixi City, Zhejiang  
 Province, China

(540)  
**VICTORIA MOTORRAD**

(591) Black, white  
 (531) 27.05.01  
 (511)  
 12 – Electric tricycles; electric vehicles; motorized tri-  
 cycles; vehicles for locomotion by land, air, water and  
 rail; motorcycles; electric motorcycles; motorcycle  
 saddles; motorcycle frames; motorcycle engines; au-  
 tomobiles.

(260) AM 2022 115033 A  
 (800) 1619903  
 (151) 2021 08 30  
 (891) 2021 08 30  
 (731) Joint Stock Company  
 "OBNINSKORGSINTEZ"  
 Kievskoye Shosse, 57, Obninsk, RU-249030  
 Kaluga region, Russian Federation

(540)  
**La isla Bonita**

(591) Black, white  
 (511)  
 3 – Soap; laundry bleaching preparations; cleaning  
 preparations; preparations for unblocking drain pipes;  
 chemical cleaning preparations for household purpo-  
 ses; scouring solutions; detergents, other than for use  
 in manufacturing operations and for medical purpo-  
 ses; douching preparations for personal sanitary or  
 deodorant purposes; toiletry preparations.

(260) AM 2022 115036 A  
 (800) 1619953  
 (151) 2021 06 10  
 (891) 2021 06 10  
 (731) Egis Gyógyszergyár Zrt.  
 Keresztúri út 30-38., H-1106 Budapest,  
 Hungary

(540)  
**НИДИЛИОН**

(591) Black, white  
 (531) 28.05  
 (511)  
 3 – Cosmetics and cosmetic preparations.  
 5 – Human pharmaceutical preparations; dietetic sub-  
 stances adapted for medical use; dietary supplements;

medicinal ointments; medicated skin creams; plasters,  
 materials for dressings.

(260) AM 2022 115038 A  
 (800) 1619956  
 (151) 2021 06 10  
 (891) 2021 06 10  
 (731) Egis Gyógyszergyár Zrt.  
 Keresztúri út 30-38, H-1106 Budapest, Hungary

(540)  
**РАМИКОМЪ**

(591) Black, white  
 (531) 28.05  
 (511)  
 5 – Human pharmaceutical preparations.

(260) AM 2022 115039 A  
 (800) 1619958  
 (151) 2021 06 10  
 (891) 2021 06 10  
 (731) Egis Gyógyszergyár Zrt.  
 Keresztúri út 30-38, H-1106 Budapest, Hungary

(540)  
**АЛЬБАЛИВА**

(591) Black, white  
 (531) 28.05  
 (511)  
 3 – Cosmetics and cosmetic preparations.  
 5 – Human pharmaceutical preparations; dietetic sub-  
 stances adapted for medical use; dietary supplements;  
 medicinal ointments; medicated skin creams; plasters,  
 materials for dressings.

(260) AM 2022 115077 A  
 (800) 1621375  
 (151) 2021 03 24  
 (891) 2021 03 24  
 (731) Reckitt & Colman (Overseas) Health Limited  
 103-105 Bath Road, Slough, Berkshire  
 SL1 3UH, United Kingdom

(540)  
**RECKITT**

(591) Black, white  
 (511)  
 10 – Artificial limbs, eyes and teeth; orthopaedic ar-  
 ticles; sexual activity apparatus, devices and articles;  
 massage apparatus; orthopaedic insoles; orthopaedic  
 cushions; orthotic insoles; orthopaedic compression  
 supports; orthopaedic, orthotic, chiroprody, foot care  
 apparatus and instruments; apparatus for exercising  
 the foot; orthopaedic articles; apparatus for measu-  
 ring, examining and taking impressions of the feet;

body massagers; electrically operated massagers; foot massagers; massage apparatus, instruments and appliances; electric and electronic massage apparatus, instruments and appliances; body massagers; personal massagers; vibrators; vibrating rings; marital aids; sex toys; sex aids; cushions for care of the feet; aids for the correction of the feet including supports for the arch of the foot; apparatus for the separation and the straightening of the toes; apparatus for the fixing of fingers and toes; elastic bandages for joints, elastic gaiters, elastic knee joints, elastic bandages, bandages for the waist, bandages for orthopaedic purposes; protective apparatus against the hardening of areas of skin calluses and inflammation of the toes; cushions for the heels and under-heels; metatarsal cushions; boot inserts, foot rings and foot supports; shoe insoles, orthopaedic insoles, disposable insoles, deodorized insoles for orthopaedic footwear.

29 – Meat, fish, poultry and game; meat extracts; preserved, frozen, dried and cooked fruits and vegetables; jellies, jams, compotes; eggs; milk, cheese, butter, yogurt and other milk products; dairy products; milk substitutes; oils and fats for food; powdered milk; dried milk; milk powder for nutritional purposes; soya-based beverages used as milk substitutes; milk based snack foods; fruit-based snack foods; nut-based snack foods; snacks made from fruit; snacks made from vegetables; snacks made from dairy products; meal-based nutritional products; fruit-based meal replacement bars; nut-based meal replacement bars; dairy-based dips; extracts used for food; fruit purees; vegetable purees; milk; milk-based formula; meat extracts; weed extracts for food; foods prepared from fish; vegetables, tinned [canned]; jams; processed betel nuts; preparations for making soup; powdered eggs; soya milk; milk products; fatty substances for the manufacture of edible fats; fruit jellies; nuts, prepared; dry edible fungus; sausage casings, natural or artificial.

(260) AM 2022 115079 A

(800) 1621530

(151) 2021 06 23

(891) 2021 06 23

(731) Zirax LLC

Svetly Yar workers settlement, md. 4,  
bld. 6, Svetloyarsk district, RU-404171  
Volgograd region, Russian Federation

(540)



(591) Blue and white

(531) 26.04.18; 27.05.01; 29.01.12

(511)

1 – Antifreeze; lime acetate; agglutinants for concrete; gas purifying preparations; water-softening preparati-

ons; adhesives for industrial purposes; chemicals for the manufacture of pigments; gypsum for use as a fertilizer; additives, chemical, to drilling muds; beer preserving agents; paper pulp; beer-clarifying and preserving agents; cement preservatives, except paints and oils; tempering and soldering preparations; fertilizing preparations; preparations of trace elements for plants; enzyme preparations for the food industry; chemical substances for analyses in laboratories, other than for medical or veterinary purposes; chemical preparations for scientific purposes, other than for medical or veterinary use; chemical substances for preserving foodstuffs; drilling muds; chemical reagents, other than for medical or veterinary purposes; unprocessed artificial resins, unprocessed plastics; caustic soda for industrial purposes; salts [fertilizers]; salts [chemical preparations]; salts for industrial purposes; calcium salts; salts of alkaline metals; water-purifying chemicals; condensation-preventing chemicals; horticultural chemicals, except fungicides, herbicides, insecticides and parasiticides; agricultural chemicals, except fungicides, herbicides, insecticides and parasiticides; soil conditioning preparations; industrial chemicals; refrigerants; chlorine; chlorides.

(260) AM 2022 115080 A

(800) 1621635

(151) 2021 08 19

(891) 2021 08 19

(731) NIO CO., LTD.

Suite 115, 569 Anchi Road, Anting Town,  
Jiading District, 201805 Shanghai, China

(540)



(591) Black, white

(531) 26.02.07; 26.13.25; 28.03

(511)

9 – Computer software, recorded; downloadable mobile applications; computer hardware; humanoid robots with artificial intelligence; parking meters; face recognition equipment; automobile data recorders; camcorders; hi-fi equipments; navigation apparatus for vehicles [on-board computers]; electronic control unit for automobile; video screens; remote control apparatus; electronic key fobs being remote control apparatus; theft prevention installations, electric; rechargeable batteries for power electric vehicles; battery charging device; batteries, electric, for vehicles; charging devices for motor vehicles; chargeable battery; car battery; charging stations for electric vehicles.

(260) AM 2022 115082 A  
 (800) 1621738  
 (151) 2021 09 16  
 (891) 2021 09 16  
 (731) Habit Factory in Sweden AB  
 Ostmästargränd 5, SE-120 40 ÅRSTA,  
 Sweden

(540)

## NOTO

(591) Black, white  
 (511)

34 – Tobacco; articles for smoker's; tobacco substitutes (not for medical purposes); snuff and tobacco alternatives in the form of products based on vegetable fibres for oral use, not for consumption; snuff; tobacco free snuff; chewing tobacco; nicotine pouches; herbal snuff.

(260) AM 2022 115084 A  
 (800) 717141  
 (151) 1999 07 20  
 (891) 2021 09 15  
 (731) NV CAPITAL PARTNERS spółka z  
 ograniczoną odpowiedzialnością  
 ul. Powązkowska 44C, PL-01-797 Warszawa,  
 Poland

(540)

## DUKA

(591) Black, white  
 (511)

3 – Bleaching preparations and other substances for laundry use; cleaning, polishing, scouring and abrasive preparations; soaps; perfumery, essential oils, cosmetics, hair lotions; dentifrices.

4 – Industrial oils and greases; lubricants; dust absorbing, wetting and binding compositions; fuels (including motor spirit) and illuminants; candles, wicks.

8 – Hand tools and implements (hand operated); cutlery; table forks and spoons; side arms; razors.

11 – Apparatus and devices for lighting, heating, steam generating, cooking, refrigerating, drying, ventilating, water supply and sanitary purposes.

16 – Paper, cardboard and goods made from these materials, not included in other classes; printed matter; bookbinding material; photographs; stationery; adhesives for stationery and for household purposes; artists' materials; paint brushes; typewriters and office requisites (except furniture); instructional and teaching material (except apparatus); plastic materials for packaging (not included in other classes); playing cards; printers' type; printing blocks.

21 – Household and kitchen utensils and containers (not of precious metal or coated therewith); combs and sponges; brushes (except paint brushes); brush-

making materials; articles for cleaning purposes; steelwool; unworked or semi-worked glass (except glass used in building); glassware, porcelain and earthenware (not included in other classes).

24 – Fabrics and textile goods, not included in other classes; bed and table covers.

30 – Coffee, tea, cocoa, sugar, rice, tapioca, sago, artificial coffee; flour and preparations made from cereals, bread, pastry and confectionery, ices; honey, treacle; yeast, baking-powder; salt, mustard; vinegar, sauces; spices; ice.

(260) AM 2022 115085 A  
 (800) 886215  
 (151) 2006 01 20  
 (891) 2021 09 21  
 (731) ZWILLING J.A. Henckels AG  
 Grünwalder Straße 14-22, 42657 Solingen,  
 Germany

(540)



(591) Black and red

(531) 01.03.01; 28.03; 29.01.12

(511)

8 – Leather strops; flower shears; bread knives; non-electric can-openers; non-electric egg-cutters; table cutlery; non-electric finger nail polishers; carving forks; slicing knives; forks; gardener's shears; poultry shears; vegetable peelers; vegetable knives; non electric hair cutters; cleavers; hand-operated tools; hair scissors; household shears; cuticle scissors; callus removers; hand-operated sharpening instruments; cheese planes; waiter' knives; blades; chef's knives; kitchen shears; spoons; manicure sets; knives; knife cases; knife sharpeners; cutlery; nail files; cuticle tweezers; nail clippers; non-electric nail care instruments; non-electric nail scissors; nail nippers; nail extractors; nut-crackers, not of precious metal; pedicure sets; tweezers; non electric pizza cutters; electric and non-electric razors; razor blades; razor knives; razor sets; santoku knives; peeling knives; scissors; sharpening stones; cutting knives; tailor's shears; asparagus peelers; pocket knives; multi purpose shears; sharpening steels; sharpening rods; mincing knives; eye lash tongs; knife blocks; knife storage systems.

(260) AM 2022 115139 A

(800) 1621974

(151) 2021 07 13

(891) 2021 07 13

(731) SUBSIDIARY COMPANY

"CONFECTIONERY CORPORATION

"ROSHEN"

prospect Nauky, bud. 1, korpus 1, m. Kyiv

03039, Ukraine

(540)



(591) Black, white

(531) 01.03.02; 08.01.21; 08.01.23; 09.01.10;

14.01.05; 14.01.06; 26.01.04; 26.11.08

(511)

30 – Confectionery; confectionery for decorating Christmas trees; liquorice [confectionery]; almond confectionery; ice cream; peppermint sweets; lozenges [confectionery]; pralines; candy decorations for cakes; chocolate decorations for cakes, sweets; fruit jellies [confectionery]; fruit confectionery; crystallized rock sugar; sugar; chocolate.

(260) AM 2022 115156 A

(800) 1622460

(151) 2021 05 17

(891) 2021 05 17

(731) Closed Joint Stock Company "Starodvorskie kolbasy"

ul. Poliny Osipenko, d. 41, of. 210, RU-600009

g. Vladimir, Russian Federation

(540)



(591) Burgundy, white and black

(531) 07.01.08; 25.01.19; 26.11.03; 26.11.09; 28.05; 29.01.12

(526) ®

(511)

29 – Preserved peppers; aloe vera prepared for human consumption; alginates for culinary purposes; anchovy, not live; peanuts, prepared; artichokes, preserved; albumen for culinary purposes; white of eggs; beans, preserved; soya beans, preserved, for food; broth; ginger jam; ham; fatty substances for the manufacture of edible fats; toasted laver; edible birds' nests; sea-cucumbers, not live; peas, preserved; mushrooms, preserved; guacamole; game, not live; gelatine; meat jellies; jellies for food; fruit jellies; yolk of eggs; coconut fat; bone oil for food; lard; suet for food; edible fats; curd; fruit-based snack food; milk substitutes; charcuterie; raisins; caviar; eggplant paste; vegetable

marrow paste; fish roe, prepared; yogurt; galbi [grilled meat dish]; sauerkraut; kefir; kimchi; isinglass for food; clams, not live; potato-based dumplings; milk shakes; black pudding; onion rings; arrangements of processed fruit; compotes; meat, canned; vegetables, canned; fish, canned; fruits, canned; broth concentrates; corn dogs; gherkins; meat patties; frozen meat patties; shrimps, not live; prawns, not live; buttercream; croquettes; silkworm chrysalis for human consumption; sweet corn, processed; kumys; chicken wings; spiny lobsters, not live; lecithin for culinary purposes; salmon, not live; onions, preserved; margarine; marmalade; oils for food; peanut butter; cocoa butter for food; coconut oil for food; coconut butter; corn oil for food; sesame oil for food; linseed oil for food; extra virgin olive oil for food; olive oil for food; palm oil for food; palm kernel oil for food; sunflower oil for food; rape oil for food; butter; soya bean oil for food; mussels, not live; almonds, ground; animal marrow for food; mollusks, not live; milk; peanut milk; peanut milk for culinary purposes; coconut milk; coconut milk for culinary purposes; almond milk; almond milk for culinary purposes; oat milk; rice milk; rice milk for culinary purposes; protein milk; condensed milk; soya milk; powdered milk; fish meal for human consumption; vegetable mousses; fish mousses; fruit pulp; meat; meat, preserved; freeze-dried meat; chicken nuggets; milk beverages, milk predominating; peanut milk-based beverages; coconut milk-based beverages; almond milk-based beverages; edible insects, not live; sausage casings, natural or artificial; vegetables, preserved; freeze-dried vegetables; vegetables, dried; vegetables, cooked; potato fritters; olives, preserved; lobsters, not live; flavored nuts; candied nuts; coconut, desiccated; nuts, prepared; tomato paste; liver pâté; pectin for culinary purposes; liver; pickles; jams; powdered eggs; milk products; fish-based foodstuffs; soured milk; poultry, not live; bulgogi; pollen prepared as foodstuff; cranberry compote; tomato purée; apple purée; crayfish, not live; crustaceans, not live; fish, preserved; fish, not live; salted fish; fermented baked milk; vegetable salads; fruit salads; bacon; sardelki [sausages]; sardines, not live; pork; herrings, not live; seeds, prepared; sunflower seeds, prepared; cream [dairy products]; whipped cream; vegetable-based cream; fat-containing mixtures for bread slices; smetana; lemon juice for culinary purposes; tomato juice for cooking; vegetable juices for cooking; salted meats; sausages; sausages in batter; hot dog sausages; preparations for making bouillon; preparations for making soup; nut-based spreads; tripe; soups; vegetable soup preparations; whey; cheese; tahini; tofu; truffles, preserved; tuna, not live; oysters, not live; falafel; milk ferments for culinary purposes; rennet; fish fillets; dates; frosted fruits; frozen fruits; fruit, preserved; fruit preserved in alcohol; fruit, stewed; hazelnuts, prepared; potato flakes; hummus; fruit peel; preserved garlic; lentils, preserved; potato chips; low-fat potato chips; fruit chips; shpikachki

[sausages]; non-alcoholic eggnog; seaweed extracts for food; meat extracts; edible ant larvae, prepared; berries, preserved; snail eggs for consumption; eggs; yakitori.

30 – Vanilla flavorings for culinary purposes; flavorings, other than essential oils, for cakes; flavorings, other than essential oils, for beverages; coffee flavorings; food flavorings, other than essential oils; star aniseed; baozi; cereal bars; high-protein cereal bars; pancakes; noodle-based prepared meals; freeze-dried dishes with the main ingredient being pasta; freeze-dried dishes with the main ingredient being rice; buns; bread rolls; edible rice paper; edible paper; burritos; vanillin [vanilla substitute]; vareniki [stuffed dumplings]; waffles; vermicelli; natural sweeteners; sausage binding materials; binding agents for ice cream; sea water for cooking; seaweed [condiment]; malt biscuits; cloves [spice]; mirror icing [mirror glaze]; cake frosting [icing]; glucose for culinary purposes; mustard; gluten additives for culinary purposes; yeast; fried dumplings; thickening agents for cooking foodstuffs; leaven; rice-based snack food; cereal-based snack food; artificial coffee; vegetal preparations for use as coffee substitutes; dressings for salad; fruit jellies [confectionery]; candy decorations for cakes; confectionery for decorating Christmas trees; cakes; pastries; peanut confectionery; almond confectionery; pasta; ginger [spice]; frozen yogurt [confectionery ices]; cocoa; cream of tartar for culinary purposes; capers; caramels [sweets]; curry [spice]; ketchup [sauce]; prepared rice rolled in seaweed; quiches; gluten prepared as foodstuff; flour-based dumplings; sweets; liquorice [confectionery]; peppermint sweets; dulce de leche; cinnamon [spice]; coffee; unroasted coffee; starch for food; crackers; custard; hominy grits; semolina; oatmeal; crushed barley; groats for human food; ice cubes; corn, milled; corn, roasted; meat pies; turmeric; couscous; noodles; ice for refreshment; ice, natural or artificial; edible ices; candies; rice cakes; mayonnaise; macarons; macaroni; maltose; hominy; piccalilli; marinades; marzipan; honey; miso [seasoning]; royal jelly; ice cream; bean meal; tapioca flour; potato flour; corn flour; nut flours; flour; wheat flour; soya flour; barley meal; dessert mousses [confectionery]; chocolate mousses; muesli; mint for confectionery; cocoa beverages with milk; coffee beverages with milk; coffee-based beverages; cocoa-based beverages; chamomile-based beverages; tea-based beverages; chocolate beverages with milk; chocolate-based beverages; infusions, not medicinal; crushed oats; husked oats; savory pancakes; onigiri; nutmegs; chocolate-coated nuts; stick liquorice [confectionery]; pastilles [confectionery]; molasses for food; pâtés en croûte; pelmeni; pepper; allspice; peppers [seasonings]; pesto; cookies; petit-beurre biscuits; bibimbap [rice mixed with vegetables and beef]; pies; pizzas; meat gravies; fondants [confectionery]; popcorn; powders for making ice cream; baking powder; mustard meal; pralines; aromatic preparations for food; condiments;

meat tenderizers for household purposes; cereal preparations; oat-based food; bee glue; gingerbread; spices; petits fours [cakes]; rice pudding; puddings; cake powder; fruit coulis [sauces]; ravioli; ramen; chewing gum; relish [condiment]; rice; instant rice; wheat germ for human consumption; spring rolls; sago; palm sugar; sugar; sesame seeds [seasonings]; linseed for culinary purposes [seasoning]; processed seeds for use as a seasoning; aniseed; agave syrup [natural sweetener]; golden syrup; confectionery; savory pancake mixes; baking soda [bicarbonate of soda for cooking purposes]; malt for human consumption; salt for preserving foodstuffs; cooking salt; celery salt; sherbets [ices]; ham glaze; soya sauce; tomato sauce; sauces [condiments]; pasta sauce; spaghetti; seasonings; chocolate-based spreads; chocolate spreads containing nuts; preparations for stiffening whipped cream; rusks; breadcrumbs; sushi; senbei [rice crackers]; sandwiches; tabbouleh; tacos; tapioca; tarts; dough; pastry dough; almond paste; rice pulp for culinary purposes; cake dough; tortillas; garden herbs, preserved [seasonings]; chocolate decorations for cakes; vinegar; beer vinegar; ferments for pastes; halvah; bread; unleavened bread; chips [cereal products]; corn flakes; oat flakes; hot dog sandwiches; flowers or leaves for use as tea substitutes; jiaozi; chicory [coffee substitute]; tea; iced tea; chutneys [condiments]; chebureki [deep-fried pies]; minced garlic [condiment]; cheeseburgers [sandwiches]; chow-chow [condiment]; saffron [seasoning]; chocolate; malt extract for food; essences for foodstuffs, except etheric essences and essential oils; husked barley.

35 – Arranging subscriptions to telecommunication services for others; import-export agency services; commercial information agency services; publicity agency services; cost price analysis; rental of advertising space; business auditing; business intermediary services relating to the matching of potential private investors with entrepreneurs needing funding; employment agency services; computerized file management; accounting; retail services through vending machines; invoicing; demonstration of goods; transcription of communications [office functions]; opinion polling; market studies; business information; commercial information and advice for consumers in the choice of products and services; business investigations; business research; marketing research; personnel recruitment; business management and organization consultancy; business organization consultancy; consultancy regarding public relations communication strategies; business management consultancy; personnel management consultancy; professional business consultancy; consultancy regarding advertising communication strategies; layout services for advertising purposes; marketing; business management of performing artists; business management of sports people; writing of résumés for others; scriptwriting for advertising purposes; news clipping services; updating and maintenance of information in registries; updating and ma-

intenance of data in computer databases; updating of advertising material; word processing; organization of exhibitions for commercial or advertising purposes; arranging newspaper subscriptions for others; organization of fashion shows for promotional purposes; organization of trade fairs for commercial or advertising purposes; shop window dressing; preparation of advertising materials; business appraisals; payroll preparation; data search in computer files for others; sponsorship search; business management assistance; commercial or industrial management assistance; commercial intermediation services; providing business information via a web site; providing commercial and business contact information; provision of an online marketplace for buyers and sellers of goods and services; web indexing for commercial or advertising purposes; presentation of goods on communication media, for retail purposes; economic forecasting; auctioneering; wholesale services for pharmaceutical, veterinary and sanitary preparations and medical supplies; retail services for pharmaceutical, veterinary and sanitary preparations and medical supplies; sales promotion for others; production of teleshopping programs; production of advertising films; office machines and equipment rental; rental of advertising time on communication media; publicity material rental; rental of billboards [advertising boards]; rental of vending machines; rental of sales stands; rental of photocopying machines; publication of publicity texts; radio advertising; bill-posting; outdoor advertising; distribution of samples; dissemination of advertising matter; direct mail advertising; registration of written communications and data; writing of publicity texts; advertising; online advertising on a computer network; advertising by mail order; television advertising; document reproduction; compilation of statistics; compilation of information into computer databases; business inquiries; systemization of information into computer databases; advisory services for business management; negotiation of business contracts for others; negotiation and conclusion of commercial transactions for third parties; compiling indexes of information for commercial or advertising purposes; tax preparation; drawing up of statements of accounts; telemarketing services; psychological testing for the selection of personnel; outsourced administrative management for companies; business management of hotels; business management for freelance service providers; business project management services for construction projects; commercial administration of the licensing of the goods and services of others; business management of reimbursement programs for others; administration of consumer loyalty programs; administration of frequent flyer programs; administrative processing of purchase orders; public relations; modelling for advertising or sales promotion; typing; appointment reminder services [office functions]; web site traffic optimization; administrative services for the relocation of businesses; tax filing services; search engi-

ne optimization for sales promotion; appointment scheduling services [office functions]; price comparison services; pay per click advertising; secretarial services; procurement services for others [purchasing goods and services for other businesses]; shorthand; outsourcing services [business assistance]; telephone answering for unavailable subscribers; photocopying services; business efficiency expert services.

43 – Accommodation bureau services [hotels, boarding houses]; rental of temporary accommodation; rental of meeting rooms; tourist home services; hotel reservations; boarding house bookings; temporary accommodation reservations; hotel services; retirement home services; snack-bar services; information and advice in relation to the preparation of meals; café services; cafeteria services; motel services; boarding house services; boarding for animals; rental of cooking apparatus; rental of chairs, tables, table linen, glassware; rental of lighting apparatus; rental of tents; rental of transportable buildings; rental of drinking water dispensers; restaurant services; self-service restaurant services; reception services for temporary accommodation [management of arrivals and departures]; food sculpting; canteen services; decorating of food; cake decorating; holiday camp services [lodging]; bar services; providing campground facilities; food and drink catering; washoku restaurant services; udon and soba restaurant services; day-nursery [crèche] services.

(260) AM 2022 115162 A

(800) 1622629

(151) 2021 06 17

(891) 2021 06 17

(731) MRH TURİZM OTEL İŞLETMELERİ  
SANAYİ VE TİCARET ANONİM ŞİRKETİ  
Okurcalar Mahallesi Alparslan, Türkiye  
Bulvarı No:191 Alanya, Antalya, Turkey

(540)



(591) Blue, brown

(531) 01.01.05; 01.01.10; 24.09.05; 26.11.02;  
26.11.08; 27.05.01; 27.05.07; 27.05.09;  
27.05.10; 27.05.11; 29.01.13

(526) Luxury hotels

(511)

43 – Services for providing food and drink, cafe services, coffee shop services, cafeteria services, canteen services, food and drink catering, restaurant services, self-service restaurant services, mobile restaurant services, snackbar services, udon and soba restaurant services, bar services, hookah lounge services,

providing reviews of restaurants and bars; rental of cooking apparatus, rental of drinking water dispensers, rental of chairs, tables, table linen, glassware; temporary accommodation services, accommodation bureau services [hotels, boarding houses], boarding house services, boarding house bookings, providing campground facilities, holiday camp services [lodging], hotel services, resort hotel services, motel services, hostel services, tourist home services, reception services for temporary accommodation [management of arrivals and departures], temporary accommodation reservations, hotel reservations, hotel information services, providing information about temporary accommodation services; rental of temporary accommodation, rental of holiday homes, rental of tents, rental of function rooms, rental of meeting rooms, rental of rooms for wedding receptions, rental of transportable buildings; day-nursery services; retirement home services; boarding for animals.

(260) AM 2022 115163 A

(800) 1622639

(151) 2021 03 09

(891) 2021 03 09

(731) MATRIZE Handels-GmbH

Alter Fischmarkt 11, 20457 Hamburg, Germany

(540)

## PALISAD

(591) Black, white

(511)

8 – Tool belts [holders]; waistcoats for holding hand tools and instruments; cases for hand tools and instruments; belts for hand instruments bags; belts for hand instrument cases; wall mounted holders for hand tools and instruments; covers for hand tools and instruments.

18 – Tool bags, empty; shopping bags; wheeled shopping bags; backpacks; business cases.

19 – Swimming pools [structures], not of metal; porches [structures], not of metal.

25 – Footwear for household, building or repair purposes, including boots, high boots, sandals, galoshes; clothing for household, building or repair purposes, including combinations, jackets, trousers, gloves, waistcoats.

28 – Swimming pools [play articles].

(260) AM 2022 115164 A

(800) 1622646

(151) 2021 06 25

(891) 2021 06 25

(731) IPSUB HOLDING LIMITED

7-9 Riga Feraiou, LIZANTIA COURT,  
Office 310, Agios Omologites, CY-1087  
Nicosia, Cyprus

(540)



(591) White and red

(531) 27.05.24; 29.01.12

(511)

35 – Administrative processing of purchase orders; rental of advertising space; advertising and publicity services; advertising and publicity; professional business consultancy; business management consultancy; business management assistance; business management and organization consultancy; business organization consultancy; advisory services for business management; business efficiency expert services; commercial information and advice for consumers [consumer advice shop]; commercial or industrial management assistance; commercial intermediation services; compilation of statistics; compilation of information into computer databases; computerized file management; data search in computer files for others; drawing up of statements of accounts; economic forecasting; invoicing; on-line advertising on computer networks; office machines and equipment rental; outsourcing services [business assistance]; pay per click advertising; personnel management consultancy services; public relations; publicity material rental; search engine optimization; systemization of information into computer databases; telephone answering for unavailable subscribers; updating and maintenance of data in computer databases; web site traffic optimization.

38 – Providing access to databases; communication by computer terminals; computer aided transmission of messages and images; information about telecommunication; rental of modems; providing online forums; transmission of digital files; providing user access to global computer networks; wireless broadcasting.

41 – Providing casino facilities; providing casino facilities [gambling]; providing of casino and gaming facilities; entertainment information; gambling; game services provided online from a computer network, not downloadable; providing on-line electronic publications, not downloadable; providing on-line videos, not downloadable; operating lotteries; timing of sports events; provision of information relating to sports; provision of entertainment and sports information relating to horse riding; provision of entertainment and sports information relating to racehorses; provision of information relating to motor sports; provision of information relating to motor racing; provision of information relating to racing; racing information services; handicapping for sporting events; entertainment in the nature of automobile races; entertainment in the nature of gymnastic performances; entertainment in



the nature of wrestling contests; entertainment in the nature of basketball games; entertainment in the nature of yacht races; entertainment in the nature of football games; entertainment in the nature of soccer games; entertainment in the nature of golf tournaments; entertainment in the nature of hockey games; entertainment in the nature of tennis tournaments; entertainment in the nature of baseball games; entertainment in the nature of boxing contests; entertainment in the nature of ice hockey games; entertainment in the nature of weight lifting competitions; entertainment in the nature of track and field competitions; entertainment services in the nature of skating events; providing wrestling news and information via a global computer network; sporting results services; betting services; horses (betting on -); casino, gaming and gambling services; dog races; football pools services; wagering services; online gaming services; gaming services for entertainment purposes; gambling services; electronic game services and competitions provided by means of the internet; games equipment rental.

42 – Cloud computing; cloud seeding; computer programming; computer software design; computer software consultancy; rental of computer software; computer system design; computer system analysis; consultancy in the design and development of computer hardware; creating and maintaining web sites for others; data conversion of computer programs and data [not physical conversion]; duplication of computer programs; electronic data storage; hosting computer sites [web sites]; information technology [IT] consultancy; installation of computer software; maintenance of computer software; monitoring of computer systems by remote access; off-site data backup; recovery of computer data; research and development of new products for others; providing search engines for the Internet; server hosting; Software as a service [SaaS]; updating of computer software; rental of web servers; web site design consultancy.

(260) AM 2022 115165 A  
 (800) 1622675  
 (151) 2021 08 27  
 (891) 2021 08 27  
 (731) Obshchestvo s ogranichennoi, otvetstvennostyu "VKS"  
 ul.50 let Oktyabrya, 113, g.Dimitrovgrad,  
 RU-433510 Ul'yanovskaya oblast, 502,  
 Russian Federation

(540)

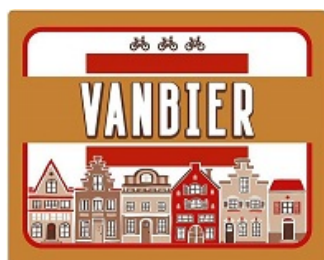

(591) Red, white, brown, light brown, dark brown, gray, gray-brown, beige, gray-beige, light beige  
 (531) 07.01.12; 07.01.24; 18.01.05; 26.04.07;  
 26.04.16; 27.05.03; 29.01.15

(511)

32 – Barley wine [beer]; kvass; beer-based cocktails; non-alcoholic beverages; non-alcoholic honey-based beverages; beer; ginger beer; malt beer; must; beer wort; malt wort; extracts of hops for making beer.

33 – Aperitifs; alcoholic beverages, except beer; spirits [beverages]; hydromel [mead].

(260) AM 2022 115168 A

(800) 1622784

(151) 2021 08 16

(891) 2021 08 16

(731) Claudiu – Virgil ȚĂRAN

Str. Grădinarilor, nr. 52A, Sântandrei, județ  
 Bihor, Romania

(540)

*Kifra*

(591) Black, white

(531) 27.05.01

(511)

3 – Essential vegetable oils; room fragrancng preparations; air fragrancng preparations; carpet freshening preparations; scented linen sprays; essential oils as perfume for laundry purposes; blended essential oils; essential oils for personal use; air fragrance reed diffusers; incense spray; perfumery, essential oils; fragrances for automobiles; essential oils for use in the manufacture of scented products; emulsified essential oils; aromatics [essential oils]; room perfumes in spray form; perfumes for cardboard; essential oils for aromatherapy use; aromatherapy oil; essential oils for soothing the nerves; aromatic essential oils; perfumes for ceramics; ethereal essences; essential oils for industrial use; refills for electric room fragrance dispensers; oils for perfumes and scents; scented oils used to produce aromas when heated; essential oils for household use; scented fabric refresher sprays; floral water; essential oils for use in manufacturing processes; ethereal essences and oils; aromatherapy preparations; aromatic oils; fragrance refills for non-electric room fragrance dispensers; deodorants for pets; scented room sprays; scented oils; ethereal oils; natural essential oils; scented linen water.

(260) AM 2022 115169 A

(800) 1622794

(151) 2020 08 25

(891) 2020 08 25

(731) OBI GmbH & Co. Deutschland KG

Albert-Einstein-Str. 7-9; 42929

Wermelskirchen, Germany

(540)



(591) Orange (RAL 2008) and black

(531) 27.05.01; 27.05.02; 27.05.17; 29.01.12

(511)

1 – Filtering materials [chemical, mineral, vegetable and other unprocessed materials]; unprocessed plastics; adhesives used in industry; growing media, fertilizers and chemicals for use in agriculture, horticulture and forestry; putties, and fillers and pastes for use in industry; fillers for vehicle body and tire repair; chemicals used in industry, and photography, as well as in agriculture, horticulture and forestry; manures; fire extinguishing compositions; tempering and soldering preparations; chemical substances for preserving foodstuffs; gritting salt for ice and snow; plant substrates, potting soil; filter materials made from chemical and non-chemical substances, included in this class; chemical preparations and materials for film, photography and printing; detergents for use in manufacture and industry; chemical substances, chemical materials and chemical preparations; salts for industrial purposes; synthetic resins; unprocessed starches for use in manufacturing and industry.

2 – Thinners and thickeners for coatings, dyes and inks; coatings; metal in foil and powder form for use in painting, decorating, printing and art; paints and washes; lacquers and varnishes; raw natural resins; varnish; anti-rust preparations; preservatives against deterioration of wood; mordants; metals in foil and powder form for painters, decorators, printers and artists; additives in connection with the aforesaid goods, included in this class.

3 – Cleaning and fragrancng preparations; household fragrances; vehicle cleaning preparations; laundry preparations; leather and shoe cleaning and polishing preparations; grinding preparations; tailors' and cobblers' wax; bleaching preparations and other substances for laundry use; cleaning, polishing, scouring and abrasive preparations; soaps; perfumery; essential oils; cosmetics; hair lotions, dentifrices; abrasive paper; polishing creams.

4 – Fuels and illuminants; candles and wicks for lighting; wood for use as fuel; non-chemical fuel additives; fuels from biological sources; dust controlling compositions; lubricants and industrial greases, waxes and fluids; industrial oils and greases; lubricants; dust

absorbing, wetting and binding compositions; fuels (including motor spirit) and illuminants.

5 – Medical dressings, medical plaster; plasters, materials for dressings; disinfectants; first-aid boxes, filled; preparations for destroying vermin; fungicides, herbicides, insecticides.

6 – Building and construction materials and elements of metal; pipes, tubes and hoses, and fittings therefor, including valves, of metal; unwrought or semi-wrought common metals; metal hardware; nuts, bolts and fasteners, of metal; locks and keys, of metal; welding wire, solder pastes; molds of metal; cables, wires and chains, of metal; doors, gates, windows and window coverings of metal; structures and transportable buildings of metal; signs, and information and advertising displays, of metal; ladders and scaffolding, of metal; vaults and safes, of metal; statues and works of art of common metals; containers of metal for the storage, and transportation of goods; packaging, wrapping and bundling articles, of metal; ironmongery, small items of metal hardware; pipes and tubes of metal; garage doors of metal; tool chests of metal, empty; safes; fences of metal; non-electric locks of metal; padlocks; chains of metal; hoppers of metal, non-mechanical; ladders of metal, stepladders of metal; metal hardware; parts and accessories for all the aforesaid goods, included in this class; tanks of metal; tent pegs of metal; window sills of metal; lintels of metal; fittings of metal for windows; shutters of metal; non-electric devices for opening windows (in analogy "with "electric devices for opening windows"); metallic insect screens for windows; window casements of metal; metal rolling window shutters; window hinges of metal; window seals of metal; latticework of metal; swimming pools [metal structures]; metal roofing; construction kits of metal; pre-fabricated houses of metal.

7 – Agricultural, earthmoving, construction, oil and gas extraction and mining equipment; agricultural, gardening and forestry machines and apparatus; construction machines; pumps, compressors and blowers; current generators; moving and handling equipment; opening and closing mechanisms; lifting and hoisting equipment, elevators and escalators; conveyors and conveyors belts; packing machines; machines and machine tools for treatment of materials and for manufacturing; cutting, drilling, abrading, sharpening and surface treatment machines and apparatus; power drills and bores; power saws; mills and crushing machines; shaping and moulding machines; machines, machine tools, and power-operated tools and apparatus, for fastening and joining; welding and soldering machines and devices; filtering machines, separators and centrifuges; coating machines; material production and processing machines; wheels and tracks for machines; sweeping, cleaning, washing and laundering machines; exterior clearing and cleaning machines; machines, namely paint mixing machines, construction machines, rinsing machines, washing machi-

nes and parts therefor, included in this class; machine tools, mechanical tools for construction, horticultural and craft purposes, mechanical horticultural and agricultural tools; vacuum cleaners and vacuum cleaner bags; pumps for heating installations, ponds, aquariums and aquarium systems; compressors [machines]; spray guns for paint, compressed air guns for the extrusion of mastics, glue guns (electric), tackers (electric), pistols and pumps for applying paints, mastics and other viscous products; gas-operated soldering irons; drill chucks [parts of machines], drilling machines, electric hand drills, die-cutting and tapping machines, drill stands for electric hand drills; planing machines; sharpening wheels [parts of machines], cutting discs (parts of machines), saws, power saws; current generators; gas-operated welding apparatus; lawn mowers, leaf blowers, scarifiers (other than hand-operated); snow blowers (other than hand-operated); cleaning (machines and apparatus for -), electric; steam cleaning machines; high pressure washers; parts for motors and engines, namely spark plugs for internal combustion engines, mufflers for motors and engines (exhausts), petrol and oil filters, filters for cleaning cooling air for motors and engines, cylinders for motors and engines, cylinder heads for motors and engines, pistons for motors and engines, piston rings; roller blind drives (electric), garage door drives (electric); lifts; pumps, compressors and fans; motors and engines, drive units; dispensing machines; parts and accessories for all the aforesaid goods, included in this class; boat motors; window openers, electric; hydraulic window openers, pneumatic window openers; machines and apparatus for polishing [electric]; electric soldering irons, electric welding apparatus; escalators; electric soldering and welding apparatus.

8 – Hand-operated tools and implements for treatment of materials, and for construction, repair and maintenance; animal slaughtering and butchering implements; agricultural, gardening and landscaping tools; fire tending implements; hand tools for construction, repair and maintenance; hammers, mallets and sledgehammers; fastening and joining tools; cutting, drilling, grinding, sharpening and surface treatment hand tools; emergency and rescue hand tools; lifting tools; manually operated tools; hand-operated implements for agricultural, horticultural and forestry purposes, and for structural engineering; hand-operated vaporisers; hand-operated guns for applying paints, mastics and other thick fluid products, guns, hand-operated, for the extrusion of mastics; lasts [shoemakers' hand tools]; cutlery, cutlery of plastic or metal; silver plate [knives, forks and spoons]; snow shovels (hand tools); frost scrapers; sharpening stones; tackers (hand-operated); riveters [hand tools]; trowels; saws [hand tools]; files [tools]; clamps for carpenters or coopers; tongs [hand tools]; screwdrivers; spanners; hammers [hand tools]; axes; lawn clippers [hand instruments]; border shears; planes; paper shears; hygienic and beauty implements for humans and animals; edged and blunt

weapons; hand-operated implements for chopping, dicing and slicing food, kitchen knives and cutlery; hand-operated tools and implements for treatment of materials, and for construction, repair and maintenance; parts and accessories for all the aforesaid goods, included in this class; electric irons.

9 – Optical data media; recorded and downloadable media; communications equipment; computer networking and data communications equipment; point-to-point communications equipment; broadcasting equipment; antennas and aerials as communications apparatus; data processing equipment and accessories (electrical and mechanical); apparatus, instruments and cables for electricity; apparatus and instruments for accumulating and storing electricity; apparatus and instruments for controlling electricity; photovoltaic apparatus for generating electricity; electric and electronic components; cables and wires; electrical circuits and circuit boards; antennas and aerials as components; safety, security, protection and signalling devices; alarms and warning equipment; electronic access control systems for interlocking doors; signalling apparatus; protective and safety equipment; head protection; eye protection; navigation, guidance, tracking, targeting and map making devices; measuring, detecting and monitoring instruments, indicators and controllers; scientific, nautical, surveying, photographic, cinematographic, optical, weighing, measuring, signalling, checking (supervision), life-saving and teaching apparatus and instruments; apparatus and instruments for conducting, switching, transforming, accumulating, regulating or controlling electricity; apparatus for recording, transmission or reproduction of sound or images; magnetic data carriers, recording discs; fire-extinguishing apparatus; electric installation material (included in this class) electric battery chargers, namely electric cables, electrical wire, lustre terminals; voltmeters; electronic controls for roller blinds, time switches, automatic; electronic monitoring and measuring apparatus, namely motion detectors, gas, smoke and carbon monoxide alarms, radio transmitters and receivers for controlling light, burglar alarm installations (electric), bells (alarm installations), door phones, telephone terminals, answering machines; vehicle radios, compact disc players (CDP), aerials and aerial accessories (included in this class); satellite receivers and satellite receiver aerials, optical data carriers relating to construction and gardening articles, and craftsmen services; video cassettes relating to construction and gardening articles, and craftsmen services; cycle computers; solar energy collectors for electricity generation; electric batteries, battery charging equipment; measuring apparatus; measuring tools; temperature controlling apparatus; thermometers, not for medical purposes; scales; luminous signs; protective work clothing (included in this class); protective helmets, protective sports helmets, arm, knee and wrist guards (work safety); gloves for protection against accidents; recorded data relating to

construction and gardening articles, and craftsmen services; information technology and audiovisual apparatus; magnets, magnetizers and demagnetizers; optical devices, enhancers and correctors; security, safety, protective and signalling apparatus and equipment; diving equipment; scientific research and laboratory apparatus, educational apparatus and simulators; parts and accessories for all the aforesaid goods, included in this class; starter cables for motors; ergometers; video telephones; hands free kits for phones; downloadable ring tones for mobile phones; cell phones; cell phone straps; telephone receivers; telephone transmitters; usb flash drives; cases adapted for mobile phones; covers for mobile telephones; headphones; communications head sets; wireless headsets for smartphones; telephone headsets; microphones for telephones; chargers for mobile phones; batteries for use in mobile telephones; batteries for cellular phones; usb cables for cellphones; data transmission cables; adapters; adapters for mobile phones; adapter plugs for mobile telephones; adapter cables (electric-); electrical adapters; flash memory cards; optical cards; memory cards; sim cards for mobile telephones; display screen protectors in the nature of films for mobile phones; holders adapted for mobile phones; styluses for operating mobile telephones; downloadable graphics for mobile phones; downloadable ring tones for mobile phones; carriers adapted for mobile phones; smartwatches; fitness trackers; read only memory [rom] cards; telephones incorporating intercommunication systems; intercommunication apparatus; guided wave intercoms.

11 – Flues and installations for conveying exhaust gases; sanitary installations, water supply and sanitation equipment; water purifying installations, desalination plants and installations for processing; sterilization, disinfection and decontamination equipment; sanitary and bathroom installations and plumbing fixtures; decorative fountains, sprinkler and irrigation systems; steam baths, saunas and spas; burners, boilers and heaters; lighting and lighting reflectors; vehicle lighting and lighting reflectors; cooking, heating, cooling and preservation equipment, for food and beverages; fireplaces, domestic; filters for drinking water, filters for use with apparatus for ventilating, filters for use with apparatus for heating, filters for air extractor hoods, filters for use with swimming pools, dust filters, filters for use with a lighting apparatus, filters for chimneys; personal heating and drying implements; drying installations; refrigerating and freezing equipment; regulating and safety accessories for water and gas installations; heating, ventilating, and air conditioning and purification equipment (ambient); air treatment equipment; hvac systems (heating, ventilation and air conditioning); vehicle hvac systems (heating, ventilation and air conditioning); igniters; apparatus for lighting heating steam generating cooking refrigerating drying ventilating water supply and sanitary purposes; electric lamps; lamps; ceiling lights; electric

torches; lamp shades; water closets; toilet bowls; toilet seats; flushing apparatus; toilets, portable; flushing tanks; sinks; wash-hand basins [parts of sanitary installations]; bidets; bathtubs; whirlpool-jet apparatus; shower stalls; shower handsets; roasting devices; roasting spits; lights, electric, for christmas trees; water-pipes for sanitary installations; air conditioning installations; air conditioning fans; sun tanning appliances; sanitary installations, water supply and sanitary fixtures; industrial treatment installations, namely gas filters and purifiers, industrial ovens and furnaces (not for food or beverages), chemical processing equipment, industrial installations for filtering liquids, installations for the collection of gases, installations for the collection of liquids, installations for cutting impurities from molten metals, bioreactors for clarifying industrial waste water, apparatus for draining food waste; personal heating and drying implements; nuclear installations; apparatus and installations for ventilating, air conditioning and air purification; parts and accessories for all the aforesaid goods, included in this class; turkish bath cabinets, portable; fountains; decorative water fountains; sauna bath installations.

12 – Vehicles and conveyances; land vehicles and conveyances; wheelbarrows; parts and fittings for vehicles; tyres and wheels for land vehicles; anti-theft, security and safety devices and equipment for vehicles; parts and fittings for land vehicles; powertrains, including engines and motors, for land vehicles; vehicles; apparatus for locomotion by land, air or water; luggage carriers for vehicles; luggage nets for vehicles; trailers [vehicles]; trailer hitches for vehicles; tyres for motor vehicles; anti-skid chains; hub caps; rims for vehicle wheels; bicycles, including motorised bicycles.

13 – Pyrotechnic products; fireworks.

14 – Gemstones, pearls and precious metals, and imitations thereof; jewels; time instruments; jewellery boxes and watch boxes; key rings and key chains, and charms therefor; precious metals and their alloys; jewellery, precious stones; horological and chronometric instruments.

16 – Paper party decorations, table decorations of paper; arts, crafts and modelling equipment; filtering materials of paper; stationery and educational supplies; writing and stamping implements; correcting and erasing implements; office machines; photo albums and collectors' albums; adhesives for stationery or household purposes; paper and cardboard; industrial paper and cardboard; printed matter relating to construction and gardening articles, and craftsmen services; bookbinding material; paintbrushes; typewriters and office requisites (except furniture); instructional and teaching material (except apparatus); plastic materials for packaging, included in this class; painting rollers; craft requisites, namely craft stencils (stationery), paste for modelling; adhesive tapes for stationery).

ry or household purposes; bags [envelopes, pouches] of paper or plastics, for packaging; scrapbooks; architectural models; bags and articles for packaging, wrapping and storage of paper, cardboard or plastics; money holders; parts and accessories for all the aforesaid goods, included in this class; modelling paste.

17 – Flexible pipes, tubes, hoses and fittings therefor (including valves), and fittings for rigid pipes, all non-metallic; seals, sealants and fillers; waterproofing and moisture proofing articles and materials; insulation and barrier articles and materials; thermal insulation articles and materials; electrical insulation articles and materials; acoustic insulation articles and materials; fire resistant and fire preventive articles and materials; membranes and semi-processed synthetic filtering materials; adhesive tapes, strips, bands and films other than stationary and not for medical or household purposes; rubber, gutta-percha, gum, asbestos, mica; packing, stopping and insulating materials, adhesive tapes and adhesive strips (other than for medical purposes, for stationery or for household purposes); flexible pipes, not of metal; insulating gloves; non-metallic flexible pipes, tubes, hoses and connecting parts, including rubber valves; unprocessed and semi-processed materials, not adapted for a specific use, included in this class, namely polyester, mineral fibres, elastomers, cellulose, fibres impregnated with synthetic resins; finished or semi-finished goods adapted for a specific use, included in this class, namely shock-absorbing and packaging materials, vibration dampers, membranes and semi-processed synthetic filtering materials; finished or semi-finished goods, adapted for a specific use, included in this class, namely clutch and brake linings, tyre restoration and repair materials, anti-corrosion tapes, foam supports for flower arrangements, fixing foils, glass tapes and strips, marking tapes, pouches of rubber, protective articles of rubber, protective asbestos screens, rubber bands, handles and supports of rubber, threads of plastic for soldering, stoppers of plastic; parts and accessories for all the aforesaid goods, included in this class; glass wool for insulation; mineral wool for insulation.

18 – Umbrellas and parasols; walking sticks; luggage, bags, wallets and carrying bags; saddlery, whips and apparel for animals; leather and imitation leather; animal skins, hides; trunks and travelling bags; saddlery, harnesses; tool bags of leather, empty; tool bags of leather (empty); backpacks.

19 – Building and construction materials and elements, not of metal; doors, gates, windows and window coverings, not of metal; structures and transportable buildings, not of metal; signs, and information and advertising displays, non-metallic; scaffolding, not of metal; pitch, tar, bitumen and asphalt; stone, rock, clay and minerals; building material made of wood and artificial wood; statues and works of art made of materials such as stone, concrete and marble, included in the class; non-metallic rigid pipes for build-

ing; asphalt, pitch and bitumen; monuments, not of metal; statues of stone, concrete or marble; parquet flooring; floors, not of metal; furrings of wood; moldings, not of metal, for building; construction materials of wood; veneer wood; manufactured timber; wood, semi-worked; veneers; wood panelling; beams of wood, wood sheeting, wood rafters, hobby wood, wood boards; plywood; paving slabs, not of metal; doors (non-metallic -) for use in garages; unprocessed and semi-processed materials, not adapted for a specific use, included in this class, namely pitch, tar, bitumen and asphalt, stone, rock, clay and minerals, wood and artificial wood; statues and works of art, included in this class; parts and accessories for all the aforesaid goods, included in this class; lintels, not of metal; non-metal window sills; non-metal window frames; wooden shutters; shutters, not of metal; latticework, not of metal; swimming pools [structures, not of metal]; non-metal roofing; construction kits for prefabricated houses; prefabricated houses (not of metal).

20 – Locks and keys, non-metallic; door, gate and window fittings, non-metallic; valves, non-metallic; fasteners, non-metallic; cable fasteners, connectors and holders, non-metallic; pipe fasteners, connectors and holders, non-metallic; statues, figurines, works of art and ornaments and decorations, made of materials such as wood, wax, plaster or plastic, included in the class; furniture; furniture fittings, not of metal; beds, bedding, mattresses, pillows and cushions; picture frames; mirrors (silvered glass); indoor blinds, and fittings for curtains and indoor blinds; clothes hangers, clothes stands [furniture] and clothes hooks; animal housing and beds; containers, and closures and holders therefor, non-metallic; baskets, non-metallic; barrels and casks, non-metallic; letter boxes, non-metallic; closures for containers, non-metallic; crates and pallets, non-metallic; ladders and movable steps, non-metallic; mirrors, picture frames; work benches; ladders (included in this class); pasting tables; poles for curtains; flower-pot pedestals (furniture); mounts, not of metal, for flower pots; barrier chains of plastic or wood; clothes hangers and clothes hooks; indoor blinds for windows (furnishings) of textile or plastic; goods, not of metal, namely mooring buoys, locks and keys, clappers, clips, connectors and connections, compartments, clack valves, handles and rails, knuckles, hooks and mounts, identification bracelets, moulds and stretchers, holders for pennants; goods, not of metal, namely dowels, protectors and support equipment, spools, stiffening materials, rings, poles, saw benches, mats for sinks, spacer rings, intermediate layers for bathtubs, staircase fittings, spiral springs, stackable adapters, staves, posts and masts, suction cups, overhead rail systems, trailers, tension rollers, tent parts, paper towel holders, trays; statues, figurines, works of art and ornaments and decorations, included in this class; animal housing and beds; bird houses of metal; unprocessed and semi-processed materials, included in this class and not adapted for any

specific use, namely yellow amber, stuffed animals, meerscham, parts of plants; containers, as well as lids and holders therefor; showcases [furniture], display stands and signboards of wood or plastic; parts and accessories for all the aforesaid goods, included in this class; tent pegs, not of metal; bird houses, not of metal; reservoirs, not of metal nor of masonry; non-metallic window openers (non-electric); coatstands; indoor blinds of textile or plastic.

21 – Statues, figurines, plaques and works of art, made of materials such as porcelain, terra-cotta or glass, included in the class; unworked and semi-worked glass, not specified for use, except building; household utensils for cleaning, brushes and brush-making materials; air fragrancing apparatus; dustbins; tableware, cookware and containers; glasses, drinking vessels and barware; coin banks (piggy banks); cosmetic and toilet utensils; aquaria and vivaria; devices for pest and vermin control; household or kitchen utensils and containers (not of precious metal or coated therewith); combs and sponges; unworked or semi-worked glass (except glass used in building); glassware, porcelain and earthenware (included in this class); steel wool for cleaning; candlesticks; buckets; soap dishes; soap dispensers; watering can sprinklers; flower pots; griddles [cooking utensils]; funnels; gloves for household purposes, gardening gloves; clothes drying racks; laundry drying racks; ironing boards; statues, figurines, signs and works of art, included in this class; brushes and brooms, cleaning articles; cosmetic and toilet utensils, and bathroom articles; articles for animal husbandry, namely aquariums and vivariums, pest and vermin repellents, bird baths, cages, feeding and drinking articles, fish bowls, grooming articles, nesting articles, swing tags, waste disposal articles; household articles for clothing and footwear, namely boot jacks and shoehorns, button hooks, stretchers for clothing, trouser presses and mangles for clothing, wax-polishing appliances, non-electric, for shoes, shoe trees (stretchers) and shapers; parts and accessories for all the aforesaid goods, included in this class; glass wool, other than for insulation; polishing leather.

22 – Raw textile fibers and substitutes; non-metal slings for loading and non-metal bands for wrapping or binding; bags and sacks for packaging, storage and transport; tarpaulins, awnings, tents, and unfitted coverings; sails; ropes and strings; nets; padding and stuffing materials; nets, tents, tarpaulins, sails, sacks and bags (included in this class); liber; harness, not of metal, for handling loads; awnings of plastic or textile; car towing ropes.

24 – Textile material; textiles and substitutes for textiles; coverings for furniture; curtains; labels of textile; wall hangings; linens; kitchen and table linens; bed linen; sleeping bags for the camping; bath linen; filters made of textile materials; bed and table covers, included in this class; linens, table and bed linen, not

of paper, oilcloth for use as tablecloths; shower curtains of textile or plastic.

25 – Clothing, namely work clothing; footwear; headwear (including for garden use), included in this class.

26 – Artificial fruit, flowers and vegetables.

27 – Floor coverings and artificial ground coverings; carpets, rugs and mats; vehicles mats and carpets; artificial ground coverings; wall and ceiling coverings; carpets, rugs, mats and matting, linoleum and materials for covering existing floors; wall hangings, included in this class; wall hangings (non-textile); textile wallpaper.

28 – Sporting articles and equipment; hunting and fishing equipment; inflatable games for swimming pools; Christmas tree decorations and artificial Christmas trees; fairground and playground apparatus; toys, games, playthings and novelties; video game apparatus; games and playthings; gymnastic and sporting articles, included in this class; ornaments and stands for Christmas trees, except illumination articles and confectionery; fishing tackle and accessories (included in this class); scale model vehicles; pools (swimming -) [play articles].

31 – Live animals; agricultural and aquacultural crops, horticulture and forestry products; plants; fresh fruits, nuts, vegetables and herbs; natural turf; flowers; seeds, bulbs and seedlings for plant breeding; trees and forestry products; plant residues (raw materials); foodstuffs and fodder for animals; bedding and litter for animals; grains and other propagation material not included in other classes; natural plants and flowers; malt; raw timber; flowers, dried, for decoration; plants, dried, for decoration; straw mulch.

35 – Advertising, marketing and promotional services; public relations services; product demonstrations and product display services; organizing and conducting trade shows and exhibitions for commercial or advertising purposes; loyalty, incentive and bonus program services; provision of advertising space, time and media; distribution of advertising, marketing and promotional material; advertising, marketing and promotional consultancy, advisory and assistance services; rental of advertising space, time and materials; business assistance, management and administrative services; accountancy, book keeping and auditing; administrative data processing; human resources management and recruitment services; clerical services; business consultancy and advisory services; office machines and equipment rental; business analysis, research and information services; marketing studies; collection and systematization of business data; wholesaling and retailing relating to construction, DIY and gardening articles, tools, metal hardware, paints, wood, floor coverings, kitchens, plants, installation material, building materials, telephone networks, animal foodstuffs and zoo requisites, including via the

internet; professional business consultancy for franchising concepts; arranging of contracts for the providing of craft services; photocopying; operating a bonus system for purchases in hardware stores, namely processing discount transactions and issuing encoded cards for processing discount transactions; telemarketing services.

36 – Issuance of prepaid cards and tokens of value; payment card services; financing and funding services; financial services relating to the provision of vouchers for the purchase of goods; monetary affairs; issuing, exchanging and redeeming vouchers; clearing and discounting services; cash card services; issuing stored value cards; issuing of cash vouchers.

37 – Building, construction and demolition; rental of tools, construction equipment and apparatus for building, demolition, cleaning and maintenance work; alarm, lock and safe installation, maintenance and repair; hvac (heating, ventilation and air conditioning) installation, maintenance and repair; vehicle repair, maintenance and refuelling; building maintenance and repair; interior and exterior cleaning of buildings; glazing, installation, maintenance and repair of glass, windows and blinds; plumbing installation, maintenance and repair; building construction; repair work, namely repair of buildings; repair and maintenance of machines and mechanical tools and implements, repair of hand tools (hand-operated); painting, interior and exterior; repair of shoes; heating equipment installation and repair; installation and repair of telephones, installation and repair of telephone installations; rental of construction machines, construction tools and construction equipment, included in this class; rental of tools, plant and equipment for construction and demolition; mining and gas and oil extraction; extermination, disinfection and pest control; leasing and rental in relation to the aforesaid services, included in this class; consultancy and information in relation to the aforesaid services, included in this class; building consultancy; assembly of prefabricated houses; construction works for prefabricated houses; sharpening and grinding of knives, lawnmower blades and saws; rental of machines, tools and apparatus for building construction.

38 – Telecommunication services; telephone and mobile telephone services; provision and rental of telecommunications facilities and equipment; telecommunications; internet telephony services, internet based telecommunication services; provision of on-line forums; provision of internet access services; computer communication and internet access; internet access services; provision of internet access services; electrical data transmission over a global remote data processing network, including the internet; provision of telecommunication access and links to computer databases and to the internet; internet service provider services.

39 – Transport; transportation and delivery of goods; freight and cargo transportation and removal services; mail delivery and courier services; packaging and storage of goods; loading and unloading of vehicles; providing packages and parcels for collection by the receiver; providing goods for collection by the receiver; rental services related to transportation and storage; rental of means of transportation; rental of units and containers, for storage and transportation; rental of passenger vehicle trailers; delivery of goods; delivery of goods by mail order; vehicle hire; packing and packaging services; transport (removal) and storage of waste and recycling materials.

40 – Key cutting; engraving; cutting of wood, boards, frames and materials; sewing of curtains; paint mixing services; thread cutting; food and beverage treatment; energy production; printing, and photographic and cinematographic development; duplication of audio and video recordings; air and water conditioning and purification; slaughtering of animals; rental of generators; rental of air-conditioning apparatus; rental of space heating apparatus; recycling of waste and trash.

41 – Education, entertainment and sports; organisation of conferences, exhibitions and competitions; education and instruction; providing of training; entertainment services by means of providing of ringtones (non-downloadable) from the Internet.

42 – Software development, programming and implementation; rental of computer hardware and facilities; engineering services; architectural and urban planning services; testing, authentication and quality control; design services; architecture; design of interior decor; architectural consultation; kitchen planning; bathroom planning; consultancy in the field of energy-saving.

44 – Agriculture, aquaculture, horticulture and forestry services; horticulture, gardening and landscaping; landscape design; floral design; rental of equipment for agriculture, aquaculture, horticulture and forestry; services in the field of agriculture, horticulture and forestry, pond and aquarium maintenance (included in this class), lawn maintenance, animal grooming; landscape design; landscape gardening.

45 – Consultation services in the field of security; security services for the protection of property and individuals; issuing licences for franchising concepts; licensing of industrial property rights and copyright; opening of security locks.

(260) AM 2022 115170 A

(800) 1622799

(151) 2020 12 31

(891) 2020 12 31

(731) MEHMET ATMACA BİLİŞİM ANONİM ŞİRKETİ

Bahçelievler Mahallesi, Fevzi Çakmak 2 Cadde, Beylerbeyi Sokak, No: 208, Güzelşehir Sitesi, Güzelce, Büyükçekmece – İstanbul, Turkey

(540)

**Onvo**

(591) Black, white

(511)

7 – Machines, machine tools and industrial robots for processing and shaping wood, metals, glass, plastics and minerals, 3D printers; construction machines and robotic mechanisms (machines) for use in construction, bulldozers, diggers (machines), excavators, road construction and road paving machines, drilling machines, rock drilling machines, road sweeping machines; lifting, loading and transmission machines and robotic mechanisms (machines) for lifting, loading and transmission purposes, elevators, escalators and cranes; machines and robotic mechanisms (machines) for use in agriculture and animal breeding, machines and robotic mechanisms (machines) for processing cereals, fruits, vegetables and food; beverage preparation machines, electromechanical; beverage processing machines; engines and motors, other than for land vehicles, parts and fittings therefor, hydraulic and pneumatic controls for engines and motors, brakes other than for vehicles, brake linings for engines, crankshafts, transmission gears for machines, cylinders for engines, pistons for engines, turbines, not for land vehicles, filters for engines and motors, oil, air and fuel filters for land vehicle engines, exhausts for land vehicle engines, exhaust manifolds for land vehicle engines, engine cylinders for land vehicles, engine cylinder heads for land vehicles, pistons for land vehicle engines, carburetors for land vehicles, fuel conversion apparatus for land vehicle engines, injectors for land vehicle engines, fuel economizers for land vehicle engines, pumps for land vehicle engines, valves for land vehicle engines, starters for motors and engines, dynamos for land vehicle engines, sparking plugs for land vehicle engines; bearings (parts of machines), roller or ball bearings; machines for mounting and detaching tires; alternators, current generators, electric generators, current generators operated with solar energy; painting machines, automatic spray guns for paint, electric, hydraulic and pneumatic punching machines and guns, electric adhesive tape dispensers (machines), electric guns for compressed gas or liquid spraying machines, electric hand drills, electric hand saws, electric jigsaw machines, spiral machines, compressed air machines, compressors (machines), vehicle washing installations, robotic mechanisms (machines) with the abovementioned functions; electric and gas-operated welding apparatus, electric arc welding apparatus, electric soldering apparatus, electric arc cutting apparatus, electrodes for welding machines, industrial robots (machines) with the abovementioned functions; printing machines; packaging machines, filling, plugging and sealing machines, labelers (machines), sorting machines, industrial robots (machines) with the abovementioned functions, electric packing machines for plugging and sealing of plastics; machines for textile processing, sewing ma-

chines, industrial robots (machines) with the abovementioned functions; pumps [machines], self-regulating fuel pumps; electric kitchen machines for chopping, grinding, crushing, mixing and mincing foodstuffs, washing machines, laundry washing machines, dishwashers, spin driers (not heated), electric cleaning machines for cleaning floors, carpets or floorings, vacuum cleaners and parts thereof; automatic vending machines; galvanizing and electroplating machines; electric door openers and closers; joints (parts of engines).

9 – Measurement apparatus and equipment including those for scientific, nautical, topographic, meteorological, industrial and laboratory purposes, thermometers, not for medical purposes, barometers, ammeters, voltmeters, hygrometers, testing apparatus not for medical purposes, telescopes, periscopes, directional compasses, speed indicators, laboratory apparatus, microscopes, magnifying glasses, binoculars, stills, ovens and furnaces for laboratory experiments; electronic advertisement boards featuring a neon lamp, electronic scoreboards, electronic sliding letter boards; apparatus for recording, transmission or reproduction of sound and images, radios, television receivers, video tape and video disk, players, video recorders, CD and DVD players and recorders, MP3 players, cameras, photographic cameras, audio devices and parts, namely, audio cassette players, audio cassette recorders, cinematographic machines and apparatus, remote control devices for radios, televisions, headphones, audio speakers, megaphones, intercoms, slide or photograph projection apparatus, television apparatus, microphones, loudspeakers, earphones; data processors, namely, computers, desktop computers, tablet computers, wearable activity trackers, computer hardware, printers, laser printers, scanners [data processing equipment], automatic cash registers, calculators, barcode scanners and their accessories; car navigation computers, all kinds of photographic cameras, parts of photographic cameras and accessories, photographic flashbulbs, photographic viewfinders; communication devices, namely, telephones, fax machines, telegraph machines, radio telephones, automatic telephone exchanges; telecommunications apparatus, apparatus for the reproduction of sound or images, computer peripheral devices, cell phones, covers for cell phones, telephone apparatus; photocopy machines, machines for blueprints; screen filters for computers and televisions; magnetic and optical data carriers and computer software and programs recorded thereto, downloadable and recordable electronic publications, blank record disks, blank audio cassettes, blank discs for computers, blank optical discs, blank CDs for sound or video recording, exposed cinematographic films, exposed camera films, exposed X-ray films; computer software for the collection, editing, organizing, modifying, book marking, transmission, storage and sharing of data and information; electronic or magnetic cards, optic cards, pre-paid telephone calling cards,



magnetically encoded, magnetically encoded credit cards, automatic magnetically encoded key cards, magnetic cards for use with meters, prerecorded motion picture films; prerecorded music videos; antennas, satellite dishes, satellite antennas, satellite receivers, amplifiers for antennas, parts of the aforementioned goods; ticket dispensers, automatic teller machines (ATM); electronic components used in the electronic parts of machines and apparatus, semi-conductors, electronic circuits, integrated circuits, chips [integrated circuits], diodes, transistors [electronic], magnetic heads for electronic apparatus, electronic locks, photocells, remote control apparatus for opening and closing doors, optical sensors; counters and quantity indicators for measuring the quantity of consumption, automatic time switches; clothing for protection against accidents, irradiation and fire, safety vests and life-saving apparatus and equipment; eyeglasses, sunglasses, optical lenses and cases, containers, parts and components thereof; apparatus and instruments for conducting, transforming, accumulating or controlling electricity, electric plugs, junction boxes [electricity], electric switches, circuit breakers, fuses, lighting ballasts, battery starter cables, electrical circuit boards, electric resistances, electric sockets, transformers [electricity], electrical adapters, battery chargers, electric door bells, electric and electronic cables, batteries, electric accumulators; solar panels for production of electricity; alarms and anti-theft alarms, other than for vehicles, electric bells; signalling apparatus and instruments, luminous or mechanical signs for traffic use; fire extinguishing apparatus, fire engines, fire hose and fire hose nozzles; radar apparatus, sonars, night vision apparatus and instruments; decorative magnets; metronomes.

11 – Lighting installations, lighting apparatus for vehicles, interior and exterior lights; lamps, light bulbs, projector lamps, lanterns, chandeliers, lamp glasses, lamp mantles, lamps for directional signals and parking lights of vehicles (bulbs), headlights, stop lights, light bulbs for signals and park lights, vehicle reflectors, reflector lamps; devices for heating installations and steam generating installations, stoves (heating apparatus), boilers for central heating and natural gas installations, gas boilers, burners, heaters, heaters for baths, radiators, heat pumps, electric water boilers, solar collectors and devices (heating); heating apparatus for solid, liquid or gaseous fuels, cookers; steam, gas and fog generators, steam boilers, other than parts of machines, acetylene generators, oxygen generators, nitrogen generators; air-conditioning installations and apparatus, fans (air-conditioning), ventilators, air-conditioning apparatus including for vehicles; air sterilizers and purifying devices, installations and their parts and accessories for residences, exhaust hoods for kitchens; refrigerators, deep freezers, ice boxes, ice machines and devices; electric and gas operated apparatus, machines and equipment used in cooking and boiling, namely, toasters, bread toasters, deep fryers,

grills, ovens, stoves, electric popcorn poppers, autoclaves, electric coffee and tea makers, electric water boilers (kettles) and their parts; clothes drying machines (electric, for household purposes), electric hair-dryers, hand drying apparatus for washrooms; bath tubs, bidets, bath installations, shower enclosures, urinals (sanitary fixtures) water closets, toilets, portable; lavatories, sinks, taps [faucets] for water and gas installations, hand-held shower heads, flexible pipes being parts of shower plumbing installations; thermostatic valves as parts of heating installations, level controlling valves in tanks, regulating accessories for water or gas apparatus, whirlpool-jet apparatus; automatic watering installations, water-pipes for sanitary installations, watering machines for agricultural purposes; washers for water taps; water softening apparatus and installations, water purifying apparatus and machines, water purification installations, incinerators, water purifiers; bedwarmers and blankets, electric, not for medical purposes; electric heating pads and cushions, not for medical purposes; electric footwarmers; footmuffs, electrically heated; hot water bottles; socks, electrically heated; aquarium filters, filtration apparatus incorporating a motor device; aquarium heaters and lights; industrial type furnaces, industrial type dryer installations, industrial type cooling installations, cooling towers, air cooling apparatus; pasteurizers and sterilizers.

(260) AM 2022 115171 A

(800) 1622840

(151) 2021 04 30

(891) 2021 04 30

(731) Alekto GmbH

Frankstahlgasse 2, A-2353 Guntramsdorf,  
Austria

(540)

## ALEKTO

(591) Black, white

(511)

35 – Online retail services in relation to brushes; retail services in relation to gratings of metal; retail services in relation to metalworking machines; retail services in relation to piston seals of metal; wholesale services in relation to ingots of precious metals; online retail services in relation to soldering chemicals; retail services in relation to wire stretchers [tension links]; wholesale services in relation to collars, not of metal, for fastening pipes; retail services in relation to gutter pipes of metal; retail services in relation to sealing and insulating materials; wholesale services in relation to fittings of metal for windows; retail services in relation to duckboards of metal; wholesale services in relation to locks and keys, of metal; online retail services in relation to drain traps [valves] of metal; retail services in relation to ironwork for doors; retail services in relation to hammers [hand tools]; retail services in relation to staircases of metal; retail services in re-

lation to gouges [hand tools]; wholesale services in relation to rivets of metal; online retail services in relation to measuring devices; retail services in relation to junctions of metal for pipes; retail services in relation to steel in bar form; retail services in relation to stair treads [steps] of metal; retail services in relation to louvres made of metal; online retail services in relation to nuts, not of metal; online retail services in relation to radiator valves; retail services in relation to resins in extruded form; retail services in relation to brass, unwrought or semi-wrought; wholesale services in relation to paring irons [hand tools]; wholesale services in relation to screw covers of metal; wholesale services in relation to flanges of metal [collars]; online retail services in relation to iron strip; retail services in relation to plugs of metal; wholesale services in relation to nuts, bolts and fasteners, of metal; retail services in relation to plastics in the form of sheets, films, blocks, rods and tubes; wholesale services in relation to fire hose nozzles; wholesale services in relation to protective clothing for the prevention of injury; online retail services in relation to gratings of metal; wholesale services in relation to non-metallic couplings for pipes; wholesale services in relation to sealing and insulating materials; retail services in relation to penstock pipes, not of metal; online retail services in relation to tanks of metal; online retail services in relation to sleeves [metal hardware]; retail services in relation to frames for umbrellas or parasols; wholesale services in relation to extruded plastics in the form of bars for use in manufacture; wholesale services in relation to angle irons of metal; retail services in relation to sheets and plates of metal; wholesale services in relation to door, gate and window fittings, non-metallic; retail services in relation to fire hose nozzles; retail services in relation to adhesives for use in industry; wholesale services in relation to laths of metal; wholesale services in relation to junctions of metal for pipes; online retail services in relation to nuts, bolts and fasteners, of metal; retail services in relation to waterproofing and moisture proofing articles and materials; retail services in relation to elbows of metal for pipes; wholesale services in relation to manifolds of metal for pipelines; online retail services in relation to piston seals of metal; wholesale services in relation to doors, gates, windows and window coverings, not of metal; wholesale services in relation to seals for pipe connections; wholesale services in relation to branching pipes, not of metal; online retail services in relation to runners of metal for sliding doors; retail services in relation to agricultural, gardening and landscaping tools; retail services in relation to white metal; wholesale services in relation to steel in bar form; retail services in relation to stainless steel in sheet form; wholesale services in relation to measuring apparatus; wholesale services in relation to rods of metal for brazing; wholesale services in relation to doors, gates, windows and window coverings of metal; wholesale services in relation to couplings; online

retail services in relation to electric surface heating tapes; retail services in relation to fittings, not of metal, for flexible pipes; wholesale services in relation to gutter pipes, not of metal; retail services in relation to lead, unwrought or semi-wrought; retail services in relation to doors, gates, windows and window coverings, not of metal; retail services in relation to metal cable wire; retail services in relation to penstock pipes of metal; online retail services in relation to copper, unwrought or semi-wrought; retail services in relation to parapet supports of metal; wholesale services in relation to penstock pipes, not of metal; wholesale services in relation to dehumidifiers; retail services in relation to rods of metal; retail services in relation to iron strip; online retail services in relation to bright steel bars; retail services in relation to pipes, tubes and hoses, and fittings therefor, including valves, of metal; online retail services in relation to pipes and tubes of metal; wholesale services in relation to steel pens; wholesale services in relation to hand-operated tools and implements for treatment of materials, and for construction, repair and maintenance; online retail services in relation to non-metallic couplings for pipes; online retail services in relation to hearing protection devices; online retail services in relation to staircases of metal; online retail services in relation to angle irons of metal; retail services in relation to jets of metal; online retail services in relation to nuts of metal; retail services in relation to nuts, bolts and fasteners, of metal; wholesale services in relation to measuring devices; retail services in relation to metal brackets; wholesale services in relation to white metal; retail services in relation to protective clothing for the prevention of injury; wholesale services in relation to rods of metal for welding; online retail services in relation to apparatus and instruments for accumulating and storing electricity; online retail services in relation to extruded plastics in the form of bars for use in manufacture; retail services in relation to nuts of metal; retail services in relation to bars for metal railings; wholesale services in relation to building glass; wholesale services in relation to squares [hand tools]; retail services in relation to tubes of metal; online retail services in relation to collars of metal for fastening pipes; retail services in relation to brackets of metal for furniture; online retail services in relation to tents; online retail services in relation to sensors, detectors and monitoring instruments; online retail services in relation to plastics in the form of sheets, films, blocks, rods and tubes; online retail services in relation to couplings; retail services in relation to locks and keys, non-metallic; wholesale services in relation to bright steel bars; online retail services in relation to couplings of metal for tubing; retail services in relation to screws of metal; wholesale services in relation to poles of metal; wholesale services in relation to earth terminals; wholesale services in relation to iron wire; online retail services in relation to penstock pipes of metal; wholesale services in relation to measuring ins-

truments; wholesale services in relation to metalworking machines; retail services in relation to alloys of precious metal; retail services in relation to flexible hoses, not of metal; wholesale services in relation to chimney shafts of metal; online retail services in relation to containers, and transportation and packaging articles, of metal; online retail services in relation to cast iron, unwrought or semi-wrought; retail services in relation to ladders and scaffolding, of metal; wholesale services in relation to sheet piles of metal; online retail services in relation to ironwork for doors; wholesale services in relation to gloves for protection against accidents; retail services in relation to capping stones for support posts; online retail services in relation to electric cables and wires; wholesale services in relation to building and construction materials and elements, not of metal; wholesale services in relation to umbrellas and parasols; retail services in relation to apparatus, instruments and cables for electricity; wholesale services in relation to stair treads [steps] of metal; wholesale services in relation to aluminium ladder rungs; online retail services in relation to radiator caps; wholesale services in relation to shaft couplings [machines]; wholesale services in relation to signs, and information and advertising displays, of metal; online retail services in relation to refractory construction materials of metal; online retail services in relation to steel in bar form; wholesale services in relation to cable connectors (non-electric -) of non-metallic materials; wholesale services in relation to tube cutters [hand tools]; retail services in relation to safety, security, protection and signalling devices; wholesale services in relation to penstock pipes of metal; online retail services in relation to electrical and electronic components; online retail services in relation to metal pipe supports; online retail services in relation to railway material of metal; online retail services in relation to tube cutters [hand tools]; online retail services in relation to protective preparations for metals; wholesale services in relation to hammers [hand tools]; retail services in relation to signs, and information and advertising displays, of metal; online retail services in relation to brackets of metal for furniture; wholesale services in relation to beams (non-metallic -) for building purposes; retail services in relation to buckles of common metal [hardware]; wholesale services in relation to steel sheets; online retail services in relation to plugs of metal; online retail services in relation to stretchers for iron bands [tension links]; wholesale services in relation to metal hardware; retail services in relation to radiator valves; retail services in relation to hooks [metal hardware]; wholesale services in relation to alloys of precious metal; online retail services in relation to paring irons [hand tools]; retail services in relation to latticework of metal; retail services in relation to rigid pipes and valves therefor, non-metallic; wholesale services in relation to building materials of metal; online retail services in relation to protective clothing [body armour]; online retail

services in relation to iron, unwrought or semi-wrought; online retail services in relation to rods of metal for brazing; retail services in relation to umbrellas and parasols; online retail services in relation to sealing and insulating materials; online retail services in relation to laths of metal; retail services in relation to gutter pipes, not of metal; retail services in relation to ingots of precious metals; retail services in relation to gloves for industrial purposes for protection against injury; online retail services in relation to ironwork for windows; online retail services in relation to release agents [oils]; retail services in relation to metal pipe supports; retail services in relation to steel rods; online retail services in relation to metal railings; retail services in relation to metal billets; online retail services in relation to rods of metal for welding; online retail services in relation to railing holders of metal; wholesale services in relation to runners of metal for sliding doors; wholesale services in relation to ladders and scaffolding, of metal; wholesale services in relation to common metals, unwrought or semi-wrought; retail services in relation to paring irons [hand tools]; wholesale services in relation to flexible hoses, not of metal; online retail services in relation to aluminium ladder rungs; online retail services in relation to white metal; retail services in relation to tents; online retail services in relation to gutter pipes, not of metal; wholesale services in relation to drain traps [valves] of metal; wholesale services in relation to sheets of metal including those from alloy steel and titanium; online retail services in relation to fire hose nozzles; retail services in relation to cable connectors (non-electric -) of non-metallic materials; online retail services in relation to building glass; retail services in relation to steel tubes; online retail services in relation to beams, not of metal; wholesale services in relation to metal in foil and powder form for use in painting, decorating, printing and art; online retail services in relation to hammers [hand tools]; online retail services in relation to steel tubes; wholesale services in relation to branching pipes of metal; retail services in relation to common metals, unwrought or semi-wrought; online retail services in relation to locks and keys, of metal; online retail services in relation to iron wire; retail services in relation to collapsible tubes of metal; retail services in relation to railing holders of metal; online retail services in relation to building panels of metal; retail services in relation to ducts of metal, for central heating installations; online retail services in relation to gutter pipes of metal; online retail services in relation to junctions, not of metal, for pipes; online retail services in relation to safety, security, protection and signalling devices; wholesale services in relation to rigid pipes and valves therefor, non-metallic; retail services in relation to insulation and barrier articles and materials; retail services in relation to branching pipes, not of metal; online retail services in relation to precious metals, unwrought or semi-wrought; online retail services in relation to gloves for industrial

purposes for protection against injury; online retail services in relation to measuring apparatus; online retail services in relation to shaft couplings [machines]; online retail services in relation to ladders and scaffolding, of metal; wholesale services in relation to steel tubes; retail services in relation to steel pens; retail services in relation to runners of metal for sliding doors; retail services in relation to non-metallic couplings for pipes; wholesale services in relation to collars of metal for fastening pipes; wholesale services in relation to wire of common metal; retail services in relation to seals, sealants and fillers; wholesale services in relation to railway material of metal; online retail services in relation to cane connectors of metal; retail services in relation to refractory construction materials of metal; online retail services in relation to louvres made of metal; online retail services in relation to ventilation suits; online retail services in relation to rivets of metal; wholesale services in relation to boiler pipes [tubes] for heating installations; wholesale services in relation to building and construction materials and elements made of wood and artificial wood; online retail services in relation to resins in extruded form; wholesale services in relation to steel masts; wholesale services in relation to busts of precious metal; wholesale services in relation to stretchers for iron bands [tension links]; online retail services in relation to bands of metal for tying-up purposes; wholesale services in relation to pipe muffers, not of metal; wholesale services in relation to metal pipe supports; online retail services in relation to unprocessed and semi-processed materials of metal, not specified for use; wholesale services in relation to pumps, compressors and blowers; online retail services in relation to hand tools for construction, repair and maintenance; retail services in relation to valves, non-metallic; retail services in relation to doors, gates, windows and window coverings of metal; retail services in relation to flexible pipes, tubes, hoses and fittings therefor (including valves), and fittings for rigid pipes, all non-metallic; retail services in relation to tube cutting instruments; retail services in relation to screws, not of metal; online retail services in relation to rigid pipes and valves therefor, non-metallic; wholesale services in relation to stainless steel in sheet form; online retail services in relation to beams of metal; online retail services in relation to junctions of metal for pipes; retail services in relation to junctions, not of metal, for pipes; wholesale services in relation to ventilation suits; wholesale services in relation to tiles; wholesale services in relation to hand tools for construction, repair and maintenance; wholesale services in relation to lead, unwrought or semi-wrought; retail services in relation to pumps, compressors and blowers; online retail services in relation to ingots of precious metals; online retail services in relation to rings of metal; retail services in relation to containers of metal for compressed gas or liquid air; online retail services in relation to sanitary installations, water supply and sa-

nitiation equipment; wholesale services in relation to resins in extruded form; wholesale services in relation to cast steel; wholesale services in relation to regulators [valves] of metal other than parts of machines; online retail services in relation to fasteners, non-metallic; retail services in relation to rods of metal for welding; retail services in relation to steel in sheet, rod, bar and billet form; online retail services in relation to hot-rolled steel bars; wholesale services in relation to hand tools and implements [hand-operated]; retail services in relation to curtains of plastic; wholesale services in relation to gratings (non-metallic -); wholesale services in relation to curtains of plastic; online retail services in relation to stabilisation fabrics (non-metallic -) for use in construction; online retail services in relation to steel rods; wholesale services in relation to apparatus, instruments and cables for electricity; online retail services in relation to building and construction materials and elements of metal; online retail services in relation to molds of metal; wholesale services in relation to rods of metal for brazing and welding including those from alloy steel and titanium; retail services in relation to electric surface heating tapes; wholesale services in relation to safety, security, protection and signalling devices; retail services in relation to drain traps [valves] of metal; online retail services in relation to parapet supports of metal; online retail services in relation to building and construction materials and elements, not of metal; online retail services in relation to window blinds [outdoor] of metal; online retail services in relation to steel sheets; wholesale services in relation to flexible pipes, tubes, hoses, and fittings therefor, including valves, non-metallic; online retail services in relation to sheets of metal including those from alloy steel and titanium; wholesale services in relation to cane connectors of metal; online retail services in relation to gratings (non-metallic -); online retail services in relation to boiler pipes [tubes] for heating installations; online retail services in relation to agricultural, gardening and landscaping tools; retail services in relation to railway material of metal; wholesale services in relation to controllers and regulators; online retail services in relation to building materials of metal; wholesale services in relation to brass, unwrought or semi-wrought; retail services in relation to cane connectors of metal; online retail services in relation to buckles of common metal [hardware]; retail services in relation to squares [hand tools]; retail services in relation to iron wire; wholesale services in relation to building materials, not of metal; retail services in relation to brackets, not of metal, for furniture; retail services in relation to measuring instruments; wholesale services in relation to springs [metal hardware]; wholesale services in relation to fences, not of metal; online retail services in relation to taps for pipes and pipelines; retail services in relation to sheets of metal including those from alloy steel and titanium; wholesale services in relation to pegs of metal; wholesale services in

relation to iron strip; online retail services in relation to pipes [parts of sanitary installations]; online retail services in relation to brass, unwrought or semi-wrought; online retail services in relation to bindings of metal; wholesale services in relation to locks and keys, non-metallic; retail services in relation to gloves for protection against accidents; wholesale services in relation to roof coverings of metal; retail services in relation to roof coverings of metal; wholesale services in relation to electric surface heating tapes; retail services in relation to cast iron, unwrought or semi-wrought; retail services in relation to gaskets; wholesale services in relation to steel strip; wholesale services in relation to frames for umbrellas or parasols; retail services in relation to overalls; wholesale services in relation to parapet supports of metal; online retail services in relation to measuring instruments; wholesale services in relation to plastics in the form of sheets, films, blocks, rods and tubes; wholesale services in relation to steel in sheet, rod, bar and billet form; wholesale services in relation to fittings, not of metal, for rigid pipes; online retail services in relation to pipe muffs of metal; online retail services in relation to rods of metal for brazing and welding including those from alloy steel and titanium; wholesale services in relation to collapsible tubes of metal; retail services in relation to bands of metal for tying-up purposes; online retail services in relation to steel strip; retail services in relation to unprocessed and semi-processed materials of metal, not specified for use; retail services in relation to gratings (non-metallic -); online retail services in relation to umbrellas and parasols; retail services in relation to pipes and tubes of metal; retail services in relation to flexible pipes, tubes, hoses, and fittings therefor, including valves, non-metallic; online retail services in relation to metal sheet, strip and coil; wholesale services in relation to adhesives for use in industry; wholesale services in relation to railing holders of metal; wholesale services in relation to containers, and transportation and packaging articles, of metal; online retail services in relation to screw covers of metal; wholesale services in relation to clad steel plates and sheets; online retail services in relation to gouges [hand tools]; online retail services in relation to grindstones [hand tools]; online retail services in relation to curtain rings; retail services in relation to locks and keys, of metal; retail services in relation to clad steel plates and sheets; online retail services in relation to hand-operated tools and implements for treatment of materials, and for construction, repair and maintenance; retail services in relation to poles of metal; wholesale services in relation to brackets of metal for furniture; online retail services in relation to welding and soldering materials; online retail services in relation to rods of metal; wholesale services in relation to sheets and plates of metal; wholesale services in relation to jets of metal; retail services in relation to fittings of metal for windows; retail services in relation to angle irons of metal; wholesale services in rela-

tion to bastion defence walls of metal materials; wholesale services in relation to steel wire; online retail services in relation to pumps, compressors and blowers; online retail services in relation to metal cable wire; wholesale services in relation to apparatus and instruments for accumulating and storing electricity; retail services in relation to pipework of metal; retail services in relation to dehumidifiers; wholesale services in relation to metal brackets; retail services in relation to bindings of metal; wholesale services in relation to shelf brackets (non-metallic -); retail services in relation to iron, unwrought or semi-wrought; online retail services in relation to steel in sheet, rod, bar and billet form; wholesale services in relation to ironwork for doors; retail services in relation to extruded plastics in the form of bars for use in manufacture; retail services in relation to taps for pipes and pipelines; wholesale services in relation to grindstones [hand tools]; retail services in relation to wire of common metal; wholesale services in relation to hearing protection devices; wholesale services in relation to ironwork for windows; wholesale services in relation to soldering chemicals; online retail services in relation to steel, unwrought or semi-wrought; online retail services in relation to non-metal elbows for pipes; retail services in relation to collars, not of metal, for fastening pipes; wholesale services in relation to staircases of metal; retail services in relation to thread of metal for tying-up purposes; wholesale services in relation to building panels of metal; wholesale services in relation to gutter pipes of metal; wholesale services in relation to non-metal elbows for pipes; retail services in relation to apparatus and instruments for accumulating and storing electricity; retail services in relation to fences, not of metal; retail services in relation to aluminium ladder rungs; online retail services in relation to heating elements; online retail services in relation to seals, sealants and fillers; wholesale services in relation to fittings of metal for building; online retail services in relation to door, gate and window fittings, non-metallic; retail services in relation to boiler tubes [parts of machines]; wholesale services in relation to gratings of metal; wholesale services in relation to pipe muffs of metal; online retail services in relation to stainless steel in sheet form; retail services in relation to non-metal elbows for pipes; retail services in relation to earth terminals; wholesale services in relation to nuts of metal; online retail services in relation to steel pens; retail services in relation to rings of metal; online retail services in relation to elbows of metal for pipes; wholesale services in relation to seals, sealants and fillers; wholesale services in relation to gloves for industrial purposes for protection against injury; online retail services in relation to ducts of metal, for central heating installations; wholesale services in relation to precious metals, unwrought or semi-wrought; retail services in relation to work clothes; retail services in relation to brazing alloys; wholesale services in relation to sleeves [metal hardware]; online retail

services in relation to small items of metal hardware; online retail services in relation to chimney shafts of metal; retail services in relation to cast steel; wholesale services in relation to duckboards of metal; online retail services in relation to lead, unwrought or semi-wrought; retail services in relation to collars of metal for fastening pipes; online retail services in relation to pipes, tubes and hoses, and fittings therefor, including valves, of metal; wholesale services in relation to window blinds [outdoor] of metal; online retail services in relation to joint connectors (metal -) for pipes; retail services in relation to metal railings; wholesale services in relation to elbows of metal for pipes; wholesale services in relation to radiator valves; wholesale services in relation to containers of metal for compressed gas or liquid air; retail services in relation to bastion defence walls of metal materials; online retail services in relation to pipe muffers, not of metal; wholesale services in relation to radiator caps; retail services in relation to metal in foil and powder form for use in painting, decorating, printing and art; retail services in relation to steel in the form of sheets; retail services in relation to cables, wires and chains, of metal; wholesale services in relation to unprocessed and semi-processed materials of metal, not specified for use; retail services in relation to electric cables and wires; wholesale services in relation to release agents [oils]; online retail services in relation to beams (non-metallic -) for building purposes; online retail services in relation to sheets and plates of metal; retail services in relation to branching pipes of metal; wholesale services in relation to sanitary installations, water supply and sanitation equipment; online retail services in relation to busts of precious metal; retail services in relation to pipes [parts of sanitary installations]; wholesale services in relation to pipes and tubes of metal; online retail services in relation to seals for pipe connections; online retail services in relation to duckboards of metal; retail services in relation to soldering chemicals; retail services in relation to nuts, not of metal; online retail services in relation to pegs of metal; wholesale services in relation to overalls; retail services in relation to building and construction materials and elements, not of metal; retail services in relation to sheet piles of metal; online retail services in relation to steel in the form of sheets; retail services in relation to hot-rolled steel bars; retail services in relation to controllers and regulators; retail services in relation to brushes; retail services in relation to grindstones [hand tools]; retail services in relation to springs [metal hardware]; wholesale services in relation to welding and soldering materials; online retail services in relation to films and sheets made from metal for use in the manufacture of circuit boards; online retail services in relation to shelf brackets (non-metallic -); wholesale services in relation to extruded plastic in the form of bars, blocks, pellets, rods, sheets and tubes for use in manufacturing; retail services in relation to pipe muffers, not of metal; online retail services in relation to

valves, non-metallic; wholesale services in relation to heating elements; retail services in relation to shaft couplings [machines]; retail services in relation to copper, unwrought or semi-wrought; retail services in relation to tube cutters [hand tools]; retail services in relation to boiler pipes [tubes] for heating installations; online retail services in relation to brackets, not of metal, for furniture; online retail services in relation to sheet piles of metal; wholesale services in relation to steel rods; online retail services in relation to curtains of plastic; online retail services in relation to gloves for protection against accidents; retail services in relation to radiator caps; wholesale services in relation to pipes, tubes and hoses, and fittings therefor, including valves, of metal; online retail services in relation to flexible hoses, not of metal; wholesale services in relation to plugs of metal; online retail services in relation to penstock pipes, not of metal; wholesale services in relation to tube cutting instruments; retail services in relation to steel alloys; retail services in relation to fittings of metal for building; retail services in relation to pegs of metal; retail services in relation to beams of metal; online retail services in relation to cast steel; online retail services in relation to alloys of precious metal; online retail services in relation to cable connectors (non-electric -) of non-metallic materials; wholesale services in relation to steel alloys; wholesale services in relation to cables, wires and chains, of metal; online retail services in relation to extruded plastic in the form of bars, blocks, pellets, rods, sheets and tubes for use in manufacturing; retail services in relation to sensors, detectors and monitoring instruments; retail services in relation to rivets of metal; retail services in relation to building materials, not of metal; wholesale services in relation to metal cable wire; online retail services in relation to metal billets; retail services in relation to metal sheet, strip and coil; online retail services in relation to metal hoses for plumbing use; retail services in relation to couplings; online retail services in relation to stair treads [steps] of metal; online retail services in relation to pipework of metal; retail services in relation to sleeves [metal hardware]; wholesale services in relation to boiler tubes [parts of machines]; online retail services in relation to common metals, unwrought or semi-wrought; retail services in relation to electrical and electronic components; retail services in relation to molds of metal; online retail services in relation to building materials, not of metal; wholesale services in relation to gaskets; wholesale services in relation to apparatus and instruments for controlling electricity; online retail services in relation to earth terminals; retail services in relation to apparatus and instruments for controlling electricity; retail services in relation to shelf brackets (non-metallic -); online retail services in relation to steel alloys; online retail services in relation to containers of metal for compressed gas or liquid air; retail services in relation to plastic rods and bars; retail services in relation to seals for pipe con-

nections; wholesale services in relation to peeled metal bars; retail services in relation to measuring apparatus; online retail services in relation to gaskets; retail services in relation to release agents [oils]; wholesale services in relation to steel in the form of sheets; online retail services in relation to bastion defence walls of metal materials; retail services in relation to building and construction materials and elements of metal; online retail services in relation to metal brackets; wholesale services in relation to thread of metal for tying-up purposes; online retail services in relation to controllers and regulators; retail services in relation to bright steel bars; retail services in relation to door, gate and window fittings, non-metallic; wholesale services in relation to metal hoses for plumbing use; wholesale services in relation to films and sheets made from metal for use in the manufacture of circuit boards; online retail services in relation to flanges of metal [collars]; wholesale services in relation to stabilisation fabrics (non-metallic -) for use in construction; retail services in relation to metal hardware; online retail services in relation to apparatus and instruments for controlling electricity; online retail services in relation to boiler tubes [parts of machines]; online retail services in relation to wire stretchers [tension links]; retail services in relation to heating elements; retail services in relation to regulators [valves] of metal other than parts of machines; online retail services in relation to branching pipes, not of metal; retail services in relation to hand tools for construction, repair and maintenance; wholesale services in relation to piston seals of metal; online retail services in relation to work clothes; wholesale services in relation to work clothes; retail services in relation to protective preparations for metals; wholesale services in relation to rods of metal; online retail services in relation to waterproofing and moisture proofing articles and materials; retail services in relation to screw covers of metal; retail services in relation to fittings, not of metal, for rigid pipes; online retail services in relation to peeled metal bars; retail services in relation to containers, and transportation and packaging articles, of metal; wholesale services in relation to electrical and electronic components; wholesale services in relation to valves, non-metallic; retail services in relation to iron-work for windows; online retail services in relation to flexible pipes, tubes, hoses, and fittings therefor, including valves, non-metallic; online retail services in relation to wire of common metal; online retail services in relation to brazing alloys; wholesale services in relation to junctions, not of metal, for pipes; online retail services in relation to clad steel plates and sheets; online retail services in relation to locks and keys, non-metallic; retail services in relation to measuring devices; wholesale services in relation to packaging, wrapping and bundling articles, of metal; wholesale services in relation to copper, unwrought or semi-wrought; online retail services in relation to fittings of metal for windows; online retail services in relation to

jets of metal; wholesale services in relation to taps for pipes and pipelines; wholesale services in relation to couplings of metal for tubing; retail services in relation to laths of metal; online retail services in relation to thread of metal for tying-up purposes; retail services in relation to sanitary installations, water supply and sanitation equipment; wholesale services in relation to capping stones for support posts; online retail services in relation to fittings of metal for building; wholesale services in relation to cast iron, unwrought or semi-wrought; wholesale services in relation to pipework of metal; retail services in relation to tanks of metal; online retail services in relation to collars, not of metal, for fastening pipes; online retail services in relation to building and construction materials and elements made of wood and artificial wood; online retail services in relation to hand tools and implements [hand-operated]; retail services in relation to steel wire; wholesale services in relation to protective clothing [body armour]; retail services in relation to manifolds of metal for pipelines; retail services in relation to stretchers for iron bands [tension links]; wholesale services in relation to wire stretchers [tension links]; wholesale services in relation to nuts, not of metal; wholesale services in relation to ducts of metal, for central heating installations; online retail services in relation to steel wire; online retail services in relation to protective clothing for the prevention of injury; online retail services in relation to overalls; retail services in relation to chimney shafts of metal; online retail services in relation to doors, gates, windows and window coverings of metal; wholesale services in relation to metal sheet, strip and coil; retail services in relation to steel, unwrought or semi-wrought; online retail services in relation to tubes of metal; online retail services in relation to adhesives for use in industry; wholesale services in relation to bands of metal for tying-up purposes; online retail services in relation to hooks [metal hardware]; retail services in relation to building and construction materials and elements made of wood and artificial wood; wholesale services in relation to pipes [parts of sanitary installations]; online retail services in relation to cables, wires and chains, of metal; wholesale services in relation to beams, not of metal; retail services in relation to busts of precious metal; retail services in relation to building panels of metal; wholesale services in relation to building and construction materials and elements of metal; wholesale services in relation to tubes of metal; retail services in relation to beams, not of metal; retail services in relation to rods of metal for brazing; online retail services in relation to squares [hand tools]; wholesale services in relation to bindings of metal; wholesale services in relation to hooks [metal hardware]; wholesale services in relation to paints and washes; wholesale services in relation to plastic rods and bars; retail services in relation to steel strip; wholesale services in relation to joint connectors (metal -) for pipes; retail services in relation to rods of metal for brazing and

welding including those from alloy steel and titanium; online retail services in relation to capping stones for support posts; wholesale services in relation to metal railings; wholesale services in relation to brazing alloys; online retail services in relation to paints and washes; online retail services in relation to dehumidifiers; retail services in relation to packaging, wrapping and bundling articles, of metal; wholesale services in relation to electric cables and wires; wholesale services in relation to gouges [hand tools]; retail services in relation to peeled metal bars; wholesale services in relation to curtain rings; retail services in relation to steel sheets; retail services in relation to pipe muffs of metal; wholesale services in relation to louvres made of metal; online retail services in relation to roof coverings of metal; online retail services in relation to poles of metal; retail services in relation to paints and washes; retail services in relation to extruded plastic in the form of bars, blocks, pellets, rods, sheets and tubes for use in manufacturing; online retail services in relation to screws of metal; wholesale services in relation to fasteners, non-metallic; retail services in relation to protective clothing [body armour]; wholesale services in relation to agricultural, gardening and landscaping tools; retail services in relation to tiles; wholesale services in relation to iron, unwrought or semi-wrought; wholesale services in relation to steel, unwrought or semi-wrought; online retail services in relation to doors, gates, windows and window coverings, not of metal; retail services in relation to welding and soldering materials; online retail services in relation to insulation and barrier articles and materials; online retail services in relation to screws, not of metal; retail services in relation to curtain rings; online retail services in relation to apparatus, instruments and cables for electricity; online retail services in relation to branching pipes of metal; wholesale services in relation to protective preparations for metals; wholesale services in relation to tanks of metal; wholesale services in relation to rings of metal; retail services in relation to ventilation suits; wholesale services in relation to bars for metal railings; retail services in relation to hand-operated tools and implements for treatment of materials, and for construction, repair and maintenance; wholesale services in relation to flexible pipes, tubes, hoses and fittings therefor (including valves), and fittings for rigid pipes, all non-metallic; wholesale services in relation to waterproofing and moisture proofing articles and materials; online retail services in relation to steel wool for cleaning; wholesale services in relation to latticework of metal; wholesale services in relation to beams of metal; online retail services in relation to manifolds of metal for pipelines; online retail services in relation to tube cutting instruments; wholesale services in relation to refractory construction materials of metal; wholesale services in relation to fittings, not of metal, for flexible pipes; wholesale services in relation to brushes; retail services in relation to flanges of metal [collars]; who-

lesale services in relation to screws of metal; online retail services in relation to bars for metal railings; online retail services in relation to fittings, not of metal, for flexible pipes; online retail services in relation to plastic rods and bars; wholesale services in relation to tents; retail services in relation to hand tools and implements [hand-operated]; online retail services in relation to fences, not of metal; online retail services in relation to flexible pipes, tubes, hoses and fittings therefor (including valves), and fittings for rigid pipes, all non-metallic; online retail services in relation to signs, and information and advertising displays, of metal; wholesale services in relation to steel wool for cleaning; wholesale services in relation to hot-rolled steel bars; retail services in relation to films and sheets made from metal for use in the manufacture of circuit boards; retail services in relation to fasteners, non-metallic; retail services in relation to hearing protection devices; retail services in relation to building materials of metal; retail services in relation to building glass; online retail services in relation to collapsible tubes of metal; retail services in relation to joint connectors (metal -) for pipes; wholesale services in relation to buckles of common metal [hardware]; online retail services in relation to frames for umbrellas or parasols; online retail services in relation to steel masts; retail services in relation to steel masts; wholesale services in relation to metal billets; online retail services in relation to latticework of metal; wholesale services in relation to brackets, not of metal, for furniture; retail services in relation to beams (non-metallic -) for building purposes; wholesale services in relation to molds of metal; online retail services in relation to springs [metal hardware]; online retail services in relation to packaging, wrapping and bundling articles, of metal; online retail services in relation to metal in foil and powder form for use in painting, decorating, printing and art; retail services in relation to precious metals, unwrought or semi-wrought; retail services in relation to couplings of metal for tubing; wholesale services in relation to insulation and barrier articles and materials; retail services in relation to metal hoses for plumbing use; retail services in relation to stabilisation fabrics (non-metallic -) for use in construction; online retail services in relation to fittings, not of metal, for rigid pipes; retail services in relation to steel wool for cleaning; wholesale services in relation to screws, not of metal; online retail services in relation to tiles; retail services in relation to window blinds [outdoor] of metal; online retail services in relation to regulators [valves] of metal other than parts of machines; online retail services in relation to metalworking machines; wholesale services in relation to sensors, detectors and monitoring instruments.

40 – Enamelling of metals; treatment of metal parts to prevent corrosion; treatment and coating of metal surfaces; desalination; hard nickel plating of metal surfaces; degaussing; material treatment information; drilling of metals; extruding of metal alloys; processing



of metal surfaces by precision grinding and abrasive polishing; hard chromium plating of metal surfaces; stainless steel polishing services; stainless steel brushing services.

(260) AM 2022 115174 A

(800) 1622913

(151) 2021 06 10

(891) 2021 06 10

(731) Ecolab Deutschland GmbH

Ecolab-Allee 1, 40789 Monheim, Germany

(540)

## ECOSURE

(591) Black, white

(511)

35 – Advertising, marketing and promotional services, in particular advertising [in particular relating to public health, food safety, food sanitation, food manufacturing, food preparation, storage of food, packing and repacking of food, food temperature control, transportation and delivery of food, cleaning and disinfecting and sanitizing as well as infection control and pest elimination, running of restaurants and pubs, reputation management, workplace safety, customer safety, customer satisfaction, maintenance as well as condition and performance of commercial kitchen equipment]; business assistance, management and administrative services, in particular business data analysis services [in particular relating to public health, food safety, food sanitation, food manufacturing, food manufacturing recalls, food preparation, storage of food, packing and repacking of food, food temperature control, transportation and delivery of food, cleaning and disinfecting and sanitizing as well as infection control and pest elimination, running of restaurants and pubs, reputation management, workplace safety, customer safety, customer satisfaction, maintenance of the condition and the performance of commercial kitchen equipment], business consulting [in particular relating to public health, food safety, food sanitation, food manufacturing, food manufacturing recalls, food preparation, storage of food, packing and repacking of food, food temperature control, transportation and delivery of food, cleaning and disinfecting and sanitizing as well as infection control and pest elimination, running of restaurants and pubs, reputation management, workplace safety, customer safety, customer satisfaction, maintenance of the condition and the performance of commercial kitchen equipment], preparing business reports [in particular relating to public health, food safety, food sanitation, food manufacturing, food manufacturing recalls, food preparation, storage of food, packing and repacking of food, food temperature control, transportation and delivery of food, cleaning and disinfecting and sanitizing as well as infection control and pest elimination, running of restaurants and pubs, reputation management, workplace safety, customer safety, customer sa-

tisfaction, maintenance of the condition and the performance of commercial kitchen equipment], providing business information, [in particular relating to public health, food safety, food sanitation, food manufacturing, food manufacturing recalls, food preparation, storage of food, packing and repacking of food, food temperature control, transportation and delivery of food, cleaning and disinfecting and sanitizing as well as infection control and pest elimination, running of restaurants and pubs, reputation management, workplace safety, customer safety, customer satisfaction, maintenance of the condition and the performance of commercial kitchen equipment], business auditing [in particular relating to public health, food safety, food sanitation, food manufacturing, food manufacturing recalls, food preparation, storage of food, packing and repacking of food, food temperature control, transportation and delivery of food, cleaning and disinfecting and sanitizing as well as infection control and pest elimination, running of restaurants and pubs, reputation management, workplace safety, customer safety, customer satisfaction, maintenance of the condition and the performance of commercial kitchen equipment], business appraisals [in particular relating to public health, food safety, food sanitation, food manufacturing, food manufacturing recalls, food preparation, storage of food, packing and repacking of food, transportation and delivery of food, cleaning and disinfecting and sanitizing as well as infection control and pest elimination, running of restaurants and pubs, reputation management, workplace safety, customer safety, customer satisfaction, maintenance of the condition and the performance of commercial kitchen equipment], providing business information in the field of social media.

41 – Education and teaching, in particular provision of training courses [in particular organization and implementation of educational and training programs relating to public health, food safety, food sanitation, food manufacturing, food manufacturing recalls, food preparation, storage of food, packing and repacking of food, food temperature control, transportation and delivery of food, cleaning and disinfecting and sanitizing as well as infection control and pest elimination, running of restaurants and pubs, reputation management, workplace safety, customer safety, customer satisfaction, maintenance of the condition and the performance of commercial kitchen equipment, organization of webinars].

42 – Quality control and authentication services, in particular quality control [in particular relating to public health, food safety, food sanitation, food manufacturing, food preparation, storage of food, packing and repacking of food, food temperature control, transportation and delivery of food, cleaning and disinfecting and sanitizing as well as infection control and pest elimination, running of restaurants and pubs, reputation management, workplace safety, customer safety,

customer satisfaction, maintenance of the condition and the performance of commercial kitchen equipment], consultancy services relating to quality control [in particular relating to public health, food safety, food sanitation, food manufacturing, food preparation, storage of food, packing and repacking of food, food temperature control, transportation and delivery of food, cleaning and disinfecting and sanitizing as well as infection control and pest elimination, running of restaurants and pubs, reputation management, workplace safety, customer safety, customer satisfaction, maintenance of the condition and the performance of commercial kitchen equipment]; software as a service [SaaS], in particular for collecting, auditing, simulating, assessing, monitoring, managing, optimising, analysing and reporting data relating to public health, food safety, food sanitation, food manufacturing, food manufacturing recalls, food preparation, storage of food, packing and repacking of food, food temperature control, transportation and delivery of food, cleaning and disinfecting and sanitizing as well as infection control and pest elimination, running of restaurants and pubs, reputation management, workplace safety, customer safety, customer satisfaction, maintenance of the condition and the performance of commercial kitchen equipment; technical data analysis services, in particular relating to public health, food safety, food sanitation, food manufacturing, food manufacturing recalls, food preparation, storage of food, packing and repacking of food, food temperature control, transportation and delivery of food, cleaning and disinfecting and sanitizing as well as infection control and pest elimination, running of restaurants and pubs, reputation management, workplace safety, customer safety, customer satisfaction, maintenance of the condition and the performance of commercial kitchen equipment; conducting sampling and analysis services to check for contamination; computerised food analysis services; bacteriological analysis; designing food safety programs for others.

---

(260) AM 2022 115179 A

(800) 1623023

(151) 2021 07 09

(891) 2021 07 09

(731) LASAK s.r.o.

Českobrodská 1047/46, Praha 9, CZ-190 01

Hloubětín, Czech Republic

(540)

## Uni-Base

(591) Black, white

(511)

10 – Implant abutments for dental purposes, prosthetic parts for dentistry, instruments for use in prosthetic dentistry, dental implants.

(260) AM 2022 115191 A

(800) 1364450

(151) 2017 03 06

(891) 2021 10 01

(731) TEQBALL HOLDING S.A.R.L.

44, avenue John F. Kennedy, L-1855

Luxembourg, Luxembourg

(540)

## TEQBALL

(591) Black, white

(511)

41 – Education; training; entertainment; entertainment services relating to sporting events and sporting activities; sport-related betting and game services; organization of sporting competitions; organization of events and sporting activities; television and radio coverage of sports events and sports competitions; recording of sports events and sports competitions for transmission across the internet; live transmissions accessible via home pages on the internet (terms considered too vague by the International Bureau – rule 13.2.b) of the Common Regulations); production services for radio and television programs and videotapes; information about education, training, entertainment, sporting activities and events, provided online from a computer database or via the Internet or via any wireless electronic communication network; provision of sports information related to statistical information; electronic game services transmitted via the Internet or on mobile telephones; organization of computer game competitions; computer game competitions organized on-line; book publishing; on-line publishing of electronic books, newspapers and blogs; publication of multimedia material online; online digital publishing services; providing online tutorials; audio and video recording services; operation and provision of sports facilities for sporting events, sports and athletic competitions and awards programmes; sport education services; providing sports information; providing of training courses; ticket reservation services for entertainment and sporting events; sports camps services; timing during sports events; interactive entertainment; arranging and conducting of conferences, conventions, exhibitions, classes, lectures, seminars and workshops; distance learning services related to sports provided online.

---

(260) AM 2022 115249 A

(800) 1623641

(151) 2021 06 21

(891) 2021 06 21

(731) PLATINUM GmbH & Co. KG

Am Ockenheimer Graben 23, 55411 Bingen

am Rhein, Germany

(540)

## FSG

(591) Black, white

(511)  
31 – Animal foodstuffs; foodstuffs for animals, in particular for dogs and cats; formula animal feed for dogs and cats; edible pet treats.

(260) AM 2022 115250 A

(800) 1623647

(151) 2021 07 09

(891) 2021 07 09

(731) KERVAN GIDA SANAYİ VE TİCARET ANONİM ŞİRKETİ  
Yakuplu Mahallesi Beysan, Sanayi Sitesi  
Fuar Caddesi, No:9/1 Beylikdüzü, İstanbul,  
Turkey

(540)



(591) Black, white

(531) 26.04.05; 26.04.18; 26.04.24; 27.01.01;  
27.05.01; 27.05.02; 27.05.09; 29.01.15

(511)

28 – Games, toys and playthings; video game apparatus; gymnastic and sporting articles; decorations for Christmas trees.

30 – Coffee, tea, cocoa and artificial coffee; rice, pasta and noodles; tapioca and sago; flour and preparations made from cereals; bread, pastries and confectionery; chocolate; ice cream, sorbets and other edible ices; sugar, honey, treacle; yeast, baking-powder; salt, seasonings, spices, preserved herbs; vinegar, sauces and other condiments; ice (frozen water).

(260) AM 2022 115252 A

(800) 1623701

(151) 2021 09 01

(891) 2021 09 01

(731) Red Bull GmbH  
Am Brunnen 1, A-5330 Fuschl am See, Austria

(540)

**GIVES YOU WINGS**

(591) Black, white

(511)

32 – Beers; mineral waters; aerated waters; non-alcoholic beverages; fruit beverages and fruit juices; syrups for making beverages; non-alcoholic preparations for making beverages; energy drinks.

(260) AM 2022 115254 A

(800) 1623766

(151) 2021 06 08

(891) 2021 06 08

(731) Adnan Alnen and Partners company – "AL-Durra Food Products"  
Abdel mouniam Riad Street, P.O Box 92,  
Erbeen, Damascus Countryside, Syrian Arab  
Republic

(540)



**ALDURRA**

(591) Red, green and white

(531) 26.01.03; 26.01.24; 26.03.01; 26.03.05;  
27.05.01; 28.01; 29.01.13

(511)

29 – Yogurt; milk; dairy products; dates; processed citrus fruits; snack (potato starters); processed vegetables; tahina (sesame seed paste).

(260) AM 2022 115255 A

(800) 1623821

(151) 2021 08 12

(891) 2021 08 12

(731) Museum of Future Technologies LLC  
pr. Primorskiy 70, bldg. 1, of. 212, RU-197374  
Saint-Petersburg, Russian Federation

(540)

**M+FT**

(591) Black, white

(531) 21.03.21; 27.03.15

(511)

9 – 3D spectacles; DVD players; ticket dispensers; juke boxes, musical; answering machines; accumulators, electric; ear pads for headphones; high-frequency apparatus; remote control apparatus; monitoring apparatus, other than for medical purposes; sound recording apparatus; Global Positioning System [GPS] apparatus; sound transmitting apparatus; cash registers; electric apparatus for commutation; intercommunication apparatus; projection apparatus; blueprint apparatus; telephone apparatus; facsimile machines; phototelegraphy apparatus; automated teller machines [ATM]; solar batteries; solar panels for the production of electricity; batteries, electric; balances [steelyards]; binoculars; biochips; electronic tags for goods; magnetic tape units for computers; computer memory devices; encoded identification bracelets, magnetic; con-

nected bracelets [measuring instruments]; electronic key fobs being remote control apparatus; scales; camcorders; video baby monitors; video cassettes; video projectors; video telephones; video screens; viewfinders, photographic; mechanical signs; signs, luminous; hands-free kits for telephones; holograms; loudspeakers; detectors; joysticks for use with computers, other than for video games; dictating machines; floppy disks; phonograph records; disks, magnetic; optical disks; disk drives for computers; juke boxes for computers; wearable video display monitors; electronic numeric displays; electronic interactive whiteboards; electronic notice boards; life jackets; reflective safety vests; audio interfaces; acoustic conduits; road signs, luminous or mechanical; downloadable emoticons for mobile phones; eyewear; reflective articles for wear, for the prevention of accidents; measuring instruments; mathematical instruments; interfaces for computers; satellite finder meters; calculating machines; pocket calculators; cinematographic cameras; thermal imaging cameras; electronic pens [visual display units]; biometric identity cards; identity cards, magnetic; video game cartridges; toner cartridges, unfilled, for printers and photocopiers; ink cartridges, unfilled, for printers and photocopiers; memory cards for video game machines; encoded magnetic cards; riding helmets; protective helmets; cinematographic film, exposed; computer keyboards; thin client computers; encoded key cards; downloadable cryptographic keys for receiving and spending cryptocurrency; electronic book readers; electronic agendas; push buttons for bells; mouse pads; magnetic encoders; visors for helmets; commutators; compact discs [audio-video]; compact discs [read-only memory]; marine compasses; computers; wearable computers; laptop computers; tablet computers; notebook computers; traffic cones; downloadable e-wallets; magnetic tapes; videotapes; surveying chains; fire escapes; rulers [measuring instruments]; contact lenses; correcting lenses [optics]; close-up lenses; optical lenses; magnifying glasses [optics]; magnets; decorative magnets; resuscitation mannequins [teaching apparatus]; mouse [computer peripheral]; trackballs [computer peripherals]; protective masks; respiratory masks, other than for artificial respiration; megaphones; portable media players; dressmakers' measures; mechanisms for coin-operated apparatus; mechanisms for counter-operated apparatus; coin-operated mechanisms for television sets; micrometers; microprocessors; microscopes; microphones; audio mixers; modems; monitors [computer hardware]; monitors [computer programs]; selfie sticks [hand-held monopods]; temperature indicator labels, not for medical purposes; headphones; earpieces for remote communication; sound recording carriers; magnetic data media; optical data media; electronic sheet music, downloadable; computer software, recorded; weighing machines; computer hardware; life saving equipment; shoes for protection against accidents, irradiation and fire; objectives [lenses] [optics]; selfie

lenses; fire extinguishers; rescue laser signalling flares; electrified fences; clothing for protection against accidents, irradiation and fire; clothing for protection against fire; asbestos clothing for protection against fire; clothing especially made for laboratories; survival blankets; wrist rests for use with computers; spectacle frames; spectacles; sunglasses; goggles for sports; electronic collars to train animals; finger sizers; signalling panels, luminous or mechanical; biometric passports / e-passports; wah-wah pedals; radio pagers; pince-nez; electronic pocket translators; transmitters [telecommunication]; telephone transmitters; transmitters of electronic signals; data gloves; gloves for protection against accidents; plane tables [surveying instruments]; computer software platforms, recorded or downloadable; wafers for integrated circuits; printed circuit boards; compact disc players; cassette players; protective films adapted for computer screens; protective films adapted for smartphones; sound recording strips; digital signs; stands adapted for laptops; personal digital assistants [PDAs]; fire pumps; distance recording apparatus; distance measuring apparatus; speed measuring apparatus [photography]; teaching apparatus; time recording apparatus; measuring apparatus; measuring devices, electric; observation instruments; telecommunication apparatus in the form of jewellery; precision measuring apparatus; audio- and video-receivers; computer software applications, downloadable; ticket printers; printers for use with computers; hemline markers; retorts' stands; apparatus for changing record player needles; drainers for use in photography; cleaning apparatus for phonograph records; fire beaters; sighting telescopes for firearms; telescopic sights for artillery; test tubes; pressure indicator plugs for valves; magnetic wires; telegraph wires; telephone wires; wires, electric; conductors, electric; copper wire, insulated; fuse wire; computer screen saver software, recorded or downloadable; computer programs, recorded; computer game software, downloadable; computer game software, recorded; computer programs, downloadable; computer operating programs, recorded; record players; processors [central processing units]; rods for water diviners; electronic publications, downloadable; distribution consoles [electricity]; control panels [electricity]; radar apparatus; baby monitors; transmitting sets [telecommunication]; radios; vehicle radios; walkie-talkies; security surveillance robots; laboratory robots; teaching robots; telepresence robots; humanoid robots with artificial intelligence; speaking tubes; horns for loudspeakers; subwoofers; nets for protection against accidents; fire alarms; signals, luminous or mechanical; rescue flares, non-explosive and non-pyrotechnic; sirens; electronic access control systems for interlocking doors; scanners [data processing equipment]; hand-held electronic dictionaries; integrated circuit cards [smart cards]; smartglasses; smartwatches; smartphones; protection devices for personal use against accidents; audiovisual teaching apparatus;

spectacle lenses; personal stereos; bags adapted for laptops; integrated circuits; printed circuits; counters; parking meters; mileage recorders for vehicles; television apparatus; teleprompters; teleprinters; mobile telephones / cell phones; cordless telephones; credit card terminals; interactive touch screen terminals; thermo-hygrometers; thermometers, not for medical purposes; climate control digital thermostats; transponders; neon signs; headgear being protective helmets; gauges; electric installations for the remote control of industrial operations; bar code readers; video recorders; sound reproduction apparatus; invoicing machines; tape recorders; data processing apparatus; theft prevention installations, electric; devices for the projection of virtual keyboards; optical character readers; battery chargers; chargers for electric accumulators; chargers for electronic cigarettes; acoustic alarms; apparatus for editing cinematographic film; couplers [data processing equipment]; wearable activity trackers; anti-theft warning apparatus; computer peripheral devices; anti-interference devices [electricity]; demagnetizing apparatus for magnetic tapes; acoustic couplers; alarms; adding machines; readers [data processing equipment]; heat regulating apparatus; photocopiers [photographic, electrostatic, thermic]; electric and electronic effects units for musical instruments; downloadable ring tones for mobile phones; downloadable image files; downloadable music files; animated cartoons; filters for use in photography; USB flash drives; magic lanterns; signal lanterns; optical lanterns; cameras [photography]; digital photo frames; containers for contact lenses; spectacle cases; containers for microscope slides; cases for smartphones; cases especially made for photographic apparatus and instruments; spectacle chains; time clocks [time recording devices]; sleeves for laptops; covers for personal digital assistants [PDAs]; covers for tablet computers; covers for smartphones; chips [integrated circuits]; jigs [measuring instruments]; pedometers; meteorological balloons; electrified rails for mounting spot lights; asbestos screens for firemen; fire hose; virtual reality headsets; protective helmets for sports; head guards for sports; lifeboats; snorkels; cell phone straps; spectacle cords; switchboards; distribution boards [electricity]; equalizers [audio apparatus]; screens [photography]; workmen's protective face-shields; projection screens; fluorescent screens; exposure meters [light meters]; ducts [electricity]; galvanic cells; downloadable graphics for mobile phones; epidiascopes; ergometers; armatures [electricity]; black boxes [data recorders].

12 – Gyrocopters; driverless cars [autonomous cars]; cars; robotic cars; sports cars; caravans; suspension shock absorbers for vehicles; aeronautical apparatus, machines and appliances; ski carriers for cars; luggage carriers for vehicles; bicycles; electric bicycles; pushchair hoods; hoods for vehicles; hydroplanes; seaplanes; self-balancing scooters; dirigible balloons; trolley railways [cable cars]; self-balancing boards;

dredgers [boats]; handcars; military drones; civilian drones; delivery drones; camera drones; vehicle bonnet pins; bicycle bells; portholes; cars for cable transport installations; inner tubes for bicycle tyres; boats; vehicle wheels; pushchairs; pet strollers; side cars; prams; ships; baskets adapted for bicycles; panniers adapted for bicycles; panniers adapted for motorcycles; bodies for vehicles; self-balancing electric unicycles; mopeds; motor scooters; motorcycles; anti-theft devices for vehicles; push scooters [vehicles]; sleighs [vehicles]; kick sledges; bicycle saddles; saddles for motorcycles; luggage nets for vehicles; dress guards for bicycles; fitted pushchair mosquito nets; anti-theft alarms for vehicles; reversing alarms for vehicles; safety seats for children, for vehicles; vehicle seats; mobility scooters; snowmobiles; rolling stock for funicular railways; spoilers for vehicles; vehicles for locomotion by land, air, water or rail; water vehicles; remote control vehicles, other than toys; tricycles; bags adapted for pushchairs; saddlebags adapted for bicycles; wheelbarrows; handling carts; two-wheeled trolleys; shopping trolleys; fishing trolleys; hose carts; brakes for vehicles; funiculars; vans [vehicles]; undercarriages for vehicles; pushchair covers; spare wheel covers; covers for vehicle steering wheels; saddle covers for bicycles; saddle covers for motorcycles; seat covers for vehicles; vehicle covers [shaped]; vehicle chassis; bicycle tyres; automobile tyres; tyres for snow ploughs; pneumatic tyres; solid tyres for vehicle wheels; launches; mudguards; bicycle mudguards; tow trucks; yachts; kayaks for surfing.

16 – Fountain pens; aquarelles; albums; almanacs; atlases; posters; banknotes; banners of paper; paper bows, other than haberdashery or hair decorations; name badges [office requisites]; table linen of paper; tickets; baggage claim check tags of paper; forms, printed; announcement cards [stationery]; glitter for stationery purposes; note books; pads [stationery]; drawing pads; wristbands for the retention of writing instruments; pamphlets; booklets; paper; papers for painting and calligraphy; wrapping paper; newsletters; modelling wax, not for dental purposes; signboards of paper or cardboard; sewing patterns; bunting of paper; newspapers; modelling clay; polymer modelling clay; terrestrial globes; drawing sets; engravings; slate pencils; document holders [stationery]; pencil holders; chalk holders; holders for cheque books; holders for stamps [seals]; page holders; name badge holders [office requisites]; diagrams; table runners of paper; advertisement boards of paper or cardboard; engraving plates; writing slates; blackboards; magazines [periodicals]; money clips; clips for name badge holders [office requisites]; tags for index cards; pen clips; bookmarks; periodicals; printed publications; graphic representations; credit card imprinters, non-electric; drawing instruments; calendars; pencils; pencil lead holders; charcoal pencils; pictures; transfers [decalcomanias]; paintings [pictures], framed or unframed; cardboard; cards; index cards [stationery]; geographi-

cal maps; trading cards, other than for games; catalogues; flower-pot covers of paper; paintbrushes; painters' brushes; writing brushes; typewriter keys; glue for stationery or household purposes; books; comic books; manifolds [stationery]; drawing pins; envelopes [stationery]; boxes of paper or cardboard; cases for stamps [seals]; paint boxes for use in schools; correcting fluids [office requisites]; printed coupons; stencils [stationery]; paper ribbons, other than haberdashery or hair decorations; gummed tape [stationery]; adhesive bands for stationery or household purposes; adhesive tapes for stationery or household purposes; drawing rulers; flyers; lithographs; architects' models; postage stamps; plastics for modelling; graphic prints; modelling materials; teaching materials [except apparatus]; adhesives [glues] for stationery or household purposes; packing [cushioning, stuffing] materials of paper or cardboard; packaging material made of starches; table place setting mats of paper; writing chalk; tailors' chalk; bags [envelopes, pouches] of paper or plastics, for packaging; garbage bags of paper or of plastics; painters' easels; bibs of paper; bibs, sleeved, of paper; stickers [stationery]; fingers-talls for office use; writing cases [stationery]; paper knives [letter openers]; printed sheet music; bottle envelopes of paper or cardboard; sealing wafers; covers [stationery]; passport holders; embroidery designs [patterns]; handwriting specimens for copying; musical greeting cards; greeting cards; postcards; etchings; conical paper bags; palettes for painters; ink sticks; file folders [office requisites]; document covers; loose-leaf binders; papier mâché; pastels [crayons]; modelling paste; pen cases; pen wipers; pens [office requisites]; seals [stamps]; sealing stamps; clipboards; address plates for addressing machines; handkerchiefs of paper; plastic film for wrapping; desk mats; trays for sorting and counting money; coasters of paper; bookends; stamp stands; mats for beer glasses; stands for pens and pencils; photograph stands; stamp pads; towels of paper; portraits; paperweights; writing cases [sets]; inkstands; office requisites, except furniture; writing materials; writing instruments; drawing materials; school supplies [stationery]; hand labelling appliances; printed matter; lithographic works of art; prospectuses; printed timetables; ledgers [books]; indexes; rubber erasers; elastic bands for offices; graphic reproductions; retractable reels for name badge holders [office requisites]; pen holders; marking pens [stationery]; paper wipes for cleaning; place mats of paper; tablemats of paper; tablecloths of paper; paper clasps; document files [stationery]; scrapers [erasers] for offices; clips for offices; figurines of papier mâché; arithmetical tables; placards of paper or cardboard; writing or drawing books; stationery; pencil sharpeners, electric or non-electric; transparencies [stationery]; stencil plates; stencils for decorating food and beverages; cardboard tubes; Indian inks; moisteners [office requisites]; moisteners for gummed surfaces [office requisites]; squares for drawing; chart pointers,

non-electronic; bottle wrappers of paper or cardboard; envelope sealing machines for offices; sealing machines for offices; vignetting apparatus; apparatus for mounting photographs; stapling presses [office requisites]; manuals [handbooks]; paper coffee filters; flags of paper; silver paper; moulds for modelling clays [artists' materials]; photo-engravings; photographs [printed]; stencil cases; canvas for painting; chromolithographs [chromos]; animation cels; compasses for drawing; numbers [type]; artists' watercolour saucers; ink; inkwells; blueprints; stencils; printing type; address stamps; stamps [seals]; shields [paper seals]; prints [engravings]; labels of paper or cardboard.

18 – Mountaineering sticks; slings for carrying infants; luggage tags; pocket wallets; business card cases; reins for guiding children; sling bags for carrying infants; credit card cases [wallets]; umbrellas; parasols; saddlery; card cases [notecases]; cases of leather or leatherboard; hat boxes of leather; boxes of leather or leatherboard; boxes of vulcanized fibre; purses; chain mesh purses; bags [envelopes, pouches] of leather, for packaging; travelling sets [leatherware]; vanity cases, not fitted; clothing for pets; covers for animals; trimmings of leather for furniture; collars for animals; hiking sticks; conference folders; music cases; leather leashes; garment bags for travel; briefcases; randsels [Japanese school satchels]; haversacks; leather straps; grips for holding shopping bags; umbrella handles; walking stick handles; suitcase handles; rucksacks; travelling bags; net bags for shopping; bags; pouch baby carriers; bags for climbers; tool bags, empty; handbags; beach bags; saddlebags; compression cubes adapted for luggage; bags for sports; bags for campers; shopping bags; wheeled shopping bags; school bags; travelling trunks; trunks and travelling bags; nose bags [feed bags]; walking sticks; umbrella sticks; walking stick seats; harnesses for animals; key cases; suitcases; motorized suitcases; suitcases with wheels; valises; attaché cases; umbrella covers; labels of leather.

25 – Bandanas [neckerchiefs]; underwear; berets; overalls; boas [necklets]; teddies [underclothing]; boxer shorts; ski boots; boots for sports; breeches for wear; trousers; football shoes; valenki [felted boots]; mittens; collars [clothing]; detachable collars; shirt yokes; galoshes; neckties; ascots; leggings [leg warmers]; gaiters; jerseys [clothing]; waistcoats; sports jerseys; hosiery; hoods [clothing]; neck scarves being mufflers; caps being headwear; kimonos; visors being headwear; combinations [clothing]; wet suits for water-skiing; suits; bathing suits; masquerade costumes; beach clothes; headscarves; leotards; jackets [clothing]; stuff jackets [clothing]; fishing vests; leggings [trousers]; sports singlets; cuffs; short-sleeve shirts; sleep masks; furs [clothing]; fingerless gloves; muffs [clothing]; footmuffs, not electrically heated; bibs, not of paper; bibs, sleeved, not of paper; fur stoles; hairdressing capes; heel protectors for shoes; ear muffs

[clothing]; socks; footwear; beach shoes; sports shoes; clothing; clothing containing slimming substances; paper clothing; outerclothing; embroidered clothing; ready-made clothing; motorists' clothing; cyclists' clothing; clothing for gymnastics; clothing of imitations of leather; latex clothing; clothing of leather; waterproof clothing; clothing incorporating LEDs; uniforms; parkas; pelerines; gloves [clothing]; pyjamas; bathing trunks; pocket squares; dresses; headbands [clothing]; heel inserts; braces for clothing [suspenders]; ponchos; money belts [clothing]; belts [clothing]; non-slipping devices for footwear; jumpers [pullovers]; shirts; jumper dresses; inner soles; bath slippers; knitwear [clothing]; underpants; shoes; headwear; aprons [clothing]; judo uniforms; karate uniforms; tee-shirts; rash guards; dressing gowns; bath robes; stockings; shawls; paper hats [clothing]; neck tube scarves; hats; babies' pants [underwear]; pelisses; skirts.

28 – Arcade video game machines; video game machines; gaming machines for gambling; amusement machines, automatic and coin-operated; toy vehicles; swimming pools [play articles]; trampolines; novelty toys for parties; scratch cards for playing lottery games; starting blocks for sports; bodyboards; boots with skates attached to them; boomerangs; dolls' feeding bottles; tricycles for infants [toys]; stationary exercise bicycles; spinning tops [toys]; dumb-bells; gyroscopes and flight stabilizers for model aircraft; jigsaw puzzles; punching bags; hang gliders; joysticks for video games; flying discs [toys]; discs for sports; dolls' houses; playhouses for children; dominoes; swimming kickboards; paddleboards; surfboards; spring boards [sports articles]; skateboards; sailboards; chessboards; draughtboards; drones [toys]; darts; Christmas trees of synthetic material; cups for dice; swimming jackets; kites; toys; toys for pets; stuffed toys; inflatable games for swimming pools; plush toys; toy mobiles; novelty toys for playing jokes; games; building games; portable games and toys incorporating telecommunication functions; parlour games; table-top games; ring games; toy imitation cosmetics; swimming pool air floats; kaleidoscopes; trading cards for games; bingo cards; playing cards; fairground ride apparatus; swings; yoga swings; skittles; skittles [games]; billiard cues; golf clubs; hockey sticks; baby gyms; controllers for game consoles; controllers for toys; confetti; ice skates; roller skates; dice; paintball guns [sports apparatus]; ski bindings; dolls' beds; building blocks [toys]; dolls; flippers for diving; flippers for swimming; swimming webs; bows for archery; skis; waterskis; roller skis; mah-jong; toy models; puppets; masks [playthings]; carnival masks; theatrical masks; toy putty; matryoshka dolls; masts for sailboards; ball pitching machines; teddy bears; targets; electronic targets; scale model kits [toys]; scale model vehicles; kite reels; balls for games; artificial fishing bait; backgammon games; pumps specially adapted for use with balls for games; dolls' clothes; play tents;

ski sticks for roller skis; ski sticks; twirling batons; paragliders; pachinkos; baseball gloves; boxing gloves; golf gloves; gloves for games; batting gloves [accessories for games]; piñatas; toy pistols; percussion caps [toys]; caps for pistols [toys]; toy dough; protective films adapted for screens for portable games; rattles [playthings]; horseshoe games; candle holders for Christmas trees; Christmas tree stands; sole covers for skis; water wings; portable games with liquid crystal displays; swimming belts; waist trimmer exercise belts; archery implements; soap bubbles [toys]; video game consoles; hand-held consoles for playing video games; rackets; surfboard leashes; harness for sailboards; toy robots; sling shots [sports articles]; rollers for stationary exercise bicycles; plush toys with attached comfort blanket; scooters [toys]; sleds [sports articles]; butterfly nets; landing nets for anglers; nets for sports; tennis nets; slot machines [gaming machines]; snowshoes; snowboards; remote-controlled toy vehicles; clay pigeon traps; billiard tables; tables for table tennis; strings for rackets; golf bags, with or without wheels; cricket bags; slides [playthings]; machines for physical exercises; ornaments for Christmas trees, except lights, candles and confectionery; conjuring apparatus; apparatus for games; bowling apparatus and machinery; toy figures; counters [discs] for games; foosball tables; Christmas crackers [party novelties]; party poppers [party novelties]; bags especially designed for skis; marbles for games; billiard balls; playing balls; party balloons; paintballs [ammunition for paintball guns] [sports apparatus]; snow globes; chess games; draughts [games]; poles for pole vaulting; paper party hats; shin guards [sports articles]; camouflage screens [sports articles]; chest expanders [exercisers].

30 – Flavourings, other than essential oils, for cakes; flavourings, other than essential oils, for beverages; food flavourings, other than essential oils; star aniseed; baozi; cereal bars; pancakes; freeze-dried dishes with the main ingredient being pasta; freeze-dried dishes with the main ingredient being rice; noodle-based prepared meals; buns; bulgur; bread rolls; pains au chocolat / chocolatines; edible paper; burritos; vanillin [vanilla substitute]; waffles; vermicelli; natural sweeteners; seaweed [condiment]; malt biscuits; cloves [spice]; cake frosting [icing]; glucose for culinary purposes; mustard; croûtons; buckwheat, processed; gluten additives for culinary purposes; yeast; thickening agents for cooking foodstuffs; leaven; rice-based snack food; cereal-based snack food; artificial coffee; dressings for salad; fruit jellies [confectionery]; candy decorations for cakes; confectionery for decorating Christmas trees; cakes; pastries; peanut confectionery; almond confectionery; fruit confectionery; pasta; ground ginger; frozen yogurt [confectionery ices]; cocoa; capers; coffee capsules, filled; caramels [sweets]; curry [spice]; ketchup [sauce]; quinoa, processed; quiches; gluten prepared as foodstuff; flour-based dumplings; sweets; dulce de leche; cinnamon [spice]; cof-

fee; starch for food; crackers; crème brûlée; custard; croissants; groats for human food; ice cubes; corn, milled; corn, roasted; meat pies; turmeric; couscous; laksa; noodles; ice for refreshment; ice, natural or artificial; edible ices; ice pops; potato-based flatbreads; rice cakes; mayonnaise; macarons; macaroni; maltose; hominy; piccalilli; marinades; marzipan; honey; miso; royal jelly; ice cream; flour; dessert mousses [confectionery]; chocolate mousses; muesli; mint for confectionery; cocoa beverages with milk; coffee beverages with milk; coffee-based beverages; cocoa-based beverages; chamomile-based beverages; tea-based beverages; chocolate beverages with milk; chocolate-based beverages; infusions, not medicinal; nougat; crushed oats; husked oats; kimchi pancakes; onigiri; chocolate-coated nuts; nutmegs; stick liquorice [confectionery]; ginger paste [seasoning]; lozenges [confectionery]; molasses for food; pâtés en croûte; pelmeni; pepper; allspice; peppers [seasonings]; pesto; biscuits; bibimbap [rice mixed with vegetables and beef]; pies; pizzas; meat gravies; fondants [confectionery]; popcorn; baking powder; pralines; aromatic preparations for food; condiments; cereal preparations; oat-based food; propolis; profiteroles; gingerbread; spices; petits fours; puddings; rice pudding; cake powder; fruit coulis [sauces]; ravioli; ramen; chewing gum; relish [condiment]; rice; prepared rice rolled in seaweed; wheat germ for human consumption; spring rolls; sago; sugar; processed seeds for use as a seasoning; agave syrup [natural sweetener]; golden syrup; confectionery; savoury pancake mixes; batter mixes; baking soda [bicarbonate of soda for cooking purposes]; malt for human consumption; salt for preserving foodstuffs; cooking salt; sorbets [ices]; ham glaze; sauces [condiments]; spaghetti; seasonings; chocolate-based spreads; preparations for stiffening whipped cream; shaved ice with sweetened red beans; rusks; sushi; sandwiches; tabbouleh; tacos; tamarind [condiment]; tapioca; tarts; dough; tortillas; garden herbs, preserved [seasonings]; chocolate decorations for cakes; vinegar; ferments for pastes; halvah; harissa [condiment]; bread; chips [cereal products]; hot dog sandwiches; flowers or leaves for use as tea substitutes; jiaozi; chicory [coffee substitute]; tea; kelp tea; iced tea; chutneys [condiments]; minced garlic [condiment]; cheeseburgers [sandwiches]; chow-chow [condiment]; saffron [seasoning]; chocolate; malt extract for food; essences for foodstuffs, except etheric essences and essential oils; husked barley.

38 – News agency services; wireless broadcasting; television broadcasting; cable television broadcasting; electronic bulletin board services [telecommunications services]; providing user access to global computer networks; providing access to databases; providing internet chatrooms; providing telecommunications connections to a global computer network; providing telecommunication channels for teleshopping services; video-on-demand transmission; transmission of podcasts; transmission of greeting cards online; mes-

sage sending; computer aided transmission of messages and images; transmission of telegrams; transmission of digital files; providing information in the field of telecommunications; providing online forums; videoconferencing services; rental of message sending apparatus; rental of access time to global computer networks; rental of modems; rental of telecommunication equipment; rental of smartphones; rental of telephones; rental of facsimile apparatus; radio broadcasting; radio communications; transmission of electronic mail; communications by fibre optic networks; communications by cellular phones; communications by computer terminals; satellite transmission; communications by telegrams; communications by telephone; facsimile transmission; paging services [radio, telephone or other means of electronic communication]; teleconferencing services; telex services; voice mail services; telecommunications routing and junction services; streaming of data; telegraph services; telephone services.

41 – Modelling for artists; academies [education]; rental of indoor aquaria; rental of artwork; rental of sports grounds; rental of tennis courts; lending library services; booking of seats for shows; videotaping; physical education; production of music; discotheque services; animal training; dubbing; gambling services; publication of books; film distribution; movie studio services; nightclub services [entertainment]; health club services [health and fitness training]; layout services, other than for advertising purposes; microfilming; videotape editing; production of radio and television programmes; screenplay writing; religious education; aikido instruction; gymnastic instruction; judo instruction; correspondence courses; practical training [demonstration]; training services provided via simulators; organization of balls; organization of exhibitions for cultural and educational purposes; providing recreation facilities; arranging and conducting of colloquiums; arranging and conducting of congresses; arranging and conducting of conferences; arranging and conducting of concerts; arranging and conducting of workshops [training]; arranging and conducting of in-person educational forums; arranging and conducting of seminars; arranging and conducting of symposiums; organization of competitions [education or entertainment]; arranging of beauty contests; organization of cosplay entertainment events; organization of lotteries; organization of fashion shows for entertainment purposes; organization of shows [impresario services]; organization of sports competitions; vocational guidance [education or training advice]; amusement park services; sign language interpretation; know-how transfer [training]; television entertainment; mobile library services; vocational retraining; providing online videos, not downloadable; providing information in the field of education; providing information relating to recreational activities; providing information in the field of entertainment; providing online music, not downloadable; providing television programmes, not



downloadable, via video-on-demand services; providing films, not downloadable, via video-on-demand services; providing user reviews for entertainment or cultural purposes; providing golf facilities; providing user rankings for entertainment or cultural purposes; providing sports facilities; providing amusement arcade services; cinema presentations; providing online electronic publications, not downloadable; presentation of circus performances; presentation of variety shows; presentation of live performances; theatre productions; conducting guided climbing tours; conducting fitness classes; educational examination; film production, other than advertising films; rental of audio equipment; rental of video cameras; rental of video cassette recorders; rental of videotapes; rental of show scenery; rental of sound recordings; toy rental; rental of cinematographic apparatus; rental of motion pictures; games equipment rental; rental of stadium facilities; rental of lighting apparatus for theatrical sets or television studios; rental of radio and television sets; rental of skin diving equipment; rental of sports equipment, except vehicles; rental of stage scenery; rental of training simulators; electronic desktop publishing; online publication of electronic books and journals; publication of texts, other than publicity texts; radio entertainment; entertainer services; entertainment services; writing of texts; sado instruction [tea ceremony instruction]; zoological garden services; news reporters services; film directing, other than advertising films; party planning [entertainment]; music composition services; subtitling; tutoring; holiday camp services [entertainment]; video editing services for events; conducting guided tours; disc jockey services; sound engineering services for events; game services provided online from a computer network; personal trainer services [fitness training]; providing casino facilities [gambling]; calligraphy services; karaoke services; club services [entertainment or education]; songwriting; cultural, educational or entertainment services provided by art galleries; providing museum facilities [presentation, exhibitions]; teaching; educational services provided by special needs assistants; educational services provided by schools; orchestra services; translation; scriptwriting, other than for advertising purposes; physical fitness assessment services for training purposes; face painting; ticket agency services [entertainment]; educational examination for users to qualify to pilot drones; coaching [training]; lighting technician services for events; sport camp services; recording studio services; language interpretation; nursery schools; photography; photographic reporting; timing of sports events; boarding school education; production of shows.

42 – Computer system analysis; recovery of computer data; business card design; graphic design of promotional materials; interior design; industrial design; graphic arts design; computer virus protection services; engineering; installation of computer software; research in the field of environmental protection; mecha-

nical research; research in the field of telecommunications technology; research in the field of physics; chemical research; research and development of new products for others; scientific research; technological research; calibration [measuring]; website design consultancy; computer security consultancy; information technology [IT] consultancy; computer technology consultancy; consultancy in the design and development of computer hardware; architectural consultancy; internet security consultancy; computer software consultancy; data security consultancy; technological consultancy; updating of computer software; monitoring of computer systems to detect breakdowns; monitoring of computer systems for detecting unauthorized access or data breach; monitoring of computer systems by remote access; software as a service [SaaS]; maintenance of computer software; design of interior decor; digitization of documents [scanning]; conversion of data or documents from physical to electronic media; providing information relating to computer technology and programming via a website; providing search engines for the internet; platform as a service [PaaS]; conversion of computer programs and data, other than physical conversion; conducting technical project studies; computer system design; rental of web servers; computer rental; rental of computer software; unlocking of mobile phones; geological prospecting; oil prospecting; hosting computer sites [web sites]; server hosting; development of computer platforms; construction drafting; computer software design; software development in the framework of software publishing; cloud seeding; consultancy in the field of energy-saving; creating and designing website-based indexes of information for others [information technology services]; creating and maintaining websites for others; computer programming; technical writing; copying of computer programs; cloud computing; architectural services; information technology services provided on an outsourcing basis; packaging design; off-site data backup; telecommunications technology consultancy; scientific laboratory services; user authentication services using single sign-on technology for online software applications; user authentication services using technology for e-commerce transactions; styling [industrial design]; data encryption services; electronic data storage; surveying.

43 – Accommodation bureau services [hotels, boarding houses]; rental of temporary accommodation; rental of meeting rooms; snack-bar services; information and advice in relation to the preparation of meals; café services; cafeteria services; restaurant services; self-service restaurant services; canteen services; bar services; hookah lounge services; food and drink catering; washoku restaurant services; udon and soba restaurant services; day-nursery [crèche] services.

(260) AM 2022 115256 A

(800) 1623873

(151) 2021 08 11

(891) 2021 08 11

(731) Joint-Stock Company "Fabrika "Russkiy shokolad"

ul. Vereyskaya, d. 29, str. 143, et. 1, pom. III, kom. 1, RU-121357 Moscow, Russian Federation

(540)

## **ВОЗЬМИ! ЗАРЯДИСЬ С МЕГА DRIVE**

(591) Black, white

(531) 28.05

(511)

30 – Star aniseed; pancakes; buns; waffles; sweets; cocoa; coffee; cinnamon [spice]; biscuits; capers; seasonings; caramels [sweets]; cereal preparations; fondants [confectionery]; cake powder; mint for confectionery; gingerbread; chewing gum; ice, natural or artificial; chips [cereal products]; corn flakes; pies; groats for human food; cocoa beverages with milk; pastilles [confectionery]; coffee beverages with milk; chocolate beverages with milk; pralines; sago; molasses for food; chocolate; marzipan; condiments; crackers; halvah; hominy grits; chocolate mousses; peppermint sweets; chocolate paste for sandwiches for human consumption.

(260) AM 2022 115257 A

(800) 1623874

(151) 2021 08 11

(891) 2021 08 11

(731) Joint-Stock Company "Fabrika "Russkiy shokolad"

ul. Vereyskaya, 29, str. 143, et. 1, pom. III, kom. 1, RU-121357 Moscow, Russian Federation

(540)

## **МЕГА DRIVE С ТОБОЙ В ЛЮБЫХ ПРИКЛЮЧЕНИЯХ**

(591) Black, white

(531) 28.05

(511)

30 – Star aniseed; pancakes; buns; waffles; sweets; cocoa; coffee; cinnamon [spice]; biscuits; capers; seasonings; caramels [sweets]; cereal preparations; fondants [confectionery]; cake powder; mint for confec-

tionery; gingerbread; chewing gum; ice, natural or artificial; chips [cereal products]; corn flakes; pies; groats for human food; cocoa beverages with milk; pastilles [confectionery]; coffee beverages with milk; chocolate beverages with milk; pralines; sago; molasses for food; chocolate; marzipan; condiments; crackers; halvah; hominy grits; chocolate mousses; peppermint sweets; chocolate paste for sandwiches for human consumption.

(260) AM 2022 115258 A

(800) 1623875

(151) 2021 08 11

(891) 2021 08 11

(731) Joint-Stock Company "Fabrika "Russkiy shokolad"

ul. Vereyskaya, d. 29, str. 143, et. 1, pom. III, kom. 1, RU-121357 Moscow, Russian Federation

(540)

## **БЫСТРАЯ ЗАРАДКА С МЕГА DRIVE**

(591) Black, white

(531) 28.05

(511)

30 – Star aniseed; pancakes; buns; waffles; sweets; cocoa; coffee; cinnamon [spice]; biscuits; capers; seasonings; caramels [sweets]; cereal preparations; fondants [confectionery]; cake powder; mint for confectionery; gingerbread; chewing gum; ice, natural or artificial; chips [cereal products]; corn flakes; pies; groats for human food; cocoa beverages with milk; pastilles [confectionery]; coffee beverages with milk; chocolate beverages with milk; pralines; sago; molasses for food; chocolate; marzipan; condiments; crackers; halvah; hominy grits; chocolate mousses; peppermint sweets; chocolate paste for sandwiches for human consumption.

(260) AM 2022 115269 A

(800) 1624043

(151) 2021 04 30

(891) 2021 04 30

(731) Veld World (UK) Limited

Suite 23039, 8 Shepherd market, Mayfair, London W1J 7JY, United Kingdom

(540)



(591) Dark green – Pantone 7731 C, green – Pantone 7739 C, light green – Pantone 366 C, red – Pantone 485 C, orange – Pantone 144 C, yellow – Pantone 142 C, blue – Pantone 2717 C, Pantone 2975 C, light grey – Pantone 427 C, grey – Pantone COOL GREY 4 C and white – Pantone FFFFFFFF

(531) 06.19.09; 07.01.19; 24.09.02; 24.09.03; 25.01.19; 26.13.25; 27.05.01; 29.01.15

(511)

29 – Meat, fish, poultry and game; meat extracts; preserved, frozen, dried and cooked fruits and vegetables; vegetables, tinned (canned); fruits, tinned (canned); fish, tinned (canned); meat, tinned (canned); fruit and vegetable spreads; jellies and jams; compotes; eggs; milk; cheese; butter; yogurt; cream; whipped cream; condensed milk; milk substitutes; almond milk; coconut milk; peanut milk; rice milk; soya milk; oat milk; oils and fats for food; olive oil for food; extra-virgin olive oil; olives, preserved; mushrooms, preserved; berries, preserved; beans, preserved; gherkins; pickled gherkins; peas, preserved; soya beans, preserved, for food; lentils, preserved; vegetable pastes; vegetable marrow paste; tomato paste; nut-based spreads; processed nuts; edible seeds; seed butters; seeds, prepared; cooked sesame seeds, not being seasonings or flavorings; preserved chopped chilli peppers, not being seasonings or flavorings; artichoke paste; processed artichokes; artichokes, preserved; seaweed extracts for food; caviar; tuna, not live; dried shrimps; shrimp paste; shrimp floss; potato chips; potato flakes; potato-based dumplings; fruit chips; mussels, not live; crustaceans, not live; anchovy; non-living crustaceans; anchovy paste; anchovy fillets.

30 – Coffee, tea, cocoa and artificial coffee; rice; tapioca and sago; flour and preparations made from cereals; bread, pastries and confectionery; pasta; macaroni; ravioli; noodles; noodle-based prepared meals; potato-based flatbreads; tortillas; edible ices; ice-cream; sorbets; sugar, honey, treacle; yeast, baking-powder; salt; mustard; vinegar, sauces (condiments); spices; ketchup (sauce); mayonnaise; marinades; dressings for salad; pesto (sauce); tomato sauce; soya sauce; pasta sauce; apple sauce (condiment); fruit coulis (sauces); fruit jellies (confectionery); chocolate; dessert mousses (confectionery); chocolate mousses; cho-

colate-based spreads; high-protein cereal bars; cereal bars; gluten-free bread; oat flakes; corn chips; corn flakes; muesli; chips (cereal products); flour-based dumplings; groats for human food; capers; seasonings; preserved herbs; processed seeds for use as a seasoning; garden herbs, preserved (seasonings); preserved, frozen, dried and cooked capers.

(260) AM 2022 115271 A

(800) 1624067

(151) 2021 06 01

(891) 2021 06 01

(731) SIMVALIN HOLDINGS LIMITED

Kritis, 32 Papachristoforou Build., 4th floor,  
CY-3087 Limassol, Cyprus

(540)

## PROIMMUNE

(591) Black, white

(511)

5 – Food for babies; lacteal flour for babies; dietetic food and beverages adapted for medical purposes; albuminous foodstuffs for medical purposes included in this class.

(260) AM 2022 115272 A

(800) 1624127

(151) 2021 09 03

(891) 2021 09 03

(731) Red Bull GmbH

Am Brunnen 1, A-5330 Fuschl am See, Austria

(540)



(591) Blue Silver

(531) 25.05.25; 26.04.05; 26.04.09; 26.04.24;  
29.01.12

(511)

32 – Beers; mineral waters; aerated waters; non-alcoholic beverages; fruit beverages and fruit juices; syrups for making beverages; non-alcoholic preparations for making beverages; energy drinks.

(260) AM 2022 115273 A

(800) 1624145

(151) 2021 09 07

(891) 2021 09 07

(731) Obshchestvo s ogranichennoj otvetstvennostyu

"Atelie CHastnyh marok"

ul. Udal'tsova, dom 50, kv. 39, RU-119607

Moskva, Russian Federation

(540)

**IKRA**

(591) Black, white

(511)

33 – Alcoholic beverages with the exception of beers.

(260) AM 2022 115274 A

(800) 1624160

(151) 2021 07 16

(891) 2021 07 16

(731) OBSHCHESTVO S OGRANICHENNOY

OTVETSTVENNOSTYU "NPO Petrovaks

Farm"

yl. Sosnovaya, d.1, s. Pokrov, g. Podolsk,

RU-142143 Moscow region, Russian

Federation

(540)

**Uronext**

(591) White, yellow and black

(531) 27.05.01; 29.01.13

(511)

5 – Acaricides; aconitine; alkaloids for medical purposes; alginates for pharmaceutical purposes; algicides; aldehydes for pharmaceutical purposes; dental amalgams of gold; dental amalgams; amino acids for veterinary purposes; amino acids for medical purposes; analgesics; anaesthetics; antibiotics; antiseptics; medicine cases, portable, filled; first-aid boxes, filled; aluminium acetate for pharmaceutical purposes; acetates for pharmaceutical purposes; germicides; oxygen cylinders, filled, for medical purposes; balms for medical purposes; bandages for dressings; diagnostic biomarker reagents for medical purposes; biocides; bracelets impregnated with insect repellent; bromine for pharmaceutical purposes; paper for mustard plasters; fly catching paper; reagent paper for veterinary purposes; reagent paper for medical purposes; moth-proofing paper; petroleum jelly for medical purposes; vaccines; oxygen baths; antiseptic cotton; aseptic cotton; absorbent cotton; wadding for medical purposes; cotton for medical purposes; dietetic substances adapted for medical use; radiological contrast substances for medical purposes; nutritive substances for microorganisms; radioactive substances for medical purposes; melissa water for pharmaceutical purposes; seawater for medicinal bathing; mineral waters for me-

dical purposes; thermal water; dietary fibre; moulding wax for dentists; gases for medical purposes; guaiacol for pharmaceutical purposes; massage gels for medical purposes; sexual stimulant gels; haematogen; haemoglobin; hydrastine; hydrastinine; glycerine for medical purposes; glycerophosphates; glucose for medical purposes; gentian for pharmaceutical purposes; hormones for medical purposes; mustard for pharmaceutical purposes; mustard plasters; mud for baths; medicinal mud; contraceptive sponges; gamboge for medical purposes; gurjun balsam for medical purposes; air deodorizing preparations; deodorants, other than for human beings or for animals; deodorants for clothing and textiles; diastase for medical purposes; digitalin; vitamin supplement patches; mineral food supplements; nutritional supplements; albumin dietary supplements; dietary supplements for animals; yeast dietary supplements; alginate dietary supplements; glucose dietary supplements; casein dietary supplements; lecithin dietary supplements; linseed oil dietary supplements; propolis dietary supplements; protein dietary supplements; protein supplements for animals; royal jelly dietary supplements; pollen dietary supplements; wheat germ dietary supplements; linseed dietary supplements; acai powder dietary supplements; dietary supplements with a cosmetic effect; enzyme dietary supplements; yeast for pharmaceutical purposes; gelatine for medical purposes; cod liver oil; isotopes for medical purposes; immunostimulants; insecticides; iodine for pharmaceutical purposes; iodides for pharmaceutical purposes; alkaline iodides for pharmaceutical purposes; iodoform; calomel [fungicide]; tartar for pharmaceutical purposes; camphor for medical purposes; capsules for medicines; cachets for pharmaceutical purposes; capsules made of dendrimer-based polymers, for pharmaceuticals; haemostatic pencils; wart pencils; caustic pencils; carbolineum [parasiticide]; caustics for pharmaceutical purposes; cachou for pharmaceutical purposes; quassia for medical purposes; quebracho for medical purposes; oxygen for medical purposes; gallic acid for pharmaceutical purposes; acids for pharmaceutical purposes; adhesives for dentures; surgical glues; stem cells for veterinary purposes; stem cells for medical purposes; cocaine; collagen for medical purposes; collodion for pharmaceutical purposes; corn rings for the feet; cannabis for medical purposes; medicated sweets; barks for pharmaceutical purposes; cedar wood for use as an insect repellent; croton bark; mangrove bark for pharmaceutical purposes; myrobalan bark for pharmaceutical purposes; quinquina for medical purposes; medicated animal feed; medicinal roots; rhubarb roots for pharmaceutical purposes; lint for medical purposes; starch for dietetic or pharmaceutical purposes; creosote for pharmaceutical purposes; blood for medical purposes; cultures of microorganisms for medical or veterinary use; curare; dental lacquer; liquorice for pharmaceutical purposes; milk sugar for pharmaceutical purposes; adhesive plasters; medicines for

alleviating constipation; lecithin for medical purposes; lotions for veterinary purposes; medicated hair lotions; lotions for pharmaceutical purposes; medicated after-shave lotions; personal sexual lubricants; lupulin for pharmaceutical purposes; magnesia for pharmaceutical purposes; liniments; ointments for pharmaceutical purposes; sunburn ointments; mercurial ointments; frostbite salve for pharmaceutical purposes; gauze for dressings; medicinal oils; mustard oil for medical purposes; camphor oil for medical purposes; castor oil for medical purposes; oil of turpentine for pharmaceutical purposes; dill oil for medical purposes; dental mastics; dental abrasives; dental impression materials; teeth filling material; dressings, medical; surgical dressings; drugs for medical purposes; medicines for veterinary purposes; serotherapeutic medicines; medicines for human purposes; medicines for dental purposes; menthol; medicinal drinks; moleskin for medical purposes; almond milk for pharmaceutical purposes; powdered milk for babies; royal jelly for pharmaceutical purposes; milk ferments for pharmaceutical purposes; Irish moss for medical purposes; flour for pharmaceutical purposes; linseed meal for pharmaceutical purposes; fish meal for pharmaceutical purposes; fly glue; antibacterial soap; disinfectant soap; medicated soap; freeze-dried meat adapted for medical purposes; mint for pharmaceutical purposes; dietetic beverages adapted for medical purposes; malted milk beverages for medical purposes; bone void fillers comprised of living tissues; narcotics; medicinal infusions; tincture of iodine; eucalyptol for pharmaceutical purposes; tinctures for medical purposes; opium; opodeldoc; decoctions for pharmaceutical purposes; antiparasitic collars for animals; stick liquorice for pharmaceutical purposes; sulfur sticks [disinfectants]; pastilles for pharmaceutical purposes; medicated toothpaste; pectin for pharmaceutical purposes; pepsins for pharmaceutical purposes; peptones for pharmaceutical purposes; hydrogen peroxide for medical purposes; pesticides; food for babies; leeches for medical purposes; blood plasma; nicotine patches for use as aids to stop smoking; eyepatches for medical purposes; poultices; compresses; scapulars for surgical purposes; babies' diapers; diapers for pets; swim diapers, reusable, for babies; swim diapers, disposable, for babies; diapers for incontinence; diaper changing mats, disposable, for babies; bunion pads; breast-nursing pads; pomades for medical purposes; powder of cantharides; pyrethrum powder; anti-uric preparations; bacterial preparations for medical and veterinary use; bacteriological preparations for medical and veterinary use; balsamic preparations for medical purposes; albuminous preparations for medical purposes; biological preparations for veterinary purposes; biological preparations for medical purposes; veterinary preparations; bismuth preparations for pharmaceutical purposes; vitamin preparations; diagnostic preparations for medical purposes; bath preparations for medical purposes; therapeutic preparations

for the bath; haemorrhoid preparations; preparations for callouses; lice treatment preparations [pediculicides]; acne treatment preparations; preparations to facilitate teething; preparations for the treatment of burns; fumigation preparations for medical purposes; ootherapy preparations; air purifying preparations; bronchodilating preparations; preparations for reducing sexual activity; sterilizing preparations; soil-sterilizing preparations; corn remedies; pharmaceutical preparations for treating dandruff; preparations for destroying noxious animals; herbicides; preparations for destroying dry rot fungus; larvae exterminating preparations; fly destroying preparations; preparations for destroying mice; slug exterminating preparations; vermin destroying preparations; pharmaceutical preparations for skin care; contact lens cleaning preparations; preparations of microorganisms for medical or veterinary use; lime-based pharmaceutical preparations; hemostatics for medical purposes; medicated eye-washes; medicinal hair growth preparations; nutraceutical preparations for therapeutic or medical purposes; opiates; anticryptogamic preparations; aloe vera preparations for pharmaceutical purposes; preparations of trace elements for human and animal use; sulfonamides [medicines]; pharmaceutical preparations; pharmaceutical preparations for treating sunburn; enzyme preparations for veterinary purposes; enzyme preparations for medical purposes; phytotherapy preparations for medical purposes; chemico-pharmaceutical preparations; chemical preparations for veterinary purposes; chemical preparations for the diagnosis of pregnancy; chemical preparations for medical purposes; chemical preparations for treating diseases affecting cereal plants; chemical preparations for treating wheat blight; chemical preparations for treating diseases affecting vine plants; chemical preparations for treating mildew; chemical preparations for treating phylloxera; chemical preparations for pharmaceutical purposes; chilblain preparations; mothproofing preparations; collyrium; lead water; chemical conductors for electrocardiograph electrodes; albuminous foodstuffs for medical purposes; dietetic foods adapted for medical purposes; by-products of the processing of cereals for dietetic or medical purposes; homogenized food adapted for medical purposes; freeze-dried food adapted for medical purposes; pharmaceuticals; sanitary towels; panty liners [sanitary]; propolis for pharmaceutical purposes; pearl powder for medical purposes; radium for medical purposes; hydrated chloral for pharmaceutical purposes; solvents for removing adhesive plasters; vaginal washes for medical purposes; solutions for contact lenses; chemical reagents for medical or veterinary purposes; gum for medical purposes; rubber for dental purposes; chewing gum for medical purposes; nicotine gum for use as an aid to stop smoking; insect repellents; insect repellent incense; repellents for dogs; tissues impregnated with pharmaceutical lotions; sarsaparilla for medical purposes; sugar for medical purposes; crystallized rock sugar for

medical purposes; asthmatic tea; fumigating sticks; massage candles for therapeutic purposes; suppositories; linseed for pharmaceutical purposes; tobacco-free cigarettes for medical purposes; siccatives [drying agents] for medical purposes; syrups for pharmaceutical purposes; turpentine for pharmaceutical purposes; greases for veterinary purposes; greases for medical purposes; lacteal flour for babies; infant formula; soporifics; bicarbonate of soda for pharmaceutical purposes; bath salts for medical purposes; salts for mineral water baths; salts for medical purposes; potassium salts for medical purposes; sodium salts for medical purposes; smelling salts; mineral water salts; malt for pharmaceutical purposes; semen for artificial insemination; alcohol for pharmaceutical purposes; medicinal alcohol; alloys of precious metals for dental purposes; ergot for pharmaceutical purposes; cooling sprays for medical purposes; antibacterial handwashes; adjuvants for medical purposes; astringents for medical purposes; vermifuges; disinfectants; disinfectants for hygiene purposes; disinfectants for chemical toilets; appetite suppressants for medical purposes; medical preparations for slimming purposes; parasitocides; mouthwashes for medical purposes; medicated dentifrices; febrifuges; depuratives; animal washes [insecticides]; detergents for medical purposes; cattle washes [insecticides]; dog washes [insecticides]; insecticidal veterinary washes; vesicants; purgatives; remedies for perspiration; remedies for foot perspiration; chemical contraceptives; antiparasitic preparations; sedatives; laxatives; tonics [medicines]; medicated toiletry preparations; digestives for pharmaceutical purposes; nervines; bouillons for bacteriological cultures; steroids; headache relief sticks; strychnine; serums; tanning pills; appetite suppressant pills; slimming pills; jujube, medicated; antioxidant pills; sanitary tampons; vulnerary sponges; thymol for pharmaceutical purposes; biological tissue cultures for veterinary purposes; biological tissue cultures for medical purposes; smoking herbs for medical purposes; medicinal herbs; surgical implants comprised of living tissues; pants, absorbent, for incontinence; sanitary panties; babies' diaper-pants; charcoal for pharmaceutical purposes; porcelain for dental prostheses; phenol for pharmaceutical purposes; enzymes for veterinary purposes; enzymes for medical purposes; ferments for pharmaceutical purposes; formic aldehyde for pharmaceutical purposes; phosphates for pharmaceutical purposes; fungicides; quinine for medical purposes; chinoline for medical purposes; diabetic bread adapted for medical use; chloroform; flowers of sulfur for pharmaceutical purposes; cement for animal hooves; bone cement for surgical and orthopaedic purposes; dental cements; medicinal tea; herbal teas for medicinal purposes; insecticidal animal shampoos; medicated shampoos; medicated shampoos for pets; pediculicidal shampoos; medicated dry shampoos; pre-filled syringes for medical purposes; eucalyptus for pharmaceutical purposes; herbal extracts for medical purpo-

ses; plant extracts for pharmaceutical purposes; tobacco extracts [insecticides]; extracts of hops for pharmaceutical purposes; elixirs [pharmaceutical preparations]; ethers for pharmaceutical purposes; esters for pharmaceutical purposes; cellulose esters for pharmaceutical purposes; rat poison; poisons; bacterial poisons; jalap; bismuth subnitrate for pharmaceutical purposes; cream of tartar for pharmaceutical purposes; angostura bark for medical purposes; condurango bark for medical purposes; adhesive tapes for medical purposes; injectable dermal fillers; cotton swabs for medical purposes; diagnostic preparations for veterinary purposes; douching preparations for medical purposes; milking grease; transplants [living tissues]; fennel for medical purposes; cellulose ethers for pharmaceutical purposes.

29 – Agar-agar for culinary purposes; aloe vera prepared for human consumption; alginates for culinary purposes; andouillettes; anchovy, not live; peanuts, prepared; artichokes, preserved; albumen for culinary purposes; white of eggs; beans, preserved; soya beans, preserved, for food; broth; ginger jam; ham; fatty substances for the manufacture of edible fats; laver, preserved; edible birds' nests; cabbage rolls stuffed with meat; peas, preserved; mushrooms, preserved; guacamole; game, not live; gelatine; meat jellies; jellies for food; fruit jellies; yolk of eggs; coconut fat; bone oil for food; lard; suet for food; edible fats; rennet; fruit-based snack food; milk substitutes; charcuterie; raisins; caviar; aubergine paste; vegetable marrow paste; fish roe, processed; ginger, preserved; crystallized ginger; pickled ginger; yogurt; sauerkraut; cassoulet; quark; kephir; kimchi; isinglass for food; clams, not live; potato-based dumplings; klipfish [salted and dried cod]; milk shakes; black pudding; onion rings; arrangements of processed fruit; compotes; meat, tinned; vegetables, tinned; fish, tinned; fruits, tinned; duck confits; broth concentrates; vegetable-based concentrate for cooking; fruit-based concentrate for cooking; corn dogs; gherkins; shrimps, not live; prawns, not live; buttercream; croquettes; silkworm chrysalis for human consumption; sweet corn, processed; koumiss; spiny lobsters, not live; lecithin for culinary purposes; edible ant larvae, prepared; salmon, not live; onions, preserved; margarine; marmalade; oils for food; peanut butter; cocoa butter for food; coconut oil for food; coconut butter; maize oil for food; sesame oil for food; linseed oil for food; extra virgin olive oil for food; olive oil for food; palm oil for food; palm kernel oil for food; sunflower oil for food; rape oil for food; butter; soya bean oil for food; shellfish, not live; almonds, ground; animal marrow for food; mussels, not live; milk; peanut milk; peanut milk for culinary purposes; coconut milk; coconut milk for culinary purposes; almond milk; almond milk for culinary purposes; oat milk; rice milk; rice milk for culinary purposes; albumin milk; condensed milk; soured milk; soya milk; powdered milk; fermented baked milk; fish meal for human consumption; vegetable mousses; fish

mousses; fruit pulp; meat; meat, preserved; freeze-dried meat; lactic acid drinks; milk beverages, milk predominating; peanut milk-based beverages; coconut milk-based beverages; almond milk-based beverages; edible insects, not live; sausage casings, natural or artificial; vegetables, preserved; freeze-dried vegetables; vegetables, processed; vegetables, dried; vegetables, cooked; hash browns; potato fritters; olives, preserved; lobsters, not live; omelettes; flavoured nuts; candied nuts; coconut, desiccated; nuts, prepared; tomato purée; pressed fruit paste; liver pâté; pectin for culinary purposes; preserved peppers; liver; pickles; jams; powdered eggs; milk products; fish-based foodstuffs; poultry, not live; white pudding; bulgogi; pollen prepared as foodstuff; cranberry compote; tomato paste; apple purée; crayfish, not live; crustaceans, not live; ratatouille; fish, preserved; fish, not live; salted fish; vegetable salads; fruit salads; bacon; sardines, not live; satay; pork; herrings, not live; seeds, prepared; sunflower seeds, prepared; cream [dairy products]; whipped cream; vegetable-based cream; fat-containing mixtures for bread slices; smetana; lemon juice for culinary purposes; tomato juice for cooking; vegetable juices for cooking; salted meats; sausages; sausages in batter; hot dog sausages; preparations for making bouillon; preparations for making soup; tofu skin; vegetable-based spreads; nut-based spreads; tripe; soups; vegetable soup preparations; whey; cottage cheese fritters; cheese; tajine [prepared meat, fish or vegetable dish]; tahini; cottage cheese; tofu; tempeh; sea-cucumbers, not live; truffles, preserved; tuna, not live; oysters, not live; falafel; milk ferments for culinary purposes; dates; crystallized fruits; frozen fruits; fruit, preserved; fruit, processed; fruit preserved in alcohol; fruit, stewed; hazelnuts, prepared; potato flakes; hummus; edible flowers, dried; fruit peel; preserved garlic; lentils, preserved; potato crisps; low-fat potato crisps; fruit chips; choucroute garnie; non-alcoholic eggnog; seaweed extracts for food; meat extracts; berries, preserved; eggs; snail eggs for consumption; yakitori; soya patties; tofu patties; fish fillets.

35 – Arranging subscriptions to telecommunication services for others; import-export agency services; commercial information agency services; advertising agency services; cost price analysis; rental of office equipment in co-working facilities; rental of advertising space; business auditing; financial auditing; business intermediary services relating to the matching of potential private investors with entrepreneurs needing funding; employment agency services; computerized file management; book-keeping; invoicing; demonstration of goods; transcription of communications [office functions]; opinion polling; market studies; business investigations; business research; marketing research; personnel recruitment; business management and organization consultancy; business organization consultancy; business management consultancy; personnel management consultancy; professional business consultancy; consultancy regarding advertising

communication strategies; consultancy regarding public relations communication strategies; layout services for advertising purposes; marketing; marketing in the framework of software publishing; targeted marketing; business management of performing artists; business management of sports people; writing of curriculum vitae for others; scriptwriting for advertising purposes; news clipping services; updating and maintenance of information in registries; updating and maintenance of data in computer databases; updating of advertising material; word processing; online retail services for downloadable and pre-recorded music and movies; online retail services for downloadable ring tones; online retail services for downloadable digital music; organization of exhibitions for commercial or advertising purposes; arranging newspaper subscriptions for others; organization of fashion shows for promotional purposes; organization of trade fairs; shop window dressing; business appraisals; payroll preparation; data search in computer files for others; sponsorship search; administrative assistance in responding to calls for tenders; business management assistance; commercial or industrial management assistance; commercial intermediation services; providing business information; providing business information via a website; providing commercial and business contact information; providing commercial information and advice for consumers in the choice of products and services; providing user reviews for commercial or advertising purposes; web indexing for commercial or advertising purposes; providing user rankings for commercial or advertising purposes; economic forecasting; auctioneering; retail services for works of art provided by art galleries; sales promotion for others; promotion of goods and services through sponsorship of sports events; production of teleshopping programmes; production of advertising films; office machines and equipment rental; rental of advertising time on communication media; publicity material rental; rental of billboards [advertising boards]; rental of vending machines; rental of sales stands; rental of photocopying machines; consumer profiling for commercial or marketing purposes; publication of publicity texts; radio advertising; development of advertising concepts; bill-posting; distribution of samples; dissemination of advertising matter; direct mail advertising; registration of written communications and data; writing of publicity texts; advertising; online advertising on a computer network; advertising by mail order; television advertising; compilation of statistics; compilation of information into computer databases; business inquiries; systemization of information into computer databases; administrative services for medical referrals; advisory services for business management; corporate communications services; negotiation of business contracts for others; negotiation and conclusion of commercial transactions for third parties; compiling indexes of information for commercial or advertising purposes; tax preparation; drawing up

of statements of accounts; telemarketing services; psychological testing for the selection of personnel; interim business management; business management of hotels; business management for freelance service providers; business project management services for construction projects; commercial administration of the licensing of the goods and services of others; business management of reimbursement programmes for others; administration of consumer loyalty programs; administration of frequent flyer programs; administrative processing of purchase orders; administrative services for the relocation of businesses; public relations; commercial lobbying services; competitive intelligence services; modelling for advertising or sales promotion; typing; market intelligence services; appointment reminder services [office functions]; website traffic optimization; tax filing services; search engine optimization for sales promotion; retail services relating to bakery products; gift registry services; price comparison services; pay per click advertising; secretarial services; procurement services for others [purchasing goods and services for other businesses]; shorthand; outsourcing services [business assistance]; telephone answering for unavailable subscribers; telephone switchboard services; photocopying services; business efficiency expert services; retail and wholesale services; retail and wholesale store services; retail services provided by means of mail order catalogs; retail services provided by television stores or via a website; provision of an online marketplace for buyers and sellers of goods and services; presentation of goods on communication media, for retail purposes; media relations services; wholesale services for pharmaceutical, veterinary and sanitary preparations and medical supplies; retail services for pharmaceutical, veterinary and sanitary preparations and medical supplies; outsourced administrative management for companies; appointment scheduling services [office functions].

44 – Rental of animals for gardening purposes; rental of beehives; public bath services for hygiene purposes; Turkish bath services; hospital services; depilatory waxing; reforestation services; cultivation of plants; rehabilitation for substance abuse patients; landscape design; health centre services; nursing home services; wreath making; hair implantation; medical advice for individuals with disabilities; consultancy in the field of viticulture; pharmacy advice; aromatherapy services; animal-assisted therapy; manicuring; chiropractic; massage; medical testing; horticulture; providing information in the field of orthodontics; artificial insemination services; palliative care; hairdressing; body piercing; midwife services; veterinary assistance; dentistry services; medical assistance; tree planting for carbon offsetting purposes; preparation of prescriptions by pharmacists; medical equipment rental; rental of hair styling apparatus; rental of sanitary installations; farming equipment rental; aerial and surface spreading of fertilizers and other agricultural che-

micals; animal breeding; gardening; landscape gardening; beauty salon services; sanatorium services; medical screening; blood bank services; health care; health counselling; flower arranging; tattooing; vermin exterminating for agriculture, aquaculture, horticulture and forestry; weed killing; health spa services; human tissue bank services; aquaculture services; viticulture services; visagists' services; convalescent home services; rest home services; medical clinic services; medical analysis services for diagnostic and treatment purposes provided by medical laboratories; home-visit nursing care; alternative medicine services; opticians' services; orthodontic services; plant nursery services; pest control services for agriculture, aquaculture, horticulture and forestry; speech therapy; in vitro fertilization services; services of a psychologist; sauna services; solarium services; telemedicine services; therapy services; nursing, medical; lawn care; animal grooming; pet grooming; physiotherapy; plastic surgery; tree surgery; hospice services.

(260) AM 2022 115275 A

(800) 1624161

(151) 2021 07 16

(891) 2021 07 16

(731) OBSHCHESTVO S OGRANICHENNOY OTVETSTVENNOSTYU "NPO Petrovaks Farm"  
yl. Sosnovaya, d. 1, s. Pokrov, g. Podolsk,  
RU-142143 Moscow region, Russian  
Federation

(540)

**Уролекст**

(591) White, yellow and black

(531) 28.05; 29.01.13

(511)

5 – Acaricides; aconitine; alkaloids for medical purposes; alginates for pharmaceutical purposes; algicides; aldehydes for pharmaceutical purposes; dental amalgams of gold; dental amalgams; amino acids for veterinary purposes; amino acids for medical purposes; analgesics; anaesthetics; antibiotics; antiseptics; medicine cases, portable, filled; first-aid boxes, filled; aluminium acetate for pharmaceutical purposes; acetates for pharmaceutical purposes; germicides; oxygen cylinders, filled, for medical purposes; balms for medical purposes; bandages for dressings; diagnostic biomarker reagents for medical purposes; biocides; bracelets impregnated with insect repellent; bromine for pharmaceutical purposes; paper for mustard plasters; fly catching paper; reagent paper for veterinary purposes; reagent paper for medical purposes; mothproofing paper; petroleum jelly for medical purposes; vaccines; oxygen baths; antiseptic cotton; aseptic cotton; absorbent cotton; wadding for medical purposes; cotton for medical purposes; dietetic substances adap-



ted for medical use; radiological contrast substances for medical purposes; nutritive substances for microorganisms; radioactive substances for medical purposes; melissa water for pharmaceutical purposes; seawater for medicinal bathing; mineral waters for medicinal purposes; thermal water; dietary fibre; moulding wax for dentists; gases for medical purposes; guaiacol for pharmaceutical purposes; massage gels for medicinal purposes; sexual stimulant gels; haematogen; haemoglobin; hydrastine; hydrastinine; glycerine for medicinal purposes; glycerophosphates; glucose for medicinal purposes; gentian for pharmaceutical purposes; hormones for medical purposes; mustard for pharmaceutical purposes; mustard plasters; mud for baths; medicinal mud; contraceptive sponges; gamboge for medical purposes; gurjun balsam for medical purposes; air deodorizing preparations; deodorants, other than for human beings or for animals; deodorants for clothing and textiles; diastase for medical purposes; digitalin; vitamin supplement patches; mineral food supplements; nutritional supplements; albumin dietary supplements; dietary supplements for animals; yeast dietary supplements; alginate dietary supplements; glucose dietary supplements; casein dietary supplements; lecithin dietary supplements; linseed oil dietary supplements; propolis dietary supplements; protein dietary supplements; protein supplements for animals; royal jelly dietary supplements; pollen dietary supplements; wheat germ dietary supplements; linseed dietary supplements; acai powder dietary supplements; dietary supplements with a cosmetic effect; enzyme dietary supplements; yeast for pharmaceutical purposes; gelatine for medical purposes; cod liver oil; isotopes for medical purposes; immunostimulants; insecticides; iodine for pharmaceutical purposes; iodides for pharmaceutical purposes; alkaline iodides for pharmaceutical purposes; iodoform; calomel [fungicide]; tartar for pharmaceutical purposes; camphor for medical purposes; capsules for medicines; cachets for pharmaceutical purposes; capsules made of dendrimer-based polymers, for pharmaceuticals; haemostatic pencils; wart pencils; caustic pencils; carbolineum [parasiticide]; caustics for pharmaceutical purposes; cachou for pharmaceutical purposes; quassia for medical purposes; quebracho for medical purposes; oxygen for medical purposes; gallic acid for pharmaceutical purposes; acids for pharmaceutical purposes; adhesives for dentures; surgical glues; stem cells for veterinary purposes; stem cells for medical purposes; cocaine; collagen for medical purposes; collodion for pharmaceutical purposes; corn rings for the feet; cannabis for medical purposes; medicated sweets; barks for pharmaceutical purposes; cedar wood for use as an insect repellent; croton bark; mangrove bark for pharmaceutical purposes; myrobalan bark for pharmaceutical purposes; quinquina for medical purposes; medicated animal feed; medicinal roots; rhubarb roots for pharmaceutical purposes; lint for medical purposes; starch for dietetic or pharmaceutical purposes; creosote for

pharmaceutical purposes; blood for medical purposes; cultures of microorganisms for medical or veterinary use; curare; dental lacquer; liquorice for pharmaceutical purposes; milk sugar for pharmaceutical purposes; adhesive plasters; medicines for alleviating constipation; lecithin for medical purposes; lotions for veterinary purposes; medicated hair lotions; lotions for pharmaceutical purposes; medicated after-shave lotions; personal sexual lubricants; lupulin for pharmaceutical purposes; magnesia for pharmaceutical purposes; liniments; ointments for pharmaceutical purposes; sunburn ointments; mercurial ointments; frostbite salve for pharmaceutical purposes; gauze for dressings; medicinal oils; mustard oil for medical purposes; camphor oil for medical purposes; castor oil for medical purposes; oil of turpentine for pharmaceutical purposes; dill oil for medical purposes; dental mastics; dental abrasives; dental impression materials; teeth filling material; dressings, medical; surgical dressings; drugs for medical purposes; medicines for veterinary purposes; serotherapeutic medicines; medicines for human purposes; medicines for dental purposes; menthol; medicinal drinks; moleskin for medical purposes; almond milk for pharmaceutical purposes; powdered milk for babies; royal jelly for pharmaceutical purposes; milk ferments for pharmaceutical purposes; Irish moss for medical purposes; flour for pharmaceutical purposes; linseed meal for pharmaceutical purposes; fish meal for pharmaceutical purposes; fly glue; antibacterial soap; disinfectant soap; medicated soap; freeze-dried meat adapted for medical purposes; mint for pharmaceutical purposes; dietetic beverages adapted for medical purposes; malted milk beverages for medical purposes; bone void fillers comprised of living tissues; narcotics; medicinal infusions; tincture of iodine; eucalyptol for pharmaceutical purposes; tinctures for medical purposes; opium; opodeldoc; decoctions for pharmaceutical purposes; antiparasitic collars for animals; stick liquorice for pharmaceutical purposes; sulfur sticks [disinfectants]; pastilles for pharmaceutical purposes; medicated toothpaste; pectin for pharmaceutical purposes; pepsins for pharmaceutical purposes; peptones for pharmaceutical purposes; hydrogen peroxide for medical purposes; pesticides; food for babies; leeches for medical purposes; blood plasma; nicotine patches for use as aids to stop smoking; eyepatches for medical purposes; poultices; compresses; scapulars for surgical purposes; babies' diapers; diapers for pets; swim diapers, reusable, for babies; swim diapers, disposable, for babies; diapers for incontinence; diaper changing mats, disposable, for babies; bunion pads; breast-nursing pads; pomades for medical purposes; powder of cantharides; pyrethrum powder; anti-uric preparations; bacterial preparations for medical and veterinary use; bacteriological preparations for medical and veterinary use; balsamic preparations for medical purposes; albuminous preparations for medical purposes; biological preparations for veterinary purposes; biological preparations for

medical purposes; veterinary preparations; bismuth preparations for pharmaceutical purposes; vitamin preparations; diagnostic preparations for medical purposes; bath preparations for medical purposes; therapeutic preparations for the bath; haemorrhoid preparations; preparations for callouses; lice treatment preparations [pediculicides]; acne treatment preparations; preparations to facilitate teething; preparations for the treatment of burns; fumigation preparations for medical purposes; ootherapy preparations; air purifying preparations; bronchodilating preparations; preparations for reducing sexual activity; sterilizing preparations; soil-sterilizing preparations; corn remedies; pharmaceutical preparations for treating dandruff; preparations for destroying noxious animals; herbicides; preparations for destroying dry rot fungus; larvae exterminating preparations; fly destroying preparations; preparations for destroying mice; slug exterminating preparations; vermin destroying preparations; pharmaceutical preparations for skin care; contact lens cleaning preparations; preparations of microorganisms for medical or veterinary use; lime-based pharmaceutical preparations; hemostatics for medical purposes; medicated eye-washes; medicinal hair growth preparations; nutraceutical preparations for therapeutic or medical purposes; opiates; anticryptogamic preparations; aloe vera preparations for pharmaceutical purposes; preparations of trace elements for human and animal use; sulfonamides [medicines]; pharmaceutical preparations; pharmaceutical preparations for treating sunburn; enzyme preparations for veterinary purposes; enzyme preparations for medical purposes; phytotherapy preparations for medical purposes; chemico-pharmaceutical preparations; chemical preparations for veterinary purposes; chemical preparations for the diagnosis of pregnancy; chemical preparations for medical purposes; chemical preparations for treating diseases affecting cereal plants; chemical preparations for treating wheat blight; chemical preparations for treating diseases affecting vine plants; chemical preparations for treating mildew; chemical preparations for treating phylloxera; chemical preparations for pharmaceutical purposes; chilblain preparations; mothproofing preparations; collyrium; lead water; chemical conductors for electrocardiograph electrodes; albuminous foodstuffs for medical purposes; dietetic foods adapted for medical purposes; by-products of the processing of cereals for dietetic or medical purposes; homogenized food adapted for medical purposes; freeze-dried food adapted for medical purposes; pharmaceuticals; sanitary towels; panty liners [sanitary]; propolis for pharmaceutical purposes; pearl powder for medical purposes; radium for medical purposes; hydrated chloral for pharmaceutical purposes; solvents for removing adhesive plasters; vaginal washes for medical purposes; solutions for contact lenses; chemical reagents for medical or veterinary purposes; gum for medical purposes; rubber for dental purposes; chewing gum for medical purposes; nicotine gum for

use as an aid to stop smoking; insect repellents; insect repellent incense; repellents for dogs; tissues impregnated with pharmaceutical lotions; sarsaparilla for medical purposes; sugar for medical purposes; crystallized rock sugar for medical purposes; asthmatic tea; fumigating sticks; massage candles for therapeutic purposes; suppositories; linseed for pharmaceutical purposes; tobacco-free cigarettes for medical purposes; siccatives [drying agents] for medical purposes; syrups for pharmaceutical purposes; turpentine for pharmaceutical purposes; greases for veterinary purposes; greases for medical purposes; lacteal flour for babies; infant formula; soporifics; bicarbonate of soda for pharmaceutical purposes; bath salts for medical purposes; salts for mineral water baths; salts for medical purposes; potassium salts for medical purposes; sodium salts for medical purposes; smelling salts; mineral water salts; malt for pharmaceutical purposes; semen for artificial insemination; alcohol for pharmaceutical purposes; medicinal alcohol; alloys of precious metals for dental purposes; ergot for pharmaceutical purposes; cooling sprays for medical purposes; antibacterial handwashes; adjuvants for medical purposes; astringents for medical purposes; vermifuges; disinfectants; disinfectants for hygiene purposes; disinfectants for chemical toilets; appetite suppressants for medical purposes; medical preparations for slimming purposes; parasiticides; mouthwashes for medical purposes; medicated dentifrices; febrifuges; depuratives; animal washes [insecticides]; detergents for medical purposes; cattle washes [insecticides]; dog washes [insecticides]; insecticidal veterinary washes; vesicants; purgatives; remedies for perspiration; remedies for foot perspiration; chemical contraceptives; antiparasitic preparations; sedatives; laxatives; tonics [medicines]; medicated toiletry preparations; digestives for pharmaceutical purposes; nervines; bouillons for bacteriological cultures; steroids; headache relief sticks; strychnine; serums; tanning pills; appetite suppressant pills; slimming pills; jujube, medicated; antioxidant pills; sanitary tampons; vulnerary sponges; thymol for pharmaceutical purposes; biological tissue cultures for veterinary purposes; biological tissue cultures for medical purposes; smoking herbs for medical purposes; medicinal herbs; surgical implants comprised of living tissues; pants, absorbent, for incontinence; sanitary panties; babies' diaper-pants; charcoal for pharmaceutical purposes; porcelain for dental prostheses; phenol for pharmaceutical purposes; enzymes for veterinary purposes; enzymes for medical purposes; ferments for pharmaceutical purposes; formic aldehyde for pharmaceutical purposes; phosphates for pharmaceutical purposes; fungicides; quinine for medical purposes; chinoline for medical purposes; diabetic bread adapted for medical use; chloroform; flowers of sulfur for pharmaceutical purposes; cement for animal hooves; bone cement for surgical and orthopaedic purposes; dental cements; medicinal tea; herbal teas for medicinal purposes; insecticidal animal shampoos;

medicated shampoos; medicated shampoos for pets; pediculicidal shampoos; medicated dry shampoos; pre-filled syringes for medical purposes; eucalyptus for pharmaceutical purposes; herbal extracts for medical purposes; plant extracts for pharmaceutical purposes; tobacco extracts [insecticides]; extracts of hops for pharmaceutical purposes; elixirs [pharmaceutical preparations]; ethers for pharmaceutical purposes; esters for pharmaceutical purposes; cellulose esters for pharmaceutical purposes; rat poison; poisons; bacterial poisons; jalap; bismuth subnitrate for pharmaceutical purposes; cream of tartar for pharmaceutical purposes; angostura bark for medical purposes; condurango bark for medical purposes; adhesive tapes for medical purposes; injectable dermal fillers; cotton swabs for medical purposes; diagnostic preparations for veterinary purposes; douching preparations for medical purposes; milking grease; transplants [living tissues]; fennel for medical purposes; cellulose ethers for pharmaceutical purposes.

29 – Agar-agar for culinary purposes; aloe vera prepared for human consumption; alginates for culinary purposes; andouillettes; anchovy, not live; peanuts, prepared; artichokes, preserved; albumen for culinary purposes; white of eggs; beans, preserved; soya beans, preserved, for food; broth; ginger jam; ham; fatty substances for the manufacture of edible fats; laver, preserved; edible birds' nests; cabbage rolls stuffed with meat; peas, preserved; mushrooms, preserved; guacamole; game, not live; gelatine; meat jellies; jellies for food; fruit jellies; yolk of eggs; coconut fat; bone oil for food; lard; suet for food; edible fats; rennet; fruit-based snack food; milk substitutes; charcuterie; raisins; caviar; aubergine paste; vegetable marrow paste; fish roe, processed; ginger, preserved; crystallized ginger; pickled ginger; yogurt; sauerkraut; cassoulet; quark; kephir; kimchi; isinglass for food; clams, not live; potato-based dumplings; klipfish [salted and dried cod]; milk shakes; black pudding; onion rings; arrangements of processed fruit; compotes; meat, tinned; vegetables, tinned; fish, tinned; fruits, tinned; duck confits; broth concentrates; vegetable-based concentrate for cooking; fruit-based concentrate for cooking; corn dogs; gherkins; shrimps, not live; prawns, not live; buttercream; croquettes; silkworm chrysalis for human consumption; sweet corn, processed; koumiss; spiny lobsters, not live; lecithin for culinary purposes; edible ant larvae, prepared; salmon, not live; onions, preserved; margarine; marmalade; oils for food; peanut butter; cocoa butter for food; coconut oil for food; coconut butter; maize oil for food; sesame oil for food; linseed oil for food; extra virgin olive oil for food; olive oil for food; palm oil for food; palm kernel oil for food; sunflower oil for food; rape oil for food; butter; soya bean oil for food; shellfish, not live; almonds, ground; animal marrow for food; mussels, not live; milk; peanut milk; peanut milk for culinary purposes; coconut milk; coconut milk for culinary purposes; almond milk; almond milk for culinary pur-

poses; oat milk; rice milk; rice milk for culinary purposes; albumin milk; condensed milk; soured milk; soya milk; powdered milk; fermented baked milk; fish meal for human consumption; vegetable mousses; fish mousses; fruit pulp; meat; meat, preserved; freeze-dried meat; lactic acid drinks; milk beverages, milk predominating; peanut milk-based beverages; coconut milk-based beverages; almond milk-based beverages; edible insects, not live; sausage casings, natural or artificial; vegetables, preserved; freeze-dried vegetables; vegetables, processed; vegetables, dried; vegetables, cooked; hash browns; potato fritters; olives, preserved; lobsters, not live; omelettes; flavoured nuts; candied nuts; coconut, desiccated; nuts, prepared; tomato purée; pressed fruit paste; liver pâté; pectin for culinary purposes; preserved peppers; liver; pickles; jams; powdered eggs; milk products; fish-based foodstuffs; poultry, not live; white pudding; bulgogi; pollen prepared as foodstuff; cranberry compote; tomato paste; apple purée; crayfish, not live; crustaceans, not live; ratatouille; fish, preserved; fish, not live; salted fish; vegetable salads; fruit salads; bacon; sardines, not live; satay; pork; herrings, not live; seeds, prepared; sunflower seeds, prepared; cream [dairy products]; whipped cream; vegetable-based cream; fat-containing mixtures for bread slices; smetana; lemon juice for culinary purposes; tomato juice for cooking; vegetable juices for cooking; salted meats; sausages; sausages in batter; hot dog sausages; preparations for making bouillon; preparations for making soup; tofu skin; vegetable-based spreads; nut-based spreads; tripe; soups; vegetable soup preparations; whey; cottage cheese fritters; cheese; tajine [prepared meat, fish or vegetable dish]; tahini; cottage cheese; tofu; tempeh; sea-cucumbers, not live; truffles, preserved; tuna, not live; oysters, not live; falafel; milk ferments for culinary purposes; dates; crystallized fruits; frozen fruits; fruit, preserved; fruit, processed; fruit preserved in alcohol; fruit, stewed; hazelnuts, prepared; potato flakes; hummus; edible flowers, dried; fruit peel; preserved garlic; lentils, preserved; potato crisps; low-fat potato crisps; fruit chips; choucroute garnie; non-alcoholic eggnog; seaweed extracts for food; meat extracts; berries, preserved; eggs; snail eggs for consumption; yakitori; soya patties; tofu patties; fish fillets.

35 – Arranging subscriptions to telecommunication services for others; import-export agency services; commercial information agency services; advertising agency services; cost price analysis; rental of office equipment in co-working facilities; rental of advertising space; business auditing; financial auditing; business intermediary services relating to the matching of potential private investors with entrepreneurs needing funding; employment agency services; computerized file management; book-keeping; invoicing; demonstration of goods; transcription of communications [office functions]; opinion polling; market studies; business investigations; business research; marketing research; personnel recruitment; business mana-

gement and organization consultancy; business organization consultancy; business management consultancy; personnel management consultancy; professional business consultancy; consultancy regarding advertising communication strategies; consultancy regarding public relations communication strategies; layout services for advertising purposes; marketing; marketing in the framework of software publishing; targeted marketing; business management of performing artists; business management of sports people; writing of curriculum vitae for others; scriptwriting for advertising purposes; news clipping services; updating and maintenance of information in registries; updating and maintenance of data in computer databases; updating of advertising material; word processing; online retail services for downloadable and pre-recorded music and movies; online retail services for downloadable ring tones; online retail services for downloadable digital music; organization of exhibitions for commercial or advertising purposes; arranging newspaper subscriptions for others; organization of fashion shows for promotional purposes; organization of trade fairs; shop window dressing; business appraisals; payroll preparation; data search in computer files for others; sponsorship search; administrative assistance in responding to calls for tenders; business management assistance; commercial or industrial management assistance; commercial intermediation services; providing business information; providing business information via a website; providing commercial and business contact information; providing commercial information and advice for consumers in the choice of products and services; providing user reviews for commercial or advertising purposes; web indexing for commercial or advertising purposes; providing user rankings for commercial or advertising purposes; economic forecasting; auctioneering; retail services for works of art provided by art galleries; sales promotion for others; promotion of goods and services through sponsorship of sports events; production of teleshopping programmes; production of advertising films; office machines and equipment rental; rental of advertising time on communication media; publicity material rental; rental of billboards [advertising boards]; rental of vending machines; rental of sales stands; rental of photocopying machines; consumer profiling for commercial or marketing purposes; publication of publicity texts; radio advertising; development of advertising concepts; bill-posting; distribution of samples; dissemination of advertising matter; direct mail advertising; registration of written communications and data; writing of publicity texts; advertising; online advertising on a computer network; advertising by mail order; television advertising; compilation of statistics; compilation of information into computer databases; business inquiries; systemization of information into computer databases; administrative services for medical referrals; advisory services for business management; corporate communications services; ne-

gotiation of business contracts for others; negotiation and conclusion of commercial transactions for third parties; compiling indexes of information for commercial or advertising purposes; tax preparation; drawing up of statements of accounts; telemarketing services; psychological testing for the selection of personnel; interim business management; business management of hotels; business management for freelance service providers; business project management services for construction projects; commercial administration of the licensing of the goods and services of others; business management of reimbursement programmes for others; administration of consumer loyalty programs; administration of frequent flyer programs; administrative processing of purchase orders; administrative services for the relocation of businesses; public relations; commercial lobbying services; competitive intelligence services; modelling for advertising or sales promotion; typing; market intelligence services; appointment reminder services [office functions]; website traffic optimization; tax filing services; search engine optimization for sales promotion; retail services relating to bakery products; gift registry services; price comparison services; pay per click advertising; secretarial services; procurement services for others [purchasing goods and services for other businesses]; shorthand; outsourcing services [business assistance]; telephone answering for unavailable subscribers; telephone switchboard services; photocopying services; business efficiency expert services; retail and wholesale services; retail and wholesale store services; retail services provided by means of mail order catalogs; retail services provided by television stores or via a website; provision of an online marketplace for buyers and sellers of goods and services; presentation of goods on communication media, for retail purposes; media relations services; wholesale services for pharmaceutical, veterinary and sanitary preparations and medical supplies; retail services for pharmaceutical, veterinary and sanitary preparations and medical supplies; outsourced administrative management for companies; appointment scheduling services [office functions].

44 – Rental of animals for gardening purposes; rental of beehives; public bath services for hygiene purposes; Turkish bath services; hospital services; depilatory waxing; reforestation services; cultivation of plants; rehabilitation for substance abuse patients; landscape design; health centre services; nursing home services; wreath making; hair implantation; medical advice for individuals with disabilities; consultancy in the field of viticulture; pharmacy advice; aromatherapy services; animal-assisted therapy; manicuring; chiropractic; massage; medical testing; horticulture; providing information in the field of orthodontics; artificial insemination services; palliative care; hairdressing; body piercing; midwife services; veterinary assistance; dentistry services; medical assistance; tree planting for carbon offsetting purposes; preparation of

prescriptions by pharmacists; medical equipment rental; rental of hair styling apparatus; rental of sanitary installations; farming equipment rental; aerial and surface spreading of fertilizers and other agricultural chemicals; animal breeding; gardening; landscape gardening; beauty salon services; sanatorium services; medical screening; blood bank services; health care; health counselling; flower arranging; tattooing; vermin exterminating for agriculture, aquaculture, horticulture and forestry; weed killing; health spa services; human tissue bank services; aquaculture services; viticulture services; visagists' services; convalescent home services; rest home services; medical clinic services; medical analysis services for diagnostic and treatment purposes provided by medical laboratories; home-visit nursing care; alternative medicine services; opticians' services; orthodontic services; plant nursery services; pest control services for agriculture, aquaculture, horticulture and forestry; speech therapy; in vitro fertilization services; services of a psychologist; sauna services; solarium services; telemedicine services; therapy services; nursing, medical; lawn care; animal grooming; pet grooming; physiotherapy; plastic surgery; tree surgery; hospice services.

(260) AM 2022 115276 A

(800) 1624251

(151) 2020 12 18

(891) 2020 12 18

(731) TRATON SE

Dachauer Str. 641, 80995 München,  
Germany

(540)

## TENTIK

(591) Black, white

(511)

1 – Chemical products for commercial and scientific purposes; chemicals for cleaning exhaust gases; chemicals as additives to liquid fuels; chemicals for internal combustion engines; chemicals for decarbonizing automobile engines and chemical preparations for decarbonizing automobile engines; additives for exhaust gas after-treatment of internal combustion engines; oils for brakes; chemical substances for stabilising oils; oils for hydraulic suspensions, circuits and cushions; chemical additives for oils; additives (chemical -) for industrial oils; chemicals in the form of water soluble oils; chemical catalysts for use in synthesis gas and olefin purification; antifreeze goods and compounds (also for glass), preparations for preventing the tarnishing of glass; adhesive substances for industrial use; chemicals for use in cylinder liners.

4 – Industrial oils and greases; lubricants and non-chemical additives for lubricants; engine oils, liquid fuels and gaseous fuels (including petrol and motor spirits), additives (non-chemical -) for fuels; automotive greases.

7 – Motors and engines (except for land vehicles) and parts, components and spare parts therefor; internal combustion and electrical engines (other than for land vehicles), machine coupling and transmission components (except for land vehicles), and parts and spare parts therefor; parts of electric and combustion engines and motors; aircraft motors and engines, industrial motors and engines, hydraulic motors and engines, gas turbine engines, gas turbo engines, ship motors and engines, motors and engines for water-vehicles, internal combustion motors and engines, electrical motors and engines, piston motors and engines; mechanical engine parts for land vehicles; compressors; exhaust systems for vehicles; clutches for machines and parts therefor; transmissions and their parts for machines, air and water vehicles; pumps, compressors and blowers; discs made of abrasive materials [parts of machines]; springs [parts of machines]; sieves [machines or parts of machines]; hoods [machine parts]; hydraulic and pneumatic controls for machines, motors and engines; electric generators, gas generators; turbo-compressor superchargers for exhaust gases (other than for land vehicles), alternators; frames and parts of internal combustion and electrical engine mounts; injection nozzles, injection combination pumps and nozzles, injection regulators, all being parts of internal combustion engines; ignition distributors; fuel filters and pumps for engines, liquid tanks [parts of machines]; exhaust gas treatment systems for engines; decontamination installation for internal combustion engines; mobile combustion engines, not for land vehicles; brake installations for internal combustion and electrical engines; mechanical and hydrodynamic brakes; grease rings; valves; hand tools (other than hand-operated) for the maintenance of motors and engines; land-based and floating power plants with diesel and diesel-gas engines; parts of electric and combustion engines and motors for land vehicles; starters for engines; pumps, compressors and blowers; supercharger compressor as a motor element; exhaust gases turbo-compressors (for land vehicles); holders for mobile combustion and electrical engines and machines; mobile combustion engines for machines; brake installation for internal combustion and electrical engines; cardan shaft and cardan shafts bearings; mechanical control mechanisms for vehicle windows; mechanical control mechanisms for vehicle doors; drive units for transportable concrete mixers; discs for starters of engines and motors; handling apparatus for loading and unloading, namely side loaders and devices for filling and emptying vehicles with tanks, silos, and containers.

9 – Navigation, surveying, photographic, audiovisual, optical, measuring, signalling, detecting, testing, inspecting apparatus and instruments; apparatus and instruments for conducting, switching, transforming, accumulating, regulating or controlling the distribution or use of electricity; apparatus and instruments for recording, transmitting, reproducing or processing so-

und, images or data; recorded and downloadable media, computer software, blank digital or analogue recording and storage media; calculating devices; computers and computer peripheral devices; vehicle simulation software; image processing software for in-vehicle cameras; artificial intelligence software for vehicles; computer programs for providing an all-around view for a vehicle; vehicle control software; computer software to operate vehicles; computer applications for vehicle navigation apparatus; recorded computer software for safe vehicle driving; computer applications and programs for automatic vehicle driving and parking control; on-board electronic systems in land vehicles for providing driving assistance; on-board computers; computer software for mobile applications that enable interaction and interface between vehicles and mobile devices; software for GPS navigation; global positioning systems (GPS); GPS receivers; amplifiers for vehicles; multimedia connectors for vehicles; communications apparatus for vehicles; mobile phone connectors for vehicles; telecommunications equipment, telephones, mobile telephones, telephone headphones; computerized vehicle engine analyzers; on board computers for vehicles; computers for autonomous-driving vehicles; audio devices and receivers for vehicles; displays for vehicles; electronic driver displays systems for vehicles; cameras for vehicles; antennas; modems; printers; electronic publications, downloadable; charging stations for electric vehicles; vehicle batteries; accumulators, electric, for vehicles; battery charging devices for motor vehicles; cell phone battery charges for use in vehicles; voltage regulators for vehicles; vehicle fuses; climate control digital thermostats; integrated electronic safety systems for land vehicles; integrated electronic driver assistance systems for land vehicles; fuel cells; fuel cell electrodes; fire fighting vehicles; driver assistance systems for motor vehicles; remote controls for operating vehicle alarms; electric locks for vehicles; electronic keys for vehicles; remote control apparatus for opening and closing vehicles doors; warning triangles; warning lamps for vehicles; vehicle tracking apparatus and systems; vehicle automatic driving control devices; multimedia navigation systems for vehicles; vehicle speed control systems and apparatus; autonomous driving control systems for vehicles; vehicle wheel alignment machines; water, oil and fuel level indicators for vehicles; tire balancing units for motor vehicles; cruise controls for vehicles; mileage and kilometer recorders for vehicles; parking sensors for vehicles; radar apparatus for vehicles; automatic indicators of low pressure in vehicle tires; vehicle drive training simulators; remote controls for motors; electronic control sensors for motors; electronic motor checking apparatus; detection and ranging [LIDAR] apparatus; engine analyzers, engine control sensors, internal combustion and electrical engine testing apparatus, temperature regulators for vehicles engines, starter cables for motors; electric control devices, in-

formation technology apparatus and instruments and software for road safety, platooning and autonomous driving; electric control devices, information technology apparatus and instruments and software for managing electric propulsion systems and energy management systems; software applications for use in transportation or commercial vehicle industry; electric control devices, information technology apparatus and instruments, software and electronic manuals and guides for diagnostics, maintenance, service, repair of vehicles, engines and motors; electronic controls for machines, motors and engines; automatic window controls; automatic controls for vehicle doors.

11 – Apparatus and installations for lighting, heating, cooling, steam generating, drying and ventilating; vehicle lighting and lighting reflectors; vehicle HVAC systems (heating, ventilation and air conditioning); air purifiers for automobiles; oil burners; gas burners; diesel burners; gas burners; ventilators for vehicles; defrosting apparatus for vehicles; aeration apparatus; valves for air conditioners; gas scrubbing and purification apparatus.

12 – Vehicles; parts and fittings for vehicles; land vehicles; commercial vehicles; buses; trucks; lorries, pickup trucks; cargo trailers; coaches; concrete mixing vehicles; construction vehicles for transportation purposes; driverless [autonomous] motor vehicles; dump trucks; electric land vehicles; electric lift trucks; electric reach trucks; electric buses; electric trucks [vehicles]; engines and motors for land vehicles; gas, diesel, combustion and electrical engines and motors for land vehicles; transmissions for land vehicles; reduction and reversing gears for land vehicles; steering wheels, steering wheel covers; shock absorbers; oil, fuel and gas tanks for land vehicles; mechanical and hydrodynamic brakes; mechanical, automatic, hydrodynamic and hydrostatic transmissions for land vehicles; vehicle bodies; body panels for vehicles; frames for motor vehicles; suspension struts; frame and body brackets adapted for vehicle chassis; floor panels being structural parts of vehicles; metal floor panels being structural parts of vehicles; vehicle roofs, vehicle bodies, vehicle hoods and floor panels being structural parts of vehicles; support plating and plates for vehicles; cabins (trucks) with or without beds specially adapted for vehicles; chassis for vehicles; gear lever knobs and steering wheel knobs for vehicles; gear, brake, transmission and shift levers for land vehicles; cam controllers being stability control systems for vehicles; accelerator pedals for land vehicles; brake and clutch pedals; vehicle suspensions; torsion bars; anti-freeze devices for land vehicles; vehicle bumpers; axles and their parts for vehicles; housings adapted for vehicle axles; vehicle wheels; wheel rims, caps for wheel rims; brakes and brake parts for vehicles; auxiliary brake pumps for land vehicles; anti-theft locks for use on automobile steering wheels; steering gears for vehicles; steering gear casings and

covers; steering units for land vehicles, namely steering worms, steering columns, steering arms, steering pins, steering rods, steering couplings; radiator grills for vehicles and parts thereof; vehicle seats; seat post racks and holders for land vehicles; seat cushions for vehicles; seat cushions; back rests, arm rests, head rests and foot rests for vehicles; safety belts; vehicle windows and screens; vehicle windows and windshields having heat regulating functions; window control levers and cranks for vehicles; doors for vehicles; dashboards for vehicles; security and safety alarms for vehicles; horns for vehicles; glove boxes for vehicles; hoods for vehicle engines; trunk tailgates and covers; mudguards; fitted protective covers for vehicles; bug shields as parts of vehicles; headlights protectors for vehicles; mirrors for vehicles; direction signals for automobiles and number plates holders; ashtrays; sun visors for automobiles; luggage nets, carriers, carts and racks for vehicles; ski racks for vehicles; snow chains for land vehicles; windscreen wipers for automobiles; mechanical and electric sunroofs for land vehicles; tires for land vehicles; towing devices and their parts for vehicles; lifting and support devices for vehicles; friction clutches for land vehicles; covers for vehicles seats; fuel cell electric land vehicles; clutches for land vehicles; couplings for use with clutches for land vehicles; reservoirs being parts of land vehicle clutches; steering wheels; covers for steering wheels.

(260) AM 2022 115278 A

(800) 1624298

(151) 2021 04 30

(891) 2021 04 30

(731) Limited Liability Company "Scientific and production enterprise Rogneda"  
Dorozhnaya str., 4B, Staraya Kupavna, the city of Noginsk, RU-142450 Moscow region,  
Russian Federation

(540)

**ЭКОДОМ**

(591) Black, white

(531) 28.05

(511)

2 – Whites [colorants or paints]; primers; carbonyl [wood preservative]; alizarine dyes; aniline dyes; ink for leather; shoe dyes; asbestos paints; distempers; fireproof paints; enamels for painting; anti-fouling paints; bactericidal paints; wood stains; ceramic paints; printing ink; creosote for wood preservation; lacquers; anti-rust oils; oils for the preservation of wood; lime wash; thickeners for paints; coatings for roofing felt [paints]; undercoating for vehicle chassis; varnishes; agglutinants for paints; anti-corrosive preparations; protective preparations for metals; wood mordants; thinners for paints; thinners for lacquers; whitewash; siccatives [drying agents] for paints; badi-

geon; anti-tarnishing preparations for metals; wood preservatives; blacks [colorants or paints].

(260) AM 2022 115289 A

(800) 930137

(151) 2007 07 06

(891) 2021 10 18

(731) QB Trademarks S.à r.l.

121, avenue de la Faiencerie, L-1511

Luxembourg, Luxembourg

(540)

**GREENALL'S**

(591) Black, white

(531) 27.05.01

(511)

32 – Beers; ales; lagers; porter; mineral and aerated waters; non-alcoholic beverages; fruit drinks and fruit juices; isotonic beverages; ginger ale; ginger beer; seltzer water; soda water; syrups and other preparations for making beverages; tomato juice; table waters.

33 – Alcoholic beverages; wines; spirits; liqueurs; cider; cocktails; perry; vodka; rum; tequila; whisky; whiskey; gin; brandy.

(260) AM 2022 115290 A

(800) 979254

(151) 2008 05 22

(891) 2021 03 30

(731) LEA NATURE SERVICES

23 AVENUE PAUL LANGEVIN, F-17180

PERIGNY, France

(540)



(591) Blue, white and brown

(531) 25.05.02; 26.04.04; 26.04.18; 29.01.13

(511)

3 – Bleaching preparations and other substances for laundry use; cleaning, polishing, degreasing and abrasive preparations; soaps; perfumery, essential oils, cosmetics, hair lotions; dentifrices; toilet water, products for perfuming linen, perfumery products, bases for flower and plant perfumes, scented micro-capsules, incense, scented water, oils for perfumery, shampoos, oils for cosmetic use, cosmetic creams, face and body milk, cleansing milk for toilet purposes, pomades for cosmetic use, cosmetic preparations for baths

not for medical use, bath salts not for medical use, deodorants for personal use; aromatics (essential oils), scented wood, eau de cologne, disinfectant and deodorant soaps, lavender water, fumigation products (perfumes), bath foam not for medical use, cosmetic preparations for slimming, beauty masks, sun-tanning preparations (cosmetics), depilatory products, cosmetics for animals, make-up removing products, lotions for cosmetic use, make-up products, nail care products, cosmetic scrubs, mint for perfumery, potpourris (fragrances), soaps for foot perspiration, tissues impregnated with cosmetic lotions, scented waters, extracts of flowers and plants (perfumery), mint essence for perfumery; lozenges and chewing gum for cosmetic use, all these goods being produced by organic farming or made from goods produced by organic farming.

(260) AM 2022 115292 A  
 (800) 1281637  
 (151) 2015 09 17  
 (891) 2021 09 27  
 (731) Joint Stock Company "Savushkin Product"  
 118, Ya. Kupaly str., 224028 Brest, Belarus  
 (540)



(591) Black, white  
 (531) 11.03.08; 26.13.25; 28.05  
 (511)  
 5 – Food for babies; dietetic foods adapted for medical purposes; candy for medical purposes, confectionery, medicated; mineral food supplements; nutritional supplements for medical purposes; mustard for pharmaceutical purposes; glucose for medical purposes; cod liver oil; haematogen; mineral waters for medical purposes, dietetic beverages adapted for medical purposes, thermal water, sea water for medicinal bathing; cultures of microorganisms for medical use; lactose for pharmaceutical purposes; liquorice for pharmaceutical purposes; albumin milk and milk ferments for pharmaceutical purposes; flour for baby nutrition, malted milk beverages for medical purposes; albuminous preparations for medical purposes; vitamin preparations; preparations of trace elements for human and animal use; media for bacteriological cultures; herbal teas for medicinal purposes.

29 – Meat, fish, poultry and game; meat extracts; preserved, dried and cooked fruits and vegetables; jellies, jams, compotes; eggs; milk and milk products inclu-

ding yoghurt, kephir (milk beverage), butter cream, koumiss (milk beverage), whey, milk beverages (milk predominating), cream including whipped cream (dairy products), cheese, cottage cheese, sour cream, curd snacks; edible oils and fats, butter, margarine; rennet.

32 – Beers; mineral and aerated waters and other non-alcoholic beverages; fruit beverages and fruit juices; syrups and other preparations for making beverages.

35 – Advertising; sales promotion for others; services related to wholesales and retail sales of the goods of classes 5, 29 and 32 via shops.

(260) AM 2022 115296 A  
 (800) 1435666  
 (151) 2018 06 05  
 (891) 2021 09 24  
 (731) ITP S.A.  
 ul. Domaniewska 37, PL-02-672 Warszawa,  
 Poland  
 (540)

## NEAUVIA

(591) Black, white  
 (511)  
 3 – Cosmetics; lip glosses; cleaning preparations; make-up removing preparations; detergents other than for use in manufacturing operations and for medical purposes; cosmetic preparations for baths; cosmetic preparations for slimming purposes; make-up; cosmetic creams; skin whitening creams; lotions for cosmetic purposes; make-up preparations; beauty masks; oils for cosmetic purposes; hair lotions; after-shave lotions; sunscreen preparations; cosmetic preparations for eyelashes; cosmetic preparations for skin care; cosmetic kits; cosmetic preparations for skin renewal; body lustre preparations for cosmetic purposes; wrinkle-minimizing skin care preparations; cosmetic preparations for skin renewal; anti-ageing effect, anti-ageing, anti-pollution and anti-sagging cosmetics; cosmeceuticals; cosmetics with complementary medical effects (cosmeceuticals); cosmetic products with added medical properties (cosmeceuticals): cosmeceuticals for cosmetic purposes; cosmeceuticals for skin care after aesthetic medicine treatment; anti-aging, regenerative and skin protective cosmeceuticals; cosmeceuticals with fractional hyaluronic acid; cosmetics, concealers and fillers for lines and wrinkles, anti-aging skin care preparation, anti-aging, regenerative and skin protective cosmetics and preparations, beauty serums with anti-aging properties, cosmetic preparations for skin care, cosmetics for use in the treatment of wrinkled skin; all these goods being sold exclusively in: medical clinics, medical aesthetic clinics, cosmetics and plastic surgery clinics as well as in medical spa and aesthetic medicine salons.

5 – Pharmaceutical preparations; dietetic food and substances adapted for medical use; dietary supple-



ments for humans; amino acids for medical purposes; protein dietary supplements; albumin dietary supplements; chemical preparations for pharmaceutical purposes; chemical preparations for medical purposes; chemico-pharmaceutical preparations; tissues impregnated with pharmaceutical lotions; disinfectants for hygiene purposes; pharmaceutical preparations; acids for pharmaceutical purposes; medicinal infusions; lotions for pharmaceutical purposes; mineral food supplements; eyepatches for medical purposes; medical preparations for slimming purposes; slimming pills; nutritional supplements; pomades for medical purposes; pharmaceutical preparations for skin care; serums; antioxidant pills; hair growth preparations; disinfectant soap; sanitizer and disinfectant liquids; disinfection gel for hands; mineral food supplements; medical preparations for slimming purposes; pharmaceutical, pharmacological, chemical preparations and products for medical purposes; pharmaceutical, pharmacological and chemical preparations and products for use in aesthetic medicine and for skin care; cosmetics for medical or therapeutic purposes; skin care preparations for medical use; dermatological products and preparations; pharmaceutical, pharmacological and chemical preparations sold in prefilled syringes; filled syringes for medical purposes [containing pharmaceuticals]; pre-filled syringes for medical use; injectable dermal fillers; medicated skin lotions, medicated skin creams, medicated skin tonics, medicated skin care preparations, medicated preparations for skin treatment sold exclusively in: medical clinics, medical aesthetic clinics, cosmetics and plastic surgery clinics as well as in medical spa and aesthetic medicine salons.

10 – Surgical, medical, apparatus and instruments; apparatus for use in medical analysis; anaesthetic apparatus; microdermabrasion apparatus; vibromassage apparatus; surgical apparatus and instruments; diagnostic apparatus for medical purposes; electrodes for medical use; needles for medical purposes; surgical implants [artificial materials]; syringes for injections; esthetic massage apparatus; lasers for medical purposes; massage apparatus; anaesthetic masks; masks for use by medical personnel; medical apparatus and instruments; body rehabilitation apparatus for medical purposes; injectors for medical purposes; syringes for medical purposes; vaginal syringes; surgical, medical devices; apparatus, devices and instruments to be used in dermatology, cosmetology, plastic surgery and aesthetic medicine; surgical and medical apparatus, instruments and devices used for electrosurgical, radiofrequency, laser, infrared or ultrasound treatment and procedures; surgical and medical apparatus, instruments and devices used for thermal lifting, skin photobiostimulation and cosmetology; surgical, medical apparatus, devices and instruments incorporating lasers; ultrasound surgical, medical apparatus, devices and instruments; radiofrequency medical and surgical apparatus, devices and instruments; infrared medical

and surgical apparatus, devices and instruments apparatus for use in medical analysis; disposable hypodermic and inflation syringes for medical and surgical use; disposable needles for hypodermic syringes; syringes and needles for medical aesthetics purposes.

41 – Education; providing of training; education information; practical training [demonstration]; arranging and conducting of conferences; arranging and conducting of congresses; arranging and conducting of workshops [training]; arranging and conducting of seminars; arranging and conducting of symposiums; organization of exhibitions for cultural or educational purposes; publication of electronic books and journals on-line; providing on-line electronic publications, not downloadable; publication of books; publication of texts other than publicity texts; academies [education]; provision of medical instruction courses; education services, training courses and teaching relating to aesthetics medicine and use of surgical and medical apparatus, devices and instruments; arranging of beauty contests.

44 – Medical services; hygienic and beauty care for human beings; plastic surgery; beauty salons; medical clinic services; health spa services; cosmetics and plastic surgery clinic services; aesthetics medicine services; medical spa services; aesthetics medicine salons; providing information about beauty, health and in the fields of aesthetics medicine; providing medical information via website.

(260) AM 2022 115297 A

(800) 1452740

(151) 2018 06 28

(891) 2021 07 13

(731) "KONTI-RUS" JOINT STOCK COMPANY  
ul. Zolotaia, 13, RU-305000 Kursk,  
Russian Federation

(540)

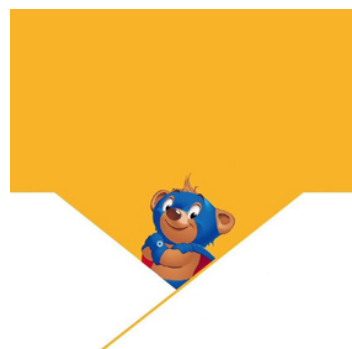

(591) Yellow, light brown, brown, dark brown, blue, red, white and black

(531) 03.01.14; 03.01.25; 26.05.15; 29.01.15

(511)

30 – Fruit jellies [confectionery]; pastries; peanut confectionery; caramels [candy]; confectionery; sweetmeats [candy]; candy; marzipan; dessert mousses [confectionery]; chocolate mousses; chocolate-coated

nuts; cookies; biscuits; petit-beurre biscuits; cakes; fondants [confectionery]; pralines; gingerbread; sugar confectionery; halvah; chocolate.

---

(260) AM 2022 115298 A

(800) 1531292

(151) 2020 04 06

(891) 2021 10 05

(731) Velinor AG

c/o Dr.iur. Adrian von Segesser, Kapellplatz 1,  
CH-6004 Luzern, Switzerland

(540)

## ZISCOVA

(591) Black, white

(511)

5 – Pharmaceutical preparations.

---

(260) AM 2022 115300 A

(800) 1574494

(151) 2020 12 07

(891) 2021 10 18

(731) F. Hoffmann-La Roche AG

Grenzacherstrasse 124, CH-4070 Basel,  
Switzerland

(540)

## TYGITUDE

(591) Black, white

(511)

5 – Pharmaceutical preparations for use in oncology and hematology.

---

(260) AM 2022 115302 A

(800) 1610850

(151) 2020 12 18

(891) 2021 09 09

(731) EUROFINS SCIENTIFIC (IRELAND)  
LIMITED

Clogherane, Dungarvan, Co Waterford, Ireland

(540)

## EUROFINS

(591) Black, white

(511)

1 – Chemical preparations not for medical use; chemical preparations for scientific use; reagents for chemical analyses; diagnostic preparations and materials for scientific and research use; diagnostic preparations and materials for laboratory or industrial use; analytical and diagnostic testing kits for laboratory and industrial use (diagnostic test materials other than for medical use); analytical and diagnostic testing kits for scientific and research use (diagnostic test materials other than for medical use); analytical and diagnostic testing kits for scientific and research use namely reagents and buffers; analytical and diagnostic testing

kits for industrial and laboratory use namely reagents and buffers; PCR kits namely diagnostic test materials other than for medical use; PCR kits namely reagents and control samples not for medical diagnostic or veterinary diagnostic use; chemical compounds for laboratory or industrial use namely oligonucleotides, polynucleotides, synthetic genes; chemical compounds for scientific use and non-medical research use namely oligonucleotides, polynucleotides, synthetic genes; peptide microchips and DNA microchips of a chemical nature; DNA microarrays of a chemical nature; peptide microarrays of a chemical nature; biochips of a chemical nature; oligonucleotide sets for DNA microchips of a chemical nature namely chemical compositions and materials for scientific, laboratory, industrial or research use; oligonucleotide sequences for DNA microchips namely chemical compositions and material for scientific use; gene libraries as collections of DNA and RNA fragments, fragments, variants or combination of genes, of a chemical nature, prepared and offered for sale, for scientific or research use, for industrial or laboratory use not for medical or veterinary use; genetic engineering materials, including genes, fragments and combinations thereof, all these products being chemical compositions and materials for scientific use, laboratory use, industrial use or research; ELISA-based and other antibody-based kits not for medical use (diagnostic test materials other than for medical use); ELISA-based and other antibody-based kits namely, test strips and dipsticks, microtiter plates, coated test tubes and magnetic particles for detection of chemical and biochemical and biological molecules or parts thereof for scientific, laboratory and industrial use and not for medical diagnostic use; analytical standard solutions for detection of chemical or biochemical molecules for scientific, laboratory and industrial use and not for medical diagnostic use; chemically-modified magnetic beads for binding chemical or biochemical compounds for detection of chemical and biochemical compounds for scientific, laboratory and industrial use and not for medical diagnostic use; reagent kits comprised of proteins, polypeptides and chemical reagents not for medical use.

42 – Scientific and industrial research; research and development in the fields of animal and plant biology, physical chemistry, food chemistry, microbiology, molecular biology, epidemiology, immunology, chemistry, biochemistry; research and development in the food and feed industries; research and development for environment testing and field sampling for air, soil, sediment, water, waste, gas, soil gas; carrying out physical, chemical, physical-chemical, biochemical, biological, epidemiological, microbiological, molecular biological or immunological analyses in the fields of plant and animal products; carrying out physical, chemical, physical-chemical, biochemical, biological, epidemiological, microbiological, molecular biological or immunological analyses, clinical and in-vitro

studies in the food and feed, agro-food, chemical, pharmaceutical, cosmetic, health, environmental, agrochemical, biotechnology, aerospace, automobile, consumer products, semiconductor, electronics, energy, magnetic storage and any science-oriented industries; carrying out genetic analyses in the fields of plant and animal products; carrying out genetic analyses in the food, feed, agro-food, chemical, pharmaceutical, cosmetic, health, biotechnology and consumer product industries and in environmental testing; carrying out nuclear magnetic resonance analyses in the food, feed, agro-food, chemical, pharmaceutical, cosmetic industries and in environmental testing; scientific and industrial research; development of methods namely establishment and carrying out of physical, chemical, physical-chemical, biochemical, biological, epidemiological, microbiological, molecular biological, immunological and biomolecular testing methods; preparing scientific, medical or industrial expert reports for scientists and engineers; technical project studies; professional consultancy in the field of scientific research and medical treatments; DNA, RNA and virus analyses for scientific purposes; technical project studies; design of gene libraries such as collections of DNA and RNA fragments, variants or combination of genes, of chemical nature or for medical or veterinary use; scientific and technological services namely, research, analysis, inspection, quality audit, consulting, design, engineering, development and laboratory testing services for others; sample taking services and services for the collection of material for environmental, agro-food, food and feed and genetic testing; on-line data provision, data interpretation, consultancy and advisory services related to environmental, agro-food, food and feed testing services; scientific and technological services related to the development, commercialization, life cycle management, improvement and regulatory compliance of products manufactured by pharmaceutical, agrochemical, chemical, biotechnology, aerospace, automobile, consumer products, semiconductor, electronics, energy, magnetic storage and other science-oriented industries; consulting and advisory services related to analytical techniques, regulatory requirements and product development processes; consulting and advisory services related to the development, life cycle management, improvement and regulatory compliance of products manufactured by pharmaceutical, agrochemical, chemical, biotechnology, aerospace, automobile, consumer products, semiconductor, electronics, energy, magnetic storage and other science-oriented industries; product development, manufacturing and advisory services for others; database design and development; analysis and provision of online information about industrial analysis and research services; analysis and provision of scientific research information, data analysis and results from an online searchable database; information technology (IT) services including online searchable databases and algorithms, for managing

and providing scientific analysis results based on genomics data; analysis and provision of online information in the field of technological research from a computer database or the Internet; food product and beverage certification services [quality control]; accreditation services [certification of competence and quality] in the field of food and drink industries; accreditation services [certification of competence and quality] in the field of scientific analysis; testing, analysis and evaluation of the goods and services of others for the purpose of certification; testing, analysis and evaluation of the goods and services of others to determine conformity with certification standards; testing, analysis and evaluation of the goods and services of others to determine conformity with certification standards in the field of scientific analysis; carrying out experts test panels namely sensory analysis; carrying out consumer test panels namely sensory analysis; product testing including digital testing and cyber security testing; consumer product safety testing; product quality control testing; product safety testing; testing of new products; consultancy relating to consumer product safety testing; design and testing for new product development; design and testing of new products; development and testing of chemical production methods; quality control testing of products for certification purposes; scientific and technical research for others for pharmaceuticals, biotech products and chemicals; scientific and technical research for others in the field of physical testing, acoustic testing, flowability, atmosphere testing, electric and electronic safety testing; pharmaceutical drug discovery services; development and research in the pharmaceutical, biotechnological, chemical and agro-chemical fields; clinical trials for pharmaceutical drugs; research services in the areas of genomics, proteomics, chemistry, pharmacology, biology, epidemiology, medicinal chemistry, organic and inorganic chemistry, synthetic chemistry, analogue chemistry and computational chemistry; providing information in the field of epidemiology, genomics and proteomics of living organisms including human beings based on existing biological data by using information technology tools and techniques; clinical trials for pharmaceutical, products, cosmetics and personal care products; services for ensuring safety and efficiency of pharmaceutical drugs; computer services, namely use of information technology tools and techniques to work with existing biological data and to generate information on the epidemiology, genomics and proteomics of living organisms including human beings through research and study, all these services included in this class; scientific and technological services namely scientific and medical laboratory services, laboratory research and development in the fields of epidemiology, biomedicine and biobanking; quality audit (quality control) in the field of hygiene in hospitals, food industry, restaurants, hotels and retailers' sites or any public places; technical and scientific audits and

onsultancy in the consumer product industry, food industry, hospitality industry and in retailers' sites; product quality inspection for consumer products, food and feed industry and healthcare industry; quality audit services in the field of systems and certification according to national and international standards in the consumer product industry, food and feed industry, hospitality industry and healthcare industry; environmental impact studies; environmental impact studies for pharmaceuticals, veterinary products, agrochemicals and chemicals; consultation and analysis services in the fields of biotechnology, pharmaceutical research and development, diagnostics and drug therapy; pharmaceutical, biopharmaceutical and clinical research and development for others; services related to the development of veterinary products and their applications; testing and support services for the registration of veterinary products and their applications; DNA, RNA and virus testing for scientific purposes; DNA and RNA examination for scientific purposes.

44 – Medical services for blood testing, saliva, urine, tissue, hair and body fluid testing services; serological and urinary testing services for medical, epidemiological and veterinary use; medical testing services in the field of epidemiology and genetics; DNA, RNA and virus analyses for medical purposes; DNA and RNA screening for medical purposes; medical and health services in connection with DNA and RNA; genetic testing for medical use; hospital services; medical assistance and medical services in the field of epidemiology and genetics; medical clinic services; medical consultation services; genetic and epidemiological consultation; medical equipment rental; provision of medical record services online except in the dentistry field; human fertility treatment services; hygiene and beauty care for human beings and animals; collection, sampling and preservation of human blood, saliva, urine, tissue, hair and body fluids; medical testing for diagnostic and epidemiological use; testing, monitoring and reporting of medical diagnosis in the field of cardiovascular diseases; providing information relating to cardiovascular health and cardiovascular health examination; medical services, namely health and well-being programs in the field of cardiovascular disease; medical testing for diagnostic and treatment purposes, namely for genetic causes of lipid abnormalities; medical diagnostic testing in the field of diabetes; medical testing for diagnostic purposes in the field of preventive medicine; carrying out test panels in the field of preventive medicine; medical services namely preventive medicine and tests in the field of micro-nutrition; medical diagnostic testing in the field of sports; medical diagnostic testing in the field of antiageing medicine; medical assistance services in the field of preventive medicine; carrying out medical biology test panels, interpretation of medical biology test results; bio-pathological information and advice relating to medical biology tests; testing for as-

sessing immunogenicity, hypersensitivity and adverse immune stimulation; allergy and immunology testing; infectious disease screening; prenatal diagnostic testing for medical use; prenatal diagnostic testing; genetic counselling; human fertility treatment services; seed phenotyping and seed breeding services; seed development services; services related to compliance with seed breeding regulations, namely application support for plant breeders' rights.

---

(260) AM 2022 115361 A

(800) 1624635

(151) 2021 05 14

(891) 2021 05 14

(731) Orthomol pharmazeutische Vertriebs GmbH  
Herzogstr. 30, 40764 Langenfeld, Germany

(540)

## **orthomol**

(591) Black, white

(511)

5 – Dietary supplements and dietetic preparations; dietetic preparations adapted for medical use; dietetic food preparations adapted for medical use; dietetic beverages adapted for medical purposes; dietetic substances adapted for medical use; dietetic foods adapted for medical purposes; liquid vitamin supplements; nutraceuticals for use as a dietary supplement; powdered fruit-flavored dietary supplement drink mix; medicated food supplements; mineral food supplements; mineral dietary supplements for humans; nutritional supplements; enzyme dietary supplements; glucose dietary supplements; protein dietary supplements; nutritional supplement meal replacement bars for boosting energy; mineral nutritional supplements; food supplements consisting of amino acids; yeast dietary supplements; food supplements consisting of trace elements; dietary supplements consisting of vitamins; dietary supplements for humans; dietary supplements for humans not for medical purposes; food supplements; health food supplements for persons with special dietary requirements; powdered nutritional supplement drink mix; food for medically restricted diets; food supplements for non-medical purposes; probiotic supplements; vitamin and mineral supplements; vitamins and vitamin preparations; mixed vitamin preparations; vitamin preparations in the nature of food supplements; health food supplements made principally of minerals; health food supplements made principally of vitamins; pharmaceuticals and natural remedies; mineral food preparations for medical purposes.

---

(260) AM 2022 115449 A  
 (800) 1626067  
 (151) 2021 06 17  
 (891) 2021 06 17  
 (731) Limited liability company "BITREND"  
 str. Mykhailivs'ka, b. 24a, Kyiv 01001, Ukraine  
 (540)

## SAMEKEY

(591) Black, white  
 (511)  
 9 – Answering machines; 3D spectacles; circuit breakers; electrical adapters; actinometers; accumulators, electric; acoustic couplers; ammeters; anemometers; high tension batteries; antennas; remote control apparatus; data processing apparatus; global positioning system [GPS] apparatus; anti-theft warning apparatus; audio- and video-receivers; audio interfaces; batteries, electric; cordless telephones; biochips; computer memory devices; connected bracelets [measuring instruments]; electric plugs; measuring instruments; gauges; measuring devices, electric; measures; branch boxes [electricity]; camcorders; video screens; video telephones; peepholes [magnifying lenses] for doors; virtual reality headsets; parking sensors for vehicles, telemeters; detectors, smoke detectors; bells [warning devices]; electric door bells; telerupters; electrified fences; electric installations for the remote control of industrial operations; electro-dynamic apparatus for the remote control of signals; electronic key fobs being remote control apparatus, downloadable e-wallets; electronic numeric displays; electronic notice boards, electronic access control systems for interlocking doors; encoded identification bracelets, magnetic; locks, electric; padlocks, electronic; acoustic alarms; sound transmitting apparatus; couplers [data processing equipment]; readers [data processing equipment]; bar code readers; identity cards, magnetic; interactive touch screen terminals; infrared detectors; integrated circuit cards [smart cards]; push buttons for bells; terminals [electricity]; encoded magnetic cards; wearable computers; thin client computers; computer hardware; computer software, recorded; magnetic tape units for computers; computer peripheral devices; computer programs, downloadable; computer programs, recorded; computer operating programs, recorded; computer software applications, downloadable; computer software platforms, recorded or downloadable; commutators; electric apparatus for commutation; contacts, electric; junction boxes [electricity]; downloadable cryptographic keys for receiving and spending cryptocurrency, magnetic encoders; magnetic data media; microprocessors; modems; neon signs; semi-conductors; parking meters; intercommunication apparatus; time switches, automatic; switches, electric; video recorders; tape recorders; theft prevention installations, electric; transmitting sets [telecommunication]; relays, electric; scanners [data processing equipment]; smart rings; observation instruments; moni-

toring apparatus, other than for medical purposes; photovoltaic cells; sound locating instruments.

42 – Computer system analysis; off-site data backup; electronic monitoring of personally identifying information to detect identity theft via the internet; electronic monitoring of credit card activity to detect fraud via the internet; installation of computer software; information technology services provided on an outsourcing basis; computer programming; conversion of data or documents from physical to electronic media; computer technology consultancy; telecommunications technology consultancy; information technology [IT] consultancy; computer software consultancy; monitoring of computer systems by remote access; maintenance of computer software; platform as a service [PaaS]; user authentication services using technology for e-commerce transactions; user authentication services using single sign-on technology for online software applications; software as a service [SaaS].

(260) AM 2022 115450 A  
 (800) 1626074  
 (151) 2021 06 29  
 (891) 2021 06 29  
 (731) Shenzhen invt Electric Co., Ltd  
 501, Building A7, Nanshan Zhiyuan, No. 1001,  
 Xueyuan Avenue, Changyuan Community,  
 Taoyuan Street, Nanshan District, 518000  
 Shenzhen, China  
 (540)



(591) Black, white  
 (531) 27.05.01; 27.05.17  
 (511)

7 – Electric kitchen machines; agricultural machines; sewing machines; laundry washing machines; electro-mechanical machines for food preparation; elevators [lifts]; metalworking machines; hand-held tools, other than hand-operated; machines for the electronic industry; transmissions for machines; electric motors, other than for land vehicles; gear boxes, other than for land vehicles; starters for motors and engines; dynamos; driving motors other than for land vehicles; propulsion mechanisms other than for land vehicles; exhausts for motors and engines; gears, other than for land vehicles; pumps [parts of machines, engines or motors]; dynamo belts; couplings other than for land vehicles; electric spindles (machines parts); spindle motors; elevator operating apparatus; threading machines; lathes [machine tools]; cutting machines; finishing machines; machine tools; crushing machines; machines and apparatus for polishing [electric]; dri-

ling machines; notchers [machine tools]; milling machines; planing machines; electroplating machines; electric welding apparatus; alternating current servo motors; generators of electricity; hydraulic controls for machines, motors and engines; control mechanisms for machines, engines or motors; wind-powered electricity generators; hydraulic motors and engines; machine coupling and transmission components [except for land vehicles]; motors, electric, other than for land vehicles; handling machines, automatic [manipulators]; industrial robots.

9 – Automatic control apparatus for power stations; explosion-proof frequency converters for high voltage; control panels [electricity]; distribution consoles [electricity]; distribution boxes [electricity]; electric apparatus for commutation; converters, electric; switches, electric; current rectifiers; inverters [electricity]; stabilized voltage supply units; low-voltage power supply units; autotransformer starters being control apparatus; computer programs [downloadable software]; electronic tags for goods; signal bells; telephone apparatus; optical communications instruments; measuring instruments; radiological apparatus for industrial purposes; protection devices for personal use against accidents; theft prevention installations, electric; time clocks [time recording devices]; television apparatus; cameras [photography]; materials for electricity mains [wires, cables]; integrated circuits; electrolyzers; accumulators, electric; accumulator boxes; battery chargers; variometers; capacitors; resistances, electric; rheostats; transformers [electricity]; lightning arresters; computer software for database management; computer software for controlling self-service terminals; computer software platforms, recorded or downloadable; network cards; interactive touch screen terminals; programmable logic controllers; display monitors; computer terminals; monitoring apparatus, electric; fiber optic couplers; servo amplifiers; electric control devices; power controllers; reactive power compensation devices; photovoltaic inverters; battery charging devices for motor vehicles; battery charge devices; battery boxes; portable power supplies (rechargeable batteries); data processing apparatus; heat regulating apparatus; apparatus for transmitting communications; photovoltaic installations for generating electricity [photovoltaic power plants]; photovoltaic cells; photovoltaic apparatus and installations for generating solar electricity; direct current converters; charging devices for rechargeable equipments.

---

(260) AM 2022 115451 A  
 (800) 1626136  
 (151) 2021 07 19  
 (891) 2021 07 19  
 (731) TOKUYAMA DENTAL CORPORATION  
 38-9, Taito 1-chome, Taito-ku, Tokyo  
 110-0016, Japan

(540)



(591) Blue, gray, white  
 (531) 26.01.03; 26.01.24; 26.02.07; 26.13.25;  
 29.01.13

(511)  
 5 – Materials for dental crowns and dental bridges; materials for artificial teeth; materials for use in dental prosthetics and dental fillings; dental composite materials; materials for tooth restoration; dental adhesives; dental cements; primers for dental purposes; denture relining materials; dental materials for denture base; dental materials; dental impression materials; gauze for dressings; detergents for medical purposes; other pharmaceutical preparations.

10 – Dispensing instruments for dental purposes; mixing instruments for dental purposes; filling instruments for dental purposes; polishing instruments for dental purposes; grinding instruments for dental purposes; drills for dental use; instruments for use in prosthetic dentistry; dental band for use in prosthetic dentistry; dental retainer for use in prosthetic dentistry; dental wedge for use in prosthetic dentistry; dental loupes; shade guides for dental use; dental articulators; orthodontic appliances; polymerization apparatus for use in dental treatment; dental apparatus for impression taking; dental apparatus for making denture, dental crowns and dental bridges; dentures; dental crowns; dental bridges; pins for artificial teeth; gloves for dental purposes; gloves for medical purposes; sanitary masks for medical purposes; surgical mask; face protection shields for medical purposes; dental apparatus and instruments; medical apparatus and instruments; sanitary masks for personal use.

---

(260) AM 2022 115452 A  
 (800) 1626143  
 (151) 2021 07 23  
 (891) 2021 07 23  
 (731) Individual entrepreneur Minkin Denis  
 Andreevich  
 Leningradskoe shosse, building 3, building 1,  
 apartment 133, RU-125080 Moscow, Russian  
 Federation

(540)



(591) Black, white

(531) 15.09.12; 18.01.09; 18.01.23; 27.05.01

(511)

9 – Fire engines; answering machines; electrical adapters; batteries for electronic cigarettes; accumulators, electric; accelerometers; actinometers; alidades; altimeters; ear pads for earphones; ammeters; nanoparticle size analysers; anemometers; anodes; aerials; anticathodes; apertometers [optics]; high-frequency apparatus; testing apparatus not for medical purposes; electro-dynamic apparatus for the remote control of signals; monitoring apparatus, other than for medical purposes; sound recording apparatus; Global Positioning System [GPS] apparatus; diffraction apparatus [microscopy]; air analysis apparatus; cash registers; intercommunication apparatus; projection apparatus; fire extinguishing apparatus; blueprint apparatus; flashing lights [luminous signals]; telephone apparatus; acid hydrometers; acidimeters for batteries; aerometers; automated teller machines [ATM]; barometers; anode batteries; galvanic batteries; ignition batteries; solar batteries; batteries, electric; betatrons; binoculars; biochips; lens hoods; magnetic tape units for computers; computer memory devices; fire hose nozzles; encoded identification bracelets, magnetic; directional compasses; vacuum gauges; electrolyzers; variometers; verniers; scales; precision balances; scales with body mass analysers; camcorders; video baby monitors; video projectors; video telephones; video screens; electric plugs; viscosimeters; wavemeters; voltmeters; mechanical signs; signs, luminous; switchboxes [electricity]; current rectifiers; gas testing instruments; galvanometers; hands-free kits for telephones; heliographic apparatus; hygrometers; hydrometers; holograms; plotters; range finders; parking sensors for vehicles; piezoelectric sensors; densimeters; densitometers; detectors; smoke detectors; infrared detectors; dictating machines; dynamometers; light-emitting diodes [LED]; quantum dot light-emitting diodes [QLED]; floppy disks; phonograph records; disks, magnetic; circular slide rules; disk drives for computers; wearable video display monitors; electronic numeric displays; electronic interactive whiteboards; electronic notice boards; life jackets; identification threads for electric wires; locks, electric; bells [warning devices]; signal bells; audio interfaces; acoustic conduits; probes for scientific purposes; measures; pressure measuring apparatus; inverters [electricity]; automatic indicators of low pressure in vehicle

tyres; temperature indicators; measuring instruments; cosmographic instruments; instruments containing eyepieces; interfaces for computers; satellite finder meters; spark-guards; coaxial cables; fibre optic cables; cables, electric; calipers; slide calipers; screw-tapping gauges; calorimeters; calculating machines; thermal imaging cameras; electronic pens [visual display units]; biometric identity cards; memory cards for video game machines; encoded magnetic cards; cathodes; choking coils [impedance]; coils, electric; electromagnetic coils; computer keyboards; solenoid valves [electromagnetic switches]; thin client computers; encoded key cards; electronic book readers; electronic agendas; magnetic encoders; collectors, electric; commutators; compact discs [audio-video]; comparators; computers; tablet computers; notebook computers; condensers [capacitors]; contacts, electric; traffic cones; branch boxes [electricity]; distribution boxes [electricity]; junction boxes [electricity]; battery boxes; cabinets for loudspeakers; lasers, not for medical purposes; amplifying tubes; correcting lenses [optics]; optical lenses; optical condensers; magnets; decorative magnets; close-up lenses; crash test dummies; resuscitation mannequins [teaching apparatus]; pressure gauges; material testing instruments and machines; megaphones; portable media players; diaphragms [acoustics]; diaphragms for scientific apparatus; digital weather stations; mechanisms for coin-operated apparatus; micrometers; microprocessors; microscopes; microtomes; microphones; audio mixers; modems; lightning conductors; monitors [computer hardware]; terminals [electricity]; junction sleeves for electric cables; headphones; earpieces for remote communication; sound recording carriers; optical data media; sheaths for electric cables; weighing machines; computer hardware; objectives [lenses] [optics]; rescue laser signalling flares; limiters [electricity]; survival blankets; ozonisers [ozonators]; octants; eyepieces; ohmmeters; oscillographs; mirrors [optics]; spectacles; signalling panels, luminous or mechanical; transmitters [telecommunication]; telephone transmitters; transmitters of electronic signals; switches, electric; data gloves; plates for batteries; wafers for integrated circuits; printed circuit boards; stands adapted for laptops; semi-conductors; polarimeters; personal digital assistants [PDAs]; fuses; converters, electric; telerupters; distance measuring apparatus; speed checking apparatus for vehicles; teaching apparatus; time recording apparatus; apparatus and instruments for astronomy; navigational instruments; apparatus and instruments for physics; measuring apparatus; observation instruments; satellite navigational apparatus; telecommunication apparatus in the form of jewellery; audio- and video-receivers; prisms [optics]; magnetic wires; telegraph wires; telephone wires; conductors, electric; copper wire, insulated; record players; control panels [electricity]; radar apparatus; masts for wireless aerials; transmitting sets [telecommunication]; radios; flowmeters; walkie-talkies;

voltage regulators for vehicles; speed regulators for record players; cell switches [electricity]; time switches, automatic; relays, electric; body harnesses for support when lifting loads; rheostats; respirators for filtering air; retorts; refractometers; refractors; grids for batteries; laboratory robots; teaching robots; humanoid robots with artificial intelligence; height measuring instruments; speaking tubes; horns for loudspeakers; subwoofers; optical fibres [light conducting filaments]; traffic-light apparatus [signalling devices]; signals, luminous or mechanical; sirens; integrated circuit cards [smart cards]; smartglasses; smartphones; smartwatches; connections for electric lines; couplings, electric; sonars; sound locating instruments; lighting ballasts; resistances, electric; spectrograph apparatus; spectrometers; speed indicators; satellites for scientific purposes; audiovisual teaching apparatus; radiotelegraphy sets; anti-glare glasses; optical glass; personal stereos; stroboscopes; bags adapted for laptops; printed circuits; counters; mileage recorders for vehicles; abacuses; taximeters; tachometers; television apparatus; telegraphs [apparatus]; telescopes; teleprompters; teleprinters; cordless telephones; mobile telephones; theodolites; credit card terminals; interactive touch screen terminals; thermo-hygrometers; thermometers, not for medical purposes; thermostats; climate control digital thermostats; transponders; transformers [electricity]; step-up transformers; triodes; gauges; quantity indicators; petrol gauges; electric loss indicators; light-emitting electronic pointers; amplifiers; particle accelerators; baby monitors; steering apparatus, automatic, for vehicles; video recorders; sound reproduction apparatus; data processing apparatus; optical character readers; chargers for electric accumulators; acoustic alarms; cathodic anti-corrosion apparatus; anti-theft warning apparatus; anti-interference devices [electricity]; acoustic couplers; alarms; whistle alarms; adding machines; bar code readers; animated cartoons; filters for respiratory masks; filters for ultraviolet rays, for photography; USB flash drives; optical lanterns; signal lanterns; photometers; flash-bulbs [photography]; digital photo frames; cases especially made for photographic apparatus and instruments; chronographs [time recording apparatus]; cyclotrons; frequency meters; sleeves for laptops; covers for tablet computers; fire blankets; chips [integrated circuits]; pedometers; meteorological balloons; electrified rails for mounting spot lights; snorkels; cell phone straps; distribution boards [electricity]; equalizers [audio apparatus]; projection screens; fluorescent screens; ducts [electricity]; galvanic cells; epidiascopes; ergometers; armatures [electricity]; 3D spectacles; woofers; sound masking loudspeakers; loudspeakers with built-in amplifiers; trackballs [computer peripherals]; laptop computers; light dimmers [regulators], electric; scanners [data processing equipment]; screens [photography].

12 – Motor buses; motor coaches; camping cars; motor racing cars; cars; robotic cars; sports cars; refrige-

rated vehicles; caravans; shock absorbers for automobiles; space vehicles; aircraft; air cushion vehicles; hot air balloons; ski carriers for cars; luggage carriers for vehicles; bumpers for automobiles; vehicle bumpers; tyres for vehicle wheels; armoured vehicles; bicycles; electric bicycles; helicopters; helicams; automobile hoods; lug nuts for vehicle wheels; hydroplanes; seaplanes; lorries; doors for vehicles; bicycle motors; engines for land vehicles; driving motors for land vehicles; screw-propellers; brake discs for vehicles; military drones; civilian drones; delivery drones; camera drones; bicycle bells; rearview mirrors; port-holes; inner tubes for pneumatic tyres; hoods for vehicle engines; boats; caissons [vehicles]; bicycle wheels; vehicle wheels; casters for trolleys [vehicles]; brake pads for automobiles; hub caps; pushchairs; side cars; prams; brake linings for vehicles; ship hulls; panniers adapted for bicycles; panniers adapted for motorcycles; bands for wheel hubs; caps for vehicle fuel tanks; automobile bodies; bodies for vehicles; treads for retreading tyres; golf carts [vehicles]; sprinkling trucks; mopeds; motor scooters; motorcycles; tyre mousse inserts; freewheels for land vehicles; repair outfits for inner tubes; pumps for bicycle tyres; upholstery for vehicles; rims for bicycle wheels; windows for vehicles; axles for vehicles; headlight wipers; bicycle pedals; ashtrays for automobiles; gearing for land vehicles; carts; head-rests for vehicle seats; bicycle kickstands; cup holders for vehicles; casings for pneumatic tyres; cigar lighters for automobiles; sun-blinds adapted for automobiles; bicycle trailers; shock absorbing springs for vehicles; motorcycle frames; reduction gears for land vehicles; vehicle suspension springs; rudders; bicycle handlebars; motorcycle handlebars; vehicle joysticks; push scooters [vehicles]; aeroplanes; amphibious airplanes; rescue sleds; brake segments for vehicles; bicycle saddles; luggage nets for vehicles; dress guards for bicycles; fitted pushchair mosquito nets; anti-theft alarms for vehicles; safety seats for children, for vehicles; hydraulic circuits for vehicles; snowmobiles; vehicle wheel spokes; spoilers for vehicles; air vehicles; vehicles for locomotion by land, air, water or rail; water vehicles; electric vehicles; delivery tricycles; inclined ways for boats; windscreens; windshield wipers; hubs for vehicle wheels; bags adapted for pushchairs; saddlebags adapted for bicycles; bicycle brakes; torsion bars for vehicles; tractors; tramcars; military vehicles for transport; aerial conveyors; turbines for land vehicles; automobile chains; motorcycle chains; driving chains for land vehicles; anti-skid chains; transmission chains for land vehicles; pushchair covers; spare wheel covers; saddle covers for bicycles; saddle covers for motorcycles; seat covers for vehicles; vehicle covers [shaped]; vehicle chassis; axle journals; tubeless tyres for bicycles; bicycle tyres; automobile tyres; tyres for snow ploughs; pneumatic tyres; spikes for tyres; bicycle mudguards; tow trucks; motors, electric, for land vehicles; yachts; gyrocopters; self-



balancing scooters; self-balancing electric unicycles; air pumps [vehicle accessories]; saddles for cycles and bicycles.

(260) AM 2022 115453 A

(800) 1626167

(151) 2021 08 16

(891) 2021 08 16

(731) Doronin Kirill Leonidovich

Nursultan Nazarbayev street, 35, building 1,  
apartment 150, RU-420049 Kazan, Republic of  
Tatarstan, Russian Federation

(540)



FINIKO

(591) White and blue

(531) 02.03.01; 02.03.23; 03.07.17; 26.01.03;  
26.01.14; 26.01.24; 29.01.12

(511)

35 – Advertising; office functions; administration of consumer loyalty programs; administration of frequent flyer programs; administrative assistance in responding to requests for proposals [RFPs]; administrative processing of purchase orders; administrative services for the relocation of businesses; publicity; advertising agency services; publicity agency services; advertising by mail order; production of advertising films; rental of advertising space; rental of advertising time on communication media; appointment reminder services [office functions]; appointment scheduling services [office functions]; auctioneering; rental of billboards [advertising boards]; book-keeping; accounting; advisory services for business management; business appraisals; business auditing; business efficiency expert services; business inquiries; business intermediary services relating to the matching of potential private investors with entrepreneurs needing funding; business investigations; business management and organization consultancy; business management assistance; business management consultancy; business management for freelance service providers; business management of hotels; business management of performing artists; business management of reimbursement programmes for others; business management of reimbursement programs for others; business management of sports people; business organization consultancy; business project management services for

construction projects; business research; professional business consultancy; providing business information; providing business information via a website; commercial administration of the licensing of the goods and services of others; commercial information agency services; commercial intermediation services; commercial or industrial management assistance; providing commercial and business contact information; providing commercial information and advice for consumers in the choice of products and services; compilation of information into computer databases; compilation of statistics; compiling indexes of information for commercial or advertising purposes; computerized file management; consultancy regarding advertising communication strategies; consultancy regarding public relations communication strategies; cost price analysis; data search in computer files for others; demonstration of goods; development of advertising concepts; direct mail advertising; dissemination of advertising matter; distribution of samples; drawing up of statements of accounts; economic forecasting; employment agency services; organization of exhibitions for commercial or advertising purposes; organization of fashion shows for promotional purposes; import-export agency services; invoicing; layout services for advertising purposes; market studies; marketing; marketing research; modelling for advertising or sales promotion; negotiation and conclusion of commercial transactions for third parties; negotiation of business contracts for others; news clipping services; arranging newspaper subscriptions for others; office machines and equipment rental; online advertising on a computer network; provision of an online marketplace for buyers and sellers of goods and services; opinion polling; outdoor advertising; outsourced administrative management for companies; outsourcing services [business assistance]; pay per click advertising; payroll preparation; personnel management consultancy; personnel recruitment; photocopying services; rental of photocopying machines; presentation of goods on communication media, for retail purposes; price comparison services; procurement services for others [purchasing goods and services for other businesses]; psychological testing for the selection of personnel; public relations; publication of publicity texts; publicity material rental; radio advertising; registration of written communications and data; rental of sales stands; sales promotion for others; scriptwriting for advertising purposes; search engine optimization for sales promotion; search engine optimisation for sales promotion; secretarial services; shop window dressing; shorthand; sponsorship search; arranging subscriptions to telecommunication services for others; systemization of information into computer databases; tax filing services; tax preparation; telemarketing services; telephone answering for unavailable subscribers; production of teleshopping programmes; production of teleshopping programs; television advertising; organization of trade fairs for commercial

or advertising purposes; transcription of communications [office functions]; typing; updating and maintenance of data in computer databases; updating and maintenance of information in registries; updating of advertising material; providing user ratings for commercial or advertising purposes; rental of vending machines; web indexing for commercial or advertising purposes; website traffic optimization; website traffic optimisation; word processing; writing of curriculum vitae for others; writing of résumés for others; writing of publicity texts.

36 – Insurance services; accident insurance underwriting; accommodation bureau services [apartments]; actuarial services; antique appraisal; apartment house management; rental of apartments; art appraisal; bail-bonding; banking; brokerage of carbon credits; brokerage; business liquidation services, financial; capital investment; charitable fund raising; cheque verification; check verification; clearing, financial; clearing-houses, financial; credit bureau services; issuance of credit cards; debt advisory services; debt collection agency services; deposits of valuables; electronic funds transfer; exchanging money; factoring; rental of farms; arranging finance for construction projects; financial analysis; financial appraisals in responding to calls for tenders; financial appraisals in responding to requests for proposals [RFPs]; financial consultancy; financial customs brokerage services; financial evaluation [insurance, banking, real estate]; financial evaluation of development costs relating to the oil, gas and mining industries; financial evaluation of standing timber; financial valuation of standing timber; financial evaluation of wool; financial valuation of wool; financial management; financial management of reimbursement payments for others; financial research; financial sponsorship; providing financial information; providing financial information via a website; financing services; fire insurance underwriting; fiscal valuation; health insurance underwriting; hire-purchase financing; lease-purchase financing; instalment loans; insurance brokerage; insurance consultancy; insurance underwriting; providing insurance information; investment of funds; jewellery appraisal; jewelry appraisal; lending against security; life insurance underwriting; loans [financing]; marine insurance underwriting; organization of monetary collections; mortgage banking; mutual funds; numismatic appraisal; rental of offices [real estate]; rental of offices for co-working; online banking; pawnbrokerage; processing of credit card payments; processing of debit card payments; provident fund services; real estate affairs; real estate agency services; real estate appraisal; real estate brokerage; real estate management; rental of real estate; providing rebates at participating establishments of others through use of a membership card; rent collection; repair costs evaluation [financial appraisal]; retirement payment services; safe deposit services; savings bank services; securities brokerage; stamp appraisal; stock brokerage services; stock exchange quo-

tations; stocks and bonds brokerage; surety services; issuance of tokens of value; issuance of travellers' cheques; issuance of travelers' checks; trusteeship; fiduciary.

41 – Education; providing of training; entertainment; sporting and cultural activities; academies [education]; aikido instruction; amusement park services; providing amusement arcade services; animal training; rental of artwork; rental of audio equipment; organization of balls; arranging of beauty contests; boarding school education; booking of seats for shows; calligraphy services; providing casino facilities [gambling]; cinema presentations; movie theatre presentations; rental of cinematographic apparatus; club services [entertainment or education]; coaching [training]; arranging and conducting of colloquiums; organization of competitions [education or entertainment]; arranging and conducting of concerts; arranging and conducting of conferences; arranging and conducting of congresses; correspondence courses; organization of cosplay entertainment events; cultural, educational or entertainment services provided by art galleries; disc jockey services; discotheque services; dubbing; educational examination; educational examination for users to qualify to pilot drones; educational services provided by schools; educational services provided by special needs assistants; electronic desktop publishing; entertainer services; entertainment services; organization of exhibitions for cultural or educational purposes; organization of fashion shows for entertainment purposes; film directing, other than advertising films; film distribution; film production, other than advertising films; providing films, not downloadable, via video-on-demand services; conducting fitness classes; gambling services; game services provided online from a computer network; games equipment rental; providing golf facilities; conducting guided climbing tours; conducting guided tours; gymnastic instruction; health club services [health and fitness training]; holiday camp services [entertainment]; arranging and conducting of in-person educational forums; rental of indoor aquaria; providing information in the field of education; providing information in the field of entertainment; providing information relating to recreational activities; judo instruction; karaoke services; know-how transfer [training]; language interpretation; layout services, other than for advertising purposes; lending library services; lighting technician services for events; rental of lighting apparatus for theatrical sets or television studios; organization of lotteries; microfilming; mobile library services; bookmobile services; modelling for artists; rental of motion pictures; movie studio services; providing museum facilities [presentation, exhibitions]; music composition services; production of music; news reporters services; nightclub services [entertainment]; nursery schools; online publication of electronic books and journals; providing online electronic publications, not downloadable; providing online music, not downloa-

dable; providing online videos, not downloadable; orchestra services; party planning [entertainment]; personal trainer services [fitness training]; photographic reporting; photography; physical education; practical training [demonstration]; presentation of circus performances; presentation of live performances; presentation of variety shows; publication of books; publication of texts, other than publicity texts; production of radio and television programmes; radio entertainment; rental of radio and television sets; recording studio services; providing recreation facilities; religious education; sado instruction [tea ceremony instruction]; screenplay writing; scriptwriting, other than for advertising purposes; arranging and conducting of seminars; rental of show scenery; organization of shows [impresario services]; production of shows; sign language interpretation; rental of skin diving equipment; songwriting; rental of sound recordings; sound engineering services for events; sport camp services; organization of sports competitions; providing sports facilities; rental of sports equipment, except vehicles; rental of sports grounds; rental of stadium facilities; rental of stage scenery; subtitling; arranging and conducting of symposiums; teaching; educational services; instruction services; providing television programmes, not downloadable, via video-on-demand services; providing television programs, not downloadable, via video-on-demand services; television entertainment; rental of tennis courts; theatre productions; ticket agency services [entertainment]; timing of sports events; toy rental; training services provided via simulators; translation; tutoring; providing user ratings for entertainment or cultural purposes; rental of video cameras; rental of camcorders; rental of video cassette recorders; video editing services for events; videotape editing; rental of videotapes; videotaping; vocational guidance [education or training advice]; vocational retraining; arranging and conducting of workshops [training]; writing of texts; zoological garden services.

42 – Design and development of computer hardware and software; analysis for oil-field exploitation; architectural consultancy; architectural services; authenticating works of art; bacteriological research; biological research; business card design; calibration [measuring]; cartography services; chemical analysis; chemical research; chemistry services; clinical trials; cloud computing; cloud seeding; computer programming; computer rental; computer security consultancy; computer software consultancy; computer software design; computer system analysis; computer system design; computer technology consultancy; computer virus protection services; rental of computer software; construction drafting; consultancy in the design and development of computer hardware; consultancy in the field of energy-saving; conversion of computer programs and data, other than physical conversion; conversion of data or documents from physical to electronic media; cosmetic research; creating and de-

signing website-based indexes of information for others [information technology services]; creating and maintaining websites for others; data encryption services; data security consultancy; design of interior decor; interior design; development of computer platforms; digitization of documents [scanning]; dress designing; duplication of computer programs; electronic data storage; electronic monitoring of credit card activity to detect fraud via the internet; electronic monitoring of personally identifying information to detect identity theft via the internet; energy auditing; engineering; exploration services in the field of the oil, gas and mining industries; geological prospecting; geological research; geological surveys; graphic arts design; graphic design of promotional materials; handwriting analysis [graphology]; hosting computer sites [web sites]; industrial design; information technology [IT] consultancy; information technology services provided on an outsourcing basis; providing information relating to computer technology and programming via a website; installation of computer software; internet security consultancy; land surveying; maintenance of computer software; mechanical research; medical research; meteorological information; rental of meters for the recording of energy consumption; monitoring of computer systems by remote access; monitoring of computer systems for detecting unauthorized access or data breach; monitoring of computer systems to detect breakdowns; off-site data backup; oil prospecting; oil-field surveys; oil-well testing; packaging design; platform as a service [PaaS]; quality control; quality evaluation of standing timber; quality evaluation of wool; recovery of computer data; research and development of new products for others; research in the field of building construction; research in the field of environmental protection; research in the field of physics; research in the field of telecommunications technology; research in the field of welding; providing scientific information, advice and consultancy relating to carbon offsetting; scientific and technological research in the field of natural disasters; scientific and technological research relating to patent mapping; scientific laboratory services; scientific research; providing search engines for the internet; server hosting; software as a service [SaaS]; software development in the framework of software publishing; styling [industrial design]; surveying; conducting technical project studies; technical writing; technological consultancy; technological research; telecommunications technology consultancy; material testing; textile testing; underwater exploration; unlocking of mobile phones; updating of computer software; urban planning; vehicle roadworthiness testing; water analysis; weather forecasting; rental of web servers; website design consultancy.

45 – Legal services; security services for the physical protection of tangible property and individuals; personal and social services rendered by others to meet the needs of individuals; arbitration services; astrology

consultancy; babysitting; bereavement counseling; burial services; cartomancy services; chaperoning; escorting in society [chaperoning]; clothing rental; concierge services; copyright management; crematorium services; dating services; detective agency services; dog walking services; embalming services; evening dress rental; rental of fire alarms; rental of fire extinguishers; fire-fighting; conducting funeral ceremonies; funerary undertaking; genealogical research; guard services; horoscope casting; house sitting; inspection of factories for safety purposes; intellectual property consultancy; kimono dressing assistance; leasing of internet domain names; legal administration of licences; legal advice in responding to calls for tenders; legal advice in responding to requests for proposals [RFPs]; legal advocacy services; legal consultancy relating to patent mapping; legal document preparation services; legal research; legal services in relation to the negotiation of contracts for others; legal watching services; licensing [legal services] in the framework of software publishing; licensing of computer software [legal services]; licensing of intellectual property; litigation services; lost property return; marriage agency services; mediation; missing person investigations; monitoring intellectual property rights for legal advisory purposes; monitoring of burglar and security alarms; night guard services; online social networking services; opening of security locks; personal background investigations; personal bodyguarding; personal letter writing; personal wardrobe styling consultancy; pet sitting; physical security consultancy; planning and arranging of wedding ceremonies; organization of political meetings; registration of domain names [legal services]; releasing doves for special occasions; conducting religious ceremonies; organization of religious meetings; rental of safes; security screening of baggage; spiritual consultancy; tracking of stolen property.

(260) AM 2022 115454 A  
 (800) 1626184  
 (151) 2021 08 31  
 (891) 2021 08 31  
 (731) PRIVATE JOINT STOCK COMPANY  
 "TECHNOLOGIA"  
 Kurskiy Avenue, 147-A, Sumy 40031, Ukraine  
 (540)



(591) Black, white  
 (531) 26.04.04; 26.04.09; 26.04.18; 26.04.24;  
 27.05.10; 27.05.15; 27.05.24

(511)  
 6 – Foils of metal for wrapping and packaging; packaging containers of metal; sealing caps of metal; bottle caps of metal; bottle closures of metal; labels of metal; bottle fasteners of metal; clips of metal for sealing bags; containers of metal (storage, transport).

16 – Plastic sheets, films and bags for wrapping and packaging; labels of paper or cardboard; boxes of paper or cardboard; bags (envelopes, pouches) of paper or plastics, for packaging; containers for food, including containers for beverages (wrappers of paper or cardboard).

17 – Plastics and resins in extruded form for use in manufacture; packing (cushioning, stuffing) materials of rubber or plastics; rubber stoppers; bags (envelopes, pouches) of rubber, for packaging.

20 – Sealing caps, not of metal; bottle caps, not of metal; closures, not of metal, for containers; bottle closures, not of metal; bottle fasteners, not of metal; containers, not of metal, for storage or transport; clips of plastic for sealing bags; packaging containers of plastic; casks, not of metal; barrels, not of metal; bins, not of metal; labels of plastic; boxes of wood or plastic.

21 – Beverage urns, non-electric; containers for household or kitchen use; disposable aluminium foil containers for household purposes; thermally insulated containers for food; heat-insulated containers for beverages; pouring spouts; isothermic bags; heat-insulated containers.

(260) AM 2022 115455 A  
 (800) 1626196  
 (151) 2021 09 16  
 (891) 2021 09 16  
 (731) Stefanovich Irina Evgen'evna  
 Vera Voloshina Street 46, 165, Mytishchi,  
 RU-141014 Moscow region, Russian  
 Federation  
 (540)



(591) Black, white  
 (531) 26.11.03; 26.11.13; 27.05.01; 27.05.09;  
 27.05.10; 27.05.19

(511)

3 – Amber [perfume]; aromatics [essential oils]; breath freshening sprays; balms, other than for medical purposes; lip glosses; polishing stones; petroleum jelly for cosmetic purposes; cotton wool for cosmetic purposes; adhesives for cosmetic purposes; scented water; toilet water; depilatory wax; creams for leather; massage gels, other than for medical purposes; dental bleaching gels; make-up; deodorants for human beings or for animals; depilatory preparations; air fragrance reed diffusers; scented wood; perfumes; greases for cosmetic purposes; perfumery; decorative transfers for cosmetic purposes; eyebrow pencils; cosmetic pencils; adhesives for affixing false eyelashes; adhesives for affixing false hair; beard dyes; cosmetic dyes; cosmetic creams; skin whitening creams; hair spray; nail varnish; hair lotions; lotions for cosmetic purposes; after-shave lotions; beauty masks; oils for perfumes and scents; oils for cleaning purposes; oils for cosmetic purposes; oils for toilet purposes; essential oils; bergamot oil; gaultheria oil; jasmine oil; lavender oil; almond oil; rose oil; almond milk for cosmetic purposes; cleansing milk for toilet purposes; musk [perfumery]; soap; deodorant soap; shaving soap; cakes of toilet soap; antiperspirant soap; soap for foot perspiration; almond soap; mint for perfumery; cosmetic kits; nail art stickers; false nails; eau de cologne; bases for flower perfumes; joss sticks; toothpaste; lipstick cases; hydrogen peroxide for cosmetic purposes; breath freshening strips; teeth whitening strips; lipsticks; pomades for cosmetic purposes; shaving preparations; cosmetic preparations for baths; bath preparations, not for medical purposes; hair straightening preparations; hair waving preparations; leather bleaching preparations; mouthwashes, not for medical purposes; cosmetic preparations for slimming purposes; eye-washes, not for medical purposes; paint stripping preparations; lacquer-removing preparations; make-up removing preparations; nail care preparations; preparations for cleaning dentures; collagen preparations for cosmetic purposes; breath freshening preparations for personal hygiene; aloe vera preparations for cosmetic purposes; sunscreen preparations; make-up powder; nail varnish removers; vaginal washes for personal sanitary or deodorant purposes; false eyelashes; tissues impregnated with cosmetic lotions; tissues impregnated with make-up removing preparations; massage candles for cosmetic purposes; potpourris [fragrances]; bath salts, not for medical purposes; fumigation preparations [perfumes]; leather preservatives [polishes]; astringents for cosmetic purposes; eyebrow cosmetics; make-up preparations; sun-tanning preparations [cosmetics]; hair dyes; neutralizers for permanent waving; cosmetic preparations for eyelashes; cosmetic preparations for skin care; cosmetics; cosmetics for children; mascara; cleansers for intimate personal hygiene purposes, non medicated; douching preparations for personal sanitary or deodorant purposes [toiletries]; detergents, other than for use in manu-

facturing operations and for medical purposes; degreasers, other than for use in manufacturing processes; bleaching preparations [decolorants] for cosmetic purposes; toiletry preparations; antiperspirants [toiletries]; phytocosmetic preparations; talcum powder, for toilet use; cotton swabs for cosmetic purposes; terpenes [essential oils]; henna [cosmetic dye]; shampoos; dry shampoos; herbal extracts for cosmetic purposes; extracts of flowers [perfumes]; ethereal essences.

44 – Public bath services for hygiene purposes; Turkish bath services; depilatory waxing; hair implantation; manicuring; chiropractic; massage; hairdressing; beauty salon services; visagists' services; sauna services; solarium services.

(260) AM 2022 115456 A

(800) 1626197

(151) 2021 09 24

(891) 2021 09 24

(731) X-Rite, Incorporated

4300 44th Street SE, Grand Rapids, US-MI  
49512, USA

(540)

**X-RITE**

(591) Black, white

(511)

9 – Electronic apparatus, instruments, displays, computer hardware, software, and systems consisting of combinations thereof, all aforementioned goods used for acquiring, formulating, specifying, measuring, controlling, visualizing, communicating, and selecting colors, for color calibration and color profiling, for capturing and communicating data relating to the appearance of products and for managing the color and appearance of virtual materials displayed in digital images; electronic spectrophotometers for use in identifying and measuring colors and appearance, densitometers not for medical use, reflectometers, colorimeters; scientific, photographic, cinematographic, video, optical, and measuring apparatus and instruments for measuring color.

(260) AM 2022 115469 A

(800) 1626755

(151) 2021 05 11

(891) 2021 05 11

(731) FEMAS METAL SANAYİ VE TİCARET  
ANONİM ŞİRKETİOrganize Sanayi Bölgesi, 9. Cadde, No:17,  
Melikgazi – Kayseri, Turkey

(540)



(591) Blue

(531) 27.05.01; 27.05.17; 27.05.19; 29.01.04

(511)

11 – Lighting installations; lights for vehicles and interior-exterior spaces; heating installations using solid, liquid or gas fuels or electricity, central heating boilers, boilers for heating installations, radiators [heating], heat exchangers, not parts of machines, stoves, kitchen stoves, solar thermal collectors [heating], steam, gas and fog generators, steam boilers, other than parts of machines, acetylene generators, oxygen generators, nitrogen generators; installations for air-conditioning and ventilating; cooling installations and freezers; electric and gas-powered devices, installations and apparatus for cooking, drying and boiling, cookers, electric cooking pots, electric water heaters, barbecues, electric laundry driers; hair driers; hand drying apparatus; sanitary installations, taps [faucets], shower installations, toilets [water-closets], shower and bathing cubicles, bath tubs, toilet seats, sinks, wash-hand basins [parts of sanitary installations]; washers for water taps; water softening apparatus; water purification apparatus; water purification installations; waste water purification installations; electric bed warmers and electric blankets, not for medical use; electric pillow warmers; electric or non-electric foot-warmers; hot water bottles; socks, electrically heated; filters for aquariums and aquarium filtration apparatus; industrial type installations for cooking, drying and cooling purposes; pasteurizers and sterilizers.

(260) AM 2022 115470 A

(800) 1626816

(151) 2021 02 24

(891) 2021 02 24

(731) Hitachi Astemo, Ltd.

2520 Takaba, Hitachinaka-shi, Ibaraki  
312-8503, Japan

(540)

## ASTEMO

(591) Black, white

(511)

7 – Metalworking machines and tools; mining machines and apparatus; construction machines and apparatus; loading- unloading machines and apparatus; industrial fishing machines; chemical processing machines and apparatus; textile machines and apparatus; food or beverage processing machines and apparatus; lumbering, woodworking, or veneer or plywood making machines and apparatus; pulp making, papermaking or paper-working machines and apparatus; printing or bookbinding machines and apparatus; sewing machines; plowing machines and implements, other than hand- held tools; cultivating machines and implements; harvesting machines and implements; plant fiber processing machines and implements for agricultural purposes; fodder presses; fodder cutting machines; fodder mixing machines; cake-fodder crushing

machines; milk filtering machines; chick brooders; incubators for eggs; sericultural machines and implements; shoe making machines; leather tanning machines; tobacco processing machines; glassware manufacturing machines and apparatus; painting machines and apparatus; power-operated potters' wheels; plastic processing machines; machines and apparatus for manufacturing rubber goods; stone working machines and apparatus; non-electric prime movers, not for land vehicles, other than water mills and wind mills; parts of non-electric prime movers, other than water mills and wind mills; balancers for internal combustion engines; camshafts for vehicle engines; variable valve lift devices; valve timing control devices; valve lifters; pistons for engines; alternators for land vehicles; ignition coils; engine injectors; fuel pumps; starters for engines; outboard motors; gas filters for compressed natural gas automobiles; pressure control valves for injectors; hydraulic pumps for continuously variable transmissions; control valves for fuel cell; high pressure hydrogen regulators; gas injectors for compressed natural gas automobiles; gas regulators for compressed natural gas automobiles; electronically controlled throttle bodies; fuel pumps for high pressure direct injection; intake manifolds for engines; exhaust gas recirculation valves for engines; cooling water flow path switching valves; oil jet, parts of machines; fuel pumps for tanks; idle speed control valves; valves for valve timing control devices; cooling water adjustment valves; transmission control valves; carburetors; intake valves for engines; fuel cocks, parts of machines; turbochargers for engines; variable compression ratio control devices; accelerator work unit [machines]; intake manifolds for two-wheeled vehicles; backflow prevention valves for carburetors; air injection valves; water mills; windmills; pneumatic or hydraulic machines and instruments; air compressors; pumps, not for specified purposes; power steering pumps; oil pumps; water pumps for automobiles; superchargers; turbocompressors; adhesive tape dispensing machines; automatic stamping machines; automatic vending machines; fuel dispensing machines for service stations; electric washing machines for industrial purposes; electric washing machines for household purposes; repairing or fixing machines and apparatus; mechanical parking systems; vehicle washing machines; food mixing machines for commercial use; food peeling machines for commercial use; food cutting, chopping and slicing machines for commercial use; dishwashers for industrial purposes; dishwashers for household purposes; electric wax-polishing machines for industrial purposes; vacuum cleaners for industrial purposes; electric wax-polishing machines for household purposes; vacuum cleaners for household purposes; power sprayers for disinfecting, insecticides and deodorants [not for agricultural purposes]; shafts, axles or spindles, machine elements other than land vehicles; bearings, machine elements not for land vehicles; shafts, couplings or connectors, machine ele-

ments not for land vehicles; power transmissions and gearing, machine elements not for land vehicles; differential gears; viscous coupling for machines; control valves for transmissions; differential pinion shaft; shock absorbers, machine elements not for land vehicles; dampers for prosthetics including artificial limbs [parts of machines]; residential damping dampers, parts of machines; springs, machine elements not for land vehicles; gas springs; brakes, machine elements not for land vehicles; valves, machine elements not for land vehicles; lawnmowers; curtain drawing devices electrically operated; electric door openers; waste compacting machines and apparatus for industrial purposes; waste crushing machines for industrial purposes; 3D printers; starters for motors and engines; AC motors and DC motors [not including those for land vehicles but including parts for any AC motors and DC motors]; AC generators; DC generators; portable electric power generators; electric food blenders for household purposes; dynamo brushes; dampers [parts of machines]; oil hydraulic presses; mounting brackets for engine, mission or diff; mechanical parking systems; variable valve lift devices.

9 – Measuring or testing machines and instruments; pressure sensors; sensors, other than for medical use; oxygen sensors; vehicle speed sensors; differential pressure sensors; fuel temperature sensors; throttle position sensors; variable valve lift sensors; stroke sensors; rotation sensors; simulators for the steering and control of vehicles; coin-operated mechanisms for operating gates for car parking lots; life saving apparatus and equipment; fire extinguishers; fireplugs; fire hoses; fire hose nozzles; sprinkler systems for fire protection; fire alarms; gas alarms; anti-theft warning apparatus; protective helmets; railway signals; vehicle breakdown warning triangles; luminous or mechanical road signs; breathing apparatus for underwater swimming, not for sports; game programs for arcade video game machines; laboratory apparatus and instruments; photographic apparatus and instruments; cinematographic apparatus; optical machines and apparatus; dashboard cameras; power distribution or control machines and apparatus; inverters; HEV/EV Inverters; battery chargers; phase modifiers; solar batteries; oscilloscopes; electric wires and cables; electrical communication machines and apparatus; central gateway; telematics communication units; global positioning system; map positioning units; personal digital assistants; electronic machines, apparatus and their parts; computer programs; computer hardware; computer software; millimeter wave radar; automotive radar; radar apparatus; automotive radar detector; magnetic cores; resistance wires; electrodes; fire boats; satellites for scientific purposes; welding masks; fire-proof garments; disaster prevention hoods; gloves for protection against accidents; spectacles; game programs for home video game machines; electronic circuits and CD-ROMs recorded with programs for

hand-held games with liquid crystal displays; protective helmets for sports; sports whistles; weight belts for scuba diving; air tanks for scuba diving; snorkels; regulators for scuba diving; metronomes; electronic circuits and CD-ROMs recorded with automatic performance programs for electronic musical instruments; effects units for electric or electronic musical instruments; phonograph records; downloadable music files; downloadable image files; recorded video discs and video tapes; electronic publications; exposed cinematographic films; exposed slide films; slide film mounts; controllers for Advanced Driver Assistance Systems; controllers for Autonomous Driving; downloadable computer software for providing geographic information; camshaft position sensors for internal combustion engine; knock sensors for automobile engines; airflow sensors; valve timing controllers; variable valve lift controllers; controllers for control suspension; vehicle batteries; battery charge devices for vehicles; automotive diagnostic devices; automotive performance test automatic inspection device; ignition coil checkers; battery checkers; electronic stability controllers; map data for navigation; front light automatic dimmers; front light optical axis adjustment devices; front light irradiation range adjustment devices; DC/DC converters; fuel cell control devices; stack impedance control devices; regulators for scuba diving; speedometer gears.

12 – Automobiles and their parts and fittings; engine control devices for land vehicles; valve timing control devices for land vehicles; power steering gears; power steering units; power steering units for automobiles and their parts; transmission control devices for land vehicles; four-wheel drive control units; anti-lock braking systems for automobiles; valves for stability control system for land vehicles; valves for anti-lock braking systems; hydraulic cylinders for suspension for automobiles; suspension control devices for land vehicles; vehicle height control devices; rear gate switchgear; vehicle-mounted camera with washer nozzle and washing system for vehicle-mounted camera (parts of vehicles); bumpers; passive entry/passive start devices for automobiles; four-wheel steering devices; rear wheel steering device; steering links; wheels for land vehicles; differential device; traction engine; ropeways for cargo or freight handling; non-electric prime movers for land vehicles, not including their parts; electric motors for driving two-wheeled vehicles; machine elements for land vehicles; shafts, axles or spindles, machine elements for land vehicles; drive shafts; propeller shafts; transmission shafts for land vehicles; bearings, machine elements for land vehicles; shaft couplings or connectors, machine elements for land vehicles; power transmissions and gearing, machine elements for land vehicles; differential gears; viscous couplings; shock absorbers; vehicle bumpers; shock absorbers for vehicles; suspension struts for vehicles; front forks for vehicles; rear dampers for two-wheeled vehicles; springs for land vehic-

les; springs for self-driving vehicles; air springs for air suspension; brakes, machine elements for land vehicles; brake calipers for vehicles; brake pads for vehicles; brake rotors for vehicles; brake linings for vehicles; brake drums for vehicles; brake master cylinders; brake boosters; clutch master cylinders; reservoir tank for two-wheeled vehicle brake; interlocking brakes; electric parking brakes; brake pedal stroke simulators; electric actuation devices for brakes; accumulators for brake hydraulic circuit; proportioning valves for land vehicles; hill stop valve for vehicles; clutch operation devices for automobiles; clutch operation cylinders for automobiles; clutch mechanisms for land vehicles; clutches for land vehicles; brake piping joints; valves for negative pressure boosters; brake pad hoses; brake pads for land vehicles; parachutes; anti-theft alarms for vehicles; wheelchairs; AC motors or DC motors for land vehicles, not including their parts; motors for electric vehicles or hybrid electric vehicles; vessels and their parts and fittings; power tilt trims for land vehicles; outboard motor angle adjusters; gas-liquid separators for outboard motors; lifting and lowering hydraulic devices for outboard motors; aircraft and their parts and fittings; civilian drones and their parts and fittings; industrial drones and their parts and fittings; railway rolling stock and their parts and fittings; dampers for railway rolling stock; damper controllers for railway rolling stock; height controlled device for railway rolling stock; two-wheeled motor vehicles, bicycles and their parts and fittings; variable valve lift systems for two-wheeled motor vehicles; engine control devices for two-wheeled motor vehicles; valve timing control devices for two-wheeled motor vehicles; valves for stability control system for two-wheeled motor vehicles; valves for anti-lock braking systems for two-wheeled motor vehicles; hydraulic cylinders for suspension for two-wheeled vehicles; suspension control devices for two-wheeled vehicles; two-wheeled vehicle height control devices; steering dampers; front forks for vehicles; front fork mounting parts; drive shafts for two-wheeled vehicles; rickshaws; sleighs and sleds [vehicles]; trolleys; carts; horse drawn carriages; bicycle trailers; adhesive rubber patches for repairing tubes or tires; baby carriage; tie rods for power steering; controllers for power steering.

(260) AM 2022 115471 A  
 (800) 1626884  
 (151) 2021 07 07  
 (891) 2021 07 07  
 (731) Toruńskie Zakłady Materiałów Opatrunkowych,  
 Spółka Akcyjna  
 Żółkiewskiego 20/26, PL-87-100 Toruń, Poland  
 (540)

**matopat**

(591) Black, white  
 (511)

5 – Compresses, sets of compresses, hygienic and gynecological towels, operation serviettes, dressing materials, gauze dressings, eye dressings, nose dressings, cotton and cotton wool for hygienic and medical purposes, cotton sticks and swabs and cotton wool swabs for hygienic and medical purposes, sterility tests, plasters, medical adhesive tapes, tampons for medical purposes, adhesive tapes with sterilization indicators.

9 – Covers for medical device cables.

10 – Elastic bandages, supportive bandages, plaster bandages for orthopaedic purposes, padding for orthopedic casts, medical bedding, namely protective bedclothes, bed underpads, bed underpads for incontinent persons, sheets for use in surgical operations, surgical gowns, apron for surgeon being protective clothing for medical use, gloves for medical purposes, bags for collecting liquids for medical purposes, containers especially made for transmitting human organs; kits consisting of surgical instruments for use during surgical operations; kits and sets of medical instruments for use during surgical procedures; medical trays, surgical drapes, sets of surgical drapes, sterile sheets (surgical), protective clothing for medical purposes, protective clothing for surgical purposes, clothing especially for operating rooms, bandage clips, surgical shoe covers, covers for the patients' legs for medical purposes, incision foils for surgical use.

16 – Disposable bibs made from paper or cellulose; sterilizations bags; sterilization sleeves.

21 – Gloves for household purposes, gloves for farming purposes.

22 – Body bags.

25 – Disposable clothing, waterproof clothing, caps for nurse, aprons for nurses, bibs (not of paper), support garments, other than for medical use, shoe protectors other than for medical purposes, clothing (not disposable).

(260) AM 2022 115472 A  
 (800) 1626902  
 (151) 2021 06 22  
 (891) 2021 06 22  
 (731) Smal Yaroslav Ihorovych  
 vul. B. Khmelnytskoho, 79, kv. 1,  
 m. Pohrebyshche, Vinnytska obl. 22200,  
 Ukraine;  
 Samarskiy Sergiy Volodymyrovych  
 vul. Horodetskoho, 35, kv. 1; m. Vinnytsia  
 21018, Ukraine

(540)

**BEZBRENDU**

(591) Black, white  
 (531) 27.05.01; 27.05.17



(511)

25 – Albs; wimples; bandanas [neckerchiefs]; berets; boas [necklets]; bodies [underclothing]; ankle boots; breeches for wear; football shoes; brassieres; adhesive brassieres; camisoles; valenki [felted boots]; wooden shoes; bath slippers; beach shoes; footwear; cuffs; non-slipping devices for footwear; knitwear [clothing]; embroidered clothing; stuff jackets [clothing]; wet suits for water-skiing; shirt yokes; veils [clothing]; leggings [leg warmers]; gaiters; ready-made linings [parts of clothing]; corselets; fittings of metal for footwear; sweaters; bibs, sleeved, not of paper; esparto shoes or sandals; waistcoats; detachable collars; galoshes; hats; paper hats [clothing]; hoods [clothing]; slippers; hat frames [skeletons]; pockets for clothing; kimonos; judo uniforms; karate uniforms; cap peaks; visors being headwear; tights; slips [underclothing]; combinations [clothing]; collars [clothing]; bodices [lingerie]; corsets [underclothing]; suits; bathing suits; masquerade costumes; neckties; spats; skull caps; leotards; jackets [clothing]; leggings [trousers]; liveries; shirt fronts; mantillas; sleep masks; mitres [hats]; mittens; muffs [clothing]; foot-muffs, not electrically heated; heelpieces for footwear; ear muffs [clothing]; headwear; fur stoles; underwear; tips for footwear; outerclothing; ready-made clothing; motorists' clothing; cyclists' clothing; clothing for gymnastics; clothing of leather; clothing incorporating LEDs; gabardines [clothing]; jerseys [clothing]; latex clothing; clothing of imitations of leather; waterproof clothing; paper clothing; beach clothes; clothing; clothing containing slimming substances; maniples; overcoats; knickers; hosiery; stockings; sweat-absorbent stockings; parkas; pelerines; sashes for wear; footwear uppers; hairdressing capes; fingerless gloves; half-boots; heels; garters; soles for footwear; dress shields; braces for clothing [suspenders]; pyjamas; bathing trunks; ascots; coats; headbands [clothing]; ponchos; belts [clothing]; money belts [clothing]; layettes [clothing]; heel protectors for shoes; heelpieces for stockings; welts for footwear; rash guards; fishing vests; chasubles; overalls; ski gloves; gloves [clothing]; sandals; bath sandals; jumper dresses; saris; sarongs; shirts; short-sleeve shirts; skirts; petticoats; skorts; girdles; underwear; sweat-absorbent underwear; boots for sports; sports jerseys; sports singlets; dresses; togas; underpants; babies' pants [underwear]; women's panties; boxer shorts; shoes; gymnastic shoes; sports shoes; turbans; inner soles; aprons [clothing]; uniforms; tee-shirts; dressing gowns; bath robes; boot uppers; pocket squares; headscarves; scarves; furs [clothing]; top hats; ski boots; boots; lace boots; shawls; caps being headwear; shower caps; bathing caps; scarves; neck tube scarves; studs for football boots; socks; sweat-absorbent socks; stocking suspenders; sock suspenders; trousers; gaiter straps; pelisses.

(260) AM 2022 115476 A

(800) 1627087

(151) 2021 07 16

(891) 2021 07 16

(731) NORMA HELLAS SA

54 Menandrou Str., GR-104 31 Athens, Greece

(540)

## DORM

(591) Black, white

(511)

5 – Pharmaceutical preparations.

(260) AM 2022 115479 A

(800) 1627161

(151) 2021 06 15

(891) 2021 06 15

(731) Havatzelet Cultural &amp; Educational Institutions

of Hashomer Hatzair

3785000 Giv'at Haviva, Israel

(540)

## Hashomer Hatzair

(591) Black, white

(511)

41 – Activities in the fields of culture, education, science, sports in kibbutzim in Israel and worldwide; providing education and training to beginner artists in the fields of exhibitions and projects to encourage and support young persons in the fields of culture, education, science and sports; organization of cultural activities in the nature of youth movements and summer camps; organizing of community educational and cultural events, such as bar and bat mitzvahs, weddings, training workshops and knowledge development held in community and cultural centers; educational services such as operating kindergartens and schools, all included in this class.

(260) AM 2022 115480 A

(800) 1627175

(151) 2021 08 17

(891) 2021 08 17

(731) Amgen Inc.

Trademark Operations MS 28-5-A, One

Amgen Center Drive, Thousand Oaks CA

91320-1799, USA

(540)



(591) Black, white  
 (531) 26.03.01; 26.07.18; 26.11.03; 26.11.08  
 (511)

5 – Pharmaceutical preparations for the treatment of respiratory diseases and disorders, pulmonary diseases and disorders, cardiovascular diseases and disorders, inflammation, inflammatory diseases and disorders, autoimmune diseases and disorders, cancer, oncological diseases and disorders, hematological diseases and disorders, tumorous diseases, neurological diseases and disorders and metabolic diseases and disorders.

(260) AM 2022 115482 A  
 (800) 1627318  
 (151) 2021 09 29  
 (891) 2021 09 29  
 (731) Limited liability company, "Confectionery Complex "Ozersky souvenir"  
 Lenina street, 13, room 3, lit. M, Ozery,  
 RU-140560 Moscow region, Russian  
 Federation

(540)

## NUTSTORY

(591) Black, white  
 (511)  
 30 – Sweets; chocolate paste.

(260) AM 2022 115483 A  
 (800) 1627326  
 (151) 2021 08 31  
 (891) 2021 08 31  
 (731) Zhejiang Changling Chuanbao Motorcycle Co.,  
 Ltd.  
 No. 189 Huacheng East Road, Chengxi New  
 District, Yongkang, Jinhua City, Zhejiang  
 Province, China

(540)

## CHANPOW SHINING

(591) Black, white  
 (531) 27.05.01  
 (511)  
 12 – Electric motorcycles; motorcycles; mobility scooters; electric bicycles; mopeds; moped.

(260) AM 2022 115499 A  
 (800) 1473414  
 (151) 2018 12 27  
 (891) 2021 08 19  
 (731) KİĞİLİ GİYİM TİCARET ANONİM ŞİRKETİ  
 Şekerpınar Mahallesi, Otomotiv Caddesi No: 3,  
 Çayırova/Kocaeli, Turkey

(540)



(591) black  
 (531) 27.05.01; 27.05.11  
 (511)

35 – The bringing together, for the benefit of others, of a variety of goods, namely, unworked or semi-worked leather and animal skins, imitations of leather, stout leather, leather used for linings, goods made of leather, imitations of leather or other materials, designed for carrying items, included in this class, bags, wallets, boxes and trunks made of leather or stout leather, keycases, trunks [luggage], suitcases, umbrellas, parasols, sun umbrellas, walking sticks, whips, harness, saddlery, stirrups, straps of leather (saddlery), woven or non-woven textile fabrics, clothing, including underwear and outerclothing, other than special purpose protective clothing, socks, mufflers [clothing], shawls, bandanas, scarves, belts [clothing], footwear, shoes, slippers, sandals, headgear, hats, caps with visors, berets, caps [headwear], skull caps, enabling customers to conveniently view and purchase those goods, such services may be provided by retail stores, wholesale outlets, by means of electronic media or through mail order catalogues.

(260) AM 2022 115500 A  
 (800) 1523242  
 (151) 2019 10 17  
 (891) 2021 09 21  
 (731) Tovarystvo z obmezhenoiu vidpovidalnistiu  
 "LYSOFORM MEDICAL"  
 Office 314, Yevhena Konovaltsia str., 31,  
 Kyiv 01133, Ukraine

(540)

## BLANIDAS

(591) Black, white  
 (511)  
 5 – Dental abrasives; acaricides; aconitine; alkaloids for medical purposes; algicides; aldehydes for pharmaceutical purposes; dental amalgams; amino acids for veterinary purposes; amino acids for medical purposes; analgesics; anaesthetics; antibiotics; appetite suppressant pills; first-aid boxes, filled; acetates for pharmaceutical purposes; cotton for medical purposes; tonics [medicines]; germicides; bacterial poisons; bacterial preparations for medical and veterinary use; bacteriological preparations for medical and veterinary use; balms for medical purposes; balsamic preparations for medical purposes; sanitary bandages; menstruation bandages; aseptic cotton; tobacco-free ciga-

rettes for medical purposes; bandages for dressings; bicarbonate of soda for pharmaceutical purposes; albuminous preparations for medical purposes; albuminous foodstuffs for medical purposes; biological preparations for veterinary purposes; biological preparations for medical purposes; biocides; bismuth subnitrate for pharmaceutical purposes; flour for pharmaceutical purposes/ meal for pharmaceutical purposes; bracelets impregnated with insect repellent; bromine for pharmaceutical purposes; bronchodilating preparations; vaginal washes for medical purposes; petroleum jelly for medical purposes; vaccines; oxygen baths; bath preparations for medical purposes; wadding for medical purposes; absorbent cotton / absorbent wadding; veterinary preparations; decoctions for pharmaceutical purposes; tartar for pharmaceutical purposes; vitamin preparations; sea water for medicinal bathing; mineral waters for medical purposes; hydrated chloral for pharmaceutical purposes; dietary fibre / dietary fiber; charcoal for pharmaceutical purposes; gases for medical purposes; gallic acid for pharmaceutical purposes; haematogen / hematogen; haemoglobin / hemoglobin; herbicides / weedkillers / preparations for destroying noxious plants; sanitary panties / menstruation knickers / sanitary knickers / sanitary pants; sanitary towels / sanitary napkins / sanitary pads; hydrastine; stick liquorice for pharmaceutical purposes; mustard for pharmaceutical purposes; mustard oil for medical purposes; mustard plasters/mustard poultices; vermifuges/anthelmintics; glycerine for medical purposes; glycerophosphates; glucose for medical purposes; hormones for medical purposes; mud for baths; medicinal mud / medicinal sediment [mud]; vulnerary sponges; rubber for dental purposes; rubber for medical purposes; gamboge for medical purposes; gurjun balsam for medical purposes; disinfectants; disinfectants for hygiene purposes; disinfectants for chemical toilets; deodorants, other than for human beings or for animals; detergents for medical purposes; digitalin; diagnostic preparations for medical purposes; diastase for medical purposes; dietetic beverages adapted for medical purposes; dietetic substances adapted for medical use; dietetic foods adapted for medical purposes; yeast for pharmaceutical purposes; eucalyptus for pharmaceutical purposes; eucalyptol for pharmaceutical purposes; elixirs [pharmaceutical preparations]; esters for pharmaceutical purposes; ethers for pharmaceutical purposes; gelatine for medical purposes; cod liver oil; greases for veterinary purposes; greases for medical purposes; jujube, medicated; chewing gum for medical purposes; nervines; sedatives / tranquilizers; dental abrasives; dental lacquer; dental mastics; dental cements; isotopes for medical purposes; immunostimulants; insecticides; Irish moss for medical purposes; caustic pencils; caustics for pharmaceutical purposes; iodine for pharmaceutical purposes; alkaline iodides for pharmaceutical purposes; iodides for pharmaceutical purposes; iodoform; calomel [fungicide]; gum for medical purposes; camphor for medical

purposes; camphor oil for medical purposes; capsules for medicines; capsules made of dendrimer-based polymers, for pharmaceuticals; carbolineum [parasiticide]; castor oil for medical purposes; cachou for pharmaceutical purposes; quassia for medical purposes; quebracho for medical purposes; cedar wood for use as an insect repellent; acids for pharmaceutical purposes; bone cement for surgical and orthopaedic purposes / bone cement for surgical and orthopedic purposes; adhesives for dentures; fly glue / fly catching adhesives; cocaine; collodion for pharmaceutical purposes; insect repellent incense; compresses; condurango bark for medical purposes; quinquina for medical purposes / cinchona for medical purposes; medicinal roots; rhubarb roots for pharmaceutical purposes; lint for medical purposes; cream of tartar for pharmaceutical purposes; creosote for pharmaceutical purposes; blood for medical purposes; depuratives; haemostatic pencils / hemostatic pencils; styptic preparations; blood plasma; dill oil for medical purposes; croton bark; starch for dietetic or pharmaceutical purposes; cultures of microorganisms for medical or veterinary use; curare; milk sugar for pharmaceutical purposes / lactose for pharmaceutical purposes; sticking plasters; lecithin for medical purposes; fly catching paper; adhesive tapes for medical purposes / adhesive bands for medical purposes; medicinal alcohol; medicine cases, portable, filled; medicines for veterinary purposes; medicines for human purposes; medicines for dental purposes; medicinal tea; medicinal herbs; remedies for foot perspiration; medicinal drinks; medicinal infusions; medicinal oils; medicinal hair growth preparations; liniments; liquorice for pharmaceutical purposes; lotions for veterinary purposes; lotions for pharmaceutical purposes; lupulin for pharmaceutical purposes; candy for medical purposes; linseed for pharmaceutical purposes / flaxseed for pharmaceutical purposes; magnesia for pharmaceutical purposes; ointments for pharmaceutical purposes; gauze for dressings; royal jelly for pharmaceutical purposes; melissa water for pharmaceutical purposes; sanitary tampons / menstruation tampons; menthol; almond milk for pharmaceutical purposes; myrobalan bark for pharmaceutical purposes; mineral food supplements; bunion pads; moleskin for medical purposes; milk ferments for pharmaceutical purposes; mint for pharmaceutical purposes; scapulars for surgical purposes; vesicants; narcotics; narcotics for medical purposes; tincture of iodine; tinctures for medical purposes; antiparasitic collars for animals; fumigation preparations for medical purposes; fumigating sticks; fumigating pastilles; cachets for pharmaceutical purposes; insect repellent oils; oil of turpentine for pharmaceutical purposes; opium; opodeldoc; poisons; sulfur sticks [disinfectants]; pants, absorbent, for incontinence; paper for mustard plasters / paper for mustard poultices; mothproofing paper / mothproof paper; parasiticides; pectin for pharmaceutical purposes; pepsins for pharmaceutical purposes; peptones for pharmaceutical

purposes; scapulars for surgical purposes; dressings, medical; surgical dressings; hydrogen peroxide for medical purposes; pesticides; pastilles for pharmaceutical purposes / lozenges for pharmaceutical purposes; pyrethrum powder; medical plasters; breast-nursing pads; nutritional supplements; nutritive substances for microorganisms; bouillons for bacteriological cultures; pomades for medical purposes; powder of cantarides; porcelain for dental prostheses; laxatives; menstruation bandages; poultices; chemical conductors for electrocardiograph electrodes; food for babies; by-products of the processing of cereals for dietetic or medical purposes; purgatives / evacuants; asthmatic tea; febrifuges; chemical contraceptives; antiseptic cotton; antiseptics; corn rings for the feet; antiparasitic preparations; anti-uric preparations; anticryptogamic preparations; leeches for medical purposes; radium for medical purposes; radioactive substances for medical purposes; chemical reagents for medical or veterinary purposes; radiological contrast substances for medical purposes; insect repellents; repellents for dogs; fish meal for pharmaceutical purposes; ergot for pharmaceutical purposes; solutions for contact lenses / solutions for use with contact lenses; solvents for removing adhesive plasters; mercurial ointments; sarsaparilla for medical purposes; lead water / Goulard water; massage candles for therapeutic purposes; serotherapeutic medicines; siccatives [drying agents] for medical purposes; serums; syrups for pharmaceutical purposes; turpentine for pharmaceutical purposes; soporifics; salts for mineral water baths; mineral water salts; salts for medical purposes; malt for pharmaceutical purposes; malted milk beverages for medical purposes; semen for artificial insemination; alcohol for pharmaceutical purposes; alloys of precious metals for dental purposes; sterilizing preparations/sterilising preparations; steroids; strychnine; sulfonamides [medicines]; pastilles for pharmaceutical purposes; adhesive plasters; thermal water; thymol for pharmaceutical purposes; gentian for pharmaceutical purposes; tissues impregnated with pharmaceutical lotions; smoking herbs for medical purposes; herbal teas for medicinal purposes; sedatives / tranquillizers; tobacco extracts [insecticides]; pharmaceutical preparations; pharmaceutical preparations for treating dandruff; phenol for pharmaceutical purposes; fennel for medical purposes; ferments for veterinary purposes; ferments for medical purposes; ferments for pharmaceutical purposes; enzyme preparations for veterinary purposes; enzyme preparations for medical purposes; formic aldehyde for pharmaceutical purposes; moulding wax for dentists / molding wax for dentists; phosphates for pharmaceutical purposes; fungicides; chemico-pharmaceutical preparations; chemical preparations for veterinary purposes; chemical preparations for pharmaceutical purposes; quinine for medical purposes; chinoline for medical purposes; surgical implants comprised of living tissues; diabetic bread adapted for

medical use; chloroform; flowers of sulfur for pharmaceutical purposes; cement for animal hooves; candy, medicated; sugar for medical purposes; contact lens cleaning preparations; jalap.

---

(260) AM 2022 115501 A  
 (800) 1548218  
 (151) 2020 07 10  
 (891) 2021 11 03  
 (731) Bausch + Lomb Ireland Limited  
 3013 Lake Drive, Citywest Business Campus,  
 Dublin 24, Ireland  
 (540)

## LUXSMART

(591) Black, white  
 (511)  
 10 – Intraocular lenses, preloaded lens inserters.

---

(260) AM 2022 115502 A  
 (800) 1563069  
 (151) 2020 10 26  
 (891) 2021 11 03  
 (731) Bausch + Lomb Ireland Limited  
 3013 Lake Drive, Citywest Business Campus,  
 Dublin 24, Ireland  
 (540)

## LUXGOOD

(591) Black, white  
 (511)  
 10 – Intraocular lenses; preloaded intraocular lens inserters.

---

(260) AM 2022 115541 A  
 (800) 1627631  
 (151) 2021 04 22  
 (891) 2021 04 22  
 (731) FEMAS METAL SANAYİ VE TİCARET  
 ANONİM ŞİRKETİ  
 Organize Sanayi Bölgesi, 9. Cadde, No:17,  
 Melikgazi – Kayseri, Turkey  
 (540)

# Ferre

(591) Blue  
 (531) 27.05.01; 29.01.04  
 (511)  
 11 – Lighting installations; lights for vehicles and interior-exterior spaces; heating installations using solid, liquid or gas fuels or electricity, central heating boilers, boilers for heating installations, radiators [heating], heat exchangers, not parts of machines, stoves, kitchen stoves, solar thermal collectors [heating];

steam, gas and fog generators, steam boilers, other than parts of machines, acetylene generators, oxygen generators, nitrogen generators; installations for air-conditioning and ventilating; cooling installations and freezers; electric and gas-powered devices, installations and apparatus for cooking, drying and boiling, cookers, electric cooking pots, electric water heaters, barbecues, electric laundry driers; hair driers; hand drying apparatus; sanitary installations, taps [faucets], shower installations, toilets [water-closets], shower and bathing cubicles, bath tubs, toilet seats, sinks, wash-hand basins [parts of sanitary installations]; washers for water taps; water softening apparatus; water purification apparatus; water purification installations; waste water purification installations; electric bed warmers and electric blankets, not for medical use; electric pillow warmers; electric or non-electric footwarmers; hot water bottles; socks, electrically heated; filters for aquariums and aquarium filtration apparatus; industrial type installations for cooking, drying and cooling purposes; pasteurizers and sterilizers.

(260) AM 2022 115542 A  
(800) 1627649  
(151) 2021 09 24  
(891) 2021 09 24  
(731) "Holding company Varton" Limited Liability Company  
Dorogobuzhskaya ul., d. 14, str. 6, et/pom 2/7,  
RU-121354 Moskva, Russian Federation

(540)

**VARTON**

(591) Black, white  
(511)  
9 – Optical lenses; fuses; converters, electric; telerrupters; transistors [electronic]; step-up transformers; transformers [electricity]; circuit breakers.

11 – Acetylene flares; safety lamps; gas lamps; curling lamps; germicidal lamps for purifying air; light bulbs for directional signals for vehicles; arc lamps; laboratory lamps; oil lamps; ultraviolet ray lamps, not for medical purposes; miners' lamps; electric lamps; chandeliers; luminous house numbers; lamp reflectors; lighting apparatus and installations; light-emitting diodes [LED] lighting apparatus; light diffusers; lamps; ceiling lights; discharge tubes, electric, for lighting; lamp chimneys; luminous tubes for lighting; bicycle lights; lights for vehicles; electric torches; lanterns for lighting; standard lamps; lamp globes; lights, electric, for Christmas trees.

35 – Advertising agency services; cost price analysis; personnel recruitment; updating of advertising material; word processing; organization of exhibitions for commercial or advertising purposes; arranging newspaper subscriptions for others; shop window dressing; bill-posting; distribution of samples; dissemination of

advertising matter; direct mail advertising; writing of publicity texts; advertising; online advertising on a computer network; advertising by mail order; television advertising; document reproduction; compilation of statistics; compilation of information into computer databases; business inquiries.

(260) AM 2022 115544 A  
(800) 1627729  
(151) 2021 07 08  
(891) 2021 07 08  
(731) Crystalex CZ, s.r.o.  
Masarykovo nábřeží 2360, CZ-110 00 Praha 1,  
Nové Město, Czech Republic

(540)

**BOHEMIA CRYSTAL**

(591) Black, white  
(531) 27.05.01; 27.05.09  
(511)  
21 – Glass products of all kinds included in this class; products of utility and smooth and refined art glass.

(260) AM 2022 115545 A  
(800) 1627772  
(151) 2021 08 27  
(891) 2021 08 27  
(731) JIANGSU DONGCHENG POWER TOOLS  
Co., LTD.  
Industrial Park, Tianfen Town, Qidong City,  
226244 Jiangsu, China

(540)

**DCA**

(591) Black, white  
(511)  
8 – Nail clippers, electric or non-electric; hand-operated hand tools, namely, emery grinding wheels, wrenches, spanners, pliers, hand drills, chisels, hammers, screwdrivers, files, knives, bits, cutting tools, scraping tools, bushhammers, pick hammers, shovels, spades, riveters, three-jaw bearing pullers, graving tools, saw blades, scissors, shears.

(260) AM 2022 115641 A  
(800) 1629895  
(151) 2021 08 25  
(891) 2021 08 25  
(731) Ningbo Unibono Appliance Co., Ltd.  
Southern, Second floor, NO.2 buliding,  
#29 Xinyi Road, Daxie Development  
Zone, Ningbo, Zhejiang, China

(540)

**unibono**

(591) Black, white  
(531) 27.05.01; 27.05.17  
(511)

8 – Battery-powered animal nail grinders; beard clippers; razors, electric or non-electric; nail buffers, electric or non-electric; hair clippers; electric hair trimmers; hair trimmers for babies; depilation appliances, electric and non-electric; nail clippers, electric or non-electric; manicure sets, electric; hand tools, hand-operated; hair clippers for animals [hand instruments].

10 – Vibrating massage equipment; ear picks; teething rings; feeding bottles; breast pumps; feeding bottle valves; dummies for babies; baby feeding pacifiers; gum massagers for babies; orthopedic articles.

(260) AM 2022 115642 A  
(800) 1629905  
(151) 2021 10 18  
(891) 2021 10 18  
(731) R&S consumer goods GmbH  
Wasserburger Landstr. 264, 81827 München,  
Germany  
(540)

## Lube me

(591) Black, white  
(511)  
3 – Massage fluids, namely massage oils, massage lotions; massage oils, not medicated.

5 – Intimate personal lubricants; lubricants for medical purposes, namely vaginal lubricants, medicated gels for medical sonography and ultrasound applications; massage fluids for medical purposes, namely medicated massage oils, creams and lotions.

(260) AM 2022 115643 A  
(800) 1629938  
(151) 2021 07 08  
(891) 2021 07 08  
(731) DLMS User Association  
Industriestrasse 53, CH-6312 Steinhausen,  
Switzerland  
(540)



(591) Black, white  
(531) 26.02.03; 26.02.24; 27.05.01; 27.05.17  
(511)  
7 – Machines, machine tools and mechanical tools; motors and engines, other than for land vehicles; couplings and transmission components, other than for land vehicles; agricultural instruments other than

hand-operated hand tools; incubators for eggs; automatic distribution machines.

9 – Scientific, research, navigation, surveying, photographic, cinematographic, audiovisual, optical, weighing, measuring, signaling, detecting, testing, inspecting, life-saving and teaching apparatus and instruments; apparatus and instruments for conducting, switching, transforming, accumulating, regulating or controlling the distribution or use of electricity; apparatus and instruments for recording, transmitting, reproducing or processing sound, images or data; downloadable or recorded media, software, blank digital or analog recording and storage media; mechanisms for coin-operated apparatus; cash registers, calculating devices; computers and computer peripherals; diving suits, diving masks, earplugs for diving, nose clips for divers and swimmers, diving gloves, breathing apparatus for underwater swimming; fire extinguishers.

11 – Apparatus and installations for lighting, heating, cooling, steam generating, cooking, drying, ventilating, water distribution and sanitary installations.

37 – Construction services; installation and repair services; mining, oil and gas drilling.

38 – Telecommunication services.

39 – Transport; packaging and storage of merchandise; travel organization.

42 – Scientific and technological services as well as research and design services relating thereto; industrial analysis, industrial research and industrial design services; quality control and authentication services; design and development of computers and software.

(260) AM 2022 115644 A  
(800) 1629942  
(151) 2021 08 06  
(891) 2021 08 06  
(731) DLMS User Association  
Industriestrasse 53, CH-6312 Steinhausen,  
Switzerland  
(540)



(591) Black, white  
(531) 27.05.01  
(511)  
7 – Machines, machine tools and mechanical tools; motors and engines, other than for land vehicles; couplings and transmission components, other than

for land vehicles; agricultural instruments other than hand-operated hand tools; incubators for eggs; automatic distribution machines.

9 – Scientific, research, navigation, surveying, photographic, cinematographic, audiovisual, optical, weighing, measuring, signaling, detecting, testing, inspecting, life-saving and teaching apparatus and instruments; apparatus and instruments for conducting, switching, transforming, accumulating, regulating or controlling the distribution or use of electricity; apparatus and instruments for recording, transmitting, reproducing or processing sound, images or data; downloadable or recorded media, software, blank digital or analog recording and storage media; mechanisms for coin-operated apparatus; cash registers, calculating devices; computers and computer peripherals; diving suits, diving masks, earplugs for diving, nose clips for divers and swimmers, diving gloves, breathing apparatus for underwater swimming; fire extinguishers.

11 – Apparatus and installations for lighting, heating, cooling, steam generating, cooking, drying, ventilating, water distribution and sanitary installations.

39 – Transport; packaging and storage of merchandise; travel organization.

42 – Scientific and technological services as well as research and design services relating thereto; industrial analysis, industrial research and industrial design services; quality control and authentication services; design and development of computers and software.

(260) AM 2022 115645 A

(800) 1629999

(151) 2021 09 16

(891) 2021 09 16

(731) Limited Liability Company

"PRODKONTRAKTINVEST"

Sovkhoznyaya st., vld. 52a, RU-347040 Belaya Kalitva, Rostov region, Russian Federation

(540)

НОЧНОЙ  
ОХОТНИК

(591) Black, white

(531) 28.05

(511)

31 – Animal foodstuffs.

35 – Advertising; business management services.

(260) AM 2022 115646 A

(800) 1630015

(151) 2021 11 01

(891) 2021 11 01

(731) Apple Inc.

One Apple Park Way, Cupertino CA 95014, USA

(540)



(591) Black, white

(531) 05.07.13; 05.07.23; 27.05.01

(511)

14 – Key rings; key chains.

(260) AM 2022 115647 A

(800) 1630064

(151) 2021 11 01

(891) 2021 11 01

(731) Apple Inc.

One Apple Park Way, Cupertino CA 95014, USA

(540)

**A15 BIONIC**

(591) Black, white

(511)

9 – Computer hardware, namely, integrated circuits and computer chips.

(260) AM 2022 115648 A

(800) 1630105

(151) 2021 04 30

(891) 2021 04 30

(731) Veld World (UK) Limited

Suite 23039, 8 Shepherd market, Mayfair, London W1J 7JY, United Kingdom

(540)



(591) Black, white

(531) 24.09.03; 24.09.05; 26.13.25; 27.05.01

(511)

29 – Meat, fish, poultry and game; meat extracts; preserved, frozen, dried and cooked fruits and vegetables; vegetables, tinned (canned); fruits, tinned (canned); fish, tinned (canned); meat, tinned (canned); fruit and vegetable spreads; jellies and jams; compotes; eggs; milk; cheese; butter; yogurt; cream; whipped

cream; condensed milk; milk substitutes; almond milk; coconut milk; peanut milk; rice milk; soya milk; oat milk; oils and fats for food; olive oil for food; extra-virgin olive oil; olives, preserved; mushrooms, preserved; berries, preserved; beans, preserved; gherkins; pickled gherkins; peas, preserved; soya beans, preserved, for food; lentils, preserved; vegetable pastes; vegetable marrow paste; tomato paste; nut-based spreads; processed nuts; edible seeds; seed butters; seeds, prepared; cooked sesame seeds, not being seasonings or flavorings; preserved chopped chilli peppers, not being seasonings or flavorings; artichoke paste; processed artichokes; artichokes, preserved; seaweed extracts for food; caviar; tuna, not live; dried shrimps; shrimp paste; shrimp floss; potato chips; potato flakes; potato-based dumplings; fruit chips; mussels, not live; crustaceans, not live; anchovy; non-living crustaceans; anchovy paste; anchovy fillets.

30 – Coffee, tea, cocoa and artificial coffee; rice; tapioca and sago; flour and preparations made from cereals; bread, pastries and confectionery; pasta; macaroni; ravioli; noodles; noodle-based prepared meals; potato-based flatbreads; tortillas; edible ices; ice-cream; sorbets; sugar, honey, treacle; yeast, baking powder; salt; mustard; vinegar, sauces (condiments); spices; ketchup (sauce); mayonnaise; marinades; dressings for salad; pesto (sauce); tomato sauce; soya sauce; pasta sauce; apple sauce (condiment); fruit coulis (sauces); fruit jellies (confectionery); chocolate; dessert mousses (confectionery); chocolate mousses; chocolate-based spreads; high-protein cereal bars; cereal bars; gluten-free bread; oat flakes; corn chips; corn flakes; muesli; chips (cereal products); flour-based dumplings; groats for human food; capers; seasonings; preserved herbs; processed seeds for use as a seasoning; garden herbs, preserved (seasonings); preserved, frozen, dried and cooked capers.

32 – Beers; non-alcoholic beverages; mineral and aerated waters; fruit beverages and fruit juices; fruit nectars, non-alcoholic; smoothies; sherbets (beverages); sorbets (beverages); non-alcoholic fruit extracts; vegetable juices (beverages); syrups and other non-alcoholic preparations for making beverages; protein-enriched sports beverages; waters (beverages).

(260) AM 2022 115649 A

(800) 1630169

(151) 2021 09 14

(891) 2021 09 14

(731) ZTO EXPRESS CO., LTD.

Building 1, No. 1685 Huazhi Road,

HuaXin Town, Qingpu, Shanghai, China

(540)

**ZTO:**

(591) Black, white

(531) 27.05.17; 27.05.19

(511)

39 – Packaging of goods; freighting; freight brokerage; vehicle rental; transportation information; storage of goods; storage information; car transport; parcel delivery; courier services [messages or merchandise].

(260) AM 2022 115661 A

(800) 1477510

(151) 2019 05 08

(891) 2021 11 12

(731) H & M Hennes & Mauritz AB

SE-106 38 Stockholm, Sweden

(540)

HELLO  MEMBER

(591) Black, white

(531) 24.17.25; 27.05.09; 27.05.10

(511)

35 – Loyalty scheme services; loyalty, incentive and bonus program services; customer club services, for commercial, promotional and/or advertising purposes; advertising; marketing and promotional services; commercial trading and consumer information services; retailing in relation to cosmetics and toiletry preparations, perfumery, essential oil, bleaching preparations and other substances for laundry use, cleaning, polishing, scouring and abrasive preparations, soap, hair care and treatment preparations, tooth pastes, nail polish, toiletries, after-shave, facial masks, facial creams, facial cleansing preparations, baby oil, bath gel, bath salts, cotton balls for cosmetic purposes, swabs (toiletries), cosmetic pencils, eyeliner, hair colorants, false nails; retailing in relation to cosmetic wipes, styling gels, styling waxes, hand creams, skin care preparations, mouthwashes, mouth sprays, body cream, body scrubs, powder, lip balms, lip glosses, lip liners, lipsticks, false eyelashes, mascara, eye shadows, scented body spray, hair care and treatment preparations, rouge, sun-tanning preparations, make-up foundations, bath and shower gels, incense, deodorants, air fragrancing preparations, shampoos, hair conditioners, air fragrance reed diffusers; retailing in relation to scented room sprays, potpourris (fragrances); retailing of candles, scented candles, christmas tree decorations for lighting (candles), electronic publications, downloadable applications for mobile telephones, selfie sticks for use as smartphone accessories, cases adapted for mobile telephones, mobile telephone cases, battery chargers for mobile telephones, auxiliary speakers for mobile telephones, headphones, loudspeakers, eyeglass frames, eyewear for skiers, swim goggles, boxes [cases] for sunglasses, sun glasses; retailing in relation to sleeves for laptops, laptop bags, bags adapted for carrying photographic apparatus, glasses, cords for eyeglasses, eyeglasschains, ca-



ses for glasses, rulers (measuring instruments), power packs (batteries), decorative magnets, jewellery, charms (jewellery) of common metal, paste jewellery, badges for wear, diadems, rings (jewellery), ankle bracelets, bangles, necklaces [jewellery], chains (jewellery), tie pins, bells, cufflinks, keyrings, earrings; retailing in relation to jewellery boxes and watch cases, brooches [jewellery], key chains as jewellery, jewellery boxes and cases, ornaments [jewellery], ornaments (jewellery), paper and cardboard, printed matter, photographs, stationery and office requisites, except furniture, adhesives and glue for stationery or household use, drawing materials and artists' materials, painters' brushes, packaging material made of card, posters, face towels of paper, of books; retailing in relation to decorative paper centrepieces, table napkins of paper, decorations and artists' materials, staplers, paper-weights, figures made of paper, disposable paper products, works of art and figurines of paper and cardboard, and architectural models, cards, boxes of cardboard, paper handkerchiefs, mail order catalogue, bags made of paper or plastic for packaging, paper, cardboard and plastic for packaging and storage, gift paper, pens, pencil holders, sanitary pads, printed publications; retailing in relation to books, magazines (periodicals), booklets, newsletters, boxes for pencils, boxes for pens, paper boxes, art prints on canvas, christmas cards, birthday cards, cards for correspondence, table linen of paper, towels of paper, tissues of paper for removing make-up, place mats of paper, cardboard articles, catalogues, printed matter, pictures, figurines (statuettes) of papier mâché, wrapping paper, boxes of paper, drawing materials, travel baggage and bags, umbrellas and parasols; retailing in relation to clothing for pets, travelling bags, pocket wallets (handbags), evening bags, work bags, shoulder bags, canvas bags, shopping bags, cases adapted for toilet utensils, animal carriers, card holders, make-up cases, courier bags, leather straps, belt bags, briefcases (leatherware), rucksacks, gym bags, cases for keys, vanity cases, not fitted, credit card cases, gut for making sausages, baggage, trunks [luggage], card cases (notecases), household or kitchen utensils and containers; retailing in relation to kitchen utensils and tableware, combs and spongers, brushes, household utensils for cleaning, crystal, porcelain and earthenware, storage cans, cooking utensils, non-electric, containers for foodstuffs and drinks, combs and sponges, hair brushes, toothbrushes, toothbrush holders, toothbrush containers, trivets (table utensils), vases, watering cans, services (dishes), table plates, paper plates, napkin rings, statuettes and works of art of glass, ceramics or porcelain, fitted vanity cases; retailing in relation to dishwashing brushes, dish cloths, dishes, laundry baskets, candlesticks, dispensers for soap, cookie (biscuit) cutters, waste baskets, teapots, soap holders, bowls (basins), table plates, bowls (basins), salt cellars, pepper mills, hand-operated, pot holders, containers for household or kitchen use, plas-

tic storage containers for household use, beverage-ware, tea sets, coffee sets, toilet utensils, dental floss, cleaning instruments, hand-operated, brushes, makeup brushes, brushes for household purposes; retailing in relation to cosmetic utensils, clothing, footwear, headgear, swimming trunks, swimsuits, beach robes, bikinis, sashes, shower caps, sleep masks, ready-made clothing, waterproof clothing, layettes (clothing), lamps, standard lamps, rugs, yoga mats, flowers, artificial flowers, scissors, chocolate, coffee, tea, spices, furniture, pillows, storage boxes, newspaper display stands, frames, chair pads, clothes hangers, hampers (baskets) for the transport of items, mirrors; retailing in relation to works of art of wood, waxes, plaster or plastic, clothes stretchers, cushions, boxes of wood or plastic, storage canisters, laundry baskets, glass receptacles, jars and cans, vases, decanters, table plates, bowls (basins), glasses [drinking vessels], glassware for household purposes, painted china, travelling sets, cutting boards, salt and pepper shakers, bread baskets, bed linen and beds, tablemats of textile, towels, place mats, (textile), shower curtains of textiles or plastic material; retailing relating to textiles and textile goods, cloth, bed clothes and blankets, sheets, pillow covers, quilt covers, bedspreads, curtains of textile or of plastic, household textile articles, games, toys and playthings, video games apparatus, gymnastic and sporting articles, decorations for christmas trees; retail services in relation to sporting equipment, lace and embroidery, decorative articles for the hair, clothing accessories, sewing articles, decorations of textile articles, hair bands, barrettes (hair slides), badges for clothing, ornamental novelty buttons, badges for wear, tassels (haberdashery); promotional marketing; promoting the sale of goods and services of others through the distribution of printed material and promotional contests; sales promotion for others; marketing; presentation of goods on communication media, for retail purposes; organisation of fashion shows for commercial purposes; assistance in management of business activities; computerized file management; accounting; sponsorship search.

36 – Issuance of prepaid cards and tokens of value; issuing tokens of value as a reward for customer loyalty; issuing electronic payment cards in connection with bonus and reward schemes.

---

(260) AM 2022 115662 A

(800) 1517975

(151) 2019 11 06

(891) 2021 11 03

(731) ASP Global Manufacturing GmbH

Im Majorenacker, 10, CH-8207 Schaffhausen,  
Switzerland

(540)

**ASP** Advanced  
Sterilization  
Products

(591) Black, white

(531) 27.05.19; 27.05.22; 27.05.23

(511)

1 – Chemicals used for sterilization and for testing for sterilization; biological indicators for monitoring sterilization processes other than for medical or veterinary purposes; reagents for testing the sterility of medical equipment; reagents for testing the sterility of pharmaceuticals and injectable solutions.

5 – Disinfectants; disinfectants for sanitary use; sterilizing preparations.

9 – Electronic apparatus for testing the sterility of medical equipment; electronic apparatus for testing the sterility of pharmaceuticals and injectable solutions.

11 – Sterilizers, not for medical purposes; sterilization equipment and apparatus and other supplies; steam sterilizers for laboratory use; sterilization trays for medical instruments; sterilization units for medical purposes.

(260) AM 2022 115663 A

(800) 1524299

(151) 2019 11 06

(891) 2021 11 03

(731) ASP Global Manufacturing GmbH  
Im Majorenacker, 10, CH-8207 Schaffhausen,  
Switzerland

(540)

**ASP**

(591) Black, white

(531) 27.05.19; 27.05.22; 27.05.23

(511)

1 – Chemicals used for sterilization and for testing for sterilization; biological indicators for monitoring sterilization processes other than for medical or veterinary purposes; reagents for testing the sterility of medical equipment; reagents for testing the sterility of pharmaceuticals and injectable solutions.

5 – Disinfectants; disinfectants for sanitary use; sterilizing preparations.

9 – Electronic apparatus for testing the sterility of medical equipment; electronic apparatus for testing the sterility of pharmaceuticals and injectable solutions.

11 – Sterilizers, not for medical purposes; sterilization equipment and apparatus and other supplies; steam

sterilizers for laboratory use; sterilization trays for medical instruments; sterilization units for medical purposes.

(260) AM 2022 115664 A

(800) 1537764

(151) 2020 05 20

(891) 2021 10 26

(731) F. Hoffmann-La Roche AG  
Grenzacherstrasse 124, CH-4070 Basel,  
Switzerland

(540)

**COLUMVI**

(591) Black, white

(511)

5 – Pharmaceutical preparations for use in oncology.

(260) AM 2022 115665 A

(800) 1583464

(151) 2021 02 04

(891) 2021 10 27

(731) F. Hoffmann-La Roche AG  
Grenzacherstrasse 124, CH-4070 Basel,  
Switzerland

(540)

**KUDOCETRO**

(591) Black, white

(511)

5 – Pharmaceutical preparations.

(260) AM 2022 115666 A

(800) 1598723

(151) 2021 03 30

(891) 2021 11 10

(731) GIORGIO ARMANI S.P.A.  
Via Borgonuovo, 11, I-20121 MILANO  
(Milano), Italy

(540)

**A | X**

**ARMANI EXCHANGE**

(591) Black, white

(531) 26.11.01; 26.11.07; 27.05.10

(511)

9 – Spectacles, sunglasses, lenses and frames therefor, contact lenses, cases for glasses and spectacles, chains and cords for glasses and spectacles, parts and fittings for all the aforesaid goods; covers for portable multimedia players; covers for mobile phones; covers for DVDs; covers for CDs; covers for computer cables; covers for audio reproduction devices; covers for pal-

mtops; covers for electronic agendas; covers for photographic cameras and covers for film cameras; cellular phones; smartphones; wireless communication devices featuring telecommunication functionality to allow the transmission of text, data, audio, image and video files; electronic monitoring devices comprised of microprocessors and accelerometers, for identifying, storing, reporting, monitoring, uploading and downloading data and information for personal physical fitness and training purposes; downloadable applications and software for smart watches and mobile devices, for processing, reviewing and editing data, to enable users to control the presentation and information available from the devices; wearable sensors for personal physical fitness and training purposes to gather biometric data and also including monitors and displays sold as a unit; smartwatches; wearable activity trackers; pedometers; smartwatches featuring software for sending and receiving data or to be used to monitor personal fitness activity; smart bracelets, rings or necklaces featuring software for sending and receiving data or to be used to monitor personal fitness activity.

14 – Watches and clocks; chronographs and chronometers; earrings; rings; necklaces; bracelets; ornamental pins made of precious metal; shoe ornaments of precious metal; boxes of precious metal; pins; tie clips; cuff links; watch straps; watch bands; jewelry.

18 – Handbags; traveling bags; briefcases; leather briefcases; leather credit card holders; wallets; leather document briefcases; leather key cases; purses; suit cases; cosmetic bags sold empty; sports bags; evening and shoulder bags for ladies; leather shopping bags; school bags; garment bags for travel; suit carriers for travel; shoe bags for travel; beach bags; diaper bags; backpacks; Boston bags; traveling trunks; duffel bags; overnight bags; carry-on bags; satchels; opera bags; vanity cases (not fitted); hides; cases and boxes made of leather; bags made of leather for packaging; leather straps; umbrellas; leather leashes; saddlery.

25 – Coats; jackets; trousers; skirts; tops; raincoats; overcoats; belts; braces for clothing; suits; stuff jackets; jumpers; jeans; dresses; cloaks; parkas; shirts; T-shirts; sweaters; underwear; baby-dolls being nightwear; bathrobes; bathing costumes; negligee; swim suits; dressing gowns; shawls; neckerchiefs; scarves; ties; neckties; sweat shirts; under shirts; polo shirts; body suits; shorts; combinations [clothing]; wedding dresses; stockings; socks; shoes; slippers; overshoes; galoshes; wooden clog; soles for footwear; footwear upper; boots; ski boots; snow boots; half boots; esparto shoes or sandals; sandals; bath sandals; gloves; mittens; hats and caps; visors (headwear).

35 – The bringing together, for the benefit of others of cosmetics, perfumery, spectacles, optical goods and cases for optical goods, electronic devices, telephones, smartwatches and covers for smart watches, sen-

sors for health purposes and heart rate monitoring apparatus; the bringing together, for the benefit of others of jewelry, timepieces, paper stationery, office stationery, bags, wallets, saddlery, clothing, footwear, headwear, belts, buttons, zippers, buckles; all the aforesaid goods, excluding the transport thereof, enabling customers to conveniently view and purchase those goods.

(260) AM 2022 115667 A

(800) 1600225

(151) 2020 11 08

(891) 2021 10 27

(731) LOBANOV VIKTOR VIKTOROVICH  
ul. Lyusinovskaya, d.37, kv.9, RU-115093  
Moscow, Russian Federation

(540)



(591) Dark green, light green and white

(531) 26.02; 26.02.05; 26.02.18; 26.02.24; 27.05;  
27.05.09; 27.05.10; 27.05.24; 29.01; 29.01.13

(511)

3 – Bleaching preparations and other substances for laundry use, including laundry soaking preparations, laundry bleaching preparations, washing machine capsules for washing clothes, laundry preparations, bleaching salts, fabric softeners for laundry use, color-brightening chemicals for household purposes [laundry]; starch glaze for laundry purposes; sachets for perfuming linen; detergents, other than for use in manufacturing operations and for medical purposes; cleaning preparations for dishes; dishwasher tablets; dishwasher detergents; soap; deodorant soap; descaling preparations for household purposes; antistatic preparations for household purposes; perfumery; essential oils; cosmetics; hair lotions; dentifrices; amber [perfume]; aromatics [essential oils]; air fragrancing preparations; air fragrance reed diffusers; toiletry preparations; douching preparations for personal sanitary or deodorant purposes [toiletries]; cleaning, polishing, scouring and abrasive preparations, including abrasives, abrasive cloth, chemical cleaning preparations for household purposes, scouring solutions, glass cleaning liquids, including windshield cleaning liquids, dry-cleaning preparations, stain removers, paint stripping preparations, lacquer-removing preparations, rust removing preparations, preparations for unblocking drain pipes; shoe wax; household cleaning products; cloths impregnated with a detergent for cleaning.

5 – Deodorants, other than for human beings or for animals; air deodorizing preparations; deodorants for clothing and textiles; air purifying preparations; antibacterial soap; disinfectant soap; medicated soap; lotions for pharmaceutical purposes; medicated shampoos; antibacterial handwashes; medicated toothpaste; sanitary preparations for personal hygiene, other than toiletries; disinfectants; disinfectants for hygiene purposes.

6 – Foils of metal for wrapping and packaging; aluminium foil.

16 – Wrapping paper; parchment paper, namely baking parchment paper; bags for microwave cooking; absorbent sheets of paper or plastic for foodstuff packaging; bags [envelopes, pouches] of plastics for packaging; plastic film for wrapping; garbage bags of paper or of plastics; plastic bags for pet waste disposal; handkerchiefs of paper; towels of paper; place mats of paper; table napkins of paper; table linen of paper; tablecloths of paper; silver paper.

21 – Utensils for household purposes; kitchen utensils and cookware; combs; sponges; brushes, except paintbrushes; material for brush-making; articles for cleaning purposes; brushes; glass, unworked or semi-worked, except building glass; glassware, porcelain and earthenware not included in other classes; buckets; mop wringer buckets; stretchers for clothing; abrasive sponges for scrubbing the skin; sponges for household purposes; toilet sponges; containers for household or kitchen use; heat-insulated containers; heat-insulated containers for beverages; thermally insulated containers for food; toothpicks; baking mats; lunch boxes; polishing materials for making shiny, except preparations, paper and stone; tablemats, not of paper or textile; lint removers, electric or non-electric; isothermic bags; scourers for cleaning, including saucepan scourers of metal; cold packs for chilling food and beverages; gloves for household purposes; gardening gloves; kitchen mitts; pads for cleaning; deodorising apparatus for personal use; clothes-pegs; place mats, not of paper or textile; scoops for household purposes; cloth for washing floors; polishing cloths; cloths for cleaning; dusting cloths [rags]; furniture dusters; aerosol dispensers, not for medical purposes; cooking utensils, non-electric; cake moulds; ice cube moulds; mops; mop wringers; dishwashing brushes; scrubbing brushes; tar-brushes, long handled; garbage cans.

---

(260) AM 2022 115668 A

(800) 1606017

(151) 2021 05 21

(891) 2021 11 01

(731) PJSC "Cherkizovo Group"

ul. Cherkizovskaya, (Myasopererabotka ter.), 1,  
pomeshchenie 1, kab. 2, d. Topkanovo,  
g. Kashira, RU-142931 Moskovskaya oblast,  
Russian Federation

(540)

## CHERKIZOVO 77

(591) Black, white

(511)

29 – Broth; ham; cabbage rolls stuffed with meat; game, not live; meat jellies; bone oil for food; lard; suet for food; charcuterie; cassoulet; black pudding; kielbasa; meat, tinned; broth concentrates; corn dogs; animal marrow for food; meat; meat, preserved; freeze-dried meat; sausage casings, natural or artificial; liver pâté; liver; poultry, not live; bulgogi; bacon; satay; pork; salted meats; sausages; sausages in batter; hot dog sausages; preparations for making bouillon; preparations for making soup; tripe; tajine [prepared meat, fish or vegetable dish]; meat extracts.

---

(260) AM 2022 115669 A

(800) 1610362

(151) 2021 05 18

(891) 2021 10 26

(731) F. Hoffmann-La Roche AG

Grenzacherstrasse 124, CH-4070 Basel,  
Switzerland

(540)

## LUNSUMIO

(591) Black, white

(511)

5 – Pharmaceutical preparations.

---

---

**INTERNATIONAL TRADEMARKS PROTECTED IN GEORGIA**

(260) AM 2022 110618 A  
(800) 1561378  
(151) 2020 07 15  
(181) 2030 07 15  
(891) 2020 07 15  
(511) 05

---

(260) AM 2022 112971 A  
(800) 1590849  
(151) 2020 11 19  
(181) 2030 11 19  
(891) 2020 11 19  
(511) 29, 30

---

(260) AM 2022 111805 A  
(800) 1576542  
(151) 2020 12 02  
(181) 2030 12 02  
(891) 2020 12 02  
(511) 33

---

(260) AM 2022 112993 A  
(800) 1591512  
(151) 2019 11 01  
(181) 2029 11 01  
(891) 2019 11 01  
(511) 05, 16

---

(260) AM 2022 112869 A  
(800) 1589554  
(151) 2020 09 29  
(181) 2030 09 29  
(891) 2020 09 29  
(511) 05, 29

---

(260) AM 2022 112994 A  
(800) 1591547  
(151) 2020 12 31  
(181) 2030 12 31  
(891) 2020 12 31  
(511) 05, 10, 12

---

(260) AM 2022 112871 A  
(800) 1589693  
(151) 2021 02 24  
(181) 2031 02 24  
(891) 2021 02 24  
(511) 35, 36, 42

---

(260) AM 2022 112995 A  
(800) 650604  
(151) 1996 01 15  
(181) 2026 01 15  
(891) 2021 04 26  
(511) 01, 05

---

(260) AM 2022 112968 A  
(800) 1590777  
(151) 2020 11 19  
(181) 2030 11 19  
(891) 2020 11 19  
(511) 29, 30, 43

---

(260) AM 2022 112996 A  
(800) 714135  
(151) 1999 05 04  
(181) 2029 05 04  
(891) 2021 03 30  
(511) 11

---

(260) AM 2022 112969 A  
(800) 1590838  
(151) 2021 02 09  
(181) 2031 02 09  
(891) 2021 02 09  
(511) 25, 41

---

(260) AM 2022 112998 A  
(800) 792264  
(151) 2002 10 22  
(181) 2022 10 22  
(891) 2021 04 22  
(511) 07

---

(260) AM 2022 112970 A  
(800) 1590840  
(151) 2021 03 09  
(181) 2031 03 09  
(891) 2021 03 09  
(511) 35

---

(260) AM 2022 112999 A  
(800) 1038054  
(151) 2009 12 22  
(181) 2029 12 22  
(891) 2021 04 29  
(511) 03, 05, 29

---

(260) AM 2022 113000 A  
(800) 1059799  
(151) 2010 10 12  
(181) 2030 10 12  
(891) 2021 04 12  
(511) 04

---

(260) AM 2022 113001 A  
(800) 1260330  
(151) 2015 07 16  
(181) 2025 07 16  
(891) 2021 04 23  
(511) 01

---

(260) AM 2022 113002 A  
(800) 1402052  
(151) 2017 12 13  
(181) 2027 12 13  
(891) 2021 04 15  
(511) 33

---

(260) AM 2022 113003 A  
(800) 1459355  
(151) 2019 02 06  
(181) 2029 02 06  
(891) 2021 04 19  
(511) 33

---

(260) AM 2022 113004 A  
(800) 1479651  
(151) 2019 06 17  
(181) 2029 06 17  
(891) 2021 04 12  
(511) 12

---

(260) AM 2022 113006 A  
(800) 1576238  
(151) 2020 11 23  
(181) 2030 11 23  
(891) 2021 04 23  
(511) 12

---

(260) AM 2022 113007 A  
(800) 1582226  
(151) 2020 11 23  
(181) 2030 11 23  
(891) 2021 04 23  
(511) 03, 06, 07, 08, 09, 11, 14, 16, 18, 20, 21, 24, 25,  
27, 28

---

(260) AM 2022 113053 A  
(800) 1591619  
(151) 2020 12 31  
(181) 2030 12 31  
(891) 2020 12 31  
(511) 03, 05

---

(260) AM 2022 113054 A  
(800) 1591645  
(151) 2021 01 26  
(181) 2031 01 26  
(891) 2021 01 26  
(511) 30

---

(260) AM 2022 113056 A  
(800) 1591770  
(151) 2020 10 30  
(181) 2030 10 30  
(891) 2020 10 30  
(511) 09, 16, 41

---

(260) AM 2022 113057 A  
(800) 1591807  
(151) 2020 12 08  
(181) 2030 12 08  
(891) 2020 12 08  
(511) 32, 33

---

(260) AM 2022 113059 A  
(800) 1591822  
(151) 2021 02 15  
(181) 2031 02 15  
(891) 2021 02 15  
(511) 34

---

(260) AM 2022 113074 A  
(800) 1592231  
(151) 2021 03 30  
(181) 2031 03 30  
(891) 2021 03 30  
(511) 30

---

(260) AM 2022 113076 A  
(800) 1592275  
(151) 2021 02 11  
(181) 2031 02 11  
(891) 2021 02 11  
(511) 37, 40

---

(260) AM 2022 113077 A  
(800) 1592285  
(151) 2021 01 07  
(181) 2031 01 07  
(891) 2021 01 07  
(511) 08, 13, 14, 15, 16, 20, 42, 45

---

(260) AM 2022 113079 A  
(800) 1592449  
(151) 2021 03 11  
(181) 2031 03 11  
(891) 2021 03 11  
(511) 03, 05

---

(260) AM 2022 113087 A  
(800) 1592739  
(151) 2021 04 03  
(181) 2031 04 03  
(891) 2021 04 03  
(511) 34

---

(260) AM 2022 113088 A  
(800) 1592741  
(151) 2020 12 30  
(181) 2030 12 30  
(891) 2020 12 30  
(511) 29

---

(260) AM 2022 113152 A  
(800) 1592918  
(151) 2021 03 04  
(181) 2031 03 04  
(891) 2021 03 04  
(511) 01, 11, 21, 31, 32

---

(260) AM 2022 113164 A  
(800) 1593551  
(151) 2021 04 26  
(181) 2031 04 26  
(891) 2021 04 26  
(511) 41, 44

---

(260) AM 2022 113165 A  
(800) 1593622  
(151) 2021 03 04  
(181) 2031 03 04  
(891) 2021 03 04  
(511) 01

---

(260) AM 2022 113166 A  
(800) 1593757  
(151) 2020 09 14  
(181) 2030 09 14  
(891) 2020 09 14  
(511) 07, 11

---

(260) AM 2022 113167 A  
(800) 1593795  
(151) 2020 10 26  
(181) 2030 10 26  
(891) 2020 10 26  
(511) 35

---

(260) AM 2022 113169 A  
(800) 742589  
(151) 2000 07 14  
(181) 2030 07 14  
(891) 2021 05 10  
(511) 14, 18, 25

---

(260) AM 2022 113170 A  
(800) 970093  
(151) 2007 12 17  
(181) 2027 12 17  
(891) 2021 04 16  
(511) 01, 02

---

(260) AM 2022 113171 A  
(800) 999636  
(151) 2009 03 11  
(181) 2029 03 11  
(891) 2021 04 09  
(511) 05

---

(260) AM 2022 113173 A  
(800) 1190522  
(151) 2013 07 22  
(181) 2023 07 22  
(891) 2021 03 31  
(511) 14, 18

---

(260) AM 2022 113177 A  
(800) 1357146  
(151) 2016 10 06  
(181) 2026 10 06  
(891) 2021 04 30  
(511) 09, 37, 42

---

(260) AM 2022 113180 A  
(800) 1523638  
(151) 2019 11 23  
(181) 2029 11 23  
(891) 2021 05 11  
(511) 03, 05, 10

---

(260) AM 2022 113299 A  
(800) 1594559  
(151) 2021 02 09  
(181) 2031 02 09  
(891) 2021 02 09  
(511) 30

---

(260) AM 2022 113300 A  
(800) 1594560  
(151) 2021 02 09  
(181) 2031 02 09  
(891) 2021 02 09  
(511) 30

---

(260) AM 2022 113301 A  
(800) 1594563  
(151) 2021 03 19  
(181) 2031 03 19  
(891) 2021 03 19  
(511) 09

---

(260) AM 2022 113330 A  
(800) 1352505  
(151) 2017 03 29  
(181) 2027 03 29  
(891) 2021 04 27  
(511) 33

---

(260) AM 2022 113442 A  
(800) 1595406  
(151) 2021 02 18  
(181) 2031 02 18  
(891) 2021 02 18  
(511) 21

---

(260) AM 2022 113465 A  
(800) 1596108  
(151) 2021 04 12  
(181) 2031 04 12  
(891) 2021 04 12  
(511) 03

---

(260) AM 2022 113467 A  
(800) 1596142  
(151) 2021 02 25  
(181) 2031 02 25  
(891) 2021 02 25  
(511) 09, 35, 41, 42

---

(260) AM 2022 113469 A  
(800) 1596232  
(151) 2020 11 26  
(181) 2030 11 26  
(891) 2020 11 26  
(511) 09, 35, 36, 38, 39, 42

---

(260) AM 2022 113470 A  
(800) 564220  
(151) 1991 01 25  
(181) 2031 01 25  
(891) 2021 03 19  
(511) 01

---

(260) AM 2022 113480 A  
(800) 1534422  
(151) 2020 04 28  
(181) 2030 04 28  
(891) 2021 05 24  
(511) 32

---

(260) AM 2022 113525 A  
(800) 1596290  
(151) 2021 03 31  
(181) 2031 03 31  
(891) 2021 03 31  
(511) 30

---

(260) AM 2022 113526 A  
(800) 1596308  
(151) 2021 03 11  
(181) 2031 03 11  
(891) 2021 03 11  
(511) 01, 17, 19

---

(260) AM 2022 113527 A  
(800) 1596336  
(151) 2021 04 07  
(181) 2031 04 07  
(891) 2021 04 07  
(511) 33

---



---

(260) AM 2022 113532 A  
(800) 1596571  
(151) 2021 03 11  
(181) 2031 03 11  
(891) 2021 03 11  
(511) 34

---

---

(260) AM 2022 113555 A  
(800) 1597129  
(151) 2020 12 04  
(181) 2030 12 04  
(891) 2020 12 04  
(511) 17, 19

---

---

(260) AM 2022 113533 A  
(800) 1596599  
(151) 2020 10 22  
(181) 2030 10 22  
(891) 2020 10 22  
(511) 12, 35

---

---

(260) AM 2022 113568 A  
(800) 936754  
(151) 2007 08 01  
(181) 2027 08 01  
(891) 2021 04 28  
(511) 01

---

---

(260) AM 2022 113535 A  
(800) 1596669  
(151) 2021 02 19  
(181) 2031 02 19  
(891) 2021 02 19  
(511) 30

---

---

(260) AM 2022 113569 A  
(800) 1059869  
(151) 2010 10 18  
(181) 2030 10 18  
(891) 2021 03 05  
(511) 05

---

---

(260) AM 2022 113551 A  
(800) 1597084  
(151) 2021 02 19  
(181) 2031 02 19  
(891) 2021 02 19  
(511) 30

---

---

(260) AM 2022 113744 A  
(800) 1600163  
(151) 2021 04 28  
(181) 2031 04 28  
(891) 2021 04 28  
(511) 30

---

---

(260) AM 2022 113552 A  
(800) 1597095  
(151) 2021 02 19  
(181) 2031 02 19  
(891) 2021 02 19  
(511) 30

---

---

(260) AM 2022 113755 A  
(800) 1216440  
(151) 2014 06 17  
(181) 2024 06 17  
(891) 2021 04 28  
(511) 30

---

---

(260) AM 2022 113553 A  
(800) 1597101  
(151) 2021 05 19  
(181) 2031 05 19  
(891) 2021 05 19  
(511) 12

---

---

(260) AM 2022 113756 A  
(800) 1266345  
(151) 2015 07 13  
(181) 2025 07 13  
(891) 2021 04 30  
(511) 04

---

---

(260) AM 2022 113554 A  
(800) 1597122  
(151) 2021 04 01  
(181) 2031 04 01  
(891) 2021 04 01  
(511) 29

---

---

(260) AM 2022 113757 A  
(800) 1366863  
(151) 2017 06 30  
(181) 2027 06 30  
(891) 2021 06 16  
(511) 03, 05

---

(260) AM 2022 113758 A  
(800) 1409169  
(151) 2018 03 13  
(181) 2028 03 13  
(891) 2021 06 14  
(511) 43

---

(260) AM 2022 113759 A  
(800) 1457651  
(151) 2018 03 13  
(181) 2028 03 13  
(891) 2021 06 14  
(511) 43

---

(260) AM 2022 113761 A  
(800) 1513889  
(151) 2019 12 02  
(181) 2029 12 02  
(891) 2021 05 21  
(511) 03, 05, 29, 30, 32

---

(260) AM 2022 113845 A  
(800) 1592931  
(151) 2020 11 23  
(181) 2030 11 23  
(891) 2021 05 11  
(511) 35, 36, 37, 39, 41, 43

---

(260) AM 2022 113890 A  
(800) 1601502  
(151) 2021 03 05  
(181) 2031 03 05  
(891) 2021 03 05  
(511) 05

---

(260) AM 2022 113891 A  
(800) 1601519  
(151) 2021 04 20  
(181) 2031 04 20  
(891) 2021 04 20  
(511) 09

---

(260) AM 2022 113892 A  
(800) 1601550  
(151) 2021 04 12  
(181) 2031 04 12  
(891) 2021 04 12  
(511) 12

---

(260) AM 2022 113893 A  
(800) 1601599  
(151) 2020 12 17  
(181) 2030 12 17  
(891) 2020 12 17  
(511) 11, 21

---

(260) AM 2022 113939 A  
(800) 1602681  
(151) 2021 05 28  
(181) 2031 05 28  
(891) 2021 05 28  
(511) 35, 41, 42

---

(260) AM 2022 113940 A  
(800) 1602683  
(151) 2020 12 16  
(181) 2030 12 16  
(891) 2020 12 16  
(511) 05

---

(260) AM 2022 113941 A  
(800) 1602745  
(151) 2021 04 02  
(181) 2031 04 02  
(891) 2021 04 02  
(511) 03

---

(260) AM 2022 113943 A  
(800) 1602816  
(151) 2021 04 23  
(181) 2031 04 23  
(891) 2021 04 23  
(511) 02

---

(260) AM 2022 114021 A  
(800) 1256535  
(151) 2015 06 03  
(181) 2025 06 03  
(891) 2021 06 03  
(511) 05

---

(260) AM 2022 114119 A  
(800) 1550011  
(151) 2020 07 28  
(181) 2030 07 28  
(891) 2021 06 25  
(511) 05

---

(260) AM 2022 114120 A  
(800) 1550066  
(151) 2020 07 28  
(181) 2030 07 28  
(891) 2021 06 22  
(511) 44

---

(260) AM 2022 114121 A  
(800) 1555760  
(151) 2020 07 31  
(181) 2030 07 31  
(891) 2021 06 20  
(511) 07

---

---

**OFFICIAL NOTIFICATIONS  
INVENTIONS  
RESTORATION OF PATENTS**

(21) AP 2013 13532  
(11) P 2017 6767 B  
(73) Chiesi Farmaceutici S.P.A.  
(54) DRY POWDER FORMULATION COMPRISING A CORTICOSTEROID AND A BETA-ADRENERGIC  
FOR ADMINISTRATION BY INHALATION  
DATE OF PATENT CANCELLATION: 2022 01 23  
DATE OF PATENT RESTORATION: 2022 06 27

---

(21) AP 2018 14757  
(11) P 2019 7027 B  
(73) Georgian Technical University;  
Nikoloz Mghebrishvili;  
Gregory Moiseev;  
Giorgi Mghebrishvili  
(54) SYSTEM FOR INDICATION OF WEAR WEIGHTS OF MOBILE TRAINS AND RAILS  
DATE OF PATENT CANCELLATION: 2022 04 13  
DATE OF PATENT RESTORATION: 2022 06 27

---

(21) AP 2018 15169  
(11) P 2020 7202 B  
(73) Chiesi Farmaceutici S.P.A.  
(54) TYROSINE AMIDE DERIVATIVES AS RHO-KINASE INHIBITORS  
DATE OF PATENT CANCELLATION: 2022 01 26  
DATE OF PATENT RESTORATION: 2022 06 27

---

(21) AP 2018 15219  
(11) P 2021 7318 B  
(73) H. Lundbeck A/S  
(54) PYRAZOLE MAGL INHIBITORS  
DATE OF PATENT CANCELLATION: 2022 05 22  
DATE OF PATENT RESTORATION: 2022 06 27

---

(21) AP 1998 5034  
(11) P 2003 3002 B  
(73) Amgen Inc.  
(54) OSTEOPROTEGERIN BINDING PROTEIN AND RECEPTORS  
DATE OF PATENT CANCELLATION: 2022 04 15  
DATE OF PATENT RESTORATION: 2022 06 27

---

(21) AP 2004 8200  
(11) P 2006 3744 B  
(73) Giorgi Kakhiani  
(54) METHOD FOR PRODUCTION OF VACCINE AGAINST ANTHRAX  
DATE OF PATENT CANCELLATION: 2022 05 10  
DATE OF PATENT RESTORATION: 2022 06 27

---

---

**ABOLITION OF PATENTS WITH THE RIGHT TO RESTORE**

(21) AP 2012 13315  
(11) P 2017 6679 B  
(73) Chiesi Farmaceutici S.P.A.  
(54) COMPOUNDS HAVING MUSCARINIC RECEPTOR ANTAGONIST AND BETA2 ADRENERGIC RECEPTOR AGONIST ACTIVITY  
DATE OF PATENT CANCELLATION: 2022 06 07  
LIMITED DATE OF PATENT RESTORATION: 2023 06 07

---

(21) AP 2017 14402  
(11) P 2018 6897 B  
(73) LEPL "Technical University of Georgia";  
LEPL "Shota Rustaveli National Science Foundation"  
(54) METHOD FOR CEMENT PRODUCTION  
DATE OF PATENT CANCELLATION: 2022 02 02  
LIMITED DATE OF PATENT RESTORATION: 2023 02 02

---

(21) AP 2016 14669  
(11) P 2021 7271 B  
(73) Macrogenics Inc.  
(54) COMBINATION THERAPY FOR THE TREATMENT OF CANCER  
DATE OF PATENT CANCELLATION: 2022 06 09  
LIMITED DATE OF PATENT RESTORATION: 2023 06 09

---

(21) AP 2017 14978  
(11) P 2020 7160 B  
(73) Vernalis (R&D) LTD;  
Les Laboratoires Servier  
(54) NEW PIPERIDINYL DERIVATIVES, A PROCESS FOR THEIR PREPARATION AND PHARMACEUTICAL COMPOSITIONS CONTAINING THEM  
DATE OF PATENT CANCELLATION: 2022 06 09  
LIMITED DATE OF PATENT RESTORATION: 2023 06 09

---

(21) AP 2017 14982  
(11) P 2020 7161 B  
(73) Les Laboratoires Servier;  
Vernalis (R&D) LTD  
(54) NEW (HETERO)ARYL-SUBSTITUTED-PIPERIDINYL DERIVATIVES, A PROCESS FOR THEIR PREPARATION AND PHARMACEUTICAL COMPOSITIONS CONTAINING THEM  
DATE OF PATENT CANCELLATION: 2022 06 09  
LIMITED DATE OF PATENT RESTORATION: 2023 06 09

---

(21) AP 2018 15251  
(11) P 2022 7336 B  
(73) METYS PHARMACEUTICALS AG  
(54) SYNERGISTIC COMPOSITIONS COMPRISING (R)-DIMIRACETAM (1) AND (S)-DIMIRACETAM (2) IN A NON-RACEMIC RATIO  
DATE OF PATENT CANCELLATION: 2022 05 30  
LIMITED DATE OF PATENT RESTORATION: 2023 05 30

---

## EXPIRATION OF TERMS OF RESTORATION OF PATENTS

(21) AP 2006 10459  
(11) P 2011 5324 B  
(73) Biogen MA Inc.  
(54) TWEAK BINDING ANTIBODIES  
DATE OF PATENT CANCELLATION: 2021 05 25  
DATE OF PATENT RESTORATION VALIDITY HAS EXPIRED: 2022 05 25

---

(21) AP 2012 12736  
(11) P 2015 6339 B  
(73) Les Laboratoires Servier  
(54) NEW CO-CRYSTALS OF AGOMELATINE, PROCESS FOR THEIR PREPARATION AND  
PHARMACEUTICAL COMPOSITIONS CONTAINING THEM  
DATE OF PATENT CANCELLATION: 2021 06 05  
DATE OF PATENT RESTORATION VALIDITY HAS EXPIRED: 2022 06 05

---

(21) AP 2011 12941  
(11) P 2015 6234 B  
(73) Les Laboratoires Servier  
(54) AGOMELATINE INTERMEDIATES AND PREPARATION METHOD THEREOF  
DATE OF PATENT CANCELLATION: 2021 06 08  
DATE OF PATENT RESTORATION VALIDITY HAS EXPIRED: 2022 06 08

---

(21) AP 2014 13984  
(11) P 2017 6762 B  
(73) Takeda Pharmaceutical Company Limited  
(54) PEPTIDE COMPOUND  
DATE OF PATENT CANCELLATION: 2021 05 27  
DATE OF PATENT RESTORATION VALIDITY HAS EXPIRED: 2022 05 27

---

(21) AP 2016 14155  
(11) P 2018 6814 B  
(73) LEPL "Technical University of Georgia"  
(54) CRITICAL METEOROLOGICAL SITUATION MONITORING, DETECTION AND NOTIFICATION  
SYSTEM  
DATE OF PATENT CANCELLATION: 2021 05 24  
DATE OF PATENT RESTORATION VALIDITY HAS EXPIRED: 2022 05 24

---

(21) AP 2015 14361  
(11) P 2018 6923 B  
(73) Egis Gyogyszergyar ZRT.  
(54) DASATINIB SALTS  
DATE OF PATENT CANCELLATION: 2021 05 26  
DATE OF PATENT RESTORATION VALIDITY HAS EXPIRED: 2022 05 26

---

(21) AP 2017 14510  
(11) P 2021 7245 B  
(73) David Kopaleishvili;  
Otar Barbakadze;  
Vasil Kopaleishvili;

---

Mzia Tabagari;  
Irakli Kashakashvili  
(54) STEEL FOR THE PRODUCTION OF PENETRATING DEVICE ARBORS  
DATE OF PATENT CANCELLATION: 2021 06 05  
DATE OF PATENT RESTORATION VALIDITY HAS EXPIRED: 2022 06 05

---

(21) AP 2005 9756  
(11) P 2010 4895 B  
(73) Upjohn US 1 LLC  
(54) PREPARATION OF PREGABALIN AND RELATED COMPOUNDS  
DATE OF PATENT CANCELLATION: 2021 06 09  
DATE OF PATENT RESTORATION VALIDITY HAS EXPIRED: 2022 06 09

---

## TRANSFER OF RIGHTS

(21) AP 2014 14012  
(11) P 2019 6996 B  
(54) SHEET FOR CUTANEOUS APPLICATION CONTAINING VITAMIN E OR AN ESTER THEREOF  
NEW NAME AND ADDRESS OF PATENT OWNER: Hulka S.R.L. (IT)  
Viale della Scienza 26, 45100, Rovigo, Italy (IT)  
FORMER NAME AND ADDRESS OF PATENT OWNER: BIO.LO.GA. S.R.L.  
Via Giuseppe Lazzarin 66, I-31015 Conegliano  
(Treviso) , Italy (IT)  
DATE OF REGISTRATION: 2022 06 17

---

(21) AP 2015 14289  
(11) P 2017 6765 B  
(54) FORMULATION FOR PERSONAL HYGIENE  
NEW NAME AND ADDRESS OF PATENT OWNER: Hulka S.R.L. (IT)  
Viale della Scienza 26, 45100, Rovigo, Italy (IT)  
FORMER NAME AND ADDRESS OF PATENT OWNER: BIO.LO.GA. S.R.L.  
Via Giuseppe Lazzarin 66, I-31015 Conegliano  
(Treviso) , Italy (IT)  
DATE OF REGISTRATION: 2022 06 13

---

(21) AP 2015 14382  
(11) P 2018 6830 B  
(54) COMPOSITION COMPRISING ESTER OF ALPHA-TOCOPHEROL FOR PREVENTION AND  
TREATMENT OF ALLERGIC RHINITIS  
NEW NAME AND ADDRESS OF PATENT OWNER: Hulka S.R.L. (IT)  
Viale della Scienza 26, 45100, Rovigo, Italy (IT)  
FORMER NAME AND ADDRESS OF PATENT OWNER: BIO.LO.GA. S.R.L.  
Via Giuseppe Lazzarin 66, I-31015 Conegliano  
(Treviso) , Italy (IT)  
DATE OF REGISTRATION: 2022 06 13

---

(21) AP 2015 14463  
(11) P 2018 6863 B  
(54) PHARMACEUTICAL COMPOSITION FOR USE IN INCREASING THE TROPHISM OF NASAL MUCOSA

NEW NAME AND ADDRESS OF PATENT OWNER: Hulka S.R.L. (IT)  
Viale della Scienza 26, 45100, Rovigo, Italy (IT)

FORMER NAME AND ADDRESS OF PATENT OWNER: BIO.LO.GA. S.R.L.  
Via Giuseppe Lazzarin 66, I-31015 Conegliano (Treviso) , Italy (IT)

DATE OF REGISTRATION: 2022 06 13

---

(21) AP 2016 14731  
(11) P 2019 6971 B  
(54) HYDROPHOBIC GEL BASED ON VITAMIN E FREE FROM SILICONE PRODUCTS FOR TOPICAL APPLICATION

NEW NAME AND ADDRESS OF PATENT OWNER: Hulka S.R.L. (IT)  
Viale della Scienza 26, 45100, Rovigo, Italy (IT)

FORMER NAME AND ADDRESS OF PATENT OWNER: BIO.LO.GA. S.R.L.  
Via Giuseppe Lazzarin 66, I-31015 Conegliano (Treviso) , Italy (IT)

DATE OF REGISTRATION: 2022 06 13

---

(21) AP 2017 15008  
(11) P 2020 7094 B  
(54) COMPOSITION FOR TOPICAL APPLICATION WITH ANTIFUNGAL ACTIVITY

NEW NAME AND ADDRESS OF PATENT OWNER: Hulka S.R.L. (IT)  
Viale della Scienza 26, 45100, Rovigo, Italy (IT)

FORMER NAME AND ADDRESS OF PATENT OWNER: BIO.LO.GA. S.R.L.  
Via Giuseppe Lazzarin 66, I-31015 Conegliano (Treviso) , Italy (IT)

DATE OF REGISTRATION: 2022 06 13

---

(21) AP 2018 15201  
(11) P 2020 7179 B  
(54) FORMULATION BASED ON VITAMIN E OR ESTER THEREOF FOR TREATING BACTERIAL AND FUNGAL BIOFILMS

NEW NAME AND ADDRESS OF PATENT OWNER: Hulka S.R.L. (IT)  
Viale della Scienza 26, 45100, Rovigo, Italy (IT)

FORMER NAME AND ADDRESS OF PATENT OWNER: BIO.LO.GA. S.R.L.  
Via Giuseppe Lazzarin 66, I-31015 Conegliano (Treviso) , Italy (IT)

DATE OF REGISTRATION: 2022 06 13

---



## UTILITY MODELS

## ABOLITION OF PATENTS WITH THE RIGHT TO RESTORE

(21) AU 2014 13486  
(11) U 2015 1876 Y  
(73) Nugzar Joglidze;  
Konstantine Maghradze  
(54) PRODUCT OF CLINICAL NUTRITION  
DATE OF PATENT CANCELLATION: 2022 06 04  
LIMITED DATE OF PATENT RESTORATION: 2023 06 04

---

(21) AU 2020 15358  
(11) U 2021 2077 Y  
(73) Savle Chkhitudze  
(54) HYDROPOWER ON COMMUNICATING VESSELS PRINCIPLE  
DATE OF PATENT CANCELLATION: 2022 06 06  
LIMITED DATE OF PATENT RESTORATION: 2023 06 06

---

## EXPIRATION OF TERMS OF RESTORATION OF PATENTS

(21) AU 2013 13112  
(11) U 2014 1825 Y  
(73) Elguja Shapakidze;  
Vladimer Miruashvili  
(54) DEVICE REELING THREAD FROM COCOON  
DATE OF PATENT CANCELLATION: 2021 06 06  
DATE OF PATENT RESTORATION VALIDITY HAS EXPIRED: 2022 06 06

---

(21) AU 2018 14800  
(11) U 2020 2031 Y  
(73) Tatiana Gegechkori;  
Grigor Mamniashvili;  
Vakhtang Peikrishvili;  
Akaki Peikrishvili;  
Bagrat Godibadze  
(54) SHOCK CONSOLIDATION OF MgB<sub>2</sub> SUPERCONDUCTING COMPOSITES IN LIQUID CONDITION  
DATE OF PATENT CANCELLATION: 2021 05 29  
DATE OF PATENT RESTORATION VALIDITY HAS EXPIRED: 2022 05 29

---

(21) AU 2019 15097  
(11) U 2020 2036 Y  
(73) Revaz Sikharulidze  
(54) DEVICE FOR PRODUCING TWO-LAYER BLOCKS  
DATE OF PATENT CANCELLATION: 2021 05 30  
DATE OF PATENT RESTORATION VALIDITY HAS EXPIRED: 2022 05 30

---

## DESIGNS

### CANCELLATION OF DESIGN REGISTRATION

(11) D 2017 716 S  
(73) LTD "Greifi" (GE)  
Nushi Str. 7, 0178, Tbilisi, Georgia (GE)  
(54) "TATARA" SHAPES  
(18) 2021 11 25  
(58) 2022 06 06

---

### CANCELLATION OF INTERNATIONAL DESIGNS REGISTRATION

(11) DM/66586  
(73) DAIMLERCHRYSLER AG  
Epplestrasse 225, 70567 Stuttgart (DE)  
CANCELLATION DATE OF REGISTRATION: 2020 05 06  
(58) 2022 06 09

---

(11) DM/66627  
(73) Daimler AG  
Mercedesstrasse 120 70372 Stuttgart (DE)  
CANCELLATION DATE OF REGISTRATION: 2020 05 17  
(58) 2022 06 09

---

(11) DM/66742  
(73) SWATCH AG (SWATCH SA) (SWATCH LTD.)  
94, Rue Jakob Stämpfli, CH-2502 BIENNE (CH)  
CANCELLATION DATE OF REGISTRATION: 2019 12 20  
(58) 2022 06 09

---

(11) DM/67192  
(73) Daimler AG  
Mercedesstrasse 120 70372 Stuttgart (DE)  
CANCELLATION DATE OF REGISTRATION: 2020 11 11  
(58) 2022 06 09

---

(11) DM/67193  
(73) Daimler AG  
Mercedesstrasse 120 70372 Stuttgart (DE)  
CANCELLATION DATE OF REGISTRATION: 2020 11 11  
(58) 2022 06 09

---

(11) DM/67197  
(73) Daimler AG  
Mercedesstrasse 120 70372 Stuttgart (DE)  
CANCELLATION DATE OF REGISTRATION: 2020 11 09  
(58) 2022 06 09

---

(11) DM/67198  
(73) Daimler AG  
Mercedesstrasse 120 70372 Stuttgart (DE)  
CANCELLATION DATE OF REGISTRATION: 2020 11 09  
(58) 2022 06 09

---

(11) DM/67199  
(73) Daimler AG  
Mercedesstrasse 120 70372 Stuttgart (DE)  
CANCELLATION DATE OF REGISTRATION: 2020 11 09  
(58) 2022 06 09

---

(11) DM/67249  
(73) SWATCH AG (SWATCH SA) (SWATCH LTD.)  
94, Rue Jakob Stämpfli, CH-2502 BIENNE (CH)  
CANCELLATION DATE OF REGISTRATION: 2020 12 06  
(58) 2022 06 09

---

(11) DM/67254  
(73) SWATCH AG (SWATCH SA) (SWATCH LTD.)  
94, Rue Jakob Stämpfli, CH-2502 BIENNE (CH)  
CANCELLATION DATE OF REGISTRATION: 2020 12 05  
(58) 2022 06 09

---

(11) DM/67266  
(73) Daimler AG  
Mercedesstrasse 120 70372 Stuttgart (DE)  
CANCELLATION DATE OF REGISTRATION: 2020 11 11  
(58) 2022 06 09

---

(11) DM/67307  
(73) SWATCH AG (SWATCH SA) (SWATCH LTD.)  
94, Rue Jakob Stämpfli, CH-2502 BIENNE (CH)  
CANCELLATION DATE OF REGISTRATION: 2020 12 22  
(58) 2022 06 09

---

(11) DM/67308  
(73) SWATCH AG (SWATCH SA) (SWATCH LTD.)  
94, Rue Jakob Stämpfli, CH-2502 BIENNE (CH)  
CANCELLATION DATE OF REGISTRATION: 2020 12 22  
(58) 2022 06 10

---

(11) DM/67370  
(73) URS HÄRRI, ENGINEERING-BERATUNG  
2, Erlenmoosweg, CH-8840 EINSIEDELN (CH)  
CANCELLATION DATE OF REGISTRATION: 2020 12 07  
(58) 2022 06 10

---

(11) DM/67402  
(73) BRAUN GMBH  
Frankfurter Str. 145, 61476 Kronberg (DE)  
CANCELLATION DATE OF REGISTRATION: 2021 01 09  
(58) 2022 06 10

---

(11) DM/67441  
(73) Daimler AG  
Mercedesstrasse 120 70372 Stuttgart (DE)  
CANCELLATION DATE OF REGISTRATION: 2021 01 27  
(58) 2022 06 10

---

(11) DM/67446  
(73) Daimler AG  
Mercedesstrasse 120 70372 Stuttgart (DE)  
CANCELLATION DATE OF REGISTRATION: 2021 02 01  
(58) 2022 06 10

---

(11) DM/67513  
(73) SOCIÉTÉ DES PRODUITS NESTLÉ S.A.  
CH-1800 Vevey (CH)  
CANCELLATION DATE OF REGISTRATION: 2021 02 01  
(58) 2022 06 10

---

(11) DM/67560  
(73) Daimler AG  
Mercedesstrasse 120 70372 Stuttgart (DE)  
CANCELLATION DATE OF REGISTRATION: 2021 02 24  
(58) 2022 06 17

---

(11) DM/67588  
(73) MONTRES JAQUET DROZ SA (MONTRES JAQUET DROZ AG) (MONTRES JAQUET DROZ LTD.)  
5, rue Jaquet Droz, CH-2300 La Chaux-de-Fonds (CH)  
CANCELLATION DATE OF REGISTRATION: 2021 03 28  
(58) 2022 06 17

---

(11) DM/67630  
(73) Daimler AG  
Mercedesstrasse 120 70372 Stuttgart (DE)  
CANCELLATION DATE OF REGISTRATION: 2021 03 17  
(58) 2022 06 17

---

(11) DM/67681  
(73) EBEL WATCHES SA  
Nidaugasse 35, CH-2502 Bienne (CH)  
CANCELLATION DATE OF REGISTRATION: 2021 03 29  
(58) 2022 06 17

---

(11) DM/67742  
(73) THE SWATCH GROUP MANAGEMENT SERVICES AG (THE SWATCH GROUP MANAGEMENT SERVICES SA) (THE SWATCH GROUP MANAGEMENT SERVICES LTD)  
Seevorstadt 6, CH-2502 Biel/Bienne (CH)  
CANCELLATION DATE OF REGISTRATION: 2021 03 29  
(58) 2022 06 10

---

(11) DM/67791  
(73) THE SWATCH GROUP MANAGEMENT SERVICES AG (THE SWATCH GROUP MANAGEMENT SERVICES SA) (THE SWATCH GROUP MANAGEMENT SERVICES LTD)  
Seevorstadt 6, BIEL (CH)  
CANCELLATION DATE OF REGISTRATION: 2021 03 28  
(58) 2022 06 17

---

(11) DM/67795  
(73) COMPAGNIE DES MONTRES LONGINES, FRANCILLON S.A. (LONGINES WATCH CO., FRANCILLON LTD.)  
CH-2610 SAINT-IMIER (CH)  
CANCELLATION DATE OF REGISTRATION: 2021 05 02  
(58) 2022 06 17

---

(11) DM/67796  
(73) COMPAGNIE DES MONTRES LONGINES, FRANCILLON S.A. (LONGINES WATCH CO., FRANCILLON LTD.)  
CH-2610 SAINT-IMIER (CH)  
CANCELLATION DATE OF REGISTRATION: 2021 05 02  
(58) 2022 06 17

---

(11) DM/67842  
(73) TEFAL  
Zone Industrielle des Granges, F-74150 RUMILLY (FR)  
CANCELLATION DATE OF REGISTRATION: 2021 05 23  
(58) 2022 06 17

---

(11) DM/68053  
(73) SOCIÉTÉ DES PRODUITS NESTLÉ S.A.  
CH-1800 Vevey (CH)  
CANCELLATION DATE OF REGISTRATION: 2021 08 02  
(58) 2022 06 17

---

(11) DM/68091  
(73) SOCIÉTÉ DES PRODUITS NESTLÉ S.A.  
CH-1800 Vevey (CH)  
CANCELLATION DATE OF REGISTRATION: 2021 08 02  
(58) 2022 06 17

---

(11) DM/68114  
(73) MONTRES JAQUET DROZ SA (MONTRES JAQUET DROZ AG) (MONTRES JAQUET DROZ LTD.)  
Allée du Tourbillon 2, CH-2300 La Chaux-de-Fonds (CH)  
CANCELLATION DATE OF REGISTRATION: 2021 09 08  
(58) 2022 06 17

---

(11) DM/68154  
(73) CERTINA, KURTH FRERES S.A. (CERTINA, GEHR. KURTH AG) (CERTINA, KURTH BROS. LTD.)  
Chemin des Tourelles 17, LE LOCLE (CH)  
CANCELLATION DATE OF REGISTRATION: 2021 09 13  
(58) 2022 06 17

---

(11) DM/68173  
(73) THE PROCTER & GAMBLE COMPANY  
One Procter & Gamble Plaza, Cincinnati, OH 45202 (US)  
CANCELLATION DATE OF REGISTRATION: 2021 09 25  
(58) 2022 06 17

---

(11) DM/68179  
(73) THE PROCTER & GAMBLE COMPANY  
One Procter & Gamble Plaza, Cincinnati, OH 45202 (US)  
CANCELLATION DATE OF REGISTRATION: 2021 09 11  
(58) 2022 06 17

---

(11) DM/74675  
(73) KRALLMANN KUNSTSTOFFVERARBEITUNG GMBH  
Siemensstraße 24, 32120 Hiddenhausen (DE)  
CANCELLATION DATE OF REGISTRATION: 2020 09 24  
(58) 2022 06 17

---

(11) DM/74678  
(73) VERTU CORPORATION LIMITED  
Beacon Hill Road Church Crookham, Hampshire GU52 8DY (GB)  
CANCELLATION DATE OF REGISTRATION: 2015 10 15  
(58) 2022 06 17

---

(11) DM/74704  
(73) THE SWATCH GROUP MANAGEMENT SERVICES AG (THE SWATCH GROUP MANAGEMENT SERVICES SA) (THE SWATCH GROUP MANAGEMENT SERVICES LTD.)  
Seevorstadt 6, CH-2501 BIEL/BIENNE (CH)  
CANCELLATION DATE OF REGISTRATION: 2020 11 05  
(58) 2022 06 17

---

(11) DM/75193  
(73) SAR PRINCESSE AREEJ BINT TURKI NASSER AL SAUD  
37 avenue d'Iéna, F-75116 Paris (FR)  
CANCELLATION DATE OF REGISTRATION: 2020 12 09  
(58) 2022 06 17

---

(11) DM/75225  
(73) ETA SA MANUFACTURE HORLOGERE SUISSE  
CH-2540 GRENCHEN (CH)  
CANCELLATION DATE OF REGISTRATION: 2021 02 03  
(58) 2022 06 17

---

(11) DM/75277  
(73) ETA SA MANUFACTURE HORLOGÈRE SUISSE  
CH-2540 Grenchen (CH)  
CANCELLATION DATE OF REGISTRATION: 2021 02 14  
(58) 2022 06 17

---

(11) DM/75355  
(73) ALFRED KÄRCHER GMBH & CO. KG  
Alfred-Kärcher-Str. 28-40, 71364 Winnenden (DE)  
CANCELLATION DATE OF REGISTRATION: 2021 02 11  
(58) 2022 06 17

---

(11) DM/75453  
(73) COMPAGNIE DES MONTRES LONGINES, FRANCILLON S.A.  
CH-2610 SAINT-IMIER (CH)  
CANCELLATION DATE OF REGISTRATION: 2021 02 24  
(58) 2022 06 17

---

(11) DM/75477  
(73) RULENCE DAMIEN  
12 clos des Maraîchers, F-91310 Longpont sur Orge (FR)  
CANCELLATION DATE OF REGISTRATION: 2020 10 21  
(58) 2022 06 17

---

(11) DM/75498  
(73) ETA SA MANUFACTURE HORLOGÈRE SUISSE  
CH-2540 Grenchen (CH)  
CANCELLATION DATE OF REGISTRATION: 2021 03 08  
(58) 2022 06 17

---

(11) DM/75585  
(73) THE SWATCH GROUP MANAGEMENT SERVICES AG (THE SWATCH GROUP MANAGEMENT SERVICES SA) (THE SWATCH GROUP MANAGEMENT SERVICES LTD.)  
Faubourg du Lac 6, CH-2502 Biel/Bienne (CH)  
CANCELLATION DATE OF REGISTRATION: 2021 03 11  
(58) 2022 06 17

---

(11) DM/87841  
(73) VELINE COSMETICS S.A. S.K.A.  
ul. Zytnia 19, 05-506 LESZNOWOLA, Poland  
CANCELLATION DATE OF REGISTRATION: 2020 06 25  
(58) 2022 06 17

---

(11) DM/87992  
(73) OJC CO., LTD  
153, Yangpyeong-ro, Yeongdeungpo-gu, Seoul 07207 (KR)  
CANCELLATION DATE OF REGISTRATION: 2020 09 14  
(58) 2022 06 17

---

(11) DM/88167  
(73) IVAYLO EMILOV VELEV  
"Debelo Guno" str. 999, BG-1137 Pancharevo (BG)  
CANCELLATION DATE OF REGISTRATION: 2019 11 19  
(58) 2022 06 17

---

(11) DM/88327  
(73) VALENTINO S.P.A.  
Via Turati, 16/18, I-20121 MILANO (EM)  
CANCELLATION DATE OF REGISTRATION: 2020 11 11  
(58) 2022 06 17

---

(11) DM/93675  
(73) PATROIS GUILLAUME  
55 avenue Marceau, F-75016 Paris (FR)  
CANCELLATION DATE OF REGISTRATION: 2021 04 24  
(58) 2022 06 17

---



**TRADEMARKS****EXTENSION OF TERMS OF TRADEMARKS REGISTRATION**

(111) M 2002 14499 R2  
(156) 2002 06 13  
(186) 2032 06 13  
(732) Zebco Holdings LLC  
6101 East Apache, Tulsa, OK 74115, USA

---

(111) M 2002 14500 R2  
(156) 2002 06 13  
(186) 2032 06 13  
(732) Zebco Holdings LLC  
6101 East Apache, Tulsa, OK 74115, USA

---

(111) M 2012 22396 R1  
(156) 2012 03 16  
(186) 2032 03 16  
(732) JSC "Badagoni"  
Vill. Zemo Khodasheni, Akhmeta Region,  
Georgia

---

(111) M 2012 22447 R1  
(156) 2012 04 05  
(186) 2032 04 05  
(732) JSC "Badagoni"  
Vill. Zemo Khodasheni, 0910, Akhmeta  
Region, Georgia

---

(111) M 2012 22634 R1  
(156) 2012 05 16  
(186) 2032 05 16  
(732) Tiffany and Company  
727 Fifth Avenue, New York, New York,  
USA

---

(111) M 2012 22635 R1  
(156) 2012 05 16  
(186) 2032 05 16  
(732) Tiffany and Company  
727 Fifth Avenue, New York, New York,  
USA

---

(111) M 2012 22636 R1  
(156) 2012 05 16  
(186) 2032 05 16  
(732) Tiffany and Company  
727 Fifth Avenue, New York, New York,  
USA

---

(111) M 2012 22883 R1  
(156) 2012 08 30  
(186) 2032 08 30  
(732) Discovery Communications LLC  
8403 Colesville Road, Silver Spring, Maryland  
20910, USA

---

(111) M 2012 22884 R1  
(156) 2012 08 30  
(186) 2032 08 30  
(732) Shakro Bakuradze  
Gabashvili Str. 3, app. 43, Tbilisi, Georgia;  
Shakespeare Yusupov  
Nutsubidze Slope, III mcr., II qu., bld. 8,  
app. 22, 0183, Tbilisi, Georgia

---

(111) M 2012 22902 R1  
(156) 2012 08 30  
(186) 2032 08 30  
(732) Gap (ITM) Inc.  
2 Folsom Street, San Francisco, CA 94105,  
USA

---

(111) M 2012 22903 R1  
(156) 2012 08 30  
(186) 2032 08 30  
(732) Gap (ITM) Inc.  
2 Folsom Street, San Francisco, CA 94105,  
USA

---

(111) M 2012 22904 R1  
(156) 2012 08 30  
(186) 2032 08 30  
(732) Gap (ITM) Inc.  
2 Folsom Street, San Francisco, CA 94105,  
USA

---

(111) M 2012 22905 R1  
(156) 2012 08 30  
(186) 2032 08 30  
(732) Gap (ITM) Inc.  
2 Folsom Street, San Francisco, CA 94105,  
USA

---

(111) M 2012 22906 R1  
(156) 2012 08 30  
(186) 2032 08 30  
(732) Gap (ITM) Inc.  
2 Folsom Street, San Francisco, CA 94105,  
USA

---

(111) M 2012 22913 R1  
(156) 2012 08 30  
(186) 2032 08 30  
(732) Gap (ITM) Inc.  
2 Folsom Street, San Francisco, CA 94105,  
USA

---

(111) M 2012 22907 R1  
(156) 2012 08 30  
(186) 2032 08 30  
(732) Gap (ITM) Inc.  
2 Folsom Street, San Francisco, CA 94105,  
USA

---

(111) M 2012 22914 R1  
(156) 2012 08 30  
(186) 2032 08 30  
(732) Gap (ITM) Inc.  
2 Folsom Street, San Francisco, CA 94105,  
USA

---

(111) M 2012 22908 R1  
(156) 2012 08 30  
(186) 2032 08 30  
(732) Gap (ITM) Inc.  
2 Folsom Street, San Francisco, CA 94105,  
USA

---

(111) M 2012 22915 R1  
(156) 2012 08 30  
(186) 2032 08 30  
(732) Gap (ITM) Inc.  
2 Folsom Street, San Francisco, CA 94105,  
USA

---

(111) M 2012 22909 R1  
(156) 2012 08 30  
(186) 2032 08 30  
(732) Gap (ITM) Inc.  
2 Folsom Street, San Francisco, CA 94105,  
USA

---

(111) M 2012 22916 R1  
(156) 2012 08 30  
(186) 2032 08 30  
(732) Gap (ITM) Inc.  
2 Folsom Street, San Francisco, CA 94105,  
USA

---

(111) M 2012 22910 R1  
(156) 2012 08 30  
(186) 2032 08 30  
(732) Gap (ITM) Inc.  
2 Folsom Street, San Francisco, CA 94105,  
USA

---

(111) M 2012 23214 R1  
(156) 2012 12 24  
(186) 2032 12 24  
(732) Best Western Internarional Inc.  
6201 North 24-th Parkway, Phoenix, Arizona  
85016, USA

---

(111) M 2012 22911 R1  
(156) 2012 08 30  
(186) 2032 08 30  
(732) Gap (ITM) Inc.  
2 Folsom Street, San Francisco, CA 94105,  
USA

---

(111) M 2012 23216 R1  
(156) 2012 12 24  
(186) 2032 12 24  
(732) Best Western Internarional Inc.  
6201 North 24-th Parkway, Phoenix, Arizona  
85016, USA

---

(111) M 2012 22912 R1  
(156) 2012 08 30  
(186) 2032 08 30  
(732) Gap (ITM) Inc.  
2 Folsom Street, San Francisco, CA 94105,  
USA

---

(111) M 2012 23217 R1  
(156) 2012 12 24  
(186) 2032 12 24  
(732) Best Western Internarional Inc.  
6201 North 24-th Parkway, Phoenix, Arizona  
85016, USA

---

## COMPLETE TRANSFER OF RIGHTS

(111) M 2014 25411 R  
(732) Sayidat Alsalam Fze  
Workstation No. S10123 O101 WS67,  
Jebel Ali Free Zone, Dubai, United Arab  
Emirates  
(770) Al-Zawra'a for Tobacco and Cigarettes  
Trading  
S.k. 941936, Amani 11194, Jordan  
(580) 2022 06 07

---

(111) M 1997 6592 R  
(732) Volvo Traq Korporeishen  
SE-405 08, Goteborg, Sweden  
(770) AB Volvo  
SE-405 08, Goteborg, Sweden  
(580) 2022 05 30

---

(111) M 1997 6592 R  
(732) AB Volvo  
SE-405 08, Goteborg, Sweden  
(770) Mack Trucks, Inc.  
7900 Natioinal Service Road, Greensboro,  
North Carolina 27409, USA  
(580) 2022 05 30

---

## CHANGES OF NAMES AND/OR ADDRESSES OF TRADEMARKS OWNERS

(111) M 2000 13182 R  
(732) Barry Callebaut AG  
Hardturmstrasse 181, 8005 Zürich,  
Switzerland

(770) Barry Callebaut AG  
Westpark, Pfingstweidstrasse 60,  
CH-8005 Zurich, Switzerland  
(580) 2022 06 13

(111) M 2012 22396 R  
(732) JSC "Badagoni"  
Vill. Zemo Khodasheni, 0910, Akhmeta  
Region, Georgia  
(770) LTD "Badagoni"  
Vill. Zemo Khodasheni, 0910, Akhmeta  
Region, Georgia  
(580) 2022 06 15

(111) M 2012 22447 R  
(732) JSC "Badagoni"  
Vill. Zemo Khodasheni, 0910, Akhmeta  
Region, Georgia  
(770) LTD "Badagoni"  
Vill. Zemo Khodasheni, 0910, Akhmeta  
Region, Georgia  
(580) 2022 06 15

(111) M 2012 22883 R  
(732) Discovery Communications LLC  
8403 Colesville Road, Silver Spring,  
Maryland 20910, USA  
(770) Discovery Communications LLC  
One Discovery Place, Silver Spring,  
Maryland 20910, USA  
(580) 2022 06 07

(111) M 1997 7531 R  
(732) Barry Callebaut AG  
Hardturmstrasse 181, 8005 Zürich,  
Switzerland  
(770) Barry Callebaut AG  
Westpark, Pfingstweidstrasse 60,  
8005 Zurich, Switzerland  
(580) 2022 06 13

(111) M 1997 7532 R  
(732) Barry Callebaut AG  
Hardturmstrasse 181, 8005 Zürich,  
Switzerland  
(770) Barry Callebaut AG

Westpark, Pfingstweidstrasse 60,  
8005 Zurich, Switzerland  
(580) 2022 06 13

(111) M 1998 8458 R  
(732) RoC Opco LLC  
261 Madison Avenue, 16th Floor, New York,  
New York 10016, USA  
(770) RoC Opco LLC  
c/o Gryphon Investors, One Maritime Plaza,  
Suite 2300, San Francisco, California 94111,  
USA  
(580) 2022 05 19

(111) M 1997 5722 R  
(732) Barry Callebaut AG  
Hardturmstrasse 181, 8005 Zürich,  
Switzerland  
(770) Barry Callebaut AG  
Westpark, Pfingstweidstrasse 60,  
8005 Zurich, Switzerland  
(580) 2022 06 13

## CANCELLATION OF TRADEMARKS REGISTRATION

(111) M 2001 14162 R  
(151) 2001 12 04  
(732) Philip Morris Brands SARL  
Quai Jeanrenaud 3, 2000 Neuchâtel,  
Switzerland  
(141) 2022 06 16

---

(111) M 2011 22030 R  
(151) 2011 12 07  
(732) The Gillette Company LLC  
One Gillette Park, Boston, Massachusetts  
02127, USA  
(141) 2022 06 15

---

(111) M 2011 22032 R  
(151) 2011 12 07  
(732) LTD "Alpenfood"  
M. Kostava Str. 63a, app. 1, 0171, Tbilisi,  
Georgia  
(141) 2022 06 15

---

(111) M 2011 22007 R  
(151) 2011 11 30  
(732) LTD "Multipharma"  
Bakhtrioni Str. 20, Tbilisi, Georgia  
(141) 2022 06 07

---

(111) M 2011 22008 R  
(151) 2011 11 30  
(732) LTD "Multipharma"  
Bakhtrioni Str. 20, Tbilisi, Georgia  
(141) 2022 06 07

---

(111) M 2011 22009 R  
(151) 2011 11 30  
(732) LTD "Multipharma"  
Bakhtrioni Str. 20, Tbilisi, Georgia  
(141) 2022 06 07

---

(111) M 2011 22010 R  
(151) 2011 11 30  
(732) LTD "Multipharma"  
Bakhtrioni Str. 20, Tbilisi, Georgia  
(141) 2022 06 07

---

(111) M 2011 22011 R  
(151) 2011 11 30  
(732) LTD "Multipharma"  
Bakhtrioni Str. 20, Tbilisi, Georgia  
(141) 2022 06 07

---

(111) M 2011 22013 R  
(151) 2011 11 30  
(732) Aleksandre Kavtaradze  
Varketili 3, II mcr., bld. 14, app. 96,  
0163 Tbilisi, Georgia  
(141) 2022 06 07

---

(111) M 2011 22034 R  
(151) 2011 12 07  
(732) LTD "A-B-C Pharmacy"  
Gamsakhurdia's coast St. 10a, 0108, Tbilisi,  
Georgia  
(141) 2022 06 15

---

(111) M 2011 22036 R  
(151) 2011 12 07  
(732) JSC "Gefa"  
Akaki Beliashvili Str. 142, 0159, Tbilisi,  
Georgia  
(141) 2022 06 15

---

(111) M 2011 22014 R  
(151) 2011 11 30  
(732) LTD "Multipharma"  
Bakhtrioni Str. 20, Tbilisi, Georgia  
(141) 2022 06 07

---

(111) M 2011 22037 R  
(151) 2011 12 07  
(732) JSC "Aideko"  
Brose Str. 2, 0108, Tbilisi, Georgia  
(141) 2022 06 15

---

(111) M 2011 22039 R  
(151) 2011 12 07  
(732) LTD "A-B-C Pharmacy"  
Gamsakhurdia's coast St. 10a, 0108, Tbilisi,  
Georgia  
(141) 2022 06 15

---

(111) M 2011 22040 R  
 (151) 2011 12 07  
 (732) Kopaş Kozmetik Pazarlama ve  
 Sanayi Anonim Şirketi  
 Maslak Mahallesi Sümer Sk. N:4 Şişli  
 İstanbul, Turkey  
 (141) 2022 06 15

---

(111) M 2011 22046 R  
 (151) 2011 12 07  
 (732) LTD "Sofia +"  
 Vazha-Pshavela Ave., VII qu., bld. 6, app. 20,  
 Tbilisi, Georgia  
 (141) 2022 06 15

---

(111) M 2011 22029 R  
 (151) 2011 12 07  
 (732) LTD "New Cement"  
 V. Dolidze Str., bld. 27, app. 19, 0171,  
 Tbilisi Georgia  
 (141) 2022 06 15

---

(111) M 2011 22047 R  
 (151) 2011 12 07  
 (732) Harrington Development Inc.  
 Elvira Mendez Street, Vallarino bldg.,  
 3rd Floor, Panama, Republic of Panama  
 (141) 2022 06 16

---

(111) M 2011 21995 R  
 (151) 2011 11 29  
 (732) Harrington Development Inc.  
 Elvira Mendez Street, Vallarino bldg.,  
 3rd Floor, Panama, Republic of Panama  
 (141) 2022 06 07

---

(111) M 2011 21996 R  
 (151) 2011 11 29  
 (732) Harrington Development Inc.  
 Arango-Orillac Bldg. East 54 th street,  
 Republic of Panama  
 (141) 2022 06 06

---

(111) M 2011 21997 R  
 (151) 2011 11 29  
 (732) Harrington Development Inc.  
 Elvira Mendez Street, Vallarino bldg.,  
 3rd Floor, Panama, Republic of Panama  
 (141) 2022 06 06

---

(111) M 2011 22048 R  
 (151) 2011 12 08  
 (732) Ministry of Internal Affairs of Georgia  
 Gulua Str. 10, 0114, Tbilisi, Georgia  
 (141) 2022 06 16

---

(111) M 2011 22049 R  
 (151) 2011 12 08  
 (732) LTD "Geoloc"  
 Vill. Urekhi, 6415, Khelvachauri Region,  
 Georgia  
 (141) 2022 06 16

---

(111) M 2011 22051 R  
 (151) 2011 12 09  
 (732) Allied Global Tobacco Ltd  
 Wey Court West, Union Road, Farnham,  
 Surrey GU9 7PT, United Kingdom  
 (141) 2022 06 17

---

(111) M 2011 22052 R  
 (151) 2011 12 09  
 (732) Global Tobacco International LLC  
 520 S. 7th Street, Suite C, Las Vegas, Nevada,  
 NV 89101, USA  
 (141) 2022 06 17

---

(111) M 2012 22582 R  
 (151) 2012 05 10  
 (732) Allied Global Tobacco Limited  
 Wey Court West, Union Road, Farnham,  
 GU9 7PT Surrey, United Kingdom  
 (141) 2022 06 10 – Registration is canceled by court  
 decision.  
 Ground: Article 2 (a) of the Law of Georgia on  
 Enforcement Proceedings  
 (511) Canceled List of goods and/or services:  
 Class – 34

---

## REGISTRATION OF LICENSE AGREEMENTS

(111) M 2020 33097 R  
(732) LTD "Neogas"  
Gazapkhuli Str. 18, 0177, Tbilisi, Georgia  
(791) LTD "Gas and Petrol Company"  
Kiziki Str. 40, Samgori District, Tbilisi,  
Georgia  
(793) №1703  
from 01 03 2022 to 25 01 2032  
Simple  
Class – 4, 35, 37

---

(793) №1706  
from 01 03 2022 to 25 01 2032  
Simple  
Class – 4, 35, 37

---

(111) M 2020 33098 R  
(732) LTD "Neogas"  
Gazapkhuli Str. 18, 0177, Tbilisi, Georgia  
(791) LTD "Gas and Petrol Company"  
Kiziki Str. 40, Samgori District, Tbilisi,  
Georgia  
(793) №1702  
from 01 03 2022 to 25 01 2032  
Simple  
Class – 4, 35, 37

---

(111) M 2012 23208 R  
(732) LTD "Neogas"  
Gazapkhuli Str. 18, 0177, Tbilisi, Georgia  
(791) LTD "Gas and Petrol Company"  
Kiziki Str. 40, Samgori District, Tbilisi,  
Georgia  
(793) №1707  
from 01 03 2022 to 25 01 2032  
Simple  
Class – 4, 35, 37

---

(111) M 2016 27449 R  
(732) LTD "Neogas"  
Gazapkhuli Str. 18, 0177, Tbilisi, Georgia  
(791) LTD "Gas and Petrol Company"  
Kiziki Str. 40, Samgori District, Tbilisi,  
Georgia  
(793) №1705  
from 01 03 2022 to 25 01 2032  
Simple  
Class – 4, 35, 37

---

(111) M 2016 27454 R  
(732) LTD "Neogas"  
Gazapkhuli Str. 18, 0177, Tbilisi, Georgia  
(791) LTD "Gas and Petrol Company"  
Kiziki Str. 40, Samgori District, Tbilisi,  
Georgia

## INTERNATIONAL LICENSE AGREEMENT

(800) 1181560

(732) Joint-Stock Company "AgroCom"  
Gagarin Str. 61, RU-357100 Nevinnomyssk,  
Stavropol region, Russian Federation

(791) Otkritoe Aktsionernoe Obshchestvo  
"Company "Arnest"  
Kombinatskaya Str. 6, Nevinnomyssk,  
357107, Stavropol region, Russian Federation

(793) №1704  
Special  
from 01 12 2021 to 01 12 2031

Class – 1, 3, 5, 9, 21, 37, 40, 42, 44

---



---

# CLASSIFICATION INDEXES

## INVENTIONS

### CONCORDANCE TABLE OF INTERNATIONAL CLASSIFICATION INDEX AND PUBLICATION NUMBERS

INTERNATIONAL CLASSIFICATION INDEXES (51)	NUMBER OF PUBLISHED APPLICATION (10)
A 01 N 43/78; C 07 D 277/56; C 07 D 411/12	AP 2022 15671 A
A 23 F 3/00	AP 2022 15792 A
A 61 K 8/73; A 61 K 8/891; A 61 K 8/19; A 61 K 8/67; A 61 K 8/92; A 61 K 8/34; A 61 K 8/27; A 61 K 8/37; A 61 Q 15/00	AP 2022 15769 A
A 61 K 9/16; A 61 K 47/02; A 61 K 9/06; A 61 K 47/42; A 61 K 33/26	AP 2022 14903 A
A 61 K 31/19; A 61 K 9/00; A 61 K 31/191; A 61 K 31/185; A 61 K 47/38; A 61 K 9/06	AP 2022 15586 A
A 61 K 31/4196; A 61 K 31/444; A 61 K 31/437; A 61 P 35/00; C 07 D 471/04	AP 2022 15630 A
B 22 B 3/08; B 22 B 47/00; C 22 C 1/06	AP 2022 15489 A
B 30 B 9/02	AP 2022 15442 A
B 66 D 5/26	AP 2022 15650 A
C 12 M 1/34	AP 2022 15657 A
C 22 C 33/04	AP 2022 15513 A
G 01 N 27/12; G 08 B 21/16	AP 2022 15369 A
H 01 L 29/66	AP 2022 15678 A
H 02 K 19/00	AP 2022 15722 A

### CONCORDANCE TABLE OF PUBLICATION NUMBERS AND INTERNATIONAL CLASSIFICATION INDEX

NUMBER OF PUBLISHED APPLICATION (10)	INTERNATIONAL CLASSIFICATION INDEXES (51)
AP 2022 14903 A	A 61 K 9/16; A 61 K 47/02; A 61 K 9/06; A 61 K 47/42; A 61 K 33/26
AP 2022 15369 A	G 01 N 27/12; G 08 B 21/16
AP 2022 15442 A	B 30 B 9/02
AP 2022 15489 A	B 22 B 3/08; B 22 B 47/00; C 22 C 1/06
AP 2022 15513 A	C 22 C 33/04
AP 2022 15586 A	A 61 K 31/19; A 61 K 9/00; A 61 K 31/191; A 61 K 31/185; A 61 K 47/38; A 61 K 9/06
AP 2022 15630 A	A 61 K 31/4196; A 61 K 31/444; A 61 K 31/437; A 61 P 35/00; C 07 D 471/04
AP 2022 15650 A	B 66 D 5/26
AP 2022 15657 A	C 12 M 1/34
AP 2022 15671 A	A 01 N 43/78; C 07 D 277/56; C 07 D 411/12
AP 2022 15678 A	H 01 L 29/66
AP 2022 15722 A	H 02 K 19/00
AP 2022 15769 A	A 61 K 8/73; A 61 K 8/891; A 61 K 8/19; A 61 K 8/67; A 61 K 8/92; A 61 K 8/34; A 61 K 8/27; A 61 K 8/37; A 61 Q 15/00
AP 2022 15792 A	A 23 F 3/00

**CONCORDANCE TABLE OF INTERNATIONAL CLASSIFICATION INDEX,  
PATENT NUMBERS AND PUBLICATION NUMBERS**

INTERNATIONAL CLASSIFICATION INDEX (51)	NUMBER OF PATENT (11)	NUMBER OF PUBLISHED APPLICATION (10)
A 01 N 25/02; A 01 N 25/04; A 01 N 25/16; A 01 N 53/00; A 01 P 7/04	P 2022 7391 B	AP 2022 14391 A
B 07 B 1/28; B 07 B 1/42; B 07 B 1/46	P 2022 7390 B	AP 2022 15368 A
B 64 D 27/10; F 02 K 3/77	P 2022 7393 B	AP 2022 15579 A
C 07 K 16/18; C 07 K 16/44	P 2022 7392 B	AP 2022 15170 A

**CONCORDANCE TABLE OF PATENT NUMBERS,  
PUBLICATION NUMBERS AND INTERNATIONAL CLASSIFICATION INDEX**

NUMBER OF PATENT (11)	NUMBER OF PUBLISHED APPLICATION (10)	INTERNATIONAL CLASSIFICATION INDEX (51)
P 2022 7390 B	AP 2022 15368 A	B 07 B 1/28; B 07 B 1/42; B 07 B 1/46
P 2022 7391 B	AP 2022 14391 A	A 01 N 25/02; A 01 N 25/04; A 01 N 25/16; A 01 N 53/00; A 01 P 7/04
P 2022 7392 B	AP 2022 15170 A	C 07 K 16/18; C 07 K 16/44
P 2022 7393 B	AP 2022 15579 A	B 64 D 27/10; F 02 K 3/77

**CONCORDANCE TABLE OF APPLICATION NUMBERS,  
PUBLICATION NUMBERS AND PATENTS**

NUMBER OF APPLICATION (21)	NUMBER OF PUBLISHED APPLICATION (10)	NUMBER OF PATENT (11)
AP 2015 14391	AP 2022 14391 A	P 2022 7391 B
AP 2018 15170	AP 2022 15170 A	P 2022 7392 B
AP 2020 15368	AP 2022 15368 A	P 2022 7390 B
AP 2021 15579	AP 2022 15579 A	P 2022 7393 B

**UTILITY MODELS****CONCORDANCE TABLE OF INTERNATIONAL CLASSIFICATION INDEX  
AND PUBLICATION NUMBERS**

INTERNATIONAL CLASSIFICATION INDEXES (51)	NUMBER OF PUBLISHED APPLICATION (10)
B 22 F 3/11; B 22 F 3/23 ; C 22 C 1/08	AU 2022 15433 U
B 66 B 9/00	AU 2022 15099 U

**CONCORDANCE TABLE OF PUBLICATION NUMBERS  
AND INTERNATIONAL CLASSIFICATION INDEX**

NUMBER OF PUBLISHED APPLICATION (10)	INTERNATIONAL CLASSIFICATION INDEXES (51)
AU 2022 15099 U	B 66 B 9/00
AU 2022 15433 U	B 22 F 3/11; B 22 F 3/23 ; C 22 C 1/08

**CONCORDANCE TABLE OF INTERNATIONAL CLASSIFICATION INDEX,  
PATENT NUMBERS AND PUBLICATION NUMBERS**

INTERNATIONAL CLASSIFICATION INDEX (51)	NUMBER OF PATENT (11)	NUMBER OF PUBLISHED APPLICATION (10)
A 61 L 2/16	U 2022 2120 Y	AU 2022 15637 U
F 01 K 23/10	U 2022 2119 Y	AU 2022 15699 U

**CONCORDANCE TABLE OF PATENT NUMBERS,  
PUBLICATION NUMBERS AND INTERNATIONAL CLASSIFICATION INDEX**

NUMBER OF PATENT (11)	NUMBER OF PUBLISHED APPLICATION (10)	INTERNATIONAL CLASSIFICATION INDEX (51)
U 2022 2119 Y	AU 2022 15699 U	F 01 K 23/10
U 2022 2120 Y	AU 2022 15637 U	A 61 L 2/16

**CONCORDANCE TABLE OF APPLICATION NUMBERS,  
PUBLICATION NUMBERS AND PATENTS**

NUMBER OF APPLICATION (21)	NUMBER OF PUBLISHED APPLICATION (10)	NUMBER OF PATENT (11)
AU 2021 15637	AU 2022 15637 U	U 2022 2120 Y
AU 2021 15699	AU 2022 15699 U	U 2022 2119 Y

## DESIGNS

### CONCORDANCE TABLE OF INTERNATIONAL CLASSIFICATION INDEX AND PUBLICATION NUMBERS

INTERNATIONAL CLASSIFICATION INDEXES (51)	NUMBER OF PUBLISHED APPLICATION (10)
11-01	AD 2022 1258 S
19-08	AD 2022 1263 S
21-01	AD 2022 1257 S

### CONCORDANCE TABLE OF PUBLICATION NUMBERS AND INTERNATIONAL CLASSIFICATION INDEX

NUMBER OF PUBLISHED APPLICATION (10)	INTERNATIONAL CLASSIFICATION INDEXES (51)
AD 2022 1257 S	21-01
AD 2022 1258 S	11-01
AD 2022 1263 S	19-08

### CONCORDANCE TABLE OF INTERNATIONAL CLASSIFICATION INDEX, NUMBERS OF REGISTRATION AND PUBLICATION NUMBERS

INTERNATIONAL CLASSIFICATION INDEX (51)	NUMBER OF REGISTRATION (11)	NUMBER OF PUBLISHED APPLICATION (10)
01-01	D 2022 937 S	AD 2022 1248 S

### CONCORDANCE TABLE OF NUMBERS OF REGISTRATION, PUBLICATION NUMBERS AND INTERNATIONAL CLASSIFICATION INDEX

NUMBER OF REGISTRATION (11)	NUMBER OF PUBLISHED APPLICATION (10)	INTERNATIONAL CLASSIFICATION INDEX (51)
D 2022 937 S	AD 2022 1248 S	01-01

### CONCORDANCE TABLE OF APPLICATION NUMBERS, PUBLICATION NUMBERS AND NUMBERS OF REGISTRATION

NUMBER OF APPLICATION (21)	NUMBER OF PUBLISHED APPLICATION (10)	NUMBER OF REGISTRATION (11)
AD 2021 1248	AD 2022 1248 S	D 2022 937 S

## TRADEMARKS

### CONCORDANCE TABLE OF REGISTRATION NUMBERS, APPLICATION NUMBERS, PUBLICATION NUMBERS AND BULLETIN NUMBERS

NUMBER OF REGISTRATION (111)	NUMBER OF APPLICATIONS (210)	NUMBER OF PUBLISHED APPLICATIONS (260)	NUMBER OF BULLETIN
M 2022 35556 R	AM 118003	–	12(591)2022
M 2022 35557 R	AM 117746	–	12(591)2022
M 2022 35558 R	AM 117838	–	12(591)2022
M 2022 35559 R	AM 118062	–	12(591)2022
M 2022 35560 R	AM 118063	–	12(591)2022
M 2022 35561 R	AM 117742	–	12(591)2022
M 2022 35562 R	AM 117744	–	12(591)2022
M 2022 35563 R	AM 117745	–	12(591)2022
M 2022 35564 R	AM 117919	–	12(591)2022
M 2022 35565 R	AM 118018	–	12(591)2022
M 2022 35566 R	AM 118019	–	12(591)2022
M 2022 35567 R	AM 118083	–	12(591)2022
M 2022 35568 R	AM 117923	–	12(591)2022
M 2022 35569 R	AM 117931	–	12(591)2022
M 2022 35570 R	AM 117804	–	12(591)2022
M 2022 35571 R	AM 118075	–	12(591)2022
M 2022 35572 R	AM 118076	–	12(591)2022
M 2022 35573 R	AM 117985	–	12(591)2022
M 2022 35574 R	AM 118139	–	12(591)2022
M 2022 35575 R	AM 111082	AM 2022 111082 A	4(583)2022
M 2022 35576 R	AM 112666	AM 2021 112666 A	22(578)2021
M 2022 35577 R	AM 112667	AM 2021 112667 A	22(578)2021
M 2022 35578 R	AM 112670	AM 2021 112670 A	22(578)2021
M 2022 35579 R	AM 112671	AM 2021 112671 A	22(578)2021
M 2022 35580 R	AM 112732	AM 2021 112732 A	22(578)2021
M 2022 35581 R	AM 113024	AM 2021 113024 A	23(579)2021
M 2022 35582 R	AM 113115	AM 2022 113115 A	1(580)2022
M 2022 35583 R	AM 113134	AM 2021 113134 A	22(578)2021
M 2022 35584 R	AM 113218	AM 2022 113218 A	3(582)2022
M 2022 35585 R	AM 113269	AM 2022 113269 A	2(581)2022
M 2022 35586 R	AM 113270	AM 2022 113270 A	2(581)2022
M 2022 35587 R	AM 113271	AM 2022 113271 A	2(581)2022
M 2022 35588 R	AM 113272	AM 2022 113272 A	2(581)2022
M 2022 35589 R	AM 113274	AM 2021 113274 A	23(579)2021
M 2022 35590 R	AM 113345	AM 2022 113345 A	1(580)2022
M 2022 35591 R	AM 113346	AM 2022 113346 A	2(581)2022
M 2022 35592 R	AM 113365	AM 2022 113365 A	2(581)2022
M 2022 35593 R	AM 113373	AM 2022 113373 A	2(581)2022
M 2022 35594 R	AM 113392	AM 2022 113392 A	2(581)2022
M 2022 35595 R	AM 113422	AM 2022 113422 A	3(582)2022
M 2022 35596 R	AM 113430	AM 2022 113430 A	2(581)2022
M 2022 35597 R	AM 113516	AM 2022 113516 A	2(581)2022
M 2022 35598 R	AM 113517	AM 2022 113517 A	2(581)2022
M 2022 35599 R	AM 113608	AM 2022 113608 A	2(581)2022
M 2022 35600 R	AM 113619	AM 2022 113619 A	2(581)2022
M 2022 35601 R	AM 113703	AM 2022 113703 A	4(583)2022

1	2	3	4
M 2022 35602 R	AM 113764	AM 2022 113764 A	2(581)2022
M 2022 35603 R	AM 113774	AM 2022 113774 A	3(582)2022
M 2022 35604 R	AM 113787	AM 2022 113787 A	4(583)2022
M 2022 35605 R	AM 113790	AM 2022 113790 A	4(583)2022
M 2022 35606 R	AM 113793	AM 2022 113793 A	4(583)2022
M 2022 35607 R	AM 113876	AM 2022 113876 A	3(582)2022
M 2022 35608 R	AM 113971	AM 2022 113971 A	3(582)2022
M 2022 35609 R	AM 113973	AM 2022 113973 A	4(583)2022
M 2022 35610 R	AM 113979	AM 2022 113979 A	4(583)2022
M 2022 35611 R	AM 113981	AM 2022 113981 A	3(582)2022
M 2022 35612 R	AM 114034	AM 2022 114034 A	4(583)2022
M 2022 35613 R	AM 114035	AM 2022 114035 A	4(583)2022
M 2022 35614 R	AM 114040	AM 2022 114040 A	5(584)2022
M 2022 35615 R	AM 114042	AM 2022 114042 A	4(583)2022
M 2022 35616 R	AM 114044	AM 2022 114044 A	4(583)2022
M 2022 35617 R	AM 114060	AM 2022 114060 A	4(583)2022
M 2022 35618 R	AM 114140	AM 2022 114140 A	4(583)2022
M 2022 35619 R	AM 114327	AM 2022 114327 A	5(584)2022
M 2022 35620 R	AM 114332	AM 2022 114332 A	5(584)2022
M 2022 35621 R	AM 114336	AM 2022 114336 A	5(584)2022
M 2022 35622 R	AM 110746	AM 2022 110746 A	1(580)2022
M 2022 35623 R	AM 113507	AM 2022 113507 A	2(581)2022
M 2022 35624 R	AM 114045	AM 2022 114045 A	5(584)2022
M 2022 35625 R	AM 114046	AM 2022 114046 A	5(584)2022
M 2022 35626 R	AM 114047	AM 2022 114047 A	5(584)2022

CONCORDANCE TABLE OF PUBLICATION NUMBERS  
AND APPLICATION NUMBERS

NUMBER OF PUBLISHED APPLICATION (260)	NUMBER OF APPLICATION (210)	1	2
		1	2
		AM 2022 115511 A	AM 115511
		AM 2022 115512 A	AM 115512
		AM 2022 115514 A	AM 115514
		AM 2022 115518 A	AM 115518
		AM 2022 115585 A	AM 115585
		AM 2022 115586 A	AM 115586
		AM 2022 115587 A	AM 115587
		AM 2022 115596 A	AM 115596
		AM 2022 115599 A	AM 115599
		AM 2022 115600 A	AM 115600
		AM 2022 115605 A	AM 115605
		AM 2022 115670 A	AM 115670
		AM 2022 115675 A	AM 115675
		AM 2022 115676 A	AM 115676
		AM 2022 115677 A	AM 115677
		AM 2022 115679 A	AM 115679
		AM 2022 115683 A	AM 115683
		AM 2022 115686 A	AM 115686
		AM 2022 115687 A	AM 115687
		AM 2022 115691 A	AM 115691
		AM 2022 115692 A	AM 115692
		AM 2022 115744 A	AM 115744
AM 2022 108680 A*	AM 108680		
AM 2022 112702 A*	AM 112702		
AM 2022 115325 A	AM 115325		
AM 2022 115405 A	AM 115405		
AM 2022 115406 A	AM 115406		
AM 2022 115408 A	AM 115408		
AM 2022 115410 A	AM 115410		
AM 2022 115411 A	AM 115411		
AM 2022 115412 A	AM 115412		
AM 2022 115414 A	AM 115414		
AM 2022 115415 A	AM 115415		
AM 2022 115416 A	AM 115416		
AM 2022 115418 A	AM 115418		
AM 2022 115419 A	AM 115419		
AM 2022 115420 A	AM 115420		
AM 2022 115433 A	AM 115433		
AM 2022 115510 A	AM 115510		

CONCORDANCE TABLE OF INDEX OF GOODS AND/OR SERVICES  
AND APPLICATION NUMBERS

INDEX OF GOODS AND/OR SERVICES (511)	NUMBER OF PUBLISHED APPLICATIONS (260)	1	2
1	2	33	AM 2022 108680 A*
3	AM 2022 115596 A	33	AM 2022 115585 A
5	AM 2022 112702 A*	33	AM 2022 115586 A
5	AM 2022 115419 A	33	AM 2022 115587 A
5	AM 2022 115596 A	34	AM 2022 115518 A
5	AM 2022 115670 A	35	AM 2022 115405 A
5	AM 2022 115675 A	35	AM 2022 115406 A
9	AM 2022 115605 A	35	AM 2022 115408 A
9	AM 2022 115686 A	35	AM 2022 115410 A
9	AM 2022 115687 A	35	AM 2022 115411 A
11	AM 2022 115599 A	35	AM 2022 115412 A
11	AM 2022 115600 A	35	AM 2022 115414 A
11	AM 2022 115605 A	35	AM 2022 115415 A
11	AM 2022 115683 A	35	AM 2022 115416 A
12	AM 2022 115676 A	35	AM 2022 115418 A
16	AM 2022 115596 A	35	AM 2022 115420 A
16	AM 2022 115687 A	35	AM 2022 115511 A
20	AM 2022 115408 A	35	AM 2022 115512 A
22	AM 2022 115599 A	35	AM 2022 115514 A
22	AM 2022 115600 A	35	AM 2022 115686 A
25	AM 2022 115687 A	35	AM 2022 115687 A
29	AM 2022 112702 A*	41	AM 2022 115744 A
30	AM 2022 112702 A*	42	AM 2022 115433 A
30	AM 2022 115406 A	42	AM 2022 115686 A
30	AM 2022 115514 A	42	AM 2022 115687 A
30	AM 2022 115691 A	42	AM 2022 115744 A
30	AM 2022 115692 A	43	AM 2022 115406 A
32	AM 2022 112702 A*	43	AM 2022 115514 A
32	AM 2022 115510 A	43	AM 2022 115677 A
		43	AM 2022 115679 A
		44	AM 2022 115325 A

CONCORDANCE TABLE OF INDEX OF GOODS AND/OR SERVICES  
AND NUMBERS OF TRADEMARKS REGISTERED ACCORDING  
TO THE ACCELERATED PROCEDURE

INDEX OF GOODS AND/OR SERVICES (511)	NUMBERS OF REGISTERED ACCORDING TO THE ACCELERATED PROCEDURE (111)
1	2
5	M 2022 35571 R
5	M 2022 35572 R
9	M 2022 35557 R
9	M 2022 35561 R
9	M 2022 35562 R
9	M 2022 35563 R
16	M 2022 35557 R
16	M 2022 35561 R
18	M 2022 35557 R
18	M 2022 35561 R
18	M 2022 35562 R
18	M 2022 35563 R
25	M 2022 35557 R
25	M 2022 35561 R
25	M 2022 35562 R
25	M 2022 35563 R
25	M 2022 35567 R
28	M 2022 35556 R
29	M 2022 35570 R
33	M 2022 35558 R
33	M 2022 35565 R
33	M 2022 35566 R
33	M 2022 35573 R
34	M 2022 35564 R
34	M 2022 35568 R
34	M 2022 35569 R
35	M 2022 35557 R
35	M 2022 35561 R
35	M 2022 35562 R
35	M 2022 35563 R
35	M 2022 35571 R
35	M 2022 35572 R
35	M 2022 35574 R
36	M 2022 35557 R
36	M 2022 35561 R
36	M 2022 35562 R
36	M 2022 35563 R
37	M 2022 35557 R
37	M 2022 35561 R
37	M 2022 35562 R
37	M 2022 35563 R
38	M 2022 35557 R
38	M 2022 35559 R
38	M 2022 35560 R
38	M 2022 35561 R
38	M 2022 35562 R
38	M 2022 35563 R



---

1	2
41	M 2022 35557 R
41	M 2022 35561 R
41	M 2022 35562 R
41	M 2022 35563 R
42	M 2022 35556 R
42	M 2022 35557 R
42	M 2022 35561 R
42	M 2022 35562 R
42	M 2022 35563 R
44	M 2022 35557 R
44	M 2022 35561 R
44	M 2022 35562 R
44	M 2022 35563 R

# OFFICIAL BULLETIN OF THE INDUSTRIAL PROPERTY

**INVENTIONS**  
**UTILITY MODELS**  
**DESIGNS**  
**TRADEMARKS**

## **12(591)**

EDITOR-IN-CHIEF: N. Bebrishvili

EDITOR-TRANSLATOR: E. Gabunia

PROOFREADER: A. Shikhashvili

COMPUTER LAYOUT: M. Ordenidze  
K. Svanidze

[info@sakpatenti.gov.ge](mailto:info@sakpatenti.gov.ge)  
[www.sakpatenti.gov.ge](http://www.sakpatenti.gov.ge)