

# Official Bulletin of the Industrial Property

Inventions

Utility Models

Designs

Trademarks



საქართველოს ინტელექტუალური  
საკუთრების ეროვნული ცენტრი

**საქპატენტი**

**SAKPATENTI**

NATIONAL INTELLECTUAL PROPERTY  
CENTER OF GEORGIA

[www.sakpatenti.gov.ge](http://www.sakpatenti.gov.ge)

Date of Publication – 2023 06 26

**12(615)**

# INID CODES FOR IDENTIFICATION OF BIBLIOGRAPHIC DATA

## INVENTIONS, UTILITY MODELS

- (10) Number of publication for application, which has been examined
- (11) Number of patent and kind of document
- (21) Serial number of application
- (22) Date of filing of the application
- (23) Date of exhibition or the date of the earlier filing and the number of application, if any
- (24) Date from which patent may have effect
- (31) Number of priority application
- (32) Date of filing of priority application
- (33) Code of the country or regional organization allotting priority application number
- (44) Date of publication of application not granted, but examined and number of bulletin
- (45) Date of publication of registered document
- (51) International Patent Classification Index

- (54) Title of the invention
- (57) Abstract
- (60) Number of examined patent document granted by foreign patent office, date from which patent has effect and country code
- (62) Number of the earlier application and in case of divided application, date of filing an application
- (71) Name, surname and address of applicant (country code)
- (72) Name, surname of inventor (country code)
- (73) Name, surname and address of patent owner (country code)
- (74) Name, surname of representative or patent attorney
- (85) Date of commencement of the national phase of International Application
- (86) Number and date of filing of international application
- (87) Number and date of publication of international application
- (94) Calculated date of expiry of the SPC or the duration of the SPC

## DESIGNS

- (10) Number of publication for application
- (11) Number of patent and kind of document or number of registration
- (15) Date of registration/Date of patent renewal
- (18) Expected expiration date of patent or registration
- (21) Serial number of application
- (22) Date of filing of the application
- (23) Date of exhibition or the date of the earlier filing and the number of application, if any
- (24) Date from which patent may have effect
- (28) Number of designs included in the application
- (30) Data relating to priority (number of application, date of filing of application, two-letter code identifying the authority with whom the priority application was made)
- (31) Number of priority application
- (32) Date of filing of priority application
- (33) Code of the country or regional organization allotting priority application number
- (34) Two-letter code according to WIPO St.3 identifying the authority with which the priority application was made
- (44) Date of publication of design and number of bulletin (the first publication)
- (45) Date of publication of design registered by WIPO and number of bulletin

- (51) International Classification for designs (class and subclass of the Locarno Classification)
- (54) Title of the invention
- (55) Reproduction of the design
- (57) Description of characteristic features of the design including indication of colors
- (58) Date of recording of any kind of amendment in the Register
- (62) Number of the earlier application, registration and document number and if available the date of filing an application in case of divided application
- (71) Name, surname and address of applicant (country code)
- (72) Name, surname of creator (country code)
- (73) Name, surname and address of patent owner (country code)
- (74) Name, surname of representative or patent attorney
- (81) Contracting states concerned
  - II designated contracting states according to the 1960 Act
  - III designated contracting states according to the 1999 Act
- (85) Owner's permanent address
- (86) Owner's nationality
- (87) Owner's residence
- (88) State in which the owner has a real and effective industrial or commercial establishment

## TRADEMARKS

- (111) - Number of registration
- (151) - Date of registration
- (156) - Date of the renewal
- (181) - Expected expiration date of registration
- (186) - Renewal expiration date of registration
- (141) - Date of cancel of duration of the mark
- (210) - Serial number of application
- (220) - Date of filing of the application
- (230) - Data concerning exhibition
- (260) - Number of application, for which favorable decision of examination about registration has been taken (publication number)
- (310) - Number of the first application
- (320) - Date of filing of the first application
- (330) - Code, identifying national or regional Office where the first application was made
- (511) - International Classification of Goods and Services for the purposes of registration of trade marks and/or list of goods and/or services classified according thereto
- (526) - Disclaimer
- (531) - Description of figurative elements of Trade Marks according to the International Classification of the Figurative Elements of Marks

- (540) - Reproduction of Trade Mark
- (550) - Nature and kind of Trade Mark
- (551) - Indication to the effect that the mark is a collective mark, a certification mark or a guarantee mark
- (554) - Three-dimensional mark
- (580) - Date of recording of any kind changes in respect of applications or registrations
- (591) - Information concerning colors claimed
- (731) - Name and address of the applicant
- (732) - Name and address of the holder of the registration
- (740) - Name and address of the representative
- (750) - Addreses for correspondence
- (770) - Name and address of the previous applicant or holder in case of change in ownership
- (771) - Previous name and address of the applicant or holder in case of change in ownership
- (791) - Name and address of the licensee
- (793) - Indication of conditions and/or restrictions under the license (Type of license, number of license agreement, data of license, data of validity of license)
- (800) - Certain data relating to the international registration of Trade Marks under the Protocol Relating to Madrid Agreement (International registration number
- (852) - Partial cancellation of the list of goods and services
- (891) - Date of subsequent designation

## CODES FOR PUBLICATION IN BULLETIN

- (21) AP 0000 000000 - serial number of application for invention
- (10) AP 0000 0000 A - number of published application for invention (first publication)
- (11) P 0000 0000 B - number of patent for invention (second publication)
- (21) API 0000 000000 - number of application for imported patent
- (11) PI 0000 0000 A - number of imported patent (first publication)
- (21) AU 0000 000000 - serial number of application for utility model
- (10) AU 0000 000 U - number of published application for utility model (first publication)
- (11) U 0000 000 Y - number of patent for utility model (second publication)
- (21) AD 0000 000000 - serial number of application for design
- (10) AD 0000 000 S - number of published application for design (first publication)
- (11) D 0000 000 S - registered design

## INTERNATIONAL PATENT CLASSIFICATION FOR INVENTIONS AND UTILITY MODELS

- SECTION A - HUMAN NECESSITIES
- SECTION B - PERFORMING OPERATIONS; TRANSPORTING
- SECTION C - CHEMISTRY; METALLURGY
- SECTION D - TEXTILES; PAPER
- SECTION E - FIXED CONSTRUCTIONS
- SECTION F - MECHANICAL ENGINEERING; LIGHTING; HEATING; WEAPONS; BLASTING
- SECTION G - PHYSICS
- SECTION H - ELECTRICITY

- 
- M - Trade Mark
  - (210) AM 0000 000000 - Serial number of application;
  - (260) AAM 0000 00000 A - Publication number of application;
  - (111) M 0000 00000 R - Number of registration;
  - (111) MMM0000 00000 Rn - Number of renewals, in which n=1,2,3;
  - (111) M 0000 00000 R(P) - Number of registration under partial assignment of rights
-

# Official Bulletin of the Industrial Property

Inventions

Utility Models

Designs

Trademarks

# CONTENT

<b>PUBLISHED TITLES OF PROTECTION</b> .....	3
<b>INVENTIONS</b>	
▪ APPLICATIONS APPROVED FOR GRANTING PATENT .....	4
▪ PATENTED INVENTIONS .....	6
<b>UTILITY MODELS</b>	
PATENTED UTILITY MODELS .....	7
<b>DESIGNS</b>	
▪ APPLICATION APPROVED FOR REGISTRATION .....	8
▪ DESIGNS, WHICH HAVE BEEN REGISTERED WITH THE INTERNATIONAL BUREAU CLAIMING PRIORITY ON THE TERRITORY OF GEORGIA .....	9
<b>TRADEMARKS</b>	
▪ APPLICATIONS FILED UNDER THE NATIONAL PROCEDURE APPROVED FOR REGISTRATION .....	22
▪ REGISTERED TRADEMARKS .....	31
▪ TRADEMARKS REGISTERED ACCORDING TO THE ACCELERATED PROCEDURE .....	34
▪ INTERNATIONAL TRADEMARKS FOR WHICH A DECISION ON GRANTING PROTECTION IS TAKEN .....	37
▪ INTERNATIONAL TRADEMARKS PROTECTED IN GEORGIA .....	118
<b>OFFICIAL NOTIFICATIONS</b>	
<b>INVENTIONS</b>	
▪ RESTORATION OF PATENTS .....	125
▪ ABOLITION OF PATENTS WITH THE RIGHT TO RESTORE .....	126
▪ DATE OF PATENTS RESTORATION EXPIRATION .....	126
<b>UTILITY MODELS</b>	
▪ ABOLITION OF PATENTS WITH THE RIGHT TO RESTORE .....	127
▪ DATE OF PATENT RESTORATION EXPIRATION .....	127
<b>DESIGNS</b>	
EXTENSION OF TERMS OF DESIGN REGISTRATION .....	128
<b>TRADEMARKS</b>	
▪ EXTENSION OF TERMS OF TRADEMARKS REGISTRATION .....	129
▪ COMPLETE TRANSFER OF RIGHTS .....	129
▪ CANCELLATION OF TRADEMARKS REGISTRATION .....	131
<b>CLASSIFICATION INDEXES</b>	
INVENTIONS .....	134
UTILITY MODELS .....	135
DESIGNS .....	136
TRADEMARKS .....	137

# PUBLISHED TITLES OF PROTECTION

## INVENTIONS

- **APPLICATIONS APPROVED FOR GRANTING PATENT:**  
15793; 14803; 15989; 15935
- **PATENTED INVENTIONS:**  
7516, 7517

## UTILITY MODELS

- PATENTED UTILITY MODELS:**  
2150, 2151

## DESIGNS

- **APPLICATION APPROVED FOR REGISTRATION:**  
1297
- **DESIGNS, WHICH HAVE BEEN REGISTERED WITH THE INTERNATIONAL BUREAU CLAIMING PRIORITY ON THE TERRITORY OF GEORGIA:**  
224148; 224557; 223612; 224311; 228052; 228000

## TRADEMARKS

- **APPLICATIONS FILED UNDER THE NATIONAL PROCEDURE APPROVED FOR REGISTRATION:**  
118297\*; 119075; 119353; 119482; 119998; 120021-120024; 120127; 120129; 120147, 120148; 120152; 120154; 120163, 120164; 120172-120174; 120233, 120234; 120239; 120245; 120253; 120255, 120256; 120336; 120343; 120351; 120353, 120354; 120362; 120433, 120434; 120437; 120444, 120445; 120500; 120506, 120507; 120513; 120518, 120519; 120522; 120532-120535; 120595-120597
- **REGISTERED TRADEMARKS:**  
36933-36954; 36961-36966
- **TRADEMARKS REGISTERED ACCORDING TO THE ACCELERATED PROCEDURE:**  
36926-36932; 36955-36960
- **INTERNATIONAL TRADEMARKS FOR WHICH A DECISION ON GRANTING PROTECTIONS IS TAKEN:**  
118284; 118769; 119434-119439; 119520; 119554; 119559-119566; 119568-119572; 119626-119635; 119657-119659; 119662-119665; 119667; 119671; 119674; 119710; 119718, 119719; 119721-119730; 119740-119743; 119745; 119747; 119755-119759; 119827; 119844-119848; 119854-119863; 119874, 119875; 119938-119940; 119972; 120054, 120055; 120082-120085; 120178-120183; 120189, 120190; 120222-120224; 120290
- **INTERNATIONAL TRADEMARKS PROTECTED IN GEORGIA:**  
113172; 116046; 116096; 116179; 116602; 117774; 118100-118109; 118188, 118189; 118191-118195; 118203; 118249; 118268; 118270; 118278-118281; 118285, 118286; 118317; 118319-118322; 118324-118326; 118336-118338; 118340-118342; 118357, 118358; 118361, 118362; 118422, 118423; 118425; 118435-118444; 118465-118468; 118523; 118570, 118571; 118669-118673; 118679-118688; 118710; 118712; 118716; 118873

---

# INVENTIONS

## APPLICATIONS APPROVED FOR GRANTING PATENT

The decision can be appealed at the Chamber of Appeal of Sakpatenti within 3 months from the publication or at the Mtskheta District Court Administrative Cases Board (Address: №17, Samkhedro St., Mtskheta), within 1 month following the publication.

### PART A

#### A 61

- (10) AP 2023 15793 A (51) Int. Cl. (2006)  
A 61 K 45/06  
A 61 K 31/5377  
A 61 K 31/496  
A 61 P 25/00
- (21) AP 2020 15793 (22) 2020 04 09  
(31) P1900121  
(32) 2019 04 10  
(33) HU
- (71) Richter Gedeon Nyrt. (HU)  
Gyömrői út. 19-21, H-1103 Budapest,  
Hungary (HU)
- (72) ADHAM-PARANGI, Nika (HU);  
ROGER EARLEY, Willie (HU);  
PO-JEN YEUNG, Paul (HU);  
ROMÁN, Viktor (HU)
- (74) Liliana Darakhvelidze  
(85) 2021 11 10  
(86) PCT/IB2020/053382 , 2020 04 09
- (54) CARBAMOYL CYCLOHEXANE DERIVATIVES FOR TREATING AUTISM SPECTRUM DISORDER
- (57) Cariprazine is used for the treating of autism spectrum disorders.  
Claims: 2 independents  
12 dependents  
Fig.: 6
- 

- (10) AP 2023 14803 A (51) Int. Cl. (2006)  
A 61 K 39/395  
A 61 K 39/00  
A 61 P 37/02  
A 61 P 7/02  
C 07 K 16/40
- (21) AP 2016 14803 (22) 2016 11 09  
(31) 62/252,814; 62/406,726  
(32) 2015 11 09; 2016 10 11  
(33) US; US
- (71) University Of Leicester (GB)  
University Rd, Leicester LE1, 7RH, UK (GB);  
Omeros Corporation (US)  
201 Elliott Avenue West, Seattle,  
WA 98119, USA (US)
- (72) DUDLER, Thomas (US);  
DEMOPULOS, Gregory, A. (US);  
SCHWAEBLE, Hans-Wilhelm (GB)

- (74) Tamar Kochlamazashvili  
(85) 2018 06 08  
(86) PCT/US2016/061113, 2016 11 09
- (54) METHODS FOR TREATING CONDITIONS ASSOCIATED WITH MASP-2 DEPENDENT COMPLEMENT ACTIVATION
- (57) Present invention relates to a method of MASP-2 inhibiting monoclonal antibodies usage for the treating of thrombotic microangiopathies (TMA) related to hematopoietic stem cell transplant (HSCT-TMA).  
Claims: 1 independent  
10 dependents  
Fig.: 60
- 

### PART G

#### G 09

- (10) AP 2023 15989 A (51) Int. Cl. (2006)  
G 09 B 19/06
- (21) AP 2022 15989 (22) 2022 06 24  
(71) Merab Topuria (GE)  
Gogebashvili St. 7, 3300, Mtskheta,  
Georgia (GE)
- (72) Merab Topuria (GE)
- (54) LANGUAGE GRAMMAR LEARNING DEVICE
- (57) A device includes, at least, ten-point-prismatic-tube-shaped axis, and the componentry capable to be put on executed in the shape of different width and color rings, with the same amount of grooves; at that, each slot is empty on the axis and rings, and corresponding monolingual parts of speech in learning language are marked according to color, on each ring. The arrangement and sequence of rings for each individual language is fixed on the axis, and derived from the syntax of particular language; at that, the rings are disposed rotatable around the axis, and capable to slide thereon.  
Claims: 1 independent  
1 dependent  
Fig.: 20
-

**PART H****H 02**

(10) AP 2023 15935 A (51) Int. Cl. (2006)  
H 02 J 7/00

(21) AP 2022 15935 (22) 2022 04 21

(71) Saba Turmanidze (GE)  
Nutsubidze Plateau, IV m/r, bld. 1, ap. 10,  
Tbilisi, Georgia (GE);  
Vakhtang Niauri (GE)  
Nutsubidze Plateau, IV m/r, bld. 10a, ap. 1,  
Tbilisi, Georgia (GE)

(72) Saba Turmanidze (GE);  
Vakhtang Niauri (GE)

(54) DOUBLE CAPACITY (DC) CONSTANT  
CURRENT POWER SUPPLY SYSTEM

(57) DC constant current power supply system is disclosed. The system includes two power packs, accumulator battery and electronic commutator, entrances whereof are connected to power packs and accumulator battery exits, and the exit is connected to the load passing throughout voltage relay.

Claims: 1 independent

Fig.: 2

---

## PATENTED IVENTIONS

### PART A

#### A 61

- (11) P 2023 7517 B (51) Int. Cl. (2006)  
A 61 K 9/28  
(10) AP 2023 15682 A (44) 3(606)/2023  
(21) AP 2019 15682  
(22) 2019 12 05  
(24) 2019 12 05  
(31) 18211154.2  
(32) 2018 12 07  
(33) EP  
(86) PCT/EP2019/083909, 2019 12 05  
(73) Tillots Pharma AG (CH)  
Baslerstrasse 15. CH-4310 Rheinfelden,  
Switzerland (CH)  
(72) VARUM, Filipe (CH);  
BRAVO GONZALEZ, Roberto Carlos (CH)  
(74) Shalva Gvaramadze  
(54) COLON DRUG DELIVERY FORMULATIONS
- 

### PART C

#### C 22

- (11) P 2023 7516 B (51) Int. Cl. (2006)  
C 22 B 15/00  
C 22 B 3/00  
C 22 B 3/08  
C 22 B 47/00  
(10) AP 2023 15666 A (44) 4(607)/2023  
(21) AP 2019 15666  
(22) 2019 12 10  
(24) 2019 12 10  
(31) 18215028.4  
(32) 2018 12 21  
(33) EP  
(86) PCT/EP2019/084306, 2019 12 10  
(73) Umicore (BE)  
Rue du Marais 31, B-1000 Brussels,  
Belgium (BE)  
(72) DANIELS, Michel (BE);  
SCOYER, Jean (BE);  
BALTES, Michael (BE);  
NEVEN, Margot (BE);  
LEYSSSEN, Jan (BE)  
(74) Tamaz Shilakadze  
(54) PROCESS FOR RECOVERY OF METALS  
FROM POLYMETALLIC NODULES
-



---

# UTILITY MODEL

## PATENTED UTILITY MODELS

### PART C

#### C 12

- (11) U 2023 2150 Y (51) Int. Cl. (2006)  
C 12 G 3/06
- (10) AU 2023 16001 U (44) 5(608)/2023
- (21) AU 2022 16001
- (22) 2022 07 06
- (24) 2022 07 06
- (73) LTD "Colored Degree" (GE)  
Liberty Av. 11, ap. 15, 1400, Gori, Gori  
Municipality, Georgia (GE)
- (72) Ketevan Kutateladze (GE)
- (54) BLUE ALCOHOLIC DRINK "KESANE"
- 

### PART G

#### G 02

- (11) U 2023 2151 Y (51) Int. Cl. (2006)  
G 02 B 23/16
- (10) AU 2023 15530 U (44) 4(607)/2023
- (21) AU 2020 15530
- (22) 2020 12 30
- (24) 2020 12 30
- (73) Teimuraz Ghazhonia (GE)  
Nutsbidze Plateau, III mcr., I qu., bldg. 10,  
ap. 3, 0183, Tbilisi, Georgia (GE)
- (72) Teimuraz Ghazhonia (GE)
- (54) OPTICAL TELESCOPE EQUATORIAL  
STAND
-

---

# DESIGNS

## APPLICATION APPROVED FOR REGISTRATION

The decision can be appealed at the Chamber of Appeal of Sakpatenti within 3 months from the publication or at the Mtskheta District Court Administrative Cases Board (Address: №17, Samkhedro str., Mtskheta), within 1 month following the publication.

- (10) AD 2023 1297 S (51) 32-01  
(21) AD 2023 1297 (22) 2023 02 07  
(28) 1  
(71) LTD "Askaneli Brothers" (GE)  
Kakheti Highway 110a, 0198, Isani-Samgori District, Tbilisi, Georgia (GE)  
(72) Giorgi Kalmakhelidze (GE);  
Shalva Radiani (GE);  
Davit Mchedlishvili (GE)  
(74) Davit Dzamukashvili (GE)  
(54) GRAPHICAL COMPOSITION  
(55)

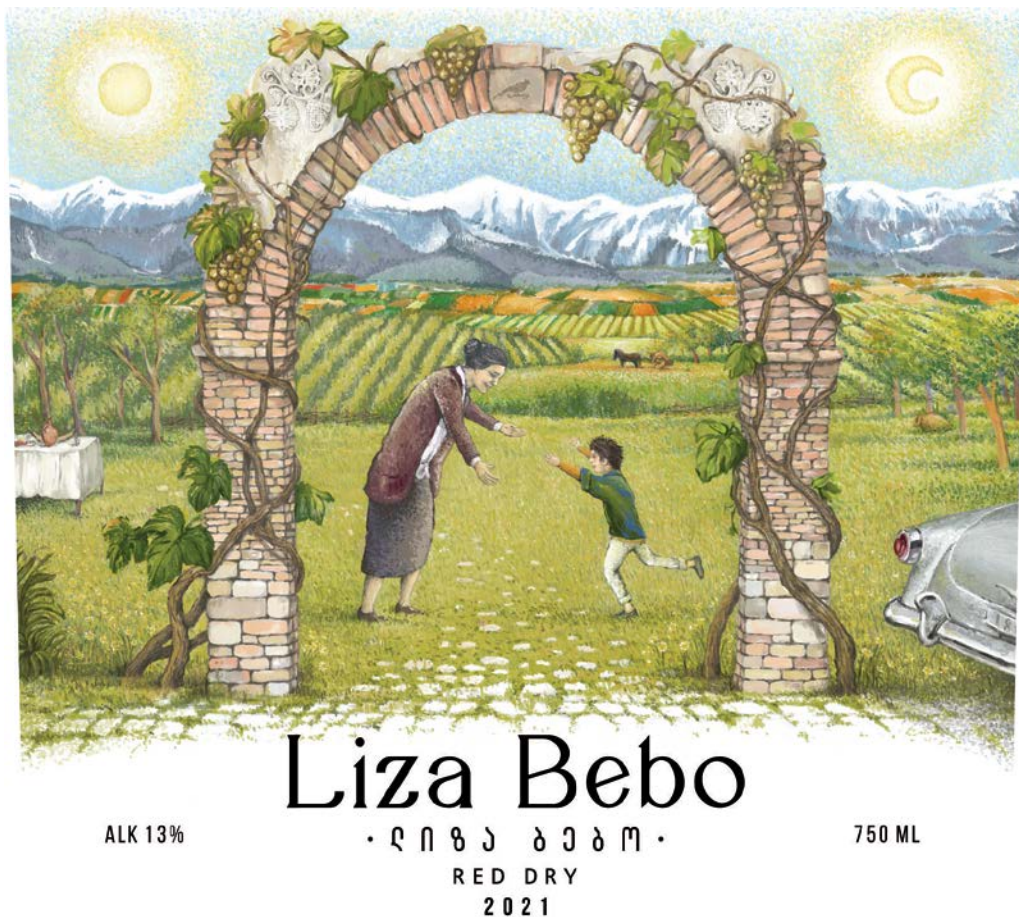

1.1

# DESIGNS

## DESIGNS, WHICH HAVE BEEN REGISTERED WITH THE INTERNATIONAL BUREAU CLAIMING PRIORITY ON THE TERRITORY OF GEORGIA

The decision can be appealed at the Chamber of Appeal of Sakpatenti within 3 months from the publication or at the Mtskheta District Court Administrative Cases Board (Address: №17, Samkhedro St., Mtskheta), within 1 month following the publication.

- (11) DM/224 148 (51) 11-01  
 (15) 2022 10 07 (44) 14/2023 (2023 04 07)  
 (22) 2022 10 07  
 (28) 3  
 (73) Harry Winston SA  
 Chemin Du Tourbillon 8, 1228 Plan-les-Ouates (CH)  
 (85) CH  
 (86) CH  
 (87) CH  
 (88) CH  
 (89) CH  
 (81) III. KG, LI, OM, GE, TR, CA, MK, BA, MN, NO, CH, EM, AL, AM, UA, SG, MA, MC, MD, ME, BZ, AZ, TN, GB  
 (72) 1. Tobias WUEST  
 C/o Harry Winston Inc., 718 Fifth Avenue, 10019, New York (US);  
 2. Delphine ABDOURAHIM  
 C/o Harry Winston Inc., 718 Fifth Avenue, 10019, New York (US);  
 3. Rie YATSUGI-KANG  
 C/o Harry Winston Inc., 718 Fifth Avenue, 10019, New York (US)  
 (74) The Swatch Group AG (The Swatch Group SA) (The Swatch Group Ltd.)  
 Faubourg Du Lac 6, 2501 Biel/Bienne (CH)  
 (46) 2023 04 07  
 (54) 1. NECKLACE, 2. BROOCH, 3. NECKLACE  
 (55)



1.1



1.2



1.3



1.4



1.5



1.6



1.7



1.8



2.1



2.2



2.3

2.4



2.5



2.6



2.7



2.8



3.1



3.2



3.3



3.4



3.5



3.6



3.7



3.8

---

- (11) DM/224 557 (51) 23-04  
 (15) 2022 04 06 (44) 14/2023 (2023 04 07)  
 (22) 2022 04 06  
 (28) 1  
 (30) No1: 06.10.2021; 29810585; US  
 (73) RZ Industries LLC  
 3201 County Road 42 W, Suite 102, 55306 Burnsville, Minnesota (US)  
 (85) US  
 (86) US  
 (87) US  
 (88) US  
 (89) US  
 (81) III. RO, GE, CA, OM, EE, RS, NO, BG, RW, SY, DK, EM, AM, BW, TJ, MD, VN, TN, PL, SR, MN, JP, KR, LT, UA, OA, SI, BX, ME, AZ, SM, WS, KG, LI, MK, BA, DE, EG, JM, RU, FI, IS, HU, ES, BY, GB, KH, TR, ST, GH, IL, KP, CH, LV, HR, MX, AL, FR, BN, NA, SG, MC, BZ, TM  
 (72) Steve Gordon Torbenson  
 3201 Country Road 42 W Suite 102, 55306, Burnsville (US)  
 (74) Crawford Maunu  
 1150 Northland Drive, Suite 100, 55120 Mendota Heights (US)  
 (46) 2023 04 07  
 (54) 1. FILTER FOR AIR HANDLING APPARATUS  
 (55)

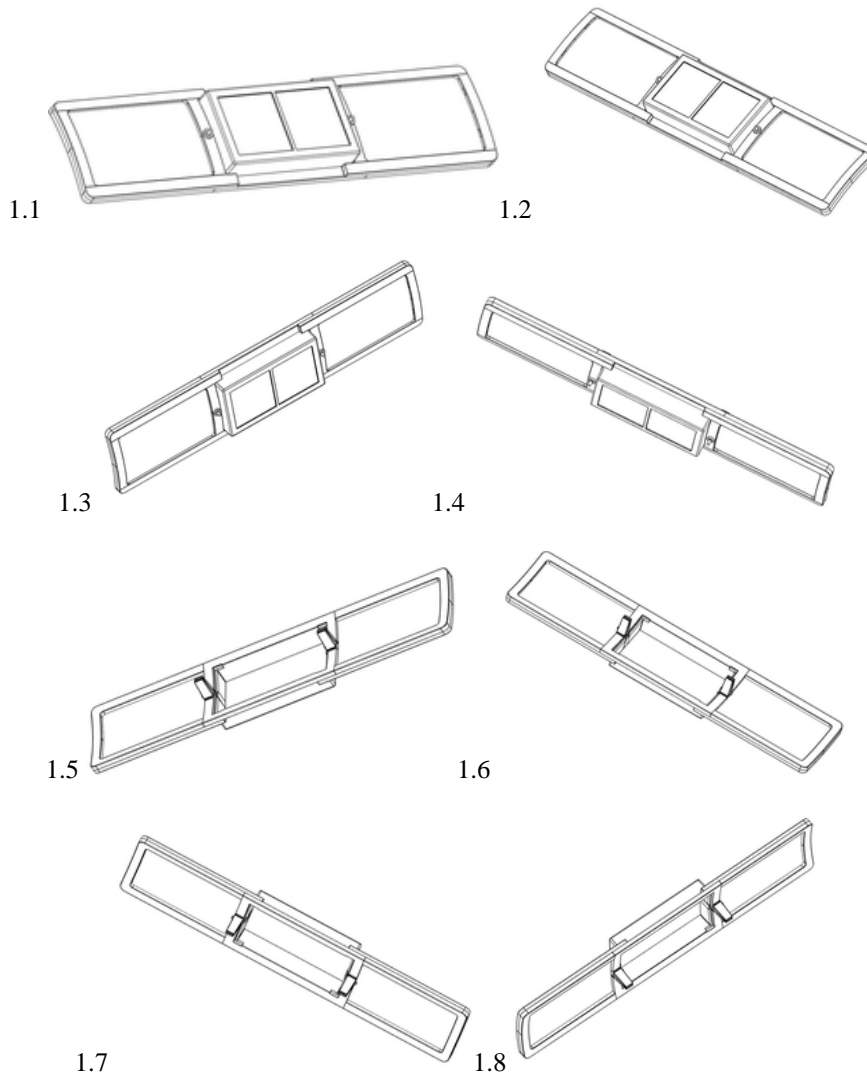

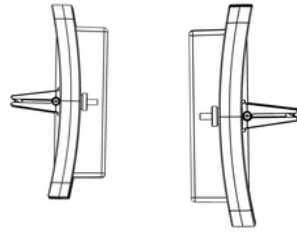
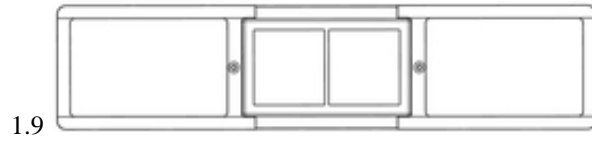

1.10

1.11

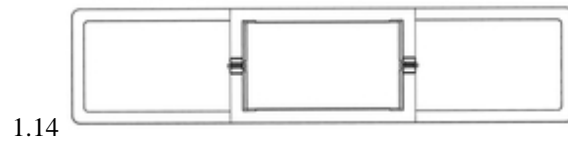



- (11) DM/223 612
- (15) 2022 04 04
- (22) 2022 04 04
- (28) 3
- (73) Ideal Industries Lighting LLC  
9201 Washington Avenue, 53406 Racine, WI (US)
- (85) –
- (86) US
- (87) US
- (88) US
- (89) US
- (81) III. US, GE, EG, EM, GB
- (72) Tommaso Ghelardi  
Via Sandro Pertini 122, 50019, Sesto Fiorentino, FI (IT)
- (74) Nexsen Pruet, PLLC / J. Clinton Wimbish  
227 West Trade St., Suite 1550, 28202 Charlotte, NC (US)
- (46) 2023 04 07
- (54) 1.-3. HEAT SINK FOR LUMINAIRE
- (55)

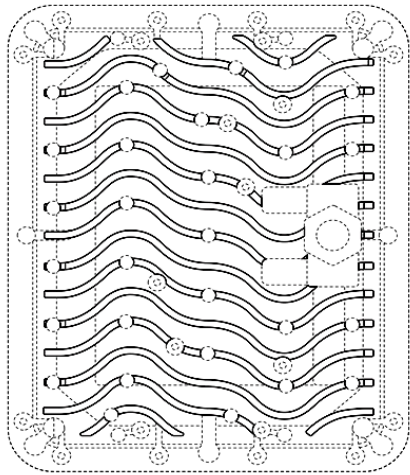

1.1

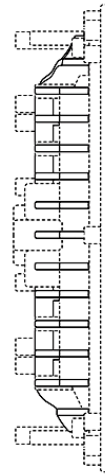

2.1

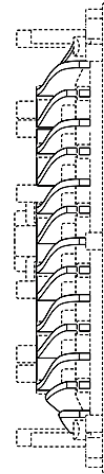

2.2

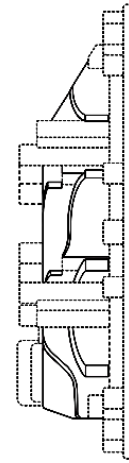

2.3

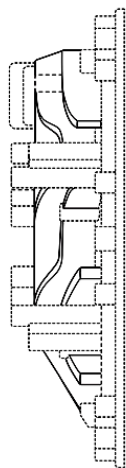

2.4

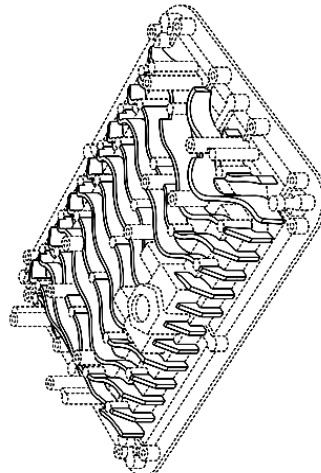

2.5

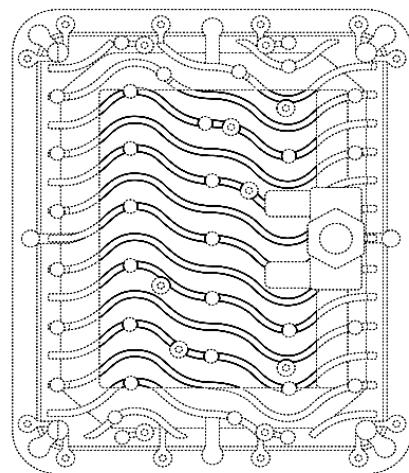

3.1

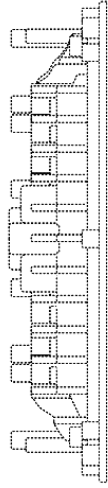

3.2

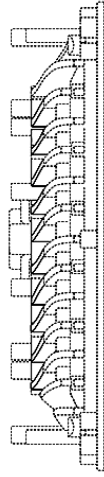

3.3

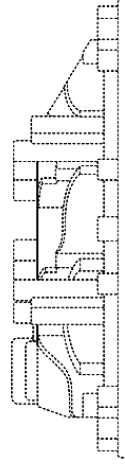

3.4

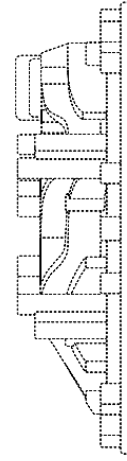

3.5

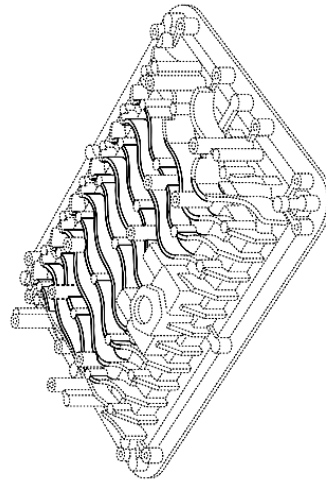

3.6

- (11) DM/224 311 (51) 11-01  
(15) 2022 10 14 (44) 15/2023 (2023 04 14)  
(22) 2022 10 14  
(28) 1  
(73) Harry Winston SA  
Chemin Du Tourbillon 8, 1228 Plan-les-Ouates (CH)  
(85) CH  
(86) CH  
(87) CH  
(88) CH  
(89) CH  
(81) III. KG, LI, MK, CA, GE, OM, BA, NO, RU, EM, AM, MD, TN, GB, TR, MN, CH, AL, UA, MA, SG, MC,  
ME, BZ, AZ  
(72) Christina YANG  
C/o Harry Winston Inc. 718 Fifth Avenue, 10019, New York (US)  
(74) The Swatch Group AG (The Swatch Group SA) (The Swatch Group Ltd.)  
Faubourg Du Lac 6, 2501 Biel/Bienne (CH)  
(46) 2023 04 14  
(54) 1. NECKLACE  
(55)



1.1



1.2



1.3



1.4



1.5



1.6



1.7



1.8

---

- (11) DM/228 052 (51) 12-02  
(15) 2023 02 27 (44) 15/2023 (2023 04 14)  
(22) 2023 02 27  
(28) 1  
(73) Daniel Hagos  
52 Harlinger Street, SE185SY London (GB)  
(85) –  
(86) GB  
(87) GB  
(88) –  
(89) GB  
(81) III. RO, CA, OM, GE, EE, RS, NO, BG, RW, SY, DK, EM, AM, BW, TJ, MD, VN, TN, PL, SR, MN, JP, KR,  
LT, CN, UA, OA, BX, SI, ME, AZ, SM, WS, KG, LI, MK, US, BA, DE, EG, RU, FI, JM, IS, HU, ES, BY,  
B, KH, TR, ST, GH, IL, KP, CH, LV, HR, MX, AL, BN, FR, NA, SG, MC, BZ, TM  
(72) Daniel Hagos  
52 Harlinger Street, SE185SY London (GB)  
(46) 2023 04 14  
(54) 1. FOLDING SHOPPING TROLLEY FRAME AND BAG  
(55)

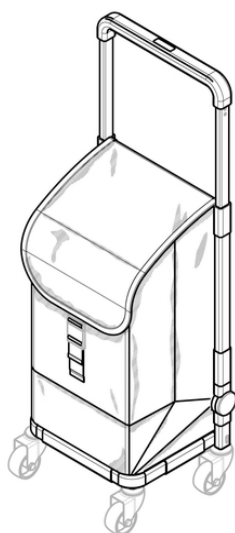

1.1

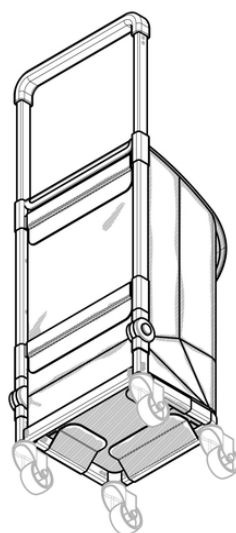

1.2



1.3

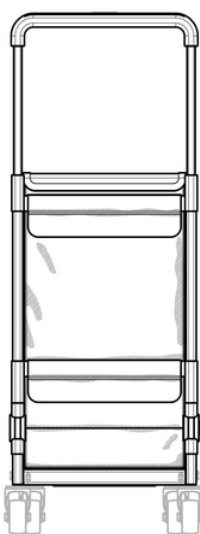

1.4

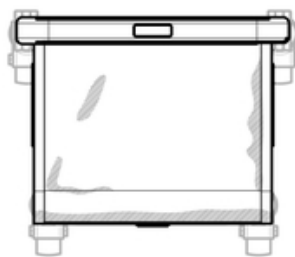

1.5

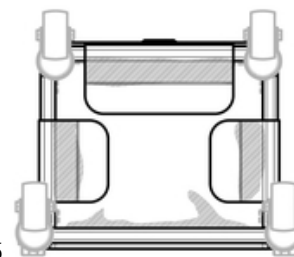

1.6

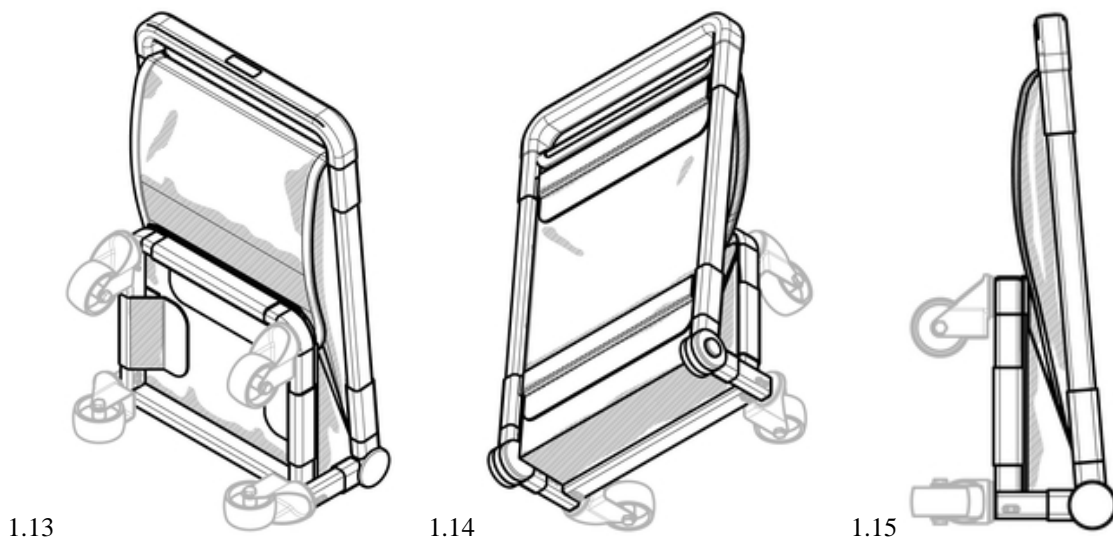
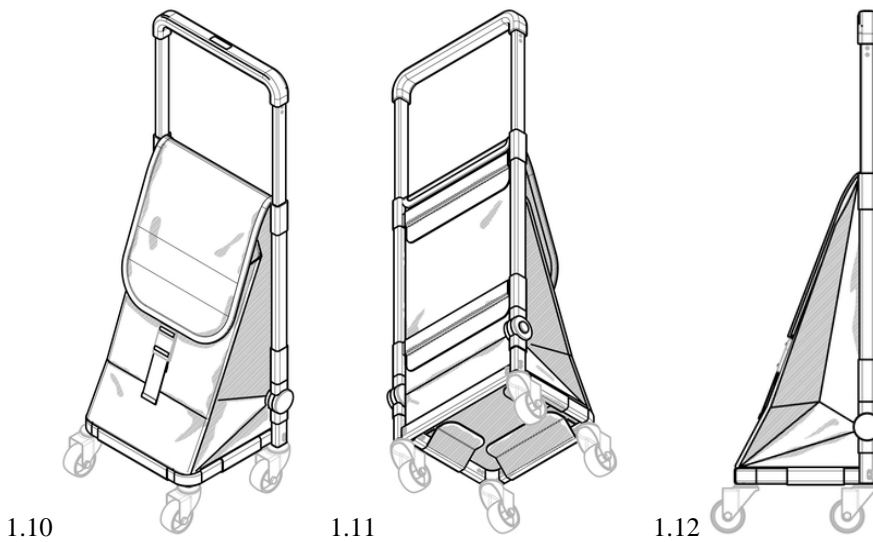
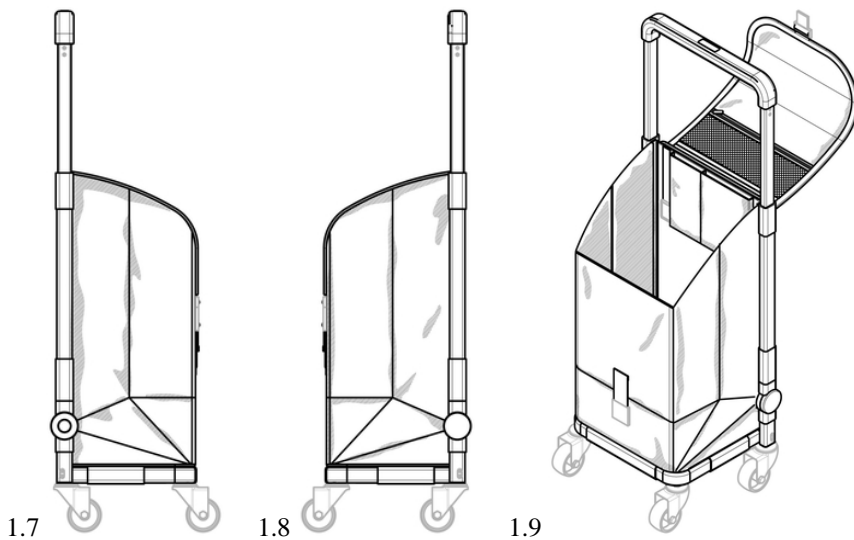

- (11) DM/228 000 (51) 20-03  
(15) 2023 03 29 (44) 15/2023 (2023 04 14)  
(22) 2023 03 29  
(28) 1  
(30) No1: 29.09.2022; 2022/011512; TR  
(73) Birlik Medya Reklamcılık Ticaret Ve Sanayi Limited Şirketi  
Mevlana Mah. Fetihbey Cad. 10 1 Ataşehir İstanbul (TR)  
(85) TR  
(86) TR  
(87) TR  
(88) TR  
(89) TR  
(81) III. KG, UA, GE, IL, EM, ME, AZ, GB  
(72) Abdullah Bölükçü  
Mevlana Mah. Fetihbey Cad. 10 1 Ataşehir, İstanbul (TR)  
(74) İnfö Patent Marka Ve Fikri Hakları Danışmanlığı Ltd. ŞTİ.  
Barbaros Mah. Deluxia Suits No:3 D:163 Ataşehir İstanbul (TR)  
(46) 2023 04 14  
(54) 1. BILLBOARD  
(55)

1.1

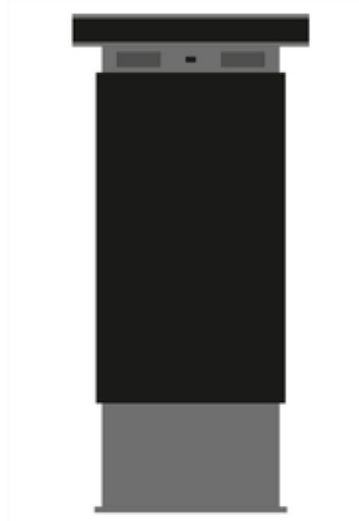

1.2

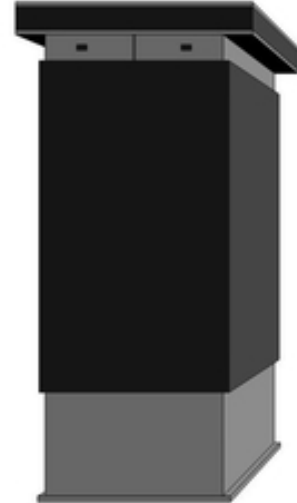

1.3

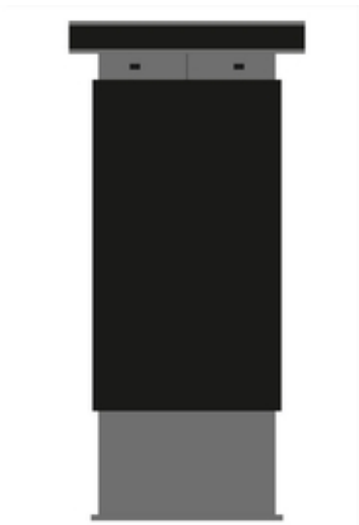

1.4

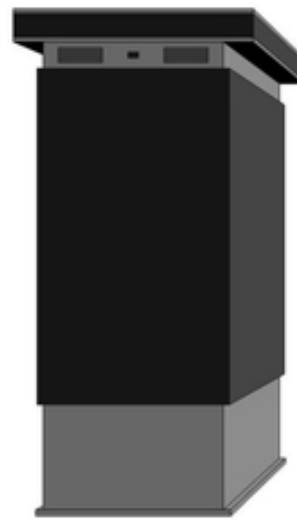

---

# TRADEMARKS

## APPLICATIONS FILED UNDER THE NATIONAL PROCEDURE APPROVED FOR REGISTRATION

The decision can be appealed at the Chamber of Appeal of Sakpatenti within 3 months from the publication or at the Mtskheta District Court Administrative Cases Board (Address: №17, Samkhedro St., Mtskheta), within 1 month following the publication.

(260) AM 2023 118297 A\*  
(210) AM 118297  
(220) 2022 06 24  
(731) British American Tobacco (Brands) Limited  
Globe House, 4 Temple Place, WC2R 2PG,  
London, United Kingdom  
(740) Tamar Kotchlamazashvili  
(540)



(591) Black, brown, grey, white, orange, yellow  
(531) 25.12.03; 26.04.07; 26.04.22; 26.04.24;  
27.05.01; 27.05.10; 27.05.24; 29.01.15  
(511) 34

---

(260) AM 2023 119075 A  
(210) AM 119075  
(220) 2022 08 19  
(731) Mzia Maskhulia  
Mshvidoba St. 117, Senaki, Georgia  
(540)



(591) Black, white, golden  
(531) 01.01.04; 01.01.10; 02.07.12; 24.09.07;  
26.01.14; 26.01.21  
(526) სამეგრელო, ზუგდიდი, SAMEGRELO,  
ZUGDIDI  
(511) 41

(260) AM 2023 119353 A  
(210) AM 119353  
(220) 2022 09 12  
(731) Mzia Maskhulia  
Mshvidoba St. 117, Senaki, Georgia  
(540)



(591) Black-white  
(531) 02.07.01; 02.07.02; 05.13.01; 05.13.07;  
05.13.08; 24.09.07; 25.01.05  
(526) საქართველო, GEORGIA  
(511) 41

---

(260) AM 2023 119482 A  
(210) AM 119482  
(220) 2022 09 19  
(731) LTD "Prime Models Management"  
Vazisubani Settlement, I m/r, bld. 3, ap. 87,  
Tbilisi, Georgia  
(540)



(591) Black, golden  
(531) 24.09.03; 24.09.24; 24.09.25; 25.01.25;  
27.05.01; 27.05.11; 27.05.23; 27.05.24;  
29.01.12



(526) GEORGIA  
(511) 41

(260) AM 2023 119998 A  
(210) AM 119998  
(220) 2022 10 21  
(731) LLC "Kakhetian Traditional Winery"  
Sulkhan Tsintsadze St. 12, floor 3,  
non-residential area 3-6, 0160, Tbilisi, Georgia  
(540)

ვინჩერო  
**Vincero**  
Винчero

(591) Black-white  
(511) 33

(260) AM 2023 120021 A  
(210) AM 120021  
(220) 2022 10 24  
(731) Farm Fresh L.L.C.  
P.O. Box 7011, GMG Building, Umm  
Hurair Rd, Oud Metha, Bur Dubai, Dubai,  
United Arab Emirates  
(540)

**Sapora**

(591) Black-white  
(531) 27.05.01  
(511) 30

(260) AM 2023 120022 A  
(210) AM 120022  
(220) 2022 10 24  
(731) BMJ Industries FZ-LLC  
Al-Hamra Industrial Zone-FZ, Ras Al Khaimah,  
United Arab Emirates  
(740) Pavle Meipariani  
(540)



(591) Yellow, golden, white  
(531) 05.07.14; 05.07.19; 27.05.01; 28.01; 29.01.02  
(511) 34

(260) AM 2023 120023 A  
(210) AM 120023  
(220) 2022 10 25  
(731) Henesa LLC  
251 Little Falls Drive, Wilmington, DE 19808,  
USA  
(740) Giorgi Taktakishvili  
(540)

**GALLET**

(591) Black-white  
(511) 14

(260) AM 2023 120024 A  
(210) AM 120024  
(220) 2022 10 25  
(731) Shenzhen TCL New Technology CO., LTD.  
9/F, Building D4, International E City, 1001  
Zhongshan Park Road, Xili Street, Nanshan  
District, Shenzhen, 518000, Guangdong,  
People's Republic of China  
(740) Shalva Gvaramadze  
(540)

**AIPQ**

(591) Black-white  
(511) 9

(260) AM 2023 120127 A  
(210) AM 120127  
(220) 2022 10 28  
(731) FMC Agricultural Solutions A/S  
(Denmark Public Limited Company)  
Thyborønvej 78, 7673 Harboøre, Ronland,  
Denmark  
(740) Tamaz Shilakadze  
(540)

**VANTEX**

(591) Black-white  
(511) 5

(260) AM 2023 120129 A  
(210) AM 120129  
(220) 2022 10 28  
(731) JSC "Gepha"  
142, Akaki Beliashvili St., 0159, Tbilisi,  
Georgia  
(740) Salome Jeladze  
(540)

ბღბ ბილი ბ მოსტანო

ბღბ HEALLY ბ BOSTANO

(591) 000000 Black-white

(531) 24.17.09; 27.05.01; 28.19  
(511) 5, 32, 35

(260) AM 2023 120147 A  
(210) AM 120147  
(220) 2022 11 01  
(731) JSC "ProCredit Bank"  
Al. Kazbegi Av. 21, 0160, Saburtalo District,  
Tbilisi, Georgia  
(740) Zurab Bezhashvili;  
Lia Shikhiashvili;  
Ioane Iarajuli  
(540)



(591) Lilac, orange, red, yellow, dark green,  
light green, black, white, ivory, blue, grey  
(531) 06.07.05; 06.07.06; 07.01.24; 27.05.01;  
29.01.15  
(511) 9, 36

(260) AM 2023 120148 A  
(210) AM 120148  
(220) 2022 11 01  
(731) LLC "Solid Capital"  
Guram Rcheulishvili St. 11, 0179, Mtatsminda  
District, Tbilisi, Georgia  
(540)



(591) FFFFFFF white, F5A066 orange, 0F2F36 blue  
(531) 26.04.11; 26.04.24; 27.05.01; 27.05.24;  
29.01.13  
(511) 37

(260) AM 2023 120152 A  
(210) AM 120152  
(220) 2022 11 01  
(731) LLC Airline "Geo Sky"  
Arboshiki St. 2, 0144, Isani District, Tbilisi,  
Georgia

(540)

**Geosky**

(591) 11034C inky blue  
(531) 27.05.01; 27.05.08; 27.05.17; 29.01.05  
(511) 12, 16, 35, 38, 39, 41, 43

(260) AM 2023 120154 A  
(210) AM 120154  
(220) 2022 11 02  
(731) LLC Airline "Geo Sky"  
Arboshiki St. 2, 0144, Isani District, Tbilisi,  
Georgia

(540)



(591) White, inky blue, black, grey, brown, red  
(531) 18.05.01; 27.05.01; 29.01.12  
(511) 12, 35, 39

(260) AM 2023 120163 A  
(210) AM 120163  
(220) 2022 11 03  
(731) Giorgi Merabashvili  
Iasamani St. 6, ap. 99, 0159, Tbilisi, Georgia  
(540)

**step up**

(591) Black-white  
(511) 9, 35, 37, 42

(260) AM 2023 120164 A  
(210) AM 120164  
(220) 2022 11 03  
(731) Giorgi Merabashvili  
Iasamani St. 6, ap. 99, 0159, Tbilisi, Georgia  
(540)

**სტეპ აპ**

(591) Black-white  
(511) 9, 35, 37, 42

(260) AM 2023 120172 A  
(210) AM 120172  
(220) 2022 11 03  
(731) Güven Hastanesi Anonim Şirketi  
Paris Caddesi, No:58, Çankaya, Ankara,  
Türkiye  
(740) Giorgi Kartvelishvili

(540)



(591) Grey, red  
 (531) 02.07.23; 27.05.01; 29.01.12  
 (511) 39, 44

(260) AM 2023 120173 A  
 (210) AM 120173  
 (220) 2022 11 03  
 (731) Getz Pharma International FZ LLC  
 Office No: 1307, 13th floor, Al-Thuraya  
 Tower 1, Dubai Media city, United Arab  
 Emirates  
 (740) Nino Bakhtadze  
 (540)

**Livity**

(591) Black-white  
 (511) 5, 29

(260) AM 2023 120174 A  
 (210) AM 120174  
 (220) 2022 11 03  
 (731) Getz Pharma International FZ LLC  
 Office No: 1307, 13th floor, Al-Thuraya  
 Tower 1, Dubai Media city, United Arab  
 Emirates  
 (740) Nino Bakhtadze  
 (540)

**LivWell**

(591) Black-white  
 (511) 5, 29

(260) AM 2023 120233 A  
 (210) AM 120233  
 (220) 2022 11 07  
 (731) LLC "Rich Group"  
 Vill. Mughanlo, Marneuli Region, Georgia  
 (540)

**PAINDENT  
შპინდენტო**

(591) Black-white  
 (511) 5

(260) AM 2023 120234 A  
 (210) AM 120234  
 (220) 2022 11 07  
 (731) LLC "Rich Group"  
 Vill. Mughanlo, Marneuli Region, Georgia  
 (540)

**DENTPAIN  
დენტპაინი**

(591) Black-white  
 (511) 5

(260) AM 2023 120239 A  
 (210) AM 120239  
 (220) 2022 11 07  
 (731) Lela Ghviniashvili  
 Ikalto Gori St., bld. 1, ap. 10, 0171, Tbilisi,  
 Georgia  
 (540)

**ლელამე  
Lelame**

(591) Black-white  
 (511) 33

(260) AM 2023 120245 A  
 (210) AM 120245  
 (220) 2022 11 08  
 (731) LLC "IDS Borjomi Beverages Co.N.V. "  
 45 Pareraveg, Curaçao  
 (740) Giorgi Jokharidze  
 (540)

**ლიკანი – შემართება  
გემართება!**

(591) Black-white  
 (511) 32, 35

(260) AM 2023 120253 A  
 (210) AM 120253  
 (220) 2022 11 09  
 (731) JFP Gulf General Trading LLC  
 201, 2nd Floor, Al Mulla Building Murshid  
 Bazar P.O. Box: 122658, Deira Dubai, United  
 Arab Emirates  
 (740) Liliana Darakhvelidze  
 (540)

**ALISHAAN**

(591) Black-white  
 (511) 30

(260) AM 2023 120255 A  
 (210) AM 120255  
 (220) 2022 11 09  
 (731) JFP Gulf General Trading LLC  
 201, 2nd Floor, Al Mulla Building Murshid  
 Bazar P.O. Box: 122658, Deira Dubai, United  
 Arab Emirates  
 (740) Liliana Darakhvelidze  
 (540)



(591) Golden, white  
 (531) 01.15.07; 05.05.20; 27.05.21; 28.19; 29.01.02;  
 29.01.12  
 (511) 30

(260) AM 2023 120256 A  
 (210) AM 120256  
 (220) 2022 11 09  
 (731) Kraft Foods Italia Intellectual Property Srl  
 Via Nizzoli, 3, Milano, 20147, Italy  
 (740) Giorgi Taktakishvili  
 (540)



(591) Dark red, light red, white  
 (531) 26.13.25; 27.05.01; 27.05.24; 29.01.12  
 (511) 29, 30

(260) AM 2023 120336 A  
 (210) AM 120336  
 (220) 2022 11 11  
 (731) Soso Shengelia  
 Dighomi, VI qu., bld. 22b, ap. 10, 0159,  
 Tbilisi, GEorgia  
 (540)



(591) 211B3A black, 633D21 dark brown, D39A58  
 dark beige, AD2222 dark brown, 1C601A dark  
 green, F9F4F4 light carnelian, FCF9F9  
 white, AA0B63 carnelian, F2B91D beige,  
 F21F3B red, B707A0 purple, 249E3A green,  
 824D28 brown  
 (531) 05.03.04; 05.03.19; 05.03.20; 05.07.10;  
 11.03.02; 19.01.01; 19.01.05; 19.07.01;  
 29.01.15  
 (511) 33

(260) AM 2023 120343 A  
 (210) AM 120343  
 (220) 2022 11 14  
 (731) AstraZeneca AB  
 SE-151 85 Södertälje, Sweden, Sweden  
 (740) Tamaz Shilakadze  
 (540)

## KOSELUGO

(591) Black-white  
 (511) 5

(260) AM 2023 120351 A  
 (210) AM 120351  
 (220) 2022 11 16  
 (731) Partner Center sp. z o.o.  
 (Partner Center Limited Liability Company)  
 ul. Piotrkowska 89, 90-423, Lodz, Poland  
 (740) Nino Bakhtadze  
 (540)



(591) Red, white, transparent, black  
 (531) 24.13.01; 24.13.09; 24.13.23; 25.05.02;  
 26.04.02; 26.04.16; 26.04.24; 27.05.24;  
 29.01.13  
 (511) 33

(260) AM 2023 120353 A  
 (210) AM 120353  
 (220) 2022 11 16  
 (731) Nicoventures Holdings Limited  
 Globe House, 1 Water Street, London, WC2R  
 3LA, United Kingdom

(740) Tamar Kotchlamazashvili  
(540)

## VUSE CREAMY BLEND

(591) Black-white  
(511) 34

(260) AM 2023 120354 A

(210) AM 120354

(220) 2022 11 16

(731) Nicoventures Holdings Limited  
Globe House, 1 Water Street, London, WC2R  
3LA, United Kingdom

(740) Tamar Kotchlamazashvili

(540)

## VUSE CRYSTAL ICE

(591) Black-white  
(511) 34

(260) AM 2023 120362 A

(210) AM 120362

(220) 2022 11 16

(310) UK00003830391

(320) 2022 09 16

(330) UK

(731) Softline Holding PLC  
Kosta Charaki 11, Office 302, 3041, Limassol,  
Cyprus

(740) Giorgi Taktakishvili

(540)

## NOVENTIQ

(591) Black-white  
(511) 9, 35, 41, 42

(260) AM 2023 120433 A

(210) AM 120433

(220) 2022 11 18

(731) LTD "Geotradlers Group"  
Junker Shalva Eristavi St. 5, Didube District,  
Tbilisi, Georgia

(540)



(591) Dark blue, light blue, swamp green  
(531) 26.13.25; 27.05.01; 29.01.12  
(511) 19, 35

(260) AM 2023 120434 A

(210) AM 120434

(220) 2022 11 21

(731) Ivane Abaiadze  
Davit Aghmashenebli St. 25, 1400, Gori,  
Georgia

(540)

## Malnizari მალნიზარი

(591) Black-white  
(511) 33

(260) AM 2023 120437 A

(210) AM 120437

(220) 2022 11 21

(731) LLC "Kakhetian Traditional Winery"  
Sulkhan Tsintsadze St. 12, floor 3,  
non-residential area 3-6, 0160, Tbilisi, Georgia

(540)

## მოველი

moveli

МОВЕЛИ

(591) Black-white  
(511) 33

(260) AM 2023 120444 A

(210) AM 120444

(220) 2022 11 22

(731) Ferrari S.P.A.  
Via Emilia Est 1163, Modena, Italy

(740) Giorgi Taktakishvili

(540)



(591) Black-white  
(531) 24.01.09  
(511) 12

(260) AM 2023 120445 A

(210) AM 120445

(220) 2022 11 22

(731) Ferrari S.P.A.  
Via Emilia Est 1163, Modena, Italy

(740) Giorgi Taktakishvili

(540)

**Ferrari**

(591) Black-white  
 (531) 27.05.01; 27.05.11; 27.05.17  
 (511) 12

(260) AM 2023 120500 A  
 (210) AM 120500  
 (220) 2022 11 25  
 (731) Sayidat Alsalam FZE  
 Workstation No. S10123 O101 WS67,  
 Jebel Ali Free Zone, Dubai, United Arab  
 Emirates

(540)

**LIKE**

(591) Black-white  
 (531) 27.05.01  
 (511) 34

(260) AM 2023 120506 A  
 (210) AM 120506  
 (220) 2022 11 28  
 (731) LLC "Aversi Pharma"  
 Davit Aghmashenebeli Av. 148, 0112, Tbilisi,  
 Georgia

(540)

**მენოსტანი**  
**Меностан**  
**Menostan**

(591) Black-white  
 (511) 5

(260) AM 2023 120507 A  
 (210) AM 120507  
 (220) 2022 11 28  
 (731) LLC "L.L. Distillery"  
 Tsabadze St. 2, Zugdidi, Georgia

(540)



**ARIKI**  
**აჩიკი**

(591) Yellow, golden, brown, black, white  
 (531) 03.04.11; 03.04.13; 26.01.15; 27.05.01;  
 29.01.12  
 (511) 33

(260) AM 2023 120513 A  
 (210) AM 120513  
 (220) 2022 11 28  
 (731) Zaman Alakhyarov  
 Technical St. 94, ap. 306, Yekaterinburg,  
 Russian Federation

(540)



*Chumo Pants*

(591) White, red, black  
 (531) 27.05.02; 27.05.09; 27.05.10; 29.01.13  
 (511) 25

(260) AM 2023 120518 A  
 (210) AM 120518  
 (220) 2022 11 29  
 (731) Individual Entrepreneur Vitaly Stanishevskiy  
 Lochin St. 3, floor 2, b. 5, 0102, Chugureti  
 District, Tbilisi, Georgia

(540)



(591) White, red, black  
 (531) 07.01.03; 27.05.09; 27.05.10; 29.01.13  
 (511) 41

(260) AM 2023 120519 A  
 (210) AM 120519  
 (220) 2022 11 29  
 (731) Ilia Skanadze  
 Gela Kakiashvili St. 30, Khashuri, Georgia  
 (740) Giorgi Taktakishvili  
 (540)





(591) 000000 black, FFFFFFF white  
 (531) 24.09.02; 24.09.03; 24.09.05; 24.09.24;  
 24.09.25; 26.01.02; 26.01.16; 26.04.02;  
 26.04.05; 26.04.10  
 (511) 3, 5, 35

(260) AM 2023 120522 A  
 (210) AM 120522  
 (220) 2022 11 30  
 (731) LTD "Mogzauri"  
 Vazha-Pshavela Av., VI qu., bld. 10, ap. 36,  
 0186, Tbilisi, Georgia  
 (540)



(591) Dark blue, light green, white  
 (531) 26.04.22; 26.04.24; 27.05.21; 27.05.24;  
 29.01.13  
 (511) 35

(260) AM 2023 120532 A  
 (210) AM 120532  
 (220) 2022 12 01  
 (731) Philip Morris Products S.A.  
 Quai Jeanrenaud 3, 2000 Neuchâtel,  
 Switzerland  
 (740) Pavle Meipariani  
 (540)



(591) Various shades of grey, white  
 (531) 26.01.01; 26.01.03; 26.04.02; 26.04.10;  
 26.04.22; 26.04.24; 27.05.01; 27.05.24  
 (511) 34

(260) AM 2023 120533 A  
 (210) AM 120533  
 (220) 2022 12 02  
 (731) Philip Morris Products S.A.  
 Quai Jeanrenaud 3, 2000 Neuchâtel,  
 Switzerland

(740) Pavle Meipariani  
 (540)



(591) Various shades of grey, white  
 (531) 01.01.10; 24.17.03; 26.01.01; 26.01.03;  
 26.04.02; 26.04.10; 26.04.22; 26.04.24;  
 27.05.01; 27.05.24  
 (511) 34

(260) AM 2023 120534 A  
 (210) AM 120534  
 (220) 2022 12 02  
 (731) Philip Morris Products S.A.  
 Quai Jeanrenaud 3, 2000 Neuchâtel,  
 Switzerland  
 (740) Pavle Meipariani  
 (540)



(591) Various shades of grey, white  
 (531) 26.01.01; 26.01.04; 26.04.10; 26.04.22;  
 26.04.24; 27.05.01; 27.05.24  
 (511) 34

(260) AM 2023 120535 A  
 (210) AM 120535  
 (220) 2022 12 02  
 (731) Philip Morris Products S.A.  
 Quai Jeanrenaud 3, 2000 Neuchâtel,  
 Switzerland  
 (740) Pavle Meipariani  
 (540)



(591) Black-white  
 (531) 26.01.03; 26.01.24; 27.05.21  
 (511) 34

(260) AM 2023 120595 A  
(210) AM 120595  
(220) 2022 12 02  
(731) Philip Morris Products S.A.  
Quai Jeanrenaud 3, 2000 Neuchâtel,  
Switzerland  
(740) Pavle Meipariani  
(540)



(591) Black-white  
(531) 26.01.01; 26.01.04; 27.05.01; 27.05.21  
(511) 34

---

(260) AM 2023 120596 A  
(210) AM 120596  
(220) 2022 12 02  
(731) Philip Morris Products S.A.  
Quai Jeanrenaud 3, 2000 Neuchâtel,  
Switzerland  
(740) Pavle Meipariani  
(540)



(591) Black-white  
(531) 01.01.02; 01.01.10; 26.01.16; 27.05.21  
(511) 34

---

(260) AM 2023 120597 A  
(210) AM 120597  
(220) 2022 12 02  
(731) LTD "Green Lab"  
D. Arakishvili St. 7, ap. 9, Vake District,  
Tbilisi, Georgia  
(740) Nana Lartsuliani  
(540)



(591) Green, white, grey, black  
(531) 05.03.13; 05.03.20; 19.11.05; 27.05.01;  
29.01.13  
(511) 1, 31

---



## REGISTERED TRADEMARKS

(111) M 2023 36933 R  
 (151) 2023 06 12  
 (181) 2033 06 12  
 (260) AM 2022 118371 A  
 (220) 2022 07 01

(732) Nicoventures Holdings Limited  
 Globe House 1 Water Street, London, WC2R  
 3LA, United Kingdom

Makateb Business Centers, Office No.26,  
 Al Shorafa Complex, Sh Khalifa Bin Zayed  
 Road, P.O. Box 380, Ajman, United Arab  
 Emirates

(111) M 2023 36934 R  
 (151) 2023 06 12  
 (181) 2033 06 12  
 (260) AM 2022 118369 A  
 (220) 2022 07 01

(732) Nicoventures Holdings Limited  
 Globe House 1 Water Street, London, WC2R  
 3LA, United Kingdom

(111) M 2023 36939 R  
 (151) 2023 06 12  
 (181) 2033 06 12  
 (260) AM 2022 118222 A  
 (220) 2022 06 20

(732) Brass Monkey Holding Limited  
 The Gold and Diamond Park, Office  
 102&103, Building 6, P.O. Box 450676, Jebel  
 Ali Free Zone, Dubai, United Arab Emirates

(111) M 2023 36935 R  
 (151) 2023 06 12  
 (181) 2033 06 12  
 (260) AM 2022 117531 A  
 (220) 2022 04 18

(732) Ekaterina Shahin  
 Guram Panjikidze St. 22, Block A, ap. 87,  
 0160, Tbilisi, Georgia

(111) M 2023 36940 R  
 (151) 2023 06 12  
 (181) 2033 06 12  
 (260) AM 2022 118563 A  
 (220) 2022 07 14

(732) LTD "Iani "  
 Iia Chavchavadze Av. 50b, ap. 72, Tbilisi, Georgia

(111) M 2023 36936 R  
 (151) 2023 06 12  
 (181) 2033 06 12  
 (260) AM 2022 117650 A  
 (220) 2022 04 29

(732) Nikoloz Ghvinadze  
 Melikishvili St. 10, floor 7, 0179, Tbilisi,  
 Georgia

(111) M 2023 36941 R  
 (151) 2023 06 12  
 (181) 2033 06 12  
 (260) AM 2022 118750 A  
 (220) 2022 07 27

(732) Huayao Intelligent Technology Co., Limited  
 RM 1003,10 / F, Tower One, Lippo Centre, 89  
 Queensway, Admiralty, Hong Kong

(111) M 2023 36937 R  
 (151) 2023 06 12  
 (181) 2033 06 12  
 (260) AM 2022 118762 A  
 (220) 2022 07 28

(732) LTD "Inexphone"  
 Kote Marjanishvili St. 28, Tbilisi, Georgia

(111) M 2023 36942 R  
 (151) 2023 06 12  
 (181) 2033 06 12  
 (260) AM 2022 118223 A  
 (220) 2022 06 20

(732) LLC "White Square"  
 Taras Shevchenko St. 1, Entrance 2, Floor 3,  
 ap. 41, 0186, Tbilisi, Georgia

(111) M 2023 36938 R  
 (151) 2023 06 12  
 (181) 2033 06 12  
 (260) AM 2022 118235 A  
 (220) 2022 06 21

(732) Vistros INTL-F.Z.E

(111) M 2023 36943 R  
 (151) 2023 06 12  
 (181) 2033 06 12  
 (260) AM 2022 118378 A  
 (220) 2022 07 01

(732) LTD "Impexpharm"  
 Giorgi Saakadze Str., II Exit 17, 0160, Tbilisi,  
 Georgia

(111) M 2023 36944 R  
(151) 2023 06 12  
(181) 2033 06 12  
(260) AM 2022 118476 A  
(220) 2022 07 08  
(732) LTD "Bolero & Company"  
Kuchishvili St. 12-14-16, 0179, Tbilisi,  
Georgia

---

(111) M 2023 36945 R  
(151) 2023 06 12  
(181) 2033 06 12  
(260) AM 2022 118844 A  
(220) 2022 08 03  
(732) Nodar Mindiashvili  
Sairme St., bld. 1, ap. 5, 0194, Tbilisi,  
Georgia

---

(111) M 2023 36946 R  
(151) 2023 06 12  
(181) 2033 06 12  
(260) AM 2022 118231 A  
(220) 2022 06 21  
(732) Davit Gigauri  
Vill. Kvemo Sobisi, Gori Region, Georgia

---

(111) M 2023 36947 R  
(151) 2023 06 12  
(181) 2033 06 12  
(260) AM 2022 118731 A  
(220) 2022 07 25  
(732) Natalia Pautova  
Mukhiani Settlement 4b Micro, bld. 21,  
ap. 29, Tbilisi, Georgia

---

(111) M 2023 36948 R  
(151) 2023 06 12  
(181) 2033 06 12  
(260) AM 2022 118842 A  
(220) 2022 08 03  
(732) LTD "Demasi"  
Right bank, Nearby 9 March Park, Tbilisi,  
Georgia

---

(111) M 2023 36949 R  
(151) 2023 06 12  
(181) 2033 06 12  
(260) AM 2022 118558 A  
(220) 2022 07 13  
(732) LTD "3D"  
Nutsubidze St. 10, ap. 9, Tbilisi, Georgia

---

(111) M 2023 36950 R  
(151) 2023 06 12  
(181) 2033 06 12  
(260) AM 2022 118299 A  
(220) 2022 06 28  
(732) Mikheil Songhulashvili  
Village Dighomi, Davit Aghmashenebeli  
Dead End 2, ap. 5, 0159, Tbilisi, Georgia

---

(111) M 2023 36951 R  
(151) 2023 06 13  
(181) 2033 06 13  
(260) AM 2022 118372 A  
(220) 2022 07 01  
(732) Nicoventures Holdings Limited  
Globe House 1 Water Street, London, WC2R  
3LA, United Kingdom

---

(111) M 2023 36952 R  
(151) 2023 06 13  
(181) 2033 06 13  
(260) AM 2022 118370 A  
(220) 2022 07 01  
(732) Nicoventures Holdings Limited  
Globe House 1 Water Street, London, WC2R  
3LA, United Kingdom

---

(111) M 2023 36953 R  
(151) 2023 06 13  
(181) 2033 06 13  
(260) AM 2022 118374 A  
(220) 2022 07 01  
(732) Nicoventures Holdings Limited  
Globe House 1 Water Street, London, WC2R  
3LA, United Kingdom

---

(111) M 2023 36954 R  
(151) 2023 06 13  
(181) 2033 06 13  
(260) AM 2022 118373 A  
(220) 2022 07 01  
(732) Nicoventures Holdings Limited  
Globe House 1 Water Street, London, WC2R  
3LA, United Kingdom

---

(111) M 2023 36961 R  
(151) 2023 06 21  
(181) 2033 06 21  
(260) AM 2022 117833 A  
(220) 2022 05 18  
(732) LTD "Caru"  
Vill. Tchala, VII Lane 3, Sachkhere Region,  
Georgia

---

(111) M 2023 36962 R  
(151) 2023 06 21  
(181) 2033 06 21  
(260) AM 2019 100059 A  
(220) 2019 04 03  
(732) GSH Trademarks Limited  
Afroditis, 25, 2nd Floor, Flet/Office 204,  
Nicosia, Cyprus

---

(111) M 2023 36963 R  
(151) 2023 06 21  
(181) 2033 06 21  
(260) AM 2022 118728 A  
(220) 2022 07 23  
(732) LTD "Archil Mchedlidze's Law Company"  
Kote Marjanishvili St. 6, 0102, Tbilisi, Georgia

---

(111) M 2023 36964 R  
(151) 2023 06 21  
(181) 2033 06 21  
(260) AM 2022 117801 A  
(220) 2022 05 13  
(732) LLC "Linus & Co"  
Borough Kazreti, Madneuli St. 10, Bolnisi,  
Georgia

---

(111) M 2023 36965 R  
(151) 2023 06 21  
(181) 2033 06 21  
(260) AM 2022 116854 A  
(220) 2022 03 02  
(732) Bagi Professional Cleaning Products LTD  
194 Akko Rd, Kiryat Bialik 27232, Israel

---

(111) M 2023 36966 R  
(151) 2023 06 21  
(181) 2033 06 21  
(260) AM 2022 118234 A  
(220) 2022 06 21  
(732) Artessence FZC  
Elob Office No. E2-127G-14, Hamriyah Free  
Zone, Sharjahri Zon, Sharja, United Arab  
Emirates

---

## TRADEMARKS REGISTERED ACCORDING TO THE ACCELERATED PROCEDURE

The decision can be appealed at the Chamber of Appeal of Sakpatenti within 3 months from the publication.

(111) M 2023 36926 R  
(151) 2023 06 06  
(181) 2033 06 06  
(210) AM 123073  
(220) 2023 05 29  
(732) LLC "Champions 111"  
Ilia Chavchavadze Av. 29, floor 5, 0179,  
Tbilisi, Georgia

(540)



(591) 231F20 black, F15A22 orange,  
FCFCFC white  
(531) 26.01.03; 26.01.24; 26.04.10; 26.04.22;  
26.04.24; 27.05.01; 27.05.24; 29.01.13  
(511) 35

(111) M 2023 36927 R  
(151) 2023 06 06  
(181) 2033 06 06  
(210) AM 119911  
(220) 2022 10 20  
(732) Luka Alliance Limited  
Akara Bldg. 24 De Castro Street,  
Wickhams Cay I, Road Town,  
Tortola, British Virgin Islands  
(740) Rima Lomauri  
(540)



(591) Green, white  
(531) 05.03.13; 05.03.15; 05.03.20; 27.05.01;  
29.01.03  
(511) 16, 21, 24, 25, 28, 32, 33, 34, 35, 39

(111) M 2023 36928 R  
(151) 2023 06 08  
(181) 2033 06 08  
(210) AM 122859  
(220) 2023 05 18  
(732) LTD "Gloria Jeans Georgia"  
Patardzeuli St. 22/11, Tbilisi,  
Georgia

(540)



(591) Orange, white, black  
(531) 02.09.14; 11.03.04; 26.04.02; 26.04.05;  
26.04.14; 26.04.16; 26.04.22; 26.04.24;  
27.05.01; 27.05.11; 27.05.24; 28.19; 29.01.13  
(511) 32

(111) M 2023 36929 R  
(151) 2023 06 08  
(181) 2033 06 08  
(210) AM 123071  
(220) 2023 05 29  
(732) Noreva Pharma  
66 Avenue des Champs Elysées, Paris,  
F-75008, France  
(740) Tamar Kotchlamazashvili  
(540)

**NOREVA**

(591) Black-white  
(511) 3

(111) M 2023 36930 R  
(151) 2023 06 08  
(181) 2033 06 08  
(210) AM 122981  
(220) 2023 05 25  
(732) Sergey Kubasov  
Herbert Samuel 56, Tel Aviv-Yafo, 6330308,  
Israel  
(740) Irakli Gvilia  
(540)

**scalable.**

(591) Black, white, red  
(531) 24.17.02; 27.05.01; 29.01.12  
(511) 35, 42

(111) M 2023 36931 R  
 (151) 2023 06 08  
 (181) 2033 06 08  
 (210) AM 123076  
 (220) 2023 05 29  
 (732) LLC "Geo Sweets Group"  
 Leonidze St. 27, Batumi, Georgia



(591) 771616 Brown, red, white, black, different shades of green, sky-blue  
 (531) 03.04.02; 06.19.11; 06.19.13; 25.01.19; 29.01.15  
 (511) 1

(111) M 2023 36932 R  
 (151) 2023 06 08  
 (181) 2033 06 08  
 (210) AM 122856  
 (220) 2023 05 18  
 (732) LLC "AmaLine Group"  
 Dighomi, IV qu., bld. 25, ap. 48, 0159, Tbilisi, Georgia

(740) Giorgi Meipariani  
 (540)

**MUSTANG**

(591) Black-white  
 (511) 32

(111) M 2023 36955 R  
 (151) 2023 06 14  
 (181) 2033 06 14  
 (210) AM 122677  
 (220) 2023 05 04  
 (732) Ornu Co Operative Limited  
 Grattan House, Lower Mount Street, Dublin 2, Ireland  
 (740) Giorgi Taktakishvili

(540)



(591) Green, yellow, white, grey, black  
 (531) 03.04.02; 19.03.03; 19.03.24; 29.01.14  
 (511) 29

(111) M 2023 36956 R  
 (151) 2023 06 20  
 (181) 2033 06 20  
 (210) AM 123077  
 (220) 2023 05 29  
 (732) LTD "Geowine Trading"  
 Kostava St. 37-39, Office Space 606, Floor 7, Tbilisi, Georgia

(540)

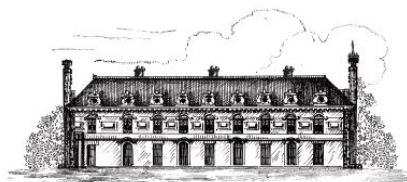

CHÂTEAU  
**LEUVILLE**

(591) Black-white  
 (531) 07.01.01; 27.05.01; 27.05.10  
 (511) 33

(111) M 2023 36957 R  
 (151) 2023 06 20  
 (181) 2033 06 20  
 (210) AM 122972  
 (220) 2023 05 24  
 (732) LTD "Dry Line Dry Clean"  
 Vazha-Pshavela Av. 91, IV qu., bld. 2, Tbilisi, Georgia

(540)



(591) White, brown, grey  
(531) 02.03.15; 02.03.16; 02.03.23; 09.01.07;  
11.07.03; 12.01.22; 25.01.05; 26.01.01;  
26.01.14; 27.05.01; 28.19  
(511) 37

---

(111) M 2023 36958 R  
(151) 2023 06 21  
(181) 2033 06 21  
(210) AM 123093  
(220) 2023 06 01  
(732) Joint Stock Company "Lomisi"  
Vill. Natakhtari, 3308, Mtskheta,  
Georgia

(540)

**Shift**  
**შიფტი**

(591) Black-white  
(511) 32, 33

---

(111) M 2023 36959 R  
(151) 2023 06 21  
(181) 2033 06 21  
(210) AM 123097  
(220) 2023 06 01  
(732) Giorgi Melikishvili  
Tornike Eristavi Lane 3, ap. 83, Tbilisi,  
Georgia

(540)

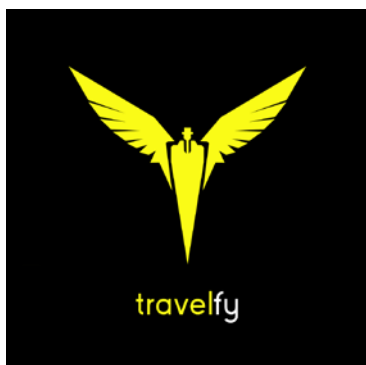

(591) Black, yellow, white  
(531) 03.07.16; 03.07.24; 03.07.25; 26.04.01;  
26.04.05; 26.04.15; 26.04.22; 26.04.24;  
27.05.24; 29.01.13  
(511) 39

---

(111) M 2023 36960 R  
(151) 2023 06 21  
(181) 2033 06 21  
(210) AM 123091  
(220) 2023 05 31  
(732) Joint Stock Company "Lomisi"  
Vill. Natakhtari, 3308, Mtskheta,  
Georgia

(540)

**Peak Energy**  
**პიკ ენერჯი**

(591) Black-white  
(511) 32

---

## INTERNATIONAL TRADEMARKS FOR WHICH A DECISION ON GRANTING PROTECTIONS IS TAKEN

The decision can be appealed at the Chamber of Appeal of Sakpatenti within 3 months from the publication or at the Mtskheta District Court Administrative Cases Board (Address: №17, Samkhedro St., Mtskheta), within 1 month following the publication.

(260) AM 2023 118284 A  
 (800) 1575203  
 (151) 2021 01 08  
 (891) 2022 05 27  
 (731) SPARTA Holdings, LLC  
 14-34 110th Street, Suite 303-Room 100,  
 College Point NY 11356, USA  
 (540)



(591) Black, white  
 (531) 02.09.01; 03.09.10; 03.09.24; 24.11.18;  
 24.13.02  
 (511)  
 35 – On-line retail store services featuring a wide variety of consumer goods of others, namely, clothing, jewelry, home and kitchen goods, novelty goods, car accessories, stationary, wedding and christening goods, and religious artifacts.

(260) AM 2023 118769 A  
 (800) 1674253  
 (151) 2022 06 27  
 (891) 2022 06 27  
 (731) Aktsionernoe obshchestvo "Moskovsky pivobezalkogolny kombinat "OCHAKOVO"  
 ul. Ryabinovaya, d. 44, RU-121471 MOSKVA,  
 Russian Federation  
 (540)



(591) Red, blue and white  
 (531) 25.05.03; 27.05.10; 27.05.17; 27.05.24;  
 29.01.13

(511)  
 32 – Aperitifs, non-alcoholic; carbonated water; cocktails, non-alcoholic; lemonades; non-alcoholic beverages; isotonic beverages; soft drinks; energy drinks; powders for effervescing beverages; syrups for beverages; starch-based dry mixes for beverage preparation; preparations for making carbonated water; must; pastilles for effervescing beverages; non-alcoholic essences for making beverages; sherbets [beverages].

(260) AM 2023 119434 A  
 (800) 1683885  
 (151) 2022 04 06  
 (891) 2022 04 06  
 (731) TV Žaidimai  
 Saltoniškių g. 9, LT-08105 Vilnius, Lithuania  
 (540)

## STARZLE

(591) Black, white  
 (511)  
 9 – Recorded content; software; computer gaming software; electronic game software for wireless devices; electronic game software for handheld electronic devices; simulation software [entertainment]; interactive multimedia software for playing games; interactive entertainment software for use with personal computers; interactive multimedia computer game programs; interactive multimedia game programs; interactive computer game programs; interactive entertainment computer software for video games; interactive entertainment software; interactive video game programs; computer programmes for interactive television and for interactive games and/or quizzes; pre-recorded compact discs featuring games; computer game software, recorded; computer games of chance; programmed video games contained on cartridges [software]; computer games programs recorded on tapes [software]; interactive casino games provided through a computer or mobile platform; interactive game software; computer programs for pre-recorded games; recorded computer game programs; recorded programs for hand-held games with liquid crystal displays; computer video game software; computer game discs; games software; computer game software for use on mobile and cellular phones; computer game software for use with on-line interactive games; computer games programmes for simulating financial securities trading [software]; computer software for the administration of on-line games and gaming; computer software for entertainment; computer game cartrid-

ges; computer games programmes downloaded via the internet [software]; augmented reality game software; educational software featuring instructions for playing games; electronic game software for mobile phones; computer application software featuring games and gaming; games software for use with video game consoles; computer software that permits games to be played; computer game software downloadable from a global computer network; downloadable computer game software via a global computer network and wireless devices; computer game software, downloadable; downloadable interactive entertainment software for playing computer games; downloadable electronic game software for wireless devices; downloadable computer games; downloadable interactive entertainment software for playing video games; downloadable electronic game programs; downloadable game software; downloadable computer game programs; downloadable video game programs; entertainment software; software for arcade video game machines; programs for arcade video game machines; computer programs for video and computer games; video games [computer games] in the form of computer programs recorded on data carriers; gaming software that generates or displays wager outcomes of gaming machines; virtual reality game software; video game programs; software programs for video games; video games on disc [computer software]; game programs for arcade video game machines; downloadable software; artificial intelligence software for analysis; electronic lottery tickets; data processing programs; integrated software packages; electronic scratch cards; software for smartphones; interactive multimedia computer programs; interactive software; interactive computer software; adaptive software; animation software; sports betting applications; game development software; databases; electronic publications, downloadable, relating to games and gaming; electronic publications relating to games and gaming; electronic publications featuring games; holographic images; interactive dvds; audio visual recordings; interactive electronic publications; downloadable electronic publications in the nature of magazines in the field of video games; electronic downloadable publications in the field of video games.

28 – Lottery wheels; toys, games, and playthings; table-top games and gambling devices; automatic mah-jong tables; machines for playing games of skill or chance; bingo cards; gaming machines for gambling; bingo game playing equipment; bingo markers; go games; electronic board games; dominoes; raffle tickets; karuta playing cards (Japanese card game); stone-pieces pots for go game (goke pots); go stones; go boards; Japanese dice games (sugoroku); Japanese playing cards; dice; war games using model soldiers; foosball tables; wooden pieces for shogi game (koma); shogi boards; Japanese playing cards (hanafuda); Japanese playing cards (utagaruta); slot machines [counter-freed amusement apparatus]; chips for gambling;

playing card shuffling device; lottery scratch cards; lottery tickets; racing car games; skittles [games]; playing cards; card shuffling machines; Korean chess pieces (jang-gi pieces); Korean playing cards (hwa-too); Korean board games (yut nori sets); Korean dominos (glopae); game boards for trading card games; chinese checkers [games]; building games; trading card games; keno cards; kendo cards; chinese chess; mah-jong; manipulative games; miniatures for use in war games; miniatures for use in games; models for use with role playing games; roulette wheels; roulette chips; poker chips; scratch cards for playing lottery games; roulette sets; roulette tables; shogi game equipment (Japanese chess); printed lottery tickets; board games; table-top games; tables for table shuffleboard; tabletop basketball games; carrying cases specially designed for portable games; question sets for board games; draughts [games]; draughtboards; checkers pieces; chessboards; chess pieces; chess games; marbles for games; backgammon games; backgammon sets; role playing games; indoor football tables; cups for dice; games relating to fictional characters; memory games; quiz games; equipment sold as a unit for playing card games (terms too vague in the opinion of the International Bureau (Rule 13 (2) (b) of the Common Regulations); markers [counters] for playing games; counters [discs] for games; marbles for playing games; cases for playing cards; chips and dice [gaming equipment]; hockey games; video game apparatus, arcade games, and amusement machines; automatic coin-operated games; automatic gaming machines; amusement machines, automatic and coin-operated; free-standing video games apparatus; protective cases for video game device remote controls; amusement game machines; automatic electronic games; bill-operated gaming equipment; electronic games; electronic educational teaching games; arcade games (electronic -) [coin or counter operated apparatus]; electronic amusement apparatus incorporating a liquid crystal display; electronic games other than those adapted for use with television receivers only; electronic games apparatus; apparatus for electronic games adapted for use with an external display screen or monitor; horizontal pinball machine (korinto-game machines); Japanese horizontal pinball machines [smartball machines]; interactive gaming chairs for video games; external cooling fans for game consoles; Japanese vertical pinball machine (pachinko machines); pinball games machines [coin or counter operated]; pinball machines [coin or non-coin operated]; pinball machines; video game apparatus; slot machines [gaming machines]; coin-operated electrical amusement apparatus; coin-operated electronic amusement apparatus; coin-operated amusement gaming machines; coin-operated arcade video game machines; coin-operated video amusement apparatus; coin-operated games; coin-operated amusement machines; home video game machines; portable games and toys incorporating telecommunication functions; portable



games with liquid crystal displays; hand-held game consoles; portable gaming devices; protective films adapted for screens for portable games; poker machines; amusement apparatus for use in arcades; hand-held electronic video games; electronic hand-held game units; hand-held games with liquid crystal displays; hand-held consoles for playing video games; video game machine cases; video game apparatus; protective films for video game device remote controls; gamepads for video game machines; joysticks for video games; games adapted for use with television receivers; apparatus for games adapted for use with television receivers; amusement apparatus adapted for use with television receivers only; gaming chip sets; gaming keypads; claw crane game machines; token-operated video game machines; controllers for game consoles; arcade game machines; smart toys.

41 – Education, entertainment and sports; education, entertainment and sport services; gambling services; conducting multiple player games of chance; bingo services; bingo hall services; football pools services; gambling information services; online sports betting services; providing of casino and gaming facilities; card room services; betting exchange services; services for the operation of computerised bingo; casino, gaming and gambling services; on-line casino services; betting services; organization of lotteries; wagering services; conducting lotteries for others; provision of information relating to racing; on-line gambling services; providing casino facilities [gambling]; casino services; providing casino facilities; administration [organisation] of poker games; poker game services; prize draws [lotteries]; sports betting services; sporting results services; chess room services; video game services; arcade game services; organisation of esports events; production of esports events; production of esports events for television; esports coaching; organising of esports activities; electronic games services; arranging and conducting e-sports competitions; providing esports facilities; organization of electronic sports competitions; electronic game services and competitions provided by means of the internet; electronic game services provided by means of the internet; electronic games services provided by means of a global communication network; electronic games services provided via a global computer network; electronic games services provided from a computer database or by means of the internet; electronic games services, including provision of computer games on-line or by means of a global computer network; organization of electronic game competitions; provision of information relating to esports; provision of on-line computer games; provision of online information relating to game players; information relating to computer gaming entertainment provided online from a computer database or a global communication network; providing information on-line relating to computer games and computer enhancements for games; providing interactive multi-player computer games via the internet

and electronic communication networks; provision of non-downloadable games on the Internet; on-line gaming services; online game services through mobile devices; providing a computer game that may be accessed by users on a global network and/or the internet; gaming services for entertainment purposes; providing a computer game that may be accessed network-wide by network users; entertainment in the nature of e-sports competitions; entertainment services relating to esports; entertainment services for matching users with computer games; computer and video game amusement services; virtual reality game services provided on-line from a computer network; providing online information on computer and video game strategies; providing amusement arcade services; interactive computer game services; esports officiating; providing on-line interactive computer games; video game entertainment services; video arcade services; providing on-line information in the field of computer gaming entertainment; conducting of live esports events; providing on-line video games; game services provided online from a computer network; provision of games by means of a computer based system; game services provided by means of communications by computer terminals or mobile telephone; amusement arcade services; virtual reality arcade services; games services provided via computer networks and global communication networks; rental services relating to equipment and facilities for education, entertainment, sports and culture; rental of slot machines [gaming machines]; leasing of casino games; rental of amusement machines and apparatus; games equipment rental; amusement arcade machine rental services; rental of game machines and apparatus; information about entertainment and entertainment events provided via online networks and the internet; entertainment services in the nature of interactive television programmes; online interactive entertainment; interactive entertainment services; provision of on-line entertainment; internet radio entertainment services; providing slot machine parlors; organising and conducting lotteries; provision of facilities for outdoor recreational activities; organisation of events for cultural, entertainment and sporting purposes; gaming machine entertainment services; entertainment in the nature of ongoing game shows; providing games; game shows; providing online entertainment in the nature of game shows; providing online entertainment in the nature of game tournaments; administration [organisation] of gaming services.

---

(260) AM 2023 119435 A  
 (800) 1683915  
 (151) 2022 05 16  
 (891) 2022 05 16  
 (731) Victron Energy B.V.  
 De Paal 35, NL-1351 JG Almere,  
 Netherlands

(540)

**BlueSolar**

(591) Black, white

(511)

9 – Apparatus and instruments for the conduction, distribution, conversion, storage, regulation and management of electricity; apparatus and instruments for accumulating and storing electricity; apparatus and instruments for controlling electricity; photovoltaic apparatus for generating electricity; electric cables and wires; electric cords for adapters; electric cords for splitters; power inlets; junction boxes for electric wires; measuring, detecting, monitoring and controlling devices; electricity measuring instruments; electric controllers and electric regulators; sensors, detectors and monitoring instruments; solar charge controllers; dongles; autotransformers; galvanic isolators; solar home systems being photovoltaic apparatus for generating solar electricity; inverters; photovoltaic inverters; electrical inverters; dc/ac inverters; ac/dc inverters; inverters for power supply; inverters used in solar power generation; isolation transformers; chargers; current collectors; current transformers; current meters; current limiters; current converters; current shunts; current breakers; current rectifiers; current testers; fault current breakers; alternating current adaptors; electric current adaptors; current overload protectors; direct current converters; dc-dc converters; electric current sensors; ac current sensors; energy meters; electric current transformers; voltage transformers; voltage stabilizers; voltage regulators; voltage dividers; voltage meters; voltage limiters; voltage detectors; voltage testers; high voltage transformers; voltage monitor modules; induction voltage regulators; voltage surge suppressors; static voltage regulators; maximum power point trackers; electric current switches; electric current rectifiers; fuses for electric current; electric current control devices; instruments for distributing electric current; voltage converters; voltage multipliers; voltage-to-current converters; voltage stabilizing power supply; voltage regulators for vehicles; high voltage power supplies; low voltage power supplies; distribution amplifiers; distribution transformers; distribution boards; electricity distribution boards; distribution consoles (electricity); electric power distribution apparatus; panels for the distribution of electricity; power conditioners; power modules; power connectors; power adaptors; power distribution systems; power adaptors; power amplifiers; power controllers; power capacitors; power switches; power analyzers; power testers; power stabilisers; power meters; power cables; power banks; power wires; electric power units; power units [transformers]; power conditioning apparatus; power packs [batteries]; electrical power adaptors; power units [batteries]; power line protectors; power line conditioners; static power convertors; power packs [transformers]; electric power analyzers; power distributing boxes; electronic power controllers; outdoor power relays; elec-

tronic power transformers; underwater power cables; power regulating apparatus; low power microcontrollers; electric power converters; power distributors [electrical; electrical distributing busbars; high current distributors; switching power supply apparatus; uninterruptible power supply apparatus; electrical power distribution blocks; electric power supply sockets; electrical power outlet boxes; electric power supply units; mains power units (electric -); power-line transmission apparatus; electrical power extension cords; power transformers for amplification; ac/dc power supplies; dc input power supplies; high-voltage power supplies; lowvoltage power supplies; accumulators for photovoltaic power; solar-powered battery chargers; solarpowered rechargeable batteries; distribution boxes for electrical power; voltage regulators for electric power; high-frequency switching power supplies; uninterruptible power supply apparatus [battery]; modules for photovoltaic power generation; apparatus for improving power efficiency; crystalline silicon solar power cells; portable power supplies (rechargeable batteries); apparatus for diagnosing electrical power installations; electric batteries for powering electric vehicles; photovoltaic installations for generating electricity [photovoltaic power plants]; apparatus and instruments for regulating the distribution of electricity; apparatus and instruments for conducting the distribution of electricity; apparatus and instruments for controlling the distribution of electricity; apparatus and instruments for switching the distribution of electricity; apparatus and instruments for transforming the distribution of electricity; apparatus and instruments for accumulating the distribution of electricity; measurement apparatus; data loggers and recorders; computer networking and data communications equipment; controller area network (can bus); computer networks; data processing equipment and accessories (electrical and mechanical); sensors; sensor controllers; electronic sensors; infrared sensors; detectors; electric monitoring apparatus; electric monitoring units; voltage monitoring units; electronic measurement sensors; monitoring control apparatus [electric]; panels for the control of electricity; electric control devices for energy management; electronic apparatus for the remote control of signals; computer software for controlling and managing electricity; apparatus and instruments for controlling the use of electricity; wireless controllers to remotely monitor and control the function and status of other electrical, electronic, and mechanical devices or systems; remote controls; programmable controls; microprocessor controls; electrical controls; remote controllers; multiport controllers; inverter controllers; programmable controllers; electrical controllers; energy control devices; electronic control systems; stud-type electrical dual terminal blocks; stud-type electrical terminal blocks; automatic control apparatus; electric control panels; electric control apparatus; process controlling software; electric power controllers; software for operating and mana-

ging integrated circuit components; auxiliary battery packs; transfer switches; dc distribution systems; battery adapters; battery booster cables; battery boxes; battery cables; battery cases; battery charge devices; battery chargers; battery charging devices for motor vehicles; battery charging equipment; battery compensation chargers; battery jars; battery jump starters; battery leads; battery packs; battery preheaters; battery separators; battery starters; battery terminals; battery management systems; battery protectors; battery isolators; battery connectors; battery switches; software for apparatus and instruments for the conduction, distribution, conversion, storage, regulation and management of electricity; software for monitoring, analysing, controlling and running physical world operations; electrical engineering software; networking software; computer network hardware; computer bus network; network management control apparatus; network management software; network communication apparatus; software for remote diagnostics; diagnostic apparatus, not for medical purposes; testing apparatus for diagnostic purposes [other than medical]; cellular modem; cellular network modem; gps receivers; automatic solar tracking sensors; electronic sensors for measuring solar radiation; solar energy collectors for electricity generation; photovoltaic apparatus and installations for generating solar electricity; photovoltaic apparatus for converting solar radiation to electrical energy; monitors; monitor screens; tablet monitors; touchscreen monitors; monitoring instruments; monitoring apparatus and instruments; mains monitoring apparatus (electric -); temperature monitors for industrial use; temperature monitors for household use; non-intrusive load monitoring [nilm] apparatus; apparatus for monitoring electrical energy consumption; monitoring apparatus, other than for medical purposes; software for apparatus for measuring, monitoring and analyzing electricity consumption; power relays; midi fuses; mega fuses; field effect transistors (fet); buck-boost converters; solar cells; photovoltaic solar modules; load break isolators; electric transformers; electric voltage transformers; electronic power supplies; power dividers [electric]; regulated power supply apparatus; battery balancers; battery combiners; software for battery monitors; software for power inverters; software for electric inverters.

(260) AM 2023 119436 A

(800) 1683918

(151) 2022 05 05

(891) 2022 05 05

(731) H & M Hennes & Mauritz AB

Mäster Samuelsgatan 46A, SE-106 38

Stockholm, Sweden

(540)

**HOWEVER YOU MOVE**

(591) Black, white

(511)

9 – Pedometers; sunglasses; cases adapted for mobile phones; goggles for sports; swim goggles.

10 – Graduated compression hosiery; compression panty hose; foam massage rollers; trigger balls; massage balls; pressure relief pads and cushions; face masks for medical use.

18 – Leather and imitations of leather; animal skins; luggage; bags; sports packs; umbrellas; suitcases; pocket wallets; handbags; evening handbags; work bags; shoulder bags; canvas bags; reusable shopping bags; rucksacks; bags for sports; purses; trunks [luggage]; key cases; toiletry bags.

25 – Clothing; footwear; headgear; gym suits; bathing trunks; bathing suits; bath robes; bikinis; pantsuits; sports pants; neckerchiefs; gloves [clothing]; sports jackets; shell jackets; fleece jackets; quilted jackets [clothing]; training shorts; skirts; underwear for sports; short-sleeve shirts; sports jerseys; coveralls; pocket squares; rainwear; scarves; casual shirts; beach clothes; sports singlets; sports bras; athletic tights; sports socks; sweaters; sports T-shirts; waistcoats; fingerless gloves; outerclothing; coats; jackets [clothing]; children's wear; tee-shirts; shorts; tights; tank tops; pants; tops [clothing]; underwear; stockings; hats; caps being headwear; baseball caps; knitted caps; visors; headbands [clothing]; running shoes; training shoes; walking shoes; face masks [fashion wear]; wet suits; neck tubes; sweatbands.

28 – Games; toys; gymnastic and sporting articles; rubber exercise bands; dumb-bells; exercise weights; yoga blocks; gym balls for yoga; yoga straps; kettle bells; rings for sports; manually operated rings for lower and upper body resistance exercise; pilates toning balls; skipping ropes.

35 – Advertising and marketing; providing consumer information on goods and services online; retail services, in relation to the following goods: sun glasses, sports goggles, swim goggles, pedometers, compression tights, foam massage rollers, trigger balls, massage balls, pressure relief pads and cushions, pillows, facial masks, glass bottles, plastic bottles, clothing, footwear, headgear, yoga mats, games and playthings, gymnastic and sporting articles, sports accessories, mobile cases, cases for keys, card holders.

41 – Gym activity classes; training in yoga; pilates instruction; sports and fitness services; rental services relating to sports equipment and facilities.

(260) AM 2023 119437 A

(800) 1683926

(151) 2022 05 19

(891) 2022 05 19

(731) Michael Barten-Renon

Hausvogteiplatz 13, 10117 Berlin, Germany

(540)



(591) Black and red

(531) 26.04.02; 26.04.07; 26.04.18; 27.05.07; 29.01.12

(511)

9 – Sound recording carriers; apparatus for recording, transmission or reproduction of sound or images; digital storage media; magnetic data carries; compact discs, dvds and other digital recording media; none of the aforesaid goods in connection with medical technology goods; all the aforesaid goods solely in connection with content relating to medicine, health and the healing of humans, in particular psychotherapy, hypnosis, personal development and personality development, personal and specialist coaching.

16 – Printed matter; instructional and teaching material (except apparatus); books; magazine; periodicals; placards of paper or cardboard; prospectuses; flyers; newsletters; publications, printed; all the aforesaid goods solely in connection with content relating to medicine, health and the healing of humans, in particular psychotherapy, hypnosis, personal development and personality development, personal and specialist coaching.

44 – Medical services; advisory services relating to health; human hygiene and beauty care; psychosocial care; hypnotherapy for medical purposes; psychologist (services of a -); services of a non-medical practitioner; conducting therapies; therapy services; all the aforesaid services in connection with the psychotherapeutic treatment of psychic and psychosomatic illnesses; services of a psychologist and a therapist, in particular in relation to applied psychotherapy, hypnosis and mental training methods; none of the aforesaid services in connection with medical technology goods, in particular not in connection with medical technology apparatus for dermatological purposes.

(260) AM 2023 119438 A

(800) 1683931

(151) 2022 05 17

(891) 2022 05 17

(731) MURAT KASAP

GÜZELTEPE MAH. BEYAZ KÖŞK SK.,  
NO: 46/C10 İÇ KAPI NO: 3 Üsküdar, İstanbul,  
Türkiye

(540)

(591) Sea blue. Pantone: 16-5119 TCX

(531) 27.05.01; 29.01.04

(511)

30 – Pastries and bakery products based on flour, desserts based on flour and chocolate, bread, simit [Turkish ring-shaped bagel covered with sesame seeds], poğaçı [Turkish bagel], pita, sandwiches, katmer [Turkish pastry], pies, cakes, baklava [Turkish dessert based on dough coated with syrup], kadayıf [Turkish dessert based on dough], desserts based on dough coated with syrup, puddings, custard, kazandibi [Turkish pudding], rice pudding, keşkül [Turkish pudding]; condiments for foodstuff, vanilla (flavoring), spices, sauces (condiments), tomato sauce; yeast, baking powder; flour, semolina, starch for food; cereal-based snack food, popcorn, crushed oats, corn chips, breakfast cereals, processed wheat for human consumption, crushed barley for human consumption, processed oats for human consumption, processed rye for human consumption and rice; bread sticks for decorating soup, dried bread crumbs, crackers, herbs and combinations thereof, flavorings and spices, including in dried powder and paste formats, marinades, pastes, used for marinating meat/chicken/fish, seasonings, spice mixes and sauces for marinating products such as meat, fish and chicken; gluten additives for culinary purposes and thickening agents for cooking foodstuffs, in particular for delay of the bread staling process and for improving the form and color of bread, special purpose flours, special flour types, flour mixtures, additive flours, ready-made flour mixtures, flour premixes; yeast, namely bread yeast, dough yeast, sourdough yeast, fresh sourdough yeast, sourdough yeast, instant yeast and active dry yeast, dough mixes, dough, sourdough mixes, mixes for making bakery products, natural additives, mixtures, concentrates and premixes that improve the form and color of bakery products, delay the staling process, namely cereal based preparations, powdered concentrates for use in baking, starch and baking soda [bicarbonate of soda for cooking purposes], all to improve the form and color of bakery products, and delay of the bread staling process, bakery products, pastry products and extracts for use as food flavorings, other than essential oils, seasonings and flavorings, other than essential oils, for food and beverages, thickening agents for cooking foodstuffs, baking powders, vanillin, vanilla flavorings for culinary purposes, sauces.

(260) AM 2023 119439 A

(800) 1683933

(151) 2022 06 02

(891) 2022 06 02

(731) Euro Games Technology Ltd.

4, "Maritsa" Str., "Vranya-Lozen-Triugulnika",  
BG-1151 Sofia, Bulgaria

(540)

(591) Black, white

(511)

9 – Software; computer gaming software; computer software packages; computer operating system software; computer software, recorded; software drivers; virtual reality software; games software; entertainment software for computer games; computer programs for network management; operating computer software for main frame computers; monitors (computer hardware); computer hardware; apparatus for recording images; monitors (computer programs); computer game programs; computer programs for recorded games; apparatus for recording, transmission or reproduction of sound or images; communications servers [computer hardware]; electronic components for gambling machines; computer application software featuring games and gaming; computer software for the administration of on-line games and gaming; computer hardware for games and gaming; hardware and software for gambling, gambling machines, gambling games on the Internet and via telecommunication network.

28 – Gaming machines for gambling; chips for gambling; mah-jong; arcade games; gambling machines operating with coins, notes and cards; games; electronic games; parlor games; gaming chips; gaming tables; slot machines [gaming machines]; LCD game machines; slot machines and gaming devices; coin-operated amusement machines; roulette chips; poker chips; chips and dice [gaming equipment]; gaming equipment for casinos; roulette tables; gaming roulette wheels; casino games; gambling machines and amusement machines, automatic and coin-operated; coin-operated amusement machines and/or electronic coin-operated amusement machines with or without the possibility of gain; boxes for coin-operated machines, slot machines and gaming machines; electronic or electrotechnical amusement machines and apparatus, gaming machines, coin-operated entertainment machines; housings for coin-operated machines, gaming equipment, gaming machines, machines for gambling; electropneumatic and electrical gambling machines (slot machines).

41 – Gambling; entertainment services related to gambling; gaming services for entertainment purposes; casino, gaming and gambling services; training in the development of software systems; provision of gaming equipment for gambling halls; providing casino equipment [gambling]; gaming machine entertainment services; providing casino facilities [gambling]; gaming hall services; amusement arcade services; games equipment rental; rental of gaming machines; providing amusement arcade services; rental of gaming machines with images of fruits; editing or recording of sounds and images; sound recording and video entertainment services; hire of sound reproducing apparatus; provision of gaming equipment for casinos; providing of casino facilities; online gambling services; casino, gaming and gambling services; provision

of gaming facilities, gaming hall facilities, Internet casinos and online gambling services.

(260) AM 2023 119520 A

(800) 1684405

(151) 2022 08 11

(891) 2022 08 11

(731) 1141931 ONTARIO LTD.

3605 Weston Rd, Toronto ON M9L 1V7,  
Canada

(540)

**NAVA**

(591) Black, white

(511)

33 – Alcoholic bitters; alcoholic chocolate-based beverages; alcoholic cocktails; alcoholic coffee-based beverages; alcoholic fruit beverages; alcoholic tea-based beverages; aperitifs; brandy; fruit extracts, alcoholic; gin; liqueurs; rum; tequila; vodka; whiskey; wine; wine-based beverages; alcoholic extracts, namely, extracts from herbs, plants and flowers for the preparation of alcoholic cocktails; alcoholic extracts, namely, extracts from spices for the preparation of alcoholic cocktails.

(260) AM 2023 119554 A

(800) 1685458

(151) 2022 01 12

(891) 2022 01 12

(731) BASRİ TÜRKERİ

Katip Kasım Mahallesi, Güvelik Caddesi No:39  
Kat 1/103, Yenikapı, Fatih/İstanbul, Türkiye

(540)



(591) Red, black, white

(531) 02.09.12; 04.05.21; 07.01.01; 09.07.15;

25.01.25; 27.05.01; 27.05.09; 27.05.10;

29.01.13

(511)

43 – Restaurant (food and beverage services) hotel (temporary accommodation services) (terms considered too vague in the opinion of the International Bureau – Rule 13 (2) (b) of the Common Regulations), accommodation related reservation services (terms considered too vague in the opinion of the International Bureau – Rule 13 (2) (b) of the Common Regulations).

(260) AM 2023 119559 A  
 (800) 1685782  
 (151) 2022 07 18  
 (891) 2022 07 18  
 (731) SHANGHAI JIDU AUTOMOBILE CO., LTD.  
 Building 2, No. 1688 Yecheng Road, Jiading  
 District, 200000 Shanghai, China

(54)

集度

(591) Black, white  
 (531) 28.03  
 (511)  
 12 – Vehicles for locomotion by land, air, water or rail; remote control vehicles, other than toys; self-driving cars; driverless cars [autonomous cars]; robotic cars; electric cars; automobiles; bicycles; tires for vehicle wheels; windcreens.

(260) AM 2023 119560 A  
 (800) 1685792  
 (151) 2022 05 31  
 (891) 2022 05 31  
 (731) Nexus Automotive International SA  
 Chemin du Château-Bloch 11, CH-1219  
 Le Lignon, Switzerland

(540)



(591) Anthracite (Pantone PMS 425) and orange (Pantone PMS 144)  
 (531) 24.17.04; 25.03.01; 25.03.03; 26.01.03; 26.01.16; 26.01.18; 26.01.24; 26.11.01; 26.11.07; 27.05.01; 27.05.08; 27.05.09; 27.05.10; 27.05.24; 29.01.13

(511)  
 12 – Vehicles; motors, engines and parts for land vehicles, excluding bicycles as well as two-wheeled and three-wheeled motor vehicles; apparatus for locomotion by land, air or water, excluding bicycles, parts and components of bicycles as well as two-wheeled and three-wheeled motor vehicles.

37 – Maintenance and repair of motor vehicles; Rebuilding of worn or partially destroyed engines; repair information; retreading of tires; rustproofing; wheel balancing services; vehicle lubrication [greasing]; vehicle washing; vehicle polishing; vehicle service stations [refueling and maintenance]; vehicle maintenance (servicing); vehicle cleaning; repair services in the case of vehicle breakdown; charging of vehicle batte-

ries; vulcanization of tires [repair]; warehouse installation and repair.

(260) AM 2023 119561 A  
 (800) 539861  
 (151) 1989 06 02  
 (891) 2022 07 27  
 (731) Spontex  
 420 rue d'Estienne d'Orves, F-92705 Colombes  
 Cedex, France

(540)

**CALYPSO**

(591) Black, white  
 (531) 27.05.17  
 (511)  
 21 – Natural or artificial sponges.

(260) AM 2023 119562 A  
 (800) 678012  
 (151) 1997 07 29  
 (891) 2022 08 02  
 (731) Symrise AG  
 Mühlenfeldstrasse 1, 37603 Holzminden,  
 Germany

(540)

**CRINIPAN**

(591) Black, white  
 (511)  
 1 – Chemicals for use in industry.

(260) AM 2023 119563 A  
 (800) 735029  
 (151) 1999 12 21  
 (891) 2022 09 01  
 (731) Walther Spritz- und Lackiersysteme GmbH  
 18-30, Kärntner Strasse, 42306 Wuppertal,  
 Germany

(540)



(591) Black, white  
 (531) 26.01.01; 26.01.10; 27.01.01; 27.05.01  
 (511)  
 6 – Fittings for spraying guns (for paints and lacquers), namely pipes, pipe connectors, pipe extensions, cup swivel joints, nozzles; pressure containers for paints and varnish (lacquers).



7 – Paint spraying apparatus for paints and varnish (lacquers); spraying guns for paints and varnish (lacquers); pumps, air compressors.

9 – Control and measuring implements.

11 – Exhausting apparatus and implements for extraction systems.

(260) AM 2023 119564 A

(800) 785230

(151) 2002 04 26

(891) 2022 07 29

(731) Obshchestvo s ogranichennoy otvetstvennostyu "UPECO"

Chaplygina ul. 13/2, office 104, RU-103062  
Moscow, Russian Federation

(540)



(591) Black, green, yellow

(531) 03.07.13; 27.05.01; 29.01.02; 29.01.03;  
29.01.08; 29.01.13

(511)

1 – Disincrustants; antistatic preparations, other than for household purposes; antifreeze; bacterial preparations other than for medical and veterinary use; preparations for the separation of greases; purifying chemicals; distilled water; chemical additives to insecticides; chemical additives to fungicides; glue for industrial purposes; cement for boots and shoes; cement for mending broken articles; leather glue; glue for rubber; starch paste (adhesive), other than for stationary or household purposes; oils for preparing leather in the course of manufacture; mastic for leather; degumming preparations; clarification preparations; bleaching chemicals for industrial purposes; separating and unsticking (ungluing) preparations; scale removing preparations, other than for household purposes; corrosive preparations; gum solvents; solvents for varnishes; calcined soda; caustic soda for industrial purposes; bicarbonate of soda for chemical purposes; leather-renovating chemicals, leather-dressing chemicals; chemical chimney cleaners; chemical glass and metal cleaners; stain-preventing chemicals for use on fabrics; leather-waterproofing chemicals; leather-impregnating chemicals; textile-impregnating chemicals; refrigerants.

3 – Abrasives; scale removing preparations for household purposes; shaving stones (antiseptic); anti-static preparations for household purposes; leather preservatives (polishes); laundry glaze; starch for laundry purposes; sachets for perfuming linen; polishing stones;

smoothing stones; emery paper; polishing paper; cotton wool for cosmetic purposes; polish; depilatory wax; waxes for leather; shoe wax; make-up; deodorants for personal use; windscreen cleaning liquids; volcanic ash for cleaning; dentifrices; adhesives for cosmetic purposes; quillaia bark for washing; cosmetic kits; cosmetics; cosmetics for animals; cosmetic dyes; creams for leather; shoe polish; oil of turpentine for degreasing; whitening; cleaning chalk; detergents other than for use in manufacturing operations and for medical purposes; soap; ammonia (volatile alkali) (detergent); bleaching preparations (decolorants); laundry bleach; perfumery; pastes for razor strops; pumice stone; bath suds, not for medical purposes; preservatives for leather (polishes); shaving preparations; polishing preparations; bleaching preparations (laundry); rust removing preparations; scouring solutions; tissues impregnated with cosmetic lotion; bath salts, not for medical purposes, shampoos; abrasive paper; abrasive cloth.

5 – Antiseptics; germicides; balms for medical purposes; bandages for dressings; hygienic bandages; fly catching paper, mothproofing paper; herbicides; sanitary towels; disinfectants for hygienic purposes; deodorants, other than for personal use; nutritional additives for medical purposes; mineral nutritional additives; insecticides; fly catching adhesives; additives to fodder for medical purposes; rat poison; adhesive plaster; drugs for medical purposes; medicines for veterinary purposes; remedies for foot perspiration; therapeutic preparations for the bath; lotions for veterinary purposes; lotions for pharmaceutical purposes; ointments for pharmaceutical purposes; anti-horse-fly oils; carbolineum (parasiticide); animal washes; bath suds for medical purposes; pesticides; anti-corn plasters; anti-horse-fly preparations; air freshening preparations; mothproofing preparations; larvae exterminating preparations; preparations for destroying noxious animals; preparations mothproofing preparations; larvae exterminating preparations; preparations for destroying noxious animals; preparations for destroying noxious plants; fly destroying preparations; insect repellents; repellents for dogs; bath salts for medical purposes; parasiticides; nervines; pharmaceutical preparations for skin care; fungicides; antiparasitic collars for animals; poisons.

11 – Air purifying apparatus and machines; extractor hoods for kitchens; ventilation hoods; gas burners; petrol burners; germicidal burners; barbecues; lamps.

24 – Face towels of textile; table napkins of textile; mosquito nets.

25 – Gaiters; socks; footwear; clothing, fittings of metal for shoes and boots; waterproof clothing; welts for boots and shoes; inner soles; hosiery.

42 – Quality control; research and development (for others); litigation services.

(260) AM 2023 119565 A

(800) 1458216

(151) 2018 10 31

(891) 2022 08 26

(731) TARCZYŃSKI S.A.

Ujeździec Mały 80, PL-55-100 TRZEBNICA,  
Poland

(540)



(591) Blue, brown, white

(531) 24.17.04; 26.04.06; 26.04.07; 29.01.13

(511)

29 – Meats; meat preserves; beef burgers; hamburgers; bacon; chorizo; veal; poultry; game, not live; extracts of poultry; meat extracts; hot dog sausages; tripe; knuckle of ham; meat gelatines; hummus [chickpea paste]; cured sausages; sausages; pepperoni; smoked sausages; uncooked sausages; sausages in batter; bottled cooked meat; meat, preserved; pie fillings of meat; sliced meat; mortadella; meat spreads; pates; liver pâté; salami; shish kabobs; ham; vegetarian sausages; croquettes; preserves, pickles; nut-based snack foods; soy-based snack foods; meat-based snack foods; tofu-based snacks; vegetable-based snack foods; vegetable-based entrees; faggots [meatballs]; vegetable mousses; vegetable salads; chicharron; lard; fatty substances for the manufacture of edible fats; edible fats; animal fats for food; tofu; fish, not live; dishes of fish; prepared dishes consisting principally of meat; prepared meals consisting primarily of meat substitutes.

30 – Cheeseburgers [sandwiches]; flaky pastry containing ham; pies containing meat; gluten additives for culinary purposes; pies containing poultry; pies containing game; boxed lunches consisting of rice, with added meat, fish or vegetables; hot dogs (prepared); sandwiches; hamburgers contained in bread rolls; frankfurter sandwiches; sandwiches containing chicken; sandwiches containing meat; sandwiches containing minced beef; meat pies [prepared]; pot pies; meat pies; muesli; frozen pastry stuffed with meat and vegetables; pancakes; pâtés en croûte; custard; ravioli; pelmeni [dumplings stuffed with meat]; pizzas; spring rolls; sushi; pre-packaged lunches consisting primarily of rice, and also including meat, fish or vegetables; poultry and game meat pies; condiments; ham glaze; pesto [sauce].

35 – Opinion polling; market research and marketing studies; public relations studies; advertising and marketing consultancy; professional business consultancy; arranging of demonstrations for advertising purposes; organisation and conducting of product presentations; demonstration of goods for promotional purposes;

presentation of goods on communication media, for retail purposes; dissemination of advertising matter; public relations services; advertising; retail services relating to food; wholesale services in relation to foodstuffs.

(260) AM 2023 119566 A

(800) 1471534

(151) 2019 04 12

(891) 2022 08 26

(731) TARCZYŃSKI S.A.

Ujeździec Mały 80, PL-55-100 Trzebnica,  
Poland

(540)

## TARCZYŃSKI

(591) Black, white

(511)

29 – Meat; prepared meat; cooked meats; cured meats; dried meat; frozen meat; freeze-dried meat; mincemeat [chopped meat]; canned meat; preserved meat; sausage meat; bratwurst; preserved sausages; saveloys; pepperoni; hotdog sausages; smoked sausages; sausages in batter; mortadella; chorizo; meat sticks; black pudding; pastrami; salami; uncooked sausages; shish kabobs; charcuterie; ham; veal; poultry; game; pork; beef; animal marrow for food; liver; chicken balls; pork cutlets; beef burgers; hamburgers; bacon; tripe; knuckle of ham; croquettes; sliced meat; stews; luncheon meats; canned cooked meat; bottled cooked meat; vegetable pate; liver pâté; meat spreads; offal; frozen meat products; processed meat products; packaged meats; meat-based snack foods; frozen meals consisting primarily of meat; prepared dishes consisting principally of meat; prepared meals consisting primarily of meat substitutes; steaks of meat; pie fillings of meat; extracts of poultry; meat extracts; meat gelatines; preserves, pickles; bacon rinds; chicharron; poultry substitutes; meat substitutes; fish; dishes of fish; sashimi; seafood extracts; fish extracts; fish fillets; cooked fish; prepared meals consisting substantially of seafood; prepared meals consisting primarily of fish; fish eggs for human consumption; caviar; fish sausages; bottled fish products; fish, tinned [canned (Am.)]; fish sticks; fish paste; fish and seafood spreads; nut-based snack foods; soy-based snack foods; tofu-based snacks; vegetable-based snack foods; vegetable-based entrees; faggots [food]; mousses (vegetable -); vegetable salads; poultry salads; hummus [chickpea paste]; vegetarian sausages; tofu; soy burger patties; vegetable burgers; prepared vegetable products; soya patties; tofu burger patties; frozen prepared meals consisting principally of vegetables; vegetable-based meat substitutes; frozen vegetables; processed vegetables; casseroles [food]; stock [prepared]; stock; extracts for soups; broth concentrates; soup concentrates; stock cubes; mixes for making soup; soup pastes; stock; fish stock; vegetable stock; soups; sausage casings, natural or artificial; lard; fatty sub-



tances for the manufacture of edible fats; edible fats; animal fats for food; blended oil [for food]; oils for food; animal oils for food; milk-based snacks; cheese-based snack foods.

30 – Filled baguettes; filled bread rolls; frozen pastry stuffed with meat and vegetables; pies containing meat; meat pies [prepared]; pot pies; meat pies; pies containing poultry; pies containing game; flaky pastry containing ham; sandwiches; hamburgers contained in bread rolls; frankfurter sandwiches; sandwiches containing chicken; sandwiches containing meat; sandwiches containing chicken; sandwiches containing minced beef; sandwiches containing fish; wraps [sandwich]; frozen pastry stuffed with meat and vegetables; pâtés en croûte; sausage rolls; pork pies; chicken pies; vegetable pies; spaghetti and meatballs; fresh sausage rolls; pancakes; puddings; ravioli; pelmeni [dumplings stuffed with meat]; pizza; spring rolls; sushi; poultry and game meat pies; burritos; calzones; enchiladas; lasagne; pasta containing stuffings; cheeseburgers [sandwiches]; pastries consisting of vegetables and meat; pasta containing stuffings; filled yeast dough with fillings consisting of vegetables; filled yeast dough with fillings consisting of meat; boxed lunches consisting of rice, with added meat, fish or vegetables; pre-packaged lunches consisting primarily of rice, and also including meat, fish or vegetables; frozen pastry stuffed with vegetables; frozen pastry stuffed with meat; muesli; gluten additives for culinary purposes; flavorings and seasonings; flavourings made from meat; spices; seasoning mixes; baking spices; marinades; ham glaze; sauces; sauces for barbecued meat; pesto [sauce]; seasoned coating for meat, fish, poultry; sausage binding materials; seaweed [condiment]; preparations for making up into sauces; hot dog sandwiches.

35 – Retail services relating to food; retail services in relation to meats; retail services in relation to baked goods; retail services via catalogues related to foodstuffs; retail services via global computer networks related to foodstuffs; wholesale services in relation to meats; wholesale services in relation to foodstuffs; wholesaling, retailing and sale via a computer network of the following goods: meat, charcuterie, sausages, pâtés, preserves, meat products, fish products, food pastes, processed meat products, prepared meat products, meat-based snack food, prepared meals consisting of meat, vegetable-based meat substitutes and prepared vegetable products; wholesaling, retailing and sale via a computer network of the following goods: bouillon, soups, fats for food, sandwiches, filled bread rolls, baked goods containing vegetables and meat, flavourings, spices, marinades and sauces; computerised online ordering in the field of foodstuffs; promotion and sale of foodstuffs; electronic commerce services, namely, providing information about products via telecommunication networks for advertising and sales purposes; unmanned retail store

services relating to food; providing commercial information to consumers; sales administration; business administration; presentation of goods and services on the Internet; sales promotion; sales promotion using audiovisual media; demonstration of goods for promotional purposes; presentation of goods on communication media, for retail purposes; business assistance, management and administrative services; providing consumer information relating to goods and services; providing consumer product information relating to foodstuffs; business management assistance in the field of franchising; services rendered by a franchisor, namely, assistance in the running or management of industrial or commercial enterprises; business management assistance in the field of franchising; business advisory services relating to the establishment and operation of franchises; professional business consulting; professional business consulting; opinion polling; market research and marketing studies; public relations studies; advertising and marketing consultancy; arranging of demonstrations for advertising purposes; organisation and conducting of product presentations; dissemination of advertising matter; public relations services; advertising.

(260) AM 2023 119568 A

(800) 1584257

(151) 2021 01 25

(891) 2022 07 07

(731) Fontaine Limited

c/o Tmf Group 8th Floor, 20 Farringdon Street,  
London EC4A 4AB, United Kingdom

(540)

## GREEN IRISH TWEED

(591) Black, white

(511)

3 – Perfumes; fragrances; eau de parfum; toilet water; colognes; shaving preparations; shaving gels; shaving soaps; shaving foams; aftershave preparations; shaving balms; lotions for beards; toiletries; non-medicated toiletry preparations; soaps; soaps for personal use; cosmetic preparations for the bath and shower; non-medicated skin care preparations; nail care preparations; hair care preparations; essential oils; scented oils; deodorants for personal use; room fragrances.

4 – Candles; perfumed candles.

(260) AM 2023 119569 A

(800) 1587416

(151) 2021 02 11

(891) 2022 09 02

(731) GRIVEN S.R.L.

VIA BULGARIA, 16, I-46042 CASTEL  
GOFFREDO (MN), Italy

(540)

## GRIVEN

(591) Black, white

(511)

9 – Projection apparatus; light-emitting diodes [LED]; flashing lights [luminous signals]; optical lamps; optical lenses; light dimmers [regulators], electric; projection screens; mirrors [optics]; optical glass; lighting ballasts; lighting control apparatus and instruments; control consoles for lighting apparatus and instruments; computer hardware and software for lighting control; low resolution LED screens.

11 – Lighting apparatus and installations; LED lighting fixtures; color filters for lighting apparatus; diffusers being parts of lighting installations; spotlights; filters for use with lighting apparatus; light-emitting diode luminaires [LED]; lights for external installation; luminous tubes for lighting; laser light projectors; lamps; lighting apparatus for underwater use; dynamic pixel lighting fixtures.

(260) AM 2023 119570 A

(800) 1624272

(151) 2021 10 05

(891) 2022 07 25

(731) LYKOS Pharma Ltd

No 1, Floor 1 Suite 24, Gwardamangia Hill,  
PTA 1319 PIETA, Malta

(540)

## DEMATSYT

(591) Black, white

(511)

5 – Pharmaceuticals, medicinal, medical and veterinary preparations; sanitary preparations for medical purposes; dietetic food and substances adapted for medical or veterinary use, food for babies; dietary supplements for humans and animals; plasters, materials for dressings; material for stopping teeth, dental wax; disinfectants; preparations for destroying vermin; fungicides, herbicides; mineral nutritional supplements; vitamin preparations.

(260) AM 2023 119571 A

(800) 1624358

(151) 2021 10 05

(891) 2022 07 25

(731) LYKOS Pharma Ltd

No 1, Floor 1 Suite 24, Gwardamangia Hill,  
PTA 1319 PIETA, Malta

(540)

## ДЕМАЦИТ

(591) Black, white

(531) 28.05

(511)

5 – Pharmaceuticals, medicinal, medical and veterinary preparations; sanitary preparations for medical purposes; dietetic food and substances adapted for medical or veterinary use, food for babies; dietary supple-

ments for humans and animals; plasters, materials for dressings; material for stopping teeth, dental wax; disinfectants; preparations for destroying vermin; fungicides, herbicides; mineral nutritional supplements; vitamin preparations.

(260) AM 2023 119572 A

(800) 1637582

(151) 2021 10 20

(891) 2022 07 01

(731) SUBSIDIARY COMPANY "CONFECTIONERY CORPORATION "ROSHEN"

1 Nauky Avenue, building 1, Kyiv 03039,  
Ukraine

(540)



The logo for 'YUMM! GUMMI' features the word 'YUMM!' in a bold, black, rounded font with a white outline, and 'GUMMI' below it in a similar but slightly smaller font. The exclamation mark in 'YUMM!' is particularly large and prominent.

(591) Black, white

(531) 24.17.04; 27.05.01

(511)

30 – Peanut confectionery; cereal bars; high-protein cereal bars; waffles; biscuits; chocolate-coated nuts; chewing gum; frozen yogurt [confectionery ices]; caramels [sweets]; confectionery; confectionery for decorating Christmas trees; crackers; rice crackers; crème brûlée; liquorice [confectionery]; mints for breath freshening; macarons; coconut macaroons; marzipan; almond confectionery; ice cream; dessert mousses [confectionery]; chocolate mousses; peppermint sweets; nougat; stick liquorice [confectionery]; lozenges [confectionery]; fondants [confectionery]; pralines; candy decorations for cakes; chocolate decorations for cakes; profiteroles; gingerbread; puddings; rice cakes; malt biscuits; sorbets [ices]; chocolate-based spreads; chocolate spreads containing nuts; petit-beurre biscuits; tarts; cakes; tortillas; fruit jellies [confectionery]; fruit confectionery; halvah; sweets; crystallized rock sugar; chocolate; chocolate beverages with milk; pains au chocolat.

(260) AM 2023 119626 A

(800) 1685940

(151) 2022 05 19

(891) 2022 05 19

(731) Euro Games Technology Ltd.

4, "Maritsa" Str., "Vranya-Lozen-Triugulnika",  
BG-1151 Sofia, Bulgaria

(540)



The logo for 'Lucky HIT' features the word 'Lucky' in a yellow, bubbly font with a white outline, and 'HIT' below it in a blue, blocky font with a white outline. The 'HIT' part has a slight shadow effect.

(591) Yellow, white, light blue, blue, cyan and purple  
(531) 27.05.02; 27.05.17; 29.01.13

(511)

9 – Software; computer gaming software; computer software packages; computer operating system software; computer software, recorded; software drivers; virtual reality software; games software; entertainment software for computer games; computer programs for network management; operating computer software for main frame computers; monitors (computer hardware); computer hardware; apparatus for recording images; monitors (computer programs); computer game programs; computer programs for recorded games; apparatus for recording, transmission or reproduction of sound or images; communications servers [computer hardware]; electronic components for gambling machines; computer application software featuring games and gaming; computer software for the administration of on-line games and gaming; computer hardware for games and gaming; hardware and software for gambling, gambling machines, gambling games on the Internet and via telecommunication network.

28 – Gaming machines for gambling; chips for gambling; mah-jong; arcade games; gambling machines operating with coins, notes and cards; games; electronic games; parlor games; gaming chips; gaming tables; slot machines [gaming machines]; LCD game machines; slot machines and gaming devices; coin-operated amusement machines; roulette chips; poker chips; chips and dice [gaming equipment]; gaming equipment for casinos; roulette tables; gaming roulette wheels; casino games; gambling machines and amusement machines, automatic and coin-operated; coin-operated amusement machines and/or electronic coin-operated amusement machines with or without the possibility of gain; boxes for coin-operated machines, slot machines and gaming machines; electronic or electrotechnical amusement machines and apparatus, gaming machines, coin-operated entertainment machines; housings for coin-operated machines, gaming equipment, gaming machines, machines for gambling; electropneumatic and electrical gambling machines (slot machines).

41 – Gambling; entertainment services related to gambling; gaming services for entertainment purposes; casino, gaming and gambling services; training in the development of software systems; provision of gaming equipment for gambling halls; providing casino equipment [gambling]; gaming machine entertainment services; providing casino facilities [gambling]; gaming hall services; amusement arcade services; games equipment rental; rental of gaming machines; providing amusement arcade services; rental of gaming machines with images of fruits; editing or recording of sounds and images; sound recording and video entertainment services; hire of sound reproducing apparatus; provision of gaming equipment for casinos;

providing of casino facilities; online gambling services; casino, gaming and gambling services; provision of gaming facilities, gaming hall facilities, Internet casinos and online gambling services.

(260) AM 2023 119627 A

(800) 1685942

(151) 2022 05 26

(891) 2022 05 26

(731) THINKCAR TECH CO., LTD.

2606, Building 4, Phase II, Tianan Yungu, Gangtou Community, Bantian, Longgang District, Shenzhen, 518100 Guangdong, China

(540)

**XHINKCAR**

(591) Black, white

(531) 27.05.17

(511)

9 – Automatic indicators of low pressure in vehicle tyres; data processing apparatus; couplers [data processing equipment]; computer programs, downloadable; personal digital assistants [PDAs]; speed checking apparatus for vehicles; mobile phone software applications, downloadable; computer peripheral devices; readers [data processing equipment]; computer software applications, downloadable; computer software platforms, recorded or downloadable; diagnostic instruments for automobile breakdowns; testing instruments; engine analyzers; remote control telemetering apparatus and instruments; automobile testing equipment; diagnostic computers for automobile breakdowns; downloadable computer software programs.

12 – Anti-skid chains; bumpers for automobiles; brake pads for automobiles; spikes for tyres; vehicle bumpers; trailer hitches for vehicles; shock absorbers for automobiles; automobile tyres; adhesive rubber patches for repairing inner tubes; anti-theft alarms for vehicles.

35 – Advertising; import-export agency services; provision of an online marketplace for buyers and sellers of goods and services; business management and organization consultancy; systemization of information into computer databases; on-line promotion of computer networks and websites; marketing; marketing services in the field of website traffic optimization; personnel management consultancy; sponsorship search.

37 – Vehicle battery charging; retreading of tyres; maintenance of tyres; maintenance of automobiles; vehicle breakdown repair services; vehicle cleaning; anti-rust treatment for vehicles; tyre balancing; motor vehicle maintenance and repair; vehicle service stations [refuelling and maintenance].

42 – Computer software design; maintenance of computer software; development of computer platforms;

vehicle roadworthiness testing; product quality testing; updating of computer software; software as a service [SaaS]; design and development of computer software; functional testing of equipment and instruments; product safety testing.

(260) AM 2023 119628 A

(800) 1685944

(151) 2022 07 18

(891) 2022 07 18

(731) Apple Inc.

One Apple Park Way, Cupertino CA 95014,  
USA

(540)

## ULTRAFUSION

(591) Black, white

(511)

9 – Computer hardware; computer hardware, namely, integrated circuits, computer chips, and interposers for computer chips.

(260) AM 2023 119629 A

(800) 1686039

(151) 2022 07 21

(891) 2022 07 21

(731) SOPHIE COMPANY Co., Ltd.

B-2404, 323, Incheon tower-daero, Yeonsu-gu,  
Incheon, Republic of Korea

(540)

## GLOWIEST

(591) Black, white

(511)

3 – Detergents for household use; lipsticks; make-up; cosmetic preparations for the hair and scalp; body lotion; blemish balm creams; sun block [cosmetics]; cleaning preparations for fabrics; cleansers for cleaning purposes; skin cleansing creams; skin care lotions [cosmetic]; preparations for unblocking sinks; glass cleaners; detergents for automobiles; anti-wrinkle creams; facial packs; hand cream; perfume; hair shampoo; cosmetics.

14 – Earrings; jewellery plated with precious metals; works of art of precious metal; statues of precious metal; bracelets of precious metal; gold; gold rings [jewelry]; diamonds; necklaces; rings [jewelry]; ankle bracelets; jewellery and precious metals; wristwatches; parts for watches; key rings [split rings with trinket or decorative fob]; pendants [jewelry].

25 – Clothing of leather; outerclothing; leggings [trousers]; caps being headwear; mufflers; shirts; undergarments; bathing suits; stockings; sports wear; children's clothing; socks; one-piece suits; clothing; gloves [clothing]; belts [clothing]; nighties; blue jeans; tee-shirts.

35 – Retail store services featuring detergents for household use; wholesale store services featuring detergents for household use; advertising; wholesale store services featuring earrings; retail store services featuring earrings; retail store services featuring jewellery plated with precious metals; wholesale store services featuring jewellery plated with precious metals; marketing services; wholesale store services featuring caps [headwear]; retail store services featuring caps [headwear]; import and export agencies; wholesale store services featuring clothing; retail store services featuring clothing; wholesale store services featuring cleansing preparations for personal use; retail store services featuring cleansing preparations for personal use; promoting the goods and services of others by means of operating an on-line comprehensive shopping mall; business intermediary services relating to mail order by telecommunications; publicity; wholesale store services featuring cosmetics; retail store services featuring cosmetics.

(260) AM 2023 119630 A

(800) 1686081

(151) 2022 06 29

(891) 2022 06 29

(731) VIENNA INSURANCE GROUP AG Wiener

Versicherung Grup

Schottenring 30, A-1010 Wien, Austria

(540)

## VIG Globe

(591) Black, white

(511)

9 – Software; computer software packages; downloadable software.

36 – Insurance; financial affairs; monetary affairs; real estate affairs.

42 – Software development, programming and implementation; software creation; software engineering; providing software on a global computer network; computer software consultancy.

(260) AM 2023 119631 A

(800) 1686082

(151) 2022 06 29

(891) 2022 06 29

(731) VIENNA INSURANCE GROUP AG Wiener

Versicherung Grup

Schottenring 30, A-1010 Wien, Austria

(540)

## VIG ICP

(591) Black, white

(511)

9 – Software; computer software packages; downloadable software.

36 – Insurance; financial affairs; monetary affairs; real estate affairs.

42 – Software development, programming and implementation; software creation; software engineering; providing software on a global computer network; computer software consultancy.

(260) AM 2023 119632 A

(800) 1686083

(151) 2022 06 29

(891) 2022 06 29

(731) VIENNA INSURANCE GROUP AG Wiener

Versicherung Grup

Schottenring 30, A-1010 Wien, Austria

(540)

**VIG KING**

(591) Black, white

(511)

9 – Software; computer software packages; downloadable software.

36 – Insurance; financial affairs; monetary affairs; real estate affairs.

42 – Software development, programming and implementation; software creation; software engineering; providing software on a global computer network; computer software consultancy.

(260) AM 2023 119633 A

(800) 1686085

(151) 2022 07 20

(891) 2022 07 20

(731) TYCUMA, LLC

1001 Crofton Landing, Suwanee GA 30024,

USA

(540)

**TYCUMA**

(591) Black, white

(511)

36 – Foreign exchange currency trading services, including currency trading, exchanging money, and other financial services related to foreign exchange currency trading.

(260) AM 2023 119634 A

(800) 1686101

(151) 2022 08 18

(891) 2022 08 18

(731) 1141931 ONTARIO LTD.

3605 Weston Rd, Toronto ON M9L 1V7,

Canada

(540)

**TZAFONA**

(591) Black, white

(511)

33 – Alcoholic bitters; alcoholic chocolate-based beverages; alcoholic cocktails; alcoholic coffee-based beverages; alcoholic fruit beverages; alcoholic tea-based beverages; aperitifs; brandy; fruit extracts, alcoholic; gin; liqueurs; rum; tequila; vodka; whiskey; wine; wine-based beverages; alcoholic extracts, namely, extracts from herbs, plants and flowers for the preparation of alcoholic cocktails; alcoholic extracts, namely, extracts from spices for the preparation of alcoholic cocktails.

(260) AM 2023 119635 A

(800) 1686168

(151) 2022 06 03

(891) 2022 06 03

(731) YANMAR TURKEY MAKİNE ANONİM

ŞİRKETİ

Çınarlı Mah. Fatih Cad. No: 16/18, Ater Tower

K:10 D:21, Konak, İzmir, Türkiye

(540)

**YTAGRI**

(591) Black, red

(531) 27.05.01; 27.05.09; 29.01.12

(511)

7 – Machines, machine tools and industrial robots for processing and shaping wood, metals, glass, plastics and minerals; construction machines and robotic mechanisms (machines) for use in construction; lifting, loading and transmission machines and robotic mechanisms (machines) for lifting, loading and transmission purposes; machines and robotic mechanisms (machines) for use in agriculture and animal breeding, machines and robotic mechanisms (machines) for processing cereals, fruits, vegetables and food; engines and motors, other than for land vehicles, parts and fittings therefor; parts of land vehicle motors and engines, included in this class; bearings (parts of machines), roller or ball bearings; machines for mounting and detaching tires; alternators, current generators, electric generators, current generators operated with solar energy; painting machines, automatic spray guns for paint, electric punching machines and guns, electric adhesive tape dispensers (machines), agricultural sprayers, liquid fertilizer machines, electric hand drills, electric hand saws, electric jigsaw machines, spiral machines, compressed air machines, compressors (machines), vehicle washing installations, robotic mechanisms (machines) with the abovementioned functions; electric welding machines, electric arc welding apparatus, electric soldering apparatus, electric arc cutting apparatus, electrodes for welding machines, industrial robots (machines) with the abovementioned functions; printing machines; packaging machines, filling, plugging and sealing machines, labe-

llers (machines), seed sorting machines, seed grading machines, industrial robots (machines) with the abovementioned functions, electric packing machines for plugging and sealing of plastics; machines for textile processing, sewing machines, industrial robots (machines) with the abovementioned functions; hydrogen distribution pumps for filling stations, compressed air pumps, fuel pumps for petrol stations, air pumps, pumps for heating systems, pumps [machines], lubrication pumps, fuel dispensing pumps for service stations, self-regulating fuel pumps; electric kitchen machines for chopping, grinding, crushing, mixing and mincing foodstuff, washing machines, laundry washing machines, dishwashers, spin driers (not heated), electric cleaning machines for cleaning floors, carpets or floorings, vacuum cleaners and parts thereof; automatic vending machines; galvanizing and electroplating machines; electric or electronic door openers and closers; joints (parts of engines).

8 – Forks, spoons, knives and non-electric cutters, slicers, peelers for kitchen use, including those made of precious metals; side arms and blades (weapons); tools and apparatus included in this class for personal beauty care use; tools and apparatus included in this class for shaving, epilation, manicure and pedicure, electric hand implements for straightening and curling hair, scissors; hand-operated [non-electric] hand tools included in this class for the repair of machines, apparatus and vehicles and for use in construction, agriculture, horticultural and forestry, none of them being power tools; electric or non-electric irons; steam irons; knife handles, handles for hand tools, scythe handles.

(260) AM 2023 119657 A  
(800) 1686940  
(151) 2022 02 23  
(891) 2022 02 23  
(731) PEPCO Poland Sp. z o.o.  
Strzeszyńska 73A, PL-60-479 Poznań, Poland  
(540)

**bekkin**

(591) Black, white  
(531) 26.03.23; 26.04.07; 26.04.09; 26.04.24;  
27.05.01; 27.05.17

(511)  
9 – Swim goggles; scuba masks; ear plugs for divers.

18 – Bags; bags for sports; rucksacks; sports packs; shoe bags; drawstring bags; pocket wallets.

21 – Sports bottles sold empty; vacuum mugs; insulating flasks; vacuum flasks for holding food; mess-tins; water bottles; food storage containers; lunch boxes.

24 – Towels of textile.

25 – Shoes; sportswear; sports socks; leggings [trousers]; trousers; short trousers; skirts; tee-shirts; warm-up tops; track jackets; sweat shirts; casual jackets; gilets; fleeces; sweaters; knitted caps; neck tube scarves; bandanas [neckerchiefs]; gloves [clothing]; fingerless gloves; bathing suits; trunks; headbands [clothing]; sweatbands; sweat bands for the wrist; headgear; sweat-absorbent underwear; belts [clothing]; peaked caps; tank tops; bathing caps.

27 – Yoga mats; gymnastic mats.

28 – Exercise weights; body-building apparatus; chest expanders [exercisers]; sports equipment; flippers for swimming; swimming kickboards; water wings; swimming belts; gymnastic and sporting articles; covers (shaped -) for sporting articles; cases adapted for sporting articles.

(260) AM 2023 119658 A  
(800) 1687013  
(151) 2021 12 22  
(891) 2021 12 22  
(731) Bepateks Tekstil Bilişim Sanayi Ve Ticaret Anonim Şirketi  
Hadımköy Mahallesi, Celal Bayar Caddesi,  
No:5/4, Arnavutköy, İstanbul, Türkiye  
(540)

**KANZ**

(591) Red and white  
(531) 27.05.17; 29.01.01  
(511)

3 – Bleaching and cleaning preparations, detergents other than for use in manufacturing operations and for medical purposes, laundry bleach, fabric softeners for laundry use, stain removers, dishwasher detergents; perfumery; non-medicated cosmetics; fragrances; deodorants for personal use and animals; soaps; dental care preparations; dentifrices, denture polishes, tooth whitening preparations, mouth washes, not for medical purposes; abrasive preparations; emery cloth; sandpaper; pumice stone; abrasive pastes; polishing preparations for leather, vinyl, metal and wood, polishes and creams for leather, vinyl, metal and wood, wax for polishing.

4 – Industrial oils and greases; cutting fluids; dust absorbing, wetting and binding compositions; solid fuels, coal, firewood; liquid and gas fuels; petrol, diesel oil, liquified petroleum gas, natural gas, fuel oil and their non-chemical additives; candles; wicks; semi-finished wax; wax and paraffin for lighting purposes; electrical energy.

5 – Food for babies, hygienic pads; hygienic tampons; plasters; materials for dressings; diapers made of paper and textiles for babies, adults and pets; deodorants, other than for human beings or for animals; air purifying preparations; air deodorising preparations; disinfectants; antiseptics; detergents for medical pur-

poses; medicated soaps; disinfectant soaps; antibacterial hand lotions.

8 – Forks, spoons, knives and non-electric cutters, slicers, peelers for kitchen use, including those made of precious metals; side arms and blades (weapons); tools and apparatus included in this class for personal beauty care use, namely hair braiders, electric, hair-removing tweezers and tattooing apparatus for the cosmetic care of eyebrows; tools and apparatus included in this class for shaving, epilation, manicure and pedicure, electric hand implements for straightening and curling hair, scissors; hand-operated [non-electric] hand tools included in this class for the repair of machines, apparatus and vehicles and for use in construction, agriculture, horticulture and forestry, none of them being power tools; electric or non-electric irons; steam irons; handles for hand-operated hand tools.

9 – Measurement apparatus and equipment including those for scientific, nautical, topographic, meteorologic, industrial and laboratory purposes, thermometers, not for medical purposes, barometers, ammeters, voltmeters, hygrometers, testing apparatus not for medical purposes, telescopes, periscopes, directional compasses, speed indicators, laboratory apparatus, microscopes, magnifying glasses, stills, binoculars, ovens and furnaces for laboratory experiments; apparatus for recording, transmission or reproduction of sound or images, cameras, photographic cameras, television apparatus, video recorders, CD and DVD players and recorders, MP3 players, computers, desktop computers, tablet computers, wearable technological devices, namely, smart watches, smart wristbands and head-mounted cameras, microphones, loudspeakers, earphones, telecommunications apparatus, apparatus for the reproduction of sound or images, computer peripheral devices, cell phones, covers for cell phones, telephone apparatus, computer printers, scanners [data processing equipment], photocopiers; magnetic and optic data carriers and computer software and programmes recorded thereto, downloadable and recordable electronic publications, encoded magnetic and optic cards, movies, tv series and video music clips recorded on magnetic, optical and electronic media; antennas, satellite antennas, amplifiers for antennas, parts of the aforementioned goods; ticket dispensers, automatic teller machines (ATM); electronic components used in the electronic parts of machines and apparatus, semi-conductors, electronic circuits, integrated circuits, chips [integrated circuits], diodes, transistors [electronic], magnetic heads for electronic apparatus, electronic locks, photocells, remote control apparatus for opening and closing doors, optical sensors; counters and quantity indicators for measuring the quantity of consumption, automatic time switches; clothing for protection against accidents, irradiation and fire, safety vests and life-saving apparatus and equipment; eyeglasses, sunglasses, optical lenses and cases, contain-

ers, parts and components thereof; apparatus and instruments for conducting, transforming, accumulating or controlling electricity, electric plugs, junction boxes [electricity], electric switches, circuit breakers, fuses, lighting ballasts, battery starter cables, electrical circuit boards, electric resistances, electric sockets, transformers [electricity], electrical adapters, battery chargers, electric door bells, electric and electronic cables, batteries, electric accumulators, solar panels for production of electricity; alarms and anti-theft alarms, other than for vehicles, electric bells; signalling apparatus and instruments, luminous or mechanical signs for traffic use; fire extinguishing apparatus, fire engines, fire hose and fire hose nozzles; radar apparatus, sonars, night vision apparatus and instruments; decorative magnets; metronomes.

11 – Lighting installations; lights for vehicles and interior-exterior spaces; heating installations using solid, liquid or gas fuels or electricity, central heating boilers, boilers for heating installations, radiators [heating], heat exchangers, not parts of machines, stoves, kitchen stoves, solar thermal collectors [heating]; steam, gas and fog generators, steam boilers, other than parts of machines, acetylene generators, oxygen generators, nitrogen generators; installations for air-conditioning and ventilating; cooling installations and freezers; electric and gas-powered devices, installations and apparatus for cooking, drying and boiling; cookers, electric cooking pots, electric water heaters, barbecues, electric laundry driers; hair driers; hand drying apparatus; sanitary installations, taps [faucets], shower installations, toilets [water-closets], shower and bathing cubicles, bath tubs, toilet seats, sinks, wash-hand basins [parts of sanitary installations], washers for water taps, taps for pipes and pipelines; water softening apparatus; water purification apparatus; water purification installations; waste water purification installations; electric bed warmers and electric blankets, not for medical use; electric pillow warmers; electric or non-electric footwarmers; hot water bottles, electrically heated socks; filters for aquariums and aquarium filtration apparatus; industrial type installations for cooking, drying and cooling purposes; pasteurizers and sterilizers.

14 – Jewellery; imitation jewellery; gold; precious stones and jewellery made thereof; cufflinks; tie pins; statuettes and figurines of precious metal; clocks, watches and chronometrical instruments; chronometers and their parts; watch straps; trophies made of precious metal; rosaries.

16 – Paper and cardboard; paper and cardboard for packaging and wrapping purposes, cardboard boxes; paper towels; toilet paper; paper napkins; plastic materials for packaging and wrapping purposes; printing blocks and types; bookbinding material; printed publications; printed matter; books, magazines, newspapers, bill books, printed dispatch notes, printed vouchers, calendars; posters; photographs [printed]; pain-



tings; stickers [stationery]; postage stamps; stationery, office stationery, instructional and teaching material [except furniture and apparatus]; writing and drawing implements; artists' materials; paper products for stationery purposes; adhesives for stationery purposes, pens, pencils, erasers, adhesive tapes for stationery purposes, cardboard cartons [artists' materials], writing paper, copying paper, paper rolls for cash registers, drawing materials, chalkboards, painting pencils, watercolors [paintings]; office requisites; paint rollers and paintbrushes for painting.

18 – Unworked or semi-worked leather and animal skins, imitations of leather, stout leather, leather used for linings; goods made of leather, imitations of leather or other materials, designed for carrying items, included in this class; bags, wallets, boxes and trunks made of leather or stout leather; keycases, trunks [luggage], suitcases; umbrellas; parasols; sun umbrellas; walking sticks; whips; harness; saddlery; stirrups; straps of leather (saddlery).

20 – Furniture, made of any kind of material; mattresses; pillows; air mattresses and cushions, not for medical purposes, water beds; mirrors; beehives, artificial honeycombs and sections of wood for honeycombs; bouncing chairs for babies, playpens for babies, cradles, infant walkers; display boards, frames for pictures and paintings, identification plates, identification tags, nameplates, identification labels made of wood or synthetic materials; packaging containers of wood or plastics, casks for use in transportation or storage, barrels, storage drums, tanks, boxes, storage containers, transportation containers, chests, loading pallets and closures for the aforementioned goods, of wood or plastics; small hardware goods of wood or synthetic materials included in this class, furniture fittings, of wood or synthetic materials, opening and closing mechanisms of wood or synthetic materials; ornaments and decorative goods of wood, cork, reed, cane, wicker, horn, bone, ivory, whalebone, shell, amber, mother-of-pearl, meerschaum, beeswax, plastic or plaster namely figurines, holiday ornaments for walls, sculptures, trophies; non-metal baskets, fishing baskets; kennels, nesting boxes and beds for household pets; portable ladders and mobile boarding stairs of wood or synthetic materials; bamboo curtains, roller indoor blinds [for interiors], slatted indoor blinds, strip curtains, bead curtains for decoration, curtain hooks, curtain rings, curtain tie-backs, curtain rods; non-metal wheel chocks.

21 – Hand-operated non-electric cleaning instruments and appliances, brushes, other than paintbrushes, steel chips for cleaning, sponges for cleaning, steel wool for cleaning, cloths of textile for cleaning, gloves for dishwashing, non-electric polishing machines for household purposes, brooms for carpets, mops; toothbrushes, electric toothbrushes, dental floss, shaving brushes, hair brushes, combs; non-electric household or kitchen utensils, included in this class, [other than

forks, knives, spoons], services [dishes], pots and pans, bottle openers, flower pots, drinking straws, non electric cooking utensils; ironing boards and shaped covers therefor, drying racks for washing, clothes drying hangers; cages for household pets, indoor aquariums, vivariums and indoor terrariums for animals and plant cultivation; ornaments and decorative goods of glass, porcelain, earthenware or clay namely statues, figurines, vases and trophies; mouse traps, insect traps, electric devices for attracting and killing flies and insects, fly catchers, fly swatters; perfume burners, perfume sprayers, perfume vaporizers, electric or non-electric make-up removing appliances, powder puffs, toilet cases; nozzles for sprinkler hose, nozzles for watering cans, watering devices, garden watering cans; unworked or semi-worked glass, except building glass, mosaics of glass and powdered glass for decoration, except for building, glass wool other than for insulation or textile use.

24 – Woven or non-woven textile fabrics; textile goods for household use, not included in other classes; curtains, bed covers, sheets (textile), pillowcases, blankets, quilts, towels; flags, pennants, labels of textile; swaddling blankets; sleeping bags for camping.

27 – Carpets, rugs, mats; prayer rugs; linoleum, artificial turf, linoleum for covering floors; gymnasium mats; wallpaper, wall hangings not of textile.

28 – Games and toys; arcade video game machines; game apparatus and machines for use with an external display screen and monitor, including those coin-operated; toys for animals; toys for outdoor playgrounds, parks and game parks; gymnastic and sporting articles not included in other classes; fishing tackle, artificial fishing bait, decoys for hunting and fishing; Christmas trees of artificial material, ornaments for Christmas trees, artificial snow for Christmas trees, rattles (playthings), novelties for parties, dances (party favors), paper party hats.

(260) AM 2023 119659 A

(800) 1687042

(151) 2022 06 06

(891) 2022 06 06

(731) İmece Plastik Tarım İnşaat Taahhüt Petrol Ürünleri Ve Gıda Sanayi Ticaret Anonim Şirketi

Aosb1kisim Mah. 4. Cad., İmece Plastik Tarım İnş, Taah Pet San Tic AŞ, 13 Döşemealtı, Antalya, Türkiye

(540)





(591) Blue, green, yellow, white

(531) 01.03.01; 05.03.13; 05.03.15; 05.05.20;  
05.05.21; 26.11.01; 26.11.12; 27.05.01;  
29.01.14

(526) The applicant disclaims protection for word  
"plastik" in the mark

(511)

16 – Paper and cardboard; paper and cardboard for packaging and wrapping purposes, cardboard boxes; paper towels; toilet paper; paper napkins; plastic materials for packaging; plastic sheets, films and bags for wrapping and packaging; plastic bubble packs for wrapping or packaging; boxes of paper or cardboard; carrier bags of paper or plastic; garbage bags of paper or of plastics; plastic film for wrapping; plastic cling film, extensible, for palletization; printing blocks and types; bookbinding material; printed publications; printed matter; books, magazines, newspapers, bill books, printed dispatch notes, printed vouchers, calendars; posters; photographs (printed); paintings; stickers (stationery); postage stamps; stationery, office stationery, instructional and teaching material (except furniture and apparatus); writing and drawing implements; artists' materials; paper products for stationery purposes; adhesives for stationery purposes, pens, pencils, erasers, adhesive tapes for stationery purposes, cardboard cartons (artists' materials), writing paper, copying paper, paper rolls for cash registers, drawing materials, chalkboards, painting pencils, watercolors (paintings); office requisites; paint rollers and paintbrushes for painting.

17 – Padding materials of rubber or plastics; rubber, raw or semi-worked; synthetic rubber; insulation, stopping and sealing materials; insulation paints, insulation fabrics, insulating tape and band, insulation covers for industrial machinery, joint sealant compounds for joints, gaskets, O-rings for sealing purposes; flexible pipes made from rubber and plastic; hoses made of plastic and rubber, including those used for vehicles; junctions for pipes of plastic and rubber; pipe jackets of plastic and rubber; hoses of textile material; junctions for pipes, not of metal; pipe jackets, not of metal; connecting hose for vehicle radiators.

35 – Advertising, marketing and public relations; organization of exhibitions and trade fairs for commercial or advertising purposes; office functions; secretarial services; arranging newspaper subscriptions for others; compilation of statistics; rental of office machines; systemization of information into computer databases; telephone answering for unavailable subscribers; business management, business administration and business consultancy; accounting; commercial consultancy services; personnel recruitment, personnel placement, employment agencies, import-export agencies; temporary personnel placement services; auctioneering; the bringing together, for the benefit of others, of a variety of goods, namely, paper and cardboard, paper and cardboard for packaging and wa-

pping purposes, cardboard boxes, paper towels, toilet paper, paper napkins, plastic materials for packaging, plastic sheets, films and bags for wrapping and packaging, plastic bubble packs for wrapping and packaging, boxes of paper or cardboard, carrier bags of paper or plastic, garbage bags of paper or of plastics, plastic film for wrapping, plastic cling film, extensible, for palletization, printing blocks and types, bookbinding material, printed publications, printed matter, books, magazines, newspapers, bill books, printed dispatch notes, printed vouchers, calendars, posters, photographs, paintings, stickers, postage stamps, stationery, office stationery, instructional and teaching material, writing and drawing implements, paper products for stationery purposes, adhesives for stationery purposes, pens, pencils, erasers, adhesive tapes for stationery purposes, writing paper, copying paper, paper rolls for cash registers, drawing materials, chalkboards, painting pencils, watercolors, office requisites, paint rollers and paintbrushes for painting, padding materials of rubber or plastics, rubber, raw or semi-worked, synthetic rubber, insulation, stopping and sealing materials, insulation paints, insulation fabrics, insulating tape and band, insulation covers for industrial machinery, joint sealant compounds for joints, gaskets, flexible pipes made from rubber and plastic, hoses made of plastic and rubber, including those used for vehicles, junctions for pipes of plastic and rubber, pipe jackets of plastic and rubber, hoses of textile material, junctions for pipes, not of metal, pipe jackets, not of metal, connecting hose for vehicle radiators, enabling customers to conveniently view and purchase those goods, such services may be provided by retail stores, wholesale outlets, by means of electronic media or through mail order catalogues.

40 – Treatment of common metals; treatment of precious metals; development of photographic and cinematographic films; photocomposing, photographic printing, photogravure; processing of foodstuffs for use in manufacture; slaughtering of animals; leather working and fur conditioning; textile treating, wool treating; tailoring, embroidery; woodworking and timber processing; framing of works of art; treatment of liquids, chemicals, gas and air for industrial use; grinding of glass and optical glass; custom assembling of materials for others; services of a dental technician; pottery firing; production of energy; rental of generators; paper treating; printing, bookbinding; treatment of plastics.

44 – Beauty care services; veterinary services, animal husbandry, animal breeding, agriculture, horticulture and forestry services; medical advisory services in the field of personnel health.

(260) AM 2023 119662 A

(800) 1687170

(151) 2022 06 22

(891) 2022 06 22

(731) Zhejiang Shijing Tools Co., Ltd.  
No.1, Weiwu West Road, Tongqin Town,  
Wuyi County, Jinhua City, Zhejiang,  
China

(540)



(591) Red and white

(531) 26.04.01; 26.04.09; 26.04.24; 29.01.12

(511)

7 – Mixing machines; machinery and equipment for the ceramic industry (including ceramic machinery for construction); engraving machines; shovels, mechanical; rammer compactor; concrete paving machines; asphalt paving machines; stone-working machines; stone-cutting machines; punching machines for metal working; gear cutting and trimming machines; notchers [machine tools]; cutting machines; electric hand drills; compressed air machines; welding machines, electric; snow ploughs.

8 – Hand tools, hand-operated; rabbeting planes; punches [hand tools]; cutting tools [hand tools]; non-electric caulking guns; tube cutters [hand tools]; embossers [hand tools]; graving tools [hand tools]; engraving drills; ceramic knives.

9 – Weighing apparatus and instruments; telemeters; surveyors' levels; tripods for measuring instruments; laser measuring instrument; bubble levels; level measuring instrument (for measurement); levels [instruments for determining the horizontal]; mercury levels; instruments containing eyepieces; remote control apparatus; charging devices for rechargeable equipment; wireless chargers.

(260) AM 2023 119663 A

(800) 1687198

(151) 2022 02 18

(891) 2022 02 18

(731) TOYOTA JIDOSHA KABUSHIKI KAISHA  
(also trading as TOYOTA MOTOR  
CORPORATION)  
1, Toyota-cho, Toyota-shi, Aichi-ken 471-8571,  
Japan

(540)



(591) Dark blue, blue, light blue, and white

(531) 01.15.09; 07.11.10; 26.01.03; 26.01.24;  
29.01.13

(511)

12 – Driving motors for land vehicles; engine mounts for land vehicles; engines for land vehicles; jet engines for land vehicles; motors for land vehicles; propulsion mechanisms for land vehicles; turbines for land vehicles; axle journals; axles for land vehicles; spindles for land vehicles; drive shafts for land vehicles; shaft couplings for land vehicles; axle bearings for land vehicles; wheel bearings for land vehicles; universal joints for land vehicles; drive chains for land vehicles; connecting rods for land vehicles, other than parts of motors and engines; gear boxes for land vehicles; gearing for land vehicles; hydraulic circuits for vehicles; reduction gears for land vehicles; torque converters for land vehicles; transmission chains for land vehicles; transmission shafts for land vehicles; transmissions for land vehicles; power transmission belts for land vehicles; brake discs for vehicles; brake linings for vehicles; brake pads for automobiles; brake segments for vehicles; brake shoes for vehicles; brakes for vehicles; brake systems for vehicles; anti-theft alarms for vehicles; alarm systems for motor vehicles; AC motors for land vehicles, not including their parts; DC motors for land vehicles not including their parts; motors, electric, for land vehicles; automobiles and structural parts thereof; buses; structural parts for buses; trucks; structural parts for trucks; vans [vehicles]; sports utility vehicles; coaches; electrically powered motor vehicles; electric cars; hybrid cars; electric tri-cycles; ambulances; racing cars; amphibious vehicles; snowmobiles; armored vehicles; fork lift trucks; camping cars; tractors; trailers; trolley buses; hearses; fuel cell cars; automobile bodies; automobile bonnets; automobile bumpers; automobile chassis; automobile dashboards; automobile doors; automobile door handles; automobile hoods; automobile horns; automobile seats; automobile seat covers; automobile sunroofs; automobile tires; automobile wheels; spokes for automobile wheels; inner tubes for automobile tires; automobile wheel rims; rearview mirrors for automobiles; automobile windows; automobile windscreens; automobile windshields; automobile convertible tops; safety belts for automobile seats; safety harnesses for automobile racing; safety harnesses for automobile seats; security harness for automobile seats; steering wheels for automobiles; steering wheel covers for automobiles; air bags for automobiles, buses and trucks; seat belt pre-tensioners for automobiles; brake pedals for land vehicles; direction signals for automobiles; leather upholstery for automobile seats; leather upholstery for automobiles; cigar lighters for automobiles; shaped automobile covers; mudguards for automobiles; luggage carriers for automobiles; spare wheel holders for automobiles; automobile roof racks; headlight wipers; windscreen wipers; windscreen wiper blades; motor vehicle brake control systems for applying emergency braking at low vehicle speeds; electronic brake control apparatus for automobiles; two-wheeled motor vehicles; structural parts for two-whe-

eled motor vehicles; bicycles; structural parts for bicycles; motorcycles; structural parts for motorcycles.

(260) AM 2023 119664 A  
 (800) 427217  
 (151) 1976 12 16  
 (891) 2022 09 08  
 (731) SCHOTT AKTIENGESELLSCHAFT  
 Hattenbergstrasse 10, 55122 Mainz,  
 Germany  
 (540)

## Pyran

(591) Black, white  
 (531) 27.05.01; 27.05.17  
 (511)  
 7 – Elevator car doors made of fire-protection glass.

19 – Building materials and building elements made of fire-protection glass, particularly for fire-resistant glazings in exterior and interior walls (partitions, including imposts), fire-protection fences, smoke-proof fences.

(260) AM 2023 119665 A  
 (800) 624092  
 (151) 1994 09 03  
 (891) 2022 09 12  
 (731) Boehringer Ingelheim Pharma, GmbH & Co.  
 KG  
 55218 Ingelheim, Germany  
 (540)

## MOVALIS

(591) Black, white  
 (531) 27.05.01  
 (511)  
 5 – Pharmaceutical and sanitary products; plasters.

(260) AM 2023 119667 A  
 (800) 915493  
 (151) 2006 11 21  
 (891) 2022 07 29  
 (731) METINVEST B.V.  
 Gustav Mablerpiein 74B, NL-1082 MA  
 Amsterdam, Netherlands  
 (540)

## METINVEST

(591) Black, white  
 (511)  
 1 – Chemicals used in industry, science and photography, as well as in agriculture, horticulture and forestry; unprocessed artificial resins, unprocessed plastics; manures; fire extinguishing compositions; tempering and soldering preparations; chemical substances for

preserving foodstuffs; tanning substances; adhesives used in industry.

6 – Common metals and their alloys; metal building materials; transportable buildings of metal; materials of metal for railway tracks; non-electric cables and wires of common metal; ironmongery, small items of metal hardware; pipes and tubes of metal; safes; goods of common metal not included in other classes; ores.

39 – Transport; packaging and storage of goods; travel arrangement.

42 – Scientific and technological services and research and design relating thereto; industrial analysis and research services; design and development of computer hardware and software; legal services.

(260) AM 2023 119671 A  
 (800) 1483795  
 (151) 2019 03 08  
 (891) 2022 08 10  
 (731) Knorr-Bremse AG  
 Moosacher Strasse 80; 80809 München,  
 Germany  
 (540)

## Knorr-Bremse

(591) Black, white  
 (511)  
 35 – Business management; professional business consultancy; supply chain management services.

37 – Assembly, modernisation, maintenance, overhauling and repair of vehicles; assembly, installation, modernisation, maintenance, overhauling and repair of electric and electronic apparatus, in particular in vehicles; maintenance and repair of motor vehicle engines; repair and overhaul of compressors, dampers, transmission components, brakes and their parts, NOTIFICATION (continued) control units, valves [machine parts], pedal systems, clutches, motor vehicle engines, heating, ventilating, air conditioning apparatus and air treatment apparatus for land vehicles; overhaul of worn or partially destroyed machines; vehicle repair consultancy; advisory services relating to the maintenance and repair of mechanical and electrical equipment

(260) AM 2023 119674 A  
 (800) 1591537  
 (151) 2021 02 12  
 (891) 2022 08 09  
 (731) SEARA ALIMENTOS LTDA.  
 Av. Marginal Direita do Tietê, 500 – Bloco  
 II – Subsolo – Sala 13, Vila Jaguará, 05118-100  
 São Paulo – SP, Brazil

(540)



(591) Red, yellow and white

(531) 01.03.01; 01.03.02; 26.01.02; 26.01.03;  
26.01.13; 26.01.18; 26.01.24; 27.05.01;  
27.05.24; 28.01; 29.01.13

(511)

29 – Poultry, not live; lard; bacon; meat; pork; meat, preserved; croquettes; margarine; pickles; ham; cheese; hot dog sausages; meatballs; chicken stock; jerky [dried salted meat]; chispe [pork's foot]; ribs [cut of meat]; cold cuts; hamburger patties; sausages; loin meats; mortadella; paio [lusobrazilian pork sausage]; meat pâté; rabada [stew oxtail-based dish]; salami; pickled vegetables; frozen vegetables; salted meats; liver pâté; french fries; fat-containing mixtures for bread slices; prepared meals consisting primarily of meat, fish, poultry or vegetables.

(260) AM 2023 119710 A

(800) 1687249

(151) 2021 12 15

(891) 2021 12 15

(731) Amusnet Interactive

Garitage Park, Building No. 4, Floor 2,  
2 Donka Ushlinova Str. BG-1766 Sofia,  
Bulgaria

(540)



(591) White, pink, yellow, red, blue and black

(531) 08.01.19; 08.01.24; 27.03.15; 29.01.15

(511)

9 – Computer software for the administration of on-line games and gaming; computer application software featuring games and gaming; betting software; gaming software that generates or displays wager outcomes of gaming machines.

28 – Slot machines [gaming machines]; gaming machines for gambling.

41 – Providing of casino and gaming facilities; betting services.

(260) AM 2023 119718 A

(800) 1687266

(151) 2022 06 08

(891) 2022 06 08

(731) Euro Games Technology Ltd.

4, "Maritsa" Str., "Vranya-Lozen-Triugulnika",  
BG-1151 Sofia, Bulgaria

(540)

## Cash Thrill

(591) Black, white

(511)

9 – Software; computer gaming software; computer software packages; computer operating system software; computer software, recorded; software drivers; virtual reality software; games software; entertainment software for computer games; computer programs for network management; operating computer software for main frame computers; monitors (computer hardware); computer hardware; apparatus for recording images; monitors (computer programs); computer game programs; computer programs for recorded games; apparatus for recording, transmission or reproduction of sound or images; communications servers [computer hardware]; electronic components for gambling machines; computer application software featuring games and gaming; computer software for the administration of on-line games and gaming; computer hardware for games and gaming; hardware and software for gambling, gambling machines, gambling games on the Internet and via telecommunication network.

28 – Gaming machines for gambling; chips for gambling; mah-jong; arcade games; gambling machines operating with coins, notes and cards; games; electronic games; parlor games; gaming chips; gaming tables; slot machines [gaming machines]; LCD game machines; slot machines and gaming devices; coin-operated amusement machines; roulette chips; poker chips; chips and dice [gaming equipment]; gaming equipment for casinos; roulette tables; gaming roulette wheels; casino games; gambling machines and amusement machines, automatic and coin-operated; coin-operated amusement machines and/or electronic coin-operated amusement machines with or without the possibility of gain; boxes for coin-operated machines, slot machines and gaming machines; electronic or electrotechnical amusement machines and apparatus, gaming machines, coin-operated entertainment machines; housings for coin-operated machines, gaming equipment, gaming machines, machines for gambling; electropneumatic and electrical gambling machines (slot machines).

41 – Gambling; entertainment services related to gambling; gaming services for entertainment purposes; casino, gaming and gambling services; training in the development of software systems; provision of gaming equipment for gambling halls; providing casino equipment [gambling]; gaming machine entertainment

services; providing casino facilities [gambling]; gaming hall services; amusement arcade services; games equipment rental; rental of gaming machines; providing amusement arcade services; rental of gaming machines with images of fruits; editing or recording of sounds and images; sound recording and video entertainment services; hire of sound reproducing apparatus; provision of gaming equipment for casinos; providing of casino facilities; online gambling services; casino, gaming and gambling services; provision of gaming facilities, gaming hall facilities, Internet casinos and online gambling services.

(260) AM 2023 119719 A

(800) 1687372

(151) 2022 03 28

(891) 2022 03 28

(731) THE BREEZE DRINKS COMPANY LTD

Hawkridge House, Hawkridge Hill, Frilsham,

THATCHAM, Berkshire RG18 9XA,

United Kingdom

(540)

## SWISH

(591) Black, white

(511)

32 – Alcohol free beverages; beer-based cocktails; non-alcoholic cocktails; non-alcoholic fruit cocktails; non-alcoholic cocktail bases; non-alcoholic cocktail mixes; frozen cocktails, non-alcoholic; premix non-alcoholic cocktails for freezing; mineral and aerated waters; fruit beverages and fruit juices; syrups and other non-alcoholic preparations for making beverages; non-alcoholic beverages; soft drinks; non-alcoholic beverages flavoured with coffee; coffee flavoured soft drinks; coffee flavoured beer; coffee flavoured ale.

33 – Alcoholic aperitifs; alcoholic beverages containing fruit; alcoholic beverages, except beer; alcoholic beverages of fruit; alcoholic cocktail mixes; alcoholic cocktails; alcoholic cocktails containing milk; alcoholic cocktails in the form of chilled gelatines; alcoholic fruit cocktail drinks; prepared alcoholic cocktails; prepared wine cocktails; prepared cocktails consisting primarily of distilled spirits; gin, vodka, tequila, whiskey/whisky, bourbon, cognac based cocktails; iced alcoholic cocktails; frozen alcoholic cocktails; alcoholic preparations for making beverages; alcoholic cordials; alcoholic punches; alcoholic wines; beverages (distilled -); beverages containing wine [sprinters]; cider; wine; spirits; alcoholic coffee based beverages; coffee based liqueurs; coffee flavoured alcoholic beverages.

35 – Retail services, including retail services offered via a general merchandising and, mail order catalogue, online, via television channel, via mobile phone and by direct marketing, all connected with the sale of ice cream and ice cream products, chilled and frozen confections and prepared desserts, alcohol free beverages, beer-based cocktails, non-alcoholic cocktails,

non-alcoholic fruit cocktails, non-alcoholic cocktail bases, non-alcoholic cocktail mixes, frozen cocktails, premix non-alcoholic cocktails for freezing, mineral and aerated waters, fruit beverages and fruit juices, syrups and other non-alcoholic preparations for making beverages, non-alcoholic beverages, soft drinks, alcoholic aperitifs, alcoholic beverages containing fruit, alcoholic beverages, except beer, alcoholic beverages of fruit, alcoholic cocktail mixes, alcoholic cocktails, alcoholic cocktails containing milk, alcoholic cocktails in the form of chilled gelatines, alcoholic fruit cocktail drinks, prepared alcoholic cocktails, prepared wine cocktails, prepared cocktails consisting primarily of distilled spirits, gin, vodka, tequila, whiskey/whisky, bourbon, cognac based cocktails, iced alcoholic cocktails, frozen alcoholic cocktails, alcoholic preparations for making beverages, alcoholic cordials, alcoholic punches, alcoholic wines, beverages (distilled -), beverages containing wine [sprinters], cider, wine, spirits, coffee, coffee extracts, coffee beans, coffee drinks, coffee flavourings, aerated beverages with coffee, extracts of coffee for use as flavours in beverages, flavoured coffee, coffee concentrates, coffee mixtures, non-alcoholic beverages flavoured with coffee, coffee flavoured soft drinks, coffee flavoured beer, coffee flavoured ale, alcoholic coffee based beverage, coffee based liqueurs, coffee flavoured alcoholic beverages.

(260) AM 2023 119721 A

(800) 1687416

(151) 2022 07 07

(891) 2022 07 07

(731) NOBLEWOOD LIMITED

Arch. Makariou III, 206, CHRYSALIA

COURT, 5TH Floor, CY-3030 Limassol,

Cyprus

(540)

## FINE DE CLAIRE

(591) Black, white

(511)

33 – Aperitifs; arrack; brandy; wine; piquette; whiskey; vodka; anisette [liqueur]; kirsch; gin; digesters [liqueurs and spirits]; cocktails; anise [liqueur]; liqueurs; pre-mixed alcoholic beverages, other than beer-based; alcoholic beverages, except beer; alcoholic beverages containing fruit; spirits [beverages]; distilled beverages; mead (hydromel); peppermint liqueurs; bitters; nira (sugarcane-based alcoholic beverage); rum; sake; perry; cider; rice alcohol; alcoholic extracts; alcoholic fruit extracts; alcoholic essences.

(260) AM 2023 119722 A

(800) 1687479

(151) 2022 08 03

(891) 2022 08 03

(731) Shenzhen Stonger Sports Technology Co., LTD  
102, Jinfulai Complex Building, 49-1 Dabao Road, Dalang Community, Xin'an Street, Bao'an District, Shenzhen, 518000 Guangdong, China

(540)

# Waterfly

(591) Black, white

(531) 27.05.01

(511)

18 – Purses; school bags; rucksacks; attache cases; handbags; travelling bags; bags, of leather, for packing; briefcases; haversacks; bags for sports.

(260) AM 2023 119723 A

(800) 1687527

(151) 2021 12 21

(891) 2021 12 21

(731) LIDERLER PAZARLAMA ITHALAT IHR.IML.TIC.VE SAN.LTD.ST  
TEVFIK ILERI MAH/SEMT POLAT SK. 3,  
PURSAKLAR, ANKARA, Türkiye

(540)



The logo consists of the word "MODA" in a bold, white, sans-serif font, followed by "Life" in a smaller, white, script font, all set against a solid blue rectangular background.

(591) Blue and white

(531) 26.04.05; 26.04.18; 26.04.24; 27.05.01;  
27.05.09; 27.05.10; 27.05.24; 29.01.12

(511)

20 – Furniture, made of any kind of material, mattresses, pillows, air mattresses and cushions, not for medical purposes, water beds, not for medical purposes, excluding sleeping bags for camping; mirrors; beehives, artificial honeycombs and sections of wood for honeycombs; bouncing chairs for babies, playpens for babies, cradles, infant walkers; display boards, frames for pictures and paintings, identification plates, identification tags, nameplates, identification labels made of wood or synthetic materials; packaging containers of wood or plastics, casks for use in transportation or storage, barrels, storage drums, tanks, boxes, storage containers, transportation containers, chests, loading pallets and closures for the aforementioned goods, of wood or plastics, small hardware goods of wood or synthetic materials included in this class, furniture fittings, of wood or synthetic materials, opening and closing mechanisms of wood or synthetic materials; ornaments and decorative goods of wood, cork, reed, cane, wicker, horn, bone, ivory, whalebone, shell, amber, mother-of-pearl, meerscham, beeswax, plastic or plaster, included in this class, namely, figurines, holiday ornaments for walls and sculptures and cups given in competitions made of these materials; baskets,

non-metallic, fishing baskets, kennels, nesting boxes and beds for household pets; portable ladders and mobile boarding stairs of wood or synthetic materials; bamboo curtains, roller indoor blinds for interiors, slatted indoor blinds, strip curtains, bead curtains for decoration, curtain hooks, curtain rings, curtain tie-backs, curtain rods; non-metal wheel chocks.

24 – Woven or non-woven textile fabrics; textile goods for household use, not included in other classes: curtains, bed covers, sheets made of textile, pillowcases, blankets, quilts, towels; flags, pennants, labels of textile; swaddling blankets; sleeping bags for camping.

35 – Advertising, marketing and public relations; organization of exhibitions and trade fairs for commercial or advertising purposes, development of advertising concepts; providing an on-line marketplace for buyers and sellers of goods and services; office functions; secretarial services, arranging newspaper subscriptions for others; compilation of statistics; rental of office machines; systemization of information into computer databases; telephone answering for unavailable subscribers; business management, business administration and business consultancy; accounting; commercial consultancy services, personnel recruitment, personnel placement, employment agencies, import-export agencies; temporary personnel placement services; auctioneering; the bringing together, for the benefit of others, of a variety of goods, namely, paper and cardboard, paper and cardboard for packaging and wrapping purposes, cardboard boxes, paper towels, toilet paper, paper napkins, plastic materials for packaging and wrapping purposes, printing blocks and types, bookbinding material, printed publications, printed matter, books, magazines, newspapers, bill books, printed dispatch notes, printed vouchers, calendars, posters, printed photographs, paintings, stickers, postage stamps, stationery, office stationery, instructional and teaching material excluding furniture and apparatus, writing and drawing implements, artists' materials, paper products for stationery purposes, adhesives for stationery purposes, pens, pencils, erasers, adhesive tapes for stationery purposes, cardboard cartons, writing paper, copying paper, paper rolls for cash registers, drawing materials, chalkboards, painting pencils, painting watercolors, office requisites, paint rollers and paintbrushes for painting, furniture, made of any kind of material, mattresses, pillows, air mattresses and cushions, not for medical purposes, water beds, not for medical purposes, excluding sleeping bags for camping, mirrors, beehives, artificial honeycombs and sections of wood for honeycombs, bouncing chairs for babies, playpens for babies, cradles, infant walkers, display boards, frames for pictures and paintings, identification plates, identification tags, nameplates, identification labels made of wood or synthetic materials, packaging containers of wood or plastics, casks for use in transportation or storage, bar-



rels, storage drums, tanks, boxes, storage containers, transportation containers, chests, loading pallets and closures for the aforementioned goods, of wood or plastics, small hardware goods of wood or synthetic materials included in this class, furniture fittings, of wood or synthetic materials, opening and closing mechanisms of wood or synthetic materials, ornaments and decorative goods of wood, cork, reed, cane, wicker, horn, bone, ivory, whalebone, shell, amber, mother-of-pearl, meerschaum, beeswax, plastic or plaster, included in this class, namely, figurines, holiday ornaments for walls and sculptures and cups given in competitions made of these materials, baskets, fishing baskets, kennels, nesting boxes and beds for household pets, portable ladders and mobile boarding stairs of wood or synthetic materials, bamboo curtains, roller indoor blinds for interiors, slatted indoor blinds, strip curtains, bead curtains for decoration, curtain hooks, curtain rings, curtain tie-backs, curtain rods, non-metal wheel chocks, hand-operated non-electric cleaning instruments and appliances, brushes, other than paintbrushes, steel chips for cleaning, sponges for cleaning, steel wool for cleaning, cloths of textile for cleaning, gloves for dishwashing, non-electric polishing machines for household purposes, brooms for carpets, mops, toothbrushes, electric toothbrushes, dental floss, shaving brushes, hair brushes, combs, non-electric household or kitchen utensils, included in this class, dishes, pots and pans, bottle openers, flower pots, drinking straws, non-electric cooking utensils, ironing boards and shaped covers therefor, drying racks for washing, clothes drying hangers, cages for household pets, indoor aquariums, vivariums and indoor terrariums for animals and plant cultivation, ornaments and decorative goods of glass, porcelain, earthenware or clay namely statues, figurines, vases and cups given in competitions, mouse traps, insect traps, electric devices for attracting and killing flies and insects, fly catchers, fly swatters, perfume burners, perfume sprayers, perfume vaporizers, electric or non-electric make-up removing appliances, powder puffs, toilet cases, nozzles for sprinkler hose, nozzles for watering cans, watering devices, garden watering cans, unworked or semi-worked glass, except building glass, mosaics of glass and powdered glass for decoration, except for building, glass wool other than for insulation or textile use, yarns and threads for textile use, threads and yarns for sewing, embroidery and knitting, thread, elastic yarns and threads for textile use, woven or non-woven textile fabrics, textile goods for household use, not included in other classes, curtains, bed covers, sheets made of textile, pillowcases, blankets, quilts, towels, flags, pennants, labels of textile, swaddling blankets, sleeping bags for camping, clothing, including underwear and outer clothing, other than special purpose protective clothing, socks, mufflers, shawls, bandanas, scarves, belts for clothing, footwear, shoes, slippers, sandals, headgear, hats, caps with visors, berets, caps, skull caps, laces

and embroidery, guipures, festoons, ribbons, ribbons and braid, fastening tapes for clothing, cords for clothing, letters and numerals for marking linen, embroidered emblems, badges for wear, not of precious metal, shoulder pads for clothing, buttons for clothing, fasteners for clothing, eyelets for clothing, zippers, buckles for shoes and belts, fasteners, shoe and belt buckles, pins, other than jewellery, adhesive patches for decoration of textile articles, laces, needles, sewing needles, needles for sewing machines, needles for knitting and embroidery, boxes for needles, needle cushions, artificial flowers, artificial fruits, hair pins, hair buckles, hair bands, decorative articles for the hair, not made of precious metal, wigs, hair extensions, electric or non-electric hair curlers, other than hand implements, carpets, rugs, mats, prayer rugs, linoleum, artificial turf, linoleum for covering floors, gymnasium mats, wallpaper, wall hangings not of textile, enabling customers to conveniently view and purchase those goods, such services may be provided by retail stores, wholesale outlets, by means of electronic media or through mail order catalogues.

37 – Construction services, rental of construction machines and equipment; interior and exterior cleaning services for buildings, public areas, industrial premises; disinfecting, vermin exterminating [other than for agriculture, aquaculture, horticulture and forestry], rental of cleaning machines and equipment, vehicles service stations for land vehicles, maintenance, repair and refueling of land vehicles, vehicles service stations for marine vehicles, maintenance, repair and refueling of marine vehicles; repair and maintenance of air vehicles, upholstery, repair and restoration of furniture; installation, maintenance and repair of heating, cooling and sanitary installations; cleaning, care and repair of clothing; installation, maintenance and repair of industrial machines and equipment, office machines and equipment, communication apparatus, electric and electronic appliances; repair and maintenance of lifts; clock and watch repair; mining extraction; repair of shoes, bags and belts.

40 – Treatment of common metals; treatment of precious metals; development of photographic and cinematographic films; photocomposing, photographic printing, photogravure, drying, canning, freezing, smoking and preserving of foodstuffs; providing information in the field of food manufacturing; slaughtering of animals; leather working and fur conditioning; saddlery working, textile treating, wool treating, tailoring, embroidery; woodworking and timber processing; framing of works of art; treatment of liquids, chemicals, gas and air for industrial use; grinding of glass and optical glass; custom assembling of materials for others; services of a dental technician; pottery firing; production of energy; rental of generators, paper treating, printing, bookbinding; treatment of plastics.

(260) AM 2023 119724 A

(800) 1687569

(151) 2022 03 21

(891) 2022 03 21

(731) Roche Diagnostics GmbH  
Sandhofer Strasse 116, 68305 Mannheim,  
Germany

(540)

## COBAS

(591) Black, white

(511)

1 – Chemical, biological and biochemical preparations for scientific and research purposes; chemical preparations for analysis in laboratories; chemical substances for analyses in laboratories, other than for medical or veterinary purposes; diagnostic reagents and preparations, except for medical or veterinary use; reagents for in-vitro laboratory use [other than for medical or veterinary purposes], diagnostic reagents for in vitro use in biochemistry, clinical chemistry and microbiology; chemical solutions for calibration and monitoring of the accuracy and function of laboratory apparatus and test results.

5 – Chemical, biological and biochemical preparations for medical purposes; in vitro diagnostic reagents for medical use; chemical substances for analyses in laboratories for medical purposes; reagents for in-vitro laboratory use for medical purposes.

9 – Scientific apparatus and instruments; scientific apparatus, equipment and instruments for performing analyses in laboratories; laboratory instruments for use in research and science; laboratory instruments for research and diagnostic purposes; laboratory equipment, namely automated sample handling equipment; computer software for use in the field of healthcare; computer software for medical and diagnostic purposes; computer software for the provision of automated diagnostic laboratory processes; computer software for use with laboratory instruments, namely, for use in providing remote automated control, connection, data analysis, and data management; computer systems and software for collecting, storing, analyzing and reporting biological information, and for sample tracking and managing projects, laboratory workflow and data, for use in the fields of scientific, diagnostic and clinical research and for clinical diagnostic purposes.

10 – Medical apparatus and instruments for medical purposes; diagnostic apparatus for medical purposes; medical apparatus for performing in-vitro diagnostic tests.

41 – Education, instruction, providing of training and further training, for others; education services relating to medicine; training and tuition relating to medical and medical technology instruments; organization of conferences in the field of medical science; arranging, organizing and conducting of conferences, congresses, symposiums, workshops in the field of medical

and laboratory apparatus, equipment and instruments and in the field of services for healthcare providers; publishing of medical publications; publication of medical periodicals, books and manuals (handbooks).

42 – Research and development, for others, in the field of information technology, medical technology, chemistry and as well as planning, consultancy, engineering and technical monitoring services in these fields; medical research; writing of computer programs for medical applications; software as a service (SaaS) in relation to medical data and information; design and development of computer software in the medical field; provision of non-downloadable computer software in the medical field; provision of non-downloadable software for use in clinical decision support and operational decision support; provision of non-downloadable software for use in providing health care information; provision of non-downloadable software for use in capture and analysis services to improve patient care; providing temporary use of non-downloadable computer software for use as programming interfaces (API); cloud computing services; development and design of databases in the medical field; medical research services; monitoring of medical devices and equipment as well as clinical facilities with the support of communication technology, in particular Internet technology; technological consultancy for medical facilities and clinics; design planning for medical facilities and clinics; medical laboratory services; clinical laboratory services; laboratory research, analysis and testing services; design of laboratory and medical apparatus and instruments.

---

(260) AM 2023 119725 A

(800) 1687613

(151) 2022 07 25

(891) 2022 07 25

(731) BWT Holding GmbH  
Walter-Simmer-Str. 4, A-5310 Mondsee,  
Austria

(540)

## BOTIFY

(591) Black, white

(511)

7 – Swimming pool cleaning machines (power operated); sweeping machines for use in swimming pools; robotic swimming pool cleaning machines; electric water pumps for swimming pools; pumps for counter-current swimming; membrane filters for use as parts of machines.

---

(260) AM 2023 119726 A

(800) 1687618

(151) 2022 07 18

(891) 2022 07 18

(731) Republican Unitary Production Enterprise



"Belmedpreparaty"  
RUE "Belmedpreparaty", Fabritsius str., 30,  
220007 Minsk, Belarus

(540)

**БЕЛМЕД**

(591) Black, white

(531) 28.05

(511)

5 – Amino acids for veterinary purposes; amino acids for medical purposes; antiseptics; germicides; balms for medical purposes; biocides; vaccines; wadding for medical purposes; radiological contrast substances for medical purposes; dietary supplements; adhesive plasters; lotions for pharmaceutical purposes; liniments; medicinal oils; drugs for medical purposes; tinctures for medical purposes; hydrogen peroxide for medical purposes; pesticides; nicotine patches for use as aids to stop smoking; biological preparations for veterinary purposes; biological preparations for medical purposes; veterinary preparations; vitamin preparations; diagnostic preparations for medical purposes; pharmaceutical preparations for skin care; pharmaceutical preparations; chemico-pharmaceutical preparations; solutions for contact lenses; chemical reagents for medical or veterinary purposes; insect repellents; tissues impregnated with pharmaceutical lotions; syrups for pharmaceutical purposes; disinfectants; parasiticides; antiparasitic preparations; fungicides; pre-filled Syringes for medical purposes; herbal extracts for medical purposes; plant extracts for pharmaceutical purposes.

(260) AM 2023 119727 A

(800) 1687620

(151) 2022 07 18

(891) 2022 07 18

(731) Republican Unitary Production Enterprise  
"Belmedpreparaty"  
RUE "Belmedpreparaty", Fabritsius str., 30,  
220007 Minsk, Belarus

(540)

**BELMED**

(591) Black, white

(511)

5 – Amino acids for veterinary purposes; amino acids for medical purposes; antiseptics; germicides; balms for medical purposes; biocides; vaccines; wadding for medical purposes; radiological contrast substances for medical purposes; dietary supplements; adhesive plasters; lotions for pharmaceutical purposes; liniments; medicinal oils; drugs for medical purposes; tinctures for medical purposes; hydrogen peroxide for medical purposes; pesticides; nicotine patches for use as aids to stop smoking; biological preparations for veterinary purposes; biological preparations for medical purposes; veterinary preparations; vitamin preparations; diagnostic preparations for medical purposes; pharma-

ceutical preparations for skin care; pharmaceutical preparations; chemico-pharmaceutical preparations; solutions for contact lenses; chemical reagents for medical or veterinary purposes; insect repellents; tissues impregnated with pharmaceutical lotions; syrups for pharmaceutical purposes; disinfectants; parasiticides; antiparasitic preparations; fungicides; pre-filled syringes for medical purposes; herbal extracts for medical purposes; plant extracts for pharmaceutical purposes.

(260) AM 2023 119728 A

(800) 1687629

(151) 2022 08 25

(891) 2022 08 25

(731) Apple Inc.

One Apple Park Way, Cupertino CA 95014,  
USA

(540)



(591) The color(s) blue and white is/are claimed as a feature of the mark

(531) 05.07.13; 10.03.11; 26.04.04; 26.04.05;  
26.04.16; 29.01.13

(511)

9 – Downloadable software used to provide retail store services and online retail store services featuring computers, computer hardware and peripherals, computer software, consumer electronics, tablet computers, smartwatches, smartphones, home automation products, set-top boxes, media players, entertainment products, audio speakers, headphones, earphones, wireless routers, computer monitors, computer keyboards, computer mice, computer cables, computer power adapters, carrying cases, computer printers for printing documents and photos, scanners and peripherals, gift cards, and accessories for the foregoing; downloadable computer software for accessing, browsing and searching online databases; downloadable computer software for generating customized product recommendations; downloadable computer software for use in credit card issuance.

(260) AM 2023 119729 A

(800) 1687714

(151) 2022 09 09

(891) 2022 09 09

(731) Seaboard Corporation

9000 West 67th Street, Shawnee Mission  
KS 66202, USA

(540)

**SEABOARD FOODS**

(591) Black, white

(526) FOODS

(511)

29 – Meat; processed meat, namely, bacon, ham and sausage.

(260) AM 2023 119730 A

(800) 1687760

(151) 2022 07 07

(891) 2022 07 07

(731) NOBLEWOOD LIMITED

Arch. Makariou III, 206, CHRYSALIA COURT, 5TH Floor, CY-3030 Limassol, Cyprus

(540)

**NOBLEWOOD**

(591) Black, white

(511)

33 – Aperitifs; arrack; brandy; wine; piquette; whiskey; vodka; anisette [liqueur]; kirsch; gin; digesters [liqueurs and spirits]; cocktails; anise [liqueur]; liqueurs; pre-mixed alcoholic beverages, other than beer-based; alcoholic beverages, except beer; alcoholic beverages containing fruit; spirits [beverages]; distilled beverages; mead (hydromel); peppermint liqueurs; bitters; nira (sugarcane-based alcoholic beverage); rum; sake; perry; cider; rice alcohol; alcoholic extracts; alcoholic fruit extracts; alcoholic essences.

(260) AM 2023 119740 A

(800) 1688040

(151) 2022 01 19

(891) 2022 01 19

(731) GEA Group Aktiengesellschaft

Peter-Müller-Str. 12; 40468 Düsseldorf, Germany

(540)

**GEA**

(591) Black, white

(531) 26.11.01; 26.11.08; 27.05.01; 27.05.12; 27.05.19; 27.05.22

(511)

1 – Chemicals and fertilizers used in industry, science and photography, as well as in agriculture, horticulture and forestry; chemicals for use in the treatment and conditioning of water and liquid manure; emulsifiers; surface-active substances; refrigerants; grease dissolving preparations for use in industrial processes; reagents used for the quantitative determination of nitrogen and other elements in chemical substances; chemical additives for use in industrial processes; chemical additives for use in cleaning agents and germicides for food processing industry, including the dairy in-

dustry; chlorinated chemical additives for use in the cleaning preparations for milking systems; boric acid and clean-in-place [CIP] water conditioners with chemical agents, all for use in sanitizing dairy milking systems; sulfuric, nitric, citric and phosphoric acids for cleaning and sanitizing milking systems on dairy farms; dchemical additives for refrigerant fluids and hydraulic fluids; filtering media of artificial or natural substances, as far as comprised in this class; unprocessed artificial resins; unprocessed plastics; fire extinguishing compositions; tempering and soldering preparations; chemical substances for preserving foodstuffs; tanning substances; adhesives used in industry.

3 – Cleaning, fragrancng, polishing, scouring and abrasive preparations [other than for office use]; detergents; laundry preparations; toiletries; soaps; skin care preparations; sanitary preparations being toiletries for livestock; cloths impregnated with a detergent for cleaning and care; cleaning agents for use in the processing industry, including the food processing industry; acid-based cleaning preparations for removing milkstone, water scale and rust from pipelines, bulk tanks, milking machines and water inflow pipes in the dairy industry; cleaning preparations for use in connection with dairy milk pipelines and milk tanks; udder washing detergents; cleaning preparations for milkers, milk-processing apparatus and systems for dairy farms and food contact surfaces; all aforementioned goods not for the cleaning and care of the eyes, eyelids and eyelashes of humans; industrial detergents and sulfuric, nitric, citric and phosphoric acids having disinfectant properties, used to clean and rinse dairy farm milking equipment and teat dip applicators; acid and other detergents having disinfectant properties, used for clean-in-place (CIP) systems in the food processing industry, including the dairy industry.

4 – Industrial oils and greases; mineral and non-mineral oil for industrial purposes, namely for machinery; lubricants; lubricating oil; dust absorbing, dust wetting and dust binding compositions; fuels [including motor spirit]; illuminants; candles and wicks for lighting; non-chemical additives for refrigerant fluids and hydraulic fluids.

5 – Disinfectants and antiseptics; germicides; disinfectants for cooling apparatus; disinfectants for the food processing industry, including the dairy industry; disinfectants for dairy animals, for milkers and for machines, devices and other equipment used in the dairy industry; teat disinfectants; germicidal teat dips; sanitizing udder washes; medicated udder salve; sanitizing foaming teat dips; veterinary preparations, namely, topical teat dips for tissue toning; medicated hoof care preparations in the form of foot bath concentrates and topical solutions; sanitizers for hoof trimming equipment and utensils; dairy sanitation products, namely, industrial sanitizer tablets used to clean, rinse and sanitize dairy farm milking installations and foaming teat dip applicators; disinfectants was-

hes; disinfectants impregnated into tissues; medical and veterinary preparations and products; veterinary products for the dairy industry; bacteriological preparations for medical or veterinary use; bacterial poisons; antiseptic sprays in aerosol form; mineral and dietary supplements for animal feed; iodine; medicated additives for animal foods; lotions for veterinary purposes; milking grease; pharmaceutical preparations; hygienic preparations and articles; pest control preparations and articles; algacides; preparations in the form of liquids or powders for removing moss; fly combating preparations; lice destroying preparations; insect repellents; biocides; preparations for destroying vermin; germicides for use in the food processing industry, including the dairy industry; reagents for use in polymerase chain reaction for DNA sequencing for medical purposes; anti-microbial hand soaps; antibody reagents for medical use; all aforementioned goods not for the treatment of eye diseases of humans.

6 – Common metals and their alloys; metal building materials; transportable buildings of metal; materials of metal for railway tracks; non-electric cables and wires of common metal; ironmongery and small items of metal hardware; pipes and tubes of metal; unwrought or semi-wrought common metals; valves of metal [other than machine parts]; expansion compensators and accessories thereof, as far as comprised in this class; pipes, tanks, rods, tubes of metal and fittings and accessories therefor, as far as comprised in this class; pipework and flanges [collars] of metal; fittings of metal for compressed air ducts; bulk milk cooling tanks, milking parlor stalls and stanchions, all made primarily of metal; manually activated metal valves, other than parts of machines; metal milking parlor equipment, namely, sequence gates, entry gates, exit gates, splashbacks, curbs, brisket boards; dairy barn facilities, namely, free stall barns, tie-stall barns, feed stanchions, keder tubes used as hem pipes, cattle traffic control gates, namely, telescoping gates, swing gates, and overhead gates, all made of metal; metal gutter grates; steel trusses for livestock barns; partitions as well as partition fittings and clamps of metal; metal barriers for livestock; treatment stalls and cattle crushes made of metal; isolation stalls and gates made of metal; parts for animal stalls, milking parlor installations, milk vats, vats, channels, tubs, gates, borders, doors, portals, barriers, grates, all mainly of metal, as well as fittings and accessories therefor; earmarks of metal for livestock; metal containers for storage or transport; closures of metal for containers; containers of metal for compressed gas or liquid air; metal hardware; pipe jackets of metal; transfer tubes of metal; milk reservoir vats of metal.

7 – Machines and machine tools for treatment of materials and for manufacturing [other than paper converting machines, including sheet-fed paper converting machines, thermal laminating machines, labelling machines, lithographic labelling machines, laminating

machines for stacks of sheets, printing machines, die-cutting machines for paper, cardboard and films, slitting and cutting machines for paper, cardboard and films, paper sheet feeding machines, machines for cutting, folding, handling, printing, rewinding, binding and laminating paper, cardboard and films, document shredding machines and machines for office use; motors and engines [except for land vehicles and other than for office use]; machine coupling and transmission components [except for land vehicles]; agricultural implements other than hand-operated; emulsifying machines and homogenizers [for chemical processing or food production]; brewing machines; kneading machines; mixers [machines]; drilling machines; electric knives; blade holders [parts of machines], other than for use in document shredding machines, paper processing machines or printing machines; knives [parts of machines], other than for use in document shredding machines, paper processing machines or printing machines; stropping machines; shaping and moulding machines [other than for office use]; pressing machines; mills and crushing machines, other than for use in document shredding machines, paper processing machines or printing machines; rasps [machines]; machines, mechanical apparatus, implements and parts thereof for the processing industry, for use in biotechnology, in the production and processing of drinking water, on oil rigs, in land vehicles and seacraft; machines, mechanical apparatus, implements and parts thereof for the industrial manufacturing and process technology, for the chemical, pharmaceutical, cosmetic, food and beverage industry, for agricultural and dairy purposes, for oil extracting and oil processing, for energy production, wastewater processing and for metal processing industries, for shipping, for drilling platforms and for use in cellars; machines for the production and processing of dry ice, cubed ice, crushed ice and flaked ice; motors, pumps and compressors for refrigerators and freezers; machines, mechanical apparatus and plants for the manufacturing of gases, chemical products, foodstuffs, including beverages; machines for dividing, clarifying, separating, mixing and conveying liquid and/or solid mixtures and substances; centrifugal mixers; powder mixers; reverse osmosis machines for increasing the concentration of dissolved substances in liquids; cartridges for filtering machines; rotating brush sieves [machines or parts of machines]; cyclones as parts of machinery; oil separators; filters, sieves and membranes as parts of machines and for motors and engines; compressors and fans as parts of machines; pumps, in particular for beverages and other foodstuffs; air condensers; blowing machines for the compression, exhaustion and transport of gases; oil refining machines; electrical engines, other than for land vehicles; blowing machines; pump diaphragms; suction machines for industrial purposes; electric machines, apparatus and implements for cleaning; steam cleaners; food and beverage processing and preparation equipment,

namely butter machines, computer-operated and non-computer-operated machines and installations for the processing, further processing and packaging of foodstuffs, namely meat, poultry, fish, cheese, potatoes, vegetables and other vegetarian products, computer-operated and non-computer-operated machines and installations for the pre-processing, processing and packaging of foodstuffs, namely meat, poultry, fish, cheese, potatoes, vegetables and other vegetarian products, in particular knives, mills, mixers [machines], emulsifying machines, machines for sausage production, apparatus for the production, processing and portioning of flour, albumen and bread crumbs, as well as automatic machines for the storage and packaging of foodstuffs, vacuum packing machines and assembly lines and machinery apparatus and mechanical equipment for the production, processing and refining of foodstuffs, semiluxury food and beverages; cutting machines, other than for document shredding purposes, paper processing purposes or office use; food slicers; slicers [machines, electric]; sausage making machines; labelling machines [other than for office use]; moving and handling equipment; agitators; lifting and hoisting equipment, as far as comprised in this class; handling machines, automatic [manipulators]; palletisers; machines for lifting and parts thereof; bottle filling machines; bottle washing machines; bottle capping machines; conveyors; belt conveyors; loading machines; automatic loading systems consisting of loading cranes and machines; manure augers; vacuum packing machines; packaging machines; foil wrapping machines; engines, powertrains, and generic parts for machines; pressure regulators [parts of machines]; heat exchangers being machine parts; crankcases for machines, motors and engines; hydraulic controls for machines, motors and engines; pneumatic controls for machines, motors and engines; pistons [parts of machines and engines]; regulators [parts of machines]; steam traps; control mechanisms for machines, engines or motors; valves [machine parts]; connection fittings for machines; expansion compensators, namely machine parts for compensating thermal stress; cleaners [machine parts]; machines for the energy and power plant industry; machines for the energy technology, as far as comprised in this class; compressors for refrigerators; machines for agglomeration, granulation and lamination [coating] of materials, including foodstuffs and pharmaceutical preparations, and plants composed of the aforementioned machines used for applying the fluid bed technology for commercial purposes; sealing machines for industrial purposes; filling machines; atomizers; machines using microwave technology for commercial purposes; machines for agricultural engineering purposes; environmental technology machines for commercial purposes; machines for industrial plant construction; machine tools; machines and installations composed thereof for applying the spraying technology and spray drying technology for commercial purposes; ag-

ricultural, earthmoving, construction, oil and gas extraction and mining equipment; agricultural equipment; electrolysis apparatus for the manufacturing of disinfectants; electric machines for the processing of foodstuffs; fodder presses; rotary and linear milking parlor installations consisting of milking installations; semi-automatic and automatic milking machines; milking installations; component parts for milking machines, namely, milk stimulators, filters for milking machines, vacuum pumps, milk pumps, air compressing pumps, water pumps, chemical dispensing pumps, power-operated teat sprayers, power-operated udder washers, aerators, milking system washers, industrial milking robots; vacuum regulators as parts of milking machines; milking machine retractors; pumps and pulsators for the dairy industry; udder washing and spraying apparatus; automatic feeding machines; milking parlor equipment, namely manure scrapers; stationary machines for automatically spraying cows with liquid insecticides and germicides; teat cups [suction cups] for milking machines; machines for supplying fodder concentrate in fodder troughs; power-operated manure scrapers; robotic and power-operated manure scrapers; manure agitators; manure separators; tractor-towed farm implements; waste management systems, processing systems and recovery systems for manure, slurry and other animal waste, namely pumps or scrapers for the transport of solid and liquid animal excretions as well as presses for the separation of undigested solid elements; mechanized livestock feeders; machines and machine-operated equipment for cleaning purposes for use in the processing industry, including the food processing industry, in particular the dairy industry, namely machines for the cleaning of teats and hooves; installations and components for processing and the disposal of manure and slurry for the generation of energy, namely pumps and conveyors; sweeping machines; cleaning machines; cleaning devices and machine-type cleaning apparatus, in particular chemical and/or mechanical cleaning apparatus and installations, in particular for the dairy industry, the brewing and beverage industry, the food industry, the chemical, pharmaceutical and cosmetics industry; stable cleaning machines; press-rollers; robots [machines]; condensing installations; mechanical watering systems for livestock; vacuum machines and installations composed thereof; vacuum installations being parts of milking machines; bottling plants for the bottling of solid, pasty and liquid substances and of heterogeneous substance mixtures; pumps for the food processing industry, including milking machine pumps; extractors for milking clusters, namely apparatus for removing the milking equipment from the udder; machines for filtering waste milk to be used for calf feeding; installations for thickening of suspensions by means of decantation or evaporation; plants and apparatus for applying the fluid bed technology for commercial and industrial purposes; plants and apparatus for app-

lying the spray technology, namely spray dryers and spray granulators; machines and mechanical equipment for concentrating, dispersing, suspending, filtering, separating, agglomerating, extracting, fermenting, homogenizing, adding gas to and aerating of solid, liquid and/or gaseous substances, including their intermediates and precursors of synthetic, plant or animal origin, in particular including milk, milk products, milk intermediates, cheese, cheese products, cheese intermediates, butter, butter products, butter intermediates, coffee, beer, juices, meat, fish products and nutritional supplements as well as in particular educts and products of the petrochemical, chemical and pharmaceutical industry and in particular of commercial or industrial waste, wastewater or exhaust gases; rotating cylindrical brushes for livestock [machine parts]; dust removing installations and equipment for cleaning purposes.

9 – Regulating, checking [supervision], control, measuring and switching installations, apparatus and instruments [other than for office use]; detecting and monitoring instruments, indicators and controllers; food analysis apparatus; quantity indicators; telemeters; diagnostic apparatus, not for medical purposes; transducers; flow meters; pressure gauges; refractometers; spectrometers; thermometers; remote controls; dosage dispensers; automatic liquid flow controls; control and regulating installations for managing and monitoring dairy herds; testing apparatus, not for medical purposes; alignment and calibrating instruments; vacuum gauges; scales; electronic measuring, control and checking [supervision] apparatus and instruments for climate monitoring and climate control; data processing and data collection installations and equipment [other than for office use]; data output installations and equipment [other than for office use]; data transmission installations and equipment [other than for office use]; electrotechnical and electronic apparatus and equipment for process monitoring and process control, for the collection, processing and output of data; apparatus and equipment for the industrial and commercial measuring, monitoring and/or controlling technology; sensors and detectors; information technology and audiovisual equipment; scanners [other than for office use]; luminescence scanners; electronically encoded identification devices; identification devices for livestock; communications equipment; transmitters; radio receivers; transponders; electric apparatus for commutation; X-ray apparatus, not for medical purposes; safety, security, protection and signalling devices; neck tags [electronic transmission and reception apparatus] and responders for livestock; protective and safety equipment; protective boots; protective gloves; protective clothing; protective goggles; software; application software; computer application software for mobile devices and computers; dairy herd management software and computer hardware; computer peripherals, other than printers, scanners or other peripherals for office use; optical devi-

ces, sensors and optical equipment, enhancers and correctors; observation instruments; closed-circuit video observation systems comprised of closed circuit television camera and video monitor; apparatus and instruments for conducting, switching, transforming, accumulating, regulating and controlling electricity [other than for office use]; electrical contacts; electric relays; apparatus for recording, storage, transmission or reproduction of sound or images [other than for office use]; scientific surveying, photographic, cinematographic, optical, weighing, signalling apparatus and instruments [other than for office use]; scientific research and laboratory apparatus, educational apparatus and simulators; chemistry apparatus and instruments [other than for office use]; electronic publications, downloadable; apparatus, instruments and cables for electricity; printed circuit boards; load cells; animal scales; electronic animal counting devices; electronic milk flow monitoring devices and milk meters; electronic data processing units, transmitters, receivers and transponders attached to cows for the automatic recognition of animals, for the supply of feed and fodder concentrate, for the cow calendar, for the determination of milk quantities and the quality of milk, for the determination of milk temperatures, and for the determination of washing temperatures; electric control panels for monitoring and operating milking systems; remote controls for automatically dispensing animal feed; automatic dispensers for supplying liquids in drinking bowls; electronic controllers for milk pipeline washers; automatic dispensers for supplying chemicals for milk pipeline washers; milking monitors, automatic liquid-flow controls for milking machines, automatic feed dispensers for dairy animals; flow sensors for milkers.

10 – Veterinary apparatus and instruments; apparatus for stimulating the udder of dairy animals; apparatus for monitoring the health status of livestock.

11 – Apparatus for lighting, heating, steam generating, cooking, refrigerating, drying, ventilating, water supply as well as sanitary installations; air treatment and air purification equipment; deodorizing apparatus; air purifying installations; ventilation hoods; commercial and industrial dehumidifiers; HVAC systems [heating, ventilation and air conditioning]; heat-recovery installations; air cooling apparatus; air purifying apparatus and machines; electrically powered blowers for ventilation; electric fans; regulating and safety accessories for water and gas installations; wet cooling towers and dry cooling towers with natural ventilation and/or forced ventilation for the cooling of liquid and/or vaporous media; burners, boilers and heaters; heat exchangers, not parts of machines; heat regenerators; furnaces; air reheaters; heat pumps; steam accumulators; heat accumulators; heat generating apparatus; stoves; incinerators; refrigerating and freezing equipment; refrigerating appliances and installations; cooling aggregates; cooling machines; refrigerating

chambers; ice machines and apparatus; gas condensers, other than parts of machines; transport refrigeration units for land, air and water vehicles, trailers, shipping boxes and containers; water cooling apparatus; cooling installations for foodstuffs, including milk cooling installations; milk cooling apparatus, namely, refrigerated milk storage tanks; milk coolers, namely, a chiller in the nature of a refrigeration unit used to cool a heat transfer medium and a heat exchanger in which the heat transfer medium cools milk as it comes from cows being milked; cooling and refrigerating installations for the construction industry for the cooling of concrete; cooling and refrigerating installations for the mining industry; cooling and refrigerating installations for sports and leisure facilities; refrigerating containers; ice making machines; lighting and lighting reflectors; lighting apparatus; LED lighting apparatus; luminaires; discharge tubes, electric, for lighting; infrared and ultraviolet lamps not for medical purposes; sanitary installations; water supply and sanitation equipment; sterilization, disinfection and decontamination equipment; disinfectant apparatus; autoclaves; water sterilizers; sterilizers for foodstuffs, including milk; steam sterilizers; water purification, desalination and conditioning installations; agricultural irrigation units; installations and apparatus for wastewater treatment; reverse osmosis devices, water filtering apparatus and water purification installations; pipes being parts of sanitary facilities; sterilizers [not for medical purposes]; food and beverage cooking, heating, roasting, grilling, cooling devices and equipment; electric deep fryers; cooker hoods for industrial use; electric cooking utensils; electric kettles; coffee bean roasting machines; food dryers; roasting apparatus; infrared and microwave ovens for industrial purposes; pasteurizers; wastewater treatment installations; sterilizers for industrial purposes; industrial ovens and furnaces [not for food or beverages]; heat exchangers for chemical processing; flare stacks; distillation columns and units; industrial water treatment plants; industrial installations for filtering liquids; gas scrubbing installations; gas scrubbing and purification apparatus; sewage treatment installations; drying apparatus and installations; crystallizers; installations for the purification of gases; vaporizing installations, apparatus and appliances; drying apparatus; humidifying installations and equipment; humidifiers; filter systems consisting of filter housings and replaceable filter elements, not used as parts of machines, motors or engines; cleaning installations and equipment for liquids; water purification, water treatment, water supply and water desalination installations and equipment; apparatus and equipment for the separation of solid and liquid materials from gaseous and/or liquid media; apparatus and equipment for exhaust steam and waste heat recovery; automatic watering installations; pressure water tanks; clean chambers [sanitary installations]; water intake apparatus; water filtering apparatus; water softening apparatus; water

distribution installations; water heaters; water heating installations; air treatment apparatus and machines; germicidal lamps for purifying air; air filters for industrial use; filters for the separation of solid or liquid substances from liquids or gases, including the air; flues and installations for conveying exhaust gases; gas condensers, other than parts of machines; ionization apparatus for the treatment of air; valves being parts of sanitary, heating, steam generating, cooking, refrigerating, drying, ventilating and water supply installations; installations and apparatus for the thermal treatment as well as for the thermal processing of foodstuffs, semiluxury food, beverages and animal feed, in particular for warming, heating, pasteurizing, distilling, refrigerating, freezing, chilling, condensing, spray drying, freeze-drying, drying, in particular educts and products of the petrochemical, chemical and pharmaceutical industry and in particular of commercial or industrial waste, wastewater or exhaust gases; milking parlor equipment, namely air curtains and aerators; distilling machines; mechanical watering systems for livestock farming, namely automatic watering installations; dairy barn equipment, namely, electronic climate control devices; all aforementioned goods also manufactured according to customers' order; dairy barn and milking parlor equipment, namely, power-operated air curtains that open and close, power-operated ventilation system for the roof of livestock barns; drying apparatus for the chemical industry, distillation apparatus for the chemical industry, evaporators for the chemical industry, steam appliances for the chemical industry.

17 – Rubber, gutta-percha, gum, asbestos, mica; plastics in extruded form for use in manufacture; packing, stopping and insulating materials; flexible tubes [not of metal]; seals, sealants and fillers; pipes of rubber, silicone rubber or other synthetic materials for the food processing industry, including milk lines; semi-processed plastic for use in the production of teat liners; flexible pipes, tubes, hoses, and fittings therefor, including valves; seals for pipe connections; insulation jackets for industrial pipes; semi-processed rubber and silicone for use in the production of teat liners.

21 – Drinking troughs; feeding troughs; mangers for animals; tableware, cookware and containers; cups; bottles; brushes; feeding troughs, primarily of metal; watering cans of metal; non-mechanized livestock waterers.

37 – Building construction; installation, repair and maintenance of machines, mechanical apparatus, implements, motors and engines for the industrial manufacturing and process technology, for the chemical, pharmaceutical, cosmetic, food and beverage industry, for agricultural and dairy purposes, for oil extracting and oil processing, for energy producing, wastewater processing and for metal processing industries, for shipping, for drilling platforms and for use in cellars; installation, repair and maintenance of regulating,

checking [supervision], control, measuring and switching installations, apparatus and instruments, detecting and monitoring instruments, data processing installations and equipment, data collection installations and equipment, data output installations and equipment and data transmission installations and equipment; installation, repair and maintenance of lighting, heating, steam generating, cooking, refrigerating, drying, ventilating, water supply as well as sanitary installations; steel structure construction works; building construction, including structural and civil engineering and including for the building of industrial and mechanical installations and of buildings; building construction supervision; installation of industrial and mechanical installations; construction information; cleaning services; installation of temporary structures for trade fairs; interference suppression in electrical apparatus; retrofitting and modification of machines; repair or maintenance of machines, installations [facilities] and apparatuses; installation, maintenance and repair of machines, installations [facilities] and apparatuses; installation, maintenance and repair of plants on farms; consultancy relating to installation, maintenance and repair services; providing information relating to installation, maintenance and repair services; rental of motors for use in oil extracting, drilling platforms and underground mining; installation and maintenance of dairy parlor equipment.

40 – Processing of metals, plastics and natural resources, namely rubber, gutta-percha, gum, asbestos, mica, stone, wood and leather; material treatment information; refrigerant recovery services; providing information relating to the processing and conversion of foodstuffs; printing, and photographic and cinematographic development; photographic processing; rental of machines, mechanical apparatus, implements, motors and engines for use in industrial manufacturing and processing for the chemical, pharmaceutical, cosmetic, food and beverage industry and for dairy purposes; rental of heating installations; providing information relating to the rental of air conditioning apparatus or of chemical processing machines and apparatus; providing information relating to the rental of machines and apparatus for food processing or beverage production; providing information relating to the rental of room cooling units for commercial or industrial purposes; providing information relating to the rental of water purification apparatus; rental of refrigerating apparatus; rental of drying, steam generating, ventilating and water supply installations.

42 – Scientific and technological services; services for technical monitoring of industrial processes; engineering services; physics research; construction drafting; architectural and urban planning services; industrial research; medical research; consultancy in the field of energy-saving; research in the field of agricultural chemistry; IT programming services; IT consultancy, advisory and information services; design and development of computer hardware; reproduction of com-

puter programs and conversion of computer programs and data [no physical conversion]; decoding of data; IT security services in the form of computer data protection and recovery; software design, development, programming and implementation; computer programming; data mining; hosting services and software as a service and rental of software; cloud computing; architectural and construction drafting and consultancy; preparation of data processing programs; rental of computer software, computer hardware and computer facilities; validation and quality assurance with respect to software components and hardware components; technological consultancy regarding maintenance work; design, technical development and technical planning of industrial plants and machines; scientific and technological services and research and design relating thereto; industrial analysis and research services; design and development of computer hardware and software; technical consultancy services for dairy producers in the field of water quality testing and analysis and maintenance assessment of the performance and reliability of milking and cooling systems and of the udder washing system function; technological consultancy services to assist dairy producers in optimizing milk production performance and in maximizing milking efficiency by analyzing data, namely, data on milking vacuum levels, pulsation rates, ratios and characteristics, teat liner design and composition, milk production and dairy operator routines; technical consultancy in the field of dairy parlors and dairy facilities by providing technological consultation on milking equipment, automation level, monitoring measures regarding technical facilities, requirements regarding electrical facilities, water quality monitoring, design and planning of milking boxes; technical consultancy in the field of science, engineering and information technology; consultancy in the field of numerical fluid mechanics and development of fluid-mechanical computer models; consultancy regarding technical research in the field of foodstuffs and beverages; consultancy in the field of biotechnology; consultancy in the field of pharmaceutical research; consultancy in the field of veterinary research and development; consultancy in the field of renewable energy; providing technological consultation to dairy producers, as part of milking system design services, relating to vacuum pumps, controllers and pulsators used with milking machines, milking units, pipelines, dairy operator performance, sanitation and supplies, milk storage and cooling, service schedules, milk pumps and milk filtering, timing and flow control devices; consultancy in the field of environmentally friendly technologies; natural science services; chemical analysis for the optimization of hygiene in the food processing industry, including on dairy farms; chemical analysis for trade and industry, including the food processing industry and the dairy industry; provision of scientific information, advice and consultancy in relation to carbon offsetting; material

testing; technical project management for the planning and development of industrial installations and machines; services of a research and development office; creation of new products; electronic data storage; data programming; technological consultancy regarding data processing for others; data programming for others; design services; dairy facility planning services, namely, laying out of milking parlors and waiting areas in front of milking robots, milking barns, calf and dam sheds as well as cow comfort and traffic patterns; dairy parlor and dairy facilities design services; new product design; planning of commercially used facilities and industrial plants, in particular of the food industry, including of dairy facilities; computer technology consulting; technological analysis services; research laboratories and laboratory testing services; chemistry services; electrical engineering services; chemical engineering; scientific research; technical project studies; surveying and exploration services; preparation of scientific reports; research, development and design of new machines and installations for others in the field of food processing and packaging; conducting scientific experiments; research and development of new products for others; testing, authentication and quality control; technical testing services; conducting chemical analyses; analysing of manufacturing processes; measuring and analysis of emission and pollutant concentration; materials testing and evaluation; product testing; calibration services; rental of regulating, checking [supervision], control, measuring and switching installations, apparatus and devices, detecting and monitoring instruments, data processing, data collection, data output and data transmission installations and equipment.

(260) AM 2023 119741 A  
 (800) 1688068  
 (151) 2022 08 12  
 (891) 2022 08 12  
 (731) GHC Systems Inc.  
 2-501 Cartwright Street, Saskatoon SK  
 S7T 1E1, Canada  
 (540)

**SURFACE**  
HAIR HEALTH ART



**AWAKEN**

(591) Black, white

(531) 05.01.03; 05.01.05; 05.01.11; 05.01.16;  
 26.01.03; 26.01.15; 27.05.01

(511)  
 3 – Hair shampoo and conditioner; hair styling products, namely, hair spray, hair cream, mousse, hair masques, hair mist and creams for the hair; lotions for hair; non-medicated hair preparations; hair care preparations.

(260) AM 2023 119742 A  
 (800) 1688071  
 (151) 2022 07 08  
 (891) 2022 07 08  
 (731) GUANGZHOU XAIRCRAFT TECHNOLOGY  
 CO., LTD.  
 Block C, 115 Gaopu Road, Tianhe District,  
 Guangzhou, Guangdong, China  
 (540)

**XAG**

(591) Black, white  
 (531) 27.05.01; 27.05.17  
 (511)

7 – Joysticks being parts of machines, other than for game machines; waste disposal units; machines and apparatus for cleaning, electric; hand-held tools, other than hand-operated; dynamos; electricity generators; cowlings [parts of machines]; fans for motors and engines; valves [parts of machines]; regulators [parts of machines]; filters being parts of machines or engines; connecting rods for machines, motors and engines; control mechanisms for machines, engines or motors; shock absorbers (parts of machines); rubber tracks being parts of crawlers on agricultural machines; agricultural seed planting machines; agricultural implements, other than hand-operated; lawnmowers [machines]; agricultural machines; pulverisers [machines]; reapers; tilling machines for agricultural purposes; shearing machines for animals; food processors, electric; guards [parts of machines]; industrial robots; hoods [parts of machines]; feeders [parts of machines]; milking machines; fodder presses; ejectors; mechanized livestock feeders; food preparation machines, electromechanical; filling machines; finishing machines.

9 – Computer software platforms, recorded or downloadable; interactive touch screen terminals; computer operating programs, recorded; time recording apparatus; biometric scanners; naval signalling apparatus; navigational instruments; electronic navigational and positioning apparatus and instruments; wide area network [WAN] routers; radar apparatus; intercommunication apparatus; global positioning system [GPS] apparatus; radio-frequency antennas; aerials; satellite navigational apparatus; wireless routers; electro-dynamic apparatus for the remote control of signals; security surveillance robots; monitoring apparatus, other



than for medical purposes; trail cameras; camcorders; cameras [photography]; levelling staffs [surveying instruments]; surveying instruments; inductors [electricity]; infrared detectors; remote control telemetering apparatus; steering apparatus, automatic, for vehicles; sensors; electric control apparatus for robots; remote control apparatus; protective helmets; protection devices for personal use against accidents; batteries, electric; battery chargers; electronic publications, downloadable; black boxes [data recorders]; computer software, recorded; humanoid robots with artificial intelligence for use in scientific research; programmable logic controllers; computer software applications, downloadable; downloadable software applications for mobile phones; couplers [data processing equipment]; radio-frequency identification [RFID] tags; data processing apparatus.

12 – Electric vehicles; vehicles for locomotion by land, air, water or rail; remote control vehicles, other than toys; driverless cars [autonomous cars]; bicycles; aerial conveyors; tyres for vehicle wheels; aeroplanes; aircraft; aeronautical apparatus, machines and appliances; military drones; air vehicles; civilian drones; camera drones; amphibious airplanes; water vehicles; vehicle joysticks; screw-propellers; fuselages for aircraft.

35 – Product display services; advertising; online advertising on computer communication networks; business consultancy services in the field of agriculture; providing business information; market research and analysis; commercial administration of the licensing of the goods and services of others; planning and conducting of trade fairs, exhibitions and presentations for commercial or advertising purposes; conducting, arranging and organizing of trade exhibitions and fairs for business and advertising purposes; marketing; sales promotion for others; provision of an online marketplace for buyers and sellers of goods and services; human resources management; systemization of information into computer databases; sponsorship search.

37 – Providing information relating to repairs; repair or maintenance of measuring machines and instruments; installation, maintenance and repair of computer hardware; repair or maintenance of agricultural machines and implements; vehicle maintenance; vehicle battery charging; providing information relating to the repair or maintenance of aircraft; rustproofing; retreading of tyres; pest control services, other than for agriculture, aquaculture, horticulture and forestry; disinfecting; burglar alarm installation and repair; pump repair.

41 – Teaching; instruction services; training in the field of communication technologies; educational examination for users to qualify to pilot drones; arranging and conducting of conferences; arranging and conducting of workshops [training]; organization of exhibitions for cultural or educational purposes; lending of

books and other publications; providing online electronic publications, not downloadable; training services provided via simulators; photography; photographic reporting; providing online videos, not downloadable; providing television programmes, not downloadable, via video-on-demand services; providing user reviews for entertainment or cultural purposes; presentation of live performances; news reporters services.

42 – Product testing; industrial design; dress designing; electronic data backup; conversion of computer programs and data, other than physical conversion; upgrading and maintenance of computer software; monitoring of computer systems by remote access; platform as a service [PaaS]; surveying; rental of measuring apparatus; aerial surveying; photogrammetry; land surveying; consultancy in the field of agricultural chemistry; meteorological information; weather forecasting; technological research; agricultural research; research and development of new products for others; software as a service [SaaS]; design and development of computer software; updating of smartphone software; design and development of databases; design of image processing software; monitoring of computer systems for detecting unauthorized access or data breach; rental of application software; providing virtual computer systems through cloud computing; cartography services; graphic design.

44 – Dietary and nutritional guidance; health spa services; animal grooming; pest control services for agriculture, aquaculture, horticulture and forestry; weed killing; aerial seeding; aerial and surface spreading of fertilizers and other agricultural chemicals; farming equipment rental; spraying of crop protection products for agricultural purposes; plant nursery services; spreading of fertilizers; gardening.

---

(260) AM 2023 119743 A

(800) 1688079

(151) 2022 08 10

(891) 2022 08 10

(731) Huizhou Jiuzi Electronic Technology Co., Ltd.  
Xiaotang, Shangnan Village, Yuanzhou Town,  
Boluo County, Huizhou City, 516000  
Guangdong Province, China

(540)

**JERRZI**

(591) Black, white

(511)

9 – Computer peripheral devices; computer keyboards; earphones; transformers [electricity]; control panels [electricity]; connectors [electricity]; switches, electric; time switches, automatic; solenoid valves [electromagnetic switches]; distribution boxes [electricity].

---

(260) AM 2023 119745 A

(800) 1688213

(151) 2022 02 18

(891) 2022 02 18

(731) SOTEMAPACK S.P.A.

Via M. Calari 11, I-40011 ANZOLA  
DELL'EMILIA (BO), Italy

(540)

## SOTEMAPACK

(591) Black, white

(511)

7 – Packing installations, bundling machines, canning machines, winding machines, lacing machines, stretch-wrapping machines for applying plastics film to palletised loads, industrial robots, machines for manufacturing packaging materials, bottling machines, wrapping machines, cartoning machines, taping [tying] machines other than for office use, pallet transferring machines, pallet stabilisation machines, compacting machines, electric garbage disposal machines.

(260) AM 2023 119747 A

(800) 1688275

(151) 2022 06 02

(891) 2022 06 02

(731) UAB "VIČIŪNŲ GRUPĖ"

Karaliaus Mindaugo pr. 38, LT-44307 Kaunas,  
Lithuania

(540)

## ЧТО УГОДНО С VIČI

(591) Black, white

(531) 28.05

(511)

29 – Surimi-based foodstuffs; fish-based foodstuffs.

(260) AM 2023 119755 A

(800) 1627073

(151) 2021 09 30

(891) 2022 09 01

(731) Philip Morris Products S.A.

Quai Jeanrenaud 3, CH-2000 Neuchâtel,  
Switzerland

(540)

## VEEV BASIC

(591) Black, white

(511)

34 – Wired vaporizers for electronic cigarettes and electronic smoking devices; tobacco, raw or manufactured; tobacco products, including cigars, cigarettes, cigarillos, tobacco for roll-your-own cigarettes, pipe tobacco, chewing tobacco, snuff tobacco, kretek; snus; tobacco substitutes (not for medical purposes); smokers' articles, including cigarette paper and tubes, cigarette filters, tobacco tins, cigarette cases and ash-

trays, pipes, pocket apparatus for rolling cigarettes, lighters; matches; tobacco sticks, tobacco products for the purpose of being heated, electronic devices and their parts for the purpose of heating cigarettes or tobacco in order to release nicotine-containing aerosol for inhalation; liquid nicotine solutions for use in electronic cigarettes; electronic smoking devices; electronic cigarettes; electronic cigarettes as substitutes for traditional cigarettes; electronic devices for the inhalation of nicotine containing aerosol; oral vaporizing devices for smokers, tobacco products and tobacco substitutes; smokers' articles for electronic cigarettes; parts and fittings for the aforesaid products included in this class; devices for extinguishing heated cigarettes and cigars as well as heated tobacco sticks; electronic rechargeable cigarette cases.

(260) AM 2023 119756 A

(800) 1635706

(151) 2021 11 18

(891) 2022 09 14

(731) Apple Inc.

One Apple Park Way, Cupertino CA 95014,  
USA

(540)

## SIGNTIME

(591) Black, white

(511)

9 – Downloadable computer software.

(260) AM 2023 119757 A

(800) 1661825

(151) 2021 11 18

(891) 2022 09 15

(731) Apple Inc.

One Apple Park Way, Cupertino CA 95014,  
USA

(540)

## SIGNTIME

(591) Black, white

(511)

35 – Retail store and online retail store services; retail store services provided via the internet and other computer, electronic and communications networks; retail store services in the field of books, magazines, periodicals, newsletters, journals and other publications on a wide range of topics of general interest, provided via the internet and other computer, electronic and communications networks; retail store services in the field of entertainment featuring movies, television programs, sporting events, musical works, and audio and audiovisual works, provided via the internet and other computer, electronic and communications networks; retail store services featuring computer, electronic and entertainment products, telecommunications apparatus, mobile phones, handheld mobile digital electronic

devices, and other consumer electronics, computer software, and accessories, peripherals, parts, and carrying cases for such products, provided via the internet and other computer, electronic and communications networks.

37 – Repair, and servicing of computers, computer peripherals, mobile phones, digital electronic devices, wearable electronic devices, audio and video products, audio, video, and media players, television set top boxes and video recorders, smartwatches, wearable computers and electronics, and other consumer electronics and entertainment products; technical support services, namely, troubleshooting in the nature of computer hardware repair; maintenance, repair and updating of computer hardware, peripherals.

38 – Videoconferencing services and communication by computer terminals enabling interactive sign language interpretation.

41 – Educational services, namely, sign language interpretation; providing information featuring viewing of videos and multimedia content featuring sign language interpretation via a website.

42 – Consultancy in the design and development of computer hardware; computer software consultancy; computer technology support services, namely, help desk services; technical support services, diagnosing and troubleshooting of computer hardware and software problems; repair and maintenance of computer software.

---

(260) AM 2023 119758 A

(800) 1676035

(151) 2022 03 28

(891) 2022 09 16

(731) La Senza International Canada, LLC  
6th Floor, 9720 Wilshire Boulevard, Beverly Hills CA 90212, USA

(540)

## LS LINGERIE

(591) Black, white

(511)

25 – Clothing and footwear, namely, lingerie, pajamas, night shirts, nighties, loungewear, camisoles, panties, brassieres, bustiers, corsets, slips, teddies, garter belts, garters, nylons, panty hose, robes, bathrobes, drawstring pants, men's briefs and boxer shorts; T-shirts, vests, sweaters, shirts, jumpsuits, leggings, tops, bottoms, blouses, boots, shoes and slippers.

---

(260) AM 2023 119759 A

(800) 1684821

(151) 2022 07 20

(891) 2022 09 17

(731) Fall Creek Farm and Nursery, Inc.  
39318 Jasper-Lowell Road, Lowell OR 97452, USA

(540)

## LIVIE

(591) Black, white

(511)

31 – Fresh fruit.

---

(260) AM 2023 119827 A

(800) 1688807

(151) 2022 05 19

(891) 2022 05 19

(731) Euro Games Technology Ltd.  
"Maritsa" Str. 4, "Vranya-Lozen-Triugulnika",  
BG-1151 Sofia, Bulgaria

(540)

## Flamy Dice

(591) Black, white

(511)

9 – Software; computer gaming software; computer software packages; computer operating system software; computer software, recorded; software drivers; virtual reality software; games software; entertainment software for computer games; computer programs for network management; operating computer software for main frame computers; monitors (computer hardware); computer hardware; apparatus for recording images; monitors (computer programs); computer game programs; computer programs for recorded games; apparatus for recording, transmission or reproduction of sound or images; communications servers [computer hardware]; electronic components for gambling machines; computer application software featuring games and gaming; computer software for the administration of on-line games and gaming; computer hardware for games and gaming; hardware and software for gambling, gambling machines, gambling games on the Internet and via telecommunication network.

28 – Gaming machines for gambling; chips for gambling; mah-jong; arcade games; gambling machines operating with coins, notes and cards; games; electronic games; parlor games; gaming chips; gaming tables; slot machines [gaming machines]; LCD game machines; slot machines and gaming devices; coin-operated amusement machines; roulette chips; poker chips; chips and dice [gaming equipment]; equipment for casinos; roulette tables; gaming roulette wheels; casino games; automats and gambling machines; coin-operated machines and/or electronic coin-operated machines with or without the possibility of gain; boxes for coin-operated machines, slot machines and gaming machines; electronic or electrotechnical gaming devices, automats and machines, coin-operated machines; housings for coin-operated machines, gaming equipment, gaming machines, machines for gambling; electropneumatic and electrical gambling machines (slot machines).

41 – Gambling; services related to gambling; gaming services for entertainment purposes; casino, gaming and gambling services; training in the development of software systems; provision of gaming equipment for gambling halls; providing casino equipment [gambling]; gaming machine entertainment services; providing casino facilities [gambling]; halls with gaming machines; amusement arcade services; games equipment rental; rental of gaming machines; providing amusement arcade services; rental of gaming machines with images of fruits; editing or recording of sounds and images; sound recording and video entertainment services; hire of sound reproducing apparatus; provision of gaming equipment for casinos; providing of casino facilities; online gambling services; casino management services; operation of gaming establishments, gaming halls, Internet casinos, online gambling sites.

(260) AM 2023 119844 A

(800) 1689414

(151) 2022 04 13

(891) 2022 04 13

(731) MEY ALKOLLÜ İÇKİLER SANAYİİ VE  
TİCARET ANONİM ŞİRKETİ  
ESENTEPE MAH. BAHAR SK. ÖZDİLEK,  
13 25 Şişli, İstanbul, Türkiye

(540)



(591) Black, white

(531) 03.01.02; 05.05.19; 05.05.20; 05.07.10;

19.07.01; 19.07.16; 19.07.23; 24.01.09;

24.01.15; 24.01.19; 25.01.06; 29.01.15

(511)

33 – Rakis which are suitable for raki geographical indication.

(260) AM 2023 119845 A

(800) 1689418

(151) 2022 06 14

(891) 2022 06 14

(731) Limited Liability Company "Manrok Import  
Export Limited"

Budennovsky Ave., 93/295, office 35,

Rostov-on-Don, RU-344011 Rostov region,

Russian Federation

(540)

 EDENBERG

(591) Black, white

(531) 27.05.01; 27.05.09

(511)

21 – Autoclaves, non-electric, for cooking; indoor aquaria; wine aerators; buckets; cookie jars; candle jars [holders]; china ornaments; dishes; vegetable dishes; saucers; goblets; boxes for sweets; bottles; demi-johns; vases; epergnes; fruit bowls; inflatable bath tubs for babies; bird baths; baby baths, portable; plungers for clearing blocked drains; waffle irons, non-electric; ice buckets; mop wringer buckets; buckets made of woven fabrics; whisks, non-electric, for household purposes; cooking skewers of metal; towel rails and rings; clothing stretchers; hair for brushes; horsehair for brush-making; funnels; carpet beaters [hand instruments]; signboards of porcelain or glass; candle extinguishers; heads for electric toothbrushes; flower pots; chamber pots; glue-pots; cruets; decanters; large-toothed combs for the hair; combs for animals; tea cosies; abrasive sponges for scrubbing the skin; make-up sponges; sponges for household purposes; bath sponges; sponge holders; stands for portable baby baths; toothpick holders; soap holders; table napkin holders; holders for flowers and plants [flower arranging]; tea bag rests; shaving brush stands; toilet paper holders; soap dispensers; plug-in diffusers for mosquito repellents; ironing boards; cutting boards for the kitchen; bread boards; washing boards; crushers for kitchen use, non-electric; strainers for household purposes; smoke absorbers for household purposes; containers for household or kitchen use; kitchen containers; glass jars [carboys]; heat-insulated containers; heat-insulated containers for beverages; thermally insulated containers for food; glass flasks [containers]; closures for pot lids; chamois leather for cleaning; toothpicks; ceramics for household purposes; majolica; works of art of porcelain, ceramic, earthenware, terra-cotta or glass; kitchen grinders, non-electric; cleaning instruments, hand-operated; cabarets [trays]; stew-pans; flower-pot covers, not of paper; shaving brushes; make-up brushes; birdcages; baking mats; ladles for serving wine; polishing leather; hot pots, not electrically heated; glass bulbs [receptacles]; napkin rings; poultry rings; rings for birds; coin banks; piggy banks; bread baskets for household purposes;

baskets for household purposes; waste paper baskets; feeding troughs; mangers for animals; lunch boxes; tea caddies; washtubs; earthenware saucepans; mess-tins; cauldrons; coffee percolators, non-electric; coffee-pots, non-electric; coffee grinders, hand-operated; beer mugs; tankards; rat traps; pot lids; aquarium hoods; butter-dish covers; dish covers; cheese-dish covers; buttonhooks; reusable ice cubes; jugs; perfume burners; watering cans; fly traps; insect traps; ice cream scoops; mixing spoons [kitchen utensils]; basting spoons [cooking utensils]; pie servers; spatulas for kitchen use; litter boxes for pets; butter dishes; material for brush-making; polishing materials for making shiny, except preparations, paper and stone; tablemats, not of paper or textile; noodle machines, hand-operated; lint removers, electric or non-electric; polishing apparatus and machines, for household purposes, non-electric; pepper mills, hand-operated; mills for household purposes, hand-operated; feather-dusters; brooms; isothermic bags; decorating bags for confectioners; bowls [basins]; mosaics of glass, not for building; saucepan scourers of metal; soap boxes; mouse traps; cooking pot sets; nozzles for watering cans; pouring spouts; cake decorating tips and tubes; nozzles for watering hose; fitted picnic baskets, including dishes; toilet cases; floss for dental purposes; fibreglass thread, other than for textile use; cookie [biscuit] cutters; pastry cutters; sprinklers; syringes for watering flowers and plants; cotton waste for cleaning; wool waste for cleaning; cleaning tow; cold packs for chilling food and beverages; chopsticks; cocktail stirrers; food steamers, non-electric; pepper pots; oven mitts; gloves for household purposes; car washing mitts; polishing gloves; gardening gloves; pestles for kitchen use; plates to prevent milk boiling over; dripping pans; trays for household purposes; trays of paper, for household purposes; lazy susans; heaters for feeding bottles, non-electric; candelabra [candlesticks]; trivets [table utensils]; coasters, not of paper or textile; grill supports; menu card holders; knife rests for the table; flat-iron stands; egg cups; abrasive pads for kitchen purposes; scouring pads; drinking troughs; serving ladles; powdered glass for decoration; pottery; pots; cooking pots, non-electric; painted glassware; tableware, other than knives, forks and spoons; porcelain ware; earthenware; crystal [glassware]; cosmetic utensils; trouser presses; tortilla presses, non-electric [kitchen utensils]; deodorizing apparatus for personal use; cruet sets for oil and vinegar; make-up removing appliances; spice sets; apparatus for wax-polishing, non-electric; bottle openers, electric and non-electric; glove stretchers; boot jacks; crumb trays; tie presses; potholders; clothes-pegs; glass stoppers; perfume vaporizers; powder puffs; dusting apparatus, non-electric; foam toe separators for use in pedicures; combs; electric combs; grills [cooking utensils]; sifters [household utensils]; drinking horns; shoe horns; candle drip rings; broom handles; salad bowls; place mats, not of paper or tex-

tile; sugar bowls; beaters, non-electric; egg separators, non-electric, for household purposes; services [dishes]; coffee services [tableware]; liqueur sets; tea services [tableware]; sieves [household utensils]; cinder sifters [household utensils]; tea strainers; siphon bottles for carbonated water; rolling pins, domestic; frying pans; steel wool for cleaning; currycombs; blenders, non-electric, for household purposes; scoops for household purposes; fruit presses, non-electric, for household purposes; straws for drinking; salt cellars; drinking vessels; vessels for making ices and ice cream, non electric; refrigerating bottles; bulb basters; cups of paper or plastic; glasses [receptacles]; drinking glasses; statues of porcelain, ceramic, earthenware, terracotta or glass; figurines of porcelain, ceramic, earthenware, terra-cotta or glass; glass for vehicle windows [semi-finished product]; plate glass [raw material]; opal glass; glass, unworked or semi-worked, except building glass; opaline glass; glass incorporating fine electrical conductors; enamelled glass, not for building; glass wool, other than for insulation; vitreous silica fibres, other than for textile use; fibreglass, other than for insulation or textile use; mortars for kitchen use; portable cool boxes, non-electric; soup tureens; drying racks for laundry; rotary washing lines; basins [receptacles]; table plates; disposable table plates; graters for kitchen use; insulating flasks; indoor terrariums [plant cultivation]; indoor terrariums [vivariums]; cloth for washing floors; polishing cloths; cloths for cleaning; dusting cloths [rags]; furniture dusters; wax-polishing appliances, non-electric, for shoes; water apparatus for cleaning teeth and gums; electric devices for attracting and killing insects; watering devices; utensils for household purposes; kitchen utensils; cooking utensils, non-electric; coffee filters, non-electric; flasks; hip flasks; drinking bottles for sports; moulds [kitchen utensils]; cake moulds; ice cube moulds; cookery moulds; deep fryers, non-electric; comb cases; bread bins; fly swatters; teapots; kettles, non-electric; cups; garlic presses [kitchen utensils]; ironing board covers, shaped; tea infusers; mops; mop wringers; cocktail shakers; cosmetic spatulas; corkscrews, electric and non-electric; animal bristles [brushware]; pig bristles for brush-making; brushes; dishwashing brushes; brushes for cleaning tanks and containers; lamp-glass brushes; horse brushes; scrubbing brushes; toothbrushes; toothbrushes, electric; basting brushes; carpet sweepers; shoe brushes; tar-brushes, long handled; toilet brushes; electric brushes, except parts of machines; eyebrow brushes; nail brushes; eyelash brushes; nutcrackers; ice tongs; salad tongs; sugar tongs; decanter tags; nest eggs, artificial; boxes for dispensing paper towels; dustbins; window-boxes; boxes of glass; paper plates; busts of porcelain, ceramic, earthenware, terra-cotta or glass; toilet paper dispensers; cages for household pets; boot stretchers of wood; shoe stretchers of wood; powder compacts, empty; wine-tasting pipettes; urns being planter pots for flowers and plants; urns being vases;

urns being planters for flowers and plants; decorative glass spheres; ski wax brushes.

35 – Arranging subscriptions to telecommunication services for others; import-export agency services; commercial information agency services; advertising agency services; cost price analysis; rental of advertising space; business auditing; financial auditing; business intermediary services relating to the matching of potential private investors with entrepreneurs needing funding; employment agency services; computerized file management; book-keeping; invoicing; demonstration of goods; transcription of communications [office functions]; opinion polling; market studies; business investigations; business research; marketing research; personnel recruitment; business management and organization consultancy; business organization consultancy; business management consultancy; personnel management consultancy; professional business consultancy; consultancy regarding advertising communication strategies; layout services for advertising purposes; marketing; targeted marketing; business management of performing artists; business management of sports people; writing of curriculum vitae for others; scriptwriting for advertising purposes; news clipping services; updating and maintenance of information in registries; updating and maintenance of data in computer databases; updating of advertising material; word processing; online retail services for downloadable and pre-recorded music and movies; online retail services for downloadable ring tones; online retail services for downloadable digital music; organization of exhibitions for commercial or advertising purposes; arranging newspaper subscriptions for others; organization of fashion shows for promotional purposes; organization of trade fairs for commercial or advertising purposes; shop window dressing; business appraisals; payroll preparation; data search in computer files for others; sponsorship search; administrative assistance in responding to calls for tenders; business management assistance; commercial or industrial management assistance; providing business information via a website; providing commercial and business contact information; provision of an online marketplace for buyers and sellers of goods and services; web indexing for commercial or advertising purposes; economic forecasting; sales promotion for others; promotion of goods and services through sponsorship of sports events; production of teleshopping programmes; production of advertising films; office machines and equipment rental; rental of advertising time on communication media; publicity material rental; rental of billboards [advertising boards]; rental of vending machines; rental of sales stands; rental of photocopying machines; publication of publicity texts; radio advertising; bill-posting; distribution of samples; dissemination of advertising matter; direct mail advertising; registration of written communications and data; editing of publicity texts; advertising; online advertising on a computer network; outdoor

advertising; advertising by mail order; television advertising; document reproduction; compilation of statistics; compilation of information into computer databases; business inquiries; systemization of information into computer databases; negotiation of business contracts for others; negotiation and conclusion of commercial transactions for third parties; compiling indexes of information for commercial or advertising purposes; tax preparation; drawing up of statements of accounts; telemarketing services; psychological testing for the selection of personnel; interim business management; outsourced administrative management for companies; business management of hotels; business management for freelance service providers; business project management services for construction projects; commercial administration of the licensing of the goods and services of others; business management of reimbursement programmes for others; administration of consumer loyalty programs; administration of frequent flyer programs; administrative processing of purchase orders; public relations; competitive intelligence services; modelling for advertising or sales promotion; typing; market intelligence services; appointment reminder services [office functions]; website traffic optimization; tax filing services; search engine optimization for sales promotion; gift registry services; price comparison services; procurement services for others [purchasing goods and services for other businesses]; shorthand; outsourcing services [business assistance]; telephone answering for unavailable subscribers; photocopying services; presentation of goods on communication media, for retail purposes; conducting of auctions; business advisory and information services; administrative services for the relocation of businesses; appointment scheduling services [office functions]; pay per click advertising; business secretarial services; promoting the goods of others.

- 
- (260) AM 2023 119846 A  
 (800) 1689431  
 (151) 2022 09 09  
 (891) 2022 09 09  
 (731) The Coffeeshop Company GmbH  
 Vienna Business Park – Turm A/34,  
 Wienerbergstraße 11, A-1100 Wien,  
 Austria  
 (540)





(591) Dark green, light green, white  
 (531) 01.15.05; 01.15.11; 05.07.27; 24.03.18;  
 24.03.19; 27.01.01; 29.01.13

(511)  
 30 – Coffee; coffee-based beverages; tea; iced tea; infusions, not medicinal; coffee substitutes; vegetal preparations for use as coffee substitutes; cocoa; cocoa-based beverages; cocoa products; chocolate; chocolate-based beverages; coffee beverages with milk; cocoa beverages with milk; chocolate beverages with milk; coffee flavourings; flavourings, other than essential oils, for beverages; essences for foodstuffs, except etheric essences and essential oils; syrups for flavouring coffee beverages.

43 – Café services, cafeteria services.

(260) AM 2023 119847 A  
 (800) 1689435  
 (151) 2022 09 09  
 (891) 2022 09 09  
 (731) The Coffeeshop Company GmbH  
 Vienna Business Park – Turm A/34,  
 Wienerbergstraße 11, A-1100 Wien,  
 Austria

(540)



(591) Black, green, white  
 (531) 01.15.05; 01.15.11; 05.07.24; 05.07.27;  
 27.05.10; 29.01.13

(511)  
 30 – Coffee; coffee-based beverages; tea; iced tea; infusions, not medicinal; coffee substitutes; vegetal preparations for use as coffee substitutes; cocoa; cocoa-based beverages; cocoa products; chocolate; chocolate-based beverages; coffee beverages with milk; cocoa beverages with milk; chocolate beverages with milk; coffee flavourings; flavourings, other than essential oils, for beverages; essences for foodstuffs, except etheric essences and essential oils; syrups for flavouring coffee beverages.

43 – Café services, cafeteria services.

(260) AM 2023 119848 A  
 (800) 1689437  
 (151) 2022 08 15  
 (891) 2022 08 15  
 (731) QUANZHOU UNICARE HYGIENE  
 PRODUCTS CO., LTD.  
 Xiayi Village, Heshi Town, Luojiang District,  
 Quanzhou City, 362013 Fujian Province, China

(540)



(591) Black, white  
 (531) 26.04.04; 26.04.09; 26.04.18; 26.04.24;  
 27.05.01; 27.05.02; 27.05.17; 27.05.24

(526) BABY

(511)  
 5 – Medicines for human purposes; disinfectants; powdered milk for babies; food for babies; dressings, medical; sanitary towels; diapers for incontinence; babies' diaper-pants; disinfectant wipes; diapers for pets.

(260) AM 2023 119854 A  
 (800) 1689563  
 (151) 2022 09 05  
 (891) 2022 09 05  
 (731) DERMASOF Inc.  
 1820 Whitney Mesa Dr., Suite 100, Henderson  
 NV 89074, USA

(540)

## DERMASOF

(591) Black, white  
 (511)  
 3 – Non-medicated skin care preparations, namely, gels, serums and moisturizers for skin conditioning, skin repair and wrinkles.

5 – Medicated skin preparations, namely, gels and serums for the treatment and control of scars, stretch marks, dehydrated skin, fine lines and wrinkles; topical silicone gel sheeting for the treatment and control of hypertrophic and keloid scars.

(260) AM 2023 119855 A  
 (800) 1689583  
 (151) 2022 09 22  
 (891) 2022 09 22  
 (731) Robert Bosch GmbH  
 Robert-Bosch-Platz 1, 70839 Gerlingen-  
 Schillerhöhe, Germany

(540)

## Jet Blade

(591) Black, white  
 (511)  
 12 – Windshield wipers.

(260) AM 2023 119856 A  
 (800) 1689584  
 (151) 2022 08 01  
 (891) 2022 08 01

(731) KERAKOLL S.P.A  
VIA DELL'ARTIGIANATO 9, I-41049  
SASSUOLO (MO), Italy

(540)

**H40**

(591) Black, white

(511)

1 – Adhesives and cements for laying floorings and coverings of ceramic tiles and natural stone, in particular adhesives and cements in premixed powder with a hydraulic binder base, mineral fillers and synthetic resins used for laying floorings and coverings of ceramic tiles and natural stone.

(260) AM 2023 119857 A

(800) 1689614

(151) 2022 08 09

(891) 2022 08 09

(731) SYSTEME ELECTRIC JOINT STOCK  
COMPANY

ul. Dvintsev, d.12, k.1, etazh 6, pom I kom 15,  
RU-127018 Moscow, Russian Federation

(540)



**Excelente**

(591) Black, white

(531) 26.01.03; 26.01.18; 26.01.24; 27.05.01

(511)

9 – Batteries, electric; accumulators, electric; uninterruptible electrical power supplies and reserve electrical power supply apparatus other than generators; uninterruptible AC/DC power supplies for electrical and electronic apparatus and machines, for alarm systems, for control and observation instruments, for communication systems; voltage stabilizers; voltage surge protectors; electrical charge controllers; electronic power controllers; voltage and power regulators; induction voltage regulators; light dimmers [regulators], electric; electrical signal attenuators; current converters; voltage regulators, automatic; inverters [electricity]; voltage surge suppressors; electrical power supplies, namely accumulators, electric, including electrical power supplies with automatic transfer switch.

(260) AM 2023 119858 A

(800) 1689666

(151) 2022 07 08

(891) 2022 07 08

(731) Romy Claus

Haagestraat 56, NL-2587 TK Den Haag,  
Netherlands

(540)

**HEAVENLY**

(591) Black, white

(511)

33 – Alcoholic beverages [except beers].

(260) AM 2023 119859 A

(800) 1689727

(151) 2022 04 05

(891) 2022 04 05

(731) Union des Associations Européennes de  
Football (UEFA)

Route de Genève 46, CH-1260 Nyon,  
Switzerland

(540)



(591) Black, white

(531) 26.11.02; 26.11.12; 27.01.12; 27.05.01;  
27.05.09; 27.05.10; 27.07.01; 27.07.11

(511)

1 – Sensitized films (unexposed); chemical products used in science and/or photography; tanning materials; artificial sweeteners; chemical products for industrial use; chemical products for use in industry and/or in manufacturing processes; synthetic materials for absorbing oil; detergent additives for motor fuel; chemical additives for fuels, lubricants and greases; adhesives for industrial use; antifreeze; brake fluids; clutch fluids; brazing products; degreasing products used in manufacturing processes; oil dispersants; fluids for hydraulic circuits; chemical preparations for welding; transmission fluids; transmission oils; coolants; chemical preparations for treating cooling systems; coolant preparations for cutting fluids; dehumidifying fluids; all the aforesaid goods for industrial use; chemical products for preserving foodstuffs.

3 – Cosmetic products; soaps; cosmetic preparations for baths; powders for the body, the face, for cosmetic use and for the bath; perfumes, eaux de Cologne; pre-shave and after-shave lotions; shaving creams; shampoos, conditioners; dentifrices, mouthwashes not for medical use; deodorants and antiperspirants for personal use; care creams, cosmetic creams; make-up removing creams for the face; make-up removing preparations; lip balms; lip gloss; lip balms [non-medicated]; lipstick; lip liner pencils; breath freshening products; tooth whitening creams; tooth whitening products (tapes or pastes); sun-tanning creams and lotions; hair lotions, hair sprays; toiletry creams; make-up products, eye shadows, face powders, cosmetic pencils; decorative transfers for cosmetic use; cotton sticks for cosmetic use; cotton balls for cosmetic use; shampoos for babies; baby oils [toiletries]; baby lotions [toiletries]; liquid soaps for babies' bodies; talcum



powder for babies; wet wipes for infants; baby wipes; cleaning, polishing, scouring and abrasive preparations for household use; laundry powder detergents; synthetic cleaning products; shoe waxes and creams; leather care products.

4 – Lubricants; engine oils and fuels, including gasoline, diesel oil, gases and bio-fuels; candles; waxes; industrial greases; natural gas; liquid gases; industrial oils; lubricating oils and greases; carburants; liquefied petroleum gas; non-chemical additives for fuel, lubricants and greases; dust absorbing, wetting and binding compositions; lighting fuel; lubricants, oils and greases, and lubricating preparations for industrial use; cutting oils for industrial use; milling oils; cutting fluids for milling.

6 – Aluminum foils; metal rings and chains for keys; figurines, festive ornaments of common metals other than tree ornaments, statues, statuettes, sculptures and trophies; fixed towel dispensers of metal; towel dispensers (of metal); printed metal disks for collection purposes (pogs); badges of metal for vehicles; registration plates of metal; all the aforesaid goods made of common metals or their alloys.

7 – Aerated beverage making machines; electric can openers; electric knives, electromechanical machines for producing food; mixing apparatus for household use; electric whisks for household use; electric fruit presses for household use; electric food processors; electric blenders for household use; dishwashers; washing machines for household use; spin driers; iron pressing machines; sewing machines; vacuum cleaners and accessories thereof included in this class; compressors, on compressors, electronic; components of vehicle motors and engines; automatic distribution machines; elevators; electric apparatus, equipment and instruments for the production of electricity; turbines; generators generating electricity from solar or wind power.

8 – Hand-operated hand tools and implements; electric and non-electric razors, including razor blades; cutlery, forks; spoons; apparatus for depilation; tweezers; curling tongs; screwdrivers; scissors for household use; scissors for stationery; non-electric flat irons; electric irons.

9 – Exposed films, slides, video game disks; software (recorded programs), including game software; computer databases and programs; recorded or downloaded sounds, images or data; videotapes, magnetic tapes, magnetic disks, DVDs, mini-disks, diskettes, optical disks, compact disks, CD-ROMs, videodisks, memory cards, USB flash drives, whether blank or prerecorded with music, sound or images (which may be animated cartoons); holograms; electronic publications provided by means of CD-ROMs, databases and the Internet; spectacles, sunglasses, diving and swimming goggles; cases, cords and chains for sunglasses and spectacles; binoculars; magnets and decora-

tive magnets; directional compasses; sound and image recording, transmitting and reproducing apparatus; satellite dishes; decoders, namely, electronic hardware and software which can convert, supply and transmit audio and video data; television sets; flat screens, liquid crystal display screens, high-definition screens and plasma screens; radios; home cinema systems; video recorders; CD players; DVD players; MP3 players; cassette players; mini-disk players; digital music players; loudspeakers; headphones, earphones; computers, including laptop computers and electronic tablets; karaoke systems; systems for editing sounds and for mixing sounds; systems for editing video images, and for mixing video images; apparatus for computer data processing; computer keyboards; computer screens; modems; accessories for computers included in this class; computer mice, mouse pads; navigation apparatus; PDAs (personal digital assistants); electronic pocket translators; dictating machines; electronic agendas; scanners; printers; photocopiers; facsimile machines; telephones; answering machines; video telephones; cellular telephones; accessories for cellular telephones included in this class, namely, cases for cellular telephones, apparatus for using hands-free cellular telephones, earphones and headsets for cellular telephones, keypads for cellular telephones, straps for cellular telephones, special cases for carrying cellular telephones, cameras and video cameras integrated in cellular telephones, and portable telephone covers; remote controls for television sets and video systems; teleconferencing systems; calculating machines; credit card readers; currency converting machines; automated teller machines; video cameras, portable video cameras with built-in videocassette recorders (camcorders); photographic equipment, photographic apparatus, cameras (cinematographic apparatus), projectors, flash lamps, special cases and cords for photographic apparatus and instruments, electric cells and batteries; screen saver programs for computers; magnetic, digital or analog recording media, recorded or not, for sounds or images; magnetic cards (encoded); memory cards; integrated circuit cards (smart cards); microchip or magnetic credit cards, microchip or magnetic telephone cards, microchip or magnetic cards for cash dispensers, microchip or magnetic cards for automated teller machines and money exchange machines, prepaid microchip or magnetic cards for cellular telephones, microchip or magnetic travel and show admission cards, microchip or magnetic check guarantee cards and microchip or magnetic debit cards; alarms; wind socks (for indicating wind direction); distance-measuring apparatus; apparatus for measuring and displaying speed; protective gloves; audio receivers, sound amplifiers; television tubes; cathode ray tubes; decoders, namely computer hardware and software which can convert, supply and transmit audio and video data; disk drives for computers; protected semiconductors; integrated circuits containing programs for processing audio, visual or computer data; rechar-

geable batteries; audio and video data processors and converters; data transmission cables; payment apparatus for electronic commerce; protective helmets for sports; magnetic identification bracelets; components of electronic instruments; fuel/air coefficient analyzers; remote control devices for locking cars; photovoltaic cells; video game cassettes; scientific, weighing, measuring, signaling, checking (supervision), emergency (life-saving) and teaching apparatus and instruments, included in this class; burglar alarms, anti-theft alarm apparatus, fire alarms; measuring apparatus and instruments; remote control equipment, remote controls; navigation apparatus, navigational instruments; telematic apparatus; telematic terminals; encoded electronic tickets; tickets in the form of magnetic cards; electronic apparatus for electricity distribution.

10 – Personal diagnostic apparatus for medical use; medical measurement apparatus and instruments; massage apparatus for personal use; apparatus for physical training for medical purposes; imaging apparatus for medical diagnosis; feeding bottles; babies' pacifiers (teats); condoms; support bandages; ice and thermal bags for medical use.

11 – Flashlights; flashlights for lighting; table lamps; decorative lamps; lamp shades; incandescent lamps; Light bulbs; lighting apparatus; bicycle lights; refrigerators, freezers; ovens; gas cookers, electric cookers; barbecues; cooking ranges, microwave ovens; electric coffee machines; electric kettles; electric bread toasters; electric deep fryers; electric laundry driers or electric hair driers; heating apparatus; air humidifiers; air conditioning apparatus, air purifying apparatus; water filters; drinking water fountains; fans for air conditioning for personal use; toilet seats; paper lanterns; headlights for vehicles; air-conditioning installations for vehicles; drying machines.

12 – Bicycles, motorcycles, motor cars, trucks, vans, utility vehicles, buses, camper vans, refrigerated vehicles; airplanes and boats; air balloons, dirigible balloons [airships]; vehicle accessories, namely sun visors, pneumatic tires, tire covers, luggage racks, ski racks, rims and hub caps for wheels; seat linings, vehicle covers, baby carriages, strollers, safety seats for infants and children (for vehicles); engines and motors for land vehicles; bull bars; headlamp covers; steering wheels for vehicles; trailers; motors, engines and distributors for land vehicles; alarm systems for vehicles, anti-theft devices for vehicles.

14 – Jewelry, necklaces; jewelry; watches; wristwatches, clocks; chronographs; pendulum clocks; medallions, pendants, brooches; bracelets; pins (jewelry); lapel pins (jewelry); tie clips and tie pins; cuff links; commemorative medals of precious metal; prize cups, commemorative plates, trophies, statues, sculptures, all of precious metal; decorative hat pins, key rings (trinkets or fobs), printed metal disks for collection

purposes (pogs), all made of precious metal; decorative key holders; collection coins; medals for clothing; cases for watches; badges of precious metal; alarm clocks; badges and pins (jewelry); leather bracelets; bracelets of plastic materials; ornamental key rings of plastic materials.

15 – Musical instruments; musical boxes; electric and electronic musical instruments.

16 – Coloring and drawing books; activity books; magazines; newspapers; books and journals, including those concerning sportsmen, sportswomen or sports events; bookmarks; printed teaching material; score sheets; event programs; albums for events; photograph albums; autograph books; printed timetables; pamphlets; collectible photographs of players; bumper stickers, stickers, albums, sticker albums; posters; photographs; tablecloths of paper; towels of paper; bags of paper; invitation cards; greeting cards; gift wrapping paper; coasters and place mats of paper; garbage bags of paper or of plastics; food wrapping paper; small bags for preserving foodstuffs; coffee filters of paper; labels (not of textile); hand towels of paper; wet hand-wipes of paper; toilet paper; tissues of paper for removing make-up; paper and cardboard boxes for pocket handkerchiefs; handkerchiefs of paper; stationery and instructional and teaching material (except apparatus); typewriter paper; copying paper; envelopes; notepads; folders for papers; tissue paper; writing books; paper sheets for note-taking; writing paper; binder paper; files; covering paper; luminous paper; adhesive paper for notes; paperweights; crêpe paper; tissue paper; badges or insignia of paper; flags of paper; pennants (flags) of paper; writing instruments; fountain pens; pencils; ballpoint pens; ballpoint pen and pencil sets; felt-tip pens (marking pens); fiber-tip pens and felt-tip pens; marking pens; writing ink, pen ink, stamp pads, rubber stamps; typewriters (electric or non-electric); lithograph prints, lithographic works of art; paintings (pictures), framed or unframed; paint boxes, paints and colored pencils; chalks; pencil ornaments [stationery]; printing blocks; address books; diaries (planners); personal organizers of paper; road maps; tickets, entry tickets; checks; comic books; calendars; postcards; advertising boards, banners and material included in this class; transfers (decalcomanias); sticking labels; office requisites (except furniture); correction fluids; rubber erasers; pencil sharpeners; stands for pens and pencils; paper clips; thumbtacks; drawing rulers; adhesive tapes for stationery purposes, adhesive tape dispensers; staples; stencils; document holders (stationery); paper clips; holders for notepads; bookends; stamps (seals); postage stamps, foreign postage stamps, collectible postage stamps, postage stamps for collectors; commemorative stamp sheets; credit cards, telephone cards, ATM cards, cards for traveling and for shows, check guarantee cards and debit cards, non-magnetic, and of paper or cardboard; baggage tags of paper; passport

cases; travelers' checks; holders for checkbooks; money clips of metal; letter trays.

18 – Leather and imitations of leather; leather straps; umbrellas, parasols; sports bags (other than those adapted for products they are designed to contain); leisure bags; travel bags, backpacks; school bags; bags for hanging on belts; handbags, leather bags; beach bags; garment bags; suitcases; document cases; identity card holders; belts for suitcases; briefcases (leather goods); cases for toiletry articles known as vanity cases (not fitted); toiletry bags; key cases (leather goods); business card cases; wallets; purses; whips; collars for animals; luggage tags of leather.

20 – Mirrors; goods made of plastic, namely statues, figurines, statuettes, trophies; souvenirs made of wood, wax, plaster or plastic; identification badges (not encoded), in particular ID badges, key cards (not encoded), all the aforementioned goods being made of plastic; cushions; cushions as accessories for cars; furniture, furnishings; Chairs for indoor and outdoor use; racks (furniture); racks or display stands for merchandise; fixed towel dispensers (not of metal); coat hangers, fans for personal use; inflatable or rigid advertising objects made of plastic; bookshelves; display stands or sales panels for points of sale (furniture); display racks for stationery supplies; advertising material of plastic; book shelves; printed plastic disks for collection purposes (pogs); plastic strips; frames; frames for photographs; number plates, not of metal; book rests; inflatable publicity objects; non-metal tool boxes; identification bracelets of plastic.

21 – Household or kitchen utensils and containers (non-electric); tankards, drinking vessels, beer mugs, tumblers, cups and glasses, plates and trays, trivets, decanters, coasters for glasses or bottles, saucers; teapots; kitchen gloves; household gloves; bottle openers; corkscrews; bottle cap removers; bottles; insulating flasks; non-electric containers for food and beverages; combs and hair brushes; toothbrushes; dental floss; statues, sculptures and trophies relating to football made of porcelain, terracotta or glass; decorative bottles for cosmetic use; rotary washing lines; money boxes not of metal; money boxes of metal; drinking flasks for travelers; souvenir plates; beer pitchers; beer pitchers, tankards, teapots, all of precious metal; waste paper baskets; baskets for domestic use.

24 – Sleeping bags; bed linen; sheets; eiderdowns [quilts]; bed covers; pillowcases; curtains, shower curtains; curtain fabrics; linen; hand towels, bath towels, dish towels; blankets; handkerchiefs made from textile materials, wall hangings made from textile materials, pavilions (flags); flags; pennants; table linen not of paper; labels of cloth; banners of plastic.

25 – Clothing; shoes and footwear; headwear; shirts; knitwear (clothing); pullovers; slipovers; tee-shirts; vests; jerseys; sleeveless jerseys, dresses; skirts; underwear, functional underwear, brassieres; swimsuits;

bathrobes; shorts; trousers; sweaters; stocking caps; caps; hats; long scarves; scarves, shawls; peaked caps; tracksuits; sweatshirts; jackets, sports jackets, stadium jackets (jumpers); blazers; waterproof clothing; coats; uniforms; neckties; wrist bands; headbands; gloves; aprons; bibs (not of paper); pajamas; play suits for infants and children; socks and stockings; tights and leggings, garters; belts; suspenders; sandals; sports shoes, namely, shoes for outdoor sports, basketball shoes, multi-sport shoes, cycling shoes, indoor sports shoes, track and field shoes, football shoes (indoor and outdoor), canvas shoes, tennis shoes, sneakers, sailing shoes, shoes for aerobics; hiking boots; flip-flops; sportswear, namely, fleece tops, jogging suits, sportswear of knitted fabric, casual sports pants, polo shirts, sweatshirts, tracksuit pants, football jerseys, rugby shirts, swimwear, sports jerseys, leotards, wristbands [clothing], ski suits, ski jackets, ski pants; wrist bands [clothing].

26 – Braids; tassels (haberdashery); ribbons; buttons; sewing needles; sewing boxes; badges for clothing (other than of precious metal); brooches (clothing accessories); decorative pins and needles not of precious metal; ornament pins for hats not of precious metal; hair nets, hair bands; barrettes (hair slides); hair pins; hair ribbons; pins not of precious metal; cords for clothing; bands for clothing (strips); competitors' numbers for advertising use; shoe ornaments not of precious metal; other decorative articles for the hair included in this class; badges of all kinds not of precious metal (including numbers and letters); plastic badges; badges and lapel pins (badges not of precious metal).

27 – Linoleum and other floor coverings; floor coverings, artificial turf; artificial turf for sports fields; beach mats; carpets, mats, rugs (also for cars).

28 – Games and toys; sports balls; play balloons; table-top games; tables for indoor football; dolls and plush toys; vehicles (toys); jigsaw puzzles; balloons; inflatable toys; play disks (pogs); playing cards; confetti; gymnastic and sporting articles; football equipment, namely balls for football, gloves, knee guards, elbow guards, shoulder guards, shin guards; football goals; sports bags and containers (adapted to objects) for carrying sports articles; party hats (toys); small electronic games designed for use with a television set; video game apparatus; game consoles, electronic games other than those adapted for use with television receivers only; steering wheels for video games and mats for video games (for dancing upon); hands made of rubber or foam (toys); entertainment robots; appliances for gymnastics; kites; roller skates; scooters; skateboards; coin-operated video games for game halls (arcade games); electronic games with liquid crystal display; joysticks for video games, manually or voice-activated joysticks for video games; lottery tickets; lottery cards, scratch tickets for lottery games; toys for household pets; computer game joysticks;

voice-activated or manually operated computer game joysticks.

29 – Meat; fish; poultry; game; meat extracts; canned fish and meat; cooked fruits and vegetables; canned fruits and vegetables; edible oils and fats; potato chips; French fries; prepared walnuts; jams; marmalades and jellies; milk; milk products (milk predominating), dairy products; cheeses; soy milk (milk substitute); consommés; broths.

30 – Coffee; tea; cocoa; chocolates; sugar; honey; coffee substitutes; flours; cereal preparations; cereals; bread; pastry; pastes (pastry); pasta; cakes; biscuits and cookies; crackers; candy; edible ices; confectionery; rice; dried cereal flakes; mustard; vinegar; sauces (condiments); spices; salt; honey, molasses, yeast, salt, mustard, vinegar or spices; salt and salt-based products for preserving foodstuffs; pizzas; fresh pizzas; pizza doughs; burgers inserted in brioche bread, namely hamburgers; hot dogs (sandwiches); sandwiches filled with meat; cheeseburgers (sandwiches); fish sandwiches; tea-based beverages; iced tea; instant cocoa.

32 – Non-alcoholic beverages; syrups and powders for making non-alcoholic beverages; mineral and aerated waters; energy drinks, isotonic drinks, hypertonic and hypotonic drinks; fruit and vegetable beverages; fruit and vegetable juices; sports beverages; frozen fruit drinks, frozen flavored drinks, non-carbonated and non-alcoholic; drinks enriched with added vitamins, not for medical use; beers; strong dark beers; lagers and ales; non-alcoholic or low-alcohol beers.

33 – Alcoholic beverages (with the exception of beers) including fruit-based alcoholic beverages; all the aforesaid goods with the exception of Weinbrand; cider; Weinbrand with the geographical indication "Deutscher Weinbrand".

34 – Matches; lighters for smokers; cigarette cases, ashtrays, smokers' articles; cigarettes; tobacco; ashtrays and cigarette cases of precious metal.

35 – Employment agencies; personnel recruitment; advertising services; services provided by an agency publishing advertising texts; advertising agency services; advertising agency services on a global computer network (the Internet) or via wireless electronic communication devices; dissemination of advertisements; rental of advertising space; rental of advertising time in film credits; television advertising, radio advertising; advertising in the form of animated cartoons; promotion agency services, promotion agency services for sports and public relations; promotion of football events; market study services; market research services; public opinion polling services; organization of exhibitions for commercial or advertising purposes; organization of advertising for trade fairs; compilation and systematization of data in data banks; data bank management services; establishing statistics; advertising for sports events in the field of football; retail

sale services for and bringing together of various goods for the benefit of others (excluding the transport thereof), namely clothing, footwear, headgear, sports articles, stationery, apparatus for recording, transmission and reproduction of sound and images, books, newspapers, magazines, publications, video games, toys, dolls, badges of all kinds, key rings, tickets, watches and jewelry, souvenir items in connection with football, bags, luggage, briefcases, umbrellas, flags and pennants, alcoholic and non-alcoholic beverages, confectionery, medical apparatus and instruments, vehicles and accessories for motor cars; retail sale services for solvents, paraffin, waxes, bitumen and petroleum; bringing together of the following goods for the benefit of others (excluding transport) to enable customers to conveniently view and purchase these goods in a store or on a global computer network (the Internet) or via wireless electronic communication devices, namely clothing, shoes, headgear, sports articles, stationery, apparatus for recording, transmission and reproduction of sound and images, books, newspapers, magazines, publications, video games, toys, dolls, badges of all kinds, key rings, tickets, watches and jewelry, souvenir items in connection with football, bags, luggage, briefcases, umbrellas, flags and pennants, alcoholic and non-alcoholic beverages, confectionery, medical apparatus and instruments, vehicles and accessories for motor cars; advertising and promotion services, information services with regard to advertising and promotion, commercial information agencies, all the aforesaid services provided on-line from a computer database or via a global computer network (the Internet) or via wireless electronic communication devices; design and compilation of advertisements for use as a web site on a global computer network (the Internet) or via wireless electronic communication devices; provision of space on web sites, for advertising of goods and services; auctioneering on a global computer network (the Internet) or via wireless electronic communication devices; collection of directories for publication on the Internet and on wireless electronic communication networks; business administration services for processing commercial services on a global computer network (Internet) or via wireless electronic communication devices; compilation, creation and management of databases, namely collection of domain names in a register; sales promotion, namely creation of preferential programs for customers; implementation of bonus programs for customers in stadiums by distributing encoded loyalty and membership cards which can contain the personal data of the user; development, launch and administration of loyalty programs, namely issuing loyalty cards to fans, containing personal information on the identity of the card holder; electronic commerce (e-commerce) services, namely provision of information on goods via telecommunication networks for advertising or sales purposes; compilation of data into a computer database, especially still or animated images; e-com-

merce services, namely online services for providing contracts for the purchase and sale of goods on behalf of others; promotion of sports events in the field of football; promotion of the goods and services of others, through contractual agreements, particularly partnership (sponsoring) and licensing agreements, providing them with increased notoriety and enhanced image derived from cultural and sporting events, particularly international events; compilation and recording of data and information on sporting performances; provision of personnel, particularly for selling beverages and foods; promotion of football events; retail sale of interactive educational and entertainment products, interactive compact disks, CD-ROMs and computer games; retail sale services, particularly on a global computer network, for interactive educational and entertainment products, interactive compact disks, CD-ROMs and computer games; presentation of computer programs for retail sale purposes; procurement services for others [purchasing goods and services for other businesses]; procurement services for others [purchasing goods and services for other businesses] for sports events or entertainment; promotion of the goods and services of others, through contractual agreements, particularly partnership (sponsoring) and licensing agreements, providing them with increased notoriety and/or enhanced image and/or affinity derived from cultural and sporting events, particularly international events; retail and wholesale services for motor vehicles, motor vehicle parts and motor vehicle accessories; retail and wholesale trading services on the Internet for motor vehicles, motor vehicle parts and motor vehicle accessories; compilation of data in computer data banks.

36 – Issuance and management of credit cards and travelers' checks; financial services; banking, credit and investment services; insurance services; lease-purchase financing; hire-purchase services; financial sponsorship of sports events; information services related to finance and insurance, provided from a computer database or the Internet or on all wireless electronic communication networks; home banking services; banking services on the Internet or on all wireless electronic communication networks; payment services, including services provided from a computer database or via the Internet or via mobile telephones; safe deposit services; issue of vouchers, namely issue of loyalty cards to fans, which contain personal data on the identity of the cardholder and are used for access control at sports stadiums; financing for the promotion of events in the field of football; financial payment services for electronic commerce, namely transfer of funds, all via electronic communication networks; financial sponsorship search for football competitions; financial payment services for electronic commerce in connection with the purchase of goods and services provided by others, all via electronic communication networks, and clearing and settlement of financial

transactions via electronic communication networks; issue of vouchers in the form of travel vouchers.

37 – Installation and maintenance of wireless electronic communication networks (hardware); computer connection installation services related to sports; installation and repair of sports grounds with natural or artificial turf; vehicle cleaning and washing; vehicle lubrication; repair, disassembly, maintenance and servicing of vehicles; vehicle breakdown assistance [repair]; installation and repair of burglar alarms; overhaul, lubrication, maintenance and repair of vehicles, engines and machinery; anti-rust treatment for vehicles; tire trim fitting and tire puncture repair; construction and maintenance of pipelines; extraction of gas and petroleum; construction of structures for the production of crude oil; installation of apparatus for the production of oil; installation of solar power systems; installation of wind power systems; installation of hydraulic power systems; mining extraction services; construction of electric power plants; adaptation and customization of mass-produced automobiles and engines thereof; tuning of motors and engines.

38 – Telecommunication services; communication by mobile telephones; communication by telex; communication via electronic computer terminals linked to telecommunication networks, data banks and the Internet or via wireless electronic communication devices; communication by telegraphs; communication by telephones; communications by facsimile; paging services; telephone or video conferencing services; television program broadcasting; broadcasting of cable television programs; radio program broadcasting; transmission of radio and television programs of sports and sports events; news and press agency services; other message transmission services; rental of telephones, facsimile machines and other telecommunication apparatus; transmission of commercial Internet pages online or via wireless electronic communication devices; services for transmitting and broadcasting television and radio programs provided via the Internet or via any wireless electronic communication network; electronic transmission of messages; simultaneous broadcasting of film recordings and sound and video recordings; provision of access to telematic servers and real-time chat forums; computer-aided transmission of messages and images; telecommunication via fiber-optic networks; provision of access to a global computer network or interactive communication technologies for access to private and commercial purchasing and ordering services; transmission of information and other data via websites and computers; transmission of information (including sites by telematic means) via telecommunication, computer programs and other data; transmission of information, computer programs and other data by telematic means; electronic mail services; provision of access via the Internet or on any wireless electronic communication network (telecommunication servi-

ces); providing connections for telecommunications with a global computer network (the Internet) or data banks; provision of access to websites offering digital music on the Internet by means of a global computer network or via wireless electronic communication devices; rental of access time to MP3 websites on the Internet, via a global computer network or via wireless electronic communication devices; rental of access time to a database server center (telecommunication services); rental of access time to a computer database (telecommunication services); transmission of digital music by telecommunications; online transmission of electronic publications; digital music transmission via the Internet or on any wireless electronic communication network; digital music transmission via MP3 Internet sites; simultaneous broadcasting and/or netcasting of film recordings and sound and video recordings (telecommunications); simultaneous broadcasting and/or netcasting of interactive educational and entertainment products, interactive compact disks, CD-ROMs, computer programs and computer games (telecommunications); providing access to blackboards (display and advertisement notice boards) a blog, and to discussion forums (chat rooms) in real time via a global computer network; rental and provision of access time to blackboards (boards for displaying information and advertisements) and to chat rooms in real time by means of a global computer network (communication services); telecommunication services dedicated to retail sale by means of interactive communications with customers; multimedia telecommunication; videotext and teletext transmission services; information transmission via communication satellite, microwave or by electronic, digital or analog means; transmission of digital information by cable, wire or fiber; transmission of information by mobile telephones, telephones, facsimile and telex; telecommunication services for receiving and exchanging information, messages, images and data; telecommunication services for setting up discussion groups on the Internet and on any wireless electronic communication network; provision of access to search engines on the Internet, provision of access to platforms on the Internet (also on the mobile Internet) in the form of customized online pages featuring information defined or specified by users, personal profiles, audio contents, video contents, photographic images, texts, graphic illustrations and data; provision of access to search engines for obtaining data and information on global networks.

39 – Services of a travel agency, namely, travel arrangement and reservation; ticket reservation and information services for travel; transport by airplane, railway, bus and truck; boat transport; boat travel services; tourist travel services; rental of vehicles and automobiles; rental of parking spaces; taxi services; boat transport services for goods; distribution of water, heat, gas or electricity; distribution of newspapers, magazines and books; postal services, mail delivery

and courier services; storage of merchandise; delivery of solvents, paraffins, waxes, bitumens and oil products, excluding liquid gas; distribution (delivery) of films and sound and image recordings; distribution (delivery) of interactive educational and entertainment products, interactive compact disks, CD-ROMs, computer programs and computer games; ticket distribution (transport); navigation services by global positioning system; advice relating to power and electricity distribution; transport services; packaging and storage of goods; towing, transport and taxi; car transport; rental of vehicles, especially automobiles; motor vehicle fleet tracking and monitoring services using electronic positioning and navigation devices; assistance services relating to energy and electricity distribution.

40 – Processing of cinematographic films; printing house services; enlargement of photographs, printing of photographs, photographic film development; rental of machines and equipment for developing, printing, enlarging and finishing photographs; waste disposal services; needlework; treatment of substances and materials; petroleum and gas treatment; transformation and refining of organic substances; production of energy; petroleum refining; refining services; advisory services relating to energy and electricity production.

41 – Education; training; entertainment; organization of lotteries, raffles and competitions; betting and gaming services in connection with sports; provision of entry tickets and information brochures on sports for VIPs, as well as guiding and gathering VIPs for sports or entertainment events, provision of online information in the field of sports or sports events from a computer database or the Internet; customer reception services (entertainment services) including provision of access tickets during sports or entertainment events; entertainment services relating to sporting events; entertainment services in the form of public gatherings during the retransmission of sports events; sporting and cultural activities; organization of sporting and cultural events and activities; amusement park services; sports club services [health and fitness training]; organization of sports competitions; organization of events in the field of football; sports camp services; providing sports facilities; rental of video and audiovisual installations; production, presentation, distribution and/or rental of film recordings and sound and video recordings; presentation, distribution and/or rental of interactive educational and entertainment products, interactive compact disks, CD-ROMs, and computer games; radio and television coverage of sporting events; production services for radio, television programs and video films; ticket reservation services and information services for sports or entertainment events; timing services relating to sports events; organization of beauty contests; interactive entertainment; on-line betting and gaming services on the Internet or on any wireless electronic communica-

tion network; information in the field of entertainment (including in the field of sports), provided on-line from a computer database or via the Internet or via any wireless electronic communication network; electronic game services transmitted via the Internet or on mobile telephones; editing of books; publication of books and electronic journals on-line; audio and video recording services; production of animated cartoons for the cinema, production of animated cartoons for television; rental of sound and image recordings for entertainment purposes; information in the field of education provided on-line from a computer database or via the Internet or any wireless electronic communication network; translation services; photography services; provision of entertainment infrastructure; ticket agencies in connection with sports events; entertainment information in the field of sports; provision of information in the field of sports events; publication of statistics; publication of statistics and information on sports performances; provision of entertainment infrastructure, namely VIP boxes and boxes inside and outside stadiums.

42 – Consultant services and advice in the design and development of computer hardware and software; data processing (programming); provision or rental of computer software; computer rental; compilation of websites in computer networks (particularly the Internet) or via wireless electronic communication devices; introduction of websites in computer networks (particularly the Internet) or via wireless electronic communication devices; provision of search engines for obtaining data and information on global networks; hosting services for Internet sites or wireless electronic communication sites; creation and maintenance of websites and of wireless electronic communication networks; networking and/or rental of computer programs; installation and maintenance of computer software; computer software development; application service provider [ASP], namely, hosting of third-party application software; development of software application solutions; cloud computing; design and development of operating software for access to a computer network in the cloud [cloud computing] as well as use thereof; providing non-downloadable software online to enable or facilitate the uploading, downloading, streaming, posting, displaying, blogging, linking, sharing or otherwise providing of multimedia content or electronic information on communication networks; providing temporary use of non-downloadable software applications for social networking, creation of a virtual community and transmission of audio content, video content, photographic images, texts, graphic illustrations and data; providing non-downloadable software via an online site whose technology enables online users to create personal profiles featuring social networking information and to transfer and share such information among multiple online sites; calibration; provision of Internet search engines; analysis, testing and monitoring (supervision) of oils, coolants,

greases and lubricants; analysis and diagnosis of degrees of wear, faults and breakdown on motors, engines and machines; advice relating to the aforesaid fields and provided on the basis of results from the aforesaid analysis and diagnosis; quality control services in connection with overhaul, lubrication, maintenance and repair of vehicles, motors, engines and machinery; programming of computer programs; design and development of computer programs; technical development of discussion forums on the Internet or on any wireless electronic communication network; testing services relating to prospecting in the oil and gas industry; prospecting to locate oil and gas; analyses services for exploitation of oil deposits; assistance services related to technology in the oil industry; analysis, advice, assistance and design services related to technology in the oil industry; advice on technology and services for the technical development, technical design and technical planning of photovoltaic facilities; advice on technology and services for the technical development, technical design and technical planning of wind power facilities; advisory services relating to electronic control devices for the monitoring of solar and/or wind-powered electric systems; design of energy and electricity systems; analysis of the energy requirements of others; development of energy and electricity management systems; project study and technical advice and development services, all in connection with the needs of others for electricity and energy; technical design services for electrical installations; technical developments relating to energy and electricity distribution; technical developments relating to energy and electricity production; electronic calibration services for motors, engines and transmissions.

43 – Providing food and drink, snack-bars; hospitality services, namely provision of food and drink; catering services; hotel services; providing accommodation and food and drink, booking hotels and temporary accommodation; hospitality services, namely provision of food and drink during sports or entertainment events.

44 – Medical and dental services, hospital services; doping control services; hairdressing and beauty salon services.

45 – Intellectual property licensing; management of copyright on films and videos and sound and image recordings as well as interactive compact disks, DVDs, mini-disks, CD-ROMs, computer software and computer games; granting licenses for televised program broadcasting (including football matches) on giant screens; granting of licenses for data banks; software licensing (legal services); registration of domain names (legal services); advice regarding intellectual property; security inspection services for third parties; clothing rental; granting of licenses for databases and computer files.

(260) AM 2023 119860 A

(800) 1689728

(151) 2022 05 03

(891) 2022 05 03

(731) PLANTIN

381 route d'Avignon, Usine la Rolande,  
BP2, F-84350 COURTHEZON, France

(540)

## FERTIPLANT

(591) Black, white

(511)

1 – Soluble fertilizers with trace elements.

(260) AM 2023 119861 A

(800) 1689731

(151) 2022 05 06

(891) 2022 05 06

(731) PSA AUTOMOBILES SA

2-10 boulevard de l'Europe, F-78300 POISSY,  
France

(540)

The logo for bproauto features the word 'bproauto' in a lowercase, sans-serif font. The 'b' is blue, 'pro' is orange, and 'auto' is blue. The letters are bold and modern.

(591) Blue (R: 32 G: 37 B: 59 C: 100 M: 87 Y: 45

K: 57) and yellow (R: 228 G: 168 B: 53 C:

0 M: 39 Y: 90 K: 0)

(531) 27.05.01; 27.05.09; 29.01.12

(511)

1 – Chemical products for use in industry, science, photography, agriculture, horticulture and forestry; soil fertilizers (natural and artificial); fire-extinguishing compositions; tempering preparations and chemical preparations for soldering; chemical substances for preserving foodstuffs; tanning materials; adhesive substances for industrial use; anti-freeze solution; fluids for hydraulic installations and apparatus.

2 – Paints, varnishes, lacquers; preservatives against rust and against deterioration of wood; anti-corrosive preparations; dyestuffs; mordants; Unprocessed natural resins; metal foils and powders for painters and decorators.

3 – Laundry preparations, bleaching preparations and other substances for laundry use; cleaning, polishing, degreasing and abrasive preparations; waxes for motor vehicles; pastes and liquid preparations for cleaning, polishing and protecting painted, varnished and polished metal surfaces; soaps; perfumery, essential oils, cosmetics, hair lotions; dentifrices.

4 – Industrial oils and greases (other than edible oils and fats and essential oils); lubricants; dust-binding compositions; fuels (including motor spirit) and lighting fuel; tapers, candles, nightlights and wicks for lighting.

7 – Machines and machine tools; connecting rods for internal combustion engines, motors and engines (except for land vehicles), couplings and transmission belts (except for land vehicles); agricultural implements other than hand-operated; incubators for eggs; hand-held electric tools and implements; bearings and crankshafts for automobile engines, jacks (machines); air filters and oil cleaners for internal combustion engines.

8 – Breast drills; cutlery, forks and spoons; side arms, other than firearms.

9 – Scientific, nautical, surveying, electric (including wireless), photographic, cinematographic, optical, weighing, measuring, signaling, checking (supervision), life-saving and teaching apparatus and instruments; fuel level indicators and oil level indicators for vehicles; radio receiving apparatus and parts and component parts thereof, storage batteries, insulated wires and cables, electric igniting devices for igniting at a distance and component parts thereof, switches, horns and electric alarms and parts and component parts thereof; cash registers, calculating machines; fire extinguishers.

11 – Installations for lighting, heating, steam generating, cooking, refrigerating, drying, ventilating, water distribution and sanitary installations; electric lamps, water heaters and components thereof, particularly heat exchangers, fans, blowers, distributors and manually operated regulators; electric fans.

12 – Vehicles, apparatus for locomotion by land, motor vehicles and structural parts thereof, namely, suspension shock absorbers for vehicles; shock absorbers (springs) for vehicles; motors and engines for land vehicles; gear boxes for land vehicles; vehicle chassis; vehicle bodies; transmission shafts for land vehicles; hydraulic circuits for vehicles; torque converters for land vehicles; clutches for land vehicles; axles; vehicle brakes; vehicle wheels; vehicle wheel rims; hub caps for wheels; hubs for vehicle wheels; tires; steering wheels for vehicles; vehicle seats; headrests for vehicle seats; security devices for vehicles such as safety belts and air bags; rearview mirrors; windshield wipers; torsion bars for vehicles; bumpers; protective molding rods for vehicles; deflectors for vehicles; spoilers for vehicles; windshields; retractable roofs for vehicles; windows for vehicles; caps for vehicle fuel tanks; luggage carriers for vehicles; electric cigarette lighters for land vehicles.

17 – Rubber, gutta-percha, gum, asbestos, mica being unprocessed or semi-processed and substitutes of all these materials; plastic materials and resins in extruded form used in manufacturing operations; packing, stopping and insulating materials; flexible pipes not of metal.

24 – Textiles and substitutes thereof; household linen; curtains of textile or plastic materials.



37 – Construction services; Vehicle maintenance and repair services; mining, oil and gas drilling.

40 – Treatment of materials; recycling of trash and waste; air purification and water treatment; printing services; food and beverage preservation.

(260) AM 2023 119862 A

(800) 1689741

(151) 2022 06 02

(891) 2022 06 02

(731) LA POSTE

9 rue du Colonel Pierre Avia, F-75015 PARIS,  
France

(540)



(591) Red: PANTONE 199C and gray: PANTONE 447C

(531) 26.13.25; 27.05.01; 29.01.12

(511)

9 – Software; mobile applications; downloadable applications; software and applications for mobile devices; computer platforms; software for tracing the storage, packing, shipping, delivery, transport and sale of goods and parcels; data storage apparatus; data storage media; data processing apparatus; data recovery devices; data management software; data processing software.

16 – Self-adhesive labels; labels of cardboard or paper; pre-franked parcels and envelopes; envelopes of paper, cardboard or plastic for packing and packaging; bags [envelopes, pouches] of paper, cardboard or plastic for packing and packaging; cardboard and paper for packing and packaging; plastic packaging; packing [cushioning, stuffing] materials of paper or cardboard; viscose sheets and reclaimed cellulose for packing; plastic bubble packs for wrapping or packaging; packaging boxes made of cardboard; packaging boxes of paper; cardboard boxes for delivering goods.

35 – Business advisory services relating to the delivery of parcels; computer file management services for monitoring of parcel delivery; commercial information agencies in the field of parcel delivery; marketing consultancy; database management services, address database archiving services; electronic data processing services; services for address tracing and data tracking (data processing); compilation of information in databases; services for wholesale, semi-wholesale and direct retail, online or mail order sale of foodstuffs, beverages, cosmetics, perfumery products, body hygiene products, gardening products, home construction and maintenance products; procurement service

for others (purchase of goods and services for other companies or individuals); product presentation on any communication media, for sales.

36 – Financial services; on-line financial transaction services; processing of payment transactions; electronic processing of credit card transactions via a global computer network; payment services for e-commerce; cargo insurance services.

39 – Rental of storage units; rental of containers; rental of insulated shipping containers for the transportation of products including ambient, chilled and frozen food and pharmaceutical products; transport services; transport of goods and parcels by air, rail, river, sea and road; freighting services; services for warehousing, packaging, packing, collection, loading, shipping, transport, unloading, warehousing and delivery of products, parcels, freight and goods, including food and pharmaceutical products, temperature-controlled or -managed or at ambient temperature; pick-up of letters, documents, parcels and goods; distribution of mail, newspapers, parcels and merchandise; Transport and warehousing of merchandise as logistics services; logistics services with respect to pick-up, transportation, storage and delivery; information and advice with respect to pick-up, transportation, storage and delivery; dispatch and delivery of mail order goods; courier services (mail and merchandise); tracking by electronic determination the location of goods and merchandise, in particular of packages and parcels; computerized tracing and tracking of packages in transit [information with respect to transport]; location and tracing of cargo in the context of transport; providing information with respect to the location of items in transit; franking of goods, in particular, packages and parcels; courier services; transport brokerage services; freight brokerage service; parcel delivery service in a network of merchants.

42 – Hosting of Internet sites and computer platforms; development of software for logistics, e-commerce portal and supply chain management; computer Platform as a Service [PaaS]; providing an online trading platform; development, updating and maintenance of database systems and software; conversion of data; monitoring of data, signals and information by data communication means, via the computer or telecommunication apparatus and instruments; services for encryption of documents and data with a view to ensuring the security thereof; scientific and technological research and development services in the field of the collection, transport and delivery of products, parcels and documents; quality control; environmental audits; information in the field of the environment.

(260) AM 2023 119863 A

(800) 1689759

(151) 2022 08 04

(891) 2022 08 04

(731) FEDERATION INTERNATIONALE DES  
PROFESSIONS IMMOBILIERES FIABCI  
TOUR CIT Montparnasse, 3 rue de l'Arrivée,  
PARIS, F-75015, France

(540)

**FIABCI**

(591) Black, white

(511)

35 – Business administration assistance, advice in business organization and administration, professional business consultancy, business research, business inquiries, commercial business appraisals, dissemination of advertising matter, compilation of data into a central file, computer file management, organization of exhibitions for commercial or advertising purposes, information search in computer files (for third parties), online advertising on a computer communication network, rental of advertising time by all means of communication.

36 – Real-estate affairs, real estate consultancy and information, real property brokerage, real property appraisal, real property management, wealth management; real estate transactions; real estate and/or real property management services online on telecommunication networks and computer communication networks; insurance particularly in the field of real estate.

41 – Training; organization of exhibitions for cultural or educational purposes, organizing and conducting conferences, congresses and symposiums; preparation and conducting of conferences and congresses; organizing and facilitating conferences and congresses.

(260) AM 2023 119874 A

(800) 1689990

(151) 2022 07 21

(891) 2022 07 21

(731) GUANGDONG OPPO MOBILE  
ELECOMMUNICATIONS CORP., LTD.  
No.18 Haibin Road, Wusha, Chang'an,  
Dongguan, Guangdong, China

(540)

**oppo**

(591) Black, white

(531) 27.05.01

(511)

9 – Smartwatch straps; interactive touch screen terminals; humanoid robots with artificial intelligence for use in scientific research; mobile phone software applications, downloadable; downloadable e-wallets; computer game software, downloadable; computer programs, downloadable; computer programs, recorded; tablet computers; downloadable emoticons for mobile phones; devices for the projection of virtual keyboards; smartwatches; smartglasses; electronic interacti-

ve whiteboards; electronic publications, downloadable; wearable computers; stands adapted for laptops; virtual reality game software; memory cards for video game machines; touch screen pens; computer screen saver software; facial recognition apparatus; holograms; chronographs [time recording apparatus]; facsimile machines; photocopiers [photographic, electrostatic, thermic]; scales; measures; light-emitting electronic pointers; flashing lights [luminous signals]; optical communications instruments; global positioning system [gps] apparatus; intercommunication apparatus; navigational instruments; cell phones; holders adapted for mobile telephones and smartphones; cell phone straps; selfie sticks used as smartphone accessories; smartphones; protective films adapted for smartphones; cases for smartphones; covers for smartphones; navigational apparatus for automobiles; wearable activity trackers; network communication equipment; modems; telecommunication apparatus in the form of jewellery; dvd players; portable media players; headphones; virtual reality headsets; electronic devices for learning; security surveillance robots; speech synthesizer with audio books; cabinets for loudspeakers; camcorders; wireless headsets; wireless headsets for smartphones; set-top boxes; television apparatus; earphones for cellular telephones; wearable video display monitors; earphones; ear pads for headphones; headsets for virtual reality games; car video recorders; microphones; transparency projection apparatus; enlarging apparatus [photography]; speed measuring apparatus [photography]; cameras [photography]; selfie sticks [hand-held monopods]; selfie lenses; surveying apparatus and instruments; connected bracelets [measuring instruments]; optical apparatus and instruments; telescopes; usb cables; materials for electricity mains [wires, cables]; telephone wires; sensors; low-voltage power supplies; optical fibres [light conducting filaments]; semi-conductors; semiconductor devices; printed circuits; connections, electric; electronic chips; electronic key fobs being remote control apparatus; converters for electric plugs; electrical adapters; resistances, electric; chips [integrated circuits]; video screens; touch screens; remote control apparatus; integrated circuits; heat regulating apparatus; fire extinguishing apparatus; protection devices for personal use against accidents; protective goggles; theft prevention installations, electric; 3d spectacles; sunglasses; eyeglasses; charging appliances for rechargeable equipment; wireless chargers for smartphone; batteries, electric; battery chargers; portable power supply in the nature of rechargeable batteries; batteries, electric, for vehicles; portable remote control car arresters; electrified fences; notebook computers; computers; multimedia projectors; digital projectors; smart speakers; computer monitors; tv monitors; remote controls for household purposes; remote controls for televisions; digital cameras; webcams; video monitors; locks, electric; biometric fingerprint door locks; digital door locks; electromagnetic locks;

plugs, sockets and other contacts (electric connections); switches, electric; electric control apparatus; computer keyboards; protective cases for tablet computers; protective films adapted for tablet computer screens; protective films adapted for computer screens; covers for tablet computers; electric control panels; electric door bells; smoke detectors; printers; mouse [computer peripheral]; usb flash drives; internal cooling fans for computers; pedometers; selfie ring lights for smartphones; projection screens; speed checking apparatus for vehicles; thermometers, not for medical purposes; magnifying glasses [optics]; electric plugs; time switches, automatic; electric sockets; protective masks, not for medical purposes; dust masks incorporating air purification.

(260) AM 2023 119875 A

(800) 1690010

(151) 2022 08 15

(891) 2022 08 15

(731) Montres Tudor SA

Rue François-Dussaud 3, CH-1211 Genève 26,  
Switzerland

(540)

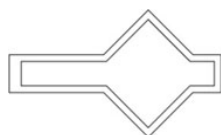

(591) Black, white

(531) 26.05.02

(511)

14 – Timepieces, namely, watches, wristwatches, component parts of timepieces and accessories for timepieces not included in other classes, clocks and other chronometric instruments, chronometers, chronographs (timepieces), dials (timepieces), boxes and cases for timepieces and jewelry, watch movements and their parts; jewelry; precious stones and semi-precious stones; precious metals and alloys thereof; key rings.

(260) AM 2023 119938 A

(800) 1690618

(151) 2022 06 21

(891) 2022 06 21

(731) TECHIIA HOLDING LIMITED

Vasili Michailidi, 9, CY-3026 Limassol, Cyprus

(540)

(591) Black, white

(531) 26.11.09; 27.05.01

(511)

19 – Building and construction materials, not of metal; rigid pipes, not of metal, for building; asphalt, pitch, tar and bitumen; buildings, transportable, not of

metal; monuments, not of metal; asbestos mortar; asbestos cement; aquaria [structures]; alabaster; arbours [structures], not of metal; reinforcing materials, not of metal, for building; asphalt; beacons, not of metal, non-luminous; balustrades, not of metal; huts; crash barriers, not of metal, for roads; swimming pools [structures], not of metal; concrete; concrete building elements; bitumen; bituminous products for building; bituminous coatings for roofing; bitumen paper for building; plastic landscape edgings; armoured doors, not of metal; armour-plating, not of metal; beams, not of metal; girders, not of metal; building stone; building paper; buildings, not of metal; buildings, transportable, not of metal; building materials, not of metal; construction materials, not of metal; rubble; bird baths [structures], not of metal; lime; limestone; calcareous stone; calcareous marl; works of stonemasonry; agglomerated bagasses of cane [building material]; windows, not of metal; shutters, not of metal; vinyl siding; stained-glass windows; tanks of masonry; refractory construction materials, not of metal; fireproof cement coatings; water-pipes, not of metal; roof gutters, not of metal; gutter pipes, not of metal; aviaries [structures], not of metal; gates, not of metal; street gutters, not of metal; binding material for road repair; binding agents for making briquettes; geotextiles; gypsum [building material]; fireclay; grog [fired refractory material]; potters' clay; earth for bricks; clay; gravel; aquarium gravel; granite; latticework, not of metal; trellises, not of metal; hips for roofing; roof coverings, not of metal; accordion doors, not of metal; doors, not of metal; swing doors, not of metal; cask wood; wood for making household utensils; wood, semi-worked; wood veneers; wooden floor boards; wood panelling; chimney cowls, not of metal; chimneys, not of metal; chimney shafts, not of metal; lengthening pieces, not of metal, for chimneys; floating floor boards, not of metal; furrings of wood; drain pipes, not of metal; jalousies, not of metal; pantiles, not of metal; railway sleepers, not of metal; outdoor blinds, not of metal and not of textile; prefabricated houses [kits], not of metal; road signs, non-luminous and non-mechanical, not of metal; non-luminous and non-mechanical signs, not of metal; cabanas, not of metal; paint spraying booths, not of metal; soundproof booths, transportable, not of metal; telephone booths, not of metal; stone; coal tar; framework, not of metal, for building; horticultural frames, not of metal; cold frames, not of metal; greenhouse frames, not of metal; cornices, not of metal; building cardboard; wood pulp board for building; quartz; sandstone pipes; caissons for construction work under water; fair huts; water-pipe valves, not of metal or plastic; drain traps [valves], not of metal or plastic; clinker ballast; mooring bollards, not of metal; skating rinks [structures], not of metal; chimney pots, not of metal; pillars, not of metal, for building; bicycle parking installations, not of metal; agglomerated cork for building; raw chalk; silica [quartz]; manhole covers, not of metal; rock

crystal; brackets, not of metal, for building; xylolith; chicken-houses, not of metal; angle irons, not of metal; foundry moulds, not of metal; building timber; manufactured timber; sawn timber; magnesia cement; macadam; marble; materials for making and coating roads; linings, not of metal, for building; wall linings, not of metal, for building; cladding, not of metal, for building; wall claddings, not of metal, for building; road coating materials; memorial plaques, not of metal; mosaics for building; tombs, not of metal; gravestones; tombs [monuments], not of metal; grave slabs, not of metal; tombstone stelae, not of metal; flashing, not of metal, for building; roof flashing, not of metal; penstock pipes, not of metal; duckboards, not of metal; wainscotting, not of metal; tomb or grave enclosures, not of metal; fences, not of metal; olivine for building; shuttering, not of metal, for concrete; rubber bearings for seismic isolation of buildings; reeds for building; monuments, not of metal; acoustic panels, not of metal; building panels, not of metal; door panels, not of metal; signalling panels, non-luminous and non-mechanical, not of metal; parquet flooring; parquet floor boards; branching pipes, not of metal; partitions, not of metal; lintels, not of metal; scantlings [carpentry]; porches [structures], not of metal; floors, not of metal; props, not of metal; aquarium sand; play sand; silver sand; sand, except foundry sand; sandstone for building; floating docks, not of metal, for mooring boats; mouldings, not of metal, for building; planks of wood for building; mouldings, not of metal, for cornices; rocket launching platforms, not of metal; platforms, prefabricated, not of metal; slabs, not of metal, for building; paving slabs, not of metal; luminous paving blocks; road marking sheets and strips of synthetic material; tiles, not of metal, for building; floor tiles, not of metal; tile floorings, not of metal; felt for building; busts of stone, concrete or marble; stringers [parts of staircases], not of metal; coatings [building materials]; asphalt paving; wood paving; paving blocks, not of metal; roofing tiles, not of metal; roofing shingles; roofing slates; roofing, not of metal; roofing, not of metal, incorporating photovoltaic cells; fireplace mantles, not of metal; joists, not of metal; sills, not of metal; porphyry [stone]; letter boxes of masonry; tarred strips for building; tar; window frames, not of metal; door frames, not of metal; door casings, not of metal; scaffolding, not of metal; mortar for building; pigsties, not of metal; silos, not of metal; perches; laths, not of metal; insect screens, not of metal; burial vaults, not of metal; alabaster glass; safety glass; building glass; window glass for building; window glass, other than vehicle window glass; glass granules for road marking; enamelled glass, for building; insulating glass for building; plate glass [windows] for building; slate; slate powder; pitch; statues of stone, concrete or marble; ceilings, not of metal; stables, not of metal; wall tiles, not of metal; posts, not of metal, for power lines; poles, not of metal, for power lines; posts, not of metal; case-

ment windows, not of metal; folding doors, not of metal; staircases, not of metal; stair-treads [steps], not of metal; tombstone plaques, not of metal; works of art of stone, concrete or marble; telegraph posts, not of metal; greenhouses, transportable, not of metal; terra-cotta [building material]; diving boards, not of metal; ducts, not of metal, for ventilating and air-conditioning installations; rigid pipes, not of metal, for building; advertisement columns, not of metal; turnstiles, not of metal; tufa; plywood; veneer wood; figurines of stone, concrete or marble; flagpoles [structures], not of metal; mouldable wood; bricks; firebricks; refractory bricks; cement for blast furnaces; cement for furnaces; cement; cement slabs; cement posts; palings, not of metal; schists; slag [building material]; slag stone; clinker stone; pilings, not of metal; plaster; artificial stone; masts [poles], not of metal.

37 – Construction services; installation and repair services; mining extraction, drilling of wells for mining petroleum and gas; asphaltting; tire balancing; road paving; shipbuilding; pier breakwater building; building of fair stalls and shops; drilling of deep oil or gas wells; drilling of wells; rebuilding engines that have been worn or partially destroyed; rebuilding machines that have been worn or partially destroyed; retreading of tires; installation of doors and windows; custom installation of exterior, interior and mechanical parts of vehicles [tuning]; elevator installation and repair; lift installation and repair; electric appliance installation and repair; irrigation devices installation and repair; heating equipment installation and repair; burglar alarm installation and repair; furnace installation and repair; fire alarm installation and repair; installation and repair of air-conditioning apparatus; telephone installation and repair; freezing equipment installation and repair; kitchen equipment installation; scaffolding; installation and repair of flood protection equipment; installation, maintenance and repair of computer hardware; machinery installation, maintenance and repair; office machines and equipment installation, maintenance and repair; vulcanization of tires [repair]; building sealing; damp-proofing [building]; knife sharpening; disinfecting; sanitizing of upholstery; disinfecting of surgical instruments; deodorizing of upholstery; mining extraction; leather care, cleaning and repair; fur care, cleaning and repair; providing information relating to repairs; providing construction information; vehicle battery charging; charging of electric vehicles; vehicle greasing; demolition of buildings; vermin exterminating, other than for agriculture, aquaculture, horticulture and forestry; building insulating; riveting; construction consultancy; varnishing; vehicle washing; masonry; bricklaying; building construction supervision; tuning of musical instruments; upholstery; vehicle service stations [refuelling and maintenance]; irradiation of medical instruments; chimney sweeping; refilling of toner cartridges; refilling of ink cartridges; underwater repair; underwater construction; re-tinning; roofing services;

vehicle polishing; renovation of clothing; services of electricians; pest control services, other than for agriculture, aquaculture, horticulture and forestry; hydraulic fracturing services; assembly services relating to the installation of furniture; vehicle breakdown repair services; quarrying services; housekeeping services [cleaning services]; hardscaping services; artificial snow-making services; cell phone battery charging services; joinery services [repair of woodwork]; washing; washing of linen; laundering; linen ironing; pressing of clothing; street cleaning; snow removal; installation of utilities in construction sites; rental of construction equipment; rental of bulldozers; rental of road sweeping machines; rental of drainage pumps; rental of excavators; rental of portable power chargers; rental of battery chargers; rental of cranes [construction equipment]; rental of dishwashing machines; rental of laundry washing machines; rental of dish drying machines; rental of cleaning machines; laying of cable; rustproofing; anti-rust treatment for vehicles; shoe repair; clock and watch repair; repair of power lines; film projector repair and maintenance; pump repair; upholstery repair; clothing repair; umbrella repair; parasol repair; repair of security locks; photographic apparatus repair; furniture restoration; restoration of musical instruments; restoration of works of art; painting, interior and exterior; excavation of ruins, not for research; factory construction; warehouse construction and repair; pipeline construction and maintenance; harbour construction; construction; sterilization of medical instruments; dry cleaning; carpentry services; swimming-pool maintenance; strong-room maintenance and repair; airplane maintenance and repair; motor vehicle maintenance and repair; burner maintenance and repair; safe maintenance and repair; furniture maintenance; maintenance of elevators [lifts] via remote; vehicle maintenance; plumbing; tuning of bodies for automobiles; laying of artificial turf; interference suppression in electrical apparatus; painting or repair of signs; cleaning of buildings [interior]; cleaning of buildings [exterior surface]; window cleaning; boiler cleaning and repair; cleaning of clothing; diaper cleaning; pumicing; sanding; vehicle cleaning; paper hanging; plastering.

40 – Material treatment; recycling of waste and trash; air purification and water treating; printing services; food and drink preservation; custom 3D printing for others; abrasion; applying finishes to textiles; fulling of cloth; fabric bleaching; wine making for others; key cutting; custom fashioning of fur; custom manufacture of boats; custom manufacture of yachts; pottery firing; custom manufacturing of bread; production of energy; skin dressing; vulcanization [material treatment]; galvanization; electroplating; engraving; decontamination of hazardous materials; air deodorizing; crushing of concrete; printing; pattern printing; photographic printing; tanning; textile dyeing; cloth dyeing; fur dyeing; providing information relating to material treatment; slaughtering of animals; freezing

of foods; custom assembly of aircraft; custom manufacturing of aircraft; boilermaking; destruction of waste and trash; gilding; gold plating; timber felling and processing; cadmium plating; permanent-press treatment of fabrics; blacksmithing; food and drink preservation; consultancy in the field of wine making; food smoking; custom tailoring; laser scribing; laminating; saddlery working; metal casting; lithographic printing; fur glossing; tin plating; flour milling; textile fireproofing; fabric waterproofing; magnetization; nickel plating; framing of works of art; leather working; waste treatment [transformation]; wool treating; water treating; woodworking; processing of cinematographic films; metal treating; processing of oil; crease-resistant treatment for clothing; stripping finishes; paper treating; textile treating; cloth treating; fur conditioning; cloth edging; irradiation of food; air freshening; paper finishing; offset printing; air purification; bookbinding; pasteurizing of food and beverages; soldering; recycling of waste and trash; upcycling [waste recycling]; clothing alteration; beer brewing for others; sawing of materials; fruit crushing; metal plating; burnishing by abrasion; cloth pre-shrinking; distillation services; colour separation services; cryopreservation services; sandblasting services; refining services; cheese processing services in the nature of ripening, maturing and aging of cheese; taxidermy; photocomposing services; welding services; services of a dental technician; dyeing services; joinery services [custom manufacturing of woodwork]; rental of batteries; rental of boilers; knitting machine rental; rental of electricity generators; rental of air-conditioning apparatus; rental of space heating apparatus; rental of industrial robots for use in manufacturing; textile mothproofing; fur mothproofing; photographic film development; cloth cutting; fur satining; custom assembling of materials for others; glass-blowing; warping [looms]; sorting of waste and recyclable material [transformation]; incineration of waste and trash; silver plating; planing of materials; quilting; metal tempering; window tinting treatment being surface coating; tinting of car windows; shoe staining; leather staining; photogravure; millworking; chromium plating; dressmaking; grinding; optical glass grinding; silkscreen printing.

42 – Scientific and technological services, research and development relating thereto; industrial analysis, industrial research and design services; quality control and authentication services; design and development of computer hardware and software; water analysis; analysis for oil-field exploitation; computer system analysis; handwriting analysis [graphology]; architectural consultancy; architectural services; construction drafting; geological test drilling; material testing; oil-well testing; recovery of computer data; authenticating works of art; geological surveys; geological prospecting; graphic arts design; graphic design of promotional materials; business card design; interior design; computer graphic design for video projection

mapping; design of costumes; packaging design; off-site data backup; research in the field of excavation; bacteriological research; biological research; geological research; cosmetic research; medical research; technological research; chemical research; geotechnical investigations; research and development of new products for others; mechanical research; research in the field of building construction; research in the field of environmental protection; research in the field of welding; research in the field of telecommunications technology; research in the field of artificial intelligence technology; research in the field of physics; duplication of computer programs; oil-field surveys; electronic data storage; electronic monitoring of personally identifying information to detect identity theft via the Internet; electronic monitoring of credit card activity to detect fraud via the Internet; energy auditing; providing virtual computer systems through cloud computing; providing geographic information; providing information relating to computer technology and programming via a website; providing scientific information, advice and consultancy relating to carbon offsetting; providing online geographic maps, not downloadable; providing search engines for the Internet; cloud seeding; engineering; installation of computer software; information technology services provided on an outsourcing basis; calibration [measuring]; cartography services; quantum computing; clinical trials; computer programming; conversion of data or documents from physical to electronic media; conversion of computer programs and data, other than physical conversion; computer technology consultancy; telecommunication network security consultancy; telecommunications technology consultancy; consultancy in the field of energy-saving; Internet security consultancy; data security consultancy; information technology [IT] consultancy; computer software consultancy; computer security consultancy; consultancy in the design and development of computer hardware; website design consultancy; artificial intelligence consultancy; quality control; culturing of cells for scientific research purposes; cryptocurrency mining; cryptomining; meteorological information; dress designing; monitoring of computer systems for detecting unauthorized access or data breach; monitoring of computer systems to detect breakdowns; monitoring of computer systems by remote access; writing of computer code; scientific research; surveying; scientific and technological research in the field of natural disasters; scientific and technological research relating to patent mapping; maintenance of computer software; updating of computer software; digitization of documents [scanning]; quality evaluation of wool; vehicle roadworthiness testing; underwater exploration; urban planning; platform as a service [PaaS]; user authentication services using blockchain technology; user authentication services using technology for e-commerce transactions; user authentication services using single sign-on technology for online software

applications; logo design services; exploration services in the field of the oil, gas and mining industries; computer programming services for data processing; software engineering services for data processing; hosting computer websites; data encryption services; cartographic or thermographic measurement services by drone; scientific laboratory services; technological consulting services for digital transformation; chemistry services; computer virus protection services; conducting technical project studies; weather forecasting; software as a service [SaaS]; design of interior decor; design of computer-simulated models; computer system design; computer software design; golf course design; design of prototypes; rental of web servers; computer rental; rental of computer software; rental of meters for the recording of energy consumption; rental of data centre facilities; industrial design; unlocking of mobile phones; oil prospecting; development of video and computer games; development of computer platforms; software development in the framework of software publishing; technical writing; digital forensic investigations in the field of computer crimes; creating and maintaining websites for others; creating and designing website-based indexes of information for others [information technology services]; technological consultancy; land surveying; chemical analysis; server hosting; styling [industrial design].

---

(260) AM 2023 119939 A

(800) 1690629

(151) 2022 08 18

(891) 2022 08 18

(731) VIENNA INSURANCE GROUP AG

Wiener Versicherung Gruppe

Schottenring 30, A-1010 Wien, Austria

(540)



(591) Black, red, yellow, green, white

(531) 02.09.01; 02.09.14; 05.05.20; 26.11.08;  
27.05.10; 27.05.11; 29.01.15

(511)

36 – Insurance; financial affairs; monetary affairs; real estate affairs.

---

(260) AM 2023 119940 A

(800) 1690644

(151) 2022 09 08

(891) 2022 09 08

(731) Samudra Pasifik Orman Ürünleri Dış Ticaret

Ve Sanayi Limited Şirketi

Y.Dudullu Mh Göztepe Cd Kuriş

SK 5B Ümraniye, İstanbul, Türkiye



(540)

**Coco Firex**

(591) Black, white

(531) 27.05.01

(511)

4 – Industrial oils and greases; cutting fluids; dust absorbing, wetting and binding compositions; solid fuels: coal, firewood; liquid and gas fuels; petrol, diesel oil, liquified petroleum gas, natural gas, fuel oil and their non-chemical additives; candles; wicks; semi-finished wax; wax and paraffin for lighting purposes.

(260) AM 2023 119972 A

(800) 1691537

(151) 2022 09 13

(891) 2022 09 13

(731) Eau de Vie de Vie

115 rue Raymond Losserand, F-75014 Paris,  
France

(540)

**VK NAPOLEON**

(591) Black, white

(511)

33 – Alcoholic beverages (with the exception of beers).

(260) AM 2023 120054 A

(800) 1691578

(151) 2022 06 23

(891) 2022 06 23

(731) Schlemmer, Waldemar

Baumgartenweg 9, CH-8854 Galgenen,  
Switzerland

(540)

**KAIF**

(591) Black, white

(511)

9 – Currency recognition machines; downloadable cryptographic keys for receiving and spending cryptocurrency; utility, security and cryptography software; downloadable cryptographic keys for receiving and spending crypto assets; downloadable computer software for managing cryptocurrency transactions using blockchain technology; downloadable computer software for blockchain technology; computer application software for blockchain-based platforms, namely, software platforms for distributed applications and software using a consensus engine with blockchain technology to secure data with cryptographic information; downloadable blockchain computer software platform.

36 – Exchange brokerage services; currency transfer services; virtual currency services; financial exchange of virtual currency; virtual currency exchange; currency trading and exchange services; currency trading; money exchange agency services; virtual currency

transfer services; trading in currencies; provision of financial protection against foreign exchange risks; electronic transfer of virtual currencies; financial transactions relating to currency swaps; financial services in relation to digital currencies; financial information services relating to currencies; financial exchange of crypto assets; electronic transfer of crypto assets; financial transactions via blockchain; electronic funds transfer provided via blockchain technology, financial services related to cryptocurrencies; financial services for the issuance of a digital currency or digital token for use by members of an online community via a global computer network; processing of electronic payments; electronic processing of payments; electronic processing of payments via a global computer network; financial management services relating to digital tokens in the nature of virtual currency financial management services; financial services for the issuance of virtual currency for use by members of an online community via a global computer network.

42 – Cryptocurrency mining; certification of data via blockchain; data storage via blockchain; user authentication services using blockchain technology; blockchain as a service [baas]; design, development and implementation of blockchain software; platform as a service [paas] with software platforms for blockchains; software as a service [saas] with software platforms for blockchains.

(260) AM 2023 120055 A

(800) 1691581

(151) 2022 06 28

(891) 2022 06 28

(731) profine GmbH

Mülheimer Str. 26, 53840 Troisdorf, Germany

(540)



(591) Blue (Pantone 285C-654C), orange (Pantone 1495C-115C), yellow (Pantone 137C-120C)

(531) 26.01.06; 26.01.24; 26.11.02; 26.11.06;  
26.11.12; 26.15.25; 27.05.01; 29.01.12

(511)

6 – Building materials made of metal, especially extruded aluminium profiles for windows and doors; windows, doors, frames and prefabricated components made of metal; window sills and roller shutters made of metal; jalousies and blinds made of metallic materials for outside and inside; metal fittings for windows and doors; accessories made of metal for windows and doors, namely, profiles for reinforcement, connecting and installation made of metal, also used for building purposes, diecasting parts made of metal for reinforcement, connecting and installation

of windows and doors; window and door fittings, of metal.

17 – Profiles made of plastic products as semi-finished products for the production of windows and doors; extruded plastics as semi-finished products in the form of foils, plastics sheets (non-textile), rods and blocks.

19 – Windows and doors made of plastic products for building and construction; profiles made of plastic products for the production of windows and doors; roller shutters, blinds and French shutters made of non-metallic materials (except of textile materials) for outside and inside; cases for roller shutters made of plastic products for building and construction; accessories for windows and doors, namely, profiles for reinforcement, connecting and installation made of plastic, also used for building purposes; diecasting parts made of plastic for reinforcement, connecting and installation of windows and doors; plastic sheets for building purposes.

(260) AM 2023 120082 A  
 (800) 1692117  
 (151) 2022 08 08  
 (891) 2022 08 08  
 (731) ZHEJIANG FONHO AUTOMOTIVE CO., LTD.  
 YONG'AN INDUSTRY PARK, XIANJU TOWN, TAIZHOU CITY, ZHEJIANG PROVINCE, China

(540)

The logo for UNITRUCK features a stylized flame or drop shape above the word "UNITRUCK" in a bold, sans-serif font.

(591) Black, white  
 (531) 01.15.15; 27.05.07; 27.05.17  
 (511)

7 – Pumps [parts of machines, engines or motors]; compressed air machines; valves [parts of machines]; hydraulic pumps; automobile oil pump; automobile water pump; automotive motor lubricating pump; pistons [parts of machines or engines]; carburetors; automobile motor cooling radiator.

12 – Motor cars; electric vehicles; motorcycles; vehicles for locomotion by land, air, water or rail; tires for vehicle wheels; air pumps [vehicle accessories]; anti-theft devices for vehicles; clutches for land vehicles; motors for land vehicles.

(260) AM 2023 120083 A  
 (800) 1692132  
 (151) 2022 07 29  
 (891) 2022 07 29  
 (731) TENDAM RETAIL, S.A.  
 Avda. Del Llano Castellano, 51, E-28034 Madrid, Spain

(540)

**HI&BYE**

(591) Black, white  
 (511)  
 25 – Ready-to-wear clothing for women, men and children; footwear (except orthopedic footwear); headwear.

(260) AM 2023 120084 A  
 (800) 1692134  
 (151) 2022 04 04  
 (891) 2022 04 04  
 (731) Union des Associations Européennes de Football (UEFA)  
 Route de Genève 46, CH-1260 Nyon, Switzerland

(540)



(591) Black, white  
 (531) 11.03.01; 24.03.08; 24.03.16; 24.03.17;  
 27.01.12; 27.05.01; 27.07.01; 27.07.11

(511)

3 – Cosmetic products; soaps; cosmetic preparations for baths; powders for the body, the face, for cosmetic use and for the bath; perfumes, eaux de Cologne; pre-shave and after-shave lotions; shaving creams; shampoos, conditioners; dentifrices, mouthwashes; deodorants and antiperspirants for personal use; care creams, cosmetic creams; make-up removing creams for the face; make-up removing preparations; lip treatment products; lip gloss; lip balms [non-medicated]; lipstick; lip liner pencils; breath freshening products; tooth whitening creams; tooth whitening products (tapes or pastes); sun-tanning creams and lotions; hair lotions, hair sprays; toiletry creams; make-up products, eye shadows, face powders, cosmetic pencils; decorative transfers for cosmetic use; cotton sticks for cosmetic use; cotton balls for cosmetic use; shampoos for babies; baby oils [toiletries]; baby lotions [toiletries]; liquid soaps for babies' bodies; talcum powder for babies; wet wipes for infants; baby wipes; cleaning, polishing, scouring and abrasive preparations for household use; laundry powder detergents; synthetic cleaning products; shoe waxes and creams; leather care products.

4 – Lubricants; engine oils and fuels, including gasoline, diesel oil, gases and bio-fuels; candles; waxes;



industrial greases; natural gas; liquid gases; industrial oils; lubricating oils and greases; carburants; liquefied petroleum gas; non-chemical additives for fuel, lubricants and greases; dust absorbing, wetting and binding compositions; lighting fuel; lubricants, oils and greases, and lubricating preparations for industrial use; cutting oils for industrial use; milling oils; cutting and milling fluids.

9 – Exposed films, slides, video game disks; software (recorded programs), including game software; computer databases and programs; recorded or downloaded sounds, images or data; videotapes, magnetic tapes, magnetic disks, DVDs, mini-disks, diskettes, optical disks, compact disks, CD-ROMs, videodisks, memory cards, USB flash drives, whether blank or prerecorded with music, sound or images (which may be animated cartoons); holograms; electronic publications provided by means of CD-ROMs, databases and the Internet; spectacles, sunglasses, diving and swimming goggles; cases, cords and chains for sunglasses and spectacles; binoculars; magnets and decorative magnets; directional compasses; sound and image recording, transmitting and reproducing apparatus; satellite dishes; decoders, namely, electronic hardware and software which can convert, supply and transmit audio and video data; television sets; flat screens, liquid crystal display screens, high-definition screens and plasma screens; radios; home cinema systems; video recorders; CD players; DVD players; MP3 players; cassette players; mini-disk players; digital music players; loudspeakers; headphones, earphones; computers, including laptop computers and electronic tablets; karaoke systems; systems for editing sounds and for mixing sounds; systems for editing video images, and for mixing video images; apparatus for computer data processing; computer keyboards; computer screens; modems; accessories for computers included in this class; computer mice, mouse pads; navigation apparatus; PDAs (personal digital assistants); electronic pocket translators; dictating machines; electronic agendas; scanners; printers; photocopiers; facsimile machines; telephones; answering machines; video telephones; cellular telephones; accessories for cellular telephones included in this class, namely, cases for cellular telephones, apparatus for using hands-free cellular telephones, earphones and headsets for cellular telephones, keypads for cellular telephones, straps for cellular telephones, special cases for carrying cellular telephones, cameras and video cameras integrated in cellular telephones, and portable telephone covers; remote controls for television sets and video systems; teleconferencing systems; calculating machines; credit card readers; currency converting machines; automated teller machines; video cameras, portable video cameras with built-in videocassette recorders (camcorders); photographic equipment, photographic apparatus, cameras (cinematographic apparatus), projectors, flash lamps, special cases and cords for photographic apparatus and instruments, electric cells and batteries;

screen saver programs for computers; magnetic, digital or analog recording media, recorded or not, for sounds or images; magnetic cards (encoded); memory cards; integrated circuit cards (smart cards); microchip or magnetic credit cards, microchip or magnetic telephone cards, microchip or magnetic cards for cash dispensers, microchip or magnetic cards for automated teller machines and money exchange machines, prepaid microchip or magnetic cards for cellular telephones, microchip or magnetic travel and show admission cards, microchip or magnetic check guarantee cards and microchip or magnetic debit cards; alarms; wind socks (for indicating wind direction); distance-measuring apparatus; apparatus for measuring and displaying speed; protective gloves; audio receivers, sound amplifiers; television tubes; cathode ray tubes; decoders, namely computer hardware and software which can convert, supply and transmit audio and video data; disk drives for computers; protected semiconductors; integrated circuits containing programs for processing audio, visual or computer data; rechargeable batteries; audio and video data processors and converters; data transmission cables; payment apparatus for electronic commerce; protective helmets for sports; magnetic identification bracelets; components of electronic instruments; fuel/air coefficient analyzers; remote control devices for locking cars; photovoltaic cells; video game cassettes; ; scientific, weighing, measuring, signaling, checking (supervision), emergency (life-saving) and teaching apparatus and instruments, included in this class; burglar alarms, anti-theft alarm apparatus, fire alarms; measuring apparatus and instruments; remote control equipment, remote controls; navigation apparatus, navigational instruments; telematic apparatus; telematic terminals; encoded electronic tickets; tickets in the form of magnetic cards; electronic apparatus for electricity distribution.

12 – Bicycles, motorcycles, motor cars, trucks, vans, utility vehicles, buses, camper vans, refrigerated vehicles; airplanes and boats; air balloons, dirigible balloons [airships]; vehicle accessories, namely sun visors, pneumatic tires, tire covers, luggage racks, ski racks, rims and hub caps for wheels; seat linings, vehicle covers, baby carriages, strollers, safety seats for infants and children (for vehicles); engines and motors for land vehicles; bull bars; headlamp covers; steering wheels for vehicles; trailers; motors, engines and distributors for land vehicles; alarm systems for vehicles, anti-theft devices for vehicles.

14 – Jewelry, necklaces; jewelry; watches; wristwatches, clocks; chronographs; pendulum clocks; medallions, pendants, brooches; bracelets; pins (jewelry); lapel pins (jewelry); tie clips and tie pins; cuff links; commemorative medals of precious metal; prize cups, commemorative plates, trophies, statues, sculptures, all of precious metal; decorative hat pins, key rings (trinkets or fobs), printed metal disks for collection

purposes (pogs), all made of precious metal; decorative key holders; coins; medals for clothing; cases for watches; badges of precious metal; alarm clocks; badges and pins (jewelry); leather bracelets; bracelets of plastic materials; ornamental key rings of plastic materials.

16 – Musical instruments; musical boxes; electric and electronic musical instruments.

18 – Leather and imitations of leather; leather straps; umbrellas, parasols; sports bags (other than those adapted for products they are designed to contain); leisure bags; travel bags, backpacks; school bags; bags for hanging on belts; handbags, leather bags; beach bags; garment bags; suitcases; document cases; identity card holders; belts for suitcases; briefcases (leather goods); cases for toiletry articles known as vanity cases (not fitted); toiletry bags; key cases (leather goods); business card cases; wallets; purses; whips; collars for animals; luggage tags of leather.

25 – Clothing; shoes and footwear; headwear; shirts; knitwear (clothing); pullovers; slippers; tee-shirts; vests; jerseys; sleeveless jerseys, dresses; skirts; underwear, functional underwear, brassieres; swimsuits; bathrobes; shorts; trousers; sweaters; stocking caps; caps; hats; long scarves; scarves, shawls; peaked caps; tracksuits; sweatshirts; jackets, sports jackets, stadium jackets (jumpers); blazers; waterproof clothing; coats; uniforms; neckties; wrist bands; headbands; gloves; aprons; bibs (not of paper); pajamas; play suits for infants and children; socks and stockings; tights and leggings, garters; belts; suspenders; sandals; sports shoes, namely, shoes for outdoor sports, basketball shoes, multi-sport shoes, cycling shoes, indoor sports shoes, track and field shoes, football shoes (indoor and outdoor), canvas shoes, tennis shoes, sneakers, sailing shoes, shoes for aerobics; hiking boots; flip-flops; sportswear, namely, fleece tops, jogging suits, knitted sportswear, casual sports pants, polo shirts, sweat shirts, sweat pants football shirts, rugby shirts, bathing suits, sports jerseys, leotards, ski suits, ski jackets, ski trousers; wrist bands [clothing].

26 – Braids; tassels (haberdashery); ribbons; buttons; sewing needles; sewing boxes; badges for clothing (other than of precious metal); brooches (clothing accessories); decorative pins and needles not of precious metal; ornament pins for hats not of precious metal; hair nets, hair bands; barrettes (hair slides); hair pins; hair ribbons; pins not of precious metal; cords for clothing; bands for clothing (strips); competitors' numbers for advertising use; shoe ornaments not of precious metal; other decorative articles for the hair included in this class; badges of all kinds not of precious metal (including numbers and letters); plastic badges; badges and lapel pins (badges not of precious metal).

28 – Games and toys; sports balls; play balloons; table-top games; tables for indoor football; dolls and plush toys; vehicles (toys); jigsaw puzzles; balloons; inflatable toys; play disks (pogs); playing cards; confetti; gymnastic and sporting articles; football equipment, namely balls for football, gloves, knee guards, elbow guards, shoulder guards, shin guards; football goals; sports bags and containers (adapted to objects) for carrying sports articles; party hats (toys); small electronic games designed for use with a television set; video game apparatus; game consoles, electronic games other than those adapted for use with television receivers only; steering wheels for video games and mats for video games (for dancing upon); hands made of rubber or foam (toys); entertainment robots; appliances for gymnastics; kites; roller skates; scooters; skateboards; coin-operated video games for game halls (arcade games); electronic games with liquid crystal display; joysticks for video games, manually or voice-activated joysticks for video games; lottery tickets; lottery cards, scratch tickets for lottery games; toys for household pets; computer game joysticks; voice-activated or manually operated computer game joysticks.

29 – Meat; fish; poultry; game; meat extracts; canned fish and meat; cooked fruits and vegetables; canned fruits and vegetables; edible oils and fats; potato chips; French fries; prepared walnuts; jams; marmalades and jellies; milk; milk products (milk predominating), dairy products; cheeses; soy milk (milk substitute); consommés; broths.

30 – Coffee; tea; cocoa; chocolates; sugar; honey; coffee substitutes; flours; cereal preparations; cereals; bread; pastry; pastes (pastry); pasta; cakes; biscuits and cookies; crackers; candy; edible ices; confectionery; rice; dried cereal flakes; mustard; vinegar; sauces (condiments); spices; salt; honey, molasses, yeast, salt, mustard, vinegar or spices; products with added vitamins for culinary use and food additives for culinary use based on coffee, tea, cocoa, sugar, rice, tapioca, sago, flour or cereal preparations, honey, molasses, yeast, salt, mustard, vinegar or spices; salt and salt-based products for preserving foodstuffs; pizzas; fresh pizzas; pizza doughs; burgers inserted in brioche bread, namely hamburgers; hot dogs (sandwiches); sandwiches filled with meat; cheeseburgers (sandwiches); fish sandwiches; tea-based beverages; iced tea; instant cocoa.

32 – Non-alcoholic beverages; syrups and powders for making non-alcoholic beverages; mineral and aerated waters; energy drinks, isotonic drinks, hypertonic and hypotonic drinks; fruit and vegetable beverages; fruit and vegetable juices; sports beverages; frozen fruit drinks, frozen flavored drinks, non-carbonated and non-alcoholic; drinks enriched with added vitamins, not for medical use; beers; strong dark beers; lagers and ales; non-alcoholic or low-alcohol beers.

35 – Employment agencies; personnel recruitment; advertising services; services provided by an agency publishing advertising texts; advertising agency services; advertising agency services on a global computer network (the Internet) or via wireless electronic communication devices; dissemination of advertisements; rental of advertising space; rental of advertising time in film credits; television advertising, radio advertising; advertising in the form of animated cartoons; promotion agency services, promotion agency services for sports and public relations; promotion of football events; market study services; market research services; public opinion polling services; organization of exhibitions for commercial or advertising purposes; organization of advertising for trade fairs; compilation and systematization of data in data banks; data bank management services; establishing statistics; advertising for sports events in the field of football; retail sale services for and bringing together of various goods for the benefit of others (excluding the transport thereof), namely clothing, footwear, headgear, sports articles, stationery, apparatus for recording, transmission and reproduction of sound and images, books, newspapers, magazines, publications, video games, toys, dolls, badges of all kinds, key rings, tickets, watches and jewelry, souvenir items in connection with football, bags, luggage, briefcases, umbrellas, flags and pennants, alcoholic and non-alcoholic beverages, confectionery, medical apparatus and instruments, vehicles and accessories for motor cars; retail sale services for solvents, paraffin, waxes, bitumen and petroleum; bringing together of the following goods for the benefit of others (excluding transport) to enable customers to conveniently view and purchase these goods in a store or on a global computer network (the Internet) or via wireless electronic communication devices, namely clothing, shoes, headgear, sports articles, stationery, apparatus for recording, transmission and reproduction of sound and images, books, newspapers, magazines, publications, video games, toys, dolls, badges of all kinds, key rings, tickets, watches and jewelry, souvenir items in connection with football, bags, luggage, briefcases, umbrellas, flags and pennants, alcoholic and non-alcoholic beverages, confectionery, medical apparatus and instruments, vehicles and accessories for motor cars; advertising and promotion services, information services with regard to advertising and promotion, commercial information agencies, all the aforesaid services provided on-line from a computer database or via a global computer network (the Internet) or via wireless electronic communication devices; design and compilation of advertisements for use as a web site on a global computer network (the Internet) or via wireless electronic communication devices; provision of space on web sites, for advertising of goods and services; auctioneering on a global computer network (the Internet) or via wireless electronic communication devices; collection of directories for publication on the

Internet and on wireless electronic communication networks; business administration services for processing commercial services on a global computer network (Internet) or via wireless electronic communication devices; compilation, creation and management of databases, namely collection of domain names in a register; sales promotion, namely creation of preferential programs for customers; implementation of bonus programs for customers in stadiums by distributing encoded loyalty and membership cards which can contain the personal data of the user; development, launch and administration of loyalty programs, namely issuing loyalty cards to fans, containing personal information on the identity of the card holder; electronic commerce (e-commerce) services, namely provision of information on goods via telecommunication networks for advertising or sales purposes; compilation of data into a computer database, especially still or animated images; e-commerce services, namely online services for providing contracts for the purchase and sale of goods on behalf of others; promotion of sports events in the field of football; promotion of the goods and services of others, through contractual agreements, particularly partnership (sponsoring) and licensing agreements, providing them with increased notoriety and enhanced image derived from cultural and sporting events, particularly international events; compilation and recording of data and information on sporting performances; provision of personnel, particularly for selling beverages and foods; promotion of football events; retail sale of interactive educational and entertainment products, interactive compact disks, CD-ROMs and computer games; retail sale services, particularly on a global computer network, for interactive educational and entertainment products, interactive compact disks, CD-ROMs and computer games; presentation of computer programs for retail sale purposes; procurement services for others [purchasing goods and services for other businesses]; procurement services for others [purchasing goods and services for other businesses] for sports events or entertainment; promotion of the goods and services of others, through contractual agreements, particularly partnership (sponsoring) and licensing agreements, providing them with increased notoriety and/or enhanced image and/or affinity derived from cultural and sporting events, particularly international events; retail and wholesale services for motor vehicles, motor vehicle parts and motor vehicle accessories; retail and wholesale trading services on the Internet for motor vehicles, motor vehicle parts and motor vehicle accessories; compilation of data in computer data banks.

36 – Issuance and management of credit cards and travelers' checks; financial services; banking, credit and investment services; insurance services; lease-purchase financing; hire-purchase services; financial sponsorship of sports events; information services related to finance and insurance, provided from a computer database or the Internet or on all wireless electronic

communication networks; home banking services; banking services on the Internet or on all wireless electronic communication networks; payment services, including services provided from a computer database or via the Internet or via mobile telephones; safe deposit services; issue of vouchers, namely issue of loyalty cards to fans, which contain personal data on the identity of the cardholder and are used for access control at sports stadiums; financial promotion of events in the field of football; financial payment services for electronic commerce, namely transfer of funds, all via electronic communication networks; financial sponsorship search for football competitions; financial payment services for electronic commerce in connection with the purchase of goods and services provided by others, all via electronic communication networks, and clearing and settlement of financial transactions via electronic communication networks; issue of vouchers in the form of travel vouchers.

38 – Telecommunication services; communication by mobile telephones; communication by telex; communication via electronic computer terminals linked to telecommunication networks, data banks and the Internet or via wireless electronic communication devices; communication by telegraphs; communication by telephones; communications by facsimile; paging services; telephone or video conferencing services; television program broadcasting; broadcasting of cable television programs; radio program broadcasting; transmission of radio and television programs of sports and sports events; news and press agency services; other message transmission services; rental of telephones, facsimile machines and other telecommunication apparatus; transmission of commercial Internet pages online or via wireless electronic communication devices; services for transmitting and broadcasting television and radio programs provided via the Internet or via any wireless electronic communication network; electronic transmission of messages; simultaneous broadcasting of film recordings and sound and video recordings; provision of access to telematic servers and real-time chat forums; computer-aided transmission of messages and images; telecommunication via fiber-optic networks; provision of access to a global computer network or interactive communication technologies for access to private and commercial purchasing and ordering services; transmission of information and other data via websites and computers; transmission of information (including sites by telematic means) via telecommunication, computer programs and other data; transmission of information, computer programs and other data by telematic means; electronic mail services; provision of access via the Internet or on any wireless electronic communication network (telecommunication services); providing connections for telecommunications with a global computer network (the Internet) or data banks; provision of access to websites offering digital music on the Internet by means of a global computer network or via

wireless electronic communication devices; rental of access time to MP3 websites on the Internet, via a global computer network or via wireless electronic communication devices; rental of access time to a database server center (telecommunication services); rental of access time to a computer database (telecommunication services); transmission of digital music by telecommunications; online transmission of electronic publications; digital music transmission via the Internet or on any wireless electronic communication network; digital music transmission via MP3 Internet sites; simultaneous broadcasting and/or netcasting of film recordings and sound and video recordings (telecommunications); simultaneous broadcasting and/or netcasting of interactive educational and entertainment products, interactive compact disks, CD-ROMs, computer programs and computer games (telecommunications); provision of access to blackboards (bulletin and announcement boards), a blog and discussion forums (chat rooms) in real time via a global computer network; rental and provision of access time to blackboards (boards for displaying information and advertisements) and to chat rooms in real time by means of a global computer network (communication services); telecommunication services dedicated to retail sale by means of interactive communications with customers; multimedia telecommunication; videotext and teletext transmission services; information transmission via communication satellite, microwave or by electronic, digital or analog means; transmission of digital information by cable, wire or fiber; transmission of information by mobile telephones, telephones, facsimile and telex; telecommunication services for receiving and exchanging information, messages, images and data; telecommunication services for setting up discussion groups on the Internet and on any wireless electronic communication network; provision of access to search engines on the Internet, provision of access to platforms on the Internet (also on the mobile Internet) in the form of customized online pages featuring information defined or specified by users, personal profiles, audio contents, video contents, photographic images, texts, graphic illustrations and data; provision of access to search engines for obtaining data and information on global networks.

39 – Services of a travel agency, namely, travel arrangement and reservation; ticket reservation and information services for travel; transport by airplane, railway, bus and truck; boat transport; boat travel services; tourist travel services; rental of vehicles and automobiles; rental of parking spaces; taxi services; boat transport services for goods; distribution of water, heat, gas or electricity; distribution of newspapers, magazines and books; postal services, mail delivery and courier services; storage of merchandise; delivery of solvents, paraffins, waxes, bitumens and oil products, excluding liquid gas; distribution (delivery) of films and sound and image recordings; distribution (delivery) of interactive educational and entertainment

products, interactive compact disks, CD-ROMs, computer programs and computer games; ticket distribution (transport); navigation services by global positioning system; advice relating to power and electricity distribution; transport services; packaging and storage of goods; towing, transport and taxi; car transport; motor vehicle fleet tracking and monitoring services using electronic positioning and navigation devices; assistance in connection with energy and electricity distribution.

41 – Education; training; entertainment; organization of lotteries, raffles and competitions; betting and gaming services in connection with sports; provision of entry tickets and information brochures on sports for VIPs, as well as guiding and gathering VIPs for sports or entertainment events, provision of online information in the field of sports or sports events from a computer database or the Internet; customer reception services (entertainment services) including provision of access tickets during sports or entertainment events; entertainment services relating to sporting events; entertainment services in the form of public gatherings during the retransmission of sports events; sporting and cultural activities; organization of sporting and cultural events and activities; amusement park services; sports club services [health and fitness training]; organization of sports competitions; organization of events in the field of football; sports camp services; providing sports facilities; rental of video and audiovisual installations; production, presentation, distribution and/or rental of film recordings and sound and video recordings; presentation, distribution and/or rental of interactive educational and entertainment products, interactive compact disks, CD-ROMs, and computer games; radio and television coverage of sporting events; production services for radio, television programs and video films; ticket reservation services and information services for sports or entertainment events; timing services relating to sports events; organization of beauty contests; interactive entertainment; on-line betting and gaming services on the Internet or on any wireless electronic communication network; information in the field of entertainment (including in the field of sports), provided on-line from a computer database or via the Internet or via any wireless electronic communication network; electronic game services transmitted via the Internet or on mobile telephones; editing of books; publication of books and electronic journals on-line; audio and video recording services; production of animated cartoons for the cinema, production of animated cartoons for television; rental of sound and image recordings for entertainment purposes; information in the field of education provided on-line from a computer database or via the Internet or any wireless electronic communication network; translation services; photography services; provision of entertainment infrastructure; ticket agencies in connection with sports events; entertainment information in the field of sports; provision of information in

the field of sports events; publication of statistics; publication of statistics and information on sports performances; provision of entertainment infrastructure, namely VIP boxes and boxes inside and outside stadiums.

43 – Providing food and drink, snack-bars; hospitality services, namely provision of food and drink; catering services; hotel services; providing accommodation and food and drink, booking hotels and temporary accommodation; hospitality services, namely provision of food and drink during sports or entertainment events.

---

(260) AM 2023 120085 A

(800) 1692175

(151) 2022 08 19

(891) 2022 08 19

(731) Alende Holdings OÜ

Kesklinna linnaosa, Rotermanni 6, EE-10111  
Tallinn, Estonia

(540)

## Alende

(591) Black, white

(511)

36 – Deposit-taking; deposit-holding; financial administration of deposit-taking; deposit accounts services; maintaining escrow accounts for investments; electronic banking services; electronic banking via a global computer network [internet banking]; electronic banking services; financial services provided by electronic means; private placement and venture capital investment services; arranging finance for businesses; financing services for companies; provision of finance for enterprises; corporate savings account services; fixed income investment services; financial and monetary services; financial assistance; financing and funding services; facilitating and arranging financing; arranging the provision of finance; financial services relating to the securing of funds; financial management via the internet; financing services; provision of finance for business ventures; merchant banking services; merchant banking services; online business banking services; providing funding for commercial entities; provision of current accounts; computerised financial services for retail businesses; computerised financial services; debit account services; electronic financial trading services; financial investment; raising of financial capital; financial banking; financial services provided over the internet and telephone; financial services provided over the telephone and by means of a global computer network or the internet; provision of financial services by means of a global computer network or the internet; conducting of financial transactions; conducting of financial affairs on-line; savings and loan associations; loan and credit, and lease-finance services; brokerage; banking; computerised banking services; financial transfers and

transactions, and payment services; international banking; deposit savings; exchange brokerage services; virtual currency transfer services; financial administration of savings accounts.

(260) AM 2023 120178 A

(800) 1692698

(151) 2022 09 13

(891) 2022 09 13

(731) F.LLI CAMPAGNOLO S.p.A.

VIA MERLO, 2, ROMANO D'EZZELINO

(VI), Italy

(540)

## JEANNE BARET

(591) Black, white

(526) The name shown in the mark does not identify a particular living individual.

(511)

18 – Walking staffs; trunks [luggage]; bags; bags for sports; baby carriers worn on the body; purses; handbags; school bags; collars for animals; bumbags; umbrellas; pocket wallets; haversacks; suitcases; daypacks; rucksacks.

25 – Clothing; footwear; headgear.

35 – Retail services in relation to sporting articles; wholesale services in relation to sporting equipment; wholesale services in relation to sporting articles; promotion of goods and services through sponsorship of sports events; retail services in relation to walking staffs; retail services in relation to trunks [luggage]; retail services in relation to bags; retail services in relation to bags for sports; retail services in relation to baby carriers worn on the body; retail services in relation to purses; retail services in relation to handbags; retail services in relation to school bags; retail services in relation to collars for animals; retail services in relation to bumbags; retail services in relation to umbrellas; retail services in relation to pocket wallets; retail services in relation to haversacks; retail services in relation to suitcases; retail services in relation to daypacks; retail services in relation to rucksacks; retail services in relation to clothing; retail services in relation to footwear; retail services in relation to headgear; wholesale services in relation to walking staffs; wholesale services in relation to trunks [luggage]; wholesale services in relation to bags; wholesale services in relation to baby carriers worn on the body; wholesale services in relation to purses; wholesale services in relation to handbags; wholesale services in relation to school bags; wholesale services in relation to collars for animals; wholesale services in relation to bumbags; wholesale services in relation to umbrellas; wholesale services in relation to pocket wallets; wholesale services in relation to haversacks; wholesale services in relation to suitcases; wholesale services in relation to daypacks; wholesale services in relation to

rucksacks; wholesale services in relation to clothing; wholesale services in relation to footwear; wholesale services in relation to headgear; online retail services in relation to walking staffs; online retail services in relation to trunks [luggage]; online retail services relating to bags; online retail services in relation to bags for sports; online retail services in relation to baby carriers worn on the body; online retail services in relation to purses; online retail services in relation to handbags; online retail services in relation to school bags; online retail services in relation to collars for animals; online retail services in relation to bumbags; online retail services in relation to umbrellas; online retail services in relation to pocket wallets; online retail services in relation to haversacks; online retail services relating to suitcases; online retail services in relation to daypacks; online retail services in relation to rucksacks; online retail services in relation to clothing; online retail services in relation to footwear; online retail services in relation to headgear.

(260) AM 2023 120179 A

(800) 1692736

(151) 2022 04 26

(891) 2022 04 26

(731) LIMITED LIABILITY COMPANY "QVANT"

Filevskiy b-r, d.40, pom, V, komn. 5, of. 3,

RU-121601 Moscow, Russian Federation

(540)



(591) Blue, white and black

(531) 27.05.01; 27.05.21; 29.01.13

(511)

9 – 3D spectacles; DVD players; ticket dispensers; juke boxes, musical; fire engines; answering machines; electrical adapters; batteries for electronic cigarettes; accumulators, electric; batteries, electric, for vehicles; accelerometers; actinometers; alidades; altimeters; ear pads for headphones; ammeters; nanoparticle size analysers; anemometers; anodes; aerials; anticathodes; apertometers [optics]; high-frequency apparatus; testing apparatus not for medical purposes; remote control apparatus; electro-dynamic apparatus for the remote control of railway points; electro-dynamic apparatus for the remote control of signals; monitoring apparatus, other than for medical purposes; sound recording apparatus; Global Positioning System [GPS] apparatus; distillation apparatus for scientific purposes; diffraction apparatus [microscopy]; air analysis apparatus; apparatus to check franking; sound transmitting apparatus; fermentation apparatus for laboratory use; breathing apparatus for underwater swimming; breathing apparatus, except for artificial respiration; appa-

ratus and installations for the production of X-rays, not for medical purposes; cash registers; electric apparatus for commutation; magnetic resonance imaging [MRI] apparatus, not for medical purposes; intercommunication apparatus; stills for laboratory experiments; projection apparatus; fire extinguishing apparatus; radiological apparatus for industrial purposes; X-ray apparatus not for medical purposes; blueprint apparatus; flashing lights [luminous signals]; stereoscopic apparatus; telephone apparatus; facsimile machines; phototelegraphy apparatus; igniting apparatus, electric, for igniting at a distance; acid hydrometers; salinometers; acidimeters for batteries; aerometers; beacons, luminous; battery jars; automated teller machines [ATM]; barometers; anode batteries; galvanic batteries; ignition batteries; solar batteries; solar panels for the production of electricity; batteries, electric; balances [steelyards]; betatrons; binoculars; biochips; electronic tags for goods; lens hoods; magnetic tape units for computers; computer memory devices; fire hose nozzles; encoded identification bracelets, magnetic; connected bracelets [measuring instruments]; safety tarpaulins; electronic key fobs being remote control apparatus; bullet-proof clothing; signalling buoys; life buoys; marking buoys; directional compasses; vacuum gauges; variometers; verniers; scales; baby scales; bathroom scales; letter scales; weighbridges; precision balances; scales with body mass analysers; levelling staffs [surveying instruments]; camcorders; video baby monitors; video cassettes; video projectors; video telephones; video screens; viewfinders, photographic; electric plugs; micrometer screws for optical instruments; viscosimeters; circuit closers; wavemeters; voltmeters; mechanical signs; signs, luminous; switchboxes [electricity]; current rectifiers; gas testing instruments; gasometers [measuring instruments]; galvanometers; hands-free kits for telephones; heliographic apparatus; hygrometers; hydrometers; weights; peepholes [magnifying lenses] for doors; hairdressing training heads [teaching apparatus]; holograms; plotters; loudspeakers; sounding leads; plumb bobs; range finders; parking sensors for vehicles; piezoelectric sensors; densimeters; densitometers; detectors; smoke detectors; infrared detectors; counterfeit coin detectors; joysticks for use with computers, other than for video games; transparencies [photography]; slide projectors; diaphragms [photography]; dictating machines; dynamometers; light-emitting diodes [LED]; quantum dot light-emitting diodes [QLED]; organic light-emitting diodes [OLED]; floppy disks; phonograph records; disks, magnetic; optical discs; circular slide rules; disk drives for computers; juke boxes for computers; wearable video display monitors; electronic numeric displays; DNA chips; electronic interactive whiteboards; electronic notice boards; electric wire harnesses for automobiles; bullet-proof vests; life jackets; reflective safety vests; identification threads for electric wires; nose clips for divers and swimmers; padlocks, electro-

nic; locks, electric; bells [warning devices]; alarm bells, electric; electric door bells; signal bells; acoustic conduits; mirrors for inspecting work; road signs, luminous or mechanical; downloadable emoticons for mobile phones; marine depth finders; probes for scientific purposes; buzzers; needles for surveying compasses; needles for record players; eyewear; reflective articles for wear, for the prevention of accidents; measures; pressure measuring apparatus; simulators for the steering and control of vehicles; inverters [electricity]; pressure indicators; automatic indicators of low pressure in vehicle tyres; temperature indicators; incubators for bacteria culture; measuring instruments; cosmographic instruments; mathematical instruments; levelling instruments; instruments containing eyepieces; surveying instruments; azimuth instruments; interfaces for computers; audio interfaces; ionization apparatus not for the treatment of air or water; satellite finder meters; spark-guards; coaxial cables; fibre optic cables; cables, electric; calipers; slide calipers; screw-tapping gauges; calorimeters; calculating machines; pocket calculators; decompression chambers; rearview cameras for vehicles; cinematographic cameras; thermal imaging cameras; mouth guards for sports; life-saving capsules for natural disasters; electronic pens [visual display units]; holders for electric coils; biometric identity cards; identity cards, magnetic; video game cartridges; toner cartridges, unfilled, for printers and photocopiers; ink cartridges, unfilled, for printers and photocopiers; memory cards for video game machines; encoded magnetic cards; riding helmets; protective helmets; carriers for dark plates [photography]; cathodes; spools [photography]; choking coils [impedance]; coils, electric; electromagnetic coils; cinematographic film, exposed; computer keyboards; solenoid valves [electromagnetic switches]; wire connectors [electricity]; thin client computers; downloadable cryptographic keys for receiving and spending crypto assets; encoded key cards; electronic book readers; electronic agendas; push buttons for bells; mouse pads; magnetic encoders; visors for helmets; collectors, electric; calibrating rings; smart rings; ring sizers; protective suits for aviators; commutators; compact discs [audio-video]; compact discs [read-only memory]; comparators; marine compasses; computers; laptop computers; tablet computers; notebook computers; wearable computers; condensers [capacitors]; contacts, electric; wind socks for indicating wind direction; traffic cones; branch boxes [electricity]; distribution boxes [electricity]; junction boxes [electricity]; connectors [electricity]; battery boxes; cabinets for loudspeakers; diving suits; downloadable e-wallets; galena crystals [detectors]; covers for electric outlets; logs [measuring instruments]; lasers, not for medical purposes; lactodensimeters; lactometers; vacuum tubes [radio]; darkroom lamps [photography]; thermionic valves; amplifying tubes; flashlights [photography]; head cleaning tapes [recording]; magnetic tapes; videotapes; surveying

chains; fire escapes; rulers [measuring instruments]; square rulers for measuring; slide-rules; contact lenses; correcting lenses [optics]; close-up lenses; optical lenses; optical condensers; sounding lines; electricity conduits; measuring spoons; magnifying glasses [optics]; thread counters; magnets; decorative magnets; crash test dummies; resuscitation mannequins [teaching apparatus]; mouse [computer peripheral]; trackballs [computer peripherals]; pressure gauges; security tokens [encryption devices]; divers' masks; soldiers' helmets; protective masks, not for medical purposes; respiratory masks, other than for artificial respiration; materials for electricity mains [wires, cables]; voting machines; money counting and sorting machines; material testing instruments and machines; furniture especially made for laboratories; megaphones; portable media players; diaphragms [acoustics]; diaphragms for scientific apparatus; metal detectors for industrial or military purposes; digital weather stations; metronomes; rules [measuring instruments]; carpenters' rules; dressmakers' measures; mechanisms for coin-operated apparatus; mechanisms for counter-operated apparatus; coin-operated mechanisms for television sets; shutter releases [photography]; micrometers; microprocessors; microscopes; microtomes; microphones; audio mixers; modems; lightning conductors; monitors [computer hardware]; monitors [computer programs]; selfie sticks [hand-held monopods]; terminals [electricity]; junction sleeves for electric cables; teeth protectors; temperature indicator labels, not for medical purposes; knee-pads for workers; headphones; earpieces for remote communication; surveyors' levels; sound recording carriers; magnetic data media; optical data media; electronic sheet music, downloadable; computer game software, recorded; computer software, recorded; sheaths for electric cables; identification sheaths for electric wires; weighing machines; computer hardware; punched card machines for offices; life saving equipment; shoes for protection against accidents, irradiation and fire; objectives [lenses] [optics]; lenses for astrophotography; selfie lenses; egg-candlers; fire extinguishers; rescue laser signalling flares; electrified fences; limiters [electricity]; clothing for protection against accidents, irradiation and fire; clothing for protection against fire; asbestos clothing for protection against fire; clothing especially made for laboratories; survival blankets; ozonisers [ozonators]; octants; eyepieces; ohmmeters; wrist rests for use with computers; spectacle frames; oscillographs; plumb lines; mirrors [optics]; spectacles; sunglasses; goggles for sports; electronic collars to train animals; finger sizers; signalling panels, luminous or mechanical; biometric passports; wah-wah pedals; radio pagers; pince-nez; electronic pocket translators; transmitters [telecommunication]; telephone transmitters; transmitters of electronic signals; switches, electric; periscopes; data gloves; gloves for divers; gloves for protection against accidents; gloves for protection against X-rays for industrial pur-

poses; asbestos gloves for protection against accidents; furnaces for laboratory use; droppers for measuring, other than for medical or household purposes; laboratory pipettes; pyrometers; planimeters; plane tables [surveying instruments]; plates for batteries; computer software platforms, recorded or downloadable; wafers for integrated circuits; printed circuit boards; compact disc players; cassette players; protective films adapted for computer screens; protective films adapted for smartphones; sound recording strips; X-ray films, exposed; films, exposed; life-saving rafts; animal signalling rattles for directing livestock; laboratory trays; digital signs; stands adapted for laptops; semi-conductors; polarimeters; personal digital assistants [PDAs]; fire pumps; measuring glassware; weight belts for divers; life belts; fuses; circuit breakers; converters, electric; telerupters; food analysis apparatus; diagnostic apparatus, not for medical purposes; distance recording apparatus; distance measuring apparatus; speed measuring apparatus [photography]; appliances for measuring the thickness of leather; apparatus for measuring the thickness of skins; speed checking apparatus for vehicles; teaching apparatus; time recording apparatus; apparatus and instruments for astronomy; surveying apparatus and instruments; weighing apparatus and instruments; nautical apparatus and instruments; navigational instruments; optical apparatus and instruments; apparatus and instruments for physics; chemistry apparatus and instruments; measuring apparatus; measuring devices, electric; boiler control instruments; meteorological instruments; naval signalling apparatus; observation instruments; navigation apparatus for vehicles [on-board computers]; satellite navigational apparatus; regulating apparatus, electric; telecommunication apparatus in the form of jewellery; precision measuring apparatus; audio- and video-receivers; prisms [optics]; computer software applications, downloadable; ticket printers; printers for use with computers; hemline markers; retorts' stands; apparatus for changing record player needles; drainers for use in photography; cleaning apparatus for phonograph records; fire beaters; sighting telescopes for firearms; telescopic sights for artillery; test tubes; pressure indicator plugs for valves; magnetic wires; telegraph wires; telephone wires; wires, electric; conductors, electric; copper wire, insulated; fuse wire; computer programs, recorded; computer game software, downloadable; computer programs, downloadable; computer operating programs, recorded; computer screen saver software, recorded or downloadable; record players; processors [central processing units]; rods for water diviners; electronic publications, downloadable; distribution consoles [electricity]; control panels [electricity]; radar apparatus; baby monitors; masts for wireless aerials; transmitting sets [telecommunication]; radios; vehicle radios; sprinkler systems for fire protection; frames for photographic transparencies; screens for photoengraving; flowmeters; walkie-talkies; voltage surge protectors;



voltage regulators for vehicles; stage lighting regulators; light dimmers [regulators], electric; speed regulators for record players; cell switches [electricity]; washing trays [photography]; marking gauges [joinery]; T-squares for measuring; time switches, automatic; relays, electric; safety restraints, other than for vehicle seats and sports equipment; body harnesses for support when lifting loads; X-ray photographs, other than for medical purposes; rheostats; respirators for filtering air; retorts; refractometers; refractors; grids for batteries; security surveillance robots; laboratory robots; teaching robots; telepresence robots; humanoid robots with artificial intelligence for use in scientific research; electric sockets; height measuring instruments; speaking tubes; horns for loudspeakers; subwoofers; saccharometers; optical fibres [light conducting filaments]; traffic-light apparatus [signalling devices]; dog whistles; signalling whistles; sports whistles; sextants; inductors [electricity]; safety nets; nets for protection against accidents; fire alarms; signals, luminous or mechanical; rescue flares, non-explosive and non-pyrotechnic; sirens; electronic access control systems for interlocking doors; scanners [data processing equipment]; hand-held electronic dictionaries; integrated circuit cards [smart cards]; smartglasses; smartphones; smartwatches; connections for electric lines; couplings, electric; sonars; sound locating instruments; lighting ballasts; resistances, electric; spectrograph apparatus; spectrometers; speed indicators; alcoholmeters; satellites for scientific purposes; protection devices for personal use against accidents; audiovisual teaching apparatus; charging stations for electric vehicles; radiotelegraphy sets; radiotelephony sets; spectacle lenses; anti-glare glasses; optical glass; personal stereos; stereoscopes; stands for photographic apparatus; stroboscopes; fire boats; sulfimeters; bags adapted for laptops; drying racks [photography]; spherometers; integrated circuits; printed circuits; counters; parking meters; mileage recorders for vehicles; revolution counters; abacuses; egg timers [sandglasses]; taximeters; ear plugs for divers; tachometers; television apparatus; telegraphs [apparatus]; telescopes; teleprompters; teleprinters; mobile telephones; cordless telephones; theodolites; credit card terminals; interactive touch screen terminals; thermo-hygrometers; thermometers, not for medical purposes; thermostats; thermostats for vehicles; climate control digital thermostats; crucibles [laboratory]; tone arms for record players; totalizers; transistors [electronic]; transponders; protractors [measuring instruments]; transformers [electricity]; step-up transformers; resuscitation training simulators; vehicle breakdown warning triangles; triodes; starter cables for motors; discharge tubes, electric, other than for lighting; capillary tubes for laboratory use; neon signs; pitot tubes; X-ray tubes not for medical purposes; telephone receivers; headgear being protective helmets; squares for measuring; gauges; quantity indicators; petrol gauges; water level indicators; electric loss indicators; light-emitting elec-

tronic pointers; slope indicators; levels [instruments for determining the horizontal]; mercury levels; spirit levels; urinometers; amplifiers; particle accelerators; electric installations for the remote control of industrial operations; steering apparatus, automatic, for vehicles; balancing apparatus; video recorders; sound reproduction apparatus; invoicing machines; tape recorders; protection devices against X-rays, not for medical purposes; railway traffic safety appliances; data processing apparatus; oxygen transpiring apparatus; theft prevention installations, electric; devices for the projection of virtual keyboards; film cutting apparatus; drying apparatus for photographic prints; optical character readers; centering apparatus for photographic transparencies; dosage dispensers; battery chargers; chargers for electric accumulators; chargers for electronic cigarettes; acoustic alarms; sounding apparatus and machines; apparatus for editing cinematographic film; cathodic anti-corrosion apparatus; couplers [data processing equipment]; wearable activity trackers; anti-theft warning apparatus; computer peripheral devices; anti-interference devices [electricity]; demagnetizing apparatus for magnetic tapes; acoustic couplers; alarms; fog signals, non-explosive; whistle alarms; adding machines; readers [data processing equipment]; heat regulating apparatus; photocopiers [photographic, electrostatic, thermic]; electric and electronic effects units for musical instruments; bar code readers; downloadable ring tones for mobile phones; downloadable image files; downloadable music files; animated cartoons; filters for respiratory masks; filters for ultraviolet rays, for photography; filters for use in photography; USB flash drives; magic lanterns; optical lanterns; signal lanterns; cameras [photography]; glazing apparatus for photographic prints; shutters [photography]; darkrooms [photography]; photometers; flash-bulbs [photography]; digital photo frames; enlarging apparatus [photography]; photovoltaic cells; containers for contact lenses; spectacle cases; containers for microscope slides; cases for smartphones; cases especially made for photographic apparatus and instruments; chromatography apparatus for laboratory use; chronographs [time recording apparatus]; laboratory centrifuges; spectacle chains; cyclotrons; compasses for measuring; frequency meters; time clocks [time recording devices]; petri dishes; sleeves for laptops; covers for personal digital assistants [PDAs]; covers for tablet computers; covers for smartphones; fire blankets; chips [integrated circuits]; jigs [measuring instruments]; pedometers; meteorological balloons; electrified rails for mounting spot lights; asbestos screens for firemen; fire hose; virtual reality headsets; protective helmets for sports; head guards for sports; lifeboats; snorkels; cell phone straps; spectacle cords; tripods for cameras; switchboards; distribution boards [electricity]; equalizers [audio apparatus]; screens [photography]; workmen's protective face-shields; projection screens; radiology screens for industrial purposes; fluorescent screens;

exposure meters [light meters]; ducts [electricity]; galvanic cells; downloadable graphics for mobile phones; epidiascopes; ergometers; armatures [electricity]; black boxes [data recorders].

11 – Lampshades; steam accumulators; heat accumulators; defrosters for vehicles; disinfectant apparatus for medical purposes; distillation apparatus; desiccating apparatus; hydromassage bath apparatus; disinfectant apparatus; air deodorizing apparatus; tanning beds; ionization apparatus for the treatment of air or water; coffee roasters; beverage cooling apparatus; hand drying apparatus for washrooms; fruit roasters; water purifying apparatus and machines; refrigerating apparatus and machines; underfloor heating apparatus and installations; drying apparatus and installations; freezers; heating and cooling apparatus for dispensing hot and cold beverages; drying apparatus; coolers for furnaces; expansion tanks for central heating installations; flushing tanks; refining towers for distillation; bidets; boilers, other than parts of machines; bath tubs; spa baths [vessels]; bath tubs for sitz baths; waffle irons, electric; fans [air-conditioning]; fans [parts of air-conditioning installations]; electric fans for personal use; roasting spits; refrigerating display cabinets; heated display cabinets; dehumidifiers; water heaters; water flushing installations; air reheaters; extractor hoods for kitchens; gas condensers, other than parts of machines; acetylene generators; fog machines; microbubble generators for baths; hydrants; fairy lights for festive decoration; burners; acetylene burners; gas burners; burners for lamps; germicidal burners; incandescent burners; oxyhydrogen burners; laboratory burners; oil burners; alcohol burners; hot water bottles; footwarmers, electric or non-electric; bed warmers; USB-powered hand warmers; pocket warmers; warming pans; roasting apparatus; food dehydrators, electric; lampshade holders; stills; showers; refrigerating containers; candle lighters; grill lighters; gas lighters; friction lighters for igniting gas; chimney blowers; coils [parts of distilling, heating or cooling installations]; furnace ash boxes; evaporators; electric appliances for making yogurt; shower cubicles; Turkish bath cabinets, portable; heating apparatus; cool boxes, electric; refrigerating chambers; fireplaces, domestic; chimney flues; coffee capsules, empty, for electric coffee machines; structural framework for ovens; air valves for steam heating installations; level controlling valves in tanks; thermostatic valves [parts of heating installations]; electrically heated carpets; light bulbs; light bulbs, electric; solar thermal collectors [heating]; distillation columns; furnace grates; ventilation hoods; ventilation hoods for laboratories; lamp globes; air-conditioning apparatus; air conditioners for vehicles; gas boilers; laundry room boilers; heating boilers; coffee machines, electric; taps; taps for pipes and pipelines; mixer taps for water pipes; forges, portable; lava rocks for use in barbecue grills; couscous cookers, electric; lights, electric, for Christmas trees; acetylene flares; safety lamps; gas lamps;

curling lamps; nail lamps; curing lamps, not for medical purposes; germicidal lamps for purifying air; light bulbs for directional signals for vehicles; arc lamps; laboratory lamps; oil lamps; ultraviolet ray lamps, not for medical purposes; miners' lamps; electric lamps; chandeliers; barbecues; bread baking machines; watering machines for agricultural purposes; ice-cream making machines; soya milk making machines, electric; pounded rice cake making machines, electric, for household purposes; multicookers; footmuffs, electrically heated; heaters for baths; heaters for heating irons; immersion heaters; brackets for gas burners; anti-splash tap nozzles; heat pumps; filaments for electric lamps; magnesium filaments for lighting; heating filaments, electric; luminous house numbers; socks, electrically heated; heating apparatus for defrosting vehicle windows; hot air bath fittings; bath fittings; loading apparatus for furnaces; kiln furniture [supports]; sauna bath installations; refrigerating appliances and installations; directional lights for bicycles; electrically heated clothing; blankets, electric, not for medical purposes; fabric steamers; lamp reflectors; vehicle reflectors; hearths; electric cooktops; food steamers, electric; steam boilers, other than parts of machines; pasteurisers; lamp mantles; sockets for electric lights; coffee percolators, electric; stoves [heating apparatus]; bakers' ovens; hot air ovens; kitchen ranges [ovens]; microwave ovens [cooking apparatus]; microwave ovens for industrial purposes; incinerators; kilns; solar furnaces; dental ovens; furnaces, other than for laboratory use; urinals being sanitary fixtures; feeding apparatus for heating boilers; heating plates; cooking stoves; hot plates; wine cellars, electric; heaters, electric, for feeding bottles; aquarium heaters; USB-powered cup heaters; aquarium lights; heating cushions, electric, not for medical purposes; clean chambers [sanitary installations]; tortilla presses, electric; water intake apparatus; deodorising apparatus, not for personal use; apparatus for dehydrating food waste; fumigation apparatus, not for medical purposes; gas scrubbing apparatus; oil-scrubbing apparatus; glue-heating appliances; drying apparatus for fodder and forage; water filtering apparatus; air purifying apparatus and machines; ice machines and apparatus; cooling appliances and installations; cooking apparatus and installations; lighting apparatus and installations; sanitary apparatus and installations; cooking rings; lighting apparatus for vehicles; light-emitting diodes [LED] lighting apparatus; heating apparatus for solid, liquid or gaseous fuels; heating apparatus, electric; hot air apparatus; steam facial apparatus [saunas]; safety accessories for water or gas apparatus and pipes; regulating and safety accessories for gas apparatus; regulating accessories for water or gas apparatus and pipes; regulating and safety accessories for water apparatus; regulating and safety accessories for gas pipes; roasting jacks; plate warmers; anti-glare devices for vehicles [lamp fittings]; rotisseries; radiator caps; searchlights; diving lights; light

projectors; washers for water taps; heat guns; radiators [heating]; central heating radiators; radiators, electric; sinks; disinfectant apparatus for dispensing solutions into water-pipes for sanitary installations; drip irrigation emitters [irrigation fittings]; light diffusers; nuclear reactors; heat regenerators; pressure water tanks; roasters; beverage urns, electric; lamps; standard lamps; ceiling lights; toilet seats; hydroponic growing systems; lighting installations for air vehicles; pressure cookers, electric; gas scrubbers [parts of gas installations]; lamp glasses; sterilizers; water sterilizers; air sterilizers; air dryers; laundry dryers, electric; hair dryers; malt roasters; tobacco roasters; tajines, electric; heat exchangers, other than parts of machines; thermo-pots, electric; bread toasters; discharge tubes, electric, for lighting; lamp chimneys; luminous tubes for lighting; pipes [parts of sanitary installations]; flues for heating boilers; boiler pipes [tubes] for heating installations; toilets [water-closets]; toilets, portable; humidifiers; humidifiers for central heating radiators; wash-hand basins [parts of sanitary installations]; toilet bowls; water conduits installations; bath installations; air-conditioning installations; desalination plants; installations for processing nuclear fuel and nuclear moderating material; watering installations, automatic; cooling installations for water; cooling installations for liquids; milk cooling installations; cooling installations for tobacco; water purification installations; purification installations for sewage; steam generating installations; water distribution installations; air filtering installations; swimming pool chlorinating apparatus; ventilation [air-conditioning] installations and apparatus; ventilation [air-conditioning] installations for vehicles; water softening apparatus and installations; cooling installations and machines; heating installations; heaters for vehicles; heating installations [water]; polymerisation installations; water supply installations; flare stacks for use in the oil industry; ash conveyor installations, automatic; whirlpool-jet apparatus; air cooling apparatus; sous-vide cookers, electric; aquarium filtration apparatus; cooking utensils, electric; flaming torches; headlights for automobiles; vehicle headlights; filters for air conditioning; filters for drinking water; wicks adapted for oil stoves; lights for automobiles; bicycle lights; motorcycle lights; lights for vehicles; electric torches; head torches; lanterns for lighting; candle lanterns; street lamps; Chinese lanterns; fountains; ornamental fountains; chocolate fountains, electric; air fryers; deep fryers, electric; fittings, shaped, for furnaces; oven fittings made of fireclay; bread-making machines; refrigerators; refrigerators, cooling apparatus and freezers for medical storage purposes; chromatography apparatus for industrial purposes; kettles, electric; dampers [heating]; book sterilization apparatus; refrigerating cabinets; carbon for arc lamps; heating elements.

34 – Flavourings, other than essential oils, for tobacco; flavourings, other than essential oils, for use in

electronic cigarettes; gas containers for cigar lighters; absorbent paper for tobacco pipes; cigarette paper; lighters for smokers; hookahs; tobacco pouches; books of cigarette papers; humidors; matchboxes; firestones; cigar cutters; cigar holders; cigarette holders; mouthpieces for cigarette holders; tips of yellow amber for cigar and cigarette holders; ashtrays for smokers; spittoons for tobacco users; pipe racks for tobacco pipes; pipe cleaners for tobacco pipes; liquid solutions for use in electronic cigarettes; electronic cigarettes; cigarettes; cigarettes containing tobacco substitutes, not for medical purposes; cigarillos; cigars; tobacco jars; match holders; matches; oral vaporizers for smokers; tobacco; chewing tobacco; snuff; snuffboxes; herbs for smoking; tobacco pipes; pocket machines for rolling cigarettes; cigarette filters; wicks adapted for cigarette lighters; cigarette tips; cigar cases; cigarette cases; liquid nicotine solutions for use in electronic cigarettes; tobacco substitutes, not for medical purposes; smokers' articles, namely cigarette paper, tobacco pipes, cigarette filters, tobacco tins, ashtrays for smokers, cigarettes cases of precious metal, cigarette cases, not of precious metal, pocket machines for rolling cigarettes, lighters for smokers; vaporizers for electronic and electronic smoking devices; oral vaporizers devices for smokers, tobacco products and tobacco substitutes; snus; tobacco, raw or manufactured; tobacco products, including cigars, cigarettes, cigarillos, hand-rolling tobacco, pipe tobacco, chewing tobacco, snuff, kreteks; tobacco sticks, tobacco products for the purpose of being heated, electronic devices and parts thereof for the inhalation of nicotine-containing aerosols; devices for extinguishing lit cigarettes, cigars and heated tobacco sticks; electronic smoking devices; electronic cigarettes containing tobacco substitutes, not for medical purposes; electronic devices for the inhalation of nicotine-containing aerosols.

(260) AM 2023 120180 A

(800) 1692743

(151) 2022 09 22

(891) 2022 09 22

(731) Apple Inc.

One Apple Park Way, Cupertino CA 95014,  
USA

(540)

## APPLE WATCH ULTRA

(591) Black, white

(526) WATCH

(511)

9 – Computers; dive computers; wearable computer hardware; mobile telephones; wireless communication devices for the transmission of voice, data, images, audio, video, and multimedia content; wearable digital electronic devices capable of providing access to the internet, for sending, receiving and storing of telephone calls, electronic mail, and other digital data; smart

watches; wearable activity trackers; computer software for setting up, configuring, operating or controlling mobile devices, wearable devices, computers, computer peripherals, and audio players; peripheral devices for smart watches; accelerometers; altimeters; distance measuring apparatus; distance recording apparatus; pedometer; pressure measuring apparatus; sound recording and reproducing apparatus; radio transmitters and receivers; global positioning systems (GPS devices); navigational instruments; battery chargers and docking stations; life saving apparatus; alarms, alarm sensors.

---

(260) AM 2023 120181 A

(800) 1692774

(151) 2022 06 16

(891) 2022 06 16

(731) Euro Games Technology Ltd.

"Maritsa" Str. 4, "Vranya-Lozen-Triugulnika",  
BG-1151 Sofia, Bulgaria

(540)



(591) Red, yellow, orange pink, purple, white, black, blue, black and silver

(531) 01.15.09; 17.02.01; 17.02.02; 17.02.04;  
27.05.03; 27.05.04; 29.01.15

(511)

9 – Software; computer gaming software; computer software packages; computer operating system software; computer software, recorded; software drivers; virtual reality software; games software; entertainment software for computer games; computer programs for network management; operating computer software for main frame computers; monitors (computer hardware); computer hardware; apparatus for recording images; monitors (computer programs); computer game programs; computer programs for recorded games; apparatus for recording, transmission or reproduction of sound or images; communications servers [computer hardware]; electronic components for gambling machines; computer application software featuring games and gaming; computer software for the administration of on-line games and gaming; computer hardware for games and gaming; hardware and software for gambling, gambling machines, gambling games on the Internet and via telecommunication network.

28 – Gaming machines for gambling; chips for gambling; mah-jong; arcade games; gambling machines operating with coins, notes and cards; games; electronic games; parlor games; gaming chips; gaming tables; slot machines [gaming machines]; LCD game machines; slot machines and gaming devices; coin-operated amusement machines; roulette chips; poker chips; chips and dice [gaming equipment]; equipment

for casinos; roulette tables; gaming roulette wheels; casino games; automats and gambling machines; coin-operated machines and/or electronic coin-operated machines with or without the possibility of gain; boxes for coin-operated machines, slot machines and gaming machines; electronic or electrotechnical gaming devices, automats and machines, coin-operated machines; housings for coin-operated machines, gaming equipment, gaming machines, machines for gambling; electropneumatic and electrical gambling machines (slot machines).

41 – Gambling; services related to gambling; gaming services for entertainment purposes; casino, gaming and gambling services; training in the development of software systems; provision of gaming equipment for gambling halls; providing casino equipment [gambling]; gaming machine entertainment services; providing casino facilities [gambling]; halls with gaming machines; amusement arcade services; games equipment rental; rental of gaming machines; providing amusement arcade services; rental of gaming machines with images of fruits; editing or recording of sounds and images; sound recording and video entertainment services; hire of sound reproducing apparatus; provision of gaming equipment for casinos; providing of casino facilities; online gambling services; casino management services; operation of gaming establishments, gaming halls, internet casinos, online gambling sites.

---

(260) AM 2023 120182 A

(800) 1692790

(151) 2022 03 10

(891) 2022 03 10

(731) A.C.N. 655 220 670 PTY LIMITED

c/o Company Matters Pty Limited, Level 12, 680  
George Street, Sydney NSW 2000, Australia

(540)

## Collimate Capital

(591) Black, white

(511)

9 – Encoded credit cards, smart cards and loyalty cards and equipment for reading them; electronic publications, including but not limited to electronic publications downloadable, distributed or sold on-line; computer software; computer hardware; application software including for banking and financial purposes; interactive computer software; software adapted for use with mobile phones, computers and tablet computers; computer software for sending messages, advertising and notifications over mobile internet devices; computer hardware and software to facilitate access to payment accounts for the purpose of commerce by electronic and wireless means; magnetic encoded cards; smart cards containing an integrated circuit chip; magnetically encoded charge cards, bank cards, credit cards, debit cards and payment cards.

35 – Providing business administration and support services, including administration of superannuation funds, reporting and administration of superannuation employee benefit and investment arrangements, investment administration services and business consulting services; business advisory and consulting services; economic forecasting and analysis for business purposes; business management services rendered by business, management and organisation consultants; business research and data analysis; business information services; economic, business and market research, forecasting and analysis for business purposes; collecting information relating to market analysis and market research; advertising, marketing and promotional services; marketing services in relation to financial planning, financial services and financial advice; business administration for investment services and business consulting services; organisation, operation and management (including online) of loyalty or rewards programmes or schemes, including in relation to insurance and financial investment; sales promotion (including online) by means of loyalty or rewards programmes or schemes; advisory and information services (including online) in relation to the organisation and management of loyalty or rewards programmes or schemes; business management services; business project management; business management of client and customer relation issues; business auditing and due diligence services; business succession and business continuation advice; provision of the aforementioned services via a global computer network; administration of land and property developments.

36 – Financial services; financial services, namely, asset management services, investment management services and investment advisory services; banking services; investment services; investment services, including but not limited to investments in direct and indirect commercial/industrial real estate portfolios; insurance and financial services including whole life insurance, endowment insurance, term insurance, investment account insurance and investment linked insurance including children's policies and single premium policies; disability insurance, business expense insurance, renewal disability insurance and annuity contracts of various kinds; general insurance (terms linguistically incorrect in the opinion of the International Bureau – Rule 13 (2) (b) of the Regulations), personal incapacity insurance, house owners and householders insurance, personal property insurance and professional indemnity insurance; financial services in this class rendered by agents engaged in insurance businesses; insurance underwriting services; money management, money investment and financial investment management services; investment fund management; investment management of funds; investment of funds; management of funds; funds management services; investment banking services; financial, investment banking and financial investment administration and advice; financial asset management; comp-

liance and risk management services in relation to finance (terms too vague in the opinion of the International Bureau – Rule 13 (2) (b) of the Regulations); valuation services; risk advisory services in relation to finance and investment management services; management of investment portfolios, property, equity and mortgage unit trusts; establishment and operation of superannuation funds, personal superannuation funds and self employed superannuation funds; provision of money and other credit and lending facilities; consulting services in the fields of superannuation, financial services and insurance; banking and investment services; financial management services; financial valuations; financial information; investment information; providing information in relation to superannuation, investment, insurance, banking and financial services; actuarial, brokerage, pension, mutual funds, mortgaging and valuation services; establishment and management of investment portfolios, cash, mortgage, property, equity, unit trusts, infrastructure, fixed interest, debt, bonds, managed investment schemes, private equity, hybrid financial instruments; management of public and private equity funds; unit trust management accounts; financial investments in assets and securities; fixed interest services, namely, providing fixed interest financial products; debt management services; debt and transaction restructuring; capital raising services; financial and investment services, namely, management and brokerage in the field of bonds; managed investment schemes, namely, management and brokerage in the fields of stocks, bonds, options, commodities, futures and other securities, and the investment of funds of others; private equity fund investment services; hybrid financial instruments, namely, operation and management of hedge funds, commodity pools and other collective investment vehicles, and trading for others of securities, options, futures, derivatives, debt instruments and commodities; property investment banking, advisory and management services; property based financial services; provision of property based financial products; property investment banking services; property management services; property asset management services; wholesale and retail investment management services; real estate property development services (terms too vague in the opinion of the International Bureau – Rule 13 (2) (b) of the Regulations); property leasing services; real estate investment; real estate investment advice; real estate management including but not limited to the management of resorts, hotels, motels, retail premises, shopping centres, entertainment premises, industrial premises, office premises, residential premises and/or development sites; commercial and residential real estate management, rental and leasing; real estate services including acquisition and management for investments and leasing; buying, selling and leasing real estate (terms too vague in the opinion of the International Bureau – Rule 13 (2) (b) of the Regulations); tenant management services; fi-

nancial, investment and asset and property management services; managing mutual funds, real estate investment trusts, and other funds comprised of real estate, real estate related assets, or securities backed by real estate, interests in real estate, or real estate related assets; rental of property; real estate brokers; rent collection services; the development and management of commercial/industrial real estate assets (terms too vague in the opinion of the International Bureau – Rule 13 (2) (b) of the Regulations); management of listed and unlisted property trusts or specialised funds; wealth management and protection services (terms too vague in the opinion of the International Bureau – Rule 13 (2) (b) of the Regulations); asset origination; financial services for the securing of funds for others; services for financial lending against security and for the financing of loans; mortgaging and financial management and valuation services; wealth planning; estate planning; financial planning; sourcing, advising and managing infrastructure funding and financial assets; financial research; investment platform and wrap services advice; debt management; debt raising and structuring services, lending services; retirement payment and planning services; pension services; pension planning services; financial administration and management of pension and retirement and superannuation plans, funds and schemes; advice in relation to managing investments; issuing tokens of value in relation to customer loyalty or rewards programmes schemes, including in relation to insurance and financial investment; funding of scholarships; financial grants; provision of financial information via online tools; provision of financial information via an online calculator, savings products and financial calculation products; financial, superannuation and insurance services in this class including financial administration of superannuation funds and employee benefits advice; financial administrative services provided to industry and corporate superannuation funds, trustees and fund managers; trustee services; providing consulting, advice and management services in relation to all the aforementioned services (terms too vague in the opinion of the International Bureau – Rule 13 (2) (b) of the Regulations).

38 – Internet transmission and telecommunications services concerning business administration and support, banking, investment and financial services, superannuation and insurance; internet broadcasting services, broadcasting and streaming of audio and video recordings of events and presentations and webcasts, providing on-line forums for transmission of messages among computer users concerning the development, planning, and conducting of multimedia presentations, providing on-line chat rooms and electronic bulletin boards for transmission of messages among users in the field of general interest; telecommunications services including providing telecommunication links to the internet, including such services in rela-

tion to business administration and support, financial services, superannuation and insurance.

41 – Arranging and conducting of conferences, seminars, lectures and continuing education programs; educational services, seminars, lectures, training workshops and continuing education programs; educational services concerning superannuation, insurance, banking, investment, financial planning and financial services; computerised training; providing online electronic publications (not downloadable), including in relation to finance and insurance; consultancy, advisory and information services in relation to the aforementioned services; provision of the aforementioned services via a global computer network.

---

(260) AM 2023 120183 A

(800) 1692791

(151) 2022 03 10

(891) 2022 03 10

(731) A.C.N. 655 220 670 PTY LIMITED

c/o Company Matters Pty Limited, Level 12,  
680 George Street, Sydney NSW 2000,  
Australia

(540)

**COLLIMATE**

(591) Black, white

(531) 27.05.01

(511)

9 – Encoded credit cards, smart cards and loyalty cards and equipment for reading them; electronic publications, including but not limited to electronic publications downloadable, distributed or sold on-line; computer software; computer hardware; application software including for banking and financial purposes; interactive computer software; software adapted for use with mobile phones, computers and tablet computers; computer software for sending messages, advertising and notifications over mobile internet devices; computer hardware and software to facilitate access to payment accounts for the purpose of commerce by electronic and wireless means; magnetic encoded cards; smart cards containing an integrated circuit chip; magnetically encoded charge cards, bank cards, credit cards, debit cards and payment cards.

35 – Providing business administration and support services, including administration of superannuation funds, reporting and administration of superannuation employee benefit and investment arrangements, investment administration services and business consulting services; business advisory and consulting services; economic forecasting and analysis for business purposes; business management services rendered by business, management and organisation consultants; business research and data analysis; business information services; economic, business and market research, forecasting and analysis for business purposes; collec-

ting information relating to market analysis and market research; advertising, marketing and promotional services; marketing services in relation to financial planning, financial services and financial advice; business administration for investment services and business consulting services; organisation, operation and management (including online) of loyalty or rewards programmes or schemes, including in relation to insurance and financial investment; sales promotion (including online) by means of loyalty or rewards programmes or schemes; advisory and information services (including online) in relation to the organisation and management of loyalty or rewards programmes or schemes; business management services; business project management; business management of client and customer relation issues; business auditing and due diligence services; business succession and business continuation advice; provision of the aforementioned services via a global computer network; administration of land and property developments.

36 – Financial services; financial services, namely, asset management services, investment management services and investment advisory services; banking services; investment services; investment services, including but not limited to investments in direct and indirect commercial/industrial real estate portfolios; insurance and financial services including whole life insurance, endowment insurance, term insurance, investment account insurance and investment linked insurance including children's policies and single premium policies; disability insurance, business expense insurance, renewal disability insurance and annuity contracts of various kinds; general insurance (terms linguistically incorrect in the opinion of the International Bureau – Rule 13 (2) (b) of the Regulations), personal incapacity insurance, house owners and householders insurance, personal property insurance and professional indemnity insurance; financial services in this class rendered by agents engaged in insurance businesses; insurance underwriting services; money management, money investment and financial investment management services; investment fund management; investment management of funds; investment of funds; management of funds; funds management services; investment banking services; financial, investment banking and financial investment administration and advice; financial asset management; compliance and risk management services in relation to finance (terms too vague in the opinion of the International Bureau – Rule 13 (2) (b) of the Regulations); valuation services; risk advisory services in relation to finance and investment management services; management of investment portfolios, property, equity and mortgage unit trusts; establishment and operation of superannuation funds, personal superannuation funds and self employed superannuation funds; provision of money and other credit and lending facilities; consulting services in the fields of superannuation, financial services and insurance; banking and investment servi-

ces; financial management services; financial valuations; financial information; investment information; providing information in relation to superannuation, investment, insurance, banking and financial services; actuarial, brokerage, pension, mutual funds, mortgaging and valuation services; establishment and management of investment portfolios, cash, mortgage, property, equity, unit trusts, infrastructure, fixed interest, debt, bonds, managed investment schemes, private equity, hybrid financial instruments; management of public and private equity funds; unit trust management accounts; financial investments in assets and securities; fixed interest services, namely, providing fixed interest financial products; debt management services; debt and transaction restructuring; capital raising services; financial and investment services, namely, management and brokerage in the field of bonds; managed investment schemes, namely, management and brokerage in the fields of stocks, bonds, options, commodities, futures and other securities, and the investment of funds of others; private equity fund investment services; hybrid financial instruments, namely, operation and management of hedge funds, commodity pools and other collective investment vehicles, and trading for others of securities, options, futures, derivatives, debt instruments and commodities; property investment banking, advisory and management services; property based financial services; provision of property based financial products; property investment banking services; property management services; property asset management services; wholesale and retail investment management services; real estate property development services (terms too vague in the opinion of the International Bureau – Rule 13 (2) (b) of the Regulations); property leasing services; real estate investment; real estate investment advice; real estate management including but not limited to the management of resorts, hotels, motels, retail premises, shopping centres, entertainment premises, industrial premises, office premises, residential premises and/or development sites; commercial and residential real estate management, rental and leasing; real estate services including acquisition and management for investments and leasing; buying, selling and leasing real estate (terms too vague in the opinion of the International Bureau – Rule 13 (2) (b) of the Regulations); tenant management services; financial, investment and asset and property management services; managing mutual funds, real estate investment trusts, and other funds comprised of real estate, real estate related assets, or securities backed by real estate, interests in real estate, or real estate related assets; rental of property; real estate brokers; rent collection services; the development and management of commercial/industrial real estate assets (terms too vague in the opinion of the International Bureau – Rule 13 (2) (b) of the Regulations); management of listed and unlisted property trusts or specialised funds; wealth management and protection ser-



vices (terms too vague in the opinion of the International Bureau – Rule 13 (2) (b) of the Regulations); asset origination; financial services for the securing of funds for others; services for financial lending against security and for the financing of loans; mortgaging and financial management and valuation services; wealth planning; estate planning; financial planning; sourcing, advising and managing infrastructure funding and financial assets; financial research; investment platform and wrap services advice; debt management; debt raising and structuring services, lending services; retirement payment and planning services; pension services; pension planning services; financial administration and management of pension and retirement and superannuation plans, funds and schemes; advice in relation to managing investments; issuing tokens of value in relation to customer loyalty or rewards programmes schemes, including in relation to insurance and financial investment; funding of scholarships; financial grants; provision of financial information via online tools; provision of financial information via an online calculator, savings products and financial calculation products; financial, superannuation and insurance services in this class including financial administration of superannuation funds and employee benefits advice; financial administrative services provided to industry and corporate superannuation funds, trustees and fund managers; trustee services; providing consulting, advice and management services in relation to all the aforementioned services (terms too vague in the opinion of the International Bureau – Rule 13 (2) (b) of the Regulations).

38 – Internet transmission and telecommunications services concerning business administration and support, banking, investment and financial services, superannuation and insurance; internet broadcasting services, broadcasting and streaming of audio and video recordings of events and presentations and webcasts, providing on-line forums for transmission of messages among computer users concerning the development, planning, and conducting of multimedia presentations, providing on-line chat rooms and electronic bulletin boards for transmission of messages among users in the field of general interest; telecommunications services including providing telecommunication links to the internet, including such services in relation to business administration and support, financial services, superannuation and insurance.

41 – Arranging and conducting of conferences, seminars, lectures and continuing education programs; educational services, seminars, lectures, training workshops and continuing education programs; educational services concerning superannuation, insurance, banking, investment, financial planning and financial services; computerised training; providing online electronic publications (not downloadable), including in relation to finance and insurance; consultancy, advisory and information services in relation to the afore-

mentioned services; provision of the aforementioned services via a global computer network.

(260) AM 2023 120189 A

(800) 1693218

(151) 2022 07 11

(891) 2022 07 11

(731) Euro Games Technology Ltd.

4, "Maritsa" Str., "Vranya-Lozen-Triugulnika",  
BG-1151 Sofia, Bulgaria

(540)



(591) Yellow, orange, red, green, black, white and beige

(531) 01.15.05; 01.15.07; 27.01.12; 27.05.01;  
27.05.02; 27.05.03; 27.05.04; 27.05.09;  
27.05.25; 29.01.15

(511)

9 – Software; computer gaming software; computer software packages; computer operating system software; computer software, recorded; software drivers; virtual reality software; games software; entertainment software for computer games; computer programs for network management; operating computer software for main frame computers; monitors (computer hardware); computer hardware; apparatus for recording images; monitors (computer programs); computer game programs; computer programs for recorded games; apparatus for recording, transmission or reproduction of sound or images; communications servers [computer hardware]; electronic components for gambling machines; computer application software featuring games and gaming; computer software for the administration of on-line games and gaming; computer hardware for games and gaming; hardware and software for gambling, gambling machines, gambling games on the Internet and via telecommunication network.

28 – Gaming machines for gambling; chips for gambling; mah-jong; arcade games; gambling machines operating with coins, notes and cards; games; electronic games; parlor games; gaming chips; gaming tables; slot machines [gaming machines]; LCD game machines; slot machines and gaming devices; coin-operated amusement machines; roulette chips; poker chips; chips and dice [gaming equipment]; gaming equipment for casinos; roulette tables; gaming roulette wheels; casino games; gambling machines and amusement machines, automatic and coin-operated; coin-operated amusement machines and/or electronic coin-operated amusement machines with or without the possibility of gain; boxes for coin-operated machines, slot machines and gaming machines; electronic or electrotechnical amusement machines and apparatus,



gaming machines, coin-operated entertainment machines; housings for coin-operated machines, gaming equipment, gaming machines, machines for gambling; electropneumatic and electrical gambling machines (slot machines).

41 – Gambling; entertainment services related to gambling; gaming services for entertainment purposes; casino, gaming and gambling services; training in the development of software systems; provision of gaming equipment for gambling halls; providing casino equipment [gambling]; gaming machine entertainment services; providing casino facilities [gambling]; gaming hall services; amusement arcade services; games equipment rental; rental of gaming machines; providing amusement arcade services; rental of gaming machines with images of fruits; editing or recording of sounds and images; sound recording and video entertainment services; hire of sound reproducing apparatus; provision of gaming equipment for casinos; providing of casino facilities; online gambling services; casino, gaming and gambling services; provision of gaming facilities, gaming hall facilities, Internet casinos and online gambling services.

(260) AM 2023 120190 A

(800) 1693245

(151) 2022 04 12

(891) 2022 04 12

(731) Stradivarius España, S.A.

Polígono Industrial de Sabón, Avenida de la Diputación, s/n, E-15142 Arteixo (A Coruña), Spain

(540)



(591) Black, white

(531) 24.17.11; 24.17.13; 26.01.03; 26.01.16

(511)

3 – Non-medicinal toiletry preparations and cosmetic products; non-medicinal dentifrices; perfumery products; essential oils; bleaching preparations and other substances for laundry use; laundry preparations; polishing preparations; degreasing substances; cleaning products; non-medicinal soaps; cosmetics; non-medicinal hair lotions; shoe creams and polishes; tailors' wax; shoemakers' wax; waxes for leather; depilatory wax; laundry wax; parquet floor wax; shampoos; cosmetic kits; depilatory products; make-up removing preparations; deodorants for human beings or animals [perfumery products]; lipsticks; pencils for cosmetic use; hair sprays; nail varnish; lacquer-removing products; tissues impregnated with cosmetic lotions; cloths impregnated with a detergent for cleaning; af-

ter-shave lotions; lotions for cosmetic use; make-up products; pomades for cosmetic use; stain removers; products for perfuming linen; nail care products; bleaches for cosmetic use; extracts of flowers [perfumery products]; incense; scented wood; decorative patterns for cosmetic use; adhesives for false eyelashes, hair and nails; pumice stone; potpourris [fragrances]; cosmetic preparations for slimming; bath preparations for cosmetic use; hair waving preparations; detergents for laundrettes; toiletries; oral hygiene products other than for medical use; bath salts other than for medical use; oils for toiletry purposes; sunscreen products; eau de Cologne; deodorant soaps; talcum powder, for toilet use; adhesives for cosmetic use; greases for cosmetic use; abrasives; shaving products; color-brightening chemicals for household use (laundry); cotton sticks for cosmetic use; beauty masks; mustache wax; bleaching products for household use; hair colorants; eyebrow cosmetics; cleaning chalk; shampoos for pets [non-medicinal sanitary preparations]; cosmetics for animals; cosmetic creams; bars of soap; antiperspirant deodorants; detergents; laundry starch; cleansing milk for toilet purposes; Javelle water; dry-cleaning products; scented water; perfumes; cosmetic preparations for eyelashes; cosmetic products for skin care; make-up powder; adhesives for affixing false hair; fabric softeners for laundry use; cosmetic dyes; color-removing products; eau de toilette; body gels; Effervescent bath bombs; exfoliants; fragrances for the home; air fragrance reed diffusers.

4 – Industrial oils and greases, lubricants; products for absorbing dust; fuels; candles [lighting]; perfumed candles; wicks for lighting; greases for preserving leather; leather preservatives [oils and greases].

9 – Scientific, research, navigation, surveying, photographic, cinematographic, audiovisual, optical, weighing, measuring, signaling, detecting, testing, inspecting, life-saving and teaching apparatus and instruments; apparatus and instruments for conducting, switching, transforming, accumulating, regulating or controlling electricity distribution or consumption; sound, image or data recording, transmission, reproduction or processing apparatus and instruments; recorded or downloadable media, software, blank digital or analog recording and storage media; mechanisms for coin-operated apparatus; cash registers, calculating devices; computers and computer peripherals; diving suits, diving masks, earplugs for divers, nose clips for divers and swimmers, gloves for divers, breathing apparatus for underwater swimming; fire extinguishers; computer peripheral devices; anti-glare glasses; pince-nez; optical lenses; pince-nez chains; contact lenses; pince-nez cords; spectacles (optics); spectacle lenses; spectacle cases; frames for spectacles and pince-nez; sunglasses; cases for pince-nez and for contact lenses; shoes for protection against accidents, irradiation and fire; bullet-proof vests; life jackets; clothing for protection against accidents, irradiation and fire; gloves

for divers; gloves for protection against accidents; diving suits; encoded magnetic cards; protective suits for aviators; electronic agendas; telephone apparatus; weighbridges (weighing apparatus); directional compasses; accounting machines; protective helmets; telescopes; chronographs (time recording apparatus); measuring spoons; pedometers; optical compact disks; mirrors (optics); binoculars (optics); temperature indicators; computer game software; cassette players; bar code readers; signal, magic and optical lanterns; magnifying glasses (optics); dictating machines; mechanisms for counter-operated apparatus; weights; electric, galvanic and solar cells and batteries; recorded computer programs; electronic pocket translators; transistors (electronics); thermometers not for medical use; intercommunication apparatus; video cassettes; animated cartoons; walkie-talkies; downloadable electronic publications; egg timers [sandglasses]; acoustic (sound) alarms; anti-theft alarms; fire alarms; mouse pads; loudspeakers; amplifiers; antennas; anti-glare visors; headphones; answering machines; counterfeit coin detectors; teeth protectors; money counting and sorting machines; apparatus for measuring the thickness of skins and leather; electronic tags for goods; spectacles for sports; magnets; light-emitting electronic pointers; mobile telephones; enlarging apparatus (photography); apparatus and instruments for astronomy; thermionic (radio) valves; coin-operated musical automata [juke boxes]; scales; life-saving rafts; magnetic tape recorders; head cleaning tapes; video tapes; magnetic tapes; demagnetizing apparatus for magnetic tapes; barometers; ticket dispensers; thermostats; cameras [photography]; cinematographic apparatus; video cameras; video game cartridges; magnetic encoders; revolution counters; transparencies; slide projectors; dynamometers; reflecting discs for wear, for the prevention of traffic accidents; hemline markers; dosage dispensers; covers for electric outlets; radiotelephony sets; scanners (data processing equipment) (computing); flash-bulbs (photography); photocopiers; holograms; compact disc players; luminous signs; neon signs (advertising); video recorders; megaphones; computer memory devices; microphones; microprocessors; modems; diving snorkels; objectives (lenses) (optics); ozonizers; projection screens; electric switches; dog whistles; push buttons for bells; radios; receivers (audio, video); wrist rests for use with computers; balances (steelyards); television apparatus; record players; word processing equipment; video telephones; carrying cases and covers for laptops, cases and covers for mobile telephones, for smartphones, protective cases and covers for digital book readers; smartphones; smart watches; magnetic wires; radiological apparatus for industrial use; personal stereos; mobile applications; downloadable software; wearable activity trackers.

14 – Precious metals and their alloys; jewelry articles; precious and semi-precious stones; timepieces; chronometric instruments; time-measuring instru-

ments; ornamental pins; tie pin; works of art of precious metal; novelty key rings of precious metals; medals; coins; badges of precious metal; footwear ornaments of precious metal; hat ornaments of precious metal; cuff links; pendants for watch chains; watch chains; watch cases; threads of precious metal (jewelry); jewelry cases; ornamental pins [jewelry]; decorative brooches [jewelry]; jewelry of yellow amber; amulets (jewelry); rings (jewelry); jet ornaments; bracelets (jewelry); brooches (jewelry); chains (jewelry); boxes of precious metal; necklaces (jewelry); tie clips; watch glasses; chronographs (watches); alarm clocks; diamonds; charms (jewelry); costume jewelry; cases for jewelry; costume jewelry; medallions (jewelry); earrings; pearls (jewelry); watch straps; grandfather clocks; rosaries; wristwatches.

16 – Paper and cardboard; printing products (printed matter); bookbinding material; photographs; stationery and office supplies, except furniture; adhesives (glues) for stationery or household use; artists' materials and drawing materials; paintbrushes; instructional or teaching material; sheets, films and bags of plastic materials for wrapping and packaging; printing type, printing blocks; works of art (engravings); boxes of cardboard or paper; printed patterns for dressmaking; tissues of paper for removing make-up; stencil cases; labels of paper or cardboard; table linen of paper; table napkins of paper; handkerchiefs (of paper); pen cases; checkbook cases; writing cases [sets]; inking sheets for duplicators; plastic sachets for packaging; tailors' chalk; tailors' soap; face towels of paper; hat boxes of cardboard; tracing cloth; bookbinding cloth; fabric for painting (canvas); towels of paper; albums; almanacs; hand-labeling apparatus; files [office requisites]; writing instruments; transfers (decals); calendars; posters; document files; catalogs; trading cards; drawing sets; newspapers; periodicals; magazines (periodicals); books; lithographs; wrapping paper; toilet paper; paperweights; mats for beer glasses; bookmarkers; book ends; inks; inkwells; bibs of paper; drawing materials; drawings (graphics); school supplies [stationery]; writing slates; comic books; trays for sorting and counting money; embroidery designs; garbage bags made of paper or plastic materials; geographical maps; terrestrial globes; moisteners [office requisites]; modeling materials; plans; stencils (stationery); paper or cardboard placards; cards; steel letters; steel pens; aquarelles; adhesive tape dispensers (stationery); adhesive tapes for stationery or household use and adhesive bands for stationery or household use; stickers (stationery goods); cigar bands (vitolas); files (office requisites); modeling clay; arithmetical tables; drawer liners of paper, perfumed or not; architects' models; atlases; flags of paper; tickets; pads; ball-point pens; bags for microwave cooking; writing board erasers; rubber erasers; erasing products; bottle wrappers of cardboard or paper; painters' easels; song books; charcoal pencils; letter paper (finished products); advertisement boards of paper or cardboard;

booklets; ink sticks; wax for modeling other than for dental use; sealing wax; thumbtacks (stationery); ribbons of paper for wrapping gifts; paper bows for wrapping gifts; inking ribbons for computer printers; ribbons for typewriters; clip boards (office requisites); desk organizers for stationery [office requisites]; compasses for drawing; paper clasps; paper cutters (letter openers); writing or drawing books; paintings (pictures), framed or unframed; finger-stalls (office requisites); bookbinding material; gummed cloth for stationery purposes; inking pads; drawing squares (rulers); shields (paper seals); greeting cards; filter paper; book covers; photograph stands; rubber bands for office use; stapling presses (office requisites); staples (office requisites); loose leaf paper (stationery); electric or non-electric pencil sharpeners; pencil holders; luminous paper; palettes for painters; silver paper; waxed paper; modeling paste; office perforators; painters' brushes; rollers for painters; postcards; publications; desk blotters; envelopes (stationery); stickers.

18 – Leather and imitation leather; animal skins; trunks and suitcases; umbrellas, parasols and walking sticks; whips, harness and saddlery; bags for climbers; camping and beach bags; handbag frames; frames for umbrellas or parasols; alpenstocks; sports bags; net bags for shopping; travel bags; bags (envelopes, pouches) of leather for packaging; bags (purses); bags; traveling sets (leatherware); key cases; attaché cases; coin purses, not of precious metal; leather backpacks for carrying infants; wheeled shopping bags; boxes of leather or leatherboard; boxes of vulcanized fiber; card cases (wallets); wallets; satchels (handbags); school satchels; vanity cases; collars for animals; dog leashes; leather laces; umbrella covers; covers for horse-saddles; haversacks; backpacks; reins; leather laces; suitcase handles; handles for walking sticks and umbrellas; whips; horse blankets; furniture coverings of leather; clothing for animals; umbrella rings; blinders (harness); harnesses for animals; harness for animals; harness fittings; walking stick seats; shoulder belts [straps] of leather; empty tool bags of leather; muzzles; bridles [harness]; halters; leather board; bands of leather; traveling trunks; re-usable shopping bags; straps for soldiers' equipment; harness straps; straps of leather (saddlery); straps for skates; trimmings of leather for furniture; leather straps; butts [parts of hides]; curried skins; covers and blankets for animals; stirrups; parts of rubber for stirrups; bits for animals (harness); reins made of rope; attaché cases; moleskin (imitation of leather); chamois leather other than for cleaning purposes; nosebags; casings, of leather, for springs; knee-pads for horses; horse riding saddles; fastenings for saddles; straps (harnesses); valves of leather.

25 – Clothing, footwear, headwear; clothing for motorists and cyclists; bibs not of paper; headbands (clothing); bath robes; bathing suits; bathing caps and sandals; boas (clothing); scarves; sports shoes and beach

shoes; hoods (clothing); shawls; belts (clothing); money belts (clothing); wet suits for water-skiing; neckties; girdles [corsets]; fur stoles; foulards; caps [headwear]; caps; gloves (clothing); raincoats; girdles (underwear); body linen [garments]; mantillas; stockings; socks; neckerchiefs; furs (clothing); pajamas; soles (for footwear); heels; veils [clothing]; suspenders; layettes (clothing); capes (clothing); sports jerseys; mittens; ear muffs (clothing); inner soles; wristbands (clothing); dress shields; beach wear; dressing gowns; pockets for clothing; sock suspenders; stocking suspenders; petticoats; tights; aprons (clothing); masquerade costumes; uniforms; cap peaks; wooden shoes; caps; coats; esparto shoes or sandals; non-slip devices for footwear; bath slippers; academic caps; blouses; bodies (clothing); berets; footmuffs, not electrically heated; lace boots; boots; boot uppers; studs for football boots; half-boots; fittings of metal for footwear; tips for footwear; heelpieces for footwear; shirts; shirt yokes; shirt fronts; T-shirts; short-sleeved tee-shirts; bodices [lingerie]; vests; jackets; fishing vests; stuff jackets; slippers (underwear); ready-made clothing; detachable collars and collars; clothing of leather; clothing of imitation leather; shower caps; slippers; skirts; trousers; ready-made linings (parts of clothing); overcoats (coats); trench coats (clothing); gymnastic shoes; jerseys (clothing); pullovers; sweaters; liveries; muffs (clothing); footwear uppers; pocket squares; parkas; pelerines; pelisses; spats; leggings; knitwear [clothing]; clothing for gymnastics; underwear; sandals; saris; underpants; hats; wimples (clothing); to-gas; trouser straps; suits; turbans; dresses; slippers; shoes; sports footwear.

26 – Lace and embroidery, ribbons and braid; buttons, hooks and eyes, pins and needles; artificial flowers; hair ornaments; hairpieces; trimmings for clothing; boxes for needles; pin and needle cushions; shoe ornaments, other than of precious metals; hat ornaments, not of precious metal; haberdashery, except threads; hair bands; armbands; brooches [clothing accessories]; sewing boxes; belt clasps; shoe laces; wreaths of artificial flowers; ornamental badges; thimbles [for sewing]; tiaras (diadems); needle cases; buckles [clothing accessories]; buckles [for footwear]; shoulder pads for clothing; hair pins; badges for wear not of precious metal; spangles for clothing; numbers or letters for marking linen; bodkins; hair slides; lace trimmings; feathers [clothing accessories]; top-knots (pompoms); picot [lace]; zipper fasteners [haberdashery]; competitors' numbers; heat-adhesive patches for decorating textile articles [haberdashery]; rug hooks; snap fasteners; ostrich feathers [clothing accessories]; whalebones for corsets; prize ribbons; rimming cords for clothing; tassels [haberdashery]; expanding bands for holding sleeves; hair nets; shoe eyelets; chenille [passementerie]; frills [lacework]; pant clips for cyclists; fastenings for clothing; hook and pile fastening tapes; elastic ribbons; tapes for curtain headings; cords for clothing; collar supports;

false hems; rosettes [passementerie]; festoons [embroidery]; fringes; artificial fruit; braids; hair coloring caps; artificial garlands; darning lasts; trimmings for clothing; tresses of hair; wigs; silver embroidery for clothing; edgings for clothing; rosettes [haberdashery]; fastenings for suspenders; skirt flounces; braids; toupees; shoe hooks.

35 – Advertising services; commercial business management; commercial administration; office functions; retail and wholesale services in stores, via global computer networks, by catalog, by mail order, by telephone, via radio and television, and via other electronic means for tanning substances, adhesives for industry, colors, varnishes, lacquers, colorants, inks for leather, indigo [colorant], inks for skin-dressing, preparations for bleaching and other substances for laundry use, preparations for cleaning, preparations for polishing, preparations for scouring and abrading [abrasive preparations], soaps, perfumery, essential oils, cosmetics, hair lotions, dentifrices, shaving preparations, waxes, shampoos, cosmetic kits, depilatory products, deodorants for personal use [perfumery], make-up products, products for perfuming linen, incense, eau de cologne, perfumes, lubricants, candles, deodorants other than for human beings or for animals, common metals and their alloys, chests of metal, metal coin banks, metal hangers, knobs not of metal, handles of metal, door handles of metal, cutlery, forks and spoons, razors and razor blades, manicure sets, razor sets and cases, scientific apparatus and instruments, nautical apparatus and instruments, surveying apparatus and instruments, photographic apparatus and instruments, cinematographic apparatus and instruments, optical apparatus and instruments, weighing apparatus and instruments, measuring apparatus and instruments, signaling apparatus and instruments, checking [supervision] apparatus and instruments, life-saving apparatus and instruments, teaching apparatus and instruments, apparatus and instruments for conducting electricity, distributing electricity, transforming electricity, accumulating electricity, regulating electricity, controlling electricity, apparatus for recording sound or images, transmission of sound or images, reproduction of sound or images, recording discs, automatic vending machines and mechanisms for coin-operated apparatus, cash registers, data processing equipment and computers, fire-extinguishers, computer peripherals, contact lenses, pince-nez cords, dressmakers' measures, spectacle cases, pince-nez cases and for contact lenses, eyeglass frames and pince-nez, spectacles [optics], sunglasses, magnetic cards, telephone apparatus, protective helmets, chronographs [time recording apparatus], audio-video compact discs, printers for computers, game programs, bar code readers, magnifying glasses [optics], computer programs [recorded programs], mouse [computer], apparatus for games intended for use with television receivers only, intercommunication apparatus, electronic publications [electronically downloadable], hourglasses, music

helmets, mousepads, protective helmets for sports, goggles for sports, memories for computers, apparatus for lighting, apparatus for heating, apparatus for steam generating, apparatus for cooking, apparatus for refrigerating, apparatus for drying, apparatus for ventilating, apparatus for water distribution and sanitary installations, lanterns, lamp globes, lamps, lanterns, displays, vehicles, safety seats for children [for vehicles], seat covers for vehicles, bicycles, structural parts for bicycles, supporting parts for bicycles, parts and accessories for land vehicles, baby carriages with removable infant carriers, covers for baby carriages, dashboards for baby carriages, covers and hoods for baby carriages, vehicle safety restraints for use with baby carriages, carriages for children, sheath, soft tops, awnings, built-in baby carriages, all being for baby carriages, precious metals and their alloys, jewelry, costume jewelry, precious stones, horological and chronometric instruments, ornamental pins, key rings [trinkets or fobs], badges of precious metals, ornaments for footwear and hats of precious metals, cuff links, wrist watches, cases for clock-and watch-making, bracelets for watches, jewelry cases, charms [jewelry], pearls [jewelry], earrings, rings, musical instruments, music boxes, cases for musical instruments, paper, cardboard, printed matter, publications, photographs, stationery, adhesives for stationery or household use, materials for artists, paint brushes, office requisites [except furniture], instructional and teaching material [except apparatus], plastic materials for packaging, boxes of cardboard or paper, hat boxes, albums, almanacs, calendars, posters, catalogs, wrapping paper, paperweights, mats for placing under beer glasses [discs], book markers, book clips, terrestrial globes, leather and imitations of leather, animal skins, hides, trunks and suitcases, umbrellas, parasols and walking sticks, whips and saddlery, bags for climbers, bags for campers, bags for the beach, handbag frames, frames for umbrellas or parasols [sun umbrellas], mountaineering sticks, bags, handbags, traveling bags, travel and key cases [leatherware], attaché cases, purses other than of precious metals, school satchels, sacks, garment bags [for travel], bags of leather [or fabric], for carrying children, wheeled shopping bags, boots and boxes of leather or leather board, wallets [folders], pocket wallets, wallets [leather goods], collars for animals, backpacks, attaché cases, moleskin [imitation of leather], furniture, mirrors, picture frames, fans for personal use, pillows, curtain tie-backs, benches [furniture], table trays, chests for toys, folding partition screens, boxes of wood or plastic materials, beds, settees, baskets not of metal, cushions, mattresses, cradles, desks [furniture], racks, jewelry boxes other than of precious metals, tables, umbrella stands, clothing and hat stands, coat stands, door handles not of metal, writing desks, chairs, armchairs, sofas, stools, bottle stoppers, high chairs for children, household and kitchen utensils and containers [other than of of precious metals], combs and

sponges, brushes [except paint brushes], glassware, porcelain and earthenware, bottle openers, cruet stands for oil and vinegar, candle extinguishers, sugar bowls, trays, bowls, tea balls, candy boxes, bottles, boxes, shoe horns, candelabras, epergnes, picnic baskets with tableware, cocktail shakers, buckets for preserving ice, ice buckets, decanters, salad bowls, dishes, shoe trees [stretchers], piggy banks, not of metal, soap boxes, jugs, vases, bird cages, butter dishes, plates, porcelain knobs, coasters, not of paper and other than table linen, perfume burners, crumb trays, plate-rests, corkscrews, salt cellars, tea and coffee sets, napkin holders, soup bowls, cups, mugs, teapots, tableware, drinking glasses, cruets, ropes, strings, nets, tents, sacks, padding materials [except of rubber or plastics materials], duvets [feathers], threads and yarns for textile use, textiles and textile goods, bed and table linen, bath linen [excluding clothing], towels of textile materials, traveling rugs, eiderdowns [down coverlets], covers for cushions, sleeping bags [sewn covers substituting sheets], bedspreads, table cloths [other than of paper], sheets, table napkins [of textile materials], bed covers, pillowcases, bed blankets, ready-to-wear clothing for women, ready-to-wear clothing for men and boys, footwear [except orthopedic footwear], headwear, apparel for motorists and cyclists, bibs, other than of paper, headbands [apparel], bath robes, bathing suits, bathing caps and sandals, boas [for wearing around the neck], underwear, scarves, hoods [clothing], shawls, belts [apparel], money belts [clothing], water ski suits, neckties, sashes for wear, fur stoles, girdles, scarves, beanies, caps, gloves [apparel], lingerie, underwear, mantillas, stockings, socks, ascots, pocket squares [clothing], pyjamas, veils [clothing], suspenders, gym and sports suits, layettes, maillots, mittens, ear muffs [clothing], bow ties, pareos, masquerade costumes, visors [headwear], dressing gowns, petticoats, tights [complete stockings or leotards], aprons [clothing], headdresses [headwear], clogs, hair coverings, caps [bonnets], blouses, teddies [underwear], berets, footmuffs for heating the feet, other than electric, boots, shirts, slippers [clothing], collars, pelerines, spats [stockings], sari, brassieres, bras, togas, turbans, lace and embroidery, ribbons and braids, buttons, hooks and eyes, pins and needles, artificial flowers, hair ornaments, shoe and hat ornaments [other than of precious metals], hair bands, carpets, rugs, mats, paper for lining and decorating, wallpaper, games, toys, gymnastic and sporting articles, decorations for Christmas trees, meat, fish [not live], poultry and game, meat extracts, fruits and green vegetables, preserved vegetables and pulses, frozen vegetables and green vegetables, dried and cooked pulses, jellies, jams, compotes, eggs, milk and milk products, edible oils and fats, pastry and confectionery products, ices, honey, treacle, yeast, baking powder, salt, mustard, vinegar, sauces [condiments], spices, ice, agricultural products, horticultural products, forestry products and grains, live animals, fresh

fruits and green vegetables, fresh vegetables and pulses, seeds, natural plants and flowers, foodstuffs for animals, malt, beer, mineral and aerated waters, non-alcoholic beverages, fruit drinks and fruit juices, syrups and other preparations for making beverages, alcoholic beverages [except beer], tobacco, smokers' articles, matches, cigar boxes [with humidifier], cigarette boxes, tobacco pouches, cigarette cases, ashtrays for smokers, lighters for smokers; commercial or industrial company management and operation assistance services; organization of exhibitions for commercial or advertising purposes; promotion of third-party goods and services through loyalty card programs; modeling for advertising or sales promotion; editing of advertising texts; shop-window dressing; services providing assistance with the operation of a franchised business; demonstration of goods; organization of trade fairs for commercial or advertising purposes; sales promotion to third parties; auctioneering; promotion and management of shopping malls; import-export agencies; on-line advertising on computer networks; procurement services for others (purchasing of goods and services for other businesses); newspaper subscription services (for others); dissemination of advertising material, in particular leaflets, prospectuses, printed matter, samples; computer file management; public relations; commercial information agencies; advertising agencies; rental of vending machines; rental of advertising space; dissemination of advertisements; business management assistance; data search in computer files (for others); compilation of data in computer databases; transcription of communications; distribution of advertising matter by mail; business management of performing artists; updating of advertising material; document reproduction; market study; bill posting (ads); opinion polling; systemization of information into computer databases; advertising; advertising by mail order; radio advertising; television advertising; presentation of goods on communication media for retail purposes.

(260) AM 2023 120222 A

(800) 1557037

(151) 2020 09 07

(891) 2022 10 18

(731) ASC REGENCY LIMITED

7 The Old Laundry Alexandre Studios,  
Haydon Way, LONDRES SW1 11YF,  
United Kingdom

(540)

## **AUGUSTINUS BADER**

(591) Black, white

(511)

3 – Bleaching preparations and other substances for laundry use; cleaning, polishing, degreasing and abrasive preparations; soaps not for medical use; perfumery, essential oils, non-medicinal cosmetics, cosmetics for skin rejuvenation and skin health, cosmetics for

skin care and protection; hair lotions; shampoos; dentifrices other than for medical use; incense; deodorants for personal use.

5 – Pharmaceutical products, pharmaceutical products for activating endogenous stem cells and repairing their microenvironment, medical and veterinary products; vitamin preparations; hygienic products for medical purposes; dietetic substances and foodstuffs for medical or veterinary use, food for babies; food supplements for humans and animals, food products and supplements for the recovery of patients; plasters, materials for dressings; material for dental fillings and dental impressions; disinfectants; products for destroying vermin; fungicides, herbicides; beverages and food enriched with vitamins for medical use; energy beverages and foodstuffs for medical use.

10 – Surgical, medical, dental and veterinary apparatus and instruments, therapeutic instruments for the treatment of blood, bone marrow or adipose tissue for use in the context of personalization procedures; artificial limbs, eyes and teeth; orthopedic articles; suture material; therapeutic and assistance apparatus for handicapped persons; massage apparatus.

41 – Education services, precision personalized medical academy, postgraduate university education for medical professionals; training; entertainment; sporting and cultural activities.

44 – Medical services, medical and therapeutic services in the field of precision, individualized and personalized medicine; therapeutic process services in the context of point of intervention operations; veterinary services; hygienic and beauty care for human beings or animals; balneotherapy and hydrotherapy treatments; provision of Turkish bath facilities; Turkish baths; rest homes; information services in the field of hygienic and beauty care; preparation of medicines and preparation of pharmaceutical products for customized medical approaches.

(260) AM 2023 120223 A

(800) 1557360

(151) 2020 09 07

(891) 2022 10 18

(731) ASC REGENITY LIMITED

7 The Old Laundry Alexandre Studios,  
Haydon Way, LONDRES SW1 11YF,  
United Kingdom

(540)

## TRIGGER FACTOR COMPLEX TFC

(591) Black, white

(511)

1 – Chemical compositions and materials for the cosmetic and food industry; reagents for medical research; vitamins for the manufacture of cosmetics; anti-

oxidants for the manufacture of cosmetics; chemical products for use in the pharmaceutical industry; preservatives for use in the pharmaceutical industry; chemical preparations for use in the manufacture of pharmaceutical products.

3 – Soaps other than for medical use; perfumery, essential oils, non-medicinal cosmetics, cosmetics for skin rejuvenation and skin health, cosmetics for skin care and protection; hair lotions; shampoos; dentifrices other than for medical use; deodorants for personal use.

5 – Pharmaceutical products; pharmaceutical products for activating endogenous stem cells and repair of their microenvironment; medical and veterinary products; vitamin preparations; hygienic products for medical or veterinary use; food for babies; food supplements for humans and animals; food supplements and products for recovery of patients; foodstuffs and beverages enriched with vitamins for medical use; energy beverages and foodstuffs for medical use.

(260) AM 2023 120224 A

(800) 1614369

(151) 2021 05 31

(891) 2022 10 18

(731) ASC Regenity Limited

7 The Old Laundry, Alexander Studios,  
Haydon Way, LONDRES SW11 1YF,  
United Kingdom

(540)



(591) Blue: Pantone Reflex Blue C, copper: Pantone Foilco 6735

(531) 26.04.02; 26.04.05; 26.04.18; 26.04.24;  
27.05.10; 27.05.22; 27.05.24; 29.01.13

(511)

3 – Soaps other than for medical use; perfumery, essential oils, non-medicinal cosmetics, cosmetics for skin rejuvenation and skin health, cosmetics for skin care and protection; hair lotions; shampoos; dentifrices other than for medical use; incense; deodorants for personal use.

5 – Pharmaceutical products, pharmaceutical products for activating endogenous stem cells and repairing their microenvironment, medical products for activating endogenous stem cells and repairing their microenvironment; vitamin preparations; hygienic products for medicine; dietetic substances and foodstuffs for medical use, food for babies; food supplements for

human beings; food products and supplements for patient recovery (food products for special diets under medical supervision); plasters, materials for dressings; disinfectants; beverages and food enriched with vitamins for medical use; energy beverages and foodstuffs for medical use.

10 – Surgical and medical apparatus and instruments; therapeutic instruments for the treatment of blood, bone marrow or adipose tissue for use in the framework of personalization procedures; orthopedic articles; suture material; therapeutic and assistance apparatus for handicapped persons; massage apparatus.

41 – Education services, precision personalized medical academy, postgraduate university education for medical professionals; training; entertainment; sporting and cultural activities.

44 – Medical services, medical and therapeutic services in the field of precision, individualized and personalized medicine; therapeutic process services in the context of point of intervention operations; hygienic and beauty care for human beings; balneotherapy and hydrotherapy treatments; provision of Turkish bath facilities; Turkish baths; rest homes; information services in the field of hygienic and beauty care; preparation of medicines and preparation of pharmaceutical products for customized medical approaches.

---

(260) AM 2023 120290 A

(800) 1694801

(151) 2022 07 11

(891) 2022 07 11

(731) Euro Games Technology Ltd.

4, "Maritsa" Str., "Vranya-Lozen-Triugulnika",  
BG-1151 Sofia, Bulgaria

(540)



The logo for 'SHINING DIAMOND' features the word 'SHINING' in a bold, blue, 3D-style font with a white outline, and 'DIAMOND' in a similar bold, red, 3D-style font with a white outline. The letters are set against a dark, reflective background that makes them appear to be floating or resting on a surface.

(591) Blue, red, yellow, white, black and cyan

(531) 01.01.05; 01.15.09; 27.05.01; 27.05.02;

27.05.03; 27.05.04; 27.07.01; 27.07.02;

27.07.03; 29.01.15

(511)

9 – Software; computer gaming software; computer software packages; computer operating system software; computer software, recorded; software drivers; virtual reality software; games software; entertainment software for computer games; computer programs for network management; operating computer software for main frame computers; monitors (computer hardware); computer hardware; apparatus for recording images; monitors (computer programs); computer game programs; computer programs for recorded games; apparatus for recording, transmission or reproduction of sound or images; communications servers [computer hardware]; electronic components for gambling machines; computer application software featuring games and gaming; computer software for

the administration of on-line games and gaming; computer hardware for games and gaming; hardware and software for gambling, gambling machines, gambling games on the Internet and via telecommunication network.

28 – Gaming machines for gambling; chips for gambling; mah-jong; arcade games; gambling machines operating with coins, notes and cards; games; electronic games; parlor games; gaming chips; gaming tables; slot machines [gaming machines]; LCD game machines; slot machines and gaming devices; coin-operated amusement machines; roulette chips; poker chips; chips and dice [gaming equipment]; gaming equipment for casinos; roulette tables; gaming roulette wheels; casino games; gambling machines and amusement machines, automatic and coin-operated; coin-operated amusement machines and/or electronic coin-operated amusement machines with or without the possibility of gain; boxes for coin-operated machines, slot machines and gaming machines; electronic or electrotechnical amusement machines and apparatus, gaming machines, coin-operated entertainment machines; housings for coin-operated machines, gaming equipment, gaming machines, machines for gambling; electropneumatic and electrical gambling machines (slot machines).

41 – Gambling; entertainment services related to gambling; gaming services for entertainment purposes; casino, gaming and gambling services; training in the development of software systems; provision of gaming equipment for gambling halls; providing casino equipment [gambling]; gaming machine entertainment services; providing casino facilities [gambling]; gaming hall services; amusement arcade services; games equipment rental; rental of gaming machines; providing amusement arcade services; rental of gaming machines with images of fruits; editing or recording of sounds and images; sound recording and video entertainment services; hire of sound reproducing apparatus; provision of gaming equipment for casinos; providing of casino facilities; online gambling services; casino, gaming and gambling services; provision of gaming facilities, gaming hall facilities, Internet casinos and online gambling services.

---

**INTERNATIONAL TRADEMARKS PROTECTED IN GEORGIA**

(260) AM 2023 113172 A  
(800) 1078160  
(151) 2010 12 03  
(181) 2030 12 03  
(891) 2021 03 18  
(511) 34

---

(260) AM 2023 116046 A  
(800) 1636568  
(151) 2021 04 14  
(181) 2031 04 14  
(891) 2021 04 14  
(511) 08, 09, 10, 11, 20, 25, 28, 29, 30, 31, 32, 36, 38,  
40, 41, 43, 44, 45

---

(260) AM 2023 116096 A  
(800) 1637223  
(151) 2021 05 10  
(181) 2031 05 10  
(891) 2021 05 10  
(511) 12, 35

---

(260) AM 2023 116179 A  
(800) 1638471  
(151) 2021 08 10  
(181) 2031 08 10  
(891) 2021 08 10  
(511) 26

---

(260) AM 2023 116602 A  
(800) 1644058  
(151) 2021 05 10  
(181) 2031 05 10  
(891) 2021 05 10  
(511) 07, 09, 12, 35, 37

---

(260) AM 2023 117774 A  
(800) 1660857  
(151) 2021 05 21  
(181) 2031 05 21  
(891) 2021 05 21  
(511) 07, 09, 11, 12, 17, 19, 20, 35, 37, 41

---

(260) AM 2023 118100 A  
(800) 1665131  
(151) 2022 03 22  
(181) 2032 03 22  
(891) 2022 03 22  
(511) 33

---

(260) AM 2023 118101 A  
(800) 1665191  
(151) 2022 03 10  
(181) 2032 03 10  
(891) 2022 03 10  
(511) 09, 35, 36, 38, 41

---

(260) AM 2023 118102 A  
(800) 1665233  
(151) 2021 11 10  
(181) 2031 11 10  
(891) 2021 11 10  
(511) 29

---

(260) AM 2023 118103 A  
(800) 1665240  
(151) 2022 01 28  
(181) 2032 01 28  
(891) 2022 01 28  
(511) 06, 11, 20, 21

---

(260) AM 2023 118104 A  
(800) 1665249  
(151) 2021 10 20  
(181) 2031 10 20  
(891) 2021 10 20  
(511) 33

---

(260) AM 2023 118105 A  
(800) 1665290  
(151) 2021 09 17  
(181) 2031 09 17  
(891) 2021 09 17  
(511) 09, 35, 36, 38, 39, 41, 42, 43, 45

---

(260) AM 2023 118106 A  
(800) 1665314  
(151) 2021 12 30  
(181) 2031 12 30  
(891) 2021 12 30  
(511) 10

---

(260) AM 2023 118107 A  
(800) 1665317  
(151) 2022 01 13  
(181) 2032 01 13  
(891) 2022 01 13  
(511) 09, 28, 41

---



(260) AM 2023 118108 A  
(800) 1665318  
(151) 2022 01 10  
(181) 2032 01 10  
(891) 2022 01 10  
(511) 41

---

(260) AM 2023 118194 A  
(800) 1666812  
(151) 2022 05 18  
(181) 2032 05 18  
(891) 2022 05 18  
(511) 18, 25, 28

---

(260) AM 2023 118109 A  
(800) 1665371  
(151) 2022 02 23  
(181) 2032 02 23  
(891) 2022 02 23  
(511) 09, 36, 42

---

(260) AM 2023 118195 A  
(800) 1666814  
(151) 2022 05 18  
(181) 2032 05 18  
(891) 2022 05 18  
(511) 18, 25, 28

---

(260) AM 2023 118188 A  
(800) 1666547  
(151) 2022 03 16  
(181) 2032 03 16  
(891) 2022 03 16  
(511) 09, 12, 35, 39, 42

---

(260) AM 2023 118203 A  
(800) 1667229  
(151) 2022 03 22  
(181) 2032 03 22  
(891) 2022 03 22  
(511) 09, 36, 42

---

(260) AM 2023 118189 A  
(800) 1666651  
(151) 2022 04 02  
(181) 2032 04 02  
(891) 2022 04 02  
(511) 09

---

(260) AM 2023 118249 A  
(800) 1667461  
(151) 2021 12 13  
(181) 2031 12 13  
(891) 2021 12 13  
(511) 01, 05

---

(260) AM 2023 118191 A  
(800) 1666767  
(151) 2022 01 30  
(181) 2032 01 30  
(891) 2022 01 30  
(511) 45

---

(260) AM 2023 118268 A  
(800) 1668255  
(151) 2022 05 24  
(181) 2032 05 24  
(891) 2022 05 24  
(511) 32

---

(260) AM 2023 118192 A  
(800) 1666769  
(151) 2021 12 29  
(181) 2031 12 29  
(891) 2021 12 29  
(511) 41

---

(260) AM 2023 118270 A  
(800) 1668314  
(151) 2022 04 08  
(181) 2032 04 08  
(891) 2022 04 08  
(511) 12

---

(260) AM 2023 118193 A  
(800) 1666787  
(151) 2022 03 23  
(181) 2032 03 23  
(891) 2022 03 23  
(511) 34

---

(260) AM 2023 118278 A  
(800) 1668472  
(151) 2022 03 12  
(181) 2032 03 12  
(891) 2022 03 12  
(511) 30

---

(260) AM 2023 118279 A  
(800) 1668519  
(151) 2022 04 20  
(181) 2032 04 20  
(891) 2022 04 20  
(511) 09

---

(260) AM 2023 118280 A  
(800) 1668564  
(151) 2022 05 05  
(181) 2032 05 05  
(891) 2022 05 05  
(511) 05, 09, 10, 35, 42, 44

---

(260) AM 2023 118281 A  
(800) 1668589  
(151) 2022 02 09  
(181) 2032 02 09  
(891) 2022 02 09  
(511) 30, 32

---

(260) AM 2023 118285 A  
(800) 1577094  
(151) 2021 01 08  
(181) 2031 01 08  
(891) 2022 05 27  
(511) 35

---

(260) AM 2023 118286 A  
(800) 1638204  
(151) 2021 12 10  
(181) 2031 12 10  
(891) 2022 06 08  
(511) 35, 42

---

(260) AM 2023 118317 A  
(800) 1668737  
(151) 2022 03 30  
(181) 2032 03 30  
(891) 2022 03 30  
(511) 10

---

(260) AM 2023 118319 A  
(800) 1668854  
(151) 2022 02 16  
(181) 2032 02 16  
(891) 2022 02 16  
(511) 07

---

(260) AM 2023 118320 A  
(800) 1668870  
(151) 2022 03 09  
(181) 2032 03 09  
(891) 2022 03 09  
(511) 05

---

(260) AM 2023 118321 A  
(800) 1668883  
(151) 2022 05 10  
(181) 2032 05 10  
(891) 2022 05 10  
(511) 03

---

(260) AM 2023 118322 A  
(800) 1668915  
(151) 2022 02 03  
(181) 2032 02 03  
(891) 2022 02 03  
(511) 11, 20

---

(260) AM 2023 118324 A  
(800) 1669002  
(151) 2022 03 23  
(181) 2032 03 23  
(891) 2022 03 23  
(511) 35, 38, 39

---

(260) AM 2023 118325 A  
(800) 1669012  
(151) 2022 03 24  
(181) 2032 03 24  
(891) 2022 03 24  
(511) 09

---

(260) AM 2023 118326 A  
(800) 1669036  
(151) 2022 05 03  
(181) 2032 05 03  
(891) 2022 05 03  
(511) 29

---

(260) AM 2023 118336 A  
(800) 1669428  
(151) 2022 02 02  
(181) 2032 02 02  
(891) 2022 02 02  
(511) 09, 28, 41

---

(260) AM 2023 118337 A  
(800) 1669429  
(151) 2022 02 02  
(181) 2032 02 02  
(891) 2022 02 02  
(511) 09, 28, 41

---

(260) AM 2023 118361 A  
(800) 1609270  
(151) 2021 07 26  
(181) 2031 07 26  
(891) 2022 05 31  
(511) 09

---

(260) AM 2023 118338 A  
(800) 1669430  
(151) 2022 02 02  
(181) 2032 02 02  
(891) 2022 02 02  
(511) 09, 28, 41

---

(260) AM 2023 118362 A  
(800) 1619803  
(151) 2021 08 10  
(181) 2031 08 10  
(891) 2022 03 03  
(511) 07

---

(260) AM 2023 118340 A  
(800) 1669492  
(151) 2022 04 20  
(181) 2032 04 20  
(891) 2022 04 20  
(511) 12, 37

---

(260) AM 2023 118422 A  
(800) 1670052  
(151) 2022 04 19  
(181) 2032 04 19  
(891) 2022 04 19  
(511) 09

---

(260) AM 2023 118341 A  
(800) 1669543  
(151) 2022 03 21  
(181) 2032 03 21  
(891) 2022 03 21  
(511) 09

---

(260) AM 2023 118423 A  
(800) 1670080  
(151) 2022 01 26  
(181) 2032 01 26  
(891) 2022 01 26  
(511) 05

---

(260) AM 2023 118342 A  
(800) 1669583  
(151) 2022 04 04  
(181) 2032 04 04  
(891) 2022 04 04  
(511) 03, 05

---

(260) AM 2023 118425 A  
(800) 1670240  
(151) 2022 03 24  
(181) 2032 03 24  
(891) 2022 03 24  
(511) 03, 05, 35, 44

---

(260) AM 2023 118357 A  
(800) 1157026  
(151) 2013 02 25  
(181) 2023 02 25  
(891) 2022 06 02  
(511) 25

---

(260) AM 2023 118435 A  
(800) 1670616  
(151) 2022 04 20  
(181) 2032 04 20  
(891) 2022 04 20  
(511) 03

---

(260) AM 2023 118358 A  
(800) 1229806  
(151) 2014 05 09  
(181) 2024 05 09  
(891) 2022 02 18  
(511) 14

---

(260) AM 2023 118436 A  
(800) 1670637  
(151) 2022 05 18  
(181) 2032 05 18  
(891) 2022 05 18  
(511) 06, 11, 20, 35, 40, 42

---

(260) AM 2023 118437 A  
(800) 1670670  
(151) 2022 04 22  
(181) 2032 04 22  
(891) 2022 04 22  
(511) 12

---

(260) AM 2023 118444 A  
(800) 1670840  
(151) 2022 05 11  
(181) 2032 05 11  
(891) 2022 05 11  
(511) 05

---

(260) AM 2023 118438 A  
(800) 1670685  
(151) 2022 06 01  
(181) 2032 06 01  
(891) 2022 06 01  
(511) 32, 33

---

(260) AM 2023 118465 A  
(800) 1610563  
(151) 2021 06 04  
(181) 2031 06 04  
(891) 2022 06 22  
(511) 25

---

(260) AM 2023 118439 A  
(800) 1670728  
(151) 2022 04 20  
(181) 2032 04 20  
(891) 2022 04 20  
(511) 03

---

(260) AM 2023 118466 A  
(800) 1620149  
(151) 2021 05 28  
(181) 2031 05 28  
(891) 2022 05 13  
(511) 05

---

(260) AM 2023 118440 A  
(800) 1670747  
(151) 2022 04 19  
(181) 2032 04 19  
(891) 2022 04 19  
(511) 01, 05, 31

---

(260) AM 2023 118467 A  
(800) 1639666  
(151) 2021 08 03  
(181) 2031 08 03  
(891) 2022 03 16  
(511) 29, 30

---

(260) AM 2023 118441 A  
(800) 1670786  
(151) 2021 12 20  
(181) 2031 12 20  
(891) 2021 12 20  
(511) 06, 07, 09, 11, 35, 37, 38, 39, 42

---

(260) AM 2023 118468 A  
(800) 1643481  
(151) 2021 10 19  
(181) 2031 10 19  
(891) 2022 05 31  
(511) 25

---

(260) AM 2023 118442 A  
(800) 1670803  
(151) 2022 02 16  
(181) 2032 02 16  
(891) 2022 02 16  
(511) 10

---

(260) AM 2023 118523 A  
(800) 1671023  
(151) 2022 05 05  
(181) 2032 05 05  
(891) 2022 05 05  
(511) 03

---

(260) AM 2023 118443 A  
(800) 1670827  
(151) 2022 04 08  
(181) 2032 04 08  
(891) 2022 04 08  
(511) 30

---

(260) AM 2023 118570 A  
(800) 1671305  
(151) 2022 06 08  
(181) 2032 06 08  
(891) 2022 06 08  
(511) 09, 31, 35, 42, 44

---

---

(260) AM 2023 118571 A  
(800) 1671331  
(151) 2021 12 17  
(181) 2031 12 17  
(891) 2021 12 17  
(511) 35, 36

---

---

(260) AM 2023 118680 A  
(800) 1673137  
(151) 2022 03 02  
(181) 2032 03 02  
(891) 2022 03 02  
(511) 08, 21

---

---

(260) AM 2023 118669 A  
(800) 1672975  
(151) 2022 06 22  
(181) 2032 06 22  
(891) 2022 06 22  
(511) 08, 11

---

---

(260) AM 2023 118681 A  
(800) 1673186  
(151) 2022 02 06  
(181) 2032 02 06  
(891) 2022 02 06  
(511) 25, 35

---

---

(260) AM 2023 118670 A  
(800) 1672976  
(151) 2022 06 22  
(181) 2032 06 22  
(891) 2022 06 22  
(511) 21

---

---

(260) AM 2023 118682 A  
(800) 1673187  
(151) 2022 02 06  
(181) 2032 02 06  
(891) 2022 02 06  
(511) 25, 35

---

---

(260) AM 2023 118671 A  
(800) 1673005  
(151) 2022 05 23  
(181) 2032 05 23  
(891) 2022 05 23  
(511) 03, 05, 08

---

---

(260) AM 2023 118683 A  
(800) 1673188  
(151) 2022 02 06  
(181) 2032 02 06  
(891) 2022 02 06  
(511) 25, 26, 35

---

---

(260) AM 2023 118672 A  
(800) 1673007  
(151) 2022 01 10  
(181) 2032 01 10  
(891) 2022 01 10  
(511) 09

---

---

(260) AM 2023 118684 A  
(800) 1673189  
(151) 2022 02 06  
(181) 2032 02 06  
(891) 2022 02 06  
(511) 25, 35

---

---

(260) AM 2023 118673 A  
(800) 1673049  
(151) 2022 06 15  
(181) 2032 06 15  
(891) 2022 06 15  
(511) 21

---

---

(260) AM 2023 118685 A  
(800) 1673190  
(151) 2022 02 06  
(181) 2032 02 06  
(891) 2022 02 06  
(511) 25, 35

---

---

(260) AM 2023 118679 A  
(800) 1673116  
(151) 2022 05 02  
(181) 2032 05 02  
(891) 2022 05 02  
(511) 35, 41, 42

---

---

(260) AM 2023 118686 A  
(800) 1673191  
(151) 2022 02 06  
(181) 2032 02 06  
(891) 2022 02 06  
(511) 25, 35

---

(260) AM 2023 118687 A  
(800) 1673195  
(151) 2022 05 31  
(181) 2032 05 31  
(891) 2022 05 31  
(511) 29, 30, 32

---

(260) AM 2023 118688 A  
(800) 1673197  
(151) 2022 03 08  
(181) 2032 03 08  
(891) 2022 03 08  
(511) 35, 39, 42

---

(260) AM 2023 118710 A  
(800) 748934  
(151) 2000 11 24  
(181) 2030 11 24  
(891) 2022 07 05  
(511) 36

---

(260) AM 2023 118712 A  
(800) 1207228  
(151) 2014 04 10  
(181) 2024 04 10  
(891) 2022 07 05  
(511) 36

---

(260) AM 2023 118716 A  
(800) 1487396  
(151) 2019 07 25  
(181) 2029 07 25  
(891) 2022 07 05  
(511) 36

---

(260) AM 2023 118873 A  
(800) 1675710  
(151) 2022 06 16  
(181) 2032 06 16  
(891) 2022 06 16  
(511) 35

---

---

**OFFICIAL NOTIFICATIONS  
INVENTIONS  
RESTORATION OF PATENTS**

(21) AP 2016 14622  
(11) P 2019 7020 B  
(73) H. Lundbeck A/S  
(54) VORTIOXETINE PYROGLUTAMATE  
DATE OF PATENT CANCELLATION: 2023 05 11  
DATE OF PATENT RESTORATION: 2023 06 26

---

(21) AP 2017 14939  
(11) P 2020 7139 B  
(73) Ipsen Biopharm Limited  
(54) LIQUID NEUROTOXIN FORMULATION STABILIZED WITH TRYPTOPHAN OR TYROSINE  
DATE OF PATENT CANCELLATION: 2023 05 26  
DATE OF PATENT RESTORATION: 2023 06 26

---

(21) AP 2018 15219  
(11) P 2021 7318 B  
(73) H. Lundbeck A/S  
(54) PYRAZOLE MAGL INHIBITORS  
DATE OF PATENT CANCELLATION: 2023 05 22  
DATE OF PATENT RESTORATION: 2023 06 26

---

(21) AP 2019 15466  
(11) P 2022 7384 B  
(73) Noon Aesthetics M.R LTD  
(54) TOPICAL FORMULATIONS COMPRISING STRONTIUM AND METHYLSULFONYLMETHANE  
(MSM) AND METHODS OF TREATMENT  
DATE OF PATENT CANCELLATION: 2023 04 04  
DATE OF PATENT RESTORATION: 2023 06 26

---

## ABOLITION OF PATENTS WITH THE RIGHT TO RESTORE

(21) AP 2013 13108  
(11) P 2015 6272 B  
(73) JSC "ZAGO Technology"  
(54) SCREW TURBINE  
DATE OF PATENT CANCELLATION: 2023 06 05  
LIMITED DATE OF PATENT RESTORATION: 2024 06 05

---

(21) AP 2017 14939  
(11) P 2020 7139 B  
(73) Ipsen Biopharm Limited  
(54) LIQUID NEUROTOXIN FORMULATION STABILIZED WITH TRYPTOPHAN OR TYROSINE  
DATE OF PATENT CANCELLATION: 2023 05 26  
LIMITED DATE OF PATENT RESTORATION: 2025 05 26

---

(21) AP 2019 15102  
(11) P 2021 7261 B  
(73) Nikoloz Labauri  
(54) LABAURI GLAUCOMA VALVE  
DATE OF PATENT CANCELLATION: 2023 06 05  
LIMITED DATE OF PATENT RESTORATION: 2024 06 05

---

(21) AP 2021 15650  
(11) P 2022 7444 B  
(73) Simon Bitsadze;  
Rusudan Bitsadze  
(54) MAGNETIC HYDRAULIC PUSHER  
DATE OF PATENT CANCELLATION: 2023 06 04  
LIMITED DATE OF PATENT RESTORATION: 2024 06 04

---

## DATE OF PATENTS RESTORATION EXPIRATION

(21) AP 2012 13315  
(11) P 2017 6679 B  
(73) Chiesi Farmaceutici S.P.A.  
(54) COMPOUNDS HAVING MUSCARINIC RECEPTOR ANTAGONIST AND BETA2 ADRENERGIC RECEPTOR AGONIST ACTIVITY  
DATE OF PATENT CANCELLATION: 2022 06 07  
DATE OF PATENT RESTORATION EXPIRATION: 2023 06 07

---

(21) AP 2018 15251  
(11) P 2022 7336 B  
(73) Metys Pharmaceuticals AG  
(54) SYNERGISTIC COMPOSITIONS COMPRISING (R)-DIMIRACETAM (1) AND (S)-DIMIRACETAM (2) IN A NON-RACEMIC RATIO  
DATE OF PATENT CANCELLATION: 2022 05 30  
DATE OF PATENT RESTORATION EXPIRATION: 2023 05 30

---



## UTILITY MODELS

### ABOLITION OF PATENTS WITH THE RIGHT TO RESTORE

(21) AU 2017 14511  
(11) U 2018 1988 Y  
(73) Zaur Katcharava  
(54) SUPPORTING DEVICE FOR AGRICULTURAL PLANTS DISPOSED ON TRELLIS WIRES  
DATE OF PATENT CANCELLATION: 2023 06 08  
LIMITED DATE OF PATENT RESTORATION: 2024 06 08

---

(21) AU 2019 15101  
(11) U 2021 2065 Y  
(73) Giorgi Gvenetadze  
(54) COMPUTER SYSTEM FOR SCHOOL ADMINISTRATION  
DATE OF PATENT CANCELLATION: 2023 06 01  
LIMITED DATE OF PATENT RESTORATION: 2024 06 01

---

(21) AU 2020 15359  
(11) U 2022 2111 Y  
(73) Tsirghvava  
(54) LOW ALCOHOL TONIC  
DATE OF PATENT CANCELLATION: 2023 06 07  
LIMITED DATE OF PATENT RESTORATION: 2024 06 07

---

### DATE OF PATENT RESTORATION EXPIRATION

(21) AU 2020 15358  
(11) U 2021 2077 Y  
(73) Savle Chkhitunidze  
(54) HYDROPOWER ON COMMUNICATING VESSELS PRINCIPLE  
DATE OF PATENT CANCELLATION: 2022 06 06  
DATE OF PATENT RESTORATION EXPIRATION: 2023 06 06

---

## DESIGNS

### EXTENSION OF TERMS OF DESIGNS REGISTRATION

(11) D 2018 786 S

(73) Nodar Tsveniashvili (GE)

Vakhtang Gorgasali St., 4th Lane II-7, 0105, Tbilisi, Georgia (GE)

(54) 1. KHINKALI-SHAPED SALTCELLAR, 2. KHINKALI-SHAPED PEPPER POT

(28) 2

(24) 2018 04 12

(18) 2028 04 12

(58) 2023 06 14

---

(11) D 2019 809 S

(73) JSC "Teliani Valley" (GE)

Tbilisi Highway 3, 2200, Telavi, Georgia (GE)

(54) 1.-8. LABELS

(28) 8

(24) 2018 09 10

(18) 2028 09 10

(58) 2023 06 08

---

**TRADEMARKS****EXTENSION OF TERMS OF TRADEMARKS REGISTRATION**

(111) M 2003 14867 R2  
 (151) 2003 01 14  
 (186) 2033 01 14  
 (732) Church & Dwight Co., Inc.  
 500 Charles Ewing Boulevard, Ewing,  
 New Jersey, 08628, USA

---

(111) M 2013 23484 R1  
 (151) 2013 03 27  
 (186) 2033 03 27  
 (732) H.J. Heinz Company Brands Llc  
 One PPG PPlace, Pittsburgh, PA 15222,  
 USA

---

**COMPLETE TRANSFER OF RIGHTS**

(111) M 2020 33082 R  
 (732) Jntl Consumer Health I (Switzerland) Gmbh  
 Gubelstrasse 34, CH-6300 Zug, Switzerland  
 (770) Cilag Gmbh International  
 Gubelstrasse 34, CH-6300, Zug, Switzerland  
 (580) 2023 06 02

---

(111) M 2006 16856 R  
 (732) Jntl Consumer Health I (Switzerland) Gmbh  
 Gubelstrasse 34, CH-6300 Zug, Switzerland  
 (770) Cilag Gmbh International  
 Gubelstrasse 34, CH-6300 Zug, Switzerland  
 (580) 2023 06 02

---

(111) M 2020 33084 R  
 (732) Jntl Consumer Health I (Switzerland) Gmbh  
 Gubelstrasse 34, CH-6300 Zug, Switzerland  
 (770) Cilag Gmbh International  
 Gubelstrasse 34, CH-6300, Zug, Switzerland  
 (580) 2023 06 02

---

(111) M 2006 16857 R  
 (732) Jntl Consumer Health I (Switzerland) Gmbh  
 Gubelstrasse 34, CH-6300 Zug, Switzerland  
 (770) Cilag Gmbh International  
 Gubelstrasse 34, CH-6300 Zug, Switzerland  
 (580) 2023 06 02

---

(111) M 2021 33911 R  
 (732) LLC "Korida"  
 Seventh Kilometer Settlement, Poti, Georgia  
 (770) LLC "Partner"  
 M. Kavtaradze st. 11, 0180, Tbilisi, Georgia  
 (580) 2023 06 02

---

(111) M 2006 16858 R  
 (732) Jntl Consumer Health I (Switzerland) Gmbh  
 Gubelstrasse 34, CH-6300 Zug, Switzerland  
 (770) Cilag Gmbh International  
 Gubelstrasse 34, CH-6300 Zug, Switzerland  
 (580) 2023 06 02

---

(111) M 2006 16855 R  
 (732) Jntl Consumer Health I (Switzerland) Gmbh  
 Gubelstrasse 34, CH-6300 Zug, Switzerland  
 (770) Cilag Gmbh International  
 Gubelstrasse 34, CH-6300 Zug, Switzerland  
 (580) 2023 06 02

---

(111) M 2012 22768 R  
 (732) Jjntl Consumer Health I (Switzerland) Gmbh  
 Gubelstrasse 34, CH-6300 Zug, Switzerland  
 (770) Cilag Gmbh International  
 Landis+Gyr-Strasse 1, CH-6300 Zug,  
 Switzerland  
 (580) 2023 06 02

---

(111) M 1999 12099 R  
(732) Jntl Consumer Health I (Switzerland) Gmbh  
Gubelstrasse 34, CH-6300 Zug, Switzerland  
(770) Cilag Gmbh International  
Landis+Gyr-Strasse 1, CH-6300 Zug,  
Switzerland  
(580) 2023 06 02

---

(111) M 2013 24399 R  
(732) Jntl Consumer Health I (Switzerland) Gmbh  
Gubelstrasse 34, CH-6300 Zug, Switzerland  
(770) Cilag Gmbh International  
Landis+Gyr-Strasse 1, CH-6300 Zug,  
Switzerland  
(580) 2023 06 02

---

(111) M 1997 4956 R  
(732) Jntl Consumer Health I (Switzerland) Gmbh  
Gubelstrasse 34, CH-6300 Zug, Switzerland  
(770) Cilag Gmbh International  
Gubelstrasse 34, CH-6300 Zug, Switzerland  
(580) 2023 06 02

---

(111) M 2019 31126 R  
(732) Jntl Consumer Health I (Switzerland) Gmbh  
Gubelstrasse 34, CH-6300 Zug, Switzerland  
(770) Cilag Gmbh International  
Gubelstrasse 34, CH-6300, Zug, Switzerland  
(580) 2023 06 05

---

(111) M 2019 31831 R  
(732) Jntl Consumer Health I (Switzerland) Gmbh  
Gubelstrasse 34, CH-6300 Zug, Switzerland  
(770) Cilag Gmbh International  
Gubelstrasse 34, CH-6300, Zug, Switzerland  
(580) 2023 06 02

---

(111) M 2019 31832 R  
(732) Jntl Consumer Health I (Switzerland) Gmbh  
Gubelstrasse 34, CH-6300 Zug, Switzerland  
(770) Cilag Gmbh International  
Gubelstrasse 34, CH-6300, Zug, Switzerland  
(580) 2023 06 02

---

## CANCELLATION OF TRADEMARKS REGISTRATION

(111) M 2002 14810 R  
(151) 2002 11 28  
(732) LLC "Borjomi Product"  
Larebi Settlement, 1200, Borjomi, Georgia  
(141) 2023 06 07

---

(111) M 2002 14811 R  
(151) 2002 11 28  
(732) LLC "Borjomi Product"  
Larebi Settlement, 1200, Borjomi, Georgia  
(141) 2023 06 07

---

(111) M 2002 14813 R  
(151) 2002 11 28  
(732) LLC "Borjomi Product"  
Larebi Settlement, 1200, Borjomi, Georgia  
(141) 2023 06 07

---

(111) M 2002 14815 R  
(151) 2002 11 28  
(732) LLC "Borjomi Product"  
Larebi Settlement, 1200, Borjomi, Georgia  
(141) 2023 06 07

---

(111) M 2002 14820 R  
(151) 2002 11 28  
(732) Eve Holdings Inc.  
1105 North Market Street, Suite 617,  
Wilmington, Delaware 19801, USA  
(141) 2023 06 08

---

(111) M 2002 14824 R  
(151) 2002 11 28  
(732) The PBN Company  
1150 18 th Street, NW, Suite 325,  
Washington, DC 20036, USA  
(141) 2023 06 08

---

(111) M 2002 14834 R  
(151) 2002 11 28  
(732) Aktsionernoe Obshchestvo "Pivovarnaya  
Moskva-Effes"  
Ul. Podolskikh Kursantov, dom 15b,  
RU-117546 Moskow, Russian Federation  
(141) 2023 06 07

---

(111) M 2002 14835 R  
(151) 2002 11 28  
(732) Aktsionernoe Obshchestvo "Pivovarnaya  
Moskva-Effes"  
Ul. Podolskikh Kursantov, dom 15b,  
RU-117546 Moskow, Russian Federation  
(141) 2023 06 07

---

(111) M 2012 23094 R  
(151) 2012 11 29  
(732) Allied Global Tobacco Limited  
Wey Court West, Union Road, Farnham,  
GU9 7PT Surrey, United Kingdom  
(141) 2023 06 07

---

(111) M 2012 23095 R  
(151) 2012 11 29  
(732) Sarana Property Finance LTD  
P.O. Box 10152 Dubai, United Arab Emirates  
(141) 2023 06 07

---

(111) M 2012 23097 R  
(151) 2012 11 29  
(732) JSC "Management Group of Hotels and  
Restaurants - EM/Group"  
Marshall Gelovani Ave 2, 5th floor, 0159,  
Tbilisi, Georgia  
(141) 2023 06 08

---

(111) M 2012 23098 R  
(151) 2012 11 29  
(732) JSC "Management Group of Hotels and  
Restaurants - EM/Group"  
Marshall Gelovani Ave 2, 5th floor, 0159,  
Tbilisi, Georgia  
(141) 2023 06 08

---

(111) M 2012 23099 R  
(151) 2012 11 29  
(732) Tea Peradze  
Ilia Chavchavadze Av. 37d, ap. 20, 0179,  
Tbilisi, Georgia  
(141) 2023 06 07

---

(111) M 2012 23100 R  
(151) 2012 11 29  
(732) Coin S.R.L.  
Via Terraglio 17, 30174 Venezia Mestre (VE),  
Italy  
(141) 2023 06 08

---

(111) M 2012 23101 R  
 (151) 2012 11 29  
 (732) Coin S.R.L.  
 Via Terraglio 17, 30174 Venezia Mestre (VE),  
 Italy  
 (141) 2023 06 08

---

(111) M 2012 23102 R  
 (151) 2012 11 29  
 (732) Coin S.R.L.  
 Via Terraglio 17, 30174 Venezia Mestre (VE),  
 Italy  
 (141) 2023 06 08

---

(111) M 2012 23103 R  
 (151) 2012 11 29  
 (732) Coin S.R.L.  
 Via Terraglio 17, 30174 Venezia Mestre (VE),  
 Italy  
 (141) 2023 06 08

---

(111) M 2012 23104 R  
 (151) 2012 11 29  
 (732) Coin S.R.L.  
 Via Terraglio 17, 30174 Venezia Mestre (VE),  
 Italy  
 (141) 2023 06 08

---

(111) M 2012 23106 R  
 (151) 2012 11 29  
 (732) Shantha Biotechnics Private Limited  
 3rd & 4t Florsi, H.No.5-10-173, Fateh Meiden  
 Roudi, Beshirbagi, Haidarabadi - 500004,  
 Telangana, India  
 (141) 2023 06 07

---

(111) M 2012 23108 R  
 (151) 2012 11 29  
 (732) Harrington Development Inc.  
 Elvira Mendez Street, Vallarino bldg.,  
 3rd Floor, Panama, Republic of Panama  
 (141) 2023 06 08

---

(111) M 2012 23109 R  
 (151) 2012 11 29  
 (732) General Motors LLC  
 300 Renaissance Center, City of Detroit,  
 State of Michigan 48265-3000, USA  
 (141) 2023 06 08

---

(111) M 2012 23110 R  
 (151) 2012 11 29  
 (732) General Motors LLC  
 300 Renaissance Center, City of Detroit,  
 State of Michigan 48265-3000, USA  
 (141) 2023 06 08

---

(111) M 2012 23112 R  
 (151) 2012 11 29  
 (732) PZ Cussons (International) Limited  
 3500 Aviator Way, Manchester Business  
 Park, Manchester M22 5TG, United Kingdom  
 (141) 2023 06 08

---

(111) M 2012 23115 R  
 (151) 2012 11 29  
 (732) LTD "Qahveji Parketi"  
 Vani St. 4 (Plot 4/51), ap. 266, Tbilisi, Georgia  
 (141) 2023 06 09

---

(111) M 2012 23116 R  
 (151) 2012 11 29  
 (732) Mars, Incorporated  
 6885 Elm Street Mclean, Virginia 22101-  
 -3883, USA  
 (141) 2023 06 07

---

(111) M 2012 23118 R  
 (151) 2012 11 29  
 (732) LTD "Georgian Bakery"  
 Vakhtang Gorgasali St. 115, 0114, Tbilisi,  
 Georgia  
 (141) 2023 06 09

---

(111) M 2012 23119 R  
 (151) 2012 11 29  
 (732) LTD "Georgian Bakery"  
 Vakhtang Gorgasali St. 115, 0114, Tbilisi,  
 Georgia  
 (141) 2023 06 09

---

(111) M 2012 23120 R  
 (151) 2012 11 29  
 (732) LTD "Georgian Bakery"  
 Vakhtang Gorgasali St. 115, 0114, Tbilisi,  
 Georgia  
 (141) 2023 06 09

---

(111) M 2012 23123 R  
(151) 2012 11 29  
(732) The Coca-Cola Company  
One Coca-Cola Plaza, Atlanta,  
Georgia 30313, USA  
(141) 2023 06 07

---

(111) M 2012 23150 R  
(151) 2012 11 30  
(732) Limited Liability Society "MTMI"  
Mechanization St. 1, 0192, Tbilisi, Georgia  
(141) 2023 06 07

---

(111) M 2012 23147 R  
(151) 2012 11 29  
(732) LTD "Larki"  
Vagzali (Station) St. 57a, ap. 74, 0165,  
Tbilisi, Georgia  
(141) 2023 06 09

---

(111) M 2012 23088 R  
(151) 2012 11 26  
(732) LLC "Parnavaz"  
Near the intersection of Georgian Military  
Road and Akhmeteli Street, 0159, Didube-  
Chughureti District, Tbilisi, Georgia  
(141) 2023 06 06

---

(111) M 2012 23148 R  
(151) 2012 11 29  
(732) Kakhaber Mekvevrishvili  
Kavkasioni St. 41, ap. 17, 2200, Telavi,  
Georgia  
(141) 2023 06 06

---

(111) M 2012 23089 R  
(151) 2012 11 27  
(732) LLC "Foodline"  
Gagra St. 2, 0186, Gldani-Nadzaladevi  
District, Tbilisi, Georgia  
(141) 2023 06 06

---

(111) M 2012 23090 R  
(151) 2012 11 27  
(732) LLC "Foodline"  
Gagra St. 2, 0186, Gldani-Nadzaladevi  
District, Tbilisi, Georgia  
(141) 2023 06 06

---

(111) M 2012 23149 R  
(151) 2012 11 30  
(732) Limited Liability Society "MTMI"  
Mechanization St. 1, 0192, Tbilisi, Georgia  
(141) 2023 06 07

---

# CLASSIFICATION INDEXES

## INVENTIONS

### CONCORDANCE TABLE OF INTERNATIONAL CLASSIFICATION INDEX AND PUBLICATION NUMBERS

INTERNATIONAL CLASSIFICATION INDEXES (51)	NUMBER OF PUBLISHED APPLICATION (10)
A 61 K 45/06; A 61 K 31/5377; A 61 K 31/496; A 61 P 25/00	AP 2023 15793 A
A 61 K 39/00; A 61 P 37/02; A 61 P 7/02; C 07 K 16/40	AP 2023 14803 A
G 09 B 19/06	AP 2023 15989 A
H 02 J 7/00	AP 2023 15935 A

### CONCORDANCE TABLE OF PUBLICATION NUMBERS AND INTERNATIONAL CLASSIFICATION INDEX

NUMBER OF PUBLISHED APPLICATION (10)	INTERNATIONAL CLASSIFICATION INDEXES (51)
AP 2023 14803 A	A 61 K 39/395; A 61 K 39/00; A 61 P 37/02; A 61 P 7/02; C 07 K 16/40
AP 2023 15793 A	A 61 K 45/06; A 61 K 31/5377; A 61 K 31/496; A 61 P 25/00
AP 2023 15935 A	H 02 J 7/00
AP 2023 15989 A	G 09 B 19/06

### CONCORDANCE TABLE OF INTERNATIONAL CLASSIFICATION INDEX, PATENT NUMBERS AND PUBLICATION NUMBERS

INTERNATIONAL CLASSIFICATION INDEX (51)	NUMBER OF PATENT (11)	NUMBER OF PUBLISHED APPLICATION (10)
A 61 K 9/28	P 2023 7517 B	AP 2023 15682 A
C 22 B 15/00; C 22 B 3/00; C 22 B 3/08; C 22 B 47/00	P 2023 7516 B	AP 2023 15666 A

### CONCORDANCE TABLE OF PATENT NUMBERS, PUBLICATION NUMBERS AND INTERNATIONAL CLASSIFICATION INDEX

NUMBER OF PATENT (11)	NUMBER OF PUBLISHED APPLICATION (10)	INTERNATIONAL CLASSIFICATION INDEX (51)
P 2023 7516 B	AP 2023 15666 A	C 22 B 15/00; C 22 B 3/00; C 22 B 3/08; C 22 B 47/00
P 2023 7517 B	AP 2023 15682 A	A 61 K 9/28



**CONCORDANCE TABLE OF APPLICATION NUMBERS,  
PUBLICATION NUMBERS AND PATENTS**

NUMBER OF APPLICATION (21)	NUMBER OF PUBLISHED APPLICATION (10)	NUMBER OF PATENT (11)
AP 2019 15666	AP 2023 15666 A	P 2023 7516 B
AP 2019 15682	AP 2023 15682 A	P 2023 7517 B

**UTILITY MODELS**

**CONCORDANCE TABLE OF INTERNATIONAL CLASSIFICATION INDEX,  
PATENT NUMBERS AND PUBLICATION NUMBERS**

INTERNATIONAL CLASSIFICATION INDEX (51)	NUMBER OF PATENT (11)	NUMBER OF PUBLISHED APPLICATION (10)
C 12 G 3/06	U 2023 2150 Y	AU 2023 16001 U
G 02 B 23/16	U 2023 2151 Y	AU 2023 15530 U

**CONCORDANCE TABLE OF PATENT NUMBERS,  
PUBLICATION NUMBERS AND INTERNATIONAL CLASSIFICATION INDEX**

NUMBER OF PATENT (11)	NUMBER OF PUBLISHED APPLICATION (10)	INTERNATIONAL CLASSIFICATION INDEX (51)
U 2023 2150 Y	AU 2023 16001 U	C 12 G 3/06
U 2023 2151 Y	AU 2023 15530 U	G 02 B 23/16

**CONCORDANCE TABLE OF APPLICATION NUMBERS,  
PUBLICATION NUMBERS AND PATENTS**

NUMBER OF APPLICATION (21)	NUMBER OF PUBLISHED APPLICATION (10)	NUMBER OF PATENT (11)
AU 2020 15530	AU 2023 15530 U	U 2023 2151 Y
AU 2022 16001	AU 2023 16001 U	U 2023 2150 Y

## DESIGNS

### CONCORDANCE TABLE OF INTERNATIONAL CLASSIFICATION INDEX AND PUBLICATION NUMBERS

INTERNATIONAL CLASSIFICATION INDEXES (51)	NUMBER OF PUBLISHED APPLICATION (10)
32-01	AD 2023 1297 S

### CONCORDANCE TABLE OF PUBLICATION NUMBERS AND INTERNATIONAL CLASSIFICATION INDEX

NUMBER OF PUBLISHED APPLICATION (10)	INTERNATIONAL CLASSIFICATION INDEXES (51)
AD 2023 1297 S	32-01

## TRADEMARKS

### CONCORDANCE TABLE OF REGISTRATION NUMBERS, APPLICATION NUMBERS, PUBLICATION NUMBERS AND BULLETIN NUMBERS

NUMBER OF REGISTRATION (111)	NUMBER OF APPLICATIONS (210)	NUMBER OF PUBLISHED APPLICATIONS (260)	NUMBER OF BULLETIN
M 2023 36926 R	AM 123073	–	12(615)2023
M 2023 36927 R	AM 119911	–	12(615)2023
M 2023 36928 R	AM 122859	–	12(615)2023
M 2023 36929 R	AM 123071	–	12(615)2023
M 2023 36930 R	AM 122981	–	12(615)2023
M 2023 36931 R	AM 123076	–	12(615)2023
M 2023 36932 R	AM 122856	–	12(615)2023
M 2023 36933 R	AM 118371	AM 2023 118371 A	4(607)2023
M 2023 36934 R	AM 118369	AM 2023 118369 A	4(607)2023
M 2023 36935 R	AM 117531	AM 2023 117531 A	4(607)2023
M 2023 36936 R	AM 117650	AM 2022 117650 A	24(603)2022
M 2023 36937 R	AM 118762	AM 2023 118762 A	4(607)2023
M 2023 36938 R	AM 118235	AM 2023 118235 A	2(605)2023
M 2023 36939 R	AM 118222	AM 2023 118222 A	2(605)2023
M 2023 36940 R	AM 118563	AM 2023 118563 A	3(606)2023
M 2023 36941 R	AM 118750	AM 2023 118750 A	4(607)2023
M 2023 36942 R	AM 118223	AM 2023 118223 A	1(604)2023
M 2023 36943 R	AM 118378	AM 2023 118378 A	4(607)2023
M 2023 36944 R	AM 118476	AM 2023 118476 A	2(605)2023
M 2023 36945 R	AM 118844	AM 2023 118844 A	4(607)2023
M 2023 36946 R	AM 118231	AM 2023 118231 A	2(605)2023
M 2023 36947 R	AM 118731	AM 2023 118731 A	4(607)2023
M 2023 36948 R	AM 118842	AM 2023 118842 A	4(607)2023
M 2023 36949 R	AM 118558	AM 2023 118558 A	4(607)2023
M 2023 36950 R	AM 118299	AM 2023 118299 A	2(605)2023
M 2023 36951 R	AM 118372	AM 2023 118372 A	4(607)2023
M 2023 36952 R	AM 118370	AM 2023 118370 A	4(607)2023
M 2023 36953 R	AM 118374	AM 2023 118374 A	4(607)2023
M 2023 36954 R	AM 118373	AM 2023 118373 A	4(607)2023
M 2023 36955 R	AM 122677	–	12(615)2023
M 2023 36956 R	AM 123077	–	12(615)2023
M 2023 36957 R	AM 122972	–	12(615)2023
M 2023 36958 R	AM 123093	–	12(615)2023
M 2023 36959 R	AM 123097	–	12(615)2023
M 2023 36960 R	AM 123091	–	12(615)2023
M 2023 36961 R	AM 117833	AM 2022 117833 A	24(603)2022
M 2023 36962 R	AM 100059	AM 2023 100059 A	3(606)2023
M 2023 36963 R	AM 118728	AM 2023 118728 A	3(606)2023
M 2023 36964 R	AM 117801	AM 2022 117801 A	23(602)2022
M 2023 36965 R	AM 116854	AM 2023 116854 A	1(604)2023
M 2023 36966 R	AM 118234	AM 2023 118234 A	1(604)2023

CONCORDANCE TABLE OF PUBLICATION NUMBERS  
AND APPLICATION NUMBERS

NUMBER OF PUBLISHED APPLICATION (260)	NUMBER OF APPLICATION (210)	1	2
1	2		
AM 2023 118297 A*	AM 118297	AM 2023 120253 A	AM 120253
AM 2023 119075 A	AM 119075	AM 2023 120255 A	AM 120255
AM 2023 119353 A	AM 119353	AM 2023 120256 A	AM 120256
AM 2023 119482 A	AM 119482	AM 2023 120336 A	AM 120336
AM 2023 119998 A	AM 119998	AM 2023 120343 A	AM 120343
AM 2023 120021 A	AM 120021	AM 2023 120351 A	AM 120351
AM 2023 120022 A	AM 120022	AM 2023 120353 A	AM 120353
AM 2023 120023 A	AM 120023	AM 2023 120354 A	AM 120354
AM 2023 120024 A	AM 120024	AM 2023 120362 A	AM 120362
AM 2023 120127 A	AM 120127	AM 2023 120433 A	AM 120433
AM 2023 120129 A	AM 120129	AM 2023 120434 A	AM 120434
AM 2023 120147 A	AM 120147	AM 2023 120437 A	AM 120437
AM 2023 120148 A	AM 120148	AM 2023 120444 A	AM 120444
AM 2023 120152 A	AM 120152	AM 2023 120445 A	AM 120445
AM 2023 120154 A	AM 120154	AM 2023 120500 A	AM 120500
AM 2023 120163 A	AM 120163	AM 2023 120506 A	AM 120506
AM 2023 120164 A	AM 120164	AM 2023 120507 A	AM 120507
AM 2023 120172 A	AM 120172	AM 2023 120513 A	AM 120513
AM 2023 120173 A	AM 120173	AM 2023 120518 A	AM 120518
AM 2023 120174 A	AM 120174	AM 2023 120519 A	AM 120519
AM 2023 120233 A	AM 120233	AM 2023 120522 A	AM 120522
AM 2023 120234 A	AM 120234	AM 2023 120532 A	AM 120532
AM 2023 120239 A	AM 120239	AM 2023 120533 A	AM 120533
AM 2023 120245 A	AM 120245	AM 2023 120534 A	AM 120534
		AM 2023 120535 A	AM 120535
		AM 2023 120595 A	AM 120595
		AM 2023 120596 A	AM 120596
		AM 2023 120597 A	AM 120597

CONCORDANCE TABLE OF INDEX OF GOODS AND/OR SERVICES  
AND APPLICATION NUMBERS

INDEX OF GOODS AND/OR SERVICES (511)	NUMBER OF PUBLISHED APPLICATIONS (260)	1	2
1	2		
1	AM 2023 120597 A	33	AM 2023 120437 A
3	AM 2023 120519 A	33	AM 2023 120507 A
5	AM 2023 120127 A	34	AM 2023 118297 A*
5	AM 2023 120129 A	34	AM 2023 120022 A
5	AM 2023 120173 A	34	AM 2023 120353 A
5	AM 2023 120174 A	34	AM 2023 120354 A
5	AM 2023 120233 A	34	AM 2023 120500 A
5	AM 2023 120234 A	34	AM 2023 120532 A
5	AM 2023 120343 A	34	AM 2023 120533 A
5	AM 2023 120506 A	34	AM 2023 120534 A
5	AM 2023 120519 A	34	AM 2023 120535 A
9	AM 2023 120024 A	34	AM 2023 120595 A
9	AM 2023 120147 A	34	AM 2023 120596 A
9	AM 2023 120163 A	35	AM 2023 120129 A
9	AM 2023 120164 A	35	AM 2023 120152 A
9	AM 2023 120362 A	35	AM 2023 120154 A
12	AM 2023 120152 A	35	AM 2023 120163 A
12	AM 2023 120154 A	35	AM 2023 120164 A
12	AM 2023 120444 A	35	AM 2023 120245 A
12	AM 2023 120445 A	35	AM 2023 120362 A
14	AM 2023 120023 A	35	AM 2023 120433 A
16	AM 2023 120152 A	35	AM 2023 120519 A
19	AM 2023 120433 A	35	AM 2023 120522 A
25	AM 2023 120513 A	36	AM 2023 120147 A
29	AM 2023 120173 A	37	AM 2023 120148 A
29	AM 2023 120174 A	37	AM 2023 120163 A
29	AM 2023 120256 A	37	AM 2023 120164 A
30	AM 2023 120021 A	38	AM 2023 120152 A
30	AM 2023 120253 A	39	AM 2023 120152 A
30	AM 2023 120255 A	39	AM 2023 120154 A
30	AM 2023 120256 A	39	AM 2023 120172 A
31	AM 2023 120597 A	41	AM 2023 119075 A
32	AM 2023 120129 A	41	AM 2023 119353 A
32	AM 2023 120245 A	41	AM 2023 119482 A
33	AM 2023 119998 A	41	AM 2023 120152 A
33	AM 2023 120239 A	41	AM 2023 120362 A
33	AM 2023 120336 A	41	AM 2023 120518 A
33	AM 2023 120351 A	42	AM 2023 120163 A
33	AM 2023 120434 A	42	AM 2023 120164 A
		42	AM 2023 120362 A
		43	AM 2023 120152 A
		44	AM 2023 120172 A

CONCORDANCE TABLE OF INDEX OF GOODS AND/OR SERVICES  
AND NUMBERS OF TRADEMARKS REGISTERED ACCORDING  
TO THE ACCELERATED PROCEDURE

INDEX OF GOODS AND/OR SERVICES (511)	NUMBERS OF REGISTERED ACCORDING TO THE ACCELERATED PROCEDURE (111)
1	M 2023 36931 R
3	M 2023 36929 R
16	M 2023 36927 R
21	M 2023 36927 R
24	M 2023 36927 R
25	M 2023 36927 R
28	M 2023 36927 R
29	M 2023 36955 R
32	M 2023 36927 R
32	M 2023 36928 R
32	M 2023 36932 R
32	M 2023 36958 R
32	M 2023 36960 R
33	M 2023 36927 R
33	M 2023 36956 R
33	M 2023 36958 R
34	M 2023 36927 R
35	M 2023 36926 R
35	M 2023 36927 R
35	M 2023 36930 R
37	M 2023 36957 R
39	M 2023 36927 R
39	M 2023 36959 R
42	M 2023 36930 R

# **OFFICIAL BULLETIN OF THE INDUSTRIAL PROPERTY**

**INVENTIONS**  
**UTILITY MODELS**  
**DESIGNS**  
**TRADEMARKS**

## **12(615)**

EDITOR-IN-CHIEF: N. Bebrishvili

EDITOR-TRANSLATOR: E. Gabunia

PROOFREADER: A. Shixashvili

COMPUTER LAYOUT: M. Ordenidze  
K. Svanidze

ISSN 2720-8486

[info@sakpatenti.gov.ge](mailto:info@sakpatenti.gov.ge)  
[www.sakpatenti.gov.ge](http://www.sakpatenti.gov.ge)