



**NATIONAL INTELLECTUAL PROPERTY CENTER OF GEORGIA
SAKPATENTI**

**OFFICIAL BULLETIN
OF THE INDUSTRIAL PROPERTY**

13(473)

**2017
TBILISI**

INID CODES FOR IDENTIFICATION OF BIBLIOGRAPHIC DATA

INVENTIONS, UTILITY MODELS

- (10) Number of publication for application, which has been examined
- (11) Number of patent and kind of document
- (21) Serial number of application
- (22) Date of filing of the application
- (23) Date of exhibition or the date of the earlier filing and the number of application, if any
- (24) Date from which patent may have effect
- (31) Number of priority application
- (32) Date of filing of priority application
- (33) Code of the country or regional organization allotting priority application number
- (44) Date of publication of application not granted, but examined and number of bulletin
- (45) Date of publication of registered document
- (51) International Patent Classification Index
- (54) Title of the invention
- (57) Abstract
- (60) Number of examined patent document granted by foreign patent office, date from which patent has effect and country code
- (62) Number of the earlier application and in case of divided application, date of filing an application
- (71) Name, surname and address of applicant (country code)
- (72) Name, surname of inventor (country code)
- (73) Name, surname and address of patent owner (country code)
- (74) Name, surname of representative or patent attorney
- (85) Date of commencement of the national phase of International Application
- (86) Number and date of filing of international application
- (87) Number and date of publication of international application

DESIGNS

- (10) Number of publication for application
- (11) Number of patent and kind of document or number of registration
- (15) Date of registration/Date of patent renewal
- (18) Expected expiration date of patent or registration
- (21) Serial number of application
- (22) Date of filing of the application
- (23) Date of exhibition or the date of the earlier filing and the number of application, if any
- (24) Date from which patent may have effect
- (28) Number of designs included in the application
- (30) Data relating to priority (number of application, date of filing of application, two-letter code identifying the authority with whom the priority application was made)
- (31) Number of priority application
- (32) Date of filing of priority application
- (33) Code of the country or regional organization allotting priority application number
- (34) Two-letter code according to WIPO St.3 identifying the authority with which the priority application was made
- (44) Date of publication of design and number of bulletin (the first publication)
- (45) Date of publication of design registered by WIPO and number of bulletin
- (51) International Classification for designs (class and subclass of the Locarno Classification)
- (54) Title of the invention
- (55) Reproduction of the design
- (57) Description of characteristic features of the design including indication of colors
- (58) Date of recording of any kind of amendment in the Register
- (62) Number of the earlier application, registration and document number and if available the date of filing an application in case of divided application
- (71) Name, surname and address of applicant (country code)
- (72) Name, surname of creator (country code)
- (73) Name, surname and address of patent owner (country code)
- (74) Name, surname of representative or patent attorney
- (81) Contracting states concerned
 - II designated contracting states according to the 1960 Act
 - III designated contracting states according to the 1999 Act
- (85) Owner's permanent address
- (86) Owner's nationality
- (87) Owner's residence
- (88) State in which the owner has a real and effective industrial or commercial establishment

TRADEMARKS

- (111) – Number of registration
- (151) – Date of registration
- (156) – Date of the renewal
- (181) – Expected expiration date of registration
- (186) – Renewal expiration date of registration
- (141) – Date of cancel of duration of the mark
- (210) – Serial number of application
- (220) – Date of filing of the application
- (230) – Data concerning exhibition
- (260) – Number of application, for which favorable decision of examination about registration has been taken (publication number)
- (310) – Number of the first application
- (320) – Date of filing of the first application
- (330) – Code, identifying national or regional Office where the first application was made
- (511) – International Classification of Goods and Services for the purposes of registration of trade marks and/or list of goods and/or services classified according thereto
- (531) – Description of figurative elements of Trade Marks according to the International Classification of the Figurative Elements of Marks
- (540) – Reproduction of Trade Mark
- (550) – Nature and kind of Trade Mark
- (580) – Date of recording of any kind changes in respect of applications or registrations
- (591) – Information concerning colors claimed
- (731) – Name and address of the applicant
- (732) – Name and address of the holder of the registration
- (740) – Name and address of the representative
- (750) – Address for correspondence
- (770) – Name and address of the previous applicant or holder in case of change in ownership
- (771) – Previous name and address of the applicant or holder in case of change in ownership
- (791) – Name and address of the licensee
- (793) – Indication of conditions and/or restrictions under the license (Type of license, number of license agreement, data of license, data of validity of license)
- (800) – Certain data relating to the international registration of Trade Marks under the Protocol Relating to Madrid Agreement (International registration number)

CODES FOR PUBLICATION IN BULLETIN

- (21) AP 0000 000000 – serial number of application for invention
- (10) AP 0000 0000 A – number of published application for invention (first publication)
- (11) P 0000 0000 B – number of patent for invention (second publication)
- (21) API 0000 000000 – number of application for imported patent
- (11) PI 0000 0000 A – number of imported patent (first publication)
- (21) AU 0000 000000 – serial number of application for utility model
- (10) AU 0000 000 U – number of published application for utility model (first publication)
- (11) U 0000 000 Y – number of patent for utility model (second publication)
- (21) AD 0000 000000 – serial number of application for design
- (10) AD 0000 000 S – number of published application for design (first publication)
- (11) D 0000 000 S – number of patent for design (second publication)

INTERNATIONAL PATENT CLASSIFICATION FOR INVENTIONS AND UTILITY MODELS

- SECTION A – HUMAN NECESSITIES
- SECTION B – PERFORMING OPERATIONS; TRANSPORTING
- SECTION C – CHEMISTRY; METALLURGY
- SECTION D – TEXTILES; PAPER
- SECTION E – FIXED CONSTRUCTIONS
- SECTION F – MECHANICAL ENGINEERING; LIGHTING; HEATING; WEAPONS; BLASTING
- SECTION G – PHYSICS
- SECTION H – ELECTRICITY

-
- M – Trade Mark
 - (210) AM 0000 000000 – Serial number of application;
 - (260) AAM 0000 00000 A – Publication number of application;
 - (111) M 0000 00000 R – Number of registration;
 - (111) MMM0000 00000 Rn – Number of renewals, in which n=1,2,3;
 - (111) M 0000 00000 R(P) – Number of registration under partial assignment of rights
-

LIST OF CODES, IN ALPHABETIC SEQUENCE, AND THE CORRESPONDING (SHORT) NAMES OF STATES, OTHER ENTITIES AND INTERGOVERNMENTAL ORGANIZATIONS
(WIPO STANDARD ST.3)

AD	Andorra				
AE	United Arab Emirates				
AF	Afghanistan				
AG	Antigua and Barbuda				
AI	Anguilla				
AL	Albania				
AM	Armenia				
AN	Netherlands Antilles				
AO	Angola				
AP	African Regional Intellectual Property Organization (ARIPO)				
AR	Argentina				
AT	Austria				
AU	Australia				
AW	Aruba				
AZ	Azerbaijan				
BA	Bosnia and Herzegovina				
BB	Barbados				
BD	Bangladesh				
BE	Belgium				
BF	Burkina Faso				
BG	Bulgaria				
BH	Bahrain				
BI	Burundi				
BJ	Benin				
BM	Bermuda				
BN	Brunei Darussalam				
BO	Bolivia				
BR	Brazil				
BS	Bahamas				
BT	Bhutan				
BV	Bouvet Island				
BW	Botswana				
BX	Benelux Office for Intellectual Property (BOIP)				
BY	Belarus				
BZ	Belize				
CA	Canada				
CD	Democratic Republic of the Congo				
CF	Central African Republic				
CG	Congo				
CH	Switzerland				
CI	Cote d'Ivoire				
CK	Cook Islands				
CL	Chile				
CM	Cameroon				
CN	China				
CO	Colombia				
CR	Costa Rica				
CU	Cuba				
CV	Cape Verde				
CY	Cyprus				
CZ	Czech Republic				
DE	Germany				
DJ	Djibouti				
DM	Dominica				
DO	Dominican Republic				
DZ	Algeria				
EA	Eurasian Patent Organization (EAPO)				
EC	Ecuador				
EE	Estonia				
EG	Egypt				
EH	Western Sahara				
EM	Office for Harmonization in the Internal Market (Trademarks and Designs)(OHIM)				
EP	European Patent Office (EPO)				
ER	Eritrea				
ES	Spain				
ET	Ethiopia				
FI	Finland				
FJ	Fiji				
FK	Falkland Islands (Malvinas)				
FO	Faroe Islands				
FR	France				
GA	Gabon				
GB	United Kingdom				
GC	Patent Office of the Cooperation Council for the Arab States of the Gulf (GCC)				
GD	Grenada				
GG	Guernsey				
GH	Ghana				
GI	Gibraltar				
GT	Guatemala				
GW	Guinea- Bissau				
GY	Guyana				
HK	The Hong Kong Special Administrative Region of the People's Republic of China				
HN	Honduras				
HR	Croatia				
HT	Haiti				
HU	Hungary				
IB	International Bureau of the World Intellectual Property Organization (WIPO)				
ID	Indonesia				
IE	Ireland				
IL	Israel				
IM	Isle of Man				
IN	India				
IQ	Iraq				
ID	Indonesia				
IE	Ireland				
IL	Israel				
IM	Isle of Man				
IN	India				
IQ	Iraq				
IR	Iran (Islamic Republic of)				
IS	Iceland				
IT	Italy				
JE	Jersey				
JM	Jamaica				
JO	Jordan				
JP	Japan				
KE	Kenya				
KG	Kyrgyzstan				
KH	Cambodia				
KI	Kiribati				
KM	Saint Kitts and Nevis				
KP	Democratic People's Republic of Korea				
KR	Republic of Korea				
KW	Kuwait				
KY	Cayman Islands				
KZ	Kazakhstan				
LA	Lao People's Democratic Republic				
LB	Lebanon				
LC	Saint Lucia				
LI	Liechtenstein				
LK	Sri Lanka				
LR	Liberia				
LS	Lesotho				
LT	Lithuania				
LU	Luxembourg				
LV	Latvia				
LY	Libyan Arab Jamahiriya				
MA	Morocco				
MC	Monaco				
MD	Republic of Moldova				
ME	Montenegro				
MG	Madagascar				
MK	The former Yugoslav Republic of Macedonia				
ML	Mali				
MM	Myanmar				
MN	Mongolia				
MO	Macao				
MP	Northern Mariana Islands				
MR	Mauritania				
MS	Montserrat				
MT	Malta				
MU	Mauritius				
MV	Maldives				
MW	Malawi				
MX	Mexico				
MY	Malaysia				
MZ	Mozambique				
NA	Namibia				
NE	Niger				
NG	Nigeria				
NI	Nicaragua				
NL	Netherlands				
NO	Norway				
NP	Nepal				
NR	Nauru				
NZ	New Zealand				
OA	African Intellectual Property Organization (OAPI)				
OM	Oman				
PA	Panama				
PE	Peru				
PG	Papua New Guinea				
PH	Philippines				
PK	Pakistan				
PL	Poland				
PT	Portugal				
PW	Palau				
PY	Paraguay				
QA	Qatar				
QZ	Community Plant Variety Office (European Community) (CPVO)				
RO	Romania				
RS	Serbia				
RU	Russian Federation				
RW	Rwanda				
SA	Saudi Arabia				
SB	Solomon Islands				
SC	Seychelles				
SD	Sudan				
SG	Singapore				
SH	Saint Helena				
SI	Slovenia				
SK	Slovakia				
SL	Sierra Leone				
SM	San Marino				
SN	Senegal				
SO	Somalia				
SR	Suriname				
ST	Sao Tome and Principe				
SV	El Salvador				
SY	Syrian Arab Republic				
SZ	Swaziland				
TC	Turks and Caicos Islands				
TD	Chad				
TG	Togo				
TH	Thailand				
TJ	Tajikistan				
TL	Timor-Leste				
TM	Turkmenistan				
TN	Tunisia				
TO	Tonga				
TR	Turkey				
SE	Sweden				
TT	Trinidad and Tobago				
TV	Tuvalu				
TW	Taiwan, Province of China				
TZ	United Republic of Tanzania				
UA	Ukraine				
UG	Uganda				
US	United States of America				
UY	Uruguay				
UZ	Uzbekistan				
VA	Holy See				
VC	Saint Vincent and the Grenadines				
VE	Venezuela				
VG	Virgin Islands (British)				
VN	Viet Nam				
VU	Vanuatu				
WO	World Intellectual Property Organization (WIPO)				
WS	Samoa				
XN	Nordic Patent Institute (NPI)				
YE	Yemen				
ZA	South Africa				
ZM	Zambia				
ZW	Zimbabwe				

**NATIONAL INTELLECTUAL PROPERTY CENTER OF GEORGIA
SAKPATENTI**

**OFFICIAL BULLETIN
OF THE INDUSTRIAL PROPERTY**

13(473)

**INVENTIONS
UTILITY MODELS
TRADEMARKS**

**DATE OF PUBLICATION
2017 07 10**

CONTENTS

PUBLISHED TITLES OF PROTECTION	2
INVENTIONS	
▪ APPLICATIONS APPROVED FOR GRANTING PATENTS	4
▪ PATENTED INVENTIONS	10
UTILITY MODELS	
▪ APPLICATION APPROVED FOR GRANTING PATENTS	13
▪ PATENTED UTILITY MODELS	15
DESIGNS	
▪ APPLICATION APPROVED FOR REGISTRATION	16
▪ REGISTERED DESIGNS	19
▪ DESIGNS REGISTERED WITH THE INTERNATIONAL BUREAU CLAIMING PRIORITY ON THE TERRITORY OF GEORGIA	20
TRADEMARKS	
▪ APPLICATIONS FILED UNDER THE NATIONAL PROCEDURE APPROVED FOR REGISTRATION	46
▪ REGISTERED TRADEMARKS	51
▪ TRADEMARKS REGISTERED ACCORDING TO THE ACCELERATED PROCEDURE	55
▪ INTERNATIONAL TRADEMARKS FOR WHICH A DECISION ON GANTING PROTECTION IS TAKEN	60
▪ INTERNATIONAL TRADEMARKS PROTECTED IN GEORGIA	76
OFFICIAL NOTIFICATIONS	
TRADEMARKS	
▪ RENEWAL OF REGISTRATIONS	80
▪ COMPLETE TRANSFER OF RIGHTS	90
▪ CHANGES IN NAMES AND/OR ADDRESSES OF OWNERS	92
▪ INVALIDATION OF TRADEMARKS REGISTRATION	93
CLASSIFICATION INDEXES	
INVENTIONS	99
UTILITY MODELS	102
DESIGNS	103
TRADEMARKS	105

PUBLISHED TITLES OF PROTECTION

INVENTIONS

- **APPLICATIONS APPROVED FOR GRANTING PATENTS:**
14289; 13618; 13923, 13924; 13659; 13771; 13877; 13950; 13977; 14180; 13892; 13984; 14061; 12872
- **PATENTED INVENTIONS:**
6693-6701

UTILITY MODELS

- **APPLICATIONS APPROVED FOR GRANTING PATENT:**
14346; 14096, 14097
- **PATENTED UTILITY MODELS:**
1939-1942

DESIGNS

- **APPLICATION APPROVED FOR REGISTRATION:**
941
- **REGISTERED DESIGNS:**
711, 712
- **DESIGNS REGISTERED WITH THE INTERNATIONAL BUREAU CLAIMING PRIORITY ON THE TERRITORY OF GEORGIA:**
93290-93292; 95792; 95869; 93501; 93557; 93577; 96040

TRADEMARKS

- **APPLICATIONS FILED UNDER THE NATIONAL PROCEDURE APPROVED FOR REGISTRATION:**
81341*; 87105; 88131, 88132; 88145; 88174; 88593; 88856; 89258, 89259; 89269; 89327; 89329; 89405, 89406; 89417; 89521; 89532; 89557; 89606; 89736; 89747; 89852, 89853; 89867; 89999; 90003
- **REGISTERED TRADEMARKS:**
28680-28718
- **TRADEMARKS REGISTERED ACCORDING TO THE ACCELERATED PROCEDURE:**
28662-28679; 28719-28723
- **INTERNATIONAL TRADEMARKS FOR WHICH A DECISION ON GRANTING PROTECTIONS IS TAKEN:**
79616; 87957; 88095; 88190; 88193; 88262; 88275, 88276; 88299; 88361; 88466; 88519, 88520; 88588; 88592; 88595; 88604; 88607; 88697; 88704, 88705; 88708; 88710; 88712; 88716; 88719; 88722; 88730; 88740; 88743; 88750; 88754; 88756, 88757; 88759-88761; 88764; 88766; 88770-88772; 88775; 88778, 88799; 88801; 88839; 88841, 88842; 88902; 88906; 89109-89111; 89117
- **INTERNATIONAL TRADEMARKS PROTECTED IN GEORGIA:**
85800; 86070; 86311; 86377; 86413, 86414; 86484; 86636; 87101; 87190, 87191; 87205; 87207; 87454-87457; 87462, 87463; 87523; 87525; 87541; 87543-87545; 87612, 87613; 87708-87713; 87740; 87768-87770; 87818; 87839; 87848; 87872, 87873; 87875; 87880; 87910, 87911; 87913; 87915, 87916; 87918-87923; 88149, 88150; 88168

INVENTIONS

APPLICATIONS APPROVED FOR GRANTING PATENTS

The decision can be appealed at the Chamber of Appeal of Sakpatenti within 3 months from the publication or at the Mtskheta District Court Administrative Cases Board (Address: №17, Samkhedro str., Mtskheta), within 1 month following the publication.

PART A

A 61

(10) AP 2017 14289 A (51) Int. Cl. (2006)

A 61 K 8/37

A 61 K 8/67

A 61 Q 19/00

A 61 Q 19/10

A 61 K 8/97

A 61 K 8/06

(21) AP 2015 014289 (22) 2015 03 20

(31) MI2014A000495

(32) 2014 03 24

(33) IT

(71) BIO.LO.GA. S.R.L. (IT)

Via Giuseppe Lazzarin, 66 I-31015

Conegliano (Treviso) (IT)

(72) PANIN, Giorgio (IT)

(74) Nugzar Ksovreli

(85) 2016 10 03

(86) PCT/EP2015/055927, 2015 03 20

(54) **FORMULATION FOR PERSONAL HYGIENE**

(57) Composition contains fatty alcohol or Glyceryl Stearate, Coco Caprylate and/or Coco Caprylate / Caprate, vitamin E or ester thereof, and Melaleuca alternifolia oil.

Claims: 1 independent

12 dependent

(10) AP 2017 13618 A (51) Int. Cl. (2006)

A 61 K 9/00

A 61 K 9/28

A 61 K 31/606

A 61 K 47/32

A 61 K 47/36

(21) AP 2013 013618 (22) 2013 04 29

(31) 12166110.2; 61/640,217

(32) 2012 04 30; 2012 04 30

(33) EP; US

(71) TILLOTTS PHARMA AG (CH)

Baslerstrasse 15 CH-4310 Rheinfelden (CH)

(72) BRAVO GONZÁLEZ, Roberto Carlos (CH);

BUSER, Thomas (CH);

GOUTTE, Frédéric Jean-Claude (FR);

BASIT, Abdul, Waseh (GB);

VARUM, Felipe, José, Oliveria (CH);

FREIRE, Ana, Cristina (GB)

(74) Tamaz Shilakadze

(85) 2014 10 29

(86) PCT/EP2013/058923, 2013 04 29

(54) **DELAYED RELEASE DRUG FORMULATION**

(57) Delayed release of drug to the colon is achieved from delayed release formulation comprising a core and its coating. The core comprises the drug, and coating comprises outer layer and at least one layer between the core and outer layer selected from the group consisting of isolation layer and inner layer. Outer layer comprises a mixture of first polymeric material which is susceptible to attack by colonic bacteria, and second polymeric material which has pH threshold at about pH 5 or above. Inner layer comprises third polymeric material which is soluble in intestinal fluid or gastrointestinal fluid, and said third polymeric material is selected from at least partially neutralised polycarboxylic acid and non-ionic polymer. In embodiments wherein third polymeric material is non-ionic polymer, inner layer comprises at least one buffer agent and a base. Isolation layer comprises non-ionic polymer soluble in intestinal fluid or gastrointestinal fluid. Outer layer is applied directly to inner or isolation layer using coating preparation formed by combining first polymeric material in aqueous medium with second polymeric material in organic medium. Advantages of formulations according to present invention include accelerated release of drug when exposed to colonic conditions and reduction or elimination of food and/or alcohol effect on drug release after administration.

Claims: 2 independent

44 dependent

Fig.: 16

(10) AP 2017 13923 A (51) Int. Cl. (2006)

A 61 K 9/00

A 69 K 9/28

A 61 K 31/606

A 61 K 47/32

A 61 K 47/36

(21) AP 2013 013923 (22) 2013 04 29

(62) 61/6540.217 2012 04 30 (US); 12166110.2

2012 04 30 (EP)
 (31) 61/6540,217; 12166110.2
 (32) 2012 04 30; 2012 04 30
 (33) US; EP
 (71) TILLOTTS PHARMA AG (CH)
 Baslerstrasse 15 CH-4310 Rheinfelden (CH)
 (72) BRAVO GONZÁLEZ, Roberto Carlos (CH);
 BUSER, Thomas (CH);
 GOUTTE, Frédéric Jean-Claude (FR);
 BASIT, Abdul, Waseh (GB);
 VARUM, Felipe, José, Oliveria (CH);
 FREIRE, Ana, Cristina (GB)
 (74) Tamaz Shilakadze
 (85) 2015 08 31
 (86) PCT/EP2013/058921, 2013 04 29
 (54) **DELAYED RELEASE DRUG
 FORMULATION**
 (57) Delayed release of drug to a colon is achieved from delayed release formulation comprising a core and its coating. The core comprises the drug, and coating comprises inner and outer layers. Outer layer comprises a mixture of first polymeric material which is susceptible to attack by colonic bacteria, and second polymeric material which has pH threshold at about pH 5 or above. Inner layer comprises third polymeric material soluble in intestinal fluid or gastrointestinal fluid, and said third polymeric material is non-ionic polymer.
 Claims: 2 independent
 26 dependent
 Fig.: 8

(10) AP 2017 13924 A (51) Int. Cl. (2006)

A 61 K 9/00
A 61 K 9/28
A 61 K 31/606
A 61 K 47/32
A 61 K 47/36

(21) AP 2013 013924 (22) 2013 04 29
 (62) 61/640,217 2012-04-30 (US); 12166110.2
 2012 04 30 (EP);
 (31) 61/640,217; 12166110.2
 (32) 2012 04 30; 2012 04 30
 (33) US; EP
 (71) TILLOTTS PHARMA AG (CH)
 Baslerstrasse 15 CH-4310 Rheinfelden (CH)
 (72) BRAVO GONZÁLEZ, Roberto Carlos (CH);
 BUSER, Thomas (CH);
 GOUTTE, Frédéric Jean-Claude (FR);
 BASIT, Abdul, Waseh (GB);
 VARUM, Felipe, José, Oliveria (CH);
 FREIRE, Ana, Cristina (GB)
 (74) Tamaz Shilakadze
 (85) 2015 08 31
 (86) PCT/EP2013/058923, 2013 04 29
 (54) **DELAYED RELEASE DRUG
 FORMULATION**

(57) Delayed release of drug to a colon is achieved from delayed release formulation comprising a core and its coating. The core comprises the drug, and coating comprises outer layer and at least one layer between the core and outer layer selected from the group consisting of isolation and inner layers. Outer layer comprises a mixture of first polymeric material which is susceptible to attack by colonic bacteria, and second polymeric material having pH threshold at about pH 5 or above. Inner layer comprises third polymeric material soluble in intestinal fluid or gastrointestinal fluid, said third polymeric material being selected from at least partially neutralised polycarboxylic acid and non-ionic polymer. In embodiments in which the third polymeric material is non-ionic polymer, inner layer comprises at least one buffer agent and a base. Isolation layer comprises non-ionic polymer soluble in intestinal fluid or gastrointestinal fluid. Outer layer is applied directly to inner or isolation layer using coating preparation formed by combining first polymeric material in aqueous medium with second polymeric material in organic medium.
 Claims: 2 independent
 48 dependent
 Fig.: 16

(10) AP 2017 13659 A (51) Int. Cl. (2006)
A 61 K 9/48

(21) AP 2013 013659 (22) 2013 05 09
 (31) 61/644,996
 (32) 2012 05 09
 (33) US
 (71) WESTERN UNIVERSITY OF HEALTH
 SCIENCES (US)
 309 E. Second Street Pomona,
 CA 91766 (US);
 TESORX PHARMA, LLC (US)
 325 Sharon Park Drive, Suite 739, Menlo
 Park, CA 94025 (US)
 (72) BETAGERI, Guru, V. (US);
 THIRUCOTE, Ramachandran (US);
 KADAJJI, Veeran, Gowda (US)
 (74) Tamar Kochlamazashvili
 (85) 2014 12 09
 (86) PCT/US2013/040325, 2013 05 09
 (54) **PROLIPOSOMAL TESTOSTERONE
 FORMULATIONS**
 (57) An invention relates to proliposomal powder dispersion composition including testosterone, preparation and usage therefor testosterone deficit treatment.
 Claims: 10 independent
 19 dependent
 Fig.: 28

- (10) AP 2017 13771 A (51) Int. Cl. (2006)
 A 61 K 31/5517
 A 61 K 31/4468
 A 61 K 31/567
 A 61 K 45/00
 A 61 P 25/20
 C 07 D 413/04
 C 07 D 413/14
 C 07 D 417/04
 C 07 D 417/14
 C 07 D 451/02
 C 07 D 451/04
 C 07 D 487/10
 C 07 D 487/18
 C 07 D 491/18
 C 07 D 515/18
 C 12 N 9/99
 C 12 N 15/09
- (21) AP 2013 013771 (22) 2013 08 30
 (31) 2012-192081
 (32) 2012 08 31
 (33) JP
 (71) PAION UK LIMITED (GB)
 Chivers Way, Histon, Cambridge,
 Cambridgeshire CB24 9ZR (GB)
- (72) KONDO, Maki (JP);
 KONOMI, Toshihiko (JP);
 SATO, Shigehito (JP)
- (74) Shalva Gvaramadze
 (85) 2015 03 25
 (86) PCT/JP2013/073414, 2013 08 30
- (54) **METHOD FOR ADMINISTERING
 HYPNOTIC/SEDATIVE AGENT**
- (57) Methyl-3-[(4S)-8-bromo-1-methyl-6-(2-pyrid-yl)-4H-imidazo[1,2-a][1,4]benzodiazepine-4-yl] propionate of 0.3-40 mg/h/kg dosage is used for sedative condition induction.
 Claims: 2 independent
 7 dependent

PART C

C 07

- (10) AP 2017 13877 A (51) Int. Cl. (2006)
 C 07 D 213/74
 A 61 K 31/444
 A 61 K 31/4545
 A 61 K 31/46
 A 61 K 31/496
 A 61 K 31/4995
 A 61 K 31/506
 A 61 K 31/5377
 A 61 K 31/5386
 A 61 K 31/541
 A 61 K 31/55
 A 61 P 25/00
 A 61 P 25/08
 A 61 P 25/14
 A 61 P 25/16
 A 61 P 25/28
 A 61 P 43/00
 C 07 D 239/42
 C 07 D 401/04
 C 07 D 401/12
 C 07 D 401/14
 C 07 D 405/14
- (21) AP 2013 013877 (22) 2013 12 10
 (31) 2012-270445; 2013-210439
 (32) 2012 12 11; 1013 10 07
 (33) JP; JP
 (71) TAKEDA PHARMACEUTICAL
 COMPANY LIMITED (JP)
 1-1, Doshomachi 4-chome, Chuo-ku,
 Osaka-shi, Osaka 5410045 (JP)
- (72) KOIKE, Tatsuki (JP);
 KAJITA, Yuichi (JP);
 YOSHIKAWA, Masato (JP);
 IKEDA, Shuhei (JP);
 KIMURA, Eiji (JP);
 HASUI, Tomoaki (JP);
 NISHI, Toshiya (JP);
 FUKUDA, Hiromi (JP)
- (74) Shalva Gvaramadze
 (85) 2015 07 06
 (86) PCT/JP2013/083140, 2013 12 10
- (54) **HETEROCYCLIC COMPOUND**
- (57) An invention relates to piperidine and piperazine compound of formula (I),

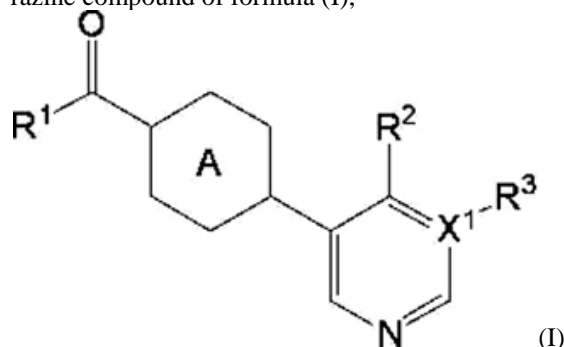

characterized with strong inhibiting activity relative to cholesterol 24-hydroxylase (CH24H), and usage therefor epilepsy and neurodegenerative disease treatment.

Claims: 10 independent
 9 dependent

- (10) AP 2017 13950 A (51) Int. Cl. (2006)
 C 07 D 307/85
 A 61 K 31/343
 A 61 P 29/00
 A 61 P 35/00
- (21) AP 2014 013950 (22) 2014 03 03

(31) 61/772,191; 13/51898
 (32) 2013 03 04; 2013 03 04
 (33) US; FR
 (71) PHARMACYCLICS LLC (US)
 995 East Arques Avenue Sunnyvale,
 CA 94085 (US)

(72) PIMONT-GARRO, Anne (FR);
 LETELLIER, Philippe (FR)

(74) Tamaz Shilakadze

(85) 2015 10 02

(86) PCT/FR2014/050455, 2014 03 03

(54) **NOVEL ABEXINOSTATE SALT,
 ASSOCIATED CRYSTALLINE FORM,
 PREPARATION METHOD THEREOF
 AND THE PHARMACEUTICAL
 COMPOSITIONS CONTAINING SAME**

(57) Abexinostate tosylate crystalline form I,
 preparation method, and pharmaceutical
 composition on basis thereof.

Claims: 3 independent
 10 dependent

**(10) AP 2017 13977 A (51) Int. Cl. (2006)
 C 07 D 401/14
 C 07 D 405/14
 C 07 D 413/14
 C 07 D 401/04
 C 07 D 417/14
 C 07 D 471/08
 C 07 D 487/06
 C 07 D 487/10
 C 07 D 491/10
 A 61 K 31/443
 A 61 K 31/4433
 A 61 K 31/4436
 A 61 K 31/4545
 A 61 K 31/496**

(21) AP 2014 013977 (22) 2014 03 26

(31) 61/916,715; 61/806,806

(32) 2013 12 16; 2013 03 29

(33) US; US

(71) TAKEDA PHARMACEUTICAL
 COMPANY LIMITED (JP)

1-1, Doshomachi 4-chome, Chuo-ku
 Osaka-shi, 541-0045 (JP)

(72) Jason, W. BROWN (US);

Melinda DAVIS (US);

Anthony IVETAC (US);

Benjamin JONES (US);

Andre, A. KIRYANOV (US);

Jon KUEHLER (US);

Marion LANIER (US);

Joanne MIURA (US);

Sean MURPHY (US);

Xiaolun WANG (US)

(74) Aleksandre Gegechkori

(85) 2015 10 28

(86) PCT/US2014/031918, 2014 03 26

(54) **6-(5-HYDROXY-1H-PYRAZOL-1-YL)
 NICOTINAMIDE DERIVATIVES AND
 THEIR USE AS PHD INHIBITORS**

(57) An invention relates to nicotinamides of
 formula III

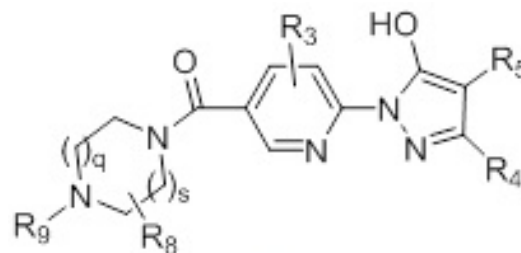

III

and preparation methods thereof.

Claims: 4 independent
 7 dependent

**(10) AP 2017 14180 A (51) Int. Cl. (2006)
 C 07 D 405/12
 A 61 K 31/498
 A 61 P 25/00**

(21) AP 2014 014180 (22) 2014 12 18

(31) PA2014000249; PA201300707

(32) 2014 05 06; 2013 12 19

(33) DK; DK

(71) H. LUNDBECK A/S (DK)

Ottiliavej 9 DK-2500 Valby (DK)

(72) KEHLER, Jan (DK);

RASMUSSEN, Lars Kyhn (DK);

LANGGÅRD, Morten (DK)

(74) Tamaz Shilakadze

(85) 2016 06 17

(86) PCT/EP2014/078475, 2014 12 18

(54) **QUINAZOLIN-THF-AMINES AS
 PDE1 INHIBITORS**

(57) Present invention provides Quinazolin-THF-
 amines as PDE1 inhibitors and their usage for
 neurodegenerative and psychiatric disorders
 treatment.

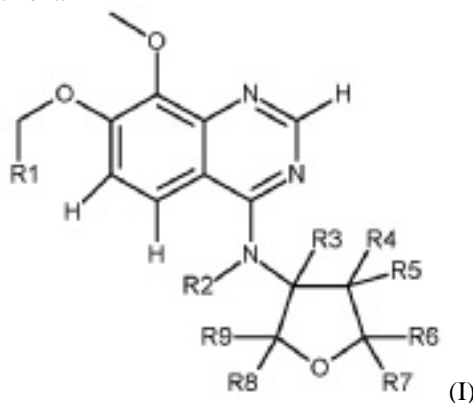

(I)

Claims: 3 independent
 5 dependent

(10) AP 2017 13892 A (51) Int. Cl. (2006)
 C 07 H 19/067
 C 07 H 19/073
 C 07 H 19/10
 C 07 H 19/167
 C 07 H 19/173
 C 07 H 19/20
 C 07 H 19/213
 A 61 K 31/708
 A 61 K 31/7076
 A 61 K 31/7072
 A 61 K 31/7068
 A 61 P 31/14

(21) AP 2013 013892 (22) 2013 12 19

(31) 61890,125; 61/745,466

(32) 2013 10 11; 2012 12 21

(33) US; US

(71) ALIOS BIOPHARMA, INC. (US)
 260 E. Grand Ave, 2nd Floor South
 San Francisco, CA 94080 (US)

(72) BEIGELMAN, Leonid (US);
 WANG, Guangyi (US);
 SMITH, David, Bernard (US)

(74) Aleksandre Gegechkori

(85) 2015 07 21

(86) PCT/US2013/076740, 2013 12 19

(54) **SUBSTITUTED NUCLEOSIDES,
 NUCLEOTIDES AND ANALOGS
 THEREOF**

(57) An invention relates to nucleosides, nucleotides and their analogs of formula (I)

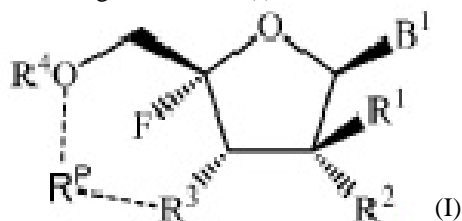

and usage therefor HCV infection treatment.

Claims: 9 independent

54 dependent

Fig.: 12

(10) AP 2017 13984 A (51) Int. Cl. (2006)
 C 07 K 14/605

(21) AP 2014 013984 (22) 2014 05 27

(31) 2013-111893

(32) 2015 05 28

(33) JP

(71) TAKEDA PHARMACEUTICAL
 COMPANY LIMITED [JP/JP];
 1-1, Doshomachi 4-chome, Chuo-ku,
 Osaka-shi, Osaka 5410045 (JP)

(72) ASAMI, Taiji (JP);
 NIIDA, Ayumu (JP)

(74) Shalva Gvaramadze

(85) 2015 11 05

(86) PCT/JP2014/002772, 2014 05 27

(54) **PEPTIDE COMPOUND**

(57) The present invention provides a novel peptide compound having an activating action on GLP-1 receptors and GIP receptors and use of the peptide compound as a medicament. Specifically, a peptide containing a partial sequence represented by the formula (I) or a salt thereof and a medicament comprising the same are provided. P1-Tyr-Aib-Glu-Gly-Thr- α MePhe-Thr-Ser-Asp-Tyr-A11-A12-A13-Leu-Asp-A16-A17-Ala-Gln-A20-Glu-Phe-Val-Lys-Trp-Leu-Leu-Lys-A29 (I) wherein each symbol is as defined herein.

Claims: 10 independent

12 dependent

C 12

(10) AP 2017 14061 A (51) Int. Cl. (2006)
 C 12 N 7/00
 A 61 K 35/76

(21) AP 2014 014061 (22) 2014 07 16

(31) 13176757.6

(32) 2013 07 16

(33) EP

(71) DITESAN LTD. (LV)

Kudras iela 7-8 Olaine 2114 Olaines
 novads (LV)

(72) VENSKUS, Dite (LV);

KALVINS, Ivars (LV);

PJANOVA, Dace (LV);

PETROVSKA, Ramona (LV);

AUZINS, Jurgis (LV)

(74) Lalisa Amirkhanyan

(85) 2016 02 15

(86) PCT/EP2014/065277, 2014 07 16

(54) **GENETICALLY STABLE
 ONCOLYTIC RNA VIRUS, METHOD OF
 MANUFACTURING AND USE
 THEREOF**

(57) In a method for manufacturing a modified enterovirus of ECHO 7 type by modification of native ECHO 7 virus, isolated by a known method from human feces and identified by genome sequence, the modification is performed initially conducting the virus adaptation in cancer cells, attenuated by anti-cancer agent dacarbazine, further passaging the modified virus in human embryonal fibroblast culture, followed by propagation in human melanoma cells and further passaging in human embryonal fibroblast culture, that was treated by ribavirin, isolation and purification by known method. The modified virus is suitable for treating various tumours.

Claims: 4 independent

10 dependent

Fig.: 11

(10) AP 2017 12872 A (51) Int. Cl. (2006)

C 12 N 9/88

C 12 N 15/82

(21) AP 2011 012872 (22) 2011 03 17

(31) 61/314,901; 61/410,802; 61/417,132

(32) 2010 03 17; 2010 11 05; 2010 11 24

(33) US; US; US

(71) BASF AGROCHEMICAL PRODUCTS

B.V. (NL)

Gebouw Rijnpoort Groningensingel 1

NL-6835 EA Arnhem (NL)

(72) VANTIEGHEM, Herve (DE);

PFENNING, Matthias (DE);

BREMER, Hagen (DE);

KEHLER, Ron (CA);

SCHOENHAMMER, Alfons (DE)

(74) Aleksandre Kartvelishvili

(85) 2012 10 17

(86) PCT/IB2011/000704, 2011 03 17

(54) **HERBICIDE-TOLERANT PLANTS**

(57) An invention relates to winter-type Brassica plant protection from weeds by treating plant with sulfonylureas as before as after plantlet; at that, said plant contains AHASL gene coding W574X mutation of sulfonylureas herbicide giving plant significantly great resistance to herbicides relative to other winter-type plants.

Claims: 6 independent

25 dependent

Fig.: 8

PATENTED INVENTIONS
PART A**A 61**

- (11) P 2017 6693 B** (51) **Int. Cl. (2006)**
A 61 K 9/20
 (10) AP 2017 12701 A (44) 6(466)/2017
 (21) AP 2010 012701
 (22) 2010 10 27
 (24) 2010 10 27
 (31) 1287/KOL/2009
 (32) 2009 10 27
 (33) IN
 (86) PCT/IN2010/000694, 2010 10 27
 (73) LUPIN LIMITED (IN)
 Lupin Limited, 159 CST Road Kalina,
 Santacruz (East) Mumbai 400 098
 Maharashtra (IN)
 (72) KULKARNI, Shirishkumar (IN);
 DALAL, Satish, Kumar (IN);
 JAHAGIRDAR, Harshal, Anil (IN)
 (74) Giorgi Meipariani
 (54) **SOLID DISPERSION OF RIFAXIMIN**
-

- (11) P 2017 6696 B** (51) **Int. Cl. (2006)**
A 61 K 31/57
A 61 K 45/06
A 61 P 15/00
 (10) AP 2017 13608 A (44) 6(466)/2017
 (21) AP 2013 013608
 (22) 2013 03 22
 (24) 2013 03 22
 (31) 61/614,785; 12160956.4
 (32) 2012 03 23; 2012 03 23
 (33) US; EP
 (86) PCT/IB2013/052274, 2013 03 22
 (73) PREGLEM SA (CH)
 Chemin du Pré-Fleuri 3, Plan-les-Ouates
 CH-1228 Geneva (CH)
 (72) GOTTELAND, Jean-Pierre (CH);
 BOUJAC, Valérie (FR);
 LOUMAYE, Ernest (CH)
 (74) Liliana Darakhvelidze
 (54) **METHOD FOR TREATING**
GYNECOLOGICAL DISEASES
-

PART B**B 01**

- (11) P 2017 6694 B** (51) **Int. Cl. (2006)**
B 01 D 53/14
B 01 D 53/50
C 01 B 17/05
 (10) AP 2017 13095 A (44) 6(466)/2017
 (21) AP 2011 013095
 (22) 2011 10 28
 (24) 2011 10 28
 (31) 61/408,420
 (32) 2010 10 29
 (33) US
 (86) PCT/US2011/058314, 2011 10 28
 (73) MECS, INC. (US)
 14522 South Outer Forty Drive Chesterfiled,
 Missouri 63017 (US)
 (72) VERA-CASTANEDA, Ernesto (US)
 (74) Tamaz Shilakadze
 (54) **REGENERATIVE RECOVERY OF**
SULFUR DIOXIDE FROM EFFLUENT
GASES
-

PART C**C 07**

- (11) P 2017 6695 B** (51) **Int. Cl. (2006)**
C 07 D 401/04
A 61 K 31/44
A 61 P 25/00
 (10) AP 2017 13508 A (44) 6(466)/2017
 (21) AP 2012 013508
 (22) 2012 11 28
 (24) 2012 11 28
 (31) 61/564,537; 13/478,361
 (32) 2011 11 29; 2012 05 23
 (33) US; US
 (86) PCT/US2012/066778, 2012 11 28
 (73) HELSINN HEALTHCARE SA (CH)
 Via Pian Scairolo 9, CH-6912
 Lugano/Pazzallo (CH)
 (72) FADINI, Luca (CH);
 MANINI, Peter (CH);
 PIETRA, Claudio (IT);
 GIULIANO, Claudio (IT);
 LOVATI, Emanuela (IT);
 CANNELLA, Roberta (IT);

VENTURINI, Alessio (IT);
 STELLA, Valentino, J. (US)
 (74) Shalva Gvaramadze
 (54) **SUBSTITUTED 4-PHENYL-PYRIDINES FOR THE TREATMENT OF NK-1 RECEPTOR RELATED DISEASES**

(11) P 2017 6699 B **(51) Int. Cl. (2006)**
C 07 D 413/14
C 07 D 413/04
C 07 D 417/14
A 61 K 31/506
A 61 P 35/00

(10) AP 2017 13934 A (44) 6(466)/2017

(21) AP 2014 013934

(22) 2014 03 12

(24) 2014 03 12

(31) 61/892,131; 61/783,210

(32) 2013 10 17; 2013 03 14

(33) US; US

(86) PCT/IB2014/059695, 2014 03 12

(73) NOVARTIS AG (CH)

Lichtstrasse 35 CH-4056 Basel (CH)

(72) CAFERRO, Thomas Raymond (US);

CHEN, Zhuoliang (CN);

CHO, Young Shin (KR);

COSTALES, Abran Q. (US);

LEVELL, Julian Roy (GB);

LIU, Gang (CN);

MANNING, James R. (US);

SENDZIK, Martin (DE);

SHAFFER, Cynthia (US);

SHULTZ, Michael David (US);

SUTTON, James (US);

WANG, Yaping (CN);

ZHAO, Qian (CN)

(74) Aleksandre Kartvelishvili

(54) **3-PYRIMIDIN-4-YL-OXAZOLIDIN-2-ONES AS INHIBITORS OF MUTANT IDH**

(11) P 2017 6698 B **(51) Int. Cl. (2006)**
C 07 D 471/04
A 61 K 31/506
A 61 K 31/444
A 61 P 31/16

(10) AP 2017 13685 A (44) 6(466)/2017

(21) AP 2012 013685

(22) 2012 08 01

(24) 2012 08 01

(62) 61/513,793 2011 08 01 (US)

(31) 61/513,793

(32) 2011 08 01

(33) US

(86) PCT/US2012/049097, 2012 08 01

(73) VERTEX PHARMACEUTICALS
 INCORPORATED (US)
 50 Northern Avenue, 15th Floor Boston,
 MA 02210 (US)

(72) CHARIFSON, Paul, S. (US);
 CLARK, Michael, P. (US);
 BANDARAGE, Upul, K. (US);
 BETHIEL, Randy, S. (US);
 BOYD, Michael, J. (CA);
 DAVIES, Ioana (RO);
 DENG, Hongbo (CN);
 DUFFY, John, P. (US);
 FARMER, Luc, J. (CA);
 GAO, Huai (CN);
 GU, Wenxin (CN);
 KENNEDY, Joseph, M. (US);
 LEDFORD, Brian (US);
 LEDEBOER, Mark, W. (US);
 MALTAIS, Francois (CA);
 PEROLA, Emanuele (IT);
 WANG, Tiansheng (US)

(74) Shalva Gvaramadze

(54) **INHIBITORS OF INFLUENZA VIRUSES REPLICATION**

C 09

(11) P 2017 6697 B **(51) Int. Cl. (2006)**
C 09 K 5/04

(10) AP 2017 13661 A (44) 6(466)/2017

(21) AP 2013 013661

(22) 2013 05 08

(24) 2013 05 08

(31) 61/645,697

(32) 2012 05 11

(33) US

(86) PCT/NO2013/050083, 2013 05 08

(73) ECO D'GAS AS (NO)

Postboks 388 N-8401 Sortland (NO)

(72) MCKENNA, Charles P. (ES)

(74) Shalva Gvaramadze

(54) **REFRIGERANT GAS COMPOSITION**

PART F

F 03

- (11) **P 2017 6701 B** (51) **Int. Cl. (2006)**
F 03 D 3/02
- (10) AP 2017 14065 A (44) 6(466)/2017
(21) AP 2016 014065
(22) 2016 02 22
(24) 2016 02 22
(73) Tamaz Shioshvili (GE)
Ir. Abashidzis q. 46, b. 17, 0179,
Tbilisi (GE)
(72) Tamaz Shioshvili (GE)
(54) **WIND RECEIVING DEVICE**
-

PART H

H 01

- (11) **P 2017 6700 B** (51) **Int. Cl. (2006)**
H 01 L 21/66
G 01 R 31/66
- (10) AP 2017 14017 A (44) 6(466)/2017
(21) AP 2015 014017
(22) 2015 12 23
(24) 2015 12 23
(73) Amiran Bibilashvili (GE)
A. Tseretlis gamz. 97, b. 57, 0119,
Tbilisi (GE);
Nugzar Dolidze (GE)
I. Chavchavadzis gamz. 24, b. 21, 0179,
Tbilisi (GE)
(72) Amiran Bibilashvili (GE);
Nugzar Dolidze (GE)
(54) **METHOD FOR ENERGY LEVEL**
DETERMINATION ON SEMICON-
DUCTOR-DIELECTRIC BOUNDARY
-

UTILITY MODELS

APPLICATION APPROVED FOR GRANTING PATENT

The decision can be appealed at the Chamber of Appeal of Sakpatenti within 3 months from the publication or at the Mtskheta District Court Administrative Cases Board (Address: №17, Samkhedro str., Mtskheta), within 1 month following the publication.

PART A

A 61

(10) AU 2017 14346 U (51) Int. Cl. (2006)
A 61 K 36/00
A 61 K 35/64
A 61 P 1/16
A 61 P 1/18

(21) AU 2016 014346 (22) 2016 12 12

(71) Roza Asoyan (GE)
Varketili 3, me-3a mkr., korp. 337, b. 15,
0163, Tbilisi (GE)

(72) Roza Asoyan (GE)

(54) **COMPOSITION FOR CIRRHOSIS
AND CHRONIC PANCREATITIS
TREATMENT**

(57) Composition contains parsley – *Petroselinum
crispum* juice, honey and olive oil.

Claims: 1 independent

PART B

B 65

(10) AU 2017 14096 U (51) Int. Cl. (2006)
B 65 D 75/08
B 65 D 75/78

(21) AU 2013 014096 (22) 2013 11 15

(31) a 2013 11301

(32) 2013 09 23

(33) UA

(71) MIROCHNIK, Irina (UA)
UK of GB & northern Irland, London,
25 Apartments, Wellington House,
70 Buckingham Gate, SW1E 6AL (GB)

(72) MIROCHNIK, Irina (UA)

(74) Shalva Gvaramadze

(85) 2016 03 21

(86) PCT/UA2013/000132, 2013 11 15

(54) **ENVELOPE FOR PACKING OF
SMALL PIECE GOODS**

(57) An envelope (1) for small goods on a basis of
flexible package material comprising contact areas

of at least single-layer inner and outer laminate
structures, which parts projecting beyond ends of
column of packed goods are shaped as tightly
closed butt-end caps (2) and reed flap (3) suitable
for repeated opening and closing and in which a
line of perforation (5) confines the reed (4). Said
line of perforation is made only in outer laminate
structure, and each prospective reed is placed
initially onto the inner laminate structure.

Claims: 1 independent

Fig.: 8

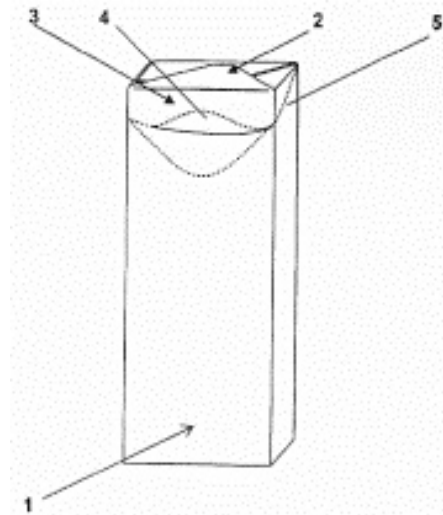

Fig. 2

(10) AU 2017 14097 U (51) Int. Cl. (2006)
B 65 D 75/08
B 65 D 75/58

(21) AU 2013 014097 (22) 2013 11 15

(31) a 2013 11301

(32) 2013 09 03

(33) UA

(71) MIROCHNIK, Irina (UA)
UK of GB & northern Irland, London,
25 Apartments, Wellington House,
70 Buckingham Gate, SW1E 6AL (GB)

(72) MIROCHNIK, Irina (UA)

(74) Shalva Gvaramadze

(85) 2016 03 21

(86) PCT/UA2013/000132, 2013 11 15

(54) **FLEXIBLE WRAPPING MATERIAL
FOR MANUFACTURE FOR PACKING
OF SMALL PIECE GOODS**

(57) Flexible wrapping material for manufacture for packing of small piece goods shaped as long-length band (1) comprising many prospective uniform envelopes' blank-segments each wherefrom has contact areas of at least single-layer inner and outer laminate structures and a zone meant for formation of a prospective reed flap (3) confined by a line of perforation (4) is executed only in outer laminate structure, and each expected reed is freely laied on inner laminate structure.

Claims: 1 independent

Fig.: 8

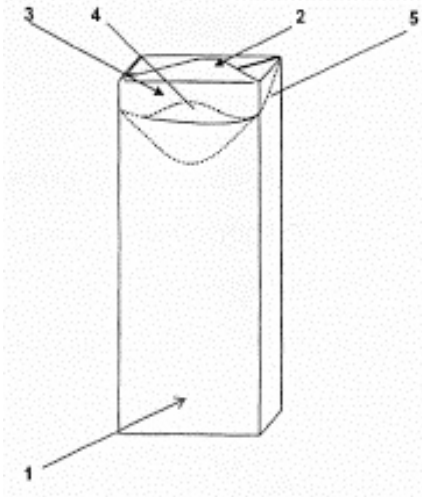

Fig. 2

PATENTED UTILITY MODELS

PART A

A 01

(11) U 2017 1940 Y **(51) Int. Cl. (2006)**
A 01 G 15/00

- (10) AU 2017 13975 U (44) 6(466)/2017
 (21) AU 2015 013975
 (22) 2015 12 03
 (24) 2015 12 03
 (73) Giorgi Gelovani (GE)
 Iosebldzis q. 61, b. 8, 0160, Tbilisi (GE);
 Viktor Chikhladze (GE)
 Kakutsa Choloqashvilis q., I kvart.,
 V korp., b. 189, 0113, Tbilisi (GE);
 Nodar Javakhishvili (GE)
 Gldani "A" mkr., korp. 54, b. 120, 0167,
 Tbilisi (GE);
 Ioseb Sauri (GE)
 Varketilis IV mkr., korp. 13, b. 10, 0163,
 Tbilisi (GE);
 Manana Kaishauri (GE)
 M. Ttsinamdzhvrishvilis q. 65, 0102,
 Tbilisi (GE)
 (72) Giorgi Gelovani (GE);
 Viktor Chikhladze (GE);
 Nodar Javakhishvili (GE);
 Ioseb Sauri (GE);
 Manana Kaishauri (GE)
 (54) **METHOD FOR IMPACT ON FIRST**
CATEGORY HAIL CLOUDS

PART B

B 60

(11) U 2017 1939 Y **(51) Int. Cl. (2006)**
B 60 D 1/12

- (10) AU 2017 13905 U (44) 6(466)/2017
 (21) AU 2015 013905
 (22) 2015 08 07
 (24) 2015 08 07
 (73) Pridon Gogiashvili (GE)
 Akhlagzrdobis gamz. 56/5, 4600,
 Kutaisi (GE);
 Isidore Kachakhidze (GE)
 Sop. Didi Jikhaishi, 3900, Samtredia (GE);
 Omar Kikvidze (GE)
 Rustavelis gamz. 154, b. 15, 4600,
 Kutaisi (GE)

- (72) Pridon Gogiashvili (GE);
 Isidore Kachakhidze (GE);
 Omar Kikvidze (GE)

(54) **HOOKUP**

B 65

(11) U 2017 1941 Y **(51) Int. Cl. (2006)**
B 65 B 3/00

- (10) AU 2017 14044 U (44) 6(466)/2017
 (21) AU 2016 014044
 (22) 2016 01 26
 (24) 2016 01 26
 (73) Gocha Pipia (GE)
 Budapeshtis q. 11, b. 55, 0160, Tbilisi (GE)
 (72) Gocha Pipia (GE)
 (74) Aleksandre Kvernadze
 (54) **BEVERAGE CONTAINER**

PART E

E 04

(11) U 2017 1942 Y **(51) Int. Cl. (2006)**
E 04 B 2/14
E 04 C 1/40

- (10) AU 2017 14280 U (44) 6(466)/2017
 (21) AU 2016 014280
 (22) 2016 09 26
 (24) 2016 09 26
 (73) Guram Kemertelidze (GE)
 Saburtalos q. 30a, b. 46, 0160, Tbilisi (GE)
 (72) Guram Kemertelidze (GE)
 (54) **WARM HOLLOW WALL**

DESIGNS

APPLICATIONS APPROVED FOR REGISTRATIONS

The decision can be appealed at the Chamber of Appeal of Sakpatenti within 3 months from the publication or at the Mtskheta District Court Administrative Cases Board (Address: №17, Samkhedro str., Mtskheta), within 1 month following the publication.

(10) AD 2017 941 S (51) 19-02

(21) AD 2017 000941 (22) 2017 02 08

(28) 2

(71) Mikheil Panjikidze (GE)

Tamarashvilis q. 10, 0162, Tbilisi (GE)

(72) Mikheil Panjikidze (GE)

(54) **1.-2. CASING FOR BUSINESS CARDS, FLYERS OR MOBILE PHONES**

(55)

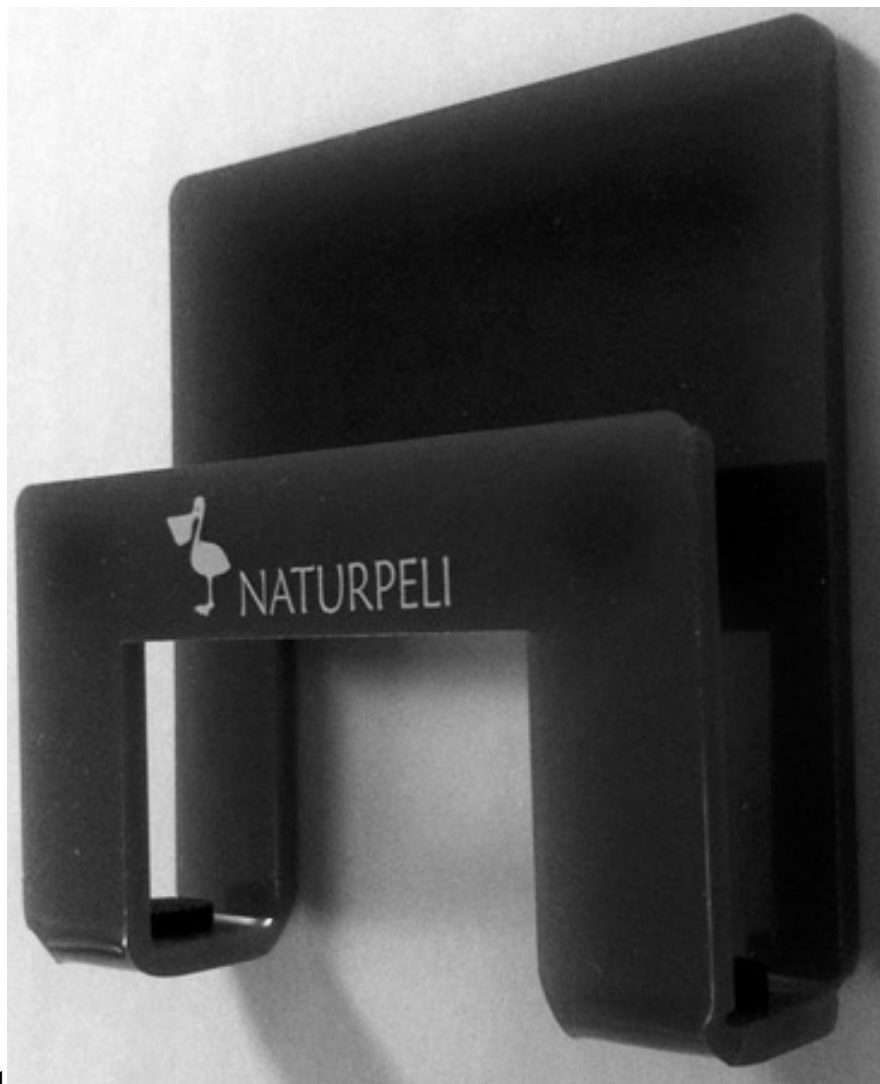

1.1



1.2



2.1



2.2

REGISTERED DESIGNS

(11) D 2017 711 S **(51) 09-01**
(10) AD 2017 929 S (44) 6(466)/2017
(21) AD 2016 000929
(22) 2016 10 19
(24) 2016 10 19
(28) 1
(18) 2021 10 19
(73) Gocha Pipia (GE)
 Budapeshtis q. 11, b. 55, 0160, Tbilisi (GE)
(72) Gocha Pipia (GE)
(74) Aleksandre Kvernadze
(54) **ORNAMENTAL JAR**

(11) D 2017 712 S **(51) 09-03**
(10) AD 2017 925 S (44) 6(466)/2017
(21) AD 2016 000925
(22) 2016 09 23
(24) 2016 09 23
(28) 2
(18) 2021 09 23
(31) 2016-006565; 2016-006495
(32) 2016 03 25; 2016 03 25
(33) JP; JP
(73) KYB CORPORATION (JP)
 World Trade Center Bldg., 4-1,
 Hamamatsucho, 2-chome, Minato-ku,
 Tokyo (JP)
(72) Eizo Ogura (JP)
(74) Shalva Gvaramadze
(54) **1.-2. BOX**

DESIGNS, WHICH HAVE BEEN REGISTERED WITH THE INTERNATIONAL BUREAU CLAIMING PRIORITY ON THE TERRITORY OF GEORGIA

The decision can be appealed at the Chamber of Appeal of Sakpatenti within 3 months from the publication or at the Mtskheta District Court Administrative Cases Board (Address: №17, Samkhedro Str., Mtskheta), within 1 month following the publication.

(11) DM/093290

(15) 2016 10 31

(22) 2016 10 31

(28) 2

(73) ETA SA MANUFACTURE HORLOGÈRE SUISSE

Schild-Rust-Strasse 17, CH-2540 Grenchen (CH)

(85) CH

(86) CH

(87) CH

(88) CH

(89) CH

(81) II. BZ, MA III. AL, AM, AZ, BA, CH, EM, GE, KG, LI, MC, MD, ME, MK, MN, NO, OM, SG, TN, TR, UA

(72) Milko BOYAROV

Birmensdorferstrasse 197, 8003 Zürich, Suisse

(54) 1.-2. Wristwatches

(55)

(51) 10-02

(45) 2017/17 (2017 05 05)



(11) DM/093291**(51) 10-07**

(15) 2016 11 02

(45) 2017/17 (2017 05 05)

(22) 2016 11 02

(28) 5

(73) MONTRES JAQUET DROZ SA (MONTRES JAQUET DROZ AG) (MONTRES JAQUET DROZ LTD.)
Allée du Tourbillon 2, CH-2300 La Chaux-de-Fonds (CH)

(85) CH

(86) CH

(87) CH

(88) CH

(89) CH

(81) II. BZ, MA III. AL, AM, AZ, BA, CH, EM, GE, KG, LI, MC, MD, ME, MK, MN, NO, OM, SG, TN,
TR, UA

(72) LATTMANN Christian

Chemin du Château-Neuf 17, 1125 Monnaz, Suisse;

LEIGGENER Yann

Avenue Léopold-Robert 11, 2300 La Chaux-de-Fonds, Suisse

(54) 1.-5. Dials

(55)

1.1



1.2



1.4

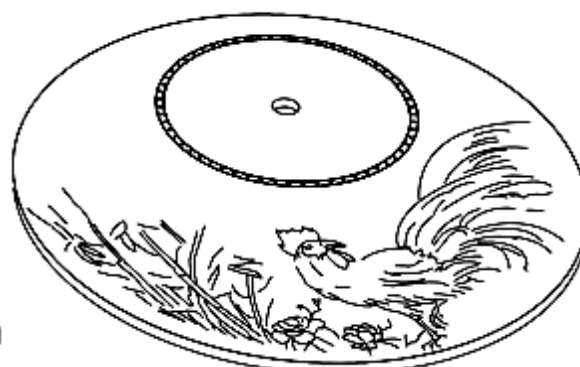

1.3



2



3.1

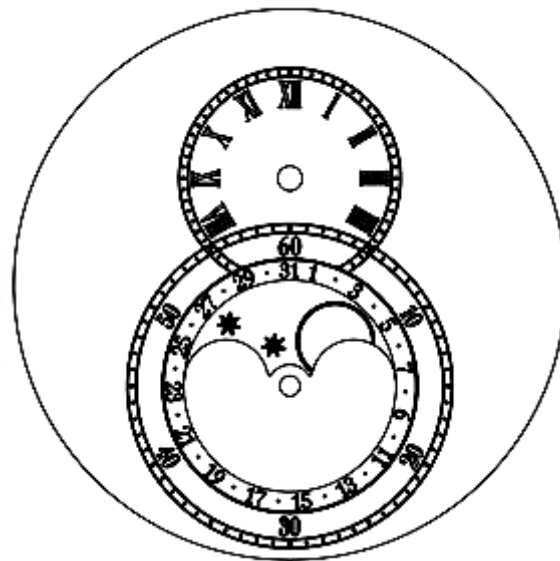

3.3



3.2



3.4

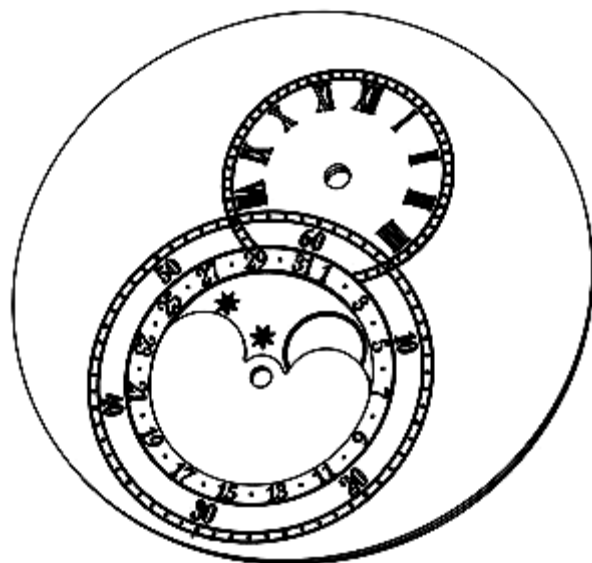

4.1

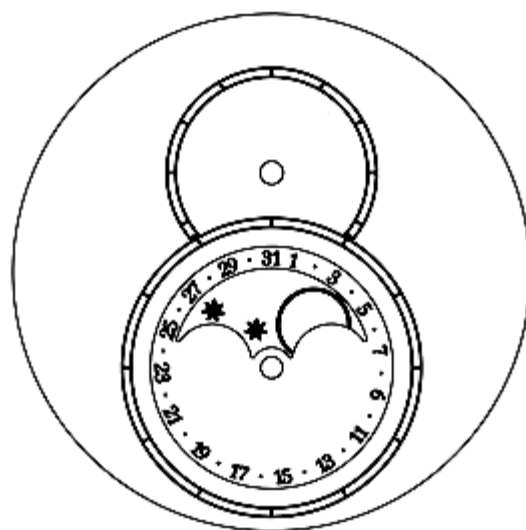

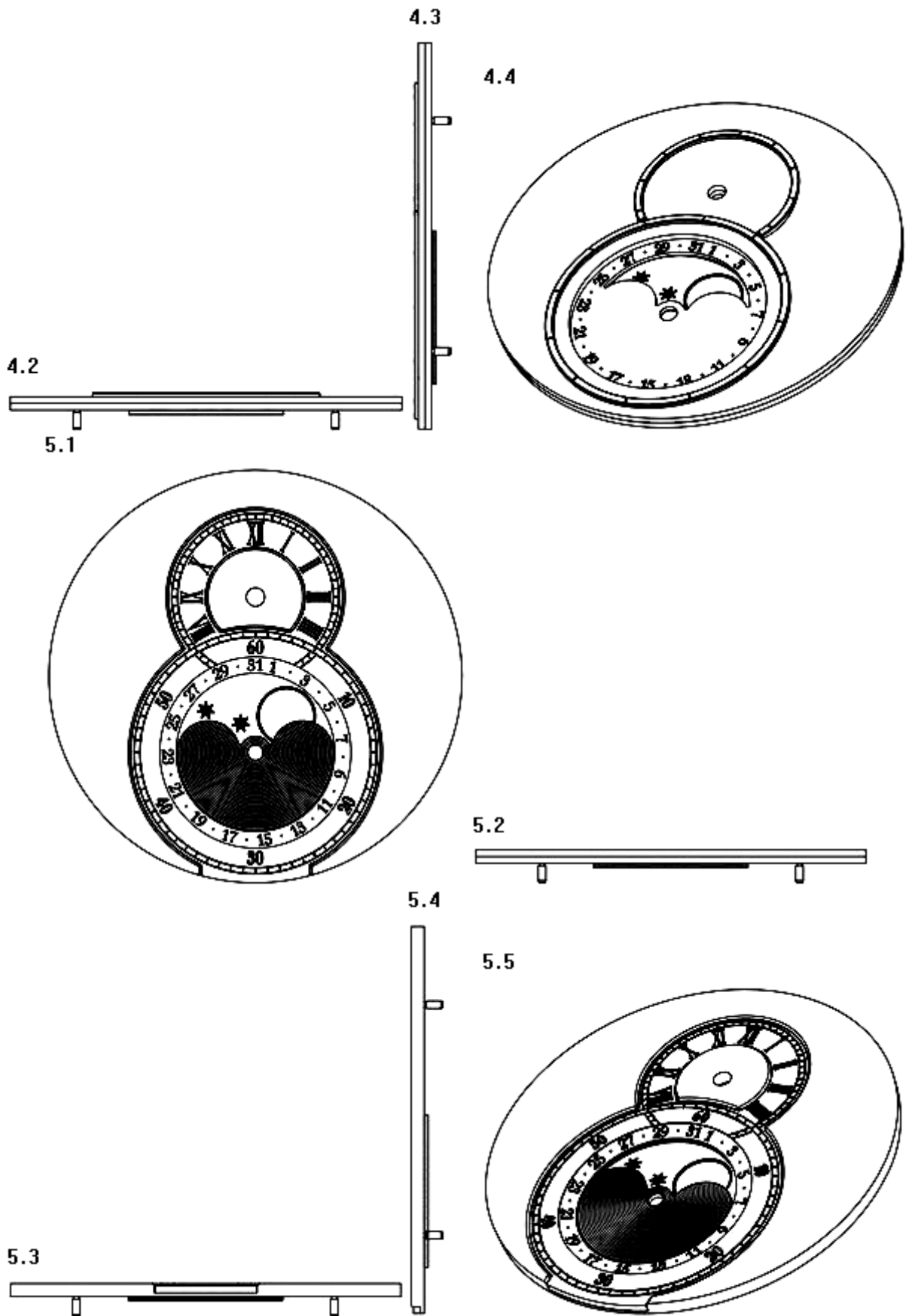

(11) DM/093292

(51) 10-02

(15) 2016 11 02

(45) 2017/17 (2017 05 05)

(22) 2016 11 02

(28) 1

(73) OMEGA SA (OMEGA AG) (OMEGA LTD.)

Jakob-Stämpfli-Strasse 96, CH-2502 Biel/Bienne (CH)

(85) CH

(86) CH

(87) CH

(88) CH

(89) CH

(81) II. BZ, MA III. AL, AM, AZ, BA, CH, EM, GE, KG, LI, MC, MD, ME, MK, MN, NO, OM, SG, TN, TR, UA

(72) Jean-Claude Monachon

Rue Alice-de-Chambrier 1, 2022 Bevaix, Suisse

(54) 1. Watch

(55)

1.1



1.2



1.3



1.4



1.5



1.6



1.7



1.8



(11) DM/095792

(51) 02-04

(15) 2017 03 30

(45) 2017/17 (2017 05 05)

(22) 2017 03 30

(28) 2

(73) VALENTINO S.P.A.

Via Turati, 16/18, I-20121 Milano (IT)

(85) --

(86) EM, IT

(87) EM, IT

(88) EM, IT

(89) EM

(81) III. AZ, EM, GE, JP, KG, KR, TJ, TR, UA

(72) SASSI Stefano

c/o VALENTINO S.p.A., Via Turati, 16/18, I-20121 Milano, Italy

(54) 1.-2. Shoes

(55)

1.1



1.2

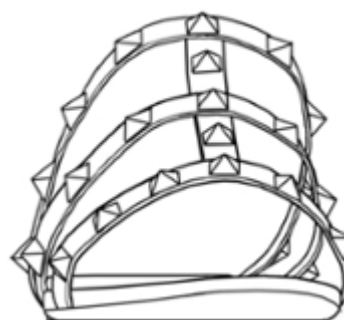

1.3

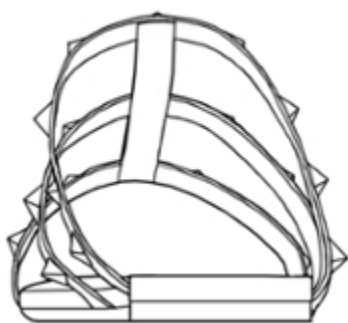

1.4

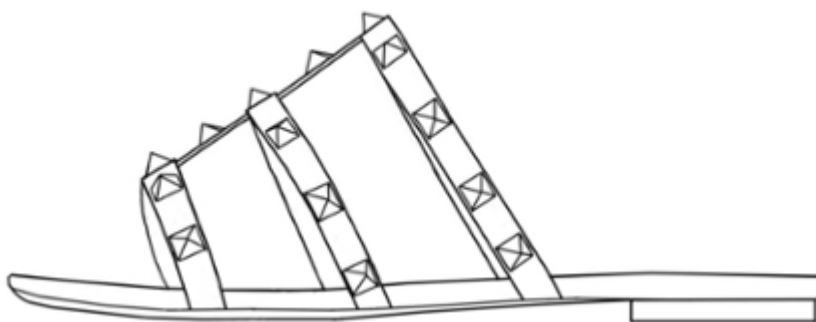

1.5

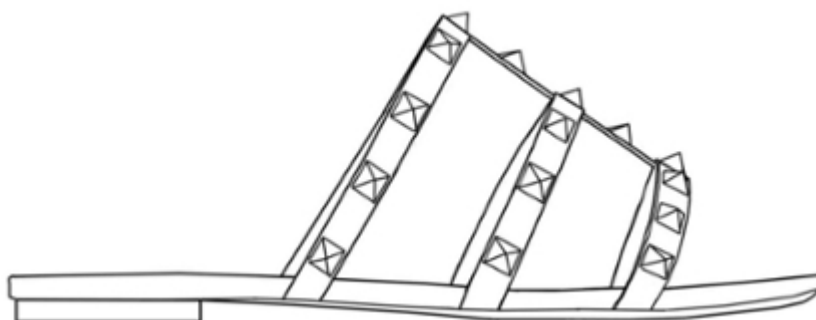

1.6

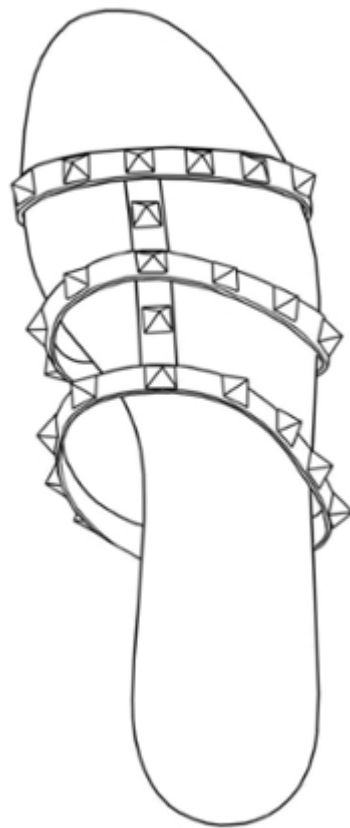

1.7

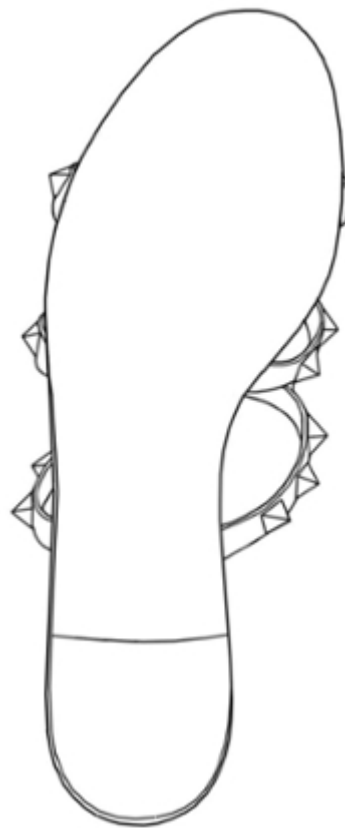

2.1

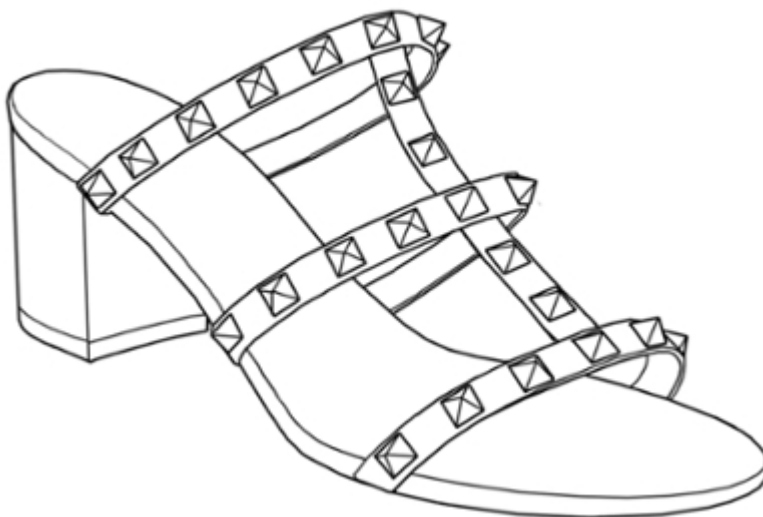

2.2

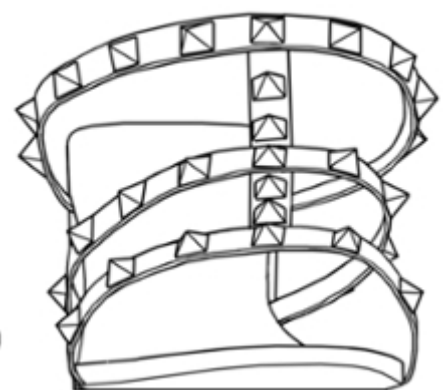

2.3

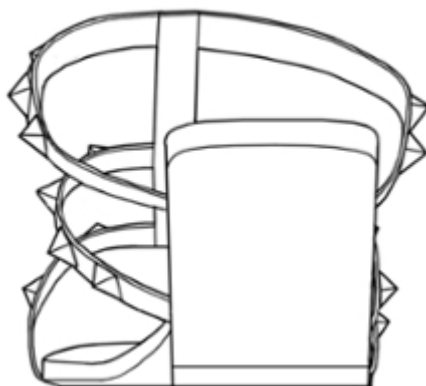

2.4

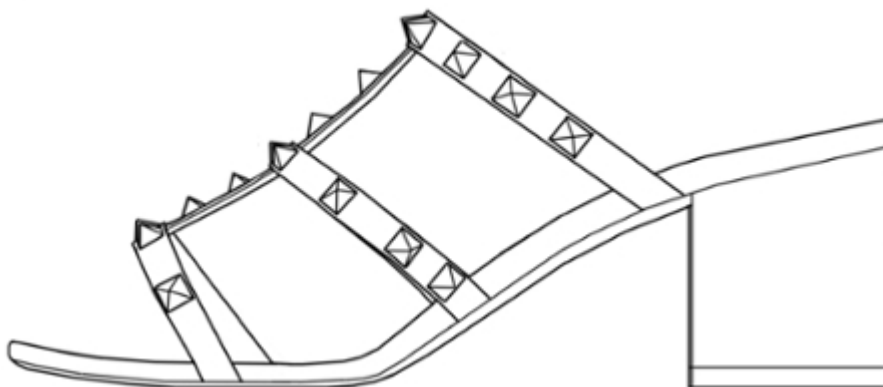

2.5

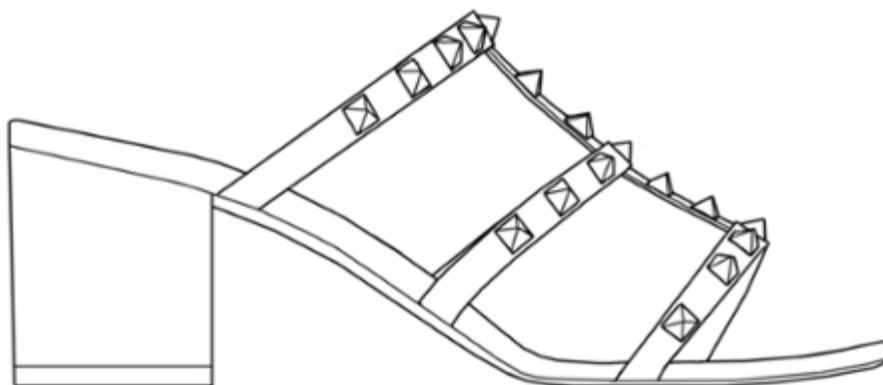

2.6

2.7

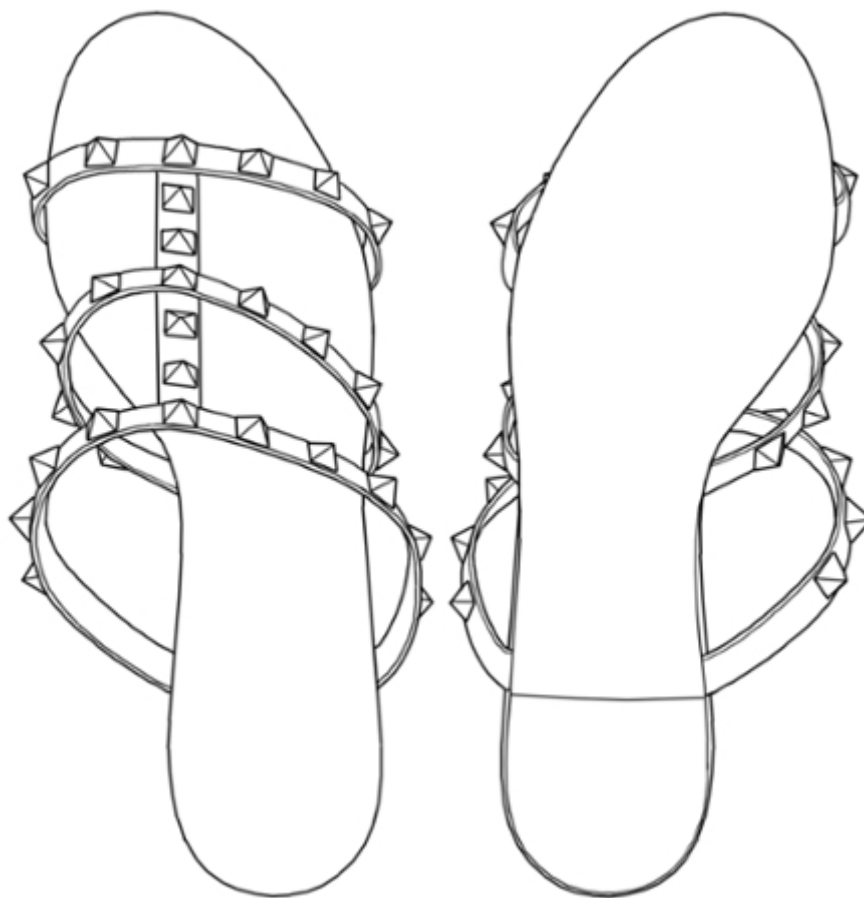

(11) DM/095869

(15) 2016 11 04

(22) 2016 11 04

(28) 4

(73) DERNEK GRUP ELEKTRİK ELEKTRONİK DIŞ TİCARET VE SANAYİ LİMİTED ŞİRKETİ

İstanbul Trakya Serbest Bölgesi, Ferhatpaşa SB Mahallesi, Sümbül Sokak, No: 5/41, Çatalca - İstanbul (TR)

(85) TR

(86) TR

(87) TR

(88) TR

(89) TR

(81) III. AL, AM, AZ, BA, BG, EG, EM, ES, FR, GE, GH, HU, KG, LT, LV, ME, MK, MN, NA, OA, OM, PL, RO, RS, SI, SY, TJ, UA

(72) TUNCAY CEYRAN

İstanbul Trakya Serbest Bölgesi Ferhatpaşa Sb Mah. Sümbül Sk. No:5/41, Çatalca - İstanbul, TURKEY

(54) 1.-2. Sockets; 3.-4. Switches; 5. Switch-socket

(55)

(51) 13-03

(45) 2017/18 (2017 05 12)

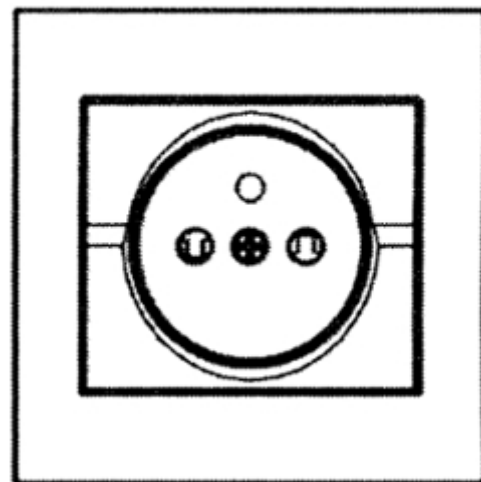
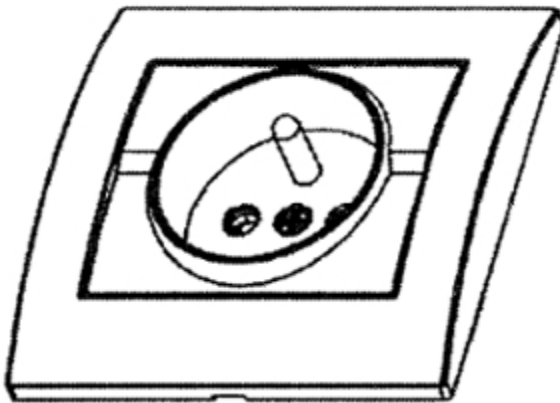
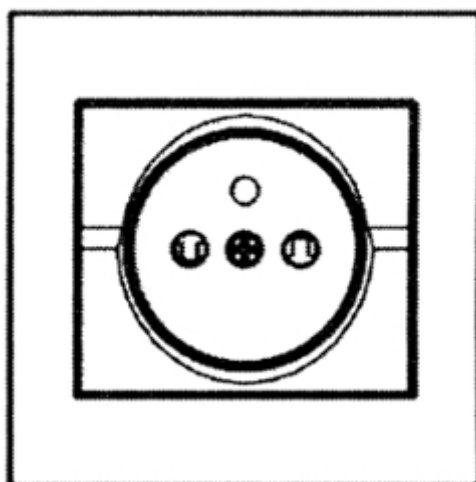
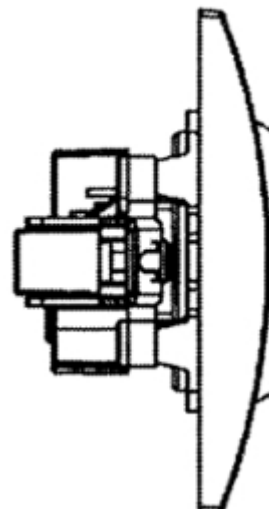
1.2**1.1****1.3****1.4**

1.5

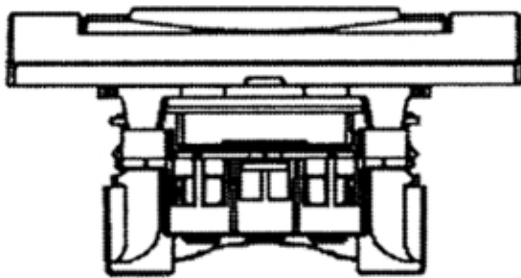

1.6

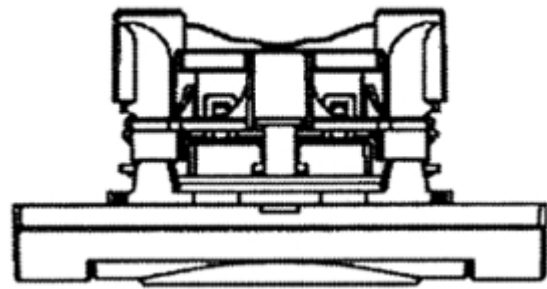

1.7

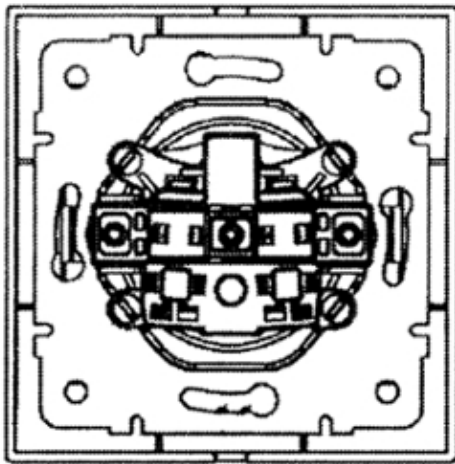

2.1

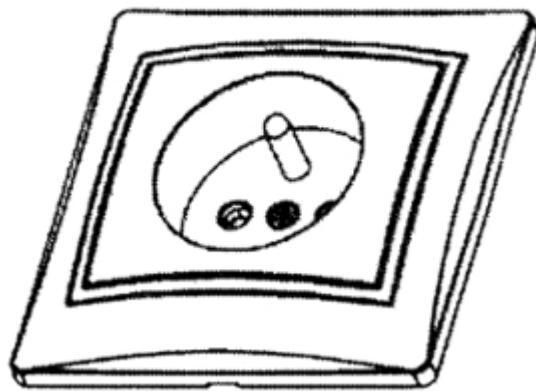

2.2

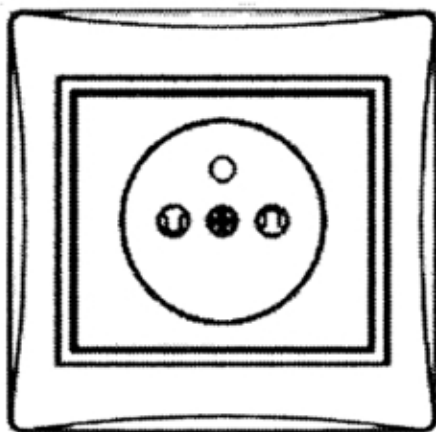

2.3

2.4

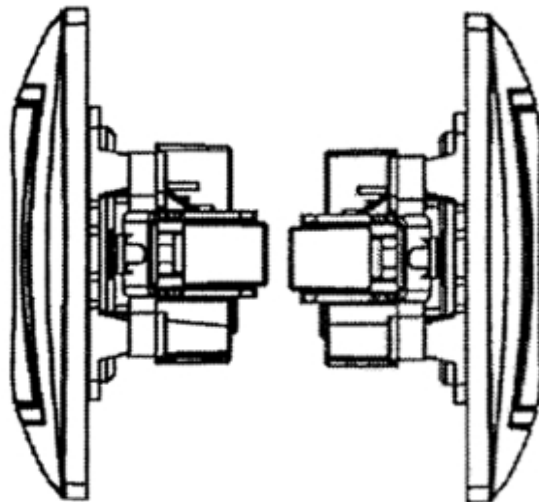

2.5

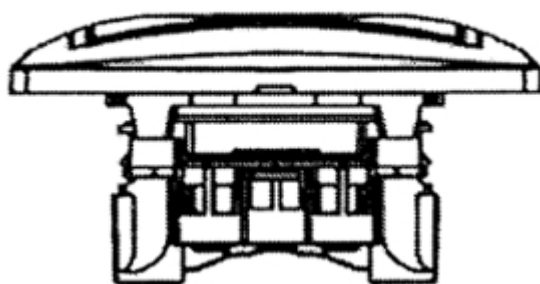

2.6

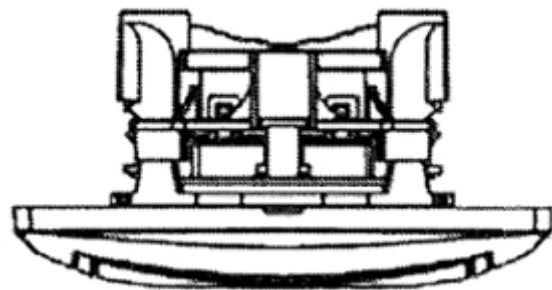

2.7

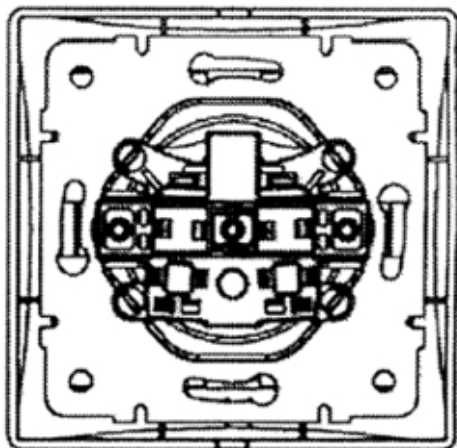

4.1



4.2

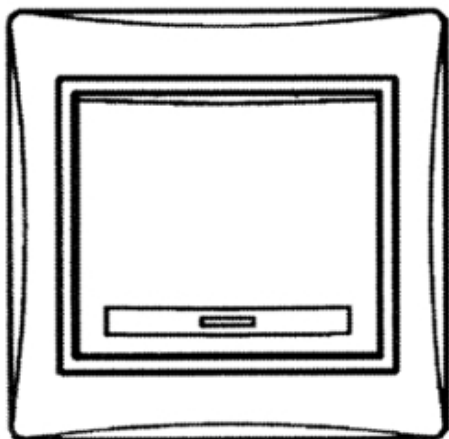

4.3

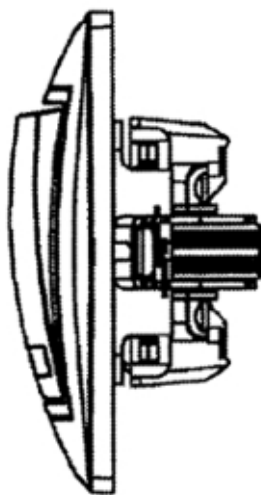

4.4

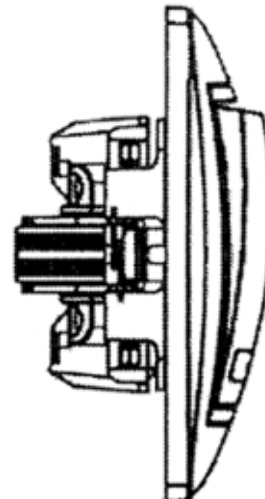

4.5

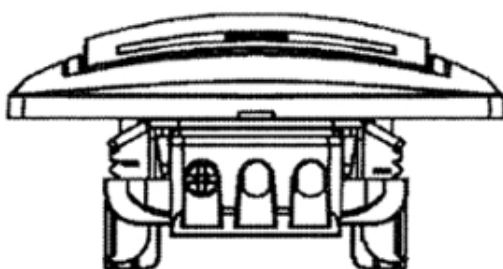

4.6

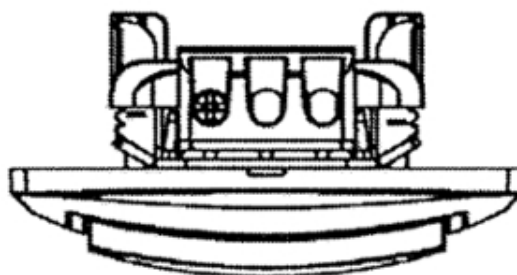

4.7

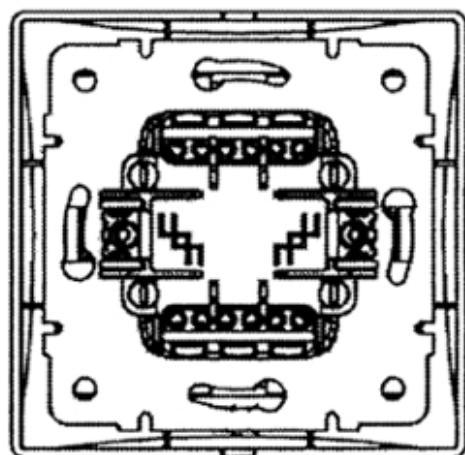

5.1

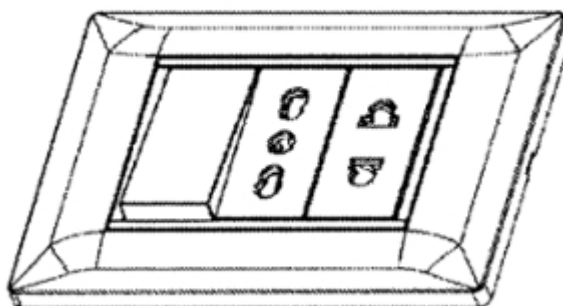

5.3

5.4

5.2

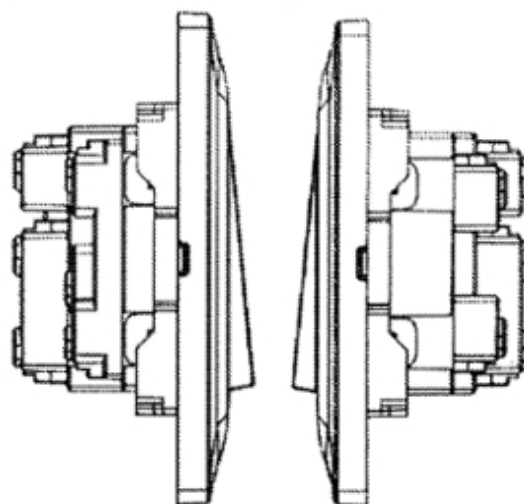
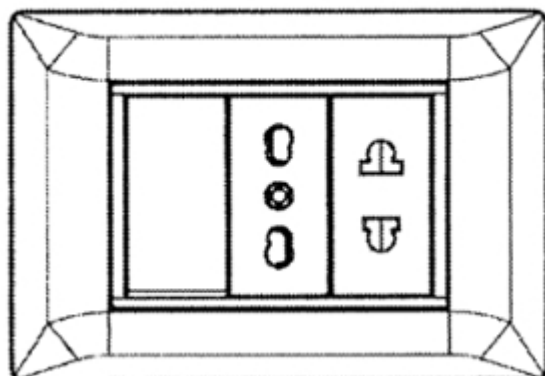

5.5

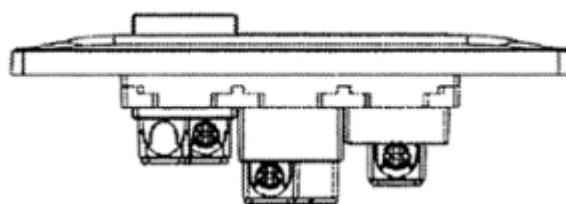

5.6

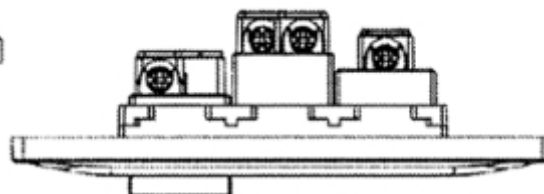

5.7

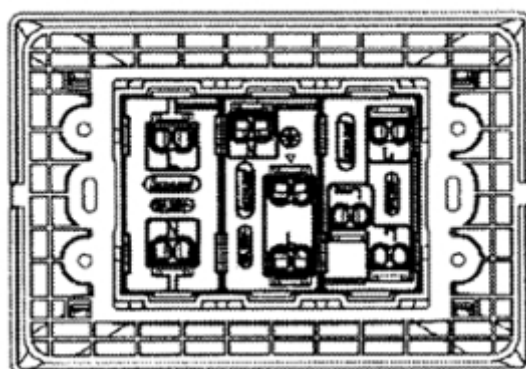

(11) DM/093501

(15) 2016 11 16

(22) 2016 11 16

(28) 3

(73) HARRY WINSTON SA

Chemin du Tourbillon 8, CH-1228 Plan-les-Ouates (CH)

(85) CH

(86) CH

(87) CH

(88) CH

(89) CH

(81) II. BZ, MA III. AL, AM, AZ, BA, CH, EM, GE, KG, LI, MC, MD, ME, MK, MN, NO, OM, SG, TN, TR, UA

(72) Maurice GALLI

25-10 31st Avenue, Apt. No. 2J, Long Island City, 11106 New York, États-Unis d'Amérique

(54) 1. Finger ring; 2. Earring; 3. Necklace

(55)

(51) 11-01

(45) 2017/19 (2017 05 19)

1.3**1.1****1.2****1.4****1.5****1.6**

1.7



1.8



2.1



2.2



2.3



2.4



2.5



2.6



3.1



2.7



2.8



3.2



3.3



3.4



3.5



3.6



3.7

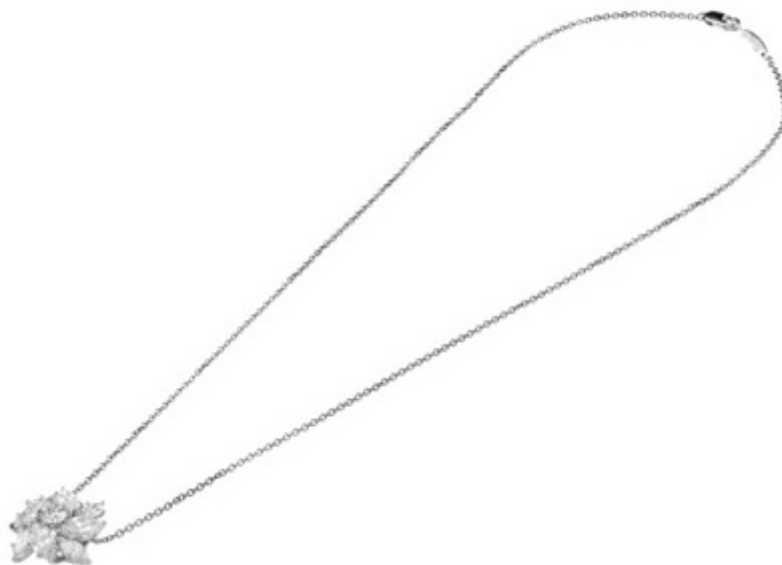

3.8

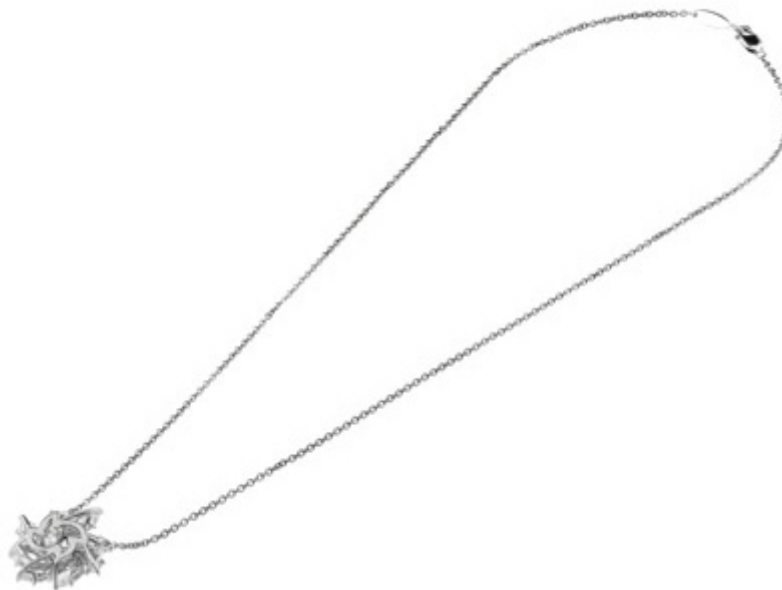

(11) DM/093557

(51) 11-01

(15) 2016 11 21

(45) 2017/20 (2017 05 26)

(22) 2016 11 21

(28) 3

(73) HARRY WINSTON SA

Chemin du Tourbillon 8, CH-1228 Plan-les-Ouates (CH)

(85) CH

(86) CH

(87) CH

(88) CH

(89) CH

(81) II. BZ, MA III. AL, AM, AZ, BA, CH, EM, GE, KG, LI, MC, MD, ME, MK, MN, NO, OM, SG, TN, TR, UA

(72) 1: Dominique RIVIERE

360 E. 72nd Street, Apt. Nb1003, 10021 New York, États-Unis d'Amérique;

2: Chaeree KWON

172 North 10th Street 3D, 11211 Brooklyn, NY, États-Unis d'Amérique;

3: Rie YATSUGI-KANG

272 Highland St, 07626 Cresskill, NJ, États-Unis d'Amérique

(54) 1. Pendant; 2. Necklace; 3. Finger ring

(55)

1.1



1.2



1.3



1.4

1.5



1.7



1.8



2.1



1.6



2.2



2.3



2.4



2.5



2.7



2.6



2.8



3.1



3.2



3.3



3.4



3.5



3.6



3.7



3.8



(11) DM/093577**(51) 10-07**

(15) 2016 11 21

(45) 2017/20 (2017 05 26)

(22) 2016 11 21

(28) 3

(73) MONTRES JAQUET DROZ SA (MONTRES JAQUET DROZ AG) (MONTRES JAQUET DROZ LTD.)
Allée du Tourbillon 2, CH-2300 La Chaux-de-Fonds (CH)

(85) CH

(86) CH

(87) CH

(88) CH

(89) CH

(81) II. BZ, MA III. AL, AM, AZ, BA, CH, EM, GE, KG, LI, MC, MD, ME, MK, MN, NO, OM, SG, TN,
TR, UA

(72) Christian LATTMANN

Chemin de Château-Neuf 17, 1125 Monnaz, Suisse;

Yann LEIGGENER

Avenue Léopold-Robert 11, 2300 La Chaux-de-Fonds, Suisse

(54) 1. Oscillating weight; 2.-3. Watch dials

(55)

1.1**1.2****1.3****2.1****2.2****2.3****2.4****3**

(11) DM/096040

(51) 24-04

(15) 2017 02 27

(45) 2017/20 (2017 05 26)

(22) 2017 02 27

(28) 5

(73) AXANOVA AG

Ottenhofenstrasse 110, CH-8738 Uetliburg (CH)

(85) –

(86) –

(87) CH

(88) –

(89) CH

(81) III. AL, AZ, BA, EM, GE, IS, LI, MC, ME, MK, NO, RS, TR, UA

(72) Martin Singer

Ottenhofenstrasse 112, 8738 Uetliburg, Switzerland; Axanova AG, Ottenhofenstrasse 110, 8738 Uetliburg, Switzerland

(54) 1. Cool and hot pads [medical]

(55)

1.1

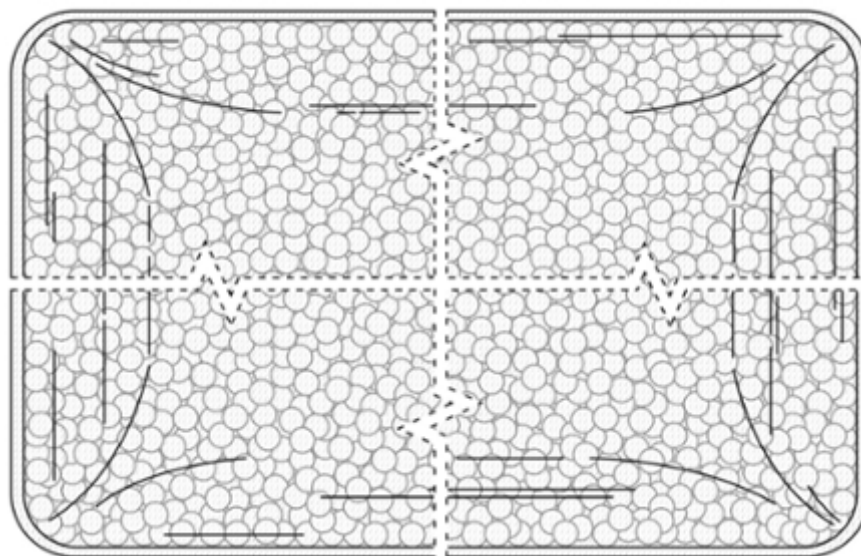

1.2

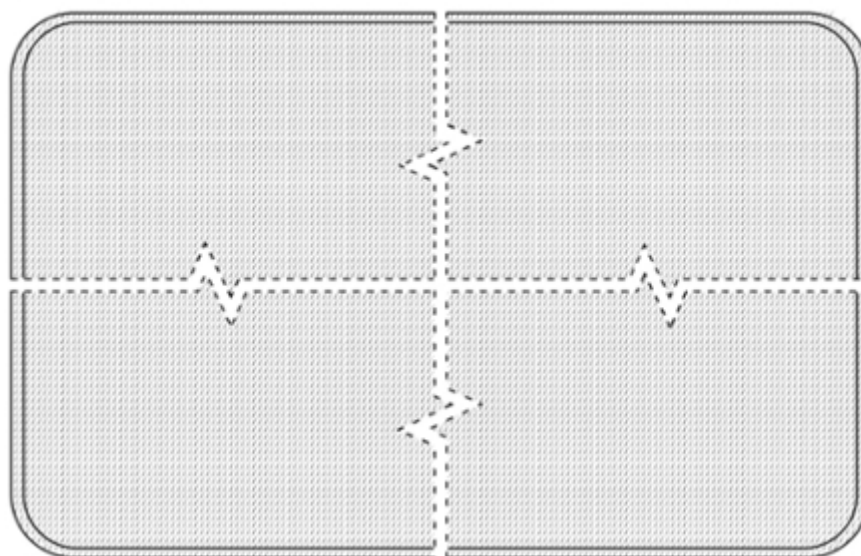

1.3

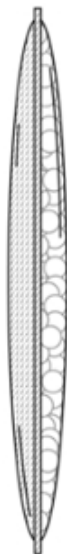

2.1

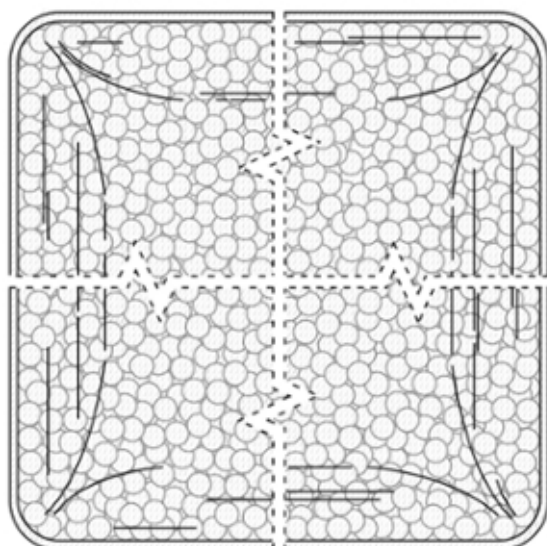

2.2

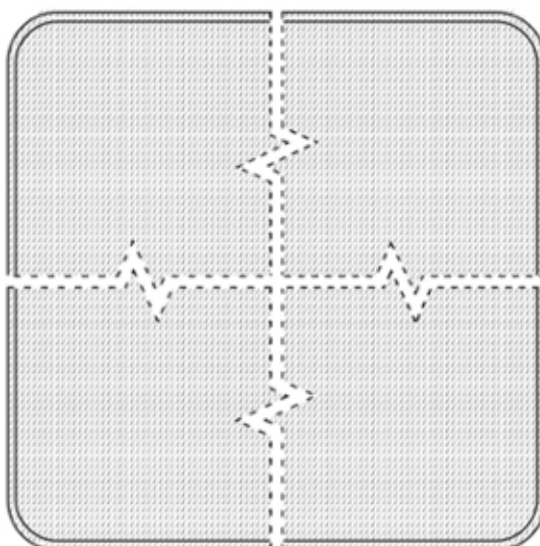

2.3

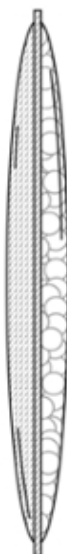

3.1

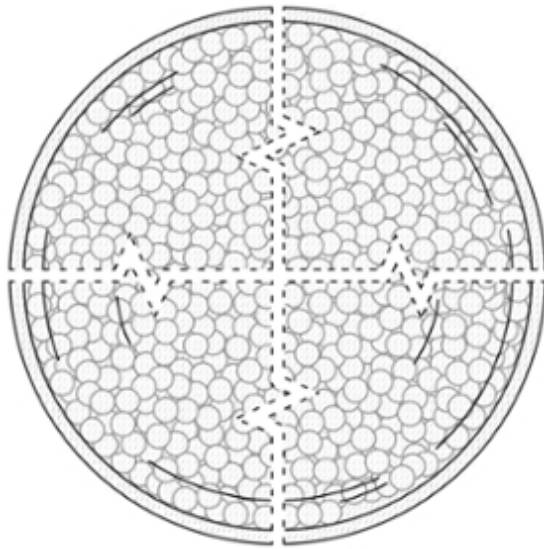

3.2

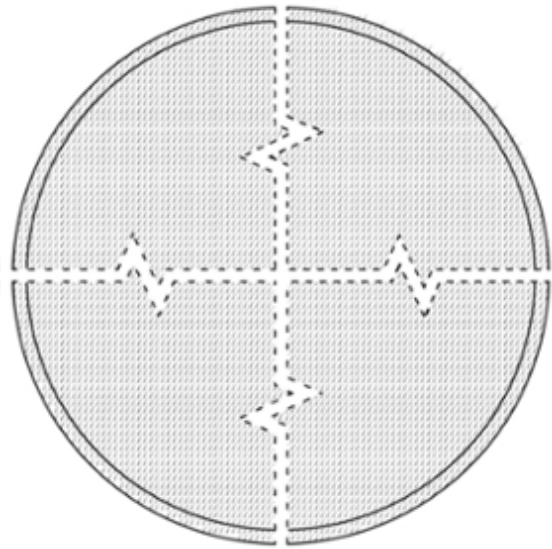

3.3

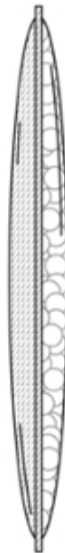

4.1

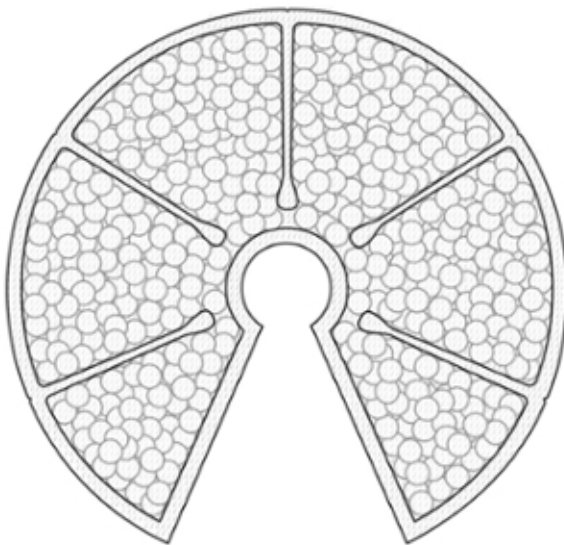

4.2

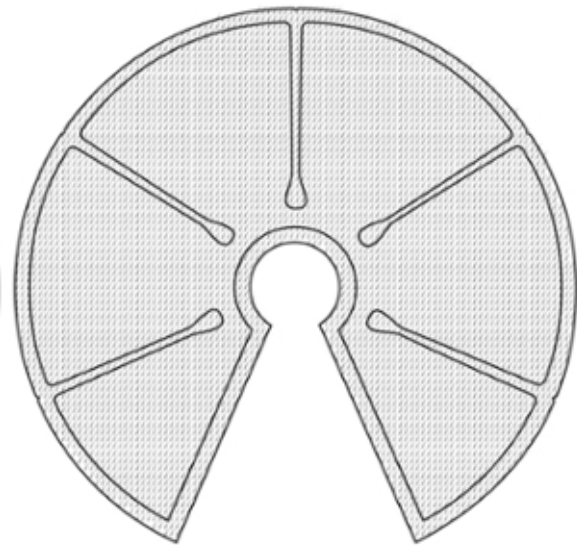

4.3

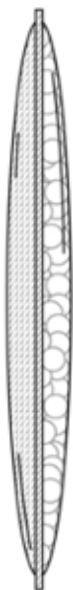

5.1

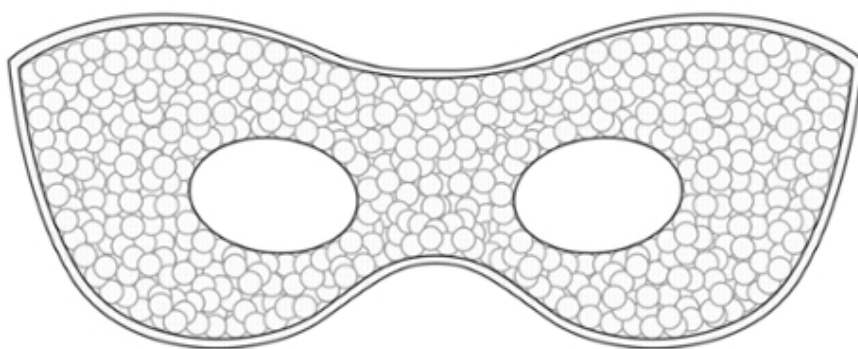

5.3

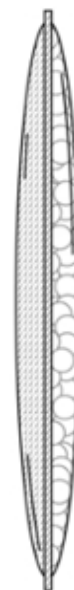

5.2

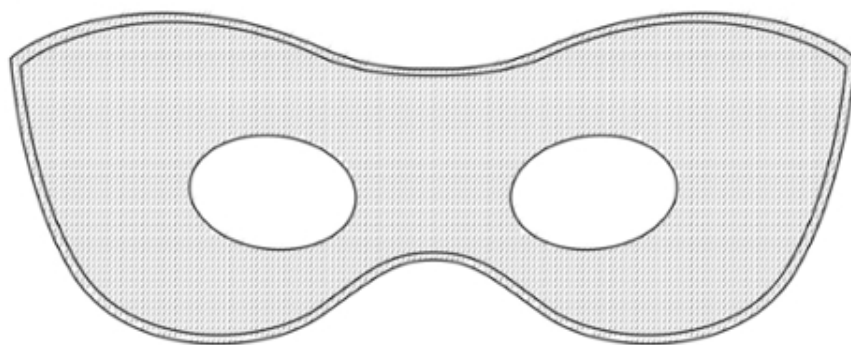

TRADEMARKS

APPLICATIONS FILED UNDER THE NATIONAL PROCEDURE APPROVED FOR REGISTRATION

The decision can be appealed at the Chamber of Appeal of Sakpatenti within 3 months from the publication or at the Mtskheta District Court Administrative Cases Board (Address: №17, Samkhedro St., Mtskheta), within 1 month following the publication.

(260) AM 2017 81341 A*
(210) AM 81341
(220) 2015 03 20
(731) LTD "FAMILY PRODUCT"
Tsatskhvebis q. 1, Isianis 2a, 4600, Kutaisi,
Georgia
(740) Murman Nikoleishvili
(540)



(591) Yellow, red, white
(531) 27.05.02, 28.05, 29.01.13
(511) 29, 30

(260) AM 2017 87105 A
(210) AM 87105
(220) 2016 04 25
(731) LTD "ALL PROPERTY GE"
Besikis q. 4, nakveti 46/10, 0108, Tbilisi,
Georgia
(740) Mariam Dateshidze
(540)

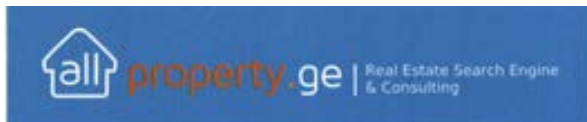

(591) White, blue, orange
(531) 07.01.09, 26.04.22, 27.05.24, 29.01.13
(511) 36

(260) AM 2017 88131 A
(210) AM 88131
(220) 2016 08 02
(330) GE
(731) PENG HAN
Qingdao, Apt. 302, st. Yanji160/7, China
(740) Giorgi Popkhadze
(540)



(591) Red, white
(531) 26.11.12, 29.01.01
(511) 3, 6, 7, 8, 9, 11, 12, 35

(260) AM 2017 88132 A
(210) AM 88132
(220) 2016 08 02
(330) GE
(731) PENG HAN
Qingdao, Apt. 302, st. Yanji160/7, China
(740) Giorgi Popkhadze
(540)



(591) Red, white
(531) 26.04.04, 26.04.07, 26.04.09, 29.01.12
(511) 3, 6, 7, 8, 9, 11, 12, 35

(260) AM 2017 88145 A
(210) AM 88145
(220) 2016 08 02
(731) AFLOFARM FARMACJA POLSKA LTD
Partyzancka str. 133/151 95-200, Pabianice
Poland.
(740) Levan Nikoladze
(540)

junical

(591) Black, white
(531) 27.05.05
(511) 5

(260) AM 2017 88174 A
(210) AM 88174
(220) 2016 08 05
(731) Malkhaz Molodini

Sop. Ksovrisi, 3313, Mtskhethis raioni, Georgia
 (740) Malkhaz Molodini
 (540)



(554) Three-dimensional
 (591) Brick-red, green, white
 (531) 05.03.04, 19.01.12, 19.09.02, 28.19, 29.01.13
 (511) 33

(260) AM 2017 88593 A
 (210) AM 88593
 (220) 2016 09 15
 (731) GUANGDONG SAIMAN INVESTMENT
 CO., LTD.
 Room 310, Zibian Building 2, No.48
 Chenjiaci Avenue, Liwan Road, Liwan
 District, Guangzhou, China
 (740) Shalva Gvaramadze
 (540)



(591) Black, white
 (531) 10.03.11, 26.04.24, 27.05.24, 28.03
 (511) 3, 9, 14, 18, 21, 25, 28, 35

(260) AM 2017 88856 A
 (210) AM 88856
 (220) 2016 10 06
 (731) LTD "GEORGIAN FRUIT COMPANY
 Krtsanisis shes, 17, Isani-Samgoris raioni,
 Tbilisi, Georgia
 (740) Inga Khutcshvili
 (540)

KHICHATELI
ხიჩატელი

(511) 31

(260) AM 2017 89258 A
 (210) AM 89258
 (220) 2016 11 03
 (731) LTD "G-M-P"
 Sop. Ponitchala 65, 0165, Tbilisi, Georgia
 (740) Nugzar Ksovreli
 (540)

დერუა Artro Formula
ДЕРУА Artro Formula
DERUA Artro Formula

(511) 5

(260) AM 2017 89259 A
 (210) AM 89259
 (220) 2016 11 03
 (731) LTD "G-M-P"
 Sop. Ponitchala 65, 0165, Tbilisi, Georgia
 (740) Nugzar Ksovreli
 (540)

მონმორსი Hepa Formula
МОММОРСИ Hepa Formula
MONMORSI Hepa Formula

(511) 5

(260) AM 2017 89269 A
 (210) AM 89269
 (220) 2016 11 03
 (731) LTD "G-M-P"
 Sop. Ponitchala 65, 0165, Tbilisi, Georgia
 (740) Nugzar Ksovreli
 (540)

აზენკური Formula Prostata
АЗЕНКУР Formula Prostata
AZENKUR Formula Prostata

(511) 5

(260) AM 2017 89327 A
 (210) AM 89327
 (220) 2016 11 07
 (731) ALISHAN GROUP LIMITED
 35/F, One Midtown, 11 Hoi Shing Road,
 Tsuen Wan, NT, Hong Kong, The Hong
 Kong Special Administrative Region
 (740) Liliana Darakhvelidze
 (540)

ALISHAN

(591) Black, white
(531) 27.05.01
(511) 34

(260) AM 2017 89329 A
(210) AM 89329
(220) 2016 11 07
(731) ALISHAN GROUP LIMITED
35/F, One Midtown, 11 Hoi Shing Road,
Tsuen Wan, NT, Hong Kong, The Hong
Kong Special Administrative Region
(740) Liliana Darakhvelidze
(540)

阿里山

(591) Black, white
(531) 28.03
(511) 34

(260) AM 2017 89405 A
(210) AM 89405
(220) 2016 11 10
(731) TURNER NETWORK TELEVISION, INC.
a Delaware corporation
1050 Techwood Drive, Atlanta GA 30318,
USA
(740) Giorgi Taktakishvili
(540)

WILL

(511) 9, 41

(260) AM 2017 89406 A
(210) AM 89406
(220) 2016 11 10
(731) LTD "ZENNI"
Nalbandyan str. 11, Yerevan, Armenia
(740) Irakli Gvilia
(540)



(591) White, lilac
(531) 26.01.04, 26.01.20, 26.01.21, 27.05.24,
29.01.12
(511) 18, 25

(260) AM 2017 89417 A
(210) AM 89417
(220) 2016 11 10
(310) 40-2016-0093335
(320) 2016 11 02
(330) KR
(731) KIA MOTORS CORPORATION
231 Yangjae-dong, Seocho-gu, Seoul,
Republic of Korea
(740) Merab Kvimsadze
(540)



(591) Black, white
(531) 26.01.20, 27.05.10
(511) 12

(260) AM 2017 89521 A
(210) AM 89521
(220) 2016 11 17
(731) LTD "FOLOU"
Z. Panaskerteli-Tsitsishvilis q. 6, b. 37, 0194,
Tbilisi, Georgia
(540)



Follow

(591) Black, white
(531) 27.05.22
(511) 33

(260) AM 2017 89532 A
(210) AM 89532
(220) 2016 11 18
(731) CHINA TOBACCO ZHEJIANG
INDUSTRIAL CO., LTD.
No.77 Zhongshan Nan Road, Hangzhou City,
Zhejiang Province, China
(740) Merab Kvimsadze
(540)

利群
Liqun

(591) Black, white
(531) 27.05.11, 28.03
(511) 34

(260) AM 2017 89557 A
(210) AM 89557
(220) 2016 11 22
(731) LTD "ARTPHARMA"
Gamrekelis q. 19 (512), 0160, Tbilisi, Georgia
(740) Giorgi Taktakishvili
(540)

ХолинАрт
ქოლინარტი
CholineArt

(511) 5

(260) AM 2017 89606 A
(210) AM 89606
(220) 2016 11 22
(731) LEPL "GEORGIAN NATIONAL
ARCHIVE"
Vazha-Pshavelas gamz. 1, 0160 Tbilisi,
Georgia
(740) Nino Topuria
(540)



(591) White and blue
(531) 25.01.25, 28.19, 29.01.04
(511) 42

(260) AM 2017 89736 A
(210) AM 89736
(220) 2016 11 30
(731) LTD "ASB"
P. Khalvashis gamz. 235, Batumi, Georgia
(740) Pavle Meipariani
(540)

ALBEREN

(511) 9

(260) AM 2017 89747 A
(210) AM 89747
(220) 2016 12 01
(731) SIEMENS AKTIENGESELLSCHAFT
Wittelsbacherplatz 2. 80333 Muenchen,
Germany
(740) Aleksandre Kartvelishvili

(540)

BEIDE

(511) 7

(260) AM 2017 89852 A
(210) AM 89852
(220) 2016 12 07
(731) Private Industrial-Trading Company
"KRIOLIT - DNEPR"
49022, Dnipro, ul. Okeanskaya 4, Ukraine
(740) Shalva Gvaramadze
(540)



(591) Black, white
(531) 26.01.02, 26.01.24, 27.05.24
(511) 29, 30

(260) AM 2017 89853 A
(210) AM 89853
(220) 2016 12 07
(731) COLGATE-PALMOLIVE COMPANY
a Delaware corporation
300 Park Avenue, New York, New York
10022, USA
(740) Shalva Gvaramadze
(540)

ДРЕВНИЕ СЕКРЕТЫ

(511) 3

(260) AM 2017 89867 A
(210) AM 89867
(220) 2016 12 07
(731) QINGDAO MAGGIE JIN INDUSTRY CO.,
LTD
Room 1202, Unit 2, Blok 1, Dongfanggin
Building, Shuangzhou Road, Huangdao
Distric, Kinngdao City, Shandong province,
China
(740) Giorgi Kartvelishvili
(540)



(591) Black, white
(531) 18.01.05, 26.13.25, 27.05.01
(511) 9, 12

(260) AM 2017 89999 A
(210) AM 89999
(220) 2016 12 16
(731) LTD "ARTPHARMA"
Gamrekelis q. 19 (512), 0160, Tbilisi, Georgia
(740) Giorgi Taktakishvili
(540)

სერკასტინი
Серкастин
Serkastin

(511) 5

(260) AM 2017 90003 A
(210) AM 90003
(220) 2016 12 16
(731) LTD "DOTS"
Ir. Abashidzis q. 73, b. 8, Tbilisi, Georgia
(740) Natia Gogadze
(540)

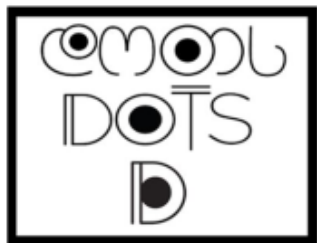

(591) Black, white
(531) 26.04.22, 27.01.06, 28.19
(511) 14, 25, 35

REGISTERED TRADEMARKS

(111) M 2017 28680 R

(151) 2017 07 03

(181) 2027 07 03

(260) AM 2016 85819 A

(220) 2016 01 21

(732) LTD "KONSIERZH TBILISI"

Mitskevichis q., korp. 1, b. 72, 0194,
Tbilisi, Georgia

Shota Rustavelis q. 29, Daba Tskneti,

Vake-Saburtalos raioni, Tbilisi, Georgia

(111) M 2017 28681 R

(151) 2017 07 03

(181) 2027 07 03

(260) AM 2016 86495 A

(220) 2016 03 09

(732) MALKHAZI BERIDZE

Sop. Kokotauri, Kedis raioni, Atcharis
avtonomiuri respublika, Georgia

(111) M 2017 28686 R

(151) 2017 07 03

(181) 2027 07 03

(260) AM 2017 86932 A

(220) 2016 04 08

(732) LTD "PSP"

I. Tsurtavelis q. 54, 01700, Dmanisi, Georgia

(111) M 2017 28682 R

(151) 2017 07 03

(181) 2027 07 03

(260) AM 2016 86659 A

(220) 2016 03 17

(732) LTD "A-B-C PHARMACY"

Sanapiros q. 10, 0108, Tbilisi, Georgia

(111) M 2017 28687 R

(151) 2017 07 03

(181) 2027 07 03

(260) AM 2017 86933 A

(220) 2016 04 08

(732) LTD "PSP"

I. Tsurtavelis q. 54, 01700, Dmanisi, Georgia

(111) M 2017 28683 R

(151) 2017 07 03

(181) 2027 07 03

(260) AM 2017 86751 A

(220) 2016 03 24

(732) LTD "ELEMENTS GROUP"

Sop. Untsa, "Baghebi", 0300, Adigeni, Georgia

(111) M 2017 28688 R

(151) 2017 07 03

(181) 2027 07 03

(260) AM 2017 87021 A

(220) 2016 04 15

(732) LTD "VICTORIA SEKURITY"

S. Chikovanis q. 2, 0171, Tbilisi, Georgia

(111) M 2017 28684 R

(151) 2017 07 03

(181) 2027 07 03

(260) AM 2016 86761 A

(220) 2016 03 25

(732) WD-40 MANUFACTURING COMPANY

1061 Cudahy Place, San Diego, California
92110, USA

(111) M 2017 28689 R

(151) 2017 07 03

(181) 2027 07 03

(260) AM 2016 87088 A

(220) 2016 04 21

(732) BALMAIN S.A.

44, rue Francois 1er, 75008 Paris, France

(111) M 2017 28685 R

(151) 2017 07 03

(181) 2027 07 03

(260) AM 2016 86878 A

(220) 2016 04 04

(732) LTD "TECHNO-ITALY"

(111) M 2017 28690 R

(151) 2017 07 03

(181) 2027 07 03

(260) AM 2016 87123 A

(220) 2016 04 26

(732) HARRINGTON DEVELOPMENT INC.

Elvira Mendez Street, Vallarino Bldg, 3rd Floor,
Panama, Panama

(111) M 2017 28691 R

(151) 2017 07 03

(181) 2027 07 03

(260) AM 2016 87124 A

(220) 2016 04 26

(732) HARRINGTON DEVELOPMENT INC.
Elvira Mendez Street, Vallarino Bldg, 3rd Floor,
Panama, Panama

(111) M 2017 28692 R
(151) 2017 07 03
(181) 2027 07 03
(260) AM 2017 87369 A
(220) 2016 05 24
(732) LTD "FARKONI"
Tamar Mepis q. 51, 4600, Kutaisi, Georgia

(111) M 2017 28693 R
(151) 2017 07 03
(181) 2027 07 03
(260) AM 2017 87418 A
(220) 2016 05 30
(732) LTD "BATONO"
Nikoladzis q. 12, 0179, Tbilisi, Georgia

(111) M 2017 28694 R
(151) 2017 07 03
(181) 2027 07 03
(260) AM 2017 87498 A
(220) 2016 06 03
(732) LTD "R.B.J."
Z. Paliashvilis q. 49, b. 10, 0179, Tbilisi,
Georgia

(111) M 2017 28695 R
(151) 2017 07 03
(181) 2027 07 03
(260) AM 2017 87502 A
(220) 2016 06 03
(732) ALI YAVUZ
MAHMUTPASA MURRYET CARSISI
NO.230 EMINONU\ISTAMBUL, Turkey

(111) M 2017 28696 R
(151) 2017 07 03
(181) 2027 07 03
(260) AM 2017 87504 A
(220) 2016 06 03
(732) ROHTO PHARMACEUTICAL CO., LTD.
8-1, Tatsuminishi 1-chome, Ikuno-ku, Osaka-shi,
Osaka 544-8666, Japan

(111) M 2017 28697 R
(151) 2017 07 03
(181) 2027 07 03
(260) AM 2017 87515 A
(220) 2016 06 07

(732) British American Tobacco (Brands) Inc.
(a Delaware corporation)
2711 Centerville Road, Suite 300, Wilmington,
Delaware 19808, USA

(111) M 2017 28698 R
(151) 2017 07 03
(181) 2027 07 03
(260) AM 2017 87552 A
(220) 2016 06 08
(732) LTD "G-M-P"
Sop. Ponitchala 65, 0165, Tbilisi, Georgia

(111) M 2017 28699 R
(151) 2017 07 03
(181) 2027 07 03
(260) AM 2017 87569 A
(220) 2016 06 10
(732) DEHA MAGAZACILIK EV TEKSTILI
URUNLERI SANAYI VE TICARET ANONIM
SIRKETI
GULBAHAR MAH. AVNI DILLIGIL SK.
CELIK IS MERKEZI B/BLOK NO: 9 G. KAT
MECIDIYEKOY SISLI ISTANBUL, Turkey

(111) M 2017 28700 R
(151) 2017 07 03
(181) 2027 07 03
(260) AM 2017 87662 A
(220) 2016 06 21
(732) LTD "TERMOROOM"
Vazha-Pshavelas gamz. 20, 0160, Tbilisi,
Georgia

(111) M 2017 28701 R
(151) 2017 07 03
(181) 2027 07 03
(260) AM 2017 87663 A
(220) 2016 06 21
(732) LTD "TERMOROOM"
Vazha-Pshavelas gamz. 20, 0160, Tbilisi,
Georgia

(111) M 2017 28702 R
(151) 2017 07 03
(181) 2027 07 03
(260) AM 2017 87677 A
(220) 2016 06 22
(732) Irakli Archvadze
G. Brtskinvales q. 19, b. 3, 0131, Tbilisi,
Georgia

(111) M 2017 28703 R (151) 2017 07 03 (181) 2027 07 03 (260) AM 2017 87775 A (220) 2016 06 29 (732) LTD "NIK-2007" E. Akhvledianis shes. 6, 0103, Tbilisi, Georgia	a Delaware corporation 1455 Market St., 4 th fl., San Francisco, California 94103, USA
(111) M 2017 28704 R (151) 2017 07 03 (181) 2027 07 03 (260) AM 2017 87778 A (220) 2016 06 29 (732) WESTERN DIGITAL TECHNOLOGIES, INC. a Delaware corporation 3355 Michelson Drive, Suite 100 Irvin California 92612, USA	(111) M 2017 28709 R (151) 2017 07 03 (181) 2027 07 03 (260) AM 2017 87963 A (220) 2016 07 14 (732) LTD "WINES PROVANCE" Ir. Abashidzis q.4, b.3 Tbilisi, Georgia
(111) M 2017 28705 R (151) 2017 07 03 (181) 2027 07 03 (260) AM 2017 87787 A (220) 2016 06 30 (732) NISSAN JIDOSHA KABUSHIKI KAISHA (also trading as Nissan Motor Co., Ltd.) No.2, Takara-cho, Kanagawa-ku, Yokohama-shi, Kanagawa-ken, Japan	(111) M 2017 28710 R (151) 2017 07 03 (181) 2027 07 03 (260) AM 2017 87967 A (220) 2016 07 15 (732) LEPL HOUSE OF JUSTICE Sanapiros q. 2, Tbilisi, Georgia
(111) M 2017 28706 R (151) 2017 07 03 (181) 2027 07 03 (260) AM 2017 87790 A (220) 2016 06 30 (732) NISSAN JIDOSHA KABUSHIKI KAISHA (also trading as Nissan Motor Co., Ltd.) No.2, Takara-cho, Kanagawa-ku, Yokohama-shi, Kanagawa-ken, Japan	(111) M 2017 28711 R (151) 2017 07 03 (181) 2027 07 03 (260) AM 2017 87968 A (220) 2016 07 15 (732) LEPL HOUSE OF JUSTICE Sanapiros q. 2, Tbilisi, Georgia
(111) M 2017 28707 R (151) 2017 07 03 (181) 2027 07 03 (260) AM 2017 87798 A (220) 2016 07 01 (732) Individual Entrepreneur Gocha Ghaghashvili Sadguris q. 5, Telavi, Georgia	(111) M 2017 28712 R (151) 2017 07 03 (181) 2027 07 03 (260) AM 2017 87977 A (220) 2016 07 18 (732) LTD "KATEVE KHOBI" S. Tsintsadzis q. 12, 0160, Tbilisi, Georgia
(111) M 2017 28708 R (151) 2017 07 03 (181) 2027 07 03 (260) AM 2017 87907 A (220) 2016 07 11 (732) UBER TECHNOLOGIES, INC.	(111) M 2017 28713 R (151) 2017 07 03 (181) 2027 07 03 (260) AM 2017 87992 A (220) 2016 07 21 (732) OJSC INTERNATIONAL COMPANY "PARS PRODUCTS" IRAN, Tehran, M. Karaj Road Special Route 10th Kilometer. PoBox: 1389737751, Islamic Republic of Iran
	(111) M 2017 28714 R (151) 2017 07 03 (181) 2027 07 03 (260) AM 2017 87995 A (220) 2016 07 21

(732) LTD "BEATY"
Melikishvilis q. 4, 6000, Batumi, Georgia

(111) M 2017 28715 R
(151) 2017 07 03
(181) 2027 07 03
(260) AM 2017 88068 A
(220) 2016 07 27
(732) LTD "MARINA COLOSSEUM"
Sh. Khimshiashvilis q. 16, 6015, Batumi,
Georgia

(111) M 2017 28716 R
(151) 2017 07 03
(181) 2027 07 03
(260) AM 2017 88076 A
(220) 2016 07 27
(732) LTD "G-M-P"
Sop. Ponitchala 65, 0165, Tbilisi, Georgia

(111) M 2017 28717 R
(151) 2017 07 03
(181) 2027 07 03
(260) AM 2017 88195 A
(220) 2016 08 08
(732) LTD "KVEVVRI AMORIS"
23-e q. 30, Sop. Tsinandali, 2200, Telavi,
Georgia

(111) M 2017 28718 R
(151) 2017 07 03
(181) 2027 07 03
(260) AM 2017 88333 A
(220) 2016 08 17
(732) ATHLETA (ITM) INC.
2 Folsom Street, San Francisco, California,
94105, USA

TRADEMARKS REGISTERED ACCORDING TO THE ACCELERATED PROCEDURE

The decision can be appealed at the Chamber of Appeal of Sakpatenti within 3 months from the publication.

(111) M 2017 28662 R
(151) 2017 06 21
(181) 2027 06 21
(210) AM 92347
(220) 2017 05 24
(732) Levan Kobiashvili
Libanis 29 Korp. B. 41, 0189, Tbilisi, Georgia
(540)



(591) Crimson, black and white
(531) 26.15.03, 27.05.24, 29.01.13
(511) 30

(111) M 2017 28663 R
(151) 2017 06 21
(181) 2027 06 21
(210) AM 92498
(220) 2017 06 01
(732) JSC "TSKALI MARGEBELI"
Sop. Nabeglavi, 4915, Chokhatauris R-ni,
Georgia
(540)



(591) Red, white
(531) 26.01.01, 26.01.20, 26.01.24, 28.19, 29.01.12
(511) 32

(111) M 2017 28664 R
(151) 2017 06 22
(181) 2027 06 22
(210) AM 92507
(220) 2017 06 02
(732) LTD "BAKLACHOFF"

Vardanianci str., b. 8, Ter. 1/4, Erevan,
Armenia
(740) Sopio Khuchua
(540)



(591) Brown, black, white
(531) 25.01.09, 25.01.10, 25.01.19, 27.05.01,
28.05, 28.19, 29.01.13
(511) 43

(111) M 2017 28665 R
(151) 2017 06 23
(181) 2027 06 23
(210) AM 92419
(220) 2017 05 29
(732) LTD "SILK ROAD BUSINESS CENTER"
Rustavelis gamz. 31, 0108, Tbilisi, Georgia
(540)

Telegraph
ტელეგრაფი
Телеграф

(591) Black, white
(511) 36, 39, 43, 44

(111) M 2017 28666 R
(151) 2017 06 27
(181) 2027 06 27
(210) AM 92737
(220) 2017 06 09
(732) LTD "TR REAL ESTATE"
I. Abashidzis q. 65-67, b. 15, Vake-Saburtalos
r-ni, Tbilisi, Georgia

(740) Irakli Gvilia

(540)

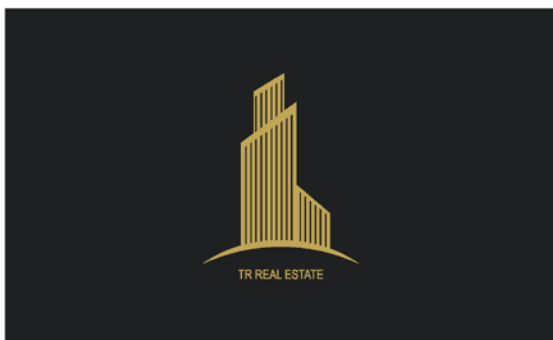

(591) Black, golden

(531) 07.01.08, 07.01.24, 26.04.16, 26.04.24,
27.05.11, 27.05.24, 29.01.12

(511) 36, 43

(111) M 2017 28667 R

(151) 2017 06 27

(181) 2027 06 27

(210) AM 92755

(220) 2017 06 12

(732) LTD "TR REAL ESTATE"

I. Abashidzis q. 65-67, b. 15, Vake-Saburtalos
r-ni, Tbilisi, Georgia

(740) Irakli Gvilia

(540)



(591) Black, golden

(531) 03.07.17, 26.04.15, 26.04.24, 28.19, 29.01.12

(511) 36, 43

(111) M 2017 28668 R

(151) 2017 06 27

(181) 2027 06 27

(210) AM 92794

(220) 2017 06 15

(732) LTD "ESPRESSO GEORGIA"

Vazha-Pshavelas shes. 3, b. 147, 0186, Tbilisi,
Georgia

(740) Teona Kakhidze

(540)



(591) Lilac, phosphorus

(531) 25.05.01, 26.04.22, 26.04.24, 27.05.23,
27.07.01, 28.19, 29.01.12

(511) 30, 43

(111) M 2017 28669 R

(151) 2017 06 29

(181) 2027 06 29

(210) AM 92891

(220) 2017 06 22

(732) LTD "NEXTRA GROUP"

Ir. Evdoshvilis q. 18, Saopise parti 3,
Didube-Chughuretis r-ni, 0154, Tbilisi,
Georgia

(540)

მელდოვინი
Meldovin
Мелдовин

(511) 5

(111) M 2017 28670 R

(151) 2017 06 29

(181) 2027 06 29

(210) AM 92893

(220) 2017 06 22

(732) LTD "NEXTRA GROUP"

Ir. Evdoshvilis q. 18, Saopise parti 3,
Didube-Chughuretis r-ni, 0154, Tbilisi,
Georgia

(540)

სოლუფლოქსი
Soluflox
Солуфлокс

(511) 5

(111) M 2017 28671 R

(151) 2017 06 29

(181) 2027 06 29

(210) AM 92895

(220) 2017 06 22

(732) LTD "NEXTRA GROUP"

Ir. Evdoshvilis q. 18, Saopise parti 3,

Didube-Chughureti r-ni, 0154, Tbilisi,
Georgia
(540)

ფენაქსოლი
Fenaxol
Фенаксол

(511) 5

(111) M 2017 28672 R
(151) 2017 06 29
(181) 2027 06 29
(210) AM 92897
(220) 2017 06 22
(732) LTD "NEXTRA GROUP"
Ir. Evdoshvilis q. 18, Saopise parti 3,
Didube-Chughureti r-ni, 0154, Tbilisi,
Georgia
(540)

ტოპიქსოლი
Topixol
Топиксол

(511) 5

(111) M 2017 28673 R
(151) 2017 06 29
(181) 2027 06 29
(210) AM 92780
(220) 2017 06 14
(732) HERBALIFE INTERNATIONAL, INC.
800 W. Olympic Blvd., Suite 406, Los
Angeles, CA 90015, United States of America
(740) Natalia Babakashvili
(540)



(591) Black,white
(531) 05.03.15, 26.01.15, 27.05.01, 28.19
(526) The trademark is protected as a whole. "და-
ბალანსებული კვება" shall not be subject to in-
dependent legal protection.
(511) 3, 5, 29, 30, 32, 35

(111) M 2017 28674 R
(151) 2017 06 30
(181) 2027 06 30
(210) AM 92909
(220) 2017 06 22

(732) LTD "NEXTRA GROUP"
Ir. Evdoshvilis q. 18, Saopise parti 3,
Didube-Chughureti r-ni, 0154, Tbilisi,
Georgia
(540)

ეტარინი
Etarin
Этарин

(511) 5

(111) M 2017 28675 R
(151) 2017 06 30
(181) 2027 06 30
(210) AM 92913
(220) 2017 06 22
(732) LTD "NEXTRA GROUP"
Ir. Evdoshvilis q. 18, Saopise parti 3,
Didube-Chughureti r-ni, 0154, Tbilisi,
Georgia
(540)

მონცეტინ-დუო
Moncetin-duo
Монцетин-дуо

(511) 5

(111) M 2017 28676 R
(151) 2017 06 30
(181) 2027 06 30
(210) AM 92914
(220) 2017 06 22
(732) LTD "NEXTRA GROUP"
Ir. Evdoshvilis q. 18, Saopise parti 3,
Didube-Chughureti r-ni, 0154, Tbilisi,
Georgia
(540)

ართროვინი
Arthrovin
Артровин

(511) 5

(111) M 2017 28677 R
(151) 2017 06 30
(181) 2027 06 30
(210) AM 92915
(220) 2017 06 22
(732) LTD "NEXTRA GROUP"
Ir. Evdoshvilis q. 18, Saopise parti 3,

Didube-Chughureti r-ni, 0154, Tbilisi,
Georgia
(540)

იტრაზილი
Itrazile
Итразил

(511) 5

(111) M 2017 28678 R
(151) 2017 06 30
(181) 2027 06 30
(210) AM 92916
(220) 2017 06 22
(732) LTD "NEXTRA GROUP"
Ir. Evdoshvilis q. 18, Saopise parti 3,
Didube-Chughureti r-ni, 0154, Tbilisi,
Georgia
(540)

ვინკასილი
Vincasile
Винкасил

(511) 5

(111) M 2017 28679 R
(151) 2017 06 30
(181) 2027 06 30
(210) AM 92534
(220) 2017 06 05
(732) H&M HENNES & MAURITZ AB
Se 106-38, Stockholm, Sweden
(740) Irakli Gvilia
(540)

კმ

(591) White and black
(531) 28.19
(511) 35

(111) M 2017 28719 R
(151) 2017 07 03
(181) 2027 07 03
(210) AM 92903
(220) 2017 06 22
(732) LTD "NEXTRA GROUP"
Ir. Evdoshvilis q. 18, Saopise parti 3,
Didube-Chughureti r-ni, 0154, Tbilisi,
Georgia

(540)

პენტაქსოლი
Pentaxol
Пентаксол

(511) 5

(111) M 2017 28720 R
(151) 2017 07 04
(181) 2027 07 04
(210) AM 92842
(220) 2017 06 19
(732) Davit Goglichidze
Shatberashvilis q. 33, 0179, Tbilisi, Georgia
(740) Giorgi Imnadze
(540)



(591) Red, white and yellow
(531) 24.09.09, 24.09.12, 26.05.02, 26.13.25,
27.05.01, 29.01.13
(526) The trademark is protected as a whole. "Queen
Tamar" shall not be subject to independent legal pro-
tection.
(511) 43

(111) M 2017 28721 R
(151) 2017 07 05
(181) 2027 07 05
(210) AM 92799
(220) 2017 06 16
(732) JSC "ARGO"
Lilo, Lotchinis Khevi (nakv.05/001), 0151,
Tbilisi, Georgia
(740) Roland Gabadze
(540)



(591) Blue, white
(531) 05.07.02, 26.01.05, 26.01.20, 26.01.21,
26.01.24, 27.05.24, 29.01.12
(526) The trademark is protected as a whole.
"GEORGIA" shall not be subject to independent
legal protection.
(511) 32

(111) M 2017 28722 R
(151) 2017 07 05
(181) 2027 07 05
(210) AM 93030
(220) 2017 06 28
(732) LTD "RUSTAR ONLINE"
Vazisubnis Dasak., korp. 7, b. 64,
Isani-Samgoris r-ni, 0152, Tbilisi, Georgia
(540)



(591) Green, white
(531) 27.05.01, 27.05.22, 29.01.12
(511) 39

(111) M 2017 28723 R
(151) 2017 07 05
(181) 2027 07 05
(210) AM 93031
(220) 2017 06 28
(732) LTD "RUSTAR ONLINE"
Vazisubnis Dasak., korp. 7, b. 64,
Isani-Samgoris r-ni, 0152, Tbilisi, Georgia
(540)



(591) White, green and golden
(531) 15.07.09, 27.05.01, 29.01.13
(511) 39

INTERNATIONAL TRADEMARKS FOR WHICH A DECISION ON GRANTING PROTECTIONS IS TAKEN

The decision can be appealed at the Chamber of Appeal of Sakpatenti within 3 months from the publication or at the Mtskheta District Court Administrative Cases Board (Address: №17, Samkhedro str., Mtskheta), within 1 month following the publication.

(260) AM 2017 79616 A
(800) 532631
(891) 2014 07 28
(731) MELITTA EUROPA GMBH & CO. KG
Ringstraße 99, 32427 Minden, Germany
(540)



(591) Gold, red and white
(511)
3 – Cleaning and polishing agents and products, grease-removing products; descaling agents.).

7 – Electric coffee and tea mills.

9 – Electric kettles.

11 – Electric coffee and tea makers, coffee and tea filters (percolators), coffee-roasting machines, machines for keeping beverages and dishes warm, hot plates; water boilers, electrically operated heating pots or containers used alone or with electric coffee machines and electric tea makers.

16 – Paper, filter paper, absorbent paper, boxes of cardboard and products made from these materials, namely conical bags, bags, small bags for making infusions, discs and rolls for the filtering of liquids, saucers and coasters made of absorbent paper, drip catchers, tablecloths, napkins, hand towels, packaging containers.

21 – Containers for household use (not of precious metals or metal-plated), small household and kitchen utensils, namely filters and filter holders for open and closed filter paper for filtering liquids, objects for household and kitchen use (included in this class) of glass, porcelain, earthenware, plastic and metal, in particular coffee and tea pots and coffee and tea sets, drinking cups, vacuum bottles and containers, trays, automatic coffee and tea makers and non-electric coffee grinders; single-use tableware (for camping).

29 – Milk, condensed milk, powdered milk of animal origin (for food); plant-based powdered milk for tea or coffee.

30 – Coffee, coffee extracts, instant coffee.

(260) AM 2017 87957 A
(800) 1301494
(891) 2016 02 29
(731) KAHVE SARAYI TİCARET LİMİTED
ŞİRKETİ
Merkez Mahallesi, Harmanyeri Sokak, No:2/4
Avcılar – İstanbul, Turkey
(540)



(591) Green and brown are the feature of the mark.

(511)

30 – Coffee, cocoa; coffee or cocoa based beverages, chocolate based beverages; coffee essences; coffee extracts; unroasted coffee; caffeine-free coffee; chocolate-coated coffee beans; coffee-based drinks; coffee-based iced beverages; coffee beverages with milk; roasted coffee beans; sugar-coated coffee beans; coffee-based beverages containing milk; pasta, stuffed dumplings, noodles; pastries and bakery products based on flour; desserts based on flour and chocolate; bread, pies, cakes; desserts based on dough coated with syrup; puddings, custard, rice pudding; honey, bee glue for human consumption, propolis for food purposes; condiments for foodstuff, vanilla (flavoring), spices, sauces (condiments), tomato sauce; yeast, baking powder; flour, semolina, starch for food; sugar, cube sugar, powdered sugar; tea, ice tea; confectionery, chocolate, biscuits, crackers, wafers; chewing gums; ice-cream, edible ices; salt; cereal-based snack food, popcorn, crushed oats, corn chips, breakfast cereals, processed wheat for human consumption, crushed barley for human consumption, processed oats for human consumption, processed rye for human consumption, rice.

43 – Services for providing food and drink; café services; coffee shop services; temporary accommodation; day-nurseries (crèches); boarding for animals; serving of tea, coffee, cocoa, carbonated drinks or fruit juice beverages.

(260) AM 2017 88095 A
 (800) 1303607
 (891) 2016 03 14
 (731) SLOBOZHANSKY SOAP-BOILER, LTD.
 Sverdlova str., 53, v. Podvorki, Dergachovski
 district, Kharkov region 62371, Ukraine
 SLOBOZHANSKY SOAP-BOILER LTD.
 vul. Sumsnyi Shliakh, 53, s. Podvirky,
 Derhachivskiy r-n, Kharkivska obl. 62371,
 Ukraine

(540)



(591) Red, white, yellow and blue

(511)

3 – Laundry bleaching preparations; laundry soaking preparations; preparations and substances for laundry use; preparations and substances for bleaching purposes; capsules for washing laundry; laundry additives; cakes of soap; detergents other than for use in manufacturing operations and for medical purposes; soap; dishwashing detergents; detergents for baths and toilet; fabric softeners for laundry use; furbishing preparations; pastes for laundry use; hands-washing pastes; hand cleaning pastes; washing powder; laundry blueing; laundry glaze; laundry preparations; detergents for household use; cleaning preparations; liquid soap; dry shampoos; laundry tablets; shampoos; shampoos for cleaning of automobiles; hair shampoos and conditioners.

(260) AM 2017 88190 A
 (800) 1061768
 (891) 2016 03 30
 (731) BERKO ILAÇ ve KIMYA SANAYI
 ANONIM SİRKETİ
 Yenisehir Mah. Ozgur Sok. No:16-18B
 Atasehir Istanbul, Turkey

(540)

BERKO ACD3 damla

(511)

5 – Pharmaceuticals for human and animal health, chemical preparations for medical purposes; dietetic substances adapted for medical purposes; dietetic foods, vitamins, dietary substances for medicinal purposes, baby food.

29 – Supplementary food products, not for medical purposes, mostly consisting of proteins and also containing carbohydrates, proteins and pollen.

(260) AM 2017 88193 A
 (800) 1120937
 (891) 2016 03 30
 (731) BERKO İLAÇ VE KİMYA SANAYİ
 ANONİM SİRKETİ
 Yenisehir Mah. Ozgur Sok. No. 16-18
 Atasehir, Istanbul, Turkey

(540)



(591) Dark blue

(511)

5 – Pharmaceuticals for human and animal health, chemical preparations for medical purposes; dietetic substances adapted for medical purposes; dietetic foods.

29 – Supplementary food products, not for medical purposes, mostly consisting of proteins and also containing carbohydrates, proteins and pollen.

(260) AM 2017 88262 A
 (800) 1305104
 (891) 2016 05 11
 (731) RIGO TRADING S.A.
 Route de Trèves 6, EBBC Building E,
 L-2633 Senningerberg, Luxembourg

(540)

STRIPES

(511)

30 – Confectionery.

(260) AM 2017 88275 A
 (800) 1305212
 (891) 2016 02 06
 (731) International Institute for Research and
 Development of Special Interest Tourism
 (SITI)
 No.1, Golfam Street, Africa Blvd. Tehran,
 Iran (Islamic Republic of)

(540)



(591) Black, green, white and gray.

(526) HALAL TOURISM

(511)

3 – Cosmetic preparations for baths, bleaching preparations, stain remover, soap, cosmetic preparations for skin care, cleaning preparations, polishing preparations, abrasives, dentifrices, eyebrow cosmetics, essential oils, hair lotions, perfumes, laundry preparations.

18 – Animal skins, umbrellas, valves of leather, suitcases, leather trimmings for furniture, travelling sets (leatherware), travelling bags, leather tool bags (empty), leather thread and laces, leather straps used for tightening and fixing of skateboard wheels, leather straps, leather shoulder straps, straps of leather [saddlery], stirrup leathers, leather leashes, casings of leather for plate springs, harness, walking sticks, furniture coverings of leather, leatherboard, leather unworked or semi-worked, leather twist, imitation leather, whips, collars of leather (for animals), kid, key cases (leather goods), hat boxes of leather, parasols, bags (envelopes, pouches) of leather for packaging, bags for campers.

25 – Headgear for wear, ready-made clothing, clothing, fur footmuffs not electrically heated.

27 – Linoleum, rugs, door mats, mats and matting, carpets, floor covering, wall hanging (non-textile).

29 – Meat, fish, poultry, compotes, jelly powder; preserved, frozen, dried or cooked vegetables; frozen, dried and frosted fruits; eggs, edible oils and fats, jams, milk and milk products, meat and game extracts.

30 – Molasses (syrup) for food, syrup for culinary purposes and extracts, other than essential oils, for flavoring foodstuffs, flour, cassava starch for food, salt, treacle, baking powder, confectionery ices, tapioca, vinegar, teas, starch for food, sauces (condiments), sago, rice, artificial coffee, coffee, cocoa, bread, confectionery and pastry products, spices, sugar, edible ices, honey, mustard.

31 – Live animals, malt, fresh fruits and vegetables, natural plants and flowers, animal foodstuffs, seeds.

32 – Non-alcoholic beverages, mineral waters, non-alcoholic beers, fruit drinks and beverages, preparations for making beverages, aerated mineral waters, syrups for beverages, fruit juices.

35 – Advertising, office functions, business administration, business management; export services for: cosmetic preparations for baths, bleaching preparations, stain remover, soap, cosmetic preparations for skin care, cleaning preparations, polishing preparations, abrasives, dentifrices, eyebrow cosmetics, essential oils, hair lotions, perfumes, laundry preparations, animal skins, umbrellas, valves and leads of leather, suitcases, leather trimmings for furniture, travelling sets (leather ware), travelling bags, leather tool bags (empty), leather thread and laces, leather

straps used for tightening and fixing of skateboard wheels, leather straps, leather shoulder straps, straps of leather [saddlery], stirrup leathers, leather leashes, casings of leather for plate springs, harness, walking sticks, furniture coverings of leather, leatherboard, leather unworked, or semi-worked, leather twist, imitation leather, whips, collars of leather (for animals), kid, key cases (leather goods), hat boxes of leather, parasols, bags (envelopes, pouches) of leather for packaging, bags for campers, headgear for wear, ready-made clothing, clothing, fur footmuffs not electrically heated, linoleum, rugs, door mats, mats and matting, carpets, floor covering, wall hangings (non-textile), meat, fish, poultry, compotes, jelly powder, preserved, frozen, dried or cooked vegetables, frozen, dried and frosted fruits, eggs, edible oils and fats, jams, milk and milk products, meat and game extracts, molasses (syrup) for food, syrup for culinary purposes and extracts, other than essential oils, for flavoring foodstuffs, flour, cassava starch for food, salt, treacle, baking powder, confectionery, ices, tapioca, vinegar, teas, starch for food, sauces (condiments), sago, rice, artificial coffee, coffee, cocoa, bread, confectionery and pastry products, spices, sugar, edible ices, honey, mustard, live animals, malt, fresh fruits and vegetables, natural plants and flowers, animal foodstuffs, seeds, non-alcoholic beverages, mineral waters, non-alcoholic beers, fruit drinks and beverages, preparations for making beverages, aerated mineral waters, syrups for beverages, fruit juices.

39 – Arranging of travel tours, arranging of travel by sea, booking of seats for travel, transport of travellers, escorting of travellers, travel reservation; transport, packaging and storage of: cosmetic preparations for baths, bleaching preparations, stain remover, soap, cosmetic preparations for skin care, cleaning preparations, polishing preparations, abrasives, dentifrices, eyebrow cosmetics, essential oils, hair lotions, perfumes, laundry preparations, animal skins, umbrellas, valves and leads of leather, suitcases, leather trimmings for furniture, travelling sets (leatherware), travelling bags, leather tool bags (empty), leather thread and laces, leather straps used for tightening and fixing of skateboard wheels, leather straps, leather shoulder straps, straps of leather [saddlery], stirrup leathers, leather leashes, casings of leather for plate springs, harness, walking slicks, furniture coverings of leather, leatherboard, leather unworked or semi-worked, leather twist, imitation leather, whips, collars of leather (for animals), kid, key cases (leather goods), hat boxes of leather, parasols, bags (envelopes, pouches) of leather for packaging, bags for campers, headgear for wear, ready-made clothing, clothing, fur footmuffs not electrically heated, linoleum, rugs, door mats, mats and matting, carpets, floor covering, wall hangings (non-textile), meat, fish, poultry, compotes, jelly powder, preserved, frozen, dried or cooked vegetables, frozen, dri-

ed and frosted fruits, eggs, edible oils and fats, jams, milk and milk products, meat and game extracts, molasses (syrup) for food, syrup for culinary purposes and extracts, other than essential oils, for flavoring foodstuffs, flour, cassava starch for food, salt, treacle, baking powder, confectionery ices, tapioca, vinegar, teas, starch for food, sauces (condiments) sago, rice, artificial coffee, coffee, cocoa, bread, confectionery and pastry products, spices, sugar, edible ices, honey, mustard, live animals, malt, fresh fruits and vegetables, natural plants and flowers, animal foodstuffs, seeds, non-alcoholic beverages, mineral waters, non-alcoholic beers, fruit drinks and beverages, preparations for making beverages, aerated mineral waters, syrups for beverages, fruit juices.

41 – Academies [education], vocational guidance [education or training advice], sporting and cultural activities, club services [entertainment or education], entertainment services, religious education.

43 – Snack-bar services, temporary accommodation, providing food and drink for others.

44 – Veterinary and medical services, agriculture, horticulture and forestry services, hygienic and beauty care for human beings or animals.

(260) AM 2017 88276 A

(800) 1305219

(891) 2016 01 22

(731) RETAL INDUSTRIES LIMITED

Epimitheos, 6, Industrial Area A, CY-3056
Limassol, Cyprus

(540)

RETAL

(591) Black, white

(511)

20 – Polymer screw caps; polymer closure caps; polyethylene caps; caps, closure caps and closures not of metal for bottles, jars, and other containers.

(260) AM 2017 88299 A

(800) 1305383

(891) 2016 03 22

(731) AC. TA. S.R.L.

Via Lepanto, 84, I-80045 POMPEI (NA), Italy

(540)



(591) Black, white

(511)

10 – Surgical apparatus and instruments; medical apparatus and instruments.

11 – Lighting apparatus; light fittings.

(260) AM 2017 88361 A

(800) 1305611

(891) 2016 04 13

(731) PRESTIGE-96 AD

6 Dalga Laka str., BG-5000 Veliko Turnovo,
Bulgaria

(540)



(591) red and white

(511)

30 – Coffee, tea, cocoa and artificial coffee; tapioca and sago; flour and preparations made from cereals; bread, pastry and confectionery; edible ices; sugar, honey, treacle; yeast, baking-powder; spices.

(260) AM 2017 88466 A

(800) 1306876

(891) 2016 05 19

(731) HYUNDAI MOTOR COMPANY

12, Heolleung-ro, Seocho-gu, Seoul 06797,
Republic of Korea

(540)

Smart Sense

(591) Black, white

(511)

12 – Braking devices for vehicles; mechanical power transmissions and gearings for land vehicles; power transmissions and gearings for land vehicles; engines for land vehicles; motors for land vehicles; transmissions for land vehicles.

(260) AM 2017 88519 A

(800) 1307479

(891) 2016 03 14

(731) SIRONA Dental Systems GmbH

Fabrikstr. 31, 64625 Bensheim, Germany

(540)

SPEEDFIRE

(511)

9 – Electric control instruments and data processing equipment and computers as part of measurement and control technology for furnaces and kilns; CAD / CAM programs, in particular for the dental field; image creation, image editing and image manage-

ment programs (software), in particular for the dental field; surveying programs (software) for 3D measurements in the dental field; programs (software) for the reconstruction of 3D data from 2D images (tomography) for the dental field; programs for the creation and management of dental radiographs; programs (software) for the planning or implementation of medical or dental treatments; video cameras for dental purposes; electrical switchgear, control panels and switch panels and combined display and switching devices, display and control desks and display and control panels for dental instruments and apparatus, in particular for dental X-ray equipment or treatment chairs; furnaces for laboratory.

11 – Industrial furnaces; furnaces for dental technology, especially kilns for ceramics, glass and sintered metal; ovens for various heat treatments; furnaces; furnaces for quenching, cooling and storage of combustible material; transport ladles for kiln run; bogies as part of furnaces and kilns; furnaces for use in kilns for semi- and fully automatic loading.

(260) AM 2017 88520 A

(800) 1307504

(891) 2016 03 14

(731) AYTAS ALCI ENERJİ MADEN VE
İNŞAAT SAN.TİC.A.Ş.

Turan Güneş Bulvarı No:12/14, Çankaya
Yıldızevler Çankaya, Ankara, Turkey

(540)



The logo for 'OUTWEAR' features the word 'OUTWEAR' in a bold, sans-serif font. 'OUT' is in grey and 'WEAR' is in green. A thick horizontal bar is positioned above the letters 'O', 'U', and 'T' in grey, and another thick horizontal bar is positioned below the letters 'W', 'E', 'A', and 'R' in green.

(591) Grey and green.

(511)

19 – Building materials as finished products, namely, sand, gravel, crushed stone, asphalt, bitumen, cement, concrete beams, concrete blocks, gypsum, non-metal slabs of clay, potters' clay, building stone, marble, multi-layered wood, plastic floorboards, and synthetic flooring materials or wall claddings for building, construction, road construction purposes; non-metallic transportable buildings; non-metallic minerals for building; non-metal poles for electric power lines; portable non-metal free-standing barriers; asphalt roof coatings in the form of panels and sheets, being building materials; bitumen cardboard coatings for roofing; bitumen coating for roofing; wooden doors and vinyl doors; vinyl windows; wood window frames.

(260) AM 2017 88588 A

(800) 1307828

(891) 2016 05 26

(731) UAB FREOR LT

Motoru g. 6, LT-02190 Vilnius, Lithuania

(540)

FREOR

(511)

11 – Freezers; refrigerating machines; refrigerating chambers; refrigerating containers; walk-in refrigerators; refrigerating appliances and installations; refrigerating cabinets; refrigerators; cooling appliances and installations; cooling installations and machines.

37 – Installation, maintenance and repair of freezers, refrigerating machines, refrigerating chambers, refrigerating containers, walk-in refrigerators, refrigerating appliances and installations, refrigerating cabinets, refrigerators, cooling appliances and installations, cooling installations and machines; warehouse construction and repair; kitchen equipment installation.

(260) AM 2017 88592 A

(800) 1307895

(891) 2016 03 11

(731) NEILOS S.R.L.

Via Bagnulo, 95, I-80063 PIANO DI
SORRENTO (NA), Italy

(540)

MELAFIBRE

591) Black, white

(511)

5 – Pharmaceuticals, medical and veterinary preparations; sanitary preparations for medical purposes; dietetic food and substances adapted for medical or veterinary use food for babies; dietary supplements for humans and animals; plasters, materials for dressings; material for stopping teeth, dental wax, disinfectants; preparations for destroying vermin, fungicides herbicides, preparations for destroying dry rot fungus; articles for headache; bath preparations for medical purposes; therapeutic preparations for the bath; balsamic preparations for medical purposes; bandages for dressings; balms for medical purposes; candy, medicated; preparations for the treatment of burns; syrups for pharmaceutical purposes; capsules for medicines; pharmaceutical preparations; poultices; chemico-pharmaceutical preparations; collyrium; compresses; vitamin preparations; medicines for alleviating constipation; solutions for contact lenses; sunburn preparations for pharmaceutical purposes; vaccines; dressings, medical; depuratives; digestives for pharmaceutical purposes; analgesics; drugs for medical purposes; elixirs [pharmaceutical preparations]; esters for pharmaceutical purposes; ethers for pharmaceutical purposes; eucalyptol for pharmaceutical purposes; eucalyptus for pharmaceutical purposes; purgatives; evacuating; flour for pharmaceutical purposes; lacteal flour for babies; febrifuges; fennel for medical purposes; medicinal infusions; laxatives; gelatine for medical purposes; medi-

cinal herbs; peptones for pharmaceutical purposes; liquorice for pharmaceutical purposes; milk ferments for pharmaceutical purposes; lotions for pharmaceutical purposes; milk sugar for pharmaceutical purposes; yeast for pharmaceutical purposes; lupulin for pharmaceutical purposes; chewing gum for medical purposes; mint for pharmaceutical purposes; pomades for medical purposes; serums; menthol; lozenges for pharmaceutical purposes; ointments for pharmaceutical purposes; phenol for pharmaceutical purposes; pharmaceutical preparations for skin care; herbal teas for medicinal purposes; pharmaceutical preparations for treating dandruff; pepsins for pharmaceutical purposes; cachets for pharmaceutical purposes; potassium salts for medical purposes; tonics [medicines]; sedatives; tranquilizers; soporifics; styptic preparations; sulfonamides [medicines]; suppositories; dietetic foods adapted for medical purposes; food for babies; sunburn ointments; bath salts for medical purposes; stick liquorice for pharmaceutical purposes; bicarbonate of soda for pharmaceutical purposes; biological preparations for medical purposes; dietetic beverages adapted for medical purposes; lecithin for medical purposes; royal jelly for pharmaceutical purposes; medical preparations for slimming purposes; cellulose esters for pharmaceutical purposes; cellulose ethers for pharmaceutical purposes; chemical preparations for pharmaceutical purposes; ferments for pharmaceutical purposes; gallic acid for pharmaceutical purposes; glucose for medical purposes; castor oil for medical purposes; iodine for pharmaceutical purposes; iodides for pharmaceutical purposes; alkaline iodides for pharmaceutical purposes; dietary fiber; dietary fibre; enzymes for medical purposes; amino acids for medical purposes; amino acids for veterinary purposes; mineral food supplements; nutritional supplements; medicinal hair growth preparations; adjuvants for medical purposes; douching preparations for medical purposes; aloe vera preparations for pharmaceutical purposes; eye-washes; appetite suppressant pills; slimming pills; tanning pills; antioxidant pills; linseed oil dietary supplements; wheat germ dietary supplements; yeast dietary supplements; royal jelly dietary supplements; propolis for pharmaceutical purposes; propolis dietary supplements; pollen dietary supplements; enzyme dietary supplements; glucose dietary supplements; lecithin dietary supplements; alginate dietary supplements; alginates for pharmaceutical purposes; casein dietary supplements; protein dietary supplements; protein supplements for animals; starch for dietetic or pharmaceutical purposes; adhesive plasters; hemorrhoid preparations.

(260) AM 2017 88595 A
 (800) 1308032
 (891) 2016 06 08
 (731) LABORATOIRES DE BIOLOGIE

VEGETALE YVES ROCHER, société anonyme
 La Croix des Archers, F-56200 LA GACILLY, France

(540)

SECRETS D'ESSENCES ACCORD CHIC YVES ROCHER

(511)

3 – Deodorants for personal use; perfumes; perfumery products for cosmetic use; home perfuming products excluding vaporizers.

(260) AM 2017 88604 A

(800) 1308299

(891) 2016 05 05

(731) KRKA, tovarna zdravil, d.d. Novo mesto
 Šmarješka cesta 6, SI-8000 Novo mesto,
 Slovenia

(540)

ETORIX

(511)

5 – Pharmaceutical preparations.

(260) AM 2017 88607 A

(800) 1308300

(891) 2016 05 06

(731) KRKA, tovarna zdravil, d.d., Novo mesto
 Šmarješka cesta 6, SI-8000 Novo mesto,
 Slovenia

(540)

TELDIPIN

(511)

5 – Pharmaceutical preparations.

(260) AM 2017 88697 A

(800) 1309526

(891) 2016 05 13

(731) Rigo Trading S.A.
 Route de Trèves 6, EBBC Building E,
 L-2633 Senningerberg, Luxembourg

(540)

Joy Mixx

(511)

30 – Confectionery.

(260) AM 2017 88704 A

(800) 1309557

(891) 2016 06 03

(731) POLFARMEX IP SP. Z O.O.
 ul. Kosciuszki 61, PL-38-200 Jaslo, Poland

(540)

asaris

(591) black and white

(511)

5 – Pharmaceutical preparations.

10 – Inhalers for medical use.

(260) AM 2017 88705 A

(800) 1309589

(891) 2016 08 10

(731) REKTOL GMBH & CO. KG

Am Kniep 2, 34497 Korbach; Germany

(540)

Rektol

(511)

4 – Industrial oils and greases; lubricants; lighting fuel.

(260) AM 2017 88708 A

(800) 1309598

(891) 2016 07 23

(731) BAYERISCHE MOTOREN WERKE

AKTIENGESELLSCHAFT

Petuelring 130, 80809 Munich, Germany

(540)

Advantec

(511)

4 – Industrial oils; industrial greases; lubricants; engine oils; gear oils; petrol additives; additives for fuels for vehicles; fuel for vehicles.

(260) AM 2017 88710 A

(800) 1309669

(891) 2016 04 29

(731) PEPSICO, INC.

(a North Carolina corporation)

700 Anderson Hill Road, Purchase NY 10577,

USA

(540)



(591) Light grey, white, green

(511)

32 – Aperitifs, non-alcoholic; aerated water; mineral water [beverages]; waters [beverages]; table waters; kvass [non-alcoholic beverage]; cocktails, non-alcoholic; lemonades; non-alcoholic beverages; isotonic

beverages; non-alcoholic honey-based beverages; non-alcoholic fruit juice beverages; fruit nectars, non-alcoholic; orgeat; beer; powders for effervescent beverages; sarsaparilla [non-alcoholic beverage]; syrups for lemonade; syrups for beverages; smoothies; vegetable juices [beverages]; fruit juices; cider, non-alcoholic; preparations for making aerated water; preparations for making mineral water; preparations for making beverages; sherbets [beverages]; non-alcoholic fruit extracts; essences for making beverages.

(260) AM 2017 88712 A

(800) 1309674

(891) 2016 04 06

(731) YDA EXPRESS ELEVATOR CO., LTD

East of JiangJiang Yang Road, South

of Lian Yi Road, Nanxun Economic

Development Zone, Huzhou City, 313009

Zhejiang, China

(540)

FUJI YIDA

(591) black and white

(511)

7 – Elevators [lifts]; hoists; elevator belts; moving staircases; lifting equipment.

(260) AM 2017 88716 A

(800) 1309676

(891) 2016 04 04

(731) Publichne aktsionerne tovarystvo

"KHARKIVSKA BISKVITNA FABRYKA"

vul. Lozivska, 8, Kharkiv 61017, Ukraine

(540)

Кураж

(591) black and white

(511)

30 – Pastries; waffles; marshmallow; caramels (candy); crackers; marmalades (confectionery); pastilles (confectionery); biscuits; confectionery; cakes; tarts; sweetmeats (candy); chocolate.

(260) AM 2017 88719 A

(800) 1309677

(891) 2016 05 23

(731) FRUTAROM GERMANY GMBH

Reeser Straße 60, 46446 Emmerich, Germany

(540)

фермаром

(591) black and white

(511)

1 – Microorganisms and bacteria for use in food industry, in particular starter cultures.

30 – Food, namely coffee, tea and cocoa and artificial coffee; rice; flour and cereals; bread, pastries and confectionery; ices; sugar, honey, treacle; yeast; baking powder; salt; mustard; vinegar; sauces (seasonings); spices; spice extracts.

(260) AM 2017 88722 A
(800) 1309706
(891) 2016 04 29
(731) RIGO TRADING S.A.
Route de Trèves 6 EBBC, Building E,
L-2633 Senningerberg, Luxembourg
(540)



(591) Red, yellow, white and purple
(511)
30 – Confectionery.

(260) AM 2017 88730 A
(800) 1309721
(891) 2016 06 08
(731) JANSSEN PHARMACEUTICA NV
Turnhoutseweg 30, B-2340 Beerse,
Belgium
(540)

НИЗОРИЛ

(591) black and white
(511)
5 – Topical antifungal medications.

(260) AM 2017 88740 A
(800) 1310182
(891) 2016 03 25
(731) NEXTEV CO., LTD.
Suite 115, 569 Anchi Road, Anting Town,
Jiading District, 201805 Shanghai, China
(540)

WEILAI

(591) black and white
(511)
12 – Sport cars; cars; motors for land vehicles; tires for vehicle wheels; steering wheels for vehicles.
37 – Motor vehicle maintenance and repair; car washing; anti-rust treatment for vehicles; vehicle breakdown assistance [repair]; vehicle battery changing.

(260) AM 2017 88743 A
(800) 1310184
(891) 2016 03 25

(731) NEXTEV CO., LTD.
Suite 115, 569 Anchi Road, Anting Town,
Jiading District, 201805 Shanghai, China
(540)

WEILAI AUTO

(591) Black, white
(511)
12 – Sport cars; cars; motors for land vehicles; tires for vehicle wheels; steering wheels for vehicles.
37 – Motor vehicle maintenance and repair; car washing; anti-rust treatment for vehicles; vehicle breakdown assistance [repair]; vehicle battery changing.

(260) AM 2017 88750 A
(800) 1310266
(891) 2016 05 02
(731) WILHELMSSEN SHIPS SERVICE AS
Strandveien 20, N-1366 Lysaker, Norway
(540)

TIMM

(511)
6 – Ropes of metal or predominantly made of metal; wire rope; wire rope slings; straps for load handling; rope thimbles of metal.
22 – Ropes, rope slings, rope ladders, cables, cords, cordage, string, twine, anchoring ropes, mooring ropes, towing ropes; sheets and halyards for sailboats; ropes for hunting, fishing and fish farming; arborist's ropes and slings; fishing nets, net pens for fish farming; nets and slings for load handling; all the aforementioned goods not being made of metal or predominantly being made of materials other than metal; sails for yachts; textile fibres; textile fibres for repairing and reinforcement of surfboards, skateboards, helmets and skis; plastic fibers for textile use.

(260) AM 2017 88754 A
(800) 1310007
(891) 2016 03 09
(731) APPLE INC.
1 Infinite Loop, Cupertino CA 95014, USA
(540)



(591) Blue and black
(511)
9 – Computer software used to wirelessly transmit, deliver and receive, and to encode, decode, format and store documents, data, text, and images for printing on a remote printer; computer software used to wirelessly transmit, deliver and receive, and to en-

code, decode, format and store documents, data, text, and images for printing on a remote printer, sold as a component feature of computer printers; printers; computer hardware; computer peripherals.

(260) AM 2017 88756 A

(800) 1310059

(891) 2016 03 18

(731) BIOIBERICA, S.A.

Ctra. Nacional II, Km. 680,6. Pol. Ind. Mas,
Puigvert Palafolls, E-08389 Barcelona, Spain

(540)



(591) gray and white

(511)

1 – Chemical products for use in industry, science, photography, as well as in agriculture, horticulture and forestry; unprocessed artificial resins, unprocessed plastics; soil fertilizers; fire extinguishing compositions; tempering and soldering preparations; chemicals for preserving foodstuffs; tanning substances; adhesives for use in industry.

5 – Pharmaceutical and veterinary products; sanitary products for medical purposes; dietetic substances for medical use, food for babies; plasters, material for dressings; material for dental fillings and for dental impressions; disinfectants; products for destroying vermin; fungicides, herbicides.

(260) AM 2017 88757 A

(800) 1310363

(891) 2016 05 20

(731) LTD "VALENTA-INTELLEKT"

ul. Generala Dorokhova, d. 18, str. 2,
RU-119530 Moscow, Russian Federation

(540)

феназепам

(511)

5 – Drugs for medical purposes; medicines for human purposes; pharmaceutical preparations; chemico-pharmaceutical preparations.

(260) AM 2017 88759 A

(800) 1310383

(891) 2016 05 20

(731) CAMILLE ENRICO SARL

2 Rue de Capri, F-75012 PARIS, France

(540)

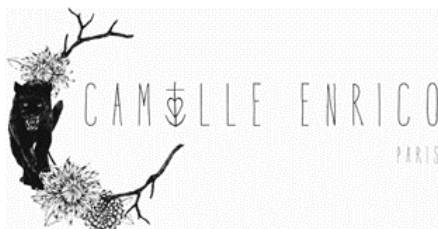

(591) Black, white

(511)

14 – Jewelry; jewelry products, precious stones; precious metals and their alloys; works of art of precious metal; all these goods are of French origin or made in France.

(260) AM 2017 88760 A

(800) 1310096

(891) 2016 04 06

(731) APPLE INC.

1 Infinite Loop, Cupertino, CA 95014, USA

(540)

CAREKIT

(591) black and white

(511)

9 – Computer software used in developing other software applications; application development software.

(260) AM 2017 88761 A

(800) 1310097

(891) 2016 04 06

(731) APPLE INC.

1 Infinite Loop, Cupertino CA 95014, USA

(540)

CAREKIT

(591) black and white

(511)

42 – Design and development of computer software; computer software consulting services; support and consultation services for developing computer systems, databases and applications; providing computer software information online.

(260) AM 2017 88764 A

(800) 1310136

(891) 2016 03 31

(731) JAKOB HATTELAND LOGISTICS AS

Stokkastrandvegen 85, N-5578 Nedre Vats,
Norway

(540)

**Stop Airhousing – Start
Warehousing**

(511)

7 – Conveying machines, robots (machines), apparatus and installations; conveying machines, robots (machines), apparatus and installations, including conveyors and roller conveyors for conveying goods for storage and retrieval; electronically controlled machines, robots (machines) and conveying apparatus for use for storage and retrieval of goods; boxes and containers customized for use with the afore-

mentioned machines, apparatus and installations; machine coupling and transmission components (except for land vehicles); parts and fittings for all the aforementioned goods.

9 – Electronically controlled apparatus and instruments, being operational and/or controlling units and parts of or for storage and retrieval apparatus and instruments for use in the warehousing of goods; boxes and containers customized for use with the aforementioned goods; electronically controlled apparatus and instruments, including computerized electronic apparatus and instruments for observation, management and/or operation of storage and retrieval machines and systems for use in the warehousing of goods, data processing apparatus and appliances for management of storage depots and warehouses, recorded computer programs and software for management and/or operation of storage depots and warehouses; electrical, electronic and/or optical apparatus and instruments for measuring, monitoring and/or checking (supervision), parts and fittings for all the aforementioned goods.

35 – Marketing services; retail and/or wholesale services in respect of conveying machines, robots (machines), apparatus and installations, and parts and fittings for the aforementioned goods; retail and/or wholesale services in respect of conveyors, roller conveyors, robots (machines) and apparatus for conveying goods for storage and retrieval, retail and/or wholesale services in respect of electronically controlled machines, robots (machines), apparatus and/or instruments, including computerized storage and retrieval machines, robots (machines), apparatus and/or instruments for use in warehousing, and parts and fittings for the aforementioned goods; retail and/or wholesale services in respect of computer software for management and/or operation of warehouses and storage depots; retail and/or wholesale services in respect of computer programs and software for management and/or operation of machines, robots (machines), apparatus and/or installations for storage and retrieval of goods; retail and/or wholesale services in respect of grids, frameworks and structures of metal or predominantly made of metal, including rail structures for conveying machines, robots (machines) and/or roller conveyors for conveying goods for storage and retrieval, retail and/or wholesale services in respect of bins, boxes and containers; retail and/or wholesale services in respect of bins, boxes and containers customized for use with machines, robots (machines) and apparatus for conveying goods for storage and retrieval.

37 – Installation, maintenance and repair of storing depots and of machines, robots (machines), apparatus and systems for storage and retrieval of goods; installation and maintenance services related to electrical and electronic apparatus and systems; installation, maintenance and repair of conveying machi-

nes, apparatus and installations, including conveyors and roller conveyors for conveying goods; installation, maintenance and repair of grids, frameworks, rail structures for conveying machines and roller conveyors for conveying goods for warehousing; installation, maintenance and repair of electronic apparatus and instruments for observation, management and/or operation of storage and retrieval machines and systems for use in warehousing; information and consultancy related to all the aforementioned services.

(260) AM 2017 88766 A

(800) 1310137

(891) 2016 03 31

(731) JAKOB HATTELAND LOGISTICS AS

Stokkastrandvegen 85, N-5578 Nedre Vats,

Norway

(540)

Stop Airhousing!

(591) black and white

(511)

7 – Conveying machines, robots (machines), apparatus and installations; conveying machines, robots (machines), apparatus and installations, including conveyors and roller conveyors for conveying goods for storage and retrieval; electronically controlled machines, robots (machines) and conveying apparatus for use for storage and retrieval of goods; boxes and containers customized for use with the aforementioned machines, apparatus and installations; machine coupling and transmission components (except for land vehicles); parts and fittings for all the aforementioned goods.

9 – Electronically controlled apparatus and instruments, being operational and/or controlling units and parts of or for storage and retrieval apparatus and instruments for use in the warehousing of goods; boxes and containers customized for use with the aforementioned goods; electronically controlled apparatus and instruments, including computerized electronic apparatus and instruments for observation, management and/or operation of storage and retrieval machines and systems for use in the warehousing of goods, data processing apparatus and appliances for management of storage depots and warehouses, recorded computer programs and software for management and/or operation of storage depots and warehouses; electrical, electronic and/or optical apparatus and instruments for measuring, monitoring and/or checking (supervision), parts and fittings for all the aforementioned goods.

35 – Marketing services; retail and/or wholesale services in respect of conveying machines, robots (machines), apparatus and installations, and parts and fittings for the aforementioned goods; retail and/or

wholesale services in respect of conveyors, roller conveyors, robots (machines) and apparatus for conveying goods for storage and retrieval, retail and/or wholesale services in respect of electronically controlled machines, robots (machines), apparatus and/or instruments, including computerized storage and retrieval machines, robots (machines), apparatus and/or instruments for use in warehousing, and parts and fittings for the aforementioned goods; retail and/or wholesale services in respect of computer software for management and/or operation of warehouses and storage depots; retail and/or wholesale services in respect of computer programs and software for management and/or operation of machines, robots (machines), apparatus and/or installations for storage and retrieval of goods; retail and/or wholesale services in respect of grids, frameworks and structures of metal or predominantly made of metal, including rail structures for conveying machines, robots (machines) and/or roller conveyors for conveying goods for storage and retrieval, retail and/or wholesale services in respect of bins, boxes and containers; retail and/or wholesale services in respect of bins, boxes and containers customized for use with machines, robots (machines) and apparatus for conveying goods for storage and retrieval.

37 – Installation, maintenance and repair of storing depots end of machines, robots (machines), apparatus and systems for storage and retrieval of goods; installation and maintenance services related to electrical and electronic apparatus and systems; installation, maintenance and repair of conveying machines, apparatus and installations, including conveyors and roller conveyors for conveying goods; installation, maintenance and repair of grids, frameworks, rail structures for conveying machines and roller conveyors for conveying goods for warehousing; installation, maintenance and repair of electronic apparatus and instruments for observation, management and/or operation of storage and retrieval machines and systems for use in warehousing; information and consultancy related to all the aforementioned services.

(260) AM 2017 88770 A
 (800) 1310435
 (891) 2016 04 29
 (731) HARIBO Holding GmbH & Co. KG
 Hans-Riegel-Straße 1, 53129 Bonn, Germany
 (540)

FULL ON – TILL IT'S GONE

(511)
 30 – Confectionery.

(260) AM 2017 88771 A
 (800) 1310448
 (891) 2016 07 01
 (731) APPLE INC.
 1 Infinite Loop, Cupertino CA 95014, USA
 (540)

NIGHT SHIFT

(511)
 9 – Computer software for controlling computer and mobile device display screens.

(260) AM 2017 88772 A
 (800) 1310460
 (891) 2016 06 17
 (731) ERYTECH PHARMA
 60 avenue Rockefeller, F-69008 LYON, France
 (540)

ERYTECH

(591) Black, white
 (511)
 5 – Pharmaceutical and veterinary products; chemical preparations for medical or pharmaceutical use.
 7 – Machines for the development and/or production of products for therapeutic use.
 9 – Scientific apparatus and instruments for the development and/or production of products for therapeutic use.
 10 – Medical apparatus and instruments for the development and/or production of products for therapeutic use.
 42 – Evaluations, assessments and research in the fields of science and technology provided by engineers; research and development of new products for others; scientific research for medical purposes.
 44 – Medical services; hospital services; health services.

(260) AM 2017 88775 A
 (800) 1310549
 (891) 2015 12 16
 (731) DEUTSCHE BAHN AG
 Potsdamer Platz 2, 10785 Berlin, Germany
 (540)



(591) Red

(511)

6 – Transport and storage pallets of metal; transport and storage bins of metal.

9 – Telephone cards.

16 – Paper, millboard, goods made from these materials included in this class, namely paper hand towels, table napkins, filter paper, paper handkerchiefs, containers for packaging, bags made of paper for packaging; printed matter, pamphlets, brochures, newspapers, periodicals, books, printed loyalty cards, stationery.

20 – Transport and storage pallets of wood or plastic; transport and storage bins of wood or plastics.

35 – Advertising; marketing; public relations services-all limited to transportation services.

37 – Repair/maintenance of railway rolling stock and machines and tools for railway rolling stock; underground construction engineering for trains including installation and assembly of signalling equipment, radio and communications devices for trains; construction of railways; maintenance of railway tracks; rental of tools for railways.

39 – Transport of passengers and freights via railways, motor vehicles and ships; arranging of transport of persons and freights with railways, motor vehicles and ships; booking of seats in railways, motor vehicles and ships; parking spaces reservation service, provision of hire cars; providing timetable and traffic information, including by means of electronic equipment; sleeping car services, namely transport of guests in sleeping cars; storage and packaging of freights; arranging of storage and packaging of freights; storage and portorage of luggage; leasing and storage of transport and storage pallets of wood, metal and plastic; transport of pallets of wood, metal and plastic with railways, motor vehicles and ships; rental of railways, motor vehicles and ships, arranging the rental of railways, motor vehicles and ships; provision of transport of railway passenger cars and railway freight wagons; operation of traffic management systems and security systems for third parties; operating railway systems; providing information about the possible solutions for control and handling of transports and for the storage and packaging of freights.

41 – Animation production services for travellers namely arranging of lectures, presentation of films and pictures, musical performances; production of folk-music, organization of quizzes and other parlor games.

42 – Development of computer software for control and handling of transports in water, land and air as well as for the storage and packaging of freights; structural engineering for railways; planning and de-

velopment of traffic management systems and security systems.

43 – Accommodation and providing of foods and drink in sleeping cars.

(260) AM 2017 88778 A

(800) 1310575

(891) 2016 02 11

(731) PAVLO VOLODYMYROVYCH

KONSTANTYNOV

Bazhana Str., 9A, apt. 99, Kyiv 02121,

Ukraine

(540)

DANNEV

(511)

1 – Chemicals used in industry, science and photography, as well as in agriculture, horticulture and forestry; unprocessed artificial resins; unprocessed plastics; manures; fire extinguishing compositions; tempering and soldering preparations; chemical substances for preserving foodstuffs; tanning substances; adhesives used in industry; chemicals used in production, repair and maintenance of suitable technical and aesthetic state of the vehicle.

3 – Bleaching preparations and other substances for laundry use; cleaning, polishing, scouring and abrasive preparations; soaps; perfumery; essential oils; cosmetics; hair lotions; dentifrices; bleaching preparations and other substances for use in production, repair and maintenance of suitable technical and aesthetic state of the vehicle, namely, shining preparations [polish], leather bleaching preparations, volcanic ash for cleaning, color-removing preparations, degreasers other than for use in manufacturing processes, detergents other than for use in manufacturing operations and for medical purposes, fumigation preparations [perfumes], oils for cleaning purposes, refurbishing preparations, polishing rouge, air fragrancing preparations, rust removing preparations, paint stripping preparations, dry-cleaning preparations, windshield cleaning liquids, turpentine for degreasing, scouring solutions, shampoos.

(260) AM 2017 88799 A

(800) 1310595

(891) 2016 02 03

(731) WORLD MEDICINE İLAÇ SANAYİ VE

TİCARET ANONİM ŞİRKETİ

Evren Mah. Camiyolu Cad. No.50, Kat 1

B Zemin 4-5-6 Güneşli / Bağcılar / İstanbul,

Turkey

(540)

IPRACORT ИПРАКОРТ

(511)
5 – Medicines for human purposes, medicines for veterinary purposes, vitamin preparations, chemical preparations for medical purposes, dietetic substances adapted for medical use, dietetic foods adapted for medical purposes, baby foods, medicinal herbs, herbal beverages adapted for medical purposes, nutritional supplements, pollen dietary supplements, mineral food supplements, protein dietary supplements, dietary supplements for animals, fodder supplements for veterinary purposes, medicines for dental purposes, hygienic products for medical purposes including sanitary pads, breast-nursing pads and bunion pads, waddings for medical purposes, plasters for medical purposes, dressings for medical purposes, babies' napkins, preparations for destroying noxious plants, preparations for destroying noxious animals, fungicides, deodorants other than for human beings or for animals, air deodorising preparations, disinfectants for hygiene purposes, antiseptics, detergents for medical purposes.

(260) AM 2017 88801 A
(800) 1310636
(891) 2016 03 21
(731) SONOSCAPE MEDICAL CORP.
4/F, 5/F, 8/F, 9/F & 10/F, Yizhe Building,
Yuquan Road, Nanshan, Shenzhen,
518051 Guangdong, China

(540)
MediScape

(591) Black, white
(511)
10 – Medical apparatus and instruments; apparatus for use in medical analysis; diagnostic apparatus for medical purposes; ultrasonic equipment and components for medical use; surgical apparatus and instruments; apparatus and installations for the production of x-rays, for medical purposes; blood testing apparatus; testing apparatus for medical purposes; electrocardiographs; dental apparatus, electric; furniture especially made for medical purposes.

(260) AM 2017 88839 A
(800) 1311025
(891) 2016 05 18
(731) BIOFARMA
50 rue Carnot, F-92284 SURESNES Cedex,
France

(540)
LIPERASP

(591) black and white
(511)
5 – Pharmaceutical and veterinary products; sanitary products for medical purposes; dietetic food and

substances for medical or veterinary use, food for babies; food supplements for humans and animals; plasters, materials for dressings; material for dental fillings and dental impressions; disinfectants; products for destroying vermin; fungicides, herbicides.

(260) AM 2017 88841 A
(800) 1311032
(891) 2016 06 10
(731) FARMALIDER, S.A.
San Rafael, 3, ALCOBENDAS (MADRID),
Spain

(540)



(591) Black, blue, white and red
(511)
5 – Pharmaceutical products; sanitary products for medical use; dietetic substances and foodstuffs for medical use; nutritional substances for human beings.

(260) AM 2017 88842 A
(800) 1311033
(891) 2016 05 26
(731) Obshchestvo s ogranichennoy
otvetstvennostyu "KAPUS KOSMETIKS"
Volokolamskoe chosse, str. 1-1, komn. 18,
RU-125080 Moskva; Russian Federation

(540)

Hilac

(591) black and white
(511)
3 – Nail polish; false nails; lacquer-removing preparations; nail care preparations, namely base, primer, restorative, protective coatings.

(260) AM 2017 88902 A
(800) 1096110
(891) 2016 09 14
(731) MARCHESINI GROUP S.P.A.
Via Nazionale, 100, I-40065 PIANORO (BO),
Italy

(540)

MARCHESINI GROUP

(511)
7 – Automatic machines and apparatus for the packaging of pharmaceuticals, foodstuffs and cosmetic

articles; filling machines, selecting machines, cartoning machines, capping machines, piping machines, labeling machines, sealing machines, all for pharmaceuticals, foodstuffs and cosmetic articles; automatic machines and apparatus used in the making and assembling of the bottles and the containers for pharmaceuticals, foodstuffs and cosmetic articles; microprocessor based automatic machines and apparatus for the packaging of pharmaceuticals, foodstuffs and cosmetic articles; microprocessor based machines, namely filling machines, selecting machines, cartoning machines, capping machines, piping machines, labeling machines, sealing machines, all for pharmaceuticals, foodstuffs and cosmetic articles; microprocessor based automatic machines and apparatus used in the making and the assembling of the bottles and the containers of pharmaceuticals, foodstuffs and cosmetic articles.

9 – Counting machines for pharmaceuticals, foodstuffs and cosmetic articles; measuring machines for pharmaceuticals, foodstuffs and cosmetic articles.

37 – Technical assistance for the repair and maintenance of machines; maintenance services, repair and revision of: automatic machines and apparatus, microprocessor based automatic machines and apparatus, all for the packaging of pharmaceuticals, foodstuffs and cosmetic articles, filling machines, counting machines, measuring machines, selecting machines, cartoning machines, capping machines, piping machines, labeling machines, sealing machines, also the microprocessor based ones, for pharmaceuticals, foodstuffs and cosmetic articles, automatic machines and apparatus, microprocessor operated automatic machines and apparatus, all used in the making and the assembling of the bottles and the containers of pharmaceuticals, foodstuffs and cosmetic articles.

(260) AM 2017 88906 A
(800) 1268794
(891) 2016 09 09
(731) CHUGAI SEIYAKU KABUSHIKI KAISHA
(Chugai Pharmaceutical Co., Ltd.)
5-1, Ukima 5-chome, Kita-ku, Tokyo
115-8543, Japan

(540)

HEMLIBRA

(511)
5 – Pharmaceutical preparations.

(260) AM 2017 89109 A
(800) 1315083
(891) 2016 06 14
(731) TANG LINGJUN
Attached 2, Building 1, No. 23, Xiangyang
Nan Road, Xidu Town, Hengyang County,
Hunan Province, China

(540)



(591) black and white

(511)

14 – Wrist watches; artificial diamond; dials [clock and watch making]; watch straps; clocks and watches, electric; timer (watch); cases for clock and watch; alarm clocks; watch cases; stopwatches.

(260) AM 2017 89110 A

(800) 1315202

(891) 2016 04 27

(731) DONGYING FANGXING RUBBER CO., LTD.

Dawang Economic Development Zone,
Dongying City, 257000 Shandong Province,
China

(540)

FANGXING

(591) black and white

(511)

12 – Inner tubes for pneumatic tires; tires for vehicle wheels; bicycle tires; treads for retreading tires; repair outfits for inner tubes; solid tires for vehicle wheels; adhesive rubber patches for repairing inner tubes; inner tubes for bicycles, cycles; pneumatic tires; vehicle wheel tires.

(260) AM 2017 89111 A

(800) 1315237

(891) 2016 07 01

(731) Joint-stock company "DELFIN INDUSTRY"

Yaroslavskoe shosse, 1a, Moskovskaya obl.,
RU-141201 Pushkino, Russian Federation

(540)



(591) White, grey, black, red and dark-red

(511)

1 – Chemicals used in industry, science and photography, as well as in agriculture, horticulture and forestry; unprocessed artificial resins, unprocessed plastics; manures; fire extinguishing compositions;

tempering and soldering preparations; chemical substances for preserving foodstuffs; tanning substances; adhesives used in industry; anti-knock substances for internal combustion engines; disincrustants; antistatic preparations, other than for household purposes; antifreeze; preparations for the separation of greases; water-softening preparations; adhesives for industrial purposes; surface-active chemical agents; chemicals for the manufacture of paints; detergent additives to gasoline [petrol]; chemical additives for oils; additives, chemical, to motor fuel; fluids for hydraulic circuits; brake fluid; transmission fluid; catalysts; biochemical catalysts; cement for pneumatic tires [tyres]; fillers for automobile bodies; oil cement [putty]; synthetic materials for absorbing oil; ceramic materials in particulate form, for use as filtering media; filtering materials [unprocessed plastics]; filtering materials [mineral substances]; filtering materials [vegetable substances]; filtering materials [chemical preparations]; anti-boil preparations for engine coolants; scale removing preparations, other than for household purposes; corrosive preparations; cryogenic preparations; degreasing preparations for use in manufacturing processes; oil-bleaching chemicals; bleaching preparations [decolorants] for industrial purposes; anti-incrustants; engine-decarbonising chemicals; fuel-saving preparations; anti-frothing solutions for accumulators; compositions for repairing inner tubes of tires [tyres]; compositions for repairing tires [tyres]; oil-separating chemicals; water-purifying chemicals; oil-purifying chemicals; radiator flushing chemicals; refrigerants; coolants for vehicle engines.

3 – Scale removing preparations for household purposes; antistatic preparations for household purposes; aromatics [essential oils]; air fragrancing preparations; breath freshening sprays; canned pressurized air for cleaning and dusting purposes; balms other than for medical purposes; lip glosses; petroleum jelly for cosmetic purposes; cotton wool for cosmetic purposes; sachets for perfuming linen; drying agents for dishwashing machines; adhesives for cosmetic purposes; toilet water; polishing wax; make-up; deodorants for pets; deodorants for human beings or for animals; perfumes; windshield cleaning liquids; greases for cosmetic purposes; dentifrices; perfumery; cosmetic pencils; color- [colour-] brightening chemicals for household purposes [laundry]; colorants for toilet purposes; cosmetic dyes; laundry starch; laundry glaze; cosmetic creams; nail polish; lotions for cosmetic purposes; beauty masks; oils for perfumes and scents; oils for cosmetic purposes; whitening; cleaning chalk; almond milk for cosmetic purposes; cleansing milk for toilet purposes; soap; cosmetic kits; nail art stickers; false nails; eau de Cologne; cotton sticks for cosmetic purposes; joss sticks; hydrogen peroxide for cosmetic purposes; lipsticks; pomades for cosmetic purposes; shaving preparations; cosmetic preparations for baths; toilet-

ries; hair waving preparations; laundry soaking preparations; body deodorants [perfumery]; smoothing preparations [starching]; starch glaze for laundry purposes; refurbishing preparations; fabric softeners for laundry use; laundry bleach; dry-cleaning preparations; make-up removing preparations; rust removing preparations; nail care preparations; cleaning preparations; preparations for unblocking drain pipes; sunscreen preparations; stain removers; false eyelashes; tissues impregnated with cosmetic lotions; laundry blueing; sun-tanning preparations [cosmetics]; hair dyes; depilatory and exfoliating preparations; cosmetic preparations for skin care; shoe cream; shoe polish; shoe wax; cosmetics; detergents other than for use in manufacturing operations and for medical purposes; degreasers other than for use in manufacturing processes; bleaching preparations [decolorants] for cosmetic purposes; cloths impregnated with a detergent for cleaning; shampoos.

4 – Industrial oils and greases; lubricants; dust absorbing, wetting and binding compositions; fuels [including motor spirit] and illuminants; candles and wicks for lighting; benzine; benzene; benzol; wood briquettes; combustible briquettes; petroleum jelly for industrial purposes; wax [raw material]; ozocerite [ozokerite]; illuminating wax; industrial wax; belting wax; carnauba wax; beeswax; gas for lighting; oil-gas; fuel gas; gasoline; producer gas; solidified gases [fuel]; fuel; lubricating graphite; additives, non-chemical, to motor fuel; firewood; paper spills for lighting; cutting fluids; fish oil, not edible; lanolin; illuminating grease; grease for leather; grease for footwear; tallow; industrial grease; kerosene; coke; xylene; xylol; ligroin; wood spills for lighting; mazut; fuel oil; oils for paints; oils for releasing form work [building]; oil for the preservation of masonry; preservatives for leather [oils and greases]; textile oil; lubricating oil; moistening oil; coal tar oil; coal naphtha; castor oil for industrial purposes; bone oil for industrial purposes; motor oil; sunflower oil for industrial purposes; rape oil for industrial purposes; naphtha; petroleum, raw or refined; night-lights [candles]; oleine; paraffin; dust removing preparations; soya bean oil preparations for non-stick treatment of cooking utensils; non-slipping preparations for belts; coal dust [fuel]; firelighters; perfumed candles; Christmas tree candles; grease for arms [weapons]; lubricating grease; grease for belts; vaporized fuel mixtures; dust binding compositions for sweeping; dust laying compositions; alcohol [fuel]; methylated spirit; stearine; diesel oil; lighting fuel; mineral fuel; carburants; fuel with an alcoholic base; peat [fuel]; peat briquettes [fuel]; tinder; lignite; charcoal [fuel]; coal; coal briquettes; lamp wicks; wicks for candles; ceresine; electrical energy; ethanol [fuel]; petroleum ether.

(260) AM 2017 89117 A

(800) 352783A

(891) 2016 08 05

(731) CONTER S.R.L.

Viale Europa, 12, I-26855 LODI VECCHIO

(LO), Italy

(540)

LEOCREMA

(591) black and white

(511)

3 – Soaps, perfumery products, essential oils, cosmetics; all these goods are in cream form and intended for export.

INTERNATIONAL TRADEMARKS PROTECTED IN GEORGIA

(260) AM 2017 85800 A
(800) 1250990
(151) 2014 10 01
(181) 2024 10 01
(891) 2015 12 23
(511) 44

(260) AM 2017 86070 A
(800) 1285716
(151) 2015 07 15
(181) 2025 07 15
(891) 2015 07 15
(511) 01, 02, 11, 19, 21, 35, 36, 37, 39, 42

(260) AM 2017 86311 A
(800) 1287753
(151) 2015 11 05
(181) 2025 11 05
(891) 2015 11 05
(511) 35

(260) AM 2017 86377 A
(800) 1289629
(151) 2015 05 21
(181) 2025 05 21
(891) 2015 05 21
(511) 01, 02, 03, 05, 06, 07, 08, 09, 10, 11, 12, 13,
14, 15, 16, 17, 18, 19, 20, 21, 22, 23, 24, 25,
26, 27, 28, 29, 30, 31, 32, 33, 34, 36, 38, 41,
42, 44, 45

(260) AM 2017 86413 A
(800) 316129
(151) 1966 07 01
(181) 2026 07 01
(891) 2016 01 29
(511) 03

(260) AM 2017 86414 A
(800) 782113
(151) 2002 03 01
(181) 2022 03 01
(891) 2016 02 09
(511) 05, 10, 35

(260) AM 2017 86484 A
(800) 1290125
(151) 2016 02 01

(181) 2026 02 01
(891) 2016 02 01
(511) 05

(260) AM 2017 86636 A
(800) 1291791
(151) 2015 08 27
(181) 2025 08 27
(891) 2015 08 27
(511) 42

(260) AM 2017 87101 A
(800) 1295765
(151) 2015 12 17
(181) 2025 12 17
(891) 2015 12 17
(511) 25

(260) AM 2017 87190 A
(800) 1296446
(151) 2015 11 30
(181) 2025 11 30
(891) 2015 11 30
(511) 30, 35

(260) AM 2017 87191 A
(800) 1296447
(151) 2015 11 30
(181) 2025 11 30
(891) 2015 11 30
(511) 30

(260) AM 2017 87205 A
(800) 1176374
(151) 2013 06 24
(181) 2023 06 24
(891) 2016 02 22
(511) 07, 37

(260) AM 2017 87207 A
(800) 1170510
(151) 2013 07 17
(181) 2023 07 17
(891) 2016 02 22
(511) 07, 37

(260) AM 2017 87454 A
(800) 1297953
(151) 2016 01 20
(181) 2026 01 20
(891) 2016 01 20
(511) 32, 35

(260) AM 2017 87455 A
(800) 1297954
(151) 2016 01 20
(181) 2026 01 20
(891) 2016 01 20
(511) 32, 35

(260) AM 2017 87456 A
(800) 1297955
(151) 2016 01 20
(181) 2026 01 20
(891) 2016 01 20
(511) 32, 35

(260) AM 2017 87457 A
(800) 1297962
(151) 2016 01 19
(181) 2026 01 19
(891) 2016 01 19
(511) 32, 33

(260) AM 2017 87462 A
(800) 1298016
(151) 2016 01 19
(181) 2026 01 19
(891) 2016 01 19
(511) 29, 30, 43

(260) AM 2017 87463 A
(800) 1298057
(151) 2015 11 02
(181) 2025 11 02
(891) 2015 11 02
(511) 17, 42

(260) AM 2017 87523 A
(800) 1298900
(151) 2016 03 24
(181) 2026 03 24
(891) 2016 03 24
(511) 30

(260) AM 2017 87525 A
(800) 904160
(151) 2006 02 15
(181) 2026 02 15

(891) 2016 02 22
(511) 09

(260) AM 2017 87541 A
(800) 1298520
(151) 2016 02 19
(181) 2026 02 19
(891) 2016 02 19
(511) 03, 21

(260) AM 2017 87543 A
(800) 1298537
(151) 2015 10 09
(181) 2025 10 09
(891) 2015 10 09
(511) 30

(260) AM 2017 87544 A
(800) 1298546
(151) 2015 11 02
(181) 2025 11 02
(891) 2015 11 02
(511) 03, 09, 14, 18, 25, 26, 35

(260) AM 2017 87545 A
(800) 1298594
(151) 2015 12 30
(181) 2025 12 30
(891) 2015 12 30
(511) 14

(260) AM 2017 87612 A
(800) 1299046
(151) 2015 12 31
(181) 2025 12 31
(891) 2015 12 31
(511) 16, 17, 22

(260) AM 2017 87613 A
(800) 1299134
(151) 2016 03 29
(181) 2026 03 29
(891) 2016 03 29
(511) 09

(260) AM 2017 87708 A
(800) 1299760
(151) 2016 01 04
(181) 2026 01 04
(891) 2016 01 04
(511) 03

(260) AM 2017 87709 A
(800) 1299772
(151) 2016 02 15
(181) 2026 02 15
(891) 2016 02 15
(511) 03

(260) AM 2017 87710 A
(800) 1299791
(151) 2015 12 29
(181) 2025 12 29
(891) 2015 12 29
(511) 41

(260) AM 2017 87711 A
(800) 1127035
(151) 2012 04 05
(181) 2022 04 05
(891) 2016 02 18
(511) 06, 27

(260) AM 2017 87712 A
(800) 1135645
(151) 2012 10 01
(181) 2022 10 01
(891) 2016 04 21
(511) 05

(260) AM 2017 87713 A
(800) 1300035
(151) 2016 02 22
(181) 2026 02 22
(891) 2016 02 22
(511) 31

(260) AM 2017 87740 A
(800) 1300033
(151) 2016 02 03
(181) 2026 02 03
(891) 2016 02 03
(511) 06, 17, 19

(260) AM 2017 87768 A
(800) 1277488
(151) 2015 08 21
(181) 2025 08 21
(891) 2015 12 30
(511) 24, 25, 26, 35

(260) AM 2017 87769 A
(800) 1285035
(151) 2015 07 15
(181) 2025 07 15

(891) 2016 05 17
(511) 20, 35

(260) AM 2017 87770 A
(800) 1287676
(151) 2015 11 04
(181) 2025 11 04
(891) 2016 05 12
(511) 32

(260) AM 2017 87818 A
(800) 1152680
(151) 2013 02 04
(181) 2023 02 04
(891) 2016 04 20
(511) 03, 05

(260) AM 2017 87839 A
(800) 1300073
(151) 2016 02 03
(181) 2026 02 03
(891) 2016 02 03
(511) 06, 17, 19

(260) AM 2017 87848 A
(800) 1300231
(151) 2016 02 03
(181) 2026 02 03
(891) 2016 02 03
(511) 06, 17, 19

(260) AM 2017 87872 A
(800) 1300653
(151) 2016 02 17
(181) 2026 02 17
(891) 2016 02 17
(511) 16

(260) AM 2017 87873 A
(800) 1300671
(151) 2016 03 08
(181) 2026 03 08
(891) 2016 03 08
(511) 12

(260) AM 2017 87875 A
(800) 1300816
(151) 2015 12 11
(181) 2025 12 11
(891) 2015 12 11
(511) 19

(260) AM 2017 87880 A
(800) 1300887
(151) 2016 04 28
(181) 2026 04 28
(891) 2016 04 28
(511) 03

(260) AM 2017 87910 A
(800) 1301544
(151) 2016 04 07
(181) 2026 04 07
(891) 2016 04 07
(511) 33

(260) AM 2017 87911 A
(800) 1301552
(151) 2016 01 12
(181) 2026 01 12
(891) 2016 01 12
(511) 03, 23, 25, 26, 35

(260) AM 2017 87913 A
(800) 1301630
(151) 2016 02 16
(181) 2026 02 16
(891) 2016 02 16
(511) 30

(260) AM 2017 87915 A
(800) 1301640
(151) 2016 02 22
(181) 2026 02 22
(891) 2016 02 22
(511) 08, 21

(260) AM 2017 87916 A
(800) 1301676
(151) 2016 02 05
(181) 2026 02 05
(891) 2016 02 05
(511) 09

(260) AM 2017 87918 A
(800) 1301695
(151) 2016 03 18
(181) 2026 03 18
(891) 2016 03 18
(511) 32

(260) AM 2017 87919 A
(800) 1301700
(151) 2016 03 30
(181) 2026 03 30

(891) 2016 03 30
(511) 30

(260) AM 2017 87920 A
(800) 1301702
(151) 2016 03 21
(181) 2026 03 21
(891) 2016 03 21
(511) 29

(260) AM 2017 87921 A
(800) 1301723
(151) 2016 04 11
(181) 2026 04 11
(891) 2016 04 11
(511) 30

(260) AM 2017 87922 A
(800) 1301724
(151) 2016 04 28
(181) 2026 04 28
(891) 2016 04 28
(511) 03

(260) AM 2017 87923 A
(800) 1301820
(151) 2015 08 20
(181) 2025 08 20
(891) 2015 08 20
(511) 05, 29, 30

(260) AM 2017 88149 A
(800) 1303774
(151) 2016 04 15
(181) 2026 04 15
(891) 2016 04 15
(511) 09

(260) AM 2017 88150 A
(800) 1303789
(151) 2016 04 11
(181) 2026 04 11
(891) 2016 04 11
(511) 05

(260) AM 2017 88168 A
(800) 1303766
(151) 2016 04 01
(181) 2026 04 01
(891) 2016 04 01
(511) 03, 05, 16

OFFICIAL NOTIFICATIONS**TRADEMARKS****RENEWAL OF REGISTRATIONS**

-
- | | |
|--|---|
| <p>(111) M 2006 16945 R1
(156) 2017 06 01
(186) 2026 10 26
(732) Pharmaceutical Chemical Cosmetic
Industry-ALKALOID AD, Skopje
Bulevar Aleksandar Makedonski No.12,
MK-1000 Skopje, The Former Yugoslav
Republic of Macedoni</p> <hr/> | <p>(111) M 2007 17425 R1
(156) 2017 04 23
(186) 2027 04 23
(732) HYUNDAI CORPORATION
226, Shinmunro-1ka, Jongno-gu, Seoul,
Republic of Korea</p> <hr/> |
| <p>(111) M 2006 17105 R1
(156) 2017 02 23
(186) 2026 11 15
(732) JSC "LOMISI"
Sop. Natakhtari, 3308, Mtskhetis raioni, Georgia</p> <hr/> | <p>(111) M 2007 17445 R1
(156) 2017 04 25
(186) 2027 04 25
(732) BASF SE
Carl-Bosch-StraJSCe 38, Ludwigshafen am
Rhein, Germany</p> <hr/> |
| <p>(111) M 2007 17329 R1
(156) 2017 06 05
(186) 2027 02 27
(732) RASHEN DAIEMOND LIMITID
LAIEBILITI KOMPANI
34, ul. Miklukho-Maklaya, officii IV,
room 37, RU-117279, Moscow, Russian
Federation</p> <hr/> | <p>(111) M 2007 17471 R1
(156) 2017 06 05
(186) 2027 04 25
(732) NINTENDO CO., LTD
11-1, Hokotate-cho, Kamitoba, Minami-ku,
Kyoto-shi, Kyoto, Japan</p> <hr/> |
| <p>(111) M 2007 17332 R1
(156) 2017 06 05
(186) 2027 02 27
(732) RASHEN DAIEMOND LIMITID
LAIEBILITI KOMPANI
34, ul. Miklukho-Maklaya, officii IV,
room 37, RU-117279, Moscow, Russian
Federation</p> <hr/> | <p>(111) M 2007 17479 R1
(156) 2017 04 27
(186) 2027 04 27
(732) LTD "AVERSI-PHARMA"
Davit Agmasheneblis gamz. 148/2, 0112,
Tbilisi, Georgia</p> <hr/> |
| <p>(111) M 2007 17344 R1
(156) 2017 05 10
(186) 2027 03 02
(732) LTD "MEGVINEOBA KHAREBA"
Davit Agmasheneblis kheivani me-6 km.,
0131, Tbilisi, Georgia</p> <hr/> | <p>(111) M 2007 17498 R1
(156) 2017 05 08
(186) 2027 05 08
(732) IRISH DISTILLERS LIMITED
Simmonscourt House, Simmonscourt Road,
Ballsbridge, Dublin 4, Ireland</p> <hr/> |
| <p>(111) M 2007 17348 R1
(156) 2017 03 23
(186) 2027 03 15
(732) AIP INTERNATIONAL LTD
PO Box 3483, Road Town, Tortola, British
Virgin Islands</p> <hr/> | <p>(111) M 2007 17509 R1
(156) 2017 05 10
(186) 2027 05 08
(732) A. MESHİ COSMETIC INDUSTRIES LTD
4, David Pinkas St., Rishon Le'Zion 57504,
Israel</p> <hr/> |
| <p>(111) M 2007 17348 R1
(156) 2017 03 23
(186) 2027 03 15
(732) AIP INTERNATIONAL LTD
PO Box 3483, Road Town, Tortola, British
Virgin Islands</p> <hr/> | <p>(111) M 2007 17514 R1
(156) 2017 05 28
(186) 2027 05 28</p> <hr/> |
-

(732) LTD "AVERSI-PHARMA"
 Davit Agmasheneblis gamz. 148/2, 0112,
 Tbilisi, Georgia

(111) M 2007 17530 R1
 (156) 2017 05 28
 (186) 2027 05 28
 (732) FRITO-LAY TRADING COMPANY
 GMBH
 Spitalgasse 2, CH-3011, Bern, Switzerland

(111) M 2007 17553 R1
 (156) 2017 06 11
 (186) 2027 06 11
 (732) NIKE INNOVATE C.V.
 One Bowerman Drive, Beaverton, Oregon
 97005-6453, USA

(111) M 2007 17554 R1
 (156) 2017 06 11
 (186) 2027 06 11
 (732) NIKE INNOVATE C.V.
 One Bowerman Drive, Beaverton, Oregon
 97005-6453, USA

(111) M 2007 17556 R1
 (156) 2017 06 11
 (186) 2027 06 11
 (732) VIÑA CONCHA Y TORO S.A.
 NUEVA TAJAMAR 481, TORRE NORTE,
 PISO 15, LAS CONDES, SANTIAGO, Chile

(111) M 2007 17660 R1
 (156) 2017 07 18
 (186) 2027 07 18
 (732) ABB ASEA BROWN BOVERI LTD
 Affolternstrasse 44, CH-8050 Zurich,
 Switzerland

(111) M 2007 17681 R1
 (156) 2017 07 25
 (186) 2027 07 25
 (732) THE COCA-COLA COMPANY
 a Corporate of the State of Delaware
 One Coca-Cola Plaza, Atlanta, Georgia
 30313, USA

(111) M 2007 17684 R1
 (156) 2017 07 25
 (186) 2027 07 25
 (732) LTD "PSP"
 Zemo Vedzisis q. 103, 0160, Tbilisi, Georgia

(111) M 2007 17685 R1
 (156) 2017 07 25
 (186) 2027 07 25
 (732) LTD "PSP"
 Zemo Vedzisis q. 103, 0160, Tbilisi, Georgia

(111) M 2007 17686 R1
 (156) 2017 07 25
 (186) 2027 07 25
 (732) LTD "PSP"
 Zemo Vedzisis q. 103, 0160, Tbilisi, Georgia

(111) M 2007 17687 R1
 (156) 2017 07 25
 (186) 2027 07 25
 (732) LTD "PSP"
 Zemo Vedzisis q. 103, 0160, Tbilisi, Georgia

(111) M 2007 17688 R1
 (156) 2017 07 25
 (186) 2027 07 25
 (732) LTD "PSP"
 Zemo Vedzisis q. 103, 0160, Tbilisi, Georgia

(111) M 2007 17689 R1
 (156) 2017 07 25
 (186) 2027 07 25
 (732) LTD "PSP"
 Zemo Vedzisis q. 103, 0160, Tbilisi, Georgia

(111) M 2007 17690 R1
 (156) 2017 07 25
 (186) 2027 07 25
 (732) LTD "PSP"
 Zemo Vedzisis q. 103, 0160, Tbilisi, Georgia

(111) M 2007 17693 R1
 (156) 2017 07 30
 (186) 2027 07 30
 (732) GOOGLE INC.
 1600 Amphitheatre Parkway, Mountain
 View, CA 94043, USA

(111) M 2007 17694 R1
 (156) 2017 07 30
 (186) 2027 07 30
 (732) BAYER CONSUMER CARE AG
 Peter Merian-Str. 84, 4052 Basel, Switzerland

(111) M 2007 17695 R1
 (156) 2017 07 30
 (186) 2027 07 30

(732) BAYER CONSUMER CARE AG
Peter Merian-Str. 84, 4052 Basel, Switzerland

(111) M 2007 17782 R1
(156) 2017 09 18
(186) 2027 09 18

(732) SAVENCIA SA
42 rue RieuJSCec, 78220 Viroflay, France

(111) M 2007 17845 R1
(156) 2017 09 18
(186) 2027 09 18

(732) THE BLACK & DECKER
CORPORATION
701 E. Joppa Road, Towson, Maryland
21286, USA

(111) M 2007 18082 R1
(156) 2017 11 30
(186) 2027 11 30

(732) MENARINI INTERNATIONAL
OPERATIONS LUXEMBOURGM S.A.
1, Avenue de la Gare L-1611 Luxembourg,
Luxembourg

(111) M 2007 18083 R1
(156) 2017 11 30
(186) 2027 11 30

(732) MENARINI INTERNATIONAL
OPERATIONS LUXEMBOURGM S.A.
1, Avenue de la Gare L-1611 Luxembourg,
Luxembourg

(111) M 2008 18416 R1
(156) 2018 05 01
(186) 2028 05 01

(732) Chubb Limited (Chubb AG) (Chubb SA)
BärengaJSCe 32, 8001 Zürich, Switzerland

(111) M 1997 4518 R2
(156) 2017 02 05
(186) 2027 02 05

(732) FIAT GROUP MARKETING &
CORPORATE COMMUNICATION S.P.A.
Via Nizza 250, 10126 Torino, Italy

(111) M 1997 4520 R2
(156) 2017 02 05
(186) 2027 02 05

(732) FIAT GROUP MARKETING &
CORPORATE COMMUNICATION S.P.A.
Via Nizza 250, 10126 Torino, Italy

(111) M 1997 4648 R2

(156) 2017 02 18

(186) 2027 02 18

(732) VALENTINO S.P.A.

Via Turati 16/18, Milano, Italy

(111) M 1997 4962 R2

(156) 2017 04 04

(186) 2027 04 04

(732) KRAFT FUDS DANMARK

INTELLECTUAL PROPERTY APS

Roskildevej 161, DK-2620 Albertslund,

Denmark

(111) M 1997 4999 R2

(156) 2017 04 07

(186) 2027 04 07

(732) SHELL BRANDS INTERNATIONAL AG

Baarermatte, 6340 Baar, Switzerland

(111) M 1997 5112 R2

(156) 2017 04 16

(186) 2027 04 16

(732) JOHNSON & JOHNSON

One Johnson & Johnson Plaza, New

Brunswick, New Jersey 08933, USA

(111) M 1997 5114 R2

(156) 2017 04 16

(186) 2027 04 16

(732) JOHNSON & JOHNSON

One Johnson & Johnson Plaza, New

Brunswick, New Jersey 08933, USA

(111) M 1997 5116 R2

(156) 2017 04 16

(186) 2027 04 16

(732) JOHNSON & JOHNSON

One Johnson & Johnson Plaza, New

Brunswick, New Jersey 08933, USA

(111) M 1997 5119 R2

(156) 2017 04 16

(186) 2027 04 16

(732) JOHNSON & JOHNSON

One Johnson & Johnson Plaza, New

Brunswick, New Jersey 08933, USA

(111) M 1997 5120 R2

(156) 2017 04 16

(186) 2027 04 16

(732) JOHNSON & JOHNSON

One Johnson & Johnson Plaza, New
Brunswick, New Jersey 08933, USA

(732) HEINZ ITALIA S.P.A.
via Migliara 45, 04100 Latina, Italy

(111) M 1997 5124 R2
(156) 2017 04 17
(186) 2027 04 17
(732) JOHNSON & JOHNSON
One Johnson & Johnson Plaza, New
Brunswick, New Jersey 08933, USA

(111) M 1997 5241 R2
(156) 2017 04 30
(186) 2027 04 30
(732) SPEEDO HOLDINGS B.V.
Claude Debussylaan 24, 1082 MD
Amsterdam, Netherlands

(111) M 1997 5137 R2
(156) 2017 04 17
(186) 2027 04 17
(732) JANJSCEN PHARMACEUTICA N.V.
Turnhoutseweg 30, B-2340 Beerse, Belgium

(111) M 1997 5242 R2
(156) 2017 04 30
(186) 2027 04 30
(732) SPEEDO HOLDINGS B.V.
Claude Debussylaan 24, 1082 MD
Amsterdam, Netherlands

(111) M 1997 5139 R2
(156) 2017 04 18
(186) 2027 04 18
(732) JANJSCEN PHARMACEUTICA N.V.
Turnhoutseweg 30, B-2340 Beerse, Belgium

(111) M 1997 5243 R2
(156) 2017 04 30
(186) 2027 04 30
(732) SPEEDO HOLDINGS B.V.
Claude Debussylaan 24, 1082 MD
Amsterdam, Netherlands

(111) M 1997 5140 R2
(156) 2017 04 18
(186) 2027 04 18
(732) JANJSCEN PHARMACEUTICA N.V.
Turnhoutseweg 30, B-2340 Beerse, Belgium

(111) M 1997 5249 R2
(156) 2017 05 01
(186) 2027 05 01
(732) ESCO CORPORATION
2141 N.W. 25-th Avenue, P.O. Box 10123
Portland, Oregon 97210, USA

(111) M 1997 5142 R2
(156) 2017 04 18
(186) 2027 04 18
(732) JANJSCEN PHARMACEUTICA N.V.
Turnhoutseweg 30, B-2340 Beerse, Belgium

(111) M 1997 5256 R2
(156) 2017 05 01
(186) 2027 05 01
(732) CLUB MED
11 rue de Cambrai, 75019 Paris, France

(111) M 1997 5143 R2
(156) 2017 04 18
(186) 2027 04 18
(732) JANJSCEN PHARMACEUTICA N.V.;
Turnhoutseweg 30, B-2340 Beerse, Belgium

(111) M 1997 5282 R2
(156) 2017 05 06
(186) 2027 05 06
(732) KRAFT FOODS SCHWEIZ HOLDING
GMBH
Chollerstrasse 4, 6301 Zug, Switzerland

(111) M 1997 5186 R2
(156) 2017 04 24
(186) 2027 04 24
(732) JOHNSON & JOHNSON
One Johnson & Johnson Plaza, New
Brunswick, New Jersey 08933, USA

(111) M 1997 5285 R2
(156) 2017 05 06
(186) 2027 05 06
(732) KRAFT FOODS SCHWEIZ HOLDING
GMBH
Chollerstrasse 4, 6301 Zug, Switzerland

(111) M 1997 5240 R2
(156) 2017 04 30
(186) 2027 04 30

(111) M 1997 5287 R2
(156) 2017 05 06
(186) 2027 05 06
(732) MONDELEZ SLOVAKIA
INTELLECTUAL PROPERTY S.R.O
Račianska street no. 44, 83242 Bratislava-
Nové Mesto, Slovakia

(111) M 1997 5290 R2
(156) 2017 05 06
(186) 2027 05 06
(732) MONDELEZ SLOVAKIA
INTELLECTUAL PROPERTY S.R.O
Račianska street no. 44, 83242 Bratislava-
Nové Mesto, Slovakia

(111) M 1997 5291 R2
(156) 2017 05 06
(186) 2027 05 06
(732) MONDELEZ SLOVAKIA
INTELLECTUAL PROPERTY S.R.O
Račianska street no. 44, 83242 Bratislava-
Nové Mesto, Slovakia

(111) M 1997 5294 R2
(156) 2017 05 06
(186) 2027 05 06
(732) EVEREADY BATTERY COMPANY, INC.
Checkerboard Square, St.Louis, Missouri
63164, USA

(111) M 1997 5311 R2
(156) 2017 05 12
(186) 2027 05 12
(732) EISAI R&D MANAGEMENT CO., LTD .
No.6-10, Koishikawa 4-chome, Bunkyo-ku,
Tokyo, Japan

(111) M 1997 5338 R2
(156) 2017 05 21
(186) 2027 05 21
(732) JOHNSON & JOHNSON
One Johnson & Johnson Plaza, New
Brunswick, New Jersey 08933, USA

(111) M 1997 5341 R2
(156) 2017 05 21
(186) 2027 05 21
(732) BIOFARMA
50, rue Carnot, 92284 Suresnes cedex,
France

(111) M 1997 5364 R2
(156) 2017 05 28
(186) 2027 05 28
(732) LEGO Juris A/S
DK-7190 Billund, Denmark

(111) M 1997 5365 R2
(156) 2017 05 28
(186) 2027 05 28
(732) LEGO Juris A/S
DK-7190 Billund, Denmark

(111) M 1997 5366 R2
(156) 2017 05 28
(186) 2027 05 28
(732) LEGO Juris A/S
DK-7190 Billund, Denmark

(111) M 1997 5369 R2
(156) 2017 05 28
(186) 2027 05 28
(732) LEGO Juris A/S
DK-7190 Billund, Denmark

(111) M 1997 5371 R2
(156) 2017 05 28
(186) 2027 05 28
(732) LEGO Juris A/S
DK-7190 Billund, Denmark

(111) M 1997 5372 R2
(156) 2017 05 28
(186) 2027 05 28
(732) LEGO Juris A/S
DK-7190 Billund, Denmark

(111) M 1997 5384 R2
(156) 2017 05 28
(186) 2027 05 28
(732) CHRISTIAN DIOR COUTURE
30 avenue Montaigne, 75008 Paris, France

(111) M 1997 5385 R2
(156) 2017 05 28
(186) 2027 05 28
(732) CHRISTIAN DIOR COUTURE
30 avenue Montaigne, 75008 Paris, France

(111) M 1997 5386 R2
(156) 2017 05 28
(186) 2027 05 28

(732) CHRISTIAN DIOR COUTURE
30 avenue Montaigne, 75008 Paris, France

(111) M 1997 5388 R2

(156) 2017 05 28

(186) 2027 05 28

(732) CHRISTIAN DIOR COUTURE
30 avenue Montaigne, 75008 Paris, France

(111) M 1997 5389 R2

(156) 2017 05 28

(186) 2027 05 28

(732) CHRISTIAN DIOR COUTURE
30 avenue Montaigne, 75008 Paris, France

(111) M 1997 5390 R2

(156) 2017 05 28

(186) 2027 05 28

(732) CHRISTIAN DIOR COUTURE
30 avenue Montaigne, 75008 Paris, France

(111) M 1997 5391 R2

(156) 2017 05 28

(186) 2027 05 28

(732) CHRISTIAN DIOR COUTURE
30 avenue Montaigne, 75008 Paris, France

(111) M 1997 5397 R2

(156) 2017 05 29

(186) 2027 05 29

(732) SYSMEX CORPORATION
1-5-1, Wakinohama-Kaigandori, Chuo-ku,
Kobe, Hyogo, Japan

(111) M 1997 5422 R2

(156) 2017 05 30

(186) 2027 05 30

(732) GlaxoSmithKline Consumer Healthcare
(UK) IP Limited
980 Great West Road, Brentford, Middlesex
TW8 9GS, United Kingdom

(111) M 1997 5425 R2

(156) 2017 05 30

(186) 2027 05 30

(732) MONTBLANC-SIMPLO GMBH
Hellgrundweg 100, D-22525 Humburg,
Germany

(111) M 1997 5434 R2

(156) 2017 06 02

(186) 2027 06 02

(732) GM KOREA COMPANY
199-1, Cheongcheon-2 Dong, Bupyeong-Gu,
Incheon, Republic of Korea

(111) M 1997 5436 R2

(156) 2017 06 02

(186) 2027 06 02

(732) BACARDI & COMPANY LIMITED
AeulestraJSCe 5, 9490 Vaduz, Liechtenstein,
Liechtenstein

(111) M 1997 5439 R2

(156) 2017 06 04

(186) 2027 06 04

(732) MASTER LOCK COMPANY
P.O. Box 927, 137 W. Forest Hill Avenue
Oak Creek, Wisconsin 53154, USA

(111) M 1997 5556 R2

(156) 2017 06 11

(186) 2027 06 11

(732) COATINGS FOREIGN IP Co. LLC
c/o The Corporation Trust Company,
Corporation
Trust Center, 1209 Orange Street,
Wilmington, Delaware 19801, USA

(111) M 1997 5562 R2

(156) 2017 06 11

(186) 2027 06 11

(732) JOHNSON & JOHNSON
One Johnson & Johnson Plaza, New
Brunswick, New Jersey 08933, USA

(111) M 1997 5563 R2

(156) 2017 06 11

(186) 2027 06 11

(732) JOHNSON & JOHNSON
One Johnson & Johnson Plaza, New
Brunswick, New Jersey 08933, USA

(111) M 1997 5662 R2

(156) 2017 06 16

(186) 2027 06 16

(732) CADBURY UK LIMITED
P.O. Box 12, Bournville Lane, Bournville,
Birmingham B30 2LU, United Kingdom

(111) M 1997 5663 R2

(156) 2017 06 16

(186) 2027 06 16

(732) CADBURY UK LIMITED

P.O. Box 12, Bournville Lane, Bournville,
Birmingham B30 2LU, United Kingdom

(111) M 1997 5664 R2

(156) 2017 06 16

(186) 2027 06 16

(732) CADBURY UK LIMITED

P.O. Box 12, Bournville Lane, Bournville,
Birmingham B30 2LU, United Kingdom

(111) M 1997 5666 R2

(156) 2017 06 16

(186) 2027 06 16

(732) CADBURY UK LIMITED

P.O. Box 12, Bournville Lane, Bournville,
Birmingham B30 2LU, United Kingdom

(111) M 1997 5667 R2

(156) 2017 06 16

(186) 2027 06 16

(732) CADBURY UK LIMITED

P.O. Box 12, Bournville Lane, Bournville,
Birmingham B30 2LU, United Kingdom

(111) M 1997 5668 R2

(156) 2017 06 16

(186) 2027 06 16

(732) CADBURY UK LIMITED

P.O. Box 12, Bournville Lane, Bournville,
Birmingham B30 2LU, United Kingdom

(111) M 1997 5725 R2

(156) 2017 06 25

(186) 2027 06 25

(732) BACARDI & COMPANY LIMITED

AeulestraJSCe 5, 9490 Vaduz, Liechtenstein,
Liechtenstein

(111) M 1997 5750 R2

(156) 2017 06 26

(186) 2027 06 26

(732) CHRISTIAN DIOR COUTURE

30 avenue Montaigne, 75008 Paris, France

(111) M 1997 5755 R2

(156) 2017 06 26

(186) 2027 06 26

(732) JOHNSON & JOHNSON

One Johnson & Johnson Plaza, New
Brunswick, New Jersey 08933, USA

(111) M 1997 5756 R2

(156) 2017 06 26

(186) 2027 06 26

(732) JOHNSON & JOHNSON

One Johnson & Johnson Plaza, New
Brunswick, New Jersey 08933, USA

(111) M 1997 5757 R2

(156) 2017 06 26

(186) 2027 06 26

(732) JOHNSON & JOHNSON

One Johnson & Johnson Plaza, New
Brunswick, New Jersey 08933, USA

(111) M 1997 5775 R2

(156) 2017 07 01

(186) 2027 07 01

(732) NIJSCAN, JIDOSHA KABUSHIKI

KAISHA (also trading as Nissan Motor
Co., LTD)

2 Takaracho, Kanagawa-ku, Yokohama-shi,
Kanagawa-ken, Japan

(111) M 1997 5776 R2

(156) 2017 07 01

(186) 2027 07 01

(732) NIJSCAN JIDOSHA KABUSHIKI KAISHA

(also trading as NiJSCan Motor Co., LTD)

2 Takaracho, Kanagawa-ku, Yokohama-shi,
Kanagawa-ken, Japan

(111) M 1997 5777 R2

(156) 2017 07 02

(186) 2027 07 02

(732) NIJSCAN JIDOSHA KABUSHIKI KAISHA

(also trading as Nissan Motor Co., LTD)

2 Takaracho, Kanagawa-ku, Yokohama-shi,
Kanagawa-ken, Japan

(111) M 1997 5778 R2

(156) 2017 07 02

(186) 2027 07 02

(732) NIJSCAN JIDOSHA KABUSHIKI KAISHA

(also trading as Nissan Motor Co., LTD)

2 Takaracho, Kanagawa-ku, Yokohama-shi,
Kanagawa-ken, Japan

(111) M 1997 5819 R2

(156) 2017 07 04

(186) 2027 07 04

(732) L'OREAL

14, rue Royale, F-75008 Paris, France

(111) M 1997 5821 R2
(156) 2017 07 04
(186) 2027 07 04
(732) L'OREAL
14, rue Royale, F-75008 Paris, France

(111) M 1997 5848 R2
(156) 2017 07 07
(186) 2027 07 07
(732) CICLEUROPE INDUSTRIES S.A.
161, rue Gabriel Peri, 10100 ROMILLY
SUR SEINE, France

(111) M 1997 5849 R2
(156) 2017 07 08
(186) 2027 07 08
(732) L'OREAL
14, rue Royale, F-75008 Paris, France

(111) M 1997 5851 R2
(156) 2017 07 08
(186) 2027 07 08
(732) L'OREAL
14, rue Royale, F-75008 Paris, France

(111) M 1997 5855 R2
(156) 2017 07 09
(186) 2027 07 09
(732) CHEVRON INTELLECTUAL PROPERTY
LLC, a State of Delaware, Limited Liability
Company
6001 Bollinger Canyon Road, San Ramon,
California 94583, USA

(111) M 1997 5859 R2
(156) 2017 07 09
(186) 2027 07 09
(732) FRIESLANDCAMPINA NEDERLAND BV
Stationsplein 4, NL-3818 LE
AMERSFOORT, Netherlands

(111) M 1997 5888 R2
(156) 2017 07 10
(186) 2027 07 10
(732) MOTOROLA TRADEMARK HOLDINGS,
LLC
222 W. Merchandise Mart Plaza, Suite
1800, Chicago, IL 60654, USA

(111) M 1997 5902 R2
(156) 2017 07 14
(186) 2027 07 14

(732) CHEVRON INTELLECTUAL PROPERTY
LLC
a State of Delaware, Limited Liability Company
6001 Bollinger Canyon Road, San Ramon,
California 94583, USA

(111) M 1997 5924 R2
(156) 2017 07 15
(186) 2027 07 15
(732) GlaxoSmithKline Consumer Healthcare
(UK) IP Limited
980 Great West Road, Brentford, Middlesex
TW8 9GS, United Kingdom

(111) M 1997 5953 R2
(156) 2017 07 15
(186) 2027 07 15
(732) TRIUMPH INTERTRADE AG
Triumphweg 6, 5330 Bad Zurzach,
Switzerland

(111) M 1997 5963 R2
(156) 2017 07 16
(186) 2027 07 16
(732) JACQUES BOGART INTERNATIONAL
BV
Westblaak 89, 3012KG Rotterdam,
Netherlands

(111) M 1997 6061 R2
(156) 2017 07 23
(186) 2027 07 23
(732) Basf SE
Carl-Bosch-StraJSCe 38, 67056
Ludwigshafen, Germany

(111) M 1997 6062 R2
(156) 2017 07 23
(186) 2027 07 23
(732) Basf SE
Carl-Bosch-Strasse 38, 67056
Ludwigshafen, Germany

(111) M 1997 6100 R2
(156) 2017 07 25
(186) 2027 07 25
(732) BIOFARMA
50, rue Carnot, 92284 Suresnes cedex, France

(111) M 1997 6126P R2
(156) 2017 07 28
(186) 2027 07 28

(732) MARKS AND SPENCER PLC
 Waterside House, 35 North Wharf Road,
 London W2 1NW, United Kingdom

103 Springer Building, Concord Plaza,
 3411 Silverside Road, Wilmington,
 Delaware, USA

(111) M 1997 6162 R2
 (156) 2017 07 29
 (186) 2027 07 29
 (732) THE POLO / LAUREN COMPANY, L.P.
 650 Medison Avenue, New York NY-10022,
 USA

(111) M 1997 6644 R2
 (156) 2017 09 04
 (186) 2027 09 04
 (732) STANLEY BLACK & DECKER, INC.
 1000 Stanley Drive, New Britain,
 Connecticut 06053, USA

(111) M 1997 6188 R2
 (156) 2017 07 30
 (186) 2027 07 30
 (732) PANASONIC CORPORATION
 1006, Oaza Kadoma, Kadoma-Shi, Osaka
 571-8501, Japan

(111) M 1997 6725 R2
 (156) 2017 09 10
 (186) 2027 09 10
 (732) SAINT-GOBAIN ISOVER
 Les Miroirs 18, avenue d'Alsace, 92400
 Courbevoie, France

(111) M 1997 6254 R2
 (156) 2017 08 04
 (186) 2027 08 04
 (732) SAMSON AKTIENGESELLSCHAFT
 Weismullerstrasse 3, 60019 Frankfurt,
 Germany

(111) M 1997 6771 R2
 (156) 2017 09 11
 (186) 2027 09 11
 (732) FRIESLANDCAMPINA NEDERLAND BV
 Stationsplein 4, NL-3818 LE
 AMERSFOORT, Netherlands

(111) M 1997 6280 R2
 (156) 2017 08 05
 (186) 2027 08 05
 (732) DEVRO PLC
 Moodiesburn, Chryston, Glasgow G69 0JE,
 United Kingdom

(111) M 1997 6956 R2
 (156) 2017 09 25
 (186) 2027 09 25
 (732) ORACLE AMERICA, INC.
 500 Oracle Parkway, Redwood Shores,
 California 94065, USA

(111) M 1997 6302 R2
 (156) 2017 08 11
 (186) 2027 08 11
 (732) BASF SE
 Carl-Bosch-Strasse 38, 67056
 Ludwigshafen, Germany

(111) M 1997 7023 R2
 (156) 2017 10 01
 (186) 2027 10 01
 (732) SOCIETE BIC
 14 rue Jeanne d'Asnieres, 92110 Clichy,
 France

(111) M 1997 6320 R2
 (156) 2017 08 11
 (186) 2027 08 11
 (732) The H.D. LEE COMPANY, INC. ;
 103 Springer Building, Concord Plaza,
 3411 Silverside Road, Wilmington,
 Delaware, USA

(111) M 1997 7100 R2
 (156) 2017 10 08
 (186) 2027 10 08
 (732) RAYMOND WEIL S.A.
 Avenue Eugene-Lance 36-38 Lancy,
 Grand-Lancy, Switzerland

(111) M 1997 6321 R2
 (156) 2017 08 11
 (186) 2027 08 11
 (732) The H.D. LEE COMPANY, INC.

(111) M 1997 7101 R2
 (156) 2017 10 08
 (186) 2027 10 08
 (732) CHEVRON INTELLECTUAL PROPERTY
 LLC

a State of Delaware, Limited Liability Company
6001 Bollinger Canyon Road, San Ramon,
California 94583, USA

980 Great West Road, Brentford, Middlesex
TW8 9GS, United Kingdom

(111) M 1997 7102 R2
(156) 2017 10 08
(186) 2027 10 08
(732) CHEVRON INTELLECTUAL PROPERTY
LLC
a State of Delaware, Limited Liability Company
6001 Bollinger Canyon Road, San Ramon,
California 94583, USA

(111) M 1997 7813 R2
(156) 2017 12 11
(186) 2027 12 11
(732) JOHNSON & JOHNSON
(a corporation the state of New Jersey)
One Johnson & Johnson Plaza, New
Brunswick, New Jersey, USA

(111) M 1997 7104 R2
(156) 2017 10 08
(186) 2027 10 08
(732) CHEVRON INTELLECTUAL
PROPERTY LLC
a State of Delaware, Limited Liability Company
6001 Bollinger Canyon Road, San Ramon,
California 94583, USA

(111) M 1998 8625 R2
(156) 2018 03 11
(186) 2028 03 11
(732) SWAROVSKI AKTIENGESELLSCHAFT
Droschistrasse 15, FL-9495 Triesen,
Liechtenstein

(111) M 1997 7137 R2
(156) 2017 10 10
(186) 2027 10 10
(732) RIEKER HOLDING AG
Stockwiesenstrasse 1, CH-8240 Thayngen,
Switzerland

(111) M 1998 8626 R2
(156) 2018 03 11
(186) 2028 03 11
(732) SWAROVSKI AKTIENGESELLSCHAFT
Droschistrasse 15, FL-9495 Triesen,
Liechtenstein

(111) M 1997 7409 R2
(156) 2017 11 07
(186) 2027 11 07
(732) CHEVRON INTELLECTUAL PROPERTY
LLC
a State of Delaware, Limited Liability Company
6001 Bollinger Canyon Road, San Ramon,
California 94583, USA

(111) M 1997 7410 R2
(156) 2017 11 07
(186) 2027 11 07
(732) CHEVRON INTELLECTUAL PROPERTY
LLC
a State of Delaware, Limited Liability Company
6001 Bollinger Canyon Road, San Ramon,
California, 94583, USA

(111) M 1997 7684 R2
(156) 2017 11 24
(186) 2027 11 24
(732) GlaxoSmithKline Consumer Healthcare
(UK) IP Limited

COMPLETE TRANSFER OF RIGHTS

-
- (111) M 2001 013989 R1
(732) EFES HOLLAND TECHNICAL AND MANAGEMENT CONSULTANCY N.V.
Strawinskyiaan 1229, 1077XX Amsterdam, Netherlands Antilles
(770) ANADOLU EFES TECHNICAL AND MANAGEMENT CONSULTANCY N.V.
Landhuis Joonchi Kava Richard J. Beaujon z/n, P.O. Box 837, Curacao, Netherlands Antilles
(580) 2017 06 27
-
- (111) M 2001 013990 R1
(732) EFES HOLLAND TECHNICAL AND MANAGEMENT CONSULTANCY N.V.
Strawinskyiaan 1229, 1077XX Amsterdam, Netherlands
(770) ANADOLU EFES TECHNICAL AND MANAGEMENT CONSULTANCY N.V.
Landhuis Joonchi Kava Richard J. Beaujon z/n, P.O. Box 837, Curacao, Netherlands Antilles
(580) 2017 06 27
-
- (111) M 2001 014118 R1
(732) EFES HOLLAND TECHNICAL AND MANAGEMENT CONSULTANCY N.V.
Strawinskyiaan 1229, 1077XX Amsterdam, Netherlands Antilles
(770) ANADOLU EFES TECHNICAL AND MANAGEMENT CONSULTANCY N.V.
Landhuis Joonchi Kava Richard J. Beaujon z/n, P.O. Box 837, Curacao, Netherlands Antilles
(580) 2017 06 27
-
- (111) M 2002 014778 R1
(732) EFES HOLLAND TECHNICAL AND MANAGEMENT CONSULTANCY N.V.
Strawinskyiaan 1229, 1077XX Amsterdam, Netherlands Antilles
(770) ANADOLU EFES TECHNICAL AND MANAGEMENT CONSULTANCY N.V.
Landhuis Joonchi Kava Richard J. Beaujon z/n, P.O. Box 837, Curacao, Netherlands Antilles
(580) 2017 06 27
-
- (111) M 2002 014783 R1
(732) EFES HOLLAND TECHNICAL AND MANAGEMENT CONSULTANCY N.V.
Strawinskyiaan 1229, 1077XX Amsterdam, Netherlands Antilles
(770) ANADOLU EFES TECHNICAL AND MANAGEMENT CONSULTANCY N.V.
Landhuis Joonchi Kava Richard J. Beaujon z/n, P.O. Box 837, Curacao, Netherlands Antilles
(580) 2017 06 27
-
- (111) M 2009 019546 R
(732) EFES HOLLAND TECHNICAL AND MANAGEMENT CONSULTANCY N.V.
Strawinskyiaan 1229, 1077XX Amsterdam, Netherlands Antilles
(770) ANADOLU EFES TECHNICAL AND MANAGEMENT CONSULTANCY N.V.
Landhuis Joonchi Kava Richard J. Beaujon Z/N P.O. Box 837, Curacao, Netherlands Antilles
(580) 2017 06 27
-
- (111) M 2009 019706 R
(732) EFES HOLLAND TECHNICAL AND MANAGEMENT CONSULTANCY N.V.
Strawinskyiaan 1229, 1077XX Amsterdam, Netherlands Antilles
(770) ANADOLU EFES TECHNICAL AND MANAGEMENT CONSULTANCY N.V.
Landhuis Joonchi Kava Richard J. Beaujon z/n, P.O. Box 837, Curacao, Netherlands Antilles
(580) 2017 06 27
-
- (111) M 2009 019707 R
(732) EFES HOLLAND TECHNICAL AND MANAGEMENT CONSULTANCY N.V.
Strawinskyiaan 1229, 1077XX Amsterdam, Netherlands Antilles
(770) ANADOLU EFES TECHNICAL AND MANAGEMENT CONSULTANCY N.V.
Landhuis Joonchi Kava Richard J. Beaujon Z/N P.O. Box 837, Curacao, Netherlands Antilles
(580) 2017 06 27
-
- (111) M 2011 021808 R
(732) EFES HOLLAND TECHNICAL AND MANAGEMENT CONSULTANCY N.V.
Strawinskyiaan 1229, 1077XX Amsterdam, Netherlands Antilles
(770) ANADOLU EFES TECHNICAL AND MANAGEMENT CONSULTANCY N.V.
Landhuis Joonchi Kava Richard J. Beaujon z/n, P.O. Box 837, Curacao, Netherlands Antilles
(580) 2017 06 27
-

MANAGEMENT CONSULTANCY N.V.
Landhuis Joonchi Kava Richard J. Beaujon
Z/N P.O. Box 837, Curacao, Netherlands
Antilles
(580) 2017 06 27

(770) JOHN HANCOCK LIFE INSURANCE
COMPANY
John Hancock Place, Boston, Massachusetts
02117, USA
(580) 2017 06 26

(111) M 2011 022153 R
(732) EFES HOLLAND TECHNICAL AND
MANAGEMENT CONSULTANCY N.V.
Strawinskylaan 1229, 1077XX Amsterdam,
Netherlands Antilles
(770) ANADOLU EFES TECHNICAL AND
MANAGEMENT CONSULTANCY N.V.
Landhuis Joonchi Kava Richard J. Beaujon
Z/N P.O. Box 837, Curacao, Netherlands
Antilles
(580) 2017 06 27

(111) M 2012 022245 R
(732) EFES HOLLAND TECHNICAL AND
MANAGEMENT CONSULTANCY N.V.
Strawinskylaan 1229, 1077XX Amsterdam,
Netherlands Antilles
(770) ANADOLU EFES TECHNICAL AND
MANAGEMENT CONSULTANCY N.V.
Landhuis Joonchi Kava Richard J. Beaujon
Z/N P.O. Box 837, Curacao, Netherlands
Antilles
(580) 2017 06 27

(111) M 2014 025235 R
(732) LTD "DUTI FRI INTERNEISHENAL"
Besikis q. 4, mimdebaed (nakveti 46/10),
Tbilisi, Georgia
(770) M7 TOBACCO FZCO
Plot N.S51302, jebel Ali, Dubai,
United Arab Emirates
(580) 2017 06 23

(111) M 1997 006332 R1
(732) JOHN HANCOCK LIFE
INSURANCE COMPANY(U.S.A.)
601 Congress Street, Boston, Massachusetts
02210, USA
(770) JOHN HANCOCK LIFE
INSURANCE COMPANY
John Hancock Place, Boston, Massachusetts
02117, USA
(580) 2017 06 26

(111) M 1997 006342 R1
(732) JOHN HANCOCK LIFE
INSURANCE COMPANY(U.S.A.)
601 Congress Street, Boston, Massachusetts
02210, USA

CHANGES IN NAMES AND/OR ADDRESSES OF OWNERS

(111) M 1997 005261 R2
(732) HUDSON PRODUCTS CORPORATION
(Texas corporation)
9660 Grunwald Road, Beasley, Texas 77417,
USA
(770) HUDSON PRODUCTS CORPORATION
(Texas corporation)
1307 Soldiers Field Drive, Sugar Land, Texas
77479, USA
(580) 2017 06 23

(111) M 1997 005263 R2
(732) HUDSON PRODUCTS
CORPORATION (Texas corporation)
9660 Grunwald Road, Beasley, Texas 77417,
USA
(770) HUDSON PRODUCTS CORPORATION
(Texas corporation)
1307 Soldiers Field Drive, Sugar Land, Texas
77479, USA
(580) 2017 06 23

(111) M 2009 020009 R
(732) Amouage LLC
P.O. Box 307, CPO 111, Seeb, Oman
(770) Oman Perfumery LLC
P. O. Box 307, CPO 111, Seeb, Oman
(580) 2017 06 28

(111) M 2009 020009 R
(732) Amouage SAOC
P.O. Box 307, CPO 111, Seeb, Oman
(770) Amouage LLC
P.O. Box 307, CPO 111, Seeb, Oman
(580) 2017 06 28

(111) M 2010 020244 R
(732) Amouage LLC
P.O. Box 307, CPO 111, Seeb, Oman
(770) Oman Perfumery LLC
P. O. Box 307, CPO 111, Seeb, Oman
(580) 2017 06 28

(111) M 2010 020244 R
(732) Amouage SAOC
P.O. Box 307, CPO 111, Seeb, Oman
(770) Amouage LLC
P.O. Box 307, CPO 111, Seeb, Oman
(580) 201706 28

(111) M 2014 025235 R
(732) M7 TOBACCO FZCO
Plot N.S51302, jebel Ali, Dubai,
United Arab Emirates
(770) M7 TOBACCO TRADING FZCO
Plot N.S51302, jebel Ali, Dubai,
United Arab Emirates
(580) 2017 06 23

(111) M 2016 28411
(732) ARCONIC INC.
201 Isabella Street, Pittsburgh, Pennsylvania
15212, USA
(770) ALCOA INC.
Alcoa Corporate Center 201 Isabella Street,
15212-5858 Pittsburgh, Pennsylvania, USA
(580) 2017 06 26

INVALIDATION OF TRADEMARKS REGISTRATION

(111) M 2006 16985 R
 (141) 2017 01 26, Not payment for prolongation of registration on the following of 10 years
 (732) Gocha Tkeshelashvili
 Gldaniskhevis me-7a kor., b. 79, 0153, Tbilisi, GE

(111) M 2006 16986 R
 (141) 2017 01 26, Not payment for prolongation of registration on the following of 10 years
 (732) Aleksandre Bolkvadze
 Paliashvilis q. 66, b.51, 0168, Tbilisi, GE

(111) M 2006 16990 R
 (141) 2017 01 26, Not payment for prolongation of registration on the following of 10 years
 (732) LTD "LONDON HAUS GEORGIA"
 Nutsubidzis me-2 m/r, I kvar., VI kor., b.6, 0183, Tbilisi, GE

(111) M 2006 16991 R
 (141) 2017 01 26, Not payment for prolongation of registration on the following of 10 years
 (732) LTD "CHKONIA TRANSPORT GROUP"
 Akaki Tseretlis gam. 114, 0119, Tbilisi, GE

(111) M 2006 16992 R
 (141) 2017 01 26, Not payment for prolongation of registration on the following of 10 years
 (732) LTD "CHKONIA TRANSPORT GROUP"
 Akaki Tseretlis gam. 114, 0119, Tbilisi, GE

(111) M 2006 16993 R
 (141) 2017 01 26, Not payment for prolongation of registration on the following of 10 years
 (732) Ioseb Mikadze
 Erekle II-is q. 8/10, 0105, Tbilisi, GE

(111) M 2006 16996 R
 (141) 2017 01 26, Not payment for prolongation of registration on the following of 10 years
 (732) AVINASHI
 Krilovis q. 8, 0102, Tbilisi, GE

(111) M 2006 16997 R
 (141) 2017 01 26, Not payment for prolongation of registration on the following of 10 years
 (732) Levan Alavidze
 Ip. Khvichias q. 17, b. 12, 0160, Tbilisi, GE

(111) M 2006 16998 R
 (141) 2017 01 26, Not payment for prolongation of registration on the following of 10 years
 (732) LTD "PHARMIMPEX"
 Chiaurelis q.2, 0159, Tbilisi, GE

(111) M 2006 17000 R
 (141) 2017 01 26, Not payment for prolongation of registration on the following of 10 years
 (732) TAMAR LEBANIDZE
 Digmis masivi, 1-li kv., 3b. korp., b. 8, 0194, Tbilisi, GE;
 GARGI AKIMIDZE
 Tsagarelis q. 12, 12, 0194, Tbilisi, GE

(111) M 2006 17001 R
 (141) 2017 01 26, Not payment for prolongation of registration on the following of 10 years
 (732) LTD "W & W"
 Ilia Chavchavadzis q., 3, 3100, Martvili, GE

(111) M 2006 17006 R
 (141) 2017 02 09, Not payment for prolongation of registration on the following of 10 years
 (732) ABDI IBRAHIM İLAÇ SANAYİ VE TİCARET ANONİM ŞİRKETİ
 Eski Büyükdere Cad. Ayazağa Yolu 34398 No:5 Maslak, İstanbul, TR

(111) M 2006 17007 R
 (141) 2017 02 09, Not payment for prolongation of registration on the following of 10 years
 (732) ABDI IBRAHIM İLAÇ SANAYİ VE TİCARET ANONİM ŞİRKETİ
 Eski Büyükdere Cad. Ayazağa Yolu 34398 No:5 Maslak, İstanbul, TR

(111) M 2006 17008 R
 (141) 2017 02 09, Not payment for prolongation of registration on the following of 10 years
 (732) ABDI IBRAHIM İLAÇ SANAYİ VE TİCARET ANONİM ŞİRKETİ
 Eski Büyükdere Cad. Ayazağa Yolu 34398 No:5 Maslak, İstanbul, TR

(111) M 2006 17009 R
 (141) 2017 02 09, Not payment for prolongation of registration on the following of 10 years
 (732) ABDI IBRAHIM İLAÇ SANAYİ VE TİCARET ANONİM ŞİRKETİ

Eski Büyükdere Cad. Ayazağa Yolu 34398
No:5 Maslak, İstanbul, TR

(111) M 2006 17050 R
(141) 2017 02 13, Not payment for prolongation of registration on the following of 10 years
(732) PFIZER PRODUCTS INC.
Eastern Point Road, Groton, Connecticut
06340, US

(111) M 2006 17058 R
(141) 2017 02 13, Not payment for prolongation of registration on the following of 10 years
(732) ASTELLAS PHARMA INC.
3-11, Nihonbashi-Honcho, 2-Chome,
Chuo-ku, Tokyo, JP

(111) M 2006 17059 R
(141) 2017 02 13, Not payment for prolongation of registration on the following of 10 years
(732) ASTELLAS PHARMA INC.
3-11, Nihonbashi-Honcho, 2-Chome,
Chuo-ku, Tokyo, JP

(111) M 2006 17101 R
(141) 2017 02 13, Not payment for prolongation of registration on the following of 10 years
(732) LTD "MAMQOLI"
Buknari, 4900, Chokhatauris raioni, GE

(111) M 2006 17107 R
(141) 2017 02 16, Not payment for prolongation of registration on the following of 10 years
(732) GEORGIAN NATIONAL OLIMPIC
COMITY
Davit Agmasheneblis gamz. 65, 0102,
Tbilisi, GE

(111) M 2006 17130 R
(141) 2017 02 28, Not payment for prolongation of registration on the following of 10 years
(732) JSC PETROLIUM NATIONAL
COMPANY "SAKNAVTOBI"
M. Kostavas q. 65, 0171, Tbilisi, GE

(111) M 2006 17132 R
(141) 2017 02 28, Not payment for prolongation of registration on the following of 10 years
(732) AJANTA PHARMA LIMITED
Charkop, Kandivli (W), Mumbai – 67, IN

(111) M 2006 17136 R
(141) 2017 03 14, Not payment for prolongation of registration on the following of 10 years
(732) JSC "TELAVI WINE CELLAR"
Sop. Kurdgelauri, 2200, Telavi, GE

(111) M 2006 17138 R
(141) 2017 03 14, Not payment for prolongation of registration on the following of 10 years
(732) LTD "AMBASSADOR"
Shavtelis q.13, 0105, Tbilisi, GE

(111) M 2006 17139 R
(141) 2017 03 14, Not payment for prolongation of registration on the following of 10 years
(732) Giorgi Tevzadze
Gogebashvilis me-2 shesakhvevi, korp. 4,
b. 20, 0179, Tbilisi, GE

(111) M 2006 17141 R
(141) 2017 03 14, Not payment for prolongation of registration on the following of 10 years
(732) CORE LABORATORIES GLOBAL N.V.
A. Mendes Chumaceiro Boulevard 11,
Willemstad, Curacao, AN

(111) M 2006 17143 R
(141) 2017 03 14, Not payment for prolongation of registration on the following of 10 years
(732) LTD "A-B-C PHARMACEUTICALS"
Lisis tba 1, 0171, Tbilisi, GE

(111) M 2006 17144 R
(141) 2017 03 14, Not payment for prolongation of registration on the following of 10 years
(732) CORE LABORATORIES GLOBAL N.V.
A. Mendes Chumaceiro Boulevard 11,
Willemstad, Curacao, AN

(111) M 2006 17157 R
(141) 2017 03 14, Not payment for prolongation of registration on the following of 10 years
(732) Marina Tsulukidze
Ipolite Khvichias q. 31, ap. 8, 0160, Tbilisi, GE

(111) M 2006 17158 R
(141) 2017 03 14, Not payment for prolongation of registration on the following of 10 years
(732) INTEL CORPORATION
2200 Mission College Boulevard, Santa
Clara, California 95052-8119, US

(111) M 2006 17166 R
 (141) 2017 03 14, Not payment for prolongation of registration on the following of 10 years
 (732) CORE LABORATORIES GLOBAL N.V.
 A. Mendes Chumaceiro Boulevard 11,
 Willemstad, Curacao, AN

Zhiuli Shartavas q. 18a, b. 41, 0160,
 Tbilisi, GE

(111) M 2006 17168 R
 (141) 2017 03 15, Not payment for prolongation of registration on the following of 10 years
 (732) Pridon Chikhelidze
 Galis q. 11, 0179, Tbilisi, GE

(111) M 2006 17177 R
 (141) 2017 03 15, Not payment for prolongation of registration on the following of 10 years
 (732) LTD "MERFI BLACK SEA"
 R. Japaridzis q. 0179, Tbilisi, GE

(111) M 2006 17169 R
 (141) 2017 03 15, Not payment for prolongation of registration on the following of 10 years
 (732) FIL LIMITED
 Pembeoke Hall, 42 Crow Lane, Pembroke
 HM 19, P.O. Box HM 670, Hamilton HMCX,
 BM

(111) M 2006 17178 R
 (141) 2017 03 15, Not payment for prolongation of registration on the following of 10 years
 (732) LTD "MERFI BLACK SEA"
 R. Japaridzis q. 0179, Tbilisi, GE

(111) M 2006 17172 R
 (141) 2017 03 15, Not payment for prolongation of registration on the following of 10 years
 (732) WRANGLER APPAREL CORP.
 3411 Silverside Road, Wilmington, DE
 19810, US

(111) M 2006 17179 R
 (141) 2017 03 15, Not payment for prolongation of registration on the following of 10 years
 (732) LTD "MERFI BLACK SEA"
 R. Japaridzis q. 0179, Tbilisi, GE

(111) M 2006 17173 R
 (141) 2017 03 15, Not payment for prolongation of registration on the following of 10 years
 (732) HARRINGTON DEVELOPMENT INC.
 Elivira Mendez Street, Valerino Bldg, 3rd
 Floor, Panama, PA

(111) M 2006 17180 R
 (141) 2017 03 15, Not payment for prolongation of registration on the following of 10 years
 (732) LTD "EUROPARK"
 Abastumnis q., korp. 1, b. 24, 0112,
 Tbilisi, GE

(111) M 2006 17174 R
 (141) 2017 03 15, Not payment for prolongation of registration on the following of 10 years
 (732) HARRINGTON DEVELOPMENT INC.
 Arango-Orillac Bldg. East 54 th street,
 Panama, PA

(111) M 2006 17181 R
 (141) 2017 03 15, Not payment for prolongation of registration on the following of 10 years
 (732) IMPERIAL CHEMICAL INDUSTRIES PLC
 20 Manchester Square, London
 W1U 3AN, GB

(111) M 2006 17175 R
 (141) 2017 03 15, Not payment for prolongation of registration on the following of 10 years
 (732) LTD "TSITELKUDA TECHNIX"
 Digmis masivi, me-6 kv., 22a korp., 0159,
 Tbilisi, GE

(111) M 2006 17182 R
 (141) 2017 03 15, Not payment for prolongation of registration on the following of 10 years
 (732) WRANGLER APPAREL CORP.
 3411 Silverside Road, Wilmington,
 DE 19810, US

(111) M 2006 17176 R
 (141) 2017 03 15, Not payment for prolongation of registration on the following of 10 years
 (732) Teimuraz Kutaladze

(111) M 2006 17183 R
 (141) 2017 03 15, Not payment for prolongation of registration on the following of 10 years
 (732) WRANGLER APPAREL CORP.
 3411 Silverside Road, Wilmington,
 DE 19810, US

(111) M 2006 17184 R
 (141) 2017 03 15, Not payment for prolongation of registration on the following of 10 years

(732) WRANGLER APPAREL CORP.
3411 Silverside Road, Wilmington,
DE 19810, US

(111) M 2006 17185 R
(141) 2017 03 15, Not payment for prolongation of
registration on the following of 10 years
(732) Ilia Tsintsadze
Enguris q. 3, b. 32, 0171, Tbilisi, GE

(111) M 2006 17186 R
(141) 2017 03 15, Not payment for prolongation of
registration on the following of 10 years
(732) Ilia Tsintsadze
Enguris q. 3, b. 32, 0171, Tbilisi, GE

(111) M 2006 17187 R
(141) 2017 03 15, Not payment for prolongation of
registration on the following of 10 years
(732) Ilia Tsintsadze
Enguris q. 3, b. 32, 0171, Tbilisi, GE

(111) M 2006 17188 R
(141) 2017 03 15, Not payment for prolongation of
registration on the following of 10 years
(732) Ilia Tsintsadze
Enguris q. 3, b. 32, 0171, Tbilisi, GE

(111) M 2006 17189 R
(141) 2017 03 15, Not payment for prolongation of
registration on the following of 10 years
(732) Ilia Tsintsadze
Enguris q. 3, b. 32, 0171, Tbilisi, GE

(111) M 2006 17190 R
(141) 2017 03 15, Not payment for prolongation of
registration on the following of 10 years
(732) ILIA TSINTSADZE
Enguris q. 3, b.32, 0171, Tbilisi, GE

(111) M 2006 17191 R
(141) 2017 03 15, Not payment for prolongation of
registration on the following of 10 years
(732) Ilia Tsintsadze
Enguris q. 3, b. 32, 0171, Tbilisi, GE

(111) M 2006 17201 R
(141) 2017 03 15, Not payment for prolongation of
registration on the following of 10 years
(732) GOOGLE INC.
1600 Amphitheatre Parkway, Mountain
View, CA 94043, US

(111) M 2006 17204 R
(141) 2017 03 15, Not payment for prolongation of
registration on the following of 10 years
(732) INTEL CORPORATION
2200 Mission College Boulevard, Santa
Clara, California 95052-8119, US

(111) M 2012 22293 R
(141) 2017 06 14, On demand of the owner
(732) LTD "KROSVASE"
26 maisis moedani 1, Saburtalos raioni,
Tbilisi, GE

(111) M 2012 22294 R
(141) 2017 06 14, On demand of the owner
(732) LTD "KROSVASE"
26 maisis moedani 1, Saburtalos raioni,
Tbilisi, GE

(111) M 2012 22295 R
(141) 2017 06 14, On demand of the owner
(732) LTD "KROSVASE"
26 maisis moedani 1, Saburtalos raioni,
Tbilisi, GE

(111) M 1996 4106 R1
(141) 2007 03 02, Not payment for prolongation of
registration on the following of 10 years
(732) UNILEVER N.V.
Weena 455, 3013 AL Rotterdam, NL

(111) M 1996 4109 R1
(141) 2007 03 05, Not payment for prolongation of
registration on the following of 10 years
(732) BRISTOL-MYERS SQUIBB COMPANY
(A DELAWARE CORPORATION)
345 Park Avenue, New York, New York
10154, US

(111) M 1996 4115 R1
(141) 2007 03 05, Not payment for prolongation of
registration on the following of 10 years
(732) A. MENARINI PORTUGAL
PHARMACEUTICA S.A.
Rua General Ferreira Martins, number 8, 7th
floor, Miraflores, Alges-, PT

(111) M 1996 4116 R1
(141) 2007 03 05, Not payment for prolongation of
registration on the following of 10 years
(732) A. MENARINI PORTUGAL
PHARMACEUTICA S.A.

Rua General Ferreira Martins, number 8, 7th floor, Miraflores, Alges-, PT

(111) M 1996 4123 R1
(141) 2007 03 05, Not payment for prolongation of registration on the following of 10 years
(732) INTERNATIONAL BUSINESS MACHINES CORPORATION
Old Orchard Road, Armonk, N.Y.10504, US

(111) M 1996 4127 R1
(141) 2007 03 05, Not payment for prolongation of registration on the following of 10 years
(732) JSC JOHNSON & SON, INC.
1525 Howe Street, Racine, Wisconsin
53402-5011, US

(111) M 1996 4132 R1
(141) 2007 03 05, Not payment for prolongation of registration on the following of 10 years
(732) INTERNATIONAL BUSINESS MACHINES CORPORATION
Old Orchard Road, Armonk, NY 10504, US

(111) M 1996 4143 R1
(141) 2007 03 05, Not payment for prolongation of registration on the following of 10 years
(732) KABUSHIKI KAISHA TOSHIBA (ALSO TRADING AS TOSHIBA CORPORATION)
1-1, Shibaura 1-chome, Minato-ku, Tokyo, JP

(111) M 1996 4144 R1
(141) 2007 03 05, Not payment for prolongation of registration on the following of 10 years
(732) KABUSHIKI KAISHA TOSHIBA (ALSO TRADING AS TOSHIBA CORPORATION)
1-1, Shibaura 1-chome, Minato-ku, Tokyo, JP

(111) M 1996 4148 R1
(141) 2007 03 05, Not payment for prolongation of registration on the following of 10 years
(732) CAFEA GMBH
Am Sandtorkai 2, D-2000 HAMBURG, DE

(111) M 1996 4176 R1
(141) 2007 03 06, Not payment for prolongation of registration on the following of 10 years
(732) ASTRAZENECA AB
Vastra Malarehamnen 9, 15185
Sodertalje, SE

(111) M 1996 4177 R1
(141) 2007 03 06, Not payment for prolongation of registration on the following of 10 years
(732) ASTRAZENECA AB
Vastra Malarehamnen 9, 15185
Sodertalje, SE

(111) M 1996 4182 R1
(141) 2007 03 12, Not payment for prolongation of registration on the following of 10 years
(732) TAKEDA GMBH
Bik-Gulden Strasse 2, 78467 Konstanz, DE

(111) M 1996 4187 R1
(141) 2006 09 12, Not payment for prolongation of registration on the following of 10 years
(732) LANXESS DEUTSCHLAND GMBH
51369 Leverkusen, DE

(111) M 1996 4193 R1
(141) 2007 03 12, Not payment for prolongation of registration on the following of 10 years
(732) FABERGE LIMITED
Walker House, P.O. Box 908GT, Mary Street, George Town, Grand Cayman, KY

(111) M 1996 4197 R1
(141) 2007 03 13, Not payment for prolongation of registration on the following of 10 years
(732) SOLVAY PHARMA
42, Rue Rouget de Lisle, 92151 Suresnes cedex, FR

(111) M 1996 4198 R1
(141) 2007 03 13, Not payment for prolongation of registration on the following of 10 years
(732) SOLVAY PHARMA
42, Rue Rouget de Lisle, 92151 Suresnes cedex, FR

(111) M 1996 4208 R1
(141) 2007 03 16, Not payment for prolongation of registration on the following of 10 years
(732) SOCIETE COOPERATIVE VIGNERONNE DES GRANDES CAVES RICHON-LE-ZION AND ZICRON-JACOB LTD
25 Hacarmel Street Richon-Le-Zion
75100, IL

(111) M 1996 4214 R1
(141) 2007 03 16, Not payment for prolongation of registration on the following of 10 years

(732) ROCKWELL AUTOMATION, INC.
1201 South Second Street, Milwaukee,
Wisconsin, US

(111) M 1996 4218 R1

(141) 2007 03 16, Not payment for prolongation of
registration on the following of 10 years

(732) LA BAGAGERIE S.A.
41, rue du Four, F-75 006 Paris, FR

CLASSIFICATION INDEXES

INVENTIONS

CONCORDANCE TABLE OF INTERNATIONAL CLASSIFICATION INDEX AND PUBLICATION NUMBERS

INTERNATIONAL CLASSIFICATION INDEXES (51)	NUMBER OF PUBLISHED APPLICATION (10)
A 61 K 8/37; A 61 K 8/67; A 61 Q 19/00; A 61 Q 19/10; A 61 K 8/97; A 61 K 8/06	AP 2017 14289 A
A 61 K 9/00; A 61 K 9/28; A 61 K 31/606; A 61 K 47/32; A 61 K 47/36	AP 2017 13618 A
A 61 K 9/00; A 61 K 9/28; A 61 K 31/606; A 61 K 47/32; A 61 K 47/36	AP 2017 13923 A
A 61 K 9/00; A 61 K 9/28; A 61 K 31/606; A 61 K 47/32; A 61 K 47/36	AP 2017 13924 A
A 61 K 9/48	AP 2017 13659 A
A 61 K 31/5517; A 61 K 31/4468; A 61 K 31/567; A 61 K 45/00; A 61 P 25/20	AP 2017 13771 A
C 07 D 213/74; A 61 K 31/444; A 61 K 31/4545; A 61 K 31/46; A 61 K 31/496; A 61 K 31/4995; A 61 K 31/506; A 61 K 31/5377; A 61 K 31/5386; A 61 K 31/541; A 61 K 31/55; A 61 P 25/00; A 61 P 25/08; A 61 P 25/14; A 61 P 25/16; A 61 P 25/28; A 61 P 43/00; C 07 D 239/42; C 07 D 401/04; C 07 D 401/12; C 07 D 401/14; C 07 D 405/14; C 07 D 413/04; C 07 D 413/14; C 07 D 417/04; C 07 D 417/14; C 07 D 451/02; C 07 D 451/04; C 07 D 487/10; C 07 D 487/18; C 07 D 491/18; C 07 D 515/18; C 12 N 9/99; C 12 N 15/09	AP 2017 13877 A
C 07 D 307/85; A 61 K 31/343; A 61 P 29/00; A 61 P 35/00	AP 2017 13950 A
C 07 D 401/14; C 07 D 405/14; C 07 D 413/14; C 07 D 401/04; C 07 D 417/14; C 07 D 471/08; C 07 D 487/06; C 07 D 487/10; C 07 D 491/10; A 61 K 31/443; A 61 K 31/4433; A 61 K 31/4436; A 61 K 31/4545; A 61 K 31/496	AP 2017 13977 A
C 07 D 405/12; A 61 K 31/498; A 61 P 25/00	AP 2017 14180 A
C 07 H 19/067; C 07 H 19/073; C 07 H 19/10; C 07 H 19/167; C 07 H 19/173; C 07 H 19/20; C 07 H 19/213; A 61 K 31/708; A 61 K 31/7076; A 61 K 31/7072; A 61 K 31/7068; A 61 P 31/14	AP 2017 13892 A
C 07 K 14/605	AP 2017 13984 A
C 12 N 7/00; A 61 K 35/76	AP 2017 14061 A
C 12 N 9/88; C 12 N 15/82	AP 2017 12872 A

**CONCORDANCE TABLE OF PUBLICATION NUMBERS
AND INTERNATIONAL CLASSIFICATION INDEX**

NUMBER OF PUBLISHED APPLICATION (10)	INTERNATIONAL CLASSIFICATION INDEXES (51)
AP 2017 12872 A	C 12 N 9/88; C 12 N 15/82
AP 2017 13618 A	A 61 K 9/00; A 61 K 9/28; A 61 K 31/606; A 61 K 47/32; A 61 K 47/36
AP 2017 13659 A	A 61 K 9/48
AP 2017 13771 A	A 61 K 31/5517; A 61 K 31/4468; A 61 K 31/567; A 61 K 45/00; A 61 P 25/20
AP 2017 13877 A	C 07 D 213/74; A 61 K 31/444; A 61 K 31/4545; A 61 K 31/46; A 61 K 31/496; A 61 K 31/4995; A 61 K 31/506; A 61 K 31/5377; A 61 K 31/5386; A 61 K 31/541; A 61 K 31/55; A 61 P 25/00; A 61 P 25/08; A 61 P 25/14; A 61 P 25/16; A 61 P 25/28; A 61 P 43/00; C 07 D 239/42; C 07 D 401/04; C 07 D 401/12; C 07 D 401/14; C 07 D 405/14; C 07 D 413/04; C 07 D 413/14; C 07 D 417/04; C 07 D 417/14; C 07 D 451/02; C 07 D 451/04; C 07 D 487/10; C 07 D 487/18; C 07 D 491/18; C 07 D 515/18; C 12 N 9/99; C 12 N 15/09
AP 2017 13892 A	C 07 H 19/067; C 07 H 19/073; C 07 H 19/10; C 07 H 19/167; C 07 H 19/173; C 07 H 19/20; C 07 H 19/213; A 61 K 31/708; A 61 K 31/7076; A 61 K 31/7072; A 61 K 31/7068; A 61 P 31/14
AP 2017 13923 A	A 61 K 9/00; A 61 K 9/28; A 61 K 31/606; A 61 K 47/32; A 61 K 47/36
AP 2017 13924 A	A 61 K 9/00; A 61 K 9/28; A 61 K 31/606; A 61 K 47/32; A 61 K 47/36
AP 2017 13950 A	C 07 D 307/85; A 61 K 31/343; A 61 P 29/00; A 61 P 35/00
AP 2017 13977 A	C 07 D 401/14; C 07 D 405/14; C 07 D 413/14; C 07 D 401/04; C 07 D 417/14; C 07 D 471/08; C 07 D 487/06; C 07 D 487/10; C 07 D 491/10; A 61 K 31/443; A 61 K 31/4433; A 61 K 31/4436; A 61 K 31/4545; A 61 K 31/496
AP 2017 13984 A	C 07 K 14/605
AP 2017 14061 A	C 12 N 7/00; A 61 K 35/76
AP 2017 14180 A	C 07 D 405/12; A 61 K 31/498; A 61 P 25/00
AP 2017 14289 A	A 61 K 8/37; A 61 K 8/67; A 61 Q 19/00; A 61 Q 19/10; A 61 K 8/97; A 61 K 8/06

**CONCORDANCE TABLE OF INTERNATIONAL CLASSIFICATION INDEX,
PATENT NUMBERS AND PUBLICATION NUMBERS**

INTERNATIONAL CLASSIFICATION INDEX (51)	NUMBER OF PATENT (11)	NUMBER OF PUBLISHED APPLICATION (10)
A 61 K 9/20	P 2017 6693 B	AP 2017 12701 A
A 61 K 31/57; A 61 K 45/06; A 61 P 15/00	P 2017 6696 B	AP 2017 13608 A
B 01 D 53/14; B 01 D 53/50; C 01 B 17/05	P 2017 6694 B	AP 2017 13095 A
C 07 D 401/04; A 61 K 31/44; A 61 P 25/00	P 2017 6695 B	AP 2017 13508 A
C 07 D 413/14; C 07 D 413/04; C 07 D 417/14; A 61 K 31/506; A 61 P 35/00	P 2017 6699 B	AP 2017 13934 A
C 07 D 471/04; A 61 K 31/506; A 61 K 31/444; A 61 P 31/16	P 2017 6698 B	AP 2017 13685 A
C 09 K 5/04	P 2017 6697 B	AP 2017 13661 A
F 03 D 3/02	P 2017 6701 B	AP 2017 14065 A
H 01 L 21/66; G 01 R 31/66	P 2017 6700 B	AP 2017 14017 A

**CONCORDANCE TABLE OF PATENT NUMBERS,
PUBLICATION NUMBERS AND INTERNATIONAL CLASSIFICATION INDEX**

NUMBER OF PATENT (11)	NUMBER OF PUBLISHED APPLICATION (10)	INTERNATIONAL CLASSIFICATION INDEX (51)
P 2017 6693 B	AP 2017 12701 A	A 61 K 9/20
P 2017 6694 B	AP 2017 13095 A	B 01 D 53/14; B 01 D 53/50; C 01 B 17/05
P 2017 6695 B	AP 2017 13508 A	C 07 D 401/04; A 61 K 31/44; A 61 P 25/00
P 2017 6696 B	AP 2017 13608 A	A 61 K 31/57; A 61 K 45/06; A 61 P 15/00
P 2017 6697 B	AP 2017 13661 A	C 09 K 5/04
P 2017 6698 B	AP 2017 13685 A	C 07 D 471/04; A 61 K 31/506; A 61 K 31/444; A 61 P 31/16
P 2017 6699 B	AP 2017 13934 A	C 07 D 413/14; C 07 D 413/04; C 07 D 417/14; A 61 K 31/506; A 61 P 35/00
P 2017 6700 B	AP 2017 14017 A	H 01 L 21/66; G 01 R 31/66
P 2017 6701 B	AP 2017 14065 A	F 03 D 3/02

**CONCORDANCE TABLE OF APPLICATION NUMBERS, PUBLICATION NUMBERS
AND PATENTS**

NUMBER OF APPLICATION (21)	NUMBER OF PUBLISHED APPLICATION (10)	NUMBER OF PATENT (11)
AP 2010 012701	AP 2017 12701 A	P 2017 6693 B
AP 2011 013095	AP 2017 13095 A	P 2017 6694 B
AP 2012 013508	AP 2017 13508 A	P 2017 6695 B
AP 2013 013608	AP 2017 13608 A	P 2017 6696 B
AP 2013 013661	AP 2017 13661 A	P 2017 6697 B
AP 2012 013685	AP 2017 13685 A	P 2017 6698 B
AP 2014 013934	AP 2017 13934 A	P 2017 6699 B
AP 2015 014017	AP 2017 14017 A	P 2017 6700 B
AP 2016 014065	AP 2017 14065 A	P 2017 6701 B

UTILITY MODELS

CONCORDANCE TABLE OF INTERNATIONAL CLASSIFICATION INDEX AND PUBLICATION NUMBERS

INTERNATIONAL CLASSIFICATION INDEXES (51)	NUMBER OF PUBLISHED APPLICATION (10)
A 61 K 36/00, 35/64; A 61 P 1/16, 1/18	AU 2017 14346 U
B 65 D 75/08; B 65 D 75/78	AU 2017 14096 U
B 65 D 75/08; B 65 D 75/58	AU 2017 14097 U

CONCORDANCE TABLE OF PUBLICATION NUMBERS AND INTERNATIONAL CLASSIFICATION INDEX

NUMBER OF PUBLISHED APPLICATION (10)	INTERNATIONAL CLASSIFICATION INDEXES (51)
AU 2017 14096 U	B 65 D 75/08; B 65 D 75/78
AU 2017 14097 U	B 65 D 75/08; B 65 D 75/58
AU 2017 14346 U	A 61 K 36/00, 35/64; A 61 P 1/16, 1/18

CONCORDANCE TABLE OF INTERNATIONAL CLASSIFICATION INDEX, PATENT NUMBERS AND PUBLICATION NUMBERS

INTERNATIONAL CLASSIFICATION INDEX (51)	NUMBER OF PATENT (11)	NUMBER OF PUBLISHED APPLICATION (10)
A 01 G 15/00	U 2017 1940 Y	AU 2017 13975 U
B 60 D 1/12	U 2017 1939 Y	AU 2017 13905 U
B 65 B 3/00	U 2017 1941 Y	AU 2017 14044 U
E 04 B 2/14; E 04 C 1/40	U 2017 1942 Y	AU 2017 14280 U

CONCORDANCE TABLE OF PATENT NUMBERS, PUBLICATION NUMBERS AND INTERNATIONAL CLASSIFICATION INDEX

NUMBER OF PATENT (11)	NUMBER OF PUBLISHED APPLICATION (10)	INTERNATIONAL CLASSIFICATION INDEX (51)
U 2017 1939 Y	AU 2017 13905 U	B 60 D 1/12
U 2017 1940 Y	AU 2017 13975 U	A 01 G 15/00
U 2017 1941 Y	AU 2017 14044 U	B 65 B 3/00
U 2017 1942 Y	AU 2017 14280 U	E 04 B 2/14; E 04 C 1/40

**CONCORDANCE TABLE OF APPLICATION NUMBERS, PUBLICATION NUMBERS
AND PATENTS**

NUMBER OF APPLICATION (21)	NUMBER OF PUBLISHED APPLICATION (10)	NUMBER OF PATENT (11)
AU 2015 013905	AU 2017 13905 U	U 2017 1939 Y
AU 2015 013975	AU 2017 13975 U	U 2017 1940 Y
AU 2016 014044	AU 2017 14044 U	U 2017 1941 Y
AU 2016 014280	AU 2017 14280 U	U 2017 1942 Y

DESIGNS

**CONCORDANCE TABLE OF INTERNATIONAL CLASSIFICATION INDEX
AND PUBLICATION NUMBERS**

INTERNATIONAL CLASSIFICATION INDEXES (51)	NUMBER OF PUBLISHED APPLICATION (10)
19-02	AD 2017 941 S

**CONCORDANCE TABLE OF PUBLICATION NUMBERS
AND INTERNATIONAL CLASSIFICATION INDEX**

NUMBER OF PUBLISHED APPLICATION (10)	INTERNATIONAL CLASSIFICATION INDEXES (51)
AD 2017 941 S	19-02

**CONCORDANCE TABLE OF INTERNATIONAL CLASSIFICATION INDEX,
PATENT NUMBERS AND PUBLICATION NUMBERS**

INTERNATIONAL CLASSIFICATION INDEX (51)	NUMBER OF PATENT (11)	NUMBER OF PUBLISHED APPLICATION (10)
09-01	D 2017 711 S	AD 2017 929 S
09-03	D 2017 712 S	AD 2017 925 S

**CONCORDANCE TABLE OF PATENT NUMBERS,
PUBLICATION NUMBERS AND INTERNATIONAL CLASSIFICATION INDEX**

NUMBER OF PATENT (11)	NUMBER OF PUBLISHED APPLICATION (10)	INTERNATIONAL CLASSIFICATION INDEX (51)
D 2017 711 S	AD 2017 929 S	09-01
D 2017 712 S	AD 2017 925 S	09-03

CONCORDANCE TABLE OF APPLICATION NUMBERS, PUBLICATION NUMBERS
AND PATENTS

NUMBER OF APPLICATION (21)	NUMBER OF PUBLISHED APPLICATION (10)	NUMBER OF PATENT (11)
AD 2016 000925	AD 2017 925 S	D 2017 712 S
AD 2016 000929	AD 2017 929 S	D 2017 711 S

TRADEMARKS

CONCORDANCE TABLE OF REGISTRATION NUMBERS, APPLICATION NUMBERS, PUBLICATION NUMBERS AND BULLETIN NUMBERS

NUMBER OF REGISTRATION (111)	NUMBER OF APPLICATIONS (210)	NUMBER OF PUBLISHED APPLICATIONS (260)	NUMBER OF BULLETIN
M 2017 28662 R	AM 92347	-	13(473)2017
M 2017 28663 R	AM 92498	-	13(473)2017
M 2017 28664 R	AM 92507	-	13(473)2017
M 2017 28665 R	AM 92419	-	13(473)2017
M 2017 28666 R	AM 92737	-	13(473)2017
M 2017 28667 R	AM 92755	-	13(473)2017
M 2017 28668 R	AM 92794	-	13(473)2017
M 2017 28669 R	AM 92891	-	13(473)2017
M 2017 28670 R	AM 92893	-	13(473)2017
M 2017 28671 R	AM 92895	-	13(473)2017
M 2017 28672 R	AM 92897	-	13(473)2017
M 2017 28673 R	AM 92780	-	13(473)2017
M 2017 28674 R	AM 92909	-	13(473)2017
M 2017 28675 R	AM 92913	-	13(473)2017
M 2017 28676 R	AM 92914	-	13(473)2017
M 2017 28677 R	AM 92915	-	13(473)2017
M 2017 28678 R	AM 92916	-	13(473)2017
M 2017 28679 R	AM 92534	-	13(473)2017
M 2017 28680 R	AM 85819	AM 2016 85819 A	24(460)2016
M 2017 28681 R	AM 86495	AM 2016 86495 A	23(459)2016
M 2017 28682 R	AM 86659	AM 2016 86659 A	24(460)2016
M 2017 28683 R	AM 86751	AM 2017 86751 A	4(464)2017
M 2017 28684 R	AM 86761	AM 2016 86761 A	24(460)2016
M 2017 28685 R	AM 86878	AM 2016 86878 A	1(461)2017
M 2017 28686 R	AM 86932	AM 2017 86932 A	5(465)2017
M 2017 28687 R	AM 86933	AM 2017 86933 A	5(465)2017
M 2017 28411 R	AM 87017	AM 2016 87017 A	23(459)2016
M 2017 28688 R	AM 87021	AM 2017 87021 A	5(465)2017
M 2017 28689 R	AM 87088	AM 2016 87088 A	24(460)2016
M 2017 28690 R	AM 87123	AM 2016 87123 A	24(460)2016
M 2017 28691 R	AM 87124	AM 2016 87124 A	24(460)2016
M 2017 28692 R	AM 87369	AM 2017 87369 A	4(464)2017
M 2017 28693 R	AM 87418	AM 2017 87418 A	4(464)2017
M 2017 28694 R	AM 87498	AM 2017 87498 A	3(463)2017
M 2017 28695 R	AM 87502	AM 2017 87502 A	4(464)2017
M 2017 28696 R	AM 87504	AM 2017 87504 A	3(463)2017
M 2017 28697 R	AM 87515	AM 2017 87515 A	4(464)2017
M 2017 28698 R	AM 87552	AM 2017 87552 A	4(464)2017
M 2017 28699 R	AM 87569	AM 2017 87569 A	3(463)2017
M 2017 28700 R	AM 87662	AM 2017 87662 A	4(464)2017
M 2017 28701 R	AM 87663	AM 2017 87663 A	4(464)2017
M 2017 28702 R	AM 87677	AM 2017 87677 A	3(463)2017
M 2017 28703 R	AM 87775	AM 2017 87775 A	4(464)2017
M 2017 28704 R	AM 87778	AM 2017 87778 A	3(463)2017
M 2017 28705 R	AM 87787	AM 2017 87787 A	5(465)2017
M 2017 28706 R	AM 87790	AM 2017 87790 A	4(464)2017
M 2017 28707 R	AM 87798	AM 2017 87798 A	5(465)2017

1	2	3	4
M 2017 28708 R	AM 87907	AM 2017 87907 A	5(465)2017
M 2017 28709 R	AM 87963	AM 2017 87963 A	4(464)2017
M 2017 28710 R	AM 87967	AM 2017 87967 A	4(464)2017
M 2017 28711 R	AM 87968	AM 2017 87968 A	4(464)2017
M 2017 28712 R	AM 87977	AM 2017 87977 A	5(465)2017
M 2017 28713 R	AM 87992	AM 2017 87992 A	5(465)2017
M 2017 28714 R	AM 87995	AM 2017 87995 A	5(465)2017
M 2017 28715 R	AM 88068	AM 2017 88068 A	5(465)2017
M 2017 28716 R	AM 88076	AM 2017 88076 A	5(465)2017
M 2017 28717 R	AM 88195	AM 2017 88195 A	5 465)2017
M 2017 28718 R	AM 88333	AM 2017 88333 A	4 464)2017
M 2017 28719 R	AM 92903	-	13(473)2017
M 2017 28720 R	AM 92842	-	13(473)2017
M 2017 28721 R	AM 92799	-	13(473)2017
M 2017 28722 R	AM 93030	-	13(473)2017
M 2017 28723 R	AM 93031	-	13(473)2017

CONCORDANCE TABLE OF PUBLICATION NUMBERS
AND APPLICATION NUMBERS

NUMBER OF PUBLISHED APPLICATION (260)	NUMBER OF APPLICATION (210)	1	2
1	2		
AM 2017 81341 A*	AM 81341 A*	AM 2017 89327 A	AM 89327 A
AM 2017 87105 A	AM 87105 A	AM 2017 89329 A	AM 89329 A
AM 2017 88131 A	AM 88131 A	AM 2017 89405 A	AM 89405 A
AM 2017 88132 A	AM 88132 A	AM 2017 89406 A	AM 89406 A
AM 2017 88145 A	AM 88145 A	AM 2017 89417 A	AM 89417 A
AM 2017 88174 A	AM 88174 A	AM 2017 89521 A	AM 89521 A
AM 2017 88593 A	AM 88593 A	AM 2017 89532 A	AM 89532 A
AM 2017 88856 A	AM 88856 A	AM 2017 89557 A	AM 89557 A
AM 2017 88858 A	AM 88858 A	AM 2017 89606 A	AM 89606 A
AM 2017 88859 A	AM 88859 A	AM 2017 89736 A	AM 89736 A
AM 2017 89269 A	AM 89269 A	AM 2017 89747 A	AM 89747 A
		AM 2017 89852 A	AM 89852 A
		AM 2017 89853 A	AM 89853 A
		AM 2017 89867 A	AM 89867 A
		AM 2017 89999 A	AM 89999 A
		AM 2017 90003 A	AM 90003 A

CONCORDANCE TABLE OF INDEX OF GOODS AND/OR SERVICES
AND APPLICATION NUMBERS

INDEX OF GOODS AND/OR SERVICES (511)	NUMBER OF PUBLISHED APPLICATIONS (26)	1	2
1	2	12	AM 2017 88131 A
3	AM 2017 88131 A	12	AM 2017 88132 A
3	AM 2017 88132 A	12	AM 2017 89417 A
3	AM 2017 88593 A	12	AM 2017 89867 A
3	AM 2017 89853 A	12	AM 2017 89867 A
5	AM 2017 88145 A	14	AM 2017 88593 A
5	AM 2017 89258 A	14	AM 2017 90003 A
5	AM 2017 89259 A	18	AM 2017 88593 A
5	AM 2017 89269 A	18	AM 2017 89406 A
5	AM 2017 89557 A	21	AM 2017 88593 A
5	AM 2017 89999 A	25	AM 2017 88593 A
6	AM 2017 88131 A	25	AM 2017 89406 A
6	AM 2017 88132 A	25	AM 2017 90003 A
7	AM 2017 88131 A	28	AM 2017 88593 A
7	AM 2017 88132 A	29	AM 2017 81341 A*
7	AM 2017 89747 A	29	AM 2017 89852 A
8	AM 2017 88131 A	30	AM 2017 81341 A*
8	AM 2017 88132 A	30	AM 2017 89852 A
8	AM 2017 88132 A	31	AM 2017 88856 A
9	AM 2017 88131 A	33	AM 2017 88174 A
9	AM 2017 88132 A	33	AM 2017 89521 A
9	AM 2017 88593 A	34	AM 2017 89327 A
9	AM 2017 89405 A	34	AM 2017 89329 A
9	AM 2017 89736 A	34	AM 2017 89532 A
9	AM 2017 89867 A	35	AM 2017 88131 A
11	AM 2017 88131 A	35	AM 2017 88132 A
11	AM 2017 88132 A	35	AM 2017 88593 A
		35	AM 2017 90003 A
		36	AM 2017 87105 A
		41	AM 2017 89405 A
		42	AM 2017 89606 A

**CONCORDANCE TABLE OF INDEX OF GOODS AND/OR SERVICES
AND NUMBERS OF TRADEMARKS REGISTERED ACCORDING
TO THE ACCELERATED PROCEDURE**

INDEX OF GOODS AND/OR SERVICES (511)	NUMBERS OF REGISTERED ACCORDING TO THE ACCELERATED PROCEDURE (111)
3	M 2017 28673 R
5	M 2017 28669 R
5	M 2017 28670 R
5	M 2017 28671 R
5	M 2017 28672 R
5	M 2017 28673 R
5	M 2017 28674 R
5	M 2017 28675 R
5	M 2017 28676 R
5	M 2017 28677 R
5	M 2017 28678 R
5	M 2017 28719 R
29	M 2017 28673 R
30	M 2017 28662 R
30	M 2017 28668 R
30	M 2017 28673 R
32	M 2017 28663 R
32	M 2017 28673 R
32	M 2017 28721 R
35	M 2017 28665 R
35	M 2017 28673 R
35	M 2017 28679 R
36	M 2017 28665 R
36	M 2017 28666 R
36	M 2017 28667 R
39	M 2017 28665 R
39	M 2017 28722 R
39	M 2017 28723 R
41	M 2017 28665 R
43	M 2017 28664 R
43	M 2017 28665 R
43	M 2017 28666 R
43	M 2017 28667 R
43	M 2017 28668 R
43	M 2017 28720 R
44	M 2017 28665 R

OFFICIAL BULLETIN OF THE INDUSTRIAL PROPERTY

13(473)

EDITOR-IN-CHIEF: N. Bebrishvili

EDITORS-TRANSLATORS: E. Gabunia

PROOFREADER: A. Shikhashvili

COMPUTER LAYOUT: M. Ordenidze
K. Svanidze

www.sakpatenti.org.ge

E-mail: info@sakpatenti.org.ge