



**NATIONAL INTELLECTUAL PROPERTY CENTER OF GEORGIA  
SAKPATENTI**

**OFFICIAL BULLETIN  
OF THE INDUSTRIAL PROPERTY**

**13(497)**

**2018  
TBILISI**

# INID CODES FOR IDENTIFICATION OF BIBLIOGRAPHIC DATA

## INVENTIONS, UTILITY MODELS

- (10) Number of publication for application, which has been examined
- (11) Number of patent and kind of document
- (21) Serial number of application
- (22) Date of filing of the application
- (23) Date of exhibition or the date of the earlier filing and the number of application, if any
- (24) Date from which patent may have effect
- (31) Number of priority application
- (32) Date of filing of priority application
- (33) Code of the country or regional organization allotting priority application number
- (44) Date of publication of application not granted, but examined and number of bulletin
- (45) Date of publication of registered document
- (51) International Patent Classification Index
- (54) Title of the invention
- (57) Abstract
- (60) Number of examined patent document granted by foreign patent office, date from which patent has effect and country code
- (62) Number of the earlier application and in case of divided application, date of filing an application
- (71) Name, surname and address of applicant (country code)
- (72) Name, surname of inventor (country code)
- (73) Name, surname and address of patent owner (country code)
- (74) Name, surname of representative or patent attorney
- (85) Date of commencement of the national phase of International Application
- (86) Number and date of filing of international application
- (87) Number and date of publication of international application

## DESIGNS

- (10) Number of publication for application
- (11) Number of patent and kind of document or number of registration
- (15) Date of registration/Date of patent renewal
- (18) Expected expiration date of patent or registration
- (21) Serial number of application
- (22) Date of filing of the application
- (23) Date of exhibition or the date of the earlier filing and the number of application, if any
- (24) Date from which patent may have effect
- (28) Number of designs included in the application
- (30) Data relating to priority (number of application, date of filing of application, two-letter code identifying the authority with whom the priority application was made)
- (31) Number of priority application
- (32) Date of filing of priority application
- (33) Code of the country or regional organization allotting priority application number
- (34) Two-letter code according to WIPO St.3 identifying the authority with which the priority application was made
- (44) Date of publication of design and number of bulletin (the first publication)
- (45) Date of publication of design registered by WIPO and number of bulletin
- (51) International Classification for designs (class and subclass of the Locarno Classification)
- (54) Title of the invention
- (55) Reproduction of the design
- (57) Description of characteristic features of the design including indication of colors
- (58) Date of recording of any kind of amendment in the Register
- (62) Number of the earlier application, registration and document number and if available the date of filing an application in case of divided application
- (71) Name, surname and address of applicant (country code)
- (72) Name, surname of creator (country code)
- (73) Name, surname and address of patent owner (country code)
- (74) Name, surname of representative or patent attorney
- (81) Contracting states concerned
  - II designated contracting states according to the 1960 Act
  - III designated contracting states according to the 1999 Act
- (85) Owner's permanent address
- (86) Owner's nationality
- (87) Owner's residence
- (88) State in which the owner has a real and effective industrial or commercial establishment

## TRADEMARKS

- (111) – Number of registration
- (151) – Date of registration
- (156) – Date of the renewal
- (181) – Expected expiration date of registration
- (186) – Renewal expiration date of registration
- (141) – Date of cancel of duration of the mark
- (210) – Serial number of application
- (220) – Date of filing of the application
- (230) – Date concerning exhibition
- (260) – Number of application, for which favorable decision of examination about registration has been taken (publication number)
- (310) – Number of the first application
- (320) – Date of filing of the first application
- (330) – Code, identifying national or regional Office where the first application was made
- (511) – International Classification of Goods and Services for the purposes of registration of trade marks and/or list of goods and/or services classified according thereto
- (531) – Description of figurative elements of Trade Marks according to the International Classification of the Figurative Elements of Marks
- (540) – Reproduction of Trade Mark
- (550) – Nature and kind of Trade Mark
- (580) – Date of recording of any kind changes in respect of applications or registrations
- (591) – Information concerning colors claimed
- (731) – Name and address of the applicant
- (732) – Name and address of the holder of the registration
- (740) – Name and address of the representative
- (750) – Address for correspondence
- (770) – Name and address of the previous applicant or holder in case of change in ownership
- (771) – Previous name and address of the applicant or holder in case of change in ownership
- (791) – Name and address of the licensee
- (793) – Indication of conditions and/or restrictions under the license (Type of license, number of license agreement, data of license, data of validity of license)
- (800) – Certain data relating to the international registration of Trade Marks under the Protocol Relating to Madrid Agreement (International registration number)

## CODES FOR PUBLICATION IN BULLETIN

- (21) AP 0000 000000 – serial number of application for invention
- (10) AP 0000 0000 A – number of published application for invention (first publication)
- (11) P 0000 0000 B – number of patent for invention (second publication)
- (21) API 0000 000000 – number of application for imported patent
- (11) PI 0000 0000 A – number of imported patent (first publication)
- (21) AU 0000 000000 – serial number of application for utility model
- (10) AU 0000 000 U – number of published application for utility model (first publication)
- (11) U 0000 000 Y – number of patent for utility model (second publication)
- (21) AD 0000 000000 – serial number of application for design
- (10) AD 0000 000 S – number of published application for design (first publication)
- (11) D 0000 000 S – number of patent for design (second publication)

## INTERNATIONAL PATENT CLASSIFICATION FOR INVENTIONS AND UTILITY MODELS

- SECTION A – HUMAN NECESSITIES
- SECTION B – PERFORMING OPERATIONS; TRANSPORTING
- SECTION C – CHEMISTRY; METALLURGY
- SECTION D – TEXTILES; PAPER
- SECTION E – FIXED CONSTRUCTIONS
- SECTION F – MECHANICAL ENGINEERING; LIGHTING; HEATING; WEAPONS; BLASTING
- SECTION G – PHYSICS
- SECTION H – ELECTRICITY

- 
- M – Trade Mark
  - (210) AM 0000 000000 – Serial number of application;
  - (260) AAM 0000 00000 A – Publication number of application;
  - (111) M 0000 00000 R – Number of registration;
  - (111) MMM0000 00000 Rn – Number of renewals, in which n=1,2,3;
  - (111) M 0000 00000 R(P) – Number of registration under partial assignment of rights
-

**LIST OF CODES, IN ALPHABETIC SEQUENCE, AND THE CORRESPONDING (SHORT) NAMES OF STATES, OTHER ENTITIES AND INTERGOVERNMENTAL ORGANIZATIONS**  
(WIPO STANDARD ST.3)

AD	Andorra				
AE	United Arab Emirates				
AF	Afghanistan				
AG	Antigua and Barbuda				
AI	Anguilla				
AL	Albania				
AM	Armenia				
AN	Netherlands Antilles				
AO	Angola				
AP	African Regional Intellectual Property Organization (ARIPO)				
AR	Argentina				
AT	Austria				
AU	Australia				
AW	Aruba				
AZ	Azerbaijan				
BA	Bosnia and Herzegovina				
BB	Barbados				
BD	Bangladesh				
BE	Belgium				
BF	Burkina Faso				
BG	Bulgaria				
BH	Bahrain				
BI	Burundi				
BJ	Benin				
BM	Bermuda				
BN	Brunei Darussalam				
BO	Bolivia				
BR	Brazil				
BS	Bahamas				
BT	Bhutan				
BV	Bouvet Island				
BW	Botswana				
BX	Benelux Office for Intellectual Property (BOIP)				
BY	Belarus				
BZ	Belize				
CA	Canada				
CD	Democratic Republic of the Congo				
CF	Central African Republic				
CG	Congo				
CH	Switzerland				
CI	Cote d'Ivoire				
CK	Cook Islands				
CL	Chile				
CM	Cameroon				
CN	China				
CO	Colombia				
CR	Costa Rica				
CU	Cuba				
CV	Cape Verde				
CY	Cyprus				
CZ	Czech Republic				
DE	Germany				
DJ	Djibouti				
DM	Dominica				
DO	Dominican Republic				
DZ	Algeria				
EA	Eurasian Patent Organization (EAPO)				
EC	Ecuador				
EE	Estonia				
EG	Egypt				
EH	Western Sahara				
EM	Office for Harmonization in the Internal Market (Trademarks and Designs)(OHIM)				
EP	European Patent Office (EPO)				
ER	Eritrea				
ES	Spain				
ET	Ethiopia				
FI	Finland				
FJ	Fiji				
FK	Falkland Islands (Malvinas)				
FO	Faroe Islands				
FR	France				
GA	Gabon				
GB	United Kingdom				
GC	Patent Office of the Cooperation Council for the Arab States of the Gulf (GCC)				
GD	Grenada				
GG	Guernsey				
GH	Ghana				
GI	Gibraltar				
GT	Guatemala				
GW	Guinea- Bissau				
GY	Guyana				
HK	The Hong Kong Special Administrative Region of the People's Republic of China				
HN	Honduras				
HR	Croatia				
HT	Haiti				
HU	Hungary				
IB	International Bureau of the World Intellectual Property Organization (WIPO)				
ID	Indonesia				
IE	Ireland				
IL	Israel				
IM	Isle of Man				
IN	India				
IQ	Iraq				
ID	Indonesia				
IE	Ireland				
IL	Israel				
IM	Isle of Man				
IN	India				
IQ	Iraq				
IR	Iran (Islamic Republic of)				
IS	Iceland				
IT	Italy				
JE	Jersey				
JM	Jamaica				
JO	Jordan				
JP	Japan				
KE	Kenya				
KG	Kyrgyzstan				
KH	Cambodia				
KI	Kiribati				
KM	Saint Kitts and Nevis				
KP	Democratic People's Republic of Korea				
KR	Republic of Korea				
KW	Kuwait				
KY	Cayman Islands				
KZ	Kazakhstan				
LA	Lao People's Democratic Republic				
LB	Lebanon				
LC	Saint Lucia				
LI	Liechtenstein				
LK	Sri Lanka				
LR	Liberia				
LS	Lesotho				
LT	Lithuania				
LU	Luxembourg				
LV	Latvia				
LY	Libyan Arab Jamahiriya				
MA	Morocco				
MC	Monaco				
MD	Republic of Moldova				
ME	Montenegro				
MG	Madagascar				
MK	The former Yugoslav Republic of Macedonia				
ML	Mali				
MM	Myanmar				
MN	Mongolia				
MO	Macao				
MP	Northern Mariana Islands				
MR	Mauritania				
MS	Montserrat				
MT	Malta				
MU	Mauritius				
MV	Maldives				
MW	Malawi				
MX	Mexico				
MY	Malaysia				
MZ	Mozambique				
NA	Namibia				
NE	Niger				
NG	Nigeria				
NI	Nicaragua				
NL	Netherlands				
NO	Norway				
NP	Nepal				
NR	Nauru				
NZ	New Zealand				
OA	African Intellectual Property Organization (OAPI)				
OM	Oman				
PA	Panama				
PE	Peru				
PG	Papua New Guinea				
PH	Philippines				
PK	Pakistan				
PL	Poland				
PT	Portugal				
PW	Palau				
PY	Paraguay				
QA	Qatar				
QZ	Community Plant Variety Office (European Community) (CPVO)				
RO	Romania				
RS	Serbia				
RU	Russian Federation				
RW	Rwanda				
SA	Saudi Arabia				
SB	Solomon Islands				
SC	Seychelles				
SD	Sudan				
SG	Singapore				
SH	Saint Helena				
SI	Slovenia				
SK	Slovakia				
SL	Sierra Leone				
SM	San Marino				
SN	Senegal				
SO	Somalia				
SR	Suriname				
ST	Sao Tome and Principe				
SV	El Salvador				
SY	Syrian Arab Republic				
SZ	Swaziland				
TC	Turks and Caicos Islands				
TD	Chad				
TG	Togo				
TH	Thailand				
TJ	Tajikistan				
TL	Timor-Leste				
TM	Turkmenistan				
TN	Tunisia				
TO	Tonga				
TR	Turkey				
SE	Sweden				
TT	Trinidad and Tobago				
TV	Tuvalu				
TW	Taiwan, Province of China				
TZ	United Republic of Tanzania				
UA	Ukraine				
UG	Uganda				
US	United States of America				
UY	Uruguay				
UZ	Uzbekistan				
VA	Holy See				
VC	Saint Vincent and the Grenadines				
VE	Venezuela				
VG	Virgin Islands (British)				
VN	Viet Nam				
VU	Vanuatu				
WO	World Intellectual Property Organization (WIPO)				
WS	Samoa				
XN	Nordic Patent Institute (NPI)				
YE	Yemen				
ZA	South Africa				
ZM	Zambia				
ZW	Zimbabwe				

**NATIONAL INTELLECTUAL PROPERTY CENTER OF GEORGIA  
SAKPATENTI**

**OFFICIAL BULLETIN  
OF THE INDUSTRIAL PROPERTY**

**13(497)**

**INVENTIONS  
UTILITY MODELS  
DESIGNS  
TRADEMARKS**

**DATE OF PUBLICATION  
2018 07 10**

# CONTENTS

<b>PUBLISHED TITLES OF PROTECTION</b> .....	3
<b>INVENTIONS</b>	
▪ APPLICATIONS APPROVED FOR GRANTING PATENTS .....	4
▪ PATENTED INVENTIONS .....	9
<b>UTILITY MODELS</b>	
▪ APPLICATIONS APPROVED FOR GRANTING PATENT .....	11
▪ PATENTED UTILITY MODEL .....	12
<b>DESIGNS</b>	
▪ APPLICATION APPROVED FOR REGISTRATION .....	13
▪ DESIGNS, WHICH HAVE BEEN REGISTERED WITH THE INTERNATIONAL BUREAU CLAIMING PRIORITY ON THE TERRITORY OF GEORGIA .....	16
<b>TRADEMARKS</b>	
▪ APPLICATIONS FILED UNDER THE NATIONAL PROCEDURE APPROVED FOR REGISTRATION .....	54
▪ REGISTERED TRADEMARKS .....	66
▪ TRADEMARKS REGISTERED ACCORDING TO THE ACCELERATED PROCEDURE .....	70
▪ INTERNATIONAL TRADEMARKS FOR WHICH A DECISION ON GRANTING PROTECTION IS TAKEN .....	74
▪ INTERNATIONAL TRADEMARKS PROTECTED IN GEORGIA .....	98
<b>OFFICIAL NOTIFICATIONS</b>	
<b>INVENTIONS</b>	
▪ RENEWAL OF PATENTS .....	107
▪ CANCELLATION OF PATENTS .....	108
<b>UTILITY MODELS</b>	
▪ RENEWAL OF PATENTS .....	109
▪ CANCELLATION OF PATENTS .....	110
▪ COMPLETE TRANSFER OF RIGHT .....	110
<b>TRADEMARKS</b>	
▪ RENEWAL OF REGISTRATIONS .....	111
▪ COMPLETE TRANSFER OF RIGHTS .....	121
▪ CHANGES IN NAMES AND/OR ADDRESSES OF OWNERS .....	122
▪ INVALIDATION OF TRADEMARK REGISTRATION .....	124
<b>CLASSIFICATION INDEXES</b>	
INVENTIONS .....	125
UTILITY MODELS .....	127
DESIGNS .....	128
TRADEMARKS .....	129

## PUBLISHED TITLES OF PROTECTION

### INVENTIONS

- **APPLICATIONS APPROVED FOR GRANTING PATENT:**  
14479; 14256; 14632; 14366; 14093; 14272; 14455; 14273; 13496
- **PATENTED INVENTIONS:**  
6875-6879

### UTILITY MODELS

- **APPLICATION APPROVED FOR GRANTING PATENT:**  
14570
- **PATENTED UTILITY MODEL:**  
1971

### DESIGNS

- **APPLICATION APPROVED FOR REGISTRATION:**  
1027
- **DESIGNS WHICH HAVE BEEN REGISTERED WITH THE INTERNATIONAL BUREAU CLAIMING PRIORITY ON THE TERRITORY OF GEORGIA:**  
98168; 98195; 100455; 100458; 100557; 98296; 100617; 100631; 100760; 100785; 100798; 98434; 99270

### TRADEMARKS

- **APPLICATIONS FILED UNDER THE NATIONAL PROCEDURE APPROVED FOR REGISTRATION:**  
90032; 92585; 92797; 94010; 94018, 94019; 94402; 94433; 94561; 94578-94580; 94583; 94612, 94613; 94622; 94658; 94671; 94741; 94760; 94833; 94865; 94873; 94889; 94926; 94956; 94984-94987; 95006; 95009; 95011; 95020; 95026, 95027; 95031; 95033; 95039; 95052-95054; 95065, 95066; 95119; 95148; 95183, 95184; 95210-95213; 95238; 95259; 95317; 95320; 95339, 95340; 95346-95350; 95352; 95356; 95365; 95370; 95396; 95554; 95606; 95663, 95664; 95695
- **REGISTERED TRADEMARKS:**  
29852-29894
- **TRADEMARKS REGISTERED ACCORDING TO THE ACCELERATED PROCEDURE:**  
29835-29851; 29895-29897
- **INTERNATIONAL TRADEMARKS FOR WHICH A DECISION ON GRANTING PROTECTIONS IS TAKEN:**  
91971; 92288; 93656; 93746; 93749; 93760; 93784, 93785; 93906; 93910; 93916; 93923; 93945, 93946; 94048; 94051; 94072; 94088; 94092, 94093; 94113; 94115; 94121; 94125; 94162; 94202; 94209; 94213; 94215, 94216; 94218; 94289; 94294; 94296; 94306; 94447; 94451; 94474, 94475; 94477, 94478; 94519; 94521; 94748-94753; 94755; 94779; 94901, 94902; 94904- 94906; 94909, 94910
- **INTERNATIONAL TRADEMARKS PROTECTED IN GEORGIA:**  
89443; 90620; 90784; 91897; 92036; 92132; 92142; 92145, 92146; 92155, 92156; 92169; 92173, 92174; 92177-92179; 92181; 92198, 92199; 92201; 92203; 92207; 92210, 92211; 92214; 92227, 92228; 92230-92233; 92235-92238; 92241, 92242; 92248-92250; 92255; 92261; 92264, 92265; 92267; 92272; 92275-92277; 92279; 92399, 92400; 92403, 92404; 92406, 92407; 92410, 92411; 92421; 92423; 92430; 92447; 92450; 92455; 92457-92459; 92514, 92515; 92517; 92531; 92568; 92571; 92591, 92592; 92599; 92601; 92637-92639; 92641, 92642; 92644-92647; 92840; 92859; 92861, 92862; 92867-92869; 92872, 92873; 92875-92878; 92880, 92881; 93020, 93021; 93151; 93157, 93158; 93183; 93192; 93195; 93197; 93212; 93261; 93276; 93281; 93283, 93284; 93286; 93365; 93421, 93422; 93448, 93449; 94024

# INVENTIONS

## APPLICATIONS APPROVED FOR GRANTING PATENTS

The decision can be appealed at the Chamber of Appeal of Sakpatenti within 3 months from the publication or at the Mtskheta District Court Administrative Cases Board (Address: №17, Samkhedro str., Mtskheta), within 1 month following the publication.

### PART A

#### A 61

(10) AP 2018 14479 A (51) Int. Cl. (2006)  
A 61 B 17/32  
A 61 B 17/3207

(21) AP 2017 014479 (22) 2017 04 21

(71) Grigol Kvaratskhelia (GE);  
Petritsis q. 15, b. 4, 0156, Tbilisi (GE);  
Tamaz Obgadze (GE)  
Mukhianis dasakhl., IVa mkr., korp. 3,  
b. 115, 0174, Tbilisi (GE);  
Archil Prangishvili (GE)  
L. Pasteris q. 1, Tbilisi (GE)

(72) Grigol Kvaratskhelia (GE);  
Tamaz Obgadze (GE);  
Archil Prangishvili (GE)

(54) **DEVICE FOR CLEANING BLOOD  
VESSELS FROM HARMFUL  
DEPOSITION**

(57) A device 1 includes a catheter 2 and hauling block 3, wherein the catheter includes a flexor 4 executed in a form of sleeve; flexible axle 5 passing through it; a cutter 6; a chamber 8 collecting ground deposition having mesh or grid structure; hollow tip 16, and switched to hauling block the mover providing catheter motion with uniform velocity into blood vessel. Furthermore, hollow tip includes main case 17, and a head 18, wherein case one end is connected to sleeve-shaped flexor, and the head is formed as conic component 21 having ring basis 20; conic part of head is executed capable to be open, and the mover is executed as caterpillar mover.

Claims: 1 independent  
12 dependent

Fig.: 6

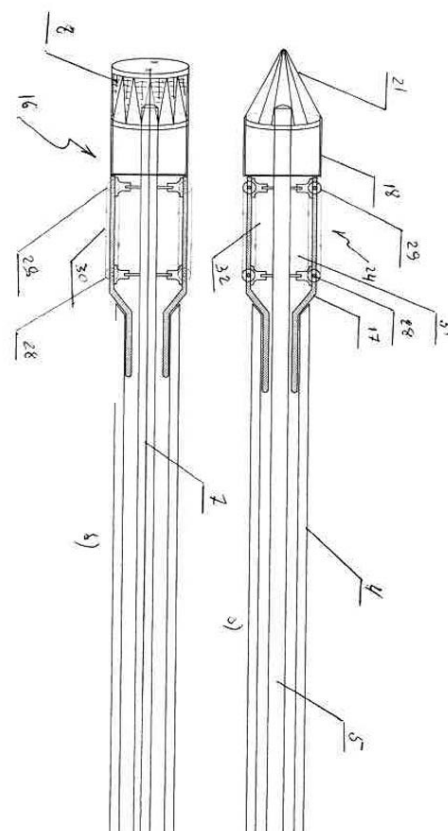

Fig. 2

(10) AP 2018 14256 A (51) Int. Cl. (2006)  
A 61 N 2/00  
A 61 N 2/02

(21) AP 2016 014256 (22) 2016 09 01

(71) Besik Surguladze (GE)  
Baratashvilis q. 6/10, b. 48, 0107,  
Tbilisi (GE)

(72) Besik Surguladze (GE)

(74) Davit Dzamukashvili

(54) **INDUCTION HEATING SYSTEM  
UNIT FOR LOCATOR HYPERTHERMIA  
DEVICE AND METHOD FOR  
HYPERTHERMIA**

(57) There is represented induction heating system unit for locator hyperthermia device and method for hyperthermia. The unit includes couple of Helmholtz coils disposed under 60-110° angles, which rings are executed with cupreous pipes. The

method provides nanoparticles introduction in damaged organ and heating therewith low-frequency magnetic field.

Claims: 2 independent  
2 dependent

Fig.: 1

## PART B

### B 01

(10) AP 2018 14632 A (51) Int. Cl. (2006)  
B 01 D 24/28

(21) AP 2017 14632 (22) 2017 11 22

(71) Avtandil Rokhvadze (GE)

Al. Kazbegis gamz. 10a, b. 66, 0177,  
Tbilisi (GE)

(72) Avtandil Rokhvadze (GE)

(54) **CONSTRUCTIVELY COMBINED  
NODE FOR NONPRESSURE SANDY  
FILTERS AND SAID FILTERS  
EQUIPPED THEREWITH**

(57) A filter includes a case 1 consisting of main part 2 and conic-shaped hollow basis 3. The case is equipped with pipelines 4, 5 and 6 for, subject of purification, the liquid supplement and withdrawal thereof and washing liquid, accordingly. Filtering material 7 as quartz sand is placed in the case. Filtering aggregate, which in its turn includes an airlift 8, washing node 9 installed thereon, and air reservoir 10 executed capable to be connected to condensed air source, is installed along case vertical axle. Distributing liquid node 11 and distributing sand node 12 are placed in the case, as well. Washing node is formed with two parts, lower part 13 wherefrom has one compartment with zigzag channel 14 formed therein, and upper part has two concentrically disposed inner 15 and outer 16 compartments, disposed relative to each other in liquid connection. Inner head compartment is disposed under zigzag channel, and pipeline withdrawing washing liquid is connected to outer compartment. Barrier, reducing washing liquid speed and incoming in washing node inner compartment upper part stream pressure, is executed in inner compartment. The filter is equipped with vibrating aerator 20 inserted or executed capable to be installed in filtering aggregate washing node lower part zigzag channel. Said filter can be equipped with a means providing airlift vibration. Disposed on the airlift the air reservoir 10, wherein the balls made with flexible material or executed as separate componentry can be represented as said means.

Claims: 3 independent  
21 dependent

Fig.: 8

Table: 1

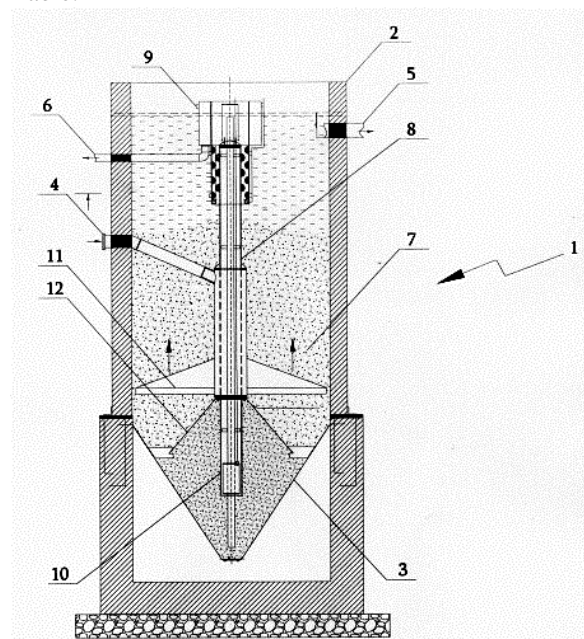

Fig. 1

### B 23

(10) AP 2018 14366 A (51) Int. Cl. (2006)  
B 23 K 20/04  
B 22 D 11/06

(21) AP 2016 014366 (22) 2016 12 27

(71) LEPL Ferdinand Tavadze Metallurgy  
and Materials Science Institute (GE)  
Mindelis q. 10, 0186, Tbilisi (GE)

(72) Giorgi Kevkhishvili (GE);  
Teimuraz Namicheishvili (GE);  
Irakli Zhordania (GE);  
Vazha Ramishvili (GE);  
Dzhulieta Loria (GE);  
Natela Kvataia (GE);  
Giorgi Tavadze (GE);  
Orest Ivasishin (UA)

(54) **METHOD FOR ALUMINUM BASED  
COMPOSITE ARMoured PLATE  
PRODUCTION**

(57) A method provides forming high firmness aluminum medium layer in a form of plate workpiece, before hitting therein said workpiece rolling zone. Relatively low firmness and high plasticity aluminum melt (Al - Zn - Mg) supplement is executed between roll crystallizers and before layers direct connection by rolling therewith each other. The workpiece is initially passed through soft slag layer preliminarily disposed under said melt material and then in roll crystallizers in liquid phase of already formed casting; wherein, before passing between the rolls,



centering thereof is executed by means of contraction cavity.

Claims: 1 independent

Fig.: 2

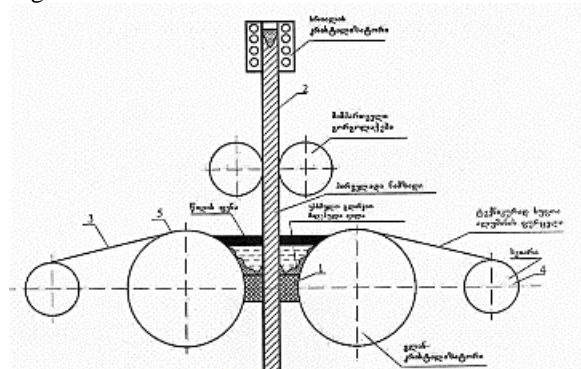
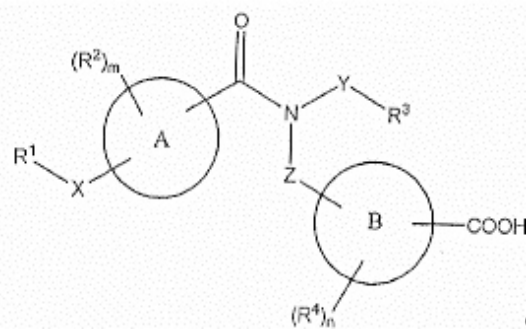

Fig. 2

## PART C

### C 07

- (10) AP 2018 14093 A (51) Int. Cl. (2006)  
 C 07 C 235/52  
 C 07 D 213/81  
 C 07 D 239/34  
 A 61 K 31/44  
 A 61 K 31/505  
 A 61 P 9/10  
 A 61 P 29/00
- (21) AP 2014 014093 (22) 2014 08 20  
 (31) 1314926.5  
 (32) 2013 08 20  
 (33) GB  
 (71) TAKEDA PHARMACEUTICAL COMPANY LIMITED (JP)  
 1-1, Doshomachi 4-Chome Chuo-Ku  
 Osaka-Shi, Osaka 541-0045 (JP)
- (72) BUFFHAM, William (GB);  
 CANNING, Hannah (GB);  
 DAVENPORT, Richard (GB);  
 FARNABY, William (GB);  
 MACK, Stephen (GB);  
 PARMAR, Alka (GB);  
 WRIGHT, Susanne (GB)
- (74) Aleksandre Gegechkori  
 (85) 2016 03 17  
 (86) PCT/GB2014/052558, 2014 08 20
- (54) **AMIDE DERIVATIVES AS LYSOPHOSPHATIDIC ACID RECEPTOR ANTAGONISTS**
- (57) Compound of formula (I),



(I)

wherein values of R<sup>1</sup>, R<sup>2</sup>, R<sup>3</sup>, R<sup>a</sup>, R<sup>b</sup>, L, X substituents and n, m variables are provided in the claims or pharmaceutically acceptable salt thereof, pharmaceutical composition on a basis thereof. Preparation method of said compound and usage thereat the treatment of conditions related to LPAR1 activity, such as fibrosis, hepatopathy, atherosclerosis, pain, etc.

Claims: 7 independent

10 dependent

Table: 8

- (10) AP 2018 14272 A (51) Int. Cl. (2006)  
 C 07 D 401/04  
 C 07 D 277/82  
 C 07 D 263/58  
 A 61 K 31/428  
 A 61 P 25/18

- (21) AP 2015 014272 (22) 2015 02 19  
 (31) 14156010.2  
 (32) 2014 02 20  
 (33) EP  
 (71) TAKEDA PHARMACEUTICAL COMPANY LIMITED (JP)  
 1-1, Doshomachi 4-Chome Chuo-Ku  
 Osaka-Shi, Osaka 541-0045 (JP)
- (72) FIELDHOUSE, Charlotte (GB);  
 GLEN, Angela (GB);  
 FUJIMOTO, Tatsuhiko (JP);  
 ROBINSON, John Stephen (GB)
- (74) Tamar Kochlamazashvili  
 (85) 2016 09 20  
 (86) PCT/GB2015/050482, 2015 02 19
- (54) **SUBSTITUTED CYCLOPENTANES, TETRAHYDROFURANES AND PYRROLIDINES AS OREXIN RECEPTOR ANTAGONISTS**
- (57) Compound of formula (I),

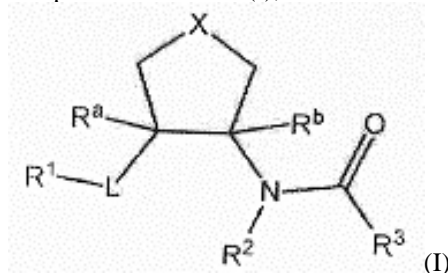

(I)

wherein values of  $R^1$ ,  $R^2$ ,  $R^3$ ,  $R^a$ ,  $R^b$ , L, X substituents are provided in the claims or pharmaceutically acceptable salt thereof, pharmaceutical compositions containing them, and their usage at the therapy.

Claims: 5 independent  
10 dependent

Table: 1

**(10) AP 2018 14455 A (51) Int. Cl. (2006)**  
**C 07 D 401/14**  
**A 61 K 31/454**  
**A 61 P 29/02**  
**A 61 P 37/08**

(21) AP 2015 014455 (22) 2015 09 22  
(31) 62/209,124; 62/110,048; 62/055,811  
(32) 2015 08 24; 2015 01 30; 2014 09 26  
(33) US; US; US  
(71) PFIZER INC. (US)  
235 East 42<sup>nd</sup> Street New York, NY 10017 (US)  
(72) FLICK, Andrew Christopher (US);  
JONES, Peter (GB);  
KAILA, Neelu (US);  
MENTE, Scot Richard (US);  
SCHNUTE, Mark Edward (US);  
TRZUPEK, John David (US);  
VAZQUEZ, Michael L. (US);  
XING, Li (US);  
ZHANG, Liying (CN);  
WENNERSTÅL, Göran Mattias (SE);  
ZAMARATSKI, Edouard (SE)

(74) Shalva Gvaramadze

(85) 2017 03 23

(86) PCT/IB2015/057314, 2015 09 22

**(54) METHYL-AND TRIFLUOROMETHYL-SUBSTITUTED PYRROLOPYRIDINE MODULATORS OF RORC2 AND METHODS OF USE THEREOF**

(57) An invention relates to methyl-and trifluoromethyl-substituted pyrrolopyridines, of formula (I),

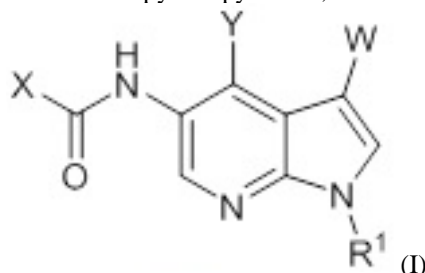

pharmaceutical compositions thereof, methods of modulating ROR $\gamma$  activity and/or reducing amount of IL-17 in a subject, and usage of pyrrolopyridines and pharmaceutical compositions thereof at the treatment of various medical disorders.

Claims: 7 independent  
2 dependent

Fig.: 2

**(10) AP 2018 14273 A (51) Int. Cl. (2006)**  
**C 07 D 213/74**  
**C 07 D 239/42**  
**C 07 D 249/06**  
**C 07 D 271/07**  
**C 07 D 231/12**  
**A 61 K 31/44**  
**A 61 K 31/506**  
**A 61 P 25/18**

(21) AP 2015 014273 (22) 2015 02 19

(31) 14156011.0

(32) 2014 02 20

(33) EP

(71) TAKEDA PHARMACEUTICAL COMPANY LIMITED (JP)

1-1, Doshomachi 4-Chome Chuo-Ku  
Osaka-Shi, Osaka 541-0045 (JP)

(72) FIELDHOUSE, Charlotte (GB);

GLEN, Angela (GB);

MAINE, Stephanie (GB);

FUJIMOTO, Tatsuhiko (JP);

ROBINSON, John Stephen (GB)

(74) Tamar Kochlamazashvili

(85) 2016 09 20

(86) PCT/GB2015/050480, 2015 02 19

**(54) 1,2-SUBSTITUTED CYCLOPENTANES AS OREXIN RECEPTOR ANTAGONISTS**

(57) Compound of formula (I),

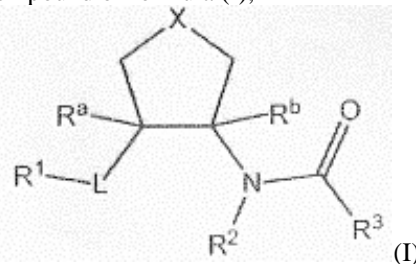

wherein values of  $R^1$ ,  $R^2$ ,  $R^3$ ,  $R^a$ ,  $R^b$ , L, X substituents are provided in the claims or pharmaceutically acceptable salt thereof, pharmaceutical compositions containing them, and their usage at the therapy.

Claims: 5 independent

11 dependent

Table: 1

**(10) AP 2018 13496 A (51) Int. Cl. (2006)**  
**C 07 K 16/28**  
**A 61 K 39/395**  
**A 61 P 35/02**  
**A 61 P 37/00**

(21) AP 2012 013496 (22) 2012 11 15

(31) 61/560,144; 61/560,149; 61/560,162;  
61/560,178; 61/560,183; 61/651,486;  
61/651,474

(32) 2011 11 15; 2011 11 15; 2011 11 15;  
2011 11 15; 2011 11 15; 2012 05 24;  
2012 05 24

(33) US; US; US; US; US; US; US

(71) Amgen Research (Munich) GMBH (DE)

Staffelsestr. 2 81477 Munich (DE);

Boehringer Ingelheim International

GMBH (DE)

Binger Strasse 173 55216 Ingelheim

am Rhein (DE)

(72) KUFER, Peter (DE);

RAUM, Tobias (DE);

HOFFMANN, Patrick (DE);

KISCHEL, Roman (DE);

LUTTERBUESE, Ralf (DE);

RAU, Doris (DE);

ADAM, Paul (DE);

BORGES, Eric (DE);

HEBEIS, Barbara (DE);

HIPP, Susanne (DE)

(74) Aleksandre Gegechkori

(85) 2014 06 09

(86) PCT/EP2012/072699, 2012 11 15

(54) **BINDING MOLECULES FOR BCMA**

**AND CD3**

(57) An invention relates to binding molecules, wherein first binding domain is capable of binding to epitope cluster 3 of BCMA, and second binding domain is capable of binding to Tcell CD3 epsilon. Said molecules are usefull at the treatment of diseases related to plasma- and other Bcells disorders.

Claims: 9 independent

13 dependent

Fig.: 17

---

# PATENTED INVENTIONS

## PART A

### A 61

- (11) **P 2018 6877 B**      (51) **Int. Cl. (2006)**  
    **A 61 K 36/537**  
    **A 61 K 36/258**  
    **A 61 K 31/343**  
    **A 61 K 31/192**  
    **A 61 K 31/11**  
    **A 61 K 31/045**  
    **A 61 K 9/20**  
    **A 61 K 9/10**
- (10) AP 2018 14057 A      (44) 6(490)/2018  
 (21) AP 2014 014057  
 (22) 2014 07 11  
 (24) 2014 07 11  
 (31) 201410085152.6; 201410044675.6;  
       201310384234.6; 201310290968.8  
 (32) 2014 03 10; 2014 01 30; 2013 08 29;  
       2013 07 11  
 (33) CN; CN; CN; CN  
 (86) PCT/CN2014/082102, 2014 07 11  
 (73) **TASLY PHARMACEUTICAL GROUP**  
       **CO., LTD (CN)**  
       Tasly Modern TCM Garden, Pu Jihe East  
       Road No.2, Beichen District, Tianjin  
       300410 (CN)  
 (72) **YAN, Xijun (CN);**  
       **WU, Naifeng (CN);**  
       **YAN, Kaijing (CN);**  
       **YE, Zhengliang (CN);**  
       **ZHANG, Shunnan (CN);**  
       **ZHOU, Lihong (CN);**  
       **ZHANG, Wensheng (CN);**  
       **DONG, Hai'ou (CN)**  
 (74) Larisa Amirkhanyan  
 (54) **TRADITIONAL CHINESE MEDICINE**  
       **COMPOSITION, AND PREPARATION**  
       **AND APPLICATION THEREOF**

## PART C

### C 07

- (11) **P 2018 6876 B**      (51) **Int. Cl. (2006)**  
    **C 07 D 401/14**  
    **C 07 D 413/14**  
    **A 61 K 31/454**  
    **A 61 K 31/497**  
    **A 61 K 31/506**  
    **A 61 K 31/519**  
    **A 61 K 31/5355**  
    **C 07 D 401/04**  
    **C 07 D 407/14**  
    **C 07 D 413/04**  
    **C 07 D 417/14**  
    **C 07 D 471/04**  
    **C 07 D 487/04**  
    **A 61 P 29/02**  
    **A 61 P 37/08**
- (10) AP 2018 14046 A      (44) 5(489)/2018  
 (21) AP 2014 014046  
 (22) 2014 07 24  
 (24) 2014 07 24  
 (31) 61/861,709  
 (32) 2013 08 02  
 (33) US  
 (86) PCT/IB2014/063383, 2014 07 24  
 (73) **PFIZER INC. (US)**  
       235 East 42<sup>nd</sup> Street New York, NY 10017 (US)  
 (72) **BLINN, James, Robert (US);**  
       **FLICK, Andrew, Christopher (US);**  
       **WENNERSTÅL, Göran, Mattias (SE);**  
       **JONES, Peter (US);**  
       **KAILA, Neelu (US);**  
       **KIEFER, James, Richard, Jr. (US);**  
       **KURUMBAIL, Ravi, G. (US);**  
       **MENTE, Scot, Richard (US);**  
       **MEYERS, Marvin, Jay (US);**  
       **SCHNUTE, Mark, Edward (US);**  
       **THORARENSEN, Atli (US);**  
       **XING, Li (US)'**  
       **ZAMARATSKI, Edouard (SE);**  
       **ZAPF, Christoph, Wolfgang (US)**  
 (74) Shalva Gvaramadze  
 (54) **HETEROBICYCLOARYL RORC2**  
       **INHIBITORS AND METHODS OF USE**  
       **THEREOF**

- (11) **P 2018 6875 B**      (51) **Int. Cl. (2006)**  
    **C 07 D 403/06**  
    **A 61 K 31/506**  
    **A 61 K 31/7072**

**A 61 P 35/00**  
**A 61 P 43/00**

(10) AP 2018 14034 A (44) 5(489)/2018  
(21) AP 2014 014034  
(22) 2014 06 17  
(24) 2014 06 17  
(31) 2013-126567  
(32) 2013 06 17  
(33) JP  
(86) PCT/JP2014/065985, 2014 06 17  
(73) TAIHO PHARMACEUTICAL CO., LTD  
1-27 Kandnishiki-cho, Chiyoda-ku, Tokyo  
1018444 (JP)  
(72) KAZUNO, Hideki (JP);  
MUTSUMI, Tomonobu (JP)  
(74) Shalva Gvaramadze  
(54) **STABILIZED CRYSTAL OF TIPIRACIL  
HYDROCHLORIDE, AND CRYSTALLI-  
ZATION METHOD FOR SAME**

---

(11) P 2018 6879 B (51) Int. Cl. (2006)  
C 07 D 417/08  
A 61 K 31/433  
A 61 P 35/00

(10) AP 2018 14314 A (44) 6(490)/2018  
(21) AP 2015 014314  
(22) 2015 04 17  
(24) 2015 04 17  
(31) 61/986,876  
(32) 2014 04 30  
(33) US  
(86) PCT/IB2015/052833, 2015 04 17  
(73) PFIZER INC. (US)  
235 East 42<sup>nd</sup> Street New York, NY 10017 (US)  
(72) BURNS, Aaron Craig (US);  
COLLINS, Michael Raymond (US);  
GREASLEY, Samantha Elizabeth (GB);  
HOFFMAN, Robert Louis (US);  
HUANG, Qinhua (CN);  
KANIA, Robert Steven (US);  
KUNG, Pei-Pei (US);  
LINTON, Maria Angelica (US);  
NARASIMHAN, Lakshmi Sourirajan (US);  
RICHARDSON, Paul Francis (GB);  
RICHTER, Daniel Tyler (US);  
SMITH, Graham (GB)  
(74) Tamar Kochlamazashvili  
(54) **CYCLOALKYL-LINKED DIHETEROCYCLE  
DERIVATIVES**

---

(11) P 2018 6878 B (51) Int. Cl. (2006)  
C 07 D 473/16  
C 07 D 473/18  
C 07 D 519/00  
A 61 K 31/522  
A 61 P 35/00

(10) AP 2018 14151 A (44) 6(490)/2018

(21) AP 2014 014151  
(22) 2014 11 10  
(24) 2014 11 10  
(31) 61/907,322  
(32) 2013 11 21  
(33) US  
(86) PCT/IB2014/065935, 2014 11 10  
(73) PFIZER INC. (US)  
235 East 42<sup>nd</sup> Street New York, NY 10017 (US)  
(72) BEHENNA, Douglas Carl (US);  
CHENG, Hengmiao (US);  
CHO-SCHULTZ, Sujin (US);  
JOHNSON JR., Theodore Otto (US);  
KATH, John Charles (US);  
NAGATA, Asako (JP);  
NAIR, Sajiv Krishnan (US);  
PLANKEN, Simon Paul (US)  
(74) Tamar Kochlamazashvili  
(54) **2,6-SUBSTITUTED PURINE DERIVATIVES  
AND THEIR USE IN THE TREATMENT  
OF PROLIFERATIVE DISORDERS**

---

---

# UTILITY MODELS

## APPLICATION APPROVED FOR GRANTING PATENT

The decision can be appealed at the Chamber of Appeal of Sakpatenti within 3 months from the publication or at the Mtskheta District Court Administrative Cases Board (Address: №17, Samkhedro str., Mtskheta), within 1 month following the publication.

### PART A

#### A 61

(10) AU 2018 14570 U (51) Int. Cl. (2006)  
A 61 K 35/76

(21) AU 2017 14570 (22) 2017 08 16

(71) Taras Gabisonia (GE)

I. Chavchavadzis gamz. 39b, 0162,

Tbilisi (GE);

G. Eliava Institute of Bacteriophages,

Microbiology and Virology (GE)

Gotuas q. 3, Tbilisi (GE)

(72) Taras Gabisonia (GE)

(54) **METHOD FOR BACTERIOPHAGE**

**DRUGS PREPARATION TO USE**

**THEREIN VETERINARY MEDICINE**

(57) There is executed cultivation of staphylococccic bacteria (S.aureus, S.epidermidis), various serotypes of colibacilli, proteuses (P.hauseri, P.mirabilis, P.myxofaciens, P.vulgaris), and salmonellae (S. Enteritidis, S. Cholera suis, S. Typhimurium, S. Gallinarum) separately on the broth; passaging thereon the bacteriophages; their race selection; phage lysates chromatographic purification; and their mixing together for bacteriophage drugs preparation. At that, bacteria cultivation is executed on the broth containing the following componentry, g/l:

Beef heart-brain decoction tincture – 5;

Sodium chloride – 5;

Beef extract – 1,5;

Yeast extract –1,5;

Dextrose –1 ;

Gelatine – 1.

Claims: 1 independent

---

## PATENTED UTILITY MODEL

### PART E

#### E 04

**(11) U 2018 1971 Y (51) Int. Cl. (2006)  
E 04 B 5/00**

(10) AU 2018 14331 U (44) 4(488)/2018

(21) AU 2016 014331

(22) 2016 11 28

(24) 2016 11 28

(73) Gia Bokhua (GE)

O. Oniashvilis q. 37/39-41, b. 4, 0160,  
Tbilisi (GE)

(72) Gia Bokhua (GE)

(54) **SLIDING ROOF**

---

# DESIGNS

## APPLICATION APPROVED FOR REGISTRATION

The decision can be appealed at the Chamber of Appeal of Sakpatenti within 3 months from the publication or at the Mtskheta District Court Administrative Cases Board (Address: №17, Samkhedro str., Mtskheta), within 1 month following the publication.

- (10) AD 2018 1027 S (51) 19-08  
(21) AD 2018 1027 (22) 2018 03 13  
(28) 3  
(71) LLC "KARTVELI" (GE)  
Kakhetis gzatk. 110a, 0151, Tbilisi, Isani-Samgoris r-ni, Georgia(GE)  
(72) Zviad Tsikolia (GE)  
(74) Davit Dzamukashvili (GE)  
(54) 1.-3. LABEL  
(55)



1.1

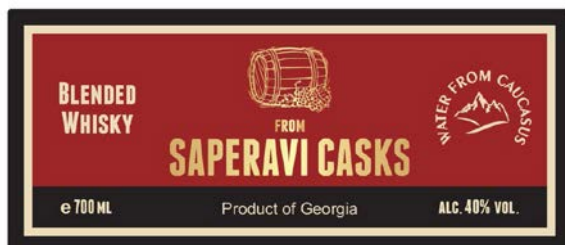

1.2



1.3





2.1



2.2



2.3



3.1

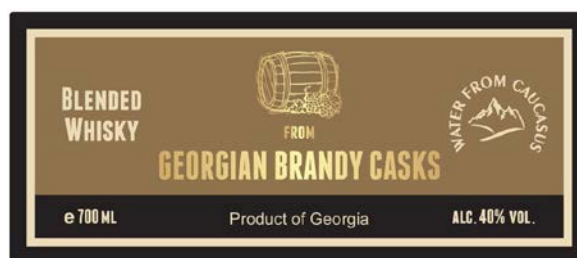

3.2



3.3

## DESIGNS, WHICH HAVE BEEN REGISTERED WITH THE INTERNATIONAL BUREAU CLAIMING PRIORITY ON THE TERRITORY OF GEORGIA

The decision can be appealed at the Chamber of Appeal of Sakpatenti within 3 months from the publication or at the Mtskheta District Court Administrative Cases Board (Address: №17, Samkhedro Str., Mtskheta), within 1 month following the publication.

(11) DM/098168

(51) 10-02, 07

(15) 2017 10 17

(45) 2018/15 (2018 04 20)

(22) 2017 10 17

(28) 4

(73) OMEGA SA (OMEGA AG) (OMEGA LTD.)

Jakob-Stämpfli-Strasse 96, CH-2502 Biel/Bienne (CH)

(85) CH

(86) CH

(87) CH

(88) CH

(89) CH

(81) II. BZ, MA III. AL, AM, AZ, BA, CH, EM, GE, KG, LI, MC, MD, ME, MK, MN, NO, OM, SG, TN, TR, UA

(72) Jean-Claude Monachon

Rue Alice-de-Chambrier 1, 2022 Bevaix, Suisse

(54) 1. Watch case; 2.-3. Watches; 4. Watch winding crown

(55)

1.1

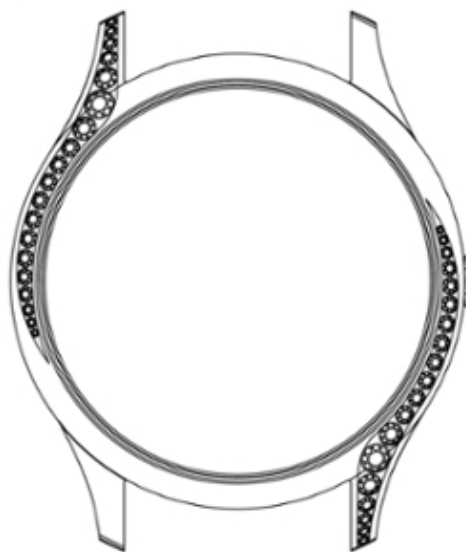

1.2

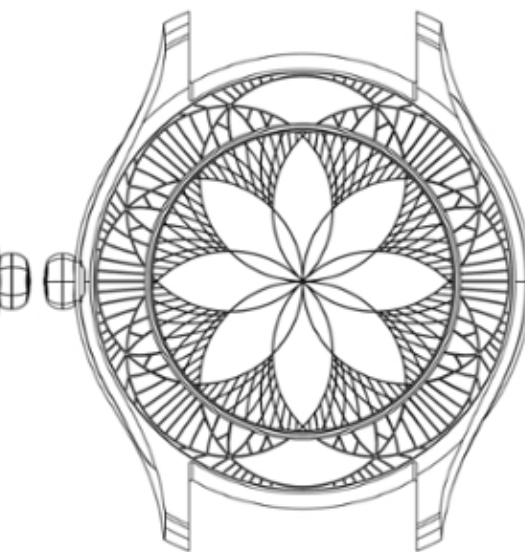

1.3



1.4



1.5



1.6



1.7



1.8

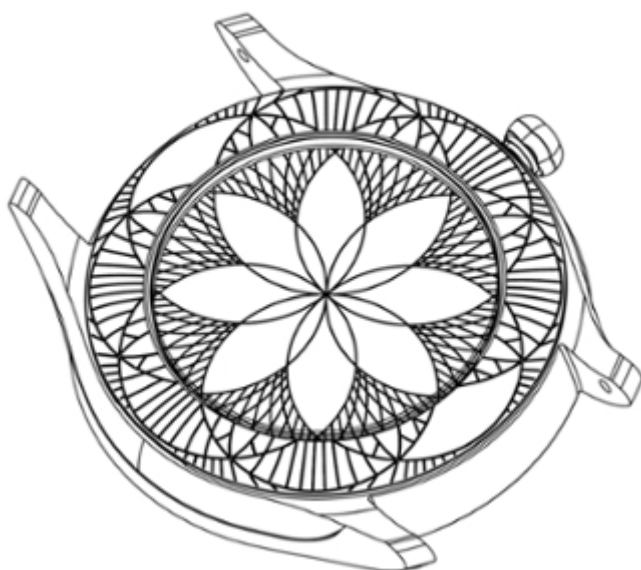

2.1

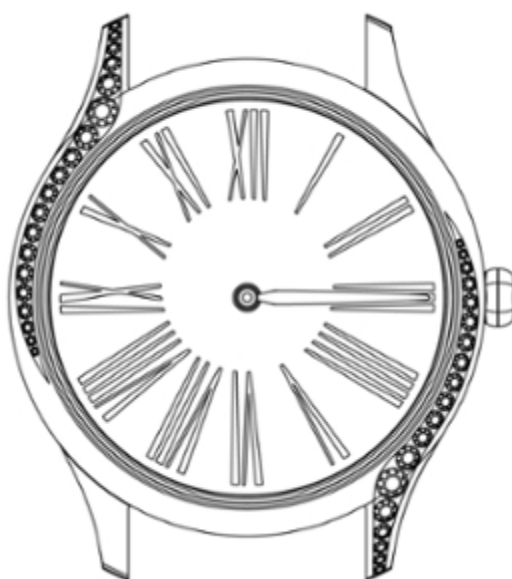

2.2

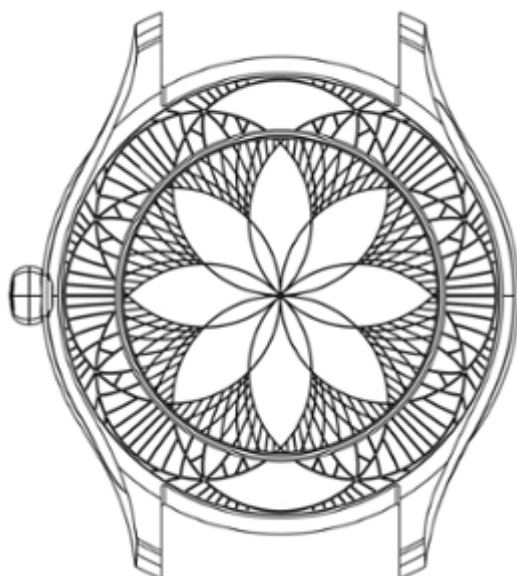

2.3



2.4



2.5



2.6



2.7



3.1

2.8

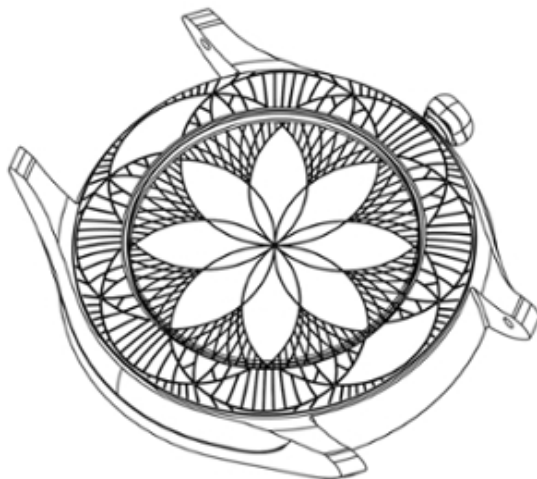

3.2

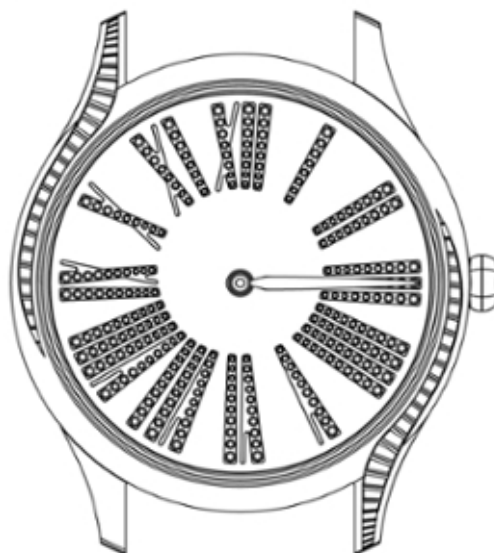

3.3

3.4

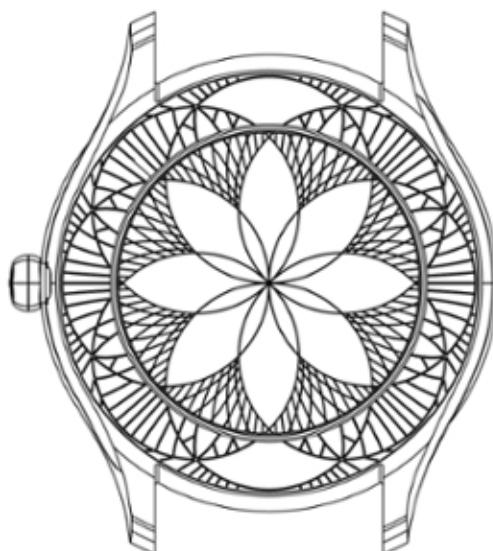

3.5



3.6



3.8

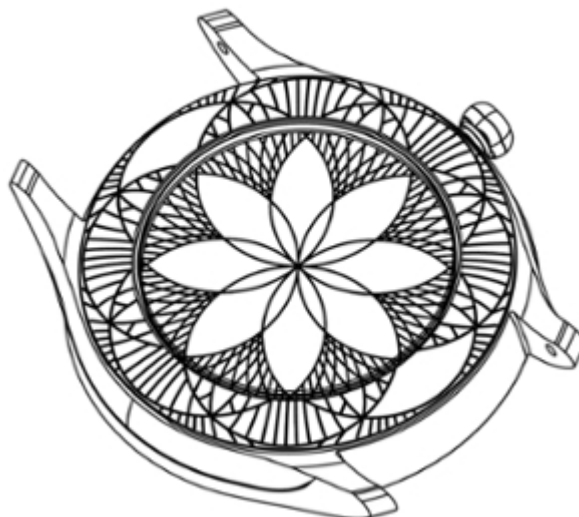

3.7

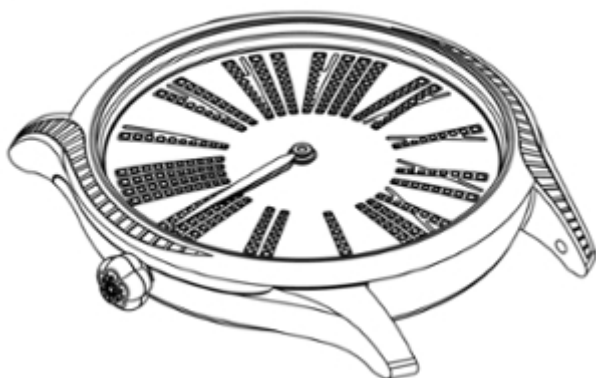

4.1

4.2

4.3

4.4

4.5

4.6



4.7

4.8



(11) DM/098195

(51) 10-07

(15) 2017 10 18

(45) 2018/15 (2018 04 20)

(22) 2017 10 18

(28) 2

(73) OMEGA SA (OMEGA AG) (OMEGA LTD.)

Jakob-Stämpfli-Strasse 96, CH-2502 Biel/Bienne (CH)

(85) CH

(86) CH

(87) CH

(88) CH

(89) CH

(81) II. BZ, MA III. AL, AM, AZ, BA, CH, EM, GE, KG, LI, MC, MD, ME, MK, MN, NO, OM, SG, TN, TR, UA

(72) Jean-Claude Monachon

Rue Alice-de-Chambrier 1, 2022 Bevaix, Suisse

(54) 1.-2. Dials

(55)

1.1

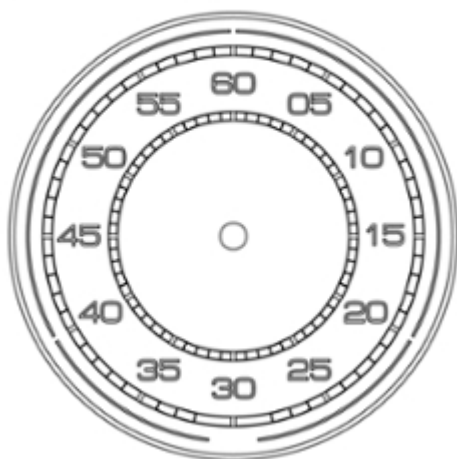

1.2

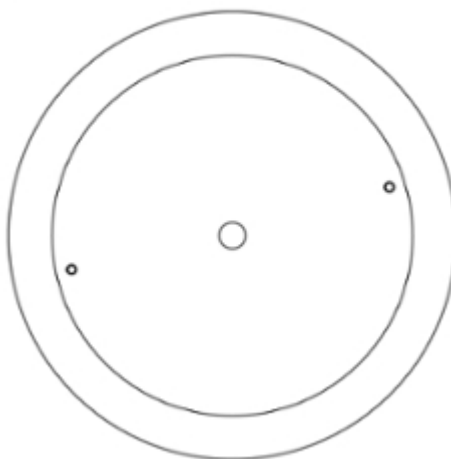

1.3



1.4



1.5



1.6



1.8

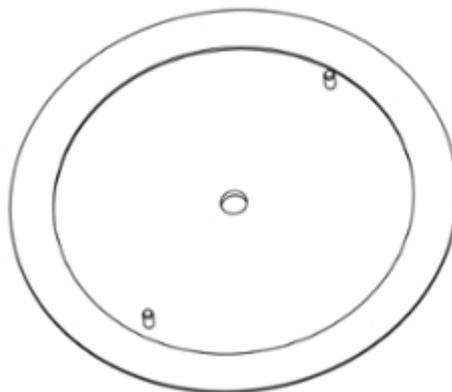

1.7

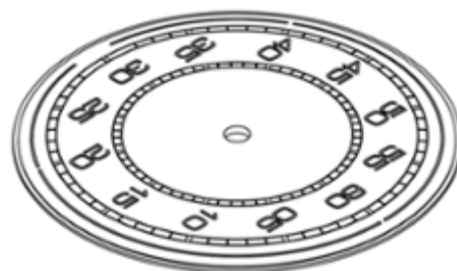

2.1



2.2

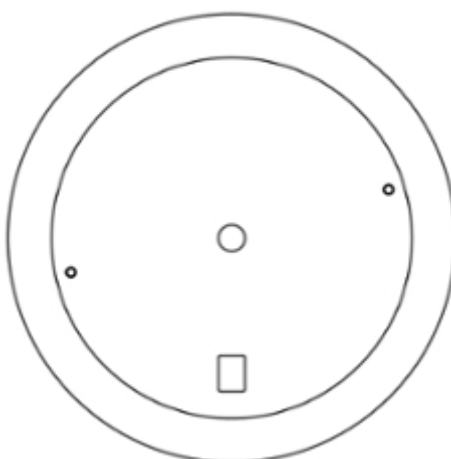

2.3 2.4



2.5



2.6



2.8

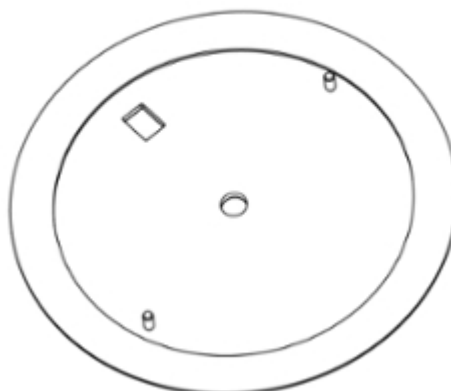

2.7





(11) DM/100455

(51) 10-02, 07

(15) 2018 03 21

(45) 2018/15 (2018 04 20)

(22) 2018 03 21

(28) 2

(73) OMEGA SA (OMEGA AG) (OMEGA LTD.)

Jakob-Stämpfli-Strasse 96, CH-2502 Biel/Bienne (CH)

(85) CH

(86) CH

(87) CH

(88) CH

(89) CH

(81) II. BZ, MA III. AL, AM, AZ, BA, CH, EM, GE, KG, LI, MC, MD, ME, MK, MN, NO, OM, SG, TN, TR, UA

(72) Jean-Claude Monachon

Rue Alice-de-Chambrier 1, 2022 Bevaix,

(54) 1. Watch; 2. Watch movement

(55)

1.1



1.2



1.3



1.4



2.1



2.2



2.3



2.4



(11) DM/100458

(51) 03-01

(15) 2018 03 29

(45) 2018/15 (2018 04 20)

(22) 2018 03 29

(28) 3

(73) VALENTINO S.P.A.

Via Turati, 16/18, I-20121 Milano (IT)

(85) –

(86) EM, IT

(87) EM, IT

(88) EM, IT

(89) EM

(81) III. AZ, EM, GE, JP, KG, KR, RU, TJ, TR, UA

(72) SASSI Stefano

c/o VALENTINO S.p.A. Via Turati, 16/18, I-20121 Milano, Italy

(54) 1.-3. Bags

(55)

1.1



1.2



1.3

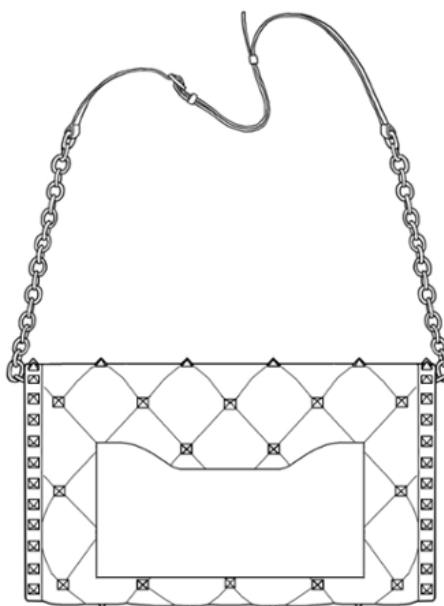

1.4



1.5



1.6

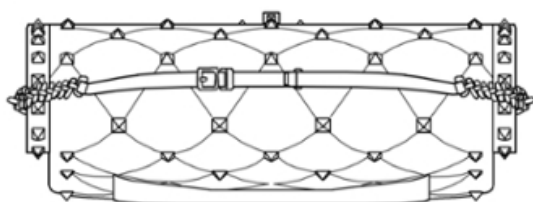

1.7

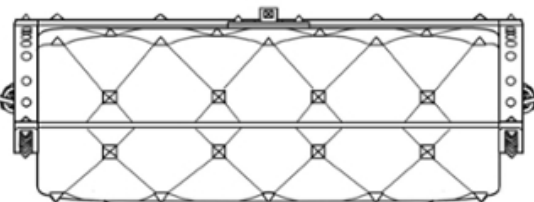

2.1



2.2



2.3



2.4



2.5

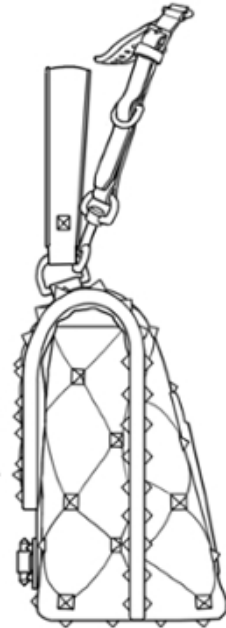

2.6

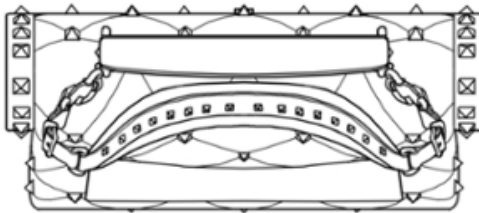

2.7

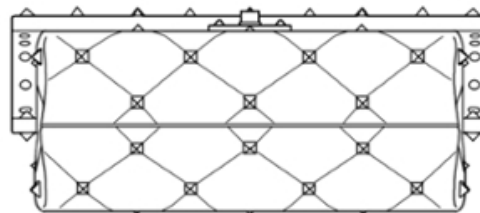

3.1

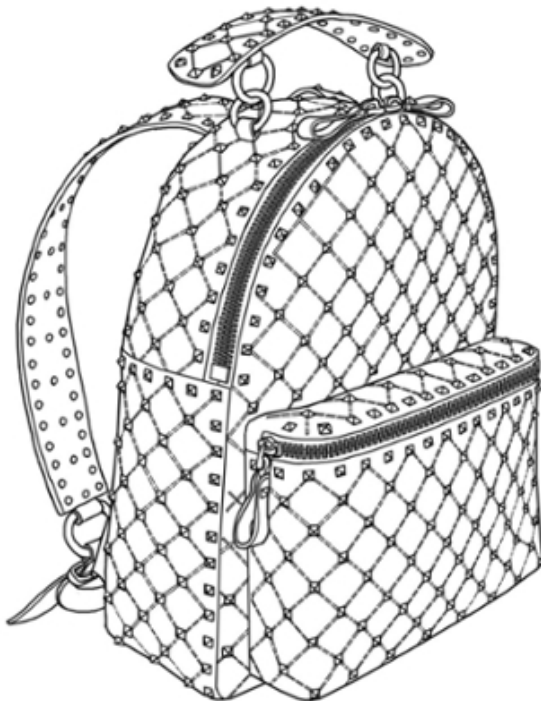

3.2



3.3

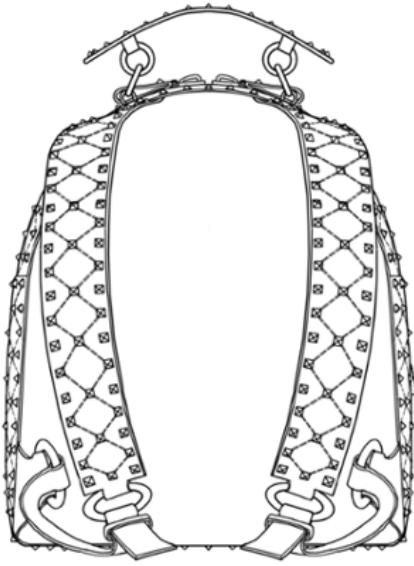

3.4

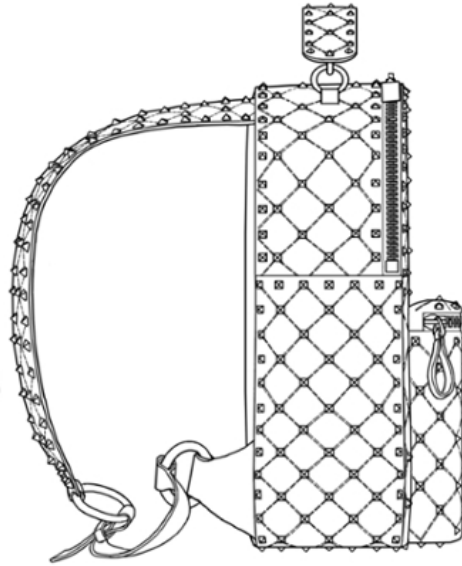

3.5

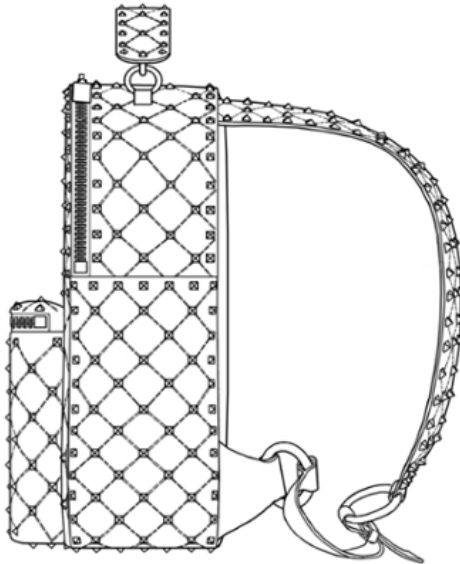

3.6

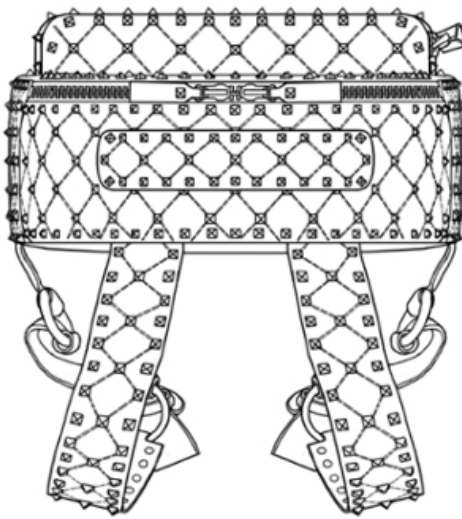

3.7

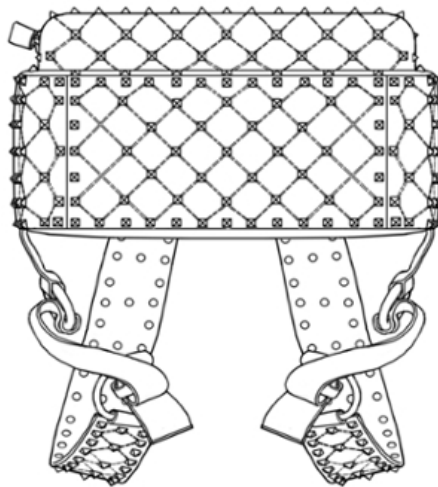

**(11) DM/100557**

(15) 2017 12 26

(22) 2017 12 26

(28) 4

(73) DERNEK GRUP ELEKTRİK ELEKTRONİK DİŞ TİCARET VE SANAYİ LİMİTED SİRKETİ

Istanbul Trakya Serbest Bolgesi Ferhatpasa Sb Mahallesi, Sumbul Sokak No:5/41, Catalca, Istanbul (TR)

(85) TR

(86) TR

(87) TR

(88) TR

(89) TR

(81) III. AL, AM, AZ, BA, BG, EG, EM, ES, FR, GE, GH, HU, KG, LT, LV, ME, MK, MN, NA, OA, OM, PL, RO, RS, SI, SY, TJ, UA

(72) TUNCAY CEYRAN

ISTANBUL TRAKYA SERBEST BOLGESİ FERHATPASA SB MAHALLESİ SUMBUL SOKAK

NO:5/41, ISTANBUL, Turkey

(54) 1.-2. Electrical switches; 3.-4. Electrical sockets

(55)

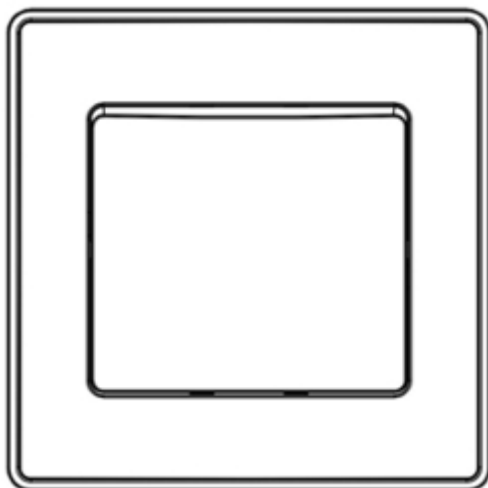
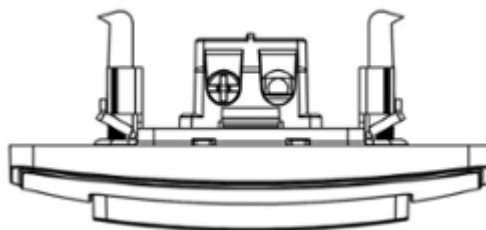
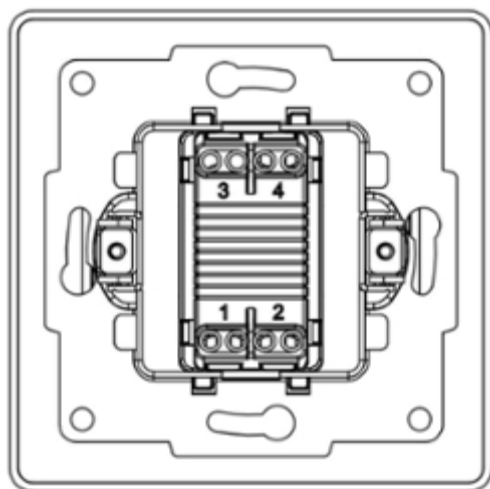
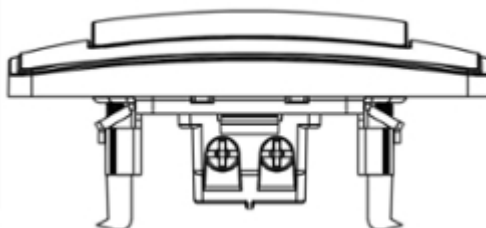
**1.1****1.2****1.3****1.4**

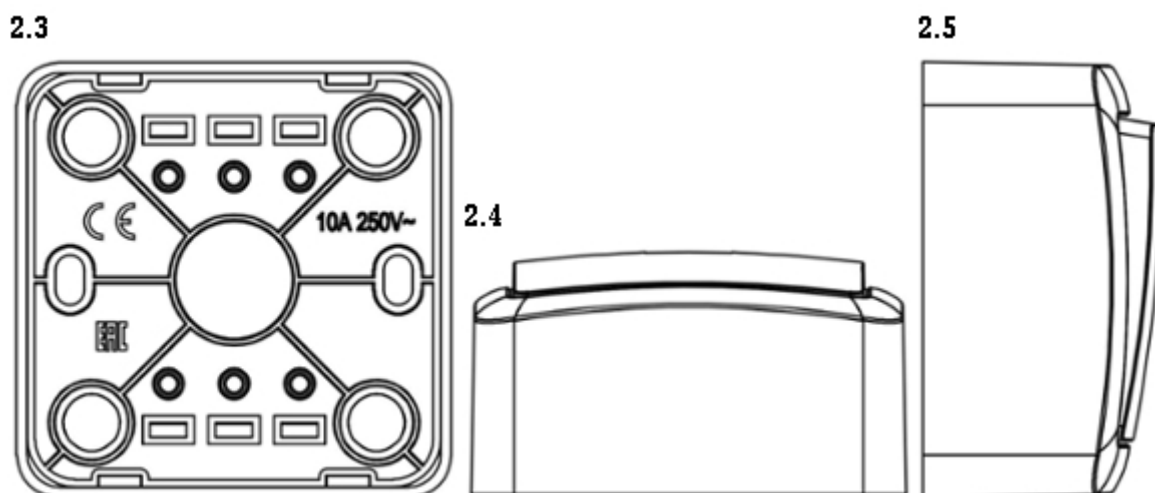
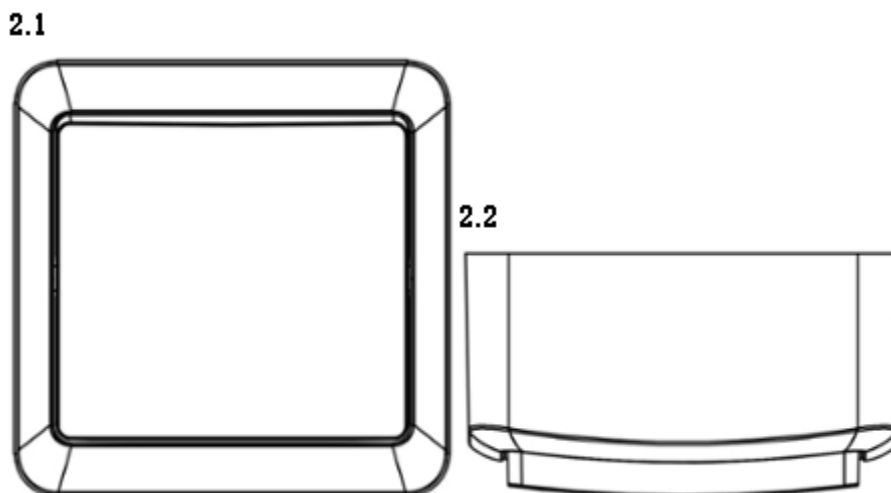
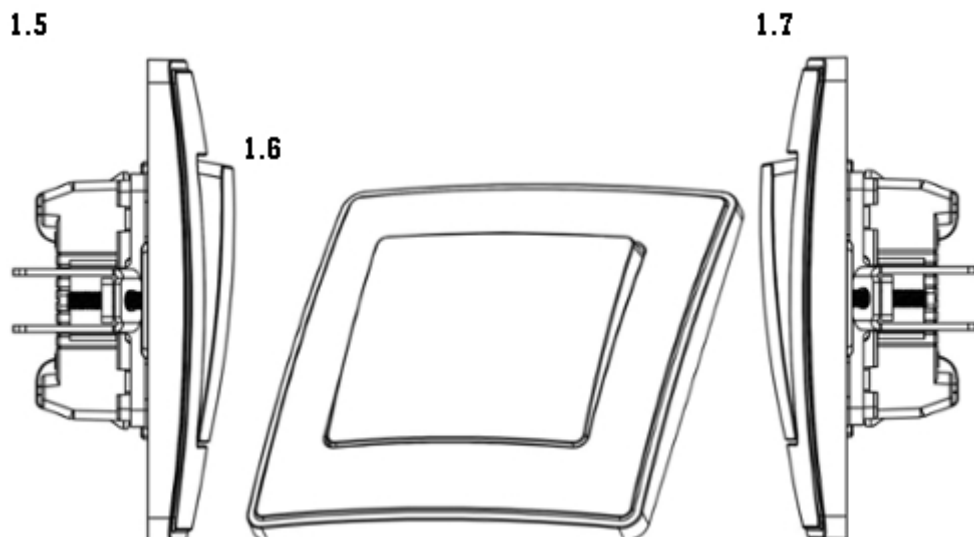



2.6

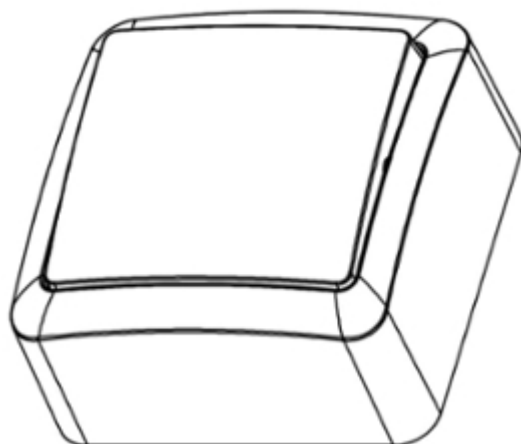

2.7



3.1

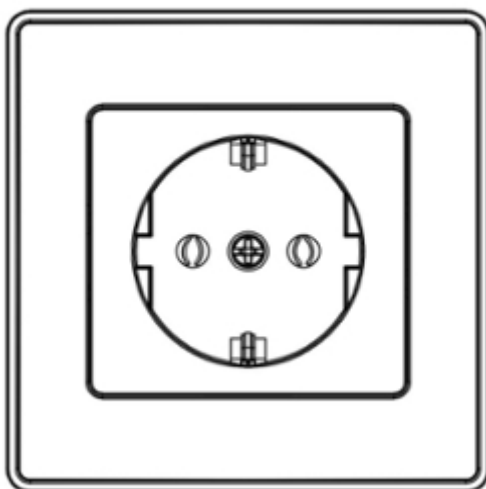

3.2

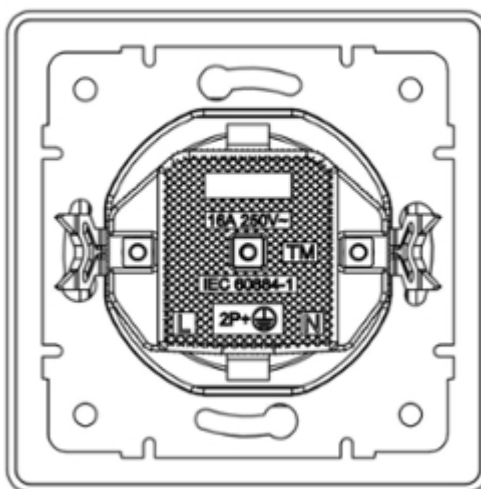

3.3

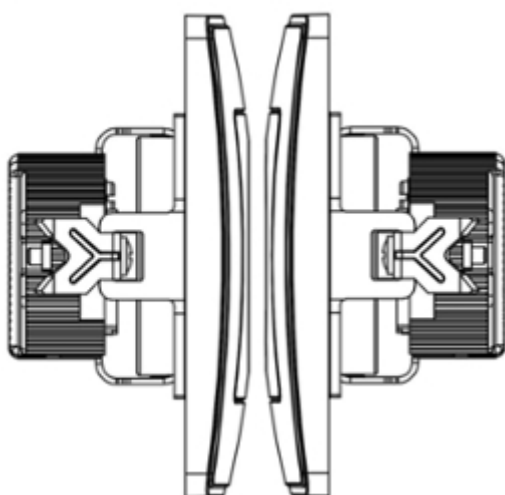

3.4

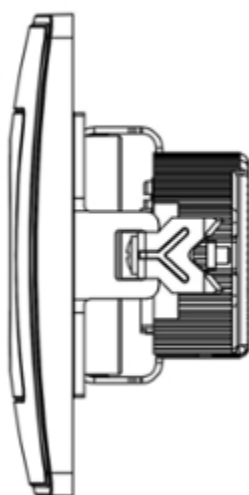

3.5

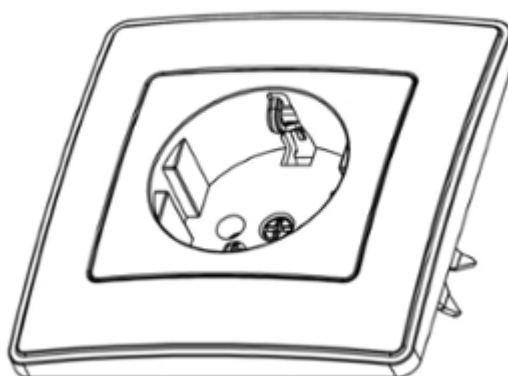

3.6

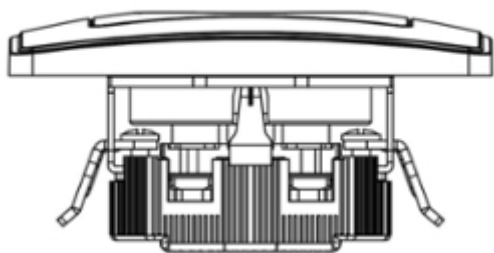

3.7

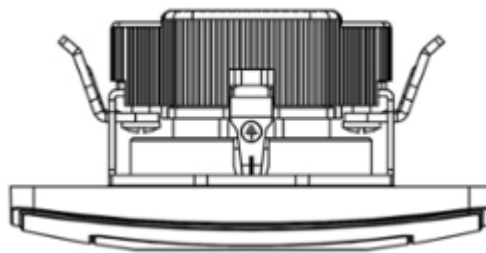

4.1

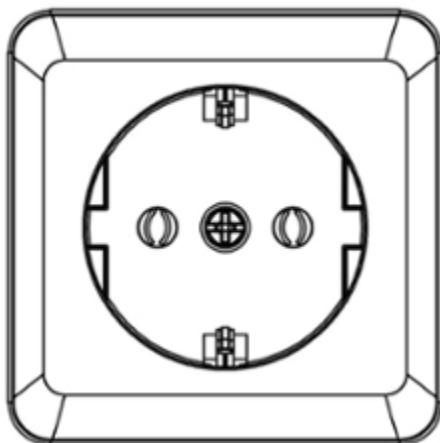

4.2

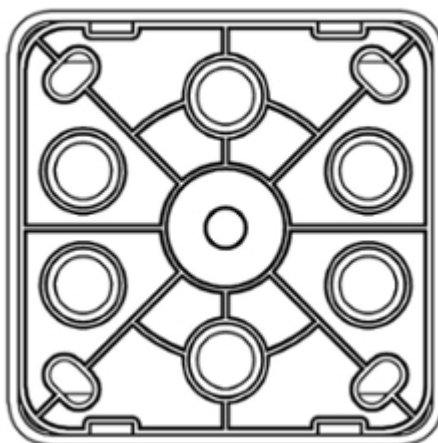

4.3



4.4



4.5

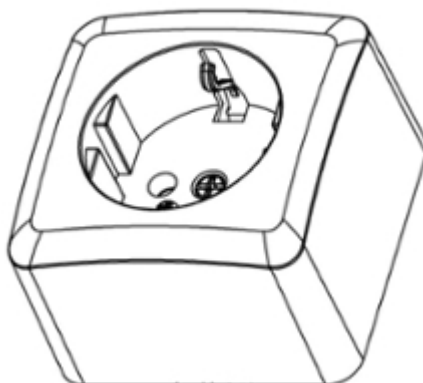

4.6



4.7



(11) DM/098296

(15) 2017 10 25

(22) 2017 10 25

(28) 17

(73) THE PROCTER & GAMBLE COMPANY

One Procter & Gamble Plaza, Cincinnati, OH 45202 (US)

(85) –

(86) DE, EM

(87) DE, EM

(88) DE, EM

(89) EM

(81) II. MA III. AM, AZ, CH, EG, EM, GE, NO, OM, TR, UA

(72) Rob Clarke

c/o Elmwood 105 Water Lane, Leeds, LS11 5WD, England, Leeds, United Kingdom;  
Alex Jessel

c/o Elmwood 105 Water Lane, Leeds, LS11 5WD, England, Leeds, United Kingdom;  
Andy Lawrence

c/o Elmwood 105 Water Lane, Leeds, LS11 5WD, England, Leeds, United Kingdom;  
Zoe Phillipson

c/o Elmwood 105 Water Lane, Leeds, LS11 5WD, England, Leeds, United Kingdom

(54) 1.-17. Ornamentation

(55)

1



2



3



4



5



6



7



8



9



10



11



12



13



14



15



16



17



(11) DM/100617

(51) 02-04

(15) 2018 03 29

(45) 2018/16 (2018 04 27)

(22) 2018 03 29

(28) 1

(73) VALENTINO S.P.A.

Via Turati, 16/18, I-20121 Milano (IT)

(85) –

(86) EM, IT

(87) EM, IT

(88) EM, IT

(89) EM

(81) III. AZ, EM, GE, JP, KG, KR, RU, TJ, TR, UA, US

(72) SASSI Stefano

c/o VALENTINO S.p.A. Via Turati, 16/18, I-20121 Milano, Italy

(54) 1. Shoe

(55)

1.1

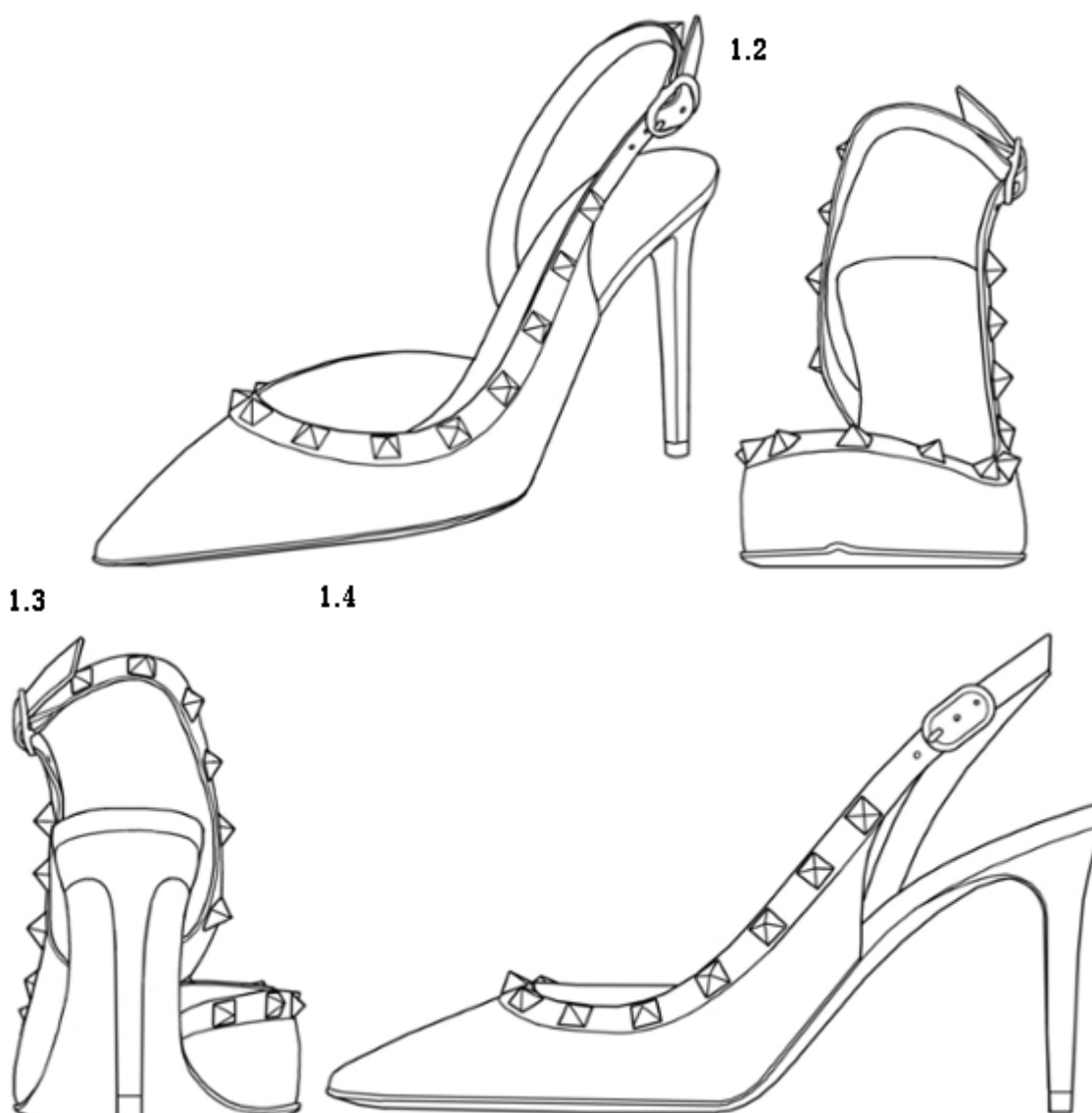

1.5

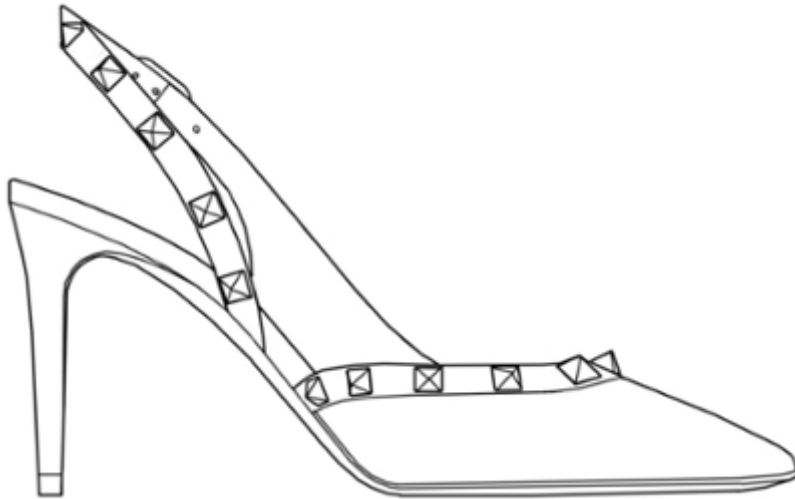

1.6

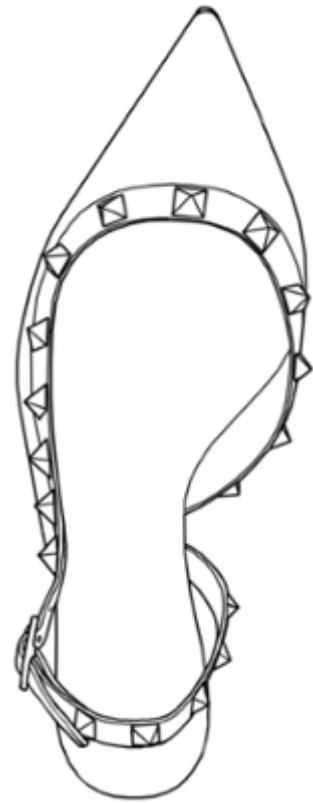

1.7





(11) DM/100631

(15) 2018 04 10

(22) 2018 04 10

(28) 4

(73) CHANEL SARL

Quai du Général-Guisan 24, CH-1204 Genève (CH)

(85) CH

(86) CH

(87) CH

(88) CH

(89) CH

(81) II. GR, MA III. AZ, BG, DK, EG, FI, GE, NO, PL, RU, TN, TR, UA

(72) Marianna NITSCH

135 avenue Charles De Gaulle, 92200 Neuilly-sur-Seine, France

(54) 1.-4. Shopping bags

(55)

1.1

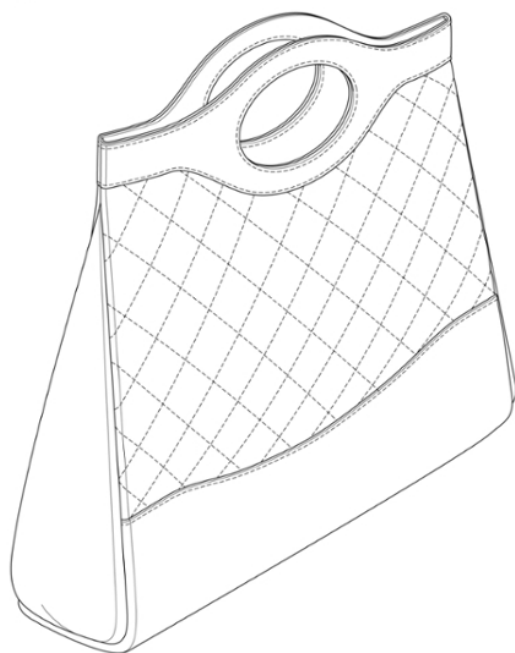

1.2

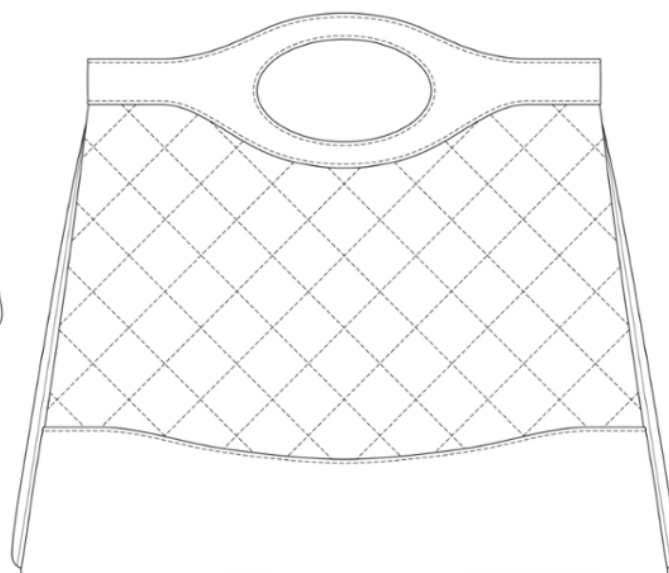

1.3

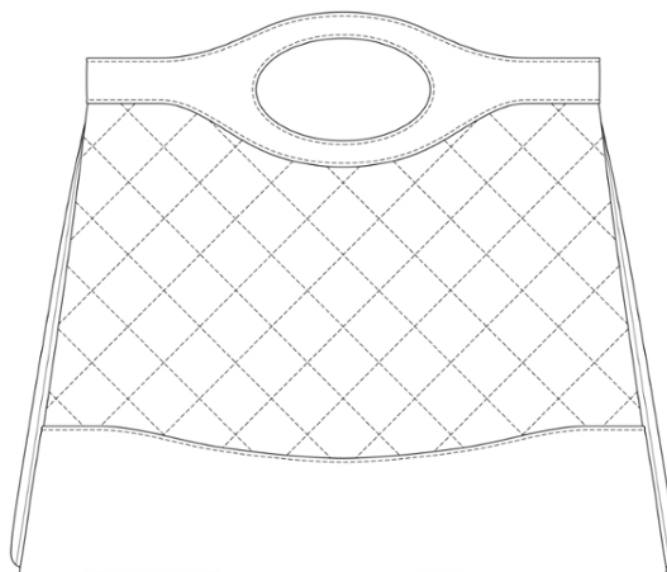

1.4

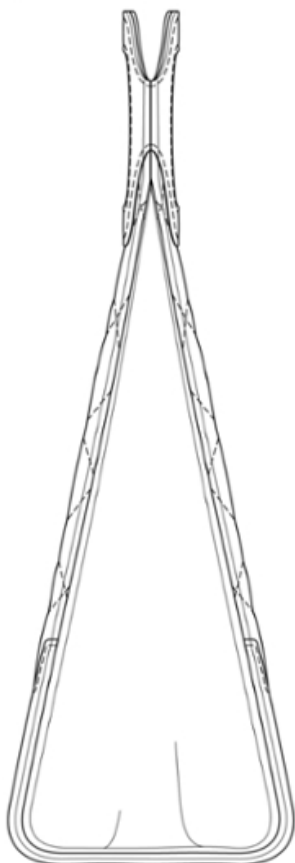

1.5

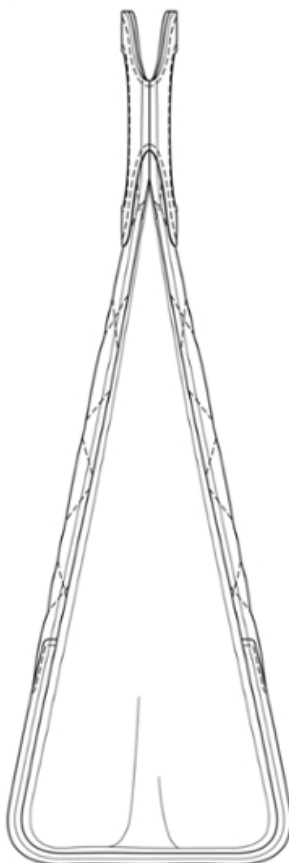

1.6

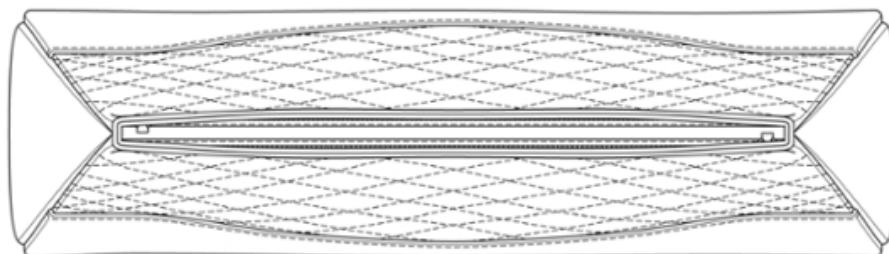

1.7



2.1



2.2



2.3



2.4



2.5

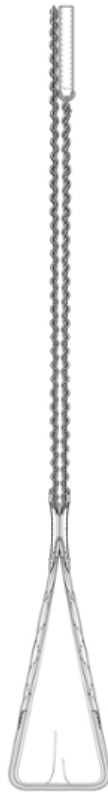

2.6

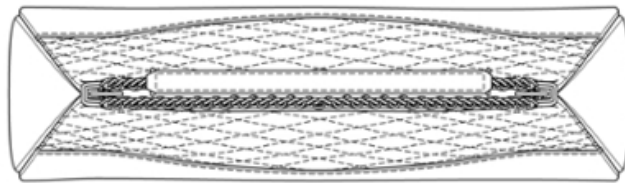

2.7



3.1

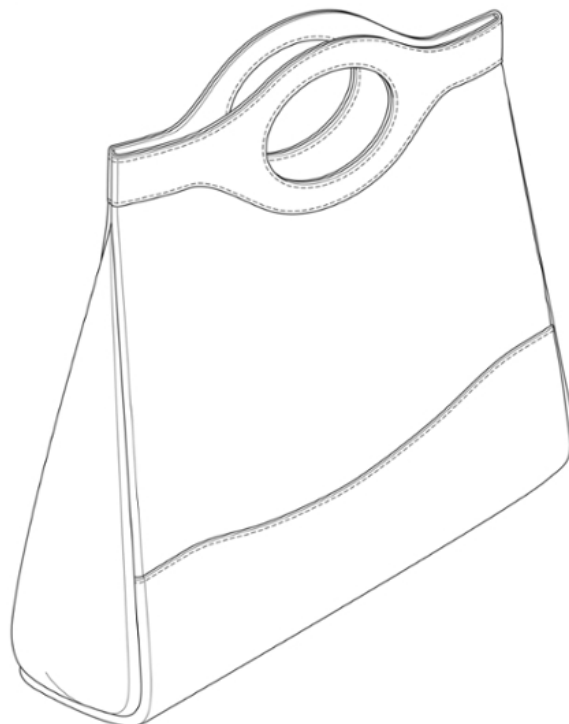

3.2

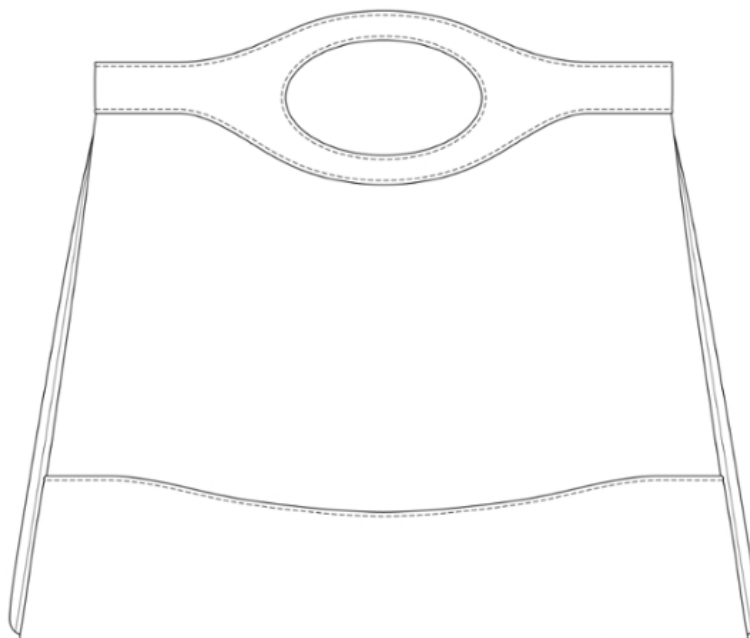

3.3

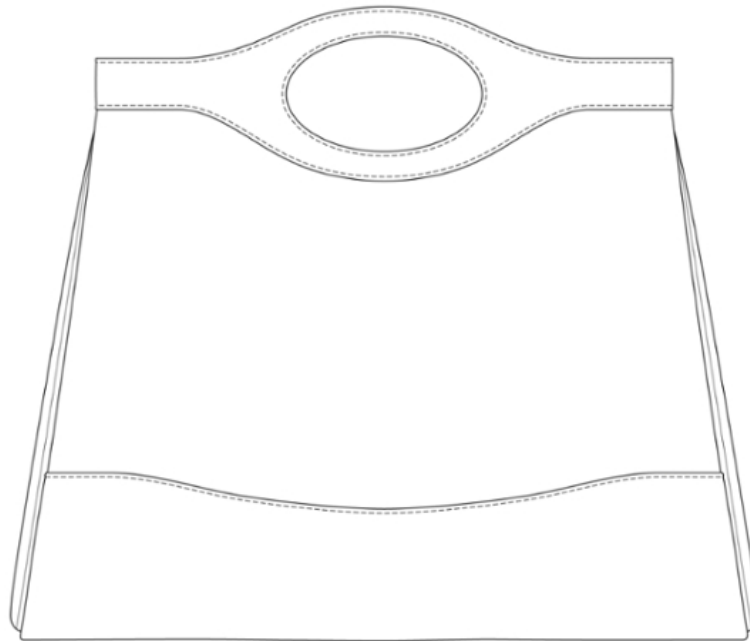

3.4

3.5

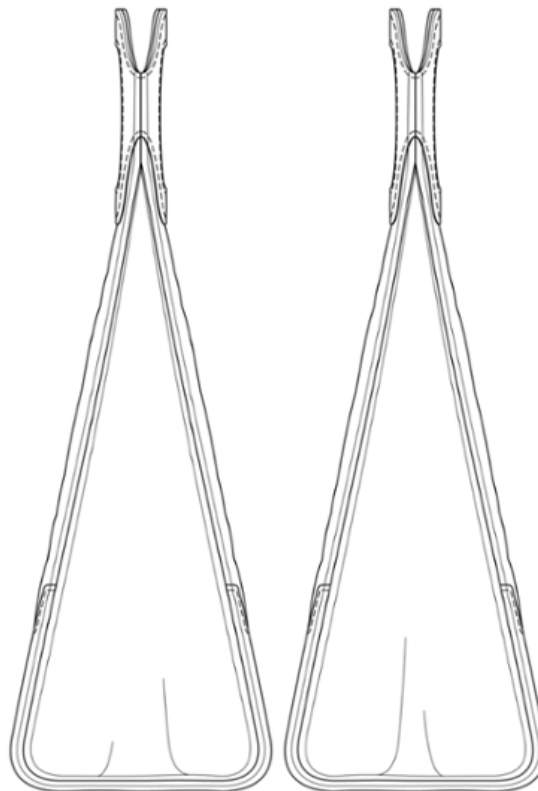

3.6

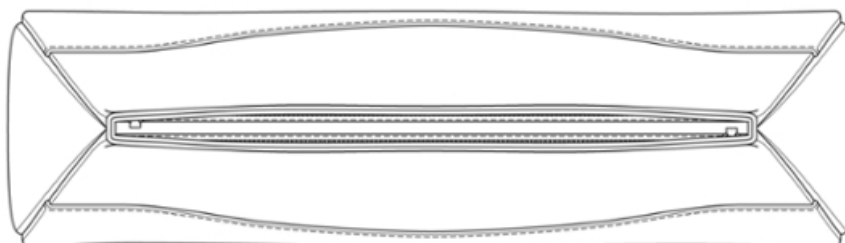

3.7

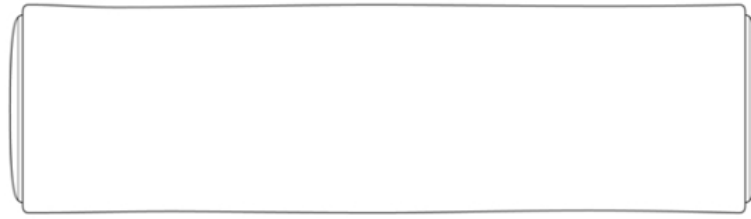

4.1



4.2

4.3

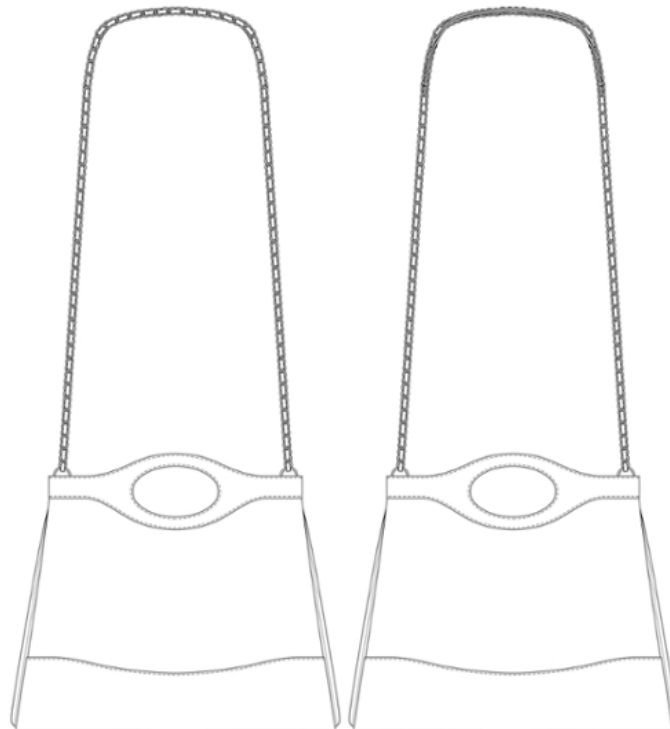

4.4

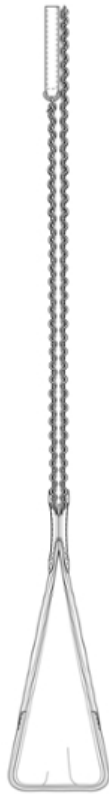

4.5



4.6

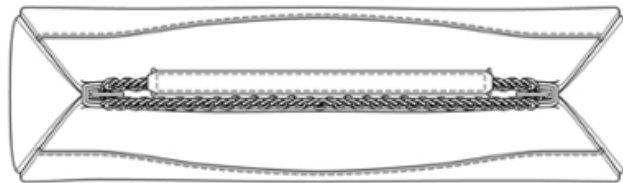

4.7



**(11) DM/100760**

(15) 2018 04 17

(22) 2018 04 17

(28) 10

(73) PORTABLE MULTIMEDIA LIMITED

Dorna House Two, Guildford Road, West End, Woking GU24 9PW (GB)

(85) –

(86) –

(87) –

(88) NO

(89) NO

(81) III. AM, AZ, GE, IS, JP, MD, NO, RS, RU, TR, UA

(72) Portable Multimedia Limited

Dorna House Two Guildford Road, West End, GU24 9PW Woking, United Kingdom

(54) 1.-10. Dashboard cameras

(55)

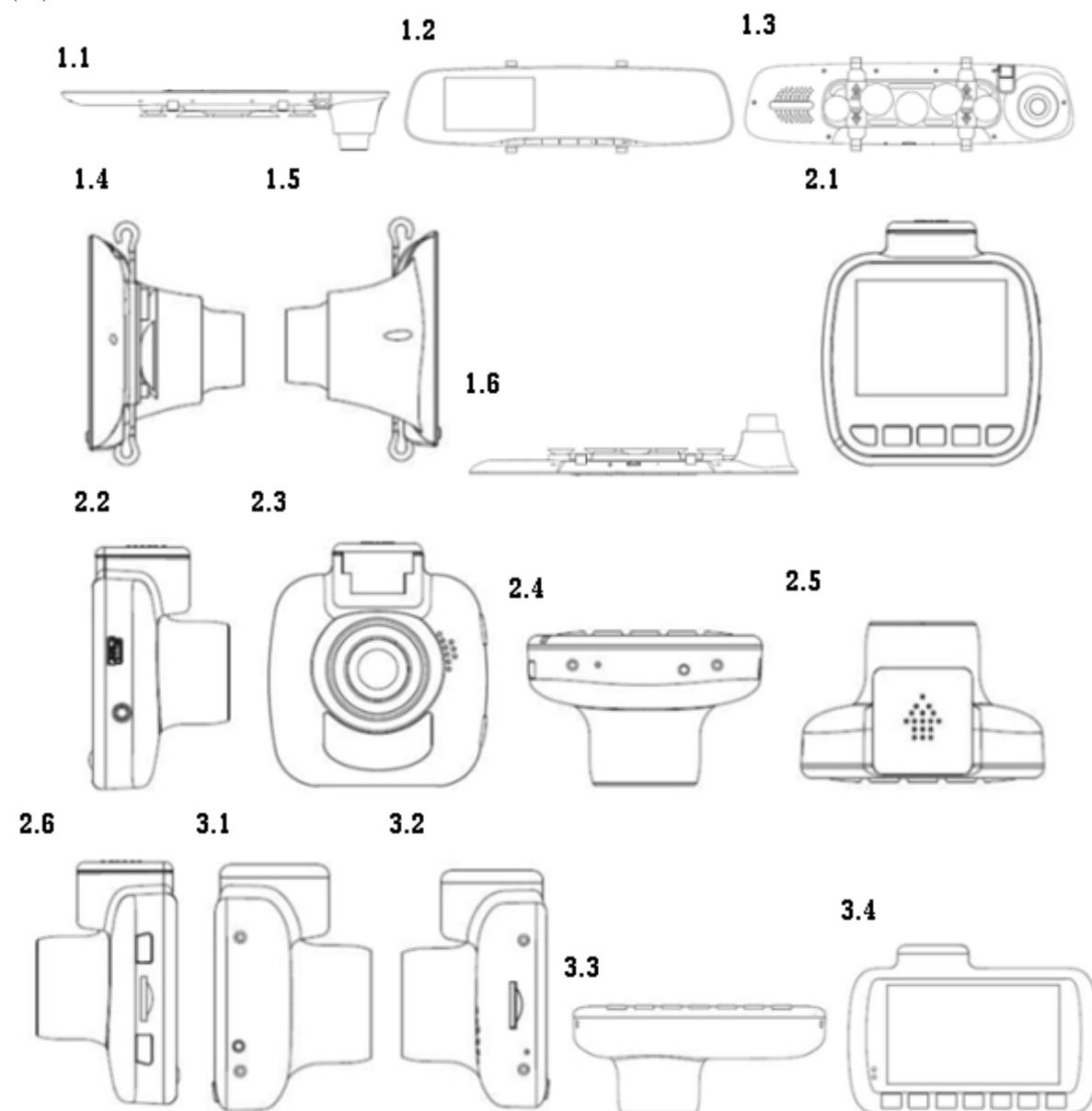



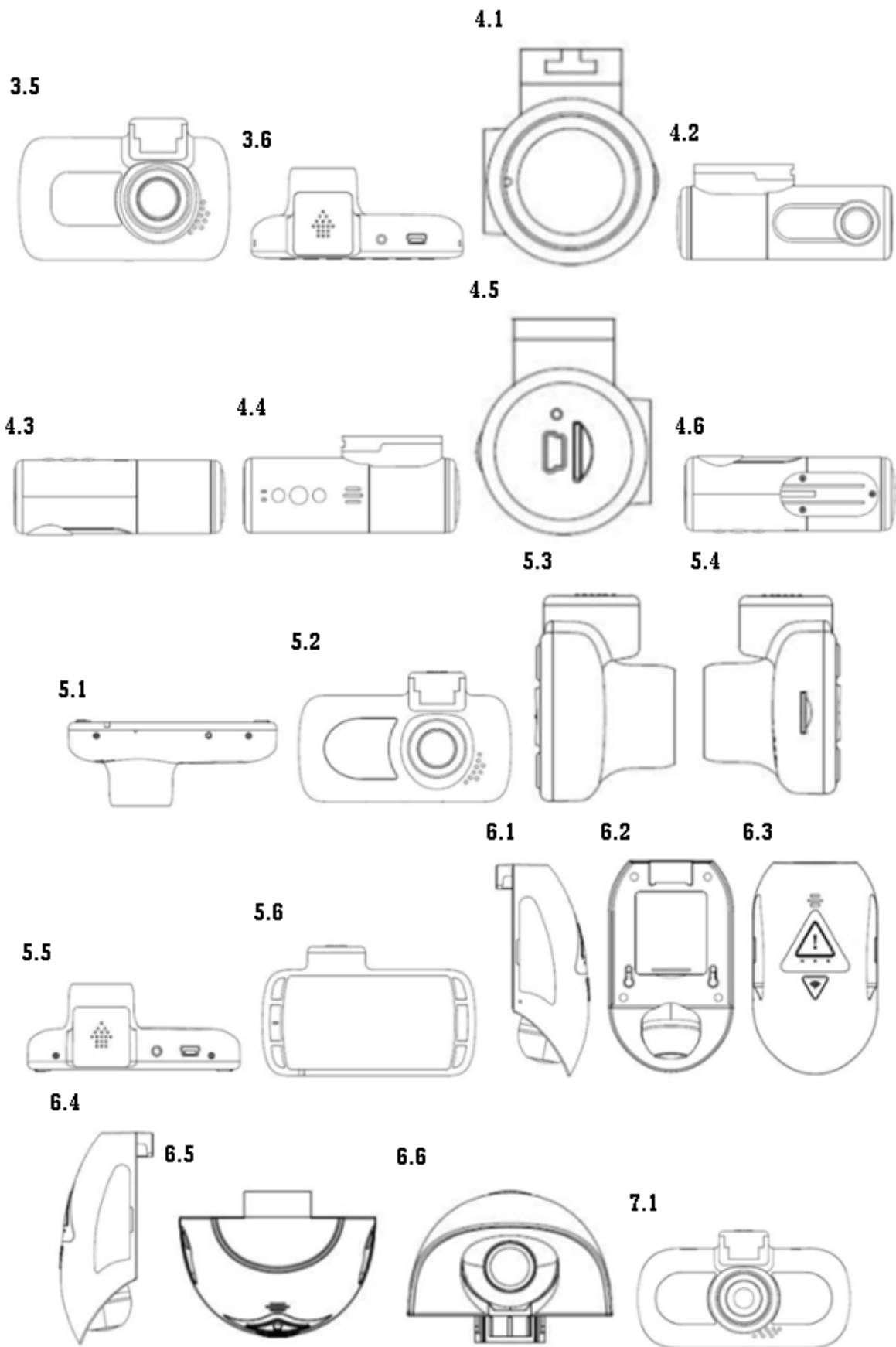

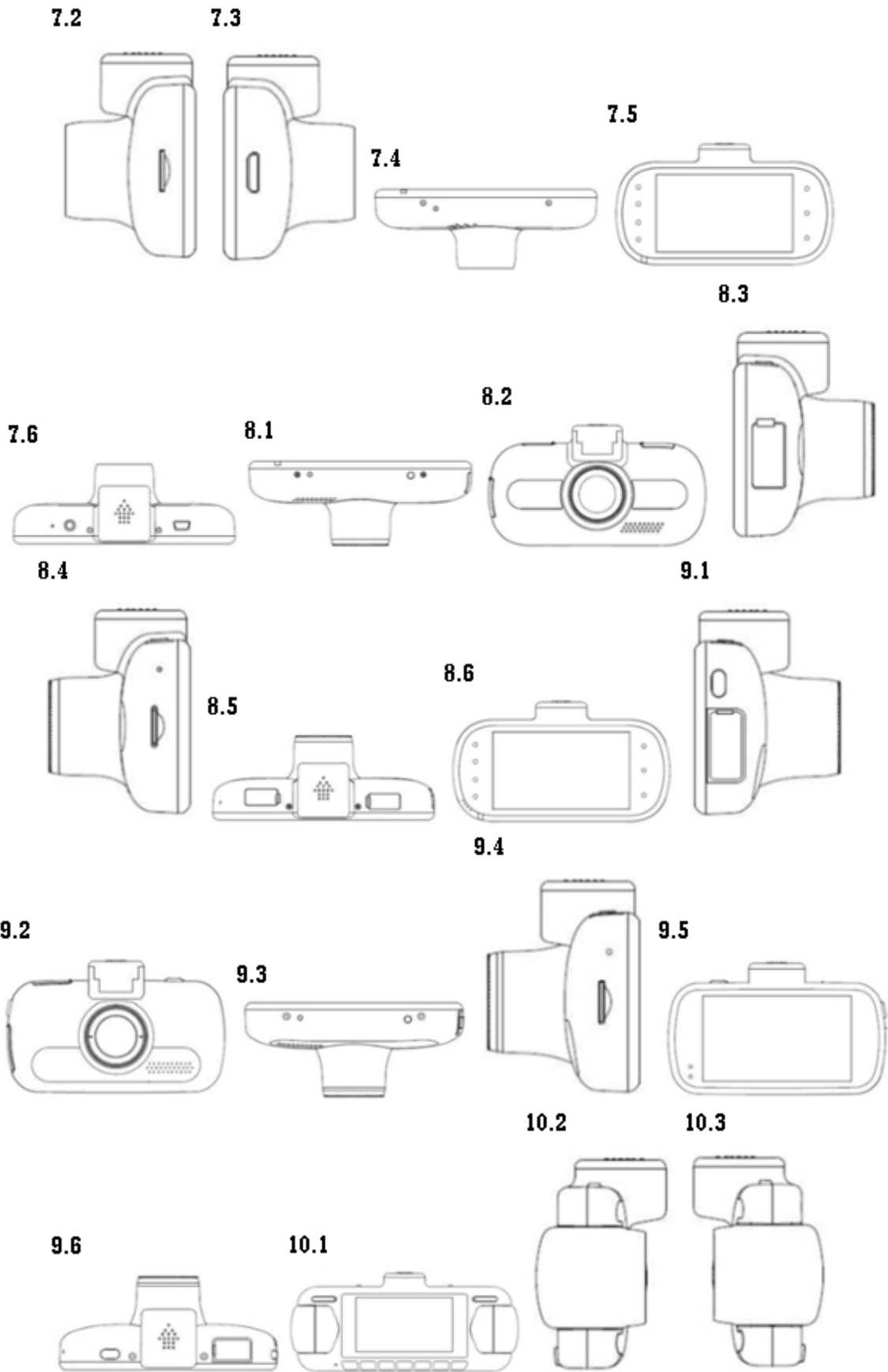



- (11) DM/100785 (51) 09-03  
(15) 2018 04 18 (45) 2018/17 (2018 05 04)  
(22) 2018 04 18  
(28) 1  
(73) HLEBOZAVOD TIMS EOOD  
Dunav 1A, BG-6300 Haskovo (BG)  
(85) BG, EM  
(86) BG, EM  
(87) BG, EM  
(88) BG, EM  
(89) BG  
(81) III. AL, BA, GE, ME, RS, RU, TR, UA  
(72) Pavlina Sarcheva  
Lipa 6, 6300 Haskovo, Bulgaria  
(54) 1. Package for foodstuffs  
(55)

1



**(11) DM/100798****(51) 24-02**

(15) 2018 04 06

(45) 2018/17 (2018 05 04)

(22) 2018 04 06

(28) 1

(30) No. 1: 07.11.2017; 004497238-0001; EM

(73) BAYER INTELLECTUAL PROPERTY GMBH

Alfred-Nobel-Straße 10, 40789 Monheim am Rhein (DE)

(85) DE, EM

(86) DE, EM

(87) DE, EM

(88) DE, EM

(89) EM

(72) Bruno Chazel

20 Impasse Des Écureuils, 38500 Voiron, France

(54) 1. Spatula for medical use

(55)

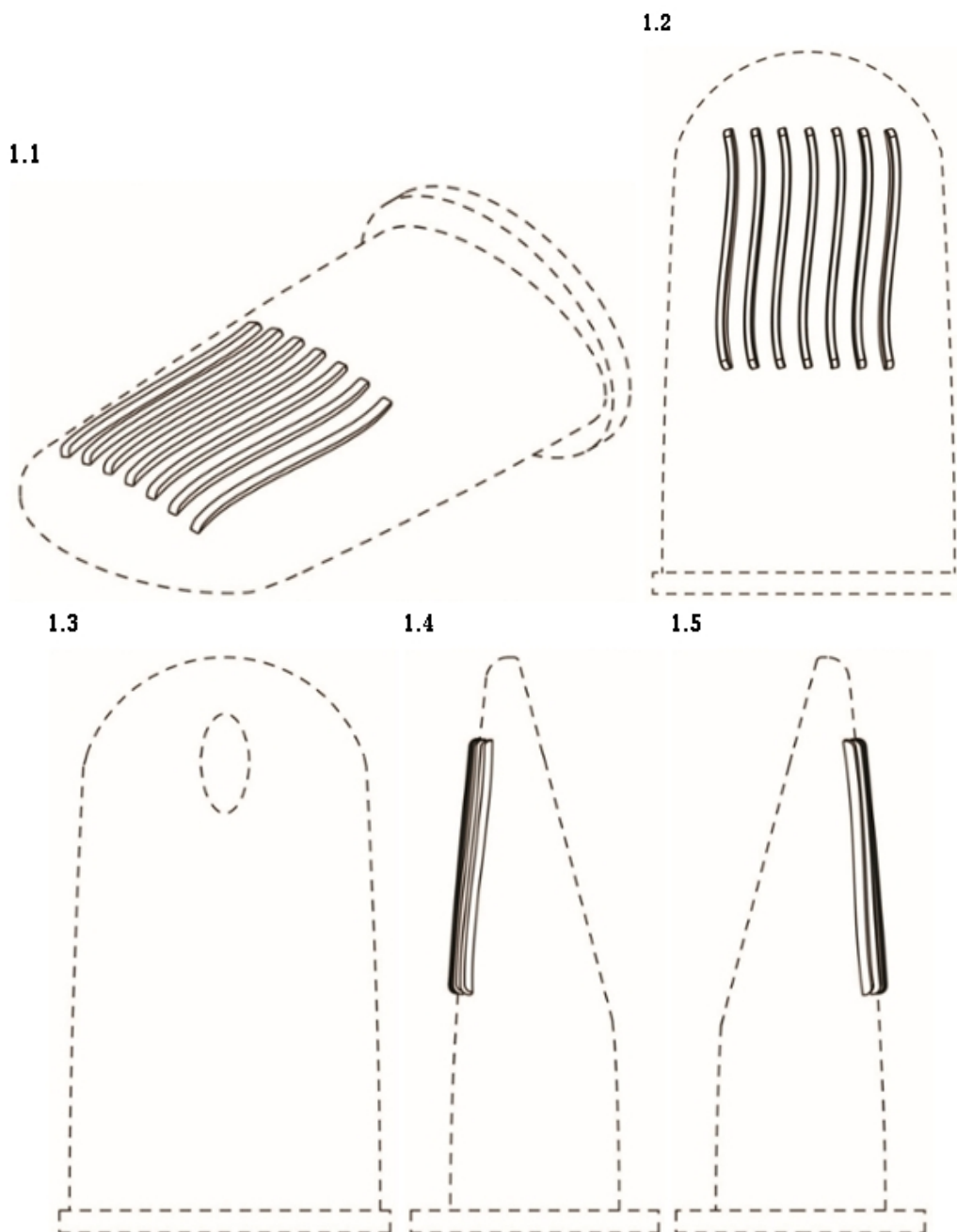

1.6

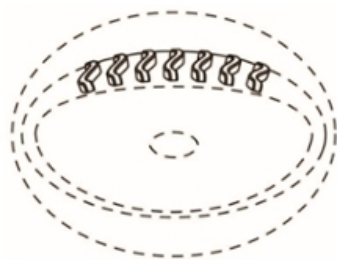

1.7

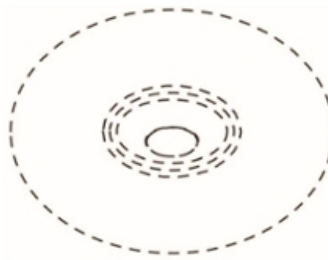

(11) DM/098434

(15) 2017 11 06

(22) 2017 11 06

(28) 2

(73) BLANCPAIN SA

Le Rocher 12, CH-1348 LE BRASSUS (CH)

(85) CH

(86) CH

(87) CH

(88) CH

(89) CH

(81) II. BZ, MA III. AL, AM, AZ, BA, CH, EM, GE, KG, LI, MC, MD, ME, MK, MN, NO, OM, SG, TN, TR, UA

(72) Patrice NANGA

Avenue Dapples 26, CH-1006 Lausanne, Suisse;

1: Daniel VILLARD

Chemin de la Fauvette 1, CH-1185 Mont-sur-Rolle, Suisse

(54) 1.-2. Dials

(55)

(51) 10-07

(45) 2018/18 (2018 05 11)

1.1



1.2

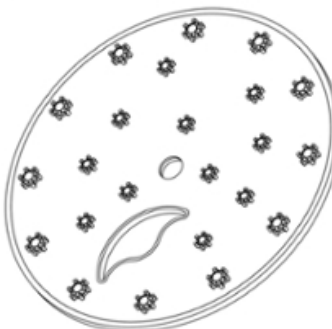

2.1



2.2



**(11) DM/099270**

(15) 2017 11 08

(22) 2017 11 08

(28) 2

(30) No. 1: 11.05.2017; 29/603,632; US; No. 2: 11.05.2017; 29/603,634; US

(73) CURT G. JOA, INC.

100 Crocker Avenue, Sheboygan Falls, WI 53085 (US)

(85) US

(86) US

(87) US

(88) US

(89) US

(81) III. AL, AM, AZ, BA, BG, BN, BW, CH, DE, DK, EE, EG, EM, ES, FI, FR, GE, GH, HR, HU, IS, JP, KG, KH, KP, KR, LI, LT, LV, MC, MD, ME, MK, MN, NA, NO, OA, OM, PL, RO, RS, RW, SG, SI, ST, SY, TJ, TM, TN, TR, UA

(72) Jeffrey W. Fritz

N4989 Country Aire Road, Plymouth, WI 53073, US

(54) 1.-2. Parts of a machine brake for use in minimizing rethreading of broken elastic

(55)

**(51) 15-99**

(45) 2018/18 (2018 05 11)

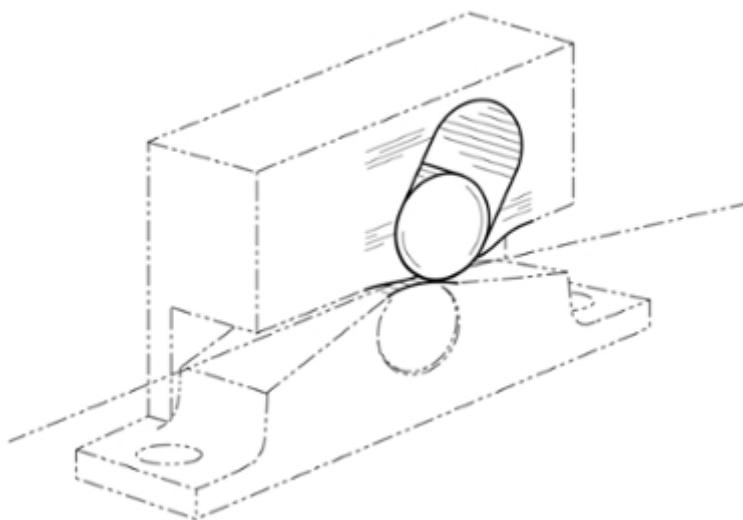
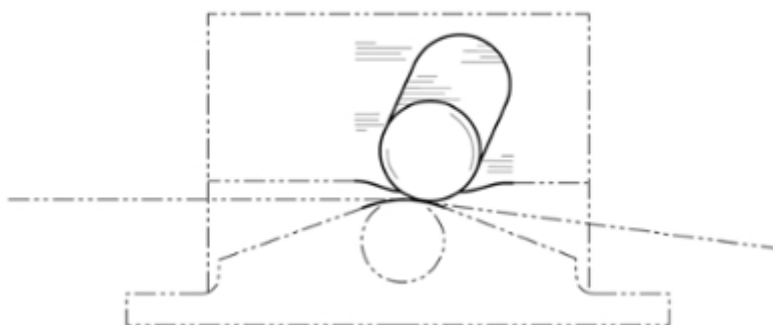
**1.1****1.2**

1.3

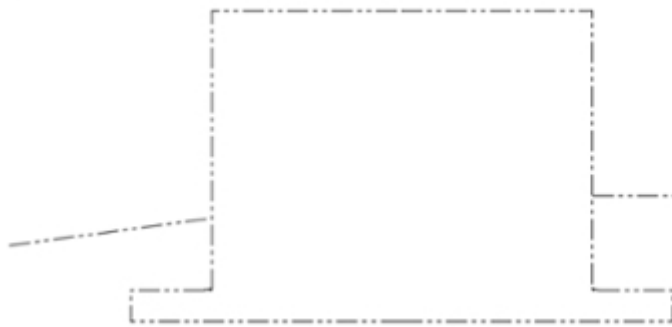

1.4

1.5

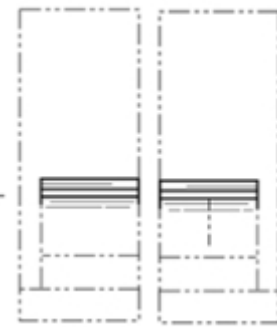

1.6



1.7



2.1

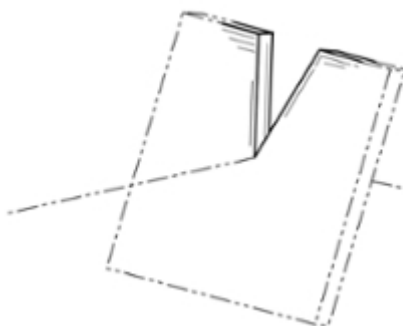

2.2

2.3

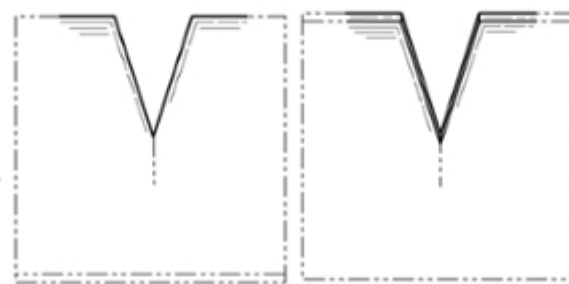

2.4



2.5



2.6

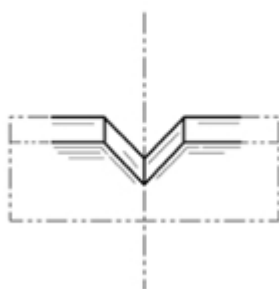

2.7

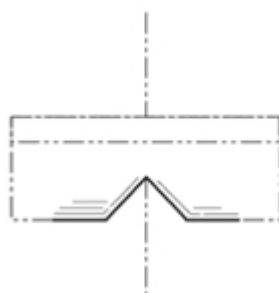



# TRADEMARKS

## APPLICATIONS FILED UNDER THE NATIONAL PROCEDURE APPROVED FOR REGISTRATION

The decision can be appealed at the Chamber of Appeal of Sakpatenti within 3 months from the publication or at the Mtskheta District Court Administrative Cases Board (Address: №17, Samkhedro St., Mtskheta), within 1 month following the publication.

(260) AM 2018 90032 A  
(210) AM 90032  
(220) 2016 12 20  
(731) LTD "EUROPHARMA GEORGIA"  
Machabelis q. 5, 0114, Tbilisi, Georgia  
(740) Nia Masiukovich  
(540)

ბრონქოტუსი  
БронхоТус  
BronkhoTuss

(511) 35

(260) AM 2018 92585 A  
(210) AM 92585  
(220) 2017 06 06  
(731) LTD "VIVO MEDICAL GROUP"  
Lublianas q. 5, 0159, Tbilisi, Georgia  
(740) Natia Kakhetelidze  
(540)



(591) Black and sky-blue  
(531) 26.01.01; 26.01.19; 26.01.24; 27.05.10;  
29.01.12  
(511) 44

(260) AM 2018 92797 A  
(210) AM 92797  
(220) 2017 12 04  
(731) NODAR MINDIASHVILI  
Sairmis q. I, korp. b.5, 0194, Tbilisi,  
Georgia

(540)



(591) Red, yellow, white, green  
(531) 05.07.10; 26.04.15; 26.04.24; 27.05.03; 28.19;  
29.01.15  
(511) 1, 5

(260) AM 2018 94010 A  
(210) AM 94010  
(220) 2017 09 01  
(731) PADIDEH SHIMI GHARB  
4t Flor, No.22, Ias Bilding, Tavanir Strit,  
Valiasr Strit, Teirani, Safosto Kodi  
14348-87736, Iran (Islamic Republic of)  
(740) Shalva Gvaramadze  
(540)

HOBO

(591) Dark blue, sky-blue, white  
(531) 27.05.03; 29.01.12  
(511) 1, 3, 16, 35, 39

(260) AM 2018 94018 A  
(210) AM 94018  
(220) 2017 09 04  
(310) 2017 33686  
(320) 2017 07 25  
(330) AZ  
(731) ROTMANS OF PEL MEL LIMITED  
Rut De Frans 17, 2926, Boncourt, Switzerland  
(740) Tamar Kochlamazashvili  
(540)



(591) Black, white  
 (531) 01.15.05; 01.15.11; 25.03.07; 25.03.13;  
 25.03.15; 26.01.19  
 (511) 34

(260) AM 2018 94019 A  
 (210) AM 94019  
 (220) 2017 09 04  
 (310) 2017 33685  
 (320) 2017 07 25  
 (330) AZ  
 (731) ROTMANS OF PEL MEL LIMITED  
 Rut De Frans 17, 2926, Boncourt, Switzerland  
 (740) Tamar Kochlamazashvili  
 (540)



(591) Silver, white  
 (531) 01.15.05; 01.15.11; 25.03.07; 25.03.13;  
 25.03.15; 26.01.21  
 (511) 34

(260) AM 2018 94402 A  
 (210) AM 94402  
 (220) 2017 10 03  
 (731) Karen Vardanyan  
 Bairon Str.3, ap. 36, Yerevan, Armenia  
 (740) Giorgi Taktakishvili  
 (540)



(554) Three-dimensional  
 (591) White, pink, red, brown, golden, black  
 (531) 03.01.15; 24.01.10; 27.05.01; 29.01.14  
 (511) 30

(260) AM 2018 94433 A  
 (210) AM 94433  
 (220) 2017 10 03  
 (731) LTD "MIRA-HOTELS"  
 Mtkvris Marjvena Sanapirova Da Broses  
 quchis kutkhe, Tbilisi, Georgia  
 (740) Giorgi Taktakishvili

(540)  
**HOTEL EXCELSIOR**  
 (591) Black, white  
 (511) 43

(260) AM 2018 94561 A  
 (210) AM 94561  
 (220) 2017 10 11  
 (731) LTD "SHINAURI"  
 Shalva Nutsubidzis Perdobi, mkr. II,  
 kvart. II, korp. 1, b. 11, 0183, Tbilisi, Georgia  
 (540)



(591) Light green, blue, dark brown, beige  
 (531) 07.01.09; 27.05.01; 27.05.10; 28.19; 29.01.14  
 (511) 29, 30, 32, 35

(260) AM 2018 94578 A  
 (210) AM 94578  
 (220) 2017 10 12  
 (310) 2017/537  
 (320) 2017 05 19  
 (330) MK  
 (731) PHILIP MORRIS PRODUCTS S.A.  
 Quai Jeanrenaud 3, 2000 Neuchâtel,  
 Switzerland  
 (740) Shalva Gvaramadze  
 (540)



(591) Black, white, brown, gray  
 (531) 24.09.12; 25.01.01; 27.05.04; 29.01.14  
 (511) 34

(260) AM 2018 94579 A  
 (210) AM 94579  
 (220) 2017 10 12  
 (310) 2017/536  
 (320) 2017 05 19  
 (330) MK  
 (731) PHILIP MORRIS PRODUCTS S.A.  
 Quai Jeanrenaud 3, 2000 Neuchâtel,  
 Switzerland  
 (740) Shalva Gvaramadze  
 (540)



(591) Black, white, blue, gray  
 (531) 24.09.12; 25.01.01; 25.01.05; 25.07.17;  
 27.05.04; 29.01.13  
 (511) 34

(260) AM 2018 94580 A  
 (210) AM 94580  
 (220) 2017 10 12  
 (731) PHILIP MORRIS PRODUCTS S.A.  
 Quai Jeanrenaud 3, 2000 Neuchâtel,  
 Switzerland  
 (740) Shalva Gvaramadze  
 (540)



(591) Black, white  
 (531) 24.01.25; 24.09.25  
 (511) 34

(260) AM 2018 94583 A  
 (210) AM 94583  
 (220) 2017 10 13

(731) LTD "EASTERN PROMOTION"  
 Melikishvilis gamz.1, 0179, Tbilisi,  
 Georgia  
 (740) Tamar Mzhavanadze  
 (540)



(591) White, yellow, green, lilac, purple  
 (531) 26.01.12; 26.01.20; 26.01.22; 27.05.24;  
 29.01.15  
 (526) KAKHETI  
 (511) 41

(260) AM 2018 94612 A  
 (210) AM 94612  
 (220) 2017 10 16  
 (731) LTD "GEORGIAN ALLIANCE"  
 Nadareishvilis q. 4, 0137, Tbilisi, Georgia  
 (540)

## Chocopanda

(591) Black, white  
 (511) 30

(260) AM 2018 94613 A  
 (210) AM 94613  
 (220) 2017 10 16  
 (731) LTD "GEORGIAN ALLIANCE"  
 Nadareishvilis q. 4, 0137, Tbilisi, Georgia  
 (540)

## Chocogrib

(591) Black, white  
 (511) 30

(260) AM 2018 94622 A  
 (210) AM 94622  
 (220) 2017 10 17  
 (731) LTD "GEORGIAN ALLIANCE"  
 Nadareishvilis q. 4, 0137, Tbilisi, Georgia  
 (540)



(591) Black, grey, white

(531) 03.01.15; 03.01.16; 27.05.01  
(511) 30

(260) AM 2018 94658 A

(210) AM 94658

(220) 2017 10 17

(731) LTD "GEORGIAN ALLIANCE"

Nadareishvilis q. 4, 0137, Tbilisi, Georgia

(540)



(591) Black, green, white

(531) 03.01.15; 27.05.01; 29.01.13

(511) 30

(260) AM 2018 94671 A

(210) AM 94671

(220) 2017 10 18

(731) LTD "AVERSI-PHARMA"

Davit Aghmashenebelis Gamz. 148/2, 0112,  
Tbilisi, Georgia

(540)

აქვიტაბინო

Аквитабин

Aqvitabin

(591) Black, white

(511) 5

(260) AM 2018 94741 A

(210) AM 94741

(220) 2017 10 24

(731) LTD "TIMELESS"

Rustavelis gamz. 46, Dzveli Tbilisis r-ni,  
0108, Tbilisi, Georgia

(540)



(591) Orange, dark gray, light yellow

(531) 24.17.25; 27.05.01; 27.05.04; 27.05.08;  
27.05.10; 27.05.14; 27.05.17; 27.05.23;  
27.05.25; 28.11; 29.01.13

(511) 14, 16, 18, 35, 37

(260) AM 2018 94760 A

(210) AM 94760

(220) 2017 10 25

(731) THE PROCTER & GAMBLE COMPANY

One Procter & Gamble Plaza, Cincinnati,  
Ohio 45202, USA

(740) Merab Kvimsadze

(540)



(591) Blue-green, white, yellow

(531) 02.09.01; 27.05.01; 27.05.24; 29.01.13

(511) 3, 5

(260) AM 2018 94833 A

(210) AM 94833

(220) 2017 10 31

(731) LTD "S.v.g."

Moskovis gamz. 37, b. 2, 0137, Tbilisi,  
Georgia

(540)

SVG

(591) Black, white

(511) 33

(260) AM 2018 94865 A

(210) AM 94865

(220) 2017 11 01

(731) ALAUDDIN FEROUZUDDIN

P. O. Box 113633, Dubai, United Arab  
Emirates

(740) Merab Kvimsadze

(540)



(591) Black, white

(531) 03.09.04; 26.04.24; 27.05.01; 27.05.24

(511) 16

(260) AM 2018 94873 A

(210) AM 94873

(220) 2017 11 01

(731) LTD "GEORGIAN WATER AND POWER"

Kostavas I shes.33, Dzveli Tbilisis Raioni,  
0179, Tbilisi, Georgia

(740) Grigol Sidamonidze  
(540)



(591) Light sky-blue, sky-blue, white  
(531) 01.15.15; 28.19; 29.01.04  
(511) 32, 35, 39

(260) AM 2018 94889 A  
(210) AM 94889  
(220) 2017 11 02  
(731) LTD "GEORGIAN GASIMPORT"  
Vazisubnis das., korp. 4, b. 72, 0152,  
Tbilisi, Georgia  
(540)



(591) White, green and blue  
(531) 01.15.05; 26.04.22; 26.04.24; 26.11.13;  
27.05.11; 27.05.17; 27.05.19; 27.05.22;  
27.05.24; 29.01.13  
(511) 37, 39

(260) AM 2018 94926 A  
(210) AM 94926  
(220) 2017 11 03  
(731) LTD "OXYGEN"  
Vazha Pshavelas gamz. , kvart. III, korp. 21  
b. 1, 0186, Tbilisi, Georgia  
(740) Nino Bakhtadze  
(540)

**ColiceZ**

(591) Black, white  
(511) 5

(260) AM 2018 94956 A  
(210) AM 94956  
(220) 2017 11 06  
(731) MEIZU TEQNOLOJI KO., LTD  
(korporacia Organizebulia Da Arsebobs  
Chinetis Kanonmdeblobis Shesabamisad)  
Meizu Teqnoloji Biding, Teqnoloji  
& Inoveishn Qoust, Juhai, Guangdongi, China  
(740) Shalva Gvaramadze  
(540)

**mblu**

(591) Black, white  
(511) 9, 35

(260) AM 2018 94984 A  
(210) AM 94984  
(220) 2017 11 07  
(731) YILDIZ HOLDİNG ANONİM ŞİRKETİ  
Qisiqli Mahalesi Cheshme Chiqmazi, Soqaq  
No:6/1 Iusqiudar Stamboli, Turkey  
(740) Tamaz Shilakadze  
(540)

**ÜLKER HALLEY**

(591) Black, white  
(511) 30

(260) AM 2018 94985 A  
(210) AM 94985  
(220) 2017 11 07  
(731) YILDIZ HOLDİNG ANONİM ŞİRKETİ  
Qisiqli Mahalesi Cheshme Chiqmazi, Soqaq  
No:6/1 Iusqiudar Stamboli, Turkey  
(740) Tamaz Shilakadze  
(540)

**ÜLKER DELUXE**

(591) Black, white  
(511) 30

(260) AM 2018 94986 A  
(210) AM 94986  
(220) 2017 11 07  
(731) YILDIZ HOLDİNG ANONİM ŞİRKETİ  
Qisiqli Mahalesi Cheshme Chiqmazi, Soqaq  
No:6/1 Iusqiudar Stamboli, Turkey  
(740) Tamaz Shilakadze  
(540)

**ÜLKER  
CHOCOSANDWICH**

(591) Black, white

(260) AM 2018 94987 A  
(210) AM 94987  
(220) 2017 11 07  
(731) YILDIZ HOLDİNG ANONİM ŞİRKETİ  
Qisiqli Mahalesi Cheshme Chiqmazi, Soqaq  
No:6/1 Iusqiudar Stamboli, Turkey  
(740) Tamaz Shilakadze  
(540)

**ÜLKER HOBBY**

(591) Black, white  
(511) 30

(260) AM 2018 95006 A  
(210) AM 95006  
(220) 2017 11 08

(731) LUJOU LAO JIAO KO., LTD.  
 (korporacia Organizebulia Da Arsebobs  
 Chinetis Kanonmdeblobis Shesabamisad)  
 Guo Jiao Sqvea, Lujou, Sichuani, China  
 (740) Shalva Gvaramadze  
 (540)

**nihao**

(591) Black, white  
 (511) 33

(260) AM 2018 95009 A  
 (210) AM 95009  
 (220) 2017 11 08  
 (731) LTD "MARNISKARI"  
 Sh. Askuravas q. 17, Tbilisi, Georgia  
 (740) Davit Gogidze  
 (540)

**Chitoni Читони**

(591) Black, white  
 (511) 33

(260) AM 2018 95011 A  
 (210) AM 95011  
 (220) 2017 11 09  
 (731) JSC "GEPHA"  
 Sanapiros q. 6, 0108, Tbilisi, Georgia  
 (740) Salome Jeladze  
 (540)

**MEGAPLAST**  
**მეგაპლასტი**

(511) 5, 10

(260) AM 2018 95020 A  
 (210) AM 95020  
 (220) 2017 11 10  
 (731) IOSEB SHAVERDASHVILI  
 Sanzona, korp. 2b, b. 1, 0192, Tbilisi, Georgia  
 (540)

**Guliani**  
**გულიანი**  
**Гулиани**

(591) Black, white  
 (511) 29

(260) AM 2018 95026 A  
 (210) AM 95026  
 (220) 2017 11 10

(731) LLC "ICR TRADE"  
 Agmashenebeli Alley 12th km, Shopping  
 and Business Center "My House", fl. 5,  
 Digomi training-trial farming territory, 0159,  
 Tbilisi, Georgia, 0159, Tbilisi, Georgia  
 (740) Mariam Gobejishvili  
 (540)



(591) Red, green  
 (531) 01.01.02; 01.01.10; 09.09.05; 09.09.07;  
 26.01.16; 28.19; 29.01.13  
 (511) 25, 35

(260) AM 2018 95027 A  
 (210) AM 95027  
 (220) 2017 11 10  
 (731) LLC "ICR TRADE"  
 D. Agmashenebeli Alley 12th km, Shopping  
 and Business Center "My House", fl. 5,  
 Dighomi training-trial farming territory, 0159,  
 Tbilisi, Georgia, 0159, Tbilisi, Georgia  
 (740) Mariam Gobejishvili  
 (540)



(591) Red, green  
 (531) 01.01.02; 01.01.10; 09.09.05; 09.09.07;  
 26.01.16; 27.05.01; 29.01.13  
 (511) 25, 35

(260) AM 2018 95031 A  
 (210) AM 95031  
 (220) 2017 11 10  
 (731) LTD "GEORGIAN CEMENT COMPANY"  
 Al. Kazbegis gamz. 34, (igive Marika  
 Baratashvilis chikhi 6), 0177, Tbilisi, Georgia  
 (540)



(591) Orange, white, black, cream color  
 (531) 07.15.01; 07.15.22; 14.07.23; 28.19; 29.01.13  
 (511) 19

(260) AM 2018 95033 A  
 (210) AM 95033  
 (220) 2017 11 10  
 (731) LTD GEORGIAN CEMENT COMPANY  
 Al. Kazbegis gamz 34, (igive Marika  
 Baratashvilis chikhi 6), 0177, Tbilisi, Georgia  
 (540)



(591) Lilac, white, black, light cream color  
 (531) 07.15.01; 07.15.22; 14.07.23; 28.19; 29.01.14  
 (511) 19

(260) AM 2018 95039 A  
 (210) AM 95039  
 (220) 2017 11 13  
 (731) BEKAR MIKABERIDZE  
 P. Ingorokvas q. 26, 0108, Tbilisi, Georgia  
 (540)

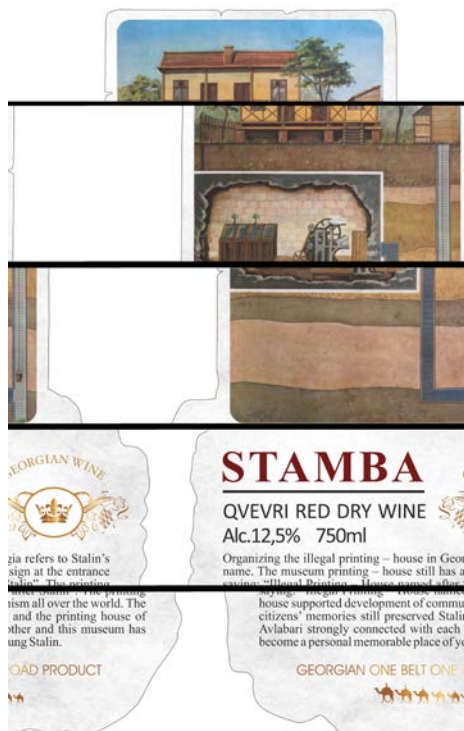

(591) Brown, blue, ivory, golden  
 (531) 07.01.09; 07.01.17; 29.01.15  
 (511) 33

(260) AM 2018 95052 A  
 (210) AM 95052  
 (220) 2017 11 14  
 (731) LTD "KAKHETIAN TRADITIONAL  
 WINEMAKING-AGRO-CHOKHATAURI"  
 S. Tsintsadzis q. 12, A/P 3-6, sart. 3,  
 Vake-Saburtalos r-ni, 0170, Tbilisi, Georgia  
 (540)

**MIMI**  
**მიმი**  
**МИМИ**

(511) 29, 32

(260) AM 2018 95053 A  
 (210) AM 95053  
 (220) 2017 11 14  
 (731) LTD "KAKHETIAN TRADITIONAL  
 WINEMAKING-AGRO-CHOKHATAURI"  
 S. Tsintsadzis q. 12, A/P 3-6, sart. 3,  
 Vake-Saburtalos r-ni, 0170, Tbilisi, Georgia  
 (540)

**LALI**  
**ლალი**  
**ЛАЛИ**

(511) 29, 32

(260) AM 2018 95054 A  
 (210) AM 95054  
 (220) 2017 11 14  
 (731) LTD "KAKHETIAN TRADITIONAL  
 WINEMAKING-AGRO-CHOKHATAURI"  
 S. Tsintsadzis q. 12, A/P 3-6, sart. 3,  
 Vake-Saburtalos r-ni, 0170, Tbilisi, Georgia  
 (540)

**ლილე**  
**LILE**

(511) 32

(260) AM 2018 95065 A  
 (210) AM 95065  
 (220) 2017 11 14  
 (731) DAROINK LIMITED LIABILITY  
 COMPANY  
 86/1 Sevani Str., 0026, Yerevan, Armenia  
 (740) Nugzar Ksovreli

(540)



(591) Red, white

(531) 25.03.11; 26.04.04; 26.04.06; 26.04.07;  
26.04.24; 27.05.24; 29.01.12

(511) 30

(260) AM 2018 95066 A

(210) AM 95066

(220) 2017 11 14

(731) LTD "OXYGEN"

Vazha Pshavelas gamz., kvart. III, korp. 21  
b. 1, 0186, Tbilisi, Georgia

(740) Khatuna Imnadze

(540)

## Decefin

(591) Black, white

(511) 5

(260) AM 2018 95119 A

(210) AM 95119

(220) 2017 11 17

(731) ABBOTT LABORATORIES

100 Abbott Park Road, Illinois, 60064, Abbott  
Park, USA

(740) Tamar Kochlamazashvili

(540)

## UNIVANTS OF HEALTHCARE EXCELLENCE

(591) Black, white

(511) 35, 41, 44

(260) AM 2018 95148 A

(210) AM 95148

(220) 2017 11 21

(731) MAKER'S MARK DISTILLERY, INC.

6200 Dutchman's Lane, Suite 103, Louisville,  
Kentucky 40205, USA

(740) Shalva Gvaramadze

(540)



(591) Black, white

(531) 01.01.02; 01.01.10; 26.01.18; 27.05.01;  
27.05.17

(511) 33

(260) AM 2018 95183 A

(210) AM 95183

(220) 2017 11 22

(731) S.A. VICHY CATALAN.

Roger de Lluria, 126., 08037, Barcelona,  
Spain

(740) Tamar Kochlamazashvili

(540)

## FONT D'OR

(591) Black, white

(511) 32

(260) AM 2018 95184 A

(210) AM 95184

(220) 2017 11 22

(731) S.A. VICHY CATALAN.

Roger de Lluria, 126., 08037, Barcelona,  
Spain

(740) Tamar Kochlamazashvili

(540)



(591) Yellow, blue

(531) 02.01.02; 02.01.15; 02.01.23; 19.07.01;  
26.01.01; 26.01.04; 26.01.21; 29.01.12

(511) 32

(260) AM 2018 95210 A

(210) AM 95210

(220) 2017 11 28

(731) GETZ PHARMA INTERNATIONAL  
FZ LLCOffice No. 1307, 13th Floor, Al-Thuraya  
Tower 1, Dubai Media City, Dubai, United  
Arab Emirates

(740) Merab Kvimsadze

(540)

## MONTIGET

(591) Black, white

(531) 27.05.01

(511) 5



(260) AM 2018 95211 A  
 (210) AM 95211  
 (220) 2017 11 28  
 (731) LINKEDIN CORPORATION  
 (a Delaware Corporation)  
 1000 W. Maude Avenue Sunnyvale,  
 California 94085, USA  
 (740) Natela Otavidze  
 (540)

## LINKEDIN

(591) Black, white  
 (511) 9, 35, 41, 42, 45

(260) AM 2018 95212 A  
 (210) AM 95210  
 (220) 2017 11 28  
 (731) LINKEDIN CORPORATION  
 (a Delaware Corporation)  
 1000 W. Maude Avenue Sunnyvale,  
 California 94085, USA  
 (740) Natela Otavidze  
 (540)



(591) Black, white  
 (531) 26.04.01; 26.04.18; 26.04.24; 27.05.23;  
 27.05.24  
 (511) 9, 35, 41, 42, 45

(260) AM 2018 95213 A  
 (210) AM 95213  
 (220) 2017 11 28  
 (731) GETZ PHARMA INTERNATIONAL FZ  
 FZ LLC  
 Office No. 1307, 13th Floor, Al-Thuraya  
 Tower 1, Dubai Media City, Dubai, United  
 Arab Emirates  
 (740) Merab Kvimsadze  
 (540)

## CELCOXX

(591) Black, white  
 (531) 27.05.01  
 (511) 5

(260) AM 2018 95238 A  
 (210) AM 95238  
 (220) 2017 11 29  
 (731) LTD "PORTO FRANKO"  
 Memed Abashidzis q. 39, 6000, Batumi,  
 Georgia

(740) Lana Chikhladze  
 (540)



(591) White, brown  
 (531) 15.07.07; 15.07.09; 18.03.21; 27.05.11  
 (511) 43

(260) AM 2018 95259 A  
 (210) AM 95259  
 (220) 2017 11 29  
 (731) SHANGHAI YU FLY MILKY WAY  
 TECHNOLOGY CO., LTD.  
 Room 1418, Building 2, No. 700 Jiahao Road,  
 Jiading District, Shanghai, China  
 (740) Merab Kvimsadze  
 (540)



## YU FLY

(591) Black, white  
 (531) 18.05.05; 18.05.10; 27.05.01  
 (511) 9, 35

(260) AM 2018 95317 A  
 (210) AM 95317  
 (220) 2017 12 01  
 (731) LTD "TIFLISSKI VINNI POGREB"  
 Iumashevis q. 27, 0198, Tbilisi, Georgia  
 (740) Shalva Gvaramadze  
 (540)



(591) Black, white  
 (531) 19.09.02; 24.07.01; 24.13.01; 25.01.19;  
 27.05.01  
 (526) "Kvevri" and Georgian Flag (Imitation)  
 (511) 33

(260) AM 2018 95320 A  
 (210) AM 95320  
 (220) 2017 12 01  
 (731) Enriko Beridze  
 T. Tabidzis q.10, Chikhi 1, Tbilisi, Georgia  
 (540)



(591) Light grey, black  
 (531) 26.04.12; 26.11.12; 27.05.01  
 (511) 9, 35, 42, 45

(260) AM 2018 95339 A  
 (210) AM 95339  
 (220) 2017 12 04  
 (731) PHILIP MORRIS PRODUCTS S. A.  
 Quai Jeanrenaud 3, 2000, Neuchâtel,  
 Switzerland  
 (740) Shalva Gvaramadze  
 (540)

**CHESTERFIELD TUNED  
 AQUA**

(511) 34

(260) AM 2018 95340 A  
 (210) AM 95340  
 (220) 2017 12 04  
 (731) PHILIP MORRIS PRODUCTS S. A.  
 Quai Jeanrenaud 3, 2000, Neuchâtel,  
 Switzerland  
 (740) Shalva Gvaramadze  
 (540)



(591) Different tone blue, dark blue, white, golden  
 (531) 05.03.01; 05.03.16; 24.09.12; 25.07.25;  
 27.05.04; 29.01.13  
 (511) 34

(260) AM 2018 95346 A  
 (210) AM 95346  
 (220) 2017 12 04  
 (731) LTD "GMP"  
 Sop. Ponitchala 65, 0165, Tbilisi, Georgia  
 (740) Nugzar Ksovreli  
 (540)

**ბრინჯოტიმოლი  
 БРИНЗОТИМОЛ  
 BRINZOTIMOL**

(511) 5

(260) AM 2018 95347 A  
 (210) AM 95347  
 (220) 2017 12 04  
 (731) LTD "GMP"  
 Sop. Ponitchala 65, 0165, Tbilisi, Georgia  
 (740) Nugzar Ksovreli  
 (540)

**გლაუსანო  
 ГЛАУСАН  
 GLAUSAN**

(511) 5

(260) AM 2018 95348 A  
 (210) AM 95348  
 (220) 2017 12 04  
 (731) LTD "GMP"  
 Sop. Ponitchala 65, 0165, Tbilisi, Georgia  
 (740) Nugzar Ksovreli  
 (540)

**ტაფლობესტი  
 ТАФЛОБЕСТ  
 TAFLOBEST**

(511) 5

(260) AM 2018 95349 A  
 (210) AM 95349  
 (220) 2017 12 04  
 (731) LTD "GMP"  
 Sop. Ponitchala 65, 0165, Tbilisi, Georgia  
 (740) Nugzar Ksovreli  
 (540)

**აზაპენტოლი**  
**АЗАПЕНТОЛ**  
**AZAPENTOL**

(511) 5

(260) AM 2018 95350 A  
(210) AM 95350  
(220) 2017 12 04  
(731) LTD "GMP"  
Sop. Ponitchala 65, 0165, Tbilisi, Georgia  
(740) Nugzar Ksovreli  
(540)

**ტაფტილი**  
**ТАФТИЛ**  
**TAFTIL**

(511) 5

(260) AM 2018 95352 A  
(210) AM 95352  
(220) 2017 12 04  
(731) LTD "GMP"  
Sop. Ponitchala 65, 0165, Tbilisi, Georgia  
(740) Nugzar Ksovreli  
(540)

**აზარექსი**  
**АЗАРЕКС**  
**AZAREX**

(511) 5

(260) AM 2018 95356 A  
(210) AM 95356  
(220) 2017 12 05  
(731) LTD "GEORGIAN WINE HOUSE"  
Sop. Zegaani, Gurjaani, Georgia  
(740) Sopia Vacheishvili  
(540)



(591) Brown, cream color, white  
(531) 05.01.03; 05.01.16; 05.01.19; 05.07.10;  
26.01.21; 27.01.12; 28.19; 29.01.07  
(511) 33

(260) AM 2018 95365 A  
(210) AM 95365  
(220) 2017 12 05  
(731) T.Y.C. BROTHER INDUSTRIAL CO., LTD  
N72-2, Shin Leh Roud, 70248, Tainan,  
Taiwan, Province of China  
(740) Khatuna Imnadze  
(540)



(591) Black, white  
(531) 27.05.22  
(511) 11

(260) AM 2018 95370 A  
(210) AM 95370  
(220) 2017 12 06  
(731) SIEMENS AKTIENGESELLSCHAFT  
Werner-von-Siemens-Straße 1, München,  
Germany  
(740) Giorgi Kartvelishvili  
(540)



(591) Purple, white, blue  
(531) 26.01.02; 26.01.03; 26.01.18; 26.11.12;  
27.05.21; 29.01.13  
(511) 7

(260) AM 2018 95396 A  
(210) AM 95396  
(220) 2017 12 06  
(731) Vladimer Saanishvili  
I. Abashidzis q. 31, b. 19, 0179, Tbilisi,  
Georgia  
(540)

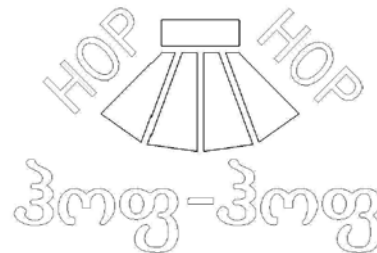

(591) Black, white

(531) 26.04.09; 27.05.02  
(511) 8

(260) AM 2018 95554 A  
(210) AM 95554  
(220) 2017 12 18  
(731) LTD "AGROHAB"  
Krtsanisis q. 8, korp. 2, b. 23, 0114, Tbilisi,  
Georgia  
(740) Nugzar Ksovreli  
(540)



(591) White, yellow, grey, different tone green  
(531) 01.15.03; 02.09.01; 02.09.04; 02.09.08;  
02.09.15; 28.19; 29.01.13  
(511) 35, 43

(260) AM 2018 95606 A  
(210) AM 95606  
(220) 2017 12 22  
(731) NINGBO GENIN INDUSTRIAL CO., LTD.  
Room 536, Bld. 5, No. 22 Henghe Road,  
Beilun District, Ningbo, Zhejiang Province,  
China  
(740) Shalva Gvaramadze  
(540)

**HOTECHE**

(591) Black, white  
(531) 27.05.01; 27.05.11  
(511) 7, 8

(260) AM 2018 95663 A  
(210) AM 95663  
(220) 2017 12 25  
(731) LTD "ARTPHARMA"  
Gamrekelis q. 19 (512), 0160, Tbilisi, Georgia

(740) Giorgi Taktakishvili  
(540)

**Cycloflex**  
**Циклофлекс**  
**ციკლოფლექსი**

(591) Black, white  
(511) 5

(260) AM 2018 95664 A  
(210) AM 95664  
(220) 2017 12 25  
(731) LTD "ARTPHARMA"  
Gamrekelis q. 19 (512), 0160, Tbilisi, Georgia  
(740) Giorgi Taktakishvili  
(540)

**Carnifol**  
**Карнифол**  
**კარნიფოლი**

(591) Black, white  
(511) 5

(260) AM 2018 95695 A  
(210) AM 95695  
(220) 2017 12 28  
(731) EMIRATES NATIONAL OIL COMPANY  
LIMITED (ENOC) LLC  
P.O. Box: 6442, Dubai, United Arab Emirates  
(740) Merab Kvimsadze  
(540)



(591) Black, white  
(531) 01.15.05; 25.05.01; 26.01.13; 26.02.07; 28.01  
(511) 4

---

**REGISTERED TRADEMARKS**

(111) M 2018 29852 R  
 (151) 2018 07 04  
 (181) 2028 07 04  
 (260) AM 2016 89788 A  
 (220) 2016 12 02

(732) STAFFORD-MILLER (IRELAND) LIMITED  
 Clocherane, Youghal Road, Dungarvan, Co.  
 Waterford, Ireland

---

(111) M 2018 29853 R  
 (151) 2018 07 04  
 (181) 2028 07 04  
 (260) AM 2017 90678 A  
 (220) 2017 02 02

(732) UNILEVER N.V.  
 Weena 455, 3013 AL Rotterdam, The  
 Netherlands, Netherlands

---

(111) M 2018 29854 R  
 (151) 2018 07 04  
 (181) 2028 07 04  
 (260) AM 2017 91088 A  
 (220) 2017 03 01

(732) LTD "ASPHARMA GEORGIA  
 PHARMACEUTICAL COMPANY"  
 Mtskhmetis q. 8, 0179, Tbilisi, Georgia

---

(111) M 2018 29855 R  
 (151) 2018 07 04  
 (181) 2028 07 04  
 (260) AM 2017 91382 A  
 (220) 2017 03 24

(732) LTD "GEOMIL"  
 Tchirnakhulis q. 4, Isani-Samgoris r-ni, 0151,  
 Tbilisi, Georgia

---

(111) M 2018 29856 R  
 (151) 2018 07 04  
 (181) 2028 07 04  
 (260) AM 2017 91535 A  
 (220) 2017 03 31

(732) LTD "GEOCELL"  
 Gotuas q. 3, Mtkvris marjvena sanapiro,  
 Tbilisi, Georgia

---

(111) M 2018 29857 R  
 (151) 2018 07 04  
 (181) 2028 07 04  
 (260) AM 2017 91556 A  
 (220) 2017 04 04

(732) ANHUI CONCH GROUP COMPANY  
 LIMITED  
 No.39, Wenhua Rd., Wuhu City, Province  
 Anhui, China

---

(111) M 2018 29858 R  
 (151) 2018 07 04  
 (181) 2028 07 04  
 (260) AM 2017 91667 A  
 (220) 2017 04 12

(732) JSC "TBC BANK"  
 Marjanishvilis q. 7, Old Tbilisi r-n, Georgia

---

(111) M 2018 29859 R  
 (151) 2018 07 04  
 (181) 2028 07 04  
 (260) AM 2017 91721 A  
 (220) 2017 04 13

(732) LTD "OKROTAPLI"  
 Pshavis q. 7, 0900, Akhmetis R-ni, Georgia

---

(111) M 2018 29860 R  
 (151) 2018 07 04  
 (181) 2028 07 04  
 (260) AM 2017 91736 A  
 (220) 2017 04 18

(732) PREMIUM TOBACCO FZ LLC  
 P.O. Box: 31291, Al Jazeera Al-hamra,  
 Ras Al Khaimah, United Emirates of Arabia

---

(111) M 2018 29861 R  
 (151) 2018 07 04  
 (181) 2028 07 04  
 (260) AM 2017 91757 A  
 (220) 2017 04 19

(732) LTD "ASPHARMA Georgian Pharmaceutical  
 Company"  
 Mtskhmetis q. 8, 0179, Tbilisi, Georgia

---

(111) M 2018 29862 R  
 (151) 2018 07 04  
 (181) 2028 07 04  
 (260) AM 2017 91759 A  
 (220) 2017 04 19

(732) LTD "ASPHARMA Georgian Pharmaceutical  
 Company"  
 Mtskhmetis q. 8, 0179, Tbilisi, Georgia

---

(111) M 2018 29863 R  
 (151) 2018 07 04  
 (181) 2028 07 04  
 (260) AM 2017 91802 A  
 (220) 2017 04 21  
 (732) LTD "GLOBAL TRADE MARKETS"  
 Apakidzis q. 11, ზ. 138, 0171, Tbilisi, Georgia

(111) M 2018 29864 R  
 (151) 2018 07 04  
 (181) 2028 07 04  
 (260) AM 2017 91813 A  
 (220) 2017 04 24  
 (732) LTD "GEORGIAN WINE HOUSE"  
 Sop. Zegaani, Gurjaani, Georgia

(111) M 2018 29865 R  
 (151) 2018 07 04  
 (181) 2028 07 04  
 (260) AM 2017 91814 A  
 (220) 2017 04 24  
 (732) LTD "GEORGIAN WINE HOUSE"  
 Sop. Zegaani, Gurjaani, Georgia

(111) M 2018 29866 R  
 (151) 2018 07 04  
 (181) 2028 07 04  
 (260) AM 2017 91955 A  
 (220) 2017 05 03  
 (732) LTD "GEORGIAN WINE HOUSE"  
 Sop. Zegaani, Gurjaani, Georgia

(111) M 2018 29867 R  
 (151) 2018 07 04  
 (181) 2028 07 04  
 (260) AM 2017 91958 A  
 (220) 2017 05 03  
 (732) LTD "NEW PHARM GROUP"  
 D. Aghmasheneblis kheivsni XII km., korp. 2,  
 b. 43, Vake-Saburtalos r-ni, 0131, Tbilisi,  
 Georgia

(111) M 2018 29868 R  
 (151) 2018 07 04  
 (181) 2028 07 04  
 (260) AM 2017 91959 A  
 (220) 2017 05 03  
 (732) Yongkang Xulang Industry and Trade Co., Ltd  
 No.216 Meilong Roud, Khicheng, Iongkang,  
 Jejiang, China

(111) M 2018 29869 R  
 (151) 2018 07 04  
 (181) 2028 07 04

(260) AM 2017 91978 A  
 (220) 2017 05 04  
 (732) LTD "NEW PHARM GROUP"  
 D. Aghmasheneblis kheivsni XII km., korp. 2,  
 b. 43, Vake-Saburtalos r-ni, 0131, Tbilisi,  
 Georgia

(111) M 2018 29870 R  
 (151) 2018 07 04  
 (181) 2028 07 04  
 (260) AM 2017 91986 A  
 (220) 2017 05 04  
 (732) LTD "NEW PHARM GROUP"  
 D. Aghmasheneblis kheivsni XII km., korp. 2,  
 b. 43, Vake-Saburtalos r-ni, 0131, Tbilisi,  
 Georgia

(111) M 2018 29871 R  
 (151) 2018 07 04  
 (181) 2028 07 04  
 (260) AM 2017 91989 A  
 (220) 2017 05 04  
 (732) LTD "NEW PHARM GROUP"  
 D. Aghmasheneblis kheivsni XII km., korp. 2,  
 b. 43, Vake-Saburtalos r-ni, 0131, Tbilisi,  
 Georgia

(111) M 2018 29872 R  
 (151) 2018 07 04  
 (181) 2028 07 04  
 (260) AM 2017 92025 A  
 (220) 2017 05 05  
 (732) LTD "NEW PHARM GROUP"  
 D. Aghmasheneblis kheivsni XII km., korp. 2,  
 b. 43, Vake-Saburtalos r-ni, 0131, Tbilisi,  
 Georgia

(111) M 2018 29873 R  
 (151) 2018 07 04  
 (181) 2028 07 04  
 (260) AM 2017 92026 A  
 (220) 2017 05 05  
 (732) LTD "NEW PHARM GROUP"  
 D. Aghmasheneblis kheivsni XII km., korp. 2,  
 b. 43, Vake-Saburtalos r-ni, 0131, Tbilisi,  
 Georgia

(111) M 2018 29874 R  
 (151) 2018 07 04  
 (181) 2028 07 04  
 (260) AM 2017 92128 A  
 (220) 2017 05 16  
 (732) LTD "MINING COMPANY PARAVAN-  
 PERLITE"

---

Vazha-Pshavelas gamz., VII kvart., korp. 8, b. 54, 0186, Tbilisi, Georgia	(732) LTD "Dogning City Tianchi Trade CO." Dongning-Chzen, Czinlao-Uaninan, Dongning Town, 157200, China
--	--

---

(111) M 2018 29875 R (151) 2018 07 04 (181) 2028 07 04 (260) AM 2017 92184 A (220) 2017 05 17 (732) JSC "M2 REAL ESTATE" I. Chavchavadzis gamz. 29, Sart. 3, Tbilisi, Georgia	(111) M 2018 29881 R (151) 2018 07 04 (181) 2028 07 04 (260) AM 2017 92561 A (220) 2017 06 06 (732) LTD "Dogning City Tianchi Trade CO." Dongning-Chzen, Czinlao-Uaninan, Dongning Town, 157200, China
--	---

---

(111) M 2018 29876 R (151) 2018 07 04 (181) 2028 07 04 (260) AM 2017 92215 A (220) 2017 05 18 (732) LTD "GEORGIAN WINE HOUSE" Sop. Zegaani, Gurjaani, Georgia	(111) M 2018 29882 R (151) 2018 07 04 (181) 2028 07 04 (260) AM 2017 92563 A (220) 2017 06 06 (732) LTD "Dogning City Tianchi Trade CO." Dongning-Chzen, Czinlao-Uaninan, Dongning Town, 157200, China
---	---

---

(111) M 2018 29877 R (151) 2018 07 04 (181) 2028 07 04 (260) AM 2017 92359 A (220) 2017 05 25 (732) LTD "ASPHARMA Georgian Pharmaceutical Company" Mtskhetis q. 8, 0179, Tbilisi, Georgia	(111) M 2018 29883 R (151) 2018 07 04 (181) 2028 07 04 (260) AM 2017 92581 A (220) 2017 06 06 (732) LTD "VIVO MEDICAL GROUP" Lublianas q. 5, Tbilisi, Georgia
--	---

---

(111) M 2018 29878 R (151) 2018 07 04 (181) 2028 07 04 (260) AM 2017 92493 A (220) 2017 05 31 (732) NAVIGATOR PAPER FIGUEIRA S.A. Lavos, 3090-451 Figeira Da Foz, Portugal	(111) M 2018 29884 R (151) 2018 07 04 (181) 2028 07 04 (260) AM 2017 92583 A (220) 2017 06 06 (732) LTD "VIVO MEDICAL GROUP" Lublianas q. 5, Tbilisi, Georgia
--	---

---

(111) M 2018 29879 R (151) 2018 07 04 (181) 2028 07 04 (260) AM 2017 92550 A (220) 2017 06 06 (732) LTD "GLOBALPHARMI" Almasyanis q. 13a/ Berbutis q. 8, 0171, Tbilisi, Georgia	(111) M 2018 29885 R (151) 2018 07 04 (181) 2028 07 04 (260) AM 2017 92738 A (220) 2017 06 12 (732) LTD "GLOBALPHARMI" Almasyanis q. 13a/ Berbutis q. 8, 0171, Tbilisi, Georgia
--	--

---

(111) M 2018 29880 R (151) 2018 07 04 (181) 2028 07 04 (260) AM 2017 92559 A (220) 2017 06 06	(111) M 2018 29886 R (151) 2018 07 04 (181) 2028 07 04
---	--

---

(260) AM 2017 92745 A  
(220) 2017 06 12  
(732) LTD "AVALIANI BROTHERS"  
Sop. Gogiashvilebi Me-3 q.18, Kedis r-ni,  
6100, Georgia

---

(111) M 2018 29887 R  
(151) 2018 07 04  
(181) 2028 07 04  
(260) AM 2017 92753 A  
(220) 2017 06 12  
(732) JSC "GEORGIAN BEER COMPANY"  
Sop. Saguramo, 3300, Mtskheta, Georgia

---

(111) M 2018 29888 R  
(151) 2018 07 04  
(181) 2028 07 04  
(260) AM 2017 92864 A  
(220) 2017 06 21  
(732) DAVIT GAGUA  
Andronikashvilis q. 6, Tbilisi, Georgia

---

(111) M 2018 29889 R  
(151) 2018 07 04  
(181) 2028 07 04  
(260) AM 2017 92886 A  
(220) 2017 06 22  
(732) SAVENCIA SA  
42 Rue Rieussec, 78220 Viroflay, France

---

(111) M 2018 29890 R  
(151) 2018 07 04  
(181) 2028 07 04  
(260) AM 2017 93060 A  
(220) 2017 06 29  
(732) MARINE NIKOLOZASHVILI-KUTCHAVA  
A. Mitskevichis q. 18, sad. 2, b. 33, 0194,  
Tbilisi, Georgia

---

(111) M 2018 29891 R  
(151) 2018 07 04  
(181) 2028 07 04  
(260) AM 2017 93245 A  
(220) 2017 07 07  
(732) JSC "GEPHA"  
Sanapiros q. 6, 0108, Tbilisi, Georgia

---

(111) M 2018 29892 R  
(151) 2018 07 04  
(181) 2028 07 04

(260) AM 2017 93272 A  
(220) 2017 07 11  
(732) MUBADALA TRADE MARKS HOLDING  
COMPANY – LLC  
P. O. Box 45005, Abu Dhabi, United Arab  
Emirates

---

(111) M 2018 29893 R  
(151) 2018 07 04  
(181) 2028 07 04  
(260) AM 2017 93296 A  
(220) 2017 07 11  
(732) LTD "NOVA PRODUCTION"  
Z. Paliashvilis q. 64, 0179, Tbilisi, Georgia

---

(111) M 2018 29894 R  
(151) 2018 07 04  
(181) 2028 07 04  
(260) AM 2017 93429 A  
(220) 2017 07 19  
(732) ALTIA PLC  
P.O. Box 350, FI-00101 Helsinki, Finland

---



## TRADEMARKS REGISTERED ACCORDING TO THE ACCELERATED PROCEDURE

The decision can be appealed at the Chamber of Appeal of Sakpatenti within 3 months from the publication.

(111) M 2018 29835 R  
 (151) 2018 06 20  
 (181) 2028 06 20  
 (210) AM 97680  
 (220) 2018 05 11  
 (310) UK00003271770  
 (320) 2017 11 20  
 (330) UK  
 (732) ELAID GLOBAL TOBAKO LIMITED  
 Uei Qort Uest, Iunion Roudi,  
 Sari GU9 7PT, Farnham,  
 United Kingdom  
 (740) Givi Akopashvili  
 (540)

### FIRST DIPLOMAT

(591) Black, white  
 (511) 34



(591) Red and white  
 (531) 03.07.17; 07.01.08; 07.01.12; 07.01.24;  
 27.05.01; 27.05.15; 29.01.13  
 (511) 36

(111) M 2018 29836 R  
 (151) 2018 06 21  
 (181) 2028 06 21  
 (210) AM 97988  
 (220) 2018 06 08  
 (732) Andro Tchiabrishvili  
 Tsotne Dadianis q. 319, b.8, 0192, Tbilisi,  
 Georgia  
 (540)

(591) Black, white  
 (531) 18.01.19; 27.05.01  
 (511) 12

(111) M 2018 29838 R  
 (151) 2018 06 27  
 (181) 2028 06 27  
 (210) AM 97892  
 (220) 2018 05 30  
 (732) LTD "CROSTY GLOBAL"  
 N. Zhvania q. 12, fl. 10, b. 39  
 (block II), Tbilisi, Georgia  
 (740) Nikoloz Shekiladze  
 (540)

(591) Black  
 (531) 26.04.09; 27.05.01  
 (511) 25

(111) M 2018 29837 R  
 (151) 2018 06 22  
 (181) 2028 06 22  
 (210) AM 97981  
 (220) 2018 06 07  
 (732) LTD "INVEST AND EXIM TECHNOLOGY  
 GROUP"  
 Gakhokidzis q. 49, Isani-Samgoris r-ni,  
 0182, Tbilisi, Georgia  
 (540)

(111) M 2018 29839 R  
 (151) 2018 06 28  
 (181) 2028 06 28  
 (210) AM 98165  
 (220) 2018 06 19  
 (732) LTD "NEXTRA GROUP"  
 Irodion Evdoshvilis q. 18, sart. 2, Saopise  
 Parti 3, Didube-Chughuretis r-ni,  
 0154, Tbilisi, Georgia

(540)

ლემოტირეზი  
**Lemotirez**  
 Лемотирез

(511) 5

(111) M 2018 29840 R

(151) 2018 06 28

(181) 2028 06 28

(210) AM 98175

(220) 2018 06 21

(732) LTD "CAUCASUS AUTO IMPORT"  
 D. Aghmasheneblis gamz. 156, sart. 6, 0112,  
 Tbilisi, Georgia

(540)



(591) Red, white, black, grey

(531) 26.02.01; 26.02.07; 26.03.01; 26.03.24;  
 26.11.12; 27.05.01; 27.05.15; 29.01.13

(511) 36, 39

(111) M 2018 29841 R

(151) 2018 06 28

(181) 2028 06 28

(210) AM 97903

(220) 2018 05 31

(732) LTD "MULTI COLOR"  
 V. Janjghavas q., II shesakhv. 10, Gldani-  
 Nadzaladevis r-ni, 0153, Tbilisi, Georgia

(740) Davit Dzamukashvili

(540)



(591) Main thing colors are red and white, and  
 drop colors are variable for example: as in  
 the image: yellow, green, blue, black

(531) 26.04.02; 26.04.05; 26.04.22; 26.04.24;  
 26.11.03; 26.11.07; 29.01.15

(511) 2

(111) M 2018 29842 R

(151) 2018 07 02

(181) 2028 07 02

(210) AM 98159

(220) 2018 06 18

(732) LTD "BROTMEISTER"

Gotuas q. 12, 0160, Tbilisi, Georgia

(540)



(591) Wheat color, brown and green

(531) 02.01.01; 27.05.01; 27.05.04; 27.05.10; 28.19;  
 29.01.13

(511) 30, 43

(111) M 2018 29843 R

(151) 2018 07 03

(181) 2028 07 03

(210) AM 98197

(220) 2018 06 22

(732) LTD "NEXTRA GROUP"

Irodion Evdoshvilis q. 18, Sar. 2, Saofise  
 Farti 3, Didube-Chughuretis r-ni, 0154,  
 Tbilisi, Georgia

(540)

ნიუმიქსინი  
**Newmixin**  
 Ньюмиксин

(511) 5

(111) M 2018 29844 R

(151) 2018 07 03

(181) 2028 07 03

(210) AM 98193

(220) 2018 06 22

(732) LTD "NEXTRA GROUP"

Irodion Evdoshvilis q. 18, sart. 2, Saopise  
 Parti 3, Didube-Chughuretis r-ni,  
 0154, Tbilisi, Georgia

(540)

დუოშპირონი  
**Duospiron**  
 Дуошпирон

(511) 5

(111) M 2018 29845 R  
 (151) 2018 07 03  
 (181) 2028 07 03  
 (210) AM 98196  
 (220) 2018 06 22  
 (732) LTD "NEXTRA GROUP"  
 Irodion Evdoshvilis q. 18, sart. 2, Saopise  
 Parti 3, Didube-Chughuretis r-ni,  
 0154, Tbilisi, Georgia

(540)

**დინოპრიდი**  
**Dinoprid**  
**Диноприд**

(511) 5

(111) M 2018 29846 R  
 (151) 2018 07 03  
 (181) 2028 07 03  
 (210) AM 98191  
 (220) 2018 06 22  
 (732) LTD "NEXTRA GROUP"  
 Irodion Evdoshvilis q. 18, sart. 2, Saopise  
 Parti 3, Didube-Chughuretis r-ni,  
 0154, Tbilisi, Georgia

(540)

**ადოლორი ბ12**  
**Adolor B12**  
**Адолор Б12**

(511) 5

(111) M 2018 29847 R  
 (151) 2018 07 03  
 (181) 2028 07 03  
 (210) AM 98179  
 (220) 2018 06 21  
 (732) Ruslan Sverdlov  
 Grozno, Me-3 Shesak., M. Mazaeva,  
 Sakhli 21, Russian Federation

(740) Bakur Gvarliani

(540)



(591) White, black, golden, grey  
 (531) 03.01.01; 03.01.02; 03.01.16; 24.09.02;  
 24.09.07; 25.01.10; 25.01.25; 26.01.04;  
 26.01.21; 26.01.24; 27.05.01; 27.05.24;  
 29.01.13

(511) 34

(111) M 2018 29848 R  
 (151) 2018 07 03  
 (181) 2028 07 03  
 (210) AM 98008  
 (220) 2018 06 13  
 (732) LTD "REGIONAL HOSPITAL"  
 Petre Kavtaradzis 23, 0177, Tbilisi,  
 Georgia

(740) Ana Akhvlediani

(540)



(591) Blue, sky-blue, grey  
 (531) 27.05.22; 28.19; 29.01.12  
 (511) 44

(111) M 2018 29849 R  
 (151) 2018 07 03  
 (181) 2028 07 03  
 (210) AM 98009  
 (220) 2018 06 13  
 (732) LTD "REGIONAL HOSPITAL"  
 Petre Kavtaradzis 23, 0177, Tbilisi,  
 Georgia

(740) Ana Akhvlediani

(540)



(591) Blue, sky-blue, grey  
 (531) 27.05.01; 27.05.22; 29.01.12  
 (511) 44

(111) M 2018 29850 R  
 (151) 2018 07 03  
 (181) 2028 07 03  
 (210) AM 97977  
 (220) 2018 06 07  
 (732) ONUR İNŞ. SAN. VE DIŞ TİC. LTD ŞTİ.  
 Opr. Cemil Topuzlu Cad. Onur Apt. No.81/1  
 Caddebostan Kadıköy/İstanbul,  
 Turkey  
 (740) Giorgi Taktakishvili

(540)



(591) Golden, blue  
 (531) 05.07.02; 26.01.01; 26.01.15; 26.01.22;  
 27.05.10; 29.01.13  
 (511) 30, 35, 43

(111) M 2018 29851 R  
 (151) 2018 07 03  
 (181) 2028 07 03  
 (210) AM 97997  
 (220) 2018 06 11  
 (732) WOLT ENTERPRISES OY  
 Köydenpunojankatu 2a "D", 00180 Helsinki,  
 Finland  
 (740) Natalia Babakishvili  
 (540)

## Wolt

(591) Black, white  
 (511) 36, 39, 43

(111) M 2018 29895 R  
 (151) 2018 07 05  
 (181) 2028 07 05  
 (210) AM 98150  
 (220) 2018 06 15  
 (732) LADURÉE INTERNATIONAL SA  
 Route des Rez 2, 1667 Enney, France  
 (740) Giorgi Taktakishvili  
 (540)

## LADURÉE

(591) Black, white  
 (511) 29, 30, 32, 33, 35, 43

(111) M 2018 29896 R  
 (151) 2018 07 05  
 (181) 2028 07 05  
 (210) AM 98176  
 (220) 2018 06 21  
 (732) LTD "ITECHNIC"  
 P. Kavtaradzis q. 1, 0186, Tbilisi, Georgia

(540)



(591) Sky-blue, black, white  
 (531) 26.04.02; 26.04.05; 26.04.22; 27.05.01; 28.19;  
 29.01.13  
 (511) 35

(111) M 2018 29897 R  
 (151) 2018 07 06  
 (181) 2028 07 06  
 (210) AM 98170  
 (220) 2018 06 20  
 (732) OLGARLAR SPOR MALZEMELERİ  
 TURİZM İLAN REKLAM AJANSLIĞI  
 YAYINCILIK VE TİCARET ANONİM  
 ŞİRKETİ  
 Ulus Mahallesi Öztopuz Caddesi No:30,  
 Ulus Beşiktaş, İstanbul, Turkey  
 (740) Shalva Gvaramadze  
 (540)



(591) Red, black, white  
 (531) 26.13.25; 27.05.01; 27.05.10; 27.05.17;  
 27.05.23; 29.01.13  
 (511) 18, 25, 35, 38

## INTERNATIONAL TRADEMARKS FOR WHICH A DECISION ON GRANTING PROTECTIONS IS TAKEN

The decision can be appealed at the Chamber of Appeal of Sakpatenti within 3 months from the publication or at the Mtskheta District Court Administrative Cases Board (Address: №17, Samkhedro str., Mtskheta), within 1 month following the publication.

(260) AM 2018 91971 A  
 (800) 1340595  
 (151) 2017 01 24  
 (891) 2017 01 24  
 (731) PALMERS TEXTIL AKTIENGESELLSC-  
 HAFT  
 Ares Tower, Donau-City-Straße 11 A-1220  
 Wien, Austria  
 (540)

### **P-PALMERS SECOND SKIN**

(591) Black, white  
 (511)  
 25 – Clothing; underwear.

(260) AM 2018 92288 A  
 (800) 1146129  
 (151) 2012 12 14  
 (891) 2017 04 24  
 (731) ADAMA AGAN LTD.  
 Northern Industrial Zone, 7710201 Ashdod,  
 Israel  
 (540)

### **ADAMA**

(591) Black, white  
 (511)  
 44 – Agriculture, horticulture and forestry services.

(260) AM 2018 93656 A  
 (800) 1358020  
 (151) 2017 04 10  
 (891) 2017 08 07  
 (731) DAIICHI SANKYO COMPANY, LIMITED  
 3-5-1, Nihonbashi Honcho, Chuo-ku Tokyo  
 103-8426, Japan  
 (540)

### **Prasaspin**

(591) Black and white  
 (531) 27.05.01  
 (511)  
 5 – Pharmaceutical preparations and substances.

(260) AM 2018 93746 A  
 (800) 1359235  
 (151) 2017 04 07  
 (891) 2017 04 07  
 (731) Eagle Investment SICAV plc, acting on behalf  
 of ITT FUND  
 Alpine House, Naxxar Road SGN 9032 San  
 Gwann, Malta  
 (540)

### **Lucky 81**

(591) Black and white  
 (511)  
 9 – Games software; software programs for video  
 games; interactive video game programs; software  
 cartridges for computer games; software cartridges  
 for video games; software; educational software; ap-  
 plication software; community software; computer  
 telephony software; interactive computer software;  
 communication software; programs for computers;  
 electronic components for gambling machines; ga-  
 mes cartridges for use with electronic games appa-  
 ratus; juke boxes; automated teller machines.

28 – Games; sports games; manipulative games; me-  
 chanical games; musical games; electronic games;  
 parlor games; board games; quiz games; apparatus  
 for games; arcade games; skill and action games; el-  
 ectronic hand-held game units; handheld computer  
 games; lottery wheels; lottery tickets; slot machines;  
 automatic gaming machines; coin-operated amuse-  
 ment machines; bill-operated gaming equipment;  
 LCD game machines; counters for games; amuse-  
 ment apparatus for use in arcades.

41 – Gambling; operating lotteries; prize draws; or-  
 ganizing and conducting lotteries; games equipment  
 rental; casino services; leasing of casino games; pro-  
 viding of casino and gaming facilities; casino, ga-  
 ming and gambling services; providing amusement  
 arcade services; video arcade services.

(260) AM 2018 93749 A  
 (800) 1359291  
 (151) 2017 04 14  
 (891) 2017 04 14  
 (731) Zakrytoe aktsionernoe obshchestvo  
 "PHARMFIRMA "SOTEX"  
 d.11, pos. Belikovo, selskoe poselenie  
 Bereznjakovskoe, Sergievo-Posadsky  
 municipalny rayon RU-141345 Moskovskaya  
 obl., Russian Federation

(540)

**Меманталъ**

(591) Black and white

(531) 28.05

(511)

5 – Adhesive plasters; sticking plasters; candy, medicated; chewing gum for medical purposes; dietetic foods adapted for medical purposes; dietetic substances adapted for medical use; enzymes for medical purposes; medicines for human purposes; nutritional supplements; ointments for pharmaceutical purposes; pastilles for pharmaceutical purposes; lozenges for pharmaceutical purposes; pharmaceutical preparations; suppositories; tissues impregnated with pharmaceutical lotions; vaccines; vitamin preparations.

(260) AM 2018 93760 A

(800) 1360004

(151) 2017 01 26

(891) 2017 01 26

(731) Euro Games Technology Ltd.

"Maritsa" Str. 4, "Vranya-Lozen-Triugulnika",  
BG-1151 Sofia, Bulgaria

(540)

**20 DiamondDs**

(591) Blue, green, yellow, brown and white. Blue, green, yellow, brown and white, for the word and figurative elements

(531) 01.15.07; 27.05.02; 27.05.03; 27.07.02;  
29.01.15

(511)

9 – Apparatus for recording, transmission or reproduction of sound or image; computer software, recorded; monitors; computer hardware; computer games.

28 – Games that are not included in other classes; gaming machines operating with coins, banknotes and cards; gaming machines for gambling, adapted for use with external screen or monitor; slot machines, gaming machines.

(260) AM 2018 93784 A

(800) 1359378

(151) 2017 05 31

(891) 2017 05 31

(731) HANKOOK TIRE CO., LTD.

133, Teheran-ro (Yeoksamdong), Gangnam-gu  
Seoul, Republic of Korea

(540)

**Winter i\*cept evo<sup>3</sup> x**

(591) Black, white

(531) 24.17.03; 24.17.05; 24.17.06; 24.17.07;  
27.05.01

(511)

12 – Wheels for automobiles; wheel rims [for automobiles]; automobile chains; parts and accessories for automobiles; structural parts for automobiles; doors for automobiles; spokes for automobiles; spare wheel covers; anti-skid chains; automobile bodies; wheel arch extensions; automobile spare wheel holders; wheels for motorcycles; parts and accessories for motorcycles; automobiles; tires [tyres] for vehicle wheels; automobile tires [tyres]; tires [tyres] for two-wheeled motor vehicles or bicycles; tubes for vehicle wheels.

(260) AM 2018 93785 A

(800) 1359393

(151) 2017 06 07

(891) 2017 06 07

(731) MBDA FRANCE 1 AV RÉAUMUR

F-92350 LE PLESSIS ROBINSON, France

(540)

**MMP**

(591) Black, white

(531) 27.05.17; 27.05.23

(511)

13 – Missiles and weapon systems therefor.

(260) AM 2018 93906 A

(800) 207666

(151) 1958 02 24

(891) 2017 06 28

(731) HENKEL AG &amp; CO. KGAA

Henkelstrasse 67, 40589 Düsseldorf, Germany

(540)

**SILHOUETTE**

(591) Black, white

(511)

3 – Essential oils, bleaching preparations, substances for washing hair, cosmetics, perfumery goods, soaps, washing products.

(260) AM 2018 93910 A

(800) 941175

(151) 2007 05 28

(891) 2017 06 14

(731) VALOSUN a.s.

Na hřebenech II 1718/8, CZ-14000 Praha 4,  
Nusle, Czech Republic

(540)

**BIOPRON**

(591) Black, white

(511)

29 – Food supplements and nutritional supplements in the framework of this class, food supplements not for medicinal purposes, plant-based nutritional supplements, dietetic supplements, dietetic nutritional supplements, food supplements containing enzymes, food supplements, foodstuffs of animal origin, meat, fish, poultry and game, meat extracts, fruit and vegetables in cans, being dry and in the form of jams, jellies, jams, eggs, milk and dairy products, edible oils and fats, all included in this class.

30 – Food supplements and nutritional supplements, food supplements and foodstuffs for special nutrition containing plant-based substances, dietetic supplements, nutritional dietetic supplements, food supplements containing enzymes, food supplements, all included in this class.

(260) AM 2018 93916 A

(800) 1022168

(151) 2009 09 18

(891) 2017 08 10

(731) HUECK System GmbH &amp; Co. KG

Loher Straße 9, 58511 Lüdenscheid, Germany

(540)

**Hueck**

(591) Black, white

(511)

6 – Profiles of metal, in particular of aluminium, as well as mechanical closing and opening devices of metal; semi-finished products of metal, in particular of aluminium.

17 – Insulating materials and gaskets for doors, windows, facades, partitions, canopies, conservatories, glass extensions and fire-protection barriers; goods of plastics (semi-finished products), in particular profiles (included in this class).

19 – Building materials not of metal, in particular for manufacturing and assembling windows, doors, facades, partitions, canopies, conservatories, glass extensions and fire-protection barriers.

20 – Mechanical closing and opening devices, not of metal and non-electric.

(260) AM 2018 93923 A

(800) 1197869

(151) 2013 12 05

(891) 2017 07 20

(731) Liqui – Moly Gesellschaft mit beschränkter Haftung

Jerg-Wieland-Strasse 4, 89081 Ulm, Germany

(540)

**MOLYGEN**

(591) Black, white

(511)

1 – Chemicals used in industry, in particular chemical and physical additives for lubricants, industrial oils, and for engine oils, gear oils, compressor oils and hydraulic oils, and additives for motor fuels, in particular petrol and diesel fuels; chemical additives for coolant fluids; anti-freezing preparations for coolant fluids and for windscreen washer fluid; antifreeze; chemical impregnation preparations for motor vehicle hoods; hydraulic oils.

4 – Lubricants; industrial oils, including motor oils, gear oils, compressor oils; contact oils for industrial purposes; lubricants, namely lubricating lacquer, non-chemical oil additives and additives for motor fuels (in particular petrol and diesel fuels); non-chemical additives for industrial oils, motor oils, gear oils, compressor oils and hydraulic oils.

(260) AM 2018 93945 A

(800) 1361295

(151) 2017 03 14

(891) 2017 03 14

(731) ORANGE RESTAURANTS BRANDS LIMITED

2 Riga Feraiou Street, Limassol Center, Block B, 6th floor, Office 601 CY-3095 Limassol, Cyprus

(540)



(591) Black, white, purple, orange, shades of red, blue and green

(531) 01.01.02; 01.01.10; 05.05.01; 05.05.20; 25.07.01; 26.01.16; 29.01.15

(511)

43 – Bar services; café services; cafeteria services; canteen services; food and drink catering; restaurant services; self-service restaurant services; snack-bar services.

(260) AM 2018 93946 A

(800) 1361297

(151) 2017 04 28

(891) 2017 04 28

(731) SATIUS LLC

ofis 192, etaj 2, korp. 3, d. 38, prospect Andropova RU-115487 Moscow, Russian Federation

(540)

**AMNIOQUICK DUO**

(591) Black, white

(511)

10 – Surgical, medical, dental and veterinary apparatus and instruments; diagnostic apparatus for medical purposes; blood testing apparatus; testing apparatus for medical purposes; diagnostic devices for medical purposes.

(260) AM 2018 94048 A

(800) 1362701

(151) 2017 03 31

(891) 2017 03 31

(731) ŠKODA AUTO a.s.

ř. Václava Klementa 869 CZ-293 01 Mladá Boleslav II, Czech Republic

(540)

**KAROQ**

(591) Black and white

(511)

12 – Automobiles and their parts and accessories, all included in this class, except bicycles, bicycle parts and bicycle accessories.

(260) AM 2018 94051 A

(800) 1362761

(151) 2017 04 04

(891) 2017 04 04

(731) COMMEND INTERNATIONAL GMBH

Saalachstraße 51 A-5020 Salzburg, Austria

(540)



(591) Grey, Magenta, Yellow, Keycolour and blue

(531) 27.05.10; 29.01.13

(511)

9 – Apparatus for recording, transmission or reproduction of sound or images.

35 – Office functions.

38 – Telecommunications.

42 – Scientific and technological services and research and design relating thereto, industrial analysis and research services, design and development of computer hardware and software.

(260) AM 2018 94072 A

(800) 492919

(151) 1985 03 14

(891) 2017 06 29

(731) PURATOS

Industrialaan 25 B-1702 Groot-Bijgaarden, Belgium

(540)

**PURATOS**

(591) Black, white

(511)

1 – Chemical products for use in the field of bakery, pastry, trading in ice cream, rusks, biscuits and cookies.

29 – Meat, fish, fruit and vegetable jellies; jams; eggs, milk and other dairy products; edible oils and fats; canned meat, fish, fruit and vegetables, for use in industry, crafts and for household use.

30 – Coffee, tea, cocoa, sugar, rice, tapioca, sago, artificial coffee; flour, cereal preparations, bread, cookies, biscuits, cakes, pastry and confectionery, edible ices; honey, treacle; yeast, baking-powder; salt, mustard; pepper, vinegar, sauces (except salad dressings); spices; ices for use in industry, crafts and for household use.

(260) AM 2018 94088 A

(800) 1364535

(151) 2017 04 18

(891) 2017 04 18

(731) HMK SATIŞ DESTEKLEME ÜRÜNLERİ

İMALAT İTHALAT İHRACAAT SANAYİ

VE TİCARET ANONİM ŞİRKETİ

Ambarhdere Yolu, Lotus World Avm,

No.6, K.-I, Beşiktaş, İstanbul, Turkey

(540)



(591) Green and black

(531) 27.05.10; 29.01.12

(511)

6 – Security fixtures for use in retail stores, namely, primarily metal display hooks; goods and materials of common metal used for storage, wrapping, packaging and sheltering purposes, containers of metal (storage, transport), buildings of metal, frames of metal for building, poles of metal for building, metal boxes, packaging containers of metal, aluminium foil, fences made of metal, guard barriers of metal, metal tubes, storage containers of metal, metal containers for the transportation of goods, ladders of metal; metal panels or boards (non-luminous and non-mechanical) used for signalling, route showing, publicity purposes, signboards of metal, advertisement columns of metal, signaling panels of metal, non-luminous and non-mechanical traffic signs of metal.

9 – Measurement apparatus and equipment including those for scientific, nautical, topographic, meteorological, industrial and laboratory purposes, thermome-



ters, not for medical purposes, barometers, ammeters, voltmeters, hygrometers, testing apparatus not for medical purposes, telescopes, periscopes, directional compasses, speed indicators, laboratory apparatus, microscopes, magnifying glasses, binoculars, stills, ovens and furnaces for laboratory experiments; clothing for protection against accidents, irradiation and fire, safety vests and life-saving apparatus and equipment; apparatus and instruments for conducting, transforming, accumulating or controlling electricity, electric plugs, junction boxes [electricity], electric switches, circuit breakers, fuses, lighting ballasts, battery starter cables, electrical circuit boards, electric resistances, electric sockets, transformers [electricity], electrical adapters, battery chargers, electric door bells, electric and electronic cables, batteries, electric accumulators; solar panels for production of electricity; alarms and anti-theft alarms, other than for vehicles, electric bells; electronic security devices for use in retail stores, namely, (garment alarms) line alarms, free standing alarm modules, alarm module stands, and cabinet alarms; decorative magnets.

(260) AM 2018 94092 A

(800) 1364639

(151) 2017 06 08

(891) 2017 06 08

(731) HAZUKI COMPANY KABUSHIKI  
KAISHA

10-1, Roppongi 6-chome, Minato-ku Tokyo,  
Japan

(540)

# Hazuki Large

(591) Black, white

(511)

9 – Magnifying glasses; spectacles-type magnifying glasses.

(260) AM 2018 94093 A

(800) 1364640

(151) 2017 06 08

(891) 2017 06 08

(731) HAZUKI COMPANY KABUSHIKI  
KAISHA

10-1, Roppongi 6-chome, Minato-ku Tokyo,  
Japan

(540)

# Hazuki Compact

(591) Black, white

(511)

9 – Magnifying glasses; spectacles-type magnifying glasses.

(260) AM 2018 94113 A

(800) 1253713

(151) 2014 12 22

(891) 2017 03 07

(731) TRADE CORPORATION  
INTERNATIONAL, S.A.

Unipersonal Alcalá, 498, planta 2, E-28027

MADRID, Spain

(540)



(591) Yellow, green, black and white

(531) 01.03.01; 06.19.11; 29.01.13

(511)

1 – Fertilizers and manures for soils.

(260) AM 2018 94115 A

(800) 1313253

(151) 2016 05 03

(891) 2017 07 20

(731) PARNASSIA GROEP B.V.

Monsterseweg 93, NL-2553 RJ 's-Gravenhage,  
Netherlands

(540)

# TRIORA

(591) Black, white

(511)

41 – Upbringing, education, training and courses, including in the field of health; education and training in the areas of health, as well as medical and psychological area; training courses on psychological and medical matters and health care, including regarding addiction and treatment options; issuing publications, in printed or electronic form; information, advice and consultancy in these fields, whether or not by electronic and telecommunications channels, including the internet.

42 – Scientific and technological services and research relating thereto; laboratory services (research).

44 – Medical services; medical services in the field of social and mental health care; services rendered by psychiatrists, psychologists, therapists, medical practitioners, paramedics and nurses; services in the fields of health care; services rendered by general and psychiatric hospitals, nursing homes, homes for the elderly, sanatoriums, rest homes, convalescent homes, and shelters for psychiatric patients and others; psychological and medical treatment, care and counselling; medical services to prevent addiction; providing treatment, nursing, therapy, care and counselling to addicts, patients with behavioral disorders and psychiatric patients; forensic psychiatric care and forensic medical care for the benefit of persons in custody under a hospital order; services ren-

dered by medical specialists, including psychologists and psychiatrists, for treatment, care and counselling addicts, patients with behavioural disorders and psychiatric patients; information, advice and consultancy with regard to aforesaid services, whether or not by electronic and telecommunications channels, including internet.

45 – Legal services; legal advices, including legal opinions in medical and psychological area, as well as on legislation in the area of healthcare and treatment methods; information, advice and consultancy with regard to aforesaid services, whether or not by electronic and telecommunication means, including internet.

(260) AM 2018 94121 A

(800) 1363803

(151) 2017 06 22

(891) 2017 06 22

(731) ARISTO PHARMA GMBH

Wallenroder Str. 8-10, 13435 Berlin, Germany

(540)

**Aristo**

(591) Black, white

(511)

44 – Medical services, in particular consultancy in the pharmaceutical medical field; hygienic care for human beings and animals.

(260) AM 2018 94125 A

(800) 1364013

(151) 2017 06 28

(891) 2017 06 28

(731) JOYOUNG COMPANY LIMITED

NO.999 MEILI ROAD, HUAIYIN

DISTRICT, JINAN CITY, 250000

SHANDONG PROVINCE, China

(540)



(591) Black, white

(531) 26.04.02; 26.04.04; 26.04.05; 26.04.06;  
26.04.24; 27.05.17; 27.05.24

(511)

7 – Food preparation machines, electromechanical; beverage preparation machines, electromechanical; food processors, electric; kitchen machines, electric; fruit presses, electric, for household purposes; dishwashers; kitchen grinders, electric; soybean milk machines for household use; washing machines [laundry]; robots [machines]; machines and apparatus for cleaning, electric; cleaning appliances utilizing steam.

9 – Scientific, nautical, surveying, photographic, cinematographic, optical, weighing, measuring, signalling, checking (supervision), life-saving and teaching apparatus and instruments; apparatus and instruments for conducting, switching, transforming, accumulating, regulating or controlling electricity; apparatus for recording, transmission or reproduction of sound or images; magnetic data carriers, recording discs; compact discs, DVDs and other digital recording media; mechanisms for coin-operated apparatus; cash registers, calculating machines, data processing equipment, computers; computer software; fire-extinguishing apparatus.

11 – Lamps; cooking apparatus and installations; pressure cookers [autoclaves], electric; kettles, electric; coffee machines, electric; electric rice cooker; cooking utensils, electric; roasting apparatus; cooling appliances and installations; air conditioning apparatus; extractor hoods for kitchens; heating apparatus; heating installations; heaters for baths; water purifying apparatus and machines; radiators, electric; lighters.

21 – Cooking utensils, non-electric; iron pan; kitchen utensils; containers for household or kitchen use; cooking pots; daily use glassware (including cups, plates, pots, crocks); daily use chin aware (including basins, bowls, plates, pots, tablewares, crocks, jars, cans); drinking vessels; toilet utensils; toothbrushes, electric; kettles, non-electric; cleaning instruments, hand-operated.

(260) AM 2018 94162 A

(800) 1363685

(151) 2017 01 10

(891) 2017 01 10

(731) MANN & SCHRÖDER GMBH

Bahnhofstrasse 14 74936 Siegelbach,

Germany

(540)



(591) Blue

(531) 03.05.01; 29.01.04

(511)

3 – Soaps, cosmetics, preferably for infants, children and their mothers and pregnant women, particularly cosmetic bath preparations, shampoos, cosmetic creams and lotions, pre-moistened cosmetic wipes, moist paper hand towels impregnated with a cos-

metic lotion, tissues impregnated with cosmetic lotions, oils for cosmetic purposes, oil for cleaning purposes, conditioning creams, impregnated cleaning pads impregnated with toilet preparations, baby care products (non-medicated -), hand creams, cosmetics in the form of powders, non-medicated diaper rash cream, night creams, bath oil, cosmetics for protecting the skin from sunburn, after-sun preparations for cosmetic use, after-sun milk, sunscreen preparations, sun cream, massage oils, shower creams, shower and bath gel, shower preparations, cosmetics in the form of gels, cosmetic preparations for dry skin during pregnancy, cleansing lotion, particularly lotion for personal sanitary purposes; essential oils and aromatic extracts; cleaning and fragranting preparations; perfumery; hair lotions; dentifrice.

5 – Breast-nursing pads.

16 – Paper and cardboard; artistic works and statuettes of paper and cardboard; decoration and art materials and media; bags and articles for packaging, wrapping and storage of paper, cardboard or plastics; stationery and educational supplies; disposable paper products; printed matter; posters made of paper, mounted posters, poster magazines; photographs; office requisites, except furniture; parts and accessories for all the aforesaid goods, included in this class.

18 – Luggage, bags, wallets and other carriers; umbrellas and parasols; saddlery; trunks and suitcases; parts and accessories for all the aforesaid goods, included in this class.

20 – Displays, stands and signage, non-metallic, baby changing mats, poster display apparatus, display stands for posters; goods made of non-metallic materials, namely, hand-held fans, identification bracelets, holders for pennants, tags, tissue dispensers, trays; statues, figurines, works of art and ornaments and decorations, included in this class; furniture and site furnishings; containers, and closures and holders therefor, non-metallic; mirrors; picture frames; parts and accessories for all the aforesaid goods, included in this class; clothes racks [furniture].

21 – Statues, figurines, signs and works of art, included in this class; unworked and semi-worked glass; brushes and brush-making articles; plates, cooking pot sets and containers, particularly children's crockery; cleaning articles; cosmetic and toilet utensils and bathroom articles; devices for pest and vermin control; articles for clothing and footwear, namely, boot jacks and shoehorns, buttoning aids for boots, clothing stretchers, ironing cloths and cloths presses, ironing boards, polishing appliances for shoes, shoe stretchers and formers; household or kitchen utensils and containers; combs and sponges; steelwool; parts and accessories for all the aforesaid goods, included in this class.

24 – Bath towels; textile material; textile goods and substitutes for textile goods; bed blankets; table linen.

(260) AM 2018 94202 A  
(800) 265004  
(151) 1963 01 29  
(891) 2017 06 30  
(731) C. Bechstein Pianofortefabrik AG  
Kantstrasse 17, 10623 Berlin, Germany  
(540)

## W. Hoffmann

(591) Black, white  
(511)  
15 – Musical instruments, parts and strings for these instruments, harpsichords, pianos.

(260) AM 2018 94209 A  
(800) 1148015  
(151) 2012 11 07  
(891) 2017 08 17  
(731) ZELLSTOFF PÖLS AG  
Dr. Luigi Angeli-Straße 9, A-8761 Pöls,  
Austria  
(540)

**starkraft** 

(531) 03.02.07; 04.03.07  
(511)  
16 – Tear-resistant, bleached paper of long fibre sulphate pulp, in particular for use in the manufacture of shopping bags and flexible packages, wrapping paper and for use in the medical sector.

(260) AM 2018 94213 A  
(800) 1309140  
(151) 2016 03 24  
(891) 2017 07 24  
(731) ZHU ZHI QIN  
No.3, Building 88, WuAi Village, Jiangdong  
Street, Yiwu Zhejiang, China  
(540)

## PI'LATEN

(591) Black, white  
(531) 27.05.01  
(511)  
3 – Soap; stain removers; shoe wax; abrasive pastes; essential oils; incense; cosmetics; dentifrices; shampoos for pets; cosmetic kits.

(260) AM 2018 94215 A

(800) 1338623

(151) 2016 11 29

(891) 2017 07 14

(731) MARKER DALBELLO VÖLKL  
(INTERNATIONAL) GMBH  
Ruessenstrasse 6 CH-6340 Baar, Switzerland

(540)



(591) Black, white

(531) 26.13.25

(511)

9 – Helmets for use in sports, protective helmets for sports purposes; spectacles for athletes, snow goggles.

18 – Casual bags, namely handbags, luggage, carrying bags, bumbags, duffel bags, clutch bags, drawstring bags, universal sports bags, holdalls; backpacks.

25 – Wearing apparel, namely shirts, athletic suits, skirts, sweat shirts, tee-shirts, shorts, socks, undershirts, jackets, trousers, chemises; headgear, namely ski hats, snowboard hats, tennis caps, headbands and hats; ski gloves and snowboarding gloves, ski boots, apres-ski shoes, snowboarding boots and tennis shoes.

28 – Sporting apparatus and articles, namely skis and snowboards, ski poles, ski bindings and snowboard bindings, tennis racquets, squash racquets, racquetball racquets, badminton racquets; parts for these sporting apparatus and articles, namely containers specifically adapted to these sporting apparatus and articles, namely bags and covers; climbing skins and crampons (climbing irons) for use with touring skis; back protectors, namely back protectors for sports; shin, knee and elbow protectors, namely kneepads for sports, shin guards [sports articles], elbow pads for sports; grip tape and strings for racquet.

41 – Arranging and conducting sporting competitions; coordination of sports competitions; providing of sporting facilities for camps; providing of sports camp facilities.

(260) AM 2018 94216 A

(800) 1362977

(151) 2017 06 20

(891) 2017 08 30

(731) LA LURTONERIE

Domaine de Poumeyrade, F-33870 VAYRES,  
France

(540)

# SORGIN

(591) Black, white

(531) 27.05.17

(511)

33 – Alcoholic beverages (except beers); wines; wines protected by an appellation of origin; wines protected by a geographical indication.

(260) AM 2018 94218 A

(800) 1365075

(151) 2017 02 23

(891) 2017 02 23

(731) COMITATI OLIMPICI EUROPEI

Via della Pallacanestro, 19, Rome, Italy

(540)



(591) Azure, blue, sky blue and white.

(531) 26.15.01; 26.15.15; 29.01.04

(511)

9 – Scientific, nautical, surveying, photographic, cinematographic, optical, weighing, measuring, signalling, checking (supervision), life-saving and teaching apparatus and instruments; apparatus for recording, transmission or reproduction of sound or images; magnetic data carriers, recording discs; protective helmets for sports; spectacles, sports goggles, sunglasses; computer software, including computer software for video camera games; cameras; magnetic data carriers; data processing software and computer hardware; power supplies, namely batteries, portable digital electronic devices and software related thereto; portable electronic devices for wireless data reception and/or transmission, computer games software for mobile phone computers and smartphones; acoustic machines and apparatus, radio equipment, headset, headphones, microphones, laser disc players, video compact disc players, video CD software, DVD video players/recorders, telephones, mobile phones, smartphones, carrying cases for mobile phones, banking cards, debit cards; encoded magnetic cards, flashlights, integrated circuit chip cards; banking card, credit cards, debit cards including such cards having integrated circuits and microprocessors; memory boards.

25 – Clothing, footwear, headgear.

28 – Games and playthings; gymnastic and sporting articles not included in other classes; decorations for Christmas trees; playing cards, electric floats for fishing, apparatus for tying fishing lines to hooks, electronic apparatus for practicing golf, stationary exercise bicycles and rollers.

38 – Telecommunications; broadcasting of television programmes, television broadcasting (live or recorded); cellular telephone communication; communications by electronic computer terminals, databases and Internet related telecommunications networks; telephone and mobile telephone services; facsimile communication services; services of a press agency; other message transmission services; broadcasting of a commercial site on the Internet; radio and television broadcasting services provided via the Internet; electronic mail, provision of internet access services, electronic bulletin board services.

41 – Education; providing of training; entertainment; sporting and cultural activities; organization of exhibitions for cultural and educational purposes; organisation of lotteries and competitions; entertainment services provided at or relating to sports events; organisation of sporting and cultural events and activities; arranging real or virtual sports competitions; exploitation of sports facilities; rental services for audio and video equipment; radio and television production and broadcasting of sports and sporting events; production services for radio and television programs and videotapes; production of animated movies; seat booking services for shows and sporting events; timing of sports events, provision of games over the Internet, providing on-line electronic publications, not downloadable; publication of books, journals, texts (except publicity texts) and periodicals; online publication of electronic books, journals, texts (except publicity texts) and periodicals; providing digital music from the Internet; making sporting results available; information services in relation to sport and sporting events; information relating to sporting events provided on-line from a computer database or the Internet.

(260) AM 2018 94289 A

(800) 1163002

(151) 2013 04 29

(891) 2017 07 11

(731) CONTINENTAL MATADOR RUBBER,  
S.R.O.  
Terézie Vansovej 1054, SK-020 01 Púchov,  
Slovakia

(540)

## CONQUERRA

(591) Black, white

(511)

12 – Tires.

(260) AM 2018 94294 A

(800) 1166124

(151) 2013 04 24

(891) 2017 07 12

(731) CONTINENTAL MATADOR RUBBER,  
S.R.O.  
Terézie Vansovej 1054, SK-020 01 Púchov,  
Slovakia

(540)

## ADHESSA

(591) Black, white

(511)

12 – Tires.

(260) AM 2018 94296 A

(800) 1198048

(151) 2013 11 26

(891) 2017 07 18

(731) FROMAGERIES BEL  
2 allée de Longchamp, F-92150 Suresnes,  
French Guiana

(540)

## KIRI

(591) Black, white

(511)

30 – Cocoa; rice; tapioca and sago; flour and preparations made from cereals; bread, pastry and confectionery; edible ices; sugar, honey, treacle; yeast, baking powder; salt; mustard; vinegar, sauces (condiments); spices; ice for refreshment; sandwiches; pasta; pizzas; cereal, pasta or rice-based prepared dishes; biscuits, cookies and cakes.

(260) AM 2018 94306 A

(800) 1366010

(151) 2017 04 28

(891) 2017 04 28

(731) SUNING INTERNATIONAL SERVICES  
23/25 avenue Mac-Mahon F-75017 PARIS,  
France

(540)

## SUNING

(591) Black and white

(531) 27.05.17

(511)

1 – Solidified gases for industrial use; radioactive elements for scientific use; industrial chemicals; agricultural chemicals except fungicides, herbicides, insecticides and parasiticides; chemical preparations for scientific use other than for medical or veterinary

use; unprocessed plastics; fertilizers; vitamins for the food industry; leather-dressing chemicals; glues for use in industry.

2 – Colorants; pigments; food dyes; printing inks; inks for skin-dressing; paints; coatings [paints]; anti-corrosive preparations; protective products for metals; mastic [natural resin].

3 – Bath preparations, not for medical use; cleaning products; polishing preparations; grinding products; perfumery products; cosmetics; dentifrices; incense; cosmetics for animals; air fragrances.

4 – Industrial grease; industrial oils; fuels; fuel gas; coal [fuel]; firelighters; waxes for industrial use; candles [lighting]; dust removers; electrical energy.

5 – Medicines for human medicine; disinfectants; dietetic substances for medical use; food for babies; depuratives; veterinary products; pesticides; sanitary towels; medical dressings; alloys of precious metals for dental use.

6 – Unwrought or semi-worked common metals; pipes of metal; building materials of metal; wires of metal; hardware of metal; safes [of metal or not of metal]; reinforcing materials of metal for machine belts; tanks of metal; signboards of metal; works of art of common metal.

7 – Stereotype machines; electromechanical food preparation machines; electromechanical apparatus for beverage preparation; electric kitchen machines; electric food processors; washing machines [laundry]; machines for processing plastics; metalworking machines; hand-held tools, other than hand-operated; electric machines and apparatus for cleaning.

8 – Hand-operated hand tools; hand-operated garden tools; manicure sets; cutting tools [tools]; stamping-out tools [hand tools]; hobby knives [scalpels]; knives; daggers; table cutlery [cutlery, forks and spoons]; handles for hand-operated hand tools.

9 – Downloadable computer software applications; radios; televisions; photographic apparatus; surveying apparatus and instruments; mirrors [optics]; materials for electricity mains [wires, cables]; switches; computer peripheral devices; protection devices for personal use against accidents; data processing apparatus; smartwatches; smart glasses; downloadable electronic publications; photocopiers; computers; mobile telephones; cabinets for loudspeakers; spectacles [optics]; batteries.

10 – Medical apparatus and instruments; veterinary apparatus and instruments; dental apparatus and instruments; apparatus and installations for the production of X-rays for medical use; special furniture for medical use; feeding bottles; condoms; surgical implants comprised of artificial materials; orthopedic articles; suture materials.

11 – Apparatus and installations for lighting; cooking apparatus and installations; refrigerating apparatus and machines; air conditioning installations; heating apparatus; heating installations; bath installations; water purifying apparatus and machines; electric radiators; gas lighters.

12 – Vehicles for locomotion by land, air, water or rail; cars; bicycles; aerial conveyors; strollers; sleighs [vehicles]; tires for vehicle wheels; air vehicles; boats; safety seats for children, for vehicles.

13 – Firearms; guns [weapons]; cartridges; gunpowder; explosives; detonators; fireworks; pyrotechnic products; Bengal lights; sprays for personal defense.

14 – Unwrought or semi-wrought precious metals; alloys of precious metal; boxes of precious metal; jewelry boxes; primers for jewelry; works of art of precious metal; jewelry articles; trinkets for key fobs; electric clocks; wristwatches.

15 – Musical instruments; horns [musical instruments]; drums [musical instruments]; string instruments [music]; electronic musical instruments; musical boxes; strings for musical instruments; stands for musical instruments; music stands; pedals for musical instruments.

16 – Paper; printing products; printed publications; periodicals; pictures; wrapping paper; paper shredders for office use; office requisites except furniture; writing materials; instructional material except apparatus.

17 – Raw or semi-worked rubber; reinforcing materials, not of metal, for pipes; adhesive bands other than stationery and not for medical or household purposes; semi-processed plastic materials; plastic film, other than for wrapping; flexible pipes not of metal; insulating refractory materials; floating anti-pollution barriers; insulating materials; waterproof packings.

18 – Unworked or semi-worked leather; animal skins; backpacks; bags; wallets; trimmings of leather for furniture; leather laces; umbrellas; walking sticks; garments for pets.

19 – Lumber; stone; cement; concrete building elements; bricks; refractory construction materials, not of metal; mantels for fireplaces, not of metal; building materials, not of metal; buildings, not of metal; building glass.

20 – Furniture; containers not of metal; ladders of wood or plastics; mirrors [looking glasses]; plaited straw except matting; art objects of wood, wax, plaster or plastic; nesting boxes for household pets; furniture fittings not of metal; pillows; door fittings not of metal.

21 – Kitchen utensils; glass flasks [containers]; ceramics for household purposes; ornaments of porce-

lain; drinking vessels; toilet utensils; perfume burners; toothbrushes; cosmetic utensils; thermally insulated containers for food.

22 – Ropes; packing rope; nets; tents; large-capacity bags for the transport and storage of materials in bulk; straw wrappers for bottles; padding and stuffing materials not of rubber or plastics, not of paper or cardboard; feathers for bedding; raw fibrous textile materials; textile fibers.

23 – Thread and yarn; cotton thread and yarn; darning thread and yarn; spun wool; rayon thread and yarn; linen thread and yarn; silk thread and yarn; chenille yarn; woolen thread and yarn; sewing thread and yarn.

24 – Fabrics; non-woven textile fabrics; wall hangings of textile; towels of textile; bed linen; loose covers for furniture; curtains of textile or plastic; marabouts [cloths]; flags made of textile or plastic materials; shrouds.

25 – Clothing; shoes; hats; hosiery; gloves [clothing]; shawls; scarves; neckties; girdles [underwear]; shower caps.

26 – Embroidery; lace; trimmings for clothing; buttons; false hair; haberdashery, except yarns; artificial plants; shoulder pads for clothing; heat adhesive patches for repairing textile articles; competitors' numbers.

27 – Carpets; mats; reed mats; coverings for floors; carpets for automobiles; bath mats; non-slip mats; gymnastic mats; wallpapers; textile wallpaper.

28 – Games; toys; playing cards; balls for games; body-building apparatus; archery implements; machines for physical exercises; swimming pools [play articles]; gloves [accessories for games]; knee guards [sports articles].

29 – Meat; fish, not live; canned fruits; fruit-based snack food; freeze-dried vegetables; eggs; dairy products; oils for food; prepared nuts; tofu.

30 – Coffee; tea; sugar; honey; cereal-based snacks; instant rice; cereal preparations; noodles; ice cream; food flavorings, other than essential oils.

31 – Undressed timber; grains [cereals]; plants; live animals; fresh fruits; fresh vegetables; seeds for planting; animal foodstuffs; malt for brewing and distilling; aromatic sand [litter] for pets.

32 – Beers; beer wort; beer-based cocktails; waters [beverages]; fruit juices; carbonated waters; non-alcoholic beverages; preparations for making beverages; essences for making beverages; orgeat.

33 – Wines; alcoholic beverages, except beer; eaux-de-vie (brandy); rice alcohol; baijiu [Chinese distilled alcoholic beverage]; alcoholic beverages containing fruit; cocktails; vodka; whisky; pre-

mixed alcoholic beverages, other than beer-based beverages.

34 – Tobacco; cigarettes; pipes; ashtrays for smokers; matches; match boxes; lighters for smokers; flintstones; cigarette filters; cigarette paper.

35 – Advertising; business management and organization consultancy; commercial administration of the licensing of the goods and services of others; sales promotion for others; provision of on-line sales areas for sellers and buyers of goods and services; business management for sports people; consulting services relating to personnel management; systematization of information in computer databases; accounting; sponsorship search; administrative management of hotels; commercial information and advice for consumers (consumer advice shop); retail or wholesale services for pharmaceutical, veterinary and sanitary preparations as well as for medical supplies; rental of advertising space.

36 – Insurance underwriting; banking services; financing services; art appraisal; real estate agency services; brokerage; surety services; charitable fundraising services; trusteeship; lending against security; insurance brokerage; capital investment; fund investment; on-line banking services; financial information by means of websites; financial evaluation [insurance, banking, real estate]; real estate management.

37 – Construction information; construction; cleaning of buildings [interior]; upholstering; heating equipment installation and repair; installation and repair of electric apparatus; installation, maintenance and repair of computer hardware; motor vehicle maintenance and repair; repair of photographic apparatus; dry cleaning.

38 – Television broadcasting; news agency services; cable television broadcasting; wireless broadcasting services; message transmission; telephone communications; provision of chat rooms on the Internet; transmission of video-on-demand footage; provision of user access to global computer networks; radio communications.

39 – Transport; packaging of goods; hauling; car rental; parking services; warehousing; rental of warehouses; physical storage of electronically-stored data or documents; messaging [mail or goods]; travel reservations.

40 – Grinding; treatment of metals; textile treating; timber felling and processing; bookbinding; freezing of foods; dressmaking; photographic printing; recycling of trash and waste; air purification.

41 – Teaching; organization and conducting of congresses; organization of competitions [education or entertainment]; publication of texts other than advertising texts; production of radio and television

programs; production of films other than advertising films; entertainment services; provision of sports facilities; toy rental; rental of equipment for games.

42 – Technical research; quality control; industrial design; indoor architecture; dress designing; software as a service [SaaS]; software development [design]; software installation; packaging design services; provision of Internet search engines; computer virus protection services; creation and maintenance of web sites for others; cloud computing; electronic data storage.

43 – Canteen services; hotel services; bar services; coffee shop services; snack bar services; rental of temporary accommodation; tourist home services; retirement home services; day-care centers; rental of cooking apparatus.

44 – Medical clinic services; health counseling services; rest home services; nursing home services; beauty salon services; visagist's services; animal breeding; pet grooming; gardening; opticians' services.

45 – Services provided by consultant relating to physical security; monitoring of burglar alarms; escorting in society [chaperoning]; house sitting; clothing rental; online social networking services; planning and arranging of wedding ceremonies; fire-fighting services; rental of safes; intellectual property consultancy.

(260) AM 2018 94447 A

(800) 1366994

(151) 2017 08 29

(891) 2017 08 29

(731) FONT SALEM, S.L.

Ptda. del Fronton, s/n, E-46843 SALEM

(VALENCIA), Spain

(540)

## CONTACT

(591) Black, white

(511)

32 – Beers; mineral and aerated waters and other non-alcoholic beverages; fruit beverages and fruit juices; syrups and other preparations for making beverages; energy drinks; energy drinks containing caffeine.

(260) AM 2018 94451 A

(800) 1367138

(151) 2017 08 22

(891) 2017 08 22

(731) HATHOR NUTRITION LLC

C/o Moritt Hock & Hamroff LLP, 400 Garden

City Plaza Garden City NY 11530, USA

(540)

## CEREMIL

(591) Black, white

(531) 27.05.17

(511)

5 – Food supplements; dietetic foods and beverages adapted for medical purposes; dietetic foods and beverages adapted for medical use; dietary and nutritional supplements; vitamin preparations; infant formula; food for babies.

(260) AM 2018 94474 A

(800) 1368248

(151) 2017 06 23

(891) 2017 06 23

(731) LAARA ENTERPRISES LIMITED

Suite 1003, Khalid Al Attar Tower,

P.O. Box No. 71241, Sheikh Zayed

Road Dubai (AE), United Arab Emirates

(540)



(591) Blue and white.

(531) 27.05.02; 29.01.12

(511)

3 – Scale removing preparations for household purposes; antistatic preparations for household purposes; canned pressurized air for cleaning and dusting purposes; drying agents for dishwashing machines; laundry wax; parquet floor wax; non-slipping wax for floors; polish for furniture and flooring; polishing wax; deodorants for pets; non-slipping liquids for floors; windshield cleaning liquids; colorants for toilet purposes; laundry starch; laundry glaze; cleaning chalk; soap for brightening textile; laundry soaking preparations; smoothing preparations [starching]; polishing preparations; starch glaze for laundry purposes; refurbishing preparations; fabric softeners for laundry use; laundry bleach; dry-cleaning preparations; cleaning preparations; preparations for unblocking drain pipes; laundry preparations; color-brightening chemicals for household purposes [laundry]; shining preparations [polish]; stain removers; scouring solutions; laundry blueing; bleaching soda; washing soda, for cleaning; bleaching salts; ammonia [volatile alkali] [detergent]; detergents other than for use in manufacturing operations and for medical purposes; degreasers other than for use in manufacturing processes; cloths impregnated with a detergent for cleaning.

5 – Air deodorising preparations; deodorants, other than for human beings or for animals; deodorants for clothing and textiles; air purifying preparations.

35 – Demonstration of goods namely, the above stated goods in classes 03 and 05; marketing studies



related to the above stated goods in classes 03, 05; marketing related to the above stated goods in classes 03, 05; organization of exhibitions for commercial or advertising purposes of the above stated goods in classes 03 and 05; presentation of the above stated goods in classes 03 and 05 on communication media, for retail purposes; sales promotion of the above stated goods in classes 03 and 05 for others; distribution of samples related to the above stated goods in classes 03, 05; procurement services for others [purchasing goods and services for other businesses] related to the above stated goods in classes 03, 05.

(260) AM 2018 94475 A

(800) 1367976

(151) 2017 07 24

(891) 2017 07 24

(731) AVA Benelux B.V.

Slibbroek 15 NL-5081 NR Hilvarenbeek,  
Netherlands

(540)



(591) Red, white, dark blue, light blue and black

(531) 26.11.13; 27.05.10; 27.05.17; 29.01.13

(511)

7 – Cooling systems for combustion engines and alternative drives (including electric motors, fuel cells) for motor vehicles, for machines, in particular machine tools, and for mechanical and hydraulic gears, and parts for the aforesaid cooling systems, in particular cooling modules, oil modules, exhaust gas recirculation modules, coolant coolers, refrigerant condensers, charge coolers, oil coolers, water coolers, air-to-heat exchangers, ventilators and ventilator cowls, ventilator drives, ventilator couplings, exhaust gas heat exchangers, exhaust gas recirculation valves, fuel coolers, coolant pumps, coolant thermostats and coolant hoses.

11 – Cooling, ventilating, air-conditioning and heating installations for motor vehicles and for industrial purposes and parts for the aforesaid systems, in particular oil coolers, water coolers, air-to-heat exchangers, heat exchangers, including radiators, refrigerant evaporators and condensers, auxiliary ptc (positive temperature coefficient) heating apparatus and regulating apparatus, refrigerant expansion units, refrigerant pipes and collectors and dryers for refrigerants.

37 – Building, installation, repair and maintenance of cooling systems for combustion engines and alternative drives (including electric motors, fuel cells) for motor vehicles, for machines, in particular machine tools, and for mechanical and hydraulic

gears, and of parts for the aforesaid cooling systems, in particular cooling modules, oil modules, exhaust gas recirculation modules, coolant coolers, refrigerant condensers, charge coolers, oil coolers, water coolers, air-to-heat exchangers, ventilators and ventilator cowls, ventilator drives, ventilator couplings, exhaust gas heat exchangers, exhaust gas recirculation valves, fuel coolers, coolant pumps, coolant thermostats and coolant hoses; building, installation, repair and maintenance of ventilating, air-conditioning and heating systems for motor vehicles and for industrial purposes, and of parts for the aforesaid systems, in particular oil coolers, water coolers, air-to-heat exchangers, heat exchangers, including radiators, refrigerant evaporators and condensers, auxiliary ptc (positive temperature coefficient) heating apparatus and regulating apparatus, refrigerant expansion units, refrigerant pipes and collectors and dryers for refrigerants.

(260) AM 2018 94477 A

(800) 1368261

(151) 2017 06 15

(891) 2017 06 15

(731) PIAM FARMACEUTICI SPA

Via Fieschi, 8/7, I-16121 GENOVA (GE),  
Italy

(540)

**AFENIL**

(591) Black, white

(531) 27.05.17

(511)

5 – Dietetic foods adapted for medical purposes; dietetic substances adapted for medical use; food supplements; dietary supplements; food for special medical purpose.

(260) AM 2018 94478 A

(800) 1367982

(151) 2017 07 12

(891) 2017 07 12

(731) XINGYUAN TIRE GROUP CO., LTD.

Xishui Industrial Zone, Dongying Shandong,  
China

(540)



(591) Black, white

(531) 01.01.03; 01.01.09; 01.13.05; 27.05.01; 28.03

(511)

12 – Inner tubes for vehicles; vehicle tires; automobile tires; car tires; tires for vehicles; treads for vehicles, namely, roller belts; solid tires for vehicles; pneumatic tires; casings for pneumatic tires; airplane tyres.

(260) AM 2018 94519 A

(800) 1368167

(151) 2017 05 17

(891) 2017 05 17

(731) Maison de Fleurs Limited

C/O Mark Davies &amp; Associates Ltd,

25 Southampton Buildings, Chancery Lane

London WC2A 1AL, United Kingdom

(540)

## MAISON DE FLEURS

(591) Black, white

(511)

3 – Bleaching preparations and other substances for laundry use; cleaning, polishing, scouring and abrasive preparations; soaps; perfumery, essential oils, cosmetics, hair lotions; dentifrices; abrasive paper; abrasives; adhesives for affixing false eyelashes; adhesives for affixing false hair; adhesives for cosmetic purposes; after-shave lotions; air fragrancing preparations; almond milk for cosmetic purposes; almond oil; almond soap; aloe vera preparations for cosmetic purposes; alum stones [astringents]; amber [perfume]; ammonia [volatile alkali] [detergent]; antiperspirant soap; antiperspirants [toiletries]; antistatic preparations for household purposes; aromatics [essential oils]; astringents for cosmetic purposes; badian essence; balms other than for medical purposes; bases for flower perfumes; bath salts, not for medical purposes; beard dyes; beauty masks; bergamot oil; bleaching preparations [decolorants] for cosmetic purposes; bleaching salts; bleaching soda; breath freshening sprays; breath freshening strips; cake flavourings [essential oils]; cakes of soap; canned pressurized air for cleaning and dusting purposes; carbides of metal [abrasives]; cleaning chalk; cleaning preparations; cleansing milk for toilet purposes; cloths impregnated with a detergent for cleaning; cobblers' wax; color-brightening chemicals for household purposes [laundry]; color-removing preparations; colorants for toilet purposes; corundum [abrasive]; cosmetic creams; cosmetic dyes; cosmetic kits; cosmetic pencils; cosmetic preparations for baths; cosmetic preparations for eyelashes; cosmetic preparations for skin care; cosmetic preparations for slimming purposes; cosmetics; cosmetics for animals; cotton sticks for cosmetic purposes; cotton wool for cosmetic purposes; decorative transfers for cosmetic purposes; degreasers other than for use in manufacturing processes; dental bleaching gels; dentifrices; denture polishes; deodorant soap; deodorants for human beings or for animals; deodorants

for pets; depilatories; depilatory wax; detergents other than for use in manufacturing operations and for medical purposes; diamantine [abrasive]; douching preparations for personal sanitary or deodorant purposes [toiletries]; dry-cleaning preparations; dry shampoos; drying agents for dishwashing machines; eau de cologne; emery; emery cloth; emery paper; essential oils of cedarwood; essential oils of citron; essential oils of lemon; ethereal essences; ethereal oils; extracts of flowers [perfumes]; eyebrow cosmetics; eyebrow pencils; fabric softeners for laundry use; false eyelashes; false nails; flavorings for beverages [essential oils]; floor wax; floor wax removers [scouring preparations]; fumigation preparations [perfumes]; furbishing preparations; gaultheria oil; geraniol; glass cloth; greases for cosmetic purposes; grinding preparations; hair dyes; hair lotions; hair spray; hair waving preparations; heliotropine; henna [cosmetic dye]; hydrogen peroxide for cosmetic purposes; incense; ionone [perfumery]; jasmine oil; javelle water; joss sticks; lacquer-removing preparations; laundry bleach; laundry blueing; laundry glaze; laundry preparations; laundry soaking preparations; laundry starch; laundry wax; lavender oil; lavender water; leather bleaching preparations; leather preservatives [polishes]; lip glosses; lipsticks; lotions for cosmetic purposes; make-up; make-up powder; make-up preparations; make-up removing preparations; mascara; massage gels other than for medical purposes; mint essence [essential oil]; mint for perfumery; mouth washes, not for medical purposes; musk [perfumery]; mustache wax; nail art stickers; nail care preparations; nail polish; neutralizers for permanent waving; non-slipping liquids for floors; non-slipping wax for floors; oil of turpentine for degreasing; oils for cleaning purposes; oils for cosmetic purposes; oils for perfumes and scents; oils for toilet purposes; paint stripping preparations; pastes for razor strops; perfumery; perfumes; petroleum jelly for cosmetic purposes; polish for furniture and flooring; polishing creams; polishing paper; polishing preparations; polishing rouge; polishing stones; polishing wax; pomades for cosmetic purposes; potpourris [fragrances]; preparations for cleaning dentures; preparations for unblocking drain pipes; preparations to make shiny the leaves of plants; pumice stone; quillaia bark for washing; rose oil; rust removing preparations; sachets for perfuming linen; safrol; sandcloth; sandpaper; scale removing preparations for household purposes; scented water; scented wood; scouring solutions; shampoos; shampoos for pets; shaving preparations; shaving soap; shaving stones [astringents]; shining preparations [polish]; shoe cream; shoe polish; shoe wax; shoemakers' wax; silicon carbide [abrasive]; skin whitening creams; smoothing preparations [starching]; smoothing stones; soap; soap for brightening textile; soap for foot perspiration; soda lye; stain removers; starch glaze for laundry purposes; sun-tanning preparations

[cosmetics]; sunscreen preparations; tailors' wax; talcum powder, for toilet use; terpenes [essential oils]; tissues impregnated with cosmetic lotions; toilet water; toiletries; tripoli stone for polishing; turpentine, for degreasing; varnish-removing preparations; volcanic ash for cleaning; wallpaper cleaning preparations; washing soda, for cleaning; waxes for leather; whitening; windscreen cleaning liquids.

4 – Industrial oils and greases; lubricants; dust absorbing, wetting and binding compositions; fuels (including motor spirit) and illuminants; candles and wicks for lighting; additives, non-chemical, to motor fuel; alcohol [fuel]; anthracite; beeswax; belting wax; benzene fuel; blocks of peat [fuel]; bone oil for industrial purposes; carburants; carnauba wax; castor oil for technical purposes; ceresine; charcoal [fuel]; Christmas tree candles; coal; coal briquettes; coal dust [fuel]; coal naphtha; coal tar oil; coke; combustible briquettes; cutting fluids; dust binding compositions for sweeping; dust laying compositions; dust removing preparations; electrical energy; ethanol [fuel]; firelighters; firewood; fish oil, not edible; fuel; fuel gas; fuel oil; fuel with an alcoholic base; gas for lighting; gas oil; gasoline; grease for arms [weapons]; grease for belts; grease for boots; grease for leather; illuminating grease; illuminating wax; industrial grease; industrial oil; industrial wax; kerosene; lamp wicks; lanolin; lighting fuel; lignite; lignin; lubricants; lubricating graphite; lubricating grease; lubricating oil; mazut; methylated spirit; mineral fuel; moistening oil; motor oil; naphtha; nightlights [candles]; non-slipping preparations for belts; oil for the preservation of leather; oil for the preservation of masonry; oil-gas; oils for paints; oils for releasing form work [building]; oleine; ozocerite [ozokerite]; paper spills for lighting; paraffin; peat [fuel]; perfumed candles; petrol; petroleum ether; petroleum jelly for industrial purposes; petroleum, raw or refined; preservatives for leather [oils and greases]; producer gas; rape oil for industrial purposes; solidified gas [fuel]; soya bean oil preparations for non-stick treatment of cooking utensils; stearine; sunflower oil for industrial purposes; tallow; tapers; textile oil; tinder; vaporized fuel mixtures; wax [raw material]; wicks for candles; wood briquettes; wood spills for lighting; wax for skis; xylene fuel.

21 – Household or kitchen utensils and containers; combs and sponges; brushes (except paint brushes); brush-making materials; articles for cleaning purposes; steelwool; unworked or semi-worked glass (except glass used in building); glassware, porcelain and earthenware not included in other classes; abrasive pads for kitchen purposes; abrasive sponges for scrubbing the skin; aerosol dispensers, not for medical purposes; animal bristles [brushware]; apparatus for wax-polishing, non-electric; aquarium hoods; autoclaves [pressure cookers], non-electric; baby baths, portable; baking mats; basins [bowls];

basins [receptacles]; baskets for domestic use; basting spoons, for kitchen use; beaters, non-electric; beer mugs; bird baths; birdcages; blenders, non-electric, for household purposes; boot jacks; boot trees [stretchers]; bottle gourds; bottle openers; bottles; boxes for dispensing paper towels; boxes of glass; bread baskets, domestic; bread bins; bread boards; brooms; brush goods; brushes; brushes for cleaning tanks and containers; brushes for footwear; buckets made of woven fabrics; buckskin for cleaning; busts of porcelain, ceramic, earthenware or glass; butter-dish covers; butter dishes; buttonhooks; cabarets [trays]; cages for household pets; cake molds [moulds]; candle extinguishers; candle rings; candlesticks; candy boxes; carboys; carpet beaters, not being machines; carpet sweepers; cauldrons; ceramics for household purposes; chamber pots; cheese-dish covers; china ornaments; chopsticks; cinder sifters [household utensils]; cleaning instruments, hand-operated; cleaning tow; closures for pot lids; cloth for washing floors; clothes-pegs; clothes racks, for drying; clothing stretchers; coasters, not of paper and other than table linen; cocktail stirrers; coffee filters, non-electric; coffee grinders, hand-operated; coffee percolators, non-electric; coffee services [tableware]; coffeepots, non-electric; comb cases; combs; combs for animals; confectioners' decorating bags [pastry bags]; containers for household or kitchen use; cookery molds [moulds]; cookie [biscuit] cutters; cookie jars; cooking pins of metal; cooking pot sets; cooking pots; cooking utensils, non-electric; corkscrews; cosmetic utensils; cotton waste for cleaning; crockery; cruet sets for oil and vinegar; cruets; crumb trays; crystal [glassware]; cups; cups of paper or plastic; currycombs; cutting boards for the kitchen; decanters; deep fryers, non-electric; deodorising apparatus for personal use; dish covers; dishes; dish-washing brushes; disposable table plates; drinking glasses; drinking horns; drinking straws; drinking troughs; drinking vessels; drying racks for washing; dustbins; dusting apparatus, non-electric; dusting cloths [rags]; earthenware saucepans; egg cups; electric brushes, except parts of machines; electric combs; electric devices for attracting and killing insects; enamelled glass; epergnes; eyebrow brushes; feather-dusters; feeding troughs; fiberglass other than for insulation or textile use; fiberglass thread, not for textile use; fitted picnic baskets, including dishes; flasks; flat-iron stands; floss for dental purposes; flower-pot covers, not of paper; flower baskets, bowls, vases, holders and containers, flower pots; fly swatters; food cooling devices, containing heat exchange fluids, for household purposes; fruit cups; fruit presses, non-electric, for household purposes; frying pans; funnels; furniture dusters; fused silica [semi-worked product], other than for building; gardening gloves; garlic presses [kitchen utensils]; glass bowls; glass bulbs [receptacles]; glass caps; glass flasks [containers]; glass for vehicle win-

dows [semi-finished product]; glass incorporating fine electrical conductors; glass jars [carboys]; glass [receptacles]; glass, unworked or semi-worked, except building glass; glass wool other than for insulation; glove stretchers; gloves for household purposes; glue-pots; graters [household utensils]; grill supports; grills [cooking utensils]; hair for brushes; heat-insulated containers; heat insulated containers for beverages; heaters for feeding bottles, non-electric; holders for flowers and plants [flower arranging]; horse brushes; hot pots, not electrically heated; ice cube molds; ice pails; indoor aquaria; indoor terrariums [plant cultivation]; indoor terrariums [vivariums]; insect traps; ironing board covers, shaped; ironing boards; isothermic bags; jugs; kettles, non-electric; kitchen containers; kitchen mixers, non-electric; kitchen utensils; knife rests for the table; lamp-glass brushes; large-toothed combs for the hair; lazy susans; liqueur sets; litter trays for pets; lunch boxes; majolica; make-up removing appliances; mangers for animals; material for brush-making; menu card holders; mess-tins; mills for domestic purposes, hand-operated; mixing spoons [kitchen utensils]; molds [kitchen utensils]; mop wringers; mops; mosaics of glass, not for building; mouse traps; mugs; nail brushes; napkin holders; napkin rings; nest eggs, artificial; non-electric portable cold-boxes; noodle machines, hand-operated; nozzles for sprinkler hose; opal glass; opaline glass; pails; painted glassware; paper plates; pastry cutters; pepper mills, hand-operated; pepper pots; perfume burners; perfume sprayers; pie servers; pig bristles; piggy banks; plate glass [raw material]; plates to prevent milk boiling over; plungers for clearing blocked drains; polishing apparatus and machines, for household purposes, non-electric; polishing gloves; polishing leather; polishing materials for making shiny, except preparations, paper and stone; porcelain ware; pot lids; pots; pottery; poultry rings; powder compacts; powder puffs; powdered glass for decoration; rags for cleaning; rat traps; refrigerating bottles; rings for birds; rolling pins, domestic; roses for watering cans; salad bowls; salt cellars; saucepan scourers of metal; saucers; scoops [tableware]; scouring pads; scrubbing brushes; services [dishes]; shakers; shaving brush stands; shaving brushes; shoe horns; shoe trees [stretchers]; sieves [household utensils]; sifters [household utensils]; signboards of porcelain or glass; siphons for carbonated water; smoke absorbers for household purposes; soap boxes; soap dispensers; soap holders; soup bowls; spatulas [kitchen utensils]; spice sets; sponge holders; sponges for household purposes; spouts; sprinklers; statues of porcelain, ceramic, earthenware or glass; statuettes of porcelain, ceramic, earthenware or glass; steel wool for cleaning; stew-pans; strainers; strainers for household purposes; sugar bowls; syringes for watering flowers and plants; table plates; tableware, other than knives, forks and spoons; tan-

kards; tar-brushes, long handled; tea balls; tea caddies; tea cosies; tea services [tableware]; tea strainers; teapots; thermally insulated containers for food; tie presses; toilet brushes; toilet cases; toilet paper dispensers; toilet paper holders; toilet sponges; toilet utensils; toothbrushes; toothbrushes, electric; toothpick holders; toothpicks; towel rails and rings; trays for domestic purposes; trays for domestic purposes, of paper; trivets [table utensils]; trouser presses; urns; utensils for household purposes; vacuum bottles; vases; vegetable dishes; vessels of metal for making ices and iced drinks; vitreous silica fibers [fibres], not for textile use; waffle irons, non-electric; washing boards; washtubs; waste paper baskets; water apparatus for cleaning teeth and gums; watering cans; watering devices; wax-polishing appliances, non-electric, for shoes; whisks, non-electric, for household purposes; window-boxes; wine tasters [siphons]; wool waste for cleaning; works of art of porcelain, ceramic, earthenware or glass.

26 – Lace and embroidery, ribbons and braid; buttons, hooks and eyes, pins and needles; appliqués [haberdashery]; artificial fruit; artificial garlands; artificial plants; badges for wear, not of precious metal; barrettes [hair-slides]; beads other than for making jewelry; belt clasp; binding needles; birds' feathers [clothing accessories]; blouse fasteners; bobbins for retaining embroidery floss or wool [not parts of machines]; bodkins; bows for the hair; boxes for needles; braids; brassards; brooches [clothing accessories]; buckles [clothing accessories]; buttons; chenille [passementerie]; collar supports; competitors' numbers; cords for clothing; cords for rimming, for clothing; corset busks; darning lasts; darning needles; dress fastenings; edgings for clothing; elastic ribbons; embroidering crochet hooks; embroidery; expanding bands for holding sleeves; eyelets for clothing; false beards; false hair; false hems; false moustaches; fastenings for braces; feathers [clothing accessories]; festoons [embroidery]; frills for clothing; frills [lacework]; fringes; gold embroidery; haberdashery, except thread; hair bands; hair coloring caps; hair curlers, other than hand implements; hair curling papers; hair curling pins; hair extensions; hair grips [slides]; hair nets; hair ornaments; hair pins; hat ornaments, not of precious metal; heat adhesive patches for decoration of textile articles [haberdashery]; heat adhesive patches for repairing textile articles; hook and pile fastening tapes; hooks for corsets; hooks [haberdashery]; human hair; knitting needles; lace for edgings; letters for marking linen; mica spangles; monogram tabs for marking linen; needle cases; needle cushions; needles; needles for wool combing machines; numerals for marking linen; ornamental novelty badges [buttons]; orsedew [trimmings for clothing]; ostrich feathers [clothing accessories]; passementerie; picot [lace]; pin cushions; pins, other than jewellery [jewelry]; plaited hair; prize ribbons; ribbons [haberdashery]; rosettes

[haberdashery]; rug hooks; saddlers' needles; sewing boxes; sewing needles; sewing thimbles; shoe buckles; shoe eyelets; shoe fasteners; shoe hooks; shoe laces; shoe ornaments, not of precious metal; shoemakers' needles; shoulder pads for clothing; shuttles for making fishing nets; silver embroidery; skirt flourishes; snap fasteners; spangles for clothing; tapes for curtain headings; tassels [haberdashery]; top-knots [pompoms]; toupees; trimmings for clothing; trouser clips for cyclists; wigs; woollen laces; zippers; zippers for bags.

28 – Games and playthings; gymnastic and sporting articles not included in other classes; decorations for Christmas trees; air pistols [toys]; amusement machines, automatic and coin-operated; apparatus for games; appliances for gymnastics; arcade video game machines; archery implements; artificial fishing bait; artificial snow for Christmas trees; ascenders [mountaineering equipment]; backgammon games; bags especially designed for skis and surfboards; balls for games; bar-bells; baseball gloves; batting gloves [accessories for games]; bells for Christmas trees; billiard balls; billiard cue tips; billiard cues; billiard markers; billiard table cushions; billiard tables; bingo cards; bite indicators [fishing tackle]; bite sensors [fishing tackle]; bladders of balls for games; board games; bob-sleighs; body boards; body-building apparatus; bowling apparatus and machinery; bows for archery; boxing gloves; building blocks [toys]; building games; butterfly nets; camouflage screens [sports articles]; candle holders for Christmas trees; caps for pistols [toys]; chalk for billiard cues; checkerboards; checkers [games]; chess games; chessboards; chips for gambling; Christmas tree stands; Christmas trees of synthetic material; clay pigeon traps; clay pigeons [targets]; climbers' harness; coin-operated billiard tables; confetti; conjuring apparatus; controllers for game consoles; cosques [toy fireworks]; counters [discs] for games; creels [fishing traps]; cricket bags; cups for dice; darts; toys used as decorations during Easter and Christmas; detonating caps [toys]; dice; discuses for sports; divot repair tools [golf accessories]; dolls; dolls' beds; dolls' clothes; dolls' feeding bottles; dolls' houses; dolls' rooms; dominoes; edges of skis; elbow guards [sports articles]; electronic targets; exercisers [expanders]; fairground ride apparatus; fencing gloves; fencing masks; fencing weapons; fish hooks; fishing tackle; flippers for swimming; floats for fishing; flying discs [toys]; games; gaming machines for gambling; gloves for games; golf bags, with or without wheels; golf clubs; golf gloves; gut for fishing; gut for rackets; hang gliders; harness for sailboards; harpoon guns [sports articles]; hockey sticks; horseshoe games; hunting game calls; ice skates; in-line roller skates; jigsaw puzzles; kaleidoscopes; kite reels; kites; knee guards [sports articles]; landing nets for anglers; lines for fishing; lures for hunting or fishing; machines for physical exerci-

ses; mah-jong; marbles for games; masts for sailboards; men's athletic supporters [sports articles]; mobiles [toys]; nets for sports; ninepins; novelties for parties, dances [party favors, favours]; ornaments for christmas trees, except illumination articles and confectionery; pachinkos; paintball guns [sports apparatus]; paintballs [ammunition for paintball guns] [sports apparatus]; paper party hats; paragliders; parlor games; piñatas; play balloons; playing balls; playing cards; plush toys; poles for pole vaulting; portable games with liquid crystal displays; practical jokes [novelties]; protective paddings [parts of sports suits]; punching bags; puppets; quoits; rackets; radio-controlled toy vehicles; rattles [playthings]; reels for fishing; ring games; rocking horses; rods for fishing; roller skates; rollers for stationary exercise bicycles; rosin used by athletes; roulette wheels; sailboards; scale model kits [toys]; scale model vehicles; scent lures for hunting or fishing; scooters [toys]; scratch cards for playing lottery games; seal skins [coverings for skis]; shin guards [sports articles]; shuttlecocks; skateboards; skating boots with skates attached; ski bindings; skis; skittles; sleighs [sports articles]; slides [playthings]; sling shots [sports articles]; slot machines [gaming machines]; snow globes; snowboards; snowshoes; soap bubbles [toys]; sole coverings for skis; spinning tops [toys]; spring boards [sports articles]; starting blocks for sports; stationary exercise bicycles; strings for rackets; stuffed toys; surf boards; surf skis; surfboard leashes; swimming belts; swimming jackets; swimming kick boards; swimming pools [play articles]; swings; tables for indoor football; tables for table tennis; targets; teddy bears; tennis ball throwing apparatus; tennis nets; theatrical masks; toy masks; toy pistols; toy vehicles; toys; toys for domestic pets; trampolines; twirling batons; video game machines; water wings; waterskis; weight lifting belts [sports articles].

31 – Grains and agricultural products, live animals; fresh fruits and vegetables; foodstuffs for animals; malt; algae for human or animal consumption; algarovilla for animal consumption; almonds [fruits]; animal fattening preparations; animal foodstuffs; aromatic sand for pets [litter]; bagasses of cane [raw material]; barley; beans, fresh; beet; berries, fresh fruits; beverages for pets; bird food; bran; bran mash for animal consumption; bred stock; bushes; cereal seeds, unprocessed; chestnuts, fresh; chicory roots; chicory [salad]; christmas trees; citrus fruit; cocoa beans, raw; coconut shell; coconuts; cola nuts; copra; crayfish, live; crustaceans, live; cucumbers, fresh; cuttle bone for birds; distillery waste for animal consumption; dog biscuits; draff; edible chews for animals; eggs for hatching, fertilised; fish, live; fish meal for animal consumption; fish spawn; fishing bait, live; flax meal [fodder]; fodder; fruit, fresh; garden herbs, fresh; grains [cereals]; grains for animal consumption; grapes, fresh; groats for poul-

try; hay; hazelnuts; hop cones; hops; juniper berries; leeks, fresh; lemons, fresh; lentils, fresh; lettuce, fresh; lime for animal forage; linseed for animal consumption; linseed meal for animal consumption; litter peat; live animals; lobsters, live; locust beans; maize; maize cake for cattle; malt for brewing and distilling; marc; marrows; mash for fattening livestock; meal for animals; menagerie animals; mushroom spawn for propagation; mushrooms, fresh; mussels, live; nettles; nuts [fruits]; oats; oil cake; olives, fresh; onions, fresh vegetables; oranges; oysters, live; palm trees; palms [leaves of the palm tree]; peanut cake for animals; peanut meal for animals; peanuts, fresh; peas, fresh; peppers [plants]; pet food; pine cones; plant seeds; plants; plants, dried, for decoration; pollen [raw material]; potatoes, fresh; poultry, live; preparations for egg laying poultry; products for animal litter; rape cake for cattle; raw barks; residual products of cereals for animal consumption; residue in a still after distillation; rhubarb; rice meal for forage; rice, unprocessed; roots for food; rose bushes; rough cork; rye; salt for cattle; sanded paper for pets [litter]; sea-cucumbers, live; seed germ for botanical purposes; seedlings; sesame; shellfish, live; silkworm eggs; silkworms; sod; spinach, fresh; spiny lobsters, live; stall food for animals; straw [forage]; straw litter; straw mulch; strengthening animal forage; sugarcane; trees; truffles, fresh; trunks of trees; undressed timber; unsawn timber; vegetables, fresh; vine plants; wheat; wheat germ for animal consumption; wood chips for the manufacture of wood pulp; yeast for animal consumption.

35 – Advertising; business management; business administration; office functions; accounting; administrative processing of purchase orders; advertising by mail order; advisory services for business management; arranging newspaper subscriptions for others; arranging subscriptions to telecommunication services for others; auctioneering; bill-posting; business appraisals; business auditing; business efficiency expert services; business information; business inquiries; business investigations; business management and organization consultancy; business management assistance; business management consultancy; business management of hotels; business management of performing artists; business management of sports people; business organization consultancy; business research; commercial administration of the licensing of the goods and services of others; commercial information agencies; commercial information and advice for consumers [consumer advice shop]; commercial or industrial management assistance; compilation of information into computer databases; compilation of statistics; computerized file management; cost price analysis; data search in computer files for others; demonstration of goods; direct mail advertising; dissemination of advertising matter; distribution of samples; document reproduc-

tion; drawing up of statements of accounts; economic forecasting; employment agencies; import-export agencies; invoicing; layout services for advertising purposes; marketing; marketing research; marketing studies; modelling for advertising or sales promotion; news clipping services; office machines and equipment rental; on-line advertising on a computer network; opinion polling; organization of exhibitions for commercial or advertising purposes; organization of fashion shows for promotional purposes; organization of trade fairs for commercial or advertising purposes; outsourcing services [business assistance]; payroll preparation; personnel management consultancy; personnel recruitment; photocopying services; presentation of goods on communication media, for retail purposes; price comparison services; procurement services for others [purchasing goods and services for other businesses]; production of advertising films; professional business consultancy; psychological testing for the selection of personnel; public relations; publication of publicity texts; publicity; publicity agencies; advertising services, namely preparation of publicity materials; publicity material rental; radio advertising; relocation services for businesses; rental of advertising space; rental of advertising time on communication media; rental of photocopying machines; rental of vending machines; retail or wholesale services for cosmetics, perfumes, candles, decorations, games, and oils; sales promotion for others; secretarial services; shop window dressing; shorthand; sponsorship search; systemization of information into computer databases; tax preparation; telemarketing services; telephone answering for unavailable subscribers; television advertising; transcription; typing; updating of advertising material; word processing; writing of publicity texts.

44 – Medical services; veterinary services; hygienic and beauty care for human beings or animals; agriculture and forestry services; aerial and surface spreading of fertilizers and other agricultural chemicals; alternative medicine services; animal breeding; animal grooming; aquaculture services; aromatherapy services; artificial insemination services; beauty salons; blood bank services; chiropractics; dentistry; farming equipment rental; hair implantation; hair-dressing salons; health care; health centers; health counseling; health spa services; horticulture; hospices; hospitals; in vitro fertilization services; landscape design; lawn care; manicuring; massage; medical assistance; medical clinic services; medical equipment rental; midwife services; nursing homes; nursing, medical; opticians' services; pet grooming; pharmacists' services to make up prescriptions; pharmacy advice; physiotherapy; plant nurseries; plastic surgery; public baths for hygiene purposes; rehabilitation for substance abuse patients; rental of sanitation facilities; rest homes; sanatoriums; sauna services; services of a psychologist; solarium services;

speech therapy services; tattooing; telemedicine services; therapy services; tree planting for carbon offsetting purposes; tree surgery; turkish baths; vermin exterminating for agriculture, horticulture and forestry; veterinary assistance; visagists' services; weed killing; wreath making.

(260) AM 2018 94521 A  
 (800) 1367941  
 (151) 2017 05 24  
 (891) 2017 05 24  
 (731) Société Emerging Market knowledge Holding  
 Branch Tunisia  
 Rue du lac Neuchatel, Les Berges du  
 lac, Tunis, Tunisia  
 (540)



(591) Brown  
 (531) 01.03.15; 27.01.01; 27.01.06; 27.01.25;  
 27.05.01; 27.05.11; 29.01.07  
 (511)  
 41 – Education; training; entertainment; sporting and cultural activities; entertainment information; information relating to education; vocational retraining; provision of recreational facilities; publication of books; book lending; motion picture production; rental of sound recordings; rental of television sets; rental of show scenery; videotape editing; photography services; organization of competitions (education or entertainment); organization and conducting of colloquiums; organization and conducting of conferences; Organization and conducting of congresses organization of exhibitions for cultural or educational purposes; booking of seats for shows; game services provided on-line from a computer network; gambling services; electronic publication of books and journals online; electronic desktop publishing.  
 42 – Technical evaluations concerning design (engineers' services); scientific research; technical research; design of computers for others; development of computers; software design; software development; research and development of new products for others; technical project study services; architecture; design of interior decor; software development (design); software installation; software maintenance; updating of software; software rental; programming for computers; computer system analysis; computer system design; consultancy in the design and development of computers; digitization of documents; software as a service (SaaS); cloud computing; information technology (IT) consultancy; hosting of servers; vehicle roadworthiness testing; graphic arts design services; styling (industrial design); authenti-

cation of works of art; audits relating to energy; electronic data storage.

(260) AM 2018 94748 A  
 (800) 1371396  
 (151) 2017 08 21  
 (891) 2017 08 21  
 (731) APPLE INC.  
 1 Infinite Loop, Cupertino CA 95014, USA  
 (540)



(591) Black, white  
 (531) 05.07.13  
 (511)  
 10 – General wellness instruments, namely, health, fitness, exercise, and wellness sensors, monitors and displays for measuring, displaying, tracking, monitoring, storing, and transmitting biometric data, heart rate, body movement, and calories burned; general wellness apparatus and devices to measure, display, track, monitor, store, and transmit biometric data, heart rate, body movement, and calories burned.

(260) AM 2018 94749 A  
 (800) 798619  
 (151) 2003 02 21  
 (891) 2017 09 28  
 (731) FRILAB SA  
 Rue des Pierres-du-Niton 17, CH-1207  
 GENEVE, Switzerland  
 (540)

## FRILAB

(591) Black, white  
 (511)  
 5 – Pharmaceutical products, chemical-pharmaceutical products, chemical preparations for pharmaceutical use, chemical preparations for medical use, medicines for human purposes, medicines for dental use, vaccines, anesthetics, chemical reagents for medical use, diagnostic products for medical use, lotions, decoctions, infusions, pastilles, herbal teas, tablets, drinks, syrups, ointments, balms, pastilles, salves and pills for pharmaceutical or medical use, disinfectants for sanitary use, detergents for medical use, sterilizing products, dietetic substances for medical use, food for babies, chemical preparations for veterinary use, medicines for veterinary use.

10 – Medical apparatus and instruments, surgical apparatus and instruments, dental and orthodontic apparatus and instruments, diagnostic apparatus for medical use, testing apparatus for medical use, radiological apparatus for medical use, anesthetic apparatus, resuscitation apparatus, massage apparatus, orthopedic articles, prostheses, artificial implants, artificial teeth, artificial limbs, veterinary apparatus and instruments.

(260) AM 2018 94750 A

(800) 1004776

(151) 2009 05 15

(891) 2017 06 02

(731) ZABBIX, SIA

Dzelzavas iela 117, LV-1021 Riga, Latvia

(540)

## ZABBIX

(591) Black, white

(511)

41 – Training.

42 – Computer software as well as monitoring software development, enhancement, support and consultancy services in this field.

(260) AM 2018 94751 A

(800) 1113965

(151) 2012 02 24

(891) 2017 09 28

(731) José Juan Cascales Sánchez

Polígono Industrial La Capellanía,  
Parcela 39, E-30600 Archena (Murcia),  
Spain

(540)



(591) Black, white

(531) 05.01.05; 05.01.16; 26.04.02; 26.04.05;  
26.04.15; 26.04.24; 27.05.11; 27.05.24

(511)

3 – Bleaching preparations and other substances for laundry use; cleaning, polishing, degreasing and abrasive preparations; soap; perfumery, essential oils, cosmetics, hair lotions; dentifrices.

(260) AM 2018 94752 A

(800) 1144320

(151) 2012 12 11

(891) 2017 08 21

(731) XIA BING

No.1 Xinjian Street, Yicheng City,  
Hubei Province, China

(540)

# B BINGER

(591) Black, white

(531) 27.05.01; 27.05.17; 27.05.23

(511)

14 – Alloys of precious metal; jewellery cases [cases]; wristwatches; bracelets [jewellery, jewelry (am.)]; charms [jewellery, jewelry (am.)]; necklaces [jewellery, jewelry (am.)]; jewellery; earrings; rings [jewellery, jewelry (am.)]; straps for wristwatches.

(260) AM 2018 94753 A

(800) 1287330

(151) 2015 03 06

(891) 2017 08 21

(731) MONCLER S.P.A.

Via Stendhal, 47, I-20144 MILANO, Italy

(540)



(591) Black, white

(531) 27.05.01; 27.05.21

(511)

18 – Boxes of leather or leatherboard; cases, of leather or leatherboard; leather straps; card cases [note-cases]; credit card cases [wallets]; calling card cases; furniture coverings of leather; business card cases; document cases; bags [envelopes, pouches] of leather, for packaging, leather address hang-tags; clothing for pets; collars for pets; bags for carrying animals; nose bags [feed bags]; bridles [harness]; leather, unworked or semi-worked; moleskin [imitation of leather]; fur-skins; raw skins; bags; handbags; evening handbags; shopping bags; leather shopping bags; duffel bags; waist bags; Boston bags; shoulder bags; travelling bags; travelling trunks; beach bags; clutch bags; attaché cases; school bags; school satchels; schoolchildren's backpacks; bags for sports; garment bags for travel: purses; wallets; pocket wallets; carrying cases for documents; keycases; key bags; key wallets; backpacks; briefcases; pouc-



hes, of leather, for packaging; luggage; pouches for holding make-up, keys and other personal items; shoe bags for travel; all purpose sports bags; tote bags; saddle bags; knapsacks; rucksacks; haversacks; suitcases; trunks [luggage]; vanity cases, not fitted; hat boxes for travel; hat boxes of leather; handbag frames; leather key cases; leather shoulder belts; leather pouches; travelling sets [leatherware]; travelling bags of leather; sling bags for carrying infants; pouch baby carriers; umbrellas; parasols; canes; harness fittings; leather and imitations of leather; animal skins and hides; luggage and carrying bags; umbrellas and parasols; walking sticks; whips, harness and saddlery; collars, leashes and clothing for animals.

25 – Jackets [clothing]; sleeved or sleeveless jackets; heavy jackets; lightweight jackets [clothing]; bomber jackets; reversible jackets; rain jackets; leather jackets; padded jackets; wind-resistant jackets; waterproof jackets; stuff jackets [clothing]; down jackets; sleeveless down jackets; sports jackets; ski jackets; snowboard jackets; long jackets; windcheaters; ski windcheaters; snowboard windcheaters; anoraks; down anoraks; parkas; down parkas; fur jackets; waistcoats; waistcoats with removable lining; overcoats; coats; fur coats; raincoats; cardigans; pullovers; shirts; T-shirts; polo shirts; sport shirts; undershirts; shirts for wear with suits; chemises; camisoles; blouses; blousons; sweatshirts; sweaters; jumpers [pullovers]; jerseys [clothing]; sports jerseys; trousers; ski trousers; snowboard pants; ski pants; shorts; bermuda shorts; jeans; skirts; overalls; clothing for gymnastics; jogging suits; jogging suit trousers; training suits; track suits; ski suits; snowboard suits; suits; dresses; evening dresses; gowns; blazers; formal dresses; petticoats; corselets; wristbands [clothing]; headbands [clothing]; twin sets; leggings [trousers]; leggings [leg warmers]; leg warmers; dungarees; ponchos; veils; wedding dresses; ready-made clothing; outer clothing; masquerade costumes; tops [clothing]; tank-tops; knitwear [clothing]; hosiery; clothing of leather or imitations of leather; furs [clothing]; waterproof clothing; pants; sweat pants; pelerines; pinafore dresses; tuxedos; rompers; leotards; gabardines [clothing]; slacks; tunics; school uniforms; athletic uniforms; breeches for wear, golf clothing, other than gloves; cuffs; dance clothing; aprons [clothing]; smocks; ski masks [clothing]; bathing suits; bathing caps; shower caps; beach clothes; swimming costumes; swimsuits; bathing drawers; bathing trunks; bikinis; bath robes; pareus; children's clothing; infants' clothing; children's footwear; baby sleeping bags [sleepwear]; babies' pants [clothing]; bibs, not of paper; layettes [clothing]; socks; stockings; tights; sport socks; panty hose; unitards; garters; sock suspenders; stocking suspenders; shoes; leather shoes: sports shoes; gymnastic shoes; beach shoes; mountaineering shoes; running shoes: ski footwear; after ski footwear; footwear for snowbo-

arding; rain footwear; sneakers; slippers; bath slippers; sandals; bath sandals; flip flops [footwear]; heels; heelpieces for boots and shoes; inner soles; tips for footwear; soles for footwear; footwear uppers; boots; half-boots; lace boots; rain boots; ski boots; after ski boots; snowboard boots; boots for sports; horse-riding boots; clogs; overshoes; galoshes; gaiters; scarves; cloaks; shawls; stoles; fur stoles; bandanas [neckerchiefs]; foulards [clothing articles]; neckties; bow-ties; ascots; neckerchiefs; pocket squares; neck warmers; gloves [clothing]; muffs [clothing]; mittens; ski gloves; snowboard gloves; belts [clothing]; braces for clothing [suspenders]; suspenders; waistbands [parts of clothing]; money belts [clothing]; sashes for wear; boas [necklets]; collars [clothing]; underwear; singlets; slips [undergarments]; panties; underpants; drawers [clothing]; briefs; boxer briefs; pyjamas; dressing gowns; nightgowns; vests; brassieres; corsets [underclothing]; bodices [lingerie]; girdles; caps [headwear]; hats; cap peaks; caps with visors; berets; hoods [clothing]; ear muffs [clothing]; swimming caps; visors [headwear]; clothing, footwear, headgear.

(260) AM 2018 94755 A

(800) 1316525

(151) 2016 07 18

(891) 2017 09 08

(731) DE RUCCI BEDDING CO., LTD.

Shuanggang Shanghuan Industrial Zone,

Houjie Town, Dongguan City, 523948

Guangdong Province, China

(540)



**DeRUCCI**

(591) Black, white

(531) 27.05.01; 27.05.17; 27.05.21

(511)

20 – Mattress; beds; massage tables; furniture; sofas; cots; bed bases; cases of wood or plastic; ladders, not of metal; bamboo curtains; works of art of wood, wax, plaster or plastic; beds for household pets; furniture fittings, not of metal; pillows; cushions; sleeping bags for camping; indoor window blinds; mirrors; display boards; decorations of plastic for foodstuffs; identification bracelets, not of metal; coffins.

24 – Bedspread; bed linen; bed coverings; bed blankets; quilts; cloth; upholstery fabrics; non-woven fabrics; wall hangings of textile; felt; towels of textile; textile material; covers [loose] for furniture;

curtains of textile or plastic; fitted toilet lid covers of fabric; flags [not of paper]; shrouds.

35 – Advertising; publicity; presentation of goods on communication media, for retail purposes; organization of trade fairs for commercial or advertising purposes; procurement services for others [purchasing goods and services for other businesses]; import-export agencies; sales promotion [for others]; marketing, personnel management consulting; relocation services for businesses; compilation of information into computer databases; book-keeping; sponsorship search.

(260) AM 2018 94779 A

(800) 1371061

(151) 2017 08 24

(891) 2017 08 24

(731) ROLEX SA

3-5-7, rue François-Dussaud CH-1211  
GENEVE 26, Switzerland

(540)

**DAYTONA**

(591) Black and white

(511)

14 – Timepieces, watches, chronographs (timepieces), chronometers; component parts of timepieces not included in other classes, particularly dials, watch movements and parts thereof.

(260) AM 2018 94901 A

(800) 1371960

(151) 2017 07 03

(891) 2017 07 03

(731) ZİVAK TEKNOLOJİ SANAYİ VE

TİCARET LİMİTED ŞİRKETİ

Gürsel Mah. Eski Beşiktaş Cad. No:44/1-2

Kağıthane TR-34400 İstanbul, Turkey

(540)

**ZİVAK**

(591) VAK" is written in blue on a white background

(531) 27.05.01; 29.01.04

(511)

10 – Surgical, medical, dental and veterinary apparatus and instruments; furniture especially made for medical purposes; artificial limbs and prostheses; medical orthopedic articles: corsets for medical purposes, orthopedic shoes, elastic bandages and supportive bandages; surgical gowns and surgical sterile sheets; adult sexual aids; condoms; babies' bottles; babies' pacifiers; teats; teethingers for babies.

(260) AM 2018 94902 A

(800) 1371975

(151) 2017 08 08

(891) 2017 08 08

(731) CHINA MOBILE COMMUNICATIONS CORPORATION

No.29, Financial Street, Xicheng District,  
100032 Beijing, China

(540)



(591) Black, white

(531) 26.11.12; 26.11.13; 28.03

(511)

38 – Radio broadcasting; television broadcasting; message sending; communications by cellular phones; communications by computer terminals; transmission of electronic mail; computer aided transmission of messages and images; providing user access to a global computer network; providing telecommunication channels for teleshopping services; providing telecommunications connections to a global computer network.

(260) AM 2018 94904 A

(800) 1372006

(151) 2017 09 01

(891) 2017 09 01

(731) GLOBAL FUNCTIONAL DRINKS AG

Dammstrasse 19, CH-6301 Zug, Switzerland

(540)



(591) Yellow, red, orange, brown, gray, black, green, white and light gray.

(531) 05.07.12; 05.07.22; 07.01.08; 07.11.01;  
27.05.10; 27.05.11; 27.05.24; 29.01.15

(511)

32 – Non-alcoholic beverages, non-alcoholic aperitifs, non-alcoholic cocktails, syrups for beverages, vegetable juices (beverages), fruit juices, non-alcoholic fruit drinks, essences for making energy drinks.

(260) AM 2018 94905 A

(800) 1372016

(151) 2016 11 16

(891) 2016 11 16

(731) FARMAPRIM S.R.L.

Str. Crinilor nr.5, Porumbeni, MD-4829  
Criuleni, Moldova (Republic of)

(540)

**ASCOMETRIN**  
**АСКОМЕТРИН**

(591) Black, white

(511)

5 – Pharmaceutical products; sanitary products for medical purposes; dietetic substances and foodstuffs for medical use, food for babies; food supplements for human beings; material for dressings, bandages, plasters and medical applicators; material for dental fillings and dental impressions.

(260) AM 2018 94906 A

(800) 1372034

(151) 2017 08 01

(891) 2017 08 01

(731) CHAUX ET ENDUITS DE SAINT ASTIER

Lieudit la Jarthe, F-24110 SAINT-ASTIER,  
France

(540)

 **SAINT-ASTIER**

(591) Black, white

(531) 26.05.03

(511)

19 – Lime whitewash for coatings; building materials, not of metal; non-metallic panels, rolls and shells intended for thermal and acoustic insulation and protection from moisture and fire used in construction; mortar for interior finishing; sealing mortar; ready-to-use coated bodies; mortar and coatings for building; casting and stone repair mortar; binder or mortar based on natural lime for grout; binding agents for making briquettes; ready-to-use stucco; decorative moldings and decorative trim not of metal for construction and the building industry; raw and coated chipboard for the building industry, furniture and interior decorating; plaster; coatings [building materials]; ready-to-use plastering bodies; casting and stone repair mortar; ready-to-use mortar; linings not of metal [building]; natural lime for whitewash coatings; hydraulic lime; decorative mortar for finishing coatings; cement; masonry cement; mortar mixtures; binder or mortar based on natural lime for grout; non-metallic building materials namely cements, concretes, ready-to-use concretes and decorative concretes; decorative aggregates and sands; decorative moldings and decorative trim not of metal

for construction and the building industry; raw and coated chipboard for the building industry, furniture and interior decorating.

(260) AM 2018 94909 A

(800) 1372058

(151) 2017 08 21

(891) 2017 08

(731) HUAWEI TECHNOLOGIES CO., LTD.

Administration Building Huawei  
Technologies Co., Ltd.

Bantian, Longgang District Shenzhen, China

(540)

**HUAWEI Y8**

(591) Black, white

(531) 27.05.01; 27.07.01

(511)

9 – Smartwatches; wearable activity trackers; smart-glasses; selfie sticks (hand-held monopods); covers for smartphones; cases for smartphones; protective films adapted for smartphones; protective films adapted for computer screens; joysticks for use with computers, other than for video games; connected bracelets (measuring instruments); holograms; tablet computers; mobile phones; sleeves for laptops; modems; cabinets for loudspeakers; earphones; mobile power source (rechargeable batteries); network communication equipment; smartphones; cellular phones; video telephones; camcorders; portable media players; television apparatus; headphones; horns for loudspeakers; audio and video receivers.

(260) AM 2018 94910 A

(800) 1372059

(151) 2017 08 21

(891) 2017 08 21

(731) HUAWEI TECHNOLOGIES CO., LTD.

Administration Building Huawei  
Technologies Co., Ltd.

Bantian, Longgang District Shenzhen, China

(540)

**HUAWEI Y9**

(591) Black, white

(531) 27.05.01; 27.07.01

(511)

9 – Smart watches; wearable activity trackers; smart-glasses; selfie sticks (hand-held monopods); covers for smartphones; cases for smartphones; protective films adapted for smartphones; protective films adapted for computer screens; joysticks for use with computers, other than for video games; connected bracelets (measuring instruments); holograms; tablet computers; mobile phones; sleeves for laptops; modems; cabinets for loudspeakers; earphones; mobile

power source (rechargeable batteries); network communication equipment; smartphones; cellular phones; video telephones; camcorders; portable media players; television apparatus; headphones; horns for loudspeakers; audio and video receivers.

---

---

**INTERNATIONAL TRADEMARKS PROTECTED IN GEORGIA**

(260) AM 2018 89443 A  
(800) 1318300  
(151) 2016 08 01  
(181) 2026 08 01  
(891) 2016 08 01  
(511) 30, 35

---

(260) AM 2018 92145 A  
(800) 1342276  
(151) 2016 11 03  
(181) 2026 11 03  
(891) 2016 11 03  
(511) 16, 21, 29, 30, 35, 43

---

(260) AM 2018 90620 A  
(800) 1329059  
(151) 2016 10 18  
(181) 2026 10 18  
(891) 2016 10 18  
(511) 11

---

(260) AM 2018 92146 A  
(800) 1342283  
(151) 2017 01 30  
(181) 2027 01 30  
(891) 2017 01 30  
(511) 01, 35

---

(260) AM 2018 90784 A  
(800) 1329606  
(151) 2016 10 13  
(181) 2026 10 13  
(891) 2016 10 13  
(511) 12, 37

---

(260) AM 2018 92155 A  
(800) 1342461  
(151) 2017 01 19  
(181) 2027 01 19  
(891) 2017 01 19  
(511) 12

---

(260) AM 2018 91897 A  
(800) 1340924  
(151) 2016 12 22  
(181) 2026 12 22  
(891) 2016 12 22  
(511) 03, 16, 21

---

(260) AM 2018 92156 A  
(800) 1342496  
(151) 2017 02 07  
(181) 2027 02 07  
(891) 2017 02 07  
(511) 03, 05, 35

---

(260) AM 2018 92036 A  
(800) 1341837  
(151) 2017 02 16  
(181) 2027 02 16  
(891) 2017 02 16  
(511) 30

---

(260) AM 2018 92169 A  
(800) 880825  
(151) 2005 08 22  
(181) 2025 08 22  
(891) 2017 04 07  
(511) 09

---

(260) AM 2018 92132 A  
(800) 1342637  
(151) 2016 01 29  
(181) 2026 01 29  
(891) 2016 01 29  
(511) 01, 06, 07, 12, 40, 42

---

(260) AM 2018 92173 A  
(800) 1220646  
(151) 2014 06 25  
(181) 2024 06 25  
(891) 2017 04 14  
(511) 03

---

(260) AM 2018 92142 A  
(800) 1342229  
(151) 2016 11 15  
(181) 2026 11 15  
(891) 2016 11 15  
(511) 07, 09, 14, 25, 35, 36, 42

---

(260) AM 2018 92174 A  
(800) 1235541  
(151) 2014 09 27  
(181) 2024 09 27  
(891) 2017 04 05  
(511) 34, 35

---

(260) AM 2018 92177 A  
(800) 1294853  
(151) 2015 12 15  
(181) 2025 12 15  
(891) 2016 12 26  
(511) 25, 35

---

(260) AM 2018 92178 A  
(800) 1317423  
(151) 2016 06 24  
(181) 2026 06 24  
(891) 2017 01 04  
(511) 17

---

(260) AM 2018 92179 A  
(800) 1319435  
(151) 2016 04 13  
(181) 2026 04 13  
(891) 2017 01 08  
(511) 05, 10

---

(260) AM 2018 92181 A  
(800) 1338249  
(151) 2016 12 09  
(181) 2026 12 09  
(891) 2017 04 20  
(511) 32, 33

---

(260) AM 2018 92198 A  
(800) 1342836  
(151) 2016 12 20  
(181) 2026 12 20  
(891) 2016 12 20  
(511) 07

---

(260) AM 2018 92199 A  
(800) 1342850  
(151) 2016 11 10  
(181) 2026 11 10  
(891) 2016 11 10  
(511) 03, 30

---

(260) AM 2018 92201 A  
(800) 1342927  
(151) 2017 02 07  
(181) 2027 02 07  
(891) 2017 02 07  
(511) 05

---

(260) AM 2018 92203 A  
(800) 1343019  
(151) 2016 08 23  
(181) 2026 08 23

(891) 2016 08 23  
(511) 01, 16, 19

---

(260) AM 2018 92207 A  
(800) 1343162  
(151) 2017 01 18  
(181) 2027 01 18  
(891) 2017 01 18  
(511) 09

---

(260) AM 2018 92210 A  
(800) 1343214  
(151) 2016 09 02  
(181) 2026 09 02  
(891) 2016 09 02  
(511) 09

---

(260) AM 2018 92211 A  
(800) 1343248  
(151) 2017 01 10  
(181) 2027 01 10  
(891) 2017 01 10  
(511) 01, 05, 35

---

(260) AM 2018 92214 A  
(800) 1343257  
(151) 2017 02 14  
(181) 2027 02 14  
(891) 2017 02 14  
(511) 05

---

(260) AM 2018 92227 A  
(800) 1343311  
(151) 2017 02 21  
(181) 2027 02 21  
(891) 2017 02 21  
(511) 08

---

(260) AM 2018 92228 A  
(800) 1343334  
(151) 2017 02 09  
(181) 2027 02 09  
(891) 2017 02 09  
(511) 06, 12, 19, 35, 37, 42

---

(260) AM 2018 92230 A  
(800) 1343389  
(151) 2017 03 15  
(181) 2027 03 15  
(891) 2017 03 15  
(511) 05

---

(260) AM 2018 92231 A  
(800) 1343434  
(151) 2016 11 12  
(181) 2026 11 12  
(891) 2016 11 12  
(511) 05, 10

---

(260) AM 2018 92232 A  
(800) 1344517  
(151) 2017 03 03  
(181) 2027 03 03  
(891) 2017 03 03  
(511) 03

---

(260) AM 2018 92233 A  
(800) 1343435  
(151) 2016 11 12  
(181) 2026 11 12  
(891) 2016 11 12  
(511) 05, 10

---

(260) AM 2018 92235 A  
(800) 1343451  
(151) 2017 01 09  
(181) 2027 01 09  
(891) 2017 01 09  
(511) 41

---

(260) AM 2018 92236 A  
(800) 1344518  
(151) 2017 02 07  
(181) 2027 02 07  
(891) 2017 02 07  
(511) 29, 30, 35, 41, 43

---

(260) AM 2018 92237 A  
(800) 1343896  
(151) 2017 02 13  
(181) 2027 02 13  
(891) 2017 02 13  
(511) 10

---

(260) AM 2018 92238 A  
(800) 1343536  
(151) 2017 01 25  
(181) 2027 01 25  
(891) 2017 01 25  
(511) 09, 10, 11, 35

---

(260) AM 2018 92241 A  
(800) 1343958  
(151) 2016 04 27  
(181) 2026 04 27

(891) 2016 04 27  
(511) 05

---

(260) AM 2018 92242 A  
(800) 1343965  
(151) 2016 12 02  
(181) 2026 12 02  
(891) 2016 12 02  
(511) 03

---

(260) AM 2018 92248 A  
(800) 1343637  
(151) 2017 02 16  
(181) 2027 02 16  
(891) 2017 02 16  
(511) 10, 35, 36, 41, 44

---

(260) AM 2018 92249 A  
(800) 1343638  
(151) 2017 02 14  
(181) 2027 02 14  
(891) 2017 02 14  
(511) 12

---

(260) AM 2018 92250 A  
(800) 1343643  
(151) 2016 12 21  
(181) 2026 12 12  
(891) 2016 12 21  
(511) 29, 30

---

(260) AM 2018 92255 A  
(800) 1343644  
(151) 2016 12 21  
(181) 2026 12 21  
(891) 2016 12 21  
(511) 29, 30

---

(260) AM 2018 92261 A  
(800) 1343692  
(151) 2016 08 09  
(181) 2026 08 09  
(891) 2016 08 09  
(511) 03

---

(260) AM 2018 92264 A  
(800) 1343847  
(151) 2016 12 29  
(181) 2026 12 29  
(891) 2016 12 29  
(511) 11

---

(260) AM 2018 92265 A  
(800) 1343891  
(151) 2017 01 20  
(181) 2027 01 20  
(891) 2017 01 20  
(511) 05

---

(260) AM 2018 92267 A  
(800) 1344591  
(151) 2017 02 07  
(181) 2027 02 07  
(891) 2017 02 07  
(511) 29, 30, 43

---

(260) AM 2018 92272 A  
(800) 259246A  
(151) 1962 08 31  
(181) 2022 08 31  
(891) 2017 04 27  
(511) 34

---

(260) AM 2018 92275 A  
(800) 1343991  
(151) 2016 08 25  
(181) 2026 08 25  
(891) 2016 08 25  
(511) 31

---

(260) AM 2018 92276 A  
(800) 414857  
(151) 1974 12 14  
(181) 2024 12 14  
(891) 2016 11 22  
(511) 03, 09, 11, 16, 18, 20

---

(260) AM 2018 92277 A  
(800) 437005  
(151) 1978 04 24  
(181) 2028 04 24  
(891) 2017 04 21  
(511) 07, 08

---

(260) AM 2018 92279 A  
(800) 565203  
(151) 1991 01 30  
(181) 2021 01 30  
(891) 2017 01 13  
(511) 33

---

(260) AM 2018 92399 A  
(800) 1344696  
(151) 2016 11 03  
(181) 2026 11 03

(891) 2016 11 03  
(511) 16, 21, 29, 30, 35, 43

---

(260) AM 2018 92400 A  
(800) 1344709  
(151) 2017 01 30  
(181) 2027 01 30  
(891) 2017 01 30  
(511) 18, 25, 35

---

(260) AM 2018 92403 A  
(800) 1344881  
(151) 2017 02 13  
(181) 2027 02 13  
(891) 2017 02 13  
(511) 09

---

(260) AM 2018 92404 A  
(800) 1344744  
(151) 2016 11 05  
(181) 2026 11 05  
(891) 2016 11 05  
(511) 36

---

(260) AM 2018 92406 A  
(800) 1344745  
(151) 2017 01 31  
(181) 2027 01 31  
(891) 2017 01 31  
(511) 32

---

(260) AM 2018 92407 A  
(800) 1344747  
(151) 2017 01 26  
(181) 2027 01 26  
(891) 2017 01 26  
(511) 30, 31

---

(260) AM 2018 92410 A  
(800) 1344752  
(151) 2016 11 26  
(181) 2026 11 26  
(891) 2016 11 26  
(511) 03

---

(260) AM 2018 92411 A  
(800) 1344999  
(151) 2016 12 30  
(181) 2026 12 30  
(891) 2016 12 30  
(511) 09, 18, 25, 28

---



(260) AM 2018 92421 A  
(800) 1345095  
(151) 2017 02 23  
(181) 2027 02 23  
(891) 2017 02 23  
(511) 32

---

(260) AM 2018 92423 A  
(800) 1345135  
(151) 2016 11 16  
(181) 2026 11 16  
(891) 2016 11 16  
(511) 42

---

(260) AM 2018 92430 A  
(800) 1345228  
(151) 2016 12 30  
(181) 2026 12 30  
(891) 2016 12 30  
(511) 39

---

(260) AM 2018 92447 A  
(800) 1161983  
(151) 2012 12 07  
(181) 2022 12 07  
(891) 2017 03 31  
(511) 09, 14, 18, 25, 35

---

(260) AM 2018 92450 A  
(800) 1204265  
(151) 2014 01 17  
(181) 2024 01 17  
(891) 2016 12 14  
(511) 09, 16, 35, 39

---

(260) AM 2018 92455 A  
(800) 1254478  
(151) 2015 05 07  
(181) 2025 05 07  
(891) 2017 02 14  
(511) 01, 05, 29

---

(260) AM 2018 92457 A  
(800) 1255978  
(151) 2015 03 11  
(181) 2025 03 11  
(891) 2017 02 09  
(511) 09

---

(260) AM 2018 92458 A  
(800) 1259993  
(151) 2015 05 05  
(181) 2025 05 28

(891) 2017 02 14  
(511) 01, 05, 29

---

(260) AM 2018 92459 A  
(800) 1310715  
(151) 2015 12 30  
(181) 2025 12 30  
(891) 2017 03 15  
(511) 25

---

(260) AM 2018 92514 A  
(800) 1346605  
(151) 2017 02 28  
(181) 2027 02 28  
(891) 2017 02 28  
(511) 25, 35, 41

---

(260) AM 2018 92515 A  
(800) 1346616  
(151) 2016 08 24  
(181) 2026 08 24  
(891) 2016 08 24  
(511) 11

---

(260) AM 2018 92517 A  
(800) 1346675  
(151) 2016 08 25  
(181) 2026 08 25  
(891) 2016 08 25  
(511) 03, 05, 16

---

(260) AM 2018 92531 A  
(800) 1345778  
(151) 2017 02 24  
(181) 2027 02 24  
(891) 2017 02 24  
(511) 05

---

(260) AM 2018 92568 A  
(800) 1346067  
(151) 2016 09 23  
(181) 2026 09 23  
(891) 2016 09 23  
(511) 28, 30

---

(260) AM 2018 92571 A  
(800) 1346156  
(151) 2017 02 24  
(181) 2027 02 24  
(891) 2017 02 24  
(511) 29, 30

---

(260) AM 2018 92591 A  
(800) 1346298  
(151) 2017 11 24  
(181) 2026 11 24  
(891) 2016 11 24  
(511) 01, 02

---

(260) AM 2018 92592 A  
(800) 1346304  
(151) 2016 11 10  
(181) 2026 11 10  
(891) 2016 11 10  
(511) 07, 12

---

(260) AM 2018 92599 A  
(800) 1346482  
(151) 2017 01 24  
(181) 2027 01 24  
(891) 2017 01 24  
(511) 09, 11, 34

---

(260) AM 2018 92601 A  
(800) 1346483  
(151) 2017 02 20  
(181) 2027 02 20  
(891) 2017 02 20  
(511) 34, 41

---

(260) AM 2018 92637 A  
(800) 1347749  
(151) 2016 07 01  
(181) 2026 07 01  
(891) 2016 07 01  
(511) 12, 35

---

(260) AM 2018 92638 A  
(800) 1347819  
(151) 2017 03 21  
(181) 2027 03 21  
(891) 2017 03 21  
(511) 12

---

(260) AM 2018 92639 A  
(800) 1347857  
(151) 2016 11 21  
(181) 2026 11 21  
(891) 2016 11 21  
(511) 29, 30

---

(260) AM 2018 92641 A  
(800) 1347866  
(151) 2016 12 09  
(181) 2026 12 09

(891) 2016 12 09  
(511) 09, 42

---

(260) AM 2018 92642 A  
(800) 1347865  
(151) 2016 12 02  
(181) 2026 12 02  
(891) 2016 12 02  
(511) 17, 19

---

(260) AM 2018 92644 A  
(800) 1347871  
(151) 2016 12 12  
(181) 2026 12 12  
(891) 2016 12 12  
(511) 09, 28

---

(260) AM 2018 92645 A  
(800) 1347885  
(151) 2016 11 25  
(181) 2026 11 25  
(891) 2016 11 25  
(511) 09, 41

---

(260) AM 2018 92646 A  
(800) 1347894  
(151) 2017 01 26  
(181) 2027 01 26  
(891) 2017 01 26  
(511) 03, 29, 30, 32, 33

---

(260) AM 2018 92647 A  
(800) 1346908  
(151) 2017 02 06  
(181) 2027 02 06  
(891) 2017 02 06  
(511) 09, 11, 34

---

(260) AM 2018 92840 A  
(800) 1349185  
(151) 2015 11 25  
(181) 2025 11 25  
(891) 2015 11 25  
(511) 18, 25, 35

---

(260) AM 2018 92859 A  
(800) 189040  
(151) 1955 11 26  
(181) 2025 11 26  
(891) 2017 05 17  
(511) 01, 05

---

(260) AM 2018 92861 A  
(800) 552869  
(151) 1990 03 29  
(181) 2020 03 29  
(891) 2017 04 27  
(511) 03, 05

---

(260) AM 2018 92862 A  
(800) 641860  
(151) 1995 07 19  
(181) 2025 07 19  
(891) 2017 05 19  
(511) 05

---

(260) AM 2018 92867 A  
(800) 1348783  
(151) 2017 03 02  
(181) 2027 03 02  
(891) 2017 03 02  
(511) 05

---

(260) AM 2018 92868 A  
(800) 1348784  
(151) 2017 03 02  
(181) 2027 03 02  
(891) 2017 03 02  
(511) 05

---

(260) AM 2018 92869 A  
(800) 1348785  
(151) 2017 01 26  
(181) 2027 01 26  
(891) 2017 01 26  
(511) 05

---

(260) AM 2018 92872 A  
(800) 1348786  
(151) 2017 01 26  
(181) 2027 01 26  
(891) 2017 01 26  
(511) 05

---

(260) AM 2018 92873 A  
(800) 1348822  
(151) 2017 02 24  
(181) 2027 02 24  
(891) 2017 02 24  
(511) 11

---

(260) AM 2018 92875 A  
(800) 1348831  
(151) 2017 03 10  
(181) 2027 03 10

(891) 2017 03 10  
(511) 03, 05, 30

---

(260) AM 2018 92876 A  
(800) 1348839  
(151) 2017 03 21  
(181) 2027 03 21  
(891) 2017 03 21  
(511) 03

---

(260) AM 2018 92877 A  
(800) 1348887  
(151) 2016 11 14  
(181) 2026 11 14  
(891) 2016 11 14  
(511) 25, 27, 28

---

(260) AM 2018 92878 A  
(800) 1348914  
(151) 2016 12 02  
(181) 2026 12 02  
(891) 2016 12 02  
(511) 05, 07, 09, 10, 11, 38, 41, 42

---

(260) AM 2018 92880 A  
(800) 1348920  
(151) 2016 12 27  
(181) 2026 12 27  
(891) 2016 12 27  
(511) 30

---

(260) AM 2018 92881 A  
(800) 1348925  
(151) 2017 01 16  
(181) 2027 01 16  
(891) 2017 01 16  
(511) 17

---

(260) AM 2018 93020 A  
(800) 1350830  
(151) 2017 02 15  
(181) 2027 02 15  
(891) 2017 02 15  
(511) 09, 36, 38, 42

---

(260) AM 2018 93021 A  
(800) 1350851  
(151) 2017 03 23  
(181) 2027 03 23  
(891) 2017 03 23  
(511) 43

---

(260) AM 2018 93151 A  
(800) 1352007  
(151) 2017 02 20  
(181) 2027 02 20  
(891) 2017 02 20  
(511) 41

---

(260) AM 2018 93157 A  
(800) 1352173  
(151) 2017 02 22  
(181) 2027 02 22  
(891) 2017 02 22  
(511) 05

---

(260) AM 2018 93158 A  
(800) 1352187  
(151) 2017 02 28  
(181) 2027 02 28  
(891) 2017 02 28  
(511) 05

---

(260) AM 2018 93183 A  
(800) 959635  
(151) 2008 03 06  
(181) 2028 03 06  
(891) 2017 06 09  
(511) 01

---

(260) AM 2018 93192 A  
(800) 1352762  
(151) 2017 03 27  
(181) 2027 03 27  
(891) 2017 03 27  
(511) 44

---

(260) AM 2018 93195 A  
(800) 1352800  
(151) 2017 01 10  
(181) 2027 01 10  
(891) 2017 01 10  
(511) 12

---

(260) AM 2018 93197 A  
(800) 1352803  
(151) 2016 12 21  
(181) 2026 12 21  
(891) 2016 12 21  
(511) 05, 10

---

(260) AM 2018 93212 A  
(800) 1153876  
(151) 2012 09 19  
(181) 2022 09 19

(891) 2017 04 26  
(511) 06, 07, 09, 11, 17

---

(260) AM 2018 93261 A  
(800) 1353908  
(151) 2016 12 20  
(181) 2027 12 20  
(891) 2016 12 20  
(511) 09, 35, 38, 41, 42

---

(260) AM 2018 93276 A  
(800) 726307  
(151) 1999 12 02  
(181) 2019 12 02  
(891) 2016 12 30  
(511) 33

---

(260) AM 2018 93281 A  
(800) 1354018  
(151) 2017 04 10  
(181) 2027 04 10  
(891) 2017 04 10  
(511) 12

---

(260) AM 2018 93283 A  
(800) 1354093  
(151) 2017 05 17  
(181) 2027 05 17  
(891) 2017 05 17  
(511) 14

---

(260) AM 2018 93284 A  
(800) 842169  
(151) 2004 12 31  
(181) 2024 12 31  
(891) 2017 05 05  
(511) 33

---

(260) AM 2018 93286 A  
(800) 1354197  
(151) 2016 08 29  
(181) 2027 08 29  
(891) 2016 08 29  
(511) 01, 05

---

(260) AM 2018 93365 A  
(800) 1051895  
(151) 2010 06 08  
(181) 2020 06 08  
(891) 2017 04 28  
(511) 28

---

(260) AM 2018 93421 A  
(800) 1355788  
(151) 2017 04 10  
(181) 2027 04 10  
(891) 2017 04 10  
(511) 07

---

(260) AM 2018 93422 A  
(800) 1355817  
(151) 2017 04 20  
(181) 2027 04 20  
(891) 2017 04 20  
(511) 05

---

(260) AM 2018 93448 A  
(800) 1356734  
(151) 2017 04 21  
(181) 2027 04 21  
(891) 2017 04 21  
(511) 05

---

(260) AM 2018 93449 A  
(800) 1356741  
(151) 2017 04 21  
(181) 2027 04 21  
(891) 2017 04 21  
(511) 05

---

(260) AM 2018 94024 A  
(800) 926166  
(151) 2007 05 09  
(181) 2027 05 09  
(891) 2017 08 17  
(511) 05

---

---

# OFFICIAL NOTIFICATIONS

## INVENTIONS

### RENEWAL OF PATENTS

(21) AP 2012 12551

(11) P 2014 6175 B

(73) I. Javakhishvili Tbilisi State University

(54) **METHOD OF SOLID-STATE SYNTHESIS OF OXIDE CERAMIC MATERIAL**

DATE OF PATENT CANCELLATION: 2018 01 27

DATE OF PATENT RENEWAL: 2018 07 10

---

(21) AP 2012 12608

(11) P 2013 5865 B

(73) Giorgi Tedoradze;

Giorgi Topadze;

Zurab Kostava;

Irakli Topadze;

Giorgi Topadze

(54) **METHOD OF NATURAL AROMATIZER PREPARATION**

DATE OF PATENT CANCELLATION: 2018 03 01

DATE OF PATENT RENEWAL: 2018 07 10

---

(21) AP 2015 13777

(11) P 2017 6738 B

(73) Anzor Sakandelidze;

Fridon Guntsadze;

Sergo Jorbenadze;

Malkhaz Tsiskarishvili

(54) **PORT WITH FLOATING MEANS AUTOMATICALLY FIXATIVE SYSTEM AT CHOPPINESS**

**PORT WITH FLOATING MEANS AUTOMATICALLY FIXATIVE SYSTEM AT CHOPPINESS**

DATE OF PATENT CANCELLATION: 2018 03 30

DATE OF PATENT RENEWAL: 2018 07 10

---

(21) AP 2003 7204

(11) P 2006 3810 B

(73) BRF S.A.

(54) **ALIMENTARY COMPOSITION COMPRISING DIETARY FIBRES, AS WELL AS USE THEREOF IN PREPARATION OF ALIMENTARY PRODUCTS**

DATE OF PATENT CANCELLATION: 2018 05 29

DATE OF PATENT RENEWAL: 2018 07 10

---

## CANCELLATION OF PATENTS

(21) AP 2007 11074  
(11) P 2012 5464 B  
(73) PIERRE FABRE MEDICAMENT  
(54) **DHA ESTERS AND USE THEREOF IN TREATMENT AND PREVENTION OF  
CARDIOVASCULAR DISEASE**  
DATE OF PATENT CANCELLATION: 2018 06 22  
PATENT RESTORATION IS AVAILABLE: 2019 06 22

---

(21) AP 2012 12766  
(11) P 2013 5987 B  
(73) Sarkis Markaryan  
(54) **METHOD OF WATER COMPLEX DEACTIVATION AND MODULE FOR EXECUTION  
THEREOF**  
DATE OF PATENT CANCELLATION: 2018 06 27  
PATENT RESTORATION IS AVAILABLE: 2019 06 27

---

(21) AP 2012 12769  
(11) P 2014 6020 B  
(73) General Electric Company  
(54) **METHOD OF BORON POWDERING BY PRESSURE MILL WITH INERT GAS USAGE  
TO SATISFY CLEANNESS NEED**  
DATE OF PATENT CANCELLATION: 2018 06 27  
PATENT RESTORATION IS AVAILABLE: 2019 06 27

---

(21) AP 2009 13059  
(11) P 2016 6443 B  
(73) Takeda Pharmaceutical Company Limited  
(54) **HETEROCYCLIC COMPOUND AND USE THEREOF**  
DATE OF PATENT CANCELLATION: 2018 06 17  
PATENT RESTORATION IS AVAILABLE: 2019 06 17

---

(21) AP 2013 13119  
(11) P 2014 6111 B  
(73) Avtandil Balanchivadze  
(54) **CHARGRILL DRIVE**  
DATE OF PATENT CANCELLATION: 2018 06 18  
PATENT RESTORATION IS AVAILABLE: 2019 06 18

---

(21) AP 2012 13352  
(11) P 2016 6475 B  
(73) Takeda Pharmaceutical Company Limited  
(54) **CRYSTAL OF FUSED HETEROCYCLIC COMPOUND**  
DATE OF PATENT CANCELLATION: 2018 06 21  
PATENT RESTORATION IS AVAILABLE: 2019 06 21

---

(21) AP 2013 13941  
(11) P 2017 6663 B  
(73) CADILA HEALTHCARE LIMITED  
(54) **NOVEL COMPOSITION FOR NONALCOHOLIC FATTY LIVER DISEASE (NAFLD )**  
DATE OF PATENT CANCELLATION: 2018 06 25  
PATENT RESTORATION IS AVAILABLE: 2019 06 25

---

(21) AP 2016 14188  
(11) P 2017 6744 B  
(73) Rususdan Bitsadze;  
Simon Bitsadze  
(54) **MAGNETO HYDRAULIC TAPPET**  
DATE OF PATENT CANCELLATION: 2018 06 23  
PATENT RESTORATION IS AVAILABLE: 2019 06 23

---

(21) AP 1999 4873  
(11) P 2000 2256 B  
(73) Giorgi Aleksidze  
(54) **MEDICINAL PREPARATION**  
DATE OF PATENT CANCELLATION: 2018 06 29  
PATENT RESTORATION IS AVAILABLE: 2019 06 29

---

(21) AP 2002 6302  
(11) P 2004 3314 B  
(73) Orion Corporation  
(54) **PHARMACEUTICAL COMPOSITION COMPRISING ENTACAPONE, LEVODOPA, AND CARBIDOPA**  
DATE OF PATENT CANCELLATION: 2018 06 29  
PATENT RESTORATION IS AVAILABLE: 2019 06 29

---

(21) AP 2005 9837  
(11) P 2009 4694 B  
(73) MERCK SHARP & DOHME CORP.  
(54) **CETP INHIBITORS**  
DATE OF PATENT CANCELLATION: 2018 07 01  
PATENT RESTORATION IS AVAILABLE: 2019 07 01

---

## UTILITY MODELS

### RENEWAL OF PATENTS

(21) AU 2015 13782  
(11) U 2016 1888 Y  
(73) Otar Shengelia;  
Nodar Khodeli;  
Zurab Chkhaidze  
(54) **ARTIFICIAL APPARATUS FOR BLOOD CIRCULATION**  
DATE OF PATENT CANCELLATION: 2018 04 03  
DATE OF PATENT RENEWAL: 2018 07 10

---



## CANCELLATION OF PATENTS

(21) AU 2014 13507  
(11) U 2015 1881 Y  
(73) LLC "TIRED GROUP"  
(54) **ARTIFICIAL SOIL**  
DATE OF PATENT CANCELLATION: 2018 06 24  
MODEL RESTORATION IS AVAILABLE: 2019 06 24

---

(21) AU 2016 14187  
(11) U 2017 1936 Y  
(73) Nino Ghlonti;  
Vakhtang Ghlonti  
(54) **BEEHIVE**  
DATE OF PATENT CANCELLATION: 2018 06 23  
MODEL RESTORATION IS AVAILABLE: 2019 06 23

---

## COMPLETE TRANSFER OF RIGHT

(21) AU 2012 13321  
(11) U 2015 1842 Y  
(54) **SECURITY ELEMENT FOR VALUE DOCUMENTS AND METHOD FOR MANUFACTURING  
SAME**  
NEW PATENT OWNER AND ADDRESS: National Security Ventures, Fzc (AE)  
Building Z-2, Executive Suit 85 Sife Zone, Sharjah A/P P.O.Box 9015, Sharjah, United Arab Emirates (AE)  
FORMER PATENT OWNER AND ADDRESS:  
Georgi Vladimirovich Beilin (UA)  
Al. Draizer, d. 20-a, sq. 80, Kiev, 02222, Ukraine (UA);  
Vladimir Leonidovich Vozni (UA)  
P-kt Petra Grigorenko, d. 28, kv.69, Kiev, 02095, Ukraine (UA);  
Yuri Grigorievich Sidorenko (UA)  
Ul. Saksagonskogo, d. 112-a, kv. 8, Kiev, 01033, Ukraine (UA);  
Andrei Nikolaevich Tymoshenko (UA)  
Ul. Pavlovskaya, d. 26/41, kv. 80, Kiev, 01135, Ukraine (UA);  
Obshtestvo s Ogranichennoy Otvetstvennosti "Special Enterprise "HOLOGRAPHY" (UA)  
Ul. Evg. Kharchenko 64, Kiev, 02088, Ukraine (UA)  
DATE OF REGISTRATION: 2018 06 29

---

# TRADEMARKS

## RENEWAL OF REGISTRATIONS

(111) M 1998 9961 R2

(156) 1998 07 07

(186) 2028 07 07

(732) ROLEX SA

rue Francois-Dussaud 3-5-7, Geneva,  
Switzerland

(111) M 1998 9962 R2

(156) 1998 07 07

(186) 2028 07 07

(732) MONTRES TUDOR S.A.

3, rue Francois-Dussaud, CH-Geneve,  
Switzerland

(511) 14

(111) M 1998 9963 R2

(156) 1998 07 07

(186) 2028 07 07

(732) MONTRES TUDOR S.A.

3, rue Francois-Dussaud, CH-Geneve,  
Switzerland

(111) M 1998 9676 R2

(156) 1998 06 09

(186) 2028 06 09

(732) BRITISH-AMERICAN TOBACCO

(BRANDS) LIMITED  
Globe House, 4 Temple Place London  
WC2R 2PG, United Kingdom

(111) M 1998 9678 R2

(156) 1998 06 09

(186) 2028 06 09

(732) BRITISH AMERICAN TOBACCO

(BRANDS) LIMITED  
Globe House, 4 Temple Place, London,  
WC2R 2PG, United Kingdom

(111) M 1998 9696 R2

(156) 1998 06 11

(186) 2028 06 11

(732) STAR STABILIMENTO ALIMENTARE

S.P.A.  
Via Matteotti 142, 20041 Abriate Bianza,  
Milano, Italy

(111) M 1998 9702 R2

(156) 1998 06 11

(186) 2028 06 11

(732) ROTHMANS OF PALL MALL LIMITED

Zählerweg 4, Zug CH 6300,, Switzerland

(111) M 1998 9703 R2

(156) 1998 06 11

(186) 2028 06 11

(732) B. BRAUN MELSUNGEN

AKTIENGESELLSCHAFT  
Carl-Braun-Strasse 1, D-34212, Melsungen,  
Germany

(111) M 1998 9704 R2

(156) 1998 06 11

(186) 2028 06 11

(732) B. BRAUN MELSUNGEN

AKTIENGESELLSCHAFT  
Carl-Braun-Strasse 1, D-34212, Melsungen,  
Germany

(111) M 1998 9573 R2

(156) 1998 06 04

(186) 2028 06 04

(732) Essity Hygiene and Health Aktiebolag

SE-40503 Göteborg, Sweden

(111) M 1998 9574 R2

(156) 1998 06 04

(186) 2028 06 04

(732) Essity Hygiene and Health Aktiebolag

SE-40503 Göteborg, Sweden

(111) M 1998 9710 R2

(156) 1998 06 11

(186) 2028 06 11

(732) GREY GLOBAL GROUP LLC

a Delaware limited liability company  
200 Fifth Avenue New York, New York,  
USA

(111) M 1998 9146 R2

(156) 1998 05 01

(186) 2028 05 01

(732) DEUTSCHE TELEKOM AG

Friedrich-Ebert-Allee 140, 53113 Bonn,  
Germany

(111) M 1998 9149 R2  
 (156) 1998 05 01  
 (186) 2028 05 01  
 (732) DEUTSCHE TELEKOM AG  
 Fridrikh-ebert-alee 140, 53113 Boni,  
 Germany

---

(111) M 1998 9725 R2  
 (156) 1998 06 11  
 (186) 2028 06 11  
 (732) KARELIA TOBACCO COMPANY INC.  
 P.O. Box 22, Athinon Avenue, GR-24100  
 Kalamata, Greece

---

(111) M 1998 8229 R2  
 (156) 1998 02 04  
 (186) 2028 02 04  
 (732) GIORGIO ARMANI S.p.A.  
 Milan, Swiss Branch Mendrisio  
 Via Penate 4, 6850 Mendrisio, Switzerland

---

(111) M 1997 7479 R2  
 (156) 1997 11 12  
 (186) 2027 11 12  
 (732) ALCATEL LUCENT  
 148/152 route de la Reine, 92100 Boulogne-  
 Billancourt, France

---

(111) M 1998 9810 R2  
 (156) 1998 06 23  
 (186) 2028 06 23  
 (732) TRESMONTES LUCCHETTI S.A.  
 Los Conquistadores 2345, Providencia,  
 Santiago, Chile

---

(111) M 1998 9094 R2  
 (156) 1998 04 30  
 (186) 2028 04 30  
 (732) FILIGRAN TRAGERSYSTEME GMBH &  
 Co. KG  
 Am Zappenberg 6, 31633 Leese/Weser,  
 Germany

---

(111) M 1998 9815 R2  
 (156) 1998 06 23  
 (186) 2028 06 23  
 (732) LEXMARK INTERNATIONAL, INC.  
 740 New Circle Road N.W., Lexington,  
 Kentucky 40511-1876, USA

---

(111) M 1998 9825 R2  
 (156) 1998 06 23  
 (186) 2028 06 23

(732) SPIRAX-SARCO LIMITED  
 130/132, St.Georges Road, Cheltenham,  
 Gloucester, United Kingdom

---

(111) M 1998 9832 R2  
 (156) 1998 06 23  
 (186) 2028 06 23  
 (732) HEWLETT-PACKARD DEVELOPMENT  
 COMPANY, L.P.  
 11445 Compaq Center Drive West, Houston,  
 Texas 77070, USA

---

(111) M 1998 9867 R2  
 (156) 1998 06 26  
 (186) 2028 06 26  
 (732) GILBARCO INC.  
 7300 West Friendly Avenue, Greensboro,  
 North Carolina, USA

---

(111) M 1998 9874 R2  
 (156) 1998 06 26  
 (186) 2028 06 26  
 (732) UNITED PARCEL SERVICE OF  
 AMERICA, INC.  
 55 Glenlake Parkway, NE Atlanta, Georgia,  
 USA

---

(111) M 1998 9875 R2  
 (156) 1998 06 26  
 (186) 2028 06 26  
 (732) UNITED PARCEL SERVICE OF  
 AMERICA, INC.  
 55 Glenlake Parkway, NE Atlanta, Georgia,  
 USA

---

(111) M 1998 9910 R2  
 (156) 1998 06 26  
 (186) 2028 06 26  
 (732) WALA-HEILMITTEL GMBH  
 Dorfstrasse 1, 73087 Boll, Germany

---

(111) M 1998 9911 R2  
 (156) 1998 06 26  
 (186) 2028 06 26  
 (732) WALA-HEILMITTEL GMBH  
 Dorfstrasse 1, 73087 Eckwalden/Bad Boll,  
 Germany

---

(111) M 1998 9919 R2  
 (156) 1998 06 26  
 (186) 2028 06 26  
 (732) BRITISH AMERICAN TOBACCO

(BRANDS) LIMITED  
Globe House, 4 Temple Place, London,  
WC2R 2PG, United Kingdom

(111) M 1998 8607 R2  
(156) 1998 03 09  
(186) 2028 03 09  
(732) CERRUTI 1881  
3, Place de la Madeleine, 75008 Paris, France

(111) M 1998 9972 R2  
(156) 1998 07 07  
(186) 2028 07 07  
(732) COMPTOIR NOUVEAU DE LA  
PARFUMERIE  
23, rue Boissy d'Anglas, 75008 Paris, France

(111) M 1998 10404 R2  
(156) 1998 08 20  
(186) 2028 08 20  
(732) FEDERAL-MOGUL PRODUCTS, INC.  
26555 Northwestern Highway, Southfield,  
Michigan 48034, USA

(111) M 1998 10112 R2  
(156) 1998 07 31  
(186) 2028 07 31  
(732) VIACOM INTERNATIONAL INC.  
1515 Broadway, New York, NY 10036, USA

(111) M 1998 10113 R2  
(156) 1998 07 31  
(186) 2028 07 31  
(732) VIACOM INTERNATIONAL INC.  
1515 Broadway, New York, NY 10036, USA

(111) M 1998 10114 R2  
(156) 1998 07 31  
(186) 2028 07 31  
(732) VIACOM INTERNATIONAL INC.  
1515 Broadway, New York, NY 10036, USA

(111) M 1998 10115 R2  
(156) 1998 07 31  
(186) 2028 07 31  
(732) VIACOM INTERNATIONAL INC.  
1515 Broadway, New York, NY 10036, USA

(111) M 1998 10116 R2  
(156) 1998 07 31  
(186) 2028 07 31

(732) VIACOM INTERNATIONAL INC.  
1515 Broadway, New York, NY 10036, USA

(111) M 1998 10117 R2  
(156) 1998 07 31  
(186) 2028 07 31  
(732) THE GILLETTE COMPANY LLC  
One Gillette Park, Boston, Massachusetts  
02127, USA

(111) M 1998 10084 R2  
(156) 1998 07 30  
(186) 2028 07 30  
(732) LYSOFORM PHARMA GMBH & CO.  
VERWALTUNGS KG  
Kaiser-Wilhelm-Strasse 133, 12247 Berlin,  
Germany

(111) M 1998 10085 R2  
(156) 1998 07 30  
(186) 2028 07 30  
(732) Lysoform Pharma GmbH & Co. Verwaltungs KG  
Kaiser-Wilhelm-Strasse 133, 12247 Berlin,  
Germany

(111) M 1998 10166 R2  
(156) 1998 08 05  
(186) 2028 08 05  
(732) ELI LILLY AND COMPANY  
Lilly Corporate Center, City of Indianapolis,  
State of Indiana 46285, USA

(111) M 1998 10606 R2  
(156) 1998 08 27  
(186) 2028 08 27  
(732) JCB CO., LTD  
5-1-22 Minami Aoyama, Minato-ku, Tokyo,  
Japan

(111) M 1998 10237 R2  
(156) 1998 08 06  
(186) 2028 08 06  
(732) OLYMPUS CORPORATION  
2951 Ishikawa-machi, Hachioji-shi, Tokyo, Japan

(111) M 1998 10060 R2  
(156) 1998 07 14  
(186) 2028 07 14  
(732) LANCOME PARFUMS ET BEAUTE &  
CIE, societe en nom collectif  
29, Rue deu Faubourg, Saint-Honore,  
75008 Paris, France

(111) M 1998 10623 R2  
(156) 1998 08 27  
(186) 2028 08 27  
(732) LYSOFORM PHARMA GMBH & CO.  
VERWALTUNGS KG  
Kaiser-Wilhelm-Strasse 133, 12247 Berlin,  
Germany

---

(111) M 1998 10624 R2  
(156) 1998 08 27  
(186) 2028 08 27  
(732) LYSOFORM PHARMA GMBH & CO.  
VERWALTUNGS KG  
Kaiser-Wilhelm-Strasse 133, 12247 Berlin,  
Germany

---

(111) M 1998 10625 R2  
(156) 1998 08 27  
(186) 2028 08 27  
(732) LYSOFORM PHARMA GMBH &  
CO. VERWALTUNGS KG  
Kaiser-Wilhelm-Strasse 133, 12247 Berlin,  
Germany

---

(111) M 1998 10627 R2  
(156) 1998 08 27  
(186) 2028 08 27  
(732) LYSOFORM PHARMA GMBH & CO.  
VERWALTUNGS KG  
Kaiser-Wilhelm-Strasse 133, 12247 Berlin,  
Germany

---

(111) M 1998 10839 R2  
(156) 1998 09 22  
(186) 2028 09 22  
(732) ABBOTT LABORATORIES  
Abbott Park, Illinois 60064, USA

---

(111) M 1998 10557 R2  
(156) 1998 08 26  
(186) 2028 08 26  
(732) BIOPHARMA  
50, rue Carnot, 92284 Suresnes cedex, France

---

(111) M 1998 10558 R2  
(156) 1998 08 26  
(186) 2028 08 26  
(732) BIOPHARMA  
50, rue Carnot, 92284 Suresnes cedex, France

---

(111) M 1998 10559 R2  
(156) 1998 08 26  
(186) 2028 08 26

(732) BIOPHARMA  
50, rue Carnot, 92284 Suresnes cedex,  
France

---

(111) M 1998 10709 R2  
(156) 1998 09 10  
(186) 2028 09 10  
(732) DAMA S.P.A.  
Via Piemonte 174, I-21100 Varese, Italy

---

(111) M 1998 10714 R2  
(156) 1998 09 10  
(186) 2028 09 10  
(732) ABBOTT LABORATORIES  
Abbott Park, Illinois 60064, USA

---

(111) M 1998 11047 R2  
(156) 1998 10 30  
(186) 2028 10 30  
(732) SHERATON INTERNATIONAL IP LLC  
One StarPoint, Stamford, Connecticut  
06902, USA

---

(111) M 1998 11048 R2  
(156) 1998 10 30  
(186) 2028 10 30  
(732) SHERATON INTERNATIONAL IP LLC  
One StarPoint, Stamford, Connecticut 06902,  
USA

---

(111) M 1998 11346 R2  
(156) 1998 12 18  
(186) 2028 12 18  
(732) ABBOTT LABORATORIES  
Abbott Park, Illinois 60064, USA

---

(111) M 1998 11218 R2  
(156) 1998 12 09  
(186) 2028 12 09  
(732) Pfizer Manufacturing Deutschland GmbH  
Heinrich-Mack-Strasse, 35 D-89257  
Illertissen, Germany

---

(111) M 1999 12294 R2  
(156) 1999 05 24  
(186) 2029 05 24  
(732) STATE OF ART B.V.  
Westermanstraat 1, 7131 EH  
LIGHTENVOORDE, Netherlands

---

(111) M 1999 12295 R2  
 (156) 1999 05 24  
 (186) 2029 05 24  
 (732) STATE OF ART B.V.  
 Westermanstraat 1, 7131 EH  
 LIGHTENVOORDE, Netherlands

---

(111) M 1998 10037 R2  
 (156) 1998 07 09  
 (186) 2028 07 09  
 (732) SANDOZ GMBH  
 Biochemiestrasse 10, 6250 Kundl, Austria

---

(111) M 2007 18103 R1  
 (156) 2007 12 14  
 (186) 2027 12 14  
 (732) S&NF IIMITED  
 3-4 Broadway Park, South Gyle Broaddway,  
 Edinburgh, EH12 9JZ, United Kingdom

---

(111) M 2008 18762 R1  
 (156) 2008 10 16  
 (186) 2028 10 16  
 (732) "NOBEL ILAC SANAYII VE TICARET  
 ANONIM SIRKETI" Representative in  
 Georgia  
 Tavisuplebis moedani 4, Tbilisi, 0105, Georgia

---

(111) M 2008 18763 R1  
 (156) 2008 10 16  
 (186) 2028 10 16  
 (732) "NOBEL ILAC SANAYII VE TICARET  
 ANONIM SIRKETI" Representative in  
 Georgia  
 Tavisuplebis moedani 4, Tbilisi, 0105, Georgia

---

(111) M 2007 18119 R1  
 (156) 2007 12 14  
 (186) 2027 12 14  
 (732) CHECKPOINT SYSTEMS, INC.  
 a Pennsylvania corporation  
 101 Wolf Drive, P.O. Box. 188, Thorofare,  
 New Jersey 08086, USA

---

(111) M 2008 18819 R1  
 (156) 2008 11 03  
 (186) 2028 11 03  
 (732) Pharmaceutical Chemical Cosmetic Industry-  
 ALKALOID AD, Skopje  
 Bulevar Aleksandar Makedonski No.12,  
 MK-1000 Skopje, Macedonia (the former  
 Yugoslav Republic of)

(111) M 2008 18439 R1  
 (156) 2008 05 16  
 (186) 2028 05 16  
 (732) CJSC "DOMINANTA SERVICE"  
 Ul. Komsomolskaya, dom 1, Podolsk,  
 Moskovskaya Oblast, 142100, Russian  
 Federation

---

(111) M 2008 18440 R1  
 (156) 2008 05 16  
 (186) 2028 05 16  
 (732) CJSC "DOMINANTA SERVICE"  
 Ul. Komsomolskaya, dom 1, Podolsk,  
 Moskovskaya Oblast, 142100, Russian  
 Federation

---

(111) M 2008 18441 R1  
 (156) 2008 05 16  
 (186) 2028 05 16  
 (732) CJSC "DOMINANTA SERVICE"  
 Ul. Komsomolskaya, dom 1, Podolsk,  
 Moskovskaya Oblast, 142100, Russian  
 Federation

---

(111) M 2008 18442 R1  
 (156) 2008 05 16  
 (186) 2028 05 16  
 (732) CJSC "DOMINANTA SERVICE"  
 Ul. Komsomolskaya, dom 1, Podolsk,  
 Moskovskaya Oblast, 142100, Russian  
 Federation

---

(111) M 2008 18443 R1  
 (156) 2008 05 16  
 (186) 2028 05 16  
 (732) CJSC "DOMINANTA SERVICE"  
 Ul. Komsomolskaya, dom 1, Podolsk,  
 Moskovskaya Oblast, 142100, Russian  
 Federation

---

(111) M 2008 18535 R1  
 (156) 2008 06 16  
 (186) 2028 06 16  
 (732) LG CORP.  
 20, Yoido-dong, Yongdungpo-gu, Seoul,  
 Republic of Korea

---

(111) M 2008 18536 R1  
 (156) 2008 06 16  
 (186) 2028 06 16  
 (732) LG CORP.  
 20, Yoido-dong, Yongdungpo-gu, Seoul,  
 Republic of Korea

---

(111) M 2008 18595 R1 (156) 2008 07 11 (186) 2028 07 11 (732) LTD "Georgian Wines and Spirits Company" Sop. Achinebuli, Telavi, 2200 , Georgia	22, Avenue Arristide Briand, 94110 Arcueil, France
(111) M 2008 18503 R1 (156) 2008 05 27 (186) 2028 05 27 (732) ULTIMATE NUTRITION, INC. 21 Hyde Road, Farmington, Connecticut, 06032, USA	(111) M 2008 18741 R1 (156) 2008 09 26 (186) 2028 09 26 (732) NOVARTIS CONSUMER HEALTH S.A. Route de L'Etlaz, 1197 Prangins, Switzerland
(111) M 1998 10042 R2 (156) 1998 07 09 (186) 2028 07 09 (732) SYNGENTA PARTICIPATIONS AG Schwarzwaldallee 215, 4058 Basel, Switzerland	(111) M 2008 18742 R1 (156) 2008 09 26 (186) 2028 09 26 (732) NOVARTIS CONSUMER HEALTH S.A. Route de L'Etlaz, 1197 Prangins, Switzerland
(111) M 2008 18827 R2 (156) 2008 11 03 (186) 2038 11 03 (732) LTD "PRESTIGE" Petre Sarajishvilis q. 17a, Tbilisi, Georgia	(111) M 2008 18857 R1 (156) 2008 11 03 (186) 2028 11 03 (732) SWEETYET DEVELOPMENT LIMITED Unit 1704-1706, Harbour Centre, 25 Harbour Road, Wanchai, Hong Kong
(111) M 2008 18606 R1 (156) 2008 07 11 (186) 2028 07 11 (732) NOVARTIS AG 4002 Basel, Switzerland	(111) M 2009 19205 R1 (156) 2009 04 21 (186) 2029 04 21 (732) PARIS HILTON 250 North Canon Drive, 2nd Floor, Beverly Hills, California, 90210, USA
(111) M 2008 18607 R1 (156) 2008 07 11 (186) 2028 07 11 (732) NOVARTIS AG 4002 Basel, Switzerland	(111) M 2008 18954 R1 (156) 2008 11 28 (186) 2028 11 28 (732) JSC "NOBEL ILAC SANAYII VE TICARET ANONIM SIRKETI" Representative in Georgia Tavisuplebis moedani 4, Tbilisi, 0105, Georgia
(111) M 2008 18609 R1 (156) 2008 07 11 (186) 2028 07 11 (732) COLGATE-PALMOLIVE COMPANY 300 Park Avenue, New York, N.Y. 10022, USA	(111) M 2008 18955 R1 (156) 2008 11 28 (186) 2028 11 28 (732) JSC "NOBEL ILAC SANAYII VE TICARET ANONIM SIRKETI" Representative in Georgia Tavisuplebis moedani 4, Tbilisi, 0105, Georgia
(111) M 2008 18875 R1 (156) 2008 11 17 (186) 2028 11 17 (732) laboratoire Innotech International, Societe par Actions Simplifee	(111) M 2008 18956 R1 (156) 2008 11 28 (186) 2028 11 28

---

(732) JSC "NOBEL ILAC SANAYII VE  
TICARET ANONIM SIRKETI"  
Representative in Georgia  
Tavisuplebis moedani 4, Tbilisi, 0105,  
Georgia

---

(111) M 2008 18957 R1  
(156) 2008 11 28  
(186) 2028 11 28

(732) JSC "NOBEL ILAC SANAYII VE  
TICARET ANONIM SIRKETI"  
Representative in Georgia  
Tavisuplebis moedani 4, Tbilisi, 0105,  
Georgia

---

(111) M 2008 18958 R1  
(156) 2008 11 28  
(186) 2028 11 28

(732) JSC "NOBEL ILAC SANAYII VE  
TICARET ANONIM SIRKETI"  
Representative in Georgia  
Tavisuplebis moedani 4, Tbilisi, 0105,  
Georgia

---

(111) M 2008 18959 R1  
(156) 2008 11 28  
(186) 2028 11 28

(732) JSC "NOBEL ILAC SANAYII VE  
TICARET ANONIM SIRKETI"  
Representative in Georgia  
Tavisuplebis moedani 4, Tbilisi, 0105,  
Georgia

---

(111) M 2008 18960 R1  
(156) 2008 11 28  
(186) 2028 11 28

(732) JSC "NOBEL ILAC SANAYII VE  
TICARET ANONIM SIRKETI"  
Representative in Georgia  
Tavisuplebis moedani 4, Tbilisi, 0105,  
Georgia

---

(111) M 2008 18961 R1  
(156) 2008 11 28  
(186) 2028 11 28

(732) JSC "NOBEL ILAC SANAYII VE  
TICARET ANONIM SIRKETI"  
Representative in Georgia  
Tavisuplebis moedani 4, Tbilisi, 0105,  
Georgia

---

(111) M 2008 18962 R1  
(156) 2008 11 28  
(186) 2028 11 28

(732) JSC "NOBEL ILAC SANAYII VE  
TICARET ANONIM SIRKETI"  
Representative in Georgia  
Tavisuplebis moedani 4, Tbilisi, 0105,  
Georgia

---

(111) M 1998 9279 R2  
(156) 1998 05 11  
(186) 2028 05 11

(732) VOESTALPINE AG  
Voestalpine-shtr. 1, 4020 Linci, Austria

---

(111) M 2009 20011 R1  
(156) 2009 11 18  
(186) 2029 11 18

(732) ORIENTAL & MOTOLITE MARKETING  
CORPORATION  
80-82 RAMCAR Center, Roces Avenue,  
Diliman, Quezon City, Philippines

---

(111) M 2009 20012 R1  
(156) 2009 11 18  
(186) 2029 11 18

(732) ORIENTAL & MOTOLITE MARKETING  
CORPORATION  
80-82 RAMCAR Center, Roces Avenue,  
Diliman, Quezon City, Philippines

---

(111) M 2009 20027 R1  
(156) 2009 11 18  
(186) 2029 11 18

(732) ORIENTAL & MOTOLITE MARKETING  
CORPORATION  
80-82 RAMCAR Center, Roces Avenue,  
Diliman, Quezon City, Philippines

---

(111) M 1998 10057 R2  
(156) 1998 07 14  
(186) 2028 07 14

(732) WÜRTH INTERNATIONAL AG  
Aspermonstrasse 1, 7000 Chur, Switzerland

---

(111) M 1998 9792 R2  
(156) 1998 06 22  
(186) 2028 06 22

(732) AUGUST STORCK KG  
Waldstrase 27, D-13403 Berlin, Germany

---



(111) M 1998 9727 R2  
(156) 1998 06 11  
(186) 2028 06 11  
(732) WÜRTH INTERNATIONAL AG  
Aspermonstrasse 1, 7000 Chur, Switzerland

---

(111) M 1998 10068 R2  
(156) 1998 07 30  
(186) 2028 07 30  
(732) THE GILLETTE COMPANY LLC  
One Gillette Park, Boston, Massachusetts  
02127, USA

---

(111) M 1998 10067 R2  
(156) 1998 07 30  
(186) 2028 07 30  
(732) PROCTER & GAMBLE BUSINESS  
SERVICES CANADA COMPANY  
Suite 800, 1959 Upper Water Street,  
P.O.Box 997, Halifax, Nova Scotia, B3J  
2x2, Canada

---

(111) M 1998 10304 R2  
(156) 1998 08 19  
(186) 2028 08 19  
(732) ELEKTRA ENTERTAINMENT GROUP  
INC.  
75 Rockefeller plaza, New York,  
New York 10019, USA

---

(111) M 1998 10212 R2  
(156) 1998 08 05  
(186) 2028 08 05  
(732) HAW PAR CORPORATION LIMITID  
401 Commonwealth Dreve, N03-03,  
Haw Par Texhnocentre, Singapore149598,  
Singapore

---

(111) M 1998 8318 R2  
(156) 1998 02 11  
(186) 2028 02 11  
(732) COGNIS IP MANAGEMENT GmbH  
Henkelstrasse 67, 40589 Dusseldorf,  
Germany

---

(111) M 1998 10062 R2  
(156) 1998 07 15  
(186) 2028 07 15  
(732) CRODA INTERNATIONAL PLK  
Cowick Hall, Snaith, Goole, East Yorkshire,  
DN14 9AA, United Kingdom

---

(111) M 1998 8855 R2  
(156) 1998 04 10  
(186) 2028 04 10  
(732) INTERPARFUMS S.A.  
4 Rond Point des Champs Elysee, 75008  
Paris, France

---

(111) M 1998 8854 R2  
(156) 1998 04 10  
(186) 2028 04 10  
(732) INTERPARFUMS S.A.  
4 Rond Point des Champs Elysee, 75008  
Paris, France

---

(111) M 1998 10264 R2  
(156) 1998 08 18  
(186) 2028 08 18  
(732) BACARDI & COMPANY LIMITED  
Aeulestrasse 5, 9490 Vaduz, Liechtenstein,  
Liechtenstein

---

(111) M 1998 10265 R2  
(156) 1998 08 18  
(186) 2028 08 18  
(732) BACARDI & COMPANY LIMITED  
Aeulestrasse 5, 9490 Vaduz, Liechtenstein,  
Liechtenstein

---

(111) M 1998 8741 R2  
(156) 1998 03 26  
(186) 2028 03 26  
(732) FRATELLI BRANCA DISTILLERIE S. r. L.  
Via Broletto 35, Milano,, Italy

---

(111) M 1998 8647 R2  
(156) 1998 03 12  
(186) 2028 03 12  
(732) APPLE INC.  
1 Infinite loop, Cupertino, California 95014,  
USA

---

(111) M 1997 7850 R2  
(156) 1997 12 15  
(186) 2027 12 15  
(732) EBewe PHARMA GES.M.B.H. NFG. KG  
Mondseestrase 11, A-4866 Unterach, Austria

---

(111) M 1998 8679 R2  
(156) 1998 03 19  
(186) 2028 03 19  
(732) COGNIS IP MANAGEMENT GmbH

---

Henkelstrasse 67, 40589 Dusseldorf,  
Germany

(111) M 1998 10018 R2  
(156) 1998 07 09  
(186) 2028 07 09  
(732) SANDOZ AG  
35, Lichtstrasse, CH-4002 Basel, Switzerland

(111) M 1998 10028 R2  
(156) 1998 07 09  
(186) 2028 07 09  
(732) SANTEN PHARMACEUTICAL CO., LTD.  
9-19, Shimoshinjo 3-chome, Higashiyodoga-  
wa-ku, Osaka-fu, 533-8651, Japan

(111) M 1998 10029 R2  
(156) 1998 07 09  
(186) 2028 07 09  
(732) SYNGENTA PARTICIPATIONS AG  
Schwarzwaldallee 215, 4058 Basel,  
Switzerland

(111) M 1997 7876 R2  
(156) 1997 12 16  
(186) 2027 12 16  
(732) BRASSERIE KRONENBOURG Societe par  
Actions Simplifiee  
68, route d'Oberhausbergen, F-67200  
Strasbourg, France

(111) M 1998 9743 R2  
(156) 1998 06 15  
(186) 2028 06 15  
(732) PHILLIPS 66 COMPANY  
P.O. Box 4428 Houston, Texas 77210, USA

(111) M 1998 9309 R2  
(156) 1998 05 13  
(186) 2028 05 13  
(732) SANDGATE LTD  
Hamilton, Bermuda

(111) M 1998 9315 R2  
(156) 1998 05 13  
(186) 2028 05 13  
(732) BAXTER INTERNATIONAL INC.  
One Baxster Parkway, Deerfield,  
Illinois, USA

(111) M 1998 9752 R2  
(156) 1998 06 15  
(186) 2028 06 15  
(732) BAXTER INTERNATIONAL INC.  
One Baxster Parkway, Deerfield,  
Illinois, USA

(111) M 1998 9316 R2  
(156) 1998 05 13  
(186) 2028 05 13  
(732) BAXTER INTERNATIONAL INC.  
One Baxster Parkway, Deerfield,  
Illinois, USA

(111) M 1998 9363 R2  
(156) 1998 05 19  
(186) 2028 05 19  
(732) COLGATE PALMOLIVE EUROPE SÁRL,  
A SWISS COMPANY  
13-15 Cours de Rive, 1204, Geneva,  
Switzerland

(111) M 1998 9368 R2  
(156) 1998 05 20  
(186) 2028 05 20  
(732) S.C. JOHNSON & SON, INC.  
a Wisconsin corporation  
1525 Howe Street, Racine, Wisconsin  
53403, USA

(111) M 1998 8023 R2  
(156) 1998 01 08  
(186) 2028 01 08  
(732) COGNIS IP MANAGEMENT GmbH  
Henkelstrasse 67, 40589 Dusseldorf,  
Germany

(111) M 1998 8024 R2  
(156) 1998 01 08  
(186) 2028 01 08  
(732) COGNIS IP MANAGEMENT GmbH  
Henkelstrasse 67, 40589 Dusseldorf,  
Germany

(111) M 1998 8025 R2  
(156) 1998 01 08  
(186) 2028 01 08  
(732) COGNIS IP MANAGEMENT GmbH  
Henkelstrasse 67, 40589 Dusseldorf,  
Germany

(111) M 1998 8027 R2  
 (156) 1998 01 08  
 (186) 2028 01 08  
 (732) COGNIS IP MANAGEMENT GmbH  
 Henkelstrasse 67, 40589 Dusseldorf,  
 Germany

---

(111) M 1998 8029 R2  
 (156) 1998 01 08  
 (186) 2028 01 08  
 (732) COGNIS IP MANAGEMENT GmbH  
 Henkelstrasse 67, 40589 Dusseldorf, Germany

---

(111) M 1998 8030 R2  
 (156) 1998 01 08  
 (186) 2028 01 08  
 (732) COGNIS IP MANAGEMENT GmbH  
 Henkelstrasse 67, 40589 Dusseldorf, Germany

---

(111) M 1998 10032 R2  
 (156) 1998 07 09  
 (186) 2028 07 09  
 (732) L' OREAL  
 14 Rue Royale, 75008 Paris, France

---

(111) M 1999 11750 R2  
 (156) 1999 03 18  
 (186) 2029 03 18  
 (732) VAN CLEEF & ARPELS S.A.  
 8 route de Biches, CH-1752 Villars-sur-  
 -Glane, Switzerland

---

(111) M 1998 9388 R2  
 (156) 1998 05 22  
 (186) 2028 05 22  
 (732) KONINKLIJKE PHILIPS ELECTRONICS  
 N.V.  
 1, Groenewoudseweg, Eindhoven,  
 Netherlands

---

(111) M 1998 8545 R2  
 (156) 1998 03 05  
 (186) 2028 03 05  
 (732) ASPEN GLOBAL INCORPORATED  
 GBS Plaza, Cnr. La Salette and  
 Royal Roads, Grand Bay, Mauritius

---

(111) M 1998 10292 R2  
 (156) 1998 08 19  
 (186) 2028 08 19  
 (732) BAYER CONSUMER CARE AG

Peter Merian-Strasse 84, 4002 Basel,  
 Switzerland

---

(111) M 1998 9562 R2  
 (156) 1998 06 04  
 (186) 2028 06 04  
 (732) NOVARTIS AG  
 4002 Basel, Switzerland

---

(111) M 1998 9661 R2  
 (156) 1998 06 09  
 (186) 2028 06 09  
 (732) OMS INVESTMENTS, INC.  
 1105 North Market Street, Wilmington,  
 Delaware 19899, USA

---

(111) M 1998 9672 R2  
 (156) 1998 06 09  
 (186) 2028 06 09  
 (732) HERCULES INCORPORATED  
 Hercules Plaza, Wilmington, DE 19894,  
 USA

---

(111) M 1998 10206 R2  
 (156) 1998 08 05  
 (186) 2028 08 05  
 (732) FRANKE TECHNOLOGY AND  
 TRADEMARK LTD  
 Sonnenbergstrasse 9, CH-6052 Hergiswil,  
 Switzerland

---

(111) M 1998 10387 R2  
 (156) 1998 08 20  
 (186) 2028 08 20  
 (732) INTERNATIONAL BUSINESS  
 MACHINES CORPORATION  
 Armonk New York 10504, USA

---

---

**COMPLETE TRANSFER OF RIGHTS**

(111) M 1999 12524 R  
(732) CRODA INTERNATIONAL PLK  
Cowick Hall, Snaith, Goole, East Yorkshire,  
DN14 9AA, United Kingdom  
(770) UNIQEMA B.V.  
1, Buurtje, NL-2802 BE Gouda, Netherlands  
(580) 2018 05 02

---

(111) M 1998 10274 R  
(732) KRODA INTERNESHENEL PLK  
Cowick Hall, Snaith, Goole, East Yorkshire,  
DN14 9AA, United Kingdom  
(770) UNIQEMA B.V.  
1, Buurtje, NL-2802 BE Gouda, Netherlands  
(580) 2018 05 02

---

(111) M 2009 19079 R  
(732) MAMUKA AKHVLEDIANI  
Nutsubidzis Perdobi, V Mkr., korp. 2,  
b. 2, 0183, Tbilisi, Georgia  
(770) MARIETA AKHVLEDIANI  
Sulkhan-Sabas Gamz. 49, b. 21, Kutaisi,  
Georgia  
(580) 2018 06 05

---

(111) M 2009 19080 R  
(732) MAMUKA AKHVLEDIANI  
Nutsubidzis Perdobi, V Mkr., korp. 2,  
b. 2, 0183, Tbilisi, Georgia  
(770) MARIETA AKHVLEDIANI  
Sulkhan-Sabas Gamz. 49, b. 21, Kutaisi,  
Georgia  
(580) 2018 06 05

---

(111) M 1998 10062 R  
(732) CRODA INTERNATIONAL PLK  
Cowick Hall, Snaith, Goole, East Yorkshire,  
DN14 9AA, United Kingdom  
(770) UNIQEMA B.V.  
1, Buurtje, NL-2802 BE Gouda, Netherlands  
(580) 2018 05 02

---

(111) M 1998 10272 R  
(732) CRODA INTERNATIONAL PLK  
Cowick Hall, Snaith, Goole, East Yorkshire,  
DN14 9AA, United Kingdom  
(770) UNIQEMA B.V.  
1, Buurtje, NL-2802 BE Gouda, Netherlands  
(580) 2018 05 02

---

(111) M 1998 10273 R  
(732) CRODA INTERNATIONAL PLK  
Cowick Hall, Snaith, Goole, East Yorkshire,  
DN14 9AA, United Kingdom  
(770) UNIQEMA B.V.  
1, Buurtje, NL-2802 BE Gouda, Netherlands  
(580) 2018 05 02

---

## CHANGES IN NAMES AND/OR ADDRESSES OF OWNERS

(111) M 1998 9701 R  
(732) NOVARTIS INTERNATIONAL  
PHARMACEUTICAL AG  
4002 Basel, Switzerland  
(770) NOVARTIS INTERNATIONAL  
PHARMACEUTICAL LTD.  
P.O.Box HM 2899, Hamilton HM LX,  
Bermuda  
(580) 2018 06 14

---

(111) M 1998 9701 R  
(732) NOVARTIS INTERNATIONAL  
PHARMACEUTICAL AG  
Lichtstr. 35, 4056 Basel, Switzerland  
(770) NOVARTIS INTERNATIONAL  
PHARMACEUTICAL LTD.  
P.O.Box HM 2899, Hamilton HM LX,  
Bermuda  
(580) 2018 06 14

---

(111) M 1998 9573 R  
(732) ESSITY HYGIENE AND HEALTH  
AKTIEBOLAG  
SE-40503 Göteborg, Sweden  
(770) SCA HYGIENE PRODUCTS  
AKTIEBOLAG  
40503 Goteberg, Harryda, Sweden  
(580) 2018 05 23

---

(111) M 1998 9146 R  
(732) DEUTSCHE TELEKOM AG  
Friedrich-Ebert-Allee 140, 53113 Bonn,  
Germany  
(770) DEUTSCHE TELEKOM AG  
Godesberger Allee 117, 53175 Bonn,  
Germany  
(580) 2018 05 04

---

(111) M 1998 9149 R  
(732) DEUTSCHE TELEKOM AG  
Fridrikh-ebert-alee 140, 53113 Boni,  
Germany  
(770) DEUTSCHE TELEKOM AG  
Godesberger Allee 117, 53175 Bonn,  
Germany  
(580) 2018 05 04

---

(111) M 1998 10537 R  
(732) ESSITY HYGIENE AND HEALTH  
AKTIEBOLAG  
SE-40503 Göteborg, Sweden

(770) SCA HYGIENE PRODUCTS AB  
SE-40503 Göteborg, Sweden  
(580) 2018 05 23

---

(111) M 1998 10538 R  
(732) ESSITY HYGIENE AND HEALTH  
AKTIEBOLAG  
SE-40503 Göteborg, Sweden  
(770) SCA HYGIENE PRODUCTS AB  
SE-40503 Göteborg, Sweden  
(580) 2018 05 23

---

(111) M 1998 10540 R  
(732) ESSITY HYGIENE AND HEALTH  
AKTIEBOLAG  
SE-40503 Göteborg, Sweden  
(770) SCA HYGIENE PRODUCTS AB  
SE-40503 Göteborg, Sweden  
(580) 2018 05 23

---

(111) M 1995 711 R  
(732) ESSITY HYGIENE AND HEALTH  
AKTIEBOLAG  
SE-40503 Göteborg, Sweden  
(770) SCA HYGIENE PRODUCTS AB  
SE-40503 Göteborg, Sweden  
(580) 2018 05 23

---

(111) M 1996 2175 R  
(732) ESSITY HYGIENE AND HEALTH  
AKTIEBOLAG  
SE-40503 Göteborg, Sweden  
(770) SCA HYGIENE PRODUCTS AB  
SE-40503 Göteborg, Sweden  
(580) 2018 05 23

---

(111) M 1999 12524 R  
(732) CRODA INTERNATIONAL PLK  
Cowick Hall, Snaith, Goole, East Yorkshire,  
DN14 9AA, United Kingdom  
(770) Uniqema B.V.  
1, Buurtje, NL-2802 BE Gouda, Netherlands  
(580) 2018 05 02

---

(111) M 2009 19246 R  
(732) ESSITY HYGIENE AND HEALTH  
AKTIEBOLAG  
SE-40503 Göteborg, Sweden  
(770) SCA HYGIENE PRODUCTS AB  
SE-40503 Göteborg, Sweden

---

(580) 2018 05 23

---

(111) M 1998 10062 R  
(732) Uniqema B.V.  
1, Buurtje, NL-2802 BE Gouda, Netherlands  
(770) UNICHEMA CHEMIE B.V.  
1, Buurtje, NL-2802 BE Gouda, Netherlands  
(580) 2018 05 02

---

(111) M 1998 10272 R  
(732) CRODA INTERNATIONAL PLK  
Cowick Hall, Snaith, Goole, East Yorkshire,  
DN14 9AA, United Kingdom  
(770) UNIQEMA B.V.  
1, Buurtje, NL-2802 BE Gouda, Netherlands  
(580) 2018 05 02

---

(111) M 1998 10273 R  
(732) CRODA INTERNATIONAL PLK  
Cowick Hall, Snaith, Goole, East Yorkshire,  
DN14 9AA, United Kingdom  
(770) UNIQEMA B.V.  
1, Buurtje, NL-2802 BE Gouda, Netherlands  
(580) 2018 05 02

---

(111) M 1998 10274 R  
(732) CRODA INTERNATIONAL PLK  
Cowick Hall, Snaith, Goole, East Yorkshire,  
DN14 9AA, United Kingdom  
(770) UNIQEMA B.V.  
1, Buurtje, NL-2802 BE Gouda, Netherlands  
(580) 2018 05 02

---

(111) M 2014 25280 R  
(732) MANN+HUMMEL FT Poland Spółka z  
ograniczoną odpowiedzialnością Sp. k.  
ul. Wroclawska 145, 63-800 Gostyn, Poland  
(770) MANN+HUMMEL Filtration Technology  
Poland sp. z.o.o.  
ul. Wroclawska 145, 63-800 Gostyn, Poland  
(580) 2018 05 02

---

(111) M 2014 25280 R  
(732) MANN+HUMMEL FT Poland Spółka z  
ograniczoną odpowiedzialnością Sp. k.  
ul. Wroclawska 145, 63-800 Gostyn, Poland  
(770) MANN+HUMMEL Filtration Technology  
Poland sp. z.o.o.  
ul. Wroclawska 145, 63-800 Gostyn, Poland  
(580) 2018 05 02

---

(111) M 1999 11750 R  
(732) VAN CLEEF & ARPELS S.A.  
8 route de Biches, CH-1752 Villars-sur-  
Glance, Switzerland  
(770) VAN CLEEF & ARPELS S.A.  
8 route de Chandolan, CH-1752 Villars-sur-  
Glance, Switzerland  
(580) 2018 05 24

---

(111) M 1998 9563 R  
(732) HOMMEL-ETAMIC FRANCE SA  
Saint Martin Des Entrees-14400 Bayeux,  
France  
(770) ETAMIC SA  
Saint Martin Des Entrees-14400 Bayeux,  
France, France  
(580) 2018 06 05

---

## INVALIDATION OF TRADEMARKS REGISTRATION

(111) M 2011 22006 R

(151) 2011 11 30

(181) 2022 05 30

(732) UNIPHARM, INC.

350 Fifth Avenue, Suite 6701,  
New York, N.Y. 10118, USA

---

---

# CLASSIFICATION INDEXES

## INVENTIONS

### CONCORDANCE TABLE OF INTERNATIONAL CLASSIFICATION INDEX AND PUBLICATION NUMBERS

INTERNATIONAL CLASSIFICATION INDEXES (51)	NUMBER OF PUBLISHED APPLICATION (10)
A 61 B 17/32; A 61 B 17/3207	AP 2018 14479 A
A 61 N 2/00; A 61 N 2/02	AP 2018 14256 A
B 01 D 24/28	AP 2018 14632 A
B 23 K 20/04; B 22 D 11/06	AP 2018 14366 A
C 07 C 235/52; C 07 D 213/81; C 07 D 239/34; A 61 K 31/44; A 61 K 31/505; A 61 P 9/10; A 61 P 29/00	AP 2018 14093 A
C 07 D 401/04; C 07 D 277/82; C 07 D 263/58; A 61 K 31/428; A 61 P 25/18	AP 2018 14272 A
C 07 D 401/14; A 61 K 31/454; A 61 P 29/02; A 61 P 37/08	AP 2018 14455 A
C 07 D 213/74; C 07 D 239/42; C 07 D 249/06; C 07 D 271/07; C 07 D 231/12; A 61 K 31/44; A 61 K 31/506; A 61 P 25/18	AP 2018 14273 A
C 07 K 16/28; A 61 K 39/395; A 61 P 35/02; A 61 P 37/00	AP 2018 13496 A

### CONCORDANCE TABLE OF PUBLICATION NUMBERS AND INTERNATIONAL CLASSIFICATION INDEX

NUMBER OF PUBLISHED APPLICATION (10)	INTERNATIONAL CLASSIFICATION INDEXES (51)
AP 2018 13496 A	C 07 K 16/28; A 61 K 39/395; A 61 P 35/02; A 61 P 37/00
AP 2018 14093 A	C 07 C 235/52; C 07 D 213/81; C 07 D 239/34; A 61 K 31/44; A 61 K 31/505; A 61 P 9/10; A 61 P 29/00
AP 2018 14256 A	A 61 N 2/00; A 61 N 2/02
AP 2018 14272 A	C 07 D 401/04; C 07 D 277/82; C 07 D 263/58; A 61 K 31/428; A 61 P 25/18
AP 2018 14273 A	C 07 D 213/74; C 07 D 239/42; C 07 D 249/06; C 07 D 271/07; C 07 D 231/12; A 61 K 31/44; A 61 K 31/506; A 61 P 25/18
AP 2018 14366 A	B 23 K 20/04; B 22 D 11/06
AP 2018 14455 A	C 07 D 401/14; A 61 K 31/454; A 61 P 29/02; A 61 P 37/08
AP 2018 14479 A	A 61 B 17/32; A 61 B 17/3207
AP 2018 14632 A	B 01 D 24/28



**CONCORDANCE TABLE OF INTERNATIONAL CLASSIFICATION INDEX,  
PATENT NUMBERS AND PUBLICATION NUMBERS**

INTERNATIONAL CLASSIFICATION INDEX (51)	NUMBER OF PATENT (11)	NUMBER OF PUBLISHED APPLICATION (10)
A 61 K 36/537; A 61 K 36/258; A 61 K 31/343; A 61 K 31/192; A 61 K 31/11; A 61 K 31/045; A 61 K 9/20; A 61 K 9/10	P 2018 6877 B	AP 2018 14057 A
C 07 D 401/14, 413/14; A 61 K 31/454, 31/497, 31/506, 31/519, 31/5355; C 07 D 401/04, 407/14, 413/04, 417/14, 471/04, 487/04; A 61 P 29/02, 37/08	P 2018 6876 B	AP 2018 14046 A
C 07 D 403/06; A 61 K 31/506; A 61 K 31/7072; A 61 P 35/00; A 61 P 43/00;	P 2018 6875 B	AP 2018 14034 A
C 07 D 417/08; A 61 K 31/433; A 61 P 35/00	P 2018 6879 B	AP 2018 14314 A
C 07 D 473/16; C 07 D 473/18; C 07 D 519/00; A 61 K 31/522; A 61 P 35/00	P 2018 6878 B	AP 2018 14151 A

**CONCORDANCE TABLE OF PATENT NUMBERS,  
PUBLICATION NUMBERS AND INTERNATIONAL CLASSIFICATION INDEX**

NUMBER OF PATENT (11)	NUMBER OF PUBLISHED APPLICATION (10)	INTERNATIONAL CLASSIFICATION INDEX (51)
P 2018 6875 B	AP 2018 14034 A	C 07 D 403/06; A 61 K 31/506; A 61 K 31/7072; A 61 P 35/00; A 61 P 43/00;
P 2018 6876 B	AP 2018 14046 A	C 07 D 401/14, 413/14; A 61 K 31/454, 31/497, 31/506, 31/519, 31/5355; C 07 D 401/04, 407/14, 413/04, 417/14, 471/04, 487/04; A 61 P 29/02, 37/08
P 2018 6877 B	AP 2018 14057 A	A 61 K 36/537; A 61 K 36/258; A 61 K 31/343; A 61 K 31/192; A 61 K 31/11; A 61 K 31/045; A 61 K 9/20; A 61 K 9/10
P 2018 6878 B	AP 2018 14151 A	C 07 D 473/16; C 07 D 473/18; C 07 D 519/00; A 61 K 31/522; A 61 P 35/00
P 2018 6879 B	AP 2018 14314 A	C 07 D 417/08; A 61 K 31/433; A 61 P 35/00

**CONCORDANCE TABLE OF APPLICATION NUMBERS, PUBLICATION NUMBERS  
AND PATENTS**

NUMBER OF APPLICATION (21)	NUMBER OF PUBLISHED APPLICATION (10)	NUMBER OF PATENT (11)
AP 2014 014034	AP 2018 14034 A	P 2018 6875 B
AP 2014 014046	AP 2018 14046 A	P 2018 6876 B
AP 2014 014057	AP 2018 14057 A	P 2018 6877 B
AP 2014 014151	AP 2018 14151 A	P 2018 6878 B
AP 2015 014314	AP 2018 14314 A	P 2018 6879 B

**UTILITY MODEL****CONCORDANCE TABLE OF INTERNATIONAL CLASSIFICATION INDEX  
AND PUBLICATION NUMBERS**

INTERNATIONAL CLASSIFICATION INDEXES (51)	NUMBER OF PUBLISHED APPLICATION (10)
A 61 K 35/76	AU 2018 14570 U

**CONCORDANCE TABLE OF PUBLICATION NUMBERS  
AND INTERNATIONAL CLASSIFICATION INDEX**

NUMBER OF PUBLISHED APPLICATION (10)	INTERNATIONAL CLASSIFICATION INDEXES (51)
AU 2018 14570 U	A 61 K 35/76

**CONCORDANCE TABLE OF INTERNATIONAL CLASSIFICATION INDEX,  
PATENT NUMBERS AND PUBLICATION NUMBERS**

INTERNATIONAL CLASSIFICATION INDEX (51)	NUMBER OF PATENT (11)	NUMBER OF PUBLISHED APPLICATION (10)
E 04 B 5/00	U 2018 1971 Y	AU 2018 14331 U

**CONCORDANCE TABLE OF PATENT NUMBERS,  
PUBLICATION NUMBERS AND INTERNATIONAL CLASSIFICATION INDEX**

NUMBER OF PATENT (11)	NUMBER OF PUBLISHED APPLICATION (10)	INTERNATIONAL CLASSIFICATION INDEX (51)
U 2018 1971 Y	AU 2018 14331 U	E 04 B 5/00

**CONCORDANCE TABLE OF APPLICATION NUMBERS, PUBLICATION NUMBERS  
AND PATENTS**

NUMBER OF APPLICATION (21)	NUMBER OF PUBLISHED APPLICATION (10)	NUMBER OF PATENT (11)
AU 2016 014331	AU 2018 14331 U	U 2018 1971 Y

## DESIGNS

### CONCORDANCE TABLE OF INTERNATIONAL CLASSIFICATION INDEX AND PUBLICATION NUMBERS

INTERNATIONAL CLASSIFICATION INDEXES (51)	NUMBER OF PUBLISHED APPLICATION (10)
19-08	AD 2018 1027 S

### CONCORDANCE TABLE OF PUBLICATION NUMBERS AND INTERNATIONAL CLASSIFICATION INDEX

NUMBER OF PUBLISHED APPLICATION (10)	INTERNATIONAL CLASSIFICATION INDEXES (51)
AD 2018 1027 S	19-08

## TRADEMARKS

### CONCORDANCE TABLE OF REGISTRATION NUMBERS, APPLICATION NUMBERS, PUBLICATION NUMBERS AND BULLETIN NUMBERS

NUMBER OF REGISTRATION (111)	NUMBER OF APPLICATIONS (210)	NUMBER OF PUBLISHED APPLICATIONS (260)	NUMBER OF BULLETIN
M 2018 29835 R	AM 97680	–	13(497)2018
M 2018 29836 R	AM 97988	–	13(497)2018
M 2018 29837 R	AM 97981	–	13(497)2018
M 2018 29838 R	AM 97892	–	13(497)2018
M 2018 29839 R	AM 98165	–	13(497)2018
M 2018 29840 R	AM 98175	–	13(497)2018
M 2018 29841 R	AM 97903	–	13(497)2018
M 2018 29842 R	AM 98159	–	13(497)2018
M 2018 29843 R	AM 98197	–	13(497)2018
M 2018 29844 R	AM 98193	–	13(497)2018
M 2018 29845 R	AM 98196	–	13(497)2018
M 2018 29846 R	AM 98191	–	13(497)2018
M 2018 29847 R	AM 98179	–	13(497)2018
M 2018 29848 R	AM 98008	–	13(497)2018
M 2018 29849 R	AM 98009	–	13(497)2018
M 2018 29850 R	AM 97977	–	13(497)2018
M 2018 29851 R	AM 97997	–	13(497)2018
M 2018 29852 R	AM 89788	AM 2018 89788 A	3(487)2018
M 2018 29853 R	AM 90678	AM 2018 90678 A	3(487)2018
M 2018 29854 R	AM 91088	AM 2018 91088 A	5(489)2018
M 2018 29855 R	AM 91382	AM 2018 91382 A	4(488)2018
M 2018 29856 R	AM 91535	AM 2018 91535 A	1(485)2018
M 2018 29857 R	AM 91556	AM 2017 91556 A	23(483)2017
M 2018 29858 R	AM 91667	AM 2018 91667 A	1(485)2018
M 2018 29859 R	AM 91721	AM 2017 91721 A	23(483)2017
M 2018 29860 R	AM 91736	AM 2017 91736 A	23(483)2017
M 2018 29861 R	AM 91757	AM 2018 91757 A	1(485)2018
M 2018 29862 R	AM 91759	AM 2018 91759 A	1(485)2018
M 2018 29863 R	AM 91802	AM 2017 91802 A	23(483)2017
M 2018 29864 R	AM 91813	AM 2017 91813 A	23(483)2017
M 2018 29865 R	AM 91814	AM 2017 91814 A	23(483)2017
M 2018 29866 R	AM 91955	AM 2018 91955 A	1(485)2018
M 2018 29867 R	AM 91958	AM 2018 91958 A	1(485)2018
M 2018 29868 R	AM 91959	AM 2017 91959 A	24(484)2017
M 2018 29869 R	AM 91978	AM 2018 91978 A	1(485)2018
M 2018 29870 R	AM 91986	AM 2018 91986 A	1(485)2018
M 2018 29871 R	AM 91989	AM 2018 91989 A	1(485)2018
M 2018 29872 R	AM 92025	AM 2018 92025 A	1(485)2018
M 2018 29873 R	AM 92026	AM 2018 92026 A	1(485)2018
M 2018 29874 R	AM 92128	AM 2018 92128 A	5(489)2018
M 2018 29875 R	AM 92184	AM 2018 92184 A	5(489)2018
M 2018 29876 R	AM 92215	AM 2017 92215 A	21(481)2017
M 2018 29877 R	AM 92359	AM 2018 92359 A	1(485)2018
M 2018 29878 R	AM 92493	AM 2018 92493 A	4(488)2018
M 2018 29879 R	AM 92550	AM 2018 92550 A	5(489)2018
AM 2018 29880 R	AM 92559	AM 2018 92559 A	5(489)2018

1	2	3	4
AM 2018 29881 R	AM 92561	AM 2018 92561 A	5(489)2018
AM 2018 29882 R	AM 92563	AM 2018 92563 A	5(489)2018
AM 2018 29883 R	AM 92581	AM 2018 92581 A	5(489)2018
AM 2018 29884 R	AM 92583	AM 2018 92583 A	5(489)2018
AM 2018 29885 R	AM 92738	AM 2018 92738 A	5(489)2018
AM 2018 29886 R	AM 92745	AM 2018 92745 A	4(488)2018
AM 2018 29887 R	AM 92753	AM 2018 92753 A	4(488)2018
AM 2018 29888 R	AM 92864	AM 2018 92864 A	5(489)2018
AM 2018 29889 R	AM 92886	AM 2018 92886 A	3(487)2018
AM 2018 29890 R	AM 93060	AM 2018 93060 A	3(487)2018
AM 2018 29891 R	AM 93245	AM 2018 93245 A	4(488)2018
AM 2018 29892 R	AM 93272	AM 2018 93272 A	5(489)2018
AM 2018 29893 R	AM 93296	AM 2018 93296 A	4(488)2018
AM 2018 29894 R	AM 93429	AM 2018 93429 A	5(489)2018
M 2018 29895 R	AM 98150	–	13(497)2018
M 2018 29896 R	AM 98176	–	13(497)2018
M 2018 29897 R	AM 98170	–	13(497)2018

**CONCORDANCE TABLE OF PUBLICATION NUMBERS  
AND APPLICATION NUMBERS**

NUMBER OF PUBLISHED APPLICATION (260)	NUMBER OF APPLICATION (210)	1	2
		1	2
AM 2018 90032 A	AM 90032	AM 2018 94984 A	AM 94984
AM 2018 92585 A	AM 92585	AM 2018 94985 A	AM 94985
AM 2018 92797 A	AM 92797	AM 2018 94986 A	AM 94986
AM 2018 94010 A	AM 94010	AM 2018 94987 A	AM 94987
AM 2018 94018 A	AM 94018	AM 2018 95006 A	AM 95006
AM 2018 94019 A	AM 94019	AM 2018 95009 A	AM 95009
AM 2018 94402 A	AM 94402	AM 2018 95011 A	AM 95011
AM 2018 94433 A	AM 94433	AM 2018 95020 A	AM 95020
AM 2018 94561 A	AM 94561	AM 2018 95026 A	AM 95026
AM 2018 94578 A	AM 94578	AM 2018 95027 A	AM 95027
AM 2018 94579 A	AM 94579	AM 2018 95031 A	AM 95031
AM 2018 94580 A	AM 94580	AM 2018 95033 A	AM 95033
AM 2018 94583 A	AM 94583	AM 2018 95039 A	AM 95039
AM 2018 94612 A	AM 94612	AM 2018 95052 A	AM 95052
AM 2018 94613 A	AM 94613	AM 2018 95053 A	AM 95053
AM 2018 94622 A	AM 94622	AM 2018 95054 A	AM 95054
AM 2018 94658 A	AM 94658	AM 2018 95054 A	AM 95054
AM 2018 94671 A	AM 94671	AM 2018 95065 A	AM 95065
AM 2018 94741 A	AM 94741	AM 2018 95066 A	AM 95066
AM 2018 94760 A	AM 94760	AM 2018 95119 A	AM 95119
AM 2018 94833 A	AM 94833	AM 2018 95148 A	AM 95148
AM 2018 94865 A	AM 94865	AM 2018 95183 A	AM 95183
AM 2018 94873 A	AM 94873	AM 2018 95184 A	AM 95184
AM 2018 94889 A	AM 94889	AM 2018 95210 A	AM 95210
AM 2018 94926 A	AM 94926	AM 2018 95211 A	AM 95211
AM 2018 94956 A	AM 94956	AM 2018 95212 A	AM 95212
		AM 2018 95213 A	AM 95213
		AM 2018 95238 A	AM 95238
		AM 2018 95259 A	AM 95259
		AM 2018 95317 A	AM 95317
		AM 2018 95320 A	AM 95320
		AM 2018 95339 A	AM 95339

1	2
AM 2018 95340 A	AM 95340
AM 2018 95346 A	AM 95346
AM 2018 95347 A	AM 95347
AM 2018 95348 A	AM 95348
AM 2018 95349 A	AM 95349
AM 2018 95350 A	AM 95350
AM 2018 95352 A	AM 95352
AM 2018 95356 A	AM 95356

1	2
AM 2018 95365 A	AM 95365
AM 2018 95370 A	AM 95370
AM 2018 95396 A	AM 95396
AM 2018 95554 A	AM 95554
AM 2018 95606 A	AM 95606
AM 2018 95663 A	AM 95663
AM 2018 95664 A	AM 95664
AM 2018 95695 A	AM 95695

**CONCORDANCE TABLE OF INDEX OF GOODS AND/OR SERVICES  
AND APPLICATION NUMBERS**

INDEX OF GOODS AND/OR SERVICES (511)	NUMBER OF PUBLISHED APPLICATIONS (26)
1	2
1	AM 2018 92797 A
1	AM 2018 94010 A
3	AM 2018 94010 A
3	AM 2018 94760 A
4	AM 2018 95695 A
5	AM 2018 92797 A
5	AM 2018 94671 A
5	AM 2018 94760 A
5	AM 2018 94926 A
5	AM 2018 95011 A
5	AM 2018 95066 A
5	AM 2018 95210 A
5	AM 2018 95213 A
5	AM 2018 95346 A
5	AM 2018 95347 A
5	AM 2018 95348 A
5	AM 2018 95349 A
5	AM 2018 95350 A
5	AM 2018 95352 A
5	AM 2018 95663 A
5	AM 2018 95664 A
7	AM 2018 95370 A
7	AM 2018 95606 A
8	AM 2018 95396 A
8	AM 2018 95606 A
9	AM 2018 94956 A
9	AM 2018 95211 A
9	AM 2018 95212 A
9	AM 2018 95259 A
9	AM 2018 95320 A
10	AM 2018 95011 A
11	AM 2018 95365 A
14	AM 2018 94741 A
16	AM 2018 94010 A
16	AM 2018 94741 A
16	AM 2018 94865 A
18	AM 2018 94741 A

1	2
19	AM 2018 95031 A
19	AM 2018 95033 A
25	AM 2018 95026 A
25	AM 2018 95027 A
29	AM 2018 94561 A
29	AM 2018 95020 A
29	AM 2018 95052 A
29	AM 2018 95053 A
30	AM 2018 94402 A
30	AM 2018 94561 A
30	AM 2018 94612 A
30	AM 2018 94613 A
30	AM 2018 94622 A
30	AM 2018 94658 A
30	AM 2018 94984 A
30	AM 2018 94985 A
30	AM 2018 94986 A
30	AM 2018 94987 A
30	AM 2018 95065 A
32	AM 2018 94561 A
32	AM 2018 94873 A
32	AM 2018 95052 A
32	AM 2018 95053 A
32	AM 2018 95054 A
32	AM 2018 95183 A
32	AM 2018 95184 A
33	AM 2018 94833 A
33	AM 2018 95006 A
33	AM 2018 95009 A
33	AM 2018 95039 A
33	AM 2018 95148 A
33	AM 2018 95317 A
33	AM 2018 95356 A
34	AM 2018 94018 A
34	AM 2018 94019 A
34	AM 2018 94578 A
34	AM 2018 94579 A
34	AM 2018 94580 A
34	AM 2018 95339 A
34	AM 2018 95340 A
35	AM 2018 90032 A
35	AM 2018 94010 A

1	2	1	2
35	AM 2018 94561 A	39	AM 2018 94889 A
35	AM 2018 94741 A	41	AM 2018 94583 A
35	AM 2018 94873 A	41	AM 2018 95119 A
35	AM 2018 94956 A	41	AM 2018 95211 A
35	AM 2018 95026 A	41	AM 2018 95212 A
35	AM 2018 95027 A	42	AM 2018 95211 A
35	AM 2018 95119 A	42	AM 2018 95212 A
35	AM 2018 95211 A	42	AM 2018 95320 A
35	AM 2018 95212 A	43	AM 2018 94433 A
35	AM 2018 95259 A	43	AM 2018 95238 A
35	AM 2018 95320 A	43	AM 2018 95554 A
35	AM 2018 95554 A	44	AM 2018 92585 A
37	AM 2018 94741 A	44	AM 2018 95119 A
37	AM 2018 94889 A	45	AM 2018 95211 A
39	AM 2018 94010 A	45	AM 2018 95212 A
39	AM 2018 94873 A	45	AM 2018 95320 A

**CONCORDANCE TABLE OF INDEX OF GOODS AND/OR SERVICES  
AND NUMBERS OF TRADEMARKS REGISTERED ACCORDING  
TO THE ACCELERATED PROCEDURE**

INDEX OF GOODS AND/OR SERVICES (511)	NUMBERS OF REGISTERED ACCORDING TO THE ACCELERATED PROCEDURE (111)
1	2
2	M 2018 29841 R
5	M 2018 29843 R
5	M 2018 29844 R
5	M 2018 29845 R
5	M 2018 29846 R
5	M 2018 29839 R
12	M 2018 29836 R
18	M 2018 29897 R
25	M 2018 29838 R
25	M 2018 29897 R
29	M 2018 29895 R
30	M 2018 29895 R
30	M 2018 29842 R
30	M 2018 29850 R
32	M 2018 29895 R
33	M 2018 29895 R
34	M 2018 29835 R
34	M 2018 29847 R
35	M 2018 29850 R
35	M 2018 29895 R
35	M 2018 29896 R
35	M 2018 29897 R
36	M 2018 29837 R
36	M 2018 29851 R
36	M 2018 29840 R
38	M 2018 29897 R
39	M 2018 29851 R
39	M 2018 29840 R
43	M 2018 29895 R
43	M 2018 29842 R

1	2
43	M 2018 29850 R
43	M 2018 29851 R
44	M 2018 29848 R
44	M 2018 29849 R



# OFFICIAL BULLETIN OF THE INDUSTRIAL PROPERTY

INVENTIONS  
UTILITY MODELS  
DESIGNS  
TRADEMARKS

**13(497)**

EDITOR-IN-CHIEF: N. Bebrishvili

EDITOR-TRANSLATOR: E. Gabunia

PROOFREADER: A. Shikhashvili

COMPUTER LAYOUT: M. Ordenidze  
K. Svanidze

[www.sakpatenti.gov.ge](http://www.sakpatenti.gov.ge)

E-mail: [info@sakpatenti.org.ge](mailto:info@sakpatenti.org.ge)