

Official Bulletin of the Industrial Property

Inventions

Utility Models

Designs

Trademarks



საქართველოს ინტელექტუალური
საკუთრების ეროვნული ცენტრი

საქპატენტი

SAKPATENTI

NATIONAL INTELLECTUAL PROPERTY
CENTER OF GEORGIA

www.sakpatenti.gov.ge

Date of Publication – 2021 08 10

14(570)

INID CODES FOR IDENTIFICATION OF BIBLIOGRAPHIC DATA

INVENTIONS, UTILITY MODELS

- (10) Number of publication for application, which has been examined
- (11) Number of patent and kind of document
- (21) Serial number of application
- (22) Date of filing of the application
- (23) Date of exhibition or the date of the earlier filing and the number of application, if any
- (24) Date from which patent may have effect
- (31) Number of priority application
- (32) Date of filing of priority application
- (33) Code of the country or regional organization allotting priority application number
- (44) Date of publication of application not granted, but examined and number of bulletin
- (45) Date of publication of registered document
- (51) International Patent Classification Index

- (54) Title of the invention
- (57) Abstract
- (60) Number of examined patent document granted by foreign patent office, date from which patent has effect and country code
- (62) Number of the earlier application and in case of divided application, date of filing an application
- (71) Name, surname and address of applicant (country code)
- (72) Name, surname of inventor (country code)
- (73) Name, surname and address of patent owner (country code)
- (74) Name, surname of representative or patent attorney
- (85) Date of commencement of the national phase of International Application
- (86) Number and date of filing of international application
- (87) Number and date of publication of international application
- (94) Calculated date of expiry of the SPC or the duration of the SPC

DESIGNS

- (10) Number of publication for application
- (11) Number of patent and kind of document or number of registration
- (15) Date of registration/Date of patent renewal
- (18) Expected expiration date of patent or registration
- (21) Serial number of application
- (22) Date of filing of the application
- (23) Date of exhibition or the date of the earlier filing and the number of application, if any
- (24) Date from which patent may have effect
- (28) Number of designs included in the application
- (30) Data relating to priority (number of application, date of filing of application, two-letter code identifying the authority with whom the priority application was made)
- (31) Number of priority application
- (32) Date of filing of priority application
- (33) Code of the country or regional organization allotting priority application number
- (34) Two-letter code according to WIPO St.3 identifying the authority with which the priority application was made
- (44) Date of publication of design and number of bulletin (the first publication)
- (45) Date of publication of design registered by WIPO and number of bulletin

- (51) International Classification for designs (class and subclass of the Locarno Classification)
- (54) Title of the invention
- (55) Reproduction of the design
- (57) Description of characteristic features of the design including indication of colors
- (58) Date of recording of any kind of amendment in the Register
- (62) Number of the earlier application, registration and document number and if available the date of filing an application in case of divided application
- (71) Name, surname and address of applicant (country code)
- (72) Name, surname of creator (country code)
- (73) Name, surname and address of patent owner (country code)
- (74) Name, surname of representative or patent attorney
- (81) Contracting states concerned
 - II designated contracting states according to the 1960 Act
 - III designated contracting states according to the 1999 Act
- (85) Owner's permanent address
- (86) Owner's nationality
- (87) Owner's residence
- (88) State in which the owner has a real and effective industrial or commercial establishment

TRADEMARKS

- (111) - Number of registration
- (151) - Date of registration
- (156) - Date of the renewal
- (181) - Expected expiration date of registration
- (186) - Renewal expiration date of registration
- (141) - Date of cancel of duration of the mark
- (210) - Serial number of application
- (220) - Date of filing of the application
- (230) - Data concerning exhibition
- (260) - Number of application, for which favorable decision of examination about registration has been taken (publication number)
- (310) - Number of the first application
- (320) - Date of filing of the first application
- (330) - Code, identifying national or regional Office where the first application was made
- (511) - International Classification of Goods and Services for the purposes of registration of trade marks and/or list of goods and/or services classified according thereto
- (526) - Disclaimer
- (531) - Description of figurative elements of Trade Marks according to the International Classification of the Figurative Elements of Marks

- (540) - Reproduction of Trade Mark
- (550) - Nature and kind of Trade Mark
- (551) - Indication to the effect that the mark is a collective mark, a certification mark or a guarantee mark
- (554) - Three-dimensional mark
- (580) - Date of recording of any kind changes in respect of applications or registrations
- (591) - Information concerning colors claimed
- (731) - Name and address of the applicant
- (732) - Name and address of the holder of the registration
- (740) - Name and address of the representative
- (750) - Addreses for correspondence
- (770) - Name and address of the previous applicant or holder in case of change in ownership
- (771) - Previous name and address of the applicant or holder in case of change in ownership
- (791) - Name and address of the licensee
- (793) - Indication of conditions and/or restrictions under the license (Type of license, number of license agreement, data of license, data of validity of license)
- (800) - Certain data relating to the international registration of Trade Marks under the Protocol Relating to Madrid Agreement (International registration number
- (852) - Partial cancellation of the list of goods and services
- (891) - Date of subsequent designation

CODES FOR PUBLICATION IN BULLETIN

- (21) AP 0000 000000 - serial number of application for invention
- (10) AP 0000 0000 A - number of published application for invention (first publication)
- (11) P 0000 0000 B - number of patent for invention (second publication)
- (21) API 0000 000000 - number of application for imported patent
- (11) PI 0000 0000 A - number of imported patent (first publication)
- (21) AU 0000 000000 - serial number of application for utility model
- (10) AU 0000 000 U - number of published application for utility model (first publication)
- (11) U 0000 000 Y - number of patent for utility model (second publication)
- (21) AD 0000 000000 - serial number of application for design
- (10) AD 0000 000 S - number of published application for design (first publication)
- (11) D 0000 000 S - registered design

INTERNATIONAL PATENT CLASSIFICATION FOR INVENTIONS AND UTILITY MODELS

- SECTION A - HUMAN NECESSITIES
- SECTION B - PERFORMING OPERATIONS; TRANSPORTING
- SECTION C - CHEMISTRY; METALLURGY
- SECTION D - TEXTILES; PAPER
- SECTION E - FIXED CONSTRUCTIONS
- SECTION F - MECHANICAL ENGINEERING; LIGHTING; HEATING; WEAPONS; BLASTING
- SECTION G - PHYSICS
- SECTION H - ELECTRICITY

-
- M - Trade Mark
 - (210) AM 0000 000000 - Serial number of application;
 - (260) AAM 0000 00000 A - Publication number of application;
 - (111) M 0000 00000 R - Number of registration;
 - (111) MMM0000 00000 Rn - Number of renewals, in which n=1,2,3;
 - (111) M 0000 00000 R(P) - Number of registration under partial assignment of rights
-

Official Bulletin of the Industrial Property

Inventions

Utility Models

Designs

Trademarks

CONTENTS

PUBLISHED TITLES OF PROTECTION	3
INVENTIONS	
▪ APPLICATIONS APPROVED FOR GRANTING PATENTS	4
▪ PATENTED INVENTIONS	8
UTILITY MODELS	
▪ PATENTED UTILITY MODEL	11
DESIGNS	
▪ REGISTERED DESIGNS	12
▪ DESIGN REGISTERED ACCORDING TO THE ACCELERATED PROCEDURE	13
▪ DESIGNS, WICH HAVE BEEN REGISTERED WITH THE INTERNATIONAL BUREAU CLAIMING PRIORITY ON THE TERRITORY OF GEORGIA	15
TRADEMARKS	
▪ APPLICATIONS FILED UNDER THE NATIONAL PROCEDURE APPROVED FOR REGISTRATION	22
▪ TRADEMARKS REGISTERED ACCORDING TO THE ACCELERATED PROCEDURE	30
▪ INTERNATIONAL TRADEMARKS FOR WHICH A DECISION ON GRANTING PROTECTION IS TAKEN	34
▪ INTERNATIONAL TRADEMARKS PROTECTED IN GEORGIA	114
OFFICIAL NOTIFICATIONS	
INVENTIONS	
▪ EXPIRATION OF PATENT RESTORATION	120
▪ ABOLITION OF PATENTS WITH THE RIGHT TO RESTORE	120
▪ EXPIRATION OF TERM OF RESTORATION OF PATENTS	122
▪ EXPIRATION OF PATENT	123
▪ CHANGE OF NAME AND/OR ADDRESS OF PATENTOWNER	123
UTILITY MODELS	
▪ ABOLITION OF PATENTS WITH THE RIGHT TO RESTORE	124
▪ EXPIRATION OF TERM OF RESTORATION OF PATENT	124
DESIGN	
▪ CANCELLATION OF REGISTRATION OF DESIGNS	125
▪ EXTENSION OF INTERNATIONAL DESIGNS REGISTRATION	125
▪ CANCELLATION OF REGISTRATION OF INTERNATIONAL DESIGNS	128
TRADEMARKS	
▪ RENEWAL OF REGISTRATION	129
▪ COMPLET TRANSFER OF RIGHTS	132
▪ CHANGE OF NAME AND/OR ADDRESS OF OWNER	134
▪ CANCELLATION OF TRADEMARKS REGISTRATION	134
CLASSIFICATION INDEXES	
INVENTIONS	136
UTILITY MODEL	138
DESIGNS	139
TRADEMARKS	141

PUBLISHED TITLES OF PROTECTION

INVENTIONS

- **APPLICATIONS APPROVED FOR GRANTING PATENT:**
15471; 15514; 15367; 15281; 15340; 15045; 15251; 14828; 14161; 15403, 15404
- **PATENTED INVENTIONS:**
7279-7285

UTILITY MODELS

- **PATENTED UTILITY MODEL:**
2093

DESIGNS

- **REGISTERED DESIGNS:**
900, 901
- **DESIGN REGISTERED ACCORDING TO THE ACCELERATED PROCEDURE:**
902
- **DESIGNS, WHICH HAVE BEEN REGISTERED WITH THE INTERNATIONAL BUREAU CLAIMING PRIORITY ON THE TERRITORY OF GEORGIA:**
212026; 214000; 211496, 211497; 212935; 214270

TRADEMARKS

- **APPLICATIONS FILED UNDER THE NATIONAL PROCEDURE APPROVED FOR REGISTRATION:**
110044; 110358; 110376; 110680; 110750; 110766; 110781; 110797; 110870; 110875; 110941; 110949; 110977; 110980, 110981; 111060, 111061; 111063; 111067, 111068; 111070-111072; 111083; 111090, 111091; 111152; 111157, 111158; 111267-111269; 111271; 111273-111275; 111283; 111317-111319; 111322, 111323; 111325, 111326; 111333; 111335; 111410; 111449; 112594
- **TRADEMARKS REGISTERED ACCORDING TO THE ACCELERATED PROCEDURE:**
34330-34348
- **INTERNATIONAL TRADEMARKS FOR WHICH A DECISION ON GRANTING PROTECTIONS IS TAKEN:**
107214*, 107228*, 107321*, 108186*, 110064; 110077-110080; 110085, 110086; 110090; 110106; 110148; 110155; 110157, 110158; 110161; 110166-110170; 110180; 110185-110187; 110232, 110233; 110236, 110237; 110247-110249; 110253; 110263, 110264; 110267; 110274-110277; 110308-110310; 110343, 110344; 110354-110356; 110395; 110397; 110410-110412; 110425-110429; 110431; 110436, 110437; 110483; 110486-110489; 110499; 110575, 110576; 110582; 110591; 110598; 110646-110650; 110652, 110653; 110662; 110701-110706; 110716-110722; 110733-110738; 110853, 110854; 110901; 110903, 110904; 110985, 110986; 110988; 110992; 111040; 111042-111047
- **INTERNATIONAL TRADEMARKS PROTECTED IN GEORGIA:**
105413; 108829; 108908; 108909-108911; 108913-108915; 108917; 108922-108924; 108933; 108974-108976; 108978-108981; 108988; 109058; 109062; 109066; 109079-109082; 109100; 109176; 109183; 109195-109199; 109239; 109306; 109308-109310; 109347-109349; 109386-109389; 109405; 109444; 109447-109449; 109479; 109482; 109484; 109495; 109552; 109568, 109569; 109573; 109623-109625; 109639-109641; 109691; 109693; 109707-109710; 109866-109868

INVENTIONS

APPLICATIONS APPROVED FOR GRANTING PATENTS

The decision can be appealed at the Chamber of Appeal of Sakpatenti within 3 months from the publication or at the Mtskheta District Court Administrative Cases Board (Address: №17, Samkhedro str., Mtskheta), within 1 month following the publication.

PART A

A 23

- (10) AP 2021 15471 A (51) Int. Cl. (2006)
A 23 C 1/00
A 23 C 21/06
C 13 K 5/00
- (21) AP 2020 15471 (22) 2020 10 19
- (71) Shota Rukhadze (GE)
Tabukashvili St. 92/52, 4600, Kutaisi,
Georgia (GE);
Megi Apridonidze (GE)
Varlamishvili St. 9/10, 4600, Kutaisi,
Georgia (GE);
Andria Ghvinepadze (GE)
Kazbegi St. 28, 4600, Kutaisi, Georgia (GE);
Giorgi Pkhakadze (GE)
26 May St. 45, 4600, Kutaisi, Georgia (GE);
Gulnara Khetsuriani (GE)
Rustaveli Ave. 120a, app. 42, 4600, Kutaisi,
Georgia (GE);
Maria Silagadze (GE)
26 May St. 45, 4600, Kutaisi, Georgia (GE)
- (72) Shota Rukhadze (GE);
Megi Apridonidze (GE);
Andria Ghvinepadze (GE);
Giorgi Pkhakadze (GE);
Gulnara Khetsuriani (GE);
Maria Silagadze (GE)
- (54) METHOD FOR MILK SUGAR (LACTOSE)
PRODUCTION
- (57) A method for lactose production provides fat and casein particles removal from milk serum, ultra-filtration, nanofiltration, electrolysic demineralization, thickening in vacuum evaporation apparatus, lactose flow crystallization, crystals purification, and drying thereof. At that, electrolysic demineralization is executed by merging of classical and bipolar electrolysic processes.
Claims: 1 independent

-
- (10) AP 2021 15514 A (51) Int. Cl. (2006)
A 23 C 21/00
- (21) AP 2020 15514 (22) 2020 12 09
- (71) Shota Rukhadze (GE)
Tabukashvili St. 92/52, 4600, Kutaisi,
Georgia (GE);

- Megi Apridonidze (GE)
Varlamishvili St. 9/10, 4600, Kutaisi,
Georgia (GE);
Andria Ghvinepadze (GE)
Kazbegi St. 28, 4600, Kutaisi, Georgia (GE);
Giorgi Pkhakadze (GE)
26 May St. 45, 4600, Kutaisi, Georgia (GE);
Gulnara Khetsuriani (GE)
Rustaveli Ave. 120a, app. 42, 4600, Kutaisi,
Georgia (GE);
Maria Silagadze (GE)
26 May St. 45, 4600, Kutaisi, Georgia (GE)
- (72) Shota Rukhadze (GE);
Megi Apridonidze (GE);
Andria Ghvinepadze (GE);
Giorgi Pkhakadze (GE);
Gulnara Khetsuriani (GE);
Maria Silagadze (GE)
- (54) METHOD FOR DIETARY BEVERAGE
PRODUCTION ON MILK SERUM BASE
- (57) A method provides mixing of fat free milk and milk serum – 18-20% concentrated, 85-90% demineralized, and having pH 6-6.5, pasteurising and cooling thereof, adding therein a few aged matsoni (containing lactic acid bacterias), and bacterial preparation – propionic, then, condensation, blending therewith lacto-lactulose syrope containing lactose, prebiotic lactulose, and silver berry juice, then, homogenization, cooling and bottling thereof.
Claims: 1 independent

A 61

- (10) AP 2021 15367 A (51) Int. Cl. (2006)
A 61 K 9/06
A 61 K 9/00
A 61 K 31/192
A 61 K 47/40
- (21) AP 2018 15367 (22) 2018 11 28
(31) 17204585.8
(32) 2017 11 30
(33) EP
- (71) Aziende Chimiche Riunite Angelini
Francesco A.C.R.A.F. S.P.A. (IT)
Viale Amelia 70, I-00181 Roma, Italy (IT)
- (72) D'AMICO, Danilo (IT);
MARCHITTO, Leonardo (IT);
RAGNI, Lorella (IT);

DONATI, Luca (IT);
 RUSSO, Vincenzo (IT)
 (74) Liliana Darakhvelidze
 (85) 2020 06 16
 (86) PCT/EP2018/082754, 2018 11 28
 (54) STABLE LIQUID COMPOSITION OF
 KETOPROFEN, SALTS AND
 ENANTIOMERS THEREOF
 (57) Liquid composition comprises complex and
 mixture of conservants consisting of methylparaben
 and propylparaben. Complex consists of ketoprofen,
 hydroxyalkylamine and β - cyclodextrin.
 Claims: 1 independent
 19 dependents

(10) AP 2021 15281 A (51) Int. Cl. (2006)
 A 61 K 31/27
 A 61 K 31/438
 A 61 K 31/435
 C 07 D 403/04
 C 07 D 295/205
 C 07 D 471/10
 (21) AP 2018 15281 (22) 2018 08 28
 (31) 62/551,721
 (32) 2017 08 29
 (33) US
 (71) Lundbeck La Jolla Research Center Inc. (US)
 10835 Rd. To the Cure, Suite 250, San Diego,
 CA 92121, USA (US)
 (72) GRICE, Cheryl A. (US);
 WEBER, Olivia D. (US);
 BUZARD, Daniel J. (US);
 SHAGHAFI, Michael B. (US);
 JONES, Todd K. (US)
 (74) Tamaz Shilakadze
 (85) 2020 02 17
 (86) PCT/US2018/048372, 2018 08 28
 (54) SPIROCYCLE COMPOUNDS AND
 METHODS OF MAKING AND
 USING SAME
 (57) Compound of formula (II):

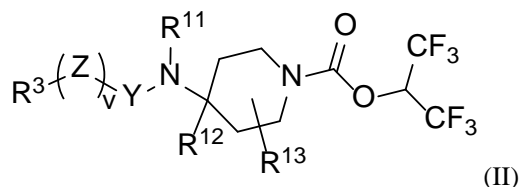

wherein Y is $-\text{CH}_2-$ or $-\text{C}(\text{O})-$; Z is C 3-6 cycloalkyle,
 and values of R^3 , R^{11} , R^{12} , R^{13} substitutes and v
 variable are provided in the claims or pharmaceuti-
 cally acceptable salt thereof, and pharmaceutical
 composition on the basis thereof.

Claims: 2 independents
 12 dependents
 Table: 2

(10) AP 2021 15340 A (51) Int. Cl. (2006)
 A 61 K 31/519
 C 07 D 403/12
 C 07 D 451/04
 C 07 D 451/14
 (21) AP 2018 15340 (22) 2018 10 26
 (31) 62/577,852
 (32) 2017 10 27
 (33) US
 (71) Theravance Biopharma R&D Ip, LLC (US)
 901 Gateway Blvd., South San Francisco,
 CA 94080, USA (US)
 (72) HUDSON, Ryan (US);
 BRANDT, Gary E.L. (US);
 DABROS, Marta (US);
 KOZAK, Jennifer (US);
 NZEREM, Jerry (US)
 MCKINNELL, Robert Murray (US)
 (74) Shalva Gvaramadze
 (85) 2020 05 22
 (86) PCT/US2018/057682, 2018 10 26
 (54) PYRIMIDINE COMPOUND AS JAK
 KINASE INHIBITOR
 (57) Attorney Docket No.: P-337-PCT compound of
 formula (I):

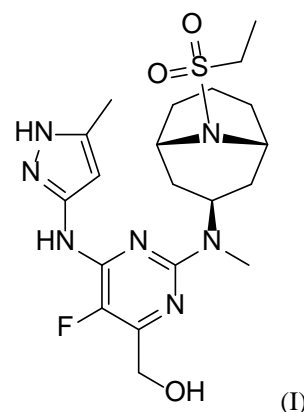

or pharmaceutically acceptable salt thereof, pharma-
 ceutical composition on the basis thereof, and usage
 therefor the treatment of inflammatory skin- and
 autoimmune diseases, such as atopic dermatitis,
 alopecia areata, vitiligo, etc.

Claims: 15 independents
 32 dependents
 Table: 16
 Fig.: 8

(10) AP 2021 15045 A (51) Int. Cl. (2006)
 A 61 K 31/4375
 A 61 P 13/00
 A 61 P 9/00
 C 07 D 471 04
 C 07 D 491 107
 (21) AP 2017 15045 (22) 2017 09 06
 (31) 16188728.6; 16202509.2
 (32) 2016 09 14; 2016 12 06

- (33) EP; EP
 (71) Bayer Aktiengesellschaft (DE)
 Kaiser-Wilhelm-Allee 1, Leverkusen, 51373,
 Germany (DE);
 Bayer Pharma Aktiengesellschaft (DE)
 Müllerstraße 178, Berlin, 13353, Germany (DE)
 (72) BRECHMANN, Markus (US);
 WITTEW, Matthias, Beat (CH);
 FREUDENBERGER, Till (DE);
 MONDRITZKI, Thomas (DE);
 STRAUB, Alexander (DE);
 KULLMANN, Maximilian, Andreas (DE);
 MARQUARDT, Tobias (DE);
 VAKALOPOULOS, Alexandros (DE);
 TINEL, Hanna (DE);
 TELLER, Henrik (DE);
 BOULTADAKIS ARAPINIS, Melissa (DE)

- (74) Giorgi Kartvelishvili
 (85) 2019 04 11
 (86) PCT/EP2017/072339, 2017 09 06
 (54) 7-SUBSTITUTED 1-ARYL-NAPHTHYRI-
 DINE-3-CARBOXYLIC ACID AMIDES
 AND USE THEREOF
 (57) Compound of formula (I)

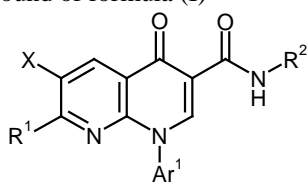

wherein values of X, Ar¹, R¹, R² substitutes are provided in the claims, a method for preparation thereof, and usage therefor the treatment and/or prevention of heart failure, coronary heart disease, atrial and ventricular arrhythmias, renal failure and nephropathy.

Claims: 11 independents
 15 dependents
 Table: 5

- (10) AP 2021 15251 A (51) Int. Cl. (2006)
 A 61 K 31/7072
 A 61 K 31/7068
 A 61 K 31/4188
 A 61 P 25/02
 A 61 P 25/24
 A 61 P 25/28
 (21) AP 2018 15251 (22) 2018 05 30
 (31) 17173760.4
 (32) 2017 05 31
 (33) EP
 (71) Metys Pharmaceuticals AG (CH)
 Gerbergasse 30, Basel, CH-4001,
 Switzerland (CH)
 (72) SCHERZ, Michael (CH);
 FARINA, Carlo (IT)
 (74) Khatuna Imnadze

- (85) 2019 12 27
 (86) PCT/EP2018/064125, 2018 05 30
 (54) SYNERGISTIC COMPOSITIONS COMPRI-
 SING (R)-DIMIRACETAM (1) AND (S)-DIMI-
 RACETAM (2) IN A NON-RACEMIC RATIO
 (57) Present invention relates to compositions of
 enantiomers of 3,6,7,7a-tetrahydro-1H-pyrrolo[1,5-
 a]imidazole-2,5-dione, and pharmaceutically accep-
 table solvates or co-crystals thereof, pharmaceutical
 compositions comprising said compositions, usage
 therefor the treatment and/or prevention of disease or
 disorder preferably selected from peripheral sensory
 neuropathy, preferably peripheral neuropathic pain,
 seizure, depression or cognitive impairment.
 Claims: 12 independents
 13 dependents
 Fig.: 7

- (10) AP 2021 14828 A (51) Int. Cl. (2006)
 A 61 K 39/395
 C 07 K 16/46
 C 07 K 16/30
 C 07 K 16/28
 (21) AP 2016 14828 (22) 2016 12 12
 (31) 62/266,944
 (32) 2015 12 14
 (33) US
 (71) Macrogenics Inc. (US)
 9704 Medical Center Drive, Rockville,
 MD 20850, USA (US)
 (72) JOHNSON, Leslie, S. (US)
 CHICHILLI, Gurunadh, Reddy (US);
 SHAH, Kalpana (US);
 LA MOTTE-MOHS, Ross (US);
 MOORE, Paul, A. (US);
 BONVINI, Ezio (US);
 KOENIG, Scott (US)

- (74) Shalva Gvaramadze
 (85) 2018 07 12
 (86) PCT/US2016/066060, 2016 12 12
 (54) BISPECIFIC MOLECULES HAVING
 IMMUNOREACTIVITY WITH PD-1
 AND CTLA-4, AND METHODS OF
 USE THEREOF
 (57) D21298 APC + D36774 CD4+ T-cells

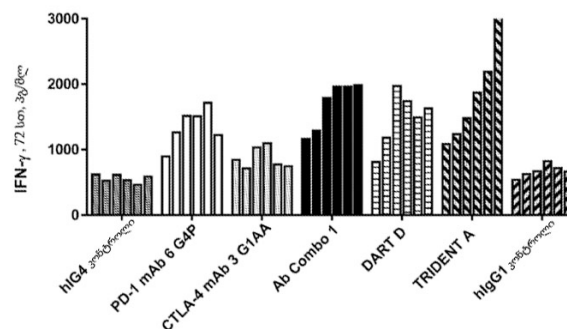

Concentration (NM): | 0.16 | 0.08 | 0.4 | 2 | 10 | 50 |

Present invention relates to PD-1× CTLA-4 bispecific molecules comprising concrete polypeptide chains, pharmaceutical compositions comprising said bispecific molecules, usage therefor stimulating immune response or the treatment of diseases or conditions related to immune system suppression, such as cancer or infection.

Claims: 13 independents
3 dependents

Fig.: 35

PART F

F 41

(10) AP 2021 14161 A (51) Int. Cl. (2006)
F 41 H 1/02

(21) AP 2016 14161 (22) 2016 06 02

(71) Ada Iakobidze (GE)

Bakhtioni St. 24, ბ. 28, 0194, Tbilisi,
Georgia (GE)

(72) Ada Iakobidze (GE)

(54) METHOD FOR PREPARATION OF
HUMAN TORSO INDIVIDUAL
RIGID PROTECTING MEANS

(57) A method provides curling of aramid threads saturated with synthetic binder on an arbor with approximately tension thereof; at that, each layer formation at curling is executed with the threads directed in one side so, that each next layer of threads be disposed creating an angle relative to previous layer of threads. After formation of several layers the formation of layer of fabric impregnated with the same binder, then ceramic screen formation by wrapping therein aramid fabric saturated with synthetic binder of ceramic plates; further, fixation of ceramic screen by twisting of threads, aramid fabric impregnated with synthetic binder usage for layered cohesive structure formation, the treatment thereby heating with two consecutive temperature regimes, release of article, and then, each therefrom is wrapped into aramid fabric saturated with above-mentioned synthetic binder is executed for complete bonded structure formation, after whereof the mentioned parts are placed and delayed into drying chamber under high pressure.

Claims: 1 independent
5 dependents

Fig.: 4

PART G

G 01

(10) AP 2021 15403 A (51) Int. Cl. (2006)
G 01 J 3/00

(21) AP 2020 15403 (22) 2020 08 04

(71) LTD "National High Technology Center
of Georgia" (GE)

Kavtaradze St. 46, 0186, Vake District, Tbilisi,
Georgia (GE)

(72) Lamzira Parulava (GE);

Vakhtang Ugrekheldidze (GE)

(74) Tamar Liluashvili

(54) METHOD FOR DETERMINATION OF
OXYGEN-17 ISOTOPE ATOMIC FRACTION
IN MOLECULAR OXYGEN

(57) A method for oxygen-17 isotope atomic fraction determination provides oxygen gas introduction into mass spectrometer, and their molecular ionization in ionization chamber by bombing therewith electrons; ionized substance ionization by means of mass spectrometer analyzer; ions with mass: 32, 33, 34, 35, 36 intensity measurement; and isotope oxygen-17 atomic fraction determination with formula having three different mass lines:

$m/z=32,33,34$; $m/z=32,33,35$; $m/z=32,33,36$;

$m/z=32,34,36$; $m/z=32,35,36$; $m/z=33,35,36$;

$m/z=34,35,36$ და $m/z=33,34,35$.

Claims: 1 independent

(10) AP 2021 15404 A (51) Int. Cl. (2006)
G 01 J 3/00

(21) AP 2020 15404 (22) 2020 08 04

(71) LTD "National High Technology Center
of Georgia" (GE)

Kavtaradze St. 46, 0186, Vake District, Tbilisi,
Georgia (GE)

(72) Lamzira Parulava (GE);

Natia Mzareulishvili (GE)

(74) Tamar Liluashvili

(54) MASS-SPECTROMETRIC METHOD
FOR DETERMINATION OF CARBON-13
ISOTOPE ATOMIC FRACTION DIRECTLY
IN SALICYLIC ACID

(57) A method for determination of carbon-13 isotope atomic fraction directly in salicylic acid is disclosed. The method provides isotope-modified center determination, peaks intensity measurement, the mass/charge ratios m/z values whereof are: 138,139; 120,121 and 92,93. The method determines carbon isotopes atomic fraction in isotopically modified salicylic acid by all carbon centers, benzene group carbonates, and carboxylic carbon centers, as well. In each case, carbon-13 isotope atomic fraction is determined by means of three completely different ionic groups with corresponding formula. Calculated values are mutually verifiable.

Claims: 1 independent

- GUTCHER, Ilona (DE);
 PLATTEN, Michael (DE);
 IRLBACHER, Horst (DE)
- (74) Tamar Kochlamazashvili
- (54) 2-HETEROARYL-3-OXO-2,3-DIHYDRO-PYRIDAZINE-4-CARBOXAMIDES FOR THE TREATMENT OF CANCER
-
- (11) P 2021 7282 B (51) Int. Cl. (2006)
 A 61 K 31/7076
 C 07 H 19/16
- (10) AP 2021 14600 A (44) 6(562)/2021
- (21) AP 2016 14600
- (22) 2016 03 07
- (24) 2016 03 07
- (31) 62/276,597; 62/253,958; 62/129,319
- (32) 2016 01 08; 2015 11 11; 2015 03 06
- (33) US; US; US
- (86) PCT/US2016/021276, 2016 03 07
- (73) Atea Pharmaceuticals Inc. (US)
 125 Summer St. Boston, MA 02110, USA (US)
- (72) SOMMADOSSI, Jean-Pierre (US);
 MOUSSA, Adel (US)
- (74) Tamaz Shilakadze
- (54) β -D-2'-DEOXY-2' α -FLUORO-2'- β -C-SUBSTITUTED-2-MODIFIED-N⁶-SUBSTITUTED PURINE NUCLEOTIDES FOR HCV TREATMENT
-

PART B

B 60

- (11) P 2021 7283 B (51) Int. Cl. (2006)
 B 60 P 3/41
 B 60 P 3/40
- (10) AP 2021 15272 A (44) 3(559)/2021
- (21) AP 2020 15272
- (22) 2020 02 06
- (24) 2020 02 06
- (73) Ramaz Tkemaladze (GE)
 Vill. Etseri, 5510, Chiatura District, Georgia (GE);
 Zaur Chitidze (GE)
 Tarkhnishvili St. 16, app. 19, 0179, Tbilisi, Georgia (GE);
 Zaur Balamtsarashvili (GE)
 Sulkhani Tsintsadze St. 7, 0160, Tbilisi, Georgia (GE);
 Malkhaz Akhvlediani (GE)
 Gldani, II mcr., cpr. 45, app. 95, 0167, Tbilisi, Georgia (GE);
 Guram Bosikov (GE)
 Gldani, III mcr., crp. 7a, app. 74, 0167, Tbilisi, Georgia (GE);

- Irakli Grdzlishvili (GE);
 Vazha-Pshavela St. 4a, app. 6, 3700, Rustavi, Georgia (GE);
 Nikoloz Gelashvili (GE);
 Dighomi Massive, III qu., crp. 1a, app. 74, 0159, Tbilisi, Georgia (GE);
 Giorgi Kvaratskhelia (GE)
 Moscow Av. 50, crp. 1, app. 8, 0137, Tbilisi, Georgia (GE);
 Tinatin Darsavelidze (GE)
 I. Chavchavadze Av. 41, app. 37, 0179, Tbilisi, Georgia (GE);
 Davit Mosulishvili (GE)
 Megobroba Av., corp. 41, app. 64, 3700, Rustavi, Georgia (GE);
 Igor Gelashvili (GE)
 Rustavi Highway 28a, app. 1, 0165, Tbilisi, Georgia (GE);
 Maia Gogotishvili (GE)
 Gali St. 23, 0179, Tbilisi, Georgia (GE)
- (72) Ramaz Tkemaladze (GE);
 Zaur Chitidze (GE);
 Zaur Balamtsarashvili (GE);
 Malkhaz Akhvlediani (GE);
 Guram Bosikov (GE);
 Irakli Grdzlishvili (GE);
 Nikoloz Gelashvili (GE);
 Giorgi Kvaratskhelia (GE);
 Tinatin Darsavelidze (GE);
 Davit Mosulishvili (GE);
 Igor Gelashvili (GE);
 Maia Gogotishvili (GE)
- (54) LOG DRAWING SELF-LOADING AGGREGATE BODY-ARROW MECHANISM WITH HYDRO-MECHANICAL ACTUATOR
-

B 61

- (11) P 2021 7280 B (51) Int. Cl. (2006)
 B 61 H 1/00
 F 16 D 69/02
 F 16 D 65/04
- (10) AP 2021 15349 A (44) 5(561)/2021
- (21) AP 2018 15349
- (22) 2018 10 15
- (24) 2018 10 15
- (31) 2017138340
- (32) 2017 11 02
- (33) RU
- (86) PCT/RU2018/000685, 2018 10 15
- (73) Open Joint Stock Company "Ural Plant Of Auto-Textile Products" (RU)
 Plekhanov St. 64, Asbest, Sverdlov Region 624269, Russian Federation (RU)
- (72) SUKHAREV, Evgeniy Albertovich (RU);
 ROMANENKO, Vitaliy Valerievich (RU)
- (74) Larisa Amirkhanyan

DESIGNS

REGISTERED DESIGNS

(11) D 2021 900 S (51) 09-03
(10) AD 2021 1191 S (44) 2021 04 12 №6
(21) AD 2020 1191
(22) 2020 11 04
(24) 2020 11 04
(28) 7
(18) 2025 11 04
(73) Gocha Pipia (GE)
 Guram Panjikidze St. 22, block B, app. 2, 0160,
 Tbilisi, Georgia (GE)
(72) Gocha Pipia (GE)
(74) Ramaz Krichinashvili (GE)
(54) ALCOHOLIC BEVERAGE PACKAGING
 BOX WITH NO FLOWING DYNAMIQUE

(11) D 2021 901 S (51) 29-02
(10) AD 2021 1192 S (44) 2021 04 12 №6
(21) AD 2020 1192
(22) 2020 11 17
(24) 2020 11 17
(28) 1
(18) 2025 11 17
(73) Ketevan Macharashvili (GE)
 Shartava St. 35/37, Entrance I, app. 47b, 0160,
 Tbilisi, Georgia (GE)
(72) Ketevan Macharashvili (GE)
(54) VEIL

DESIGN REGISTERED ACCORDING TO THE ACCELERATED PROCEDURE

The decision can be appealed at the Chamber of Appeal of Sakpatenti within 3 months from the publication.

(11) D 2021 902 S (51) 03-01
 (21) AD 2021 1223 (22) 2021 06 14
 (24) 2021 06 14
 (28) 5
 (18) 2026 06 14
 (73) Sopiko Mukhulishvili (GE)
 Vill. Vejini, 1500, Gurjaani, Georgia (GE)
 (72) Sopiko Mukhulishvili (GE)
 (54) 1.-2. BAG; 3.-5. WAIST BAG
 (55)



1.1



1.2



1.3



2.1



2.2



2.3



2.4



2.5



2.6



3.1



3.2



3.3



3.4



3.5



4.1



5.1



5.2



5.3



5.4



5.5

**DESIGNS, WHICH HAVE BEEN REGISTERED WITH THE INTERNATIONAL
BUREAU CLAIMING PRIORITY ON THE TERRITORY OF GEORGIA**

The decision can be appealed at the Chamber of Appeal of Sakpatenti within 3 months from the publication or at the Mtskheta District Court Administrative Cases Board (Address: №17, Samkhedro Str., Mtskheta), within 1 month following the publication.

- (11) DM/212 026 (51) 09-05
 (15) 2020 11 04 (44) 18/2021 (2021 05 07)
 (22) 2020 11 04
 (28) 1
 (30) No1: 07.05.2020; 29/733,947; US
 (73) BN Intellectual Properties
 4820 Fifth Avenue N., 33713 St. Petersburg, FL (US)
 (85) US
 (86) US
 (87) US
 (88) US
 (89) US
 (81) III. RO, OM, GE, CA, EE, RS, NO, BG, RW, SY, DK, EM, AM, BW, TJ, MD, VN, TN, PL, SR, MN, JP, KR, LT, UA, OA, SI, BX, ME, AZ, SM, WS, KG, LI, MK, BA, DE, EG, FI, RU, IS, HU, ES, GB, KH, TR, ST, GH, IL, CH, KP, LV, HR, MX, AL, BN, FR, NA, SG, MC, BZ, TM
 (72) Govidan NAIR
 C/o BN Intellectual Properties, 4820 Fifth Avenue N., 33713, St. Petersburg, FL (US);
 Michael SPUZA
 C/o BN Intellectual Properties, 4820 Fifth Avenue N., 33713, St. Petersburg, FL (US);
 Paula PELL
 C/o BN Intellectual Properties, 4820 Fifth Avenue N., 33713, St. Petersburg, FL (US);
 Donald PELL
 C/o BN Intellectual Properties, 4820 Fifth Avenue N., 33713, St. Petersburg, FL (US);
 Mark HOYT
 C/o BN Intellectual Properties, 4820 Fifth Avenue N., 33713, St. Petersburg, FL (US);
 Chad S FRAMPTON
 C/o BN Intellectual Properties, 4820 Fifth Avenue N., 33713, St. Petersburg, FL (US)
 (74) Randy A. NORANBROCK, HAUPTMAN HAM LLP
 2318 Mill Road, Suite 1400, 22314 Alexandria, VA (US)
 (54) 1. Capsule for pharmaceutical products
 (55)

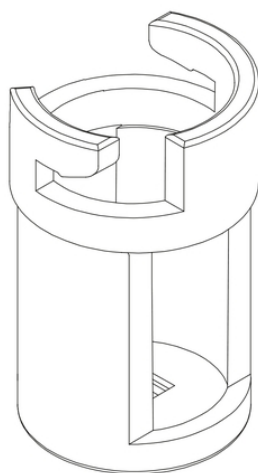

1.1

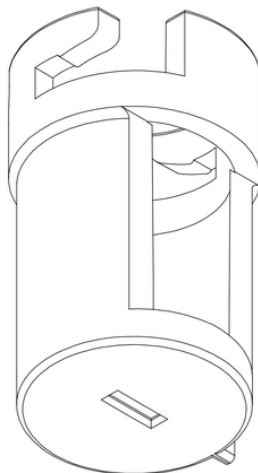

1.2

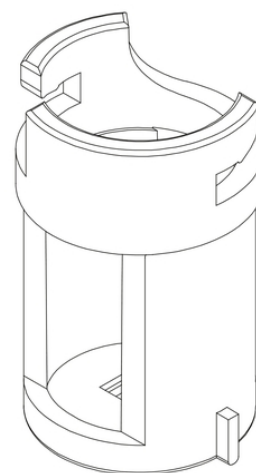

1.3

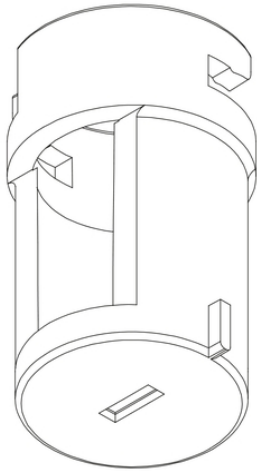

1.4

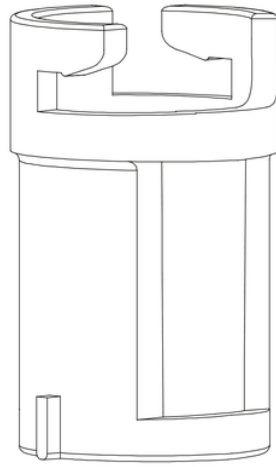

1.5

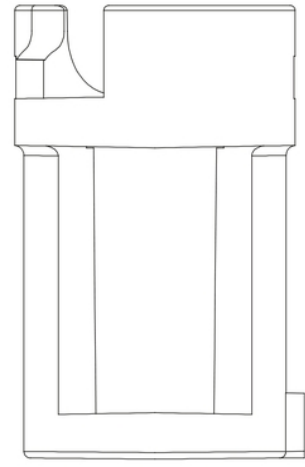

1.6

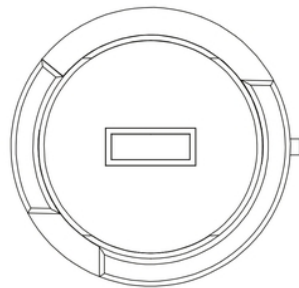

1.7

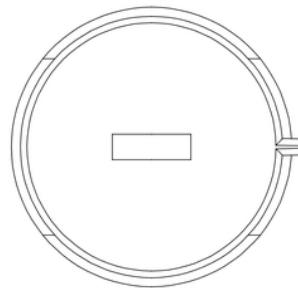

1.8

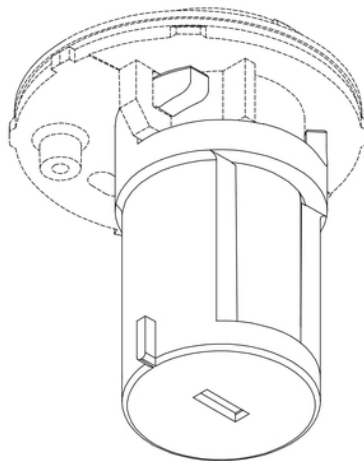

1.9

- (11) DM/214 000 (51) 20-03
(15) 2020 07 07 (44) 18/2021 (2021 05 07)
(22) 2020 07 07
(28) 1
(30) No1: 23.04.2020; 2020501860; RU
(73) LLC KARBORD
Ul. Demidova, 206/1, Of. 6, RU-356240 Mikhailovsk (RU)
(85) RU
(86) RU
(87) RU
(88) RU
(89) RU
(81) III. TR, US, GE, RS, CH, JP, KR, EM, AM, SG, TJ, AZ, GB
(72) Semyon Zubkov
Ul. Onezhskaya, D. 1, Kv. 34, RU-350018, Krasnodar (RU)
(74) LLC GARDIUM
Ryazanskiy Prospect, Dom 75, Korpus 4, 1-aya Bashnya, 7 Etazh, 109456 Moscow (RU)
(54) 1. Advertisement screen with a backpack case
(55)



- (11) DM/211 496 (51) 10-07
 (15) 2020 11 25 (44) 21/2021 (2021 05 28)
 (22) 2020 11 25
 (28) 1
 (73) HARRY WINSTON SA
 Chemin Du Tourbillon 8, 1228 Plan-les-Ouates (CH)
 (85) CH
 (86) CH
 (87) CH
 (88) CH
 (89) CH
 (81) II. MA III. AL, AM, AZ, BA, BZ, CA, CH, EM, GB, GE, KG, LI, MC, MD, ME, MK, MN, NO, OM, RU,
 SG, TN, TR, UA
 (72) Christophe LASSERRE
 C/o Harry Winston SA, Chemin Du Tourbillon 8, 1228, Plan-les-Ouates (CH)
 (74) The Swatch Group AG (The Swatch Group SA) (The Swatch Group Ltd.)
 Faubourg Du Lac 6, 2501 Biel/Bienne (CH)
 (54) 1. Dial
 (55)

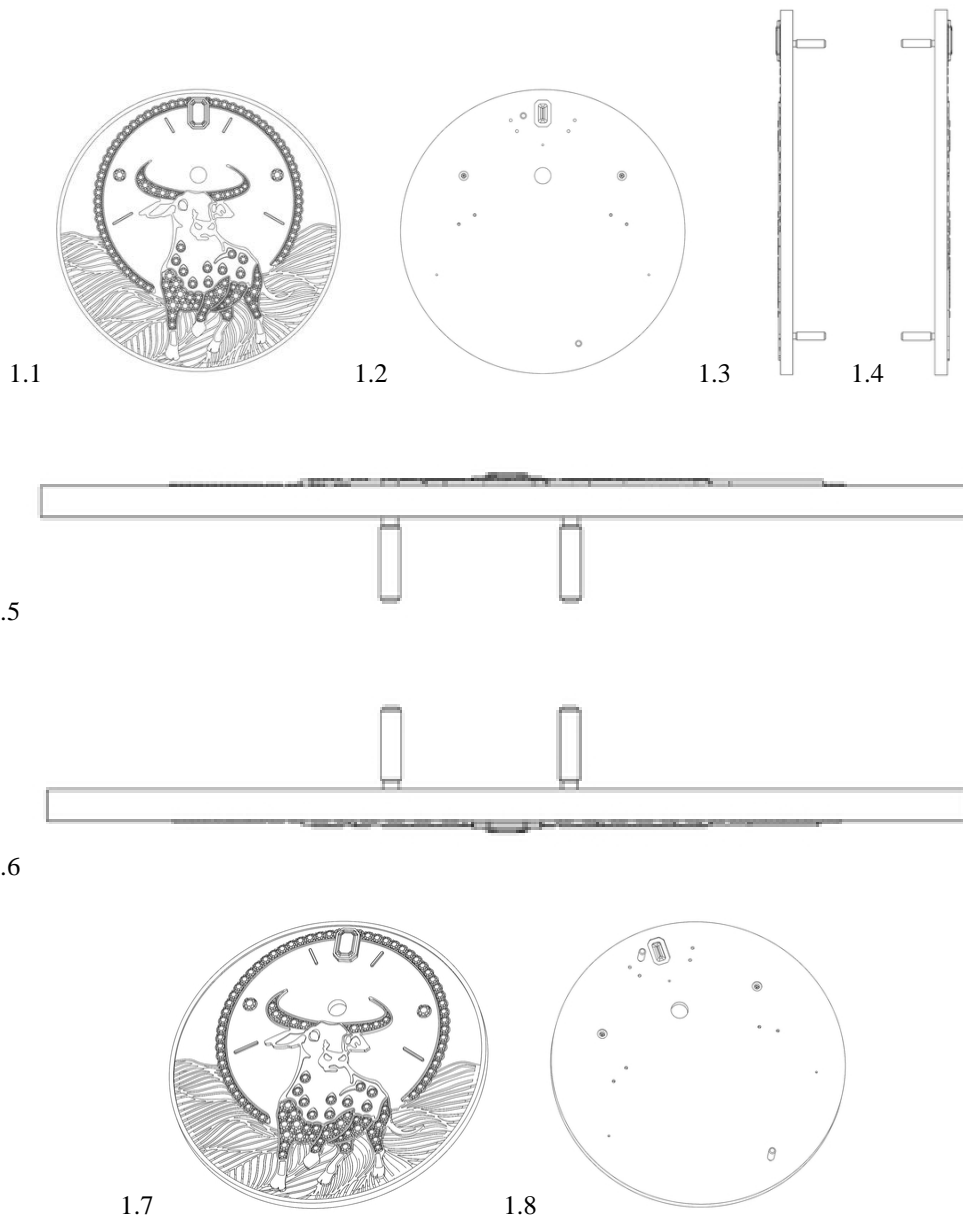

- (11) DM/211 497 (51) 10-07
 (15) 2020 11 25 (44) 21/2021 (2021 05 28)
 (22) 2020 11 25
 (28) 1
 (73) HARRY WINSTON SA
 Chemin Du Tourbillon 8, 1228 Plan-les-Ouates (CH)
 (85) CH
 (86) CH
 (87) CH
 (88) CH
 (89) CH
 (81) II. MA III. AL, AM, AZ, BA, BZ, CA, CH, EM, GB, GE, KG, LI, MC, MD, ME, MK, MN, NO, OM, RU, SG, TN, TR, UA
 (72) Christophe LASSERRE
 C/o Harry Winston SA, Chemin Du Tourbillon 8, 1228, Plan-les-Ouates (CH)
 (74) The Swatch Group AG (The Swatch Group SA) (The Swatch Group Ltd.)
 Faubourg Du Lac 6, 2501 Biel/Bienne (CH)
 (54) 1. Dial
 (55)

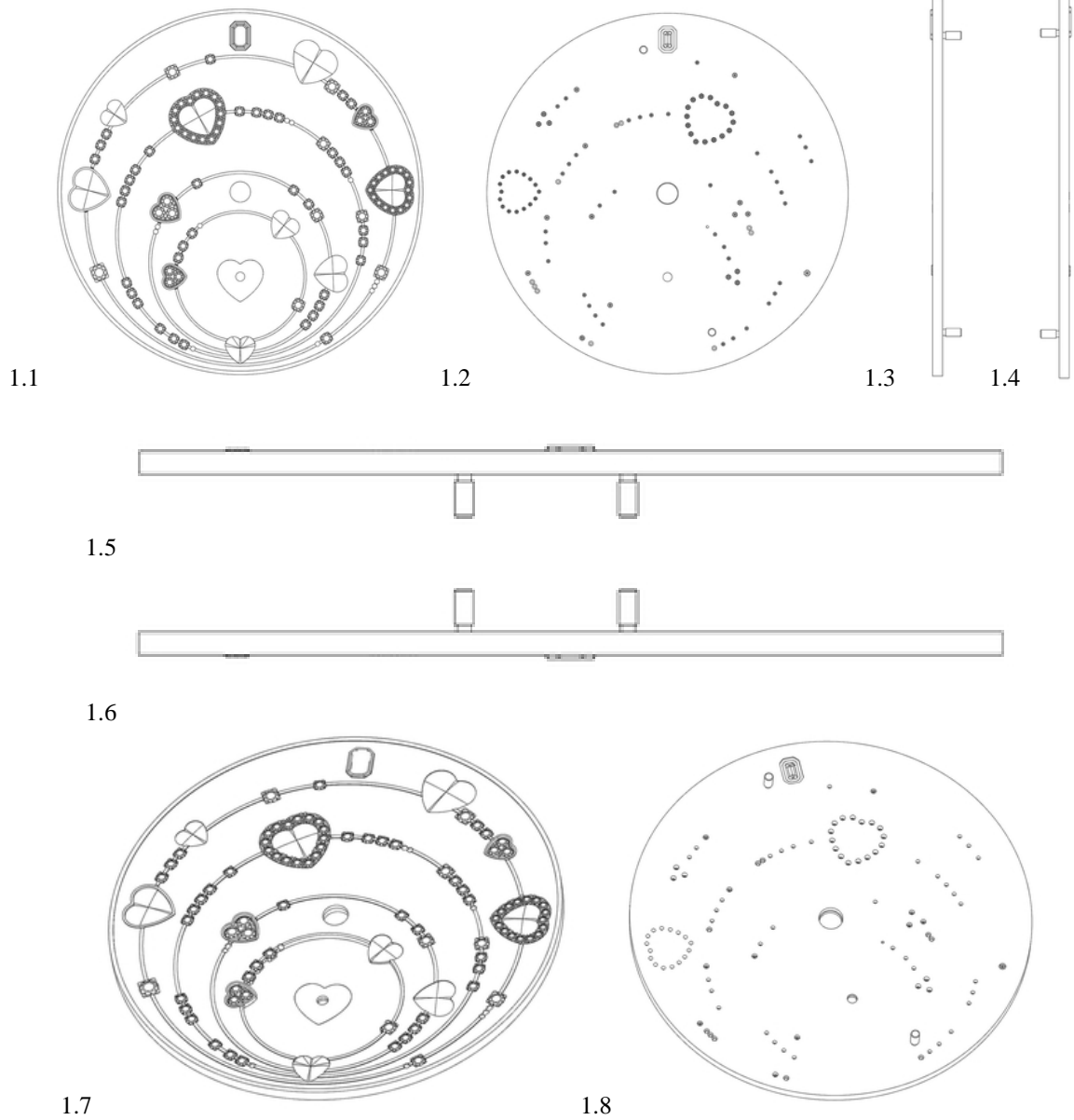

- (11) DM/212 935 (51) 21-01
(15) 2020 11 24 (44) 21/2021 (2021 06 28)
(22) 2020 11 24
(28) 1
(73) Jacky DI CICCO
13 L'orée De L'île, 26600 LA Roche DE Glun (FR)
(85) FR
(86) FR
(87) FR
(88) –
(89) FR
(81) II. BJ, CI, GA, MA, ML, NE, SN III. AL, AM, AZ, BA, BN, BW, BX, BZ, CH, GE, GH, HR, IL, IS, JP, KG, KH, KP, KR, LI, MC, MD, ME, MK, MN, NA, NO, OM, RS, RU, RW, SG, SM, SR, ST, SY, TJ, TM, TR, UA, VN, WS
(72) Jacky DI CICCO
13 L'orée De L'île, 26600 LA Roche DE Glun (FR)
(54) 1. Game piece
(55)



1.1



1.2



1.3

- (11) DM/214 270
- (15) 2021 04 27
- (22) 2021 04 27
- (28) 1
- (73) ProCredit Holding AG & Co. KGaA
Rohmerplatz 33-37, 60486 Frankfurt Am Main (DE)
- (85) –
- (86) DE
- (87) DE
- (88) DE
- (89) EM
- (81) III. AL, BA, EM, GE, MD, MK, RS, UA
- (72) Pamela Basante Romero
Río Pucuno N71-199 Y Río Bigal, Quito (EC)
- (54) 1. Logo
- (55)

1.1



The logo for ProGreen features the word "ProGreen" in a bold, sans-serif font. The "Pro" is in a dark teal color, and "Green" is in a lighter green. To the right of the text is a stylized green leaf with a central vein and a smaller leaflet below it.

TRADEMARKS

APPLICATIONS FILED UNDER THE NATIONAL PROCEDURE APPROVED FOR REGISTRATION

The decision can be appealed at the Chamber of Appeal of Sakpatenti within 3 months from the publication or at the Mtskheta District Court Administrative Cases Board (Address: №17, Samkhedro St., Mtskheta), within 1 month following the publication.

(260) AM 2021 110044 A
(210) AM 110044
(220) 2020 10 08
(731) LTD "Gionik Group"
R. Margiani St. 32, 0186, Tbilisi, Georgia
(740) Natia Gogadze
(540)



(591) FFFCFC white, 0F0E0E black
(531) 07.03.11; 26.03.23; 27.05.01; 28.19
(526) GUDAURI, გუდაური
(511) 35

(260) AM 2021 110376 A
(210) AM 110376
(220) 2020 11 04
(731) Giorgi Ezugbaia
Oniashvili St. 61, app. 4, Tbilisi, Georgia
(540)



(591) Grey, white, golden
(531) 25.01.09; 25.01.10; 25.01.25; 27.05.01;
29.01.02
(526) BEDIANI
(511) 33, 35

(260) AM 2021 110358 A
(210) AM 110358
(220) 2020 10 30
(731) LTD "Alko-Ge"
Artem Lusinyan St. 20, app. 7, 0144,
Tbilisi, Georgia
(540)



(591) Green, white
(531) 05.01.02; 07.01.09; 07.01.14; 27.07.01; 28.19;
29.01.12
(526) კახვი
(511) 29, 33

(260) AM 2021 110680 A
(210) AM 110680
(220) 2020 11 30
(731) Platinum Wines Sp. z o.o.
Ul. Wolodyjowskiego 70/1, Warszawa, 02-724,
Poland
(740) Nino Bakhtadze
(540)



(591) Red, black, beige, golden, crimson

(531) 24.03.01; 24.03.07; 24.13.01; 25.01.09;
25.01.10; 25.01.19; 29.01.14
(526) Immitation of Flag of Georgia
(511) 33

(260) AM 2021 110750 A
(210) AM 110750
(220) 2020 12 07
(731) LEPL "Georgian Mediators Association"
Ipolite Khvichia St. 19, app. 12, 0160,
Tbilisi, Georgia
(740) Giorgi Taktakishvili
(540)



(591) Blue, sky-blue
(531) 24.13.09; 26.04.03; 26.04.09; 29.01.04
(526) Georgia
(511) 45

(260) AM 2021 110766 A
(210) AM 110766
(220) 2020 12 07
(731) LLC "Pilgrim"
Mukhran Machavariani St. 6b, app. 8,
Saburtalo District, Tbilisi, Georgia
(540)

Ecoland
ეკოლენდი
ЭКОЛЭНД

(591) Black-white
(511) 29, 30, 31, 32, 35, 39, 41

(260) AM 2021 110781 A
(210) AM 110781
(220) 2020 12 09
(731) Mikheil Songhulashvili
D. Aghmashenebeli St., II Lane, House 5,
0159, Vill. Dighomi, Tbilisi, Georgia
(740) Dimitri Dzamukashvili
(540)

Ampelopolis
ამპელოპოლისი

(591) Black-white
(511) 43

(260) AM 2021 110797 A
(210) AM 110797
(220) 2020 12 11
(731) LTD "Rich Group"
Vill. Mughanlo, Marneuli Region, Georgia
(540)

Protizol
პროტიზოლი

(591) Black-white
(511) 5

(260) AM 2021 110870 A
(210) AM 110870
(220) 2020 12 14
(731) Industrias Masats, S.L.U
Calle Metalurgia 38-42, 08038,
Barcelona, Spain
(740) Merab Kvimsadze
(540)

ALPINO

(591) Black-white
(531) 27.05.01
(511) 8, 16, 28

(260) AM 2021 110875 A
(210) AM 110875
(220) 2020 12 15
(731) Faes Farma S.A.
Avenida Autonomía 10, 48940 Leioa
(Bizkaia), Spain
(740) Pavle Meipariani
(540)

Robaxisal

(591) Black-white
(511) 5

(260) AM 2021 110941 A
(210) AM 110941
(220) 2020 12 19
(731) Philip Morris Products S.A.
Quai Jeanrenaud 3, 2000 Neuchâtel,
Switzerland
(740) Pavle Meipariani
(540)

SIENNA

(591) Black-white
(511) 34

(260) AM 2021 110949 A
 (210) AM 110949
 (220) 2020 12 21
 (731) LTD "Nalan Chamashir"
 Rustavi Higway 19, corp. 3, fl. 1st,
 0165, Tbilisi, Georgia
 (740) Teona Kakhidze
 (540)



(591) Blue, red
 (531) 24.13.01; 24.13.14; 24.13.22; 27.05.01;
 29.01.12
 (511) 25, 35

(260) AM 2021 110977 A
 (210) AM 110977
 (220) 2020 12 24
 (731) LLC "U Trust"
 Queen Ketevani Ave./Bochorma St. 50/18,
 Block "G" commercial space 5, 0144, Tbilisi,
 Georgia
 (740) Ucha Chakhvadze
 (540)



(591) Black, golden
 (531) 26.11.07
 (511) 35, 36, 45

(260) AM 2021 110980 A
 (210) AM 110980
 (220) 2020 12 24
 (731) LTD "Clintech"
 Chitadze St. 6/505, Tbilisi, Georgia
 (540)

ზომა
zoma

(591) Black-white
 (511) 3, 5

(260) AM 2021 110981 A
 (210) AM 110981
 (220) 2020 12 24
 (731) LTD "Targmany"
 Merab Aleksidze St. 1, corp. 3, entrance 1,
 app. 31, 0171, Tbilisi, Georgia
 (540)



(591) Black-white
 (531) 25.05.01; 26.04.02; 26.04.22; 26.04.24;
 27.05.01; 27.05.24
 (511) 41

(260) AM 2021 111060 A
 (210) AM 111060
 (220) 2020 12 25
 (310) UK00003543759
 (320) 2020 10 13
 (330) UK
 (731) British American Tobacco (Brands) Limited
 Globe House, 4 Temple Place, London,
 WC2R 2PG, United Kingdom
 (740) Tamar Kotchlamazashvili
 (540)



(591) White, green, dark green
 (531) 26.02.07; 26.04.02; 26.04.05; 26.04.12;
 26.04.24; 26.11.03; 26.11.08; 26.11.12;
 27.05.01; 27.05.24; 29.01.13
 (511) 34

(260) AM 2021 111061 A
 (210) AM 111061
 (220) 2020 12 25
 (731) British American Tobacco (Brands)
 Limited
 Globe House, 4 Temple Place, London,
 WC2R 2PG, United Kingdom
 (740) Tamar Kotchlamazashvili
 (540)



(591) Silver, white, brown, orange, black
 (531) 05.03.01; 05.03.13; 05.03.14; 26.04.15;
 26.04.22; 26.04.24; 27.05.01; 27.05.10;
 27.05.24; 29.01.14
 (511) 34

(260) AM 2021 111063 A
 (210) AM 111063
 (220) 2020 12 25
 (731) British American Tobacco (Brands)
 Limited
 Globe House, 4 Temple Place, London,
 WC2R 2PG, United Kingdom
 (740) Tamar Kotchlamazashvili
 (540)



(591) Blue, white, black, brown
 (531) 05.03.01; 05.03.14; 05.03.15; 26.04.04;
 26.04.08; 26.04.09; 26.04.15; 26.04.22;
 26.04.24; 27.03.11; 27.05.01; 27.05.09;
 27.05.24; 29.01.14
 (511) 34

(260) AM 2021 111067 A
 (210) AM 111067
 (220) 2020 12 28
 (731) LLC "Medi Club Georgia"
 Tashkent St. 22a, 0160, Tbilisi, Georgia
 (740) Giorgi Taktakishvili
 (540)

MediClubGeorgia

(591) White, red, black
 (531) 27.05.02; 27.05.11; 29.01.12
 (526) Georgia
 (511) 41, 42, 44

(260) AM 2021 111068 A
 (210) AM 111068
 (220) 2020 12 28
 (731) LLC "Paragraph Tabor Resorts"
 Iliа Chavchavadze Av. 37m, Tbilisi, Georgia
 (540)

Daphion დაფიონი

(591) Black-white

(531) 27.05.01; 28.19
 (511) 43

(260) AM 2021 111070 A
 (210) AM 111070
 (220) 2020 12 28
 (731) LLC "Paragraph Tabor Resorts"
 Iliа Chavchavadze Av. 37m, Tbilisi, Georgia
 (540)

Mulligan მულიგანი

(591) Black-white
 (531) 27.05.01; 28.19
 (511) 43

(260) AM 2021 111071 A
 (210) AM 111071
 (220) 2020 12 28
 (731) LLC "Paragraph Tabor Resorts"
 Iliа Chavchavadze Av. 37m, Tbilisi, Georgia
 (540)

NAMA ნამა

(591) Black-white
 (531) 27.05.01; 28.19
 (511) 43

(260) AM 2021 111072 A
 (210) AM 111072
 (220) 2020 12 28
 (731) LLC "Paragraph Tabor Resorts"
 Iliа Chavchavadze Av. 37m, Tbilisi, Georgia
 (540)

Mariali მარიალი

(591) Black-white
 (531) 27.05.01; 28.19
 (511) 43

(260) AM 2021 111083 A
 (210) AM 111083
 (220) 2020 12 29
 (731) LLC "Royal Askana"
 Vill. Askana, 3504, Ozurgeti, Georgia
 (540)

Askanius
 ასკანიუს

(591) Black-white
(511) 33

(260) AM 2021 111090 A
(210) AM 111090
(220) 2020 12 30
(731) LTD "Shevi"
Il. Chavchavadze Av. 78, corp. 1, app. 4,
0179, Tbilisi, Georgia
(740) Nato Lashkhi
(540)

Shevi Korean Beauty

(591) Black-white
(511) 3, 35, 44

(260) AM 2021 111091 A
(210) AM 111091
(220) 2020 12 30
(731) LTD "Shevi"
Il. Chavchavadze Av. 78, corp. 1, app. 4,
0179, Tbilisi, Georgia
(740) Nato Lashkhi
(540)

Shevi Korean Corner

(591) Black-white
(511) 3, 35, 44

(260) AM 2021 111152 A
(210) AM 111152
(220) 2021 01 04
(731) LTD "PARK GIDA"
5th Ubani, St. 46a, 6200, Vill. Khutsubani,
Kobuleti Municipality, Georgia
(740) Dato Jaiani
(540)

YENI BURGAZ RAKI

(591) Black-white
(511) 32, 33, 35, 39

(260) AM 2021 111157 A
(210) AM 111157
(220) 2021 01 05
(731) Getz Pharma International FZ LLC
Office No. 1307, 13th Floor, Al-Thuraya
Tower 1, Dubai Media City, Dubai, United
Arab Emirates
(740) Merab Kvimsadze
(540)

LEVETAM

(591) Black-white
(531) 27.05.01
(511) 5

(260) AM 2021 111158 A
(210) AM 111158
(220) 2021 01 06
(731) LTD "Agropharm"
David Jokhadze St. 27, Vill. Tsavkisi,
Mtatsminda district, Tbilisi, Georgia
(740) Tamar Kharazishvili
(540)

აგროფარმა Agropharm

(591) Black-white
(511) 1, 5, 7, 35, 44

(260) AM 2021 111267 A
(210) AM 111267
(220) 2021 01 08
(731) EMVCo LLC
c/o Visa Holdings, Inc., 900 Metro Center
Boulevard, Foster City, California
94404, USA
(740) Pavle Meipariani
(540)



(591) Black-white
(531) 24.15.01; 24.15.11; 26.03.23; 26.05.01
(511) 9, 36, 42

(260) AM 2021 111268 A
(210) AM 111268
(220) 2021 01 08
(731) Davit Mchedlidze
N. Zhvania St. 28, app. 76, 0179, Tbilisi,
Georgia
(540)



(591) Black-white
(531) 03.01.08; 03.01.24; 27.05.01
(511) 18, 44

(260) AM 2021 111269 A
(210) AM 111269
(220) 2021 01 12
(731) LLC "Kdema"

Besarion Zhgenti St., Lane 7, app. 10, 0183,
Tbilisi, Georgia

(540)



KDEMA

(591) Black-white

(531) 28.19

(511) 25

(260) AM 2021 111271 A

(210) AM 111271

(220) 2021 01 12

(731) LLC "IDS Borjomi Beverages Company"
Pareraweg 45, Curaçao, Antilpega Islands

(740) Giorgi Jokharidze

(540)

**შუშხუნა ბაკურიანი –
ხალისიანი
შეგრძნებებისთვის**

(591) Black-white

(526) ბაკურიანი

(511) 32

(260) AM 2021 111273 A

(210) AM 111273

(220) 2021 01 12

(310) 2043410

(320) 2020 07 31

(330) CA

(731) Peak Oyun Yazilim ve Pazarlama A.S.

DBA Peak Games Inebolu

Sokak №39, 3rd Floor, Kabatas Beyoglu,
Istanbul, 34427, Turkey

(740) Giorgi Taktakishvili

(540)

TOY BLAST

(591) Black-white

(511) 9, 41

(260) AM 2021 111274 A

(210) AM 111274

(220) 2021 01 12

(310) 2043411

(320) 2020 07 31

(330) CA

(731) Peak Oyun Yazilim ve Pazarlama A.S.

DBA Peak Games Inebolu

Sokak №39, 3rd Floor, Kabatas Beyoglu,
Istanbul, 34427, Turkey

(740) Giorgi Taktakishvili

(540)

TOON BLAST

(591) Black-white

(511) 9, 41

(260) AM 2021 111275 A

(210) AM 111275

(220) 2021 01 12

(310) 90086374

(320) 2020 07 31

(330) US

(731) Peak Oyun Yazilim ve Pazarlama A.S.

DBA Peak Games Inebolu

Sokak №39, 3rd Floor, Kabatas Beyoglu,
Istanbul, 34427, Turkey

(740) Giorgi Taktakishvili

(540)



(591) Black-white

(531) 24.17.04; 26.01.01; 26.01.04; 26.01.19;
27.05.02; 27.05.03; 27.05.04

(511) 9, 41

(260) AM 2021 111283 A

(210) AM 111283

(220) 2021 01 14

(731) KTM AG

Stallhofner Straße 3, Mattighofen,
5230, Austria

(740) Giorgi Kartvelishvili

(540)



(591) White, red

(531) 26.04.02; 26.04.22; 26.04.24; 27.01.25;
27.05.01; 27.05.21; 27.05.24; 29.01.12

(511) 9, 12, 25

(260) AM 2021 111317 A

(210) AM 111317

(220) 2021 01 15

(731) KTM AG

Stallhofner Straße 3, Mattighofen, 5230,
Austria

(740) Giorgi Kartvelishvili

(540)

GASGAS

(591) Black-white
(511) 9, 12, 25

(260) AM 2021 111318 A

(210) AM 111318

(220) 2021 01 15

(731) Giorgi Kikabidze

Ilia Chavchavadze Av. 54a, 0179, Tbilisi,
Georgia

(740) Giorgi Taktakishvili

(540)

გურჯი ბებერი

Gurji Beberi

Гурджи Бебери

(591) Black-white

(511) 32, 33

(260) AM 2021 111319 A

(210) AM 111319

(220) 2021 01 15

(731) Giorgi Kikabidze

Ilia Chavchavadze Av. 54a, 0179, Tbilisi,
Georgia

(740) Giorgi Taktakishvili

(540)

გურჯი ზერო

Gurji Zero

Гурджи Зеро

(591) Black-white

(511) 32, 33

(260) AM 2021 111322 A

(210) AM 111322

(220) 2021 01 18

(731) LTD "Smart Capital Group"

Gergeti St. 3, Mtatsminda District, Tbilisi,
Georgia

(540)



(591) Blue, sky-blue, grey, white

(531) 26.05.02; 26.05.03; 27.05.01; 28.19; 29.01.13

(511) 35, 36, 37, 38, 39, 40

(260) AM 2021 111323 A

(210) AM 111323

(220) 2021 01 18

(731) AstraZeneca UK Limited

1 Francis Crick Avenue, Cambridge
Biomedical Campus, Cambridge,
CB2 0AA, United Kingdom

(740) Tamaz Shilakadze

(540)

ვაქსზევრია

(591) Black-white

(511) 5

(260) AM 2021 111325 A

(210) AM 111325

(220) 2021 01 18

(731) LTD "My Building"

Nutsubidze Plateau, IV mcr., corp. 17,
app. 75, Vake District, Tbilisi, Georgia

(540)



MBUILDING
CONSTRUCTION COMPANY

(591) Blue, dark sky-blue

(531) 27.05.01; 27.05.10; 27.05.21; 29.01.12

(511) 35, 37

(260) AM 2021 111326 A

(210) AM 111326

(220) 2021 01 18

(731) LTD "B-G-I Advisory Service Georgia"

Rustaveli Av. 18, 0108, Tbilisi, Georgia

(740) Giorgi Sarajishvili

(540)



EXPERTISE. EXPERIENCE. EFFICIENCY.

(591) Black, orange

(531) 26.04.07; 26.11.08; 27.05.01; 27.05.10;

27.05.11; 29.01.12

(511) 35, 45

(260) AM 2021 111333 A

(210) AM 111333

(220) 2021 01 20

(731) LLC "Information Communications
Systems"

Al. Kazbegi Av. 9a, Tbilisi, Georgia

(540)



(591) White, orange

(531) 26.01.01; 26.01.06; 26.01.18; 29.01.12;
29.01.12

(511) 39

(260) AM 2021 111335 A

(210) AM 111335

(220) 2021 01 21

(310) 2020 01688

(320) 2020 09 25

(330) AZ

(731) British American Tobacco (Brands) Inc.
(a Delaware corporation)
251 Little Falls Drive, Suite 100, Delaware,
Wilmington, 19808-1674, USA

(740) Tamar Kotchlamazashvili

(540)



(591) Red, ivory

(531) 26.04.02; 26.04.05; 26.04.22; 27.05.24;
29.01.12

(511) 34

(260) AM 2021 111410 A

(210) AM 111410

(220) 2021 01 25

(731) LLC "Online Molly"

V. Barnov/Tarkhnishvili St. 49/29, app. 6,
Tbilisi, Georgia

(540)



(591) Crimson, yellow, sky-blue

(531) 18.01.19; 26.04.02; 26.04.04; 26.04.22;
26.04.24; 27.03.01; 27.03.15; 29.01.13

(511) 35

(260) AM 2021 111449 A

(210) AM 111449

(220) 2021 01 28

(731) Giorgi Khechuashvili

Badri Shoshitishvili St., 6th Lane, app. 9,
Tbilisi, Georgia;

Ekaterine Tskhadadze

Guramishvili Av. 1, app. 10, Tbilisi, Georgia

(540)

GEORGE K

(591) Black-white

(511) 33, 35

(260) AM 2021 112594 A

(210) AM 112594

(220) 2021 01 18

(731) LTD "Smart Capital Group"

Gergeti St. 3, Mtatsminda District, Tbilisi,
Georgia

(540)



(591) White, grey, sky-blue, blue

(531) 26.05.02; 26.05.03; 27.05.01; 28.19; 29.01.13

(511) 35, 36, 37, 38, 39, 40

TRADEMARKS REGISTERED ACCORDING TO THE ACCELERATED PROCEDURE

The decision can be appealed at the Chamber of Appeal of Sakpatenti within 3 months from the publication.

(111) M 2021 34330 R
(151) 2021 07 20
(181) 2031 07 20
(210) AM 113776
(220) 2021 07 06
(732) JSC "Georgian Beer Company"
Vill. Saguramo, 3311, Mtskheta, Georgia
(540)

ზადენი
Zadeni
Задени

(591) Black-white
(511) 32

(111) M 2021 34331 R
(151) 2021 07 20
(181) 2031 07 20
(210) AM 113887
(220) 2021 07 15
(732) JSC "Microfinancial Organization
Swiss Capital"
Gamsakhurdia Ave. 34/Al. Kazbegi Ave. 2,
Tbilisi, Georgia
(540)

სკაპ
SCAPP

(591) Black-white
(511) 36

(111) M 2021 34332 R
(151) 2021 07 22
(181) 2031 07 22
(210) AM 113880
(220) 2021 07 15
(732) LTD "ICE-CO Company"
Abovyan St. 7, 0105, Tbilisi, Georgia
(740) Giorgi Taktakishvili
(540)



(591) Black-white
(531) 26.04.04; 26.04.05; 26.04.18; 28.19
(511) 3

(111) M 2021 34333 R
(151) 2021 07 22
(181) 2031 07 22
(210) AM 113988
(220) 2021 07 20
(732) LTD "Nikora"
M. Kavtaradze St. 11, 0180, Tbilisi, Georgia
(740) Melano Gogisvanidze
(540)

მანდოლინა

(591) Black-white
(511) 29

(111) M 2021 34334 R
(151) 2021 07 26
(181) 2031 07 26
(210) AM 113871
(220) 2021 07 14
(732) Aleksandre Buadze
Kavsadze St. 7a, 0179, Tbilisi, Georgia
(540)



(591) Black-white
(531) 27.05.04; 28.19
(511) 30

(111) M 2021 34335 R
(151) 2021 07 27
(181) 2031 07 27
(210) AM 113768
(220) 2021 07 05
(732) JSC "Corporation Kindzmarauli"
Ilia Chavchavadze St. 55, 4800, Kvareli,
Georgia
(540)

ოქროს ამფორა
Golden Amphora
Золотая Амфора

(591) Black-white
(511) 14

(111) M 2021 34336 R
(151) 2021 07 27
(181) 2031 07 27
(210) AM 113851
(220) 2021 07 12
(732) Oksana Voinova
Tank St., House 3, app. 14, Moscow, Russian
Federation
(740) Irakli Gvilia
(540)

SAKVARELI

(591) Black-white
(511) 32

(111) M 2021 34337 R
(151) 2021 07 28
(181) 2031 07 28
(210) AM 113712
(220) 2021 07 02
(732) Profsystem
G. Rcheulishvili St., corp. 6, app. 30,
Mtatsminda District, Tbilisi, Georgia
(540)



(591) White, red
(531) 26.04.02; 26.04.08; 26.04.09; 26.04.24;
26.13.25; 29.01.12
(511) 6

(111) M 2021 34338 R
(151) 2021 07 29
(181) 2031 07 29
(210) AM 113855
(220) 2021 07 12
(732) Ramaz Kharebava
VII mcr., corp. 7, app. 12, Gldani District,
0107, Tbilisi, Georgia
(740) Zurab Bezhashvili
(540)

სხვა თემა

(591) Black-white
(511) 43

(111) M 2021 34339 R
(151) 2021 07 29
(181) 2031 07 29
(210) AM 113859
(220) 2021 07 13
(732) LTD "Iveria"
Tevdore Mghdveli St. 53, 0154, Tbilisi,
Georgia
(740) Zurab Bezhashvili
(540)

მარო
Maro
Mapo

(591) Black-white
(511) 33

(111) M 2021 34340 R
(151) 2021 07 29
(181) 2031 07 29
(210) AM 113993
(220) 2021 07 21
(732) LLC "Sumbata"
King Parnavaz St. 14, Batumi, Georgia
(740) Irakli Gvilia
(540)



(591) Grey, white, black
(531) 02.09.01; 25.07.25; 26.04.02; 26.04.09
(511) 30

(111) M 2021 34341 R
(151) 2021 07 29
(181) 2031 07 29
(210) AM 113775
(220) 2021 07 06
(732) JSC "Georgian Beer Company"
Vill. Saguramo, 3311, Mtskheta, Georgia
(540)

ზენი საგურამო
Zeni Saguramo
Зени Сагурамо

(591) Black-white
 (526) საგურამო, Saguramo, Carypamo
 (511) 32

(111) M 2021 34342 R
 (151) 2021 07 30
 (181) 2031 07 30
 (210) AM 114036
 (220) 2021 07 26
 (732) Nobel Ilac Sanayii Ve Ticaret Anonim Sirketi
 Representative in Georgia
 Liberty Square 4, 0105, Tbilisi Georgia
 (740) Tinatin Tskhvediani
 (540)

NBL GYNOBIOTIC
ნკლ გინობიოტიკი

(591) Black-white
 (511) 5, 35

(111) M 2021 34343 R
 (151) 2021 08 03
 (181) 2031 08 03
 (210) AM 113969
 (220) 2021 07 16
 (732) JSC "Teliani Valley"
 Tbilisi Highway 3, 2200, Telavi,
 Georgia
 (540)

SOME SAY THAT WINE IS DIALOGUE BETWEEN MANER
 AND NATURE. IF SO THEN THE HIGHLY SKILLED GEORGIANS
 WHO MAKE WINE IN QVEVRIS ARE HAVING A REALLY INTENSE
 CONVERSATION. THE GLEKHURI JOURNEY STARTS WITH THE HARVEST-
 ONLY THEN CAN THE MANER SEE WHICH GRAPES SHOULD COME INTO
 THE QVEVRIS. SOMETIMES KUSI, KHAKHVI, TSOSKA, SAPERAU.
 EVERY DAY THE GRAPES SPEND IN THE QVEVRIS IS A DELICATE
 DANCE BETWEEN CLAY AND GRAPE AND SKIN AND SONG. ONLY
 THE MOST SKILLED MAKERS, INFUSED WITH THE WINEMAKING TRADITIONS
 OF MILLENNIA CAN TELL THAT PRECISE MOMENTS WHEN THE
 WINE IS READY. **Glekhuri** THE QVEVRI IS
 UNLOCKED AND IS RELEASED.

(591) FFFFFFF white, 000000 black
 (531) 27.05.01; 27.05.10
 (511) 33

(111) M 2021 34344 R
 (151) 2021 08 04
 (181) 2031 08 04
 (210) AM 113982
 (220) 2021 07 19
 (732) JSC "Teliani Valley"
 Tbilisi Highway 3, 2200, Telavi,
 Georgia

(540)



(591) FFFFFFF white, 000000 black
 (531) 26.04.02; 26.04.05; 26.04.22; 26.04.24;
 27.05.24
 (511) 33

(111) M 2021 34345 R
 (151) 2021 08 04
 (181) 2031 08 04
 (210) AM 113977
 (220) 2021 07 19
 (732) LTD "AD Group"
 Sanzona, corp. 7, app. 33, 0180, Tbilisi,
 Georgia
 (540)



(591) Blue, red, orange
 (531) 01.13.15; 27.05.01; 27.05.11; 28.19; 29.01.13
 (511) 1, 2

(111) M 2021 34346 R
 (151) 2021 08 04
 (181) 2031 08 04
 (210) AM 114028
 (220) 2021 07 23
 (732) LLC "Gasgo Motors"
 Vill. Kandaure, Sagarejo, Georgia
 (740) Giorgi Taktakishvili
 (540)



(591) Red, dark blue, white
 (531) 26.04.02; 26.04.22; 27.05.17; 29.01.13
 (511) 12

(111) M 2021 34347 R

(151) 2021 08 04

(181) 2031 08 04

(210) AM 114031

(220) 2021 07 23

(732) Michael Vardanyan

Bayron St. 3, app. 38, Yerevan, Armenia

(740) Giorgi Taktakishvili

(540)



(591) Bordeaux, yellow, golden, black

(531) 19.03.03; 25.07.25; 27.05.01; 27.05.09;
27.05.10; 29.01.15

(511) 34

(591) White, golden, grey, black

(531) 26.04.22; 27.05.01; 27.05.09; 27.05.10

(511) 34

(111) M 2021 34348 R

(151) 2021 08 04

(181) 2031 08 04

(210) AM 114032

(220) 2021 07 23

(732) International Masis Tabak LLC

10 Hrant Vardanyan St., 0802 Masis, Ararat
Region, Armenia

(740) Giorgi Taktakishvili

(540)



INTERNATIONAL TRADEMARKS FOR WHICH A DECISION ON GRANTING PROTECTIONS IS TAKEN

The decision can be appealed at the Chamber of Appeal of Sakpatenti within 3 months from the publication or at the Mtskheta District Court Administrative Cases Board (Address: №17, Samkhedro str., Mtskheta), within 1 month following the publication.

(260) AM 2021 107214 A*
 (800) 1515195
 (151) 2019 10 02
 (891) 2019 10 02
 (731) GELITA AG
 Uferstr. 7, 69412 Eberbach, Germany
 (540)

VEGIGEL

(591) Black, white
 (511)
 29 – Agar-agar for culinary purposes; dried pieces of agar jelly; gelatine substitutes for food based on plant proteins; all of the aforesaid goods, in particular in sheet form and powder form.

(260) AM 2021 107228 A*
 (800) 1515519
 (151) 2019 12 04
 (891) 2019 12 04
 (731) Obshchestvo s ogranichennoy otvetstvennostyu "Babkiny semechki"
 Prospekt Mira, 20, 3d floor, room 4, Tomsk,
 RU-634057 Tomskaya oblast, Russian
 Federation
 (540)



(591) White, gray, red, pink, burgundy, yellow, yellow, light brown and black
 (531) 24.09.03; 24.09.05; 25.01.10; 25.01.25; 28.05; 29.01.14
 (511)
 29 – Anchovy, not live; peanuts, prepared; beans, preserved; soya beans, preserved, for food; bouillon; ham; laver, preserved; peas, preserved; mushrooms, preserved; game, not live; jellies for food; fruit jellies; fruit-based snack food; fish-based snack foods; meat-based snack foods; game-based snack foods; vegetable-based snack foods; charcuterie; raisins; caviar; meat, tinned; vegetables, tinned; fish, tinned; fruits, tinned; bouillon concentrates; croquettes; vegetables, preserved; vegetables, dried; vegetables, cooked; oli-

ves, preserved; nuts, prepared; fish-based foodstuffs; fish, preserved; salted fish; vegetable salads; fruit salads; sunflower seeds, prepared; preparations for making bouillon; preparations for making soup; tripe; soups; vegetable soup preparations; cheese; dates; crystallized fruits; frozen fruits; fruit, preserved; fruit, stewed; potato flakes; potato chips; low-fat potato chips; fruit chips; fish roe, prepared.

30 – High-protein cereal bars; pancakes; noodle-based prepared meals; bread rolls; waffles; seaweed [condiment]; rice-based snack food; cereal-based snack food; dressings for salad; fruit jellies [confectionery]; confectionery for decorating Christmas trees; cakes; pastries; peanut confectionery; almond confectionery; pasta; ketchup [sauce]; sweetmeats [candy]; crackers; rice cakes; muesli; cookies; petit-beurre biscuits; pies; pizzas; popcorn; condiments; cereal preparations; gingerbread; spices; pelmeni [dumplings stuffed with meat]; confectionery; sauces [condiments]; seasonings; rusks; sandwiches; halvah; bread; unleavened bread; chips [cereal products]; corn flakes; oat flakes; cheeseburgers [sandwiches]; chocolate.

31 – Peanuts, fresh; almonds [fruits]; nuts [fruits].

(260) AM 2021 107321 A*
 (800) 1516316
 (151) 2019 12 04
 (891) 2019 12 04
 (731) Obshchestvo s ogranichennoy, otvetstvennostyu "Babkiny semechki"
 Prospekt Mira, 20, 3d floor, room 4, Tomsk,
 RU-634057 Tomskaya oblast, Russian
 Federation
 (540)

КИРИЕШКИ LIGHT

(591) Black, white
 (531) 28.05
 (511)
 29 – Meat; poultry, not live; game, not live; meat extracts; preserved, frozen, dried and cooked fruits and vegetables; peanuts, prepared; beans, preserved; bouillon; peas, preserved; mushrooms, preserved; meat jellies; jellies for food; charcuterie; raisins; caviar; meat, tinned; gherkins; shrimps, not live; prawns, not live; spiny lobsters, not live; onions, preserved; marmalade; vegetable oils for food; shellfish, not live; mussels, not live; meat, preserved; lobsters, not live;

crustaceans, not live; fish, not live; fish, preserved, dried fish; olives, preserved; coconut, desiccated; nuts, prepared; tomato purée; fruit salads; vegetable salads; bacon; pork; meat snacks, vegetable snacks, fish snacks; preparations for making soup; soups; vegetable soup preparations; cheese; oysters, not live; fish fillets; dates; crystallized fruits; frozen fruits; potato flakes; potato chips.

30 – Flour and preparations made from cereals; bread; salt; mustard; condiments; spices; pancakes; bread rolls; vermicelli [noodles]; pasta; quiches; corn, milled; corn, roasted; corn flour; meat pies; noodles; rice cakes; muesli; crushed oats; husked oats; molasses for food; pepper; peppers [seasonings]; pies; pizzas; oat-based food; rice; corn snacks; spaghetti; seasonings; rusks; breadcrumbs; sandwiches; bread; unleavened bread; chips [cereal products].

(260) AM 2021 108186 A*

(800) 1529649

(151) 2020 03 18

(891) 2020 03 18

(731) ENEOS Corporation

1-2, Otemachi 1-chome, Chiyoda-ku, Tokyo
100-8162, Japan

(540)

ENEOS X PRIME

(591) Black, white

(531) 27.05.01

(511)

4 – Automotive engine oils; lubricating oils; solid fuels; liquid fuels; gaseous fuels; mineral oils and greases for industrial purposes [not for fuel]; non-mineral oils and greases for industrial purposes [not for fuel]; non-chemical additives for engine oils.

(260) AM 2021 110064 A

(800) 1553761

(151) 2020 07 27

(891) 2020 07 27

(731) AIWA CO., LTD.

Metro AI Building 3th Floor, 1-54-5, Akabane,
Kita-ku, Tokyo 115-0045, Japan

(540)

aiwa

(591) Black, white

(531) 27.05.01

(511)

7 – AC generators [alternators]; DC generators; washing machines for household purposes [laundry]; dishwashers for household purposes; vacuum cleaners for household purposes; electric food blenders for household purposes; fruit presses, electric, for household purposes; fruit presses, electric, for industrial purposes; kitchen machines, electric.

sehold purposes; fruit presses, electric, for industrial purposes; kitchen machines, electric.

(260) AM 2021 110077 A

(800) 1554210

(151) 2020 06 02

(891) 2020 06 02

(731) Euro Games Technology Ltd.

4, "Maritsa" Str., "Vranya-Lozen-Triugulnika",
BG-1151 Sofia, Bulgaria

(540)

(591) Grey, beige, red, white and black

(531) 26.04.18; 27.05.02; 29.01.15

(511)

9 – Software; computer gaming software; computer software packages; computer operating system software; computer software, recorded; software drivers; virtual reality software; games software; entertainment software for computer games; computer programs for network management; operating computer software for main frame computers; monitors (computer hardware); computer hardware; apparatus for recording images; monitors (computer programs); computer game programs; computer programs for recorded games; apparatus for recording, transmission or reproduction of sound or images; communications servers [computer hardware]; electronic components for gambling machines; computer application software featuring games and gaming; computer software for the administration of on-line games and gaming; computer hardware for games and gaming; electronic components and computer software for gambling, gambling machines, gambling games on the internet and via telecommunication network.

28 – Gaming machines for gambling; chips for gambling; mah-jong; arcade games; gambling machines operating with coins, notes and cards; games; electronic games; parlor games; gaming chips; gaming tables; slot machines [gaming machines]; LCD game machines; slot machines and gaming devices; coin-operated amusement machines; roulette chips; poker chips; chips and dice [gaming equipment]; equipment for casinos; roulette tables; gaming roulette wheels; casino games; gambling machines and amusement machines, automatic and coin-operated; coin-operated amusement machines and/or electronic coin-operated amusement machines with or without the possibility of gain; boxes for coin-operated machines, slot machines and gaming machines; electronic or electrotechnical amusement machines and apparatus, gaming machines, coin-operated entertainment machines; housings for coin-operated machines, gaming equipment, gaming machines, machines for gambling; electrop-

pneumatic and electrical slot machines (gaming machines for gambling).

41 – Gambling; services related to gambling; gaming services for entertainment purposes; casino, gaming and gambling services; training in the development of software systems; provision of equipment for gambling halls; providing casino equipment [gambling]; gaming machine entertainment services; providing casino facilities [gambling]; gaming hall services; amusement arcade services; games equipment rental; rental of gaming machines; providing amusement arcade services; rental of gaming machines with images of fruits; editing or recording of sounds and images; sound recording and video entertainment services; hire of sound reproducing apparatus; provision of gaming equipment for casinos; providing of casino facilities; online gambling services; casino, gaming and gambling services; provision of gaming facilities, gaming halls, Internet casinos, online gaming services.

(260) AM 2021 110078 A

(800) 1554239

(151) 2020 08 20

(891) 2020 08 20

(731) JUKI Central Europe Sp. z o.o.

ul. Poleczki 21 C; PL-02-822 Warszawa,
Poland

(540)

JIN

(591) Black, white

(511)

7 – Sewing machines, including industrial sewing and sealing machines; motors and engines (except motors for land vehicles).

9 – Computers and computer software for apparatus for the control of sewing machines, in particular industrial sewing and sealing machines; electrical installations and electrical systems and circuits and parts therefor for sewing machines, in particular industrial sewing and sealing machines.

37 – Building construction; repair of agricultural and sewing machines; installation of assembly machines and production lines.

(260) AM 2021 110079 A

(800) 1554272

(151) 2020 09 03

(891) 2020 09 03

(731) FARCOM A.E.

Industrial Area New Redestos, GR-570 01
Thessaloniki, Greece

(540)

FARCOM

(591) Black, white

(511)

3 – Cosmetic products.

(260) AM 2021 110080 A

(800) 1554296

(151) 2020 09 11

(891) 2020 09 11

(731) Selena Marketing International Sp. z o. o.

ul. Strzegomska 2-4, PL-53-611 Wrocław,
Poland

(540)



(591) Navy blue and white

(531) 26.04.04; 26.04.05; 26.04.19; 27.01.02;
29.01.12

(511)

1 – Polyurethane adhesives; acrylic resins; unsaturated polyester resin based coatings; liquid coatings [chemical]; liquid elastomers; polymer dispersions; sealing compounds for use in building [chemical].

2 – Resinous coatings; acrylic coatings [paints].

17 – Polyurethane sealants; polyurethane foam for insulating purposes; polyurethane film for use as building insulation; weatherstrippings (non-metallic -); draught excluders of foam rubber strips; insulating bands; semi-processed resins; acrylic resins (insulating -); insulatory coatings of plastic resin; resins in liquid form [semi-processed]; semi-finished polyamide resins in the form of sheets; fluid seals; protective acrylic coatings in the form of paints for insulating purposes; silicone rubber sealants; silicon rubber joint sealing compounds; sealing membranes (non-metallic -); caulking compounds; sealing agents for use in the construction industry; weather strips (non-metallic -) for windows; insulating foils; insulating paints; insulating mastics.

(260) AM 2021 110085 A

(800) 1554431

(151) 2020 06 09

(891) 2020 06 09

(731) DAIMLER AG

Mercedesstraße 120, 70372 Stuttgart,
Germany

(540)



(591) Black and white
 (531) 01.01.02; 01.01.08
 (511)

3 – Bleaching preparations and other substances for laundry use; cleaning, polishing, scouring and abrasive preparations; soap; perfumery, essential oils; cosmetics; hair lotions; dentifrices; sandcloth; abrasive paper; adhesives for affixing false hair; adhesives for cosmetic purposes; alum stones [astringents]; antiperspirants [toiletries]; antistatic preparations for household purposes; bath salts, not for medical purposes; breath freshening sprays; cobblers' wax; cotton swabs for cosmetic purposes; cotton wool for cosmetic purposes; dental bleaching gels; denture polishes; emery cloth; emery paper; adhesives for affixing false eyelashes; false eyelashes; false nails; fumigation preparations [perfumes]; glass cloth [abrasive cloth]; sandpaper; incense; joss sticks; lacquer-removing preparations; preparations to make the leaves of plants shiny; sachets for perfuming linen; mouthwashes, not for medical purposes; paint stripping preparations; shampoos for pets [non-medicated grooming preparations]; polishing paper; potpourris [fragrances]; pumice stone; scented wood; shampoos; shaving stones [astringents]; shoemakers' wax; smoothing stones; tailors' wax; toiletry preparations; decorative transfers for cosmetic purposes; tripoli stone for polishing; varnish-removing preparations.

6 – Common metals and their alloys; metal materials for building and construction; buildings, transportable, of metal; railway material of metal; non-electric cables and wires of common metal; metal hardware; ironmongery; pipes and tubes of metal; safes [metal or non-metal]; building and construction materials and elements of metal; structures and transportable buildings of metal; statues and works of art of common metals; containers of metal for the storage and transportation of goods; packaging, wrapping and bundling articles, of metal; ores of metal; gold solder; silver solder; turnstiles.

9 – Scientific, nautical, surveying, photographic, cinematographic, optical, weighing, measuring, signalling, checking [supervision], life-saving and teaching apparatus and instruments; apparatus and instruments for conducting, switching, transforming, accumulating, regulating or controlling electricity; apparatus

for recording, transmission or reproduction of sound or images; magnetic data media; phonograph records; cash registers; calculating devices; data processing apparatus; computers; fire extinguishers; asbestos clothing for protection against fire; asbestos gloves for protection against accidents; asbestos screens for firemen; protective suits for aviators; fire boats; breathing apparatus for underwater swimming; breathing apparatus, except for artificial respiration; bullet-proof waistcoats; cabinets for loudspeakers; animated cartoons; spectacle cases, except for snow goggles; cases especially made for photographic apparatus and instruments; cases fitted with dissecting instruments [microscopy]; spectacle chains; cleaning apparatus for phonograph records; nose clips for divers and swimmers; clothing especially made for laboratories; clothing for protection against accidents, irradiation and fire; clothing for protection against fire; holders for electric coils; computer gaming software; computer keyboards; computer operating programs, recorded; computer peripheral devices; computer programs, recorded; computer programs, downloadable; computer software, recorded; holders for contact lenses; containers for contact lenses; containers for microscope slides; covers for electric outlets; diving equipment; divers' masks; diving suits; ear plugs for divers; electric installations for the remote control of industrial operations; electrified fences; electronic publications, downloadable; downloadable electronic publications; spectacle cords, except for snow goggles; spectacle frames, except for snow goggles; workmen's protective face-shields; filters for respiratory masks; fire beaters; fire blankets; fire engines; fire hose nozzles; furniture especially made for laboratories; galvanometers; gloves for divers; gloves for protection against accidents; gloves for protection against x-rays for industrial purposes; goggles for sports, except snow goggles; protective helmets, except ski helmets; protective helmets for sports, except ski helmets; riding helmets; interfaces for computers; juke boxes for computers; hands-free kits for telephones; knee-pads for workers; electronic locks; magnets; decorative magnets; protective masks; masts for wireless aerials; micrometer screws for optical instruments; monitors [computer programs]; mouse pads; safety nets; nets for protection against accidents; oxygen transvasing apparatus; plotters; protection devices against x-rays, not for medical purposes; protection devices for personal use against accidents; push buttons for bells; railway traffic safety appliances; reflecting discs for wear, for the prevention of traffic accidents; respirators for filtering air; respiratory masks, other than for artificial respiration; safety restraints, other than for vehicle seats and sports equipment; retorts' stands; road signs, luminous or mechanical; safety tarpaulins; shoes for protection against accidents, irradiation and fire; signs, luminous; solderers' helmets; spark-guards; stands for photographic apparatus; steering apparatus, automatic, for vehicles; teeth protectors; theft

prevention installations, electric; tripods for cameras; vehicle breakdown warning triangles; wrist rests for use with computers; credit cards; electronic machines for reading credit cards; credit card terminals; software for facilitating secure credit card transactions.

11 – Lighting; lighting reflectors; air-conditioning installations; heaters for vehicles; parts and accessories for the aforesaid goods.

12 – Vehicles; apparatus for locomotion by land, air or water; air bags [safety devices for automobiles]; air pumps [vehicle accessories]; anti-glare devices for vehicles; anti-skid chains; anti-theft alarms for vehicles; anti-theft devices for vehicles; coachwork for motor vehicles; automobile chains; automobile chassis; automobile hoods; automobile tyres; sun visors for automobiles; axle journals; axles for vehicles; prams; pushchair hoods; balance weights for vehicle wheels; bands for wheel hubs; torsion bars for vehicles; baskets adapted for bicycles; bells for bicycles; sleeping berths for vehicles; bicycle bells; bicycle brakes; bicycle chains; bicycle frames; bicycle handlebars; pumps for bicycle tyres; rims for bicycle wheels; bicycle saddles; spokes for bicycle wheels; bicycle kickstands; bicycle tyres; boat hooks; masts for boats; bodies for vehicles; bogies for railway cars; brake linings for vehicles; brake segments for vehicles; brake shoes for vehicles; brakes for vehicles; buffers for railway rolling stock; vehicle bumpers; bumpers for automobiles; caps for vehicle fuel tanks; luggage carriers for vehicles; casings for pneumatic tyres; casters for trolleys [vehicles]; trolleys [vehicles]; vehicle chassis; cleaning trolleys; cleats [nautical]; spoke clips for wheels; clutches for land vehicles; connecting rods for land vehicles, other than parts of motors and engines; torque converters for land vehicles; railway couplings; couplings for land vehicles; seat covers for vehicles; covers for vehicle steering wheels; crankcases for land vehicle components, other than for engines; bicycle cranks; cycle bells; hubs for bicycle wheels; bicycle mudguards; cycle stands; davits for boats; direction indicators for bicycles; signal arms for vehicles; disengaging gear for ships; doors for vehicles; dress guards for bicycles; driving chains for land vehicles; driving motors for land vehicles; ejector seats for aircraft; elevating tailgates (Am.) [parts of land vehicles]; traction engines; engines for land vehicles; fenders for ships; flanges for railway wheel tyres; freewheels for land vehicles; funnels for locomotives; funnels for ships; gear boxes for land vehicles; gearing for land vehicles; gears for cycles; trolleys; security harness for vehicle seats; head-rests for vehicle seats; pushchair hoods; hoods for vehicle engines; hoods for vehicles; horns for vehicles; hub caps; hubs for vehicle wheels; ship hulls; hydraulic circuits for vehicles; inclined ways for boats; adhesive rubber patches for repairing inner tubes; repair outfits for inner tubes; inner tubes for bicycle tyres; inner tubes for pneumatic tyres; jet engines for land vehi-

les; tailboard lifts [parts of land vehicles]; luggage nets for vehicles; two-wheeled trolleys; mine cart wheels; rearview mirrors; bicycle motors; motors, electric, for land vehicles; mudguards; non-skid devices for vehicle tyres; oars; paddles for canoes; panniers adapted for bicycles; bicycle pedals; pneumatic tyres; portholes; power tailgates (Am.) [parts of land vehicles]; propulsion mechanisms for land vehicles; pushchairs; reduction gears for land vehicles; reversing alarms for vehicles; rims for vehicle wheels; rowlocks; rudders; vehicle running boards; saddle covers for bicycles or motorcycles; saddles for bicycles, cycles or motorcycles; safety belts for vehicle seats; safety seats for children, for vehicles; screw-propellers; marine propellers; screws [propellers] for ships; sculls; vehicle seats; timbers [frames] for ships; steering gears for ships; vehicle shock absorbers; shock absorbers for automobiles; shock absorbing springs for vehicles; shopping trolleys; ski carriers for cars; spars for ships; spikes for tyres; spoke clips for wheels; vehicle wheel spokes; steering wheels for vehicles; vehicle suspension springs; tipping apparatus, parts of trucks and waggons; tipping bodies for lorries; tyres for vehicle wheels; solid tyres for vehicle wheels; trailer hitches for vehicles; transmission chains for land vehicles; transmission shafts for land vehicles; transmissions for land vehicles; treads for retreading tyres; treads for vehicles [tractor type]; tubeless tyres for bicycles; turbines for land vehicles; undercarriages for vehicles; upholstery for vehicles; valves for vehicle tyres; vehicle covers [shaped]; vehicle tires; vehicle wheels; audible warning systems for bicycles; human-powered trolleys and carts; bicycle wheels; windows for vehicles; windshield wipers; windscreens; cigarette lighters for automobiles.

14 – Precious metals and their alloys; jewels; ornaments [jewellery, jewelry (Am.)]; precious stones; clocks; chronometrical instruments; agates; anchors [clock- and watchmaking]; barrels [clock- and watchmaking]; cases for clock- and watchmaking; cases for watches [presentation]; watch chains; clock cases; clock hands; clockworks; coins; copper tokens; dials [clock- and watchmaking]; ornaments of jet; jet, unwrought or semi-wrought; jewel cases; key rings [split rings with trinket or decorative fob]; medals; movements for clocks and watches; olivine [gems]; pearls made of ambroid [pressed amber]; pendulums [clock- and watchmaking]; semi-precious stones; spinel [precious stones]; watch springs; watch bands; watch cases [parts of watches]; watch glasses.

16 – Paper and cardboard; bags and articles for packaging, wrapping and storage of paper, cardboard or plastics; printed matter; bookbinding material; photographs [printed]; stationery; adhesives for stationery or household purposes; artists' materials; paintbrushes; typewriters and office machines (except furniture); teaching materials [except apparatus]; plastic materials for packaging; printing fonts; printing

blocks; adhesive tapes for stationery or household purposes; architects' models; garbage bags of paper or of plastics; bags for microwave cooking; balls for ball-point pens; marking chalk; holders for cheque books; money clips; composing frames [printing]; composing sticks; engraving plates; galley racks [printing]; graining combs; hand labelling appliances; passport holders; house painters' rollers; apparatus for mounting photographs; packaging material made of starches; photograph stands; printers' blankets, not of textile; printers' reglets; self-adhesive tapes for stationery or household purposes; sheets of reclaimed cellulose for wrapping; steatite [tailor's chalk]; tailors' chalk; trays for sorting and counting money; vignetting apparatus; wristbands for the retention of writing instruments.

18 – Leather and imitations of leather; animal skins, hides; trunks and suitcases; umbrellas; parasols; walking sticks; whips; harnesses; saddlery; attaché cases; rucksacks; game bags [hunting accessories]; net bags for shopping; nose bags [feed bags]; sports bags; shoulder belts [straps] of leather; beach bags; briefcases; card cases [notecases]; chain mesh purses; clothing for pets; collars for animals; umbrella covers; covers for animals; dog collars; handbag frames; frames for umbrellas or parasols; goldbeaters' skin; handbags; suitcase handles; cane handles; haversacks; horse blankets; horseshoes; slings for carrying infants; kneepads for horses; music cases; muzzles; pocket wallets; purses; umbrella or parasol ribs; school bags; shopping bags; straps for skates; sling bags for carrying infants; slings for carrying infants; straps for soldiers' equipment; umbrella handles; umbrella rings; umbrella sticks; vanity cases, not fitted; walking stick seats; roller bags.

20 – Furniture; mirrors [looking glasses]; picture frames; air cushions, not for medical purposes; air mattresses, not for medical purposes; air pillows, not for medical purposes; yellow amber; animal hooves; animal horns; stuffed animals; stag antlers; works of art of wood, wax, plaster or plastic; comb foundations for beehives; bamboo; fishing baskets; bead curtains for decoration; bed casters, not of metal; bedding, except linen; vice benches [furniture]; bins, not of metal; stuffed birds; slatted indoor blinds; bolsters; bottle caps, not of metal; bottle closures, not of metal; nesting boxes; beds for household pets; picture frame brackets; mooring buoys, non-metallic; busts of wood, wax, plaster or plastic; cabinet work; sealing caps, not of metal; furniture casters, not of metal; wind chimes [decoration]; animal claws; clothes hooks, not of metal; coat hangers; coathooks, not of metal; funerary caskets; coral; corozo; costume stands; garment covers [storage]; covers for clothing [wardrobe]; curtain holders, not of textile material; curtain hooks; curtain rails; curtain rings; curtain rods; curtain rollers; curtain tie-backs; cushions; pet cushions; dog kennels; door fittings, not of metal; door handles, not

of metal; doors for furniture; mannequins and tailors' dummies; fans for personal use, non-electric; figurines [statuettes] of wood, wax, plaster or plastic; screens for fireplaces [furniture]; furniture fittings, not of metal; floating containers, not of metal; flower-pot pedestals; funerary urns; coat hangers; honeycombs; horn, unworked or semi-worked; house numbers, not of metal, non-luminous; nesting boxes for household pets; indoor window blinds [furniture]; mats for infant playpens; infant walkers; inflatable publicity objects; ivory, unworked or semi-worked; kennels for household pets; mats, removable, for sinks; mattresses; meerschau; mobiles [decoration]; mouldings for picture frames; mother-of-pearl, unworked or semi-worked; oyster shells; pillows; plaited straw, except matting; straw plaits; rattan; reeds [plaiting materials]; stair rods; saw horses; shells; statues of wood, wax, plaster or plastic; straw edgings; table tops; tortoiseshell; imitation tortoiseshell; wax figures; whalebone, unworked or semi-worked; works of art made of wood; works of art of wood, wax, plaster or plastic.

21 – Household or kitchen utensils and containers; combs and sponges; brushes; material for brush-making; articles for cleaning purposes; steelwool; glass, unworked or semi-worked, except building glass; glassware, porcelain and earthenware; indoor aquaria; aquarium hoods; bird baths; birdcages; cages for household pets; cosmetic utensils; deodorizing apparatus for personal use; feeding troughs; feeding troughs for animals; floss for dental purposes; fly catchers [traps or whisks]; fly swatters; gardening gloves; indoor terrariums [plant cultivation]; indoor terrariums [vivariums]; insect traps; litter boxes for pets; appliances for removing make-up, non-electric; mangers for animals; mangers for livestock; menu card holders; mouse traps; nest eggs, artificial; nozzles for watering hose; nozzles for watering cans; poultry rings; powder compacts; powder puffs; rat traps; rings for birds; lawn sprinklers; syringes for watering flowers and plants; watering devices; watering cans; electric devices for attracting and killing insects; electric make-up removing appliances.

24 – Textiles; bed covers; table linen of textile; banners of textile or plastic; bunting of textile or plastic; furniture coverings of plastic; curtains of textile or plastic; flags of textile or plastic; plastic material [substitute for fabrics]; shower curtains of textile or plastic; sleeping bags for camping.

25 – Clothing, except ski wear, ski balaclavas, ski suits for competition, snowboard jackets, snow boarding suits, snow suits, thermally insulated clothing, sweat-absorbent underwear, ski gloves; footwear, except ski footwear, snowboarding boots; hats, except ski hats; boot uppers; heelpieces for footwear; iron fittings for boots; non-slipping devices for boots; welts for boots; cap peaks; dress shields; metal fittings for footwear; studs for football boots; tips for footwear; footwear uppers; hat frames [skeletons]; heelpieces

for stockings; heels; inner soles; ready-made linings [parts of clothing]; non-slipping devices for footwear; pockets for clothing; shirt fronts; shirt yokes; welts for footwear; soles for footwear; cap visors.

27 – Carpets; door mats; mats; linoleum; carpet tiles for covering floors; non-textile wall coverings; artificial turf; mats of woven rope for ski slopes; wallpaper.

28 – Games; toys; gymnastic and sporting articles, except for skis and snowboards; decorations for christmas trees; bags especially designed for surfboards; lures for fishing; billiard cue tips; billiard markers; pool table cushions; bite indicators [fishing tackle]; bite sensors [fishing tackle]; bladders of balls for games; chalk for billiard cues; christmas tree stands; christmas trees of synthetic material; confetti; cricket bags; divot repair tools [golf accessories]; rollers for stationary exercise bicycles; fairground ride apparatus; fish hooks; floats for fishing; golf bags, with or without wheels; gut for fishing; gut for rackets; kite reels; fishing lines; masts for sailboards; novelty toys for playing jokes; protective paddings [parts of sports suits]; paintballs [ammunition for paintball guns] [sports apparatus]; caps for pistols [toys]; strings for rackets; reels for fishing; rosin used by athletes; surfboard leashes; swimming floats; swimming belts; swimming jackets; water wings.

35 – Advertising; business management; business administration; office functions; rental of advertising space; commercial information and advice for consumers [consumer advice shop]; auctioneering services; business investigations; business research; commercial information agency services; presentation of goods on communication media, for retail purposes; price comparison services; economic forecasting; organization of exhibitions for commercial or advertising purposes; export-import agency services; market research; modelling for advertising or sales promotion; news clipping services; rental of office machinery and equipment; opinion polling; organization of exhibitions for commercial or advertising purposes; organization of trade fairs for commercial or advertising purposes; procurement services for others [purchasing goods and services for other businesses]; personnel selection using psychological testing; public relations services; publicity material rental; rental of advertising time on communication media; rental of photocopying machines; rental of vending machines; shop window dressing; sponsorship search.

36 – Insurance services; financial services; monetary affairs; real estate affairs; charitable fund raising; organization of monetary collections; financial consultancy; insurance consultancy; deposits of valuables; financial information; financial sponsorship; insurance information; safe deposit services; processing of credit card payments; issuance of credit cards; processing of credit card payments; provision of credit

cards; financial services relating to credit cards; management of credit card services; bank card, credit card, debit card and electronic payment card services.

37 – Construction; assembly and installation, and conducting of modifications to increase performance (tuning) of motor vehicles; airplane maintenance and repair; anti-rust treatment for vehicles; artificial snow-making services; boiler cleaning and repair; building construction supervision; cleaning of buildings [exterior surface]; cleaning of building interiors; rental of bulldozers; burner maintenance and repair; automobile washing; chimney sweeping; diaper cleaning; dry cleaning; vehicle cleaning; rental of cleaning machines; cleaning of clothing; installation, maintenance and repair of computer hardware; rental of construction equipment; construction information; demolition of buildings; disinfecting; drilling of wells; rental of excavators; vermin exterminating, other than for agriculture, aquaculture, horticulture and forestry; mining extraction; film projector repair and maintenance; fur care, cleaning and repair; furniture maintenance; vehicle greasing; provision of construction information; repair information; linen ironing; laundering; leather care, cleaning and repair; machinery installation, maintenance and repair; vehicle maintenance; motor vehicle maintenance and repair; office machines and equipment installation, maintenance and repair; painting, interior and exterior; paper hanging; pipeline construction and maintenance; vehicle polishing; clothing ironing; quarrying services; rat exterminating; refilling of toner cartridges; rental of cranes [construction equipment]; rental of road sweeping machines; rustproofing; safe maintenance and repair; vehicle service stations [refuelling and maintenance]; shipbuilding; painting or repair of signs; street cleaning; strong-room maintenance and repair; swimming-pool maintenance; varnishing; vehicle cleaning; vehicle washing; washing; washing of linen; window cleaning.

39 – Transport; packaging and storage of goods; arranging of transportation for travel tours; boat rental; freight brokerage [forwarding (Am.)]; transport brokerage; operating canal locks; car parking; car rental; motor coach rental; distribution of energy; rental of diving bells; rental of diving suits; electricity distribution; escorting of travellers; franking of mail; freighting; freight forwarding; refrigerator rental; garage rental; horse rental; ice-breaking; storage information; transportation information; launching of satellites for others; parking place rental; transport by pipeline; refloating of ships; rental of motor racing cars; rental of storage containers; rental of vehicle roof racks; rental of warehouses; rental of wheelchairs; underwater salvage; salvage of ships; salvaging; shipbrokerage; sightseeing [tourism]; traffic information; rental of lorries; vehicle rental; water distribution; water supplying.

41 – Education; training; entertainment services; sporting and cultural activities; booking of seats for shows; publication of books; calligraphy services; rental of skin diving equipment; education information; electronic publishing services; entertainment information; recreation information; sign language interpretation; layout services, other than for advertising purposes; microfilming; modelling for artists; rental of movie projectors and accessories; providing online electronic publications, not downloadable; online publication of electronic books and journals; publication of texts, other than publicity texts; rental of radio and television sets; rental of video cassette recorders; rental of audio equipment; rental of video cameras; rental of lighting apparatus for theatrical sets or television studios; rental of show scenery; rental of sports equipment, except vehicles; rental of stage scenery; timing of sports events; ticket agency services [entertainment]; translation services; videotaping.

43 – Services for providing food and drink; temporary accommodation; temporary accommodation reservations; boarding house bookings; rental of transportable buildings; hotel reservations; rental of chairs, tables, table linen, glassware; rental of tents.

(260) AM 2021 110086 A
 (800) 1554467
 (151) 2020 07 17
 (891) 2020 07 17
 (731) Limited Liability Company "Russian Mining Chemical Company"
 Lyusinovskaya ul., d. 36, str. 1, et. 8,
 RU-115093 Moskva, Russian Federation

(540)



(591) Orange and its tinctures and black
 (531) 01.15.19; 26.05.02; 26.05.04; 29.01.12
 (511)

1 – Bentonite; dolomite for industrial purposes; flocculants; magnesium silicate; chemicals for use in forestry, except fungicides, herbicides, insecticides and parasiticides; magnesite; magnesium chloride; alkaline-earth metals; alkaline earth metal salts; salts [fertilizers]; talc (magnesium silicate); fertilizers; horticultural chemicals, except fungicides, herbicides, insecticides and parasiticides; chemicals for industrial use; agricultural chemicals, except fungicides, herbicides, insecticides and parasiticides; chemical reagents, other than for medical or veterinary purposes.

(260) AM 2021 110090 A
 (800) 1554559
 (151) 2020 07 13
 (891) 2020 07 13
 (731) Great Wall Motor Company Limited
 2266 Chaoyang South Street, Baoding,
 071000 Hebei, China

(540)

The logo for GWM consists of the letters 'GWM' in a bold, black, sans-serif font.

(591) Black, white
 (531) 27.05.17; 27.05.23
 (511)

12 – Vehicles for locomotion by land, air, water or rail; automobiles; trucks; motor coaches; off-road vehicles; aerial conveyors; automobile tires; electric cars; automobile chassis; motor homes.

35 – Advertising agency services; publicity; import-export agency services; auctioneering; business management assistance; business management consultancy; business auditing; procurement services for others [purchasing goods and services for other businesses]; sales promotion for others; tender offer services.

37 – Maintenance and repair of land vehicles; vehicle service stations [refuelling and maintenance]; vehicle petrol station services; retreading of tires; vehicle polishing; vehicle cleaning; vehicle lubrication; anti-rust treatment for vehicles; vehicle breakdown repair services; vehicle maintenance.

(260) AM 2021 110106 A
 (800) 1150215
 (151) 2013 01 31
 (891) 2020 09 16
 (731) GLOBACHEM, naamloze vennootschap
 Lichtenberglaan 2019, B-3800 Sint-Truiden,
 Belgium

(540)

GLOBARYLL

(591) Black, white
 (511)

1 – Chemicals used in industry, science, photography, agriculture, horticulture, silviculture, including plant growth regulators.

5 – Preparations for destroying vermin; fungicides, herbicides.

(260) AM 2021 110148 A
 (800) 1554851
 (151) 2020 07 15
 (891) 2020 07 15
 (731) Bugatti International S.A.
 412F route d'Esch, L-1030 Luxembourg,
 Luxembourg

(540)



(591) Red, white, black, silver

(531) 24.11.18; 26.01.02; 26.01.12; 26.01.18;
26.11.14; 27.05.03; 27.05.09; 27.05.22;
27.05.22; 29.01.14

(511)

8 – Hand tools and implements, hand-operated; cutlery; side arms, except firearms; razors; razors, electric or non-electric; razor blades, razor strops, razor cases, razor knives, razor blade dispensers, cartridges containing razor blades, cassettes for razor blades, containers adapted for razor blades.

9 – Scientific, research, navigation, surveying, photographic, cinematographic, audiovisual, optical, weighing, measuring, signalling, detecting, testing, inspecting, life-saving and teaching apparatus and instruments; apparatus and instruments for conducting, switching, transforming, accumulating, regulating or controlling the distribution or use of electricity; apparatus and instruments for recording, transmitting, reproducing or processing sound, images or data; recorded and downloadable media, computer software, blank digital or analogue recording and storage media; mechanisms for coin-operated apparatus; cash registers, calculating devices; computers and computer peripheral devices; diving suits, divers' masks, ear plugs for divers, nose clips for divers and swimmers, gloves for divers, breathing apparatus for underwater swimming; fire-extinguishing apparatus; power cables, chargers, battery chargers, portable chargers, charging docks, battery cases, cases adapted for battery chargers; headphones, in-ear headphones, cases for headphones, adapter cables for headphones, ear pads for headphones, two-way plugs for headphones, headphone stands; loudspeakers, loudspeaker stands, loudspeaker systems, loudspeaker cables, racks for loudspeakers, cases for loudspeakers, loudspeakers with built in amplifiers; soundbars, hi-fi sound systems, audio amplifiers, audio cable; audio apparatus; parts and fittings for audio apparatus; audio players, audio devices and radio receivers, racks adapted to house audio apparatus.

(260) AM 2021 110155 A

(800) 1555093

(151) 2020 08 11

(891) 2020 08 11

(731) Apple Inc.

One Apple Park Way, Cupertino CA 95014,
USA

(540)

SERVICETALK

(591) Black, white

(511)

9 – Computer software for creating and hosting websites, mobile computer software application development, database development and management and network infrastructure management; computer software used in developing other computer software applications; database management computer software; computer software for administration and operation of computer networks.

(260) AM 2021 110157 A

(800) 1555195

(151) 2020 08 24

(891) 2020 08 24

(731) Becton, Dickinson and Company

1 Becton Drive, Franklin Lakes NJ 07417,
USA

(540)

BD FACSFOCUS

(591) Black, white

(511)

9 – Sample enrichment system, comprised of hardware for research purposes.

(260) AM 2021 110158 A

(800) 1555245

(151) 2020 02 12

(891) 2020 02 12

(731) Volkswagen Aktiengesellschaft

Berliner Ring 2, 38440 Wolfsburg, Germany

(540)



(591) Black, white

(531) 24.11.25; 26.01.01; 26.01.03; 26.01.18;
27.05.22

(511)

4 – Wax [raw material]; candles and wicks for lighting; industrial oils and greases, motor oil; industrial oil, oleine, oil-gas, paraffin, rape oil for industrial purposes, stearine, sunflower oil for industrial purposes; industrial grease; industrial wax; lubricants, mazut, grease for belts, non-slipping preparations for belts, lubricating grease, lubricating oil; dust removing preparations, dust absorbing compositions; dust controlling compositions; fuels (including motor spirit) and

illuminants; gas for lighting, carburants, fuel, petrol, fuel gas, firewood, fuel oil, methylated spirit, fuel with an alcohol base; vaporized fuel mixtures, ethanol [fuel], diesel oil, kerosene, mineral fuel; naphtha; non-chemical fuel additives; petroleum, raw or refined, petroleum ether, producer gas, coal naphtha; solidified gases; firelighters; electrical energy; benzene fuel; xylene fuel; additives in connection with the aforesaid goods, included in this class.

5 – Pharmaceuticals; dietetic food and products, preparations and nutritional supplements adapted for medical and veterinary purposes; dental preparations and articles; sanitary preparations and articles; pest control preparations and articles; preparations for destroying noxious animals; fungicides; herbicides; medical and veterinary preparations and articles; food for babies; plasters, materials for dressings; dressings, medical; medicine cases, portable, filled; first-aid boxes, filled; surgical dressings; teeth filling material; dental impression materials; disinfectants; antiseptics; air deodorizing preparations; animal washes [insecticides]; insecticides.

6 – Building and construction materials and elements of metal; ironmongery; bag hangers of metal; labels of metal; doors, gates, windows and window coverings of metal; outdoor blinds of metal; structures and transportable buildings of metal; statues and works of art of common metals; metal containers for the storage and transportation of goods; common metals and their alloys; railway material of metal; non-electric cables and wires of common metal; metal hardware and small items of metal hardware; badges of metal for vehicles; locks of metal for vehicles; registration plates of metal; signboards of metal; wheel clamps [boots]; tool boxes of metal, empty; tool chests of metal, empty; metal ramps for use with vehicles; pipes and tubes of metal; cashboxes [metal or non-metal]; safes [metal or non-metal]; safes, electronic; ores of metal; foils of metal for wrapping and packaging; ducts of metal for ventilating and air-conditioning installations; building materials of metal; materials of metal for funicular railway permanent ways; steel wire; binding screws of metal for cables; shims; door closers of metal, non-electric; chests of metal; cattle chains; rods of metal for brazing and welding; anchors; handcuffs; weather- or wind-vanes of metal; tree protectors of metal; traps for wild animals; bronzes for tombstones; parts and accessories for all the above mentioned goods, included in this class.

7 – Power operated tools; propulsion mechanisms, other than for land vehicles; machines for plastics working, for manufacturing, repairing and dismantling of land, air and water vehicles; electromechanical machines for chemical industry, agricultural machines, mineworking machines; machines for the textile industry; machines for the food industry; machines for the beverage industry [pumps]; construction machines; packing machines; agricultural, earthmoving,

construction, oil and gas extraction and mining equipment; machine tools; motors, other than for land vehicles; motors, electric, other than for land vehicles; parts of motors of all kinds; parts of electric motors of all kinds; diesel engines, not for land vehicles; glow plugs for diesel engines; gas engines; gasoline engines not for land vehicles; hydraulic engines and motors; superchargers; turbocompressors; pumps, compressors and blowers; industrial robots; oil pumps for vehicles; lubricators [parts of machines]; couplings, other than for land vehicles; camshafts for vehicle engines; power transmissions and gearing for machines [not for land vehicles]; parts of clutches/couplings and transmissions and power transmission devices, included in this class; moving and handling equipment; generators of electricity; machines and machine tools for treatment of materials and for manufacturing; motors and drives as well as machine parts for machines and machine tools for material treatment and production; dispensing machines; sweeping, cleaning, washing and laundering machines; agricultural machines; shredders [machines] for industrial use; lawnmowers [machines]; agricultural implements, other than hand-operated; wind turbines; vending machines; dispensing machines [other than vending machines]; woodworking machines; papermaking machines; printing machines for use on sheet metal; friezing machines; sizing machines; sausage making machines; bottle washing machines; cigarette machines for industrial purposes; leather-working machines; rotary steam presses, portable, for fabrics; bicycle assembling machines; potters' wheels; engraving machines; cord making machines; adhesive tape dispensers [machines]; kerb making machines; mixing machines; washing apparatus; disintegrators; superheaters; glass-working machines; electromechanical machines for chemical industry; rinsing machines; puddling machines; oil refining machines; agitators; jacks [machines]; pneumatic jacks; metalworking machines; foundry machines; steam engines; stitching machines; screwdrivers, electric; filters for cleaning cooling air, for engines; welding machines, electric; washing installations for vehicles; hydrogen dispensing pumps for service stations; fuel dispensing pumps for service stations; incubators for eggs; parts and accessories for all the above mentioned goods, included in this class.

8 – Hygienic and beauty implements for humans and animals; edged and blunt weapons; cutlery, and food preparation implements being kitchen knives, cutting and grinding implements; hand-operated tools and implements for treatment of materials, and for construction, repair and maintenance services; lifting tools; hand-operated tools and implements for use in agriculture, horticulture and forestry, for the construction of machines, apparatus and vehicles and for the building industry; scraping tools [hand tools]; spanners [hand tools]; cutlery; table cutlery [knives, forks and spoons]; forks; scissors; side arms, other than firearms; swords; razors; razor cases; manicure sets;

sharpening stones; agricultural sprayers [hand operated]; livestock marking tools; harpoons; hand tools, hand-operated; lifting jacks, hand-operated; brick trowels; parts and fittings of all aforesaid goods, included in this class; metal tool handles.

9 – Scientific, research, navigation, surveying, photographic, cinematographic, audiovisual, optical, weighing, measuring, signalling, detecting, testing, inspecting, life-saving and teaching apparatus and instruments; apparatus and instruments for conducting, switching, transforming, accumulating, regulating or controlling the distribution or use of electricity; apparatus and instruments for recording, transmitting, reproducing or processing sound, images or data; recorded and downloadable media, computer software, blank digital or analogue recording and storage media; information technology and audiovisual equipment; magnets, magnetizers and demagnetizers; apparatus, instruments and cables for electricity; optical devices, enhancers and correctors; safety, security, protection and signalling devices; diving equipment; navigation, guidance, tracking, targeting and map making devices; measuring, detecting and monitoring instruments, indicators and controllers; automatic indicators of low pressure in vehicle tyres; mileage recorders for vehicles; scientific research and laboratory apparatus, educational apparatus and simulators; eyewear, spectacle cases, binoculars, magnifying glasses [optics]; sunglasses; vehicle breakdown warning triangles; warning lamps for vehicles; batteries, electric and their parts, accumulators, electric and their parts, fuel cells and their parts, solar batteries; batteries, electric, for vehicles; chargers for batteries, electric; burglar alarms, fire alarms, smoke alarms, gas alarms; fire extinguishers; scales; spirit levels; compasses for measuring; rulers [measuring instruments], acid hydrometers, quantity indicators; electronic control devices and power supply apparatus for vehicle headlights and their parts, light-emitting diodes [LED], electronic power controllers; electric and electronic controllers, regulating apparatus and control instruments; simulators for the steering and control of vehicles; voltage regulators for vehicles; speed indicators; revolution counters; measuring apparatus and measuring instruments; lifesaving apparatus and equipment, namely life-saving rafts, fire escapes, safety nets, safety tarpaulins, life belts, life buoys, life jackets; electrical fuses, relays, electric; laser, not for medical purposes, laser pointers; remote control apparatus, remote controls; aerials; navigation apparatus for vehicles [on-board computers]; mobile telephones; telephone apparatus; television apparatus; video telephones; radios; directional compasses, navigating apparatus [compasses], navigational instruments; telematic apparatus; telematic terminal apparatus; magnetical, electronic and optical recording medias, phonograph records, compact discs, DVDs and other digital recording medias, sound recording carriers, juke boxes, musical, compact discs [read-only memory], downloadable

music files, headphones, loudspeakers, cabinets for loudspeakers, signs, luminous, compact disc players, DVD players, video telephones, phototelegraphy apparatus; projection apparatus, cameras [photography]; films, exposed; film cameras, photocopiers, electronic translation apparatus (computers), electronic pocket translator; encoded magnetic cards, integrated circuit cards [smart cards], encoded telephone cards; coin-operated mechanisms; automated teller machines [ATM]; cash registers, calculating devices; data processing equipment; computers; electronic agendas; facsimile machines; monitors [computer hardware] and monitors [computer programs]; computer peripheral devices; computer programs for use in the autonomous driving of vehicles; computer programs for use in the autonomous navigation of vehicles; computer programs for use in autonomous control of vehicles; computer programs, recorded and downloadable, especially electronic data compilation; computer software platforms, recorded or downloadable; software; application software; pocket calculators; electronic publications, downloadable; downloadable image files; crash test dummies, microscopes; cables, electric; socket outlets; igniting apparatus, electric, for igniting at a distance; radiological apparatus for industrial purposes; head protection; electronic locks; electronic controllers and electronic control systems; security tokens [encryption devices]; electronic access control systems for interlocking doors; thermal imaging cameras; scales with body mass analysers; covers for tablet computers; black boxes [data recorders]; digital weather stations; charging stations for electric vehicles; interactive touch screen terminals; smart rings; electric and electronic effects units for musical instruments; audio interfaces; equalizers [audio apparatus]; parking sensors for vehicles; teaching robots; humanoid robots with artificial intelligence; personal digital assistants [PDAs]; rearview cameras for vehicles; electric wiring harnesses for vehicles; telecommunication apparatus in the form of jewellery; data gloves; electronic controls for motors; parts and fittings of all aforesaid goods, included in this class.

10 – Surgical, medical, dental and veterinary instruments and apparatus; artificial limbs, eyes and teeth; therapeutic devices adapted for the disabled; massage apparatus; apparatus, devices and articles for nursing infants; sexual activity apparatus, devices and articles; physical therapy equipment; hearing protection devices; feeding aids and pacifiers; feeding bottles; sex aids; medical furniture and bedding, equipment for moving patients; medical clothing; contraceptives, non-chemical; prosthetics and artificial implants; orthopedic and mobility aids; orthopaedic braces; corsetry for surgical purposes, medical hosiery, orthopaedic footwear; suture materials; X-ray apparatus for medical purposes; hearing aids; surgical implants comprised of artificial materials; orthopedic articles; parts, fittings and accessories for all the aforesaid goods, included in this class.

11 – Apparatus and installations for lighting, heating, cooling, steam generating, cooking, drying, ventilating, water supply and sanitary purposes; flues and installations for conveying exhaust gases; sun tanning appliances; sanitary installations and devices; water supply installations; burners, boilers; light reflectors; cooking, heating, cooling and preservation equipment, for food and beverages; fireplaces; industrial processing installations, namely gas filters and purifiers; industrial ovens and furnaces (not for food or beverages); industrial installations for the filtration of liquids; installations for the collection of gases; installations for the collection of liquids; launders for trapping impurities in molten metal; biological reactors for clarifying industrial effluents; apparatus for draining food waste; drying installations; refrigerating and freezing equipment; regulating and safety accessories for water and gas installations; nuclear installations; heating, ventilating, and air conditioning and purification equipment (ambient); lighting apparatus; lighting apparatus and installations; lamps; light-emitting diodes [LED] lighting apparatus; lighting installations for air vehicles; lighting installations for vehicles; light bulbs for directional signals for vehicles; light-emitting diodes [LED] lighting apparatus for vehicles; anti-dazzle devices for vehicles [lamp fittings]; anti-dazzle devices for automobiles [lamp fittings]; searchlights; arc lamps; coffee machines, electric; electric fans for personal use; discharge tubes, electric, for lighting; bicycle lights; vehicle headlights and their parts; vehicle reflectors and their parts; vehicle headlights and their parts; sockets for electric lights; friction lighters for igniting gas; igniters; light bulbs; light bulbs, electric; incandescent burners; filaments for electric lamps; miners' lamps; heating apparatus for solid, liquid or gaseous fuels; heating apparatus, electric; heating installations; heaters for vehicles; air-conditioning installations; air-conditioning apparatus; cooling installations and machines; refrigerators; air conditioners for vehicles; electric lamps; acetylene generators; gas lamps; lamp glasses; lamp mantles; lamp globes; lamp chimneys; lamp shades; lampshade holders; luminous tubes for lighting; electric discharge tubes for lighting; light diffusers; air reheaters; filters for air conditioning; air filtering installations; deodorizing apparatus, not for personal use; defrosters for vehicles; ventilation [air-conditioning] installations for vehicles; heating apparatus for defrosting vehicle windows; air cooling apparatus; air purifying apparatus and machines; germicidal lamps for purifying air; spa baths [vessels]; air sterilizers; air dryers; ventilation [air-conditioning] installations and apparatus; lamp reflectors; safety lamps; solar thermal collectors [heating]; electric torches; ultraviolet ray lamps, not for medical purposes; water conduits installations; level controlling valves in tanks; electric heaters; polymerisation installations; chocolate fountains, electric; fairy lights for festive decoration; electrically heated clothing; ice-cream making machines; directional lights for bicyc-

les; heating and cooling apparatus for dispensing hot and cold beverages; USB-powered hand warmers; USB-powered cup heaters; parts and accessories for all the aforesaid goods, included in this class.

12 – Vehicles and conveyances; vehicles for locomotion by land, air, water or rail and their parts; motor land vehicles; driverless cars [autonomous cars]; powertrains, including engines and motors, for land vehicles; propulsion mechanisms for land vehicles; chassis for vehicles; vehicle bodies; vehicle couplings; shock absorbers for vehicles; shock absorbing springs for vehicles; pneumatic tyres; tyres for vehicle wheels; rims for vehicle wheels; solid rubber tyres for vehicle wheels; vehicle wheels; hubs for vehicle wheels; lug nuts for vehicle wheels; inner tubes for pneumatic tyres; casings for pneumatic tyres; tyre mousse inserts; repair outfits for inner tubes, adhesive rubber patches for repairing inner tubes; spikes for tyres; tire snow chains [land vehicle parts]; non-skid devices for vehicle tyres; vehicle seats; rearview mirrors; headrests for vehicle seats; security systems for vehicles [other than locks], anti-theft devices for vehicles; cigar lighters for automobiles; automotive vehicles; cars; robotic cars; motor racing cars; vans [vehicles]; trailers and semi-trailers for vehicles; trailer hitches for vehicles; omnibuses; motorcycles; mopeds; bicycles; electric bicycles; camera drones; helicams; cable transport apparatus and installations; carts, shopping trolleys, luggage carts; aircrafts; boats, ships; locomotives; motor buses; caravans; tractors; two-wheeled vehicles, scooters [vehicles]; self-balancing boards; self-balancing electric unicycles; self-balancing one-wheeled electric scooters; chairlifts, cableways; wheelchairs; clips adapted for fastening automobile parts to automobile bodies; tumbler holders adapted for use in motor vehicles; parts and accessories for all the above-mentioned goods, included in this class.

14 – Precious stones, pearls, precious metals and their alloys; jewellery; chronometers and clocks; wristwatches, stopwatches, pocket watches, cases for clock-and watchmaking; jewelry cases [caskets or boxes]; bracelets made of embroidered textile [jewellery]; tie pins; cuff links; pins [jewellery], other goods made of precious metals and precious stones and imitations thereof, namely statues, figures, ornaments, coins, tokens of value; works of art made of precious metal, key rings; charms for key rings; jewel cases; jewellery charms; hat jewellery; shoe jewellery; rosaries; misbaha [prayer beads]; metal key rings; lanyards [key-cords]; parts and accessories for all the above-mentioned goods, included in this class.

16 – Paper and cardboard; printed matter; works of art and figurines of paper and cardboard, and architects' models; artists' and drawing materials; filtering materials of paper; bags and articles for packaging, wrapping and storage of paper, cardboard or plastics; bookbinding material; photographs [printed]; stationery; adhesives for stationery or household purposes; ar-

tists' materials; brushes for the application of paints; typewriters, electric or non-electric; writing instruments and office requisites, except furniture; teaching materials [except apparatus]; plastic materials for packaging; printing fonts; printing blocks; atlases; calendars; geographical maps; printed publications; printed promotional material; document holders [stationery]; pens; ball pens and pencils; flags of paper; table napkins of paper; copying paper [stationery]; toilet paper; wrapping paper; ink; stamps [seals]; drawing instruments; drawing material; modelling materials; banners of paper; parts and fittings of all the aforementioned goods included in this class.

18 – Luggage, bags, wallets; umbrellas and parasols; walking sticks; trunks and suitcases; bags included in this class, especially sport bags and attache cases; pocket wallets, purses; key cases; satchels; clothing for pets; leather and imitation leather, pelts and hides, and goods made thereof; handbags; bags [envelopes, pouches] of leather, for packaging; labels of leather, tefillin [phylacteries]; leather, unworked or semi-worked; rucksacks; animal skins, hides; saddlery, whips and clothing for pets; parts and fittings of all the aforementioned goods included in this class.

20 – Furniture and non-metallic furniture fittings; mirrors (silvered glass), picture frames, beds; racks [furniture]; cupboards; tables, desks, seats, armchairs, sofas, high chairs for babies and infant walkers, coat hangers, bolsters; boxes of wood; boxes made of plastic; goods (not included in other classes) of wood, cork, reed, cane, wicker, horn, bone, ivory, whalebone, shell, amber, mother-of-pearl, meerschaum and substitutes for all these materials, or of plastics; mooring buoys, non-metallic; locks and keys, non-metallic; door, gate and window fittings, non-metallic; valves, fasteners, clip clamps, all aforementioned non-metallic; non-metallic grab rails; non-metal hooks; identification bracelets, not of metal; holders for pennants; spring pins of plastic, spools (non-metallic -) [other than parts of machines or apparatus], rings, poles, not of metal, saw horses, mats, removable, for sinks, stair fittings of plastics, plastic suction cups, paper towel dispensers [fixed, not of metal], trays, not of metal, labels of plastic; casks, not of metal, packaging containers of plastic, containers, not of metal, for liquid fuel, inflatable publicity objects, included in this class; crates, not of metal; jerrycans, not of metal; step ladders made of wood or of plastic; picture frames; bamboo; works of art of wood, wax, plaster or plastic; display boards; decorations of plastic for foodstuffs; animal housing and beds; identification bracelets, not of metal; coffins and funerary urns; coat hooks, not of metal; curtain rings; statues, figurines, works of art and ornaments and decorations, made of materials such as wood, wax, plaster or plastic, included in the class; containers, and closures and holders therefor, non-metallic; movable steps, non-metallic; plastic ramps for use with vehicles; display stands; signbo-

ards of wood or plastics; loading gauge rods, not of metal, for railway wagons; oil drainage containers, not of metal; nesting boxes, non-metal dog tags; coatstands; parts and fittings for all aforementioned goods, included in this class.

21 – Statues, figurines, plaques and works of art, made of materials such as porcelain, terra-cotta or glass, included in the class; articles for animals, namely aquariums and vivariums, devices for pest and vermin control, bird baths, cages, feed and drinking articles, fish bowls, grooming articles, waste disposal articles; household articles for clothing and footwear, namely boot jacks and shoehorns, button hooks, stretchers for clothing, presses and mangles for clothing, shoe polishers, shoe trees (stretchers) and shapers; household or kitchen utensils and containers; ice tongs; salad tongs; serving ladles; pestles for kitchen use; mortars for kitchen use; ice cream scoops; spatulas for kitchen use; scoops for household purposes; pouring spouts; ladles for serving wine, nutcrackers; sugar tongs; portable cool boxes, non-electric, cool bags; fitted picnic baskets (including dishes); toilet cases, metal boxes for dispensing paper towels; combs and sponges; brush-making materials, brushes; articles for cleaning purposes; glass, unworked or semi-worked, except building glass; waste paper baskets; coin banks; straws for drinking; chamois leather for cleaning; dustings, cushions and pads for cleaning displays; glassware, porcelain and earthenware, included in this class; signboards of porcelain or glass vases; flower vases; heat-insulated containers for beverages; thermally insulated containers for food; glassware for daily use including mugs, table plates, kettles and jars; works of art of porcelain, ceramic, earthenware or glass; tea services [tableware]; brushes, except paint brushes; toothbrushes; toothpicks; vacuum bottles; mangers for animals; fly traps.

22 – Nets, tents, tarpaulins, ropes, strings, sails, sacks; padding, cushioning and stuffing materials, except of paper, cardboard, rubber or plastics; raw fibrous textile, hammocks; bags [envelopes, pouches] of textile, for packaging; car towing ropes; vehicle covers, not fitted.

24 – Textile material; textile goods and substitutes for textile goods; filters made of textile materials; bed blankets and table cloths; table linen, not of paper; bed linen; towels of textile; wall hangings of textile; borders (textile wall hangings); bed covers; sleeping bags; table napkins of textile; mosquito nets; pennants and flags of textile or plastics; plastic flags; non-woven textile fabrics; felt; bath mitts.

25 – Headwear; clothing; footwear; polo shirts, combinations [clothing], tee-shirts, coats, jackets [clothing], bandanas [neckerchiefs], pants, trousers, layettes [clothing], bathing suits, raincoats theatrical costumes, shoes, football shoes, hats, caps being headwear, stockings, gloves [clothing] shawls and stoles, neckties, belts [clothing], shower caps; foundation gar-

ments; parts and accessories for all the aforesaid goods, included in this class.

26 – Accessories for apparel, sewing articles and decorative textile articles [haberdashery]; hair ornaments, hair rollers, hair fastening articles and false hair; artificial fruit, flowers and vegetables; lace and embroidery; ribbons of textile materials; cords for clothing; buttons; hooks and eyes; needles, sewing kits; wigs; shoulder pads for clothing; heat adhesive patches for repairing textile articles; letters for marking linen.

27 – Carpets; door mats, mats; linoleum; artificial ground coverings and other floor coverings; carpets for automobiles; wall and ceiling coverings; non-textile wallpaper; wallpaper; textile wallpaper; wallpaper borders made of paper; parts and accessories for all the aforesaid goods, included in this class.

28 – Sporting articles and equipment, appliances for gymnastics; Christmas tree decorations and artificial Christmas trees; fairground and playground apparatus; toys, games, playthings and novelties; scale model kits [toys]; plush toys and other stuffed toys; slot machines [gaming machines], arcade video game machines; video game apparatus; video game consoles; scale model vehicles; toy vehicles; scooters [toys]; toy cars; remote-controlled toy vehicles; balls for games; kaleidoscopes; board games; playing cards; playing balls; stationary exercise bicycles; archery implements; appliances for gymnastics; racing car games; gloves for games; floats for fishing; camouflage screens [sports articles]; parts and fittings of all aforesaid goods, included in this class.

30 – Coffee, tea, cocoa, sugar, rice, tapioca flour, sago, artificial coffee; flour; cereal preparations; bread, pastries, edible ices; honey, golden syrup; fruit coulis [sauces]; yeast, baking powder; edible salt; mustard; vinegar, sauces [condiments]; spices; ice for refreshment.

34 – Tobacco; articles for use with tobacco; ashtrays for smokers; lighters for smokers; tobacco pouches; tobacco jars; cigarette cases; cigar cases; matches.

35 – Retail and wholesale services in relation to motor vehicles, vehicle parts and accessories, motors and power units for land vehicles, chassis for land vehicles, vehicle bodies and tires for vehicle wheels; retail and wholesale services for mail order in relation to motor vehicles, vehicle parts and accessories, motors and power units for land vehicles, chassis for land vehicles, vehicle body and tires for vehicle wheels; retail and wholesale services via the Internet in relation to motor vehicles, vehicle parts and accessories, motors and power units for land vehicles, chassis for land vehicles, vehicle body and tires for vehicle wheels; retail and wholesale services of teleshopping consignments in relation to motor vehicles, vehicle parts and accessories, motors and power units for land/farm

vehicles, chassis for land/farm vehicles, vehicle body and tires for vehicle wheels; the bringing together, but not transporting, of a variety of motor vehicles and their parts and accessories, motors and engines for land vehicles, vehicle chassis, vehicle bodies and tires for vehicle wheels for the benefit of others, enabling customers to view and purchase the goods in a retail outlet; mediation of contracts for third parties on the purchase and sale of motor vehicles, motor vehicle parts and accessories, engines and powertrains for land vehicles, chassis for vehicles or vehicle bodies and tires for vehicle wheels; business management of transportation fleet [for others]; commercial information and advice for consumers [consumer advice shop]; administrative order processing; arranging of contracts for others for the buying and selling of goods; business management and organization consultancy; assistance, advisory services and consultancy with regard to business management; advertising; marketing; business management; business administration; clerical services; personnel management consultancy; radio and television advertising; organization of trade fairs for commercial or advertising purposes; news clipping services; presentation of goods on communication media, for retail purposes; public relations; compiling indexes of information for commercial or advertising purposes; auctioneering; sales promotion for others; promotion of goods and services through sponsorship of sports events; personnel recruitment; administrative services for the relocation of businesses; book-keeping; sponsorship search; consultancy and information relating to the abovementioned services, included in this class.

36 – Insurance underwriting; real estate services; pawnbrokerage; issuance of prepaid cards and tokens of value; safe deposit services; financial banking, monetary affairs and banking; fundraising and financial sponsorship; financial evaluation [insurance, banking, real estate]; insurance brokerage; insurance underwriting; finance services; monetary affairs; issuance of credit cards; loans [financing]; credit brokerage; credit bureau services; financial consultancy; banking; financing services; hire-purchase financing; provision of finance for leasing; lease purchase financing of vehicles; financial sponsorship; repair costs evaluation [financial appraisal]; instalment loans; savings bank services; real estate affairs; real estate appraisal; rental of apartments; real estate procurement for others; apartment locating services for others [permanent accommodation]; rental of real estate; brokerage; securities brokerage; brokerage of carbon credits; insurance consultancy; medical insurance underwriting; accident insurance underwriting; antique appraisal; real estate brokerage; real estate management; apartment house management; rental of offices [real estate]; financial guarantees [surety services]; charitable fund raising; factoring; lending against security; consultancy and information relating to the abovementioned services, included in this class.

37 – Building, construction and demolition; cleaning and maintenance; rental of tools, plant and equipment for construction, demolition, cleaning and maintenance; mining; oil and gas extraction; extermination, disinfection and pest control; conversion, repair, servicing, dismantling, maintenance, care, cleaning and painting of vehicles, motors, wheels for vehicles and parts therefor; vehicle fueling services; vehicle breakdown repair services; custom conversion of motor vehicle bodies, chassis, motors and engines (tuning), included in this class; painting of vehicles; vehicle polishing; anti-rust treatment for vehicles; vehicle maintenance; vehicle cleaning; retreading of tyres; maintenance, cleaning and repair of boilers and burners; repair information; construction information; installation of doors and windows; quarrying services; machinery installation, maintenance and repair; airplane maintenance and repair; shipbuilding; photographic apparatus repair; clock and watch repair; repair of security locks; rustproofing; furniture maintenance; leather care, cleaning and repair; disinfecting; burglar alarm installation and repair; consultancy and information relating to the abovementioned services, included in this class.

38 – Telecommunication services; telecommunication; collection and delivery of messages by electronic mail; electronic message collection and transmission; news agency services; telecommunication services provided via Internet platforms and portals; providing access to information on the Internet; electronic exchange of messages via chat lines, chatrooms and Internet forums; transmission of electronic mail; rental of telecommunication equipment; radio broadcasting; television broadcasting; services for the electronic transmission of messages; information about telecommunication; providing user access to global computer networks; providing telecommunications connections to a global computer network; providing user access to computer programs in data networks; providing internet chatrooms; providing video conferencing services; wireless cellular phone services; wireless broadcasting; computer aided transmission of messages and images; paging services [radio, telephone or other means of electronic communication]; satellite transmission; telephone services; telephone exchange services; message sending; rental of telecommunication facilities; rental of message sending apparatus; rental of access time to global computer networks; providing access to databases; telematic [data communication] services; telematic communication services; telematic data transmission and file transfer; consultancy and information relating to the abovementioned services, included in this class.

39 – Transport; packaging and storage of goods; arranging of transportation for travel tours; travel and passenger transportation; towing; taxi transport; transport by motor vehicles; transportation logistics; vehicle rental, especially rental of automobiles; transport of

persons, in particular by buses; car sharing services; arranging of passenger transportation services for others via an online application; freight brokerage services; delivery of goods and packages; storage of electricity; electricity distribution; traffic information; tracking of automobile fleets using electronic navigation and locating devices.

42 – IT services, namely, software development, programming and implementation, computer hardware development, hosting services, software as a service and rental of software, rental of computer hardware and facilities, IT consultancy, advisory and information services, IT security, protection and restoration, data duplication and conversion services, data coding services, computer analysis and diagnostics, research and development of computers and computer systems, computer project management services, data mining services, digital watermarking, computer network services, hosting computer sites [web sites], updating the memory banks of computer systems, data migration services, updating websites for others, monitoring computer systems remotely; data encryption services; consultancy in the field of internet and data security; scientific and technological services; testing, authentication and quality control; design services; industrial analysis and research services; styling [industrial design]; development and research services for new products for third parties; provision of scientific information, advice and consultancy in relation to carbon offsetting; digitization of documents [scanning]; technical research; surveying; chemical research; biological research; weather forecasting; research in the field of physics; architectural services; fashion design; authenticating works of art; cloud seeding; software design for others; consultancy and information relating to the abovementioned services, included in this class.

(260) AM 2021 110161 A

(800) 1555396

(151) 2020 03 25

(891) 2020 03 25

(731) Zdesenko Andrii

13 Titova Street, Apartment 44, Dnipro 49055, Ukraine

(540)



(591) White, grey and red

(531) 26.04.09; 26.04.18; 27.05.10; 27.05.17; 27.05.24; 29.01.13

(511)

22 – Sacks for the transport and storage of materials in bulk; padding, cushioning and stuffing materials, except of paper, cardboard, rubber or plastics; cotton tow; bivouac sacks being shelters; wadding for padding and stuffing upholstery; wadding for filtering; raw or treated wool; laundry bags; sacks for the transport and storage of materials in bulk; body bags; cloth bags specially adapted for the storage of diapers; mesh bags for washing laundry; string; packing string; rope ladders; upholstery wool (stuffing); padding materials, not of rubber, plastics, paper or cardboard; stuffing, not of rubber, plastics, paper or cardboard; thread, not of metal, for wrapping or binding; bindings, not of metal; packing (cushioning, stuffing) materials, not of rubber, plastics, paper or cardboard; wrapping or binding bands, not of metal; binding thread, not of metal, for agricultural purposes; network; mail bags; nets; bags (envelopes, pouches) of textile, for packaging; vehicle covers, not fitted; drop cloths; cords for hanging pictures; twine for nets; twine made of paper.

(260) AM 2021 110166 A

(800) 1555629

(151) 2020 08 06

(891) 2020 08 06

(731) KIRALON GmbH

Mariahilfer Straße 32, A-1070 Wien, Austria

(540)

kiralon

(591) Black, white

(531) 27.05.01

(511)

25 – Clothing; swimwear; bikinis; bathing suits; swim briefs; bathing trunks; swim shorts; bathing costumes; swimwear for gentlemen and ladies; coverups [light-weight women's clothing to wear over swimwear]; bath slippers; sandals; beach hats; beach clothes; beach shoes; beachwear; wrap dresses for the beach [pareos]; shorts [clothing]; tops [clothing]; scarves [clothing].

(260) AM 2021 110167 A

(800) 1555644

(151) 2020 09 23

(891) 2020 09 23

(731) Jiangsu DAYI Power Tools CO., LTD

No. 99, East Hehai Road, Economic and Technological, Development Zone, Haimen District, Nantong City, 226100 Jiangsu Province, China

(540)

Dartek

(591) Black, white

(531) 27.05.01

(511)

7 – Agricultural machines; lawnmowers [machines]; pulverisers [machines]; weeding machines; agricultural implements, other than hand-operated; aerating pumps for aquaria; disintegrators; milking machines; shearing machines for animals; saw benches [parts of machines]; saw blades [parts of machines]; mixing machines; beverage preparation machines, electromechanical; stitching machines; sewing machines; engraving machines; sheaf-binding machines; mills for household purposes, other than hand-operated; kitchen machines, electric; whisks, electric, for household purposes; fruit presses, electric, for household purposes; washing machines [laundry]; machines for processing plastics; electromechanical machines for chemical industry; rinsing machines; cutters [machines]; whitewashing machines; stone-working machines; jacks [machines]; metalworking machines; steam engines; carburettor feeders; igniting devices for internal combustion engines; turbines, other than for land vehicles; threading machines; bending machines; drilling heads [parts of machines]; machines and apparatus for polishing [electric]; planing machines; industrial robots; chain saws; shears, electric; scissors, electric; hand-held tools, other than hand-operated; riveting machines; compressed air guns for the extrusion of mastics; food processors, electric; guns [tools using explosives]; nail extractors, electric; screwdrivers, electric; painting machines; spray guns for paint; piston segments; carbon brushes [electricity]; cylinders for machines; dynamos; pistons [parts of machines or engines]; stators [parts of machines]; motors, other than for land vehicles; valves [parts of machines]; compressors [machines]; pump diaphragms; pumps [machines]; compressed air machines; compressed air pumps; blowing machines; shaft couplings [machines]; crank shafts; ball-bearings; bearings [parts of machines]; welding machines, electric; soldering apparatus, gas-operated; gas-operated blow torches; high pressure washers; snow ploughs; vacuum cleaners; machines and apparatus for wax-polishing, electric; curtain drawing devices, electrically operated; shoe polishers, electric.

9 – Scales; slide calipers; measures; rulers [measuring instruments]; signal lanterns; signs, luminous; mobile telephones; security surveillance robots; audiovisual teaching apparatus; metal detectors for industrial or military purposes; detectors; range finders; measuring devices, electric; measuring instruments; levels [instruments for determining the horizontal]; levelling instruments; optical apparatus and instruments; cables, electric; magnets; control panels [electricity]; lig-

htning conductors; fire extinguishing apparatus; protective helmets; solderers' helmets; alarms; spectacles; battery chargers; batteries, electric.

11 – Electric torches; lighting apparatus and installations; kettles, electric; refrigerators; fans [air-conditioning]; hair dryers; heat guns; watering installations, automatic; taps for pipes and pipelines; sanitary apparatus and installations; disinfectant apparatus; electrically heated clothing.

(260) AM 2021 110168 A

(800) 1555645

(151) 2020 09 16

(891) 2020 09 16

(731) S.C. Johnson & Son, Inc.

1525 Howe Street, Racine WI 53403-2236,
USA

(540)

MOMENT OF ZEN

(591) Black, white

(511)

3 – Air fragrancng preparations; air perfuming preparations.

4 – Candles; perfumed candles.

(260) AM 2021 110169 A

(800) 1555660

(151) 2020 09 14

(891) 2020 09 14

(731) Aktsiaselts LIVIKO

Masina tn 11, EE-10144 Tallinn, Estonia

(540)

VEGENA

(591) Black, white

(511)

33 – Alcoholic beverages, except beers; alcoholic preparations for making beverages.

(260) AM 2021 110170 A

(800) 1555685

(151) 2020 06 02

(891) 2020 06 02

(731) Euro Games Technology Ltd.

4, "Maritsa" Str., "Vranya-Lozen-Triugulnika",
BG-1151 Sofia, Bulgaria

(540)

FRUITS
AWP COLLECTION

(591) Yellow, orange, red, green and black

(531) 27.05.02; 29.01.15

(511)

9 – Software; computer gaming software; computer software packages; computer operating system software; computer software, recorded; software drivers;

virtual reality software; games software; entertainment software for computer games; computer programs for network management; operating computer software for main frame computers; monitors (computer hardware); computer hardware; apparatus for recording images; monitors (computer programs); computer game programs; computer programs for recorded games; apparatus for recording, transmission or reproduction of sound or images; communications servers [computer hardware]; electronic components for gambling machines; computer application software featuring games and gaming; computer software for the administration of on-line games and gaming; computer hardware for games and gaming; electronic components and computer software for gambling, gambling machines, gambling games on the internet and via telecommunication network.

28 – Gaming machines for gambling; chips for gambling; mah-jong; arcade games; gambling machines operating with coins, notes and cards; games; electronic games; parlor games; gaming chips; gaming tables; slot machines [gaming machines]; LCD game machines; slot machines and gaming devices; coin-operated amusement machines; roulette chips; poker chips; chips and dice [gaming equipment]; equipment for casinos; roulette tables; gaming roulette wheels; casino games; gambling machines and amusement machines, automatic and coin-operated; coin-operated amusement machines and/or electronic coin-operated amusement machines with or without the possibility of gain; boxes for coin-operated machines, slot machines and gaming machines; electronic or electrotechnical amusement machines and apparatus, gaming machines, coin-operated entertainment machines; housings for coin-operated machines, gaming equipment, gaming machines, machines for gambling; electropneumatic and electrical slot machines (gaming machines for gambling).

41 – Gambling; services related to gambling; gaming services for entertainment purposes; casino, gaming and gambling services; training in the development of software systems; provision of equipment for gambling halls; providing casino equipment [gambling]; gaming machine entertainment services; providing casino facilities [gambling]; gaming hall services; amusement arcade services; games equipment rental; rental of gaming machines; providing amusement arcade services; rental of gaming machines with images of fruits; editing or recording of sounds and images; sound recording and video entertainment services; hire of sound reproducing apparatus; provision of gaming equipment for casinos; providing of casino facilities; online gambling services; casino, gaming and gambling services; provision of gaming facilities, gaming halls, Internet casinos, online gaming services.

(260) AM 2021 110180 A

(800) 784245

(151) 2002 06 07

(891) 2020 09 16

(731) GLOBACHEM, naamloze vennootschap
Lichtenberglaan 2019, B-3800 Sint-Truiden,
Belgium

(540)

GIBB Plus

(591) Black, white

(511)

1 – Chemicals used in industry, science, photography, agriculture, horticulture, silviculture, including plant growth regulators.

5 – Preparations for destroying vermin; fungicides, herbicides.

(260) AM 2021 110185 A

(800) 1509110

(151) 2019 11 02

(891) 2020 09 25

(731) Fenix International Limited
4th Floor, Imperial House, 8 Kean Street,
London WC2B 4AS, United Kingdom

(540)

 The logo for OnlyFans features the word "Only" in a blue, rounded sans-serif font, followed by "Fans" in a blue, cursive script font. To the left of "Only" is a blue circular icon containing a white padlock symbol.

(591) Black, blue, white

(531) 14.05.23; 27.05.08; 27.05.19; 29.01.13

(511)

9 – Downloadable computer software for enabling transmission of photographs; computer software for the collection, organizing, transmission, storage and sharing of data and information; computer software which facilitates online services for social networking, building social networking applications and for allowing data retrieval, upload, download, access and management; computer software to enable uploading, downloading, accessing, posting, displaying, tagging, blogging, streaming, linking, sharing or otherwise providing electronic media or information via computer and communication networks; computer software platforms.

35 – Online subscription services for the purpose of allowing individuals to subscribe and access content uploaded by members of the service for sporting, fitness and entertainment purposes.

38 – Telecommunications; providing access to interactive communication services (blogs); providing Internet chatrooms; telecommunications services, namely electronic transmission of data, messages, graphics, images and information; peer-to-peer photo sharing services, namely, electronic transmission of digital photo files among internet users; providing access to computer, electronic and online databases; providing

online forums for communication on topics of user interest; providing online chat rooms and electronic bulletin boards; broadcasting services over computer or other communication networks namely, uploading, posting, displaying, tagging, and electronically transmitting data, information, messages, graphics, and images; photo sharing and data sharing services, namely, electronic transmission of digital photo files, videos, audio visual content and data among internet and mobile device users; electronic exchange of messages via chat lines, chatrooms and Internet forums; video-on-demand transmission services; video broadcasting; providing access to a web site that gives users the ability to upload photographs.

41 – Providing entertainment services, namely, providing entertainment services featuring non-downloadable video, photographs, images, audio, and text through a website and via a global computer network; providing entertainment services in the fields of social and community interest groups, specifically sporting, fitness and entertainment community interest groups through computers or electronic and online databases; publication of electronic journals and web logs featuring user generated or specified content in relation to sporting, fitness and entertainment purposes; electronic publishing services for others.

42 – Technical support services, namely, providing help desk services in the field of computer software, namely, providing users with instructions and advice on the use of downloadable computer software, provided online and via e-mail; computer services, namely, providing an interactive website featuring technology that allows users to manage their online photograph and social networking accounts; online providing of non-downloadable software for displaying and sharing user location data, photographs and images, and for searching for and locating other users and places and interacting therewith; providing online non-downloadable software for displaying and sharing user location data, photographs and images, and for searching for and locating other users and places and interacting therewith; updating of Internet pages; software design services; design of computer systems; installation and maintenance of software for Internet access; rental and maintenance of memory space for websites, for others (hosting); providing or rental of electronic memory space on the Internet (web space).

(260) AM 2021 110186 A

(800) 1543473

(151) 2020 02 18

(891) 2020 08 26

(731) HIOKI E.E. CORPORATION
81, Koizumi, Ueda-shi, Nagano 386-1192,
Japan

(540)

HIOKI

(591) Black, white

(531) 27.05.01

(511)

37 – Repair or maintenance of measuring or testing machines and instruments by remote control; repair or maintenance of electric or magnetic meters and testers by remote control; repair or maintenance of electronic machines and apparatus; repair or maintenance of telecommunication machines and apparatus; repair or maintenance of power distribution or control machines and apparatus; repair or maintenance of electric or magnetic meters and testers.

42 – Computer software design, computer programming, or maintenance of computer software; rental of computers; providing computer programs on data networks; electronic storage services for archiving electronic data; off-site data backup; software as a service [SaaS]; cloud computing; backup services for data measured with measuring or testing machines and instruments by remote control; backup services for data measured with electric or magnetic meters and testers by remote control; monitoring of measuring or testing machines and instruments by remote control; monitoring of electric or magnetic meters and testers by remote control; collecting and recording data measured with measuring or testing machines and instruments by remote control and providing information thereof; collecting and recording data measured with electric or magnetic meters and testers by remote control and providing information thereof; monitoring of apparatus for generating power or power-generating equipment by remote control; monitoring of electrical equipments, electric power equipments or electric power systems by remote control.

(260) AM 2021 110187 A

(800) 1549972

(151) 2019 07 31

(891) 2020 09 17

(731) PayPal, Inc.

2211 North First Street, San Jose CA 95131,
USA

(540)

PAYPAL

(591) Black, white

(511)

9 – Computer software for processing electronic payments to and from others that may be downloaded from a global computer network and/or recorded on computer media; authentication software that may be downloaded from a global computer network and/or recorded on computer media; downloadable and recorded computer software for processing electronic

payments and for transferring funds to and from others; downloadable computer software for creating, preparing, managing, sending, processing, tracking, and reconciling invoices; downloadable computer software for issuing receipts regarding mobile payment transactions; downloadable mobile application software for processing electronic payments and for transferring funds to and from others; downloadable authentication software for controlling access to and communications with computers and computer networks; computer hardware for making, authenticating, facilitating, operating, managing, and processing payment transactions with credit cards, debit cards, prepaid cards, payment cards, gift cards, and other payment forms; electronic devices, namely, point of sale terminals, chip card readers, credit card readers, payment card readers, mobile card readers, charging stands specially adapted for chip card readers, credit card readers, payment card readers, and mobile card readers; magnetic encoded and coded card readers; electronic card readers for payment and credit cards; magnetically encoded credit cards; magnetically encoded payment cards being debit cards, gift cards, prepaid gift cards, prepaid cash cards, and prepaid debit cards; magnetically encoded credit cards.

36 – Clearing and reconciling financial transactions via a global computer network; providing a wide variety of banking services and providing financial services, namely, credit card services, processing and transmission of bills and payments thereof, and insurance for financial transactions conducted via global computer network; financial services, namely, electronic funds transfer; clearing and reconciling financial transactions via a global computer network and wireless networks; providing a wide variety of payment and financial services, namely, credit card payment processing services, issuing credit cards and providing personal and business lines of credit, electronic payment services involving electronic processing and subsequent transmission of bill payment data, bill payment services with guaranteed payment delivery, all conducted via a global communications network; credit card and debit card transaction processing services; providing payment and financial services, namely processing and acceptance of invoice payments; payment processing services in the nature of processing reimbursements for fraudulent transactions, transaction errors, and disputed transactions, namely, transactions concerning lost, damaged, misrepresented, or incorrect products or services, all in the field of electronic payment purchases; providing purchase protection services for goods and services purchased by others via a global computer network and wireless networks, namely, fraud reimbursement services in the field of credit card purchases and electronic payment purchases, secure commercial transactions for credit card purchases and electronic payment purchases, and payment processing services in the nature of processing reimbursement related to disputed transac-

tions in the field of electronic payment purchases; credit card transaction processing services; credit services, namely, providing revolving credit account services; bill payments services; providing electronic mobile payment services for others in the nature of providing secure commercial transactions and payment options using a mobile device at a point of sale; credit card transaction processing services and payment processing services in the field of credit card payments and electronic payments; electronic foreign exchange payment processing; payment processing services, namely, providing virtual currency transaction processing services for others.

42 – Providing temporary use of online non-downloadable software for processing electronic payments; providing temporary use of online non-downloadable software for creating, preparing, managing, sending, processing, tracking, and reconciling invoices; providing temporary use of online non-downloadable software for issuing receipts regarding mobile payment transactions; providing temporary use of online non-downloadable authentication software for controlling access to and communications with computers and computer networks.

(260) AM 2021 110232 A

(800) 1556041

(151) 2020 07 29

(891) 2020 07 29

(731) OPULENT CONSULTANTS LIMITED

Palladium House, 1-4 Argyll Street, London
W1F 7LD, United Kingdom

(540)

МДМИЛ ФКУ

(591) Black, white

(531) 28.05

(511)

5 – Dietetic foods adapted for medical purposes; food for babies; dietetic beverages adapted for medical purposes; dietetic substances adapted for medical use; albuminous foodstuffs for medical purposes.

(260) AM 2021 110233 A

(800) 1556072

(151) 2020 08 10

(891) 2020 08 10

(731) Li Heng bo

Room202, Unit1, No.3, Lvjing Street, Yiquan
Villa, Jiekou Street, Conghua City, Guangdong
Province, China

(540)

TRANSPPEED

(591) Black, white

(531) 27.05.01; 27.05.11

(511)

12 – Gear boxes for land vehicles; torque converters for land vehicles; transmission shafts for land vehicles; gearing for land vehicles; clutches for land vehicles; motors for land vehicles; vehicles for locomotion by land, air, water or rail; brake shoes for vehicles; air vehicles; treads for vehicles [roller belts].

(260) AM 2021 110236 A

(800) 1556143

(151) 2020 08 11

(891) 2020 08 11

(731) Open-Type Joint Stock Company

"ROT FRONT"

2-oy Novokuznetskiy pereulok, d. 13/15,
RU-115184 Moscow, Russian Federation

(540)



(591) Green, light green, white, yellow, purple, pink, red, black

(531) 01.15.15; 04.05.01; 04.05.05; 05.07.08;

25.07.08; 25.07.25; 26.03.05; 26.03.07; 28.05;
29.01.15

(526) МАЛИНА СО СЛИВКАМИ КАРАМЕЛЬ

(511)

30 – Caramels [sweets].

(260) AM 2021 110237 A

(800) 1556155

(151) 2020 06 23

(891) 2020 06 23

(731) NINGBO RUNTAI SANITARY

TECHNOLOGY CO., LTD.

No.1, Chuangxin Road, Wuma Industrial Zone,
Lubu Town, Yuyao City, Zhejiang Province,
China

(540)

SEW

(591) Black, white
 (531) 01.15.15; 26.11.08; 26.11.13; 27.03.12;
 27.05.01; 27.05.11

(511)
 6 – Metal water pipes; metal pipes; nozzles of metal; drain pipes of metal; metal valves for water pipes; metal rainwater pipe; ducts of metal for ventilating and air-conditioning installations; metal elbows for pipes; joints of metal for pipes; manifolds of metal for pipelines.

11 – Taps; flexible pipes being parts of bath plumbing installations; water-pipes for sanitary installations; pipes [parts of sanitary installations]; bath plumbing fixtures; floor drains; flushing apparatus; showers; brackets for holding shower head; bath plumbing fixtures.

(260) AM 2021 110247 A
 (800) 1556550
 (151) 2020 04 27
 (891) 2020 04 27
 (731) KOPOS HOLDING, a.s.
 Šumavská 46, CZ-120 00 PRAHA
 2 – Vinohrady, Czech Republic
 (540)

MONOFLEX

(591) Black, white
 (511)
 17 – Flexible plastic pipes for laying of electric cables, especially for wall surface, into the wall plaster or under the wall plaster installation, flexible non-metallic pipes for laying of electric cables, especially for wall surface, into a wall plaster or under the wall plaster installation, flexible non-metallic pipes for building industry, especially for laying electrical cables for wall surface, into a wall plaster or under the wall plaster installation, flexible plastic pipes for building, in particular for laying electrical cables for wall surface, into a wall plaster or under the wall plaster installation.

(260) AM 2021 110248 A
 (800) 1556560
 (151) 2019 12 27
 (891) 2019 12 27
 (731) International Fruit Genetics, LLC
 8224 Espresso Drive, Suite 200, Bakersfield
 CA 93312, USA
 (540)

JULEP

(591) Black, white
 (511)
 29 – Preserved, dried and cooked fruits and vegetables; jellies, jams and compotes; milk and milk products.

30 – Confectionery; ice cream, sorbets and other edible ices; seasonings, spices; sauces and other condiments.

31 – Fresh fruits and vegetables; grape vines, plants and plant propagating material.

(260) AM 2021 110249 A
 (800) 1556576
 (151) 2020 07 29
 (891) 2020 07 29
 (731) Qatar Airways Group (Q.C.S.C.)
 Qatar Airways Tower, Airport Road,
 P.O. Box 22550, Doha, Qatar
 (540)

QATAR AIRWAYS

(591) Black, white
 (511)
 9 – Recorded media; downloadable media; downloadable electronic publications; downloadable electronic publications, namely guides on travel and accommodation; downloadable electronic publications in the field of travel and accommodation; computer software for use in the provision of travel and accommodation services; downloadable electronic games; video game software; video game discs; application software; application software relating to travel and accommodation; mobile application software; mobile application software relating to travel and accommodation; interactive computer software that provides navigational and travel information; video films and cinematographic films; video films and cinematographic films relating to travel and accommodation services; downloadable electronic maps; computer digital maps; encoded loyalty cards; sunglasses; cases for sunglasses; magnets; decorative magnets; fridge magnets; laptop cases; phone cases; mobile phone cases; protective masks made of fabric; parts, fittings and accessories for the aforesaid goods.

16 – Paper; cardboard; printed matter; printed publications; newsletters; magazines; travel magazines; magazines relating to air transport; brochures; travel brochures; brochures relating to air transport; stationery; drawing materials; colouring books; colouring crayons; pens; pencils; stickers; postcards; business cards; tickets; airline tickets; timetables; maps; menus; vouchers; notebooks; diaries; calendars; paper labels; paper tags; parts, fittings and accessories for the aforesaid goods.

18 – Leather and imitations of leather; luggage and carrying bags; umbrellas and parasols; walking sticks; trunks and travelling bags; suitcases; luggage tags; leather luggage tags; bags; leather bags; handbags; leather handbags; briefcases; leather briefcases; travelling trunks; sports bags; beach bags; tote bags; duffel bags; rucksacks; garment bags; suit bags; fitted protective covers for luggage; toiletry bags; cosmetic

bags; card holders; credit card cases; credit card holders; purses; wallets; shopping bags; textile shopping bags; canvas bags; parts, fittings and accessories for the aforesaid goods.

25 – Clothing; footwear; headgear; t-shirts; shirts; tunics; shorts; sweatshirts; sweaters; blouses; skirts; dresses; robes; trousers; ties; jackets; hats; sun hats; caps; baseball caps; pyjamas; eye masks; socks; slippers; sports footwear; football boots; studs for football boots; football shirts; gloves; scarves; silk scarves; head scarves; uniforms; belts; parts, fittings and accessories for the aforesaid goods.

35 – Advertising; business management; business administration; office functions; marketing and promotional services; organisation, operation and supervision of loyalty and incentive schemes; management of loyalty and incentive schemes; organisation, operation and supervision of frequent flyer programmes; management of frequent flyer programmes; organisation of events for commercial and advertising purposes; promotion of special events; arranging and conducting of promotional events; arranging and conducting of promotional events in the field of travel; promotion of sports competitions and events; promotion of goods and services through sponsorship; promotion of goods and services through sponsorship of sports events; providing marketing information via a website; providing advertising information via a website; organising of prize draws for promotional purposes; organisation of prize draws for advertising purposes; retail and online retail services relating to the sale of cosmetics, toiletries, perfumes, fragrances, aftershave, makeup, reed diffusers, computer software, application software, sunglasses, cases for sunglasses, magnets, decorative magnets, fridge magnets, laptop cases, phone cases, mobile phone cases, mobile phones, smart phones, digital cameras, wireless speakers, ear phones, wireless ear phones, ear plugs, flight socks, keyrings, jewellery, watches, tie-pins, cufflinks, badges of metal, books, booklets, travel guides, journals, magazines, maps, periodicals, stationery, drawing materials, colouring books, colouring crayons, pens, pencils, stickers, postcards, posters, timetables, vouchers, notebooks, notepads, diaries, calendars, luggage, suitcases, handbags, bags, toiletry bags, card holders, purses, wallets, shopping bags, tote bags, mugs, travel mugs, coffee mugs, insulated mugs, combs, hair brushes, toothbrushes, towels, blankets, pillows, pillow cases, lanyards for wear, clothing, t-shirts, sweatshirts, hats, caps, pyjamas, eye masks, fabric face masks, socks, slippers, games, toys, soft toys, stuffed toys, dolls, puzzles, toy airplanes, model aircraft, video game machines, video game apparatus, video game software, video game discs, playing cards, balls for sports, food, chocolates, confectionery, tea, coffee, marmalade, fruit preserves; information, advisory and consultancy services in relation to the aforesaid.

39 – Transport; packaging and storage of goods; travel arrangement; reservation and booking services for transportation; travel services; travel reservation and booking services; travel information services; airline services; scheduled passenger airline services; air transport; reservation services for airline travel; airline booking services; air transportation services for passengers; airline services for the transportation of goods; reservation and booking of seats for travel; cargo storage services; cargo handling services; air charter services; aircraft chartering services; package holiday services for arranging travel; arranging and booking of travel for package holidays; arranging of excursions as part of package holidays; arranging car hire as part of package holidays; arranging of sightseeing tours as part of package holidays; arranging of tours; arranging of excursions; arranging of cruises; arranging of flights; arranging of car hire; vehicle rental services; vehicle parking services; booking agency services for travel; travel courier services; courier services; transportation of freight; air transportation of freight; provision of information relating to airline departures; provision of information relating to airline arrivals; information, advisory and consultancy services relating to the aforesaid.

(260) AM 2021 110253 A

(800) 1556693

(151) 2019 12 27

(891) 2019 12 27

(731) International Fruit Genetics, LLC

8224 Espresso Drive, Suite 200, Bakersfield
CA 93312, USA

(540)

CANDY HEARTS

(591) Black, white

(511)

29 – Preserved, dried and cooked fruits and vegetables; jellies, jams and compotes; milk and milk products.

30 – Seasonings, spices; sauces and other condiments.

31 – Fresh fruits and vegetables; grape vines, plants and plant propagating material.

32 – Beers; non-alcoholic beverages; mineral and aerated waters; fruit beverages and fruit juices; syrups and other non-alcoholic preparations for making beverages.

33 – Alcoholic beverages (except beers); preparations (for example flavorings and essences) for making alcoholic beverages (term considered too vague by the International Bureau – Rule 13 (2) (b) of the Regulations).

(260) AM 2021 110263 A

(800) 1557097

(151) 2020 02 28

(891) 2020 02 28

(731) Pickwings AG

Baarerstattstrasse 8a, CH-6340 Baar,
Switzerland

(540)

pickwings

(591) Black, white

(511)

9 – Scientific, nautical, surveying, photographic, cinematographic, optical, weighing, measuring, signaling, checking (supervision), emergency (life-saving) and teaching apparatus and instruments; apparatus and instruments for conducting, switching, transforming, accumulating, regulating or controlling electricity; apparatus for recording, transmission or reproduction of sound or images; magnetic recording media, sound recording disks; compact disks, DVDs and other digital recording media; mechanisms for coin-operated apparatus; cash registers, calculating machines, data processing equipment, computers; mobile application programs and software; fire extinguishers.

36 – Insurance services; financial affairs; monetary affairs; real estate affairs.

38 – Telecommunications, particularly transmission of speech and data; transmission of information and data between customers and companies by telecommunication means, by computers, by electronic means and by mobile applications; inquiries relating to the electronic transmission of data and information as well as of inquiries and information regarding telecommunication in the field of development of contacts with customers by means of telecommunications or by electronic channels; mediation of messages (terms considered too vague in the opinion of the International Bureau – rule 13(2)(b) of the Regulations); telephone service in the framework of a call center; transmission of data from a data bank; telephone services, communication services via computer terminals, facsimile services, mobile radiotelephone services; access to global computer networks and to computer databases; rental of access to a database (computer service) (terms considered too vague in the opinion of the International Bureau – rule 13(2)(b) of the Regulations); provision of access time to a database, for consulting or downloading data, information, graphics or images via electronic media (the Internet), free of charge and against payment; advice regarding transmission of information between customers and companies by telecommunication, computer or electronic means; advice relating to all the aforesaid services.

39 – Transport; packaging and storage of merchandise; travel organization.

42 – Scientific and technological services as well as research and design services relating thereto; analysis and research services (terms considered too vague in the opinion of the International Bureau – rule 13(2)(b) of the Regulations); design and development of computers and software; software as a service (SaaS).

(260) AM 2021 110264 A

(800) 1557160

(151) 2020 07 15

(891) 2020 07 15

(731) TIRELINK CO., LTD

Diaomeng Road, Dawang Town, Guangrao
County, Dongying City Shandong Province,
China

(540)

HIFLY

(591) Black, white

(531) 27.05.01

(511)

12 – Aircraft tires; treads for retreading tires; repair outfits for inner tubes; vehicle tires; pneumatic tires; inner tubes for vehicle tires; inner tubes for bicycle and tricycles tires; treads for vehicles [roller belts]; casings for pneumatic tires; adhesive rubber patches for repairing inner tubes.

(260) AM 2021 110267 A

(800) 1351037

(151) 2017 02 16

(891) 2020 10 05

(731) STADA Arzneimittel AG

Stadastraße 2-18, 61118 Bad Vilbel,
Germany

(540)

VirusProtect

(591) Black, white

(511)

5 – Pharmaceutical preparations; medical and veterinary preparations; sanitary preparations for medical purposes; dietetic food and substances adapted for medical or veterinary use, food for babies; dietary supplements for humans and animals; plasters, materials for dressings; material for stopping teeth and dental wax; disinfectants; preparations for destroying vermin; fungicides, herbicides.

(260) AM 2021 110274 A

(800) 1513976

(151) 2019 12 19

(891) 2020 07 16

(731) FILO BIANCO SRL

Piazza del Popolo, 14; I-22100 COMO, Italy

(540)

ITALWAX

(591) Black, white

(511)

3 – Bleaching preparations and other substances for laundry use; cleaning, polishing, scouring and abrasive preparations; soaps; perfumery, essential oils, cosmetics, hair lotions; dentifrices.

(260) AM 2021 110275 A

(800) 1522536

(151) 2020 02 10

(891) 2020 07 02

(731) Limited liability company "Royal Aurel"
ZYUZINSKAYA STREET, HOUSE 6,
BUILDING 2, PREMISE XVI, FLOOR 3,
ROOM 30, RU-117418 MOSCOW, Russian
Federation

(540)

WERKEL

(591) Brown

(531) 27.05.01; 27.05.17; 29.01.07

(511)

7 – Vending machines; welding machines, electric; welding apparatus, gas-operated; vulcanization apparatus; acetylene cleaning apparatus; high pressure washers; apparatus for drawing up beer under pressure; apparatus for aerating water; apparatus for aerating beverages; electrical apparatus for sealing plastics [packaging]; electric arc cutting apparatus; electric arc welding apparatus; electric welding apparatus; inking apparatus for printing machines; soldering apparatus, electric; drums [parts of machines]; reels, mechanical, for flexible hoses; brake shoes, other than for vehicles; concrete mixers [machines]; bobbins for weaving looms; harrows; journal boxes [parts of machines]; bulldozers; mine borers; rolling mill cylinders; crank shafts; printing rollers for machines; transmission shafts, other than for land vehicles; fans for motors and engines; saw benches [parts of machines]; winnowers; vibrators [machines] for industrial use; bearings [parts of machines]; agitators; exhausts for motors and engines; drilling rigs, floating or non-floating; lawnmowers [machines]; card clothing [parts of carding machines]; emergency power generators; alternators; dynamos; bicycle dynamos; current generators; generators of electricity; hydraulic controls for machines, motors and engines; mufflers for motors and engines; drilling heads [parts of machines]; drilling bits [parts of machines]; cylinder heads for engines; soldering blow pipes, gas-operated; gas-operated blow torches; raking machines; stalk separators [machines]; sieves [machines or parts of machines]; mud catchers and collectors [machines]; tarring machines; hydraulic engines and motors; aeronautical engines;

aeroplane engines; engines for air cushion vehicles; compressed air engines; jet engines, other than for land vehicles; engines for boats; driving motors, other than for land vehicles; propulsion mechanisms, other than for land vehicles; disintegrators; tympan [parts of printing presses]; holding devices for machine tools; turf removing ploughs; chisels for machines; moving walkways; electric hand drills; crushers, electric, for household purposes; reapers; reapers and binders; millstones; rakes for raking machines; shredders [machines] for industrial use; injectors for engines; incubators for eggs; tools [parts of machines]; hand-held tools, other than hand-operated; air condensers; calendars; rotary steam presses, portable, for fabrics; ditchers [ploughs]; carburettors; carriages for knitting machines; crankcases for machines, motors and engines; steamrollers; can openers, electric; machine wheels; freewheels, other than for land vehicles; lasts for shoes [parts of machines]; piston segments; grease rings [parts of machines]; reapers and threshers; coal-cutting machines; conveyors [machines]; belt conveyors; converters for steelworks; diggers [machines]; thermal lances [machines]; mechanized livestock feeders; boxes for matrices [printing]; gear boxes, other than for land vehicles; grease boxes [parts of machines]; housings [parts of machines]; harvesting machines; coffee grinders, other than hand-operated; taps [parts of machines, engines or motors]; spray guns for paint; cranks [parts of machines]; potters' wheels; cultivators [machines]; soldering lamps; ploughshares; belts for conveyors; igniting magnetos; handling machines, automatic [manipulators]; churns; matrices for use in printing; machine fly-wheels; hair clipping machines for animals; knitting machines; galvanizing machines; bending machines; ironing machines; mineworking machines; net hauling machines [fishing]; electroplating machines; bottle sealing machines; sealing machines for industrial purposes; engraving machines; earth moving machines; cord making machines; lace making machines; butter machines; cigarette machines for industrial purposes; sausage making machines; stereotype machines; hosiery looms; grinding machines; dyeing machines; bottle washing machines; dishwashers; bottle filling machines; racket stringing machines; leather-working machines; dairy machines; glass-working machines; tobacco processing machines; grain husking machines; painting machines; oil refining machines; peeling machines; printing machines for use on sheet metal; brewing machines; white-washing machines; bitumen making machines; paper-making machines; machines for the production of sugar; weeding machines; puddling machines; notchers [machine tools]; bread cutting machines; road making machines; railroad constructing machines; rail-laying machines; bottle capping machines; bottle stoppering machines; packaging machines; die-stamping machines; stamping machines; darning machines; drainage machines; wrapping machines; grain separators; bookbinding apparatus and machines for industrial pur-

poses; machines and apparatus for cleaning, electric; machines and apparatus for carpet shampooing, electric; machines and apparatus for polishing [electric]; sizing machines; punching machines; riveting machines; kitchen machines, electric; foundry machines; smoothing presses; fleshing machines; rinsing machines; flour mill machines; type-setting machines [printing]; hemming machines; grating machines for vegetables; braiding machines; wringing machines for laundry; cutting machines; printing machines; rotary printing presses; trimming machines; spinning machines; filling machines; friezing machines; cutters [machines]; satinizing machines; agricultural machines; mixing machines; sorting machines for industry; stitching machines; washing machines [laundry]; coin-operated washing machines; clippers [machines]; spinning frames; spin driers [not heated]; looms; kneading machines; type-setting machines [photocomposition]; beating machines; beaters, electric; packing machines; filtering machines; molding machines; carding machines; sewing machines; typecasting machines; electromechanical machines for chemical industry; labellers [machines]; mills [machines]; mills for household purposes, other than hand-operated; pepper mills, other than hand-operated; centrifugal mills; machine wheelwork; feeders [parts of machines]; forge blowers; mixers [machines]; blenders, electric, for household purposes; vacuum cleaner bags; threshing machines; hammers [parts of machines]; tilt hammers; power hammers; reeling apparatus, mechanical; motorized cultivators; motors for boats; clutches, other than for land vehicles; meat choppers [machines]; guides for machines; vacuum cleaner attachments for disseminating perfumes and disinfectants; blades [parts of machines]; knives for mowing machines; chaff cutter blades; knives, electric; shears, electric; scissors, electric; bearing brackets for machines; pulverisers [machines]; axles for machines; steam traps; chucks [parts of machines]; drill chucks [parts of machines]; exhaust manifold for engines; soldering irons, gas-operated; soldering irons, electric; gears, other than for land vehicles; reduction gears, other than for land vehicles; drilling machines; saws [machines]; chain saws; guns [tools using explosives]; glue guns, electric; compressed air guns for the extrusion of mastics; carburetter feeders; ploughs; pneumatic transporters; pneumatic controls for machines, motors and engines; hangers [parts of machines]; anti-friction bearings for machines; roller bearings; self-oiling bearings; bearings for transmission shafts; ball-bearings; saw blades [parts of machines]; pistons [parts of machines or engines]; shock absorber plungers [parts of machines]; pistons for engines; pistons for cylinders; catalytic converters; torque converters, other than for land vehicles; fuel conversion apparatus for internal combustion engines; wine presses; basket presses; fodder presses; printing presses; typographic presses; swaging machines; pedal drives for sewing machines; food processors, electric; springs [parts of machines];

spinning wheels; punches for punching machines; vacuum cleaners; tambours for embroidery machines; sewage pulverizers; air brushes for applying colour; speed governors for machines, engines and motors; knives [parts of machines]; cutting blow pipes, gas-operated; blade holders [parts of machines]; loom shafts; gears for weaving looms; belts for machines; elevator belts; fan belts for motors and engines; dynamo belts; belts for motors and engines; adhesive bands for pulleys; kick starters for motorcycles; stuffing boxes [parts of machines]; paper feeders [printing]; whisks, electric, for household purposes; sparking plugs for internal combustion engines; glow plugs for Diesel engines; brake segments, other than for vehicles; tedding machines; separators; steam/oil separators; cream/milk separators; ball rings for bearings; sowers [machines]; snow ploughs; sheaf-binding machines; shaft couplings [machines]; fruit presses, electric, for household purposes; chaff cutters; suction cups for milking machines; stands for machines; machine tools; die-cutting and tapping machines; woodworking machines; sharpening machines; bicycle assembling machines; mortising machines; stoneworking machines; metal working machines; threading machines; planing machines; lathes [machine tools]; milling machines; trueing machines; metal drawing machines; rolling mills; starters for motors and engines; stators [parts of machines]; glaziers' diamonds [parts of machines]; tables for machines; slide rests [parts of machines]; couplings, other than for land vehicles; transmissions for machines; transmissions, other than for land vehicles; wind turbines; hydraulic turbines; turbines, other than for land vehicles; connecting rods for machines, motors and engines; joints [parts of engines]; suction machines for industrial purposes; washing installations for vehicles; dust exhausting installations for cleaning purposes; sifting installations; dust removing installations for cleaning purposes; lifting apparatus; dividing machines; igniting devices for internal combustion engines; door closers, electric; washing apparatus; binding apparatus for hay; extractors for mines; door openers, electric; curtain drawing devices, electrically operated; adhesive tape dispensers [machines]; anti-pollution devices for motors and engines; beverage preparation machines, electromechanical; food preparation machines, electromechanical; elevator operating apparatus; shoe polishers, electric; machines and apparatus for wax-polishing, electric; air cushion devices for moving loads; aprons [parts of machines]; filter presses; molds [parts of machines]; printing plates; journals [parts of machines]; centrifugal machines; elevator chains [parts of machines]; driving chains, other than for land vehicles; transmission chains, other than for land vehicles; cylinders for motors and engines; cylinders for machines; printing cylinders; shuttles [parts of machines]; universal joints [Cardan joints]; pulleys [parts of machines]; vacuum cleaner hoses; brushes [parts of machines]; dynamo brushes; brushes, electri-

cally operated [parts of machines]; carbon brushes [electricity]; ejectors; fuel economisers for motors and engines; excavators; shovels, mechanical; agricultural elevators; motors, electric, other than for land vehicles; electrodes for welding machines; electric hammers; parquet wax-polishers, electric; cartridges for filtering machines; moving staircases [escalators]; automatic grapnels for marine purposes; laundry washing machines for household purposes.

8 – Glaziers' diamonds [parts of hand tools]; apparatus for tattooing; pestles for pounding; razors, electric or non-electric; scythe stones; sharpening steels; augers [hand tools]; carpenters' augers; levers; table forks; pitchforks; weeding forks [hand tools]; lawn clippers [hand instruments]; harpoons; harpoons for fishing; rakes [hand tools]; sand trap rakes; whetstone holders; priming irons [hand tools]; pickhammers; lifting jacks, hand-operated; truncheons; clamps for carpenters or coopers; spades [hand tools]; rabbeting planes; chisels; engraving needles; cutlery; edge tools [hand tools]; garden tools, hand-operated; abrading instruments [hand instruments]; numbering punches; goffering irons; implements for decanting liquids [hand tools]; depilation appliances, electric and non-electric; sharpening instruments; blade sharpening instruments; livestock marking tools; nail clippers, electric or non-electric; oyster openers; polishing irons [glazing tools]; ear-piercing apparatus; tube cutting instruments; wire strippers [hand tools]; riveters [hand tools]; expanders [hand tools]; cutting tools [hand tools]; hand tools, hand-operated; stamping-out tools [hand tools]; picks [hand tools]; sharpening stones; punch rings [knuckle dusters]; trowels; centre punches [hand tools]; daggers; pickaxes; mallets [hand instruments]; punch pliers [hand tools]; blades [weapons]; annular screw plates; wrenches [hand tools]; tap wrenches; ladles [hand tools]; foundry ladles [hand tools]; breast drills; lasts [shoemakers' hand tools]; scythe rings; instruments for punching tickets; diggers [hand tools]; rams [hand tools]; scythes; hainault scythes; fire irons; emery grinding wheels; grindstones [hand tools]; sledgehammers; tree pruners; nail drawers [hand tools]; ice picks; blades [hand tools]; razor blades; blades for planes; plane irons; jig-saws; spoons; crow bars; shovels [hand tools]; machetes; beard clippers; hair clippers for personal use, electric and non-electric; hair clippers for animals [hand instruments]; taps [hand tools]; fireplace bellows [hand tools]; hammers [hand tools]; stone hammers; masons' hammers; riveting hammers [hand tools]; mattocks; ditchers [hand tools]; mincing knives [hand tools]; manicure sets; manicure sets, electric; pedicure sets; needle files; bits [hand tools]; files [tools]; emery files; hand pumps; shaving cases; cheese slicers, non-electric; scaling knives; molding irons; can openers, non-electric; farriers' knives; budding knives; hunting knives; penknives; grafting tools [hand tools]; braiders [hand tools]; bill-hooks; paring knives; knives; cleavers; wick trimmers [scissors]; cattle shearers; border she-

ars; pruning shears; shears; shearers [hand instruments]; scissors; sword scabbards; vegetable slicers; agricultural implements, hand-operated; side arms, other than firearms; stropping instruments; screwdrivers; reamer sockets; drill holders [hand tools]; perforating tools [hand tools]; nail files; nail files, electric; saws [hand tools]; bow saws; tweezers; hair-removing tweezers; guns [hand tools]; guns, hand-operated, for the extrusion of mastics; dies [hand tools]; fruit pickers [hand tools]; saw blades [parts of hand tools]; shear blades; tool belts [holders]; table cutlery [knives, forks and spoons]; crimping irons; hand implements for hair curling; vegetable choppers; money scoops; instruments and tools for skinning animals; hackles [hand tools]; pin punches; nail punches; fish tapes [hand tools]; punches [hand tools]; insecticide sprayers [hand tools]; syringes for spraying insecticides; reamers; frames for handsaws; saw holders; rasps [hand tools]; cutters; paring irons [hand tools]; graving tools [hand tools]; milling cutters [hand tools]; razor strops; leather strops; planes; marline spikes; bits [parts of hand tools]; hollowing bits [parts of hand tools]; secateurs; silver plate [knives, forks and spoons]; pruning knives; sickles; drawing knives; scrapers [hand tools]; trowels [gardening]; mortise chisels; caulking irons; gouges [hand tools]; mortars for pounding; mitre boxes [hand tools]; branding irons; hatchets; adzes [tools]; vices; hoop cutters [hand tools]; axes; holing axes; fulling tools [hand tools]; earth rammers [hand tools]; tube cutters [hand tools]; squares [hand tools]; extension pieces for braces for screw taps; embossers [hand tools]; stretchers for wire and metal bands [hand tools]; flat irons; irons [non-electric hand tools]; razor cases; ratchets [hand tools]; scraping tools [hand tools]; awls; choppers [knives]; spatulas [hand tools]; palette knives; bayonets; pliers; curling tongs; nail nippers; cuticle tweezers; eyelash curlers; nail pullers, hand-operated; cutter bars [hand tools]; thistle extractors [hand tools]; swords; fullers [hand tools]; egg slicers, non-electric; pizza cutters, non-electric; sabres; fingernail polishers, electric or non-electric; apparatus for destroying plant parasites, hand-operated; hand instruments for slaughtering butcher's animals.

9 – DVD players; ticket dispensers; coin-operated musical automata [juke boxes]; answering machines; fire engines; accumulators, electric; accumulators, electric, for vehicles; actinometers; alidades; altimeters; ammeters; anemometers; anodes; antennas; anticathodes; apertometers [optics]; high-frequency apparatus; testing apparatus not for medical purposes; electrodynamic apparatus for the remote control of railway points; sound recording apparatus; Global Positioning System [GPS] apparatus; distillation apparatus for scientific purposes; diffraction apparatus [microscopy]; air analysis apparatus; apparatus to check franking; sound transmitting apparatus; apparatus for fermentation [laboratory apparatus]; breathing apparatus for underwater swimming; breathing apparatus, except

for artificial respiration; apparatus and installations for the production of X-rays, not for medical purposes; cash registers; electric apparatus for commutation; intercommunication apparatus; stills for laboratory experiments; projection apparatus; radiological apparatus for industrial purposes; X-ray apparatus not for medical purposes; blueprint apparatus; flashing lights [luminous signals]; stereoscopic apparatus; telephone apparatus; facsimile machines; phototelegraphy apparatus; igniting apparatus, electric, for igniting at a distance; salinometers; acidimeters for batteries; aerometers; battery jars; barometers; anode batteries; galvanic batteries; batteries for lighting; solar batteries; batteries, electric; balances [steelyards]; betatrons; binoculars; electronic tags for goods; magnetic tape units for computers; computer memory devices; fire hose nozzles; encoded identification bracelets, magnetic; safety tarpaulins; signalling buoys; life buoys; marking buoys; vacuum gauges; electrolyzers; variometers; scales; letter scales; weighbridges; precision balances; camcorders; video cassettes; video telephones; video screens; viewfinders, photographic; micrometer screws for optical instruments; viscosimeters; circuit closers; wavemeters; voltmeters; switchboxes [electricity]; current rectifiers; gas testing instruments; gasometers [measuring instruments]; galvanometers; hands-free kits for telephones; heliographic apparatus; hygrometers; hydrometers; weights; peepholes [magnifying lenses] for doors; holograms; plotters; plumb bobs; range finders; densimeters; densitometers; transparencies [photography]; slide projectors; diaphragms [photography]; dictating machines; dynamometers; light-emitting diodes [LED]; floppy disks; sound recording discs; disks, magnetic; optical discs; circular slide rules; disk drives for computers; juke boxes for computers; DNA chips; electronic notice boards; bullet-proof vests; life jackets; identification threads for electric wires; nose clips for divers and swimmers; locks, electric; bells [warning devices]; alarm bells, electric; electric door bells; signal bells; acoustic conduits; mirrors for inspecting work; road signs, luminous or mechanical; marine depth finders; probes for scientific purposes; buzzers; needles for record players; simulators for the steering and control of vehicles; inverters [electricity]; incubators for bacteria culture; measuring instruments; cosmographic instruments; mathematical instruments; levelling instruments; instruments containing eyepieces; surveying instruments; azimuth instruments; interfaces for computers; ionization apparatus not for the treatment of air or water; spark-guards; coaxial cables; fiber optic cables; cables, electric; calipers; slide calipers; screw-tapping gauges; calculating machines; pocket calculators; decompression chambers; cinematographic cameras; electronic pens [visual display units]; holders for electric coils; identity cards, magnetic; video game cartridges; encoded magnetic cards; riding helmets; carriers for dark plates [photography]; cathodes; spools [photography]; choking coils [impedance]; coils,

electric; electromagnetic coils; cinematographic film, exposed; computer keyboards; solenoid valves [electromagnetic switches]; wire connectors [electricity]; electronic agendas; push buttons for bells; magnetic encoders; collectors, electric; calibrating rings; protective suits for aviators; commutators; compact discs [audio-video]; comparators; marine compasses; computers; laptop computers; notebook computers; condensers [capacitors]; contacts, electric; wind socks for indicating wind direction; branch boxes [electricity]; distribution boxes [electricity]; junction boxes [electricity]; battery boxes; cabinets for loudspeakers; diving suits; galena crystals [detectors]; covers for electric outlets; logs [measuring instruments]; lasers, not for medical purposes; lactodensimeters; lactometers; vacuum tubes [radio]; darkroom lamps [photography]; thermionic tubes; amplifying tubes; flashlights [photography]; head cleaning tapes [recording]; magnetic tapes; videotapes; surveying chains; fire escapes; slide-rules; contact lenses; correcting lenses [optics]; optical lenses; optical condensers; electricity conduits; measuring spoons; magnifying glasses [optics]; thread counters; magnets; decorative magnets; crash test dummies; resuscitation mannequins [teaching apparatus]; mouse [computer peripheral]; divers' masks; solderers' helmets; protective masks; materials for electricity mains [wires, cables]; voting machines; money counting and sorting machines; material testing instruments and machines; furniture especially made for laboratories; megaphones; portable media players; diaphragms [acoustics]; diaphragms for scientific apparatus; metal detectors for industrial or military purposes; metronomes; rules [measuring instruments]; carpenters' rules; dressmakers' measures; mechanisms for coin-operated apparatus; mechanisms for counter-operated apparatus; coin-operated mechanisms for television sets; shutter releases [photography]; micrometers; microprocessors; microscopes; microtomes; microphones; modems; lightning rods; monitors [computer hardware]; monitors [computer programs]; terminals [electricity]; junction sleeves for electric cables; teeth protectors; knee-pads for workers; headphones; surveyors' levels; sound recording carriers; magnetic data media; optical data media; computer software, recorded; sheaths for electric cables; identification sheaths for electric wires; weighing machines; punched card machines for offices; shoes for protection against accidents, irradiation and fire; objectives [lenses] [optics]; lenses for astrophotography; egg-candlers; fire extinguishers; electrified fences; limiters [electricity]; clothing for protection against accidents, irradiation and fire; clothing for protection against fire; asbestos clothing for protection against fire; clothing especially made for laboratories; ozonizers [ozonators]; octants; eyepieces; ohmmeters; wrist rests for use with computers; eyeglass frames; oscillographs; plumb lines; mirrors [optics]; eyeglasses; sunglasses; goggles for sports; signalling panels, luminous or mechanical; radio pagers; pince-nez; electronic

pocket translators; transmitters [telecommunication]; transmitters of electronic signals; switches, electric; periscopes; gloves for divers; gloves for protection against accidents; gloves for protection against X-rays for industrial purposes; asbestos gloves for protection against accidents; furnaces for laboratory use; pyrometers; planimeters; plane tables [surveying instruments]; plates for batteries; printed circuit boards; cassette players; sound recording strips; X-ray films, exposed; films, exposed; life-saving rafts; laboratory trays; semi-conductors; polarimeters; fire pumps; measuring glassware; life belts; fuses; circuit breakers; converters, electric; food analysis apparatus; diagnostic apparatus, not for medical purposes; distance measuring apparatus; speed measuring apparatus [photography]; appliances for measuring the thickness of leather; speed checking apparatus for vehicles; teaching apparatus; time recording apparatus; hemline markers; apparatus and instruments for astronomy; surveying apparatus and instruments; weighing apparatus and instruments; nautical apparatus and instruments; navigational instruments; optical apparatus and instruments; apparatus and instruments for physics; chemistry apparatus and instruments; meteorological instruments; naval signalling apparatus; navigation apparatus for vehicles [on-board computers]; satellite navigational apparatus; regulating apparatus, electric; audio- and video-receivers; prisms [optics]; printers for use with computers; retorts' stands; drainers for use in photography; cleaning apparatus for sound recording discs; fire beaters; telescopic sights for fire-arms; test tubes; pressure indicator plugs for valves; magnetic wires; telegraph wires; telephone wires; wires, electric; conductors, electric; copper wire, insulated; fuse wire; computer programs, recorded; computer operating programs, recorded; record players; processors [central processing units]; rods for water diviners; electronic publications, downloadable; distribution consoles [electricity]; control panels [electricity]; radar apparatus; masts for wireless aerials; transmitting sets [telecommunication]; radios; vehicle radios; sprinkler systems for fire protection; frames for photographic transparencies; screens for photoengraving; walkie-talkies; voltage surge protectors; voltage regulators for vehicles; stage lighting regulators; speed regulators for record players; cell switches [electricity]; washing trays [photography]; marking gauges [joinery]; time switches, automatic; relays, electric; safety restraints, other than for vehicle seats and sports equipment; X-ray photographs, other than for medical purposes; rheostats; respirators for filtering air; retorts; refractometers; refractors; grids for batteries; speaking tubes; horns for loudspeakers; saccharometers; optical fibers [light conducting filaments]; traffic-light apparatus [signalling devices]; dog whistles; signalling whistles; sextants; inductors [electricity]; safety nets; nets for protection against accidents; fire alarms; signals, luminous or mechanical; sirens; scanners [data processing equipment]; integrated circuit

cards [smart cards]; connections for electric lines; couplings, electric; connectors [electricity]; sonars; sound locating instruments; lighting ballasts; resistances, electric; spectrograph apparatus; spectrometers; speed indicators; alcoholmeters; satellites for scientific purposes; protection devices for personal use against accidents; audiovisual teaching apparatus; radiotelegraphy sets; radiotelephony sets; spectacle lenses; optical glass; personal stereos; stereoscopes; stands for photographic apparatus; fire boats; sulfotometers; drying racks [photography]; spherometers; integrated circuits; printed circuits; counters; parking meters; kilometer recorders for vehicles; revolution counters; abacuses; egg timers [sandglasses]; taximeters; ear plugs for divers; tachometers; television apparatus; telegraphs [apparatus]; telescopes; teleprompters; teleprinters; theodolites; thermometers, not for medical purposes; thermostats; thermostats for vehicles; crucibles [laboratory]; tone arms for record players; totalizers; transistors [electronic]; protractors [measuring instruments]; transformers [electricity]; step-up transformers; vehicle breakdown warning triangles; triodes; starter cables for motors; discharge tubes, electric, other than for lighting; capillary tubes; neon signs; X-ray tubes not for medical purposes; telephone receivers; gauges; quantity indicators; electric loss indicators; light-emitting electronic pointers; slope indicators; levels [instruments for determining the horizontal]; mercury levels; spirit levels; urinometers; amplifiers; particle accelerators; electric installations for the remote control of industrial operations; steering apparatus, automatic, for vehicles; balancing apparatus; video recorders; sound reproduction apparatus; invoicing machines; tape recorders; protection devices against X-rays, not for medical purposes; railway traffic safety appliances; data processing apparatus; oxygen transvasing apparatus; theft prevention installations, electric; film cutting apparatus; drying apparatus for photographic prints; optical character readers; centering apparatus for photographic transparencies; dosage dispensers; battery chargers; chargers for electric accumulators; acoustic alarms; sounding apparatus and machines; apparatus for editing cinematographic film; cathodic anti-corrosion apparatus; couplers [data processing equipment]; computer peripheral devices; anti-interference devices [electricity]; demagnetizing apparatus for magnetic tapes; acoustic couplers; alarms; fog signals, non-explosive; whistle alarms; adding machines; readers [data processing equipment]; photocopiers [photographic, electrostatic, thermic]; bar code readers; downloadable ring tones for mobile phones; downloadable image files; downloadable music files; animated cartoons; filters for respiratory masks; filters for ultraviolet rays, for photography; magic lanterns; optical lamps; signal lanterns; cameras [photography]; glazing apparatus for photographic prints; shutters [photography]; darkrooms [photography]; photometers; flash-bulbs [photography]; enlarging apparatus [photography]; photo-

voltaic cells; containers for contact lenses; eyeglass cases; containers for microscope slides; cases especially made for photographic apparatus and instruments; chromatography apparatus for laboratory use; chronographs [time recording apparatus]; laboratory centrifuges; cyclotrons; frequency meters; time clocks [time recording devices]; fire blankets; chips [integrated circuits]; jigs [measuring instruments]; pedometers; meteorological balloons; electrified rails for mounting spot lights; asbestos screens for firemen; fire hose; protective helmets for sports; cell phone straps; tripods for cameras; switchboards; distribution boards [electricity]; workmen's protective face-shields; projection screens; radiology screens for industrial purposes; fluorescent screens; exposure meters [light meters]; ducts [electricity]; galvanic cells; epidiascopes; ergometers; electric plugs; electric sockets; plug connectors; mouse pads; computer game software, downloadable; computer programs, downloadable; light dimmers [regulators], electric; respiratory masks, other than for artificial respiration; anti-glare glasses; USB flash drives; screens [photography].

11 – Lamp shades; defrosters for vehicles; distillation apparatus; desiccating apparatus; hydromassage bath apparatus; disinfectant apparatus; air deodorizing apparatus; tanning apparatus [sun beds]; ionization apparatus for the treatment of air or water; coffee roasters; beverage cooling apparatus; hand drying apparatus for washrooms; fruit roasters; water purifying apparatus and machines; refrigerating apparatus and machines; drying apparatus and installations; freezers; drying apparatus; coolers for furnaces; flushing tanks; refining towers for distillation; bidets; spa baths [vessels]; bath tubs for sitz baths; waffle irons, electric; fans [air-conditioning]; fans [parts of air-conditioning installations]; electric fans for personal use; roasting spits; refrigerating display cabinets; water flushing installations; extractor hoods for kitchens; acetylene generators; hydrants; burners; acetylene burners; gas burners; burners for lamps; germicidal burners; incandescent burners; oxyhydrogen burners; laboratory burners; oil burners; alcohol burners; hot water bottles; footwarmers, electric or non-electric; bed warmers; pocket warmers; grills [cooking appliances]; lampshade holders; stills; showers; refrigerating containers; gas lighters; lighters; friction lighters for igniting gas; chimney blowers; furnace ash boxes; evaporators; shower enclosures; Turkish bath cabinets, portable; heating apparatus; refrigerating chambers; fireplaces, domestic; chimney flues; electrically heated carpets; light bulbs; light bulbs, electric; solar thermal collectors [heating]; distillation columns; furnace grates; ventilation hoods; ventilation hoods for laboratories; lamp globes; air-conditioning apparatus; air conditioners for vehicles; coffee machines, electric; taps; mixer faucets for water pipes; forges, portable; lava rocks for use in barbecue grills; electric lights for Christmas trees; acetylene flares; safety lamps; gas lamps; curling lamps; germicidal lamps for purifying

air; light bulbs for directional signals for vehicles; arc lamps; laboratory lamps; oil lamps; ultraviolet ray lamps, not for medical purposes; miners' lamps; electric lamps; chandeliers; barbecues; bread baking machines; watering machines for agricultural purposes; footmuffs, electrically heated; heaters for baths; heaters for heating irons; immersion heaters; brackets for gas burners; anti-splash tap nozzles; filaments for electric lamps; magnesium filaments for lighting; heating filaments, electric; luminous house numbers; heating apparatus for defrosting vehicle windows; hot air bath fittings; bath fittings; kiln furniture [supports]; sauna bath installations; refrigerating appliances and installations; blankets, electric, not for medical purposes; fabric steamers; lamp reflectors; vehicle reflectors; hearths; pasteurisers; lamp mantles; sockets for electric lights; coffee percolators, electric; bakers' ovens; hot air ovens; kitchen ranges [ovens]; microwave ovens [cooking apparatus]; microwave ovens for industrial purposes; incinerators; kilns; solar furnaces; dental ovens; cookers; hot plates; heaters, electric, for feeding bottles; aquarium heaters; aquarium lights; heating cushions, electric, not for medical purposes; clean chambers [sanitary installations]; water intake apparatus; deodorizing apparatus, not for personal use; fumigation apparatus, not for medical purposes; gas scrubbing apparatus; oil-scrubbing apparatus; glue-heating appliances; forage drying apparatus; water filtering apparatus; air purifying apparatus and machines; ice machines and apparatus; cooling appliances and installations; cooking apparatus and installations; lighting apparatus and installations; sanitary apparatus and installations; cooking rings; lighting apparatus for vehicles; light-emitting diodes [LED] lighting apparatus; steam facial apparatus [saunas]; plate warmers; rotisseries; radiator caps; diving lights; washers for water faucets; sinks; disinfectant dispensers for toilets; drip irrigation emitters [irrigation fittings]; light diffusers; nuclear reactors; pressure water tanks; roasters; lamps; ceiling lights; toilet seats; lighting installations for air vehicles; pressure cookers, electric; gas scrubbers [parts of gas installations]; lamp glasses; sterilizers; water sterilizers; air sterilizers; air dryers; laundry dryers, electric; hair dryers; malt roasters; tobacco roasters; bread toasters; discharge tubes, electric, for lighting; lamp chimneys; luminous tubes for lighting; pipes [parts of sanitary installations]; toilets [water-closets]; toilets, portable; wash-hand basins [parts of sanitary installations]; toilet bowls; air-conditioning installations; desalination plants; installations for processing nuclear fuel and nuclear moderating material; watering installations, automatic; cooling installations for water; cooling installations for liquids; milk cooling installations; cooling installations for tobacco; water purification installations; purification installations for sewage; air filtering installations; swimming pool chlorinating apparatus; ventilation [air-conditioning] installations and apparatus; ventilation [air-conditioning] installations for

vehicles; water softening apparatus and installations; cooling installations and machines; heaters for vehicles; polymerisation installations; flare stacks for use in the oil industry; ash conveyor installations, automatic; whirlpool-jet apparatus; air cooling apparatus; aquarium filtration apparatus; cooking utensils, electric; flaming torches; headlights for automobiles; vehicle headlights; filters for air conditioning; filters for drinking water; lights for automobiles; bicycle lights; motorcycle lights; lights for vehicles; electric torches; lanterns for lighting; Chinese lanterns; fountains; ornamental fountains; deep fryers, electric; bread-making machines; refrigerators; chromatography apparatus for industrial purposes; kettles, electric; refrigerating cabinets; ice boxes; carbon for arc lamps; standard lamps.

14 – Agates; diamonds; amulets [jewelry]; anchors [clock- and watchmaking]; barrels [clock- and watchmaking]; bracelets [jewelry]; watch bands; charms [jewellery, jewelry (Am.)]; key rings [trinkets or fobs]; brooches [jewelry]; alarm clocks; pins [jewelry]; ornamental pins; tie pins; beads for making jewelry; pearls made of ambroid [pressed amber]; busts of precious metal; jet, unwrought or semi-wrought; pearls [jewelry]; copper tokens; tie clips; cuff links; badges of precious metal; gold, unwrought or beaten; works of art of precious metal; jewelry; jewelry of yellow amber; iridium; precious stones; semiprecious stones; spun silver [silver wire]; necklaces [jewelry]; rings [jewelry]; boxes of precious metal; watch cases [parts of watches]; clock cases; pendulums [clock- and watchmaking]; medals; locket [jewelry]; precious metals, unwrought or semi-wrought; movements for clocks and watches; clockworks; coins; gold thread [jewelry]; threads of precious metal [jewelry]; olivine [gems]; osmium; palladium; platinum [metal]; chronometric instruments; watch springs; rhodium; ruthenium; stopwatches; silver, unwrought or beaten; earrings; ingots of precious metals; alloys of precious metal; statues of precious metal; watch glasses; paste jewelry [costume jewelry]; ornaments [jewelry]; shoe ornaments of precious metal; hat ornaments of precious metal; ornaments of jet; chronographs [watches]; chronometers; chronoscopes; chains [jewelry]; watch chains; dials [clock- and watchmaking]; atomic clocks; watches; sundials; clocks and watches, electric; control clocks [master clocks]; clocks; jewelry boxes; spinel [precious stones]; cloisonné jewelry; ivory jewelry; silver thread [jewelry]; figurines of precious metal; presentation boxes for watches; boxes for timepieces; wristwatches.

28 – Arcade video game machines; video game machines; gaming machines for gambling; amusement machines, automatic and coin-operated; swimming pools [play articles]; trampolines; novelty toys for parties; starting blocks for sports; bodyboards; skating boots with skates attached; dolls' feeding bottles; stationary exercise bicycles; creels [fishing traps]; shutt-

lecocks; spinning tops [toys]; punching bags; bite sensors [fishing tackle]; hang gliders; flying discs [toys]; discs for sports; dolls' houses; dominoes; swimming kickboards; surfboards; spring boards [sports articles]; skateboards; sailboards; chessboards; checkerboards; darts; Christmas trees of synthetic material; swimming jackets; ascenders [mountaineering equipment]; kites; toys; toys for pets; stuffed toys; plush toys; parlor games; board games; ring games; games; building games; kaleidoscopes; bladders of balls for games; rosin used by athletes; edges of skis; bingo cards; playing cards; fairground ride apparatus; reels for fishing; rocking horses; swings; skittles; skittles [games]; billiard cues; golf clubs; hockey sticks; seal skins [coverings for skis]; bells for Christmas trees; dolls' rooms; confetti; ice skates; roller skates; in-line roller skates; dice; ski bindings; dolls' beds; roulette wheels; fish hooks; building blocks [toys]; dolls; flippers for swimming; fishing lines; gut for fishing; bows for archery; skis; waterskis; surf skis; mah-jong; hunting game calls; puppets; carnival masks; theatrical masks; fencing masks; masts for sailboards; teddy bears; chalk for billiard cues; targets; electronic targets; scale model kits [toys]; scale model vehicles; balls for games; artificial fishing bait; billiard table cushions; knee guards [sports articles]; billiard cue tips; elbow guards [sports articles]; dolls' clothes; fencing weapons; twirling batons; paragliders; pachinkos; baseball gloves; boxing gloves; golf gloves; gloves for games; batting gloves [accessories for games]; fencing gauntlets; pinatas; toy pistols; percussion caps [toys]; caps for pistols [toys]; rattles [playthings]; horseshoe games; candle holders for Christmas trees; Christmas tree stands; sole coverings for skis; water wings; floats for fishing; portable games with liquid crystal displays; swimming belts; decoys for hunting or fishing; scent lures for hunting or fishing; archery implements; soap bubbles [toys]; divot repair tools [golf accessories]; billiard markers; protective paddings [parts of sports suits]; rackets; surfboard leashes; harness for sailboards; weight lifting belts [sports articles]; sling shots [sports articles]; rollers for stationary exercise bicycles; harpoon guns [sports articles]; scooters [toys]; sleds [sports articles]; bob-sleighs; butterfly nets; landing nets for anglers; nets for sports; tennis nets; bite indicators [fishing tackle]; slot machines [gaming machines]; appliances for gymnastics; quoits; bar-bells; climbers' harness; fishing tackle; artificial snow for Christmas trees; snowshoes; snowboards; clay pigeon traps; billiard tables; coin-operated billiard tables; tables for table tennis; tables for table football; strings for rackets; gut for rackets; cricket bags; slides [playthings]; radio-controlled toy vehicles; body-building apparatus; machines for physical exercises; men's athletic supporters [sports articles]; rods for fishing; tennis ball throwing apparatus; conjuring apparatus; apparatus for games; bowling apparatus and machinery; counters [discs] for games; chips for gambling; bags

especially designed for skis and surfboards; marbles for games; billiard balls; playing balls; play balloons; paintballs [ammunition for paintball guns] [sports apparatus]; snow globes; chess games; checkers [games]; poles for pole vaulting; paper party hats; shin guards [sports articles]; camouflage screens [sports articles]; chest expanders [exercisers]; jigsaw puzzles; clay pigeons [targets]; cups for dice; toy mobiles; novelty toys for playing jokes; Christmas crackers; backgammon games; ornaments for Christmas trees, except lights, candles and confectionery.

35 – Arranging subscriptions to telecommunication services for others; import-export agency services; commercial information agency services; business auditing; book-keeping; invoicing; business management of performing artists; business management of sports people; news clipping services; word processing; arranging newspaper subscriptions for others; payroll preparation; economic forecasting; office machines and equipment rental; rental of vending machines; rental of photocopying machines; tax preparation; drawing up of statements of accounts; typing; secretarial services; shorthand; telephone answering for unavailable subscribers; photocopying services.

(260) AM 2021 110276 A
(800) 1533089
(151) 2020 04 24
(891) 2020 10 07
(731) STADA Arzneimittel AG
Stadastr. 2-18, 61118 Bad Vilbel,
Germany
(540)

STADAp^oprotect

(591) Black, white
(511)
5 – Pharmaceuticals, medical and veterinary preparations; medicine; sanitary preparations for medical purposes; dietetic food and substances adapted for medical or veterinary use, food for babies; dietary supplements for humans and animals; plasters, materials for dressings; material for stopping teeth, dental wax; disinfectants; preparations for destroying vermin; fungicides, herbicides.

10 – Surgical, medical, dental and veterinary apparatus and instruments; artificial limbs, eyes and teeth; orthopedic articles; suture materials; therapeutic and assistive devices adapted for people with disabilities; massage apparatus; apparatus, devices and articles for nursing infants; sexual activity apparatus, devices and articles.

(260) AM 2021 110277 A
(800) 1544833
(151) 2020 06 23
(891) 2020 10 07

(731) BioNTech SE
An der Goldgrube 12, 55131 Mainz, Germany
(540)

KOVIMERNA

(591) Black, white
(511)
5 – Vaccines for human use.

(260) AM 2021 110308 A
(800) 1557353
(151) 2020 07 30
(891) 2020 07 30
(731) Atomo Diagnostics Limited
Level 2, 701 – 703 Parramatta Road,
Leichhardt NSW 2040, Australia
(540)



(591) Black, white
(531) 27.05.01; 29.01; 29.01.01
(511)
10 – Medical diagnostic apparatus, including medical fluid test devices including an integrated lancet and test component for detecting and measuring the level of substances in bodily fluids for detecting drugs of abuse, pregnancy testing, diagnosing and monitoring cardiovascular disease, monitoring blood components, detecting infectious diseases, antibodies, and antigens; readers for automatically reading the results of such test devices.

(260) AM 2021 110309 A
(800) 1557376
(151) 2020 06 11
(891) 2020 06 11
(731) MATRIZE Handels-GmbH
Alter Fischmarkt 11, 20457 Hamburg, Germany
(540)

PALISAD

(591) Black, white
(511)
11 – Shoe dryers, electric.

16 – Silver paper; conical paper bags; bags for microwave cooking; bags [envelopes, pouches] of paper or plastics, for packaging; vacuum bags of plastics for storage; garbage bags of paper or of plastics; waxed paper; parchment paper; wrapping paper; filter paper; roasting bags; oven bags; plastic film for wrapping; plastic bags for wrapping.

20 – Garment covers [storage]; clothes hangers; shoulder poles [yokes]; boxes for storage; lockers; chests

for toys; tool chests, not of metal, empty; boxes of wood or plastic.

21 – Plungers for clearing blocked drains; pails; mop wringer buckets; buckets made of woven fabrics; funnels; carpet beaters [hand instruments]; sponges for household purposes; ironing boards; ironing board covers, shaped; cutting boards for the kitchen; bread boards; containers for household or kitchen use; kitchen containers; thermally insulated containers for food; chamois leather for cleaning; brooms; saucepan scourers of metal; gloves for household purposes; gardening gloves; car washing mitts; polishing gloves; cold packs for chilling food and beverages; kitchen mitts; pet grooming gloves; clothes-pegs; scoops for household purposes; basins [receptacles]; cloth for washing floors; cloths for cleaning; cleaning cloth; mops; mop wringers; replacement heads for mop wringers; brushes; tar-brushes, long handled; brushes for cleaning tanks and containers; toilet brushes; dish-washing brushes; brushes for footwear; broom handles; handles for household cleaning tools; squeegees [cleaning instruments]; roller cleaners for clothes and replacement parts thereof; vacuum bottles; drinking bottles for sports; drying racks for laundry; rotary washing lines; cake moulds; ice cube molds; urns; dustbins; disposable table plates; disposable dishes; baking paper.

22 – Packing rope; jute; wrapping or binding bands, not of metal; binding thread, not of metal, for agricultural purposes; thread, not of metal, for wrapping or binding; sisal; dust sheets; sacks and bags for the transport and storage (not included in other classes); mesh bags for washing laundry.

24 – Mosquito nets.

(260) AM 2021 110310 A

(800) 1557387

(151) 2020 07 31

(891) 2020 07 31

(731) XIE RONGCHU

1, BUILDING 4, YANGXI SEA FARM,
CHENGUN TOWN, YANGXI TOWN,
YANGJIANG, GUANGDONG, China

(540)



(591) Black, white

(531) 27.05.17; 27.05.23

(511)

3 – Beauty masks; nail polish; adhesives for affixing false eyelashes; false eyelashes; cosmetic preparations for eyelashes; cosmetics; adhesives for cosmetic pur-

poses; mascara; eye beauty glue used for double-fold eyelid; make-up removing preparations.

(260) AM 2021 110343 A

(800) 807427

(151) 2003 07 21

(891) 2020 10 12

(731) SPD SWISS PRECISION DIAGNOSTICS
GMBH

Route de St Georges 47, Petit-Lancy, CH-1213
Genève, Switzerland

(540)

CLEARBLUE

(591) Black, white

(511)

1 – Chemical and biological products for scientific applications and for use in the pharmaceuticals industry; biological, diagnostic and immunological products for in vitro and in vivo use for diagnostic purposes (not for medical purposes).

5 – Pregnancy tests; fertility tests, ovulation tests; diagnostic preparations for in vitro use for medical purposes; diagnostic preparations for in vivo use for medical purposes; reagents for medical purposes; antisera.

10 – Diagnostic apparatus for medical purposes.

(260) AM 2021 110344 A

(800) 833504

(151) 2004 08 02

(891) 2020 09 30

(731) DSM IP Assets B.V.

Het Overloon 1, NL-6411 TE Heerlen,
Netherlands

(540)

SYN

(591) Black, white

(511)

1 – Chemicals particularly chemical agents for industry.

(260) AM 2021 110354 A

(800) 1456847

(151) 2019 02 21

(891) 2020 09 29

(731) Mistwalker Corporation

711 Kapiolani Blvd., Suite 1000,
Honolulu HI 96813, USA

(540)

FANTASIAN

(591) Black, white

(511)

9 – Computer game software for use on mobile and cellular phones; downloadable electronic game software for use on mobile and cellular phones, handheld computers, and personal computers.

41 – Entertainment services, namely, providing temporary use of non-downloadable computer games.

(260) AM 2021 110355 A

(800) 1543526

(151) 2020 03 06

(891) 2020 09 14

(731) SOOFT ITALIA S.p.A.

Contrada Molino, 17, I-63833

MONTEGIORGIO (FM), Italy

(540)



The logo features the word "BLU" in a large, bold, black serif font. To its right, "gel" is written in a smaller, black, lowercase sans-serif font. Further right, "A" is in a large, bold, black serif font, and "free" is in a smaller, black, lowercase cursive font below it.

(591) Black, white

(531) 27.05.09; 27.05.10

(511)

5 – Medicated eye-washes; cotton wool for medical purposes; absorbent cotton; cotton for medical purposes; cotton buds for medical purposes; contact lens solutions; ophthalmic preparations; ophthalmic preparations for use in ocular surgery; eye drops and artificial tears; medicinal preparations for use in ophthalmology; collyrium; medicated creams or gels for the contour of the eyes; eyepatches for medical purposes.

(260) AM 2021 110356 A

(800) 1544205

(151) 2020 06 05

(891) 2020 09 14

(731) Philip Morris Products S.A.

Quai Jeanrenaud 3, CH-2000 Neuchâtel,
Switzerland

(540)



The logo consists of the word "VEEV" in a bold, black, uppercase sans-serif font.

(591) Black, white

(531) 27.05.01

(511)

34 – Wired vaporizers for electronic cigarettes and electronic smoking devices; tobacco, raw or manufactured; tobacco products, including cigars, cigarettes, cigarillos, tobacco for roll-your-own cigarettes, pipe tobacco, chewing tobacco, snuff tobacco, kretek; snus; tobacco substitutes (not for medical purposes); smokers' articles, namely cigarette paper and tubes, cigarette filters, tobacco tins, cigarette cases and ashtrays, pipes, pocket apparatus for rolling cigarettes, lighters; matches; tobacco sticks, tobacco products for

the purpose of being heated, electronic devices and their parts for the purpose of heating cigarettes or tobacco in order to release nicotine-containing aerosol for inhalation; liquid nicotine solutions for use in electronic cigarettes; electronic smoking devices; electronic cigarettes; electronic cigarettes as substitutes for traditional cigarettes; electronic devices for the inhalation of nicotine-containing aerosol; oral vaporizing devices for smokers, tobacco products and tobacco substitutes; smokers' articles for electronic cigarettes; parts and fittings for the aforesaid products included in this class; devices for extinguishing heated cigarettes and cigars as well as heated tobacco sticks; electronic rechargeable cigarette cases.

(260) AM 2021 110395 A

(800) 1558665

(151) 2020 09 24

(891) 2020 09 24

(731) PUBLIC JOINT STOCK COMPANY

GAZPROM NEFT

Pochtamtskaya Ulitsa, Dom 3-5, Liter A,

Ch.Pom. 1N, Kab. 2401, RU-190000 ST

PETERSBURG, Russian Federation

(540)



The logo features the word "SYNTOLUX" in a bold, black, uppercase sans-serif font. The letter "O" is stylized with a horizontal line through its center.

(591) Gray and white

(531) 27.03.15; 27.05.01; 27.05.07; 27.05.11;
27.05.17

(511)

1 – Acetate of cellulose, unprocessed; acetates [chemicals]; acetic anhydride; acetone; acetylene; acetylene tetrachloride; acid proof chemical compositions; acids; acidulated water for recharging accumulators; acidulated water for recharging batteries; acrylic resins, unprocessed; actinium; activated carbon; activated charcoal; additives, chemical, to drilling muds; chemical additives to drilling muds; additives, chemical, to fungicides; chemical additives to fungicides; additives, chemical, to insecticides; chemical additives to insecticides; additives, chemical, to motor fuel; chemical additives to motor fuel; adhesive preparations for surgical bandages; adhesives for billposting; adhesives for industrial purposes; adhesives for wallpaper; adhesives for paperhanging; adhesives for wall tiles; adjuvants, other than for medical or veterinary purposes; agar-agar; agglutinants for concrete; agricultural chemicals, except fungicides, herbicides, insecticides and parasiticides; albumenized paper; albumin [animal or vegetable, raw material]; alcohol; aldehydes; alginates for industrial purposes; alginates for the food industry; alkalies; alkaline-earth metals; alkaline iodides for industrial purposes; alkaline metals; alkaloids; alum; alumina; aluminium acetate; aluminium alum; aluminium chloride; aluminium hydrate; aluminium iodide; aluminium silicate; americium;

ammonia; ammonia alum; ammoniacal salts; ammonia [volatile alkali] for industrial purposes; volatile alkali [ammonia] for industrial purposes; ammonium aldehyde; ammonium nitrate; ammonium salts; amyl acetate; amyl alcohol; anhydrides; anhydrous ammonia; animal albumen [raw material]; animal carbon; animal carbon preparations; animal charcoal; animal manure; anthranilic acid; anti-boil preparations for engine coolants; anti-frothing solutions for accumulators; anti-frothing solutions for batteries; anti-incrustants; anti-knock substances for internal combustion engines; anti-sprouting preparations for vegetables; anti-tarnishing chemicals for windows; antifreeze; antimony; antimony oxide; antimony sulfide; antioxidants for use in manufacture; antioxidants for use in the manufacture of cosmetics; antioxidants for use in the manufacture of food supplements; antioxidants for use in the manufacture of pharmaceuticals; antistatic preparations, other than for household purposes; argon; arsenic; arsenious acid; artificial sweeteners [chemical preparations]; astatine; auxiliary fluids for use with abrasives; bacterial preparations, other than for medical and veterinary use; bacteriological preparations, other than for medical and veterinary use; bacteriological preparations for acetification; barium; barium compounds; barium sulfate; baryta; baryta paper; barytes; bases [chemical preparations]; basic gallate of bismuth; bate for dressing skins; dressing, except oils, for skins; bauxite; beer-clarifying and preserving agents; beer preserving agents; bentonite; benzene; benzene-based acids; benzene derivatives; benzoic acid; benzoic sulfimide; benzol; berkelium; bicarbonate of soda for chemical purposes; bichloride of tin; bichromate of potassium; bichromate of soda; biochemical catalysts; biological preparations, other than for medical or veterinary purposes; biological tissue cultures, other than for medical or veterinary purposes; birdlime; bismuth; bismuth subnitrate for chemical purposes; bleaching preparations [decolorants] for industrial purposes; decolorants for industrial purposes; blood charcoal; blueprint cloth; blueprint paper; blue vitriol; copper sulfate [blue vitriol]; bone charcoal; borax; boric acid for industrial purposes; brake fluid; brazing fluxes; brazing preparations; brickwork preservatives, except paints and oils; bromine for chemical purposes; by-products of the processing of cereals for industrial purposes; caesium; calcined soda; calcium carbide; calcium cyanamide [fertilizer]; calcium cyanamide [fertiliser]; calcium salts; californium; calomel [mercurous chloride]; camphor, for industrial purposes; carbide; carbolineum for the protection of plants; carbon; carbonates; carbon black for industrial purposes; carbon disulfide; carbon for filters; carbonic acid; carbonic hydrates; carbon tetrachloride; casein for industrial purposes; casein for the food industry; catalysts; catechu; caustic alkali; caustics for industrial purposes; caustic soda for industrial purposes; cellulose; cellulose derivatives [chemicals]; cellulose esters for industrial purposes; cellulose ethers for in-

dustrial purposes; cement-waterproofing chemicals, except paints; cement for footwear; cement for mending broken articles; cement preservatives, except paints and oils; cement [metallurgy]; ceramic compositions for sintering [granules and powders]; ceramic glazings; ceramic materials in particulate form, for use as filtering media; cerium; chemical additives for oils; chemical coatings for ophthalmic lenses; chemical condensation preparations; chemical intensifiers for paper; chemical intensifiers for rubber; chemical preparations for facilitating the alloying of metals; chemical preparations for scientific purposes, other than for medical or veterinary use; chemical preparations for smoking meat; chemical preparations for use in photography; chemical preparations to prevent diseases affecting cereal plants; chemical preparations to prevent diseases affecting vine plants; chemical preparations to prevent mildew; chemical preparations to prevent wheat blight; chemical preparations to prevent wheat smut; chemical reagents, other than for medical or veterinary purposes; chemicals, except pigments, for the manufacture of enamel; chemicals for the manufacture of paints; chemicals for the manufacture of pigments; chemicals for use in forestry, except fungicides, herbicides, insecticides and parasiticides; chemical substances for analyses in laboratories, other than for medical or veterinary purposes; chemical preparations for analyses in laboratories, other than for medical or veterinary purposes; chemical substances for preserving foodstuffs; chimney cleaners, chemical; chlorates; chlorides; chlorine; cholic acid; chromates; chrome alum; chrome salts; chromic acid; chromic salts; chromium oxide; cinematographic films, sensitized but not exposed; cinematographic film, sensitized but not exposed; citric acid for industrial purposes; coal saving preparations; cobalt oxide for industrial purposes; collagen for industrial purposes; collodion; color-brightening chemicals for industrial purposes; colour-brightening chemicals for industrial purposes; combusting preparations [chemical additives to motor fuel]; compositions for repairing inner tubes of tyres; compositions for repairing inner tubes of tires; compositions for repairing tyres; compositions for repairing tires; compositions for the manufacture of phonograph records; compositions for the manufacture of technical ceramics; compositions for threading; compost; concrete-aeration chemicals; concrete preservatives, except paints and oils; condensation-preventing chemicals; coolants for vehicle engines; corrosive preparations; cream of tartar for chemical purposes; cream of tartar for industrial purposes; cream of tartar for the food industry; creosote for chemical purposes; crotonic aldehyde; cryogenic preparations; cultures of microorganisms, other than for medical and veterinary use; curium; currying preparations for leather; currying preparations for skins; cyanides [prussiates]; prussiates; cymene; damp-proofing chemicals, except paints, for masonry; defoliant; degreasing preparations for use in manufacturing pro-

cesses; grease-removing preparations for use in manufacturing processes; degumming preparations; gum solvents; dehydrating preparations for industrial purposes; dendrimer-based polymers for use in the manufacture of capsules for pharmaceuticals; descaling preparations, other than for household purposes; detergent additives to gasoline; detergent additives to petrol; detergents for use in manufacturing processes; dextrin [size]; diagnostic preparations, other than for medical or veterinary purposes; diastase for industrial purposes; diatomaceous earth; diazo paper; disincrustants; dispersions of plastics; distilled water; dolomite for industrial purposes; drilling muds; dry ice [carbon dioxide]; dysprosium; electrophoresis gels; emollients for industrial purposes; emulsifiers; enamel-staining chemicals; engine-decarbonising chemicals; chemical preparations for decarbonising engines; enzyme preparations for industrial purposes; enzyme preparations for the food industry; enzymes for industrial purposes; enzymes for the food industry; epoxy resins, unprocessed; erbium; esters; ethane; ethers; ethyl alcohol; ethyl ether; europium; expanded clay for hydroponic plant growing [substrate]; fat-bleaching chemicals; fatty acids; ferments for chemical purposes; fermium; ferrocyanides; ferrotype plates [photography]; fertilizers; fertilisers; fertilizing preparations; fertilising preparations; filtering materials of chemical substances; filtering materials of mineral substances; filtering materials of unprocessed plastics; filtering materials of vegetable substances; filtering preparations for the beverages industry; finishing preparations for use in the manufacture of steel; fire extinguishing compositions; fireproofing preparations; fish meal fertilizers; fish meal fertilisers; fissionable chemical elements; fissionable material for nuclear energy; fixing baths [photography]; fixing solutions [photography]; flashlight preparations; flavonoids [phenolic compounds] for industrial purposes; flocculants; flour for industrial purposes; flower preservatives; flowers of sulfur for chemical purposes; fluids for hydraulic circuits; liquids for hydraulic circuits; fluorine; fluorspar compounds; formic acid; formic aldehyde for chemical purposes; foundry binding substances; foundry molding preparations; foundry moulding preparations; foundry sand; francium; fuel-saving preparations; fuel for nuclear reactors; fuller's earth for use in the textile industry; fulling preparations; fulling preparations for use in the textile industry; gadolinium; gallic acid for the manufacture of ink; gallium; gallnuts; gallotannic acid; galvanizing baths; baths for galvanizing; galvanizing preparations; gambier; gas purifying preparations; preparations for the purification of gas; gelatine for industrial purposes; gelatine for photographic purposes; genes of seeds for agricultural production; getters [chemically active substances]; glass-frosting chemicals; glass-staining chemicals; glaziers' putty; glucose for industrial purposes; glucose for the food industry; glucosides; glue for industrial purposes; glutamic acid for industrial purposes; gluten for industrial

purposes; gluten for the food industry; gluten [glue], other than for stationery or household purposes; glutinous tree-grafting preparations; glutinous tree-banding preparations; glutinous preparations for tree-banding; glutinous preparations for tree-grafting; glycerides; glycerine for industrial purposes; glycol; glycol ether; gold salts; grafting mastic for trees; grafting wax for trees; graphene; graphite for industrial purposes; guano; gum arabic for industrial purposes; gums [adhesives] for industrial purposes; gum tragacanth for industrial purposes; gurjun balsam for use in the manufacture of varnish; gypsum for use as a fertilizer; heavy water; helium; holmium; hormones for hastening the ripening of fruit; horticultural chemicals, except fungicides, herbicides, insecticides and parasiticides; humus; humus top dressing; hydrates; hydrazine; hydrochlorates; hydrochloric acid; hydrofluoric acid; hydrogen; hydrogen peroxide for industrial purposes; hypochlorite of soda; hyposulfites; industrial chemicals; iodine acid; iodine for chemical purposes; iodine for industrial purposes; iodised albumen; iodised salts; ion exchangers [chemicals]; iron salts; isinglass, other than for stationery, household or alimentary purposes; isotopes for industrial purposes; kainite; kaolin; china slip; china clay; ketones; kieselgur; krypton; lactic acid; lactose for industrial purposes; lactose for the food industry; lactose [raw material]; lamp black for industrial purposes; lanthanum; lead acetate; lead arsenate; lead oxide; leather-dressing chemicals; leather-impregnating chemicals; leather-renovating chemicals; leather-waterproofing chemicals; leather glues; lecithin for industrial purposes; lecithin for the food industry; lecithin [raw material]; lime acetate; lime carbonate; lime chloride; limestone hardening substances; liquids for removing sulfates from accumulators; liquids for removing sulfates from batteries; lithia [lithium oxide]; lithium; litmus paper; loam; lutetium [cassiopium]; cassiopium [lutetium]; magnesite; magnesium carbonate; magnesium chloride; magnetic fluid for industrial purposes; malt albumen; manganate; manganese dioxide; mangrove bark for industrial purposes; masonry preservatives, except paints and oils; mastic for leather; mastic for tires; mastic for tyres; meat tenderizers for industrial purposes; mercuric oxide; mercury; mercury salts; metal annealing preparations; metal hardening preparations; metalloids; metal tempering preparations; methane; methyl benzene; methyl benzol; methyl ether; milk ferments for chemical purposes; milk ferments for industrial purposes; milk ferments for the food industry; mineral acids; moderating materials for nuclear reactors; moistening [wetting] preparations for use in bleaching; wetting preparations for use in bleaching; moistening [wetting] preparations for use in dyeing; wetting preparations for use in dyeing; moistening [wetting] preparations for use in the textile industry; wetting preparations for use in the textile industry; mold-release preparations; mould-release preparations; mordants for metals; must-finishing preparations;

nanopowders for industrial purposes; naphthalene; neodymium; neon; neptunium; nitrate paper; nitrates; nitric acid; nitrogen; nitrogenous fertilisers; nitrogenous fertilizers; nitrous oxide; oenological bactericides [chemical preparations for use in wine making]; oil-bleaching chemicals; oil-purifying chemicals; oil-separating chemicals; oil cement [putty]; oil dispersants; oils for currying leather; oils for preparing leather in the course of manufacture; oils for tanning leather; oils for the preservation of food; oleic acid; olivine [silicate mineral]; opacifiers for enamel; opacifiers for glass; organic digestate [fertilizer]; organic digestate [fertiliser]; oxalates; oxalic acid; oxygen for industrial purposes; palladium chloride; paper pulp; paste fillers for automobile body repair; paste fillers for car body repair; peat pots for horticulture; peat [fertiliser]; peat [fertilizer]; pectin for industrial purposes; pectin for the food industry; pectin [photography]; perborate of soda; percarbonates; perchlorates; persulfates; persulfuric acid; petroleum dispersants; phenol for industrial purposes; phosphates [fertilisers]; phosphates [fertilizers]; phosphatides; phosphoric acid; phosphorus; photographic developers; photographic emulsions; photographic paper; photographic sensitizers; photometric paper; photosensitive plates; picric acid; plant growth regulating preparations; plasticizers; plastics, unprocessed; plastisols; plutonium; polish removing substances; substances for removing polish; polonium; polymer resins, unprocessed; potash; potash water; potassium; potassium dioxalate; potato flour for industrial purposes; potting soil; power steering fluid; praseodymium; preparations for preventing the tarnishing of glass; preparations for preventing the tarnishing of lenses; preparations for stimulating cooking for industrial purposes; preparations for the separation of greases; preparations of microorganisms, other than for medical and veterinary use; preparations of the distillation of wood alcohol; preparations of trace elements for plants; preservatives for tiles, except paints and oils; preservatives for use in the pharmaceutical industry; promethium; propellant gases for aerosols; protactinium; protective gases for welding; proteins for the food industry; proteins for use in manufacture; proteins for use in the manufacture of food supplements; protein [raw material]; purification preparations; clarification preparations; pyrogalllic acid; quebracho for industrial purposes; radiator flushing chemicals; radioactive elements for scientific purposes; radium for scientific purposes; radon; rare earths; reagent paper, other than for medical or veterinary purposes; reducing agents for use in photography; refrigerants; renovating preparations for phonograph records; rhenium; rock salt; rubber preservatives; rubidium; saccharin; sal ammoniac; sal ammoniac spirits; salicylic acid; salt, raw; salt for preserving, other than for foodstuffs; saltpeter; salpetre; salts for coloring metal; salts for colouring metal; salts for galvanic cells; salts for galvanic batteries; salts for industrial purposes; salts from rare earth metals; salts

of alkaline metals; salts of precious metals for industrial purposes; salts [chemical preparations]; salts [fertilisers]; salts [fertilizers]; samarium; sauce for preparing tobacco; scandium; seawater for industrial purposes; seaweeds [fertilizers]; seaweeds [fertilisers]; sebacic acid; seed preserving substances; selenium; self-toning paper [photography]; sensitized cloth for photography; sensitized films, unexposed; sensitized paper; sensitized photographic plates; sensitized plates for offset printing; separating and unsticking [ungluing] preparations; ungluing preparations; unsticking and separating preparations; silicates; silicon; silicon carbide [raw material]; silicones; silver nitrate; silver salt solutions for silvering; size for finishing and priming; size for use in the textile industry; sizing preparations; slag [fertilisers]; slag [fertilizers]; soap [metallic] for industrial purposes; soda ash; sodium; sodium salts [chemical compounds]; soil conditioning preparations; soil for growing; soldering fluxes; solidified gases for industrial purposes; solutions for cyanotyping; solvents for varnishes; soot for industrial or agricultural purposes; sorrel salt; spinel [oxide mineral]; spirits of salt; spirits of vinegar [dilute acetic acid]; stain-preventing chemicals for use on fabrics; starch-liquifying chemicals [ungluing agents]; ungluing agents [chemical preparations for liquifying starch]; starch for industrial purposes; starch paste [adhesive], other than for stationery or household purposes; stearic acid; stem cells, other than for medical or veterinary purposes; strontium; substances for preventing runs in stockings; substrates for soil-free growing [agriculture]; sulfates; sulfides; sulfonic acids; sulfur; sulfuric acid; sulfuric ether; sulfurous acid; sumac for use in tanning; superphosphates [fertilisers]; superphosphates [fertilizers]; surface-active chemical agents; tensio-active agents; synthetic materials for absorbing oil; synthetic resins, unprocessed; artificial resins, unprocessed; talc [magnesium silicate]; tan; tan-wood; tannic acid; tannin; tanning substances; tapioca flour for industrial purposes; tartar, other than for pharmaceutical purposes; tartaric acid; tea extracts for the food industry; tea extracts for use in the manufacture of cosmetics; tea extracts for use in the manufacture of pharmaceuticals; technetium; tellurium; terbium; test paper, chemical; tetrachlorides; textile-brightening chemicals; textile-impregnating chemicals; textile-waterproofing chemicals; thallium; thiocarbanilide; thorium; thulium; thymol for industrial purposes; titanite; titanium dioxide for industrial purposes; toluene; toluol; toning baths [photography]; toning salts [photography]; topsoil; toxic gas neutralizers; transmission fluid; transmission oil; tree cavity fillers [forestry]; tungstic acid; uranium; uranium nitrate; uranium oxide; vinic alcohol; viscose; vitamins for the food industry; vitamins for use in the manufacture of cosmetics; vitamins for use in the manufacture of food supplements; vitamins for use in the manufacture of pharmaceuticals; vulcanization accelerators; vulcanizing preparations; wallpaper removing prepa-

rations; water-purifying chemicals; water-softening preparations; water glass [soluble glass]; wax-bleaching chemicals; welding chemicals; soldering chemicals; wine finings; witherite; wood alcohol; wood pulp; wood vinegar [pyroligneous acid]; pyroligneous acid [wood vinegar]; X-ray films, sensitized but not exposed; xenon; xylene; xylol; ytterbium; yttrium; zirconia.

4 – Additives, non-chemical, to motor fuel; alcohol [fuel]; anthracite; beeswax; beeswax for use in the manufacture of cosmetics; belting wax; benzene fuel; benzine; biomass fuel; bone oil for industrial purposes; candles; tapers; carburants; motor fuel; carnauba wax; castor oil for industrial purposes; ceresine; charcoal [fuel]; Christmas tree candles; coal; coal briquettes; coal dust [fuel]; coal naphtha; coal tar oil; coke; combustible briquettes; cutting fluids; diesel oil; gas oil; dust absorbing compositions; dust binding compositions for sweeping; dust laying compositions; dust removing preparations; electrical energy; ethanol [fuel]; firelighters; firewood; fish oil, not edible; fuel; fuel gas; fuel oil; combustible oil; fuel with an alcohol base; gas for lighting; grease for arms [weapons]; grease for belts; grease for footwear; grease for leather; greases for the preservation of leather; oils for lighting; illuminating wax; industrial grease; industrial oil; industrial wax; kerosene; lamp wicks; lanolin; wool grease; lanolin for use in the manufacture of cosmetics; lighting fuel; lignite; ligroin; lubricants; lubricating graphite; lubricating grease; lubricating oil; mazut; methylated spirit; mineral fuel; moistening oil; motor oil; naphtha; nightlights [candles]; non-slipping preparations for belts; oil-gas; oils for paints; oils for releasing form work [building]; oils for the preservation of leather; oils for the preservation of masonry; oleine; ozokerite; ozocerite; paper spills for lighting; paraffin; peat briquettes [fuel]; peat [fuel]; perfumed candles; petrol; gasoline; petroleum, raw or refined; petroleum ether; petroleum jelly for industrial purposes; producer gas; rape oil for industrial purposes; colza oil for industrial purposes; solidified gases [fuel]; soya bean oil preparations for non-stick treatment of cooking utensils; stearine; sunflower oil for industrial purposes; tallow; textile oil; tinder; vaporized fuel mixtures; wax for skis; wax [raw material]; wicks for candles; wood briquettes; wood spills for lighting; xylene fuel.

12 – Adhesive rubber patches for repairing inner tubes; aerial conveyors; aeronautical apparatus, machines and appliances; aeroplanes; air bags [safety devices for automobiles]; aircraft; air cushion vehicles; air pumps [vehicle accessories]; airships; dirigible balloons; air vehicles; ambulances; amphibious airplanes; anti-glare devices for vehicles; anti-dazzle devices for vehicles; anti-skid chains; anti-theft alarms for vehicles; anti-theft devices for vehicles; armored vehicles; armoured vehicles; ashtrays for automobiles; automobile bodies; automobile chains; automobile chassis;

automobile hoods; automobile tyres; automobile tires; autonomous underwater vehicles for seabed inspections; axle journals; axles for vehicles; baby carriages; prams; bags adapted for pushchairs; bags adapted for strollers; balance weights for vehicle wheels; bands for wheel hubs; barges; baskets adapted for bicycles; bellows for articulated buses; bicycle bells; bicycle brakes; bicycle chains; bicycle cranks; bicycle frames; bicycle handlebars; bicycle kickstands; bicycle motors; bicycle mudguards; bicycle pedals; bicycles; bicycle saddles; bicycle trailers; bicycle tyres; bicycle tires; bicycle wheels; boat hooks; boats; bodies for vehicles; bogies for railway cars; brake discs for vehicles; brake linings for vehicles; brake pads for automobiles; brake segments for vehicles; brakes for vehicles; brake shoes for vehicles; buffers for railway rolling stock; bumpers for automobiles; cable transport apparatus and installations; caissons [vehicles]; camera drones; photography drones; canoes; caps for vehicle fuel tanks; caravans; cars; automobiles; motor cars; cars for cable transport installations; carts; casings for pneumatic tires; casings for pneumatic tyres; casters for trolleys [vehicles]; casters for carts [vehicles]; casting carriages; casting cars; ladle carriages; ladle cars; chairlifts; cigar lighters for automobiles; civilian drones; cleaning trolleys; cleats [nautical]; clips adapted for fastening automobile parts to automobile bodies; clutches for land vehicles; concrete mixing vehicles; connecting rods for land vehicles, other than parts of motors and engines; couplings for land vehicles; covers for vehicle steering wheels; crankcases for land vehicle components, other than for engines; davits for boats; delivery drones; delivery tricycles; carrier tricycles; dining cars; dining carriages; disengaging gear for boats; doors for vehicles; dredgers [boats]; dress guards for bicycles; driverless cars [autonomous cars]; self-driving cars; driving chains for land vehicles; driving motors for land vehicles; ejector seats for aircraft; electric bicycles; electric vehicles; engine mounts for land vehicles; engines for land vehicles; motors for land vehicles; fenders for ships; ferry boats; fishing trolleys; fitted footmuffs for prams; fitted footmuffs for baby carriages; fitted footmuffs for pushchairs; fitted footmuffs for strollers; fitted pushchair mosquito nets; fitted stroller mosquito nets; flanges for railway wheel tyres; flanges for railway wheel tires; forklift trucks; freewheels for land vehicles; funiculars; funnels for locomotives; funnels for ships; garbage trucks; rubbish trucks; gear boxes for land vehicles; gearing for land vehicles; gears for bicycles; golf carts [vehicles]; golf cars [vehicles]; gyrocopters; handling carts; head-rests for vehicle seats; headlight wipers; helicams; helicopters; hoods for vehicle engines; hoods for vehicles; horns for vehicles; hose carts; hot air balloons; hub caps; hubs for bicycle wheels; bicycle wheel hubs; hubs for vehicle wheels; vehicle wheel hubs; hydraulic circuits for vehicles; hydroplanes; inclined ways for boats; inner tubes for bicycle tires; inner tubes for bicycle tyres; inner tubes

for pneumatic tyres; inner tubes for pneumatic tires; jet engines for land vehicles; kick sledges; launches; locomotives; luggage carriers for vehicles; luggage nets for vehicles; lug nuts for vehicle wheels; masts for boats; military drones; military vehicles for transport; mine cars; mine cart wheels; mobility scooters; mopeds; motor buses; motor coaches; motorcycle chains; motorcycle engines; motorcycle frames; motorcycle handlebars; motorcycle kickstands; motorcycles; motorcycle saddles; motor homes; camping cars; motor racing cars; motors, electric, for land vehicles; motor scooters; mudguards; non-skid devices for vehicle tires; non-skid devices for vehicle tyres; oars; paddles for canoes; panniers adapted for bicycles; panniers adapted for motorcycles; parachutes; pet strollers; pneumatic tires [tyres]; pneumatic tyres; pontoons; portholes; propulsion mechanisms for land vehicles; pumps for bicycle tires; pushchair hoods; stroller hoods; pushchairs; strollers; push scooters [vehicles]; railway carriages; railway couplings; rearview mirrors; reduction gears for land vehicles; refrigerated railway wagons; refrigerated vehicles; remote control vehicles, other than toys; remotely operated vehicles for underwater inspections; repair outfits for inner tubes; rescue sleds; reversing alarms for vehicles; rims for bicycle wheels; bicycle wheel rims; rims for vehicle wheels; vehicle wheel rims; robotic cars; roll cage trolleys; rolling stock for funicular railways; rolling stock for railways; rowlocks; oarlocks; rudders; saddlebags adapted for bicycles; saddle covers for bicycles; saddle covers for motorcycles; safety belts for vehicle seats; safety seats for children, for vehicles; screw-propellers; screw-propellers for boats; screws [propellers] for ships; sculls; stern oars; seaplanes; seat covers for vehicles; security harness for vehicle seats; self-balancing boards; self-balancing electric unicycles; self-balancing scooters; ship hulls; ships; shock absorbers for automobiles; shock absorbing springs for vehicles; shopping trolleys; shopping carts; side cars; side view mirrors for vehicles; signal arms for vehicles; ski carriers for cars; ski lifts; sleeping berths for vehicles; sleeping cars; sleighs [vehicles]; snowmobiles; solid tires for vehicle wheels; solid tyres for vehicle wheels; space vehicles; spare wheel covers; spare tire covers; spare tyre covers; spars for ships; spikes for tires [tyres]; spoilers for vehicles; spoke clips for wheels; spokes for bicycle wheels; bicycle wheel spokes; sports cars; sprinkling trucks; steering gears for ships; steering wheels for vehicles; stroller covers; pushchair covers; sun-blinds adapted for automobiles; suspension shock absorbers for vehicles; tailboard lifts [parts of land vehicles]; elevating tailgates [parts of land vehicles]; power tailgates [parts of land vehicles]; telfer railways [cable cars]; cable cars; tilting-carts; tilt trucks; timbers [frames] for ships; tipping apparatus [parts of railway wagons]; tipping bodies for lorries; tipping bodies for trucks; tires for vehicle wheels; tyres for vehicle wheels; torque converters for land vehicles; torsion bars

for vehicles; tow trucks; wreckers for transport; tractors; trailer hitches for vehicles; trailers for transporting bicycles; trailers [vehicles]; tramcars; transmission chains for land vehicles; transmissions for land vehicles; transmission shafts for land vehicles; treads for retreading tyres; treads for retreading tires; treads for vehicles [tractor type]; treads for vehicles [roller belts]; tricycles; trolleys; hand cars; trucks; lorries; trucks with a crane feature incorporated; tubeless tires for bicycles; tubeless tyres for bicycles; turbines for land vehicles; two-wheeled trolleys; luggage trucks; sack-barrows; tyre mousse inserts; tire mousse inserts; undercarriages for vehicles; upholstery for vehicles; valves for vehicle tyres; valves for vehicle tires; vans [vehicles]; vehicle bonnet pins; vehicle hood pins; vehicle bumpers; vehicle chassis; vehicle covers [shaped]; vehicle joysticks; vehicle running boards; vehicle seats; vehicles for locomotion by land, air, water or rail; vehicle suspension springs; vehicle wheels; vehicle wheel spokes; water vehicles; wheelbarrows; wheelchairs; windows for vehicles; windscreens; windshields; windshield wipers; windscreen wipers; yachts.

16 – Absorbent sheets of paper or plastic for foodstuff packaging; addressing machines; address plates for addressing machines; address stamps; adhesive bands for stationery or household purposes; adhesives [glues] for stationery or household purposes; adhesive tape dispensers [office requisites]; adhesive tapes for stationery or household purposes; advertisement boards of paper or cardboard; albums; scrapbooks; almanacs; animation cels; announcement cards [stationery]; apparatus for mounting photographs; aquarelles; watercolors [paintings]; watercolours [paintings]; architects' models; arithmetical tables; calculating tables; artists' watercolor saucers; artists' watercolour saucers; atlases; baggage claim check tags of paper; bags for microwave cooking; bags [envelopes, pouches] of paper or plastics, for packaging; balls for ball-point pens; banknotes; banners of paper; barcode ribbons; bibs, sleeved, of paper; bibs of paper; binding strips [bookbinding]; biological samples for use in microscopy [teaching materials]; blackboards; blotters; blueprints; plans; bookbinding apparatus and machines [office equipment]; bookbinding cloth; cloth for bookbinding; bookbinding material; bookends; booklets; bookmarkers; books; bottle envelopes of paper or cardboard; bottle wrappers of paper or cardboard; boxes of paper or cardboard; bunting of paper; desktop cabinets for stationery [office requisites]; calendars; canvas for painting; carbon paper; cardboard; cardboard tubes; cards; charts; cases for stamps [seals]; catalogues; chalk for lithography; chalk holders; charcoal pencils; chart pointers, non-electronic; chromolithographs [chromos]; chromos; cigar bands; clipboards; clips for name badge holders [office requisites]; coasters of paper; comic books; compasses for drawing; composing frames [printing]; composing sticks; conical paper bags; copying paper [stationery]; cords for

bookbinding; bookbinding cords; correcting fluids [office requisites]; correcting ink [heliography]; correcting tapes [office requisites]; covers of paper for flower pots; flower-pot covers of paper; covers [stationery]; wrappers [stationery]; cream containers of paper; credit card imprinters, non-electric; dental tray covers of paper; desk mats; diagrams; document files [stationery]; document holders [stationery]; document laminators for office use; drawer liners of paper, perfumed or not; drawing boards; drawing instruments; drawing materials; drawing pads; drawing pens; drawing pins; thumbtacks; drawing rulers; drawing sets; duplicators; elastic bands for offices; electrocardiograph paper; electrotypes; embroidery designs [patterns]; engraving plates; engravings; envelope sealing machines for offices; envelopes [stationery]; erasing products; erasing shields; etching needles; etchings; fabrics for bookbinding; face towels of paper; figurines of papier mâché; statuettes of papier mâché; files [office requisites]; filtering materials of paper; filter paper; finger-stalls [office requisites]; flags of paper; flyers; folders for papers; jackets for papers; forms, printed; fountain pens; franking machines for office use; postage meters for office use; French curves; galley racks [printing]; garbage bags of paper or of plastics; geographical maps; glitter for stationery purposes; glue for stationery or household purposes; pastes for stationery or household purposes; gluten [glue] for stationery or household purposes; graining combs; graphic prints; graphic representations; graphic reproductions; greeting cards; gummed cloth for stationery purposes; gummed tape [stationery]; gums [adhesives] for stationery or household purposes; hand-rests for painters; handkerchiefs of paper; hand labelling appliances; handwriting specimens for copying; hat boxes of cardboard; hectographs; histological sections for teaching purposes; holders for cheque books; holders for checkbooks; holders for stamps [seals]; house painters' rollers; humidity control sheets of paper or plastic for foodstuff packaging; index cards [stationery]; indexes; Indian inks; ink; inking pads; inking ribbons; inking sheets for document reproducing machines; inking sheets for duplicators; inkstands; ink sticks; ink stones [ink reservoirs]; inkwells; isinglass for stationery or household purposes; labels of paper or cardboard; ledgers [books]; letter trays; lithographic stones; lithographic works of art; lithographs; loose-leaf binders; ring binders; luminous paper; magazines [periodicals]; manifolds [stationery]; manuals [handbooks]; handbooks [manuals]; marking chalk; marking pens [stationery]; mats for beer glasses; mimeograph apparatus and machines; modelling clay; modelling materials; modelling paste; modelling wax, not for dental purposes; moisteners for gummed surfaces [office requisites]; moisteners [office requisites]; molds for modelling clays [artists' materials]; moulds for modelling clays [artists' materials]; money clips; musical greeting cards; name badge holders [office requisites]; name badges [office requisites]; newsle-

tters; newspapers; nibs; nibs of gold; note books; numbering apparatus; numbers [type]; obliterating stamps; office perforators; office requisites, except furniture; oleographs; packaging material made of starches; packing [cushioning, stuffing] materials of paper or cardboard; pads [stationery]; page holders; paint boxes for use in schools; paintbrushes; painters' brushes; painters' easels; paintings [pictures], framed or unframed; paint trays; palettes for painters; pamphlets; pantographs [drawing instruments]; paper; paper-clips; paper bags for use in the sterilization of medical instruments; paper bags for use in the sterilisation of medical instruments; paper bows, other than haberdashery or hair decorations; paper clasps; paper coffee filters; paper creasers [office requisites]; paper cutters [office requisites]; paper for medical examination tables; paper for radiograms; paper for recording machines; paper knives [letter openers]; paper ribbons, other than haberdashery or hair decorations; papers for painting and calligraphy; paper sheets [stationery]; paper shredders for office use; paper tapes and cards for the recordal of computer programmes; paperweights; paper wipes for cleaning; papier mâché; parchment paper; passport holders; pastels [crayons]; pen cases; boxes for pens; pencil holders; pencil lead holders; pencil leads; pencils; pencil sharpeners, electric or non-electric; pencil sharpening machines, electric or non-electric; pen clips; penholders; pens [office requisites]; pen wipers; perforated cards for Jacquard looms; periodicals; photo-engravings; photograph stands; photographs [printed]; pictures; placards of paper or cardboard; place mats of paper; plastic bags for pet waste disposal; plastic bubble packs for wrapping or packaging; plastic cling film, extensible, for palletization; plastic film for wrapping; plastics for modelling; polymer modelling clay; portraits; postage stamps; postcards; posters; printed coupons; printed matter; printed publications; printed sheet music; printed timetables; printers' blankets, not of textile; printers' reglets; printing blocks; printing sets, portable [office requisites]; printing type; prints [engravings]; prospectuses; punches [office requisites]; retractable reels for name badge holders [office requisites]; rice paper; rollers for typewriters; rubber erasers; school supplies [stationery]; scrapers [erasers] for offices; sealing compounds for stationery purposes; sealing machines for offices; sealing stamps; sealing wafers; sealing wax; seals [stamps]; self-adhesive tapes for stationery or household purposes; sewing patterns; sheets of reclaimed cellulose for wrapping; shields [paper seals]; signboards of paper or cardboard; silver paper; slate pencils; song books; spools for inking ribbons; spray chalk; square rulers for drawing; squares for drawing; stamp pads; stamp stands; stamps [seals]; stands for pens and pencils; staples for offices; clips for offices; stapling presses [office requisites]; starch paste [adhesive] for stationery or household purposes; stationery; steatite [tailor's chalk]; steel letters; steel pens; stencil cases; stencil plates; stencils;

stencils for decorating food and beverages; stencils [stationery]; stickers [stationery]; stuffing of paper or cardboard; padding materials of paper or cardboard; T-squares for drawing; tablecloths of paper; table linen of paper; tablemats of paper; table napkins of paper; table runners of paper; tags for index cards; tailors' chalk; teaching materials [except apparatus]; terrestrial globes; tickets; tissues of paper for removing make-up; toilet paper; hygienic paper; towels of paper; tracing cloth; tracing needles for drawing purposes; tracing paper; tracing patterns; trading cards, other than for games; transfers [decalcomanias]; decalcomanias; transparencies [stationery]; trays for sorting and counting money; typewriter keys; typewriter ribbons; typewriters, electric or non-electric; type [numerals and letters]; letters [type]; vignetting apparatus; viscose sheets for wrapping; washi; waxed paper; wood pulp board [stationery]; wood pulp paper; wrapping paper; packing paper; wristbands for the retention of writing instruments; writing board erasers; writing brushes; writing cases [sets]; writing cases [stationery]; writing chalk; writing instruments; writing materials; writing or drawing books; writing paper; writing slates.

25 – Albs; ankle boots; aprons [clothing]; ascots; babies' pants [underwear]; bandanas [neckerchiefs]; bathing caps; bathing suits; swimsuits; bathing trunks; bathing drawers; bath robes; bath sandals; bath slippers; beach clothes; beach shoes; belts [clothing]; berets; bibs, not of paper; bibs, sleeved, not of paper; boas [necklets]; bodices [lingerie]; boots; boots for sports; boot uppers; boxer shorts; braces for clothing [suspenders]; suspenders; brassieres; breeches for wear; camisoles; cap peaks; caps being headwear; chasubles; clothing; clothing containing slimming substances; clothing for gymnastics; clothing of imitations of leather; clothing of leather; coats; collars [clothing]; combinations [clothing]; corselets; corsets [underclothing]; cuffs; wristbands [clothing]; cyclists' clothing; detachable collars; dresses; dressing gowns; dress shields; ear muffs [clothing]; embroidered clothing; esparto shoes or sandals; fingerless gloves; fishing vests; fittings of metal for footwear; football shoes; football boots; footmuffs, not electrically heated; footwear; footwear uppers; fur stoles; furs [clothing]; gabardines [clothing]; gaiters; spats; galoshes; goloshes; garters; girdles; gloves [clothing]; gymnastic shoes; hairdressing capes; half-boots; hat frames [skeletons]; hats; headbands [clothing]; headwear; heelpieces for footwear; heelpieces for stockings; heel protectors for shoes; heels; hoods [clothing]; hosiery; inner soles; jackets [clothing]; jerseys [clothing]; judo uniforms; jumper dresses; pinafore dresses; karate uniforms; kimonos; knitwear [clothing]; lace boots; layettes [clothing]; leggings [leg warmers]; leg warmers; leggings [trousers]; leotards; liveries; maniples; mantillas; masquerade costumes; miters [hats]; mitres [hats]; mittens; money belts [clothing]; motorists' clothing; muffs [clothing]; neck scarves [mufflers];

neck scarfs [mufflers]; mufflers [neck scarves]; neckties; non-slipping devices for footwear; outerclothing; overalls; smocks; overcoats; topcoats; pajamas; pyjamas; panties; knickers; paper clothing; paper hats [clothing]; parkas; pelerines; pelisses; petticoats; pockets for clothing; pocket squares; ponchos; ready-made clothing; ready-made linings [parts of clothing]; sandals; saris; sarongs; sashes for wear; scarfs; scarves; shawls; shirt fronts; shirts; shirt yokes; shoes; short-sleeve shirts; shower caps; ski boots; ski gloves; skirts; skorts; skull caps; sleep masks; slippers; slips [underclothing]; socks; sock suspenders; soles for footwear; sports jerseys; sports shoes; sports singlets; stockings; stocking suspenders; studs for football boots; stuff jackets [clothing]; suits; sweat-absorbent socks; sweat-absorbent stockings; sweat-absorbent underwear; sweat-absorbent underclothing; sweaters; pullovers; jumpers [pullovers]; teddies [underclothing]; bodies [underclothing]; tee-shirts; tights; tips for footwear; togas; top hats; trousers; pants (Am.); trouser straps; gaiter straps; turbans; underpants; underwear; underclothing; uniforms; valenki [felted boots]; veils [clothing]; vests; waistcoats; visors being headwear; waterproof clothing; welts for footwear; wet suits for water-skiing; wimples; wooden shoes.

35 – Administration of consumer loyalty programs; administration of frequent flyer programs; administrative assistance in responding to calls for tenders; administrative assistance in responding to requests for proposals [RFPs]; administrative processing of purchase orders; advertising; publicity; advertising agency services; publicity agencies; advertising by mail order; advisory services for business management; appointment reminder services [office functions]; appointment scheduling services [office functions]; arranging newspaper subscriptions for others; arranging subscriptions to telecommunication services for others; auctioneering; bill-posting; book-keeping; accounting; business appraisals; business auditing; business efficiency expert services; business information; business inquiries; business intermediary services relating to the matching of potential private investors with entrepreneurs needing funding; business investigations; business management and organization consultancy; business management assistance; business management consultancy; business management for freelance service providers; business management of hotels; business management of performing artists; business management of reimbursement programs for others; business management of reimbursement programmes for others; business management of sports people; business organization consultancy; business project management services for construction projects; business research; commercial administration of the licensing of the goods and services of others; commercial information agency services; commercial information and advice for consumers in the choice of products and services; commercial intermediation services; commercial lobbying services; commercial or

industrial management assistance; competitive intelligence services; compilation of information into computer databases; compilation of statistics; compiling indexes of information for commercial or advertising purposes; computerized file management; consultancy regarding advertising communication strategies; consultancy regarding public relations communication strategies; corporate communications services; cost price analysis; data search in computer files for others; demonstration of goods; development of advertising concepts; direct mail advertising; dissemination of advertising matter; distribution of samples; drawing up of statements of accounts; economic forecasting; employment agency services; financial auditing; gift registry services; import-export agency services; interim business management; invoicing; layout services for advertising purposes; marketing; marketing in the framework of software publishing; marketing research; market intelligence services; market studies; media relations services; modelling for advertising or sales promotion; negotiation and conclusion of commercial transactions for third parties; negotiation of business contracts for others; news clipping services; office machines and equipment rental; online advertising on a computer network; online retail services for downloadable and pre-recorded music and movies; online retail services for downloadable digital music; online retail services for downloadable ring tones; opinion polling; organization of exhibitions for commercial or advertising purposes; organization of fashion shows for promotional purposes; organization of trade fairs for commercial or advertising purposes; outdoor advertising; outsourced administrative management for companies; outsourcing services [business assistance]; pay per click advertising; payroll preparation; personnel management consultancy; personnel recruitment; photocopying services; presentation of goods on communication media, for retail purposes; price comparison services; procurement services for others [purchasing goods and services for other businesses]; production of advertising films; production of teleshopping programmes; production of teleshopping programs; professional business consultancy; promotion of goods and services through sponsorship of sports events; providing business information via a web site; provision of an online marketplace for buyers and sellers of goods and services; provision of commercial and business contact information; psychological testing for the selection of personnel; publication of publicity texts; publicity material rental; public relations; radio advertising; registration of written communications and data; administrative services for the relocation of businesses; rental of advertising space; rental of advertising time on communication media; rental of billboards [advertising boards]; rental of office equipment in co-working facilities; rental of photocopying machines; rental of sales stands; rental of vending machines; retail services for pharmaceutical, veterinary and sanitary preparations and medical

supplies; retail services for works of art provided by art galleries; sales promotion for others; scriptwriting for advertising purposes; search engine optimization for sales promotion; search engine optimisation for sales promotion; secretarial services; shop window dressing; shorthand; sponsorship search; systemization of information into computer databases; targeted marketing; tax filing services; tax preparation; telemarketing services; telephone answering for unavailable subscribers; television advertising; transcription of communications [office functions]; typing; updating and maintenance of data in computer databases; updating and maintenance of information in registries; updating of advertising material; web indexing for commercial or advertising purposes; web site traffic optimization; web site traffic optimisation; wholesale services for pharmaceutical, veterinary and sanitary preparations and medical supplies; word processing; writing of publicity texts; writing of résumés for others; writing of curriculum vitae for others.

41 – Academies [education]; aikido instruction; amusement park services; animal training; arranging and conducting of colloquiums; arranging and conducting of concerts; arranging and conducting of conferences; arranging and conducting of congresses; arranging and conducting of in-person educational forums; arranging and conducting of seminars; arranging and conducting of symposiums; arranging and conducting of workshops [training]; arranging of beauty contests; boarding school education; booking of seats for shows; calligraphy services; cinema presentations; movie theatre presentations; club services [entertainment or education]; coaching [training]; conducting fitness classes; conducting guided climbing tours; conducting guided tours; correspondence courses; cultural, educational or entertainment services provided by art galleries; disc jockey services; discotheque services; dubbing; educational examination; educational examination for users to qualify to pilot drones; educational services provided by schools; educational services provided by special needs assistants; education information; electronic desktop publishing; entertainer services; entertainment information; entertainment services; film directing, other than advertising films; film distribution; film production, other than advertising films; gambling services; games equipment rental; game services provided online from a computer network; gymnastic instruction; health club services [health and fitness training]; holiday camp services [entertainment]; judo instruction; karaoke services; know-how transfer [training]; language interpreter services; layout services, other than for advertising purposes; lending library services; lighting technician services for events; microfilming; mobile library services; bookmobile services; modelling for artists; movie studio services; music composition services; news reporters services; nightclub services [entertainment]; nursery schools; online publication of electronic books and journals; orchestra services; organization of

balls; organization of competitions [education or entertainment]; organization of cosplay entertainment events; organization of exhibitions for cultural or educational purposes; organization of fashion shows for entertainment purposes; organization of lotteries; organization of shows [impresario services]; organization of sports competitions; party planning [entertainment]; personal trainer services [fitness training]; photographic reporting; photography; physical education; practical training [demonstration]; presentation of circus performances; presentation of live performances; presentation of variety shows; production of music; production of radio and television programmes; production of shows; providing amusement arcade services; providing casino facilities [gambling]; providing films, not downloadable, via video-on-demand services; providing golf facilities; providing museum facilities [presentation, exhibitions]; providing online electronic publications, not downloadable; providing online music, not downloadable; providing online videos, not downloadable; providing recreation facilities; providing sports facilities; providing television programmes, not downloadable, via video-on-demand services; providing television programs, not downloadable, via video-on-demand services; publication of books; publication of texts, other than publicity texts; radio entertainment; recording studio services; recreation information; religious education; rental of artwork; rental of audio equipment; rental of cinematographic apparatus; rental of indoor aquaria; rental of lighting apparatus for theatrical sets or television studios; rental of motion pictures; rental of radio and television sets; rental of show scenery; rental of skin diving equipment; rental of sound recordings; rental of sports equipment, except vehicles; rental of sports grounds; rental of stadium facilities; rental of stage scenery; rental of tennis courts; rental of video cameras; rental of camcorders; rental of video cassette recorders; rental of videotapes; sado instruction [tea ceremony instruction]; screenplay writing; scriptwriting, other than for advertising purposes; sign language interpretation; songwriting; sound engineering services for events; sport camp services; subtitling; teaching; educational services; instruction services; television entertainment; theatre productions; ticket agency services [entertainment]; timing of sports events; toy rental; training services provided via simulators; translation; tutoring; video editing services for events; videotape editing; videotaping; vocational guidance [education or training advice]; vocational retraining; writing of texts; zoological garden services.

(260) AM 2021 110397 A
 (800) 1558679
 (151) 2020 07 01
 (891) 2020 07 01
 (731) MIRZA INTERNATIONAL LIMITED
 A-7, Mohan Co-operative Industrial area,

Mathura road, New Delhi-110044,
 India

(540)



BOND STREET
 REDTAPE LONDON

(591) Black, white
 (531) 05.05.02; 05.05.20; 05.05.21; 27.05.10
 (526) LONDON
 (511)
 25 – Footwear; ready-made garments and clothing; headgear.

(260) AM 2021 110410 A
 (800) 1559000
 (151) 2020 07 29
 (891) 2020 07 29
 (731) LINYI MINGTUO IMPORT & EXPORT CO., LTD.
 2-1602, Building 3, Langrunyuan Community,
 Interchange of Yimeng Road, and Shanghai
 Road, Lanshan District, Linyi City, 276000
 Shandong Province, China

(540)

Consmos 

(591) Black, white
 (531) 27.03.12; 27.05.09
 (511)
 19 – Plywood; xylolith; wood flooring; marble; plasterboard; door panels, not of metal; ceramic tile; plastic board for building; plastic floor; plastic-steel doors and windows.

(260) AM 2021 110411 A
 (800) 1559001
 (151) 2020 08 07
 (891) 2020 08 07
 (731) Shandong Jinyu Tire Co., Ltd.
 No. 260, Qingken Road, Dawang Town,
 Guangrao County, Dongying City, Shandong
 Province, China

(540)

AMULET

(591) Black, white
 (531) 27.05.01
 (511)
 12 – Tire patches; tyres for two-wheeled vehicles; tyres for commercial vehicles; inner tubes for motor-

cycle tires; automobile tires [tyres]; airplane tyres; tires for children's bicycles; tyres for trucks; tyres for buses; tires for vehicle wheels; treads for retreading tires [tyres]; pneumatic tires; adhesive rubber patches for repairing inner tubes; casings for pneumatic tires [tyres].

(260) AM 2021 110412 A
(800) 1559020
(151) 2020 08 25
(891) 2020 08 25
(731) NINGBO DEGSON ELECTRONICS CO., LTD.
No. 1585 Xiaolin Road, Cixi, Ningbo,
315321 Zhejiang, China

(540)



(591) Black, white
(531) 26.03.04; 26.03.05; 26.03.24; 27.05.17
(511)

35 – Presentation of goods on communication media, for retail purposes; providing business information via a web site; administrative services for the relocation of businesses; sales promotion for others; personnel management consultancy; compiling indexes of information for commercial or advertising purposes; drawing up of statements of account; rental of vending machines; sponsorship search; rental of sales stands; retail or wholesale services for medical supplies; retail services for pharmaceutical, veterinary and sanitary preparations and medical supplies.

(260) AM 2021 110425 A
(800) 1559329
(151) 2020 09 23
(891) 2020 09 23
(731) Obshchestvo s ogranichennoi otvetstvennostiu "ZIL-AiPi"
ul. Avtozavodskaya, d. 23, korp. 15, etazh 9,
chast komnaty 23, RU-115280 Moscow,
Russian Federation

(540)

AMO

(591) Black, white
(511)
28 – Scale model vehicles.

(260) AM 2021 110426 A
(800) 1559333
(151) 2020 09 23
(891) 2020 09 23
(731) Obshchestvo s ogranichennoi otvetstvennostiu "ZIL-AiPi"

ul. Avtozavodskaya, d. 23, korp. 15, etazh 9,
chast komnaty 23, RU-115280 Moscow,
Russian Federation

(540)

ЗИС

(591) Black, white
(531) 28.05
(511)
28 – Toy vehicles; toys; toy mobiles; toy models; scale model kits [toys]; scale model vehicles; remote-controlled toy vehicles; toy figures.

(260) AM 2021 110427 A
(800) 1559380
(151) 2020 10 08
(891) 2020 10 08
(731) Henkel AG & Co. KgaA
Henkelstr. 67, 40589 Düsseldorf, Germany

(540)



(591) Green, red, orange, blue, yellow, grey and white
(531) 26.04.01; 26.04.09; 26.04.18; 26.04.24;
27.05.08; 27.05.09; 27.05.10; 27.05.24;
29.01.15

(511)
2 – Paints, varnishes, lacquers; preservatives against rust and against deterioration of wood; raw natural resins; metals in foil and powder form for use in painting, decorating.

17 – Unprocessed and semi-processed rubber, gutta-percha, gum, asbestos, mica and substitutes for all these materials; plastics and resins in extruded form for use in manufacture; packing, stopping and insulating materials; flexible pipes, tubes and hoses, not of metal.

19 – Materials, not of metal, for building and construction; rigid pipes, not of metal, for building; asphalt, pitch, tar and bitumen; transportable buildings, not of metal; monuments, not of metal.

(260) AM 2021 110428 A
(800) 1559423
(151) 2020 08 12
(891) 2020 08 12
(731) Oba Trading & Business (Xiamen) Co., Ltd.
No.961 Hengshan Street, Jimei District,
Xiamen City, Fujian Province, China

(540)



(591) Black, white

(531) 01.05.02; 03.07.17; 24.01.13; 24.01.15;
24.01.18; 24.01.25; 24.09.02; 25.01.06

(511)

41 – Training; teaching; practical training [demonstration]; vocational guidance [education or training advice]; organization of shows [impresario services]; publication of books; production of radio and television programmes; club services [entertainment or education]; health club services [health and fitness training]; modelling for artists.

(260) AM 2021 110429 A

(800) 1559427

(151) 2020 09 04

(891) 2020 09 04

(731) Midea Group Co., Ltd.

B 26-28F, Midea Headquarter Building, No.6
Midea Avenue, Beijiao, Shunde, Foshan,
100044 Guangdong, China

(540)

SHINSENA

(591) Black, white

(531) 27.05.17

(511)

11 – Cooking utensils, electric; cooking apparatus and installations; cookers; refrigerators; freezers; cooling appliances and installations; lighting devices; bath fittings; sanitary apparatus and installations; water purification installations; water dispenser; disinfectant apparatus; radiators, electric; ventilation [air-conditioning] installations and apparatus; air sterilizers; humidifiers; dehumidifiers for household purposes; extractor hoods for kitchens; hair dryers; heating apparatus; heating installations; air-conditioning installations; air conditioner; air-conditioning fan; air filtering installations; fans [air-conditioning]; air purifying apparatus and machines.

(260) AM 2021 110431 A

(800) 1294008

(151) 2016 02 05

(891) 2020 09 24

(731) ZHEJIANG GEELY HOLDING GROUP CO., LTD.

1760 Jiangling Road, Binjiang District,
Hangzhou, Zhejiang, China

(540)

EMGRAND

(591) Black, white

(511)

12 – Vehicles for locomotion by land, air, water or rail; automobiles; gear boxes for land vehicles; motors for land vehicles; motorcycles; bodies for vehicles; telpher railways [cable cars]; trolleys; tires for vehicle wheels.

37 – Painting or repair of signs; motor vehicle maintenance and repair; anti-rust treatment for vehicles; vehicle service stations [refuelling and maintenance]; vehicle lubrication [greasing]; vehicle wash; airplane maintenance and repair; retreading of tires [tyres]; burglar alarm installation and repair.

(260) AM 2021 110436 A

(800) 1517142

(151) 2020 01 10

(891) 2020 10 02

(731) CANPACK S.A.

Ul. Jasnogórska 1, PL-31-358 KRAKÓW,
Poland

(540)

CANPACK

(591) Navy blue

(531) 27.05.17; 29.01.04

(511)

6 – Tins of metal; preserving boxes of metal; beverage cans of metal; metal cans, sold empty; closures of metal; cap closures of metal; closures of metal for containers; tin cans [empty]; containers made of metal for use in the storage of gases; metallic containers; metal aerosol containers [empty]; metal aerosol containers sold empty; screw caps of metal; sealing caps of metal; bottle closures of metal; tinfoil; foils of metal for covering; foils of metal for cooking; aluminium; sheet metal; aluminium foil; alloys of metal.

42 – Advisory services relating to industrial engineering; advisory services relating to design engineering; engineering design and consultancy; engineering design; engineering services relating to computer programming; engineering services relating to metal forming systems; engineering services relating to metal handling systems; engineering services relating to information technology; engineering services relating to data processing; engineering services for others; computer-aided engineering design services; computer-aided engineering design and drawing services; technical design; engineering consultancy services; computer assisted engineering design services; consultancy services relating to product engineering; engineering consultancy relating to design; consultancy relating to the design of packaging; technical assessments

relating to design; product development for others; product development; professional consultancy relating to industrial design; product research and development; design and testing of new products; design and development of new products; design and testing for new product development; packaging design for others; designing of packaging and wrapping materials; new product design; design of specialist machinery; design of industrial products; consumer product design; design of ornamental layouts; provision of information relating to industrial design; styling [industrial design]; design sketching of packaging, containers, dinnerware and table utensils; engineering services for the design of machinery; engineering and computer-aided engineering services; advisory services relating to industrial design; design services relating to metal-working presses; design services relating to metal-working tools; industrial and graphic art design; industrial art design; product design and development; computer-aided industrial design.

(260) AM 2021 110437 A

(800) 1553270

(151) 2020 06 30

(891) 2020 10 16

(731) DSM IP Assets B.V.

Het Overloon 1, NL-6411 TE Heerlen,
Netherlands

(540)

PENTAVITIN

(591) Black, white

(511)

1 – Chemical ingredients for hand-sanitizing liquids, hand sanitizing sprays and hand sanitizers manufacture, chemical products for industrial use for the manufacture of beauty, eye care, hair care and skin care products, chemical and biochemical preparations for the manufacture of cosmetics, eye care products, hair care products, skin care products and sun-screen products for the absorption of ultraviolet ray.

3 – Cosmetics, also for beauty, eye care, hair care and skin care; cosmetics, hair care, eye care and skin care products for the prevention of sunburn; sun-tan and sun-screening preparations; preparations and substances for the conditioning, care and appearance of the skin, body, eye, face and hair, cosmetic preparations, cosmetics, namely powders, sprays for deodorizing and refreshing, towelettes for deodorizing and cleansing and liquids for washing and cleansing, all for use in feminine hygiene, feminine hygiene wash, deodorants and antiperspirants (toilet preparations); soaps, deodorant soaps, soaps for toilet purposes, body wash, hand wash, shower foams, shower creams, shower soaps, cleansing cream for toilet purposes and skin use, cleansing soaps for toilet purposes and skin use, bath gels and shower gels not for medical purposes, cosmetic preparations for cleaning and care of skin

and hair, bath preparations and shower bath preparations, douching preparations for personal sanitary or deodorant purposes (toiletries); personal lotions for private parts, not for medical purposes; vaginal preparations for personal sanitary or deodorant purposes [toiletries]; hand-washing paste; feminine hygiene wash (not medical), non-medicated preparations and substances for the conditioning, care and appearance of the skin, body, face and hair; cleansing milk for toilet purposes, creams, milks and lotions for cosmetic purposes, cosmetic preparations for skin care, cosmetic preparations for baths, shampoos and hair lotions.

5 – Alcohol-based antibacterial skin sanitizer products, alcohol-based antibacterial skin sanitizer gels, alcohol-based antibacterial skin sanitizer liquids, alcohol-based antibacterial skin sanitizer foams, anti-bacterial cleaning preparations for hand and body, anti-bacterial skin protection lotions, creams and gels, hand disinfectants, vaginal washes for medical purposes; douching preparations for medical purposes; bath preparations for medical purposes; antibacterial hand wash; antibacterial bar soap; anti-bacterial body wash; anti-bacterial foam hand wash, feminine hygiene wash, hand sanitizing preparations; hand sanitizer; disinfectants soaps; anti-bacterial body wash, anti-bacterial hand wash, anti-bacterial foam hand wash.

(260) AM 2021 110483 A

(800) 1559443

(151) 2020 10 07

(891) 2020 10 07

(731) STADA Arzneimittel AG

Stadastr. 2-18, 61118 Bad Vilbel, Germany

(540)

VIRUPROTECT STADA

(591) Black, white

(511)

5 – Pharmaceuticals; medical and veterinary preparations; sanitary preparations for medical purposes; dietetic food and substances adapted for medical or veterinary use, food for babies; dietary supplements for humans and animals; plasters, materials for dressings; material for stopping teeth, dental wax; disinfectants; preparations for destroying vermin; fungicides; herbicides.

(260) AM 2021 110486 A

(800) 1559488

(151) 2020 08 17

(891) 2020 08 17

(731) DELI GROUP CO., LTD.

DELI INDUSTRIAL PARK, NINGHAI
COUNTY, NINGBO, 310008 ZHEJIANG,
China

(540)



(591) Black, white
 (531) 01.15.15; 27.05.01
 (511)

2 – Colorants; pigments; metals in powder form for use in painting, decorating, printing and art; watercolour paints for use in art; oil paints for use in art; food dyes; ink for leather; printing ink; ink cartridges, filled, for printers and photocopiers; paints.

16 – Stationery; ink; pens [office requisites]; paintbrushes; drawing boards; paint boxes for use in schools; canvas for painting; drawing instruments; drawing pads; papers for painting and calligraphy.

(260) AM 2021 110487 A
 (800) 1559493
 (151) 2019 09 19
 (891) 2019 09 19
 (731) Apple Inc.

One Apple Park Way; Cupertino CA 95014,
 USA

(540)



(591) Black, white
 (531) 05.07.13; 05.07.23
 (526) Trade In
 (511)

35 – Retail services, namely, providing a trade-in and buy-back program for used computers, computer hardware and peripherals, tablet computers, smartwatches, smartphones, set-top boxes, media players, audio speakers, headphones, earphones, wireless routers, computer monitors, computer keyboards, computer mice, computer cables, computer power adapters, computer printers for printing documents and photos, scanners, and peripherals and accessories for the foregoing.

40 – Recycling; recycling of used computers, computer hardware and peripherals, tablet computers, smartwatches, smartphones, set-top boxes, media players, audio speakers, headphones, earphones, wireless routers, computer monitors, computer keyboards, computer mice, computer cables, computer power adapters, computer printers for printing documents and photos, scanners, and peripherals and accessories for the foregoing; providing a recycling program whereby par-

ticipants are incentivized to recycle by receiving payment, credit, or services in exchange for trading in used computers, computer hardware and peripherals, tablet computers, smartwatches, smartphones, set-top boxes, media players, audio speakers, headphones, earphones, wireless routers, computer monitors, computer keyboards, computer mice, computer cables, computer power adapters, computer printers for printing documents and photos, scanners, and peripherals and accessories for the foregoing.

(260) AM 2021 110488 A
 (800) 1559499
 (151) 2020 09 10
 (891) 2020 09 10

(731) Shandong Sangle Group Co., Ltd.
 No. 2639, Chunxuan Road, High-Tech
 Development Zone, 250000 Jinan, Shandong,
 China

(540)



(591) Black, white
 (531) 01.15.15; 26.01.18; 27.05.01; 28.03
 (511)

11 – Sun energy water heater; wash water heater (gas or electric heating); fireplaces, domestic; extractor hoods for kitchens; sterilized cupboard; toilets [water-closets]; showers; taps [faucets]; wash-hand basins [parts of sanitary installations]; water purifying apparatus and machines; water dispensers; air purifying apparatus and machines; air conditioners for vehicles; lighting apparatus and installations; cooling installations and machines; radiators, electric; gas burners; pipes [parts of sanitary installations].

(260) AM 2021 110489 A
 (800) 1559587
 (151) 2020 04 27
 (891) 2020 04 27

(731) LABORATORIOS NORMON, S.A.
 Ronda de Valdecarrizo, 6, E-28760 Madrid,
 Spain

(540)

DESCITAM

(591) Black, white
 (511)

5 – Pharmaceutical products; sanitary preparations and products thereof; dietetic preparations and supplements; Veterinary products and substances; hygienic and sanitary products for medical use; medicinal food supplements; food supplements for animals.

(260) AM 2021 110499 A
 (800) 460843
 (151) 1981 05 28
 (891) 2020 10 28
 (731) BODEGAS FAUSTINO, S.L.
 Ctra. Logroño, s/n, E-01320 OYON (ALAVA),
 Spain
 (540)



(591) Black, white
 (531) 02.01.01; 02.01.04; 25.01.15; 27.05.01
 (511)
 33 – Wines, spirits and liqueurs.

(260) AM 2021 110575 A
 (800) 1560815
 (151) 2020 08 07
 (891) 2020 08 07
 (731) Trynkova Ivanka Methodieva
 3rd Setunsky pr-d, d. 6, kv. 52, RU-119136
 Moscow, Russian Federation
 (540)



(591) Black, white, light-red, dark-red and red
 (531) 26.13.01; 27.05.01; 27.05.09; 27.05.17;
 27.05.21; 29.01.13

(511)
 3 – Non-medicated cosmetics and toiletry preparati-
 ons; non-medicated dentifrices; perfumery, essential
 oils; bleaching preparations and other substances for
 laundry use; cleaning, polishing, scouring and abra-
 sive preparations; abrasives; amber [perfume]; desca-
 lling preparations for household purposes; antistatic
 preparations for household purposes; air fragrancing
 preparations; cake flavorings [essential oils]; flavo-
 rings for beverages [essential oils]; food flavorings
 [essential oils]; aromatics [essential oils]; breath fres-

hening sprays; canned pressurized air for cleaning and
 dusting purposes; balms, other than for medical pur-
 poses; basma [cosmetic dye]; lip glosses; nail glitter;
 polishing stones; abrasive paper; emery paper; pol-
 ishing paper; petroleum jelly for cosmetic purposes;
 shoe wax; shoe polish; cobblers' wax; cotton wool for
 cosmetic purposes; sachets for perfuming linen; dry-
 ing agents for dishwashing machines; adhesives for
 cosmetic purposes; scented water; Javelle water; la-
 vender water; toilet water; wax for parquet floors; flo-
 or wax; non-slipping wax for floors; depilatory wax;
 mustache wax; creams for leather; polish for furniture
 and flooring; shoemakers' wax; polishing wax; tailors'
 wax; massage gels, other than for medical purposes;
 heliotropine; dental bleaching gels; geraniol; make-
 up; deodorants for pets; deodorants for human beings
 or for animals; depilatory preparations; air fragrance
 reed diffusers; scented wood; perfumes; non-slipping
 liquids for floors; windshield cleaning liquids; greases
 for cosmetic purposes; volcanic ash for cleaning; per-
 fumery; decorative transfers for cosmetic purposes;
 ionone [perfumery]; shaving stones [astringents];
 smoothing stones; eyebrow pencils; cosmetic pencils;
 silicon carbide [abrasive]; carbides of metal [abradi-
 ves]; alum stones [astringents]; tripoli stone for po-
 lishing; adhesives for affixing false eyelashes; adhesi-
 ves for affixing false hair; quillaia bark for washing;
 corundum [abrasive]; beard dyes; colorants for toilet
 purposes; cosmetic dyes; laundry starch; laundry gla-
 ze; shoe cream; polishing creams; cosmetic creams;
 skin whitening creams; polishing rouge; incense; hair
 spray; nail polish; hair lotions; lotions for cosmetic
 purposes; after-shave lotions; beauty masks; oils for
 perfumes and scents; oils for cleaning purposes; oils
 for cosmetic purposes; oils for toilet purposes; essen-
 tial oils; essential oils of cedarwood; essential oils of
 lemon; essential oils of citron; bergamot oil; gaulthe-
 ria oil; jasmine oil; lavender oil; almond oil; rose oil;
 oil of turpentine for degreasing; whitening; cleaning
 chalk; almond milk for cosmetic purposes; cleansing
 milk for toilet purposes; musk [perfumery]; soap; deo-
 dorant soap; shaving soap; soap for brightening texti-
 le; cakes of toilet soap; antiperspirant soap; soap for
 foot perspiration; almond soap; mint for perfumery;
 cosmetic kits; emery; gel eye patches for cosmetic pu-
 rposes; nail art stickers; false nails; eau de Cologne;
 bases for flower perfumes; joss sticks; pastes for razor
 strops; dentifrices; pumice stone; lipstick cases; hyd-
 rogen peroxide for cosmetic purposes; breath freshe-
 ning strips; teeth whitening strips; abrasive cloth;
 glass cloth [abrasive cloth]; lipsticks; pomades for
 cosmetic purposes; shaving preparations; cosmetic
 preparations for baths; bath preparations, not for me-
 dical purposes; hair straightening preparations; hair
 waving preparations; laundry soaking preparations;
 grinding preparations; smoothing preparations [starc-
 hing]; color-removing preparations; leather bleaching
 preparations; polishing preparations; denture polishes;
 mouthwashes, not for medical purposes; cosmetic pre-

parations for slimming purposes; starch glaze for laundry purposes; preparations to make the leaves of plants shiny; eye-washes, not for medical purposes; fabric softeners for laundry use; laundry bleach; dry-cleaning preparations; paint stripping preparations; lacquer-removing preparations; make-up removing preparations; floor wax removers [scouring preparations]; varnish-removing preparations; rust removing preparations; nail care preparations; cleaning preparations; preparations for cleaning dentures; wallpaper cleaning preparations; preparations for unblocking drain pipes; chemical cleaning preparations for household purposes; collagen preparations for cosmetic purposes; breath freshening preparations for personal hygiene; laundry preparations; bleaching preparations [decolorants] for household purposes; aloe vera preparations for cosmetic purposes; sunscreen preparations; color-brightening chemicals for household purposes [laundry]; shining preparations [polish]; make-up powder; diamantine [abrasive]; stain removers; nail varnish removers; vaginal washes for personal sanitary or deodorant purposes; scouring solutions; false eyelashes; baby wipes impregnated with cleaning preparations; tissues impregnated with cosmetic lotions; tissues impregnated with make-up removing preparations; safrol; massage candles for cosmetic purposes; laundry blueing; turpentine for degreasing; potpourris [fragrances]; bleaching soda; washing soda, for cleaning; bath salts, not for medical purposes; bleaching salts; fumigation preparations [perfumes]; preservatives for leather [polishes]; ammonia [volatile alkali] [detergent]; astringents for cosmetic purposes; eyebrow cosmetics; make-up preparations; sun-tanning preparations [cosmetics]; hair dyes; neutralizers for permanent waving; cosmetic preparations for eyelashes; cosmetic preparations for skin care; cosmetics; cosmetics for children; cosmetics for animals; mascara; cleansers for intimate personal hygiene purposes, non medicated; douching preparations for personal sanitary or deodorant purposes [toiletries]; detergents, other than for use in manufacturing operations and for medical purposes; degreasers, other than for use in manufacturing processes; bleaching preparations [decolorants] for cosmetic purposes; toiletry preparations; antiperspirants [toiletries]; phytocosmetic preparations; talcum powder, for toilet use; cotton swabs for cosmetic purposes; terpenes [essential oils]; emery cloth; cloths impregnated with a detergent for cleaning; henna [cosmetic dye]; shampoos; shampoos for animals [non-medicated grooming preparations]; shampoos for pets [non-medicated grooming preparations]; dry shampoos; sandpaper; soda lye; herbal extracts for cosmetic purposes; extracts of flowers [perfumes]; ethereal essences; badian essence; mint essence [essential oil].

35 – Advertising; business management; business administration; office functions; arranging subscriptions to telecommunication services for others; import-export agency services; commercial information agency

services; advertising agency services; cost price analysis; rental of advertising space; business auditing; financial auditing; business intermediary services relating to the matching of potential private investors with entrepreneurs needing funding; employment agency services; computerized file management; book-keeping; outsourced administrative management for companies; invoicing; demonstration of goods; transcription of communications [office functions]; opinion polling; business investigations; business research; marketing research; personnel recruitment; consultancy regarding advertising communication strategies; consultancy regarding public relations communication strategies; business management and organization consultancy; business organization consultancy; business management consultancy; personnel management consultancy; professional business consultancy; layout services for advertising purposes; marketing; marketing in the framework of software publishing; targeted marketing; business management of performing artists; business management of sports people; writing of résumés for others; scriptwriting for advertising purposes; news clipping services; updating and maintenance of information in registries; updating and maintenance of data in computer databases; updating of advertising material; word processing; online retail services for downloadable and pre-recorded music and movies; online retail services for downloadable ring tones; online retail services for downloadable digital music; organization of exhibitions for commercial or advertising purposes; arranging newspaper subscriptions for others; organization of fashion shows for promotional purposes; shop window dressing; business appraisals; payroll preparation; data search in computer files for others; market studies; sponsorship search; administrative assistance in responding to calls for tenders; business management assistance; commercial or industrial management assistance; commercial intermediation services; providing business information via a web site; providing commercial and business contact information; provision of an online marketplace for buyers and sellers of goods and services; presentation of goods on communication media, for retail purposes; economic forecasting; auctioneering; retail services for works of art provided by art galleries; sales promotion for others; promotion of goods and services through sponsorship of sports events; production of teleshopping programmes; production of advertising films; office machines and equipment rental; rental of advertising time on communication media; publicity material rental; rental of vending machines; rental of sales stands; rental of photocopying machine; publication of publicity texts; radio advertising; bill-posting; distribution of samples; dissemination of advertising matter; direct mail advertising; registration of written communications and data; writing of publicity texts; online advertising on a computer network; advertising by mail order; television advertising; compilation of information into computer

databases; compilation of statistics; business inquiries; systemization of information into computer databases; advisory services for business management; negotiation of business contracts for others; negotiation and conclusion of commercial transactions for third parties; compiling indexes of information for commercial or advertising purposes; tax preparation; drawing up of statements of account; telemarketing services; psychological testing for the selection of personnel; wholesale services for pharmaceutical, veterinary and sanitary preparations and medical supplies; retail services for pharmaceutical, veterinary and sanitary preparations and medical supplies; interim business management; business management of hotels; business management for freelance service providers; business project management services for construction projects; commercial administration of the licensing of the goods and services of others; business management of reimbursement programs for others; administration of consumer loyalty programs; administration of frequent flyer programs; administrative processing of purchase orders; public relations; competitive intelligence services; modelling for advertising or sales promotion; typing; market intelligence services; appointment reminder services [office functions]; web site traffic optimization; tax filing services; search engine optimization for sales promotion; appointment scheduling services [office functions]; gift registry services; price comparison services; pay per click advertising; secretarial services; procurement services for others [purchasing goods and services for other businesses]; shorthand; outsourcing services [business assistance]; telephone answering for unavailable subscribers; photocopying services; business efficiency expert services; administrative services for the relocation of businesses; providing business information; providing commercial information and advice for consumers in the choice of products and services; organization of trade fairs.

41 – Education; providing of training; sporting and cultural activities; modelling for artists; academies [education]; rental of indoor aquaria; rental of artwork; rental of sports grounds; rental of tennis courts; lending library services; booking of seats for shows; videotaping; physical education; production of music; discotheque services; animal training; dubbing; gambling services; publication of books; film distribution; movie studio services; health club services [health and fitness training]; nightclub services [entertainment]; layout services, other than for advertising purposes; microfilming; videotape editing; production of radio and television programmes; screenplay writing; religious education; aikido instruction; gymnastic instruction; judo instruction; correspondence courses; practical training [demonstration]; training services provided via simulators; organization of balls; organization of exhibitions for cultural or educational purposes; providing recreation facilities; arranging and conducting of colloquiums; arranging and conducting of con-

gresses; arranging and conducting of conferences; arranging and conducting of concerts; arranging and conducting of workshops [training]; arranging and conducting of in-person educational forums; arranging and conducting of seminars; arranging and conducting of symposiums; arranging of beauty contests; organization of competitions [education or entertainment]; organization of cosplay entertainment events; organization of lotteries; organization of fashion shows for entertainment purposes; organization of shows [impresario services]; organization of sports competitions; vocational guidance [education or training advice]; amusement park services; sign language interpretation; know-how transfer [training]; television entertainment; mobile library services; vocational retraining; providing online videos, not downloadable; providing online music, not downloadable; providing television programs, not downloadable, via video-on-demand services; providing films, not downloadable, via video-on-demand services; providing golf facilities; providing sports facilities; providing amusement arcade services; cinema presentations; providing online electronic publications, not downloadable; presentation of circus performances; presentation of variety shows; theatre productions; presentation of live performances; conducting guided climbing tours; conducting fitness classes; educational examination; rental of audio equipment; rental of video cameras; rental of video cassette recorders; rental of videotapes; rental of show scenery; rental of sound recordings; toy rental; rental of cinematographic apparatus; rental of motion pictures; games equipment rental; rental of stadium facilities; rental of lighting apparatus for theatrical sets or television studios; rental of radio and television sets; rental of skin diving equipment; rental of sports equipment, except vehicles; rental of stage scenery; electronic desktop publishing; online publication of electronic books and journals; publication of texts, other than publicity texts; radio entertainment; entertainer services; writing of texts; sado instruction [tea ceremony instruction]; zoological garden services; news reporters services; film directing, other than advertising films; party planning [entertainment]; music composition services; subtitling; tutoring; holiday camp services [entertainment]; video editing services for events; conducting guided tours; disc jockey services; sound engineering services for events; game services provided online from a computer network; personal trainer services [fitness training]; providing casino facilities [gambling]; calligraphy services; karaoke services; club services [entertainment or education]; songwriting; cultural, educational or entertainment services provided by art galleries; providing museum facilities [presentation, exhibitions]; teaching; educational services provided by special needs assistants; educational services provided by schools; orchestra services; translation; scriptwriting, other than for advertising purposes; ticket agency services [entertainment]; educational examination for users to

qualify to pilot drones; coaching [training]; lighting technician services for events; sport camp services; recording studio services; language interpreter services; nursery schools; photography; photographic reporting; timing of sports events; boarding school education; production of shows; providing information in the field of education; providing information relating to recreational activities; providing information in the field of entertainment; film production, other than advertising films.

44 – Hygienic and beauty care for human beings or animals; agriculture, aquaculture, horticulture and forestry services; medical services; veterinary services; rental of animals for gardening purposes; rental of beehives; public bath services for hygiene purposes; Turkish bath services; hospital services; depilatory waxing; reforestation services; landscape design; health center services; nursing home services; wreath making; hair implantation; medical advice for individuals with disabilities; pharmacy advice; aromatherapy services; animal-assisted therapy; manicuring; chiropractic; massage; medical screening; horticulture; artificial insemination services; palliative care; hairdressing; body piercing; midwife services; veterinary assistance; dentistry services; medical assistance; tree planting for carbon offsetting purposes; preparation of prescriptions by pharmacists; medical equipment rental; rental of sanitary installations; farming equipment rental; aerial and surface spreading of fertilizers and other agricultural chemicals; animal breeding; rehabilitation for substance abuse patients; gardening; landscape gardening; beauty salon services; sanatorium services; blood bank services; health care; health counselling; flower arranging; tattooing; vermin exterminating for agriculture, aquaculture, horticulture and forestry; weed killing; health spa services; human tissue bank services; visagists' services; aquaculture services; convalescent home services; rest home services; medical clinic services; medical analysis services for diagnostic and treatment purposes provided by medical laboratories; alternative medicine services; opticians' services; orthodontic services; plant nursery services; pest control services for agriculture, aquaculture, horticulture and forestry; speech therapy; in vitro fertilization services; services of a psychologist; sauna services; solarium services; telemedicine services; therapy services; nursing, medical; lawn care; animal grooming; pet grooming; physical therapy; plastic surgery; tree surgery; hospice services.

(260) AM 2021 110576 A

(800) 1560895

(151) 2020 08 27

(891) 2020 08 27

(731) Joint Stock Company "Lactis"

pr-kt Aleksandra Korsunova, dom 12B,
RU-173016 g. Veliky Novgorod, Russian
Federation

(540)



(591) Light green, blue, green, yellow and white

(531) 02.09.01; 26.03.06; 27.05.01; 29.01.14

(511)

29 – Milk, including milk-based drinks, milk-based drinks with added of juice; milk products, including whey, baked milk, cream [dairy products], powdered milk, condensed milk, dairy creams, fermented milk products, including kefir, biokefir, kefir-based drinks, kefir-based drinks with added juice, yoghurt, yoghurt with fruit- berry and grain fillers, yoghurt drinks, drinks based on yoghurt with the addition of juice, fermented baked milk, smetana, cottage cheese and curd products, including paste, curd cheeses, glazed curd cheeses, creams, mousses, butter, sour cream vegetable-butter product; cheeses including hard, soft, processed; curd; margarine; soya milk; tofu; whipped cream; buttercream; rennet; peanut milk-based beverages.

30 – Aromatic preparations for food; vanilla flavorings for culinary purposes; flavorings, other than essential oils, for cakes; flavorings, other than essential oils, for beverages; coffee flavorings; food flavorings, other than essential oils; star aniseed; baozi; cereal bars; high-protein cereal bars; pancakes; savory pancakes; freeze-dried dishes with the main ingredient being pasta; freeze-dried dishes with the main ingredient being rice; noodle-based prepared meals; buns; bulgur; bread rolls; pains au chocolat; edible paper wafers; edible rice paper; edible paper; burritos; vanillin [vanilla substitute]; waffles; vermicelli; natural sweeteners; sausage binding materials; binding agents for ice cream; orange blossom water for culinary purposes; sea water for cooking; seaweed [condiment]; malt biscuits; cloves [spice]; mirror icing [mirror glaze]; cake frosting [icing]; glucose for culinary purposes; mustard; croûtons; buckwheat, processed; gluten additives for culinary purposes; yeast; thickening agents for cooking foodstuffs; leaven; rice-based snack food; cereal-based snack food; artificial coffee; vegetal preparations for use as coffee substitutes; dressings for salad; fruit jellies [confectionery]; candy decorations for cakes; confectionery for decorating Christmas trees; cakes; pastries; peanut confectionery; almond confectionery; fruit confectionery; pasta; ground ginger; frozen yogurt [confectionery ices]; cocoa; cream of tartar for culinary purposes; capers; coffee capsules, filled; caramels [sweets]; curry [spice]; ketchup [sauce]; quinoa, processed; quiches; gluten prepared as foodstuff; flour-based dumplings; sweets; liquorice [confectionery]; peppermint sweets; mints for breath

freshening; dulce de leche; cinnamon [spice]; coffee; unroasted coffee; starch for food; crackers; rice crackers; crème brûlée; custard; croissants; hominy grits; semolina; oatmeal; crushed barley; groats for human food; ice cubes; corn, milled; corn, roasted; meat pies; turmeric; couscous; laksa; noodles; soba noodles; udon noodles; ice for refreshment; ice, natural or artificial; edible ices; ice pops; potato-based flatbreads; rice cakes; mayonnaise; macarons; macaroni; maltose; hominy; piccalilli; marinades; marzipan; honey; miso; royal jelly; ice cream, including mixes for production of ice cream; bean meal; buckwheat flour; tapioca flour; potato flour; corn flour; nut flours; flour; wheat flour; soya flour; barley meal; dessert mousses [confectionery]; chocolate mousses; muesli; mint for confectionery; cocoa beverages with milk; coffee beverages with milk; coffee-based beverages; cocoa-based beverages; chamomile-based beverages; tea-based beverages; chocolate beverages with milk; chocolate-based beverages; infusions, not medicinal; nougat; crushed oats; husked oats; kimchi pancakes; onigiri; chocolate-coated nuts; nutmegs; stick liquorice [confectionery]; ginger paste [seasoning]; pastilles [confectionery]; molasses for food; pâtés en croûte; pelmeni; pepper; allspice; peppers [seasonings]; pesto; cookies; coconut macaroons; petit-beurre biscuits; bibimbap [rice mixed with vegetables and beef]; pies; pizzas; meat gravies; fondants [confectionery]; popcorn; powders for making ice cream; baking powder; mustard meal; pralines; condiments; meat tenderizers for household purposes; cereal preparations; oat-based food; propolis; profiteroles; gingerbread; spices; petits fours; puddings; rice pudding; cake powder; fruit coulis [sauces]; ravioli; ramen; chewing gum; chewing gum for breath freshening; relish [condiment]; rice; prepared rice rolled in seaweed; instant rice; wheat germ for human consumption; spring rolls; sago; sugar; crystallized rock sugar; palm sugar; sesame seeds [seasonings]; linseed for culinary purposes [seasoning]; processed seeds for use as a seasoning; aniseed; agave syrup [natural sweetener]; golden syrup; confectionery; savory pancake mixes; batter mixes; baking soda [bicarbonate of soda for cooking purposes]; malt for human consumption; salt for preserving foodstuffs; cooking salt; celery salt; sorbets [ices]; ham glaze; cranberry sauce [condiment]; soya sauce; tomato sauce; pasta sauce; sauces [condiments]; apple sauce [condiment]; spaghetti; seasonings; chocolate-based spreads; chocolate spreads containing nuts; preparations for stiffening whipped cream; shaved ice with sweetened red beans; rusks; breadcrumbs; sushi; sandwiches; tabbouleh; tacos; tamarind [condiment]; tapioca; tarts; dough; pastry dough; almond paste; rice pulp for culinary purposes; cake dough; tortillas; garden herbs, preserved [seasonings]; chocolate decorations for cakes; vinegar; beer vinegar; ferments for pastes; halvah; harissa [condiment]; bread; gluten-free bread; unleavened bread; corn flakes; oat flakes; chips [cereal products]; hot dog sandwiches; flowers or lea-

ves for use as tea substitutes; jiaozi; chicory [coffee substitute]; tea; kelp tea; iced tea; chutneys [condiments]; minced garlic [condiment]; cheeseburgers [sandwiches]; chow-chow [condiment]; saffron [seasoning]; chocolate; malt extract for food; essences for foodstuffs, except etheric essences and essential oils; husked barley.

32 – Aperitifs, non-alcoholic; barley wine [beer]; aerated water; lithia water; seltzer water; soda water; mineral water [beverages]; waters [beverages]; table waters; kvass; cocktails, non-alcoholic; beer-based cocktails; lemonades; non-alcoholic beverages; non-alcoholic dried fruit beverages; isotonic beverages; non-alcoholic honey-based beverages; rice-based beverages, other than milk substitutes; soya-based beverages, other than milk substitutes; aloe vera drinks, non-alcoholic; whey beverages; protein-enriched sports beverages; soft drinks; non-alcoholic beverages flavored with coffee; non-alcoholic beverages flavored with tea; non-alcoholic fruit juice beverages; energy drinks; fruit nectars, non-alcoholic; orgeat; beer; ginger beer; malt beer; powders for effervescing beverages; sarsaparilla [non-alcoholic beverage]; syrups for lemonade; syrups for beverages; smoothies; vegetable juices [beverages]; fruit juices; tomato juice [beverage]; cider, non-alcoholic; non-alcoholic preparations for making beverages; preparations for making aerated water; must; grape must, unfermented; beer wort; malt wort; pastilles for effervescing beverages; shandy; sherbets [beverages]; non-alcoholic fruit extracts; extracts of hops for making beer; non-alcoholic essences for making beverages.

(260) AM 2021 110582 A
 (800) 1561203
 (151) 2020 09 29
 (891) 2020 09 29
 (731) Obschestvo s ogranichennoy otvetstvennostyu "Reckitt Benckiser IP"
 ul. Kozhevnikeskaya, 14, RU-115114
 Moscow, Russian Federation
 (540)

Reflex

(591) Black, white
 (511)
 10 – Condoms.

(260) AM 2021 110591 A
 (800) 1180570
 (151) 2013 08 19
 (891) 2020 10 16
 (731) JOINT STOCK COMPANY "FARMAK"
 63, st. Kyrylivska, Kyiv 04080, Ukraine
 (540)

Золмигрэн

(591) Black, white
 (531) 28.05
 (511)
 5 – Pharmaceutical preparations; medicines for human purposes.

(260) AM 2021 110598 A
 (800) 1515840
 (151) 2019 11 25
 (891) 2020 10 05
 (731) Arm Limited
 110 Fulbourn Road, Cambridge CB1 9NJ,
 United Kingdom
 (540)

Arm

(591) Black, white
 (511)
 9 – Interfaces between computer hardware and computer software; computer hardware and computer software for use in robots, infrastructure, machine learning, artificial intelligence, security, Internet-of-Things (IoT) devices, networking, automotive, retail, logistics, smart cities, smart spaces, smart homes, healthcare, storage, wearable devices, utilities and energy, and mobile computing; computer hardware accelerators; neural network processors; neural processing units; machine learning processors; secure microprocessors; computer hardware for secure identity verification; computer hardware for recognizing and matching faces, images and objects; computer software used in, and for use in the design, verification, construction and operation of microprocessors, neural network processors, neural processing units and machine learning processors; computer software and computer software libraries for use in relation to machine learning computer hardware platforms, deep learning computer hardware platforms and artificial intelligence computer hardware platforms; downloadable computer software for connecting, updating, operating, controlling, monitoring the connectivity and security of, interfacing with, analyzing the operation of, and managing networked and/or cloud-connected electronic data processing in the internet of things (IoT); downloadable computer software for collecting, analyzing, editing, modifying, organizing, synchronizing, integrating, visualizing, monitoring, transmitting, transferring, storing and sharing data and information; downloadable embeddable subscriber identity module computer software for connecting, updating, operating, controlling, monitoring the connectivity and security of, interfacing with, analyzing the operation of, and managing networked and/or cloud-connected electronic data processing apparatus in the internet of things (IoT); artificial intelligence, deep learning, neural processing and machine learning computer software; computer software for facilitating secure identity authentication; artificial intelligence computer software for use in robots and robotic applications;

computer software for recognizing and matching faces, images and objects; downloadable electronic data files featuring microprocessor designs, neural network processor designs, neural processing unit designs and machine learning processor designs; electronic publications, downloadable, in the nature of instruction manuals, user manuals, technical manuals, development manuals, datasheets, brochures, articles and white papers in the field of computer hardware, computer software, neural network processors, neural processing units, machine learning processors, computer hardware accelerators, facial recognition computer hardware and software, machine learning computer hardware and software platforms, deep learning computer hardware and software platforms and artificial intelligence computer hardware and software platforms, software-as-a-service (SaaS), platform-as-a-service (PaaS) and infrastructure-as-a-service (IaaS) for managing data, electronic devices and the connectivity of electronic devices in a data network.

35 – Collection, analysis, and results-distribution of operational data for providers of IoT systems and devices to enable analysis of IoT system and device data sent to and received from IoT systems and devices for business purposes.

38 – Electronic data transmission services for the dissemination and exchange of profiles of IoT devices and systems; electronic data transmission services for the dissemination and exchange of profiles of IoT devices and systems held on SIM cards and embedded SIM cards; electronic exchange of information held on SIM cards and embedded SIM cards via telecommunication networks, digital networks and electronic communication networks; providing access to and interconnectivity with IoT systems and devices, the internet, and databases.

42 – Software-as-a service (SaaS) services namely software for connecting, updating, operating, controlling, monitoring the connectivity and security of, interfacing with, analyzing the operation of, and managing networked and/or cloud-connected electronic data processing apparatus in the internet of things (IoT); software-as-a service (SaaS) services namely software for collecting, analysing, editing, modifying, organizing, synchronizing, integrating, visualising, monitoring, transmitting, transferring, storing and sharing data and information in networked and/or cloud-connected electronic data processing apparatus; software-as-a service (SaaS) services namely software for use in relation to electronic data processing apparatus for machine learning, neural processing, artificial intelligence and deep learning; recognition-as-a-service (RaaS) services namely non-downloadable software for recognizing and matching faces, images and objects; security-as-a-service (SaaS) services namely non-downloadable software for facilitating secure identity authentication; research, development and design all relating to microprocessors, processors, mic-

rocontrollers, microprocessor design files, semiconductor intellectual property cores, computer hardware accelerators, neural network processors, neural processing units, machine learning processors and artificial intelligence, deep learning, neural processing, machine learning computer software and security; research, development and design, all relating to computer software used in, and for use in the design, verification and construction of microprocessors, processors, microcontrollers, microprocessor design files, semiconductor intellectual property cores, computer hardware accelerators, neural network processors and machine learning processors; technical consultancy and technical support services in the nature of diagnosing problems with the verification and construction of microprocessors, processors, microcontrollers, microprocessor design files, semiconductor intellectual property cores, computer hardware accelerators, neural network processors and machine learning processors; technical consultancy and technical support services in the nature of diagnosing problems with microprocessors, processors, microcontrollers, application specific integrated circuits, microprocessor design files, semiconductor intellectual property cores, computer hardware accelerators, neural network processors and machine learning processors; design and development of computer software for recognizing and matching faces, images and objects; design and development of software for secure network operations.

(260) AM 2021 110646 A
 (800) 1562021
 (151) 2020 10 22
 (891) 2020 10 22
 (731) OXYGENTRACK LLC
 1209 Orange Street, Wilmington DE 19801,
 USA
 (540)

TIME TO WALK OR PUSH

(591) Black, white
 (511)
 9 – Computer software; computer software for use in reviewing, storing, organizing, and playing audio and video content; computer software for use in organizing, transmitting, manipulating, reproducing, processing, streaming, playing and reviewing audio, video, images and other multimedia content on digital electronic devices; application development software; downloadable pre-recorded audio, video and multimedia content; downloadable webcasts and podcasts featuring audio, video, and other downloadable multimedia broadcasts in the fields of music, books, news, concerts, radio, sports, games, cultural event, and entertainment-related and educational programs; downloadable digital audio, video, and multimedia files and

recordings featuring music, books, news, concerts, radio, sports, games, cultural events, and entertainment-related and education programs; distance measuring apparatus; distance recording apparatus; pedometers; computer peripheral devices.

(260) AM 2021 110647 A
 (800) 1562125
 (151) 2020 09 25
 (891) 2020 09 25
 (731) BrosMed Medical Co., Ltd.
 3F, the 15th Building, SMES Venture Park,
 Songshan Lake Hi-Tech, Industrial
 Development Zone, Dongguan, Guangdong,
 China
 (540)



(591) Black, white
 (531) 26.11.01; 26.11.12; 27.05.01
 (511)
 10 – Drainage tubes for medical purposes; cannulae; medical apparatus and instruments; heart pacemakers; defibrillators; dialyzers; medical guidewires; stents; surgical apparatus and instruments; urological apparatus and instruments.

(260) AM 2021 110648 A
 (800) 1562147
 (151) 2020 09 25
 (891) 2020 09 25
 (731) Shandong Jinyu Tire Co., Ltd.
 No. 260, Qingken Road, Dawang Town,
 Guangrao County, Dongying City, 257300
 Shandong Province, China
 (540)



(591) Black, white
 (531) 26.01.02; 26.01.18; 27.01.12; 27.05.02;
 27.05.09; 27.05.17; 27.05.22
 (511)
 12 – Inner tubes for automobile tires; vehicle tires; tires for vehicle wheels; casings for pneumatic tires; treads for vehicles [tractor type]; automobile tires (tires); solid tires for vehicle wheels; tires; automobile tires; tires for aircraft wheels.

(260) AM 2021 110649 A
 (800) 1562153
 (151) 2020 10 20
 (891) 2020 10 20
 (731) AO Kaspersky Lab
 Leningradskoe shosse, 39A/2, RU-125212
 Moscow, Russian Federation

(540)

Bring on the future

(591) Black, white

(511)

9 – Monitors [computer programs]; computer software, recorded; computer programs, recorded; computer game software, recorded; computer programs, downloadable; computer operating programs, recorded.

42 – Computer virus protection services; updating of computer software; monitoring of computer systems by remote access; computer software design.

(260) AM 2021 110650 A

(800) 1562170

(151) 2020 09 10

(891) 2020 09 10

(731) ZHEJIANG VALOGIN TECHNOLOGY CO., LTD.

Qinggang Technological Ind. Zone, Yuhuan,
Zhejiang, 317600, China

(540)



(591) Black, white

(531) 24.17.09; 27.05.17

(511)

6 – Elbows of metal for pipes; branching pipes of metal; pipes of metal; pipework of metal; drain traps [valves] of metal; nozzles of metal; jets of metal; water-pipes of metal; water-pipe valves of metal; valves of metal, other than parts of machines.

11 – Heating installations [water]; pipes [parts of sanitary installations]; taps; pipe accessories for hot water heating devices; water purifying apparatus and machines; radiators, electric.

(260) AM 2021 110652 A

(800) 1562356

(151) 2020 10 02

(891) 2020 10 02

(731) Nemiroff Intellectual Property Establishment
Städtle 31, FL-9490 Vaduz, Liechtenstein

(540)



(591) Black, white

(531) 19.07.01; 19.07.10; 19.07.12; 19.07.23;
27.05.01

(554) Three-dimensional

(511)

21 – Glassware, namely bottles.

33 – Alcoholic beverages (except beers); alcoholic beverages containing fruit; bitters; cocktails; digesters [liqueurs and spirits]; distilled beverages; liqueurs; spirits [beverages]; vodka.

(260) AM 2021 110653 A

(800) 1562421

(151) 2020 07 20

(891) 2020 07 20

(731) Euro Games Technology Ltd.

"Maritsa" Str., 4, „Vranya-Lozen-Triugulnika",
BG-1151 Sofia, Bulgaria

(540)

(591) Yellow, gold, brown, red, orange, blue, purple
and black

(531) 27.05.04; 27.07.01; 29.01.15

(511)

9 – Software; computer gaming software; computer software packages; computer operating system software; computer software, recorded; software drivers; virtual reality software; games software; entertainment software for computer games; computer programs for network management; operating computer software for main frame computers; monitors (computer hardware); computer hardware; apparatus for recording images; monitors (computer programs); computer game programs; computer programs for recorded games; apparatus for recording, transmission or reproduction of sound or images; communications servers [computer hardware]; electronic components for gambling machines; computer application software featuring games and gaming; computer software for the administration of on-line games and gaming; computer hardware for games and gaming; computer hardware and software for gambling, gambling machines, gambling games on the Internet and via telecommunication network.

28 – Gaming machines for gambling; chips for gambling; mah-jong; arcade games; gambling machines operating with coins, notes and cards; games; electronic games; parlor games; gaming chips; gaming tables; slot machines [gaming machines]; LCD game machines; slot machines and gaming devices; coin-operated amusement machines; roulette chips; poker

chips; chips and dice [gaming equipment]; gaming equipment for casinos; roulette tables; gaming roulette wheels; casino games; amusement and gambling machines; coin-operated gaming machines and / or electronic coin-operated gaming machines with or without the possibility of gain; boxes for coinoperated machines, slot machines and gaming machines; electronic or electro-technical gaming devices, amusement and gaming machines, including coin-operated machines; housings for coin-operated machines, gaming equipment, gaming machines, machines for gambling; electro-pneumatic and electrical gambling machines (slot machines).

41 – Gambling; entertainment services related to gambling; gaming services for entertainment purposes; casino, gaming and gambling services; training in the development of software systems; provision of equipment for gambling halls; providing casino equipment [gambling]; gaming machine entertainment services; providing casino facilities [gambling]; providing halls with gaming machines; amusement arcade services; games equipment rental; rental of gaming machines; providing amusement arcade services; rental of gaming machines with images of fruits; editing or recording of sounds and images; sound recording and video entertainment services; hire of sound reproducing apparatus; provision of gaming equipment for casinos; providing of casino facilities; online gambling services; provision of casino services; provision of gaming establishments, gaming halls, internet casinos, online gambling services.

(260) AM 2021 110662 A

(800) 1296541

(151) 2016 01 25

(891) 2020 10 26

(731) BROSS TEKSTİL SANAYİ VE TİCARET ANONİM ŞİRKETİ

G.O.Pasa Mah. Organize Sanayi Bölgesi 3, Cadde No:10, Çerkezköy Tekirdag, Turkey

(540)

BROSS

(591) Black, white

(531) 27.05.01; 27.05.17

(511)

25 – Socks.

(260) AM 2021 110701 A

(800) 1562702

(151) 2020 08 26

(891) 2020 08 26

(731) Burger King Corporation

5707 Blue Lagoon Drive, Miami FL 33126, USA

(540)



(591) Black, white

(531) 08.01.06; 27.05.17

(526) BURGER

(511)

29 – Chicken pieces; potato fries; French fried potatoes; hash brown potatoes; garden salads; prepared and processed nuts; milk products, milk and milk products excluding ice cream, ice milk, and frozen yogurt; milk shakes; milk-based beverages; onion rings; processed apples; whipped topping; jellies; jams; eggs; cheese; mozzarella sticks; pickles; processed onions; prepared meals consisting primarily of meat, fish, and poultry; constituents for meals, namely, beef, chicken, and fish burger patties; plant-based veggie burger patties; all of the foregoing sold in restaurants for consumption on or off the premises.

30 – Hamburger sandwiches; fish sandwiches; chicken sandwiches; veggie burger sandwiches; plant-based sandwiches; breakfast sandwiches; hot sandwiches; burritos; sandwiches; wrap sandwiches; burgers contained in bread rolls; French toast; pancakes; condiments, namely, pickle relish and sandwich relish; mustard; ketchup; mayonnaise; salad dressings; oatmeal; cinnamon rolls, doughnuts; pies; desserts consisting primarily of ice cream and ice milk and including a variety of customer-selected toppings, namely, coffee flavored syrup, cookie crumbs, cake, marshmallow topping and flavored topping; ice cream, ice milk and frozen yogurt; appetizers, namely, breaded and fried appetizers consisting primarily of macaroni and cheese; all of the foregoing sold in restaurants for consumption on or off the premises.

43 – Services of providing food and drink; cafe and coffee bar services; food and drink preparation services; food and drink take-out restaurant services; restaurant services; fast-food restaurant services; quick service restaurant services; providing prepared meals; preparation of food and meals for consumption on or off the premises.

(260) AM 2021 110702 A

(800) 1562705

(151) 2020 06 18

(891) 2020 06 18

(731) Egis Gyógyszergyár Zrt.

Keresztúri út 30-38., H-1106 Budapest, Hungary

(540)

REPAHELP

(591) Black, white

(511)

3 – Cosmetics, personal sanitary preparations.

5 – Pharmaceutical preparations for human use; ointments for pharmaceutical purposes; suppositories; hemorrhoidal ointments; anti-hemorrhoidal suppositories; haemorrhoid preparations; dietetic substances adapted for medical use; vitamin compositions, mineral food supplements, dietary supplements; sanitary preparations for medical purposes.

(260) AM 2021 110703 A

(800) 1562715

(151) 2020 06 18

(891) 2020 06 18

(731) Egis Gyógyszergyár Zrt.

Keresztúri út 30-38., H-1106 Budapest,
Hungary

(540)

REPADUO

(591) Black, white

(511)

3 – Cosmetics, personal sanitary preparations.

5 – Pharmaceutical preparations for human use except pharmaceutical preparations used in the field of gynaecology; ointments for pharmaceutical purposes except ointments used in the field of gynaecology; suppositories; hemorrhoidal ointments; anti-hemorrhoidal suppositories; haemorrhoid preparations; dietetic substances adapted for medical use except dietetic substances used in the field of gynaecology; vitamin compositions, mineral food supplements, dietary supplements; sanitary preparations for medical purposes except those used in the field of gynaecology.

(260) AM 2021 110704 A

(800) 1562767

(151) 2020 09 21

(891) 2020 09 21

(731) SHANGHAI BIAO WU (PMC) HIGH TENSILE FASTENERS CO., LTD.

Building 3, No.188, Yangnan Road, Baoshan
District, 201900 Shanghai, China

(540)



(591) Black, white

(531) 26.01.09; 26.01.18

(511)

6 – Rivets of metal; ironmongery; hardware of metal, small; buckles of common metal [hardware]; nuts of metal; shoe pegs of metal; shoe dowels of metal; stoppers of metal; tent pegs of metal; washers of metal; rings of metal; stop collars of metal; box fasteners of metal; bolts of metal; shims; pegs of metal; cotter pins of metal; nails; brads; tacks [nails]; wall plugs of metal; crampons of metal [cramps]; cramps of metal [crampons]; screws of metal; pins [hardware]; eye bolts; screw rings; crampons [climbing irons].

(260) AM 2021 110705 A

(800) 1562779

(151) 2020 08 12

(891) 2020 08 12

(731) Shanghai Pony Technology Co., Ltd

No.8, Hong'an road, Zhujing Jinshan District,
201503 Shanghai, China

(540)



(591) Green

(531) 26.11.01; 26.11.06; 26.11.07; 27.05.08;
27.05.17; 27.05.21; 29.01.03

(511)

42 – Technological research; conducting technical project studies; mechanical research; technical consultancy relating to product development; providing technical advice in the field of scientific and industrial research.

(260) AM 2021 110706 A

(800) 1562821

(151) 2020 07 17

(891) 2020 07 17

(731) Euro Games Technology Ltd.

4, "Maritsa" Str., "Vranya-Lozen-Triugulnika",
BG-1151 Sofia, Bulgaria

(540)

Blazing Coins

(591) Black, white

(511)

9 – Software; computer gaming software; computer software packages; computer operating system software; computer software, recorded; software drivers; virtual reality software; games software; entertain-

ment software for computer games; computer programs for network management; operating computer software for main frame computers; monitors (computer hardware); computer hardware; apparatus for recording images; monitors (computer programs); computer game programs; computer programs for recorded games; apparatus for recording, transmission or reproduction of sound or images; communications servers [computer hardware]; electronic components for gambling machines; computer application software featuring games and gaming; computer software for the administration of on-line games and gaming; computer hardware for games and gaming; hardware and software for gambling, gambling machines, gambling games on the internet and via telecommunication network.

28 – Gaming machines for gambling; chips for gambling; mah-jong; arcade games; gambling machines operating with coins, notes and cards; games; electronic games; parlor games; gaming chips; gaming tables; slot machines [gaming machines]; LCD game machines; slot machines and gaming devices; coin-operated amusement machines; roulette chips; poker chips; chips and dice [gaming equipment]; equipment for casinos; roulette tables; gaming roulette wheels; casino games; automats and gambling machines; coin-operated machines and / or electronic coin-operated machines with or without the possibility of gain; boxes for coin-operated machines, slot machines and gaming machines; electronic or electrotechnical gaming devices, automats and machines, coin-operated machines; housings for coin-operated machines, gaming equipment, gaming machines, machines for gambling; electropneumatic and electrical gambling machines (slot machines).

41 – Gambling; services related to gambling; gaming services for entertainment purposes; casino, gaming and gambling services; training in the development of software systems; provision of equipment for gambling halls; providing casino equipment [gambling]; gaming machine entertainment services; providing casino facilities [gambling]; halls with gaming machines; amusement arcade services; games equipment rental; rental of gaming machines; providing amusement arcade services; rental of gaming machines with images of fruits; editing or recording of sounds and images; sound recording and video entertainment services; hire of sound reproducing apparatus; provision of gaming equipment for casinos; providing of casino facilities; online gambling services; casino management services; operation of gaming establishments, gaming halls, internet casinos, online gambling sites.

(260) AM 2021 110716 A
(800) 1563206
(151) 2020 09 21
(891) 2020 09 21

(731) Fotric Inc.
Room 703-704, No. 238 Jiangchang three Road,
Jingan District, Shanghai, China

(540)

FOTRIC

(591) Black, white

(531) 27.05.01

(511)

9 – Cameras [photography]; surveying apparatus and instruments; optical apparatus and instruments; fire extinguishers; protection devices for personal use against accidents; fire alarms; data processing apparatus; computer programs, recorded; computer operating programs, recorded; computer software, recorded; computer software applications, downloadable; humanoid robots with artificial intelligence; thermal imaging cameras; measuring instruments; eyepieces; optical lenses.

(260) AM 2021 110717 A

(800) 1563270

(151) 2020 03 27

(891) 2020 03 27

(731) GÜL PRES DÖKÜM SANAYİ ANONİM
ŞİRKETİ

Bakır Piriç Sanayiciler Sitesi, Sardunya

Caddesi No:7 Beylikdüzü, TR-34524

Beylikdüzü İstanbul, Turkey

(540)



(591) Black, light blue, white

(531) 26.11.02; 26.11.13; 27.05.11; 29.01.13

(511)

11 – Regulating accessories for water or gas apparatus and pipes, taps regulating and safety accessories for water apparatus (Terms too vague in the opinion of the International Bureau – Rule 13 (2) (b) of the Regulations), bath fittings, bath installations, bidets, pipes, wash-hand basins, faucets for pipes and pipelines, mixer faucets for water pipes, sanitary apparatus and installations, sinks, bath tubs, taps for pipes, taps for wash-hand basins, bidet taps, hand-held shower heads, hand-held showers, mixer showers, water-saving shower heads, single-lever faucets for sinks, bathroom sinks, kitchen sinks, water-saving faucets, automatic faucets.

35 – The bringing together, for the benefit of others, of a variety of goods, regulating accessories for water or gas apparatus and pipes, taps regulating and safety accessories for water apparatus, bath fittings, bath installations, bidets, pipes, wash-hand basins, faucets for pipes and pipelines, mixer faucets for water pipes, sanitary apparatus and installations, sinks, bath tubs, taps for pipes, taps for wash-hand basins, bidet taps, hand-held shower heads, hand-held showers, mixer showers, water-saving shower heads, single-lever faucets for sinks, bathroom sinks, kitchen sinks, water-saving faucets, automatic faucets, enabling customers to conveniently view and purchase those goods, such services may be provided by retail stores, wholesale outlets, by means of electronic media or through mail order catalogues.

(260) AM 2021 110718 A

(800) 1563284

(151) 2020 09 15

(891) 2020 09 15

(731) Proizvodstvenny kooperativ himichesky zavod, "Luch"

Dekabristov str., 7, Promzona; RU-150029

Yaroslavl, Russian Federation

(540)



(591) Blue, red, orange and white

(531) 02.09.01; 03.13.01; 03.13.24; 28.05; 29.01.14

(511)

1 – Adhesives for industrial purposes; adhesives for billposting; leather glues; adhesives for wall tiles; adhesives for wallpaper; glue for industrial purposes; cement for mending broken articles.

2 – Watercolour paints for use in art; wood stains; ceramic paints; distempers; oil paints for use in art; paints; lacquers; coatings [paints]; coatings for roofing felt [paints]; wood coatings [paints].

4 – Wax [raw material]; wax for lighting; nightlights [candles]; perfumed candles; Christmas tree candles; candles; wicks for candles.

9 – Magnets; decorative magnets.

16 – Modelling wax, not for dental purposes; modelling clay; polymer modelling clay; slate pencils; pencil leads; pencil holders; chalk holders; drawing instruments; gums [adhesives] for stationery or household purposes; pencils; pencil lead holders; charcoal pencils; paintbrushes; painters' brushes; glue for sta-

tionery or household purposes; gluten [glue] for stationery or household purposes; paint boxes for use in schools; correcting fluids [office requisites]; stencils [stationery]; French curves; gummed tape [stationery]; adhesive bands for stationery or household purposes; adhesive tapes for stationery or household purposes; self-adhesive tapes for stationery or household purposes; square rulers for drawing; drawing rulers; paint trays; plastics for modeling; modelling materials; adhesives [glues] for stationery or household purposes; writing chalk; tailors' chalk; marking chalk; palettes for painters; pastels [crayons]; modelling paste; pen cases; drawing materials; school supplies [stationery]; adhesive tape dispensers [office requisites]; rubber erasers; stencil plates; Indian inks; squares for drawing; molds for modelling clays [artists' materials]; stencil cases; canvas for painting; artists' watercolor saucers; ink*; stencils.

19 – Stained-glass windows; gypsum [building material].

28 – Puzzles; toys; parlor games; board games; games; building games; toy models; toy figures.

(260) AM 2021 110719 A

(800) 1563298

(151) 2020 07 23

(891) 2020 07 23

(731) Vlasov Yevgen Oleksandrovych

vul. Volonterska, 70 A, kv. 26, Kharkiv 61098, Ukraine

(540)



STORM

(591) Black, white

(531) 01.15.03; 14.07.09; 26.01.16; 26.01.24; 27.05.10; 27.05.11

(511)

6 – Accordion doors of metal; acoustic panels of metal; advertisement columns of metal; alloys of common metal; aluminium; aluminium foil; aluminium wire; anchor plates; anchors; angle irons of metal; anti-friction metal; anvils; anvils [portable]; arbours [structures] of metal; armored doors of metal; armor-plating of metal; aviaries [structures] of metal; badges of metal for vehicles; bag hangers of metal; balls of steel; balustrades of metal; barbed wire; barrel hoops of metal; barrels of metal; bars for metal railings; baskets of metal; bathtub grab bars of metal; beacons of metal, non-luminous; beak-irons; beams of metal; bed casters of metal; bells; bells for animals; belt stretchers of metal; beryllium [glucinium]; bicycle parking installations of metal; binding screws of metal for cables; bindings of metal; binding thread of metal

for agricultural purposes; bird baths [structures] of metal; blooms [metallurgy]; bolts, flat; bolts of metal; bottle caps of metal; bottle closures of metal; bottles [metal containers] for compressed gas or liquid air; boxes of common metal; box fasteners of metal; braces of metal for handling loads; brackets of metal for building; brackets of metal for furniture; branching pipes of metal; brass, unwrought or semi-wrought; brazing alloys; bright steel bars; bronze; bronzes [works of art]; buckles of common metal [hardware]; building materials of metal; building panels of metal; buildings of metal; buildings, transportable, of metal; bungs of metal; burial vaults of metal; busts of common metal; cabanas of metal; cable joints of metal, non-electric; cables of metal, non-electric; cadmium; casement windows of metal; cashboxes [metal or non-metal]; casings of metal for oilwells; casks of metal; cask stands of metal; cast iron, unwrought or semi-wrought; cast steel; cattle chains; cermets; ceilings of metal; chains of metal; chests of metal; chicken-houses of metal; chill-molds [foundry]; chimney cowls of metal; chimney pots of metal; chimney shafts of metal; chimneys of metal; chrome iron; chrome ores; chromium; cladding of metal for building; clips of metal for cables and pipes; clips of metal for sealing bags; closures of metal for containers; clothes hooks of metal; cobalt, raw; collars of metal for fastening pipes; common metals, unwrought or semi-wrought; containers of metal for compressed gas or liquid air; containers of metal for liquid fuel; containers of metal for storing acids; containers of metal [storage, transport]; copper rings; copper, unwrought or semi-wrought; copper wire, not insulated; cornices of metal; cotter pins of metal; couplings of metal for chains; crampons [climbing irons]; crampons of metal [cramps]; crash barriers of metal for roads; crucifixes of common metal, other than jewelry; dispensers for dog waste bags, fixed, of metal; diving boards of metal; door bells of metal, non-electric; door bolts of metal; door closers of metal, non-electric; door fasteners of metal; door fittings of metal; door frames of metal; door handles of metal; door knockers of metal; door openers of metal, non-electric; door panels of metal; door scrapers; doors of metal; door stops of metal; drain pipes of metal; drain traps [valves] of metal; drawn and polished metal bars; duckboards of metal; ducts of metal, for central heating installations; ducts of metal for ventilating and air-conditioning installations; elbows of metal for pipes; enclosures of metal for tombs; eye bolts; faucets of metal for casks; fences of metal; ferrules of metal; ferrules of metal for handles; ferrules of metal for walking sticks; figurines of common metal; filings of metal; firedogs [andirons]; fireplace grates of metal; fireplace mantles of metal; fish plates [rails]; fittings of metal for beds; fittings of metal for building; fittings of metal for coffins; fittings of metal for compressed air lines; fittings of metal for furniture; fittings of metal for windows; flagpoles [structures] of metal; flanges of metal [collars];

flashing of metal for building; floating containers of metal; floating docks of metal, for mooring boats; floors of metal; floor tiles of metal; foils of metal for wrapping and packaging; folding doors of metal; foundry molds of metal; frames of metal for building; framework of metal for building; furnace fireguards of metal; furniture casters of metal; galena [ore]; gates of metal; germanium; gold solder; grave slabs of metal, grease nipples; greenhouse frames of metal; greenhouses of metal, transportable; grilles of metal; guard rails of metal for railways; gutter pipes of metal; hafnium [Celtium]; handcuffs; hand-held flagpoles of metal; handling pallets of metal; hardware of metal, small; hinges of metal; hooks [metal hardware]; hooks of metal for clothes rails; hooks of metal for roofing slates; hoppers of metal, non-mechanical; horseshoe nails; hot-rolled steel bars; house numbers of metal, non-luminous; ice moulds of metal; identification bracelets of metal; identity plates of metal; indium; ingots of common metal; insect screens of metal; iron ores; iron slabs; iron strip; iron, unwrought or semi-wrought; iron wire; ironwork for doors; ironwork for windows; jalousies of metal; jerrycans of metal; jets of metal; joists of metal; junctions of metal for pipes; keys of metal; knobs of metal; labels of metal; ladders of metal; latch bars of metal; latches of metal; laths of metal; lead seals; lead, unwrought or semi-wrought; letter boxes of metal; letters and numerals of common metal, except type; limonite; linings of metal for building; lintels of metal; loading gauge rods of metal for railway wagons; loading pallets of metal; lock bolts; locks of metal for bags; locks of metal for vehicles; locks of metal, other than electric; machine belt fasteners of metal; magnesium; manganese; manhole covers of metal; manifolds of metal for pipelines; masts of metal; materials of metal for funicular railway permanent ways; memorial plates of metal; metal cages for wild animals; metal ramps for use with vehicles; metals in foil or powder form for 3D printers; metals in powder form; mobile boarding stairs of metal for passengers; moldings of metal for building; moldings of metal for cornices; molybdenum; molybdenum iron; monuments of bronze for tombs; monuments of metal; monuments of metal for tombs; mooring bollards of metal; mooring buoys of metal; nails; nickel; nickel silver; niobium; nozzles of metal; nuts of metal; oil drainage containers of metal; ores of metal; outdoor blinds of metal; packaging containers of metal; padlocks of metal, other than electronic; paint spraying booths of metal; palings of metal; pantiles of metal; partitions of metal; paving blocks of metal; paving slabs of metal; peeled metal bars; pegs of metal; penstock pipes of metal; pigsties of metal; pillars of metal for building; pins [hardware]; pipe muffs of metal; pipes of metal; pipework of metal; pitons of metal; platforms, prefabricated, of metal; poles of metal; poles of metal for power lines; porches [structures] of metal; posts of metal; pot hooks of metal; prefabricated houses [kits] of metal; props of metal;

pulleys of metal, other than for machines; pyrophoric metals; railroad ties of metal; rails of metal; railway material of metal; railway points; reels of metal, non-mechanical, for flexible hoses; refractory construction materials of metal; registration plates of metal; reinforcing materials of metal for building; reinforcing materials, of metal, for concrete; reinforcing materials of metal for machine belts; reinforcing materials of metal for pipes; rings of metal; rivets of metal; road signs, non-luminous and non-mechanical, of metal; rocket launching platforms of metal; rods of metal for brazing; rods of metal for brazing and welding; rods of metal for welding; roller blinds of steel; roof coverings of metal; roof flashing of metal; roof gutters of metal; roofing of metal; roofing of metal, incorporating photovoltaic cells; roofing tiles of metal; ropes of metal; rope thimbles of metal; runners of metal for sliding doors; safes, electronic; safes [metal or non-metal]; safety cashboxes; safety chains of metal; sash fasteners of metal for windows; scaffolding of metal; screws of metal; screw tops of metal for bottles; sealing caps of metal; sheaf binders of metal; sheet piles of metal; sheets and plates of metal; shims; shoe dowels of metal; shoe pegs of metal; shuttering of metal for concrete; shutters of metal; signalling panels, non-luminous and non-mechanical, of metal; signboards of metal; signs, non-luminous and non-mechanical, of metal; silicon iron; sills of metal, silos of metal; silver-plated tin alloys; silver solder; skating rinks [structures] of metal; slabs of metal for building; sleeves [metal hardware]; slings of metal for handling loads; soldering wire of metal; soundproof booths of metal, transportable; split rings of common metal for keys; spring locks; springs [metal hardware]; spurs; stables of metal; staircases of metal; stair treads [steps] of metal; stakes of metal for plants or trees; statues of common metal; steel alloys; steel buildings; steel masts; steel pipes; steel sheets; steel strip; steel, unwrought or semi-wrought; steel wire; steps [ladders] of metal, step stools of metal; stoppers of metal; stops of metal; strap-hinges of metal; straps of metal for handling loads; street gutters of metal; stretchers for iron bands [tension links]; stretchers for metal bands [tension links]; stringers [parts of staircases] of metal; swimming pools [structures] of metal; swing doors of metal; tacks [nails]; tanks of metal; tantalum [metal]; telegraph posts of metal; telephone booths of metal; telfer cables; tension links; tent pegs of metal; thread of metal for tying-up purposes; tile floorings of metal; tiles of metal for building; tin; tin cans; tinfoil; tinsplate; tinsplate packings; titanium; titanium iron; tombac; tombs of metal; tombstone plaques of metal; tombstone stelae of metal; tool boxes of metal, empty; tool chests of metal, empty; towel dispensers, fixed, of metal; transport pallets of metal; traps for wild animals; trays of metal; tree protectors of metal; trellis of metal; troughs of metal for mixing mortar; tubbing of metal; tungsten; tungsten iron; turnstiles of metal; turntables [railways]; valves of metal, other than parts

of machines; vanadium; vats of metal; vice claws of metal; wainscotting of metal; wall linings of metal for building; wall plugs of metal; wall tiles of metal; washers of metal; water-pipes of metal; water-pipe valves of metal; weather- or wind-vanes of metal; wheel clamps [boots]; white metal; wind-driven bird-repelling devices made of metal; winding spools of metal, non-mechanical, for flexible hoses; window casement bolts; window closers of metal, non-electric; window fasteners of metal; window frames of metal; window openers of metal, non-electric; window pulleys of metal; windows of metal; window stops of metal; wire cloth; wire of common metal; wire of common metal alloys, except fuse wire; wire rope; wire stretchers [tension links]; works of art of common metal; wrapping or binding bands of metal; zinc; zirconium.

7 – 3D printers; 3D printing pens; acetylene cleaning apparatus; adhesive bands for pulleys; adhesive tape dispensers [machines]; aerating pumps for aquaria; aerocondensers; aeronautical engines; aeroplane engines; agitators; agricultural elevators; agricultural implements, other than hand-operated; agricultural machines; air brushes for applying colour; air condensers; air cushion devices for moving loads; air pumps [garage installations]; air suction machines; alternators; anti-friction bearings for machines; anti-pollution devices for motors and engines; apparatus for aerating beverages; apparatus for aerating water; apparatus for drawing up beer under pressure; aprons [parts of machines]; automatic grapnels for marine purposes; axles for machines, ball-bearings, ball rings for bearings, basket presses; bearing brackets for machines; bearings for transmission shafts, bearings [parts of machines]; beaters, electric; beer pumps; bellows [parts of machines]; belt conveyors; belts for conveyors; belts for machines; belts for motors and engines; bending machines; beverage preparation machines, electromechanical; bicycle assembling machines; bicycle dynamos; binding apparatus for hay; bitumen making machines; blade holders [parts of machines]; blade sharpening [stropping] machines; blades [parts of machines]; blenders, electric, for household purposes; blowing machines; blowing machines for the compression, exhaustion and transport of gases; blowing machines or fans for the compression, sucking and carrying of grain; bobbins for weaving looms; boiler tubes [parts of machines]; bookbinding apparatus and machines for industrial purposes; bottle capping machines; bottle filling machines; bottle sealing machines; bottle stoppering machines; bottle washing machines; boxes for matrices [printing]; braiding machines; brake linings, other than for vehicles; brake pads, other than for vehicles; brake segments, other than for vehicles; brake shoes, other than for vehicles; bread cutting machines; brewing machines; brushes, electrically operated [parts of machines]; brushes for vacuum cleaners; brushes [parts of machines]; bulldozers; butter machines; calenders; camshafts for vehicle engines; can openers, electric; capstans; carbon brushes

[electricity]; carburetter feeders; carburetters; card clothing [parts of carding machines]; carding machines; carriages for knitting machines; cartridges for filtering machines; catalytic converters; central vacuum cleaning installations; centrifugal machines; centrifugal mills; centrifugal pumps; chaff cutter blades; chaff cutters; chain saws; chisels for machines; chucks [parts of machines]; churns; cigarette machines for industrial purposes; cinder sifters [machines]; clack valves [parts of machines]; cleaning appliances utilizing steam; clippers [machines]; clutches, other than for land vehicles; coal-cutting machines; coffee grinders, other than hand-operated; coin-operated washing machines; compressed air engines; compressed air guns for the extrusion of mastics; compressed air machines; compressed air pumps; compressors for refrigerators; compressors [machines]; concrete mixers [machines]; condensing installations; connecting rods for machines, motors and engines; control cables for machines, engines or motors; control mechanisms for machines, engines or motors; converters for steelworks; conveyors [machines]; cord making machines; couplings, other than for land vehicles; cowlings [parts of machines]; cranes [lifting and hoisting apparatus]; crankcases for machines, motors and engines; crank shafts; cranks [parts of machines]; cream/milk separators; crushers for kitchen use, electric; crushing machines; cultivators [machines]; current generators; curtain drawing devices, electrically operated; cutters [machines]; cutting blow pipes, gas-operated; cutting machines; cylinder heads for engines; cylinders for machines; cylinders for motors and engines; dairy machines; darning machines; de-aerators for feedwater; degreasers [machines]; derricks; die-cutting and tapping machines; die-stamping machines; diggers [machines]; dishwashers; disintegrators; ditchers [ploughs]; dividing machines; door closers, electric; door closers, hydraulic; door closers, pneumatic; door openers, electric; door openers, hydraulic; door openers, pneumatic; drainage machines; drill chucks [parts of machines]; drilling bits [parts of machines]; drilling heads [parts of machines], drilling machines; drilling rigs, floating or non-floating; driving chains, other than for land vehicles; driving motors, other than for land vehicles; drums [parts of machines]; dust exhausting installations for cleaning purposes; dust removing installations for cleaning purposes; dyeing machines; dynamo belts; dynamo brushes; dynamos; earth moving machines; ejectors; electrical apparatus for sealing plastics [packaging]; electric arc cutting apparatus; electric arc welding apparatus; electric hammers; electric hand drills; electric welding apparatus; electrodes for welding machines; electromechanical machines for chemical industry; electroplating machines; elevating apparatus; elevator belts; elevator chains [parts of machines]; elevator operating apparatus; elevators [lifts]; embossing machines; emergency power generators; engine mounts, other than for land vehicles; engines for air cushion vehicles; engines for

boats; engraving machines; excavators; exhaust manifold for engines; exhausts for motors and engines; expansion tanks [parts of machines]; extractors for mines; fan belts for motors and engines; fans for motors and engines; feeders [parts of machines]; feeding apparatus for engine boilers; filling machines; filtering machines; filter presses; filters being parts of machines or engines; filters for cleaning cooling air, for engines; finishing machines; fittings for engine boilers; fleshing machines; flour mill machines; flues for engine boilers; fodder presses; food preparation machines, electromechanical; food processors, electric; forge blowers; foundry machines; freewheels, other than for land vehicles; friezing machines; fruit presses, electric, for household purposes; fuel conversion apparatus for internal combustion engines; fuel dispensing pumps for service stations; fuel economisers for motors and engines; galvanizing machines; gas-operated blow torches; gear boxes, other than for land vehicles; gears for weaving looms; gears, other than for land vehicles; generators of electricity; glass-working machines; glaziers' diamonds [parts of machines]; glow plugs for Diesel engines; glue guns, electric; grain husking machines, grain separators; grating machines for vegetables; grease boxes [parts of machines]; grease rings [parts of machines]; grinding machines; grindstones [parts of machines]; guides for machines; guns [tools using explosives]; hair clipping machines for animals; hammers [parts of machines]; hand-held tools, other than hand-operated; handling apparatus for loading and unloading; handling machines, automatic [manipulators]; hangers [parts of machines]; harrows; harvesting machines; heat exchangers [parts of machines]; hemming machines; high pressure washers; hoists; holding devices for machine tools; hoppers [mechanical discharging]; hosiery looms; housings [parts of machines]; hydraulic controls for machines, motors and engines; hydraulic engines and motors; hydraulic turbines; hydrogen dispensing pumps for service stations; igniting devices for internal combustion engines; igniting magnetos; incubators for eggs; industrial inkjet printing machines; industrial robots; injectors for engines; inking apparatus for printing machines; ironing machines; jacks [machines]; jet engines, other than for land vehicles; joints [parts of engines]; journal boxes [parts of machines]; journals [parts of machines]; joysticks being parts of machines, other than for game machines; juice extractors, electric; kick starters for motorcycles; kitchen grinders, electric; kitchen machines, electric; kneading machines; knitting machines; knives, electric; knives for mowing machines; knives [parts of machines]; labellers [machines]; lace making machines; lasts for shoes [parts of machines]; lathes [machine tools]; lawnmowers [machines]; leather paring machines; leather-working machines; lifting apparatus; lifts, other than ski-lifts; loading ramps; looms; loom shafts; lubricating pumps; lubricators [parts of machines]; machine fly-wheels; machines and appara-

tus for carpet shampooing, electric; machines and apparatus for cleaning, electric; machines and apparatus for polishing [electric]; machines and apparatus for wax-polishing, electric; machines for processing plastics; machines for the mineralization of drinking water; machines for the production of sugar; machines for the textile industry; machine tools; machine wheels; machine wheelwork; matrices for use in printing; meat choppers [machines]; mechanized livestock feeders; metal drawing machines; metal working machines; milking machines; milling machines; mills for household purposes, other than hand-operated; mills [machines]; millstones; mine borers; mine working machines; mixers [machines]; mixing machines; mobile cranes; molding machines; molds [parts of machines]; mortising machines; motorized cultivators; motors, electric, other than for land vehicles; motors for boats; motors, other than for land vehicles; moving staircases [escalators]; moving walkways; mud catchers and collectors [machines]; mufflers for motors and engines; nail pullers, electric; net hauling machines [fishing]; notchers [machine tools]; oil refining machines; ore treating machines; packaging machines; packing machines; painting machines; paper feeders [printing]; papermaking machines; parquet wax-polishers, electric; pasta making machines, electric; pedal drives for sewing machines; peeling machines; pepper mills, other than hand-operated; pigs for cleaning pipes; piston segments; pistons for cylinders; pistons for engines; pistons [parts of machines or engines]; planing machines; ploughs; ploughshares; pneumatic controls for machines, motors and engines; pneumatic hammers; pneumatic jacks; pneumatic transporters; pneumatic tube conveyors; pneumatic waste oil drainers; potters' wheels; power hammers; presses [machines for industrial purposes]; pressure reducers [parts of machines]; pressure regulators [parts of machines]; pressure valves [parts of machines]; printing cylinders; printing machines; printing machines for use on sheet metal; printing plates; printing presses; printing rollers for machines; propulsion mechanisms, other than for land vehicles; puddling machines; pulleys; pulleys [parts of machines]; pulverisers [machines]; pump diaphragms; pumps for counter-current swimming; pumps for heating installations; pumps [machines]; pumps [parts of machines, engines or motors]; punches for punching machines; punching machines; rack and pinion jacks; racket stringing machines; radiators [cooling] for motors and engines; rail-laying machines; railroad constructing machines; railway wagon lifts; rakes for raking machines; raking machines; rammers [machines]; rams [machines]; reapers; reapers and binders; reapers and threshers; re-duction gears, other than for land vehicles; reeling apparatus, mechanical; reels, mechanical, for flexible hoses; reels [parts of machines]; regulators [parts of machines]; rinsing machines; riveting machines; road making machines; road sweeping machines, self-propelled; robotic exoskeleton suits, other than for me-

dical purposes; roller bearings; roller bridges; rolling mill cylinders; rolling mills; rotary printing presses; rotary steam presses, portable, for fabrics; rubber tracks being parts of crawlers on agricultural machines; rubber tracks being parts of crawlers on construction machines; rubber tracks being parts of crawlers on loading-unloading machines and apparatus; rubber tracks being parts of crawlers on mining machines; rubber tracks being parts of crawlers on snow ploughs; satinizing machines; sausage making machines; Saw benches [parts of machines]; saw blades [parts of machines]; saws [machines]; scale collectors for machine boilers; scissors, electric; screwdrivers, electric; sealing machines for industrial purposes; self-oiling bearings; self-regulating fuel pumps; sewage pulverizers; sewing machines; shaft couplings [machines]; sharpening machines; sheaf-binding machines; shears, electric; shock absorber plungers [parts of machines]; shoe polishers, electric; shovels, mechanical; shredders [machines] for industrial use; shuttles [parts of machines]; sieves [machines or parts of machines]; sifting installations; sifting machines; sizing machines; ski edge sharpening tools, electric; slide rests [parts of machines]; smoothing presses; snow ploughs; soldering apparatus, electric; soldering blow pipes, gas-operated; soldering irons, electric; soldering irons, gas-operated; soldering lamps; sorting machines for industry; sowers [machines]; sparking plugs for internal combustion engines; speed governors for machines, engines and motors; spin driers [not heated]; spinning frames; spinning machines; spinning wheels; spray guns for paint; springs [parts of machines]; stalk separators [machines]; stamping machines; stands for machines; starters for motors and engines; stators [parts of machines]; steam condensers [parts of machines]; steam engine boilers; steam engines; steam mops; steam/oil separators; steamrollers; steam traps; stereotype machines; stitching machines; stone-working machines; stuffing boxes [parts of machines]; suction cups for milking machines; suction machines for industrial purposes; suction nozzles for vacuum cleaners; superchargers; superheaters; swaging machines; tables for machines; tambours for embroidery machines; taps [parts of machines, engines or motors]; tarring machines; tedding machines; thermic lances [machines]; threading machines; threshing machines; tilling machines for agricultural purposes; tilt hammers; tobacco processing machines; tools [parts of machines]; torque converters, other than for land vehicles; transmission chains, other than for land vehicles; transmissions for machines; transmission shafts, other than for land vehicles; transmissions, other than for land vehicles; trimming machines; trueing machines; turbines, other than for land vehicles; turbocompressors; turf removing ploughs; tympan [parts of printing presses]; typecasting machines; type-setting machines [photocomposition]; type-setting machines [printing]; typographic machines; typographic presses; universal joints [Cardan joints]; vacuum cleaner

attachments for disseminating perfumes and disinfectants; vacuum cleaner bags; vacuum cleaner hoses; vacuum cleaners; vacuum pumps [machines]; valves [parts of machines]; vegetable spiralizers, electric; vending machines; vibrators [machines] for industrial use; vulcanization apparatus; washing apparatus; washing installations for vehicles; washing machines [laundry]; waste compacting machines; waste disposal units; water heaters being parts of machines; water separators; weeding machines; welding apparatus, gas-operated; welding machines, electric; whisks, electric, for household purposes; whitewashing machines; winches; window closers, electric; window closers, hydraulic; window closers, pneumatic; window openers, electric; window openers, hydraulic; window openers, pneumatic; wind turbines; wine presses; winnowers; woodworking machines; wrapping machines; wringing machines for laundry.

8 – Abrading instruments [hand instruments]; adzes [tools]; agricultural forks [hand tools]; agricultural implements, hand-operated; air pumps, hand-operated; annular screw plates; apparatus for destroying plant parasites, hand-operated; apparatus for tattooing; augers [hand tools]; awls; axes; bayonets; beard clippers; bench vices [hand implements]; bill-hooks; bits [hand tools]; bits [parts of hand tools]; blades for planes; blades [hand tools]; blade sharpening instruments; blades [weapons]; border shears; borers; bow saws; box cutters; braiders [hand tools]; branding irons; breast drills; budding knives; can openers, non-electric; carpenters' augers; carving forks; carving knives; cattle shearers; caulking irons; centre punches [hand tools]; ceramic knives; cheese slicers, non-electric; chisels; choppers [knives]; clamps for carpenters or coopers; cleavers; crimping irons; crow bars; curling tongs; cuticle tweezers; cutlery; cutter bars [hand tools]; cutters; cutting tools [hand tools]; daggers; depilation appliances, electric and non-electric; dies [hand tools]; diggers [hand tools]; ditchers [hand tools]; drawing knives; drill holders [hand tools]; ear-piercing apparatus; earth rammers [hand tools]; edge tools [hand tools]; egg slicers, non-electric; embossers [hand tools]; emergency hammers; emery boards; emery files; emery grinding wheels; engraving needles; expanders [hand tools]; extension pieces for braces for screw taps; eyelash curlers; farriers' knives; files [tools]; fingernail polishers, electric or non-electric; fire irons; fireplace bellows [hand tools]; fish tapes [hand tools]; flat irons; foundry ladles [hand tools]; frames for handsaws; fruit corers; fruit pickers [hand tools]; fruit segmenters; fullers [hand tools]; fulling tools [hand tools]; garden tools, hand-operated; gimlets [hand tools]; glaziers' diamonds [parts of hand tools]; goffering irons; gouges [hand tools]; grafting tools [hand tools]; graving tools [hand tools]; grindstones [hand tools]; guns, hand-operated, for the extrusion of mastics; guns [hand tools]; hackles [hand tools]; hainault scythes; hair braiders, electric; hair clippers for animals [hand instruments]; hair clippers

for personal use, electric and non-electric; hair-removing tweezers; hammers [hand tools]; hand drills, hand-operated; hand implements for hair curling; handles for hand-operated hand tools; hand pumps; hand tools, hand-operated; harpoons; harpoons for fishing; hatchets; hobby knives [scalpels]; hoes [hand tools]; holing axes; hollowing bits [parts of hand tools]; hoop cutters [hand tools]; hunting knives; ice picks; implements for decanting liquids [hand tools]; insecticide sprayers [hand tools]; instruments and tools for skinning animals; instruments for punching tickets; irons [non-electric hand tools]; jig-saws; kitchen mandolines; knife handles; knives; ladles [hand tools]; laser hair removal apparatus, other than for medical purposes; lasts [shoemakers' hand tools]; lawn clippers [hand instruments]; leather strops; levers; lifting jacks, hand-operated; livestock marking tools; machetes; mallets [hand instruments]; manicure sets; manicure sets, electric; marline spikes; masons' hammers; mattocks; meat claws; metal band stretchers [hand tools]; metal wire stretchers [hand tools]; milling cutters [hand tools]; mincing knives [hand tools]; mitre boxes [hand tools]; molding irons; money scoops; mortars for pounding [hand tools]; mortise chisels; nail clippers, electric or non-electric; nail drawers [hand tools]; nail files; nail files, electric; nail nippers; nail pullers, hand-operated; nail punches; needle files; non-electric caulking guns; numbering punches; oyster openers; palette knives; paring irons [hand tools]; paring knives; pedicure sets; penknives; perforating tools [hand tools]; pestles for pounding [hand tools]; pickaxes; pickhammers; picks [hand tools]; pin punches; pizza cutters, non-electric; plane irons; planes; pliers; polishing irons [glazing tools]; priming irons [hand tools]; pruning knives; pruning shears; punches [hand tools]; punch pliers [hand tools]; punch rings [knuckle dusters]; rabbeting planes; rakes [hand tools]; rams [hand tools]; rasps [hand tools]; ratchets [hand tools]; razor blades; razor cases; razors, electric or non-electric; razor strops; reamers; reamer sockets; riveters [hand tools]; riveting hammers [hand tools]; sabres; sand trap rakes; saw blades [parts of hand tools]; saw holders; saws [hand tools]; scaling knives; scissors; scrapers for skis; scrapers [hand tools]; scraping tools [hand tools]; screwdrivers, non-electric; sculptors' chisels; scythe handles; scythe rings; scythes; scythe stones; secateurs; sharpening instruments; sharpening steels; sharpening stones; shaving cases; shear blades; shearers [hand instruments]; shears; shovels [hand tools]; sickles; side arms, other than firearms; silver plate [knives, forks and spoons]; ski edge sharpening tools, hand-operated; sledgehammers; spades [hand tools]; spatulas for use by artists; spatulas [hand tools]; spoons; squares [hand tools]; stamping-out tools [hand tools]; sterile body piercing instruments; stirring sticks for mixing paint; stone hammers; stopping instruments; swords; sword scabbards; syringes for spraying insecticides; table cutlery [knives, forks and spoons];

table forks; table knives, forks and spoons for babies; table knives, forks and spoons of plastic; taps [hand tools]; tap wrenches; thistle extractors [hand tools]; tongs; tool belts [holders]; tree pruners; trowels; trowels [gardening]; truncheons; tube cutters [hand tools]; tube cutting instruments; tweezers; vegetable choppers; vegetable knives; vegetable peelers [hand tools]; vegetable spiralizers, hand-operated; vices; weeding forks [hand tools]; whetstone holders; wick trimmers [scissors]; wine bottle cutters, hand-operated; wire strippers [hand tools]; wrenches [hand tools].

9 – 3D spectacles; abacuses; accelerometers; accumulators, electric; accumulators, electric, for vehicles; acid hydrometers; acidimeters for batteries; acoustic alarms; acoustic conduits; acoustic couplers, actinometers; adding machines; aerometers; air analysis apparatus; alarm bells, electric; alarms; alcoholmeters; alidades; altimeters; ammeters; amplifiers; amplifying tubes; anemometers; animal signalling rattles for directing livestock; animated cartoons; anode batteries; anodes; answering machines; antennas; anticathodes; anti-glare glasses; anti-interference devices [electricity]; anti-theft warning apparatus; apertometers [optics]; apparatus and installations for the production of X-rays, not for medical purposes; apparatus and instruments for astronomy; apparatus and instruments for physics; apparatus for changing record player needles; apparatus for editing cinematographic film; apparatus for fermentation [laboratory apparatus]; apparatus for measuring the thickness of skins; apparatus to check franking; appliances for measuring the thickness of leather; armatures [electricity]; asbestos clothing for protection against fire; asbestos gloves for protection against accidents; asbestos screens for firemen; audio- and video-receivers; audio interfaces; audio mixers; audiovisual teaching apparatus; automated teller machines [ATM]; automatic indicators of low pressure in vehicle tires; azimuth instruments; baby monitors; baby scales; bags adapted for laptops; balances [steelyards]; balancing apparatus; bar code readers; barometers; bathroom scales; batteries, electric; batteries for electronic cigarettes; batteries for lighting; battery boxes; battery chargers; battery jars; beacons, luminous; bells [warning devices]; betatrons; binoculars; biochips; black boxes [data recorders]; blueprint apparatus; body harnesses for support when lifting loads; boiler control instruments; branch boxes [electricity]; breathing apparatus, except for artificial respiration; breathing apparatus for underwater swimming; bullet-proof clothing; bullet-proof vests; buzzers; cabinets for loudspeakers; cables, electric; calculating machines; calibrating rings; calipers; calorimeters; camcorders; cameras [photography]; capillary tubes; carpenters' rules; carriers for dark plates [photography]; cases especially made for photographic apparatus and instruments; cases for smartphones; cash registers; cassette players; cathodes; cathodic anti-corrosion apparatus, cell phone straps; cell switches [el-

ectricity]; cellular phones; centering apparatus for photographic transparencies; chargers for electric accumulators; chargers for electronic cigarettes; charging stations for electric vehicles; chemistry apparatus and instruments; chips [integrated circuits]; choking coils [impedance]; chromatography apparatus for laboratory use; chronographs [time recording apparatus]; cinematographic cameras; cinematographic film, exposed; circuit breakers; circuit closers; circular slide rules; cleaning apparatus for sound recording discs; climate control digital thermostats; close-up lenses; clothing especially made for laboratories; clothing for protection against accidents, irradiation and fire; clothing for protection against fire; coaxial cables; coils, electric; coin-operated mechanisms for television sets; coin-operated musical automata [juke boxes]; collectors, electric; commutators; compact disc players; compact discs [audio-video]; compact discs [read-only memory]; comparators; compasses for measuring; computer game software, downloadable; computer game software, recorded; computer hardware; computer keyboards; computer memory devices; computer operating programs, recorded; computer peripheral devices; computer programs, downloadable; computer programs, recorded; computers; computer screen saver software, recorded or downloadable; computer software applications, downloadable; computer software platforms, recorded or downloadable; computer software, recorded; condensers [capacitors]; conductors, electric; connected bracelets [measuring instruments]; connections for electric lines; connectors [electricity]; contact lenses; contacts, electric; containers for contact lenses; containers for microscope slides; control panels [electricity]; converters, electric; copper wire, insulated; cordless telephones; correcting lenses [optics]; cosmographic instruments; counterfeit coin detectors; counters; couplers [data processing equipment]; couplings, electric; covers for electric outlets; covers for personal digital assistants [PDAs]; covers for smartphones; covers for tablet computers; crash test dummies; crucibles [laboratory]; current rectifiers; cyclotrons; darkroom lamps [photography]; darkrooms [photography]; data gloves; data processing apparatus; decompression chambers; decorative magnets; demagnetizing apparatus for magnetic tapes; densimeters; densitometers; detectors; devices for the projection of virtual keyboards; diagnostic apparatus, not for medical purposes; diaphragms [acoustics]; diaphragms for scientific apparatus; diaphragms [photography]; dictating machines; diffraction apparatus [microscopy]; digital photo frames; digital signs; digital weather stations; directional compasses; discharge tubes, electric, other than for lighting; disk drives for computers; disks, magnetic; distance measuring apparatus; distance recording apparatus; distillation apparatus for scientific purposes; distribution boards [electricity]; distribution boxes [electricity]; distribution consoles [electricity]; divers' masks; diving suits; DNA chips; dog whistles; dosage dispensers; down-

loadable emoticons for mobile phones; downloadable graphics for mobile phones; downloadable image files; downloadable music files; downloadable ring tones for mobile phones; drainers for use in photography; dressmakers' measures; droppers for measuring, other than for medical or household purposes; drying apparatus for photographic prints; drying racks [photography]; ducts [electricity]; DVD players; dynamometers; ear pads for headphones; ear plugs for divers; egg-candlers; egg timers [sandglasses]; electrical adapters; electric and electronic effects units for musical instruments; electric apparatus for commutation; electric door bells; electric installations for the remote control of industrial operations; electricity conduits; electric loss indicators; electric plugs; electric sockets; electric wire harnesses for automobiles; electrified fences; electrified rails for mounting spot lights; electro-dynamic apparatus for the remote control of railway points; electro-dynamic apparatus for the remote control of signals; electrolyzers; electromagnetic coils; electronic access control systems for interlocking doors; electronic agendas; electronic book readers; electronic collars to train animals; electronic interactive whiteboards; electronic key fobs being remote control apparatus; electronic notice boards; electronic numeric displays; electronic pens [visual display units]; electronic pocket translators; electronic publications, downloadable; electronic sheet music, downloadable; electronic tags for goods; encoded identification bracelets, magnetic; encoded key cards, encoded magnetic cards; enlarging apparatus [photography]; epidiascopes; equalizers [audio apparatus], ergometers; exposure meters [light meters]; eyeglass cases, eyeglass chains; eyeglass cords; eyeglasses; eyeglass frames; eyepieces; eyewear; facsimile machines; fiber optic cables; film cutting apparatus; films, exposed; filters for respiratory masks; filters for ultraviolet rays, for photography; filters for use in photography; finger sizers; fire alarms; fire beaters; fire blankets; fire boats; fire engines; fire escapes; fire extinguishers; fire extinguishing apparatus; fire hose; fire hose nozzles; fire pumps; flash-bulbs [photography]; flashing lights [luminous signals]; flashlights [photography]; floppy disks; flowmeters; fluorescent screens; fog signals, non-explosive; food analysis apparatus; frames for photographic transparencies; frequency meters; furnaces for laboratory use; furniture especially made for laboratories; fuses; fuse wire; galena crystals [detectors]; galvanic batteries; galvanic cells; galvanometers; gasoline gauges; gasometers [measuring instruments]; gas testing instruments; gauges; glazing apparatus for photographic prints; global positioning system [GPS] apparatus; gloves for divers; gloves for protection against accidents; gloves for protection against X-rays for industrial purposes; goggles for sports; grids for batteries; hairdressing training heads [teaching apparatus]; hand-held electronic dictionaries; hands-free kits for telephones; head cleaning tapes [recording]; headgear being protective

helmets; head guards for sports; headphones; heat regulating apparatus; height measuring instruments; heliographic apparatus; hemline markers; high-frequency apparatus; holders for electric coils; holograms; horns for loudspeakers; humanoid robots with artificial intelligence; hydrometers; hygrometers; identification sheaths for electric wires; identification threads for electric wires; identity cards, magnetic; igniting apparatus, electric, for igniting at a distance; incubators for bacteria culture; inductors [electricity]; infrared detectors; ink cartridges, unfilled, for printers and photocopiers; instruments containing eyepieces; integrated circuit cards [smart cards]; integrated circuits; interactive touch screen terminals; intercommunication apparatus; interfaces for computers; inverters [electricity]; invoicing machines; ionization apparatus not for the treatment of air or water; jigs [measuring instruments]; joysticks for use with computers, other than for video games; juke boxes for computers; junction boxes [electricity]; junction sleeves for electric cables; kilometer recorders for vehicles; knee-pads for workers; laboratory centrifuges; laboratory pipettes; laboratory robots; laboratory trays; lactodensimeters; lactometers; laptop computers; lasers, not for medical purposes; lenses for astrophotography; lens hoods; letter scales; levelling instruments; levelling staffs [surveying instruments]; levels [instruments for determining the horizontal]; life belts; lifeboats; life buoys; life jackets; life saving apparatus and equipment; life-saving capsules for natural disasters; life-saving rafts; light dimmers [regulators], electric; light-emitting diodes [LED]; light-emitting electronic pointers; lighting ballasts; lightning rods; limiters [electricity]; locks, electric; logs [measuring instruments]; loudspeakers; magic lanterns; magnetic data media; magnetic encoders; magnetic resonance imaging [MRI] apparatus, not for medical purposes; magnetic tapes; magnetic tape units for computers, magnetic wires; magnets; magnifying glasses [optics], marine compasses; marine depth finders; marking buoys; marking gauges [joinery]; masts for wireless aerials; materials for electricity mains [wires, cables]; material testing instruments and machines; mathematical instruments; measures; measuring apparatus; measuring devices, electric; measuring glassware; measuring spoons; measuring instruments; mechanical signs; mechanisms for coin-operated apparatus; mechanisms for counter-operated apparatus; megaphones; memory cards for video game machines; mercury levels; metal detectors for industrial or military purposes; meteorological balloons; meteorological instruments; metronomes; micrometers; micrometer screws for optical instruments; microphones; microprocessors; microscopes; microtomes; mirrors for inspecting work; mirrors [optics]; modems; money counting and sorting machines; monitoring apparatus, other than for medical purposes; monitors [computer hardware]; monitors [computer programs]; mouse [computer peripheral]; mouse pads; mouth guards for sports; nanoparticle size analysers;

nautical apparatus and instruments; naval signalling apparatus; navigational instruments; navigation apparatus for vehicles [on-board computers]; needles for record players; needles for surveying compasses; neon signs; nets for protection against accidents; nose clips for divers and swimmers; notebook computers; objectives [lenses] [optics]; observation instruments; octants; ohmmeters; optical apparatus and instruments; optical character readers; optical condensers; optical data media; optical discs; optical fibers [light conducting filaments]; optical glass; optical lamps; optical lenses; organic light-emitting diodes [OLED]; oscillographs; oxygen transvasing apparatus; ozonisers [ozonators]; parking meters; particle accelerators; pedometers; peepholes [magnifying lenses] for doors; periscopes; personal digital assistants [PDAs]; personal stereos; Petri dishes; photocopiers [photographic, electrostatic, thermic]; photometers; phototelegraphy apparatus; photovoltaic cells; piezoelectric sensors; pince-nez; Pitot tubes; plane tables [surveying instruments]; planimeters; plates for batteries; plotters; plumb bobs; plumb lines; pocket calculators; polarimeters; portable media players, precision balances; precision measuring apparatus, pressure gauges; pressure indicator plugs for valves; pressure indicators; pressure measuring apparatus; printed circuit boards; printed circuits; printers for use with computers; prisms [optics]; probes for scientific purposes; processors [central processing units]; projection apparatus; projection screens; protection devices against X-rays, not for medical purposes; protection devices for personal use against accidents; protective films adapted for computer screens; protective films adapted for smartphones; protective helmets; protective helmets for sports; protective masks; protective suits for aviators; protractors [measuring instruments]; punched card machines for offices; push buttons for bells; pyrometers; quantity indicators; quantum dot light-emitting diodes [QLED]; radar apparatus; radiological apparatus for industrial purposes; radiology screens for industrial purposes; radio pagers; radios; radiotelegraphy sets; radiotelephony sets; railway traffic safety appliances; range finders; readers [data processing equipment]; rearview cameras for vehicles; record players; reflective articles for wear, for the prevention of accidents; reflective safety vests; refractometers; refractors; regulating apparatus, electric; relays, electric; remote control apparatus; rescue flares, non-explosive and non-pyrotechnic; rescue laser signalling flares; resistances, electric; respirators for filtering air; respiratory masks, other than for artificial respiration; resuscitation mannequins [teaching apparatus]; resuscitation training simulators; retorts; retorts' stands; revolution counters; rheostats; riding helmets; ring sizers; road signs, luminous or mechanical; rods for water diviners; rulers [measuring instruments]; rules [measuring instruments]; saccharometers; safety nets; safety restraints, other than for vehicle seats and sports equipment; safety tarpaulins; sa-

linometers; satellite finder meters; satellite navigational apparatus; satellites for scientific purposes; scales; scales with body mass analysers; scanners [data processing equipment]; screens for photoengraving; screens [photography]; screw-tapping gauges; security surveillance robots; security tokens [encryption devices]; selfie lenses; selfie sticks [hand-held monopods]; semi-conductors; sextants; sheaths for electric cables; shoes for protection against accidents, irradiation and fire; shutter releases [photography]; shutters [photography]; signal bells; signal lanterns; signalling buoys; signalling panels, luminous or mechanical; signalling whistles; signals, luminous or mechanical; signalling whistles; signs, luminous; simulators for the steering and control of vehicles; sirens; sleeves for laptops; slide calipers; slide projectors; slide-rules; slope indicators; smartglasses; smartphones; smart rings; smoke detectors; snorkels; solar batteries; solar panels for the production of electricity; solderers' helmets; solenoid valves [electromagnetic switches]; sonars; sounding apparatus and machines; sounding leads; sounding lines; sound locating instruments; sound recording apparatus; sound recording carriers; sound recording discs; sound recording strips; sound reproduction apparatus; sound transmitting apparatus; spark-guards; speaking tubes; spectacle lenses; spectrograph apparatus; spectrometers; speed checking apparatus for vehicles; speed indicators; speed measuring apparatus [photography]; speed regulators for record players; spherometers; spirit levels; spools [photography]; sports whistles; sprinkler systems for fire protection; square rulers for measuring; squares for measuring; stage lighting regulators; stands adapted for laptops; stands for photographic apparatus; starter cables for motors; steering apparatus, automatic, for vehicles; step-up transformers; stereoscopes; stereoscopic apparatus; stills for laboratory experiments; stroboscopes; subwoofers; sulfimeters; sunglasses; surveying apparatus and instruments; surveying chains; surveying instruments; surveyors' levels; survival blankets; switchboards; switchboxes [electricity]; switches, electric; tablet computers; tachometers; tape recorders; taximeters; teaching apparatus; teaching robots; teeth protectors; telecommunication apparatus in the form of jewellery; telegraphs [apparatus]; telegraph wires; telephone apparatus; telephone receivers; telephone transmitters; telephone wires; telepresence robots; teleprinters; teleprompters; telerupters; telescopes; telescopic sights for artillery; telescopic sights for firearms; television apparatus; temperature indicator labels, not for medical purposes; temperature indicators; terminals [electricity]; testing apparatus not for medical purposes; test tubes; theft prevention installations, electric; theodolites; thermal imaging cameras; thermionic tubes; thermo-hygrometers; thermometers, not for medical purposes; thermostats; thermostats for vehicles; thin client computers; thread counters; ticket dispensers; time clocks [time recording devices]; time recording apparatus; time switches, au-

tomatic; tone arms for record players; toner cartridges, unfilled, for printers and photocopiers; totalizers; trackballs [computer peripherals]; traffic cones; traffic-light apparatus [signalling devices]; transformers [electricity]; transistors [electronic]; transmitters of electronic signals; transmitters [telecommunication]; transmitting sets [telecommunication]; transparencies [photography]; transponders; triodes; tripods for cameras; T-squares for measuring; urinometers; USB flash drives; vacuum gauges; vacuum tubes [radio]; variometers; vehicle breakdown warning triangles; vehicle radios; verniers; video baby monitors; video cassettes; video game cartridges; video recorders; video screens; videotapes; video telephones; viewfinders, photographic; virtual reality headsets; viscosimeters; visors for helmets; voltage regulators for vehicles; voltage surge protectors; voltmeters; voting machines; wafers for integrated circuits; wah-wah pedals; walkie-talkies; washing trays [photography]; water level indicators; wavemeters; wearable activity trackers; wearable computers; wearable video display monitors; weighbridges; weighing apparatus and instruments; weighing machines; weights; whistle alarms; wind socks for indicating wind direction; wire connectors [electricity]; wires, electric; workmen's protective face-shields; wrist rests for use with computers; X-ray apparatus not for medical purposes; X-ray films, exposed; X-ray photographs, other than for medical purposes; X-ray tubes not for medical purposes.

11 – Acetylene burners; acetylene flares; acetylene generators; air conditioners for vehicles; air-conditioning apparatus; air-conditioning installations; air cooling apparatus; air deodorizing apparatus; air dryers; air filtering installations; air fryers; air purifying apparatus and machines; air reheaters; air sterilizers; air valves for steam heating installations; alcohol burners, anti-glare devices for vehicles [lamp fittings]; anti-splash tap nozzles; apparatus for dehydrating food waste; aquarium filtration apparatus; aquarium heaters; aquarium lights; arc lamps; ash conveyor installations, automatic; bakers' ovens; barbecues; bath fittings; bath installations; bath tubs; bath tubs for sitz baths; bed warmers; beverage cooling apparatus; bicycle lights; bidets; blankets, electric, not for medical purposes; boiler pipes [tubes] for heating installations; boilers, other than parts of machines; book sterilization apparatus; brackets for gas burners; bread baking machines; bread-making machines; bread toasters; burners; burners for lamps; candle lanterns; carbon for arc lamps; ceiling lights; central heating radiators; chandeliers; chimney blowers; chimney flues; Chinese lanterns; chocolate fountains, electric; chromatography apparatus for industrial purposes; clean chambers [sanitary installations]; coffee capsules, empty, for electric coffee machines; coffee machines, electric; coffee percolators, electric; coffee roasters; coils [parts of distilling, heating or cooling installations]; cookers; cooking apparatus and installations; cooking

rings; cooking utensils, electric; cool boxes, electric; coolers for furnaces; cooling appliances and installations; cooling installations and machines; cooling installations for liquids; cooling installations for tobacco; cooling installations for water; couscous cookers, electric; curing lamps, not for medical purposes; curling lamps; dampers [heating]; deep fryers, electric; defrosters for vehicles; dental ovens; deodorizing apparatus, not for personal use; desalination plants; desiccating apparatus; directional lights for bicycles; discharge tubes, electric, for lighting; disinfectant apparatus; disinfectant apparatus for medical purposes; disinfectant dispensers for toilets; distillation apparatus; distillation columns; diving lights; drip irrigation emitters [irrigation fittings]; drying apparatus; drying apparatus and installations; electrically heated carpets; electrically heated clothing; electric appliances for making yogurt; electric cooktops; electric fans for personal use; electric lamps; electric lights for Christmas trees; electric torches; evaporators; expansion tanks for central heating installations; extractor hoods for kitchens; fabric steamers; fairy lights for festive decoration; fans [air-conditioning]; fans [parts of air-conditioning installations]; faucets for pipes and pipelines; feeding apparatus for heating boilers; filaments for electric lamps; filters for air conditioning; filters for drinking water; fireplaces, domestic; fittings, shaped, for ovens; flaming torches; flare stacks for use in the oil industry; flues for heating boilers; flushing tanks; food dehydrators, electric; food steamers, electric; footmuffs, electrically heated; footwarmers, electric or non-electric; forage drying apparatus; forges, portable; fountains; freezers; friction lighters for igniting gas; fruit roasters; fumigation apparatus, not for medical purposes; furnace ash boxes; furnace grates; furnaces, other than for laboratory use; gas boilers; gas burners; gas condensers, other than parts of machines; gas lamps; gas lighters; gas scrubbers [parts of gas installations]; gas scrubbing apparatus; germicidal burners; germicidal lamps for purifying air; glue-heating appliances; grills [cooking appliances]; hair dryers; hand drying apparatus for washrooms; head torches; headlights for automobiles; hearths; heat accumulators; heated display cabinets; heaters, electric, for feeding bottles; heaters for baths; heaters for heating irons; heaters for vehicles; heat exchangers, other than parts of machines; heat guns; heating and cooling apparatus for dispensing hot and cold beverages; heating apparatus; heating apparatus, electric; heating apparatus for defrosting vehicle windows; heating apparatus for solid, liquid or gaseous fuels; heating boilers; heating cushions, electric, not for medical purposes; heating elements; heating filaments, electric; heating installations; heating plates; heat pumps; heat regenerators; hot air apparatus; hot air bath fittings; hot air ovens; hot plates; hot water bottles; hot water heating installations; humidifiers for central heating radiators; hydrants; hydromassage bath apparatus; hydroponic growing systems; ice-cream making machines; ice

machines and apparatus; immersion heaters; incandescent burners; incinerators; installations for processing nuclear fuel and nuclear moderating material; ionization apparatus for the treatment of air or water; kettles, electric; kiln furniture [supports]; kilns; kitchen ranges [ovens]; laboratory burners; laboratory lamps; lamp chimneys; lamp glasses; lamp globes; lamp mantles; lamp reflectors; lamps; lampshade holders; lamp shades; lanterns for lighting; laundry dryers, electric; laundry room boilers; lava rocks for use in barbecue grills; level controlling valves in tanks; light bulbs; light bulbs, electric; light bulbs for directional signals for vehicles; light diffusers; light-emitting diodes [LED] lighting apparatus; lighters; lighting apparatus and installations; lighting apparatus for vehicles; lighting installations for air vehicles; light projectors; lights for automobiles; lights for vehicles; loading apparatus for furnaces; luminous house numbers; luminous tubes for lighting; magnesium filaments for lighting; malt roasters; microbubble generators for baths; microwave ovens [cooking apparatus]; microwave ovens for industrial purposes; milk cooling installations; miners' lamps; mixer faucets for water pipes; motorcycle lights; multicookers; nail lamps; nuclear reactors; oil burners; oil lamps; oil-scrubbing apparatus; ornamental fountains; oven fittings made of fireclay; oxyhydrogen burners; pasteurisers; pipes [parts of sanitary installations]; plate warmers; pocket warmers; polymerisation installations; pounded rice cake making machines, electric, for household purposes; pressure cookers, electric; pressure water tanks; purification installations for sewage; radiator caps; radiators, electric; radiators [heating]; refining towers for distillation; refrigerating apparatus and machines; refrigerating appliances and installations; refrigerating cabinets; refrigerating chambers; refrigerating containers; refrigerating display cabinets; refrigerators; refrigerators, cooling apparatus and freezers for medical storage purposes; regulating accessories for water or gas apparatus and pipes; regulating and safety accessories for gas apparatus; regulating and safety accessories for gas pipes; regulating and safety accessories for water apparatus; roasters; roasting jacks; roasting spits; rotisseries; safety accessories for water or gas apparatus and pipes; safety lamps; sanitary apparatus and installations; sauna bath installations; searchlights; shower enclosures; showers; sinks; sockets for electric lights; socks, electrically heated; solar furnaces; solar thermal collectors [heating]; sous-vide cookers, electric; soya milk making machines, electric; spa baths [vessels]; standard lamps; steam accumulators; steam boilers, other than parts of machines; steam facial apparatus [saunas]; steam generating installations; sterilizers; stills; stoves [heating apparatus]; street lamps; structural framework for ovens; swimming pool chlorinating apparatus; tajines, electric; tanning apparatus [sun beds]; taps; thermo-pots, electric; thermostatic valves [parts of heating installations]; tobacco roasters; toilet bowls; toilet seats; toi-

lets, portable; toilets [water-closets]; tortilla presses, electric; Turkish bath cabinets, portable; ultraviolet ray lamps, not for medical purposes; urinals being sanitary fixtures; USB-powered cup heaters; USB-powered hand warmers; vehicle headlights; vehicle reflectors; ventilation [air-conditioning] installations and apparatus; ventilation [air-conditioning] installations for vehicles; ventilation hoods; ventilation hoods for laboratories; waffle irons, electric; warming pans; washers for water faucets; wash-hand basins [parts of sanitary installations]; water conduits installations; water distribution installations; water filtering apparatus; water flushing installations; water heaters; watering installations, automatic; watering machines for agricultural purposes; water intake apparatus; water purification installations; water purifying apparatus and machines; water softening apparatus and installations; water sterilizers; water supply installations; whirlpool-jet apparatus; wicks adapted for oil stoves; wine cellars, electric.

12 – Adhesive rubber patches for repairing inner tubes; aerial conveyors; aeronautical apparatus, machines and appliances; aeroplanes; air bags [safety devices for automobiles]; aircraft; air cushion vehicles; air pumps [vehicle accessories]; airships; air vehicles; ambulances; amphibious airplanes; anti-glare devices for vehicles; anti-skid chains; anti-theft alarms for vehicles; anti-theft devices for vehicles; armored vehicles; ashtrays for automobiles; automobile bodies; automobile chains; automobile chassis; automobile hoods; automobile tires; autonomous underwater vehicles for seabed inspections; axle journals; axles for vehicles; bags adapted for pushchairs; balance weights for vehicle wheels; bands for wheel hubs; barges; baskets adapted for bicycles; bellows for articulated buses; bicycle bells; bicycle brakes; bicycle chains; bicycle frames; bicycle cranks; bicycle handlebars; bicycle kickstands; bicycle motors; bicycle mudguards; bicycle pedals; bicycles; bicycle saddles; bicycle tires; bicycle trailers; bicycle wheels; boat hooks; boats; bodies for vehicles; bogies for railway cars; brake discs for vehicles; brake linings for vehicles; brake pads for automobiles; brake segments for vehicles; brakes for vehicles; brake shoes for vehicles; buffers for railway rolling stock; bumpers for automobiles; cable transport apparatus and installations; caissons [vehicles]; camera drones; camping cars; canoes; caps for vehicle fuel tanks, caravans; cars; cars for cable transport installations; carts; casings for pneumatic tyres; casters for trolleys [vehicles]; casting carriages; chairlifts; cigar lighters for automobiles; civilian drones; cleaning trolleys; cleats [nautical]; clips adapted for fastening automobile parts to automobile bodies; clutches for land vehicles; concrete mixing vehicles; connecting rods for land vehicles, other than parts of motors and engines; couplings for land vehicles; covers for vehicle steering wheels; crankcases for land vehicle components, other than for engines; davits for boats; delivery drones; de-

livery tricycles; dining cars; disengaging gear for boats; doors for vehicles; dredgers [boats]; dress guards for bicycles; driverless cars [autonomous cars]; driving chains for land vehicles; driving motors for land vehicles; ejector seats for aircraft; electric bicycles; electric vehicles; engine mounts for land vehicles; engines for land vehicles; fenders for ships; ferry boats; fishing trolleys; fitted footmuffs for prams; fitted footmuffs for pushchairs; fitted stroller mosquito nets; flanges for railway wheel tires; forklift trucks; freewheels for land vehicles; funiculars; funnels for locomotives; funnels for ships; gear boxes for land vehicles; gearing for land vehicles; golf carts [vehicles]; gyrocopters; handling carts; headlight wipers; headrests for vehicle seats; helicams; hoods for vehicle engines; hoods for vehicles; horns for vehicles; hose carts; hot air balloons; hub caps; hubs for bicycle wheels; hubs for vehicle wheels; hydraulic circuits for vehicles; hydroplanes; inclined ways for boats; inner tubes for bicycle tires; inner tubes for pneumatic tires; jet engines for land vehicles; kick sledges; launches; locomotives; lorries; luggage carriers for vehicles; luggage nets for vehicles; lug nuts for vehicle wheels; masts for boats; military drones; military vehicles for transport; mine cars; mine cart wheels; mobility scooters; mopeds; motor buses; motor coaches; motorcycle chains; motorcycle engines; motorcycle frames; motorcycle handlebars; motorcycle kickstands; motorcycles; motorcycle saddles; motor racing cars; motor scooters; motors, electric, for land vehicles; mudguards; non-skid devices for vehicle tires; oars; paddles for canoes; panniers adapted for bicycles; panniers adapted for motorcycles; parachutes; pet strollers; pneumatic tires; pontoons; portholes; prams; propulsion mechanisms for land vehicles; pumps for bicycle tires; push scooters [vehicles]; railway carriages; railway couplings; rearview mirrors; reduction gears for land vehicles; refrigerated railway wagons; refrigerated vehicles; remote control vehicles, other than toys; remotely operated vehicles for underwater inspections; repair outfits for inner tubes; rescue sleds; reversing alarms for vehicles; rims for bicycle wheels; rims for vehicle wheels; robotic cars; roll cage trolleys; rolling stock for funicular railways; rolling stock for railways; rowlocks; rubbish trucks; rudders; saddlebags adapted for bicycles; saddle covers for bicycles; saddle covers for motorcycles; safety belts for vehicle seats; safety seats for children, for vehicles; screw-propellers; screw-propellers for boats; screws [propellers] for ships; sculls; seaplanes; seat covers for vehicles; security harness for vehicle seats; self-balancing boards; self-balancing electric unicycles; self-balancing scooters; ship hulls; ships; shock absorbers for automobiles; shock absorbing springs for vehicles; shopping trolleys; side cars; side view mirrors for vehicles; signal arms for vehicles, ski carriers for cars; ski lifts; sleeping berths for vehicles; sleeping cars; sleighs [vehicles]; snowmobiles; solid tires for vehicle wheels; space vehicles; spare wheel covers; spars for

ships; spikes for tires; spoilers for vehicles; spoke clips for wheels; spokes for bicycle wheels; sports cars; sprinkling trucks; steering gears for ships; steering wheels for vehicles; stroller covers; stroller hoods; strollers; sun-blinds adapted for automobiles; suspension shock absorbers for vehicles; tailboard lifts [parts of land vehicles]; telfer railways [cable cars]; tilting-carts; tilt trucks; timbers [frames] for ships; tipping apparatus [parts of railway wagons]; tipping bodies for lorries; tires for vehicle wheels; torque converters for land vehicles; torsion bars for vehicles; tow trucks; tractors; trailer hitches for vehicles; trailers for transporting bicycles; trailers [vehicles]; tramcars; transmission chains for land vehicles; transmissions for land vehicles; transmission shafts for land vehicles; treads for retreading tires; treads for vehicles [tractor type]; tricycles; trolleys; trucks with a crane feature incorporated; tubeless tires for bicycles; turbines for land vehicles; two-wheeled trolleys; tyre mousse inserts; tyres for snow ploughs; undercarriages for vehicles; upholstery for vehicles; valves for vehicle tires; vans [vehicles]; vehicle bonnet pins; vehicle bumpers; vehicle chassis; vehicle covers [shaped]; vehicle joysticks; vehicle running boards; vehicle seats; vehicles for locomotion by land, air, water or rail; vehicle suspension springs; vehicle wheels; vehicle wheel spokes; water vehicles; wheelbarrows; wheelchairs; windows for vehicles; windscreens; windshield wipers; yachts.

20 – Air beds, not for medical purposes; air cushions, not for medical purposes; air mattresses, not for medical purposes; air pillows, not for medical purposes; ambroid bars; ambroid plates; animal claws; animal hooves; animal horns; anti-roll cushions for babies; baby changing mats; bag hangers, not of metal; bakers' bread baskets; bamboo; bamboo curtains; barrel hoops, not of metal; barrels, not of metal; baskets, not of metal; bathroom vanities [furniture]; bath seats for babies; bathtub grab bars, not of metal; bead curtains for decoration; bed bases; bed casters, not of metal; bedding, except linen; bed fittings, not of metal; beds; beds for household pets; bedsteads of wood; beehives; benches [furniture]; binding screws, not of metal, for cables; birdhouses; bolsters; bolts, not of metal; bookcases; book rests [furniture]; bottle caps, not of metal; bottle casings of wood; bottle closures, not of metal; bottle racks; boxes of wood or plastic; brackets, not of metal, for furniture; brush mountings; bumper guards for cots, other than bed linen; bungs, not of metal; busts of wood, wax, plaster or plastic; cabinet work; camping mattresses; carts for computers [furniture]; casks, not of metal; casks of wood for decanting wine; cask stands, not of metal; chairs [seats]; chaise longues; chests for toys; chests, not of metal; chests of drawers; chopping blocks [tables]; clips, not of metal, for cables and pipes; clips of plastic for sealing bags; closures, not of metal, for containers; clothes hooks, not of metal; coat hangers; coatstands; coffin fittings, not of metal; coffins; collars, not of

meal, for fastening pipes; comb foundations for beehives; console tables; containers, not of metal, for liquid fuel; containers, not of metal [storage, transport]; coral; corks; corks for bottles; corozo; costume stands; cots for babies; counters [tables]; covers for clothing [wardrobe]; cradles; crates; crucifixes of wood, wax, plaster or plastic, other than jewelry; cupboards; curtain holders, not of textile material; curtain hooks; curtain rails; curtain rings; curtain rods; curtain rollers; curtain tie-backs; cushions; deck chairs; decorations of plastic for foodstuffs; desks; dinner wagons [furniture]; dispensers for dog waste bags, fixed, not of metal; display boards; display stands; divans; dog kennels; door bells, not of metal, non-electric; door bolts, not of metal; door closers, not of metal, non-electric; door fasteners, not of metal; door fittings, not of metal; door handles, not of metal; door knockers, not of metal; door openers, not of metal, non-electric; doors for furniture; door stops, not of metal or rubber; drafting tables; drain traps [valves] of plastic; dressing tables; edgings of plastic for furniture; embroidery frames; fans for personal use, non-electric; faucets, not of metal, for casks; feet for furniture; figurines of wood, wax, plaster or plastic; filing cabinets; fishing baskets; floating containers, not of metal; flower-pot pedestals; flower-stands [furniture]; fodder racks; footstools; freestanding partitions [furniture]; funerary urns; furniture; furniture casters, not of metal; furniture fittings, not of metal; furniture of metal; furniture partitions of wood; furniture shelves; garment covers [storage]; gun racks; hairdressers' chairs; hampers [baskets] for the transport of items; hand-held flagpoles, not of metal; hand-held mirrors [toilet mirrors]; handling pallets, not of metal; hat stands; head positioning pillows for babies; head-rests [furniture]; head support cushions for babies; high chairs for babies; hinges, not of metal; honeycombs; hooks, not of metal, for clothes rails; horn, unworked or semi-worked; hospital beds; house numbers, not of metal, non-luminous; identification bracelets, not of metal; identity plates, not of metal; imitation tortoiseshell; index cabinets [furniture]; indoor window blinds [furniture]; indoor window blinds of paper; indoor window blinds of textile; indoor window blinds of woven wood; infant walkers; inflatable furniture; inflatable publicity objects; jerrycans, not of metal; jewelry organizer displays; kennels for household pets; keyboards for hanging keys; knobs, not of metal; labels of plastic; ladders of wood or plastics; lap desks; latches, not of metal; lecterns; legs for furniture; letter boxes, not of metal or masonry; library shelves; loading gauge rods, not of metal, for railway wagons; loading pallets, not of metal; lockers; locks, not of metal, for vehicles; locks, other than electric, not of metal; magazine racks; mannequins; massage tables; mats for infant playpens; mattresses; meat safes; medicine cabinets; meerschau; mirrors [looking glasses]; mirror tiles; mobile boarding stairs, not of metal, for passengers; mobiles [decoration]; moldings for picture frames;

mooring buoys, not of metal; moses baskets; mother-of-pearl, unworked or semi-worked; nesting boxes; nesting boxes for household pets; newspaper display stands; nuts, not of metal; office furniture; oil drainage containers, not of metal; oyster shells; packaging containers of plastic; padlocks, other than electronic, not of metal; pegs [pins], not of metal; pet cushions; picture frame brackets; picture frames; pillows; placards of wood or plastics; plaited straw, except matting; plastic key cards, not encoded and not magnetic; plastic keys; plastic ramps for use with vehicles; plate racks; playpens for babies; plugs [dowels], not of metal; poles, not of metal; portable desks; pulleys of plastics for blinds; racks [furniture]; rattan; reeds [plaiting materials]; reels, not of metal, non-mechanical, for flexible hoses; reels of wood for yarn, silk, cord; registration plates, not of metal; removable mats or covers for sinks; rivets, not of metal; runners, not of metal, for sliding doors; sash fasteners, not of metal, for windows; saw benches [furniture]; saw horses; school furniture; scratching posts for cats; screens for fireplaces [furniture]; screens [furniture]; screws, not of metal; screw tops, not of metal, for bottles; sealing caps, not of metal; seats of metal; sections of wood for beehives; settees, shells; shelves for file cabinets; shelves for storage; shelving units; shoe dowels, not of metal; shoe pegs, not of metal; shoulder poles [yokes]; showcases [furniture]; shower chairs; sideboards; signboards of wood or plastics; silvered glass [mirrors]; slatted indoor blinds; sleeping mats; sofas; split rings, not of metal, for keys; stag antlers; stair rods; stakes, not of metal, for plants or trees; standing desks; stands for calculating machines; statues of wood, wax, plaster or plastic; staves of wood; steps [ladders], not of metal; step stools, not of metal; stools; stoppers, not of glass, metal or rubber; straw edgings; straw mattresses; straw plaits; stuffed animals; stuffed birds; tables; tables of metal; table tops; tanks, not of metal nor of masonry; tea carts; tent pegs, not of metal; tool boxes, not of metal, empty; tool chests, not of metal, empty; tortoiseshell; towel dispensers, fixed, not of metal; towel stands [furniture]; transport pallets, not of metal; trays, not of metal; trestles [furniture]; trolleys [furniture]; troughs, not of metal, for mixing mortar; typing desks; umbrella stands; valet stands; valves, not of metal, other than parts of machines; vats, not of metal; vice benches [furniture]; wall-mounted baby changing platforms; wardrobes, washstands [furniture]; waterbeds, not for medical purposes; water-pipe valves of plastic; whalebone, unworked or semi-worked; wickerwork; wind chimes [decoration]; winding spools, not of metal, non-mechanical, for flexible hoses; window closers, not of metal, non-electric; window fasteners, not of metal; window fittings, not of metal; window openers, not of metal, non-electric; window pulleys, not of metal; window stops, not of metal or rubber; wood ribbon; work benches; works of art of wood, wax, plaster or plastic; writing desks; yellow amber.

21 – Abrasive pads for kitchen purposes; abrasive sponges for scrubbing the skin; aerosol dispensers, not for medical purposes; animal bristles [brushware]; animal grooming gloves; apparatus for wax-polishing, non-electric; aquarium hoods; aromatic oil diffusers, other than reed diffusers, electric and non-electric; baby baths, portable; baking mats; basins [receptacles]; baskets for household purposes; basting brushes; basting spoons [cooking utensils]; beaters, non-electric; beer mugs; beverage urns, non-electric; bird baths; birdcages; blenders, non-electric, for household purposes; bootjacks; boot trees; bottle openers, electric and non-electric; bottles; bowls [basins]; boxes for dispensing paper towels; boxes for sweets; boxes of glass; bread baskets for household purposes; bread bins; bread boards; broom handles; brooms; brushes; brushes for cleaning tanks and containers; brushes for footwear; buckets; buckets made of woven fabrics; bulb basters; busts of porcelain, ceramic, earthenware, terra-cotta or glass; butter-dish covers; butter dishes; buttonhooks; cabarets [trays]; cages for household pets; cake decorating tips and tubes; cake moulds; candelabra [candlesticks]; candle drip rings; candle extinguishers; candle jars [holders]; candle warmers, electric and non-electric; carpet beaters [hand instruments]; carpet sweepers; car washing mitts; cauldrons; ceramics for household purposes; chamber pots; chamois leather for cleaning; cheese-dish covers; china ornaments; chopsticks; cinder sifters [household utensils]; cleaning instruments, hand-operated; cleaning tow; closures for pot lids, clothes-pegs; cloth for washing floors; clothing stretchers; cloths for cleaning; coasters, not of paper or textile; cocktail shakers; cocktail stirrers; coffee filters, non-electric; coffee grinders, hand-operated; coffee percolators, non-electric; coffeepots, non-electric; coffee services [tableware]; coin banks; cold packs for chilling food and beverages; comb cases; combs; combs for animals; confectioners' decorating bags [pastry bags]; containers for household or kitchen use; cookery moulds; cookie [biscuit] cutters; cookie jars; cooking mesh bags, other than for microwaves; cooking pots; cooking pot sets; cooking skewers of metal; cooking utensils, non-electric; coolers [ice pails]; corkscrews, electric and non-electric; cosmetic spatulas; cosmetic utensils; cotton waste for cleaning; couscous cooking pots, non-electric; covers, not of paper, for flower pots; cruets; cruet sets for oil and vinegar; crumb trays; crushers for kitchen use, non-electric; crystal [glassware]; cups; cups of paper or plastic; currycombs; cutting boards for the kitchen; decanters; decanter tags; decorative glass spheres; deep fryers, non-electric; demijohns; deodorizing apparatus for personal use; diaper disposal pails; dishcloths, dish covers; dishes; dishwashing brushes; disposable aluminium foil containers for household purposes; disposable table plates; drinking bottles for sports; drinking glasses; drinking horns; drinking straws; drinking troughs; drinking vessels; dripping pans; droppers for cosmetic

purposes; droppers for household purposes; drying racks for laundry; dustbins; dusting apparatus, non-electric; dusting cloths [rags]; earthenware; earthenware saucepans; egg cups; egg poachers; egg separators, non-electric, for household purposes; egg yolk separators; electric brushes, except parts of machines; electric combs; electric devices for attracting and killing insects; enamelled glass, not for building; epergnes; eyebrow brushes; eyelash brushes; feather-dusters; feeding troughs; fiberglass, other than for insulation or textile use; fiberglass thread, other than for textile use; figurines of porcelain, ceramic, earthenware, terra-cotta or glass; fitted picnic baskets, including dishes; flasks; flat-iron stands; floss for dental purposes; flower pots; fly swatters; fly traps; foam toe separators for use in pedicures; food steamers, non-electric; fruit cups; fruit presses, non-electric, for household purposes; frying pans; funnels; furniture dusters; fused silica [semi-worked product], other than for building; gardening gloves; garlic presses [kitchen utensils]; glass bulbs [receptacles]; glasses [receptacles]; glass flasks [containers]; glass for vehicle windows [semi-finished product]; glass incorporating fine electrical conductors; glass jars [carboys]; glass stoppers; glass, unworked or semi-worked, except building glass; glass wool, other than for insulation; gloves for household purposes; glove stretchers; gluepots; graters for kitchen use; grills [cooking utensils]; grill supports; hair for brushes; heads for electric toothbrushes; heaters for feeding bottles, non-electric; heat-insulated containers; heat-insulated containers for beverages; hip flasks; holders for flowers and plants [flower arranging]; horse brushes; horsehair for brush-making; hot pots, not electrically heated; ice cream scoops; ice cube molds; ice tongs; indoor aquaria; indoor terrariums [plant cultivation]; indoor terrariums [vivariums]; inflatable bath tubs for babies; insect traps; insulating flasks; ironing board covers, shaped; ironing boards; isothermic bags; kettles, non-electric; kitchen containers; kitchen grinders, non-electric; kitchen utensils; knife rests for the table; ladles for serving wine; lamp-glass brushes; large-toothed combs for the hair; lazy susans; lint removers, electric or non-electric; liqueur sets; litter boxes for pets; lunch boxes; majolica; make-up brushes; make-up removing appliances; make-up sponges; mangers for animals; material for brush-making; menu card holders; mess-tins; mills for household purposes, hand-operated; mixing spoons [kitchen utensils]; molds [kitchen utensils]; mops; mop wringer buckets; mop wringers; mortars for kitchen use; mosaics of glass, not for building; mouse traps; mugs; nail brushes; napkin rings; nest eggs, artificial; noodle machines, hand-operated; nozzles for watering cans; nozzles for watering hose; nutcrackers; opal glass; opaline glass; oven mitts; painted glassware; paper plates; pasta makers, hand-operated; pastry cutters; pepper mills, hand-operated; pepper pots; perfume burners; perfume vaporizers; pestles for kitchen use; pet feeding

bowls; pet feeding bowls, automatic; pie servers; pig bristles for brush-making; piggy banks, pitchers; place mats, not of paper or textile; plate glass [raw material]; plates for diffusing aromatic oil; plates to prevent milk boiling over; plug-in diffusers for mosquito repellents; plungers for clearing blocked drains; polishing apparatus and machines, for household purposes, non-electric; polishing cloths; polishing gloves; polishing leather; polishing materials for making shiny, except preparations, paper and stone; porcelain ware; portable cool boxes, non-electric; potholders; pot lids; pots; pottery; poultry rings; pouring spouts; powder compacts, empty; powdered glass for decoration; powder puffs; pressure cookers, non-electric; rat traps; refrigerating bottles; reusable ice cubes; reusable silicone food covers; rings for birds; roller tubes for peeling garlic; rolling pins, domestic; rotary washing lines; salad bowls; salad tongs; salt cellars; saucepan scourers of metal; saucers; scoops for household purposes; scouring pads; scrubbing brushes; services [dishes]; serving ladles; shaving brushes; shaving brush stands; shoe horns; shoe trees; sieves [household utensils]; sifters [household utensils]; signboards of porcelain or glass; siphon bottles for carbonated water; ski wax brushes; smoke absorbers for household purposes; soap boxes; soap dispensers; soap holders; soup bowls; spatulas for kitchen use; spice sets; sponge holders; sponges for household purposes; sprinklers; squeegees [cleaning instruments]; stands for portable baby baths; statues of porcelain, ceramic, earthenware, terra-cotta or glass; steel wool for cleaning; stew-pans; strainers for household purposes; sugar bowls; sugar tongs; syringes for watering flowers and plants; tablemats, not of paper or textile; table napkin holders; table plates; tableware, other than knives, forks and spoons; tajines, non-electric; tankards; tar-brushes, long handled; tea bag rests; tea caddies; tea cozies; tea infusers; teapots; tea services [tableware]; tea strainers; thermally insulated containers for food; tie presses; toilet brushes; toilet cases; toilet paper dispensers; toilet paper holders; toilet sponges; toilet utensils; toothbrushes; toothbrushes, electric; toothpaste tube squeezers; toothpick holders; toothpicks; tortilla presses, non-electric [kitchen utensils]; towel rails and rings; trays for household purposes; trays of paper, for household purposes; trivets [table utensils]; trouser presses; utensils for household purposes; vases; vegetable dishes; vessels of metal for making ices and iced drinks; vitreous silica fibers, other than for textile use; waffle irons, non-electric; washing boards; washtubs; waste paper baskets; water apparatus for cleaning teeth and gums; watering cans; watering devices; wax-polishing appliances, non-electric, for shoes; whisks, non-electric, for household purposes; window-boxes; wine aerators; wine pourers; wine-tasting pipettes; wool waste for cleaning; works of art of porcelain, ceramic, earthenware, terra-cotta or glass.

(260) AM 2021 110720 A

(800) 1563398

(151) 2020 09 07

(891) 2020 09 07

(731) FIDIA FARMACEUTICI S.p.A.

Via Ponte della Fabbrica, 3/A, I-35031

Abano Terme (PD), Italy

(540)

FIDIALEYE

(591) Black, white

(531) 27.05.01

(511)

5 – Pharmaceutical, medical and veterinary preparations; sanitary preparations for medical purposes; dietary supplements for humans and animals; medicines; food supplements; irrigating solutions for eye use; vitamins; dietetic food and substances adapted for medical or veterinary use; plasters, materials for wound dressings; parapharmaceuticals preparations for medical purposes; chemical preparations for medical and pharmaceutical purposes; ophthalmic preparations; pharmaceutical preparations and medical preparations for ophthalmic use; ophthalmic preparations for use in ocular surgery; eye care medicines; preparations for treating eyes; medicated eye lotions; ophthalmic eye-washes and artificial tears; medicinal specialties in form of collyrium; eye drops; creams or gels for the contour of the eyes; sanitizing wipes; eyepatches for medical purposes; ocular gauzes; nutritional supplements adapted for ophthalmic use; mineral nutritional supplements for ophthalmic use; disinfectants; pre-filled syringes for medical purposes; medicated eye-washes; solutions for contact lenses; contact lens cleaning preparations; wadding for medical purposes; absorbent wadding; cotton for medical purposes; cotton swabs for medical purposes; bandages for dressings; adhesive plasters; enzymes for medical purposes; capsules for medicines; pastilles for pharmaceutical purposes.

10 – Surgical, medical and veterinary apparatus and instruments; ocular implants; ocular implants made from artificial materials; eye baths; artificial eyes, prostheses; ocular speculums; ophthalmological instruments.

(260) AM 2021 110721 A

(800) 1563462

(151) 2020 07 20

(891) 2020 07 20

(731) Euro Games Technology Ltd.

"Maritsa" Str., 4, „Vranya-Lozen-Triugulnika",

BG-1151 Sofia, Bulgaria

(540)

SANDS SPIRIT

(591) White, gold, yellow, orange, brown, red, green and purple

(531) 03.07.17; 27.05.04; 29.01.15

(511)

9 – Software; computer gaming software; computer software packages; computer operating system software; computer software, recorded; software drivers; virtual reality software; games software; entertainment software for computer games; computer programs for network management; operating computer software for main frame computers; monitors (computer hardware); computer hardware; apparatus for recording images; monitors (computer programs); computer game programs; computer programs for recorded games; apparatus for recording, transmission or reproduction of sound or images; communications servers [computer hardware]; electronic components for gambling machines; computer application software featuring games and gaming; computer software for the administration of on-line games and gaming; computer hardware for games and gaming; computer hardware and software for gambling, gambling machines, gambling games on the Internet and via telecommunication network.

28 – Gaming machines for gambling; chips for gambling; mah-jong; arcade games; gambling machines operating with coins, notes and cards; games; electronic games; parlor games; gaming chips; gaming tables; slot machines [gaming machines]; LCD game machines; slot machines and gaming devices; coin-operated amusement machines; roulette chips; poker chips; chips and dice [gaming equipment]; gaming equipment for casinos; roulette tables; gaming roulette wheels; casino games; amusement and gambling machines; coin-operated gaming machines and / or electronic coin-operated gaming machines with or without the possibility of gain; boxes for coin-operated machines, slot machines and gaming machines; electronic or electro-technical gaming devices, amusement and gaming machines, including coin-operated machines; housings for coin-operated machines, gaming equipment, gaming machines, machines for gambling; electro-pneumatic and electrical gambling machines (slot machines).

41 – Gambling; entertainment services related to gambling; gaming services for entertainment purposes; casino, gaming and gambling services; training in the development of software systems; provision of equipment for gambling halls; providing casino equipment [gambling]; gaming machine entertainment services; providing casino facilities [gambling]; providing halls with gaming machines; amusement arcade services; games equipment rental; rental of gaming machines; providing amusement arcade services; rental of gaming machines with images of fruits; editing or recording of sounds and images; sound recording and video entertainment services; hire of sound reproducing apparatus; provision of gaming equipment for casinos;

providing of casino facilities; online gambling services; provision of casino services; provision of gaming establishments, gaming halls, internet casinos, online gambling services.

(260) AM 2021 110722 A

(800) 1563472

(151) 2020 09 22

(891) 2020 09 22

(731) Obshchestvo s ogranichennoy otvetstvennostyu "BREND BOKS"

Prospect Lenina, d. 58A, et. 3, off. 17,

RU-430003 g. Saransk, Republic of Mordovia, Russian Federation

(540)

ЗИМНЯЯ ДЕРЕВЕНЬКА

(591) Black, white

(531) 28.05

(511)

33 – Alcoholic beverages, except beer; aperitifs; arack [arak]; brandy; wine; piquette; whisky; vodka; gin; digesters [liqueurs and spirits]; cocktails; liqueurs; alcoholic beverages; alcoholic beverages containing fruit; spirits [beverages]; distilled beverages; mead [hydromel]; peppermint liqueurs; bitters; rum; sake; cider; rice alcohol; alcoholic extracts; fruit extracts, alcoholic; alcoholic essences.

(260) AM 2021 110733 A

(800) 1319161

(151) 2016 03 11

(891) 2020 10 30

(731) Larin Maksim Vladislavovich

d. Vybor, 5, Ivanovskoye s/p, Vesegonsk

district, RU-171721 Tver Region, Russian Federation

(540)

AFANASY

(591) Black, white

(531) 27.05.01

(511)

32 – Aperitifs, non-alcoholic; lithia water; seltzer water; soda water; waters [beverages]; aerated water; mineral water [beverages]; table waters; kvass [non-alcoholic beverage]; cocktails, non-alcoholic; lemonades; peanut milk [non-alcoholic beverage]; milk of almonds [beverage]; non-alcoholic beverages; isotonic beverages; non-alcoholic honey-based beverages; aloe vera drinks, non-alcoholic; whey beverages; non-alcoholic fruit juice beverages; fruit nectars, non-alcoholic; orgeat; beer; ginger beer; malt beer; powders for effervescing beverages; sarsaparilla [non-alcoholic beverage]; syrups for lemonade; syrups for beverages; smoothies; tomato juice [beverage]; cider, non-alcoholic; vegetable juices [beverages]; fruit juices; preparations for making aerated water; preparations for ma-

king liqueurs; preparations for making mineral water; preparations for making beverages; must; grape must, unfermented; beer wort; malt wort; pastilles for effervescing beverages; sherbets [beverages]; non-alcoholic fruit extracts; extracts of hops for making beer; essences for making beverages.

(260) AM 2021 110734 A

(800) 1328452

(151) 2016 07 11

(891) 2020 10 06

(731) Tovarichestvo s ogranitchenoy, otvetstvennostyu "Pharmacia Universal" Chaplina/Haliulina Street, 71/66, 050019 Almaty, Kazakhstan

(540)

INSTY

(591) Black, white

(531) 27.05.01

(511)

5 – Pharmaceutical, biological, vitamin, medical preparations, agents and substances; foods adapted for medical purposes, nutritional supplements and means; pharmaceutical extracts, infusions, elixirs, tinctures, syrups, capsules; tonic and medical teas and mixtures.

35 – Advertising, business management, including release, delivery, distribution, publication, distribution of samples, exhibits of advertising materials; organization of exhibitions for commercial or advertising purposes; marketing of goods (the sale of goods through intermediaries, demonstration of goods, market research), presentation of goods on all media means for the purpose of retail sale; publication of advertising texts, radio advertising, distribution of samples, distribution of advertising materials, interactive advertising in computer network, advertising by mail, television advertising, logistics services; all the aforesaid services relating to goods presented in class 5.

39 – Transportation, packaging and storage of goods, including the delivery of goods, packaging of goods, storage of goods; all the aforesaid services relating to goods presented in class 5.

(260) AM 2021 110735 A

(800) 1330042

(151) 2016 10 04

(891) 2020 11 18

(731) DAW SE

Roßdörfer Str. 50, 64372 Ober-Ramstadt, Germany

(540)

DISBON

(591) Black, white

(531) 26.04.09; 26.07.19

(511)

1 – Industrial chemicals; preservative and damp-proofing preparations for masonry, roofing tiles, cement and concrete, except paints and oils; artificial resins, unprocessed synthetic resins and unprocessed plastics; solvents (chemicals); solvents for varnishes and lacquers; adhesives used in industry; adhesives for wall-paper; adhesives used in building; filler for the treatment of subsurfaces for paints (not included in other classes).

2 – Paints; varnishes; lacquers; glazes, glazings (as far as included in this class); preservatives against rust; primers; dyes, dye stuffs, dye paste; mordants; thickeners for paints; fixatives; siccatives (drying agents) for paints; natural resins (as far as included in this class); thinners and binding agents for paints, lacquers and coatings; preservatives against deterioration of wood, wood mordants and oils for the preparation of wood; coatings (as far as included in this class), including those that are structurable; bactericidal/fungicidal paints; anti-corrosive preparations; protective preparations for metals; metals in powder form and metal foil for painters, decorators, printers and artists.

17 – Packing, thermal protection and insulating materials (included in this class); insulating paints, varnishes, fabrics and plaster; substances for insulating buildings against moisture; artificial and synthetic resins (semi-finished products); fiberglass fabrics as parts of heat insulating bonded systems for insulation; insulating tape and band; heat insulators; insulating panels, grid mats of glass fiber fabric and/or plastics (all for heat insulating bonded systems); plastic films, not for wrapping; adhesive tapes and strips for building.

19 – Building materials, not of metal or mainly not of metal, especially base rails and corner protections; locking profiles (not of metal, for building); adjusting and levelling parts, not of metal, for building; non-metallic building materials, namely, spacers; sills not of metal or mainly not of metal; natural and artificial stone; mortar (building materials); quartz; plaster (included in this class); coatings (building materials); wall and ceiling panels (not of metal or mainly not of metal, for building); fabric embedding compounds for building; filler being building materials; fabrics for building, not of metal or mainly not of metal, especially stabilizing fabrics.

(260) AM 2021 110736 A

(800) 1331068

(151) 2016 08 04

(891) 2020 10 15

(731) JUN JAE YUN

103-2103, 27, Wolgye-ro 36-gil, Seongbuk-gu, Seoul, Republic of Korea

(540)

La'dor

(591) Black, white

(531) 27.05.01

(511)

3 – Soap powder; adhesives for affixing false hair; gaultheria oil; color-brightening chemicals for household purposes; scale removing preparations for household purposes; aromatics for household purposes; soaps for household use; detergents prepared from petroleum for household purposes; cleaning preparations for household purposes; antistatic preparations for household purposes; fragrance for household purposes; de-greasing preparations for household purposes; creams for leather; cakes of soap; cakes of toilet soap; air fragrancing preparations; refurbishing preparations; polishing creams; breath freshening strips; breath freshening sprays; extracts of flowers (perfumes); bases for flower perfumes; smoothing preparations (starching); dry shampoos; dry-cleaning preparations; lavender oil; lacquer-removing preparations; essential oils of lemon; polishing powder (abrasives); shaving mousse; shaving soap; pastes for razor strops; bath soaps; eucalyptus (perfumery); liquid soap; beauty soap; mint essential oil; vanilla perfumery; body cream soap; soaps for body care; peppermint oil (perfumery); soap for foot perspiration; antiperspirant soap; deodorant soap; scented wood; bergamot oil; complex perfumery; soaps (not for personal use); non-medicated mouth washes; glass paper; sandcloth; safrol; essential oils of cedarwood; shampoos; detergents prepared from petroleum; joss sticks; soap for brightening textile; skin polishing rice bran; liquid detergents; cleaning chalk; oils for cleaning purposes; quillaia bark for washing; volcanic ash for cleaning; cloths impregnated with a detergent for cleaning; detergents other than for medical use and manufacturing processes; cleaning preparations; cleansers for detergent; laundry soap; laundry glaze; starch glaze for laundry purposes; fabric softeners for laundry use; washing soda for cleaning; laundry wax; starch for laundry purposes; laundry blueing; laundry soaking preparations; bleaching preparations for laundry use; laundry starch; volcanic ash for laundry use; soda lye; disinfectant soap; tooth paste in soft cake form; hand cleansers; nail art stickers; essential oils of citron; drying agents for dishwashing machines; detergents for machine dishwashing; washing-up liquids; dishwasher detergents; shining preparations for plant leaves; essential oils for food flavorings; silicon carbide (abrasive); almond oil; almond soap; ammonia detergent (volatile alkali); deodorants for pets; shampoos for pets; cosmetics for animals; liquid bath soaps; amber (perfume); medicated soap (not for medical use); dental rinses for non-medical purposes; stain removers; ethereal oils; ambergris (perfume); glass cleaning preparations; baby shampoo; flavourings for beverages

(essential oils); clothes rinse; denture polishes; preparations for cleaning dentures; ionone (perfumery); false eyelashes; false nails; adhesives for affixing false eyelashes; soaps for personal use; javelle water; jasmine oil; rose oil; tailors' wax; food flavorings prepared from essential oils; geraniol; blended perfumery; liquid soap used in foot bath; paper soap for personal use; parquet floor wax; natural perfumery; floor wax removers; dental bleaching gels; tooth powder; teeth cleaning lotions; tooth cleaning preparations; dentifrices; corundum; clove oils; cream soaps; toilet bowl detergents; color-removing preparations; turpentine, for degreasing; oil of turpentine for degreasing; terpenes (essential oils); facial washes; potpourris (fragrances); bleaching soda; bleaching salts; bleaching preparations; leather bleaching preparations; synthetic musk; synthetic perfumery; hand cleaners; incense; perfumery; oils for perfumes and scents; mint for perfumery; musk (perfumery); natural musk (perfumery); perfumed soap; hair rinses; cosmetic soaps; tissues impregnated with cosmetic lotions; beauty masks; cotton buds for cosmetic purposes; decorative transfers for cosmetic purposes; adhesives for cosmetic purposes; cotton wool for cosmetic purposes; cosmetics; perfume oils for the manufacture of cosmetic preparations; fumigation preparations (perfumes).

(260) AM 2021 110737 A

(800) 1527679

(151) 2019 12 30

(891) 2020 10 30

(731) Larin Maksim Vladislavovich

d. Vybor, 5, Ivanovskoye s/p, Vesjegonsk district, RU-171721 Tver Region, Russian Federation

(540)

АФНАСИЙ

(591) Black, white

(531) 28.05

(511)

32 – Beer; beer-based cocktails; ginger beer; malt beer; malt extracts for making liquors; must; grape must, unfermented; beer wort; malt wort; extracts of hops for making beer.

(260) AM 2021 110738 A

(800) 1534953

(151) 2020 04 09

(891) 2020 11 13

(731) BOSTIK SA

420 rue d'Estienne d'Orves, F-92700 Colombes, France

(540)



(591) Black, white, blue, green

(531) 03.02.01; 03.11.09; 03.11.10; 03.11.24;
25.05.01; 26.04.02; 26.04.07; 26.04.12;
26.04.16; 29.01.15

(511)

1 – Glues for industrial use, particularly for the construction industry.

16 – Adhesives (glues) for stationery or household purposes; adhesives for handicrafts; wood glues for household use; glues for fabrics for household use; glues for office use; glues for glass for household use; glues for leather for household use.

(260) AM 2021 110853 A

(800) 1523350

(151) 2020 01 20

(891) 2020 11 24

(731) FINCHIMICA S.P.A.

Via Lazio, 13, I-25025 Manerbio (BS), Italy

(540)

FLUAZINOVA

(591) Black, white

(511)

1 – Anti-pathogen plant-protecting preparations; chemicals used in industry, science and photography, as well as in horticulture and forestry; unprocessed artificial resins; unprocessed plastics; manures; fire extinguishing compositions; tempering and soldering preparations; chemical substances for preserving foodstuffs; tanning substances; adhesives used in industry.

5 – Preparations for destroying vermin; insecticides; fungicides; herbicides.

(260) AM 2021 110854 A

(800) 1529942

(151) 2020 01 20

(891) 2020 11 24

(731) FINCHIMICA S.P.A.

Via Lazio, 13, I-25025 Manerbio (BS), Italy

(540)

BOTREFIN

(591) Black, white

(511)

1 – Anti-pathogen plant-protecting preparations; chemicals used in industry, science and photography, as well as in agriculture, horticulture and forestry; synthetic resins, unprocessed; unprocessed plastics; manures; fire extinguishing compositions; tempering and soldering preparations; chemical substances for preserving foodstuffs; tanning substances; adhesives used in industry; chemically converted compound fertilizers; chemically treated peat for use in horticulture; manures; chemicals for use in agriculture; growing media, fertilizers and chemicals for use in agriculture, horticulture and forestry; chemically treated peat for use in agriculture; chemicals for use in agriculture; chemical adjuvants for use in agriculture; bacteriological preparations for use in agriculture; fertilisers, and chemicals used in agriculture, horticulture and forestry.

5 – Preparations for destroying vermin; insecticides; fungicides; herbicides; vermin destroying preparations; forestry (chemicals for -), [parasiticide]; parasitocides; pest control preparations and articles; antiparasitic preparations from chemical sources; antiparasitic preparations; fungicides; biological fungicides; fungicides; fungicides for horticultural use; fungicides for agricultural use; fungicides for killing vermin; forestry (chemicals for -), [herbicides]; biological herbicides; adhesives for agricultural use in pest control.

(260) AM 2021 110901 A

(800) 1565156

(151) 2020 10 14

(891) 2020 10 14

(731) Limited Liability Company "Stroigrand"

Sibiriyakov-Gvardeytshev Str., 49, RU-630088

Novosibirsk, Russian Federation

(540)



(591) White and olive

(531) 05.01.03; 05.01.05; 05.01.16; 27.05.11;
29.01.12

(511)

19 – Doors, not of metal; folding doors, not of metal; lintels, not of metal; door panels, not of metal; door casings, not of metal.

(260) AM 2021 110903 A

(800) 1565195

(151) 2020 09 25

(891) 2020 09 25

(731) Degaia International S.r.l.

Via Aretina, 188 A, I-50136 Firenze,
Italy

(540)

DEGAIA

(591) Black, white

(511)

18 – Key cases; bags; trunks [luggage]; travelling bags [leatherware]; leather bags; bags made of imitation leather; shoulder bags; bags for sports; beach bags; shopping bags with wheels attached; small bags for men; hip bags; vanity cases, not fitted; leather briefcases; briefcases; folding briefcases; pocket wallets; coin purses; card cases [notecases]; duffle bags; shoe bags for travel; suitcases; briefcase-type portfolios; attaché cases; rucksacks on casters; sports packs; umbrellas.

25 – Clothing; clothing of leather; denims; leisure suits; clothing for sports; suits; dresses; shirts; hosiery; sweaters; pullovers; t-shirts; trousers; leggings [trousers]; skirts; jackets [clothing]; blousons; coats; overcoats; raincoats; bathrobes; bathing suits; neckerchiefs; neckties; sweatshirts; jumpsuits [clothing]; underwear; stockings; socks; mittens; hats; berets; scarfs; shoes; boots for sports; sandals; slippers; boots; belts; beach clothes.

35 – Retail and wholesale services, also on-line, connected with the sale of clothing, sport clothing, footwear, sport footwear, leatherwear, bags.

(260) AM 2021 110904 A

(800) 1565280

(151) 2020 08 12

(891) 2020 08 12

(731) TAT KİMYA SABUN VE GLİSERİN

SANAYİ VE TİCARET ANONİM ŞİRKETİ

3. Organize Sanayi Bölgesi, Vali Muammer
Güler Bulvarı No: 33, Şehitkamil, Gaziantep,
Turkey

(540)

Dp Daily Perfection

(591) Black, white

(531) 27.05.01

(511)

3 – Bleaching and cleaning preparations, detergents other than for use in manufacturing operations and for medical purposes, laundry bleach, fabric softeners for laundry use, stain removers, dishwasher detergents; perfumery; non-medicated cosmetics; fragrances; deodorants for personal use and animals; soaps; dental care preparations; dentifrices, denture polishes, tooth whitening preparations, mouth washes, not for medical purposes; polishing preparations for leather, vinyl, metal and wood, polishes and creams for leather, vinyl, metal and wood, wax for polishing.

(260) AM 2021 110985 A

(800) 1566010

(151) 2020 09 14

(891) 2020 09 14

(731) Shenzhen Xindong Developing Co., Ltd

No. 2076, Gaoke Mansion, No. 72013
Yueliangwan Avenue, Nanshan subdistrict,
Nanshan District, Shenzhen City, 518000
Guangdong Province, China

(540)

GEOGRA

(591) Black, white

(531) 27.05.01

(511)

25 – Clothing; sandals; caps being headwear; mantilla; gloves (clothing); hosiery; scarfs; shoes (footwear); boots; sports shoes.

(260) AM 2021 110986 A

(800) 1566021

(151) 2020 09 30

(891) 2020 09 30

(731) VivaChek Biotech (Hangzhou) Co., Ltd.

Level 2, Block 2, 146 East Chaofeng Road,
Yuhang Economy Development Zone,
Hangzhou, 310000 Zhejiang, China

(540)



(591) Black, white

(531) 26.11.01; 26.11.12; 27.05.01

(511)

1 – Diagnostic preparations, other than for medical or veterinary purposes; test paper, chemical; reagent pa-

per, other than for medical or veterinary purposes; sensitized paper.

5 – Diagnostic preparations for veterinary purposes; diagnostic biomarker reagents for medical purposes; diagnostic preparations for medical purposes; reagent paper for medical purposes; reagent paper for veterinary purposes.

10 – Hypodermic syringes; arterial blood pressure measuring apparatus; blood testing apparatus; testing apparatus for medical purposes; medical apparatus and instruments; cases fitted for medical instruments; diagnostic apparatus for medical purposes.

(260) AM 2021 110988 A

(800) 1566064

(151) 2020 09 30

(891) 2020 09 30

(731) GIORGIO ARMANI S.P.A.

Via Borgonuovo, 11; I-20121 MILANO
(Milano), Italy

(540)

**R-E
A**

(591) Black, white

(531) 27.05.10; 27.05.15; 27.05.17

(511)

18 – Handbags; traveling bags; briefcases; leather briefcases; leather credit card holders; wallets; leather document briefcases; key-cases of leather and skins; purses; suit cases; cosmetic bags sold empty; gym bags; evening and shoulder bags for ladies; leather shopping bags; school bags; garment bags for travel; suit carriers for travel; shoe bags for travel; beach bags; diaper bags; backpacks; Boston bags; traveling trunks; duffel bags; overnight bags; carry-on bags; satchels; opera bags; vanity cases (not fitted); hides; cases and boxes made of leather; bags made of leather for packaging; leather straps; umbrellas; leather leashes; saddlery.

25 – Coats; jackets; trousers; skirts; tops; raincoats; overcoats; belts; braces for clothing; suits; stuff jackets; jumpers; jeans; dresses; cloaks; parkas; shirts; t-shirts; sweaters; underwear; baby-dolls being nightwear; bathrobes; bathing costumes; negligee; swim suits; dressing gowns; shawls; neckerchiefs; scarves; ties; neckties; sweat shirts; under shirts; polo shirts; body suits; shorts; combinations (clothing); wedding dresses; stockings; socks; shoes; slippers; overshoes; galoshes; wooden clog; soles for footwear; footwear upper; boots; ski boots; snow boots; half boots; esparto shoes or sandals; sandals; bath sandals; gloves; mittens; hats and caps; visors (headwear).

(260) AM 2021 110992 A

(800) 1566159

(151) 2020 10 22

(891) 2020 10 22

(731) Panda Restaurant Group, Inc.

1683 Walnut Grove Avenue, Rosemead
CA 91770, USA

(540)

PANDA EXPRESS

(591) Black, white

(526) EXPRESS

(511)

43 – Restaurant services; restaurant and café services; restaurant and catering services; café and restaurant services; mobile restaurant services; self service restaurants; take-out restaurant services.

(260) AM 2021 111040 A

(800) 1567271

(151) 2020 07 30

(891) 2020 07 30

(731) NAFODS GROUP JOINT STOCK
COMPANY

No. 47 Nguyen Canh Hoan Street, Quan Bau
Ward, Vinh City, Nghe An Province, Viet Nam

(540)



(591) Red, brown, white, black, yellow and grey

(531) 01.15.05; 24.09.02; 26.04.10; 26.04.18;

26.13.25; 27.05.07; 27.05.09; 27.05.24;

29.01.15

(511)

29 – Processed seeds; frozen fruits; dried fruits.

30 – Tea; coffee.

31 – Fresh fruits; raw seeds.

32 – Concentrated fruit juice.

(260) AM 2021 111042 A
 (800) 1567340
 (151) 2020 08 28
 (891) 2020 08 28
 (731) Miconvey Technologies Co., LTD.
 No. 56, No. 117, Yunhan Avenue, Beibei
 District, Chongqing, China

(540)

MICONVEY

(591) Black, white

(511)

5 – Medicines for human purposes; collagen for medical purposes; gelatine for medical purposes; styptic preparations; alginates for pharmaceutical purposes; diagnostic preparations for medical purposes; wadding for medical purposes; dressings, medical; hemostatic pencils; teeth filling material.

10 – Surgical apparatus and instruments; medical apparatus and instruments; diagnostic apparatus for medical purposes; biodegradable bone fixation implants; hemostatic suture apparatus; dental apparatus and instruments; ultrasound apparatus for use in medical; surgical sponges; artificial skin for surgical purposes; surgical implants comprised of artificial materials; suture materials.

(260) AM 2021 111043 A
 (800) 899279
 (151) 2006 03 23
 (891) 2020 11 30
 (731) Zakrytoe aktsionernoe Obchtchestvo
 "Stupinskii himicheskii zavod"
 vlad. 9/14, ul. Frunze, g. Stupino, RU-142800
 Moskovskaia oblast, Russian Federation

(540)



(591) Light blue, dark blue, red, pink, yellow, orange, white, black and grey

(531) 01.15.09; 11.01.01; 11.03.05; 28.05; 29.01.15

(526) Super.

(511)

3 – Bleaching preparations and other substances for laundry use; cleaning, polishing, scouring and abrasive preparations; soap; detergents other than for use in

manufacturing operations and for medical purposes; scouring solutions.

5 – Disinfectants; detergents for medical purposes; depuratives.

(260) AM 2021 111044 A

(800) 1023460

(151) 2009 11 18

(891) 2020 10 23

(731) Farmak international Holding GmbH
 Mariahilferstrasse 136, A-1150 Wien, Austria

(540)

РЕВМОКСИКАМ

(591) Black, white

(531) 28.05

(511)

5 – Medical products and means for medical needs; pharmaceutical preparations; veterinary preparations; ointments for pharmaceutical purposes; diagnostic preparations for medical purposes; tinctures for medical purposes.

(260) AM 2021 111045 A

(800) 1126216

(151) 2012 06 18

(891) 2020 10 23

(731) Farmak international Holding GmbH
 Mariahilferstrasse 136, A-1150 Wien, Austria

(540)

ЭНАЛОЗИД

(591) Black, white

(531) 28.05

(511)

5 – Pharmaceutical preparations; medicines for human purposes.

(260) AM 2021 111046 A

(800) 1131344

(151) 2012 06 18

(891) 2020 10 23

(731) Farmak international Holding GmbH
 Mariahilferstrasse 136, A-1150 Wien, Austria

(540)

ДИАЛИПОН

(591) Black, white

(531) 28.05

(511)

5 – Pharmaceutical preparations; medicines for human purposes.

(260) AM 2021 111047 A

(800) 1162946

(151) 2013 05 06

(891) 2020 12 03

(731) Caffè Motta S.p.a.

Via Roberto Wenner n.26, I-84131 Salerno,

Italy

(540)



(591) Gold, white and black

(531) 26.01.18; 27.05.19; 29.01.12

(511)

30 – Coffee.

INTERNATIONAL TRADEMARKS PROTECTED IN GEORGIA

(260) AM 2021 105413 A
(800) 1493282
(151) 2019 07 02
(181) 2029 07 02
(891) 2019 07 02
(511) 25

(260) AM 2021 108829 A
(800) 1537930
(151) 2020 02 25
(181) 2030 02 25
(891) 2020 02 25
(511) 12, 17, 37

(260) AM 2021 108908 A
(800) 1538669
(151) 2020 02 03
(181) 2030 02 03
(891) 2020 02 03
(511) 01, 05, 10

(260) AM 2021 108909 A
(800) 1538713
(151) 2020 06 03
(181) 2030 06 03
(891) 2020 06 03
(511) 07

(260) AM 2021 108910 A
(800) 1538769
(151) 2020 04 09
(181) 2030 04 09
(891) 2020 04 09
(511) 29, 30, 31, 32

(260) AM 2021 108911 A
(800) 1538780
(151) 2020 02 17
(181) 2030 02 17
(891) 2020 02 17
(511) 03

(260) AM 2021 108913 A
(800) 1538801
(151) 2020 05 28
(181) 2030 05 28
(891) 2020 05 28
(511) 05

(260) AM 2021 108914 A
(800) 1538834
(151) 2020 05 20
(181) 2030 05 20
(891) 2020 05 20
(511) 05, 29, 30, 43

(260) AM 2021 108915 A
(800) 1538872
(151) 2020 05 20
(181) 2030 05 20
(891) 2020 05 20
(511) 30

(260) AM 2021 108917 A
(800) 1538936
(151) 2020 04 13
(181) 2030 04 13
(891) 2020 04 13
(511) 09

(260) AM 2021 108922 A
(800) 1539059
(151) 2020 05 13
(181) 2030 05 13
(891) 2020 05 13
(511) 09

(260) AM 2021 108923 A
(800) 1539070
(151) 2020 05 26
(181) 2030 05 26
(891) 2020 05 26
(511) 41, 42

(260) AM 2021 108924 A
(800) 1539073
(151) 2020 02 04
(181) 2030 02 04
(891) 2020 02 04
(511) 25, 28

(260) AM 2021 108933 A
(800) 1539258
(151) 2020 04 16
(181) 2030 04 16
(891) 2020 04 16
(511) 07, 11, 21

(260) AM 2021 108974 A
(800) 1539346
(151) 2020 06 11
(181) 2030 06 11
(891) 2020 06 11
(511) 35

(260) AM 2021 108988 A
(800) 1539785
(151) 2020 06 10
(181) 2030 06 10
(891) 2020 06 10
(511) 09

(260) AM 2021 108975 A
(800) 1539374
(151) 2020 04 16
(181) 2030 04 16
(891) 2020 04 16
(511) 07, 11, 21

(260) AM 2021 109058 A
(800) 1540376
(151) 2020 05 28
(181) 2030 05 28
(891) 2020 05 28
(511) 35

(260) AM 2021 108976 A
(800) 1539378
(151) 2020 05 18
(181) 2030 05 18
(891) 2020 05 18
(511) 03

(260) AM 2021 109062 A
(800) 1540525
(151) 2019 12 17
(181) 2029 12 17
(891) 2019 12 17
(511) 01, 06, 17, 19, 20, 22, 24, 37

(260) AM 2021 108978 A
(800) 1539387
(151) 2020 06 10
(181) 2030 06 10
(891) 2020 06 10
(511) 10

(260) AM 2021 109066 A
(800) 1540771
(151) 2020 06 10
(181) 2030 06 10
(891) 2020 06 10
(511) 05, 10

(260) AM 2021 108979 A
(800) 1539394
(151) 2020 01 13
(181) 2030 01 13
(891) 2020 01 13
(511) 01, 02, 17

(260) AM 2021 109079 A
(800) 1541097
(151) 2020 04 16
(181) 2030 04 16
(891) 2020 04 16
(511) 09, 11, 42

(260) AM 2021 108980 A
(800) 1539425
(151) 2020 05 19
(181) 2030 05 19
(891) 2020 05 19
(511) 11

(260) AM 2021 109080 A
(800) 1541132
(151) 2020 05 20
(181) 2030 05 20
(891) 2020 05 20
(511) 30

(260) AM 2021 108981 A
(800) 1539516
(151) 2020 05 22
(181) 2030 05 22
(891) 2020 05 22
(511) 06, 19

(260) AM 2021 109081 A
(800) 1541141
(151) 2020 05 29
(181) 2030 05 29
(891) 2020 05 29
(511) 07

(260) AM 2021 109082 A
(800) 1541143
(151) 2020 05 11
(181) 2030 05 11
(891) 2020 05 11
(511) 41

(260) AM 2021 109198 A
(800) 1233267
(151) 2014 08 26
(181) 2024 08 26
(891) 2020 06 08
(511) 28

(260) AM 2021 109100 A
(800) 1481821
(151) 2019 06 06
(181) 2029 06 06
(891) 2020 06 26
(511) 05

(260) AM 2021 109199 A
(800) 1390014
(151) 2018 01 12
(181) 2028 01 12
(891) 2020 07 09
(511) 05

(260) AM 2021 109176 A
(800) 1542133
(151) 2020 06 16
(181) 2030 06 16
(891) 2020 06 16
(511) 30

(260) AM 2021 109239 A
(800) 1542564
(151) 2020 04 21
(181) 2030 04 21
(891) 2020 04 21
(511) 03, 10

(260) AM 2021 109183 A
(800) 1542216
(151) 2020 04 16
(181) 2030 04 16
(891) 2020 04 16
(511) 03, 10

(260) AM 2021 109306 A
(800) 1543727
(151) 2020 05 02
(181) 2030 05 02
(891) 2020 05 02
(511) 42, 44

(260) AM 2021 109195 A
(800) 1070558
(151) 2011 01 21
(181) 2021 01 21
(891) 2020 07 06
(511) 17, 19

(260) AM 2021 109308 A
(800) 1543767
(151) 2020 06 26
(181) 2030 06 26
(891) 2020 06 26
(511) 05

(260) AM 2021 109196 A
(800) 1138467
(151) 2012 09 25
(181) 2022 09 25
(891) 2020 07 06
(511) 17

(260) AM 2021 109309 A
(800) 1543779
(151) 2020 04 15
(181) 2030 04 15
(891) 2020 04 15
(511) 05

(260) AM 2021 109197 A
(800) 1143479
(151) 2012 09 28
(181) 2022 09 28
(891) 2020 06 19
(511) 16

(260) AM 2021 109310 A
(800) 1543805
(151) 2020 06 26
(181) 2030 06 26
(891) 2020 06 26
(511) 05

(260) AM 2021 109347 A
(800) 1450228
(151) 2018 12 24
(181) 2028 12 24
(891) 2020 07 07
(511) 09, 38, 42

(260) AM 2021 109405 A
(800) 1545379
(151) 2020 03 27
(181) 2030 03 27
(891) 2020 03 27
(511) 30

(260) AM 2021 109348 A
(800) 1462814
(151) 2019 02 27
(181) 2029 02 27
(891) 2020 06 15
(511) 30

(260) AM 2021 109444 A
(800) 1545975
(151) 2020 05 22
(181) 2030 05 22
(891) 2020 05 22
(511) 03, 05

(260) AM 2021 109349 A
(800) 1484041
(151) 2019 07 24
(181) 2029 07 24
(891) 2020 06 09
(511) 12, 35, 37

(260) AM 2021 109447 A
(800) 1545996
(151) 2020 05 12
(181) 2030 05 12
(891) 2020 05 12
(511) 05, 10

(260) AM 2021 109386 A
(800) 1544850
(151) 2020 05 14
(181) 2030 05 14
(891) 2020 05 14
(511) 09, 36

(260) AM 2021 109448 A
(800) 1545999
(151) 2020 03 04
(181) 2030 03 04
(891) 2020 03 04
(511) 01, 17

(260) AM 2021 109387 A
(800) 1544894
(151) 2020 05 28
(181) 2030 05 28
(891) 2020 05 28
(511) 09

(260) AM 2021 109449 A
(800) 1546011
(151) 2020 05 12
(181) 2030 05 12
(891) 2020 05 12
(511) 05, 10

(260) AM 2021 109388 A
(800) 1544914
(151) 2020 05 28
(181) 2030 05 28
(891) 2020 05 28
(511) 09

(260) AM 2021 109479 A
(800) 1546788
(151) 2020 07 21
(181) 2030 07 21
(891) 2020 07 21
(511) 03

(260) AM 2021 109389 A
(800) 1544925
(151) 2020 04 07
(181) 2030 04 07
(891) 2020 04 07
(511) 03

(260) AM 2021 109482 A
(800) 1546853
(151) 2020 04 21
(181) 2030 04 21
(891) 2020 04 21
(511) 30

(260) AM 2021 109484 A
(800) 1546887
(151) 2020 05 10
(181) 2030 05 10
(891) 2020 05 10
(511) 09, 42

(260) AM 2021 109495 A
(800) 1465469
(151) 2019 02 26
(181) 2029 02 26
(891) 2020 07 31
(511) 09, 42

(260) AM 2021 109552 A
(800) 1547540
(151) 2020 05 18
(181) 2030 05 18
(891) 2020 05 18
(511) 21

(260) AM 2021 109568 A
(800) 1024290
(151) 2009 11 10
(181) 2029 11 10
(891) 2020 08 07
(511) 05

(260) AM 2021 109569 A
(800) 1052546
(151) 2010 08 02
(181) 2030 08 02
(891) 2020 08 07
(511) 01, 04, 35

(260) AM 2021 109573 A
(800) 1268181
(151) 2015 06 15
(181) 2025 06 15
(891) 2020 08 07
(511) 09, 16, 34

(260) AM 2021 109623 A
(800) 1548213
(151) 2020 06 03
(181) 2030 06 03
(891) 2020 06 03
(511) 35

(260) AM 2021 109624 A
(800) 1548223
(151) 2020 04 03
(181) 2030 04 03
(891) 2020 04 03
(511) 18, 25

(260) AM 2021 109625 A
(800) 1548234
(151) 2020 05 29
(181) 2030 05 29
(891) 2020 05 29
(511) 35, 43

(260) AM 2021 109639 A
(800) 1548516
(151) 2020 06 16
(181) 2030 06 16
(891) 2020 06 16
(511) 01, 03, 06, 07, 09, 11, 17, 35, 36, 37, 38, 39, 40, 41, 42

(260) AM 2021 109640 A
(800) 1548518
(151) 2020 07 21
(181) 2030 07 21
(891) 2020 07 21
(511) 06, 19

(260) AM 2021 109641 A
(800) 1548545
(151) 2020 06 19
(181) 2030 06 19
(891) 2020 06 19
(511) 21

(260) AM 2021 109691 A
(800) 1549221
(151) 2020 04 28
(181) 2030 04 28
(891) 2020 04 28
(511) 05

(260) AM 2021 109693 A
(800) 1549244
(151) 2020 04 28
(181) 2030 04 28
(891) 2020 04 28
(511) 05

(260) AM 2021 109707 A
(800) 1549473
(151) 2020 03 06
(181) 2030 03 06
(891) 2020 03 06
(511) 28

(260) AM 2021 109708 A
(800) 1549492
(151) 2020 02 11
(181) 2030 02 11
(891) 2020 02 11
(511) 41

(260) AM 2021 109709 A
(800) 1549501
(151) 2020 03 10
(181) 2030 03 10
(891) 2020 03 10
(511) 09, 16, 28, 35, 41, 42

(260) AM 2021 109710 A
(800) 1549511
(151) 2020 06 19
(181) 2030 06 19
(891) 2020 06 19
(511) 34

(260) AM 2021 109866 A
(800) 1551503
(151) 2020 07 22
(181) 2030 07 22
(891) 2020 07 22
(511) 33, 35

(260) AM 2021 109867 A
(800) 1551505
(151) 2020 08 11
(181) 2030 08 11
(891) 2020 08 11
(511) 41

(260) AM 2021 109868 A
(800) 1551513
(151) 2020 06 02
(181) 2030 06 02
(891) 2020 06 02
(511) 09, 28, 41

OFFICIAL NOTIFICATIONS
INVENTIONS
EXPIRATION OF PATENTS RESTORATION

(21) AP 2007 10194
(11) P 2012 5430 B
(73) Ramzan Gaitemirov
(54) INTERNAL COMBUSTION ENGINE
DATE OF CANCELLATION OF PATENT: 2020 07 25
THE TERM OF RESTORATION OF PATENT: 2021 08 10

(21) AP 2010 11695
(11) P 2011 5360 B
(73) Vazha Khositashvili
(54) VEGETATIVE GATHERING – ANTIOXIDANT, ANTIRADIATION AND FOR TREATMENT OF
CARDIOVASCULAR DISEASES AND MEDICAL MEANS ON ITS BASIS
DATE OF CANCELLATION OF PATENT: 2021 02 23
THE TERM OF RESTORATION OF PATENT: 2021 08 10

(21) AP 2010 11696
(11) P 2011 5361 B
(73) Vazha Khositashvili;
Levan Khositashvili;
Babri Oreni
(54) PREPARATION - ANTIOXIDANT, ANTIRADIATION, REGULATING LIPIDIC EXCHANGE AND
PREPARATION FOR TREATMENT OF CARDIOVASCULAR DISEASES
DATE OF CANCELLATION OF PATENT: 2021 02 23
THE TERM OF RESTORATION OF PATENT: 2021 08 10

ABOLITION OF PATENTS WITH THE RIGHT TO RESTORE

(21) AP 2007 10194
(11) P 2012 5430 B
(73) Ramzan Gaitemirov
(54) INTERNAL COMBUSTION ENGINE
DATE OF CANCELLATION OF PATENT: 2021 07 25
THE TERM OF RESTORATION OF PATENT: 2022 07 25

(21) AP 2008 11677
(11) P 2012 5537 B
(73) Chiesi Farmaceutici S.P.A.
(54) DERIVATIVES OF 1-PHENYL-2-PYRIDINYL ALKYL ALCOHOLS AS PHOSPHODIESTERASE
INHIBITORS
DATE OF CANCELLATION OF PATENT: 2021 07 17
THE TERM OF RESTORATION OF PATENT: 2022 07 17

(21) AP 2008 11694
(11) P 2012 5672 B
(73) Takeda Pharmaceutical Company Limited
(54) SOLID COMPOSITION CONTAINING ALOGLIPTIN AND METFORMIN HYDROCHLORIDE
DATE OF CANCELLATION OF PATENT: 2021 07 16
THE TERM OF RESTORATION OF PATENT: 2022 07 16

(21) AP 2012 13225
(11) P 2017 6766 B
(73) Los Angeles Biomedical Research Center;
Novamedica Ltd Liability Company
(54) METHODS AND COMPOSITIONS FOR VACCINATING AGAINST STAPHYLOCOCCUS AUREUS
DATE OF CANCELLATION OF PATENT: 2021 07 20
THE TERM OF RESTORATION OF PATENT: 2022 07 20

(21) AP 2014 13528
(11) P 2017 6704 B
(73) Les Laboratoires Servier;
Vernalis (R & D) LTD
(54) NEW PHOSPHATE COMPOUNDS, PROCESS FOR THEIR PREPARATION AND PHARMACEUTICAL
COMPOSITIONS CONTAINING THEM
DATE OF CANCELLATION OF PATENT: 2021 07 21
THE TERM OF RESTORATION OF PATENT: 2022 07 21

(21) AP 2014 14062
(11) P 2018 6804 B
(73) Les Laboratoires Servier;
Vernalis (R & D) LTD
(54) NOVEL INDOLIZINE DERIVATIVES, METHOD FOR THE PRODUCTION THEREOF AND
PHARMACEUTICAL COMPOSITIONS CONTAINING SAME
DATE OF CANCELLATION OF PATENT: 2021 07 22
THE TERM OF RESTORATION OF PATENT: 2022 07 22

(21) AP 2016 14688
(11) P 2020 7105 B
(73) Pfizer Inc.
(54) 1,1,1-TRIFLUORO-3-HYDROXYPROPAN-2-YL CARBAMATE DERIVATIVES AND 1,1,1-
TRIFLUORO-4-
HYDROXYBUTAN-2-YL CARBAMATE DERIVATIVES AS MAGL INHIBITORS
DATE OF CANCELLATION OF PATENT: 2021 07 18
THE TERM OF RESTORATION OF PATENT: 2022 07 18

(21) AP 2017 15105
(11) P 2020 7168 B
(73) LIMITED LIABILITY COMPANY "GSGROUP"
(54) PLASTIC BOTTLE
DATE OF CANCELLATION OF PATENT: 2021 07 12
THE TERM OF RESTORATION OF PATENT: 2022 07 12

(21) AP 2019 15152
(11) P 2020 7181 B
(73) Davit Purtskhvanidze
(54) EQUIPMENT FOR PROTON-LITHIUM SYNTHESIS
DATE OF CANCELLATION OF PATENT: 2021 07 24
THE TERM OF RESTORATION OF PATENT: 2022 07 24

EXPIRATION OF TERM OF RESTORATION OF PATENTS

(21) AP 2006 10494
(11) P 2012 5431 B
(73) Geox S.P.A.
(54) WATERPROOF VAPOR-PERMEABLE SHOE
DATE OF CANCELLATION OF PATENT: 2020 07 17
THE TERM OF RESTORATION OF PATENT VALIDITY HAS EXPIRED: 2021 07 17

(21) AP 2012 12788
(11) P 2014 6077 B
(73) Amiran Bregvadze;
David Babylua;
Fridon Gogiashvili;
Gocha Lekveishvili
(54) EMBANKMENT PROTECTING BANK
DATE OF CANCELLATION OF PATENT: 2020 07 13
THE TERM OF RESTORATION OF PATENT VALIDITY HAS EXPIRED: 2021 07 13

(21) AP 2012 13383
(11) P 2016 6430 B
(73) Preglem SA
(54) TREATMENT OF EXCESSIVE MENSTRUAL BLEEDING ASSOCIATED WITH UTERINE FIBROIDS
DATE OF CANCELLATION OF PATENT: 2020 07 12
THE TERM OF RESTORATION OF PATENT VALIDITY HAS EXPIRED: 2021 07 12

(21) AP 2014 14051
(11) P 2017 6712 B
(73) Les Laboratoires Servier
(54) NOVEL SALT OF 3-[(3-[[4-(4-MORPHO-LINYLMETHYL)-1H-PYRROL-2-YL] METHYLENE]-2-OXO-2,3-DIHYDRO-1H-INDOL-5-YL)METHYL]-1,3-THI- AZOLIDINE-2,4-DIONE, PREPARATION THEREOF
AND FORMULATIONS CONTAINING SAME
DATE OF CANCELLATION OF PATENT: 2020 07 11
THE TERM OF RESTORATION OF PATENT VALIDITY HAS EXPIRED: 2021 07 11

(21) AP 2016 14211
(11) P 2018 6883 B
(73) LEPL "Scientific Research Center of Agriculture"
(54) FRUIT AND VEGETABLE DRYING EQUIPMENT
DATE OF CANCELLATION OF PATENT: 2020 07 19
THE TERM OF RESTORATION OF PATENT VALIDITY HAS EXPIRED: 2021 07 19

(21) AP 2016 14705
(11) P 2019 7041 B
(73) Envirosteel Inc.
(54) CHANNEL TYPE INDUCTION FURNACE
DATE OF CANCELLATION OF PATENT: 2020 07 15
THE TERM OF RESTORATION OF PATENT VALIDITY HAS EXPIRED: 2021 07 15

EXPIRATION OF PATENT

(21) AP 2011 12318
(11) P 2013 1753 B
(73) Eliso Khatiasvili;
Mikheil Khatiasvili;
Tinatin Khatiasvili;
Giorgi Khatiasvili
(54) METHOD OF "KHATIASHVILI MIXTURE" PREPARATION AGAINST BENIGN SKIN FORMATIONS
EXPIRATION DATE OF PATENT: 25 07 2021

CHANGE OF NAME AND/OR ADDRESS OF PATENTOWNER

(21) AP 2008 11520
(11) P 2014 6112 B
(54) BINDING PROTEINS, INCLUDING ANTIBODIES, ANTIBODY DERIVATIVES AND ANTIBODY FRAGMENTS, THAT SPECIFICALLY BIND CD154 AND USAGE THEREOF
NEW PATENTOWNER AND ADDRESS: Biogen Idec Ma Inc. (US)
225 Binney Street, Cambridge, MA 02142, USA;
UCB Pharma S.A. (BE)
60 Allee de la Recherche, B-1070 Brussels, Belgium (BE)
FORMER PATENTOWNER AND ADDRESS: Biogen Idec Ma Inc.
225 Binney Street, Cambridge, MA 02142 (US);
UCB Pharma SPRL (BE)
60 Allee de la Recherche, B-1070 Brussels, Belgium (BE)
DATE OF REGISTRATION: 28 07 2021

UTILITY MODELS

ABOLITION OF PATENTS WITH THE RIGHT TO RESTORE

(21) AU 2015 13890

(11) U 2016 1912 Y

(73) Konstantine Maghradze;
Nugzar Joglidze

(54) COMPOSITION FOR BAKERY FOR PANCREATIC DIABETIC DIETARY MEAL

DATE OF CANCELLATION OF PATENT: 2021 07 17

THE TERM OF RESTORATION OF PATENT: 2022 07 17

(21) AU 2019 15142

(11) U 2020 2049 Y

(73) Tsisana Gagnidze;
Jiuli Keadze;

Rusudan Chagelishvili;
Vazha Chagelishvili

(54) ELECTROCHEMICAL REACTOR FOR PIT-RUN AND INDUSTRIAL WASTE WATERS TREATMENT

DATE OF CANCELLATION OF PATENT: 2021 07 19

THE TERM OF RESTORATION OF PATENT: 2022 07 19

EXPIRATION OF TERM OF RESTORATION OF PATENT

(21) AU 2015 13885

(11) U 2017 1917 Y

(73) Tinatin Lezhava

(54) DRYING DEVICE

DATE OF CANCELLATION OF PATENT: 2020 07 15

THE TERM OF RESTORATION OF PATENT VALIDITY HAS EXPIRED: 2021 07 15

DESIGNS

CANCELLATION OF REGISTRATION OF DESIGNS

- (11) D 2011 478 S
(73) LLC "Agara Sugar Company" (GE)
Abuseridze Tbeli St. 13, 0120, Tbilisi, Georgia (GE)
(54) LABEL FOR PACKAGE, WRAPPING AND CONTAINERS USED FOR TRANSPORTATION OR STORAGE
OF PRODUCT
(18) 2021 01 20
(58) 2021 07 30
-

- (11) D 2016 689 S
(73) LTD "Kambechovani" (GE)
Chubinashvili St. 50, Tbilisi, Georgia (GE)
(54) **1.-2. PACKING BOX**
(18) 2021 01 22
(58) 2021 07 30
-

EXTENSION OF INTERNATIONAL DESIGNS REGISTRATION

- (11) DM/67833
(73) THE SWATCH GROUP MANAGEMENT SERVICES AG (THE SWATCH GROUP MANAGEMENT SERVICES SA) (THE SWATCH GROUP MANAGEMENT SERVICES LTD)
Seevorstadt 6, CH-2502 Biel/Bienne (CH)
(15) 2006 05 24
(24) 2006 05 24
(18) 2026 05 24
(28) 1
(28') 1
(54) Watch
-

- (11) DM/67994
(73) SWATCH AG (SWATCH SA) (SWATCH LTD.)
94, Rue Jakob Stämpfli, CH-2502 BIENNE (CH)
(15) 2006 07 13
(24) 2006 07 13
(18) 2026 07 13
(28) 1
(28') 1
(54) Wristwatch
-

- (11) DM/68182
(73) FERRERO S.P.A.
Piazzale Pietro Ferrero, 1, I-12051 Alba (Cuneo) (IT)
(15) 2006 06 20
(24) 2006 06 20
(18) 2026 06 20
(28) 1
-

(28') 1
(54) Decoration, particularly for packages

(11) DM/75560
(73) RORO GMBH - R. ROTT
Kalkgrub 1-2, 84427 Sankt Wolfgang (DE)
(15) 2011 02 28
(24) 2011 02 28
(18) 2026 02 28
(28) 4
(28') 4
(54) Pictorial instructions (printing matter)

(11) DM/76391
(73) THE SWATCH GROUP MANAGEMENT SERVICES AG (THE SWATCH GROUP MANAGEMENT SERVICES SA) (THE SWATCH GROUP MANAGEMENT SERVICES LTD.)
Seevorstadt 6, BIEL (CH)
(15) 2011 07 11
(24) 2011 07 11
(18) 2026 07 11
(28) 8
(28') 1
(54) Watch case, Watch cases, Watch case with bracelet, Watches, Wristwatch

(11) DM/76485
(73) SWATCH AG (SWATCH SA)(SWATCH LTD)
Jakob-Stämpfli-Strasse 94, CH-2502 Bienne (CH)
(15) 2011 07 27
(24) 2011 07 27
(18) 2026 07 27
(28) 10
(28') 10
(54) Watch movements, Wrist watches

(11) DM/91630
(73) VALENTINO S.P.A.
Via Turati, 16/18, I-20121 MILANO (EM)
(15) 2016 07 13
(24) 2016 07 13
(18) 2026 07 13
(28) 2
(28') 1
(54) Bags

(11) DM/91803
(73) DAMANDIS
70-74 Angle Rue de Ouled Ziane & Med Smiha, CASABLANCA (MA)
(15) 2016 04 26
(24) 2016 04 26
(18) 2026 04 26
(28) 8
(28') 8
(54) Designs for packages

(11) DM/91842
(73) HARRY WINSTON SA
Chemin du Tourbillon 8, CH-1228 Plan-les-Ouates (CH)
(15) 2016 07 26
(24) 2016 07 26
(18) 2026 07 26
(28) 2
(28') 2
(54) Earring, Necklace

(11) DM/92345
(73) YUDUM GIDA SANAYI VE TICARET ANONIM SIRKETI
Mete Plaza, Icerenkoy Mah. Bahcelerarasi Sok. K:23 No:43 Atasehir, ISTANBUL (TR)
(15) 2016 08 26
(24) 2016 08 26
(18) 2026 08 26
(28) 1
(28') 1
(54) Oil bottle

(11) DM/92347
(73) YUDUM GIDA SANAYI VE TICARET ANONIM SIRKETI
Mete Plaza, Icerenkoy Mah. Bahcelerarasi Sok. K:23 No:43 Atasehir, ISTANBUL (TR)
(15) 2016 08 26
(24) 2016 08 26
(18) 2026 08 26
(28) 1
(28') 1
(54) Oil bottle

(11) DM/93724
(73) VALENTINO S.P.A.
Via Turati, 16/18, I-20121 MILANO (EM)
(15) 2016 07 19
(24) 2016 07 19
(18) 2026 07 19
(28) 2
(28') 1
(54) Shoes

(11) DM/94459
(73) VALENTINO S.P.A.
Via Turati, 16/18, I-20121 Milano (EM)
(15) 2016 09 07
(24) 2016 09 07
(18) 2026 09 07
(28) 1
(28') 1
(54) Bag

CANCELLATION OF REGISTRATION OF INTERNATIONAL DESIGNS

(11) DM/67277
(73) DAIMLERCHRYSLER AG
Epplestrasse 225, 70567 Stuttgart (DE)
DATE OF CANCELLATION OF REGISTRATION: 2020 11 29
(58) 2021 07 19

(11) DM/67283
(73) DAIMLERCHRYSLER AG
Epplestrasse 225, 70567 Stuttgart (DE)
DATE OF CANCELLATION OF REGISTRATION: 2020 11 30
(58) 2021 07 19

(11) DM/67301
(73) DAIMLERCHRYSLER AG
Epplestrasse 225, 70567 Stuttgart (DE)
DATE OF CANCELLATION OF REGISTRATION: 2020 11 24
(58) 2021 07 19

(11) DM/67388
(73) VAN CLEEF & ARPELS LOGISTICS S.A
8, route de Chandolan, CH-1752 VILLARS-SUR-GLÂNE (CH)
DATE OF CANCELLATION OF REGISTRATION: 2020 10 26
(58) 2021 07 19

TRADEMARKS

RENEWAL OF REGISTRATIONS

(111) M 2001 14001 R2
(156) 2001 09 11
(186) 2031 09 11
(732) The Coca-Cola Company
One Coca-Cola Plaza, Atlanta,
Georgia 30313, USA

(111) M 2011 21468 R1
(156) 2011 05 16
(186) 2031 05 16
(732) LTD "Globalinvestment"
Berkuki St. 10/Almasiani St. 19/21,
0171, Tbilisi, Georgia

(111) M 2001 14090 R2
(156) 2001 10 18
(186) 2031 10 18
(732) Ratiopharm GmbH
Graf-Arco-Strasse 3, D-89079 Ulm, Germany

(111) M 2011 21306 R1
(156) 2011 03 24
(186) 2031 03 24
(732) LTD "W/M Investment"
Tashkenti St. 22, 0160, Tbilisi, Georgia

(111) M 2001 14091 R2
(156) 2001 10 18
(186) 2031 10 18
(732) Ratiopharm GmbH
Graf-Arco-Strasse 3, D-89079 Ulm, Germany

(111) M 2011 21522 R1
(156) 2011 05 27
(186) 2031 05 27
(732) LTD "Globalpharm"
King Tamar Ave. 7/13, 0112, Tbilisi, Georgia

(111) M 2001 14093 R2
(156) 2001 10 18
(186) 2031 10 18
(732) Ratiopharm GmbH
Graf-Arco-Strasse 3, D-89079 Ulm, Germany

(111) M 2011 21526 R1
(156) 2011 05 27
(186) 2031 05 27
(732) LTD "Globalpharm"
King Tamar Ave. 7/13, 0112, Tbilisi, Georgia

(111) M 2001 14066 R2
(156) 2001 10 18
(186) 2031 10 18
(732) Pfizer Products Inc.
a Connecticut Corporation
Eastern Point Road, Groton, Connecticut
06340, USA

(111) M 2011 21580 R1
(156) 2011 06 27
(186) 2031 06 27
(732) King Point Enterprise Co., LTD
15FL.-6, No.110, San Duo 4th Road,
Ling Ya Dist., Koahsiung City, Taiwan, China

(111) M 2011 21659 R1
(156) 2011 07 22
(186) 2031 07 22
(732) LTD "Pharmacy House"
Tashkenti St. 22, 0160, Tbilisi, Georgia

(111) M 2011 21643 R1
(156) 2011 07 22
(186) 2031 07 22
(732) LTD "Capitalclub"
Kakheti Highway 110a, 0198, Tbilisi, Georgia

(111) M 2011 21670 R1
(156) 2011 08 04
(186) 2031 08 04
(732) Solar Turbines Incorporated
2200 Pacific Highway, San Diego,
California 92101, USA

(111) M 2011 21644 R1
(156) 2011 07 22
(186) 2031 07 22
(732) LTD "Capitalclub"
Kakheti Highway 110a, 0198, Tbilisi, Georgia

(111) M 2011 21620 R1 (156) 2011 07 13 (186) 2031 07 13 (732) Diageo Scotland Limited Edinburgh Park, 5 Lochsidw Way, Edinburgh, EH12 9DT Scotland, United Kingdom	Rue Louis-d'Affry 6, CH-1701 Fribourg, Switzerland
<hr/>	
(111) M 2011 21553 R1 (156) 2011 06 14 (186) 2031 06 14 (732) JSC "Kievmedpreparat" Ul. Saksaganskogo 139, 01032, Kiev, Ukraine	(111) M 2011 22020 R1 (156) 2011 11 30 (186) 2031 11 30 (732) LTD "G-M-P" Vill. Ponitchala 65, 0165, Tbilisi, Georgia
<hr/>	
(111) M 2011 21582 R1 (156) 2011 06 27 (186) 2031 06 27 (732) Seven for All Mankind International SAGL Via Penate 4, 6850 Mendrisio, Switzerland	(111) M 2011 22021 R1 (156) 2011 11 30 (186) 2031 11 30 (732) LTD "G-M-P" Vill. Ponitchala 65, 0165, Tbilisi, Georgia
<hr/>	
(111) M 2011 21583 R1 (156) 2011 06 27 (186) 2031 06 27 (732) Seven for All Mankind International SAGL Via Penate 4, 6850 Mendrisio, Switzerland	(111) M 2011 22022 R1 (156) 2011 11 30 (186) 2031 11 30 (732) LTD "G-M-P" Vill. Ponitchala 65, 0165, Tbilisi, Georgia
<hr/>	
(111) M 2011 21583 R1 (156) 2011 06 27 (186) 2031 06 27 (732) Seven for All Mankind International SAGL Via Penate 4, 6850 Mendrisio, Switzerland	(111) M 2011 22023 R1 (156) 2011 11 30 (186) 2031 11 30 (732) LTD "G-M-P" Vill. Ponitchala 65, 0165, Tbilisi, Georgia
<hr/>	
(111) M 2011 21717 R1 (156) 2011 08 23 (186) 2031 08 23 (732) Burger King Corporation 5505 Blue Lagoon Drive, Miami, Florida 33126, USA	(111) M 2011 22024 R1 (156) 2011 11 30 (186) 2031 11 30 (732) LTD "G-M-P" Vill. Ponitchala 65, 0165, Tbilisi, Georgia
<hr/>	
(111) M 2011 21652 R1 (156) 2011 07 22 (186) 2031 07 22 (732) LTD "New Light" Al. Kazbegi Ave. 25a, 0160, Tbilisi, Georgia	(111) M 2011 21981 R1 (156) 2011 11 17 (186) 2031 11 17 (732) LTD "G-M-P" Vill. Ponitchala 65, 0165, Tbilisi, Georgia
<hr/>	
(111) M 2011 21770 R1 (156) 2011 09 16 (186) 2031 09 16 (732) Nufarm GmbH & Co. KG St.- Peter - Strasse 25 Linz A-4021, Austria	(111) M 2011 22084 R1 (156) 2011 12 14 (186) 2031 12 14 (732) Rum Creation & Products Inc. P.O. Box 3152, Road Town, Tórtola, Virgin Islands (British)
<hr/>	
(111) M 2011 21826 R1 (156) 2011 09 29 (186) 2031 09 29 (732) Alcon Inc.	(111) M 2011 22085 R1 (156) 2011 12 14 (186) 2031 12 14 (732) Rum Creation & Products Inc.

P.O. Box 3152, Road Town, Tórtola,
Virgin Islands (British)

(111) M 2011 22102 R1
(156) 2011 12 14
(186) 2031 12 14
(732) Marriott Worldwide Corporation
a Maryland Corporation
10400 Fernwood Road, Bethesda,
Maryland 20817, USA

(111) M 2011 22103 R1
(156) 2011 12 14
(186) 2031 12 14
(732) Marriott Worldwide Corporation
a Maryland Corporation
10400 Fernwood Road, Bethesda,
Maryland 20817, USA

(111) M 2011 22179 R1
(156) 2011 12 29
(186) 2031 12 29
(732) LTD "Maknatuna"
Gugunava St. 13 (plot №4-3/2), 4600, Kutaisi,
Georgia

(111) M 2012 22418 R1
(156) 2012 03 16
(186) 2032 03 16
(732) LTD "Askaneli Brothers"
Kakheti Highway 110a, 0198, Tbilisi, Georgia

(111) M 2012 22655 R1
(156) 2012 06 01
(186) 2032 06 01
(732) "Georgian Beer Company"
Vill. Saguramo, 3311, Mtskheta District,
Georgia

(111) M 2012 22753 R1
(156) 2012 07 06
(186) 2032 07 06
(732) LTD "Georgian Wines & Spirits Company"
Vill. Achinebuli, 2200, Telavi, Georgia

COMPLETE TRANSFER OF RIGHTS

(111) M 2020 33410 R
(732) LTD "Kate Development"
S. Tsintsadze St. 12, Space 3-6, 0160,
Vake-Saburtalo District, Tbilisi, Georgia
(770) LTD "Kakhetian Traditional Winery"
S. Tsintsadze St. 12, 3rd floor,
Non-residential area 3-6, 0160, Tbilisi
Georgia
(580) 2021 07 19

(111) M 1998 8343 R
(732) Kookai Enterprises UK Limited
28 Church Road, Stanmore, Middlesex,
HA7 4XR, United Kingdom
(770) Kookai Sas
89 Rue Du Faubourg, Saint Denis, 75010,
France
(580) 2021 07 20

(111) M 2010 20233 R
(732) LTD "Guramishvili Cellar"
Saguramo, Block 064, plot 054, Mtskheta
District, Georgia
(770) LTD "Kakhetian Traditional Winery"
Ksani St. 12, 0141, Tbilisi, Georgia
(580) 2021 07 20

(111) M 2009 20112 R
(732) LTD "Vartsikhe Group"
Paliashvili St. 64, Vake-Saburtalo District,
Tbilisi, Georgia
(770) LTD "Kakhetian Traditional Winery"
Ksani St. 12, 0141, Tbilisi, Georgia
(580) 2021 07 28

(111) M 2010 20880 R
(732) LTD "Vartsikhe Group"
Paliashvili St. 64, Vake-Saburtalo District,
Tbilisi, Georgia
(770) LTD "Kakhetian Traditional Winery"
Ksani St. 12, 0141, Tbilisi, Georgia
(580) 2021 07 19

(111) M 2013 23486 R
(732) LTD "Guramishvili Cellar"
Saguramo, Block 064, plot 054, Mtskheta
District, Georgia
(770) LTD "Kakhetian Traditional Winery"
Ksani St. 12, 0141, Tbilisi, Georgia
(580) 2021 07 20

(111) M 2013 24265 R
(732) LTD "Vartsikhe Group"
Paliashvili St. 64, Vake-Saburtalo District,
Tbilisi, Georgia
(770) LTD "Kakhetian Traditional Winery"
Ksani St. 12, 0192, Tbilisi, Georgia
(580) 2021 07 19

(111) M 2013 24266 R
(732) LTD "Vartsikhe Group"
Paliashvili St. 64, Vake-Saburtalo District,
Tbilisi, Georgia
(770) LTD "Kakhetian Traditional Winery"
Ksani St. 12, 0141, Tbilisi, Georgia
(580) 2021 07 19

(111) M 2014 25451 R
(732) LTD "Royal Askana"
Vill. Askana, Ozurgeti, Georgia
(770) LTD "Kakhetian Traditional Winery"
Ksani St. 12, 0141, Tbilisi, Georgia
(580) 2021 07 19

(111) M 2014 25447 R
(732) LTD "Keda Wine Factory"
Tsereteli St. 4, Vill. Keda, Keda District,
Georgia
(770) LTD "Kakhetian Traditional Winery"
Ksani St. 12, 0141, Tbilisi, Georgia
(580) 2021 07 19

(111) M 2016 27482 R
(732) LTD "Vartsikhe Group"
Paliashvili St. 64, Vake-Saburtalo District,
Tbilisi, Georgia
(770) LTD "Kakhetian Traditional Winery"
S. Tsintsadze St. 12, 0160, Tbilisi, Georgia
(580) 2021 07 19

(111) M 2016 27018 R
(732) LTD "Georgian Wine Bank"
Sulkhan Tsintsadze St. 12, Non-residential
area 3-6, Saburtalo District, Georgia
(770) LTD "Kakhetian Traditional Winery"
S. Tsintsadze St. 12, 0160, Tbilisi, Georgia
(580) 2021 07 19

(111) M 2015 26614 R
(732) LTD "Guramishvili Cellar"
Saguramo, Block 064, plot 054, Mtskheta
District, Georgia
(770) LTD "Kakhetian Traditional Winery"
S. Tsintsadze St. 12, 3rd floor,
Non-residential area 3-6, 0160, Tbilisi,
Georgia
(580) 2021 07 20

(111) M 2017 28462 R
(732) LTD "Georgian Wine Bank"
Sulkhan Tsintsadze St. 12, Non-residential
area 3-6, Saburtalo District, Georgia
(770) LTD "Kakhetian Traditional Winery"
S. Tsintsadze St. 12, 3rd floor,
Non-residential area 3-6, 0160, Tbilisi,
Georgia
(580) 2021 07 19

(111) M 2016 27026 R
(732) LTD "Guramishvili Cellar"
Saguramo, block 064, plot 054, Mtskheta
District, Georgia
(770) LTD "Kakhetian Traditional Winery"
S. Tsintsadze St. 12, 0160, Tbilisi, Georgia
(580) 2021 07 20

(111) M 2018 30466 R
(732) LTD "Kateve Turs"
S. Tsintsadze St. 12, 0160, Vake-Saburtalo
District, Tbilisi, Georgia
LTD "Kateve Turs"
(770) LTD "Kakhetian Traditional Winery"
S. Tsintsadze St. 12, 3rd floor,
Non-residential area 3-6, 0160, Tbilisi,
Georgia
(580) 2021 07 19

CHANGE OF NAME AND/OR ADDRESS OF OWNER

(111) M 1998 8343 R
(732) Kookai Sas
89 Rue Du Faubourg, Saint Denis, 75010,
France
(770) Kookai Sas
6-10 Boulevard Fosh, 93800 Epinay-sur-
seine, France
(580) 2021 07 20

CANCELLATION OF TRADEMARKS REGISTRATION

(111) M 2011 21055 R
(151) 2011 01 17
(732) LTD "Nomad Agriculture and Green House"
Vill. Tsinsvla, 6417, Khelvachauri District,
Georgia
(141) 2021 07 27

(111) M 2011 21056 R
(151) 2011 01 17
(732) LTD "Nomad Agriculture and Green House"
Vill. Tsinsvla, 6417, Khelvachauri District,
Georgia
(141) 2021 07 27

(111) M 2011 21057 R
(151) 2011 01 17
(732) LTD "Nomad Agriculture and Green House"
Vill. Tsinsvla, 6417, Khelvachauri District,
Georgia
(141) 2021 07 27

(111) M 2011 21058 R
(151) 2011 01 17
(732) Lasha Babuadze
Zazishvili St. 43, 0101, Tbilisi, Georgia
(141) 2021 07 27

(111) M 2011 21059 R
(151) 2011 01 17
(732) Grand Candy LLC
31 Masis St., 0061, Yerevan, Armenia
(141) 2021 07 27

(111) M 2011 21060 R
(151) 2011 01 17
(732) Kyowa Kirin Co., LTD
1-9-2, Otemachi, Chiyoda-ku, Tokyo, Japan
(141) 2021 07 27

(111) M 2011 21066 R
(151) 2011 01 17
(732) LTD "Rehki"
Tevdore Mghvdeli St. 26, 0154, Tbilisi,
Georgia
(141) 2021 07 27

(111) M 2011 21069 R
(151) 2011 01 17
(732) ImClone LLC
180 Varick Street, New York, New Yor,
10014, USA
(141) 2021 07 27

(111) M 2011 21070 R
(151) 2011 01 17
(732) ImClone LLC
180 Varick Street, New York, New Yor,
10014, USA
(141) 2021 07 27

(111) M 2011 21071 R
(151) 2011 01 17
(732) ImClone LLC
180 Varick Street, New York, New Yor,
10014, USA
(141) 2021 07 27

(111) M 2011 21072 R
(151) 2011 01 17
(732) LTD "Aversi-Pharma"
Davit Aghmashenebeli Av. 148/2, 0112,
Tbilisi, Georgia
(141) 2021 07 27

(111) M 2011 21054 R
(151) 2011 01 13
(732) Dotchirne pidpriemstvo "Konditerska
Korporatzia "Roshen"
Vul. Elektrikov 26/9, 04176, Kyiv, Ukraine
(141) 2021 07 21

(111) M 2011 21073 R
(151) 2011 01 17
(732) LTD "Aversi-Pharma"
Davit Aghmashenebeli Av. 148/2, 0112,
Tbilisi, Georgia
(141) 2021 07 27

(111) M 2011 21074 R
(151) 2011 01 17
(732) LTD "Aversi-Pharma"
Davit Aghmashenebeli Av. 148/2, 0112,
Tbilisi, Georgia
(141) 2021 07 27

(111) M 2011 21075 R
(151) 2011 01 17
(732) LTD "Aversi-Pharma"
Davit Aghmashenebeli Av. 148/2, 0112,
Tbilisi, Georgia
(141) 2021 07 27

(111) M 2011 21076 R
(151) 2011 01 17
(732) JSC "Grindeks"
53, Krustpils Street, 1057 Riga , Latvia
(141) 2021 07 27

(111) M 2011 21077 R
(151) 2011 01 17
(732) LTD "Aversi-Pharma"
Davit Aghmashenebeli Av. 148/2, 0112,
Tbilisi, Georgia
(141) 2021 07 27

(111) M 2011 21053 R
(151) 2011 01 12
(732) Karen Grant's son Vardanian
Bairon St. 3, app. 36, Yerevan, Armenia
(141) 2021 07 20

CLASSIFICATION INDEXES

INVENTIONS

CONCORDANCE TABLE OF INTERNATIONAL CLASSIFICATION INDEX AND PUBLICATION NUMBERS

INTERNATIONAL CLASSIFICATION INDEXES (51)	NUMBER OF PUBLISHED APPLICATION (10)
A 23 C 1/00; A 23 C 21/06; C 13 K 5/00	AP 2021 15471 A
A 23 C 21/00	AP 2021 15514 A
A 61 K 9/06; A 61 K 9/00; A 61 K 31/192; A 61 K 47/40	AP 2021 15367 A
A 61 K 31/27; A 61 K 31/438; A 61 K 31/435; C 07 D 403/04; C 07 D 295/205; C 07 D 471/10	AP 2021 15281 A
A 61 K 31/519; C 07 D 403/12; C 07 D 451/04; C 07 D 451/14	AP 2021 15340 A
A 61 K 31/4375; A 61 P 13/00; A 61 P 9/00; C 07 D 471 04; C 07 D 491 107	AP 2021 15045 A
A 61 K 31/7072; A 61 K 31/7068; A 61 K 31/4188; A 61 P 25/02; A 61 P 25/24; A 61 P 25/28	AP 2021 15251 A
A 61 K 39/395; C 07 K 16/46; C 07 K 16/30; C 07 K 16/28	AP 2021 14828 A
F 41 H 1/02	AP 2021 14161 A
G 01 J 3/00	AP 2021 15403 A
G 01 J 3/00	AP 2021 15404 A

CONCORDANCE TABLE OF PUBLICATION NUMBERS AND INTERNATIONAL CLASSIFICATION INDEX

NUMBER OF PUBLISHED APPLICATION (10)	INTERNATIONAL CLASSIFICATION INDEXES (51)
AP 2021 14161 A	F 41 H 1/02
AP 2021 14828 A	A 61 K 39/395; C 07 K 16/46; C 07 K 16/30; C 07 K 16/28
AP 2021 15045 A	A 61 K 31/4375; A 61 P 13/00; A 61 P 9/00; C 07 D 471 04; C 07 D 491 107
AP 2021 15251 A	A 61 K 31/7072; A 61 K 31/7068; A 61 K 31/4188; A 61 P 25/02; A 61 P 25/24; A 61 P 25/28
AP 2021 15281 A	A 61 K 31/27; A 61 K 31/438; A 61 K 31/435; C 07 D 403/04; C 07 D 295/205; C 07 D 471/10
AP 2021 15340 A	A 61 K 31/519; C 07 D 403/12; C 07 D 451/04; C 07 D 451/14
AP 2021 15367 A	A 61 K 9/06; A 61 K 9/00; A 61 K 31/192; A 61 K 47/40
AP 2021 15403 A	G 01 J 3/00
AP 2021 15404 A	G 01 J 3/00
AP 2021 15471 A	A 23 C 1/00; A 23 C 21/06; C 13 K 5/00
AP 2021 15514 A	A 23 C 21/00

**CONCORDANCE TABLE OF INTERNATIONAL CLASSIFICATION INDEX,
PATENT NUMBERS AND PUBLICATION NUMBERS**

INTERNATIONAL CLASSIFICATION INDEX (51)	NUMBER OF PATENT (11)	NUMBER OF PUBLISHED APPLICATION (10)
A 61 K 31/424; A 61 K 31/385; A 61 K 31/381; A 61 P 35/00; C 07 D 409/12; C 07 D 498/04; C 07 D 333/60	P 2021 7285 B	AP 2021 15066 A
A 61 K 31/436; A 61 P 25/00; C 07 D 491/18; C 07 D 491/04	P 2021 7279 B	AP 2021 15310 A
A 61 K 31/501; A 61 P 35/00; C 07 D 413/04; C 07 D 409/04; C 07 D 237/24; C 07 D 237/04; C 07 D 417/14; C 07 D 401/04; C 07 D 405/14; C 07 D 401/14; C 07 D 403/04; C 07 D 417/04	P 2021 7281 B	AP 2021 15183 A
A 61 K 31/7076; C 07 H 19/16	P 2021 7282 B	AP 2021 14600 A
B 60 P 3/41; B 60 P 3/40	P 2021 7283 B	AP 2021 15272 A
B 61 H 1/00; F 16 D 69/02; F 16 D 65/04	P 2021 7280 B	AP 2021 15349 A
E 04 B 5/32	P 2021 7284 B	AP 2021 15054 A

**CONCORDANCE TABLE OF PATENT NUMBERS,
PUBLICATION NUMBERS AND INTERNATIONAL CLASSIFICATION INDEX**

NUMBER OF PATENT (11)	NUMBER OF PUBLISHED APPLICATION (10)	INTERNATIONAL CLASSIFICATION INDEX (51)
P 2021 7279 B	AP 2021 15310 A	A 61 K 31/436; A 61 P 25/00; C 07 D 491/18; C 07 D 491/04
P 2021 7280 B	AP 2021 15349 A	B 61 H 1/00; F 16 D 69/02; F 16 D 65/04
P 2021 7281 B	AP 2021 15183 A	A 61 K 31/501; A 61 P 35/00; C 07 D 413/04; C 07 D 409/04; C 07 D 237/24; C 07 D 237/04; C 07 D 417/14; C 07 D 401/04; C 07 D 405/14; C 07 D 401/14; C 07 D 403/04; C 07 D 417/04
P 2021 7282 B	AP 2021 14600 A	A 61 K 31/7076; C 07 H 19/16
P 2021 7283 B	AP 2021 15272 A	B 60 P 3/41; B 60 P 3/40
P 2021 7284 B	AP 2021 15054 A	E 04 B 5/32
P 2021 7285 B	AP 2021 15066 A	A 61 K 31/424; A 61 K 31/385; A 61 K 31/381; A 61 P 35/00; C 07 D 409/12; C 07 D 498/04; C 07 D 333/60

**CONCORDANCE TABLE OF APPLICATION NUMBERS,
PUBLICATION NUMBERS AND PATENTS**

NUMBER OF APPLICATION (21)	NUMBER OF PUBLISHED APPLICATION (10)	NUMBER OF PATENT (11)
AP 2016 14600	AP 2021 14600 A	P 2021 7282 B
AP 2017 15054	AP 2021 15054 A	P 2021 7284 B
AP 2017 15066	AP 2021 15066 A	P 2021 7285 B
AP 2018 15183	AP 2021 15183 A	P 2021 7281 B
AP 2020 15272	AP 2021 15272 A	P 2021 7283 B
AP 2017 15310	AP 2021 15310 A	P 2021 7279 B
AP 2018 15349	AP 2021 15349 A	P 2021 7280 B

UTILITY MODEL

**CONCORDANCE TABLE OF INTERNATIONAL CLASSIFICATION INDEX,
PATENT NUMBERS AND PUBLICATION NUMBERS**

INTERNATIONAL CLASSIFICATION INDEX (51)	NUMBER OF PATENT (11)	NUMBER OF PUBLISHED APPLICATION (10)
A 21 C 9/06	U 2021 2093 Y	AU 2021 15553 U

**CONCORDANCE TABLE OF PATENT NUMBERS,
PUBLICATION NUMBERS AND INTERNATIONAL CLASSIFICATION INDEX**

NUMBER OF PATENT (11)	NUMBER OF PUBLISHED APPLICATION (10)	INTERNATIONAL CLASSIFICATION INDEX (51)
U 2021 2093 Y	AU 2021 15553 U	A 21 C 9/06

**CONCORDANCE TABLE OF APPLICATION NUMBERS,
PUBLICATION NUMBERS AND PATENTS**

NUMBER OF APPLICATION (21)	NUMBER OF PUBLISHED APPLICATION (10)	NUMBER OF PATENT (11)
AU 2021 15553	AU 2021 15553 U	U 2021 2093 Y

DESIGNS**CONCORDANCE TABLE OF INTERNATIONAL CLASSIFICATION INDEX,
NUMBERS OF REGISTRATION AND PUBLICATION NUMBERS**

INTERNATIONAL CLASSIFICATION INDEX (51)	NUMBER OF REGISTRATION (11)	NUMBER OF PUBLISHED APPLICATION (10)
09-03	D 2021 900 S	AD 2021 1191 S
29-02	D 2021 901 S	AD 2021 1192 S

**CONCORDANCE TABLE OF NUMBERS OF REGISTRATION,
PUBLICATION NUMBERS AND INTERNATIONAL CLASSIFICATION INDEX**

NUMBER OF REGISTRATION (11)	NUMBER OF PUBLISHED APPLICATION (10)	INTERNATIONAL CLASSIFICATION INDEX (51)
D 2021 900 S	AD 2021 1191 S	09-03
D 2021 901 S	AD 2021 1192 S	29-02

**CONCORDANCE TABLE OF APPLICATION NUMBERS,
PUBLICATION NUMBERS AND NUMBERS OF REGISTRATION**

NUMBER OF APPLICATION (21)	NUMBER OF PUBLISHED APPLICATION (10)	NUMBER OF REGISTRATION (11)
AD 2020 1191	AD 2021 1191 S	D 2021 900 S
AD 2020 1192	AD 2021 1192 S	D 2021 901 S

**DESIGN REGISTERED ACCORDING TO THE ACCELERATED
PROCEDURE**CONCORDANCE TABLE OF INTERNATIONAL CLASSIFICATION INDEXES
AND NUMBERS OF REGISTRATION

INTERNATIONAL CLASSIFICATION INDEXES (51)	NUMBER OF REGISTRATION (11)
03-01	D 2021 902 S

CONCORDANCE TABLE OF NUMBERS OF REGISTRATION
AND INTERNATIONAL CLASSIFICATION INDEXES

NUMBER OF REGISTRATION (11)	INTERNATIONAL CLASSIFICATION INDEXES (51)
D 2021 902 S	03-01

CONCORDANCE TABLE OF NUMBERS OF PUBLICATION AND NUMBERS
OF REGISTRATION

NUMBER OF PUBLISHED APPLICATION (21)	NUMBER OF REGISTRATION (11)
AD 2021 1223	D 2021 902 S

TRADEMARKS

CONCORDANCE TABLE OF REGISTRATION NUMBERS, APPLICATION NUMBERS, PUBLICATION NUMBERS AND BULLETIN NUMBERS

NUMBER OF REGISTRATION (111)	NUMBER OF APPLICATIONS (210)	NUMBER OF PUBLISHED APPLICATIONS (260)	NUMBER OF BULLETIN
M 2021 34330 R	AM 113776	–	14(570)2021
M 2021 34331 R	AM 113887	–	14(570)2021
M 2021 34332 R	AM 113880	–	14(570)2021
M 2021 34333 R	AM 113988	–	14(570)2021
M 2021 34334 R	AM 113871	–	14(570)2021
M 2021 34335 R	AM 113768	–	14(570)2021
M 2021 34336 R	AM 113851	–	14(570)2021
M 2021 34337 R	AM 113712	–	14(570)2021
M 2021 34338 R	AM 113855	–	14(570)2021
M 2021 34339 R	AM 113859	–	14(570)2021
M 2021 34340 R	AM 113993	–	14(570)2021
M 2021 34341 R	AM 113775	–	14(570)2021
M 2021 34342 R	AM 114036	–	14(570)2021
M 2021 34343 R	AM 113969	–	14(570)2021
M 2021 34344 R	AM 113982	–	14(570)2021
M 2021 34345 R	AM 113977	–	14(570)2021
M 2021 34346 R	AM 114028	–	14(570)2021
M 2021 34347 R	AM 114031	–	14(570)2021
M 2021 34348 R	AM 114032	–	14(570)2021

CONCORDANCE TABLE OF PUBLICATION NUMBERS
AND APPLICATION NUMBERS

NUMBER OF PUBLISHED APPLICATION (260)	NUMBER OF APPLICATION (210)
AM 2021 110044 A	AM 110044
AM 2021 110358 A	AM 110358
AM 2021 110376 A	AM 110376
AM 2021 110680 A	AM 110680
AM 2021 110750 A	AM 110750
AM 2021 110766 A	AM 110766
AM 2021 110781 A	AM 110781
AM 2021 110797 A	AM 110797
AM 2021 110870 A	AM 110870
AM 2021 110875 A	AM 110875
AM 2021 110941 A	AM 110941
AM 2021 110949 A	AM 110949
AM 2021 110977 A	AM 110977
AM 2021 110980 A	AM 110980
AM 2021 110981 A	AM 110981
AM 2021 111060 A	AM 111060
AM 2021 111061 A	AM 111061
AM 2021 111063 A	AM 111063
AM 2021 111067 A	AM 111067
AM 2021 111068 A	AM 111068
AM 2021 111070 A	AM 111070
AM 2021 111071 A	AM 111071
AM 2021 111072 A	AM 111072
AM 2021 111083 A	AM 111083
AM 2021 111090 A	AM 111090
AM 2021 111091 A	AM 111091
AM 2021 111152 A	AM 111152
AM 2021 111157 A	AM 111157
AM 2021 111158 A	AM 111158
AM 2021 111267 A	AM 111267
AM 2021 111268 A	AM 111268
AM 2021 111269 A	AM 111269
AM 2021 111271 A	AM 111271
AM 2021 111273 A	AM 111273
AM 2021 111274 A	AM 111274
AM 2021 111275 A	AM 111275
AM 2021 111283 A	AM 111283
AM 2021 111317 A	AM 111317
AM 2021 111318 A	AM 111318
AM 2021 111319 A	AM 111319
AM 2021 111322 A	AM 111322
AM 2021 111323 A	AM 111323
AM 2021 111325 A	AM 111325
AM 2021 111326 A	AM 111326
AM 2021 111333 A	AM 111333
AM 2021 111335 A	AM 111335
AM 2021 111410 A	AM 111410
AM 2021 111449 A	AM 111449
AM 2021 112594 A	AM 112594

CONCORDANCE TABLE OF INDEX OF GOODS AND/OR SERVICES
AND APPLICATION NUMBERS

INDEX OF GOODS AND/OR SERVICES (511)	NUMBER OF PUBLISHED APPLICATIONS (260)	1	2
1	2		
1	AM 2021 111158 A	34	AM 2021 110941 A
3	AM 2021 110980 A	34	AM 2021 111060 A
3	AM 2021 111090 A	34	AM 2021 111061 A
3	AM 2021 111091 A	34	AM 2021 111063 A
5	AM 2021 110797 A	34	AM 2021 111335 A
5	AM 2021 110875 A	35	AM 2021 110044 A
5	AM 2021 110980 A	35	AM 2021 110376 A
5	AM 2021 111157 A	35	AM 2021 110766 A
5	AM 2021 111158 A	35	AM 2021 110949 A
5	AM 2021 111323 A	35	AM 2021 110977 A
7	AM 2021 111158 A	35	AM 2021 111090 A
8	AM 2021 110870 A	35	AM 2021 111091 A
9	AM 2021 111267 A	35	AM 2021 111152 A
9	AM 2021 111273 A	35	AM 2021 111158 A
9	AM 2021 111274 A	35	AM 2021 111322 A
9	AM 2021 111275 A	35	AM 2021 111325 A
9	AM 2021 111283 A	35	AM 2021 111326 A
9	AM 2021 111317 A	35	AM 2021 111410 A
12	AM 2021 111283 A	35	AM 2021 111449 A
12	AM 2021 111317 A	35	AM 2021 112594 A
16	AM 2021 110870 A	36	AM 2021 110977 A
18	AM 2021 111268 A	36	AM 2021 111267 A
25	AM 2021 110949 A	36	AM 2021 111322 A
25	AM 2021 111269 A	36	AM 2021 112594 A
25	AM 2021 111283 A	37	AM 2021 111322 A
25	AM 2021 111317 A	37	AM 2021 111325 A
28	AM 2021 110870 A	37	AM 2021 112594 A
29	AM 2021 110358 A	38	AM 2021 111322 A
29	AM 2021 110766 A	38	AM 2021 112594 A
30	AM 2021 110766 A	39	AM 2021 110766 A
31	AM 2021 110766 A	39	AM 2021 111152 A
32	AM 2021 110766 A	39	AM 2021 111322 A
32	AM 2021 111152 A	39	AM 2021 111333 A
32	AM 2021 111271 A	39	AM 2021 112594 A
32	AM 2021 111318 A	40	AM 2021 111322 A
32	AM 2021 111319 A	40	AM 2021 112594 A
33	AM 2021 110358 A	41	AM 2021 110766 A
33	AM 2021 110376 A	41	AM 2021 110981 A
33	AM 2021 110680 A	41	AM 2021 111067 A
33	AM 2021 111083 A	41	AM 2021 111273 A
33	AM 2021 111152 A	41	AM 2021 111274 A
33	AM 2021 111318 A	41	AM 2021 111275 A
33	AM 2021 111319 A	42	AM 2021 111067 A
33	AM 2021 111449 A	42	AM 2021 111267 A
		43	AM 2021 110781 A
		43	AM 2021 111068 A
		43	AM 2021 111070 A
		43	AM 2021 111071 A

1	2
43	AM 2021 111072 A
44	AM 2021 111067 A
44	AM 2021 111090 A
44	AM 2021 111091 A
44	AM 2021 111158 A

1	2
44	AM 2021 111268 A
45	AM 2021 110750 A
45	AM 2021 110977 A
45	AM 2021 111326 A

CONCORDANCE TABLE OF INDEX OF GOODS AND/OR SERVICES
AND NUMBERS OF TRADEMARKS REGISTERED ACCORDING
TO THE ACCELERATED PROCEDURE

INDEX OF GOODS AND/OR SERVICES (511)	NUMBERS OF REGISTERED ACCORDING TO THE ACCELERATED PROCEDURE (111)
1	M 2021 34345 R
2	M 2021 34345 R
3	M 2021 34332 R
5	M 2021 34342 R
6	M 2021 34337 R
12	M 2021 34346 R
14	M 2021 34335 R
29	M 2021 34333 R
30	M 2021 34334 R
30	M 2021 34340 R
32	M 2021 34330 R
32	M 2021 34336 R
32	M 2021 34341 R
33	M 2021 34339 R
33	M 2021 34343 R
33	M 2021 34344 R
34	M 2021 34347 R
34	M 2021 34348 R
35	M 2021 34342 R
36	M 2021 34331 R
43	M 2021 34338 R

OFFICIAL BULLETIN OF THE INDUSTRIAL PROPERTY

**INVENTIONS
UTILITY MODELS
DESIGNS
TRADEMARKS**

14(570)

EDITOR-IN-CHIEF: N. Bebrishvili

EDITOR-TRANSLATOR: E. Gabunia

PROOFREADER: A. Shikhashvili

COMPUTER LAYOUT: M. Ordenidze

www.sakpatenti.gov.ge

E-mail: info@sakpatenti.org.ge