



**NATIONAL INTELLECTUAL PROPERTY CENTER OF GEORGIA
SAKPATENTI**

**OFFICIAL BULLETIN
OF THE INDUSTRIAL PROPERTY**

15(499)

**2018
TBILISI**

INID CODES FOR IDENTIFICATION OF BIBLIOGRAPHIC DATA

INVENTIONS, UTILITY MODELS

- (10) Number of publication for application, which has been examined
- (11) Number of patent and kind of document
- (21) Serial number of application
- (22) Date of filing of the application
- (23) Date of exhibition or the date of the earlier filing and the number of application, if any
- (24) Date from which patent may have effect
- (31) Number of priority application
- (32) Date of filing of priority application
- (33) Code of the country or regional organization allotting priority application number
- (44) Date of publication of application not granted, but examined and number of bulletin
- (45) Date of publication of registered document
- (51) International Patent Classification Index
- (54) Title of the invention
- (57) Abstract
- (60) Number of examined patent document granted by foreign patent office, date from which patent has effect and country code
- (62) Number of the earlier application and in case of divided application, date of filing an application
- (71) Name, surname and address of applicant (country code)
- (72) Name, surname of inventor (country code)
- (73) Name, surname and address of patent owner (country code)
- (74) Name, surname of representative or patent attorney
- (85) Date of commencement of the national phase of International Application
- (86) Number and date of filing of international application
- (87) Number and date of publication of international application

DESIGNS

- (10) Number of publication for application
- (11) Number of patent and kind of document or number of registration
- (15) Date of registration/Date of patent renewal
- (18) Expected expiration date of patent or registration
- (21) Serial number of application
- (22) Date of filing of the application
- (23) Date of exhibition or the date of the earlier filing and the number of application, if any
- (24) Date from which patent may have effect
- (28) Number of designs included in the application
- (30) Data relating to priority (number of application, date of filing of application, two-letter code identifying the authority with whom the priority application was made)
- (31) Number of priority application
- (32) Date of filing of priority application
- (33) Code of the country or regional organization allotting priority application number
- (34) Two-letter code according to WIPO St.3 identifying the authority with which the priority application was made
- (44) Date of publication of design and number of bulletin (the first publication)
- (45) Date of publication of design registered by WIPO and number of bulletin
- (51) International Classification for designs (class and subclass of the Locarno Classification)
- (54) Title of the invention
- (55) Reproduction of the design
- (57) Description of characteristic features of the design including indication of colors
- (58) Date of recording of any kind of amendment in the Register
- (62) Number of the earlier application, registration and document number and if available the date of filing an application in case of divided application
- (71) Name, surname and address of applicant (country code)
- (72) Name, surname of creator (country code)
- (73) Name, surname and address of patent owner (country code)
- (74) Name, surname of representative or patent attorney
- (81) Contracting states concerned
 - II designated contracting states according to the 1960 Act
 - III designated contracting states according to the 1999 Act
- (85) Owner's permanent address
- (86) Owner's nationality
- (87) Owner's residence
- (88) State in which the owner has a real and effective industrial or commercial establishment

TRADEMARKS

- (111) – Number of registration
- (151) – Date of registration
- (156) – Date of the renewal
- (181) – Expected expiration date of registration
- (186) – Renewal expiration date of registration
- (141) – Date of cancel of duration of the mark
- (210) – Serial number of application
- (220) – Date of filing of the application
- (230) – Date concerning exhibition
- (260) – Number of application, for which favorable decision of examination about registration has been taken (publication number)
- (310) – Number of the first application
- (320) – Date of filing of the first application
- (330) – Code, identifying national or regional Office where the first application was made
- (511) – International Classification of Goods and Services for the purposes of registration of trade marks and/or list of goods and/or services classified according thereto
- (531) – Description of figurative elements of Trade Marks according to the International Classification of the Figurative Elements of Marks
- (540) – Reproduction of Trade Mark
- (550) – Nature and kind of Trade Mark
- (580) – Date of recording of any kind changes in respect of applications or registrations
- (591) – Information concerning colors claimed
- (731) – Name and address of the applicant
- (732) – Name and address of the holder of the registration
- (740) – Name and address of the representative
- (750) – Address for correspondence
- (770) – Name and address of the previous applicant or holder in case of change in ownership
- (771) – Previous name and address of the applicant or holder in case of change in ownership
- (791) – Name and address of the licensee
- (793) – Indication of conditions and/or restrictions under the license (Type of license, number of license agreement, data of license, data of validity of license)
- (800) – Certain data relating to the international registration of Trade Marks under the Protocol Relating to Madrid Agreement (International registration number)

CODES FOR PUBLICATION IN BULLETIN

- (21) AP 0000 000000 – serial number of application for invention
- (10) AP 0000 0000 A – number of published application for invention (first publication)
- (11) P 0000 0000 B – number of patent for invention (second publication)
- (21) API 0000 000000 – number of application for imported patent
- (11) PI 0000 0000 A – number of imported patent (first publication)
- (21) AU 0000 000000 – serial number of application for utility model
- (10) AU 0000 000 U – number of published application for utility model (first publication)
- (11) U 0000 000 Y – number of patent for utility model (second publication)
- (21) AD 0000 000000 – serial number of application for design
- (10) AD 0000 000 S – number of published application for design (first publication)
- (11) D 0000 000 S – number of patent for design (second publication)

INTERNATIONAL PATENT CLASSIFICATION FOR INVENTIONS AND UTILITY MODELS

- SECTION A – HUMAN NECESSITIES
- SECTION B – PERFORMING OPERATIONS; TRANSPORTING
- SECTION C – CHEMISTRY; METALLURGY
- SECTION D – TEXTILES; PAPER
- SECTION E – FIXED CONSTRUCTIONS
- SECTION F – MECHANICAL ENGINEERING; LIGHTING; HEATING; WEAPONS; BLASTING
- SECTION G – PHYSICS
- SECTION H – ELECTRICITY

-
- M – Trade Mark
 - (210) AM 0000 000000 – Serial number of application;
 - (260) AAM 0000 00000 A – Publication number of application;
 - (111) M 0000 00000 R – Number of registration;
 - (111) MMM0000 00000 Rn – Number of renewals, in which n=1,2,3;
 - (111) M 0000 00000 R(P) – Number of registration under partial assignment of rights
-

**NATIONAL INTELLECTUAL PROPERTY CENTER OF GEORGIA
SAKPATENTI**

**OFFICIAL BULLETIN
OF THE INDUSTRIAL PROPERTY**

15(499)

INVENTIONS

UTILITY MODELS

DESIGNS

TRADEMARKS

**APPELLATIONS OF ORIGIN AND GEOGRAPHICAL
INDICATIONS OF GOODS**

DATE OF PUBLICATION

2018 08 10

CONTENTS

PUBLISHED TITLES OF PROTECTION	3
INVENTIONS	
▪ APPLICATIONS APPROVED FOR GRANTING PATENTS	4
▪ PATENTED INVENTIONS	6
UTILITY MODELS	
▪ APPLICATION APPROVED FOR GRANTING PATENT	7
▪ PATENTED UTILITY MODELS	8
DESIGNS	
▪ APPLICATIONS APPROVED FOR REGISTRATION	10
▪ REGISTERED DESIGNS	13
▪ DESIGNS, WICH HAVE BEEN REGISTERED WITH THE INTERNATIONAL BUREAU CLAIMING PRIORITY ON THE TERRITORY OF GEORGIA	14
TRADEMARKS	
▪ APPLICATIONS FILED UNDER THE NATIONAL PROCEDURE APPROVED FOR REGISTRATION	45
▪ REGISTERED TRADEMARKS	50
▪ TRADEMARKS REGISTERED ACCORDING TO THE ACCELERATED PROCEDURE	51
▪ INTERNATIONAL TRADEMARKS FOR WHICH A DECISION ON GANTING PROTECTION IS TAKEN	55
▪ INTERNATIONAL TRADEMARKS PROTECTED IN GEORGIA	132
APPELLATIONS OF ORIGIN AND GEOGRAPHICAL INDICATIONS OF GOODS	
▪ APPELLATIONS OF ORIGIN OF GOODS FILED IN GEORGIA FOR EXAMINATION UNDER LISBON AGREEMENT, ON THE BASIS OF THE INTERNATIONAL REGISTRATION	141
OFFICIAL NOTIFICATIONS	
INVENTIONS	
▪ RENEWAL OF PATENT	143
▪ CANSELLATION OF PATENTS	143
UTILITY MODELS	
▪ RENEWAL OF PATENTS	144
▪ CANSELLATION OF PATENTS	145
TRADEMARKS	
▪ RENEWAL OF REGISTRATIONS	146
▪ CHANGES IN NAMES AND/OR ADDRESSES OF OWNERS	149
CLASSIFICATION INDEXES	
INVENTIONS	150
UTILITY MODELS	151
DESIGNS	152
TRADEMARKS	155

PUBLISHED TITLES OF PROTECTION

INVENTIONS

- **APPLICATIONS APPROVED FOR GRANTING PATENT:**
14304; 14194; 14347
- **PATENTED INVENTIONS:**
6885, 6886

UTILITY MODELS

- **APPLICATION APPROVED FOR GRANTING PATENTS:**
14496
- **PATENTED UTILITY MODELS:**
1977-1982

DESIGNS

- **APPLICATIONS APPROVED FOR REGISTRATION:**
1031; 1015; 1021
- **REGISTERED DESIGNS:**
772, 773
- **DESIGNS WHICH HAVE BEEN REGISTERED WITH THE INTERNATIONAL BUREAU CLAIMING PRIORITY ON THE TERRITORY OF GEORGIA:**
770, 771
- **DESIGNS REGISTERED ACCORDING TO THE ACCELERATED PROCEDURE:**
98532; 98534, 98535; 100032; 101030; 98635; 101069, 101070; 101077; 98814; 98816; 98865; 101385; 101479, 101480

TRADEMARKS

- **APPLICATIONS FILED UNDER THE NATIONAL PROCEDURE APPROVED FOR REGISTRATION:**
92697; 92700; 92783; 93839; 94977, 94978; 95072, 95073; 95081; 95095; 95214; 95353; 95406; 95480; 95486; 95551; 95655; 95660; 95920; 95984; 95986; 96005; 96077, 96078; 96117; 96158
- **REGISTERED TRADEMARKS:**
29920-29922
- **TRADEMARKS REGISTERED ACCORDING TO THE ACCELERATED PROCEDURE:**
29907- 29917; 29999-30012
- **INTERNATIONAL TRADEMARKS FOR WHICH A DECISION ON GRANTING PROTECTIONS IS TAKEN:**
93339; 94114; 94273; 94278; 94489; 94491; 94493-94496; 94498-94500; 94506; 94511-94515; 94524-94526; 94626, 94627; 94632; 94634-94642; 94644; 94653-94657; 94659-94663; 94666, 94667; 94687; 94689; 94692; 94695; 94697, 94698; 94700; 94702, 94703; 94705-94707; 94733-94735; 94737; 94742; 94756; 94761; 94763, 94764; 94766; 94819, 94820; 94822-94825; 94827, 94828; 94834-94836; 94843-94850; 94852; 94871, 94872; 94874, 94875; 94878-94882; 94911, 94912; 94914-94920; 94971; 94973-94975; 94988; 95017-95019; 95021; 95045; 95047; 95056; 95058, 95059; 95165-95171; 95187-95189; 95253; 95268; 95272; 95274; 95330, 95331; 95368; 95371-95376; 95417; 95419-95423; 95460, 95461; 95814; 95884; 95888, 95889; 95892, 95893
- **INTERNATIONAL TRADEMARKS PROTECTED IN GEORGIA:**
89313; 90857; 91648; 91697; 91782; 91831; 91906; 92057; 92108; 92144; 92176; 92224, 92225; 92243; 92246; 92257; 92282; 92284; 92298; 92388; 92390; 92394; 92535; 92574; 92663; 92666; 92672; 92677, 92678; 92680, 92681; 92683-92686; 92688; 92690, 92691; 92748, 92749; 92758-92761; 92807, 92808; 92810; 92814; 92818; 92831; 92902; 92904; 92911; 92918, 92919; 92929; 92932-92934; 92938-92940; 92942, 92943; 92946; 92948, 92949; 92951; 92953-92955; 92967; 92976; 92979; 92982, 92983; 93001; 93004; 93011, 93012; 93014; 93019; 93028, 93029; 93034; 93037-93039; 93041; 93050; 93075; 93077; 93096; 93113, 93114; 93116-93134; 93233; 93416; 93418-93420; 93447; 93451; 93598; 93600-93612

APPELLATIONS OF ORIGIN AND GEOGRAPHICAL INDICATIONS OF GOODS

- **APPELLATIONS OF ORIGIN OF GOODS FILED IN GEORGIA FOR EXAMINATION UNDER LISBON AGREEMENT, ON THE BASIS OF THE INTERNATIONAL REGISTRATION:**
1521-1525

INVENTIONS

APPLICATIONS APPROVED FOR GRANTING PATENTS

The decision can be appealed at the Chamber of Appeal of Sakpatenti within 3 months from the publication or at the Mtskheta District Court Administrative Cases Board (Address: №17, Samkhedro str., Mtskheta), within 1 month following the publication.

PART A

A 61

- (10) AP 2018 14304 A (51) Int. Cl. (2006)
A 61 K 9/14
A 61 K 9/20
C 12 Q 1/68
A 61 K 9/28
- (21) AP 2015 014304 (22) 2015 03 26
(31) 36.046; 162/2015; 62/048,527; 61/970,595
(32) 2015 03 25; 2015 03 25; 2015 03 25;
2014 03 26
(33) UY; PK; US; US
(71) MILLENNIUM PHARMACEUTICALS, INC.
40 Landsdowne Street, Cambridge, MA, 02139
(US)
(72) BRAKE, Rachael, L. (US);
BOZON, Viviana (US);
CHOW, Ching-kuo, J. (US);
DINUNZIO, James, C. (US);
GALVIN, Katherine, M. (US);
KANNAN, Karuppiah (US);
KODONO, Yuki (JP);
XU, Qunli (US)
- (74) Shalva Gvaramadze
(85) 2016 10 21
(86) PCT/US2015/022792, 2015 03 26
(54) **PHARMACEUTICAL FORMULATIONS
OF PAN-RAF KINASE INHIBITOR, PRO-
CESSES FOR THEIR PREPARATION,
AND METHODS OF USE**
- (57) Pharmaceutical formulation contains extrudat
of solid dispersion(R)-2-(1-(6-amino-5-chloropyri-
dine-4-carboxamide) ethyl)-N-(5-chloro-4-(trifluo-
romethyl) pyridine-2-yl) thiazole-5-carboxamide,
vinylpyrrolidone-vinylacetat copolymer, and phar-
maceutically acceptable excipient.
Claims: 3 independent
23 dependent
Fig.: 8
-

- (10) AP 2018 14194 A (51) Int. Cl. (2006)
A 61 K 47/26
A 61 K 9/08
A 61 K 9/10
A 61 K 31/444
A 61 K 47/36
A 61 P 27/00

- (21) AP 2014 014194 (22) 2014 12 25
(31) 2013-266567
(32) 2013 12 25
(33) JP
(71) SANTEN PHARMACEUTICAL CO., LTD
(JP)
9-19, Shimoshin Jo 3- chome,
Higashiodogava-ku, Osaka-shi, Osaka
5338651 (JP)
- (72) OKI, Kenji (JP);
YAMADA, Kazuhito (JP);
MIYAZAKI, Tatsuya (JP);
OKABE, Komei (JP);
HABASHITA, Sayo (JP);
ENOMOTO, Hiroshi (JP);
YOSHII, Kenta (JP)
- (74) Shalva Gvaramadze
(85) 2016 06 29
(86) PCT/JP2014/084289, 2014 12 25
(54) **INJECTABLE AGENT AND DEPOT
FORMATION METHOD**
- (57) Injectable agent contains a medicine, trehalose,
gellan gum, and water based agent.
Claims: 4 independent
3 dependent
Fig.: 1
-

PART C

C 07

- (10) AP 2018 14347 A (51) Int. Cl. (2006)
C 07 D 401/14
C 07 D 405/14
C 07 D 401/06
A 61 K 31/47
A 61 P 35/00
- (21) AP 2015 014347 (22) 2015 06 05

- (31) 62/013,410; 62/156,533
(32) 2014 06 17; 2015 05 04
(33) US; US
(71) PFIZER INC. (US)
235 East 42nd Street, New York, NY 10017 (US)
(72) COLLINS, Michael, Raymond (US);
KANIA, Robert, Steven (US);
KUMPF, Robert, Arnold (US);
KUNG, Pei-Pei (US);
RICHTER, Daniel, Tyler (US);
SUTTON, Scott, Channing (US);
WYTHES, Martin, James (GB)

(74) Shalva Gvaramadze

(85) 2016 12 14

(86) PCT/IB2015/054272, 2015 06 05

(54) **SUBSTITUTED DIHYDROISOQUINO-
LINE COMPOUNDS**

(57) Compound of formula (I),

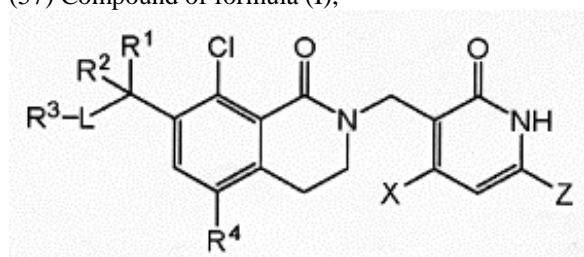

(I)

pharmaceutical compositions on a basis thereof and their usage at the treatment of anomalous cellular growth, including cancer.

Claims: 11 independent

13 dependent

Fig.: 2

PATENTED INVENTIONS**PART C****C 07**

- (11) P 2018 6886 B** **(51) Int. Cl. (2006)**
C 07 D 401/04
B 01 J 31/02
C 07 D 487/04
A 61 K 31/5517
A 61 P 25/02
A 61 P 25/20
C 07 D 61/00
- (10) AP 2018 13945 A (44) 7(491)/2018
(21) AP 2014 013945
(22) 2014 03 03
(24) 2014 03 03
(31) 2013-041492; PCT/JP2014/055329
(32) 2013 03 04
(33) JP; IB
(86) PCT/JP2014/055329, 2014 03 03
(73) PAION UK LIMITED (GB)
Chivers Way, Histon, Cambridge,
CB24 9ZR (GB)
(72) KAWAKAMI, Yuji (JP);
MURASE, Tatsushi (JP);
TANAKA, Daisuke (JP);
YOSHIYAMA, Hideyuki (JP);
KUWABE, Shinitsu (JP)
(74) Shalva Gvaramadze
(54) **OXIDATION REACTION WITH
EXCELLENT CONVERSION RATE**
-

- (11) P 2018 6885 B** **(51) Int. Cl. (2006)**
C 07 D 487/04
A 61 K 31/519
A 61 P 1/00
A 61 P 11/00
- (10) AP 2018 13860 A (44) 7(491)/2018
(21) AP 2013 013860
(22) 2013 12 16
(24) 2013 12 16
(31) 12197767.2; 13158757.8
(32) 2012 12 18; 2013 03 12
(33) EP; EP
(86) PCT/EP2013/076672, 2013 12 16
(73) CHIESI FARMACEUTICI S.P.A. (IT)
Via Palermo, 26/A I-43100 Parma (IT)
(72) ALCARAZ, Lilian (IT);
HEALD, Robert Andrew (IT);
SUTTON, Jonathan Mark (IT);
ARMANI, Elisabetta (IT);
CAPALDI, Carmelida (IT)
(74) Tamaz Shilakadze
(54) **NOVEL COMPOUNDS**
-

UTILITY MODELS

APPLICATION APPROVED FOR GRANTING PATENT

The decision can be appealed at the Chamber of Appeal of Sakpatenti within 3 months from the publication or at the Mtskheta District Court Administrative Cases Board (Address: №17, Samkhedro str., Mtskheta), within 1 month following the publication.

PART B

B 03

(10) AU 2018 14496 U (51) Int. Cl. (2006)

B 03 B 7/00

(21) AU 2017 14496 (22) 2017 05 18

(31) U201700965

(32) 2017 02 02

(33) UA

(71) LIMITED LIABILITY COMPANY

"UKRMINING" (UA)

Ul. Geroev Chernobilya 106, 53201, Nikopol
Dnipropetrovsk (UA)

(72) Maxim Mazurenko (UA)

(74) Liliana Darakhvelidze

(54) **LINE FOR MANGANESE CONCENTRATES PREPARATION WITH MANGANESE ORE PRIMARY ENRICHMENT WITHDRAWAL**

(57) A line for manganese concentrates preparation with manganese ore primary enrichment withdrawal (slimes, tails, intermediat) includes sequentially specified: device for organic dirt and lump removal, e.g. such as riddle, vibrosieve, scrubber-butare; deslimation device intended for clayey and silty fractions, e.g. such as hydrocyclone, hydraulic classifier, first device for selective accommodation or classification, e.g. such as riddle, sieve, hydrocyclone; second device for high intensity magnetic separation (HIMS-separation), e.g. such as magnetic or electromagnetic separator of wet or dry enrichment; third device for selective accommodation of product or classification, e.g. such as, riddle, sieve, hydrocyclone; fourth device for gravity concentration, e.g. such as spiral separator, spiral sluice, table concentrator; fifth device for final products dehydration, e.g. such as ribbon vacuum filter or filter press or dehydrating riddle.

Claims: 1 independent

4 dependent

Fig.: 11

PATENTED UTILITY MODELS

PART A

A 61

- (11) U 2018 1981 Y (51) Int. Cl. (2006)
A 61 K 31/045
A 61 K 35/64
A 61 K 36/00
- (10) AU 2018 14547 U (44) 7 (491) 2018
 (21) AU 2017 14547
 (22) 2017 07 18
 (24) 2017 07 18
 (73) Giorgi Machitidze (GE)
 A. Razmadzis q. 34, 0177, Tbilisi,
 Georgia (GE)
 (72) Giorgi Machitidze (GE)
 (54) **PHARMACEUTICAL COMPOSITION
 FOR TREATMENT OF DISEASES
 CAUSED BY DELETERIOUS EFFECT
 OF TOBACCO ON SMOKER'S
 ORGANISM**

-
- (11) U 2018 1979 Y (51) Int. Cl. (2006)
A 61 K 33/36
A 01 N 59/22
C 01 G 28/00
- (10) AU 2018 14175 U (44) 5(489)/2018
 (21) AU 2016 014175
 (22) 2016 06 13
 (24) 2016 06 13
 (73) LTD "COMPANY TM RG" (GE)
 Vazha-Pshavelas gamz. I, shes. 3, b. 219,
 0177, Tbilisi (GE)
 (72) Temur Kemularia (GE);
 Rusudan Gigauri (GE);
 Naira Gigauri (GE)
 (54) **METHOD FOR TIN HYDRO
 ARSENATE PREPARATION**

PART C

C 12

- (11) U 2018 1980 Y (51) Int. Cl. (2006)
C 12 Q 1/68
- (10) AU 2018 14454 U (44) 7(491)/2018
 (21) AU 2017 014454
 (22) 2017 03 21
 (24) 2017 03 21
 (31) 2016136115
 (32) 2016 09 07
 (33) RU
 (73) Marina Pochkhua (GE)
 Tseretlis gamz. 55, korp. 2, b. 117, 0153,
 Tbilisi (GE);
 Merab Chikobava (RU)
 Ul. Vesioloes 1, Sochi-Adler (RU);
 Oleg Rubalskiy (RU)
 Ul. Sophia Perovskaya 64, kv. 50,
 Astrakhan (RU);
 Ulrich Martini (DE)
 31319, Zenden, Rosenstrasse 1465 (DE);
 Vazha Patsia (RU)
 Ul. Sadovaya 5, kv. 33, Sochi-Adler (RU);
 Vakhtang Pochkhua (GE)
 Varketilis 3, mkr. III, korp. 314, b. 88,
 Tbilisi (GE);
 Giorgi Zhghenti (GE)
 Sanzona, korp. 16d, b. 30, 0141, Tbilisi (GE)
 (72) Marina Pochkhua (GE);
 Merab Chikobava (RU);
 Oleg Rubalskiy (RU);
 Ulrich Martini (DE);
 Vazha Patsia (RU);
 Vakhtang Pochkhua (GE);
 Giorgi Zhghenti (GE)
 (54) **DOSAGE FORM FOR POLYMERIC
 CHAIN REACTION**

C 25

- (11) U 2018 1977 Y (51) Int. Cl. (2006)
C 25 B 11/04
- (10) AU 2017 13988 U (44) 20(480)/2017
 (21) AU 2015 013988
 (22) 2015 11 09
 (24) 2015 11 09
 (73) Temur Chakhunashvili (GE)
 M. Aleksidzis q. 1, korp. 4, sadar. 2, b. 28,
 0194, Tbilisi (GE);

- Teimuraz Rokva (GE)
 Vazha-Pshavelas gamz. V kvart., korp. 1,
 b. 32, 0186, Tbilisi (GE);
 Zhiuli Keadze (GE)
 Nutsbidzis III mkr., II kvart., korp. 2,
 b. 69, 0186, Tbilisi (GE);
 Merab Dadunashvili (GE)
 3 Javakhetis, korp. 5b, b. 37, 0182,
 Tbilisi (GE);
 Zinaida Vatsadze (GE)
 Giorgi Brtskinvales q. 25, b. 34, 0153,
 Tbilisi (GE)
- (72) Temur Chakhunashvili (GE);
 Teimuraz Rokva (GE);
 Zhiuli Keadze (GE);
 Merab Dadunashvili (GE);
 Zinaida Vatsadze (GE)
- (54) **ANODE FOR RECEIVING
 ELECTROLYTIC MANGANESE
 DIOXIDE**

- (11) U 2018 1978 Y (51) Int. Cl. (2006)
C 25 B 11/04
- (10) AU 2017 13989 U (44) 22(482)/2017
 (21) AU 2015 013989
 (22) 2015 11 09
 (24) 2015 11 09
- (73) Temur Chakhunashvili (GE)
 M. Aleksidzis q. 1, korp. 4, sadar. 2, b. 28,
 0194, Tbilisi (GE);
 Teimuraz Rokva (GE)
 Vazha-Pshavelas V kvart., korp. 1, b. 32,
 0186, Tbilisi (GE);
 Zhiuli Keadze (GE)
 Nutsbidzis III mkr., II kvart., korp. 2,
 b. 69, 0186, Tbilisi (GE);
 Zinaida Vatsadze (GE)
 Giorgi Brtskinvales Q. 25, b. 34, 0153,
 Tbilisi (GE);
 Merab Dadunashvili (GE)
 Javakhetis q. 3, korp. 5b, b. 37, 0182,
 Tbilisi (GE)
- (72) Temur Chakhunashvili (GE);
 Teimuraz Rokva (GE);
 Zhiuli Keadze (GE);
 Zinaida Vatsadze (GE);
 Merab Dadunashvili (GE)
- (54) **CATHODE FOR RECEIVING
 ELECTROLYTIC MANGANESE
 DIOXIDE**

PART F**F 26**

- (11) U 2018 1982 Y (51) Int. Cl. (2006)
F 26 B 3/00
- (10) AU 2018 14407 U (44) 4(488)/2018
 (21) AU 2017 014407
 (22) 2017 02 03
 (24) 2017 02 03
- (73) Giorgi Khmiadashvili (GE)
 Vazha-Pshavelas Gamz. 71a, b. 3, 0186,
 Tbilisi (GE)
- (72) Giorgi Khmiadashvili (GE)
- (54) **FRUIT AND VEGETABLE DRYING
 PLANT**

DESIGNS

APPLICATIONS APPROVED FOR REGISTRATION

The decision can be appealed at the Chamber of Appeal of Sakpatenti within 3 months from the publication or at the Mtskheta District Court Administrative Cases Board (Address: №17, Samkhedro str., Mtskheta), within 1 month following the publication.

(10) AD 2018 1031 S

(51) 07-06

(21) AD 2018 1031

(22) 2018 04 12

(28) 2

(71) Nodar Tsveniashvili (GE)

V. Gorgasalis q., shesakh. IV, me-2 chikhi 7, 0105, Tbilisi, Georgia (GE)

(72) Nodar Tsveniashvili (GE)

(54) 1. KHINKALI-SHAPED SALTCELLAR, 2. KHINKALI-SHAPED PEPPER POT

(55)



1.1



1.2



2.1

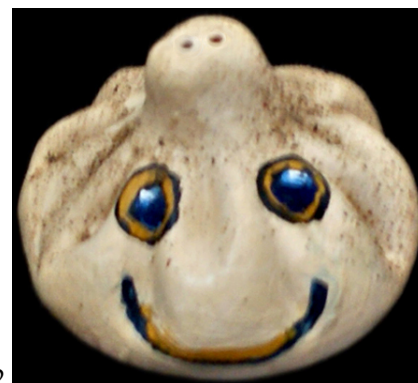

2.2

(10) AD 2018 1015 S

(21) AD 2018 1015

(28) 10

(71) Mikheil Kochakidze (GE)

T. Tabidzis q. 56, b. 1, 0162, Tbilisi, Georgia (GE)

(72) Mikheil Kochakidze (GE)

(54) 1.-10. BOTTLE WITH WORKSHEET LABEL

(55)

(51) 09-01

(22) 2018 01 18



1.1



2.1



3.1



4.1



5.1



6.1



7.1



8.1



9.1



10.1

(10) AD 2018 1021 S

(21) AD 2018 1021

(28) 1

(71) LTD "SMARTPHONE" (GE)

Samtrediis q. 2a, b. 32, 0119, Tbilisi, Georgia (GE)

(72) Davit Virabyan (GE)

(74) Inga Tskhvedadze (GE)

(54) MOBILE PHONE POST

(55)

(51) 14-99

(22) 2018 02 21



1.1

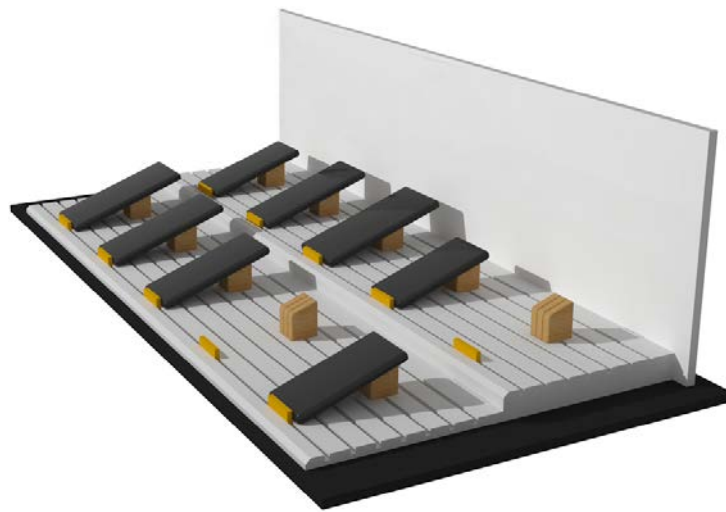

1.2

REGISTERED DESIGNS

(11) D 2018 773 S **(51) 03-01**
(10) AD 2018 998 S (44) 8(492)/ 2018 04 25
(21) AD 2017 998
(22) 2017 10 17
(24) 2017 10 17
(28) 10
(18) 2022 10 17
(73) Nino Giorgadze (GE)
 I. Abashidzis q. 69 b. 13, 0162, Tbilisi, Georgia (GE)
(72) Nino Giorgadze (GE)
(54) **HANDBAG**

(11) D 2018 772 S **(51) 09-01**
(10) AD 2018 1007 S (44) 8(492)/ 2018 04 25
(21) AD 2017 1007
(22) 2017 11 27
(24) 2017 11 27
(28) 1
(18) 2022 11 27
(73) Teimuraz Kokashvili (GE)
 Imeretis q. 69, 0180, Tbilisi, Georgia (GE)
(72) Teimuraz Kokashvili (GE)
(54) **KHINKALI-SHAPED VESSEL**

DESIGNS REGISTERED ACCORDING TO THE ACCELERATED PROCEDURE

The decision can be appealed at the Chamber of Appeal of Sakpatenti within 3 months from the publication.

- (11) **D 2018 770 S** (51) **09-01**
(21) AD 2018 1045 (22) 2018 07 05
(24) 2018 07 05
(28) 1
(18) 2023 07 05
(73) LTD "VAZIANI COMPANY" (GE)
Mshvidobis q. 42, 2200, Telavi, Georgia (GE)
(72) Lali Tsomaia (GE)
(74) Aleksandre Kvernadze (GE)
(54) **WINE BOTTLE WITH LABEL**
(55)



1.1

(11) D 2018 771 S (51) 09-03

(21) AD 2018 1040 (22) 2018 06 20

(24) 2018 06 20

(28) 3

(18) 2023 06 20

(73) LTD "COMFORT" (GE)

Georgian Agrarian University area, plot. 14/467, 0159, Tbilisi, Georgia (GE)

(72) Lia Arevadze (GE)

(74) Giorgi Kartvelishvili (GE)

(54) 1.-2. TISSUE PACKING, 3. PAPER TOWEL PACKING

(55)



DESIGNS, WHICH HAVE BEEN REGISTERED WITH THE INTERNATIONAL BUREAU CLAIMING PRIORITY ON THE TERRITORY OF GEORGIA

The decision can be appealed at the Chamber of Appeal of Sakpatenti within 3 months from the publication or at the Mtskheta District Court Administrative Cases Board (Address: №17, Samkhedro Str., Mtskheta), within 1 month following the publication.

(11) DM/098532

(51) 10-02

(15) 2017 11 14

(45) 2018/19 (2018 05 18)

(22) 2017 11 14

(28) 1

(73) RADO UHREN AG (RADO WATCH CO. LTD.) (MONTRES RADO SA)

Bielstrasse 45, CH-2543 Lengnau BE (CH)

(85) CH

(86) CH

(87) CH

(88) CH

(89) CH

(81) II. BZ, MA III. AL, AM, AZ, BA, CH, EM, GE, KG, LI, MC, MD, ME, MK, MN, NO, OM, SG, TN, TR, UA

(72) Mélanie ARMENTI

Mittelstrasse 29, CH-2560 Nidau, Suisse

(54) 1. Watch

(55)

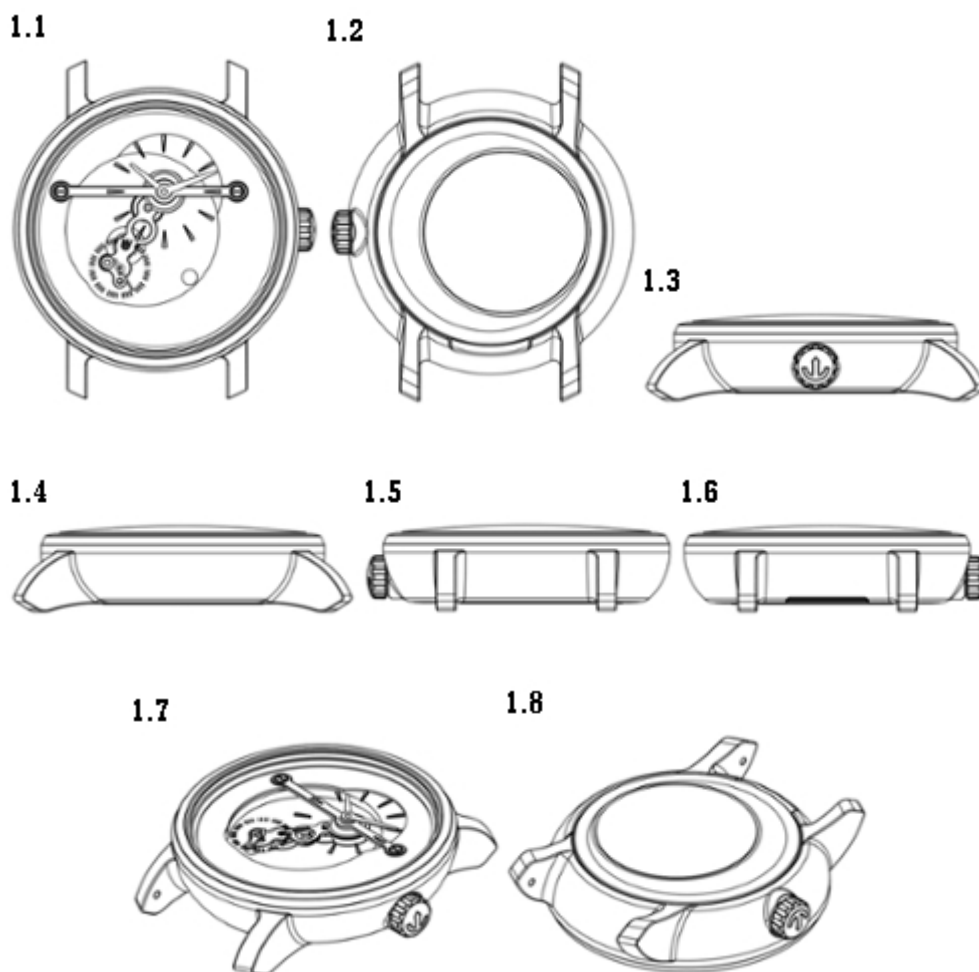

(11) DM/098534

(15) 2017 11 14

(22) 2017 11 14

(28) 1

(73) RADO UHREN AG (RADO WATCH CO. LTD.) (MONTRES RADO SA)

Bielstrasse 45, CH-2543 Lengnau BE (CH)

(85) CH

(86) CH

(87) CH

(88) CH

(89) CH

(81) II. BZ, MA III. AL, AM, AZ, BA, CH, EM, GE, KG, LI, MC, MD, ME, MK, MN, NO, OM, SG, TN, TR, UA

(72) Stéphanie LACROIX-GACHET

Rue de St-Jean 92, CH-1201 Genève, Suisse

(54) 1. Watch

(55)

(51) 10-02

(45) 2018/19 (2018 05 18)

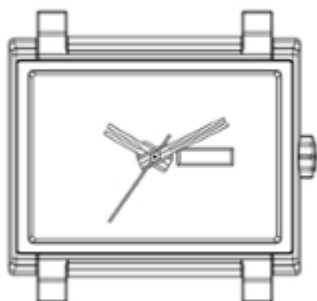
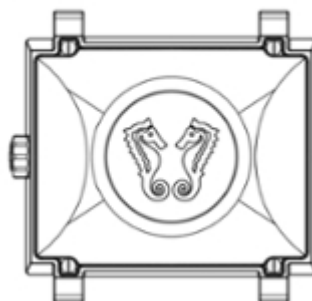
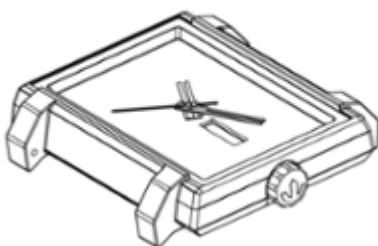
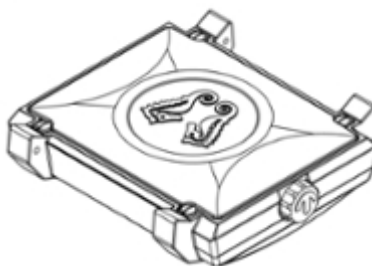
1.1**1.2****1.3****1.4****1.5****1.6****1.7****1.8**

(11) DM/098535

(15) 2017 11 14

(22) 2017 11 14

(28) 1

(73) RADO UHREN AG (RADO WATCH CO. LTD.) (MONTRES RADO SA)

Bielstrasse 45, CH-2543 Lengnau BE (CH)

(85) CH

(86) CH

(87) CH

(88) CH

(89) CH

(81) II. BZ, MA III. AL, AM, AZ, BA, CH, EM, GE, KG, LI, MC, MD, ME, MK, MN, NO, OM, SG, TN, TR, UA

(72) Fabrice DUPORT

Avenue de la Gare 4, CH-2000 Neuchâtel, Suisse

(54) 1. Wristwatch

(55)

(51) 10-02

(45) 2018/19 (2018 05 18)

1.1



1.2

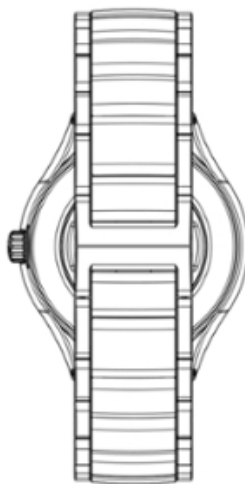

1.3



1.4



1.5

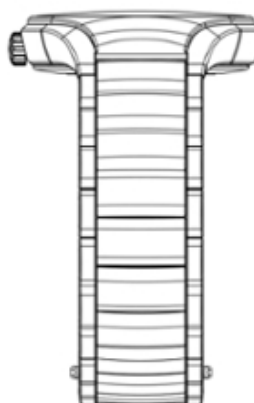

1.6

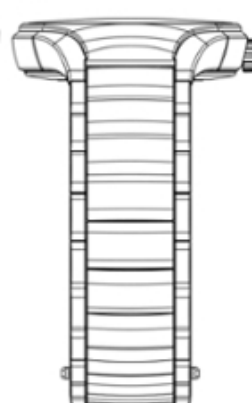

1.7



1.8



(11) DM/100032

(15) 2017 11 16

(22) 2017 11 16

(28) 1

(73) XTREME LASHES LLC

24127 West Hardy Road, Spring, TX 77373 (US)

(85) –

(86) –

(87) US

(88) IT, EM

(89) US

(81) II. BJ, BX, BZ, CI, GA, GR, IT, MA, ML, NE, SN, SR III. AL, AM, AZ, BA, BG, BN, BW, CH, DE, DK, EE, EG, EM, ES, FI, FR, GE, GH, HR, HU, IS, JP, KG, KH, KP, KR, LI, LT, LV, MC, MD, ME, MK, MN, NA, NO, OA, OM, PL, RO, RS, RW, SG, SI, ST, SY, TJ, TM, TN, TR, UA, US

(72) Joumana Mousselli

24127 West Hardy Road, 77373, Spring, Texas, US;

Ayad Mousselli

24127 West Hardy Road, 77373, Spring, Texas, US;

Noor Daoudi

24127 West Hardy Road, 77373, Spring, Texas, US

(54) 1. Tweezers

(55)

1.1

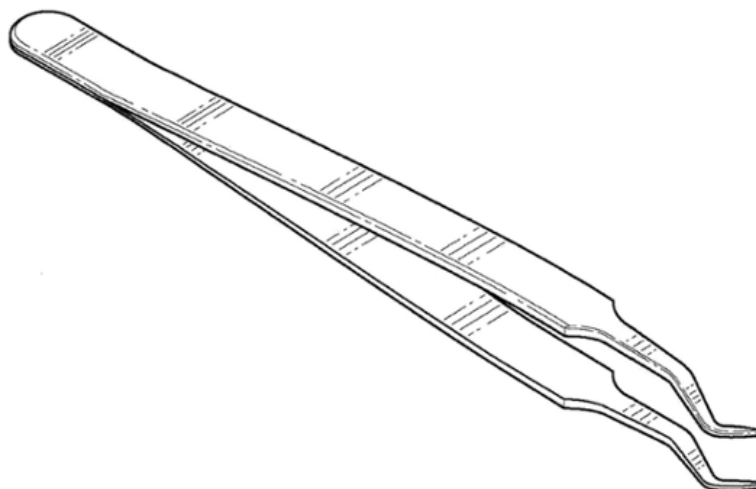

1.2



1.3



1.4



1.5

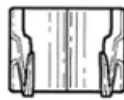

1.6



1.7

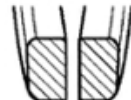

1.8

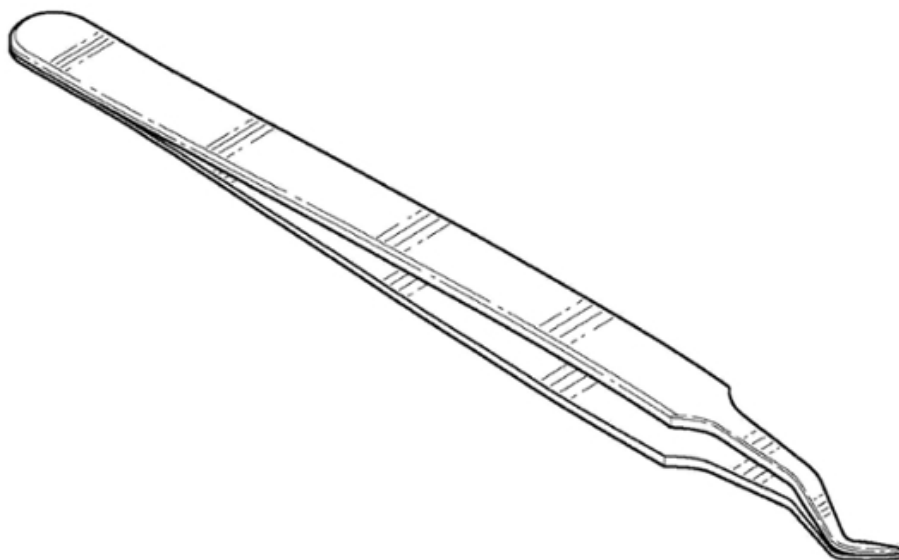

(11) DM/101030

(15) 2017 12 15

(22) 2017 12 15

(28) 79

(30) Nos. 24, 25, 26, 27, 28, 29, 30, 31, 32, 33, 34, 35, 36, 37, 38, 39, 40, 41, 42, 43, 44, 45, 46, 47, 48, 49, 50, 53, 54, 55, 56, 57, 58, 60, 71, 76, 77, 78, 79: 05.07.2017; 004089894; EM; Nos. 51, 52, 59, 61, 62, 64, 68, 69, 70, 72, 73, 74, 75: 28.08.2017; 004169225; EM; Nos. 1, 2, 3, 4, 5, 6, 7, 8, 9, 10, 11, 12, 13, 14, 15, 16, 17, 18, 19, 20, 21, 22, 23: 28.09.2017; 004376325; EM; Nos. 63, 65, 66, 67: 27.11.2017; 004524049; EM

(73) ARC HOLDINGS

104 avenue du Général de Gaulle, F-62510 ARQUES (FR)

(85) FR, EM

(86) FR, EM

(87) FR, EM

(88) FR, EM

(89) FR

(81) III. EG, GE, TR, UA

(54) 1.-10. Tumblers; 11.-13. Stemmed glasses; 14. Champagne glass; 15. Plate; 16. Ramequin dish; 17. Water jug; 18.-19. Forks; 20.-21. Spoons; 22.-23. Table knives; 24.-52. Tumblers; 53. Water jug; 54. Salad bowl; 55. Ice cream bowl; 56.-57. Salad bowls; 58.-59. Stemmed glasses; 60.-64. Champagne glasses; 65.-69. Stemmed glasses; 70. Ramequin dish; 71.-73. Dishes; 74. Stemmed glass; 75. Champagne glass; 76. Dish; 77. Cheese dish cover on its tray; 78. Stemmed glass; 79. Small bowl

(55)

3

6



4.1



4.2



5



7



8.1



8.2



9.1



9.2



10.1



10.2



11



12



13



14



15.1



15.2



15.3



15.4



16.1



16.2



16.3



16.4



17.1



17.2



17.3



17.4



18



19



20



21



22



23



24.1



24.2



24.3



24.4



25



26



27



28



29



30



31



32



33



34



35



36



37



38



39



40



42

41



43



44



45



46



47



48



50

49



53.1



53.2

51



52



53.3





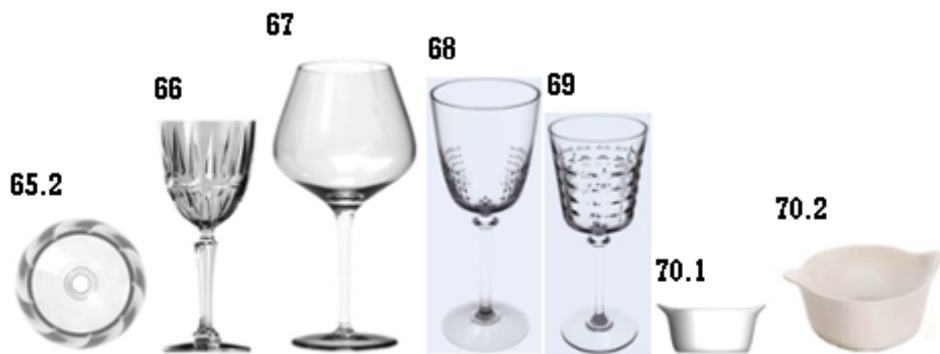

70.3

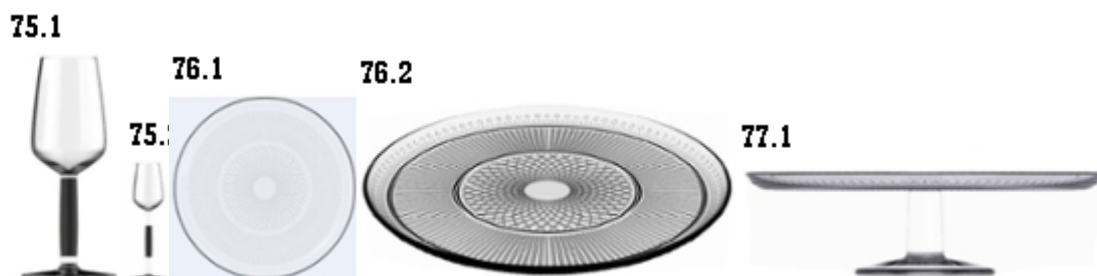

77.2



77.3



77.4



78.2

78.1

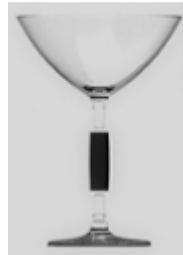

78.3



79.1



79.2

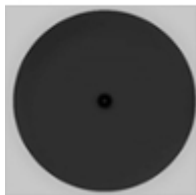

79.3



79.4



79.5



(11) DM/098635**(51) 12-08, 16**

(15) 2017 11 23

(45) 2018/20 (2018 05 25)

(22) 2017 11 23

(28) 8

(30) No. 1: 25.05.2017; 004018430-0003; EM; No. 2: 25.05.2017; 004018430-0005; EM; No. 3: 25.05.2017; 004018430-0015; EM; No. 4: 25.05.2017; 004018430-0018; EM; No. 5: 25.05.2017; 004018430-0025; EM; No. 6: 25.05.2017; 004018430-0031; EM; No. 7: 25.05.2017; 004018430-0034; EM; No. 8: 25.05.2017; 004018430-0036; EM

(73) SEAT S.A.

Autovía A-2, Km. 585, E-08760 Martorell (Barcelona) (ES)

(85) –

(86) ES, EM

(87) –

(88) –

(89) ES

(81) III. AZ, BA, CH, EG, GE, IS, LI, MD, MK, NO, OM, RS, SG, TN, TR, UA

(72) SEAT S.A

Autovía A-2, Km 585, 08760 Martorell (Barcelona), España

(54) 1. Automobile; 2. Decorative trim; 3.-5. Full front bumpers; 6. Full rear bumper;

7. Vehicle air stream deflector; 8. Full rear bumper

(55)

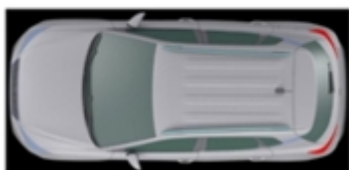
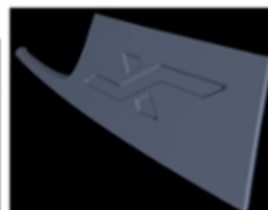
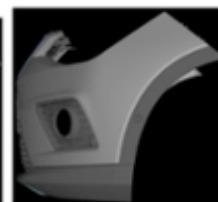
1.1**1.2****1.3****1.4****1.5****1.6****1.7****2.1****2.2****3.1****3.2****3.3**

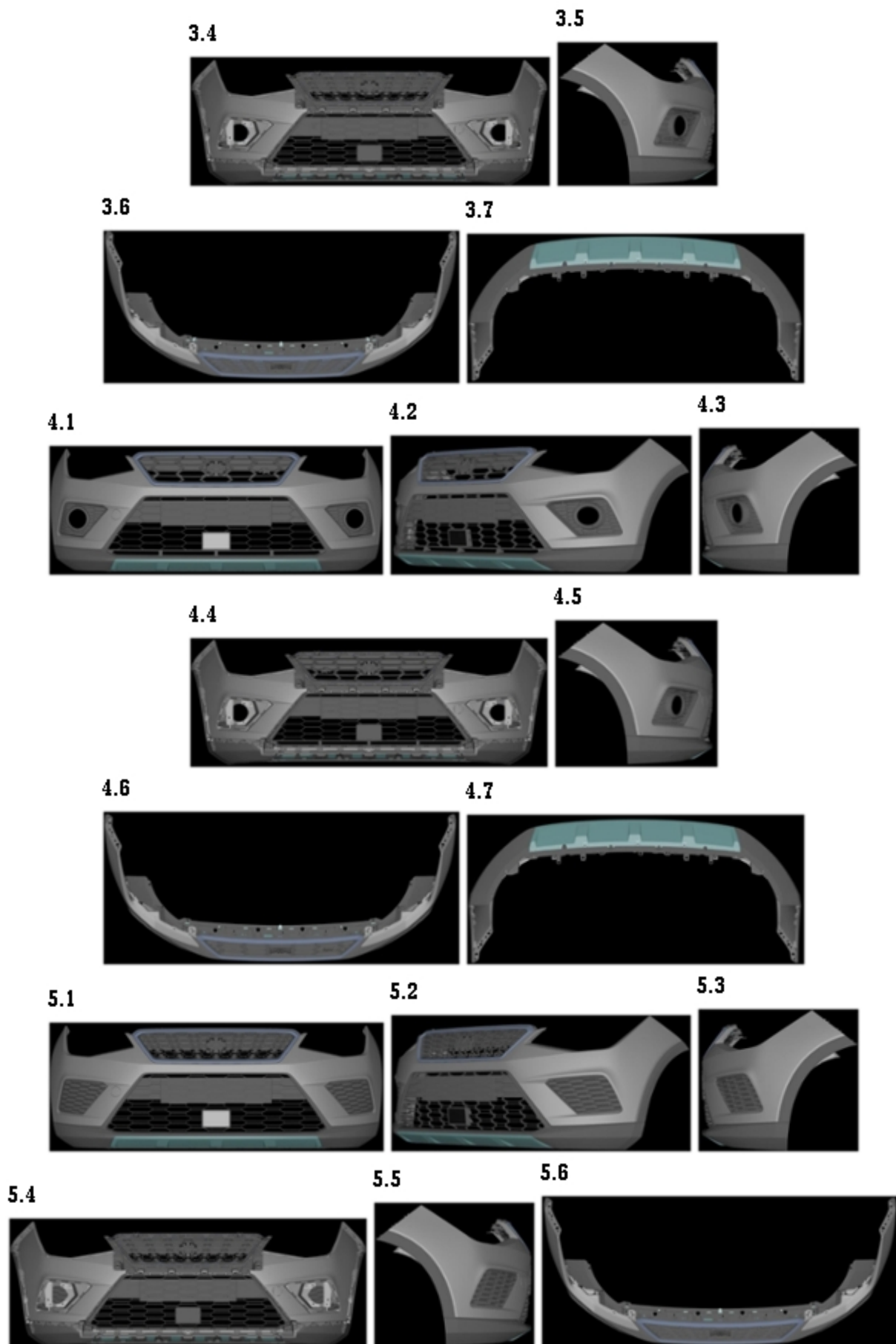

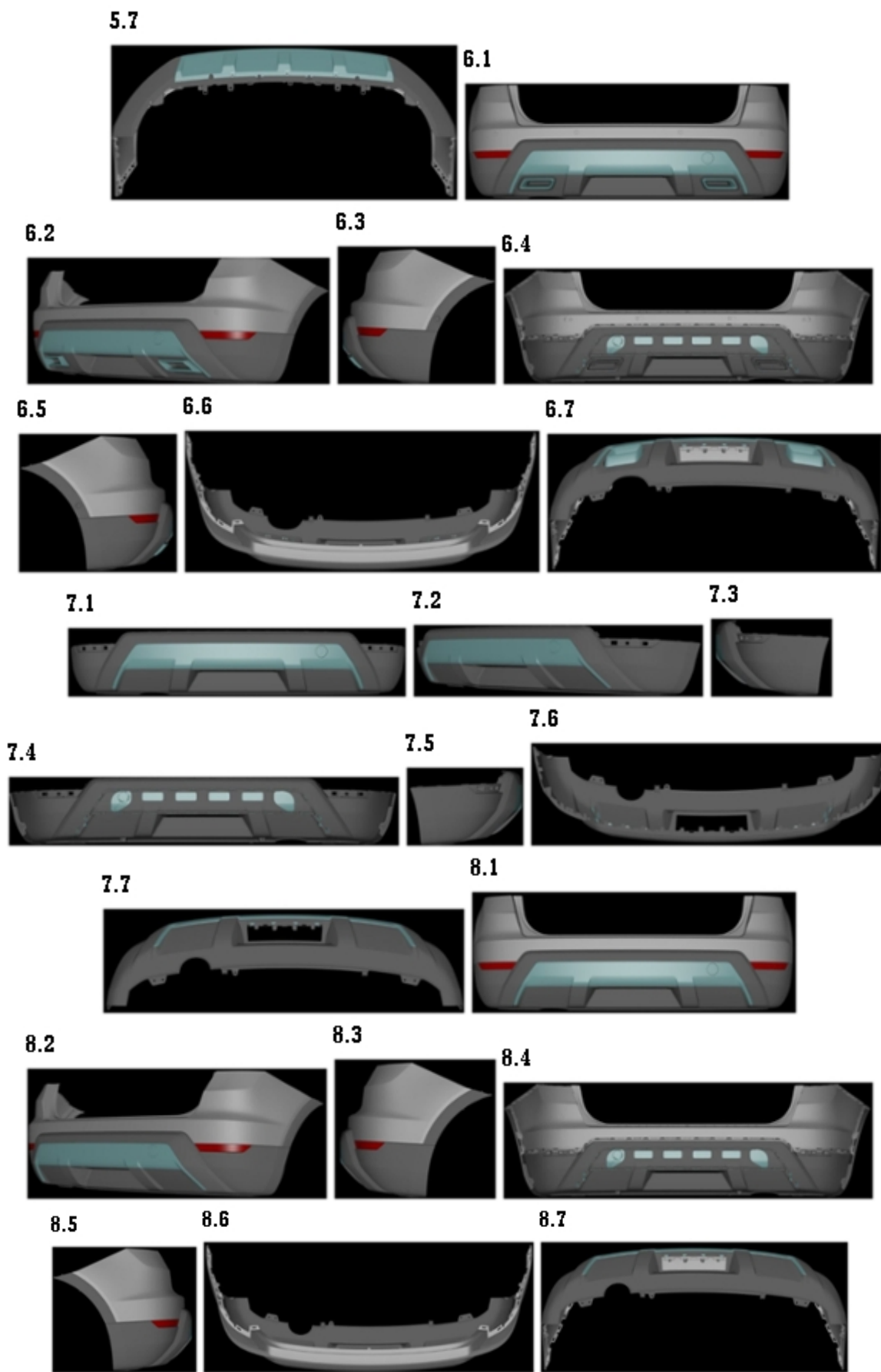

(11) DM/101069

(51) 12-12

(15) 2018 04 17

(45) 2018/20 (2018 05 25)

(22) 2018 04 17

(28) 1

(73) SUSAN GOPAUL

7317 SW 197TH PL., BEAVERTON 97007 (US)

(85) US

(86) -

(87) US

(88) -

(89) US

(81) III. AM, BA, BN, EG, EM, GE, IS, JP, KG, KH, KR, MC, MD, ME, MK, NA, OA, OM, RU, SG, SY, TM, TR

(72) SUSAN GOPAUL

7317 SW 197TH PL, 97007 BEAVERTON, United States of America

(54) 1. Baby carriage

(55)

1.1



1.2

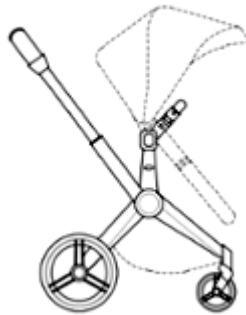

1.3

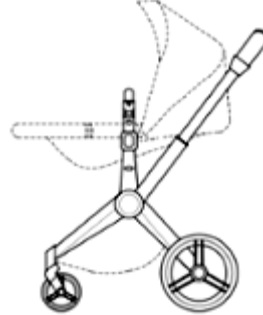

1.4

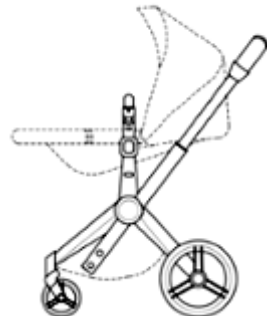

1.5

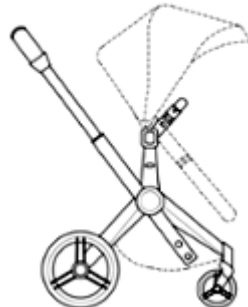

1.6



(11) DM/101070

(15) 2018 05 09

(22) 2018 05 09

(28) 1

(30) No. 1: 15.03.2018; 004757920-0001; EM

(73) FONTINI Pol. Ind. Can Bernades-Subira

C/Anoia 15, E-08130 Santa Perpetua de Mogoda (Barcelona (ES))

(85) –

(86) ES

(87) –

(88) –

(89) EM

(81) III. AM, AZ, GE, JP, RU, TR, UA, US

(72) FONT GASULLA, ROGER, PASEO JOVER I SERRA

2 P01 3, 08390 MONTGAT (BARCELONA), España

(54) 1. Electric switch

(55)

(51) 13-03

(45) 2018/20 (2018 05 25)

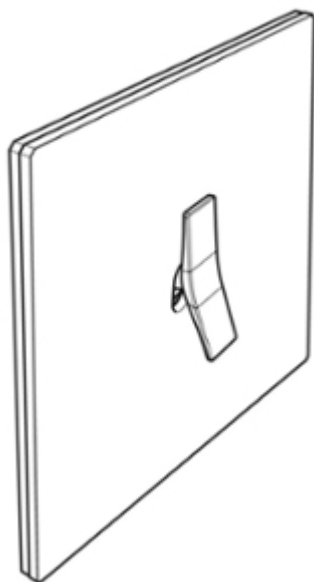
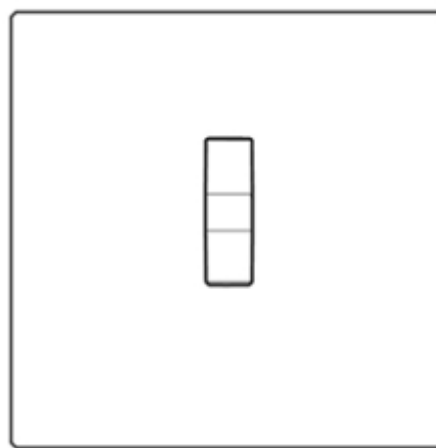
1.1**1.2****1.3****1.4**

(11) DM/101077

(51) 09-03

(15) 2018 03 31

(45) 2018/20 (2018 05 25)

(22) 2018 03 31

(28) 2

(30) Nos. 1, 2: 26.03.2018; s201800773; UA

(73) PRYVATNE PIDPRYIEMSTVO "VYROBNYCHO-TORHOVA KOMPANIJA "LUKAS"

Ivana Prykhodka, 69, Kremenchuk, Poltavska oblast 39621 (UA)

(85) –

(86) –

(87) –

(88) UA

(89) UA

(81) III. AM, AZ, EM, GE, KG, MD, TJ, TM

(72) Lukatskyi Vitalii Oleksandrovych

I tyyk Naberezhnyi, 3A, 39702 s. Kryvushi, Kremenchutskyi raion, Poltavska oblast, Ukraine

(54) 1.-2. Packages

(55)

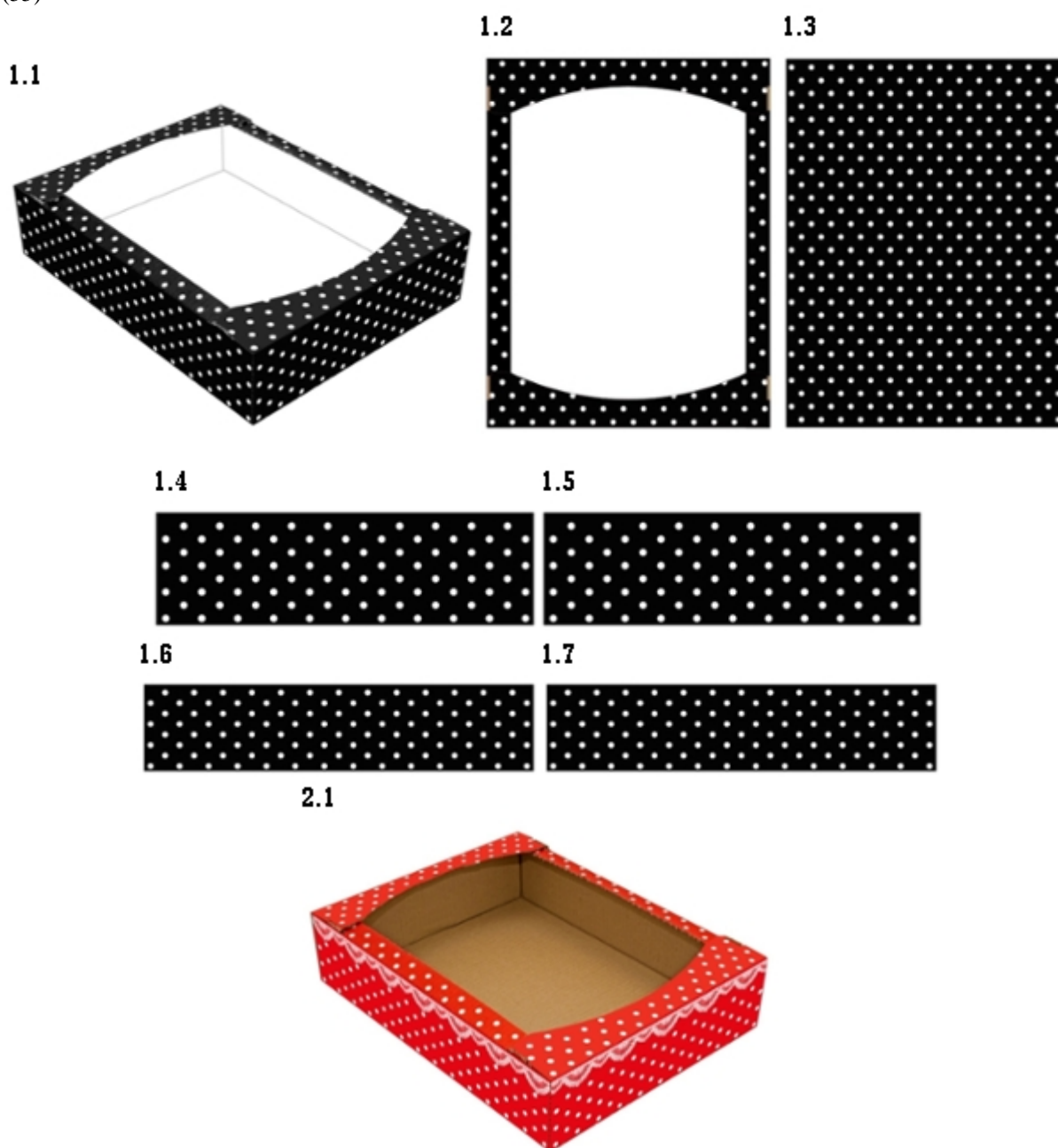

2.2



2.3

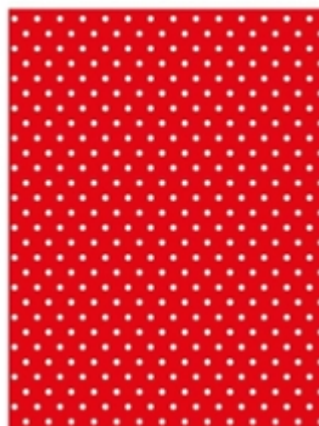

2.4



2.5



2.6



2.7



(11) DM/098814

(51) 10-02

(15) 2017 12 06

(45) 2018/22 (2018 06 08)

(22) 2017 12 06

(28) 1

(73) RADO UHREN AG (RADO WATCH CO. LTD.) (MONTRES RADO SA)

Bielstrasse 43, CH-2543 LENGNAU (CH)

(85) CH

(86) CH

(87) CH

(88) CH

(89) CH

(81) II. BZ, MA III. AL, AM, AZ, BA, CH, EM, GE, KG, LI, MC, MD, ME, MK, MN, NO, OM, SG, TN, TR, UA

(72) Stéphanie LACROIX-GACHET

Rue de St-Jean 92, CH-1201 Genève, Suisse

(54) 1. Watch

(55)

1.1



1.2



1.3

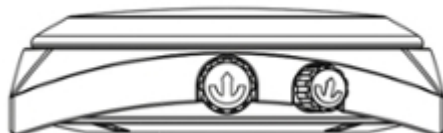

1.4



1.5



1.6



1.7

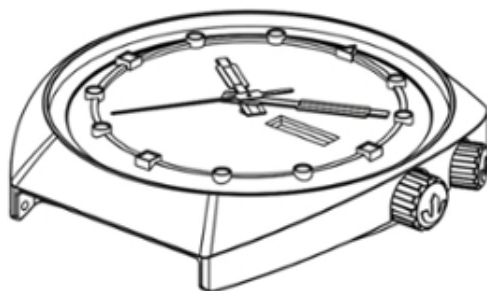

1.8

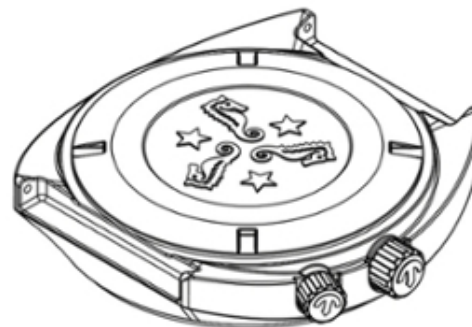

(11) DM/098816

(15) 2017 12 08

(22) 2017 12 08

(28) 1

(73) TISSOT SA (TISSOT AG) (TISSOT LTD)

Chemin des Tourelles 17, CH-2400 Le Locle (CH)

(85) CH

(86) CH

(87) CH

(88) CH

(89) CH

(81) II. BZ, MA III. AL, AM, AZ, BA, CH, EM, GE, KG, LI, MC, MD, ME, MK, MN, NO, OM, SG, TN, TR, UA

(72) Fiona MATTHEY

Rue Neuve 3, 2300 La Chaux-de-Fonds, Suisse;

David QUINCHE

Rue Jaquet Droz 5, 2300 La Chaux-de-Fonds, Suisse

(54) 1. Watch case

(55)

(51) 10-07

(45) 2018/22 (2018 06 08)

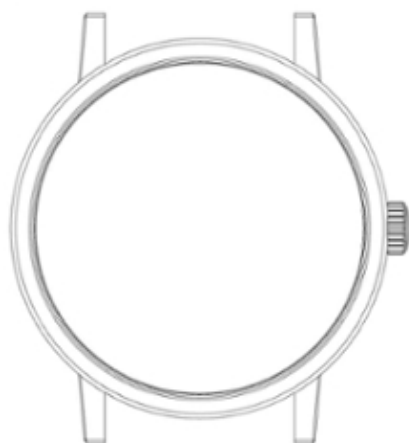
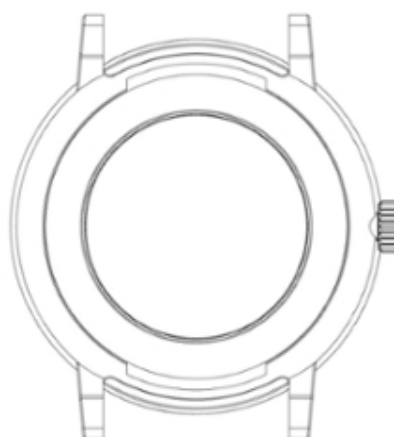
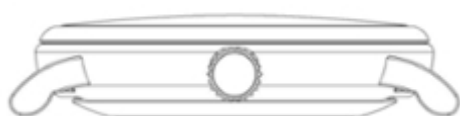
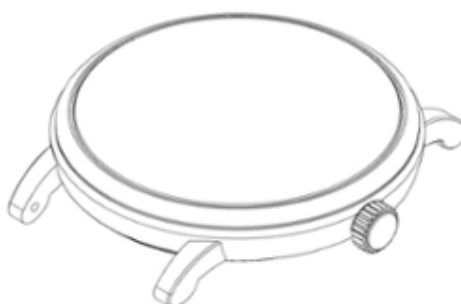
1.1**1.2****1.3****1.4****1.5****1.6****1.7**

(11) DM/098865

(51) 10-07

(15) 2017 12 04

(45) 2018/22 (2018 06 08)

(22) 2017 12 04

(28) 1

(73) BLANCPAIN SA

Le Rocher 12, CH-1348 LE BRASSUS (CH)

(85) CH

(86) CH

(87) CH

(88) CH

(89) CH

(81) II. BZ, MA III. AL, AM, AZ, BA, CH, EM, GE, KG, LI, MC, MD, ME, MK, MN, NO, OM, SG, TN, TR, UA

(72) Patrice NANGA

Avenue Dapples 26, CH-1006 Lausanne, Suisse

(54) 1. Dial

(55)

1.1



1.2



(11) DM/101385

(51) 32-00

(15) 2018 05 15

(45) 2018/22 (2018 06 08)

(22) 2018 05 15

(28) 1

(73) MAY-AGRO TOHUMCULUK SANAYİ VE TİCARET ANONİM ŞİRKETİ

Samanlı Mahallesi, Yiğitler Caddesi, No: 28, YILDIRIM-BURSA (TR)

(85) -

(86) TR

(87) TR

(88) -

(89) TR

(81) III. AZ, BG, EG, EM, ES, FR, GE, HU, KG, MD, RO, RS, RU, SY, TR, UA

(72) HAMDİ ÇİFTÇİLER

SAMANLI MAH. YIGITLER CAD. NO :28 YILDIRIM, BURSA, Turkey

(54) 1. Logo

(55)

1



(11) DM/101479

(15) 2018 05 30

(22) 2018 05 30

(28) 1

(73) VALENTINO S.P.A.

Via Turati, 16/18, I-20121 Milano (IT)

(85) –

(86) EM, IT

(87) EM, IT

(88) EM, IT

(89) EM

(81) III. AZ, EM, GE, JP, KG, KR, RU, TJ, TR, UA, US

(72) SASSI Stefano

c/o VALENTINO S.p.A. Via Turati, 16/18, I-20121 Milano, Italy

(54) 1. Bag

(55)

(51) 03-01

(45) 2018/23 (2018 06 15)

1.1



1.2

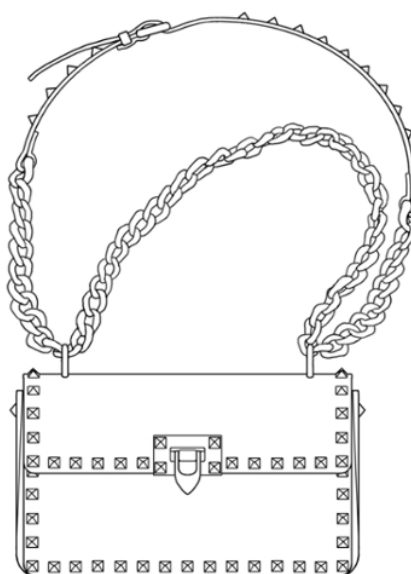

1.3

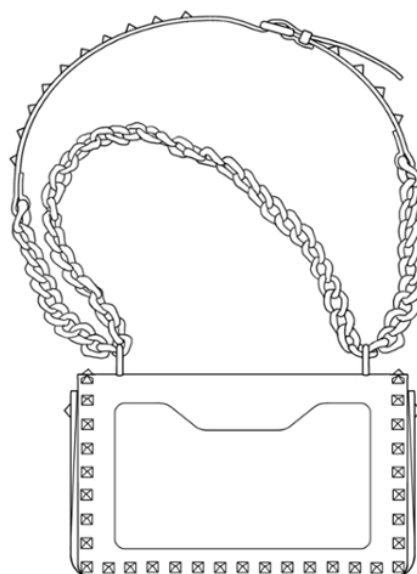

1.4



1.5



1.6

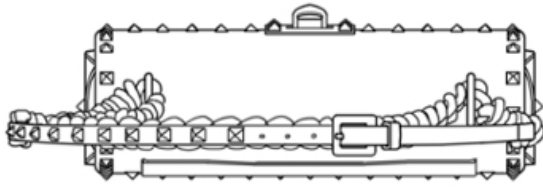

1.7

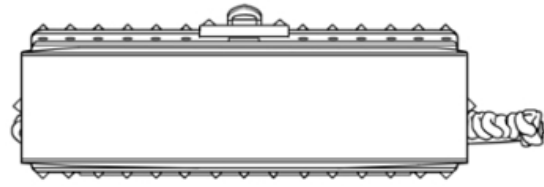

(11) DM/101480

(15) 2018 05 30

(22) 2018 05 30

(28) 2

(73) VALENTINO S.P.A.

Via Turati, 16/18, I-20121 Milano (IT)

(85) –

(86) EM, IT

(87) EM, IT

(88) EM, IT

(89) EM

(81) III. AZ, EM, GE, JP, KG, KR, RU, TJ, TR, UA

(72) SASSI Stefano

c/o VALENTINO S.p.A. Via Turati, 16/18, I-20121 Milano, Italy

(54) 1.-2. Shoes

(55)

(51) 02-04

(45) 2018/23 (2018 06 15)

1.1

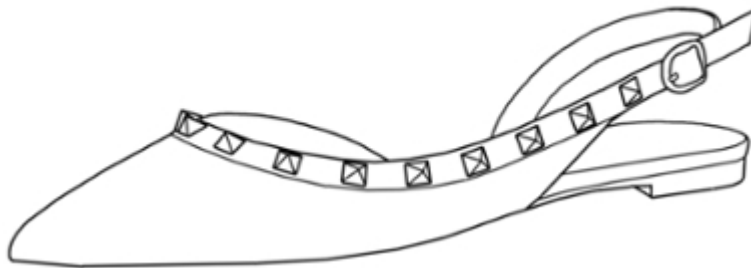

1.2

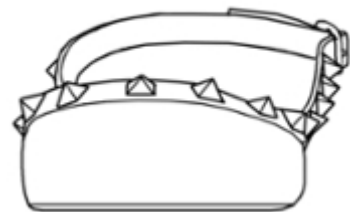

1.3

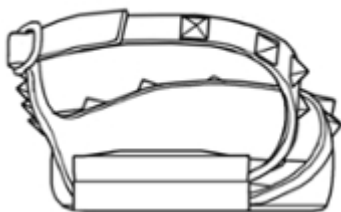

1.4



1.5

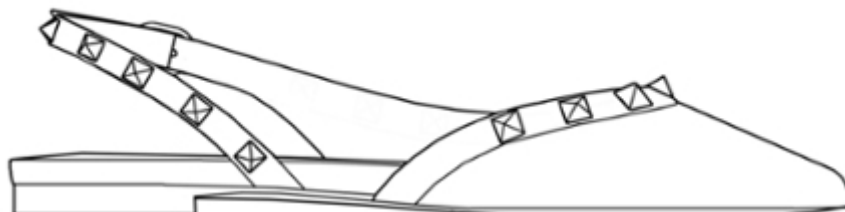

1.6

1.7

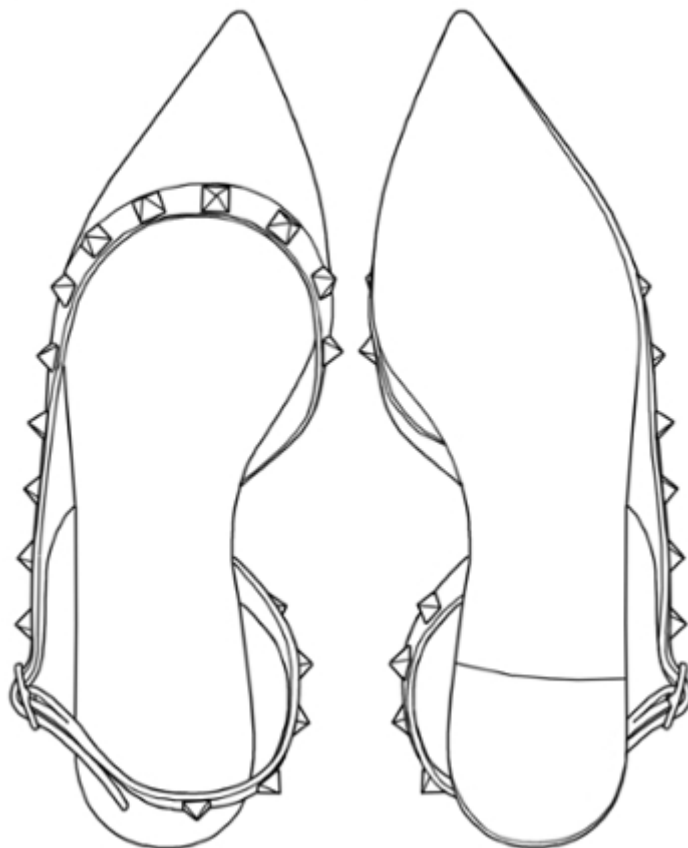

2.1

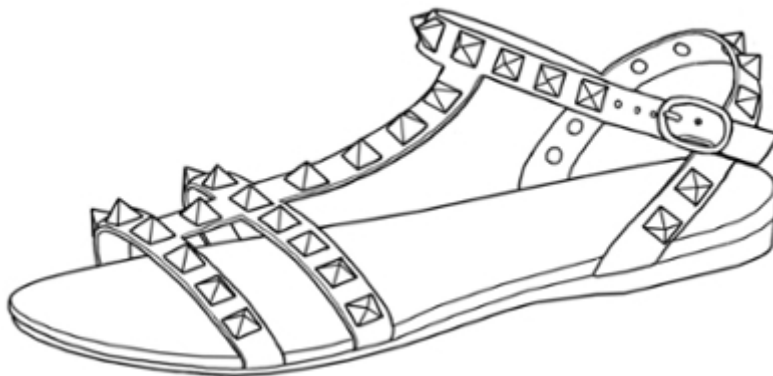

2.2

2.3

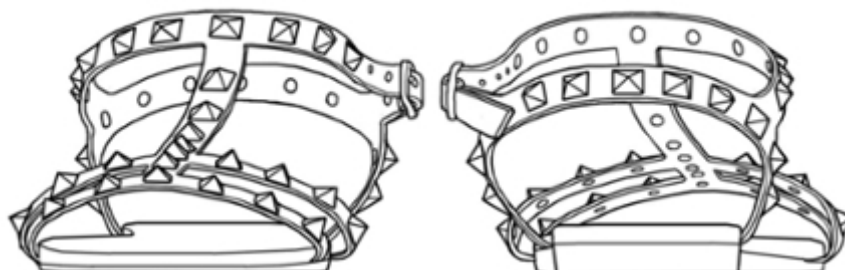

2.4

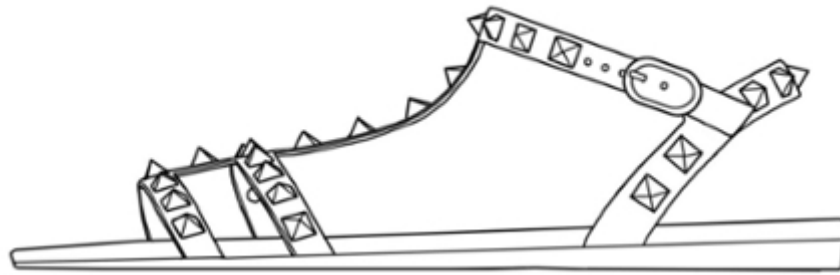

2.5

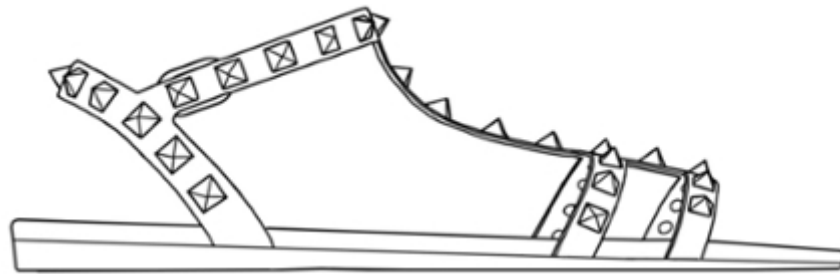

2.6

2.7

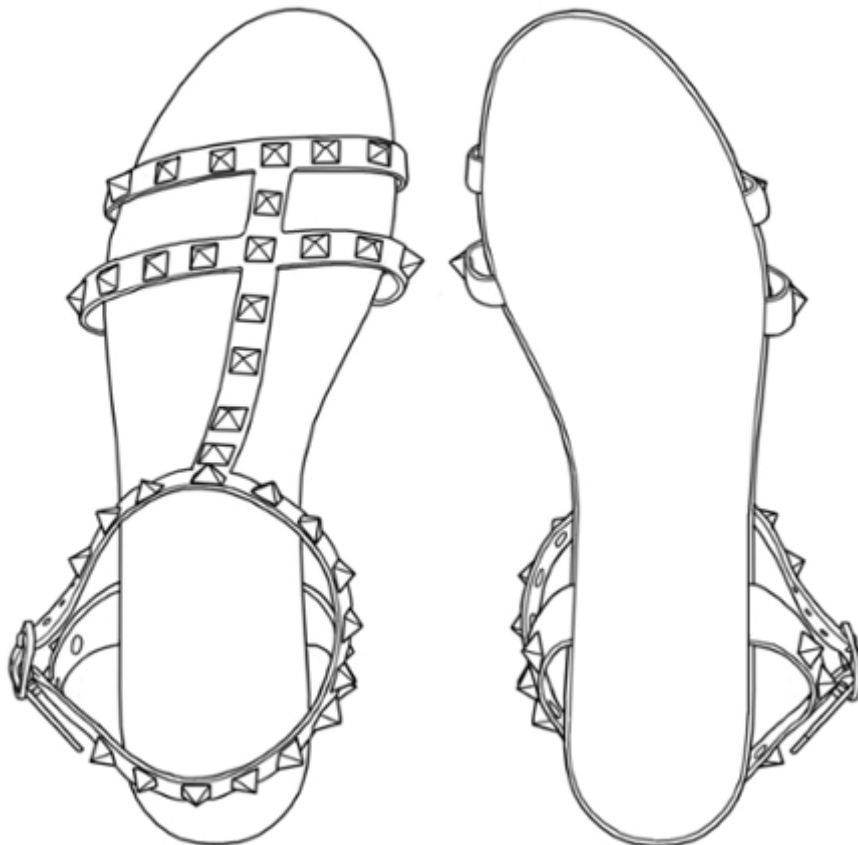

TRADEMARKS

APPLICATIONS FILED UNDER THE NATIONAL PROCEDURE APPROVED FOR REGISTRATION

The decision can be appealed at the Chamber of Appeal of Sakpatenti within 3 months from the publication or at the Mtskheta District Court Administrative Cases Board (Address: №17, Samkhedro St., Mtskheta), within 1 month following the publication.

(260) AM 2018 92697 A
(210) AM 92697
(220) 2017 06 09
(731) JSC "TBILCHEMPHARMA"
Tsuladzis q. 34, 0113, Tbilisi, Georgia
(740) Natia Matsaberidze
(540)

კასტოდერმი
КАСТОДЕРМ
CASTODERM

(511) 5

(260) AM 2018 92700 A
(210) AM 92700
(220) 2017 06 09
(731) JSC "TBILCHEMPHARMA"
Tsuladzis q. 34, 0113, Tbilisi, Georgia
(740) Natia Matsaberidze
(540)

კასტოდერმი- RED
КАСТОДЕРМ- RED
CASTODERM- RED

(511) 5

(260) AM 2018 92783 A
(210) AM 92783
(220) 2017 06 14
(731) Harrington Development Inc.
Elvira Mendez Street, Vallarino Bldg, 3rd
Floor, Panama, Republic of Panama, Republic
of Panama
(740) Givi Akopashvili
(540)



(591) White, silver, red, sky-blue, blue, golden
(531) 24.01.15; 25.01.01; 26.04.04; 26.04.24;
27.05.24; 29.01.15
(511) 34

(260) AM 2018 93839 A
(210) AM 93839
(220) 2017 08 22
(731) LTD "AISI"
I. Evdoshvilis q. 37, 1500, Gurjaani, Georgia
(740) Eter Mdivani
(540)



(591) Red, white and sky-blue
(531) 06.01.02; 08.01.18; 25.01.15; 28.19; 29.01.15
(526) გურჯაანი
(511) 30

(260) AM 2018 94977 A
(210) AM 94977
(220) 2017 11 07
(731) LTD "Credline"
Al. Kazbegis gamz. 10, Tbilisi, Georgia
(540)

LTD "Credline"

(511) 35

(260) AM 2018 94978 A
(210) AM 94978
(220) 2017 11 07
(731) LTD "Credline"
Al. Kazbegis gamz. 10, Tbilisi, Georgia
(540)



(591) Sky-blue, black, white
 (531) 26.04.18; 27.05.21; 29.01.13
 (511) 35

(260) AM 2018 95072 A
 (210) AM 95072
 (220) 2017 11 15
 (731) JSC "CITY LISING"
 Z. Paliashvilis q. 64, 0179, Tbilisi, Georgia
 (740) Giorgi Tsiklashvili
 (540)



(591) Red, grey
 (531) 28.19; 29.01.12
 (511) 36

(260) AM 2018 95073 A
 (210) AM 95073
 (220) 2017 11 15
 (731) N(N)LE Eliava Foundation in Georgia
 Bacteriophage Development Association
 L. Gotuas q.3, 0160, Tbilisi, Georgia
 (540)

**ელიავას ფაგოთერაპიის
 ცენტრი**

(511) 44

(260) AM 2018 95081 A
 (210) AM 95081
 (220) 2017 11 15
 (731) The Gillette Company LLC
 One Gillette Park, Boston, Massachusetts
 02127, USA
 (740) Merab Kvimsadze
 (540)

START

(591) Black-white
 (531) 27.05.05
 (511) 8

(260) AM 2018 95095 A
 (210) AM 95095
 (220) 2017 11 16
 (310) 2017-404
 (320) 2017 05 17
 (330) LI
 (731) Apple Inc.
 1, Infinite Loop, California, Cupertino,
 95014, USA

(740) Tamar Kochlamazashvili
 (540)

ARKIT

(591) Black-white
 (511) 9

(260) AM 2018 95214 A
 (210) AM 95214
 (220) 2017 11 28
 (731) Getz Pharma International FZ LLC
 Office No. 1307, 13th Floor, Al-Thuraya
 Tower 1, Dubai Media City, Dubai,
 United Arab Emirates

(740) Merab Kvimsadze
 (540)

ROVISTA

(591) Black-white
 (531) 27.05.01
 (511) 5

(260) AM 2018 95353 A
 (210) AM 95353
 (220) 2017 12 05
 (731) GENERAL MOTORS LLC
 300 Renaissance Center, City of Detroit,
 State of Michigan 48265-3000, USA
 (740) Giorgi Taktakishvili
 (540)

BLAZER

(591) Black-white
 (511) 12

(260) AM 2018 95406 A
 (210) AM 95406
 (220) 2017 12 06
 (731) Ivybridge Ventures Limited
 Lampuzas 1, Nicosia, 1095, Cyprus
 (740) Tamar Kochlamazashvili
 (540)



(591) Green, white, dark green
 (531) 05.03.13; 05.03.14; 28.05; 29.01.12
 (511) 3, 5

- (260) AM 2018 95480 A
 (210) AM 95480
 (220) 2017 12 11
 (731) LTD "Vazisubnis Mamuli"
 Marjanishvilis q. 7, 0102, Tbilisi,
 Georgia

(540)



- (591) Black, white, grey, golden and yellow
 (531) 05.07.10; 25.01.19; 28.19; 29.01.15
 (511) 33

- (260) AM 2018 95486 A
 (210) AM 95486
 (220) 2017 12 11
 (731) BMJ Industries FZ-LLC
 Al-Jazeera Al-Hamra, Ras Al Khaimah,
 United Arab Emirates

(740) Giorgi Kartvelishvili

(540)



- (591) Black-white
 (531) 27.05.01; 27.05.17; 27.07.01; 27.07.17
 (511) 34

- (260) AM 2018 95551 A
 (210) AM 95551
 (220) 2017 12 18
 (731) Philip Morris Brands Sàrl
 Quai Jeanrenaud 3, Nevshateli, 2000,
 Switzerland

(740) Shalva Gvaramadze

(540)



- (591) Black, gray, different tones of lilac and white
 (531) 02.01.21; 03.01.08; 10.01.25; 27.05.01;
 27.05.19;
 27.05.24; 29.01.13
 (511) 34

- (260) AM 2018 95655 A
 (210) AM 95655
 (220) 2017 12 25
 (731) FCA US LLC
 1000 Chrysler Drive, City of Auburn Hills,
 State of Michigan 48326, USA

(740) Giorgi Taktakishvili

(540)

RUBICON

- (591) Black-white
 (511) 12

- (260) AM 2018 95660 A
 (210) AM 95660
 (220) 2017 12 25
 (731) LTD "SEVTEX"
 B. Keburias das. III, q. 5a, 0157, Tbilisi,
 Isani-Samgoris r-ni, Georgia

(540)

BRUCE

- (591) Black-white
 (511) 35

- (260) AM 2018 95920 A
 (210) AM 95920
 (220) 2018 01 10
 (731) LTD "MARNISKARI"
 Apakidzis q. 11, b. 125, Tbilisi, Georgia

(740) Davit Gogidze
(540)

Maxi Макси

(591) Black-white
(511) 33

(260) AM 2018 95984 A
(210) AM 95984
(220) 2018 01 16
(731) LTD "DABI"
Pirosmanis q. 6, 0164, Tbilisi, Georgia
(740) Lavrenti Kiparoidze
(540)



(591) Dark and light green, white
(531) 26.01.19; 26.01.21; 26.11.12; 27.05.01; 28.05;
28.19; 29.01.13
(511) 29, 30, 31

(260) AM 2018 95986 A
(210) AM 95986
(220) 2018 01 16
(731) Ana Salukvadze
S. Tsintsadzis q. 18, 0160 Tbilisi, Georgia
(540)



SHAVI

(591) Black-white
(531) 02.01.01; 02.01.23; 02.03.01; 02.03.23
(511) 25

(260) AM 2018 96005 A
(210) AM 96005
(220) 2018 01 16

(731) JSC "GEFA"
Sanapiros q. 6, 0108, Tbilisi, Georgia
(740) Salome Jeladze
(540)



ESTHÉTIQUE BEAUTÉ

ესთეტიკური სილამაზის ოთახი

BEAUTY CARE SHOW ROOM

(591) Grey
(531) 03.13.01; 05.05.20; 27.05.01; 27.05.10; 28.19
(511) 44

(260) AM 2018 96077 A
(210) AM 96077
(220) 2018 01 23
(731) LLC "BORAN CONSTRUCTION"
Kandelakis q. 8, b. 56, 0160, Tbilisi,
Georgia
(540)



(591) Black-white
(531) 26.01.01; 26.01.03; 26.01.10; 26.01.18;
27.05.21
(511) 2, 3, 4, 6, 7, 8, 10, 11, 13, 15, 16, 17, 18,
19, 20, 21, 22, 23, 24, 25, 26, 27, 28, 29,
31, 32, 33, 34, 36, 38, 39, 40, 41, 42, 43, 45

(260) AM 2018 96078 A
(210) AM 96078
(220) 2018 01 23
(731) LLC "BORAN CONSTRUCTION"
Kandelakis q. 8, b. 56, 0160, Tbilisi,
Georgia
(540)

ბორან

Boran

(591) Black-white
(511) 2, 3, 4, 5, 6, 7, 8, 9, 10, 11, 12, 13, 15, 16,
17, 18, 19, 20, 21, 22, 23, 24, 25, 26, 27, 28,
29, 30, 31, 32, 33, 34, 35, 36, 38, 37,
38, 39, 40, 41, 42, 43, 44, 45

(260) AM 2018 96117 A
(210) AM 96117
(220) 2018 01 25
(731) Al-Furat for Tobacco and Cigarettes Industry Co.
Al-Basrah Street, Jabal Amman, 5th Circle,
P.O. Box 941936, Amman, 11194, Jordan
(740) Giorgi Kartvelishvili
(540)

ESCAPE

(591) Black-white
(511) 34

(260) AM 2018 96158 A
(210) AM 96158
(220) 2018 01 30
(731)) Hankook Tire Worldwide Co., Ltd
N647-15, Yoksam-dong, Kangnam-gu,
Seoul, Republic of Korea
(740) Merab Kvimsadze
(540)

 **HANKOOK** Innovative Technologies

(591) Black-white
(531) 26.13.25; 27.05.10; 27.05.17
(511) 7, 11, 12, 35

REGISTERED TRADEMARKS

(111) M 2018 29920 R
(151) 2018 07 23
(181) 2028 07 23
(260) AM 2016 89219 A
(220) 2016 11 01
(732) Luxottica Group S.p.A.
Piazzale Cadorna 3, Milano 20123, Italy

(111) M 2018 29921 R
(151) 2018 07 23
(181) 2028 07 23
(260) AM 2016 89220 A
(220) 2016 11 01
(732) Luxottica Group S.p.A.
Piazzale Cadorna 3, Milano 20123, Italy

(111) M 2018 29922 R
(151) 2018 07 23
(181) 2028 07 23
(260) AM 2017 90695 A
(220) 2017 02 06
(732) Ana Bukia
K. Marksis q. 12. b. 39, Sokhumi, Georgia

TRADEMARKS REGISTERED ACCORDING TO THE ACCELERATED PROCEDURE

The decision can be appealed at the Chamber of Appeal of Sakpatenti within 3 months from the publication.

(111) M 2018 29907 R
(151) 2018 07 17
(181) 2028 07 17
(210) AM 98237
(220) 2018 06 28
(732) LTD "NAMLANWINE TRADE"
Uiaraghos q. II gas. 3a, 0101, Tbilisi,
Georgia
(540)

**ნამის
Nama**

(591) Black-white
(511) 11, 12, 35

(111) M 2018 29908 R
(151) 2018 07 17
(181) 2028 07 17
(210) AM 98382
(220) 2018 07 05
(732) British American Tobacco (Brands) Inc.
(a Delaware corporation)
251 Little Falls Drive, Suite 100, Delaware,
Wilmington, 19808-1674, USA
(740) Tamar Kochlamazashvili
(540)

KENT SILVER

(591) Black-white
(511) 34

(111) M 2018 29909 R
(151) 2018 07 17
(181) 2028 07 17
(210) AM 98383
(220) 2018 07 05
(732) British American Tobacco (Brands) Inc.
(a Delaware corporation)
251 Little Falls Drive, Suite 100, Delaware,
Wilmington, 19808-1674, USA
(740) Tamar Kochlamazashvili
(540)

KENT NAVY BLUE

(591) Black-white
(511) 34

(111) M 2018 29910 R
(151) 2018 07 17
(181) 2028 07 17
(210) AM 98384
(220) 2018 07 05
(732) British American Tobacco (Brands) Inc.
(a Delaware corporation)
251 Little Falls Drive, Suite 100, Delaware,
Wilmington, 19808-1674, USA
(540)

KENT MODE BLUE

(591) Black-white
(511) 34

(111) M 2018 29911 R
(151) 2018 07 17
(181) 2028 07 17
(210) AM 98385
(220) 2018 07 05
(732) British American Tobacco (Brands) Inc.
(a Delaware corporation)
251 Little Falls Drive, Suite 100, Delaware,
Wilmington, 19808-1674, USA
(740) Tamar Kochlamazashvili
(540)

KENT MODE SILVER

(591) Black-white
(511) 34

(111) M 2018 29912 R
(151) 2018 07 17
(181) 2028 07 17
(210) AM 98386
(220) 2018 07 05
(732) British American Tobacco (Brands) Inc.
(a Delaware corporation)
251 Little Falls Drive, Suite 100, Delaware,
Wilmington, 19808-1674, USA
(740) Tamar Kochlamazashvili
(540)

KENT NANO BLUE

(591) Black-white
(511) 34

(111) M 2018 29913 R
(151) 2018 07 17
(181) 2028 07 17

(210) AM 98387
 (220) 2018 07 05
 (732) British American Tobacco (Brands) Inc.
 (a Delaware corporation)
 251 Little Falls Drive, Suite 100, Delaware,
 Wilmington, 19808-1674, USA
 (740) Tamar Kochlamazashvili
 (540)

KENT NANO SILVER

(591) Black-white
 (511) 34

(111) M 2018 29914 R
 (151) 2018 07 17
 (181) 2028 07 17
 (210) AM 98388
 (220) 2018 07 05
 (732) British American Tobacco (Brands) Inc.
 (a Delaware corporation)
 251 Little Falls Drive, Suite 100, Delaware,
 Wilmington, 19808-1674, USA
 (740) Tamar Kochlamazashvili
 (541)

KENT NANO WHITE

(591) Black-white
 (511) 34

(111) M 2018 29915 R
 (151) 2018 07 17
 (181) 2028 07 17
 (210) AM 98394
 (220) 2018 07 06
 (732) Nikoloz Tsiklauri
 Burdzglas q. 80, b. 7, 0194, Tbilisi, Georgia
 (540)



(591) Black-white
 (531) 24.09.02; 24.09.12; 27.05.01; 27.05.15;
 27.05.22
 (511) 43

(111) M 2018 29916 R
 (151) 2018 07 17
 (181) 2028 07 17
 (210) AM 98381
 (220) 2018 07 05
 (732) British American Tobacco (Brands) Limited
 Globe House, 4 Temple Place, London,
 WC2R 2PG, United Kingdom

(740) Tamar Kochlamazashvili
 (541)

iSWITCH

(591) Black-white
 (511) 34

(111) M 2018 29917 R
 (151) 2018 07 17
 (181) 2028 07 17
 (210) AM 98239
 (220) 2018 06 29
 (732) JSC "Georgian Beer Company"
 Sop Saguramo, 3311, Mtskheta, Georgia
 (540)

NINKASI

ნინკასი

НИНКАСИ

(591) Black-white
 (511) 32

(111) M 2018 29999 R
 (151) 2018 07 25
 (181) 2028 07 25
 (210) AM 98182
 (220) 2018 06 22
 (732) LTD "SAH & CO"
 T. Abuladzis q. 32, b. 17, 0162, Tbilisi,
 Georgia
 (740) Besarion Urumashvili
 (540)



(591) Gray, blue, white, green, yellow,
 orange, crimson
 (531) 04.05.05; 04.05.21; 05.07.15; 25.01.19; 28.19;
 29.01.15
 (511) 32

(111) M 2018 30000 R
 (151) 2018 07 25
 (181) 2028 07 25
 (210) AM 98213
 (220) 2018 06 26
 (732) LTD "SHEVARDENTI"
 Melikishvilis q. 49, 0178, Tbilisi,
 Georgia
 (740) Vakhtang Torotadze

(541)

MY WAY

(511) 39

(111) M 2018 30001 R

(151) 2018 07 27

(181) 2028 07 27

(210) AM 98423

(220) 2018 07 12

(732) LTD "EUROLEX"

A. Tseretlis gamz. 118, 0119, Tbilisi,
Georgia

(540)



(591) Red, black, white, light green

(531) 25.01.19; 26.13.25; 27.05.01; 27.05.10;
27.05.24; 27.05.25; 28.19; 29.01.15

(511) 33

(111) M 2018 30002 R

(151) 2018 07 30

(181) 2028 07 30

(210) AM 98218

(220) 2018 06 27

(732) LTD "NEW PHARM GROUP"

I. Evdoshvilis q. 18, Office room 2,
0154, Tbilisi, Didube district, Georgia

(540)

ეზოფლუქსი**Ezoflux****Эзофлукс**

(511) 5

(111) M 2018 30003 R

(151) 2018 07 30

(181) 2028 07 30

(210) AM 98547

(220) 2018 07 17

(732) LTD "NEW PHARM GROUP"

I. Evdoshvilis q. 18, Office room 2,
0154, Tbilisi, Didube district, Georgia

(540)

ლებეგარდი**Lebegard****Лебегард**

(511) 5

(111) M 2018 30004 R

(151) 2018 07 31

(181) 2028 07 31

(210) AM 98557

(220) 2018 07 18

(732) British American Tobacco (Brands) Inc.

(a Delaware corporation)

251 Little Falls Drive, Suite 100, Delaware,
Wilmington, 19808-1674, USA

(740) Tamar Kochlamazashvili

(540)



(591) Black-grey

(531) 26.01.01; 26.01.12; 26.04.10; 26.04.12;
26.04.22; 26.04.24; 26.11.09; 27.05.24

(511) 34

(111) M 2018 30005 R

(151) 2018 08 02

(181) 2028 08 02

(210) AM 98662

(220) 2018 07 23

(732) LTD "SAMI DZMA"

Gagarinis q. 13s, 0160, Tbilisi, Georgia

(540)



(591) Green and white

(531) 02.01.23; 02.03.23; 04.05.03; 28.19; 29.01.03

(511) 35

(111) M 2018 30006 R

(151) 2018 08 02

(181) 2028 08 02

(210) AM 98571

(220) 2018 07 19

(732) LTD "METAMORFOZA"

Bokuchavas q. 174, Zagreb, 95, Croatia

(740) Amza Kakauridze

(540)



**MUSEUM OF
ILLUSIONS**

(591) Black-white
(531) 26.13.25; 27.05.01
(511) 41

(111) M 2018 30007 R
(151) 2018 08 03
(181) 2028 08 03
(210) AM 98445
(220) 2018 07 16
(732) JSC "Gomi Spirit and Vodka Company"
Sop. Gomi, 5702, Khashuri, Georgia
(740) Dimitri Dزامukashvili
(540)

BOOMERANG
ბუმერანგი

(591) Black-white
(511) 32, 33

(111) M 2018 30008 R
(151) 2018 08 03
(181) 2028 08 03
(210) AM 98763
(220) 2018 07 31
(732) LTD "ARSON RECHNOLOGY"
Sop. Untsa, Adigeni district, Georgia
(540)

ARSON

(591) Black-white
(531) 27.05.01; 27.05.17
(511) 9, 35

(111) M 2018 30009 R
(151) 2018 08 03
(181) 2028 08 03
(210) AM 98576
(220) 2018 07 19
(732) JSC "GEORGIAN BEER COMPANY"
Sop. Saguramo, 3311, Mtskheta, Georgia
(540)

ზენი
zeni
ЗЕНИ

(591) Black-white
(511) 32

(111) M 2018 30010 R
(151) 2018 08 03
(181) 2028 08 03
(210) AM 98577
(220) 2018 07 19
(732) JSC "GEORGIAN BEER COMPANY"
Sop. Saguramo, 3311, Mtskheta, Georgia
(540)

ზენია
zenia
ЗЕНИЯ

(591) Black-white
(511) 32

(111) M 2018 30011 R
(151) 2018 08 03
(181) 2028 08 03
(210) AM 98578
(220) 2018 07 19
(732) JSC "GEORGIAN BEER COMPANY"
Sop. Saguramo, 3311, Mtskheta, Georgia
(540)

აკოლა
acola
АКОЛА

(591) Black-white
(511) 32

(111) M 2018 30012 R
(151) 2018 08 06
(181) 2028 08 06
(210) AM 98452
(220) 2018 07 17

(732) LTD "GEORGIA"
Tsinanuris q. 26, 0112, Tbilisi, Georgia
(540)



(591) Sky-blue, white, grey
(531) 26.01.05; 27.05.01; 29.01.13
(511) 10

INTERNATIONAL TRADEMARKS FOR WHICH A DECISION ON GRANTING PROTECTIONS IS TAKEN

The decision can be appealed at the Chamber of Appeal of Sakpatenti within 3 months from the publication or at the Mtskheta District Court Administrative Cases Board (Address: №17, Samkhedro str., Mtskheta), within 1 month following the publication.

(260) AM 2018 93339 A

(800) 1355852

(151) 2017 04 07

(891) 2017 04 07

(731) Aktsionernoie obshchestvo Gruppa SverdlovElektro
ul. Cherniakhovskogo, 61, Ekaterinburg,
RU-620010 Sverdlovskaya Oblast, Russian
Federation

(540)

SVEL

(591) Black, white

(531) 27.05.17

(511)

6 – Poles of metal for power lines; brackets of metal for building; props of metal; masts of metal; staircases of metal; railings of metal.

7 – Expansion tanks [parts of machines]; housings [parts of machines]; stators [parts of machines]; brushes [parts of machines]; generators of electricity; dynamos; alternators; electric motors for machines; steam engine boilers; boiler tubes [parts of machines]; turbines, other than for land vehicles.

17 – Dielectrics [insulators]; insulators; insulators for electric mains.

19 – Brackets, not of metal, for building; staircases, not of metal; rails, not of metal; poles, not of metal, for power lines.

37 – Installation, repair and maintenance of machinery; construction; construction consultancy; building construction supervision; construction information; repair information.

42 – Construction drafting; technical research; material testing, including testing of insulating oil for transformers; engineering; computer software design; quality control; surveying; consultancy in the field of energy-saving; scientific laboratory services; scientific research; technological consultancy; technical writing; computer-aided industrial testing.

(260) AM 2018 94114 A

(800) 1263441

(151) 2015 04 28

(891) 2017 06 29

(731) Fritz Egger GmbH & Co. OG

Weiberndorf 20, A-6380 St. Johann in Tirol,
Austria

(540)

PERFECTSENSE

(591) Black, white

(511)

17 – Plastics in extruded form for use in manufacture, plastics laminates (semi-processed products).

20 – Furniture and furniture parts made of fibre-board or chipboard such as worktops, furniture facing elements, furniture carcass parts, edge elements; laminated boards and plastics laminates for use in furniture-making.

27 – Floor and wall coverings (not of textile); underlay mats for laminated floors.

(260) AM 2018 94273 A

(800) 909972

(151) 2006 12 18

(891) 2017 07 18

(731) Hedoga AG

Oberdorf 4, CH-9055 Bühler, Switzerland

(540)

OSA

(591) Black, white

(511)

5 – Pharmaceutical preparations, including preparations for the treatment of odontalgia (toothache) in babies.

(260) AM 2018 94278 A

(800) 1365548

(151) 2017 04 21

(891) 2017 04 21

(731) Tongcheng Biyu Brush Co., Ltd
Fangang-Town Stretch of Hean Road,
Tongcheng City Anhui Province, China

(540)

BI YU

(591) Black, white

(531) 27.05.17

(511)

21 – Electric brushes, except parts of machines; brushes for dishwashing; animal bristles [brush-

ware]; material for brush-making; scrubbing brushes.

(260) AM 2018 94284 A

(800) 1365600

(151) 2017 07 19

(891) 2017 07 19

(731) Bedgear LLC

110 Bi-County Blvd, Suite 101, Farmingdale
NY 11735, USA

(540)

PERFORMANCE

(591) Black,white

(511)

35 – Retail store and online ordering services featuring pillows, pillow protectors, sheets, mattresses and other bedding essentials; retail and on-line store services featuring a personalized fitting tool for selecting pillows, pillow protectors, sheets, mattresses and other bedding essentials.

(260) AM 2018 94489 A

(800) 1368011

(151) 2017 03 03

(891) 2017 03 03

(731) VIENNA INSURANCE GROUP AG

Wiener Versicherung Gruppe
Schottenring 30, A-1010 Wien, Austria

(540)



(591) Red, black, white and grey

(531) 05.05.20; 26.11.08; 27.05.11; 29.01.12

(511)

36 – Insurance; financial affairs; monetary affairs; real estate affairs.

(260) AM 2018 94491 A

(800) 1367535

(151) 2017 01 13

(891) 2017 01 13

(731) Subway IP Inc.

700 South Royal Poinciana Blvd. Ste 500
Miami Springs FL 33166, USA

(540)



(591) Black and white

(531) 24.15.13

(511)

29 – Salads made with various ingredients, namely fruit, garden and vegetable salads; milk; fruit; potato chips; processed apples.

30 – Sandwiches and wraps for consumption on or off the premises; baked goods for consumption on or off the premises; snacks namely pretzels, corn chips, tortilla chips, puffed corn curls, popped corn, cakes, pastries, cookies; dressings for salads, salad dressings used on salads, combination meals consisting primarily of a sandwich, a snack and for consumption on or off the premises, coffee, tea, iced tea (term too vague in the opinion of the International Bureau – Rule 13(2)(b) of the Common Regulations).

32 – Beverages (term too vague in the opinion of the International Bureau – Rule 13(2)(b) of the Common Regulations), fruit juices, vegetable juices, soft drinks, bottled drinking water, tea flavored beverages, coffee flavored beverages, for consumption on or off the premises; soft drink.

35 – Consumer loyalty services for commercial, promotional and advertising purposes, namely providing an incentive rewards programs for customers through the issuance and processing of customer loyalty points and credits, and loyalty cards for the purchase of goods and services, and providing contests, sweepstakes, games and prizes; administration of an incentive rewards program enabling participants to obtain discounts and complimentary goods and services through membership; online ordering services in the field of restaurant take-out and delivery; retail services relating to food and drink.

43 – Restaurant services, namely providing of food and beverages for consumption on and off the premises; restaurant services featuring sandwiches; catering services; eat-in and take-out food restaurant services; restaurant featuring home delivery.

(260) AM 2018 94493 A

(800) 1368012

(151) 2017 03 03

(891) 2017 03 03

(731) VIENNA INSURANCE GROUP AG

Wiener Versicherung Gruppe
Schottenring 30, A-1010 Wien, Austria

(540)



(591) Red, black, white and grey.

(531) 05.05.20; 26.11.08; 27.05.10; 27.05.15;
27.05.17; 29.01.13

(511)

36 – Insurance; financial affairs; monetary affairs;
real estate affair.

(260) AM 2018 94494 A

(800) 1367553

(151) 2017 03 24

(891) 2017 03 24

(731) OBO Bettermann GmbH & Co. KG

Hüingser Ring 52 58710 Menden, Germany

(540)

OBO

(591) Black and white

(511)

6 – Small items of metal hardware, welding bolts, metal welding rods for making bolts, materials for electrotechnical installations, namely clips of metal for cables and pipes, conduit clips, cable clamps, sectional rails, slotted strip iron, sheet metal for cable channels, pegs of metal, nails, threaded bolts; materials for the installation of television and vhf aerials, namely mast fittings; metal materials for bathroom installations, namely clips, pipes, series clips for pipes, brackets for gutters, radiator brackets, radiator supports, clips for heating pipes, suspensions for pipes, construction elements for lightning protection devices, namely earth clips; wall, ceiling and underfloor trunking, shaped parts of metal for installation purposes, cable trays and cable ladders of metal, other than electric, cable fittings, earthquake-proof cable carrying systems of metal, other than electric.

9 – Electrotechnical installation material, namely junction boxes, cable boxes, cable separators, grounding materials, including earthing rods, pipes and elements driven into the ground; installation elements for lightning protection equipment, namely air terminal rods, roof ducts, conduit supports, flat and round conductors, earthing devices, connectors, isolating couplings; electric apparatus to protect against overvoltage; electric bolt welding transformers; electric measuring, signalling and checking (supervision) apparatus and instruments, apparatus for recording, transmission or reproduction of electrical signals; magnetic data carriers, data processing equipment and computers; cable carrying systems of metal designed to keep electrical systems functioning in case of fire; electric boxes of plastic; cable trays and cable ladders of metal for electric cables, cable fittings for electric cables, earthquake-proof cable carrying systems of metal for electric cables, cable conduits for electric cables, cable ways and routings of plastic for installation purposes for electric cables; screwed cable glands of plastic for electric cables.

20 – Electrotechnical installation material, namely clips of plastic for cables and pipes, pegs of plastic; non-electric cable conduits, cable boxes; cable ways and routings of plastic for installation purposes for non-electric cables; screwed cable glands of plastic for non-electric cables.

(260) AM 2018 94495 A

(800) 1368412

(151) 2016 04 13

(891) 2016 04 13

(731) UPL Ltd

Uniphos House, Madhu Park, 11th Road,
Khar (West), Mumbai 400 052, Maharashtra,
India

(540)

QUICKPHLO

(591) Black, white

(511)

5 – Pesticides including insecticide, fungicide, weedicide, herbicides and preparation for killing weeds and destroying vermin.

(260) AM 2018 94496 A

(800) 1368013

(151) 2017 03 03

(891) 2017 03 03

(731) VIENNA INSURANCE GROUP AG

Wiener Versicherung Gruppe
Schottenring 30, A-1010 Wien, Austria

(540)

VIG 
VIENNA INSURANCE GROUP
für dein besseres Leben

(591) Red, black, white and grey.

(531) 05.05.20; 26.11.08; 27.05.01; 27.05.10;
27.05.11; 27.05.17; 29.01.13

(511)

36 – Insurance; financial affairs; monetary affairs;
real estate affairs.

(260) AM 2018 94498 A

(800) 1367572

(151) 2017 05 23

(891) 2017 05 23

(731) Sebapharma GmbH & Co. KG

Binger Str. 80 56154 Boppard, Germany

(540)

sebamed PRO!

(591) Black and white

(511)

3 – Cosmetics; essential oils; oils for cosmetic purposes; hair lotions; dentifrices; soaps; shampoos; cosmetic preparations for cleaning and care of skin, hair, lips; cosmetic preparations for the external application for skin impurities; tissues impregnated with cosmetic lotions; products for baby care and children care, namely cleansing bars, foam baths, care baths, preparations for care of skin, skin creams, skin care oils, tissues impregnated with cosmetic oils, moist tissues and shampoos for children, powder for children, creams for children; preparations for cleansing and care of the body; perfumery; facial tonics; cosmetic facial cleansers and facial care products; bactericidal facial cleansers and facial care products for cosmetic purposes having an effect on spots; deodorants and antiperspirants (toiletty preparations); deodorants for personal use; bath preparations and shower bath preparations; bath preparations for cosmetic purposes; bath extracts on the basis of officinal plants and/or herbs for cosmetic purposes; preparations for foot care; sun-protecting and sun-tanning preparations; skin care preparations in form of lotions, creams and gels; cosmetic preparations for care of skin; anti-aging skincare preparations; after-sun skin balms; after-sun sprays; shower foams; shower creams; shower soaps; bath gels and shower gels not for medical purposes; shower oils.

5 – Medicines; chemical preparations for medicinal purposes; pharmaceutical and veterinary preparations; pharmaceutical products and preparations for medicinal purposes, healthcare and hygiene purposes; pharmaceutical drugs; sanitary preparations for medical purposes; pharmaceutical preparations for skin diseases, in particular skin cleansers being special preparations for seborrhoeic conditions and microbial dermatoses (in particular solid, liquid, being lotions, creams, shampoos, sprays, gels, foams) being pharmaceutical preparations for skin diseases; bactericidal facial cleansers and facial care products for pharmaceutical purposes having an effect on spots; medicinal creams for children; tissues impregnated with pharmaceutical lotions; bath extracts for pharmaceutical purposes; bath extracts on the basis of officinal plants and/or herbs for pharmaceutical purposes; pharmaceutical sun-tanning preparations and preparations for treating sunburn; food for babies; dietetic preparations for medical use; food supplements; food supplements for medical purposes; mineral food supplements; vitamin preparations; medicinal drinks; dietetic beverages adapted for medical purposes; pharmaceutical tonics; slimming preparations for medical purposes; tea for medical purposes; dietetic milk products for medical purposes; oils for medical purposes; fennel honey for medical purposes; plasters; medical plasters; haemostatic plasters;

haemostatic sprays; material for dressings, medical and surgical dressings; medical dressings; medical spray dressings; plasters and dressings in the form of spray dressings; plasters and materials for dressings impregnated with pharmaceuticals, pharmaceutical agents or health care preparations; tissues, moist tissues, pads, textile materials, impregnated with pharmaceuticals; tissues, moist tissues, pads, textile materials, impregnated with pharmaceutical agents; tissues, moist tissues, pads, textile materials, impregnated with health care preparations; disinfectants; test strips for medical purposes.

(260) AM 2018 94499 A

(800) 1368014

(151) 2017 03 03

(891) 2017 03 03

(731) VIENNA INSURANCE GROUP AG

Wiener Versicherung Gruppe

Schottenring 30, A-1010 Wien, Austria

(540)



(591) Red, black, white and grey.

(531) 05.05.20; 26.11.08; 27.05.01; 27.05.10;
27.05.17; 29.01.12

(511)

36 – Insurance; financial affairs; monetary affairs; real estate affairs.

(260) AM 2018 94500 A

(800) 1368481

(151) 2017 07 11

(891) 2017 07 11

(731) Helsinn Healthcare SA

Via Pian Scairolo 9, CH-6912 Lugano,
Switzerland

(540)



(591) Blue, gray, orange, purple and black

(531) 02.07.23; 04.05.04; 29.01.15

(511)

5 – Pharmaceutical products, veterinary products; sanitary products for medical purposes; dietetic substances for medical use, food for babies; plasters, materials for dressings; material for dental fillings and dental impressions; disinfectants; products for destroying vermin; fungicides, herbicides.

40 – Treatment and transformation of pharmaceutical products for others.

42 – Research and development of pharmaceutical products, scientific and industrial research for the development of medicines and active ingredients, as well as consultancy in the field of chemical and pharmaceutical technology; engineering services, including expertise in the field of chemical and pharmaceutical technology.

45 – Reviewing standards and practices to ensure compliance with pharmaceutical laws and rules, and consultancy relating to regulatory compliance in the pharmaceutical field; licensing of intellectual property in the field of chemical and pharmaceutical technology; exploitation of intellectual property rights, particularly licensing of intellectual property, including know-how in the field of chemical and pharmaceutical technology.

(260) AM 2018 94506 A

(800) 1368049

(151) 2017 06 22

(891) 2017 06 22

(731) Santen Pharmaceutical Co., Ltd
3-9-19, Shimoshinjo, Higashiyodogawa-ku,
Osaka 533-8651, Japan

(540)

КОСОНТ

(591) Black, white

(511)

5 – Ophthalmic preparations.

(260) AM 2018 94511 A

(800) 1367863

(151) 2016 11 16

(891) 2016 11 16

(731) Voronina Liudmyla Matviivna
pr – kt Valeriia Lobanovskoho, b.12. kv. 89
m. Kviv, 03037, Ukraine

(540)

**AQUA
JABA**

(591) Black and white

(531) 27.05.17; 27.05.19

(511)

44 – Health counseling; massage; alternative medicine services; public bath services for hygiene purposes; aromatherapy services; health spa services; health center services; convalescent home services; opticians' services; beauty salon services; sanatorium services; sauna services; Turkish bath services; therapy services.

(260) AM 2018 94512 A

(800) 1368061

(151) 2017 08 08

(891) 2017 08 08

(731) ARIAD Pharmaceuticals Inc.
40 Landsdowne Street, Cambridge,
MASSACHUSETTS 02139, USA

(540)

EVOBRIG

(591) Black, white

(511)

5 – Pharmaceutical preparations for human use, namely, for the treatment of hematological malignancies, cancer, auto-immune diseases and disorders and inflammatory diseases and disorders; pharmaceutical preparations for the treatment of cancer.

(260) AM 2018 94513 A

(800) 1367871

(151) 2017 02 06

(891) 2017 02 06

(731) QMARO LIMITED
Nicu Georgiu, 6, BLOCK C, 7th floor,
Office 703 CY-1095 Nicosia, Cyprus

(540)

MILOAN

(591) Black and white

(531) 27.05.17

(511)

35 – Providing business information via a web site; provision of an on-line marketplace for buyers and sellers of goods and services; web indexing for commercial or advertising purposes; commercial intermediation services; layout services for advertising purposes; commercial information and advice for consumers [consumer advice shop]; price comparison services; presentation of goods on communication media, for retail purposes; commercial intermediation services.

36 – Instalment loans; brokerage; credit bureau services; banking; real estate appraisal; mutual funds; capital investment; surety services; exchanging money; safe deposit services; loans [financing]; factoring; financing services; financial management; pawnbrokerage; financial analysis;

antique appraisal; art appraisal; financial consultancy; processing of credit card payments; processing of debit card payments; electronic funds transfer; financial information; jewellery appraisal; numismatic appraisal; stamp appraisal; deposits of valuables; financial sponsorship; online banking; lending against security.

38 – Electronic bulletin board services [telecommunications services].

(260) AM 2018 94514 A

(800) 1367885

(151) 2017 07 21

(891) 2017 07 21

(731) Fintrax Group Holdings Limited
Martin House, IDA Business Park Dangan,
Galway, Ireland

(540)



(591) Blue, orange, grey and white

(531) 01.05.01; 01.05.15; 25.07.20; 27.05.10;
29.01.13

(511)

36 – Tax refund processing and payment services; processing and paying refunds in respect of sales tax and value added tax to tourists; electronic value added tax refund payment processing services, credit card value added tax payment refund processing services; direct deposit value added tax payment refund processing services; electronic processing of value added tax refund payments via the internet; value added tax cash refund transaction processing services; financial information and consultancy services relating to tax refunds.

(260) AM 2018 94515 A

(800) 1368132

(151) 2017 03 23

(891) 2017 03 23

(731) ERA a.s.

Průmyslová 387, CZ-530 03 Pardubice,
Czech Republic

(540)

VERA

(591) Black, white

(511)

37 – Installation, commissioning and maintenance for systems and devices mentioned in class 9 for the area of monitoring and management of air traffic.

41 – Training services in the field of active and passive radar systems, instruments and apparatus for capturing, processing, transmission and evaluation of signals and information and in the field of monitoring and management of air traffic.

42 – Design and engineering services in the field of active and passive radar systems, instruments and apparatus for capturing, processing, transmission and evaluation of signals and information and in the field of monitoring and management of air traffic; services in the field of information technology for monitoring, evaluation and management of air traffic.

(260) AM 2018 94524 A

(800) 1368486

(151) 2017 07 11

(891) 2017 07 11

(731) SOPRO

Zone d'Activité Commerciale Athélia IV,
Avenue des Genévriers, F-13705 LA CIOTAT
CEDEX, France

(540)

SÝMBIOZ

(591) Black, white

(531) 04.05.05; 27.03.01

(511)

10 – Endoscopic insufflators for medical use; light sources for endoscopes for medical use; lamps for medical use; probes for medical use; endoscopes for medical use; endoscopic camera for medical use; apparatus for medical use for visualization and analysis of medical images or videos; apparatus for medical use for centralized control of endoscopic insufflators, endoscopic cameras and light sources for endoscopes.

(260) AM 2018 94525 A

(800) 1368178

(151) 2017 04 25

(891) 2017 04 25

(731) Ivoclar Vivadent AG

Bendererstrasse 2, FL-9494 Schaan,
Liechtenstein

(540)

Programat Dosto-Tray

(591) Black, white

(511)

11 – Dental furnaces, parts and accessories thereof.

(260) AM 2018 94526 A

(800) 1368194

(151) 2017 05 04

(891) 2017 05 04
 (731) NUOVA NAJ OLEARI SRL
 Via XXV Aprile, 10 I-13836 COSSATO
 (BI), Italy

(540)
NAJ-OLEARI

(591) Black, white

(511)

26 – Appliqués [haberdashery]; badges for wear, not of precious metal; beads, other than for making jewelry; belt clasps; blouse fasteners; bobby pins; bows for the hair; brassards; brooches [clothing accessories]; buckles [clothing accessories]; buttons; charms, other than for jewellery, key rings or key chains; chenille [passementerie]; decorative articles for the hair; edgings for clothing; elastic ribbons; embroidery; frills for clothing; frills [lacework]; fringes; haberdashery, except thread; hair bands; hair barrettes; hair coloring caps; hair curlers, other than hand implements; hair curling papers; hair curling pins; hair extensions; hair nets; hair pins; hat trimmings; heat adhesive patches for decoration of textile articles [haberdashery]; heat adhesive patches for repairing textile articles; ornamental novelty badges [buttons]; pins, other than jewellery [jewelry (Am.)]; sewing boxes; sewing kits; shoe buckles; shoe fasteners; shoe laces; skirt flounces.

(260) AM 2018 94626 A
 (800) 1369924
 (151) 2017 08 08
 (891) 2017 08 08
 (731) Shenzhen LongKeSe Technology
 Development Co., Ltd
 3602A, Huaqiang North SEG Plaza, Huaqiang
 North Street, Futian District, Shenzhen, China

(540)

lcose

(591) Black, white

(531) 27.05.01; 27.05.17

(511)

9 – Computer peripheral devices; radiotelephony sets; chips [integrated circuits]; anti-theft warning apparatus; protection devices for personal use against accidents; optical lenses; coils, electric; intercommunication apparatus.

(260) AM 2018 94627 A
 (800) 1369939
 (151) 2017 06 16
 (891) 2017 06 16
 (731) TOCKR SA
 Rue du Parc 3 Bis, CH-1207 Genève,
 Switzerland

(540)

TOCKR

(591) Black, white

(531) 27.05.01

(511)

9 – Smart watches; spectacles, sunglasses, spectacle cases.

14 – Watches, watches for men, watches for women, mechanical watches, automatic watches, jewelry watches, dress watches, watches of plastic, wristwatches, chronometers, pocket watches, sports watches, watches containing an electronic game function, watches containing a game function, watches of precious metals or coated therewith, watches for outdoor activities, chronographs [watches], diving watches, watch straps, watch straps of leather, watch straps of metal, watch straps of plastic, buckles for watch straps, watch dials, watch clasps, movements for watches, watch crowns, chains for watches, watch boxes, cases for watches, holders or cases for timepieces, pouches for watches, jewelry, bracelets [jewelry], pins [jewelry], brooches [jewelry], chains [jewelry], amulets [jewelry], necklaces [jewelry], rings [jewelry], jewelry boxes, display boxes [jewelry]; key rings (split rings with charms or trinkets), key rings, key rings of precious metals.

18 – Bags, handbags, sports bags, bags of leather or imitation leather, cases, purses, empty toilet bags, shoulder straps of leather, wallets of leather, straps of leather, suitcases of leather, imitations of leather, boxes of leather or imitation leather, key cases of leather or imitation leather; labels of leather, luggage label holders, adhesive labels of leather, luggage label holders (leather goods); umbrellas and parasols; walking sticks.

25 – Bags, handbags, sports bags, bags of leather or imitation leather, cases, purses, empty toilet bags, shoulder straps of leather, wallets of leather, straps of leather, suitcases of leather, imitations of leather, boxes of leather or imitation leather, key cases of leather or imitation leather; labels of leather, luggage label holders, adhesive labels of leather, luggage label holders (leather goods); umbrellas and parasols; walking sticks.

(260) AM 2018 94632 A
 (800) 1370033
 (151) 2017 05 31
 (891) 2017 05 31
 (731) British American Tobacco (Brands)
 Limited
 Globe House, 4 Temple Place, London WC2R
 2PG, United Kingdom

(540)



(591) Gray, orange

(531) 26.01.01; 26.01.04; 27.01.06; 27.05.23;
29.01.12

(511)

34 – Cigarettes; tobacco, raw or manufactured; tobacco products; tobacco substitutes (not for medical purposes); cigars, cigarillos; cigarette lighters; matches; smokers' articles; cigarette paper, cigarette tubes, cigarette filters; pocket apparatus for rolling cigarettes; hand held machines for injecting tobacco into paper tubes; electronic cigarettes; liquids for electronic cigarettes; tobacco products for the purpose of being heated; electronic devices and their parts for the purpose of heating cigarettes or tobacco.

(260) AM 2018 94634 A

(800) 1369319

(151) 2017 07 04

(891) 2017 07 04

(731) Richter Gedeon Nyrt.

Gyömrői út 19-21 H-1103 Budapest, Hungary

(540)

KLIMEDIX

(591) Black and white

(511)

5 – Pharmaceutical preparations.

(260) AM 2018 94635 A

(800) 1370048

(151) 2017 06 23

(891) 2017 06 23

(731) "BIGSTEP" LLC

Manandyan str. 33/27, Yerevan, Armenia

(540)



(591) Pink and white. There are white letters on the pink background

(531) 26.04.02; 26.04.22; 26.04.24; 27.05.01;
27.05.24; 29.01.12

(526) SHOES

(511)

25 – Footwear.

(260) AM 2018 94636 A

(800) 1369349

(151) 2017 03 27

(891) 2017 03 27

(731) MINGCHEN HEALTH CO., LTD

Liannan Industrial Zone, Chenghai District,
Shantou 515800 Guangdong, China

(540)



(591) Black and white

(531) 26.04.04; 26.13.25; 28.03

(511)

3 – Hair conditioner; cream for whitening the skin; hair oil; talcum powder, for toilet use; hair spray; skin cream; shampoos; nail polish; sunscreen preparations; toilet detergent; perfumes; beauty masks; liquid hand soap; abrasive paper; perfumery; incense; cosmetics; cakes of toilet soap; dentifrices; boot cream; cleaning preparations; hair lotions.

(260) AM 2018 94637 A

(800) 1370093

(151) 2017 07 21

(891) 2017 07 21

(731) Mundipharma AG

St. Alban-Rheinweg 74, CH-4020 Basel,
Switzerland

(540)

BETADINE

(591) Black, white

(511)

3 – Soaps; perfumery products; essential oils; cosmetics; hair treatments and preparations; hair lotions; toiletry products; sunscreen preparations, including sprays, lotions, creams, gels, oils for sun protection, sun balms and creams for lip care; cosmetic skin-tanning preparations; after-sun products (cosmetics); cosmetic preparations for skin care, including moisturizing treatments, protective creams, tonics for skin care, exfoliants, artificial sun-tanning preparations, degreasing products for use on the skin; cosmetic preparations, including cosmetics for the scalp, hair, skin and nails; wipes and tissues impregnated with cosmetic preparations; towels and wipes impregnated with cleaning preparations, including those for use on the skin.

10 – Surgical apparatus and instruments; medical apparatus and instruments; veterinary apparatus and instruments; suture materials; medical devices; medical apparatus and instruments for closing

wounds; wound draining apparatus for medical use; wound suction apparatus; surgical and wound-treatment equipment; nasal spray; masks for medical use; pads [pouches] for preventing pressure sores on patient bodies; heating pads and plasters for wounds; medical devices for treatment of wounds by vacuum therapy; pessaries; vaginal syringes; surgical, medical, dental and veterinary apparatus and instruments.

(260) AM 2018 94638 A

(800) 1369363

(151) 2017 06 22

(891) 2017 06 22

(731) Skliarova Olha Yuriivna

vul. Anny Akhmatovoi, 45, kv. 74 Kyiv
02095, Ukraine;

Skliarova Yuliia Yuriivna

vul. Anny Akhmatovoi, 45, kv. 74, Kyiv
02095, Ukraine

(540)

OXXI PROFESSIONAL

(591) Black and white

(511)

3 – Nail polish; nail care preparations.

(260) AM 2018 94639 A

(800) 890644

(151) 2006 02 09

(891) 2017 05 26

(731) «RN-Lubricants» LLC

District Yuzhniy Promuzel, 8 RU-390011
Ryazan, Russian Federation

(540)

MAGNUM

(591) Black, white

(511)

4 – Industrial oil and greases; lubricants; dust absorbing, wetting and binding compositions; fuels.

(260) AM 2018 94640 A

(800) 1369378

(151) 2017 07 04

(891) 2017 07 04

(731) Richter Gedeon Nyrt.

Gyömrői út 19-21 H-1103 Budapest, Hungary

(540)

PAOSONELLE

(591) Black and white

(511)

5 – Pharmaceutical preparations.

(260) AM 2018 94641 A

(800) 929717

(151) 2007 06 18

(891) 2017 09 21

(731) APPLE INC.

1 Infinite Loop, Cupertino, CA 95014, USA

(540)

PHOTO BOOTH

(591) Black, white

(511)

9 – Computer software used for image editing, image acquisition and image viewing.

(260) AM 2018 94642 A

(800) 1369382

(151) 2017 07 04

(891) 2017 07 04

(731) Richter Gedeon Nyrt.

Gyömrői út 19-21 H-1103 Budapest, Hungary

(540)

BELLAFEMY

(591) Black and white

(511)

5 – Pharmaceutical preparations.

(260) AM 2018 94644 A

(800) 1369453

(151) 2017 05 30

(891) 2017 05 30

(731) GALEOR LIMITED

Patron, 10 CY-6501 LARNACA, Cyprus

(540)

SPERCO

(591) Red, black and marigold yellow

(531) 26.11.08; 27.01.02; 27.01.25; 27.05.17;

29.01.14

(511)

5 – Pharmaceuticals, medical and veterinary preparations; sanitary preparations for medical purposes; dietetic food and substances adapted for medical or veterinary use, food for babies; dietary supplements for humans and animals; plasters, materials for dressings; material for stopping teeth, dental wax; disinfectants; preparations for destroying vermin; fungicides, herbicides.

35 – Advertising; business management; business administration; office functions; opinion polling; organization of exhibitions for commercial or advertising purposes; organization of trade fairs for commercial or advertising purposes; demonstration of goods; compilation of information into computer databases; compilation of statistics; on-line advertising on a computer network; commercial information and advice for consumers [consumer advice shop]; la-

yout services for advertising purposes; rental of advertising space; rental of advertising time on communication media; retail or wholesale services for pharmaceutical, veterinary and sanitary preparations and medical supplies; presentation of goods on communication media, for retail purposes; psychological testing for the selection of personnel; commercial intermediation services; updating and maintenance of data in computer databases.

(260) AM 2018 94653 A

(800) 1369713

(151) 2017 06 19

(891) 2017 06 19

(731) BIOFARMA

50 rue Carnot F-92284 SURESNES Cedex,
France

(540)

ВИАКОРЛИКС

(531) 28.05

(511)

5 – Pharmaceutical and veterinary products; sanitary products for medical purposes; dietetic food and substances for medical or veterinary use, food for babies; food supplements and dietary preparations for human beings and animals; plasters, materials for dressings; material for dental fillings and dental impressions; disinfectants; products for destroying vermin; fungicides, herbicides.

(260) AM 2018 94654 A

(800) 1369714

(151) 2017 07 04

(891) 2017 07 04

(731) Stadler Rail AG

Ernst-Stadler-Strasse 1 CH-9565 Bussnang,
Switzerland

(540)

STADLER

(591) Black and white

(511)

12 – Railway rolling stock and accessories thereof, included in this class.

(260) AM 2018 94655 A

(800) 1369742

(151) 2017 04 13

(891) 2017 04 13

(731) SPECCHIASOL S.R.L.

Via Bruno Rizzi, 1/3 I-37012 Bussolengo
(Verona), Italy

(540)

TOGETHAIr
MEETING NATURE

(591) Black and white

(531) 26.03.23; 26.11.13; 27.05.05

(511)

3 – Tints for the hair; hair spray; hair gel; hair mousse; hair-waving preparations; hair oils; cosmetics made from hydrogen peroxide; massage gels other than for medical purposes; cleansing milk for toilet purposes; lotions for cosmetic purposes; cosmetic masks; oils for toilet purposes; oils for cosmetic purposes; pomades for cosmetic purposes; baths (cosmetic preparations for -); bath preparations, not for medical purposes; shampoo; cosmetic hair dressing preparations; hair balm; hair care lotions; hair bleaching preparations; hair dye; bath foam.

(260) AM 2018 94656 A

(800) 1369750

(151) 2017 06 02

(891) 2017 06 02

(731) RAUCH Fruchtsäfte GmbH

Langgasse 1 A-6830 Rankweil, Austria

(540)



(591) Black and white

(531) 05.07.11; 05.07.13; 25.01.01; 26.01.02;
26.01.15; 26.01.20; 26.04.02; 26.04.24;
27.05.01; 27.05.24

(511)

29 – Milk and milk products with coffee or a coffee flavour; beverages having a milk base; milk beverages, milk predominating; milk drinks containing fruits; beverages made from or containing milk; milk-based beverages containing coffee; milk-like drinks.

30 – Coffee, artificial coffee, coffee-based beverages; iced coffee; coffee beverages with milk; coffee-based beverages with milk; coffee-based drinks containing milk; cappuccino; macchiato; latte-macchiato; coffee-based beverages; coffee-based drinks.

32 – Non-alcoholic beverages; non-alcoholic beverages flavoured with coffee, non-alcoholic energy drinks flavoured with coffee; non-alcoholic beverages flavoured with coffee; non-alcoholic beverages with coffee taste.

(260) AM 2018 94657 A
 (800) 1343314
 (151) 2017 02 24
 (891) 2017 08 18
 (731) Philip Morris Products S.A.
 Quai Jeanrenaud 3, CH-2000 Neuchâtel,
 Switzerland

(540)



(591) Black, white
 (531) 27.05.04
 (511)

34 – Tobacco, raw or manufactured; tobacco products; cigars, cigarettes, cigarillos, tobacco for roll-your-own cigarettes, pipe tobacco, chewing tobacco, snuff tobacco, kretek; snus; tobacco substitutes (not for medical purposes); electronic cigarettes; tobacco products for the purpose of being heated; electronic devices and their parts for the purpose of heating cigarettes or tobacco in order to release nicotine-containing aerosol for inhalation; liquid nicotine solutions for use in electronic cigarettes; smokers' articles, cigarette paper, cigarette tubes, cigarette filters, tobacco tins, cigarette cases, ashtrays, pipes, pocket apparatus for rolling cigarettes, lighters, matches.

(260) AM 2018 94659 A
 (800) 1345633
 (151) 2017 01 26
 (891) 2017 08 21
 (731) adp Gauselmann GmbH
 Merkur-Allee 1-15, 32339 Espelkamp,
 Germany

(540)

Key of the Nile

(591) Black, white
 (511)

9 – Software for computer games; games software for use on any computer platform, including electronic entertainment and games consoles; computer game programs; programs for operating electric and electronic apparatus for games, amusement and/or entertainment purposes; computer software for computer games on the internet; online games (software); computer software in the form of an app for mobile devices and computers; computer hardware and software for casino and amusement arcade games, for gaming machines, slot machines

or video lottery gaming machines or games of chance via the internet.

(260) AM 2018 94660 A
 (800) 1352579
 (151) 2017 02 24
 (891) 2017 08 18
 (731) Philip Morris Products S.A.
 Quai Jeanrenaud 3, CH-2000 Neuchâtel,
 Switzerland

(540)



(591) Black, white
 (531) 13.01.05; 13.01.10; 24.09.12
 (511)

34 – Tobacco, raw or manufactured; tobacco products; cigars, cigarettes, cigarillos, tobacco for roll-your-own cigarettes, pipe tobacco, chewing tobacco, snuff tobacco, kretek; snus; tobacco substitutes (not for medical purposes); electronic cigarettes; tobacco products for the purpose of being heated; electronic devices and their parts for the purpose of heating cigarettes or tobacco in order to release nicotine-containing aerosol for inhalation; liquid nicotine solutions for use in electronic cigarettes; smokers' articles, cigarette paper, cigarette tubes, cigarette filters, tobacco tins, cigarette cases, ashtrays, pipes, pocket apparatus for rolling cigarettes, lighters, matches.

(260) AM 2018 94661 A
 (800) 1354427
 (151) 2017 03 21
 (891) 2017 08 24
 (731) Shiseido Company, Limited
 7-5-5 Ginza, Chuo-ku, Tokyo 104-0061,
 Japan

(540)

ReNeura Technology

(591) Black, white
 (511)

1 – Chemicals; chemicals for use in the manufacture of cosmetics, soaps, perfumery and industrial products; collagen used as a raw ingredient in the manufacture of cosmetics; chemical preparations for use in the manufacture of cosmetics; proteins for use in the manufacture of cosmetics.

3 – Soaps; cosmetics; perfumery, fragrances and incense; dentifrices.

(260) AM 2018 94662 A

(800) 1364589

(151) 2017 07 12

(891) 2017 09 08

(731) La Place Food B.V.

Rijksweg 15 NL-5462 CE Veghel,

Netherlands

(540)



(591) Black, white

(531) 05.03.14; 27.05.01

(511)

43 – Services for providing food and drink, including services of restaurants, bar services and catering services.

(260) AM 2018 94663 A

(800) 1369238

(151) 2017 09 13

(891) 2017 09 27

(731) MIRAGE GRANITO CERAMICO S.P.A.

Via Giardini Nord, 225, I-41026 Pavullo nel

Frignano, Italy

(540)

INFINITY

(591) Black, white

(511)

19 – Ceramic tiles; porcelain stoneware tiles; ceramic slabs; porcelain stoneware slabs; tiles not of metal; wall coverings not of metal; coverings of bathroom walls not of metal; coverings of kitchen walls not of metal.

(260) AM 2018 94666 A

(800) 1368690

(151) 2017 04 17

(891) 2017 04 17

(731) Future Enterprises Pte. Ltd

31 Harrison Road, N08-01, Food Empire

Business Suites Singapore 369649,

Singapore

(540)



(591) Black, white, golden, orange, grey, red, dark red, light-red, brown, light-brown, dark brown and light-blue.

(531) 01.15.11; 05.07.01; 11.03.01; 11.03.04; 25.01.01; 27.05.24; 29.01.15

(526) "CLASSIC", "@"

(511)

30 – Coffee; coffee beverages with milk; coffee-based beverages.

(260) AM 2018 94667 A

(800) 1368705

(151) 2017 05 19

(891) 2017 05 19

(731) Polymateria Limited

Thavies Inn House, 3-4 Holborn Circus,

London EC1N 2HA, United Kingdom

(540)

POLYMATERIA

(591) Black, white

(511)

1 – Polymer solutions; polymerisation plastics, polymers for industrial use; polymerisates of organic compounds for the plastics industry; biodegradable polymer compositions; additives (chemical and organic) for use in plastic; additives (chemical and organic) for use in the processing of plastic; plastic masterbatches.

16 – Plastic wrap; plastic food wrap; plastic bin liners; garbage bags of plastic; plastic shopping bags; general purpose plastic bags; plastic oven cooking bags; plastic materials for packaging; plastic bags for packing and packaging; plastic film for packaging; plastic cling film for palletization; plastic bubble packs for wrapping or packaging; biodegradable plastic materials for packaging, in particular plastic films, plastic bags, garbage bags, plastic sacks, plastic envelopes, plastic film for wrapping, plastic bubble packs for wrapping or packaging.

20 – Plastic boxes; plastic crates; plastic stacking trays and boxes; plastic packaging containers; plastic boxes for storage purposes; plastic storage chests; plastic trays and containers used in food packaging; plastic egg trays; plastic closures for containers; plastic storage drums; plastic mailing tubes; plastic medication containers; plastic plant markers; plastic washers; biodegradable plastic boxes, crates, trays and packaging containers; plastic labels.

(260) AM 2018 94687 A

(800) 1369024

(151) 2017 08 17

(891) 2017 08 17

(731) Apple Inc.

1 Infinite Loop, Cupertino CA 95014, USA

(540)

IPOD SHUFFLE

(591) Black, white

(511)

9 – Portable and handheld digital electronic devices for recording, organizing, transmitting, manipulating, and reviewing text, data, and audio files; computer software for use in organizing, transmitting, manipulating, and reviewing text, data, and audio files on portable and handheld digital electronic devices.

(260) AM 2018 94689 A

(800) 1369026

(151) 2017 08 08

(891) 2017 08 08

(731) Kuttenteiler Mineralölhandels- und Tankstellenbetriebsgesellschaft mit beschränkter Haftung Dieselstr. 10, 50996 Köln, Germany

(540)



(591) White, dark blue and red.

(531) 26.01.02; 26.01.04; 26.01.12; 26.01.18; 26.11.13; 27.05.01; 27.05.21; 29.01.13

(511)

1 – Chemicals used in industry, science and photography, as well as in agriculture, horticulture and forestry; chemical additives for fuels, motor fuels and motor spirits; chemical additives for oils; chemical additives for fuels; anti-knock substances for internal combustion engines; engine-decarbonising chemicals; transmission fluids; power steering fluids; antifreeze; antifreeze for motor vehicle radiators; chemical deicers; chemical de-icing preparations; fluids for hydraulic circuits; chemical coolants; chemical cooling additives; coolants for vehicle engines; tensioactive agents; oil-purifying chemicals; chemical agents, preparations and plastics for absorbing oil; chemical rubber care preparations; anti-boil preparations for engine coolants; tire repairing compositions; detergent additives to gasoline [petrol]; automobile body fillers; combusting preparations (chemical additives to motor fuel); fire extinguishing compositions; fireproofing preparations; adhesives used in industry; heat exchanger fluids; coolants; brake fluid; granular absorbent compositions, not oil-based compositions for binding materials spilled on floors.

4 – Mineral oils; industrial oils; industrial grease; lubricants; dust absorbing, wetting and binding compositions; fuels (including motor spirit) and illuminants; non-chemical additives for fuels, motor

fuels and motor spirits; non-chemical additives for oils; lubricants, namely motor oils, automotive engine oils, cylinder oil, lubricants being gear oils, lubricating grease, lubricating oil; liquid and gaseous fuels; fuels, in particular liquid and gaseous fuels for internal combustion engines and components therefor; electrical energy; fuel oils; heating oils; granular absorbent oil-based compositions for binding materials spilled on floors.

35 – Retail services in the fields of chemicals, coating preparations, pharmaceuticals, cosmetics and household goods, fuels, motor fuels and motor spirits; retail services via the internet in the fields of chemicals, coating preparations, pharmaceuticals, cosmetics and household goods, fuels, motor fuels and motor spirits; wholesale services in the fields of chemicals, coating preparations, pharmaceuticals, cosmetics and household goods, fuels, motor fuels and motor spirits; wholesale services via the internet in the fields of chemicals, coating preparations, pharmaceuticals, cosmetics and household goods, fuels, motor fuels and motor spirits; online mail order retail services and mail order retail services via catalogues in the fields of chemicals, coating preparations, pharmaceuticals, cosmetics and household goods, fuels, motor fuels and motor spirits; retail services in the fields of chemicals and chemical preparations for operating and for maintenance of vehicles, mineral oils, industrial oils and greases, lubricants and lubricating agents, liquid and gaseous fuels, fuel oils, heating oils, fuels (including motor spirit); retail services in the fields of motor fuels, motor spirits and illuminants, additives for fuels, additives for motor fuels, additives for motor spirits, additives for oils, additives for coolants, additives for vehicle fuels, additives for liquid fuels, additives for fuel oils and additives for heating oils; retail services via the internet in the fields of chemicals and chemical preparations for operating and for maintenance of vehicles, mineral oils, industrial oils and greases, lubricants and lubricating agents, liquid and gaseous fuels, fuel oils, heating oils, fuels (including motor spirit); retail services via the internet in the fields of motor fuels, motor spirits and illuminants, additives for fuels, additives for motor fuels, additives for motor spirits, additives for oils, additives for coolants, additives for vehicle fuels, additives for liquid fuels, additives for fuel oils and additives for heating oils; wholesale services in the fields of chemicals and chemical preparations for operating and for maintenance of vehicles, mineral oils, industrial oils and greases, lubricants and lubricating agents, liquid and gaseous fuels, fuel oils, heating oils, fuels (including motor spirit); wholesale services in the fields of motor fuels, motor spirits and illuminants, additives for fuels, additives for motor fuels, additives for motor spirits, additives for oils, additives for coolants, additives for vehicle fuels,

additives for liquid fuels, additives for fuel oils and additives for heating oils; wholesale services via the internet in the fields of chemicals and chemical preparations for operating and for maintenance of vehicles, mineral oils, industrial oils and greases, lubricants and lubricating agents, liquid and gaseous fuels, fuel oils, heating oil, fuels (including motor spirit); wholesale via the internet in the fields of motor fuels, motor spirits and illuminants, additives for fuels, additives for motor fuels, additives for motor spirits, additives for oils, additives for coolants, additives for vehicle fuels, additives for liquid fuels, additives for fuel oils and additives for heating oils; online mail order retail services and mail order retail services via catalogues in the fields of chemicals and chemical preparations for operating and for maintenance of vehicles, mineral oils, industrial oils and greases, lubricants and lubricating agents, liquid and gaseous fuels, fuel oils, heating oils, fuels (including motor spirit); online mail order retail services and mail order retail services via catalogues in the fields of motor fuels, motor spirits and illuminants, additives for fuels, additives for motor fuels, additives for motor spirits, additives for oils, additives for coolants, additives for vehicle fuels, additives for liquid fuels, additives for fuel oils and additives for heating oils.

(260) AM 2018 94692 A

(800) 1369100

(151) 2017 08 04

(891) 2017 08 04

(731) SOREMARTEC SA

Findel Business Center, Complexe B, Rue de
Trèves FINDEL L-2632, Luxembourg

(540)

KINDER JOY

(591) Black,white

(511)

28 – Games, toys; action toys, construction toys, models (toys), scale model vehicles, game figurines.

30 – Pastry and confectionery, chocolate and chocolate-based products, edible ices, filled wafers, spread based on cocoa.

(260) AM 2018 94695 A

(800) 1369116

(151) 2027 05 12

(891) 2017 05 12

(731) Pearson plc

80 Strand, GB- London, WC2R 0RL,
United Kingdom

(540)

PEARSON

(591) Black,white

(511)

35 – Advertising; commercial management services; commercial administration; secretarial services; personnel recruitment; recruitment services; employment agency services; consulting services relating to personnel management; psychological testing for the selection of personnel; writing of résumés for others; human resources management; personnel recruitment advice; personnel placement services; evaluation of staff needs; management consultancy relating to personnel recruitment; management consulting relating to staff placement; staff evaluation services; company audits [commercial analyses]; business organization consultancy; commercial business appraisal; marketing; price comparison services.

36 – Insurance services; financial services; monetary affairs; real estate services; financial management; financial consultancy; insurance brokerage; mortgage banking operations; mutual funds; real estate management; loans [financing]; issuance of credit cards; banking services; brokerage; capital investment; charitable fundraising services; debt advice; company financing; private equity financing; private equity fund investment services; electronic funds transfer; financial underwriting and issuing of securities [investment bank].

38 – Telecommunication services; provision of chat rooms on the Internet; sending of messages [telecommunication]; satellite transmission; streaming data transmission; cable television broadcasting; connection by telecommunications to a global computer network; television broadcasting; transmission of video-on-demand footage; wireless communication services; wireless broadcasting services; transmission of data in streaming; streaming of audio, visual and audiovisual content via a global computer network; electronic transmission and streaming of digital content for others via a global and local computer network; transmission of videos on demand; broadcasting and transmission of radio and television programs; broadcasting of video and audio programs on the Internet; broadcasting services and providing of telecommunication access to video and audio content provided via an on demand online service; telecommunication services, namely, transmission of voice, data, graphics, images, audio and video provided via telecommunication networks, wireless communication networks and the Internet; telecommunication services, namely, transmission of podcasts; streaming of audio and video content via the Internet featuring music, films, news and sports; streaming of television programs and films via the Internet; subscription-based television broadcasting.

(260) AM 2018 94697 A
 (800) 1369121
 (151) 2017 06 07
 (891) 2017 06 07
 (731) SWATCH AG (SWATCH SA)
 (SWATCH LTD.)
 Jakob-Stämpfli-Strasse 94 CH-2502
 Biel/Bienne, Switzerland

(540)

YOUR MOVE

(591) Black, white

(511)

14 – Precious metals and their alloys and goods made of these materials or coated therewith included in this class, namely figurines, trophies; jewelry, namely rings, earrings, cuff links, bracelets, charms, brooches, chains, necklaces, tie pins, tie clips, jewelry caskets (cases), cases; precious stones, semi-precious stones; timepieces and chronometric instruments, namely chronometers, chronographs, clocks, watches, wristwatches, wall clocks, alarm clocks as well as parts and accessories for the aforesaid goods, namely hands, anchors, pendulums, barrels, watch cases, watch straps, watch dials, clockworks, watch chains, movements for timepieces, watch springs, watch glasses, presentation cases for timepieces, cases for timepieces.

(260) AM 2018 94698 A
 (800) 1369133
 (151) 2017 03 29
 (891) 2017 03 29
 (731) MEDTEX Sp. z o.o.
 ul. Wadowicka 6 lok.06, PL-30-415 Kraków,
 Poland

(540)



(591) White and blue.

(531) 02.07.12; 02.07.23; 24.13.14; 24.13.25;
 27.05.10; 27.05.24; 29.01.12

(511)

10 – Orthopaedic instruments; braces for joint fixation; applicators in the nature of sponges [for medical use]; orthopedic articles; orthopedic and mobility aids; orthopaedic bandages; orthopaedic knee bandages; suction bottles for medical use; medical and surgical catheters; shaped padding for supporting parts of the body [medical use]; power filters for medical use; goniometers for orthopaedic use; medical braces for application to the human

body; orthopaedic implants; artificial orthopaedic implants; surgical instruments for use in orthopedic surgery; medical instruments; orthopaedic instruments; forceps for medical use; medical blankets for the cooling of patients; medical blankets for the warming of patients; cervical collars; chairs especially made for medical use; examination couches specially made for medical use; hybrid beds being soft sided waterbeds [for medical use]; masks for use by medical personnel; support mattresses for medical use; support mattresses for medical use; support mattresses for preventing pressure sores; alternating pressure mattresses for medical use; elastomeric material for medical use; suture materials for medical use; splinting materials for medical use; medical braces; medical braces; medical support hosiery; medical compression stockings; medical support tights; medical supports for the body; mallets for medical use; medical stretchers; exercise boots [orthopaedic footwear]; exercise boots for medical rehabilitative purposes; protective breathing masks for medical applications; protective breathing masks made of non-woven materials for medical applications; electrically heated clothing for medical use; warmers for medical use; medical drapes of non-woven textile materials; ankle supports for medical use; orthopedic support bandages; orthopedic joint implants; orthotic footwear; orthopaedic compression supports; orthopaedic foot cushions; orthopaedic hip prostheses; orthopaedic femur prostheses; orthopaedic hip prostheses; orthopaedic fixation devices; toe separators [orthopaedic]; orthopaedic healing aids; orthotic inserts for footwear; orthotic inserts for footwear; orthopaedic inner soles incorporating arch supports; orthopedic joint implant prostheses; orthopaedic hosiery; mittens for medical use; eye shields for medical use; face shields for medical use; spine plates [medical apparatus]; abdominal pads for medical use; orthopedic soles; orthopedic soles; soles made of leather [orthopaedic]; toe relief pads [orthopaedic]; orthopaedic supports for heels; orthopaedic supports for feet; toe props [orthopaedic]; orthopaedic supports for heels; heel pads for orthopaedic use; alternating pressure pads for medical use; orthopaedic braces; bases for waterbeds [adapted for medical use]; pads for seats for wheelchairs [for medical use]; cushions for medical use for supporting infants being examined; cushions for medical use for supporting infants while being bathed; pillows for orthopedic use; orthopedic cushions; cervical pillows for medical use; medical stockings with decreasing compression; prostheses for medical treatment; medical prostheses; orthopaedic sheets adapted for use during orthopaedic operations; medical instruments for application in human bodies; medical devices, namely, intravascular implants comprised of artificial material; cushioning devices for medical

use; spine seats [medical apparatus]; silicone orthopedic implants; silicone orthopedic devices; compression socks for medical or therapeutic use; surgical apparatus and instruments for medical use; wrist braces for medical use; pressurised suits for medical use; forceps for medical use; orthopaedic splints; orthopaedic splints; orthopaedic strappings; slings for medical use; medical bags designed to hold medical instruments; bags [fitted] for medical instruments; diathermic handles for medical use; medical apparatus for use in laparoscopy; medical apparatus for introducing pharmaceutical preparations into the human body; medical devices for closing wounds; orthopaedic instruments; orthopedic apparatus for talipes; arch supports for footwear; insole-shells [orthopaedic]; shoe insoles for orthopedic use; orthotic inserts for footwear; toe inserts for footwear [orthopaedic]; pads for slippers [orthopaedic]; soft insoles [orthopaedic]; toe regulators [orthopaedic]; orthotic inserts for footwear; pads for shoes [orthopaedic]; arch cushions [orthopaedic]; arch supports [orthopaedic]; arch supports for orthopaedic shoes; suction bags for medical use; irrigation pouches for medical use; orthopaedic detachable insoles.

35 – Retailing and wholesaling (including via websites) of the following goods, for others, namely: orthopaedic appliances, orthopaedic apparatus for fixing joints, applicators in the form of sponges for medical use, orthopedic articles, orthopedic articles and mobility aids, orthopaedic bandages, orthopaedic knee bandages, suction bottles for medical use, medical and surgical catheters, shaped padding for supporting parts of the body (for medical use), power filters for medical use, goniometers for orthopaedic use, braces for application to the human body, orthopaedic implants, orthopaedic implants made from artificial materials, surgical instruments for use in orthopaedic surgery, medical instruments, orthopaedic instruments, forceps for medical use, medical blankets for cooling patients, medical blankets for warming patients, surgical collars, chairs, specially made for medical purposes, examination couches, specially made for medical purposes, hybrid beds being soft-sided waterbeds (for medical purposes), surgical masks, orthopaedic mattresses for medical use, orthopaedic mattresses for medical use, orthopaedic for preventing pressure sores, alternating pressure mattresses for medical purposes, elastomeric material for medical use, suture materials for medical use, splinting materials for medical use, medical braces, medical braces, medical support hosiery, medical compression stockings, medical compression panty hose, medical supports for the body, mallets for medical use, stretchers for medical use, exercise boots (orthopaedic footwear), exercise boots for medical rehabilitative purposes, protective breathing masks for medical purposes, protective breathing masks of

non-woven materials for medical purposes, electrically heated clothing for medical use, warmers for medical use, medical drapes of non-woven textile materials, ankle supports for medical use, orthopaedic support bandages, orthopaedic joint implants, orthotic footwear, orthopedic support dressings, orthopaedic foot cushions, orthopaedic prostheses, orthopaedic femur prostheses, orthopaedic hip prostheses, orthopedic fixation devices, orthopaedic toe separators, orthopaedic medicines, orthopaedic soles, orthopaedic inserts for footwear, orthopaedic inner soles with arch supports, orthopaedic joint implant prostheses, orthopaedic hosiery, mittens for medical use, eye shields for medical use, face shields for medical use, spine plates (medical apparatus), abdominal pads for medical use, soles for footwear (orthopaedic), orthopaedic soles, soles of leather (orthopaedic), toe relief pads (orthopaedic), orthopaedic supports for heels, orthopaedic supports for feet, toe props (orthopaedic), heel supports for orthopaedic use, heel pads for orthopaedic use, alternating pressure pads for medical use, orthopaedic supports, bases for waterbeds (adapted for medical purposes), pads for seats for wheelchairs (for medical purposes), cushions for medical use for supporting infants being examined, cushions for medical use for supporting infants being bathed, pillows for orthopaedic use, orthopaedic pillows, cervical pillows for medical use, medical stockings with decreasing compression, prostheses for medical treatment, medical prosthetics, orthopaedic sheets adapted for use during orthopaedic operations, medical instruments for use in human bodies, medical devices, namely intravascular implants comprised of artificial material, cushioning devices for medical use, spinal column supports (medical devices), silicone orthopaedic implants, silicone orthopaedic devices, compression socks for medical or therapeutic use, surgical apparatus and instruments for medical use, wrist braces for medical use, pressurised suits for medical use, tongs for medical use, splinting for orthopaedic use, orthopaedic splints, orthopaedic strappings, slings for medical use, medical bags designed to hold medical instruments, bags (fitted) for medical instruments, diathermic handles for medical use, medical apparatus for use in laparoscopy, medical apparatus for introducing pharmaceutical preparations into the human body, medical devices for closing wounds, orthopaedic appliances, orthopaedic apparatus for clubfoot, arch supports for footwear, insole shells (orthopaedic), shoe inserts for orthopaedic use, insoles for orthopaedic footwear, toe inserts for footwear (orthopaedic), pads for slippers (orthopaedic), soft insoles (orthopaedic), toe regulators (orthopaedic), orthopaedic insoles, orthopedic shoe inserts, arch cushions (orthopaedic), arch supports (orthopaedic), arch supports for

orthopaedic shoes, suction bags, for medical use, irrigation pouches, for medical use, detachable orthopaedic insoles; business management and organisation consultancy; retail shop and store services featuring the aforesaid goods, including via the internet; online retail sale services; mail order sale of the aforesaid goods; handling of purchase orders; conducting of online trade fairs for purchasing, selling and/or exchanging of goods and services; searching for data in a computer database, for others; auctioneering; auctioneering on the internet; computerized file management; document reproduction; marketing; advertising; preparation of publicity materials; radio advertising; television advertising; bill-posting; advertising the aforesaid goods and offered services on websites; organisation of and participation in trade fairs, exhibitions and demonstrations relating to the promotion of the aforesaid goods and offered services; commercial advice for consumers.

(260) AM 2018 94700 A

(800) 1369152

(151) 2017 05 18

(891) 2017 05 18

(731) WORLD MEDICINE İLAÇ SANAYİ VE
TİCARET ANONİM ŞİRKETİ

Evren Mah. Camiyolu Cad. No.50 K.1 B

Zemin 4-5-6 GÜNESLİ/ BAGCILAR/

İSTANBUL, Turkey

(540)

**TORVENTA
TOPBEHTA**

(591) Black,white

(531) 27.05.01; 28.05

(511)

5 – Medicines for human purposes, medicines for veterinary purposes, vitamin preparations, chemical preparations for medical purposes, dietetic substances adapted for medical use, dietetic foods adapted for medical purposes, baby foods, medicinal herbs, herbal beverages adapted for medical purposes, nutritional supplements, pollen dietary supplements, mineral food supplements, protein dietary supplements, dietary supplements for animals, fodder supplements for veterinary purposes, medicines for dental purposes, hygienic products for medical purposes including sanitary pads, breast-nursing pads and bunion pads, waddings for medical purposes, plasters for medical purposes, dressings for medical purposes, babies' napkins, preparations for destroying noxious plants, preparations for destroying noxious animals, fungicides, deodorants other than for human beings or for animals, air deodorising preparations, disinfectants for hygiene purposes, antiseptics, detergents for medical purposes.

(260) AM 2018 94702 A

(800) 1369183

(151) 2017 08 02

(891) 2017 08 02

(731) SEAT, S.A.

Autovia A-2 km.585 E-08760 Martorell

(Barcelona), Spain

(540)



(591) Red; black; gray; white.

(531) 27.05.02; 27.05.22; 29.01.13

(511)

12 – Vehicles; apparatus for locomotion by land; cars; vehicle parts and accessories

25 – Ready-to-wear clothing for women, men and children; footwear (except orthopedic footwear) and headgear; clothing for motorists and cyclists; T-shirts; scarves; belts (clothing); neckties; gloves (clothing); Ascots; caps; sun visors.

27 – Carpets for automobiles; mats for automobiles; rugs for automobiles.

(260) AM 2018 94703 A

(800) 1369184

(151) 2017 08 02

(891) 2017 08 02

(731) SEAT, S.A.

Autovia A-2 km.585, E-08760 Martorell

(Barcelona), Spain

(540)



(591) White; red; black; gray.

(531) 25.07.03; 25.07.04; 26.04.09; 27.05.02;
27.05.03; 27.05.08; 27.05.17; 27.05.21;
29.01.14

(511)

12 – Vehicles; apparatus for locomotion by land; cars; vehicle parts and accessories.

25 – Ready-to-wear clothing for women, men and children; footwear (except orthopedic footwear) and headgear; clothing for motorists and cyclists; T-shirts; scarves; belts (clothing); neckties; gloves (clothing); Ascots; caps; sun visors.

27 – Carpets for automobiles; mats for automobiles; rugs for automobiles.

(260) AM 2018 94705 A

(800) 1369203

(151) 2017 04 05

(891) 2017 04 05

(731) Essity Hygiene and Health Aktiebolag
SE-405 03 Göteborg, Sweden

(540)



(591) Dark blue and magenta.

(531) 05.05.20; 05.05.21; 27.03.01; 27.03.11;
29.01.12

(511)

3 – Bleaching preparations; substances for laundry use; detergents; cleaning polishing, scouring and abrasive preparations; skin care products, namely washing creams, cleansing creams, moisturizers, skin lotions, barrier creams, zinc creams, hand-washing substances, soaps, cakes of soap; perfumery, essential oils; bath oils; shampoos and conditioners; hair gels; after-shave lotions; toothpaste; deodorants; disposable impregnated paper and cotton articles (toiletries) for cleaning, personal sanitary and cosmetic purposes; cotton wool; cotton sticks; cleaning and polishing paper containing cellulose or not.

5 – Disposable paper and cotton articles impregnated with pharmaceutical lotions for cleaning and sanitary purposes; breast nursing pads; disposable diapers; diaper pants; disposable diapers, diaper pants and other absorbent articles; nappy liners; sanitary panty liners; tampons; sanitary napkins (towels) and other absorbent articles for sanitary purposes; ointments; diagnostic agents for pharmaceutical use; wound cleansing set composed of medical cleansers for wounds and wound dressings; plasters, dressings, wound dressings, medical strips, bandages for sanitary purposes (and/or medical purposes).

9 – Computer software in digital form containing information relating to all aspects of health care, personal care, incontinence care and geriatric care; computer software related to the measurement of patterns of urination; apparatus for the transmission of data; data storage devices; data processing equipment and accessories, communication equipment; sensors and detectors; software for analyzing business management and customer services for analyzing traffic and visitor data, consumption and stock levels; software for steering and optimizing operations, software for improvement of quality; software for providing information to customers and staff relating to traffic and visitor data, consumption and stock levels; software in form of apps; computer systems for automatic control of ventilating, air-purifying and

air-freshening apparatus and installations, sanitary apparatus and installations, in particular toilets, urinals (sanitary fixtures), wash bowls, hand drying apparatus, towel dispensers, soap dispensers, toilet paper dispensers, aerosol containers.

10 – Orthopedic support dressings and orthopedic bandages and hosiery; medical compression stockings, tights and socks, medical support stockings; casting tapes and bandages for orthopedic purposes; splints for surgical purposes; orthopedic articles; padding material for orthopedic purposes (included in this class); draw-sheets for sick beds.

16 – Paper; paper wipes containing cellulose or not, for wiping dry; paper products for household, hygienic, sanitary and cosmetic purposes, namely, tissue paper, kitchen rolls, toilet paper, paper handkerchiefs, cellulose wipes, paper hand towels, paper napkins, paper serviettes, paper washcloths, paper towels, paper tissues, babies bibs of paper, face towels of paper, facial tissues of paper; paper and plastic sachets and bags; protective covers made of paper, namely bibs of paper, paper pads for changing nappies, paper table cloths; colour prints, printed emblems, printed patterns, printed paper labels, graphic prints; printing paper, fine paper; writing paper, newsprint, paper for books, newspapers, catalogues, magazines and other printed matters; packagings made of paper or plastic; plastic material for packaging of soaps, degreasing agents, detergents; table linen of paper; absorbent paper.

20 – Non-metallic fixed stands (holders) and dispensers for products made of paper, namely towels, serviettes, kitchen rolls and toilet rolls; bins, bins for disposal of sanitary products.

21 – Household stands (holders), holders, containers and dispensers for paper, paper towels, liquid soap, air fresheners and other household, kitchen and toilet products; cleaning cloths; household and kitchen utensils and containers (not of precious metal or coated therewith).

24 – Woven fabrics and textile goods not included in other classes; bed and table linen, woven and non-woven; bed and table covers, under sheets.

35 – Business information services provided online from a computer database or the internet; distribution of samples; systematization of data in databases.

38 – Providing access to a compilation of information from computer databases matter in relation to health care, hygienic care and geriatric care; providing access to a global computer network for the transfer and dissemination of information.

41 – Education; education services relating to personal care, health care and geriatric care; arranging

and conducting of educational seminars in relation to personal care, health care and geriatric care.

42 – Industrial analysis and research services in the field of the paper industry including area of paper and cotton products for household, hygienic, sanitary and cosmetic purposes; quality assurance consultancy; advice and analysis relating to improvement of quality in relation to analysis of traffic and visitor data, product consumption and stock levels.

44 – Healthcare; consulting services relating to health; individualised and group healthcare services provided through planning, organizing and monitoring, the aforementioned services also provided online or via the internet; hygienic and beauty care for human beings

(260) AM 2018 94706 A

(800) 1369204

(151) 2017 04 05

(891) 2017 04 05

(731) ESSITY HYGIENE AND HEALTH

AKTIEBOLAG

SE-405 03 Göteborg, Sweden

(540)



(591) Dark blue and magenta.

(531) 05.05.20; 05.05.21; 29.01.12

(511)

3 – Bleaching preparations; substances for laundry use; detergents; cleaning polishing, scouring and abrasive preparations; skin care products, namely washing creams, cleansing creams, moisturizers, skin lotions, barrier creams, zinc creams, hand-washing substances, soaps, cakes of soap; perfumery, essential oils; bath oils; shampoos and conditioners; hair gels; after-shave lotions; toothpaste; deodorants; disposable impregnated paper and cotton articles (toilettries) for cleaning, personal sanitary and cosmetic purposes; cotton wool; cotton sticks; cleaning and polishing paper containing cellulose or not.

5 – Disposable paper and cotton articles impregnated with pharmaceutical lotions for cleaning and sanitary purposes; breast nursing pads; disposable diapers; diaper pants; disposable diapers, diaper pants and other absorbent articles; nappy liners; sanitary panty liners; tampons; sanitary napkins (towels) and other absorbent articles for sanitary purposes; ointments; diagnostic agents for pharmaceutical use; wound cleansing set composed of medical cleansers for wounds and wound dressings; plasters, dressings, wo-

und dressings, medical strips, bandages for sanitary purposes (and/or medical purposes).

9 – Computer software in digital form containing information relating to all aspects of health care, personal care, incontinence care and geriatric care; computer software related to the measurement of patterns of urination; apparatus for the transmission of data; data storage devices; data processing equipment and accessories, communication equipment; sensors and detectors; software for analyzing business management and customer services for analyzing traffic and visitor data, consumption and stock levels; software for steering and optimizing operations, software for improvement of quality; software for providing information to customers and staff relating to traffic and visitor data, consumption and stock levels; software in form of apps; computer systems for automatic control of ventilating, air-purifying and air-freshening apparatus and installations, sanitary apparatus and installations, in particular toilets, urinals (sanitary fixtures), wash bowls, hand drying apparatus, towel dispensers, soap dispensers, toilet paper dispensers, aerosol containers.

10 – Orthopedic support dressings and orthopedic bandages and hosiery; medical compression stockings, tights and socks, medical support stockings; casting tapes and bandages for orthopedic purposes; splints for surgical purposes; orthopedic articles; padding material for orthopedic purposes (included in this class); draw-sheets for sick beds.

16 – Paper; paper wipes containing cellulose or not, for wiping dry; paper products for household, hygienic, sanitary and cosmetic purposes, namely, tissue paper, kitchen rolls, toilet paper, paper handkerchiefs, cellulose wipes, paper hand towels, paper napkins, paper serviettes, paper washcloths, paper towels, paper tissues, babies bibs of paper, face towels of paper, facial tissues of paper; paper and plastic sachets and bags; protective covers made of paper, namely bibs of paper, paper pads for changing nappies, paper table cloths; colour prints, printed emblems, printed patterns, printed paper labels, graphic prints; printing paper, fine paper; writing paper, newsprint, paper for books, newspapers, catalogues, magazines and other printed matters; packagings made of paper or plastic; plastic material for packaging of soaps, degreasing agents, detergents; table linen of paper; absorbent paper.

20 – Non-metallic fixed stands (holders) and dispensers for products made of paper, namely towels, serviettes, kitchen rolls and toilet rolls; bins, bins for disposal of sanitary products.

21 – Household stands (holders), holders, containers and dispensers for paper, paper towels, liquid soap, air fresheners and other household, kitchen and toilet products; cleaning cloths; household and kitchen

utensils and containers (not of precious metal or coated therewith).

24 – Woven fabrics and textile goods not included in other classes; bed and table linen, woven and non-woven; bed and table covers, under sheets.

35 – Business information services provided on-line from a computer database or the internet; distribution of samples; systematization of data in databases.

38 – Providing access to a compilation of information from computer databases matter in relation to health care, hygienic care and geriatric care; providing access to a global computer network for the transfer and dissemination of information.

41 – Education; education services relating to personal care, health care and geriatric care; arranging and conducting of educational seminars in relation to personal care, health care and geriatric care.

42 – Industrial analysis and research services in the field of the paper industry including area of paper and cotton products for household, hygienic, sanitary and cosmetic purposes; quality assurance consultancy; advice and analysis relating to improvement of quality in relation to analysis of traffic and visitor data, product consumption and stock levels.

44 – Healthcare; consulting services relating to health; individualised and group healthcare services provided through planning, organizing and monitoring, the aforementioned services also provided on-line or via the internet; hygienic and beauty care for human beings.

(260) AM 2018 94707 A

(800) 1369218

(151) 2017 07 27

(891) 2017 07 27

(731) Brisio Holdings Ltd

Christodoulou Chatzipavlou, 205 Louloupis Court, 2nd Floor, Office 201, CY-3036 Limassol, Cyprus

(540)

THEVILLAGE

(591) Black,white

(531) 27.05.17

(511)

16 – Artists' materials; typewriters and office requisites [except furniture]; instructional and teaching material [except apparatus]; albums; almanacs; atlases; posters; paper bows; table linen of paper; tickets; forms, printed; note books; drawing pads; loose-leaf binders; wristbands for the retention of writing instruments; pamphlets; booklets; waxed paper; paper for recording machines; paper for radiograms; electrocardiograph paper; wood pulp paper; parchment paper; writing paper; luminous paper; toilet paper; wrapping paper; paper; blotters;

newsletters; rollers for typewriters; house painters' rollers; composing sticks; signboards of paper or cardboard; sewing patterns; newspapers; electro-types; hectographs; terrestrial globes; engravings; slate pencils; pencil leads; pencil holders; chalk holders; diagrams; engraving plates; writing slates; blackboards; galley racks [printing]; drawing boards; cream containers of paper; money clips; tags for index cards; bookmarks; etching needles; printed publications; graphic representations; graining combs; calendars; tear-off calendars; tracing paper; tracing patterns; gums [adhesives] for stationery or household purposes; lithographic stones; pencils; pencil lead holders; charcoal pencils; pictures; transfers [decalcomanias]; cardboard; hat boxes of cardboard; files [office requisites]; cards; geographical maps; perforated cards for Jacquard looms; catalogues; covers of paper for flower pots; paintbrushes; painters' brushes; writing brushes; typewriter keys; glue for stationery or household purposes; printing blocks; books; comic books; drawing pins; cigar bands; paint boxes [articles for use in school]; French curves; paper ribbons; typewriter ribbons; adhesive tapes for stationery purposes; square rulers; viscose sheets for wrapping; steel letters; type [numerals and letters]; lithographs; architects' models; postage stamps; graphic prints; modelling materials; teaching materials [except apparatus]; sealing compounds for stationery purposes; packaging material made of starches; addressing machines; postage meters; chalk for lithography; writing chalk; tailors' chalk; marking chalk; painters' easels; hand-rests for painters; bibs of paper; cords for bookbinding; numbering apparatus; sealing wafers; passport holders; plastic cling film, extensible, for palletization; handwriting specimens for copying; oleographs; musical greeting cards; greeting cards; postcards; etchings; bags for microwave cooking; palettes for painters; ink sticks; folders for papers; papier mâché; pastels [crayons]; pen cases; bookbindings; pen wipers; nibs of gold; steel pens; drawing pens; song books; sealing stamps; clipboards; address plates for addressing machines; handkerchiefs of paper; plastic film for wrapping; letter trays; trays for sorting and counting money; coasters of paper; bookends; stamp stands; mats for beer glasses; stands for pens and pencils; photograph stands; stamp pads; towels of paper; gummed cloth for stationery purposes; printers' blankets, not of textile; portraits; paperweights; writing cases [sets]; writing materials; hand labelling appliances; printed matter; prospectuses; printed timetables; indexes; graphic reproductions; face towels of paper; staples for offices; erasing products; writing board erasers; sealing wax; arithmetical tables; placards of paper or cardboard; writing or drawing books; stationery; cardboard tubes; Indian inks; chart pointers, non-electronic; envelope sealing machines for offices; sealing machines for offices;

vignetting apparatus; apparatus for mounting photographs; stapling presses [office requisites]; textbooks; paper coffee filters; silver paper; molds for modelling clays [artists' materials]; photo-engravings; stencil cases; canvas for painting; chromolithographs [chromos]; correcting ink [heliography]; ink; inkwells; blueprints; balls for ball-point pens; printing type; address stamps; paper and cardboard; plastic materials for packaging; printing fonts; printers' type, printing blocks; aquarelles; document laminators for office use; pads [stationery]; paper sheets [stationery]; drawer liners of paper, perfumed or not; carbon paper; Xuan paper for Chinese painting and calligraphy; modelling wax, not for dental purposes; holders for stamps [seals]; holders for checkbooks [cheque books]; punches [office requisites]; pen clips; tracing needles for drawing purposes; bags [envelopes, pouches] of paper or plastics, for packaging; paper shredders for office use; tracing cloth; paintings [pictures], framed or unframed; wood pulp board [stationery]; card files; index cards [stationery]; printed informational cards; paper tapes and cards for the recordal of computer programmes; spools for inking ribbons; isinglass for stationery or household purposes; starch paste [adhesive] for stationery or household purposes; business record books; envelopes [stationery]; manifolds [stationery]; cases for stamps [seals]; boxes of paper or cardboard; correcting fluids [office requisites]; office machine ribbons; inking ribbons for computer printers; plastic bubble packs for wrapping or packaging; sheets of reclaimed cellulose for wrapping; bookbinding material; adhesives [glues] for stationery or household purposes; filtering materials [paper]; bookbinding apparatus and machines [office equipment]; typewriters, electric or non-electric; folders [stationery]; garbage bags of paper or of plastics; printing sets, portable [office requisites]; stickers [stationery]; office stationery; paper knives [cutters] [office requisites]; bottle envelopes of paper or cardboard; document covers [stationery]; embroidery designs [patterns]; disposable pads of paper or cellulose for diaper changing; office perforators; pens [office requisites]; seals for office use; informational letters; binding strips [bookbinding]; inking sheets for document reproducing machines; inking sheets for duplicators; drawing materials; drawing boards [painters' articles]; rubber erasers; obliterating stamps; office requisites, except furniture; school supplies [stationery]; adhesive tape dispensers [office requisites]; stapling presses [non-electric staplers]; pencil sharpening machines, electric or non-electric; printers' reglets; elastic bands for offices; penholders; tissues of paper for removing make-up; scrapers [erasers] for offices; biological samples for use in microscopy [teaching materials]; histological sections for teaching purposes; figurines [statuettes] of papier mâché; composing frames

[printing]; transparencies [stationery]; moisteners [office requisites]; moisteners for gummed surfaces [office requisites]; bottle wrappers of paper or cardboard; flags of paper; photographs [printed]; artists' watercolor saucers; cabinets for stationery [office requisites]; stamps [seals]; advertisement boards of paper or cardboard; prints [engravings]; labels of paper.

28 – Games and playthings; decorations for Christmas trees; toy vehicles; amusement machines, automatic and coin-operated; novelties for parties, dances [party favors, favours]; skating boots with skates attached; dolls' feeding bottles; shuttlecocks; spinning tops [toys]; jigsaw puzzles; punching bags; hang gliders; discuses for sports; dolls' houses; surfboards; skateboards; sailboards; chessboards; checkerboards; darts; cups for dice; kites; toys for pets; plush toys; board games; ring games; kaleidoscopes; bladders of balls for games; rosin used by athletes; edges of skis; bingo cards; playing cards; fairground ride apparatus; rocking horses; swings; skittles; skittles [games]; billiard cues; golf clubs; hockey sticks; bells for Christmas trees; dolls' rooms; confetti; roller skates; dice; paintball guns [sports apparatus]; ski bindings; dolls' beds; toy building bricks; dolls; flippers for swimming; bows for archery; skis; waterskis; surf skis; hunting game calls; puppets; carnival masks; theatrical masks; fencing masks; masts for sailboards; chalk for billiard cues; targets; electronic targets; balls for games; billiard table cushions; billiard cue tips; dolls' clothes; fencing weapons; twirling batons; paragliders; toy pistols; percussion caps [toys]; horseshoe games; candle holders for Christmas trees; Christmas tree stands; sole coverings for skis; decoys for hunting or fishing; scent lures for hunting or fishing; archery implements; kite reels; soap bubbles [toys]; divot repair tools [golf accessories]; protective paddings [parts of sports suits]; rackets; foils for fencing; surfboard leashes; harness for sailboards; rollers for stationary exercise bicycles; scooters [toys]; butterfly nets; nets for sports; appliances for gymnastics; quoits; bar-bells; climbers' harness; artificial snow for Christmas trees; snowshoes; clay pigeon traps; billiard tables; coin-operated billiard tables; tables for table tennis; tables for table football; strings for rackets; cricket bags; radio-controlled toy vehicles; machines for physical exercises; tennis ball throwing apparatus; conjuring apparatus; bowling apparatus and machinery; bags especially designed for skis and surfboards; marbles for games; billiard balls; playing balls; chess games; spring bars for exercise; starting blocks for sports; flying discs [toys]; dominoes; spring boards [sports articles]; Christmas trees of synthetic material; pinatas; mobiles [toys]; practical jokes [novelties]; seal skins [coverings for skis]; building games; explosive bonbons [Christmas crackers]; ice skates; roulette wheels; mah-jong;

scale model vehicles; knee guards [sports articles]; elbow guards [sports articles]; gloves for games; toy air pistols; caps for pistols [toys]; rattles [playthings]; bite sensors [fishing tackle]; billiard markers; weight lifting belts [sports articles]; sling shots [sports articles]; harpoon guns [sports articles]; sleds [sports articles]; golf bags, with or without wheels; slides [playthings]; backgammon games; men's athletic supporters [sports articles]; ornaments for Christmas trees, except illumination articles and confectionery; apparatus for games; chips for gambling; checkers [games]; shin guards [sports articles]; camouflage screens [sports articles]; swimming pools [play articles].

35 – Advertising; business management; business administration; import-export agency services; commercial information agency services; advertising agency services; cost price analysis; rental of advertising space; account auditing; employment agency services; computerized file management; invoicing; demonstration of goods; opinion polling; market studies; business information; business investigations; personnel recruitment; business management and organization consultancy; business organization consultancy; business management consultancy; professional business consultancy; layout services for advertising purposes; business management of performing artists; news clipping services; updating of advertising material; word processing; organization of exhibitions for commercial or advertising purposes; organization of trade fairs for commercial or advertising purposes; shop window dressing; business appraisals; payroll preparation; sponsorship search; business management assistance; commercial or industrial management assistance; economic forecasting; auctioneering; office machines and equipment rental; publicity material rental; rental of vending machines; rental of photocopying machines; publication of publicity texts; radio advertising; billposting; distribution of samples; dissemination of advertising matter; writing of publicity texts; on-line advertising on a computer network; advertising by mail order; television advertising; document reproduction; compilation of statistics; business inquiries; systemization of information into computer databases; tax preparation; drawing up of statements of accounts; commercial administration of the licensing of the goods and services of others; public relations; modelling for advertising or sales promotion; relocation services for businesses; price comparison services; procurement services for others [purchasing goods and services for other businesses]; business efficiency expert services; arranging subscriptions to telecommunication services for others; office functions; book-keeping; transcription of communications [office functions]; commercial information and advice for consumers [consumer advice shop]; marketing consultancy;

secretarial and clerical services; arranging newspaper subscriptions for others; data search in computer files for others; presentation of goods on communication media, for retail purposes; sales promotions at point of purchase or sale, for others; rental of advertising time on communication media; typing; compilation of information into computer databases; personality testing for recruitment purposes; business management of hotels; administrative processing of purchase orders; telephone answering for unavailable subscribers; photocopying services.

38 – Telecommunications; news agency services; television broadcasting; cable television broadcasting; electronic bulletin board services [telecommunications services]; information about telecommunication; providing access to databases; providing telecommunications connections to a global computer network; providing telecommunication channels for teleshopping services; message sending; computer aided transmission of messages and images; transmission of telegrams; rental of message sending apparatus; rental of modems; rental of telecommunication equipment; rental of telephones; rental of facsimile apparatus; radio broadcasting; communications by fiber optic networks; communications by cellular phones; communications by computer terminals; satellite transmission; communications by telegrams; communications by telephone; facsimile transmission; paging services [radio, telephone or other means of electronic communication]; telex services; voice mail services; telegraph services; telephone services; telecommunications routing and junction services; providing internet chatrooms; providing user access to the Internet [service providers]; communication of data by electronic mail; providing access to a worldwide computer network; teleconferencing services.

41 – Providing of training; entertainment services; academies [education]; rental of tennis courts; lending library services; videotaping; physical education; discotheque services; animal training; dubbing; gambling services; publication of books; education information; recreation information; entertainment information; movie studio services; layout services, other than for advertising purposes; microfilming; videotape editing; production of radio and television programmes; religious education; gymnastic instruction; correspondence courses; practical training [demonstration]; organization of balls; arranging and conducting of colloquiums; arranging and conducting of congresses; arranging and conducting of conferences; arranging and conducting of concerts; arranging and conducting of workshops [training]; arranging and conducting of seminars; arranging and conducting of symposiums; arranging of beauty contests; organization of lotteries; organization of shows [impresario

services]; organization of sports competitions; vocational guidance [education or training advice]; amusement park services; sign language interpretation; television entertainment; mobile library services; providing golf facilities; providing sports facilities; providing amusement arcade services; cinema presentations; presentation of live performances; theatre productions; educational examination; production of motion pictures; rental of audio equipment; rental of video cameras; rental of video cassette recorders; rental of videotapes; rental of show scenery; rental of motion pictures; rental of stadium facilities; rental of lighting apparatus for theatrical sets or television studios; rental of radio and television sets; rental of skin diving equipment; rental of stage scenery; electronic desktop publishing; on-line publication of electronic books and journals; radio entertainment; entertainer services; zoological garden services; news reporters services; party planning [entertainment]; music composition services; subtitling; calligraphy services; providing museum facilities [presentation, exhibitions]; teaching; orchestra services; translation; ticket agency services [entertainment]; recording studio services; photography; photographic reporting; boarding school education; production of shows; modelling for artists; booking of seats for shows; nursery schools; health club services [health and fitness training]; entertainment club services; nightclub services [entertainment]; presentation of variety shows; game services provided on-line from a computer network; providing on-line electronic publications, not downloadable; organization of exhibitions for cultural or educational purposes; providing recreation facilities; organization of competitions [education or entertainment]; videotape film production, other than advertising films; rental of sound recordings; rental of cinematographic apparatus; rental of sports equipment, except vehicles; publication of texts, other than publicity texts; writing and publication of texts, other than publicity texts; sport camp services; providing casino facilities [gambling]; scriptwriting, other than for advertising purposes; on-line digital publishing services.

42 – Scientific and technological services and research and design relating thereto; industrial analysis and research services; chemical analysis; graphic arts design; computer virus protection services; engineering; installation of computer software; meteorological information; material testing; textile testing; bacteriological research; biological research; geological research; research in the field of environmental protection; cosmetic research; mechanical research; chemical research; analysis for oil-field exploitation; underwater exploration; technical research; calibration [measuring]; computer software consultancy; oil-well testing; quality control; vehicle roadworthiness

testing; dress designing; updating of computer software; design of interior decor; conversion of data or documents from physical to electronic media; urban planning; providing search engines for the internet; computer system design; rental of web servers; computer rental; geological prospecting; oil prospecting; duplication of computer programs; construction drafting; computer software design; cloud seeding; consultancy in the field of energy-saving; creating and maintaining web sites for others; computer programming; chemistry services; packaging design; surveying; design and development of computer hardware and software; architectural research; authenticating works of art; development of computer databases; technical project planning; research in the fields of chemistry, biology and physics; research and development of new products for others; consultancy in the design and development of computer hardware; architectural consultancy; consultancy in the field of construction drafting; geological estimation and research; oil-field surveys; computer software support services; conversion of computer programs and data, other than physical conversion; rental of computer software; hosting web sites on the Internet; styling [industrial design]

(260) AM 2018 94733 A

(800) 1371202

(151) 2017 03 22

(891) 2017 10 19

(731) «KONTI-RUS» JOINT STOCK COMPANY
ul. Zolotaia, 13, RU-305000 Kursk, Russian
Federation

(540)

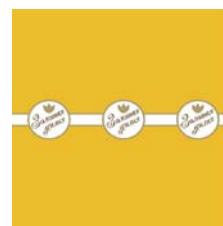

(591) Yellow, white, golden and light brown.

(531) 05.05.20; 25.07.01; 26.01.06; 26.04.01;
26.04.10; 29.01.12

(511)

30 – Confectionery.

(260) AM 2018 94734 A

(800) 1371204

(151) 2016 08 10

(891) 2017 07 31

(731) ELBİ ELEKTRİK ULUSLARARASI
TİCARET VE SANAYİ ANONİM ŞİRKETİ
Mehmet Akif Ersoy Mah. Maltepe Cad.
NO:15 Taşoluk, Arnavutköy, Gaziosmanpaşa,
İstanbul, Turkey

(540)

TIVANO

(591) Black, white

(511)

9 – Electrical distribution boards.

(260) AM 2018 94735 A

(800) 1371223

(151) 2017 04 05

(891) 2017 04 05

(731) Essity Hygiene and Health Aktiebolag
SE-405 03 Göteborg, Sweden

(540)



(591) Black, white

(531) 05.05.20; 27.05.21

(511)

3 – Bleaching preparations; substances for laundry use; detergents; cleaning polishing, scouring and abrasive preparations; skin care products, namely washing creams, cleansing creams, moisturizers, skin lotions, barrier creams, zinc creams, hand-washing substances, soaps, cakes of soap; perfumery, essential oils; bath oils; shampoos and conditioners; hair gels; after-shave lotions; toothpaste; deodorants; disposable impregnated paper and cotton articles (toilettries) for cleaning, sanitary and cosmetic purposes; cotton wool; cotton sticks.

5 – Disposable paper and cotton articles impregnated with pharmaceutical lotions for cleaning and sanitary purposes; breast nursing pads; disposable diapers; diaper pants; disposable diapers, diaper pants and other absorbent articles; nappy liners, sanitary panty liners, tampons; sanitary napkins (towels) and other absorbent articles for sanitary purposes; ointments; diagnostic agents for pharmaceutical use; wound cleansing set composed of medical cleansers for wounds and wound dressings; plasters, dressings, wound dressings, medical strips, bandages for sanitary purposes (and/or medical purposes).

9 – Computer software in digital form containing information relating to all aspects of health care, personal care, incontinence care and geriatric care; computer software related to the measurement of patterns of urination; apparatus for the transmission of data; data storage devices; data processing equipment and accessories, communication equipment; sensors and detectors; software for analyzing business management and customer services for analy-

zing traffic and visitor data, consumption and stock levels; software for steering and optimizing operations, software for improvement of quality; software for providing information to customers and staff relating to traffic and visitor data, consumption and stock levels; software in form of apps; computer systems for automatic control of ventilating, air-purifying and air-freshening apparatus and installations, sanitary apparatus and installations, in particular toilets, urinals (sanitary fixtures), wash bowls, hand drying apparatus, towel dispensers, soap dispensers, toilet paper dispensers, aerosol containers.

10 – Orthopedic support dressings and orthopedic bandages and hosiery; medical compression stockings, tights and socks, medical support stockings; casting tapes and bandages for orthopedic purposes; splints for surgical purposes; orthopedic articles; padding material for orthopedic purposes (included in this class); draw-sheets for sick beds.

16 – Paper; paper wipes containing cellulose or not, for wiping dry; paper products for household, hygienic, sanitary and cosmetic purposes, namely, tissue paper, kitchen rolls, toilet paper, paper handkerchiefs, cellulose wipes, paper hand towels, paper napkins, paper serviettes, paper washcloths, paper towels, paper tissues, babies bibs of paper, face towels of paper, facial tissues of paper; protective covers made of paper namely bibs of paper, paper pads for changing nappies; paper table cloths; printing products namely colour prints, printed emblems, printed patterns, printed paper labels, graphic prints; printing paper, fine paper; writing paper, newsprint, paper for books, newspapers, catalogues, magazines and other printed matters; packaging's made of paper or plastic; plastic material for packaging of soaps, degreasing agents, detergents; table linen of paper, absorbent paper.

20 – Non-metallic fixed stands (holders) and dispensers for products made of paper, namely towels, serviettes, kitchen rolls and toilet rolls; bins, bins for disposal of sanitary products.

21 – Household stands (holders), holders, containers and dispensers for paper, paper towels, liquid soap, air fresheners and other household, kitchen and toilet products; cleaning cloths; household and kitchen utensils and containers (not of precious metal or coated therewith).

24 – Woven fabrics and textile goods not included in other classes; bed and table linen, woven, non-woven; bed and table covers, under sheets.

35 – Business information services provided on-line from a computer database or the internet; distribution of samples; systematization of data in databases.

38 – Providing access to a compilation of information from computer databases matter in relation to health care, hygienic care and geriatric care; provi-

ding access to a global computer network for the transfer and dissemination of information.

41 – Education; education services relating to personal care, health care and geriatric care; arranging and conducting of educational seminars in relation to personal care, health care and geriatric care.

42 – Industrial analysis and research services in the field of the paper industry including area of paper and cotton products for household, hygienic, sanitary and cosmetic purposes; quality assurance consultancy; advice and analysis relating to improvement of quality in relation to analysis of traffic and visitor data, product consumption and stock levels.

44 – Healthcare; consulting services relating to health; individualised and group healthcare services provided through planning, organizing and monitoring, the aforementioned services also provided online or via the internet; hygienic and beauty care for human beings.

(260) AM 2018 94737 A

(800) 1371307

(151) 2017 06 01

(891) 2017 06 01

(731) Apple Inc.

1 Infinite Loop, Cupertino CA 95014, USA

(540)

SIRI

(591) Black, white

(511)

35 – Advertising, marketing, and promotion services; advertising and marketing services, namely, promoting the goods and services of others; computerized database and file management; data processing services; creating indexes of information, sites and other resources available on global computer networks and other electronic and communications networks for others, for advertising and commercial purposes; promoting the goods and services of others by providing, searching, browsing and retrieving information, sites, and other resources available on global computer networks and other electronic and communications networks for others; promoting the goods and services of others by organizing content of business information provided over a global computer network and other electronic and communications networks according to user preferences; providing business, consumer product, and commercial information over computer networks and global communication networks; providing consumer product information for the purpose of selecting general consumer merchandise to meet the consumer's specifications.

(260) AM 2018 94742 A

(800) 1371337

(151) 2017 06 09

(891) 2017 06 09

(731) 5K YÜZEY TEKNOLOJİLERİ ORMAN ÜRÜNLERİ MOBİLYA SANAYİ VE TİCARET ANONİM ŞİRKETİ

Güzelhisar Mah. Yıldırım Beyazıt Cad. No:9, Akyurt Ankara, Turkey

(540)



(591) Black and gold.

(531) 26.04.02; 26.04.22; 26.04.24; 27.05.01;

27.05.24; 29.01.12

(511)

19 – Sand, gravel, crushed stone, asphalt, bitumen, cement, gypsum, plaster, concrete, marble blocks for construction, included in this class, building materials (as finished products) made of concrete, gypsum, clay, potters' clay, stone, marble, wood, plastics and synthetic materials for building, construction, road construction purposes, included in this class; non-metallic buildings, non-metallic building materials, poles not of metal for power lines, barriers not of metal; natural and synthetic coatings in the form of panels and sheets, being building materials; bitumen cardboard coatings for roofing; bitumen coating for roofing; traffic signs not of metal, non-luminous and non-mechanical, for roads, monuments and statuettes of stone, concrete and marble, building glass, prefabricated swimming pools not of metal (structures), aquarium sand.

(260) AM 2018 94756 A

(800) 1318151

(151) 2016 04 13

(891) 2017 09 08

(731) Beijing Tiexue Tech. Co., Ltd

Rm.1804-1805, NO.1 Building, 18 Danling St, Haidian District, Beijing, 100080, China

(540)



(591) Black, white

(531) 24.15.21; 26.03.02; 27.05.01; 27.05.17

(511) 25 – Clothing; layettes [clothing]; wet suits for water-skiing; waterproof clothing; shoes; hats; hosiery; gloves [clothing]; neckties; girdles.

(260) AM 2018 94761 A

(800) 1370671

(151) 2017 09 08

(891) 2017 09 08

(731) Responsible Gold Operations Ltd
109 North Post Oak Lane, Suite 435 Houston
TX 77024, USA

(540)

G-COIN

(591) Black and white

(531) 27.05.17

(511)

36 – Providing an on-line exchange for trading in virtual currency and electronic money; brokerage services in the nature of virtual currency and electronic money trading; electronic funds transfer services; financial services, namely, providing a virtual currency for use by and transfer among members of an on-line community via a global computer network; currency trading services; currency transfer services; virtual currency exchange transaction services for transferable electronic cash equivalent units having specified cash value; provision of prepaid tokens, namely, processing electronic payments made through prepaid purchase tokens; money transfer services; currency dealing services; brokerage of currency; electronic cash transactions; issuance of virtual currency tokens; virtual money exchange services; commodity trading services.

(260) AM 2018 94763 A

(800) 1370769

(151) 2017 03 24

(891) 2017 03 24

(731) Probiotics International Limited
Lopen Head Somerset TA13 5JH, United
Kingdom

(540)

LEPICOL

(591) Black and white

(511)

5 – Pharmaceutical and medicinal preparations and substances; nutritional and dietetic products; healthcare formulations and supplements containing fibre and bacterial preparations; plant extracts.

(260) AM 2018 94764 A

(800) 1370779

(151) 2017 07 12

(891) 2017 07 12

(731) Wuzhanmao Wine Industry Co., Ltd
55 Tianfu Road, Xiaofeng Town, Anji County
313301 Zhejiang Province, China

(540)

乌毡帽

(591) Black and white

(531) 28.03

(511)

33 – White spirits (a kind of liquor distilled by traditional Chinese method and produced in China); yellow spirits (a kind of liquor distilled by traditional Chinese method and produced in China); distilled spirits of rice; distilled spirits; potable spirits.

(260) AM 2018 94766 A

(800) 1370821

(151) 2017 06 01

(891) 2017 06 01

(731) Apple Inc.

1 Infinite Loop Cupertino CA 95014, USA

(540)

SIRI

(591) Black and white

(531) 27.05.17

(511)

43 – Restaurant reservation services; providing information relating to dining, hotels, and temporary accommodations for travelers.

45 – Personal concierge services for others comprising making requested personal arrangements and reservations and providing customer-specific information to meet individual needs, rendered online.

(260) AM 2018 94819 A

(800) 1370564

(151) 2017 05 18

(891) 2017 05 18

(731) Limited Liability Company "EVOTOR"
ul. Timur Frunze, 24, floor 6, RU-119021
Moscow, Russian Federation

(540)

EVOTOR

(591) Black, white

(531) 27.05.01; 27.05.17

(511)

9 – Antennas; aerials; electrical adapters; accumulators, electric; accumulators, electric, for vehicles; batteries, electric, for vehicles; high-frequency apparatus; testing apparatus not for medical purposes; remote control apparatus; monitoring apparatus, electric; Global Positioning System [GPS] apparatus; cash registers; electric apparatus for commutation; intercommunication apparatus; blueprint apparatus; telephone apparatus; batteries, electric; balances [steelyards]; electronic tags for goods; magnetic tape units for computers; computer memory devices; encoded identification bracelets, magnetic; video telephones; video screens; sockets, plugs and other contacts [electric

connections]; plugs, sockets and other contacts [electric connections]; micrometer screws for optical instruments; lever scales [steelyards]; steelyards [lever scales]; letter scales; weighbridges; precision balances; mechanical signs; signs, luminous; switchboxes [electricity]; current rectifiers; hands-free kits for telephones; detectors; false coin detectors; light-emitting diodes [LED]; bells [warning devices]; disk drives for computers; juke boxes for computers; DNA chips; electronic notice boards; measures; simulators for the steering and control of vehicles; locks, electric; coaxial cables; fiber optic cables; cables, electric; measuring instruments; calculating machines; pocket calculators; interfaces for computers; electronic pens [visual display units]; holders for electric coils; identity cards, magnetic; toner cartridges, unfilled, for printers and photocopiers; memory cards for video game machines; encoded magnetic cards; encoded key cards; electronic book readers; electronic agendas; automated teller machines [ATM]; computer keyboards; commutators; compact discs [audio-video]; compact discs [read-only memory]; battery boxes; accumulator boxes; computers; laptop computers; tablet computers; notebook computers; covers for electric outlets; logs [measuring instruments]; lasers, not for medical purposes; branch boxes [electricity]; distribution boxes [electricity]; junction boxes [electricity]; magnets; decorative magnets; rulers [measuring instruments]; slide-rules; mouse [computer peripheral]; money counting and sorting machines; material testing instruments and machines; megaphones; microprocessors; modems; mechanisms for coin-operated apparatus; monitors [computer hardware]; monitors [computer programs]; sheaths for electric cables; identification sheaths for electric wires; weighing machines; computer hardware; punched card machines for offices; headphones; sound recording carriers; magnetic data media; optical data media; limiters [electricity]; computer software, recorded; electronic pocket translators; measuring apparatus; transmitters [telecommunication]; telephone transmitters; transmitters of electronic signals; switches, electric; digital signs; printed circuit boards; fuses; circuit breakers; converters, electric; diagnostic apparatus, not for medical purposes; distance recording apparatus; teaching apparatus; time recording apparatus; satellite navigational apparatus; regulating apparatus, electric; precision measuring apparatus; audio- and video-receivers; printers for use with computers; telephone wires; wires, electric; conductors, electric; computer programmes [programs], recorded; computer game software; computer programs [downloadable software]; computer operating programs, recorded; processors [central processing units]; central processing units [processors]; electronic publications, downloadable; distribution

consoles [electricity]; control panels [electricity]; voltage surge protectors; signals, luminous or mechanical; sirens; scanners [data processing equipment]; smartphones; integrated circuit cards [smart cards]; smart cards [integrated circuit cards]; connections for electric lines; couplings, electric; connections, electric; connectors [electricity]; audiovisual teaching apparatus; radiotelephony sets; bags adapted for laptops; drying racks [photography]; integrated circuits; printed circuits; counters; meters; abacuses; taximeters; tachometers; television apparatus; cellular phones; mobile telephones; cell phones; cordless telephones; transistors [electronic]; transponders; transformers [electricity]; step-up transformers; gauges; amplifiers; electric installations for the remote control of industrial operations; steering apparatus, automatic, for vehicles; sound reproduction apparatus; invoicing machines; tape recorders; data processing apparatus; theft prevention installations, electric; film cutting apparatus; optical character readers; battery chargers; chargers for electric batteries; sound alarms; couplers [data processing equipment]; computer peripheral devices; demagnetizing apparatus for magnetic tapes; readers [data processing equipment]; photocopiers [photographic, electrostatic, thermic]; bar code readers; computer software applications, downloadable; downloadable ring tones for mobile phones; downloadable image files; downloadable music files; animated cartoons; filters [photography]; USB flash drives; magic lanterns; time clocks [time recording devices]; sleeves for laptops; jigs [measuring instruments]; cell phone straps; switchboards; screens [photography]; projection screens.

35 – Arranging subscriptions to telecommunication services for others; import-export agency services; commercial information agency services; advertising agencies; publicity agencies; cost price analysis; rental of advertising space; business auditing; employment agency services; computerized file management; book-keeping; accounting; invoicing; demonstration of goods; transcription of communications [office functions]; opinion polling; market studies; business information; commercial information and advice for consumers [consumer advice shop]; business investigations; business research; marketing research; personnel recruitment; business management and organization consultancy; business organization consultancy; business management consultancy; personnel management consultancy; professional business consultancy; layout services for advertising purposes; marketing; business management of performing artists; organization of trade fairs for commercial or advertising purposes; shop window dressing; design of advertising materials; business appraisals; payroll preparation; data search in computer files for others;

sponsorship search; business management assistance; commercial or industrial management assistance; commercial intermediation services; news clipping services; updating of advertising material; updating and maintenance of data in computer databases; word processing; organization of exhibitions for commercial or advertising purposes; provision of commercial and business contact information; providing business information via a web site; provision of an on-line marketplace for buyers and sellers of goods and services; presentation of goods on communication media, for retail purposes; economic forecasting; auctioneering; retail or wholesale services for pharmaceutical, veterinary and sanitary preparations and medical supplies; sales promotion for others; production of advertising films; office machines and equipment rental; rental of advertising time on communication media; publicity material rental; rental of billboards [advertising boards]; rental of vending machines; rental of sales stands; rental of photocopying machines; publication of publicity texts; radio advertising; bill-posting; outdoor advertising; distribution of samples; dissemination of advertising matter; writing of publicity texts; advertising; publicity; on-line advertising on a computer network; television advertising; document reproduction; compilation of statistics; compilation of information into computer databases; business inquiries; systemization of information into computer databases; advisory services for business management; negotiation and conclusion of commercial transactions for third parties; tax preparation; drawing up of statements of accounts; telemarketing services; outsourced administrative management for companies; business management for freelance service providers; commercial administration of the licensing of the goods and services of others; business management of reimbursement programs for others; business management of reimbursement programmes for others; administrative processing of purchase orders; public relations; tax filing services; search engine optimization for sales promotion; search engine optimisation for sales promotion; web site traffic optimization; price comparison services; pay per click advertising; procurement services for others [purchasing goods and services for other businesses]; outsourcing services [business assistance]; business efficiency expert services.

36 – Financial analysis; lease-purchase financing; hire-purchase financing; savings bank services; issuance of credit cards; deposits of valuables; capital investment; insurance information; financial information; clearing, financial; clearing-houses, financial; insurance consultancy; financial consultancy; debt advisory services; stock exchange quotations; lending against security; business liquidation services, financial; brokerage; financial management; exchanging money; online banking;

processing of debit card payments; processing of credit card payments; factoring; organization of collections; arranging finance for construction projects; financial evaluation [insurance, banking, real estate]; electronic funds transfer; surety services; securities brokerage; insurance brokerage; loans [financing]; pawnbrokerage; providing financial information via a web site; investment of funds; charitable fund raising; instalment loans; insurance underwriting; financial management of reimbursement payments for others; banking; stock brokerage services; trusteeship; fiduciary; financing services; fiscal valuation.

38 – News agency services; providing user access to global computer networks; providing access to databases; providing internet chatrooms; providing telecommunications connections to a global computer network; providing online forums; rental of modems; rental of telecommunication equipment; radio communications; communications by fibre optic networks; communications by fiber optic networks; communications by computer terminals; telecommunications routing and junction services; streaming of data; telephone services.

42 – Computer system analysis; recovery of computer data; industrial design; graphic arts design; computer virus protection services; conducting technical project studies; engineering; installation of computer software; mechanical research; research and development of new products for others; scientific research; technical research; calibration [measuring]; web site design consultancy; consultancy in the design and development of computer hardware; computer software consultancy; technological consultancy; quality control; updating of computer software; monitoring of computer systems by remote access; software as a service [SaaS]; design of interior decor; maintenance of computer software; digitization of documents [scanning]; conversion of data or documents from physical to electronic media; providing information on computer technology and programming via a web site; providing information on computer technology and programming via a website; providing search engines for the internet; conversion of computer programs and data, other than physical conversion; computer system design; rental of web servers; computer rental; rental of computer software; hosting computer sites [web sites]; server hosting; computer software design; consultancy in the field of energy-saving; creating and maintaining web sites for others; computer programming; duplication of computer programs; outsource service providers in the field of information technology; packaging design; off-site data backup; information technology [IT] consultancy; telecommunications technology consultancy; scientific laboratory services; cloud

computing; styling [industrial design]; electronic data storage; surveying.

(260) AM 2018 94820 A

(800) 1370605

(151) 2017 06 01

(891) 2017 06 01

(731) Apple Inc.

1 Infinite Loop, Cupertino CA 95014, USA

(540)

SIRI

(591) Black,white

(531) 27.05.17

(511)

35 – Providing consumer information via voice-controlled automated inquiries, namely, through an online automated consumer resource for searching, locating, rating and providing directions for the purchase, consumption and use of a wide range of consumer products, services and information over a global communications network.

(260) AM 2018 94822 A

(800) 1370610

(151) 2017 05 23

(891) 2017 05 23

(731) Abrasive technologies, LLC

1 Mira str, g. Sosnovy Bor, RU-188540

Leningrad obl., Russian Federation

(540)

LEMON MOON

(591) Black,white

(531) 27.05.05

(511)

3 – Bleaching preparations and other substances for laundry use; cleaning, polishing, scouring and abrasive preparations; perfumery, essential oils, cosmetics, hair lotions; dentifrices; abrasives; amber [perfume]; descaling preparations for household purposes; antistatic preparations for household purposes; aromatics [essential oils]; air fragrancing preparations; cake flavorings [essential oils]; flavorings for beverages [essential oils]; food flavorings [essential oils]; breath freshening sprays; canned pressurized air for cleaning and dusting purposes; balms, other than for medical purposes; lip glosses; polishing stones; abrasive paper; emery paper; polishing paper; petroleum jelly for cosmetic purposes; shoe polish; cobblers' wax; cotton wool for cosmetic purposes; sachets for perfuming linen; drying agents for dishwashing machines; adhesives for cosmetic purposes; scented water; javelle water; lavender water; toilet water; laundry wax; floor wax; non-slipping wax for floors; depilatory wax; mustache wax; tailors' wax; creams for leather; polish for furniture and flooring; shoemakers' wax;

polishing wax; massage gels, other than for medical purposes; heliotropine; dental bleaching gels; geraniol; make-up; deodorants for pets; deodorants for human beings or for animals; depilatory preparations; scented wood; perfumes; non-slipping liquids for floors; windshield cleaning liquids; greases for cosmetic purposes; volcanic ash for cleaning; toiletries; decorative transfers for cosmetic purposes; ionone [perfumery]; shaving stones [astringents]; smoothing stones; eyebrow pencils; cosmetic pencils; silicon carbide [abrasive]; carbides of metal [abrasives]; alum stones [astringents]; tripoli stone for polishing; adhesives for affixing false eyelashes; adhesives for affixing false hair; hair conditioners; quillaia bark for washing; corundum [abrasive]; beard dyes; colorants for toilet purposes; cosmetic dyes; laundry starch; laundry glaze; shoe cream; polishing creams; cosmetic creams; skin whitening creams; polishing rouge; incense; hair spray; nail polish; lotions for cosmetic purposes; after-shave lotions; beauty masks; oils for perfumes and scents; oils for cosmetic purposes; oils for toilet purposes; essential oils of cedarwood; essential oils of lemon; essential oils of citron; oils for cleaning purposes; bergamot oil; gaultheria oil; jasmine oil; lavender oil; almond oil; rose oil; oil of turpentine for degreasing; whiting; cleaning chalk; almond milk for cosmetic purposes; cleansing milk for toilet purposes; musk [perfumery]; soap; deodorant soap; shaving soap; soap for brightening textile; cakes of toilet soap; antiperspirant soap; soap for foot perspiration; almond soap; mint for perfumery; cosmetic kits; emery; nail art stickers; false nails; eau de Cologne; bases for flower perfumes; joss sticks; pastes for razor strops; pumice stone; lipstick cases; hydrogen peroxide for cosmetic purposes; breath freshening strips; teeth whitening strips; abrasive cloth; glass cloth [abrasive cloth]; lipsticks; pomades for cosmetic purposes; shaving preparations; cosmetic preparations for baths; bath preparations, not for medical purposes; hair straightening preparations; hair waving preparations; laundry soaking preparations; grinding preparations; douching preparations for personal sanitary or deodorant purposes [toiletries]; smoothing preparations [starching]; color-removing preparations; leather bleaching preparations; denture polishes; mouthwashes, not for medical purposes; cosmetic preparations for slimming purposes; starch glaze for laundry purposes; refurbishing preparations; fabric softeners for laundry use; laundry bleach; dry-cleaning preparations; paint stripping preparations; lacquer-removing preparations; make-up removing preparations; floor wax removers [scouring preparations]; varnish-removing preparations; rust removing preparations; nail care preparations; preparations for cleaning dentures; wallpaper cleaning preparations; preparations for unblocking drain pipes; collagen preparations for cosmetic

purposes; laundry preparations; aloe vera preparations for cosmetic purposes; sunscreen preparations; color- [colour-] brightening chemicals for household purposes [laundry]; shining preparations [polish]; make-up powder; diamantine [abrasive]; stain removers; scouring solutions; false eyelashes; tissues impregnated with cosmetic lotions; tissues impregnated with make-up removing preparations; saftrol; laundry blueing; turpentine for degreasing; potpourris [fragrances]; bleaching soda; washing soda, for cleaning; bath salts, not for medical purposes; bleaching salts; fumigation preparations [perfumes]; preservatives for leather [polishes]; ammonia [volatile alkali] [detergent]; astringents for cosmetic purposes; eyebrow cosmetics; make-up preparations; sun-tanning preparations [cosmetics]; hair dyes; neutralizers for permanent waving; preparations to make the leaves of plants shiny; cosmetic preparations for eyelashes; cosmetic preparations for skin care; shoe wax; cosmetics; cosmetics for animals; mascara; detergents, other than for use in manufacturing operations and for medical purposes; degreasers, other than for use in manufacturing processes; bleaching preparations [decolorants] for cosmetic purposes; antiperspirants [toilettries]; talcum powder, for toilet use; cotton sticks for cosmetic purposes; terpenes [essential oils]; emery cloth; cloths impregnated with a detergent for cleaning; henna [cosmetic dye]; shampoos; shampoos for pets; dry shampoos; sandpaper; soda lye; extracts of flowers [perfumes]; ethereal essences; badian essence; mint essence [essential oil].

21 – Household or kitchen utensils and containers; combs and sponges; brushes, except paintbrushes; material for brush-making; articles for cleaning purposes; steel wool; glassware, porcelain and earthenware; autoclaves [pressure cookers], non-electric; pressure cookers [autoclaves], non-electric; indoor aquaria; buckets; cookie jars; candle jars [holders]; china ornaments; dishes; paper plates; vegetable dishes; saucers; mugs; candy boxes; bottles; demijohns; busts of porcelain, ceramic, earthenware or glass; vases; epergnes; fruit cups; bird baths; baby baths, portable; plungers for clearing blocked drains; waffle irons, non-electric; coolers [ice pails]; mop wringer buckets; buckets made of woven fabrics; whisks, non-electric, for household purposes; cooking skewers of metal; towel rails and rings; clothing stretchers; hair for brushes; birdcages; funnels; carpet beaters [hand instruments]; signboards of porcelain or glass; candle extinguishers; flower pots; chamber pots; glue-pots; cruets; decanters; large-toothed combs for the hair; combs for animals; tea cosies; abrasive sponges for scrubbing the skin; make-up sponges; sponges for household purposes; toilet sponges; sponge holders; toothpick holders; soap holders; napkin holders; holders for flowers and plants

[flower arranging]; shaving brush stands; toilet paper holders; soap dispensers; toilet paper dispensers; ironing boards; cutting boards for the kitchen; bread boards; washing boards; crushers for kitchen use, non-electric; strainers; smoke absorbers for household purposes; containers for household or kitchen use; kitchen containers; glass jars [carboys]; heat-insulated containers; heat-insulated containers for beverages; thermally insulated containers for food; glass flasks [containers]; closures for pot lids; chamois leather for cleaning; toothpicks; ceramics for household purposes; majolica; works of art of porcelain, ceramic, earthenware or glass; brush goods; kitchen grinders, non-electric; cleaning instruments, hand-operated; cabarets [trays]; stew-pans; covers, not of paper, for flower pots; shaving brushes; make-up brushes; basting brushes; cages for household pets; baking mats; polishing leather; hot pots, not electrically heated; glass bulbs [receptacles]; boot trees [stretchers]; shoe trees [stretchers]; napkin rings; poultry rings; rings for birds; coin banks; bread baskets for household purposes; baskets for household purposes; waste paper baskets; feeding troughs; mangers for animals; lunch boxes; tea caddies; washtubs; earthenware saucepans; mess-tins; cauldrons; coffee percolators, non-electric; coffeepots, non-electric; coffee grinders, hand-operated; fused silica [semi-worked product], other than for building; beer mugs; tankards; rat traps; pot lids; aquarium hoods; butter-dish covers; dish covers; cheese-dish covers; buttonhooks; pitchers; perfume burners; non-electric portable coldboxes; watering cans; fly traps; insect traps; mixing spoons [kitchen utensils]; basting spoons [cooking utensils]; scoops [tableware]; pie servers; cosmetic spatulas; spatulas [kitchen utensils]; butter dishes; polishing materials for making shiny, except preparations, paper and stone; noodle machines, hand-operated; polishing apparatus and machines, for household purposes, non-electric; pepper mills, hand-operated; mills for household purposes, hand-operated; feather-dusters; brooms; isothermic bags; confectioners' decorating bags [pastry bags]; bowls [basins]; mosaics of glass, not for building; saucepan scourers of metal; soap boxes; mouse traps; cooking pot sets; nozzles for watering cans; pouring spouts; nozzles for watering hose; fitted picnic baskets, including dishes; toilet cases; floss for dental purposes; fiberglass thread, not for textile use; cookie [biscuit] cutters; pastry cutters; sprinklers; syringes for watering flowers and plants; cotton waste for cleaning; wool waste for cleaning; cleaning tow; chopsticks; cocktail stirrers; food steamers, non-electric; pepper pots; oven mitts; gloves for household purposes; car washing mitts; polishing gloves; gardening gloves; plates to prevent milk boiling over; dripping pans; trays for household purposes; trays of paper, for household purposes; lazy susans; heaters for feeding bottles, non-electric;

candelabra [candlesticks]; trivets [table utensils]; coasters, not of paper and other than table linen; grill supports; menu card holders; knife rests for the table; flat-iron stands; egg cups; abrasive pads for kitchen purposes; scouring pads; drinking troughs; powdered glass for decoration; pottery; pots; cooking pots; painted glassware; tableware, other than knives, forks and spoons; porcelain ware; earthenware; crystal [glassware]; cosmetic utensils; toilet utensils; trouser presses; tortilla presses, non-electric [kitchen utensils]; deodorising apparatus for personal use; cruet sets for oil and vinegar; make-up removing appliances; spice sets; apparatus for wax-polishing, non-electric; bottle openers, electric and non-electric; glove stretchers; boot jacks; crumb trays; tie presses; potholders; clothes-pegs; glass stoppers; powder compacts; perfume vaporizers; powder puffs; dusting apparatus, non-electric; electric combs; grills [cooking utensils]; sifters [household utensils]; drinking horns; shoe horns; candle rings; salad bowls; sugar bowls; beaters, non-electric; services [dishes]; coffee services [tableware]; liqueur sets; tea services [tableware]; sieves [household utensils]; cinder sifters [household utensils]; tea strainers; pipettes [wine-tasters]; siphon bottles for carbonated water; rolling pins, domestic; frying pans; steel wool for cleaning; currycombs; blenders, non-electric, for household purposes; fruit presses, non-electric, for household purposes; drinking straws; salt cellars; drinking vessels; vessels of metal for making ices and iced drinks; refrigerating bottles; bulb basters; cups of paper or plastic; glasses [receptacles]; drinking glasses; statues of porcelain, ceramic, earthenware or glass; figurines [statuettes] of porcelain, ceramic, earthenware or glass; glass for vehicle windows [semi-finished product]; plate glass [raw material]; opal glass; glass, unworked or semi-worked, except building glass; opaline glass; glass incorporating fine electrical conductors; enamelled glass, not for building; glass wool, other than for insulation; vitreous silica fibers [fibres], not for textile use; fiberglass, other than for insulation or textile use; soup bowls; drying racks for laundry; basins [receptacles]; table plates; disposable table plates; graters for kitchen use; insulating flasks; indoor terrariums [plant cultivation]; indoor terrariums [vivariums]; cloth for washing floors; cloths for cleaning; dusting cloths [rags]; furniture dusters; litter boxes [trays] for pets; urns; aerosol dispensers, not for medical purposes; wax-polishing appliances, non-electric, for shoes; water apparatus for cleaning teeth and gums; electric devices for attracting and killing insects; watering devices; utensils for household purposes; cooking utensils, non-electric; strainers for household purposes; coffee filters, non-electric; flasks; hip flasks; drinking bottles for sports; molds [kitchen utensils]; cake molds [moulds]; ice cube molds [moulds]; cookery molds

[moulds]; deep fryers, non-electric; comb cases; bread bins; fly swatters; teapots; kettles, non-electric; cups; garlic presses [kitchen utensils]; ironing board covers, shaped; tea infusers; glass bowls; mops; mop wringers; cocktail shakers; corkscrews, electric and non-electric; animal bristles [brushware]; pig bristles; dishwashing brushes; ski wax brushes; brushes for cleaning tanks and containers; lamp-glass brushes; horse brushes; scrubbing brushes; toothbrushes; toothbrushes, electric; carpet sweepers; brushes for footwear; tar-brushes, long handled; toilet brushes; electric brushes, except parts of machines; brushes; eyebrow brushes; nail brushes; nest eggs, artificial; boxes for dispensing paper towels; dustbins; window-boxes; boxes of glass.

(260) AM 2018 94823 A

(800) 1370615

(151) 2017 08 04

(891) 2017 08 04

(731) Joint Stock Company "Yuzhuralkonditer"
ul. Darvina, d. 12, RU-454087 Chelyabinsk,
Russian Federation

(540)

Детский сад

(591) Black, white

(531) 28.05

(511)

30 – Confectionery, pastries; caramels [candy];
sweetmeats [candy]; chocolate.

(260) AM 2018 94824 A

(800) 1370616

(151) 2017 08 04

(891) 2017 08 04

(731) Joint Stock Company "ТАКФ"
ul. Oktyabrskaya, d. 22, RU-392000 Tambov,
Russian Federation

(540)

ВЕЛИЧАВЫЙ ДУБОК

(591) Black, white

(531) 28.05

(511)

30 – Caramels [candy]; sweetmeats [candy];
pralines; fondants [confectionery]; chocolate.

(260) AM 2018 94825 A

(800) 1370656

(151) 2017 08 17

(891) 2017 08 17

(731) SK BIOPHARMACEUTICALS CO., LTD
221, Pangyoyeok-ro, Bundang-gu, Seongnam-
si Gyeonggi-do, Republic of Korea

(540)

QUILCENDO

(591) Black, white

(531) 27.05.05

(511)

5 – Pharmaceutical and veterinary preparations; dietetic food and substances for medical or veterinary purposes; sanitary preparations for medical use; biological preparations for medical purposes; biochemical preparations for medical purposes; chemical preparations for pharmaceutical purposes; preparations of trace elements for human and animal use; ferments for pharmaceutical purposes; biotechnological preparations for medical purposes; blood solvent; chemical preparations for medicinal purposes; chemical preparations for medical or veterinary purposes; chemical preparations for sanitary use; pharmaceutical preparations for immunity adjustment; vitamin preparations; vaccines; dietary supplements; therapeutic drugs and agents; chemico-pharmaceutical preparations; bacteriological preparations for medical and veterinary use.

(260) AM 2018 94827 A

(800) 1372317

(151) 2017 02 21

(891) 2017 02 21

(731) Ferrari Ventilatori Industriali S.p.A.

Via Marchetti 28, I-36071 Arzignano (VI),
Russian Federation

(540)



(591) Light blue and grey. Light blue: the wordings "FERRARI INDUSTRIAL FAN TECHNOLOGY"; Grey: the crossbar of the letter "A" in the wording "FERRARI" and the circular radiant shape in the background.

(531) 01.15.23; 25.07.07; 27.05.10; 29.01.12

(511)

11 – Fans; fans for industrial use, in particular centrifugal fans and axial fans, except for automotive use.

(260) AM 2018 94828 A

(800) 1372362

(151) 2017 06 30

(891) 2017 06 30

(731) ELKO GRUPA, AS

Toma iela 4, LV-1003 Rīga, Latvia

(540)

ELKO

(591) Black, white

(511)

35 – Retail and wholesale services, including via Internet, in respect of the following goods: information technology equipment, computer hardware, peripherals adapted for use with computers, smartphones, mobile communications devices, servers, computer network devices, multimedia devices, computer game apparatus, data storage apparatus, security system equipment, photo and video equipment, domestic appliances, apparatus for recording, transmission or reproduction of sound or images, parts and accessories therefore, computer software.

(260) AM 2018 94834 A

(800) 1372387

(151) 2017 09 07

(891) 2017 09 07

(731) Faron Pharmaceuticals Oy

Joukahaisenkatu 6, FI-20520 Turku,
Finland

(540)

LUNSAVI

(591) Black, white

(511)

5 – Pharmaceuticals, medical and veterinary preparations for the treatment of diseases and disorders of the lung.

(260) AM 2018 94835 A

(800) 151605

(151) 1951 02 01

(891) 2017 10 12

(731) Sanofi-Aventis Deutschland GmbH

Brüningstrasse 50, 65926 Frankfurt am Main,
Germany

(540)

Festal

(591) Black, white

(511)

5 – Medicines for humans and animals, chemical products for medical and sanitary use, pharmaceutical drugs and preparations, plasters, surgical dressings, pesticides and herbicides, disinfectants.

(260) AM 2018 94836 A

(800) 394946

(151) 1973 01 04

(891) 2017 10 04

(731) F. HOFFMANN-LA ROCHE AG

CH-4002 BÂLE, Switzerland

(540)

LEXOTANIL

(591) Black, white
(511)
5 – Psychotropic remedies.

(260) AM 2018 94843 A
(800) 1090636
(151) 2011 08 17
(891) 2017 08 28
(731) Otkrytoe aktsionernoe obshchestvo
"Nizhegorodsky maslo-zhirovoy kombinat"
11, sh. Zhirokombinata, RU-603950 g. Nizhny
Novgorod, Russian Federation

(540)
ДУШИСТОЕ ОБЛАКО

(591) Black, white
(511)
3 – Tissues impregnated with cosmetic lotions.
5 – Sanitary napkins; tissues impregnated with
pharmaceutical lotions.
16 – Napkins of paper for removing make-up ; face
towels of paper.

(260) AM 2018 94844 A
(800) 1118291
(151) 2012 04 25
(891) 2017 10 09
(731) UNITED BISCUITS (UK) LIMITED
Hayes Park, Hayes End Road Hayes,
Middlesex UB4 8EE, United Kingdom

(540)
McVITIE'S

(591) Black, white
(511)
30 – Biscuits, cakes, flour confectionery, frozen
pizzas.

(260) AM 2018 94845 A
(800) 1150305
(151) 2012 10 23
(891) 2017 10 05
(731) Hypnos Limited
Longwick Road, Princess Risborough,
Buckinghamshire HP27 9RS, United Kingdom

(540)
HYPNOS

(591) Black, white
(511)
20 – Furniture; beds, bedsteads, bed bases,
headboards for beds, divan beds, adjustable beds,
parts and fittings for beds, including bed frames, bed
legs and bed castors; pillows; cushions; mattresses,
pocket spring mattresses; mattress toppers; bedding;
sofa beds; chairs.

24 – Mattress protectors and renovators, duvets,
duvet covers, sheets, pillow cases, valances.

(260) AM 2018 94846 A
(800) 1183743
(151) 2013 09 26
(891) 2017 08 28
(731) Otkrytoe aktsionernoe obshchestvo
"Nizhegorodsky maslo-zhirovoy kombinat"
11, sh. Zhirokombinata, RU-603950 g. Nizhny
Novgorod, Russian Federation

(540)
**ДУШИСТОЕ
ОБЛАКО**

(591) Black, white
(531) 28.05
(511)
3 – Cleaning preparations; soap; perfumery;
essential oils; cosmetics; hair lotions; dentifrices.

(260) AM 2018 94847 A
(800) 1312669
(151) 2016 05 05
(891) 2017 10 11
(731) Dmitry Safronov
Calle Francese Ferrer i Guardia, 56-60,
Sant Feliu de Guixols, E-17248 Girona, Spain

(540)
DERMATIME

(591) Black, white
(511)
3 – Perfumery products, essential oils, soaps; cos-
metics, bleaching preparations and other substances
for laundry use; cleaning, polishing, degreasing and
abrasive preparations; hair lotions; dentifrices.

5 – Pharmaceutical and veterinary products; sani-
tary products for medical use; dietetic food and
substances for medical or veterinary use, food for
babies; food supplements for humans or animals;
plasters, material for dressings; teeth filling and
dental impression materials; disinfectants; products
for destroying vermin; fungicides, herbicides.

10 – Surgical, medical, dental and veterinary
apparatus and instruments, medical stents, medical
implants and medical implants of artificial materials.

35 – Advertising; business management; business
administration; office functions; wholesale and retail
sale services, or sales by means of mail-order
catalogs or electronic communication media,
particularly the bringing together for the benefit of
others of cosmetic, medical and beauty products
(excluding the transport thereof) enabling consumers

to view and purchase them at their convenience, all the foregoing relating to cosmetic, pharmaceutical, dietetic, medical and beauty products.

(260) AM 2018 94848 A

(800) 1323775

(151) 2015 12 30

(891) 2017 06 27

(731) Oleksandr Oleksiyovych Kolisnyk

prosp. Heroiv Stalinhrada, bud. 12 "Zh",
kv. 64, Kyiv 04210, Ukraine

(540)

 **FORESTA**

(591) Green, light green and black. Figurative elements: green and light green colors; verbal elements: black color.

(531) 05.01.01; 27.05.17; 29.01.13

(511)

7 – Machines and machine tools; motors and engines (except for land vehicles); machine coupling and transmission components (except for land vehicles); agricultural implements other than hand-operated; incubators for eggs; automatic vending machines; shaft couplings [machines]; acetylene cleaning apparatus; converters for steelworks; adhesive tape dispensers [machines]; aerating pumps for aquaria; aerocondensers; agitators; agricultural machines; agricultural elevators; filters for cleaning cooling air, for engines; air condensers; apparatus for drawing up beer under pressure; sizing machines; road rollers; carburetter feeders; igniting devices for internal combustion engines; alternators; valves [parts of machines]; axles for machines; crank shafts; transmission shafts, other than for land vehicles; lifts, other than ski-lifts; elevators [lifts]; mixing machines; self-oiling bearings; ploughs; aeroplane engines; colour-washing machines; grease rings [parts of machines]; piston rings; dynamo brushes; road sweeping machines, self-propelled; saw benches [parts of machines]; belts for conveyors; belt conveyors; churns; drums [parts of machines]; housings [parts of machines]; stands for machines; mills [machines]; threshing machines; beating machines; concrete mixers [machines]; butter machines; bicycle dynamos; connecting rods for machines, motors and engines; ball-bearings; bitumen making machines; harvesting machines; sheaf-binding machines; bobbins for weaving looms; woodworking machines; hosiery looms; binding apparatus for hay; mud catchers and collectors [machines]; glow plugs for Diesel engines; threading machines; rinsing machines; bottle filling machines; bottle washing machines; brewing machines; tambours for embroidery machines; brushes [parts of machines]; bulldozers; shovels, mechanical; mortising machines; capstans; cowlings [parts of machines]; type-setting machines [printing];

injectors for engines; carburettors; card clothing [parts of carding machines]; knives [parts of machines]; boxes for matrices [printing]; cinder sifters [machines]; cream/milk separators; spin driers [not heated]; lubricators [parts of machines]; centrifugal machines; centrifugal mills; centrifugal pumps; corn and grain husking machines; milling machines; bearing brackets for machines; hangers [parts of machines]; carbon brushes [electricity]; coal-cutting machines; hoists; loading ramps; carriages for knitting machines; lathes [machine tools]; pulleys; fittings for engine boilers; wine presses; cigarette machines for industrial purposes; bending machines; shears, electric; scissors, electric; chisels for machines; clack valves [parts of machines]; filter presses; scale collectors for machine boilers; pedal drives for sewing machines; type-setting machines [photocomposition]; compressors [machines]; turbocompressors; steam condensers [parts of machines]; condensing installations; pulleys [parts of machines]; joints [parts of engines]; cord making machines; typecasting machines; clippers [machines]; cutters [machines]; current generators; drilling heads [parts of machines]; dynamo belts; elevator belts; stitching machines; air cushion devices for moving loads; bearings [parts of machines]; knives, electric; rack and pinion jacks; sifting installations; sieves [machines or parts of machines]; jacks [machines]; leather-working machines; cylinder heads for engines; cultivators [machines]; cylinders for machines; printing cylinders; rolling mill cylinders; separators; sorting machines for industry; hoppers [mechanical discharging]; cutting machines; deaerators for feedwater; turf removing ploughs; degreasers [machines]; starters for motors and engines; lace making machines; steam separators; disintegrators; pressure reducers [parts of machines]; reeling apparatus, mechanical; leather paring machines; drainage machines; apparatus for dressing; dynamos; sewage pulverisers; water heaters [parts of machines]; fleshing machines; die-cutting and tapping machines; stalk separators [machines]; grain separators; ejectors; generators of electricity; elevating apparatus; swaging machines; clutches other than for land vehicles; inking apparatus for printing machines; feeders [parts of machines]; wrapping machines; escalators; pumps [parts of machines, engines or motors]; stamping machines; die-stamping machines; labellers [machines]; metal drawing machines; excavators; extractors for mines; bedding machines; knives for mowing machines; blades [parts of machines]; spinning machines; spinning wheels; filtering machines; finishing machines; chucks [parts of machines]; fodder presses; foundry machines; pistons for cylinders; stuffing boxes [parts of machines]; blowing machines for the compression, exhaustion and transport of gases; lawnmowers

[machines]; tarring machines; blowing machines for the compression, sucking and carrying of grain; grease boxes [parts of machines]; lubricating pumps; embossing machines; engraving machines; notchers [machine tools]; guides for machines; chaff cutters; meat choppers [machines]; gears for weaving looms; harrows; atomisers [machines]; hydraulic turbines; printing machines for use on sheet metal; printing plates; printing machines; printing presses; printing rollers for machines; dairy machines; chaff cutter blades; loom shafts; blade sharpening [stropping] machines; saw blades [parts of machines]; blade holders [parts of machines]; rolling mills; thermic lances [machines]; cranks [parts of machines]; dishwashers; washing apparatus; washing machines [laundry]; vehicle washing installations; coin-operated washing machines; lifting apparatus; wringing machines for laundry; smoothing presses; driving motors other than for land vehicles; steam engines; machine tools; igniting magnetos; handling apparatus for loading and unloading; paper feeders [printing]; hammers [parts of machines]; power hammers; pneumatic hammers; tilt hammers; derricks; propulsion mechanisms other than for land vehicles; transmissions, other than for land vehicles; regulators [parts of machines]; tobacco processing machines; crushers for kitchen use, electric; pump diaphragms; metalworking machines; looms; spinning frames; millstones; crushing machines; mine borers; ore treating machines; flour mill machines; mixers [machines]; reapers; reapers and binders; reapers and threshers; truck lifts; jet engines other than for land vehicles; anti-pollution devices for motors and engines; pistons for engines; speed governors for machines, engines and motors; molds [parts of machines]; mills for household purposes, other than hand-operated; molding machines; freewheels other than for land vehicles; shuttles [parts of machines]; machines and apparatus for cleaning, electric; suction machines for industrial purposes; hemming machines; hand-held tools, other than hand-operated; tools [parts of machines]; holding devices for machine tools; can openers, electric; bread cutting machines; journal boxes [parts of machines]; bearings for transmission shafts; papermaking machines; calenders; paper machines; packing machines; kneading machines; machines for making pasta; painting machines; spray guns for paint; drilling machines; electric hand drills; stone-working machines; pistons [parts of machines or engines]; typographic presses; pneumatic transporters; punches for punching machines; punching machines; pepper mills other than hand-operated; machines and apparatus for polishing [electric]; pumps [machines]; air pumps [garage installations]; pumps for heating installations; vacuum pumps [machines]; roller bridges; adhesive bands for pulleys; beverage preparation machines, electromechanical; presses [machines for industrial

purposes]; pressure regulators [parts of machines]; pressure valves [parts of machines]; puddling machines; steam traps; planing machines; rail-laying machines; rakes for raking machines; raking machines; friezing machines; trueing machines; bookbinding apparatus and machines for industrial purposes; ironing machines; darning machines; springs [parts of machines]; curtain drawing devices, electrically operated; riveting machines; taps [parts of machines, engines or motors]; rotary printing presses; machine wheelwork; machine wheels; machine fly-wheels; roller bearings; ball rings for bearings; road building machines; saws [machines]; mineworking machines; belts for motors and engines; weeding machines; satinizing machines; sausage making machines; sealing machines for industrial purposes; sowers [machines]; welding machines, electric; forge bellows; lasts for shoes [parts of machines]; filling machines; stators [parts of machines]; stereotype machines; machines for the production of sugar; superheaters; superchargers; tables for machines; aprons [parts of machines]; dyeing machines; carding machines; slide rests [parts of machines]; journals [parts of machines]; milking machines; suction cups for milking machines; transmissions for machines; pneumatic tube conveyors; conveyors [machines]; braiding machines; winches; knitting machines; turbines other than for land vehicles; reels, mechanical, for flexible hoses; tympan [parts of printing presses]; typographic machines; winnowers; engines for air cushion vehicles; fans for motors and engines; glass-working machines; railroad constructing machines; vulcanisation apparatus; couplings other than for land vehicles; aeronautical engines; sharpening machines; grindstones [parts of machines]; beer pumps; compressed air engines; compressed air machines; compressed air pumps; sparking plugs for internal combustion engines; dashpot plungers [parts of machines]; anti-friction bearings for machines; diggers [machines]; air suction machines; fuel economisers for motors and engines; engines for boats; motors for boats; beaters, electric; rams [machines]; brake linings other than for vehicles; brake shoes other than for vehicles; brake segments other than for vehicles; reels [parts of machines]; gear boxes other than for land vehicles; bottle stoppering machines; bottle capping machines; bottle sealing machines; brushes, electrically operated [parts of machines]; garbage disposals; coffee grinders, other than hand-operated; flues for engine boilers; earth moving machines; trash compacting machines; shredders [machines] for industrial use; potters' wheels; handling machines, automatic [manipulators]; robots [machines]; food preparation machines, electromechanical; cartridges for filtering machines; driving chains other than for land vehicles; torque converters other than for land vehicles; transmission chains other than for land

vehicles; drill chucks [parts of machines]; steam engine boilers; feeding apparatus for engine boilers; hair clipping machines for animals; engines, other than for land vehicles; control cables for machines, engines or motors; control mechanisms for machines, engines or motors; matrices for use in printing; compressors for refrigerators; drain cocks; sewing machines; fan belts for motors and engines; incubators for eggs; gears, other than for land vehicles; blenders, electric, for household purposes; kitchen machines, electric; cylinders for motors and engines; reduction gears other than for land vehicles; dividing machines; drilling bits [parts of machines]; heat exchangers [parts of machines]; exhausts for motors and engines; motors, electric, other than for land vehicles; cranes [lifting and hoisting apparatus]; peeling machines; sifting machines; grating machines for vegetables; compressed air guns for the extrusion of mastics; filters [parts of machines or engines]; ditchers [ploughs]; whisks, electric, for household purposes; fruit presses, electric, for household purposes; hydraulic engines and motors; drilling rigs, floating or non-floating; fuel conversion apparatus for internal combustion engines; radiators [cooling] for motors and engines; boiler tubes [parts of machines]; hydraulic controls for machines, motors and engines; pneumatic controls for machines, motors and engines; crankcases for machines, motors and engines; food processors, electric; glue guns, electric; guns [tools using explosives]; net hauling machines [fishing]; universal joints [cardan joints]; rotary steam presses, portable, for fabrics; machines and apparatus for carpet shampooing, electric; catalytic converters; central vacuum cleaning installations; chain saws; cleaning appliances utilizing steam; cutting blow pipes, gas-operated; dust exhausting installations for cleaning purposes; dust removing installations for cleaning purposes; electric hammers; electromechanical machines for chemical industry; elevator chains [parts of machines]; emergency power generators; expansion tanks [parts of machines]; glaziers' diamonds [parts of machines]; high pressure washers; machines for the textile industry; exhaust manifold for engines; oil refining machines; packaging machines; parquet wax-polishers, electric; shoe polishers, electric; snow ploughs; soldering apparatus, gas-operated; soldering blow pipes, gas-operated; soldering irons, gas-operated; vacuum cleaner attachments for disseminating perfumes and disinfectants; vacuum cleaner hoses; vacuum cleaners; vibrators [machines] for industrial use; machines and apparatus for wax-polishing, electric; racket stringing machines; bicycle assembling machines; motorized cultivators; air brushes for applying colour; door openers, hydraulic; kick starters for motorcycles; mechanized livestock feeders; moving pavements [sidewalks]; mufflers for motors and

engines; door openers, pneumatic; vacuum cleaner bags; gas-operated blow torches; wind turbines; brake pads other than for vehicles; electrodes for welding machines; electric welding apparatus; soldering apparatus, electric; soldering irons, electric; electric arc welding apparatus; electric arc cutting apparatus; soldering lamps; basket presses; blowing machines; electroplating machines; galvanizing machines; distribution machines, automatic; door closers, electric; door openers, electric; elevator operating apparatus; electrical apparatus for sealing plastics [packaging]; fuel dispensing pumps for service stations; self-regulating fuel pumps; machines for processing plastics; window openers, electric; window closers, electric; window openers, hydraulic; window closers, hydraulic; window openers, pneumatic; window closers, pneumatic; door closers, hydraulic; door closers, pneumatic; kitchen grinders, electric; electric and gas powered tools, other than hand-operated, including cordless drills, drills-screwdrivers, screwdrivers, grinding-machines, jigsaws, rotary hammers, sanders, angle grinders, belt sanders, vibrating sanders, polishers, electric engravers, impact drills, circular saws, cordless screwdrivers, corded screwdrivers, rotary saws, miter saws, electric chain saws, electric drills, electric impact drills-screwdrivers, electric demolition hammers, electric planers, electric grinding wheels, milling machines, random orbit sanders, thermoblenders; electric and gas powered saws, other than hand-operated, including gas powered chain saws; generators gas powered; motor pumps, including motor pump gas powered; compressors, including compressors oils and piston air compressors; electric and gas powered trimmers; electric and gas powered lawn mowers; feed grinders, food choppers, grain grinders, other than hand-operated; pumps, including vibration pumps, drainage pumps, immersed drainage pumps; electric pumps; pumping stations; motor cultivators and cultivating milling cutters for motor cultivators; mounted plough (parts of machines); moto sprayers; moto sprayers gas powered; moto sprayers electric; sprayers gas powered; snow removal machines; welding apparatus; inverter welding apparatus; inverters semiautomatic; transformer welding apparatus; apparatus for electric welding; strimmers gas powered; strimmers electric.

8 – Hand tools and implements (hand-operated); cutlery; side arms; razors; abrading instruments [hand instruments]; glaziers' diamonds [parts of hand tools]; apparatus for destroying plant parasites, hand-operated; bayonets; razors, electric or non-electric; razor strops; borers; bushhammers; levers; fulling tools [hand tools]; table forks; screwdrivers; forks; shaving cases; tap wrenches; lawn clippers [hand instruments]; spanners [hand tools]; harpoons; harpoons for fishing; scythe stones; stropping

instruments; grindstones [hand tools]; leather strops; edge tools [hand tools]; nippers; goffering irons; crimping irons; rakes [hand tools]; sand trap rakes; engraving needles; cutter bars [hand tools]; whetstone holders; punch pliers [hand tools]; rams [hand tools]; chisels; mortise chisels; extension pieces for braces for screw taps; drills; nail clippers, electric or non-electric; sharpening instruments; spades [hand tools]; clamps for carpenters or coopers; side arms, other than firearms; rabbeting planes; bits [hand tools]; depilation appliances, electric and non-electric; hand implements for hair curling; priming irons [hand tools]; gouges [hand tools]; numbering punches; oyster openers; ear-piercing apparatus; cattle marking tools; molding irons; stone hammers; embossers [hand tools]; knuckle dusters; ceramic knives; centre punches [hand tools]; daggers; picks [hand tools]; mallets [hand instruments]; annular screw plates; scythe rings; riveters [hand tools]; riveting hammers [hand tools]; blades [weapons]; pliers; wire strippers [hand tools]; breast drills; fireplace bellows [hand tools]; caulking irons; diggers [hand tools]; lasts [shoemakers' hand tools]; hainault scythes; squares [hand tools]; fire irons; blades [hand tools]; razor blades; blades for planes; shear blades; blade sharpening instruments; vices; bench vices [hand implements]; foundry ladles [hand tools]; glazing irons; fingernail polishers, electric or non-electric; spoons; crow bars; shovels [hand tools]; trowels [gardening]; ice picks; manicure sets; manicure sets, electric; palette knives; machetes; hair clippers for personal use, electric and non-electric; bludgeons; taps [hand tools]; hammers [hand tools]; sledgehammers; masons' hammers; mattocks; ditchers [hand tools]; trowels; fleshing knives [hand tools]; pedicure sets; needle files; emery grinding wheels; emery files; files [tools]; dies [hand tools]; screw-thread cutters [hand tools]; hand pumps; metal wire stretchers [hand tools]; metal band stretchers [hand tools]; needle-threaders; cattle shearers; wick trimmers [scissors]; shears; shearers [hand instruments]; pruning shears; tree pruners; border shears; scissors; can openers, non-electric; farriers' knives; scaling knives; pizza cutters, non-electric; grafting tools [hand tools]; paring knives; hunting knives; cleavers; bill-hooks; penknives; knives; nail drawers [hand tools]; vegetable knives; vegetable choppers; budding knives; reamer sockets; perforating tools [hand tools]; saws [hand tools]; jig-saws; bow saws; nail files; nail files, electric; syringes for spraying insecticides; lifting jacks, hand-operated; tweezers; hair-removing tweezers; guns [hand tools]; non-electric caulking guns; guns, hand-operated, for the extrusion of mastics; sword scabbards; fruit pickers [hand tools]; paring irons [hand tools]; air pumps, hand-operated; weeding forks [hand tools]; saw blades [parts of hand tools]; tool belts [holders]; flat irons; irons [non-electric

hand tools]; money scoops; draw wires [hand tools]; apparatus for tattooing; punches [hand tools]; nail punches; pin punches; thistle extirpators [hand tools]; frames for handsaws; rasps [hand tools]; cutting tools [hand tools]; tube cutting instruments; bits [parts of hand tools]; graving tools [hand tools]; cutters; reamers; insecticide atomizers [hand tools]; expanders [hand tools]; planes; plane irons; saw holders; implements for decanting liquids [hand tools]; hand drills, hand-operated; fullers [hand tools]; hand tools, hand-operated; beard clippers; hair clippers for animals [hand instruments]; garden tools, hand-operated; pruning knives; hoes [hand tools]; augers [hand tools]; hollowing bits [parts of hand tools]; gimlets [hand tools]; drill holders [hand tools]; pruning scissors; sickles; choppers [knives]; agricultural implements, hand-operated; cheese slicers, non-electric; scraping tools [hand tools]; axes; holing axes; hatchets; hoop cutters [hand tools]; silver plate [knives, forks and spoons]; table cutlery [knives, forks and spoons]; drawing knives; mortars for pounding; mitre [miter (Am.)] boxes [hand tools]; branding irons; adzes [tools]; carpenters' augers; rammers [hand tools]; braiders [hand tools]; sharpening steels; sharpening stones; earth rammers [hand tools]; ratchets [hand tools]; tube cutters [hand tools]; razor cases; hobby knives [scalpels]; nail extractors; ladles [hand tools]; ladles for wine; hackles [hand tools]; scrapers [hand tools]; sabres; milling cutters [hand tools]; marline spikes; awls; instruments and tools for skinning animals; spatulas [hand tools]; stamping-out tools [hand tools]; nutcrackers; cuticle nippers; nail nippers; eyelash curlers; sugar tongs; curling tongs; egg slicers, non-electric; cut-off, grinding, emery, abrasive wheels [parts of hand tools]; diamond wheels [parts of hand tools]; abrasive belts [parts of hand tools].

(260) AM 2018 94849 A

(800) 1339715

(151) 2017 01 17

(891) 2017 08 25

(731) ADP Gauselmann GmbH

Merkur-Allee 1-15, 32339 Espelkamp,
Germany

(540)

Odin

(591) Black, white

(511)

9 – Scientific, nautical, surveying, photographic, cinematographic, optical, weighing, measuring, signalling, checking (supervision), life-saving and teaching apparatus and instruments; apparatus for recording, transmission or reproduction of sound or images; magnetic data carriers, recording discs; compact discs, DVDs and other digital recording media; cash registers, calculating machines;

computer software; fire-extinguishing apparatus; musical jukeboxes and parts for the aforesaid automatic machines; automatic cash dispensers, automatic money counting and money changing machines; coin-operated mechanisms; computer and video games software; games software for use on any computer platform, including electronic entertainment and games consoles; computer game programs; computer games; video games (software); computer games provided through a global computer network or supplied by means of multi-media electronic broadcast or through telecommunications or electronic transmission or via the internet; computer games, leisure and recreational software, video games and computer software, all being provided in the form of storage media; programs for operating electric and electronic apparatus for games, amusement and/or entertainment purposes; automatic lottery machines; computer software for computer games on the internet; online games (software), in particular for online betting games, online prize games, online gambling games, online games of skill and online casino games; computer software in the form of an app for mobile devices and computers; calculating apparatus in coin-operated machines and parts for the aforesaid goods; apparatus for recording, transmission, processing or reproduction of data, including sound or images, including parts for all the aforesaid goods, except radio sets, television receivers, hi-fi systems, video recorders, telephone apparatus, fax machines and telephone answering machines; computer software for casino and arcade games, for gaming machines or slot machines, video lottery gaming machines or games of chance via the internet; electric, electronic, optical or automatic apparatus, for identifying data carriers, identity cards and credit cards, bank notes and coins; electric, electronic or optical alarm and monitoring installations, including video cameras and apparatus for image transmission and image processing; electric wiring harnesses; circuit boards, printed circuit boards (electronic components) and combinations thereof, being assemblies and parts for apparatus, included in this class.

(260) AM 2018 94850 A

(800) 1341765

(151) 2017 01 31

(891) 2017 09 20

(731) M&G Hausgeräte GmbH

Potsdamer Straße 92, 10785 Berlin,
Germany

(540)

KUPPERSBERG

(591) Black, white

(511)

3 – Bleaching preparations and other substances for laundry use; cleaning, polishing, scouring and

abrasive preparations; non-medicated soaps; perfumery, essential oils, non-medicated cosmetics, non-medicated hair lotions; non-medicated dentifrices.

7 – Metalworking machines, woodworking machines, machines for processing plastics; electromechanical machines for chemical industry, agricultural machines, haulage apparatus (mining)/extractors for mining; machines for the textile industry; beverage preparation machines, electromechanical; road making machines; road building machines; packaging machines; machine tools; motors, other than for land vehicles; machine coupling and transmission components (except for land vehicles); agricultural implements, other than hand-operated; incubators for eggs; automatic vending machines.

37 – Building construction; electric appliance installation and repair; kitchen equipment installation services.

(260) AM 2018 94852 A

(800) 1342856

(151) 2017 01 17

(891) 2017 08 25

(731) adp Gauselmann GmbH

Merkur-Allee 1-15, 32339 Espelkamp,
Germany

(540)

First Dynasty

(591) Black, white

(511)

9 – Scientific, nautical, surveying, photographic, cinematographic, optical, weighing, measuring, signalling, checking (supervision), life-saving and teaching apparatus and instruments; apparatus and instruments for conducting, switching, transforming, accumulating, regulating or controlling electricity; apparatus for recording, transmission or reproduction of sound or images; magnetic data carriers, recording discs; compact discs, DVDs and other digital recording media; cash registers, calculating machines, data processing equipment, computers; computer software; fire-extinguishing apparatus; musical jukeboxes and parts for the aforesaid automatic machines; automatic cash dispensers, automatic money counting and money changing machines; coin-operated mechanisms; computer and video games software; games software for use on any computer platform, including electronic entertainment and games consoles; computer game programs; computer games; video games (software); computer games provided through a global computer network or supplied by means of multi-media electronic broadcast or through telecommunications or electronic transmission or via the internet; computer games, leisure and

recreational software, video games and computer software, all being provided in the form of storage media; programs for operating electric and electronic apparatus for games, amusement and/or entertainment purposes; automatic lottery machines; computer software for computer games on the internet; online games (software), in particular for online betting games, online prize games, online gambling games, online games of skill and online casino games; computer software in the form of an app for mobile devices and computers; calculating apparatus in coin-operated machines and parts for the aforesaid goods; apparatus for recording, transmission, processing or reproduction of data, including sound or images, including parts for all the aforesaid goods, except radio sets, television receivers, hi-fi systems, video recorders, telephone apparatus, fax machines and telephone answering machines; computer hardware and software for casino and amusement arcade games, for gaming machines, slot machines or video lottery gaming machines or games of chance via the internet; electric, electronic, optical or automatic apparatus, for identifying data carriers, identity cards and credit cards, bank notes and coins; electric, electronic or optical alarm and monitoring installations, including video cameras and apparatus for image transmission and image processing; data processing apparatus and computers, including data processing apparatus and computers being components for data networks and parts facilitating data network communications; electric wiring harnesses; circuit boards, printed circuit boards (electronic components) and combinations thereof, being assemblies and parts for apparatus, included this in class.

(260) AM 2018 94871 A
 (800) 1371587
 (151) 2017 09 07
 (891) 2017 09 07
 (731) Faron Pharmaceuticals Oy
 Joukahaisenkatu 6 FI-20520 Turku, Finland
 (540)

HEXARDSA

(591) Black and white
 (511)
 5 – Pharmaceuticals, medical and veterinary preparations; sanitary preparations for medical purposes.

(260) AM 2018 94872 A
 (800) 1371588
 (151) 2017 09 07
 (891) 2017 09 07
 (731) Faron Pharmaceuticals Oy
 Joukahaisenkatu 6 FI-20520 Turku, Finland

(540)

ARDSAVI

(591) Black and white
 (511)
 5 – Pharmaceuticals, medical and veterinary preparations; sanitary preparations for medical purposes.

(260) AM 2018 94874 A
 (800) 1371589
 (151) 2017 09 07
 (891) 2017 09 07
 (731) Faron Pharmaceuticals Oy
 Joukahaisenkatu 6 FI-20520 Turku,
 Finland
 (540)

ERARDS

(591) Black and white
 (511)
 5 – Pharmaceuticals, medical and veterinary preparations; sanitary preparations for medical purposes.

(260) AM 2018 94875 A
 (800) 1371590
 (151) 2017 09 07
 (891) 2017 09 07
 (731) Faron Pharmaceuticals Oy
 Joukahaisenkatu 6 FI-20520 Turku,
 Finland
 (540)

ARDSIVA

(591) Black and white
 (511)
 5 – Pharmaceuticals, medical and veterinary preparations; sanitary preparations for medical purposes.

(260) AM 2018 94878 A
 (800) 1371600
 (151) 2017 09 21
 (891) 2017 09 21
 (731) Tart Optical Enterprises LLC
 c/o Law Offices of Andrew C. Bagnall, 21900
 Burbank Blvd., Third Floor Woodland Hills
 CA 91367, USA
 (540)

TART

(591) Black and white
 (511)
 9 – Eyewear; cases for eyeglasses and sunglasses; chains for eyeglasses; eyeglass cords; eyeglass frames; eyeglass retaining cords; frames for

spectacles and sunglasses; optical frames; spectacle frames.

(260) AM 2018 94879 A

(800) 1371609

(151) 2017 06 22

(891) 2017 06 22

(731) ALTESSE

Valamas F-07310 SAINT-MARTIN-DE-

VALAMAS, France

(540)

ALTESSE

(591) Black and white

(511)

14 – Precious metals and their alloys; works of art of precious metal; jewelry cases [caskets]; boxes of precious metal; jewelry, costume jewelry; medals; precious stones; key rings [trinkets or fobs]; timepieces and chronometric instruments; cases or presentation cases for timepieces; watch cases, bracelets, chains, straps or glasses.

18 – Leather and imitations of leather, goods made of these materials not included in other classes, namely, wallets, purses, card cases (wallets), agenda holders, briefcases; purses, briefcases, bags and cases for documents, music cases, satchels, pouches (leather goods), handbags, backpacks, wheeled shopping bags, travel bags, beach bags, school bags, shopping bags, key cases, unfitted vanity cases, traveling sets, traveling trunks, trunks, carrying cases and suitcases; animal skins; umbrellas and parasols; collars for animals; leather laces; hat boxes of leather.

(260) AM 2018 94880 A

(800) 1371616

(151) 2017 08 04

(891) 2017 08 04

(731) MSC MEDITERRANEAN SHIPPING

COMPANY HOLDING SA

Chemin Rieu 12-14 CH-1208 Genève,

Switzerland

(540)

MEDLOG

(591) Black and white

(531) 24.15.07; 27.05.01; 27.05.19

(511)

39 – Transport; packaging and storage of goods; travel organization; transportation logistics services; logistics services consisting of the labeling, packaging, storing, transport and delivery of goods; transport and storage services relating to storage logistics, distribution logistics and returns logistics; transport reservations; national and international transport services; transport of goods by river,

railway, ferry-boat, car, truck and ship; tanker transport; collection, storage, transport, distribution and delivery of packages, parcels, freight, goods, luggage and personal effects by courier, road, rail, air or water; freight (transport of merchandise); operation of merchant ships; organization of transport services; arranging transport services; organization of the storage of goods; cargo shipping preparation; chartering of aircraft, vehicles, boats and marine vessels; airport area, station platform and ship loading quay services, namely the fixing and fastening of freight, cargo, shipping containers, refrigerated shipping containers, storage containers and storage tanks in or on aircraft, motor vehicles, cars, trucks, trains, ferry boats or ships; information services relating to moorings; packing of cargo, packing of freight, packing of goods in containers; packaging of goods; packing of transit products; packing of products to order, to the specifications of others; warehousing, storage; bulk storage; storage of containers and cargo; storage of cargo prior to transport; storage of cargo after transport; storage of bonded goods; storage of goods in transit; storage and handling of goods; storage and handling of shipping containers, refrigerated shipping containers, storage containers and storage tanks; refrigerated storage of goods; refrigerated transport of goods; rental of fixed and portable storage containers; refrigerated warehousing; warehousing of freight; goods warehousing; inspection of merchandise prior to transport; inspection of shipping containers, refrigerated shipping containers, storage containers and storage tanks prior to transport; inspection of vehicles prior to transport; lighterage services; loading, packing, storage, transportation and unloading of cargo and freight; loading of freight containers onto ships; loading of freight containers onto trucks; loading of freight containers onto rail vehicles; unloading of freight, unloading of ships; loading and unloading of airplanes; harbor crane unloading; freight forwarding services; shipping of cargo, freight forwarding; hauling; truck hauling; portage; distribution (delivery) of goods, express delivery of goods; delivery of cargo, delivery of goods by road or rail, express delivery of freight; tracking, locating and monitoring of shipping containers, refrigerated shipping containers, storage containers and storage tanks; tracking, locating and monitoring of vehicles, ships and aircrafts; monitoring and tracking of packages; rental of transport and storage containers; rental of containers for the transport and storage of goods; rental of containers for warehousing and storage; rental of loading containers; rental of containers for the marine transport industry; labeling services; removal services and provision of information relating thereto; removal services and transport of freight and cargo; industrial removal services [transport]; overseas removal services; moving van transport

services; advice services relating to moving; providing travel information from an online database; vehicle routing by computer on data networks; providing information relating to transport services; providing information relating to marine transport services; provision of information relating to railway transport; providing information relating to fares, timetables and methods of transport; providing online information in the field of transport, packaging and storage of goods; provision of information relating to cargo unloading services; provision of information relating to warehousing services; freight brokerage; transport brokerage; shipbrokerage; advisory services relating to transportation; advisory services relating to the storage and transportation of goods, freight or cargo; services provided by consultants relating to travel, transport and storage services; consultancy in the field of transport and storage services provided via telephone call centers and hotlines.

(260) AM 2018 94881 A

(800) 1371621

(151) 2017 08 23

(891) 2017 08 23

(731) Compagnie des Montres Longines,
Francillon SA (Longines Watch Co.
Francillon Ltd)
CH-2610 Saint-Imier, Switzerland

(540)

AGASSIZ

(591) Black and white

(511)

14 – Precious metals and their alloys and goods made of these materials or coated therewith included in this class, namely figurines, trophies; jewelry, namely rings, earrings, cuff links, bracelets, charms, brooches, chains, necklaces, tie pins, tie clips, jewelry caskets, jewelry cases; precious stones, semi-precious stones; timepieces and chronometric instruments, namely chronometers, chronographs, clocks, watches, bracelets, wall clocks, alarm clocks as well as parts and accessories for the aforesaid goods, namely hands, anchors, pendulums, barrels, watch cases, watch bracelets, watch dials, clockworks, watch chains, movements for timepieces, watch springs, watch glasses, presentation cases for timepieces, cases for timepieces.

(260) AM 2018 94882 A

(800) 1371710

(151) 2017 04 04

(891) 2017 04 04

(731) Far east smarter energy co., ltd
No. 12 Jinger Road, Biology Park, Chengbei
District, Xining City Qinghai Province, China

(540)



(591) Black and white

(531) 05.05.20; 27.05.01; 27.05.19; 28.03

(511)

9 – Electricity mains (materials for -) [wires, cables]; switches, electric; road signs, luminous or mechanical; cables, electric; wires, electric; masts for wireless aerials; signals (transmitters of electronic -); light conducting filaments [optical fibers [fibres]].

35 – Publicity; commercial information agencies; licensing of the goods and services of others (commercial administration of the -); telemarketing services; import-export agencies; marketing; procurement services for others [purchasing goods and services for other businesses]; administrative processing of purchase orders; retail or wholesale services for pharmaceutical, veterinary and sanitary preparations and medical supplies; systemization of information into computer databases.

40 – Production of energy; decontamination of hazardous materials; waste treatment [transformation]; dressmaking; food and drink preservation.

(260) AM 2018 94911 A

(800) 1372157

(151) 2017 04 24

(891) 2017 04 24

(731) Green for Growth Fund, Southeast Europe
S. A. SICAV-SIF
14, Boulevard Royal, L-8070 Bertrange,
Luxembourg

(540)



(591) Green, blue, orange, light orange, dark blue and yellow.

(531) 01.03.02; 01.03.15; 26.11.03; 26.11.07;
26.11.09; 29.01.15

(511)

35 – Advertising; business management; business administration; office functions; business management advice and assistance; commercial management advice and assistance; planning, consultancy, appraisal, analysis and information services, all relating to business and commerce; economic forecasting and economic advisory services; evaluation of business opportunities; market research; preparation of business statistics;

business statistical studies in the field of micro finance investment projects; information and advisory services related to the aforesaid services; organisation of exhibitions for commercial or advertising purposes; personnel recruitment; personnel management consultancy.

36 – Financial affairs; monetary affairs; real estate affairs; banking services; investment and financing services; raising of finance; financing, provision and arranging of loans; underwriting services; financial investment and financial management services; financial guarantee services; corporate finance services; financial and investment planning services; advisory, consultancy, information, assistance, analysis and appraisal services relating to the aforesaid services; financial evaluation; fund investments.

42 – Consultancy in the fields of energy-saving and environmental protection, as well as in questions of sustainability, included in this class; advisory services relating to energy efficiency.

(260) AM 2018 94912 A

(800) 1372163

(151) 2017 04 04

(891) 2017 04 04

(731) PASTIFICIO ANTONIO PALLANTE

S.r.l. S.S.

87 Km. 22,200, I-81020 CAPODRISE (CE),

Italy

(540)



(591) White, blue, red and yellow.

(531) 05.07.02; 07.01.01; 26.01.02; 26.01.20;

26.01.24; 27.05.02; 29.01.14

(526) „PASTA“

(511)

30 – Fresh pasta; dried pasta; pasta.

(260) AM 2018 94914 A

(800) 1372169

(151) 2017 04 26

(891) 2017 04 26

(731) Kyle Burns

La Tour Shibakoen 3010, 3-8-2 Shiba,

Minato-ku Tokyo 105-0014, Japan

(540)

GIGAZON

(591) Black,white

(511)

36 – Capital investment; buying and selling of securities; trading of securities index futures; trading of securities options; trading of overseas market securities futures; agencies for brokerage of securities, securities index futures, securities options, and overseas market securities futures; agencies for brokerage of entrusting agents with on-commission trading in domestic markets of securities, securities index futures and securities options; agencies for brokerage of entrusting agents with on-commission trading in overseas markets of securities and securities index futures; agencies for brokerage of forward agreement of securities, for forward agreement of securities index futures, for forward agreement of securities options, spot and forward transaction of securities index futures; brokerage for securities liquidation; securities underwriting; securities offering; brokerage services relating to securities subscription or offering; providing stock market information; agencies for commodity' futures trading; acceptance of deposits [including substitute bond issuance] and acceptance of fixed interval installment deposits; loans [financing] and discount of bills; domestic exchange settlement; liability guarantee and acceptance of bills; securities lending; acquisition and transfer of monetary claims; safekeeping of valuables including securities and precious metals [safe deposit services]; money exchange [exchanging money]; trusteeship of financial futures contracts; trusteeship of money, securities, monetary claims, personal property and land (rights on land fixtures, surface rights or lease on land); agencies for bond subscriptions; foreign exchange transactions; banking services namely letter-of-credit services; brokerage of credit purchase; electronic commerce payment services; agencies for collecting gas or electric power utility payments; consigned collection of payment for goods; life insurance brokerage; life insurance underwriting; agencies for non-life insurance; claim adjustment for non-life insurance; non-life insurance underwriting; insurance premium rate computing; management of buildings; agency services for the leasing or rental of buildings; leasing or renting of buildings; purchase and sale of buildings; agency services for the purchase or sale of buildings; real estate appraisal; land management; agency services for the leasing or rental of land; leasing of land; purchase and sale of land; agency services for the purchase or sales of land; provision of information in relation to real estate affairs, namely regarding rental of buildings and land.

(260) AM 2018 94915 A

(800) 1372186

(151) 2017 06 20

(891) 2017 06 20

(731) Wikimedia Foundation, Inc.
1 Montgomery Street, Suite 1600,
San Francisco CA 94104, USA

(540)

WIKIMEDIA CLOUD

(591) Black,white

(511)

41 – Providing online publications in the nature of articles and reference guides on the use of and contribution to software development.

42 – Providing virtual computer systems and virtual computer environments through cloud computing; computer services, namely, acting as an application services provider for internet users featuring remote hosting of operating systems and computer applications; computer services, namely, hosting a virtual computing environment accessible via the internet for registered users to access databases and software development tools; hosting a virtual computing environment accessible via the internet for registered users to create and develop computer software.

(260) AM 2018 94916 A

(800) 1372219

(151) 2017 07 21

(891) 2017 07 21

(731) Vingroup Joint Stock Company
No. 7, Bang Lang 1 street, Vinhomes
Riverside ecological urban area, Viet Hung
Ward, Long Bien District Hanoi City,
Viet Nam

(540)

VINFAST

(591) Black,white

(531) 27.05.17

(511)

4 – Lubricating oils; lubricating greases; motor oils; fuel oils.

11 – Air conditioners for vehicles; anti-glare devices for vehicles [lamp fittings]; defrosters for vehicles; headlights for automobiles; lights for vehicles; heaters for vehicles; lamps for directional signals of automobiles; vehicle reflectors.

12 – Land vehicles; automobiles; off road light utility vehicles; motorcycles; scooters; three-wheeled motorcycles; three-wheeled scooters; mopeds; bicycles; electric bicycles; electric assist bicycles; all terrain vehicles; snowmobiles; golf cars; engines and motors for land vehicles; cars; sports cars; electric vehicles; tricycles; vehicles for locomotion by rail; structural parts and components for all the aforesaid goods included in class 12.

35 – Advertising and publicity services; retail

services or wholesale services for automobile and their parts, fuels, lubricating oil, lubricating grease.

37 – Installation, maintenance and repair of land vehicles, automobiles, motorcycles; automobile cleaning; automobile polishing.

42 – Industrial design, including design of automobiles and parts thereof; furnishing design services for the interiors of automobiles; vehicle roadworthiness testing; quality control; mechanical research; research and development of new products relating automobiles for others.

(260) AM 2018 94917 A

(800) 1372232

(151) 2017 06 23

(891) 2017 06 23

(731) LAARA ENTERPRISES LIMITED

Suite 1003, Khalid Al Attar Tower, P.O. Box
No 71241, Sheikh Zayed Road Dubai (AE),
United Arab Emirates

(540)



(591) Blue, white, dark-blue, light blue, dark-green, green and light green.

(531) 01.15.09; 01.15.21; 05.03.16; 27.05.02;
29.01.13

(511)

3 – Scale removing preparations for household purposes; antistatic preparations for household purposes; aromatics [essential oils]; air fragrancing preparations; canned pressurized air for cleaning and dusting purposes; sachets for perfuming linen; drying agents for dishwashing machines; scented water; toilet water; laundry wax; parquet floor wax; non-slipping wax for floors; polish for furniture and flooring; polishing wax; deodorants for pets; perfumes; non-slipping liquids for floors; windshield cleaning liquids; perfumery; colorants for toilet purposes; laundry starch; laundry glaze; oils for cleaning purposes; cleaning chalk; soap; deodorant soap; soap for brightening textile; cakes of toilet soap; joss sticks; laundry soaking preparations; smoothing preparations [starching]; polishing preparations; starch glaze for laundry purposes; refurbishing preparations; fabric softeners for laundry use; laundry bleach; dry-cleaning preparations; cleaning preparations; preparations for unblocking drain pipes; laundry preparations; color-brightening chemicals for household purposes [laundry]; shining

preparations [polish]; stain removers; scouring solutions; laundry blueing; bleaching soda; washing soda, for cleaning; bleaching salts; fumigation preparations [perfumes]; ammonia [volatile alkali] [detergent]; detergents other than for use in manufacturing operations and for medical purposes; degreasers other than for use in manufacturing processes; cloths impregnated with a detergent for cleaning.

5 – Air deodorising preparations; deodorants, other than for human beings or for animals; deodorants for clothing and textiles; air purifying preparations; disinfectant soap.

(260) AM 2018 94918 A
(800) 1372272
(151) 2017 07 14
(891) 2017 07 14
(731) Abstragan Holding Limited
Astra House, Arklow Road, London SE14
6EB, United Kingdom

(540)

GLOBALVIX

(591) Black,white
(531) 27.05.17
(511)

5 – Pharmaceutical and veterinary preparations; sanitary preparations for medical purposes; dietetic food and substances adapted for medical or veterinary use, food for babies; dietary supplements for humans and animals; plasters, materials for dressings; material for stopping teeth, dental wax; disinfectants; preparations for destroying vermin; fungicides, herbicides.

(260) AM 2018 94919 A
(800) 1372274
(151) 2017 07 14
(891) 2017 07 14
(731) Abstragan Holding Limited
Astra House, Arklow Road, London SE14
6EB, United Kingdom

(540)

URSOJEL

(591) Black,white
(511)

5 – Pharmaceutical and veterinary preparations; sanitary preparations for medical purposes; dietetic food and substances adapted for medical or veterinary use, food for babies; dietary supplements for humans and animals; plasters, materials for dressings; material for stopping teeth, dental wax; disinfectants; preparations for destroying vermin; fungicides, herbicides.

(260) AM 2018 94920 A
(800) 1372275
(151) 2017 07 14
(891) 2017 07 14
(731) Abstragan Holding Limited
Astra House, Arklow Road, London SE14
6EB, United Kingdom

(540)

MARJESTIN

(591) Black,white
(531) 27.05.17
(511)

5 – Pharmaceutical and veterinary preparations; sanitary preparations for medical purposes; dietetic food and substances adapted for medical or veterinary use, food for babies; dietary supplements for humans and animals; plasters, materials for dressings; material for stopping teeth, dental wax; disinfectants; preparations for destroying vermin; fungicides, herbicides.

(260) AM 2018 94971 A
(800) 1269146
(151) 2015 02 24
(891) 2017 05 10
(731) LC WAIKIKI MAĞAZACILIK
HİZMETLERİ TİCARET ANONİM
ŞİRKETİ
Evren Mahallesi, Gülbahar Caddesi, No. 96
Bağcılar İstanbul, Turkey

(540)

WAIKIKI

(591) Black and white
(531) 27.05.17
(511)

3 – Detergents for household use and laundry preparations, bleaching preparations for household use, laundry starch, fabric softeners for laundry use, lime removers for laundry use, granulated soaps, polishing preparations for household use; essential oils for personal use, perfumes and Colognes, cosmetics and cosmetic preparations, namely, shaving lotions, shaving foam, shaving gel, non-medicated stimulating lotions for the skin, after-shave creams, cosmetic creams for skin care, depilatories, shower and bath gel, rose oil for cosmetic purposes, nail varnish for cosmetic purposes, nail polish remover, lipsticks, eyeliner pencils, cosmetic preparations for eyelashes, namely, mascaras, hair dyes, hair sprays and hair gels, hair care kits comprising non-medicated hair care preparations, namely, shampoo, conditioner; petroleum jelly for cosmetic purposes, depilatories, henna for cosmetic purposes, cosmetic preparations for slimming and for skin tanning; antiperspirants

for personal use, deodorants and antiperspirants (including deodorants for human beings and animals); soaps for personal use namely, medicated soaps, perfumed soaps, liquid soaps, hand soaps, disinfectant soaps, cosmetic soaps, antiperspirant soaps; toothpastes, dentifrices in the form of chewing gum, dental bleaching gel, tooth powders, denture cleaning preparations, non-medicated mouth wash and rinse, tartar control toothpastes; emery paper, abrasive paste, pumice stones for personal use; leather polishes, polishes for metallic items, furniture polishes, floor polishes.

18 – Leather and imitation leather, animal skins; animal hides, artificial leathers, stout leathers; goods made of leather, imitation leather or synthetic materials, namely, travel bags, valises, wallets, handbags, backpacks for carrying babies, leather and stout leather boxes for storing greeting cards, leather hat boxes for travel; make-up cases sold empty, toiletry bags sold empty, vanity cases sold empty, tool bags sold empty; book bags; carrying cases for documents, briefcases, backpacks, school bags, leather shopping bags, leather cases for banknotes; umbrellas, sun umbrellas, namely, parasols and canes; whips, harnesses and saddlery, stirrups, horse bridles.

25 – Clothing, namely, trousers, jackets, overcoats, coats, skirts, suits, jerseys, waistcoats, shirts, ready-made leather linings (parts of clothing), T-shirts, sweatshirts, dresses, bermuda shorts, shorts, pajamas, pullovers, jeans, tracksuits, rainwear, beachwear, bathing suits, swimming suits; clothing for sports (for exclusive use for sports), clothing for babies, namely, shirts, pants, coats, dresses; underclothing, namely, boxer shorts, brassieres, briefs, pants, socks; footwear, namely shoes excluding orthopedic shoes, sandals, waterproof boots, walking boots, booties, sporting shoes, slippers; shoe parts namely heelpieces, insoles for footwear, footwear uppers; headgear, namely caps, skull caps, sports caps, hats, berets; gloves (clothing), stockings, belts (clothing), camisoles, sarongs, scarves, neck scarves, shawls, collars, neckties, ties, suspender belts.

35 – Advertising, marketing and public relations; organization of exhibitions and trade fairs for commercial or advertising purposes; office functions; secretarial services; arranging newspaper subscriptions for others; compilation of statistics; rental of office machines; systemization of information into computer databases; telephone answering for unavailable subscribers; business management, business administration and business consultancy; accounting; commercial consultancy services; personnel recruitment, personnel placement, employment agencies, import-export agencies; temporary personnel placement services; auctioneering; the bringing together, for the benefit

of others, of bleaching preparations and other substances for laundry use, cleaning, polishing, scouring and abrasive preparations, soaps, perfumery, essential oils, cosmetics, hair lotions, dentifrices, leather and imitations of leather, and goods made of these materials, animal skins, hides, trunks and travelling bags, umbrellas and parasols, walking sticks, whips, harness and saddlery, clothing, footwear, headgear (excluding the transport thereof), enabling customers to conveniently view and purchase those goods; all the aforementioned retail services may be provided by retail stores, wholesale outlets, through mail order catalogues or by means of electronic media, including, through web sites or television shopping programmes.

(260) AM 2018 94973 A

(800) 1337905

(151) 2017 01 17

(891) 2017 09 01

(731) adp Gauselmann GmbH

Merkur-Allee 1-15 32339 Espelkamp,
Germany

(540)

Ghost Slider

(591) Black and white

(511)

9 – Scientific, nautical, surveying, photographic, cinematographic, optical, weighing, measuring, signalling, checking (supervision), life-saving and teaching apparatus and instruments; apparatus and instruments for conducting, switching, transforming, accumulating, regulating or controlling electricity; apparatus for recording, transmission or reproduction of sound or images; magnetic data carriers, recording discs; compact discs, DVDs and other digital recording media; cash registers, calculating machines, data processing equipment, computers; computer software; fire-extinguishing apparatus; musical jukeboxes and parts for the aforesaid automatic machines; automatic cash dispensers, automatic money counting and money changing machines; coin-operated mechanisms; computer and video games software; games software for use on any computer platform, including electronic entertainment and games consoles; computer game programs; computer games; video games (software); computer games provided through a global computer network or supplied by means of multi-media electronic broadcast or through telecommunications or electronic transmission or via the internet; computer games, leisure and recreational software, video games and computer software, all being provided in the form of storage media; programs for operating electric and electronic apparatus for games, amusement and/or entertainment purposes; automatic lottery machines; computer software for computer games on the

internet; online games (software), in particular for online betting games, online prize games, online gambling games, online games of skill and online casino games; computer software in the form of an app for mobile devices and computers; calculating apparatus in coin-operated machines and parts for the aforesaid goods; apparatus for recording, transmission, processing or reproduction of data, including sound or images, including parts for all the aforesaid goods, except radio sets, television receivers, hi-fi systems, video recorders, telephone apparatus, fax machines and telephone answering machines; computer hardware and software for casino and amusement arcade games, for gaming machines, slot machines or video lottery gaming machines or games of chance via the internet; electric, electronic, optical or automatic apparatus, for identifying data carriers, identity cards and credit cards, bank notes and coins; electric, electronic or optical alarm and monitoring installations, including video cameras and apparatus for image transmission and image processing; data processing apparatus and computers, including data processing apparatus and computers being components for data networks and parts facilitating data network communications; electric wiring harnesses; circuit boards, printed circuit boards (electronic components) and combinations thereof, being assemblies and parts for apparatus, included in this class.

(260) AM 2018 94974 A

(800) 1338158

(151) 2017 01 17

(891) 2017 09 01

(731) adp Gauselmann GmbH

Merkur-Allee 1-15 32339 Espelkamp,

Germany

(540)

Captain Stack

(591) Black and white

(511)

9 – Scientific, nautical, surveying, photographic, cinematographic, optical, weighing, measuring, signalling, checking (supervision), life-saving and teaching apparatus and instruments; apparatus and instruments for conducting, switching, transforming, accumulating, regulating or controlling electricity; apparatus for recording, transmission or reproduction of sound or images; magnetic data carriers, recording discs; compact discs, DVDs and other digital recording media; cash registers, calculating machines, data processing equipment, computers; computer software; fire-extinguishing apparatus; musical jukeboxes and parts for the aforesaid automatic machines; automatic cash dispensers, automatic money counting and money changing machines; coin-operated mechanisms; computer and video games software; games software

for use on any computer platform, including electronic entertainment and games consoles; computer game programs; computer games programs; video games (software); computer games provided through a global computer network or supplied by means of multimedia electronic broadcast or through telecommunications or electronic transmission or via the internet; computer games, leisure and recreational software, video games and computer software, all being provided in the form of storage media; programs for operating electric and electronic apparatus for games, amusement and/or entertainment purposes; automatic lottery machines; computer software for computer games on the internet; online games (software), in particular for online betting games, online prize games, online gambling games, online games of skill and online casino games; computer software in the form of an app for mobile devices and computers; calculating apparatus in coin-operated machines and parts for the aforesaid goods; apparatus for recording, transmission, processing or reproduction of data, including sound or images, including parts for all the aforesaid goods, except radio sets, television receivers, hi-fi systems, video recorders, telephone apparatus, fax machines and telephone answering machines; computer hardware and software for casino and amusement arcade games, for gaming machines, slot machines or video lottery gaming machines or games of chance via the internet; electric, electronic, optical or automatic apparatus, for identifying data carriers, identity cards and credit cards, bank notes and coins; electric, electronic or optical alarm and monitoring installations, including video cameras and apparatus for image transmission and image processing; data processing apparatus and computers, including data processing apparatus and computers being components for data networks and parts facilitating data network communications; electric wiring harnesses; circuit boards, printed board assemblies (electronic components) and combinations thereof being assemblies and equipment parts, included in this class.

(260) AM 2018 94975 A

(800) 1371897

(151) 2017 09 20

(891) 2017 11 12

(731) NOVARTIS AG

CH-4002 Basel, Switzerland

(540)

ZIEXTENZO

(591) Black and white

(511)

5 – Pharmaceutical preparations for human use.

(260) AM 2018 94988 A

(800) 1372853

(151) 2017 08 26

(891) 2017 08 26

(731) JX Holdings, Inc.

1-2 Otemachi 1-chome, Chiyoda-ku Tokyo

100-8161, Japan

(540)

JXTG

(591) Black, white

(511)

1 – Chemical additives for lubricating oils; anti-mony; selenium; thallium; tellurium; lithium; silicon for solar batteries; silicon for semiconductors; rare earth metals; surface preparation agents for metals, resins, ceramics or rubber; heat storage agents; detergents for use in manufacturing processes; detergents for industrial use as part of manufacturing operations; solvents for detergents for industrial use as part of manufacturing operations; solvents for cleaning machines and apparatus and machine parts; detergents for machines and apparatus and machine parts for industrial use as part of manufacturing operations; carbon powder for condensers or rechargeable batteries; carbon powder for oil absorbent; chemical plating solutions; metal oxides for sputtering targets; high purity copper sulfate; chemicals; plastic adhesives not for stationery or household purposes; plant growth regulating preparations, fertilizers; ceramic glazings; priming putty; higher fatty acids; non-metallic minerals; chemical compositions for developing, printing and enlarging photographs; chemical test paper; artificial sweeteners; flour and starch for industrial purposes; unprocessed plastics [plastics in primary form]; cellulose pulp; wood pulp for manufacturing purposes; wood pulp; lactose for industrial purposes; lactose [raw material]; lactose for the food industry; chemicals used in industry, science and photography, as well as in agriculture, horticulture and forestry; unprocessed artificial resins, unprocessed plastics; manures, fire extinguishing compositions; tempering and soldering preparations; chemical substances for preserving foodstuffs; tanning substances; adhesives used in industry; chemical additives for motor fuel; chemical additives for oils; anti-boil preparations for engine coolants; anti-knock substances for internal combustion engines; detergent additives to gasoline [petrol]; coolants for vehicle engines; fuel saving preparations; oil-purifying chemicals; transmission oils, brake oils; oils for hydraulic circuits; power steering oils.

3 – Aromatic hydrocarbon detergents other than for use in manufacturing processes or for medical purposes; cleaning agents for machines and apparatus and machine parts other than for use in manufacturing processes or for medical purposes; anti-static preparations for household purposes; de-

greasing preparations for household purposes; rust removing preparations; stain removing benzene; fabric softeners for laundry use; laundry bleach; adhesives for affixing false hair; adhesives for affixing false eyelashes; laundry starch; seaweed gelatine for laundry use [funori], paint stripping preparations; shoe cream; shoe black [shoe polish]; polishing preparations; industrial soap; soaps and detergents; dentifrices; cosmetics and toiletries; natural perfumery prepared from vegetables; natural perfumery prepared from animals; synthetic perfumery; blended perfumery; food flavorings prepared from essential oils; incenses and fragrances; abrasive paper [sandpaper]; abrasive cloth; abrasive sand; artificial pumice stone; polishing paper; false nails; false eyelashes; detergents for automobiles; cleaning agents other than for use in manufacturing processes and for medical purposes; bleaching preparations and other substances for laundry use; cleaning, polishing, scouring and abrasive preparations; soaps; perfumery, essential oils, cosmetics, hair lotions; dentifrices.

4 – Lubricating oils; lubricants and lubricating grease; industrial lubricants; industrial lubricating oils; lubricants and lubricating oils for automobiles; moistening oil; liquefied petroleum gas; solid lubricants; lubricating graphite; grease for shoes and boots; leather preserving oil and grease; solid fuels; liquid fuels; gaseous fuels; industrial gasoline; industrial grease; industrial oils; non-mineral oils and greases for industrial purposes [not for fuel]; waxes [raw material]; lamp wicks; candles, industrial oils and greases; lubricants; fuels (including motor spirit) and illuminants; candles and wicks for lighting; engine oil; fuels; engine oils and greases for industrial purposes (not for fuel); fuel gas; fuel oil; lubricating grease; coal; cutting fluids; gas oil; gasoline; kerosene; motor oil; oil-gas; petrol; petroleum, raw or refined; non-chemical additives for motor fuel; non-chemical additives for oils.

6 – Copper and its alloys; indium and its alloys; titanium and its alloys; tungsten and its alloys; cobalt and its alloys; cadmium and its alloys; outdoor blinds of metal; iron and steel; nonferrous metals and their alloys for sputtering targets; nonferrous metals and their alloys; ores of metal; metal materials for building or construction; prefabricated building assembly kits of metal; loading and unloading pallets of metal; turntables for load handling; traversers for load handling; artificial fish reefs of metal; prefabricated sectional poultry houses of metal; paint spraying booths of metal; metal moulds for forming cement products; pulleys [of metal, not machine elements]; valves [of metal, not machine elements]; metal junctions for pipes; metal flanges, keys [mechanical element]; cotter pins; railway points; road signs of metal [not

luminous nor mechanical]; beacons of metal [non-luminous]; liquid storage tanks or reservoirs [of metal]; liquid storage tanks or reservoirs of metal, not of masonry, industrial water storage tanks [of metal]; industrial water tanks of metal, not of masonry; liquefied gas storage tanks [of metal]; gas storage tanks [of metal]; internal floating lids of aluminium for use with gas or liquefied gas storage tanks; anchors; mooring bits of metal; mooring bollards of metal; containers of metal for transport; anvils; swage blocks; metal hardware; wire ropes; wire nets and gauzes; industrial packaging containers of metal [not including metal stoppers, lids and caps]; metal stoppers [for industrial packaging containers]; metal lids and caps [for industrial packaging containers]; metal nameplates and door nameplates; chains for dogs; metal stepladders and ladders; letter boxes of metal; hat-hanging hooks of metal; water tanks of metal for household purposes; tool boxes of metal (empty); towel dispensers of metal; metal joinery fittings; safes; upright signboards of metal; transportable greenhouses of metal for household use; metal tombs and metal tomb plaques; ferrules of metal for canes and walking-sticks; crampons [climbing irons]; carabiners; rock pitons; diving platforms of metal; spurs; sculptures of metal, man-made garden ponds of metal [structures]; common metals and their alloys; metal building materials; transportable buildings of metal; materials of metal for railway tracks; non-electric cables and wires of common metal; pipes and tubes of metal; safes; ores.

7 – Machines for cleaning the inside of engines of automobiles; machines and apparatus for cleaning engine cooling systems of automobiles; machines and apparatus for collecting, reproducing and filling chlorofluorocarbon for car air-conditioners; metalworking machines and tools; mining machines and apparatus; construction machines and apparatus; loading-unloading machines and apparatus; industrial fishing machines; apparatus for purifying liquid fuels of biomass; oil refining apparatus; chemical processing machines and apparatus; textile machines and apparatus; food or beverage processing machines and apparatus; lumbering, woodworking, or veneer or plywood making machines and apparatus; pulp making, papermaking or paperworking machines and apparatus; printing or bookbinding machines and apparatus; sewing machines; plowing machines and implements [other than hand-held tools]; cultivating machines and implements; harvesting machines and implements; plant fiber processing machines and implements for agricultural purposes; fodder presses; fodder cutting machines [feed cutters]; fodder mixing machines [feed mixers]; cake-fodder crushing machines [feed mills]; milk filtering machines; milking machines; chick brooders; incubators for eggs; sericultural machines and implements; shoe making machines;

leather tanning machines; tobacco processing machines; glassware manufacturing machines and apparatus; painting machines and apparatus; packaging or wrapping machines and apparatus; power-operated potters' wheels; plastic processing machines and apparatus; semiconductor manufacturing machines and systems; machines and apparatus for manufacturing rubber goods; stone working machines and apparatus; non-electric prime movers, not for land vehicles [other than water mills and wind mills]; parts for non-electric prime movers for land vehicles; water mills; wind mills; pneumatic or hydraulic machines and instruments; adhesive tape dispensing machines; automatic stamping machines; washing machines for industrial purposes [laundry]; food mixing machines for commercial use; food peeling machines for commercial use; dishwashers for industrial purposes; food cutting, chopping and slicing machines for commercial use; electric wax-polishing machines for industrial purposes; vacuum cleaners for industrial purposes; dishwashers for household purposes; electric wax-polishing machines for household purposes; washing machines for household purposes [laundry]; vacuum cleaners for household purposes; electric food blenders [for household purposes]; repairing or fixing machines and apparatus; mechanical parking systems; vehicle washing installations; power sprayers for disinfecting, insecticides and deodorants [not for agricultural purposes]; shafts, axles or spindles [not for land vehicles]; bearings [machine elements not for land vehicles]; shaft couplings or connectors [machine elements not for land vehicles]; transmissions for machines; shock absorbers [machine elements not for land vehicles]; springs [machine elements not for land vehicles]; brakes [machine elements not for land vehicles]; valves [machine elements not for land vehicles]; lawnmowers; curtain drawing devices electrically operated; waste compacting machines and apparatus; waste crushing machines; starters for motors and engines; AC motors and DC motors [not including those for land vehicles but including parts for any AC motors and DC motors]; AC generators [alternators]; DC generators, dynamo brushes; electric arc welding machines; electric metal cutting machines (by arc, gas or plasma); electric welding apparatus; vending machines; fuel dispensing machines for service stations; electric door openers; boilers for non-electric prime movers and engines; fuel cell generators; motors and engines (except for land vehicles); machine coupling and transmission components (except for land vehicles); automatic vending machines; pulleys [machine elements not for land vehicles].

9 – Batteries and cells for electric cars; batteries and cells for vehicles; magnetic disks and magnetic tapes whereon computer software is recorded; computer peripheral devices; computers; billing

machines; slide-rules; semiconductor wafers; solar batteries; fuel cells; card readers; films for liquid crystal displays to expand viewing field; batteries for automobiles; optical glass; ozonisers [ozonators]; electrolyzers [electrolytic cells]; egg-candlers; blueprint apparatus; cash registers; coin counting or sorting machines; electric sign boards for displaying target figures, current outputs or the like; photocopying machines; manual calculator; mathematical instruments; time and date stamping machines; time clocks [time recording devices]; punched card office machines; voting machines; postage stamp checking apparatus; mechanisms for coin-operated car parking gates; life-saving apparatus and equipment; fire extinguishers; fireplugs; fire hose nozzles; sprinkler systems for fire protection; fire alarms; gas alarms; anti-theft warning apparatus; protective helmets, railway signal apparatus, luminous or mechanical; vehicle breakdown warning triangles; luminous or mechanical road signs; breathing apparatus for divers, namely, rebreathers; breathing apparatus for divers, namely, compressed air bailout units; simulators for the steering and control of vehicles; sports training simulators; laboratory apparatus and instruments; photographic machines and apparatus; cinematographic machines and apparatus; optical apparatus and instruments; optical machines and apparatus; measuring or testing machines and instruments; power distribution or control machines and apparatus; rotary converters; phase modifiers; batteries and cells; electric or magnetic meters and testers; electric wires and cables; electric buzzers; telecommunication devices and apparatus; electronic machines, apparatus and their parts; magnetic cores; resistance wires; electrodes, other than welding electrodes or medical electrodes; fire engines; gloves for protection against accidents; dust masks; gas masks; welding masks; fireproof garments; spectacles [eyeglasses and goggles]; electronic circuits and CD-ROMs recorded with programs for hand-held games with liquid crystal displays; weight belts [for scuba diving]; protective helmets for sports; air tanks [for scuba diving]; regulators [for scuba diving]; phonograph records; metronomes; electronic circuits and CD-ROMs recorded with automatic performance programs for electronic musical instruments; downloadable music files; exposed cinematographic films, exposed slide films; slide film mounts; downloadable image files; recorded video discs and video tapes; electronic publications; fire hose; ear plugs for swimmers; ear plugs for divers; observation rockets; nautical, surveying, photographic, cinematographic, optical, weighing, measuring, life-saving and teaching apparatus and instruments; apparatus and instruments for conducting, switching, transforming, accumulating, regulating or controlling electricity; apparatus for recording, transmission or reproduction of sound or images, magnetic data carriers, recording discs;

compact discs, DVDs and other digital recording media; cash registers, hand-operated calculating machines, data processing equipment, computers; computer software; fire-extinguishing apparatus.

11 – Apparatus for storing heat; heat accumulating tanks for air conditioning apparatus; toilet bowls and seats sold as a unit; bathroom sinks; bathroom installations; bathroom basins (parts of sanitary installations); drying apparatus [for chemical processing]; recuperators [for chemical processing]; steamers [for chemical processing]; evaporators [for chemical processing]; distillers [for chemical processing]; heat exchangers [for chemical processing]; milk sterilizers; industrial furnaces; nuclear reactors [atomic piles]; forage drying apparatus; air-conditioning apparatus [for industrial purposes]; freezing machines and apparatus; laundry dryers [electric, for industrial purposes]; nail drying machines for beauty purposes; hair steamers for use in beauty salons; cooking apparatus and installations for commercial use; industrial dish drying apparatus and installations; dish disinfectant apparatus for industrial purposes; tap water faucets; level controlling valves for tanks; pipe line cocks; waste water treatment tanks [for industrial purposes]; septic tanks [for industrial purposes]; garbage incinerators for industrial purposes; garbage incinerators for household purposes; solar water heaters; water purifying apparatus, electric lamps and lighting apparatus; floor heating appliances for household use; household electrothermic appliances; washers for water taps; washers for water taps; gas water heaters [for household purposes]; cooking ovens for household purposes; kitchen worktops with integrated sinks; kitchen sinks; ice chests [for household purposes, non-portable]; ice-cooling refrigerators [for household purposes]; household tap-water filters; bath fittings; standing paper lanterns [Andon]; portable paper lanterns [chochin]; gas lamps; oil lamps; lamp chimneys; warming pans [non-electric]; pocket warmers [non-electric]; Japanese pocket warmers filled with fuel; hot water bottles [for warming one's feet in bed]; toilet stool units with a washing water squirter; disinfectant dispensers for toilets; toilet bowls; seatings for use with Japanese style toilet bowls; waste water treatment tanks for household purposes; septic tanks for household purposes; heating or cooling packs filled with chemical substances ready to react when required; boilers [other than parts of prime movers, engines]; stoves for household purposes [non-electric]; apparatus for lighting, heating, steam generating, cooking, refrigerating, drying, ventilating and water supply.

12 – Rearview mirrors with antidazzle devices for automobiles; ropeways specifically adapted for vehicles for cargo or freight handling; tipping apparatus, parts of railway freight cars; pusher cars

for mining; puller cars for mining; engines (traction-); traction engines, non-electric prime movers for land vehicles [not including their parts]; shafts, axles or spindles [for land vehicles]; bearings [for land vehicles]; shaft couplings or connectors [for land vehicles]; shock absorbers [for land vehicles]; springs [for land vehicles]; brakes [for land vehicles]; parachutes; anti-theft alarms for vehicles; wheelchairs; AC motors or DC motors for land vehicles [not including their parts]; vessels and their parts and fittings [other than air cushion vehicles]; air-cushion vehicles; aircraft and their parts and fittings; railway rolling stock and their parts and fittings; automobiles and their parts and fittings; two-wheeled motor vehicles, bicycles and their parts and fittings; baby carriage [prams]; rickshaws; sleighs and sleds [vehicles]; trolleys; carts; horse drawn carriages; bicycle trailers [Riyakah]; adhesive rubber patches for repairing tubes or tires; cigar lighters for automobiles; rockets for launching satellites.

17 – Mica [raw or partly processed]; valves of rubber or vulcanized fiber [not including machine elements]; gaskets; junctions for pipes [not of metal]; packings; asbestos fire curtains; safety curtains of asbestos; floating anti-pollution barriers; electrical insulating oils; electrical insulating materials; washers of rubber or vulcanized fiber; chemical fiber for insulating purposes [not for textile use]; asbestos; rock wool; slag wool; rubber thread and covered rubber yarn [not for textile use]; chemical fiber yarn and thread [not for textile use]; asbestos yarn; asbestos fabrics; asbestos felt; insulating gloves; rubber cords and laces; asbestos cords and strings; asbestos nets; industrial packaging containers of rubber; rubber stoppers; rubber lids and caps [for industrial packaging containers]; plastic sheeting for agricultural purposes; condenser paper; asbestos paper; vulcanized fiber; plastic semi-worked products including carbon fibers; plastic semi-worked products; rubber [raw or semi-worked]; soundproofing materials of rock wool [not for building purposes]; asbestos boards; asbestos powder; unprocessed and semi-processed rubber, gutta-percha, gum, asbestos, and mica; plastics in extruded form for use in manufacture; flexible pipes, not of metal; plastic sheeting for agricultural purposes; plastic substances, semi-processed; insulating oils. Materials for storing heat for air conditioning apparatus;

21 – Polishing cloth.

37 – Mining extraction; installation of air conditioning apparatus; installation of air conditioning systems; installation of machines and apparatus; anti-corrosion treatment services for construction purposes; car washing services; rental of coin-operated washing machines; rental of coin-operated drying machines; repair works of underground tanks

and buried piping; earth pollution removal work; advisory services relating to earth pollution removal work; repair, refurbishment and maintenance of automobiles or two-wheeled motor vehicles; providing information relating to the repair, refurbishment and maintenance of automobile or two-wheeled motor vehicles; advisory services in the fields of repair, refurbishing and maintenance of automobiles or two-wheeled motor vehicles; cleaning the inside polishing, waxing and washing of automobiles, and other cleaning services of automobiles; application of coatings for the maintenance or repair of automobiles; replacement services of oils, batteries, tires and structural components of automobiles or two-wheeled motor vehicles; attaching glass film onto automobile windows, repair and maintenance services relating to the protecting and treating and polishing of coating films on the bodies of automobiles, vehicle body repair and other repair and maintenance of automobiles; construction; construction consultancy; construction or maintenance of buildings; shipbuilding; repair or maintenance of vessels; aircraft repair or maintenance; repair of bicycles; repair or maintenance of automobiles; repair or maintenance of railway rolling stocks; repair or maintenance of two-wheeled motor vehicles; repair or maintenance of cinematographic machines and apparatus; repair or maintenance of optical machines and apparatus; repair or maintenance of photographic machines and apparatus; repair or maintenance of loading-unloading machines and apparatus; repair or maintenance of fire alarms; repair or maintenance of office machines and equipment; repair or maintenance of air-conditioning apparatus [for industrial purposes]; repair or maintenance of burners; repair or maintenance of boilers; repair or maintenance of pumps; repair or maintenance of freezing machines and apparatus; repair or maintenance of electronic machines and apparatus; repair or maintenance of telephone apparatus; repair of radio receivers or television receivers; repair or maintenance of telecommunication machines and apparatus, other than telephone sets, radio receivers and television receivers repair or maintenance of construction machines and apparatus; repair or maintenance of consumer electric appliances; repair or maintenance of electric lighting apparatus; repair or maintenance of power distribution or control machines and apparatus; repair or maintenance of power generators; repair or maintenance of electric motors; repair or maintenance of laboratory apparatus and instruments; repair or maintenance of measuring and testing machines and instruments; repair or maintenance of medical apparatus and instruments; repair or maintenance of firearms; repair or maintenance of printing or bookbinding machines and apparatus; repair or maintenance of chemical processing machines and apparatus; repair

or maintenance of glassware manufacturing machines and apparatus; repair or maintenance of fishing machines and instruments; repair or maintenance of metalworking machines and tools; repair or maintenance of shoe making machines; repair or maintenance of industrial furnaces; repair or maintenance of mining machines and apparatus; repair or maintenance of rubber-goods manufacturing machines and apparatus; repair or maintenance of integrated circuits manufacturing machines and systems; repair or maintenance of semiconductor manufacturing machines and systems; repair or maintenance of machines and apparatus for processing foods or beverages; repair or maintenance of machines and apparatus for lumbering, woodworking, or veneer or plywood making; repair or maintenance of textile machines and apparatus; repair or maintenance of tobacco processing machines; repair or maintenance of painting machines and apparatus; repair or maintenance of plowing machines and implements [other than hand-held tools]; repair or maintenance of cultivating machines and implements, repair or maintenance of harvesting machines and implements; repair or maintenance of plant fiber processing machines and implements; repair or maintenance of fodder presses; repair or maintenance of fodder cutting machines; repair or maintenance of fodder mixing machines; repair or maintenance of cake-fodder crushing machines; repair or maintenance of milk filtering machines; repair or maintenance of milking machines; repair or maintenance of chick brooders; repair or maintenance of egg incubators; repair or maintenance of sericultural machines and implements; repair or maintenance of machines and apparatus for pulp-making, paper-making or paper-working; repair or maintenance of plastic processing machines and apparatus; repair or maintenance of packaging or wrapping machines and apparatus; repair or maintenance of sewing machines; repair or maintenance of reservoirs; repair or maintenance of gasoline station equipment; repair or maintenance of mechanical parking systems; repair or maintenance of bicycle parking apparatus; repair or maintenance of dishwashers for industrial purposes; repair or maintenance of cooking equipment for industrial purposes; repair or maintenance of electric washing machines for industrial purposes; repair or maintenance of vehicle washing installations; repair or maintenance of vending machines; repair or maintenance of power-driven floor cleaning machines; repair or maintenance of amusement machines and apparatus; repair or maintenance of machines and apparatus for use in beauty salons or barbers' shops; repair or maintenance of water pollution control equipment; repair or maintenance of water purifying apparatus; repair or maintenance of waste compacting machines and apparatus; repair or maintenance of waste

crushing machines; repair or maintenance of divers' apparatus; repair or maintenance of nuclear power plants; repair or maintenance of chemical plants; furniture restoration; umbrella repair; repair or maintenance of musical instruments; safe maintenance or repair, shoe repair; clock and watch repair or maintenance; sharpening of scissors and kitchen knives; setup or repair of locks; repair or maintenance of gas water heaters; repair or maintenance of non-electric cooking heaters; repair or maintenance of cooking pots and pans; repair or maintenance of signboards; repair of bags or pouches, repair of personal ornaments; repair of toys or dolls; repair of sports equipment; repair of billiard equipment; repair of game machines and apparatus; repair or maintenance of bath fittings; repair of toilet stool units with a washing water squirts; repair of fishing tackle; repair of spectacles; fur care and repair; laundering; pressing of clothing; clothing repair [mending clothing]; fluffing of cotton batting for futon, repair of tatami mats; chimney sweeping; cleaning of building exterior surfaces; window cleaning; carpet and rug cleaning; floor polishing; septic tank cleaning; bathtub and bath boiler cleaning; street cleaning; reservoirs cleaning; disinfecting of telephone hand-sets; vermin exterminating, other than for agriculture, forestry or horticulture; sterilization of medical machines and apparatus; rental of construction machines and apparatus; rental of floor cleaning machines; rental of mops; rental of car-washing apparatus; rental of electric washing machines; rental of laundry dryers; rental of spin dryers for clothes; rental of mining machines and apparatus; rental of electric irons for household purposes; rental of drainage pumps; rental of pumps; rental of compressing machines; building constructions; installation services; vehicle service stations, vehicle maintenance; vehicle lubrication; vehicle greasing; vehicle polishing; vehicle cleaning; vehicle wash; car wash; vehicle repair; anti-rust treatment for vehicles.

39 – Propane gas supplying; liquefied natural gas supplying; liquefied petroleum gas supplying; railway transport; car transport; providing road and traffic information; vehicle-driving services; marine transport; air transport; packaging of goods; freight brokerage; cargo unloading; removal services; brokerage for rental, selling, purchasing or chartering of vessels; refloating of ships; ship piloting; arranging and booking of travel for package holidays; escorting of travel tours; travel arrangement and reservation services [excluding those for lodging]; warehousing services; temporary safekeeping of personal belongings; temporary storage of deliveries; gas supplying [distribution]; electricity distribution; water supplying [distribution]; heat supplying [distribution]; rental of warehouse space; parking services; providing toll roads; providing vessel mooring facilities; airport services; operating

of parking places; rental of loading-unloading machines and apparatus; car rental; rental of vessels; rental of wheelchairs; rental of bicycles; rental of aircraft; rental of mechanical parking systems; rental of packaging or wrapping machines and apparatus; rental of refrigerator-freezers for household purposes; rental of freezers for household purposes; rental of freezing machines and apparatus; rental of gasoline station equipment [not for repair and maintenance of automobiles]; rental of non-electric prime movers for vehicles; packaging and storage of goods; travel arrangement.

42 – Inspection of automobiles for automobile safety purposes; agency services for inspection of automobiles for automobile safety purposes; research and provision of scientific technology information; design of air conditioning systems; design of machines and apparatus; research on soil pollution, design of industrial processing plants; plant engineering; engineering services in the nature of design and development of refinery plants of oil; chemical analysis of petroleum products; chemical analysis of metals; research, exploration and development of petroleum oil and natural gas resources; research, development, testing and analysis relating to manufacturing, processing and using of petroleum products and raw materials thereof; providing meteorological information; architectural design; surveying; geological surveys or research; designing of machines, apparatus, instruments [including their parts] or systems composed of such machines, apparatus and instruments; designing; computer software design, computer programming, or maintenance of computer software; technological advice relating to computers, automobiles and industrial machines; testing, inspection or research of pharmaceuticals, cosmetics or foodstuffs; research on building construction or city planning; testing or research on prevention of pollution; testing or research on electricity; testing or research on civil engineering; testing, inspection or research on agriculture, livestock breeding or fisheries; testing or research on machines, apparatus and instruments; rental of measuring apparatus; rental of computers; providing temporary use of non-downloadable computer programs; rental of laboratory apparatus and instruments; rental of technical drawing instruments; design and development of computer hardware and software.

(260) AM 2018 95017 A

(800) 1374287

(151) 2017 04 20

(891) 2017 04 20

(731) "BOLERO Co." Ltd

No 1, Dragalevska str., office 2, Lozenetz
Region BG-1407 Sofia, Bulgaria

(540)

BOLERO ADVANCED HYDRATION

(591) Black and white

(511)

5 – Dietetic substances adapted for medical use; vitamin drinks; vitamin preparations; effervescent vitamin tablets; liquid vitamin supplements; nutritional additives for medical purposes; dietary supplemental drinks; dietetic beverages adapted for medical purposes; medicinal beverages; dietary fiber as digestive aid; glucose dietary supplements; protein dietary supplements; starch for dietetic or pharmaceutical purposes; pectin for pharmaceutical purposes; sugar for medical purposes; powdered drink mix containing fruit-flavored dietary supplements; powdered drink mix containing nutritional supplements; bicarbonate of soda for pharmaceutical purposes; herbal teas for medical purposes; medicinal tea; artificial tea [for medicinal use]; mineral water salts; pharmaceutical preparations for skin care; medical preparations for slimming purposes.

30 – Coffee, teas and substitutes therefor; aerated beverages [with coffee, cocoa or chocolate base]; artificial coffee; chicory [coffee substitute]; coffee flavourings; coffee beverages and coffee beverages with milk; coffee-based beverages; vegetal preparations for use as coffee substitutes; iced coffee; tea-based beverages; flavourings of tea; aromatic teas [other than for medicinal use]; fruit teas; instant powder for making tea [other than for medical use]; iced tea; aromatic preparations for making non-medicated tisanes; chocolate beverages and chocolate beverages with milk; chocolate-based beverages; cocoa beverages and cocoa beverages with milk; cocoa-based beverages; powders for ice cream; powder for edible ices; natural sweeteners; vanilla [flavouring]; flavourings for beverages.

32 – Beers; ginger beer; ginger ale; malt beer; alcohol-free beers; low-alcohol beer; beer based beverages; non-alcoholic malt beverages; whey beverages; cocktails, non-alcoholic; preparations for making liqueurs; non-carbonated soft drinks; mineral and aerated waters and other non-alcoholic drinks; waters [beverages]; soda water; lemonades; syrups and other preparations for making beverages; fruit drinks and fruit juices; vegetable juices [beverages]; fruit-based soft drinks flavored with tea; non-alcoholic fruit extracts used in the preparation of beverages; juices; smoothies; aloe vera drinks, non-alcoholic; non-alcoholic honey-based beverages; sorbets [beverages]; kvass [non-alcoholic beverage]; beverages containing vitamins; vitamin enriched sparkling water [beverages]; nutritionally fortified beverages; energy drinks [not for medical purposes]; isotonic beverages; soft drinks for energy supply; sports drinks; sports drinks containing electrolytes; concentrates for use in the

preparation of soft drinks; powders for the preparation of beverages; powders for effervescing beverages; pastilles (tablets) for effervescing beverages.

(260) AM 2018 95018 A

(800) 1374294

(151) 2017 04 07

(891) 2017 04 07

(731) E-LAB LABORATUAR HİZMETLERİ

ANONİM Şirketi

Maçka Cad. Feza Apt. No: 1/1 Maçka

İstanbul, Turkey

(540)



(591) Black and dark blue

(531) 24.17.02; 26.01.06; 27.05.10; 29.01.13

(511)

44 – Medical services, medical assistance services, hospital services, medical clinic services, medical laboratory services for the analysis of samples taken from patients, blood bank services, dentistry services, nursing services, opticians' services, physiotherapy/physical therapy services, massage services for medical purposes, pharmacy advice, pharmacy services, services of a psychologist.

(260) AM 2018 95019 A

(800) 1374315

(151) 2017 05 26

(891) 2017 05 26

(731) Drone Racing League, Inc.

40 W. 27th St. New York NY 10001, USA

(540)

DRL

(591) Black and white

(511)

9 – Downloadable video game software namely, computer and electronic game software via a global computer network and wireless devices relating to drone and unmanned aerial vehicle (UAV) racing, events, competitions, exhibitions, competitions; computer application software that may be downloaded via global computer networks for use in connection with computers, mobile computers, smart phones, media players, cell and mobile phones, wireless devices and portable handheld digital electronic devices, namely, software for the purpose of displaying information relating to drone and UAV racing, events, competitions, exhibitions, schedules, and media guides; audio visual recordings featuring

content in the nature of drone and UAV racing, competitions, events, exhibitions, education and training; DVDs and compact discs all featuring content in the nature of drone and UAV racing, exhibitions, activities, competitions, tournaments, events, education and training.

25 – Clothing, namely, t-shirts, shirts, sweatpants, sweatshirts, caps, coats and jackets.

28 – Toys and sporting goods in the nature of drones and unmanned aerial vehicles (UAVs).

41 – Education and entertainment services in the nature of professional drone and unmanned aerial vehicles (UAVs) racing, events, competitions, tournaments, and exhibitions; providing sports and entertainment information via a global computer network or a commercial on-line computer service, or by cable, satellite, television or radio in the nature of drone and UAV racing, competitions, tournaments and events; arranging and conducting drone and UAV competitions, namely, professional drone and UAV racing, tournaments, events, competitions, and exhibitions; drone and UAV fan club services, namely, personal appearances by drone and UAV racing pilots and professional drone and UAV racing teams; entertainment services, namely, live musical and dance performances provided during intervals at drone and UAV racing events and exhibitions; educational services, namely, conducting programs on drones and UAVs, and the piloting of drones and UAVs; production of radio and television programs featuring drone and UAV racing, events, competitions, tournaments, and exhibitions; presentation of live show performances featuring drone and UAV racing, games, events, exhibitions, competitions and pilots in the nature of drone racing and UAV racing; organization of sporting and cultural activities featuring drone and UAV racing, competition, exhibitions, tournaments and events; entertainment services, namely, an on-going series featuring drone and UAV racing, events, competitions, and exhibitions provided through cable television, satellite television, digital and wireless transmission, and television and radio broadcasts; providing a website featuring non-downloadable television and video programming in the nature of drone and UAV racing, events, competitions, exhibitions, and tournaments; entertainment services in the nature of the development, production and distribution of films, movie trailers, video films, television, podcasts, and radio programs and online television programs featuring drone and UAV racing, events, competitions, pilots and UAVs and drones; providing temporary use of non-downloadable interactive online video games, computer games and online video electronic games via an on-demand service featuring drone and UAV racing, competitions and tournaments; entertainment and

educational services in the nature of development and production of multi-media entertainment content featuring drones and UAVs, drone and UAV racing, events, competitions, tournaments, drone and UAV operation; educational services, namely, providing clinics, programs, classes, seminars, workshops, courses, presentations and trainings in the fields of piloting of drones and UAVs, professional drone and unmanned aerial vehicles (UAVs) racing, events, competitions, tournaments, and exhibitions.

(260) AM 2018 95021 A

(800) 1374394

(151) 2017 07 05

(891) 2017 07 05

(731) MM Beteiligungs GmbH

Schorn 1 82319 Starnberg, Germany

(540)

STUDIO ITALY

(591) Black and white

(511)

35 – Advertising; online advertising on a computer network; marketing; sales promotion; business management; business administration; display services for merchandise; organisation of exhibitions and trade fairs for business and promotional purposes; product demonstrations and product presentation services, also via the internet; demonstration of goods and services by electronic means, also for the benefit of the so-called teleshopping and homeshopping services; loyalty, incentive and bonus program services; film and television advertising; product demonstration services in shop windows and teleshopping programmes by live models; retail and wholesale services (including teleshopping programmes) as well as online and catalogue mail order services for the following goods: perfumery, cosmetics, personal deodorants, soap, shampoos, hair lotions, after-shave lotions, sunscreen preparations, ethereal oils, nail varnish, lipsticks, body powder, laundry preparations, household fragrances, air fragrancing preparations, potpourris [fragrances], joss sticks, scented wood, candles, including scented candles, candles and wicks for lighting, spectacles, spectacle lenses, sunglasses, snow goggles, goggles for sports, spectacle frames, spectacle cases, encoded credit cards, encoded identity cards, bags adapted for laptops, sleeves for laptops, covers for smartphones, cell phone covers, covers for tablet computers, usb-sticks, computer software, downloadable application software, interactive multimedia computer software, computer programs [downloadable software], jewelry, ornaments [jewelry], clocks and watches, watch straps, watch chains, jewelry cases, alarm clocks, key rings [trinkets or fobs], paper, millboard, printed matter, photographs [printed], stationery, wrapping materials made of paper or plastic, albums,

calendars, notebooks, pencil boxes, seals, sealing wax, stamps [seals], stamp pads, writing paper, books, newspapers, periodicals, magazines, office requisites, except furniture, pictures made from wood or plastic, table napkins of paper, cases of leather or leatherboard, boxes of leather or leatherboard, hat boxes of leather, luggage tags [leatherware], purses, wallets, credit-card holders, key cases of leather or imitation leather, briefbags, attaché cases, trunks and suitcases, vanity cases, not fitted, toiletry bags, pouches and packaging sleeves and packaging bags, all of the aforementioned goods made of leather, for storing and carrying fashion items and fashion accessories, jewelry and costume jewelry; retail and wholesale services (including teleshopping programmes) as well as online and catalogue mail order services for the following goods: travelling sets [leatherware], umbrellas, parasols, garment bags, backpacks, bags, handbags, carried skins and hides, mirrors (silvered glass), furniture, frames, works of art of wood, wax, plaster or plastic, boxes of wood or plastic, picture frames, hooks for clothing and coat hangers [not made of metal], mannequins and tailors' dummies, coatstands, curtain rods, curtain hooks and curtain rings, garment covers [storage], mattresses, air mattresses, not for medical purposes, air cushions, not for medical purposes, sleeping bags for sports and camping purposes, space dividers [furniture], wickerwork, high chairs for babies, clothing stretchers, brushes, in particular toilet brushes and brushes for cleaning clothing articles and footwear, trouser presses, trouser stretchers, flasks, glassware, crystal [glassware], boxes of glass, glasses [receptacles], decanters, insulating flasks, heat-insulated containers for beverages, thermally insulated containers for food, tea and coffee services [tableware], in particular cups and mugs, porcelain ware, glass tableware, drinking vessels, drinking glasses, place mats, not of paper or textile, fruit cups, dishes [household utensils], salad bowls, butlers' trays, napkin rings, combs, comb cases, corkscrews, electric and non-electric, tie presses, fitted picnic baskets, including dishes, flower vases, fireproof dishes, candle holders not of precious metal, candelabra [candlesticks], polishing gloves, polishing leather, shaving brushes, shaving brush stands, shoe horns, shoe trees [stretchers], soap dispensers, boot jacks, fabrics, textiles for making up into articles of clothing, textile piece goods for furnishing purposes, knitted fabric, bed blankets, bed clothes and blankets, table runners [not of paper], table linen [not of paper], sleeping bag liners, curtains of textile or plastic, curtains, linings [textile], home textiles, furniture covers or covers of plastic or textiles [unfitted], protective coverings of textile for furniture [unfitted], place mats, not of paper, quilt bedding mats, travelling rugs (lap robes), towels of textile, table napkins of textile,

handkerchiefs of textile, clothing, in particular skirts, dresses, trousers, leggings [trousers], hosiery, blouses, shirts, tops [clothing], tee-shirts, sweaters, cardigans, blazers, jackets [clothing], coats; retail and wholesale services (including teleshopping programmes) as well as online and catalogue mail order services for the following goods: underwear, bathing suits, bikinis, bathing trunks, bathrobes, belts [clothing], gloves [clothing], pocket squares, mufflers [clothing], scarfs, sleep masks, footwear, headgear, buttons, snap fasteners, hooks and eyes [haberdashery], needles, zippers, cords, tying laces, lace, embroidery, games, gymnastic and sporting articles, golf club bags, golf gloves, billiard balls, billiard cues, billiard tables, board games, parlour games, golf clubs, golf bags, with or without wheels, playing cards, nordic walking poles, chess games, skis, snowboards, bags specially adapted for sports equipment, tennis rackets.

(260) AM 2018 95045 A
 (800) 1374683
 (151) 2017 08 11
 (891) 2017 08 11
 (731) DR. JOHANNES SCHUMANN
 Waldspielplatz 30 82319 Starnberg, Germany
 (540)

DESIDOSA

(591) Black and white
 (511)
 43 – Restaurant services; self-service restaurant services; washoku restaurant services; providing food and drink in bars; fast-food restaurant services; restaurant services in hotels; providing reviews of restaurants and bars; agency services for reservation of restaurants; providing food and drink in restaurants and bars; booking of restaurant seats; restaurant information services; take-out restaurant services; making reservations and bookings for restaurants and meals; mobile restaurant services; providing food and drink for guests in restaurants.

(260) AM 2018 95047 A
 (800) 1374739
 (151) 2017 09 27
 (891) 2017 09 27
 (731) HENKEL AG & CO. KGAA
 Henkelstraße 67 40589 Düsseldorf,
 Germany
 (540)

Shapex

(591) Black and white
 (511)
 3 – Essential oils for household use; bleaching preparations for laundry purposes; scented linen sprays; pomanders (aromatic substances) for laundry purposes;

scented oils for laundry purposes; scented sachets for laundry purposes; sachets for perfuming linen; fragrance preparations for laundry purposes; laundry blueing; laundry preparations for attracting dyes; color-removing preparations for laundry purposes; grease-removing preparations for laundry purposes; stain removers for laundry purposes; laundry liquids; laundry glaze for laundry purposes; starch glaze for laundry purposes; smoothing preparations (starching) for laundry purposes; hand washes; adhesive removers for laundry purposes; leather bleaching preparations; cloths impregnated with a detergent for cleaning; soap powder; oils for cleaning purposes for laundry purposes; scented soaps for laundry purposes; washing conservation agents; upholstery cleaners; dry-cleaning preparations for laundry purposes; cleansing gels for laundry purposes; cleaning fluids for laundry purposes; foam detergents for laundry purposes; rust removing preparations for laundry purposes; spray cleaners for use on textiles; rinsing agents for laundry; starch for cleaning purposes; synthetic detergents for clothes; detergent strengtheners; agents for removing wax for laundry purposes; laundry soaking preparations; fabric softener for laundry; laundry balls containing laundry detergent; laundry preparations; washing liquids; detergent soap; laundry additives.

(260) AM 2018 95056 A
 (800) 1216651
 (151) 2014 06 11
 (891) 2017 10 19
 (731) HEALTHTEX APPAREL CORP
 100 West 33rd Street, Suite 1012 New
 York NY 10001, USA
 (540)

HEALTHTEX

(591) Black and white
 (511)
 25 – Clothing; namely, jeans, casual pants, slacks, capri pants, shorts, skirts, coveralls, overalls, rompers, creepers, sunsuits, playsuits, dresses, unitard (leggings), cotton panties, socks, sweatshirts, sweat-pants, sweatshorts, jogging suits, T-shirts, shirts, blouses, tank tops, crop tops, one piece dress silhouette with a split skirt, skorts, shortalls, bodyshirts, cardigans, jackets, jumpers, short sets, pant sets, overall sets, romper sets, swimsuits, cover-ups, gowns, sacque sets, hats, bibs, booties, pajamas, coats, shoes and boots.

(260) AM 2018 95058 A
 (800) 1247017
 (151) 2015 01 16
 (891) 2017 10 26
 (731) 13:E PROTEIN IMPORT AKTIEBOLAG
 BETONGVÄGEN 4B SE-142 50 SKOGÅS,
 Sweden

(540)



(591) Black and white

(531) 26.05.02; 27.05.01; 27.05.10; 27.05.17

(511)

5 – Pharmaceutical, veterinary and sanitary preparations; dietetic substances adapted for medical use, food for babies; plasters, materials for dressings; disinfectants; preparations for destroying vermin; antifungal preparations, herbicides, nutritional supplements, parapharmaceutical preparations, vitamin and multimineral preparations; dietetic substances adapted for nutraceutical use; nutritional supplements consisting of proteins, amino acids, enzymes, herbal minerals and vitamins; dietetic foods and beverages adapted for nutraceutical use; dietary supplements for supplementing a normal diet or for a healthy lifestyle; meal substitutes, dietetic foods and beverages, adapted for nutraceutical use; protein dietary supplements; dietary supplements consisting of whey protein concentrate; enzyme dietary supplements; creatine dietary supplements; arginine dietary supplements, casein dietary supplements; dietary supplements consisting of milk proteins.

25 – Belts (clothing); pullovers; shirts; clothing; pants (Am.); gloves for protection against cold; jumpers; singlets; jackets [clothing]; clothing for gymnastics; tee-shirts.

28 – Games and playthings; gymnastic and sporting articles not included in other classes; decorations for christmas trees; gymnastic articles; elbow guards (sports articles); weightlifting belts (sporting articles); weight training machines (other than for therapeutic use); abdomen protectors for sports; bags adapted to carry sporting articles; body-training apparatus; chest expanders [exercisers]; dumb-bells; sports bags especially designed for football boots.

29 – Meat, fish, poultry and game; meat extracts; preserved, frozen, dried and cooked fruits and vegetables; jellies, jams, compotes; eggs, milk and milk products; edible oils and fats; dairy-based beverages and drinks made from dairy products; protein milk; protein-based nutritional food and snack bars; snacks and natural sweets made of fruits and root vegetables; skimmed milk powder; whey; soya beans, soybean oil, soya milk (milk substitute) and soy-based snacks.

30 – Coffee, tea, cocoa and artificial coffee; rice, tapioca, sago, coffee substitutes; flour and preparations made from cereals, bread, pastry and confectionery, ices, honey, treacle; yeast, baking-powder; salt, mustard; vinegar, sauces (condiments); spices; ice; food preparations based on grains; coffee, tea, cocoa, cereal or chocolate-based beverages and foodstuffs; infusions, not medicinal; herbal preparations for making beverages; ice creams products; carbohydrate-

based nutrition snack bars and nutrition food bars; wheat germ; grape sugar; filled chocolates (confectionery); confectionery; cocoa mixes; cake dough; wafers; glucose for food; maltose; snacks, biscuits and natural sweets made from cereals; rice, starch and cereal-based snacks; high-protein cereal bars; biscuits made from cereals; maltodextrin; aromatic preparations for food; glucose syrup; wheat germ [other than a dietary supplement]; flour; soya flour; propolis for food purposes; cake and pancake mixes; soya bean paste [condiment]; snack food products made from soya flour; malted food beverages; malt for human consumption; substances imparting flavour for addition to food [other than essential oils].

32 – Beers; mineral and aerated waters and other non-alcoholic beverages; fruit beverages and fruit juices; syrups and preparations for making beverages; non-alcoholic beverages, namely energy drinks and sports drinks; non-alcoholic fruit juice beverages; isotonic drinks; whey beverages; grape must, unfermented; vegetable juices (beverages); beverages enriched with vitamins; non-alcoholic protein and/or carbohydrate energy drinks; non-alcoholic mineral and glucose beverages; powdered beverage mixes.

(260) AM 2018 95059 A

(800) 1340259

(151) 2017 01 30

(891) 2017 09 01

(731) ADP GAUSELMANN GMBH

Merkur-Allee 1-15 32339 Espelkamp,
Germany

(540)

Tizona

(591) Black and white

(511)

9 – Computer software; computer and video games software; games software for use on any computer platform, including electronic entertainment and games consoles; computer game programs; computer games programs; video games (software); computer games provided through a global computer network or supplied by means of multimedia electronic broadcast or through telecommunications or electronic transmission or via the internet; computer games, leisure and recreational software, video games and computer software, all being provided in the form of storage media; programs for operating electric and electronic apparatus for games, amusement and/or entertainment purposes; automatic lottery machines; computer software for computer games on the internet; online games (software), in particular for online betting games, online prize games, online gambling games, online games of skill and online casino games; computer software in the form of an app for mobile devices and computers; computer software

for casino and amusement arcade games, for gaming machines, slot machines or video lottery gaming machines or games of chance via the internet.

(260) AM 2018 95165 A

(800) 1375632

(151) 2017 07 14

(891) 2017 07 14

(731) PCC Consumer Products Kosmet sp. z o.o.
ul. Sienkiewicza 4, PL-56-120 Brzeg Dolny,
Poland

(540)

SAVANTI

(591) Black, white

(531) 27.05.17

(511)

3 – Cosmetics and cosmetic preparations, lotions for cosmetic purposes, cosmetic creams, body cleaning cosmetic preparations, body cleaning liquids, shampoos, hair care lotions, skin care cosmetic preparations, soaps, cleaning preparations with antibacterial properties, liquids, gels and lotions for the bath and shower, bath oils, foams for use in the shower and bath, bath preparations, not for medical purposes, bath salts, cleansers for intimate personal hygiene purposes, non medicated, skin cleaning and freshening sprays, cosmetic body scrubs, deodorants, fragrance preparations, essential oils for use in air fresheners, oils for cosmetic purposes, room perfumes in spray form, room scented sprays, incense, potpourris, room fragrancing preparations, scented sachets, air fragrancing preparations.

(260) AM 2018 95166 A

(800) 1375658

(151) 2017 08 30

(891) 2017 08 30

(731) DONGYING FANGXING RUBBER CO., LTD
Dawang Economic Development Zone, Dongying
City, 257000 Shandong Province, China

(540)



(591) Black, white

(531) 07.15.22; 26.13.25

(511)

12 – Inner tubes for pneumatic tires; tires for vehicle wheels; tires for bicycles, cycles; treads for retreading tires; pneumatic tires; tires, solid, for vehicle wheels; vehicle wheel tires; adhesive rubber patches for repairing inner tubes; inner tubes for bicycles, cycles; repair outfits for inner tubes.

(260) AM 2018 95167 A

(800) 1375664

(151) 2017 09 01

(891) 2017 09 01

(731) BYD COMPANY LIMITED

Yan an Road, Kuichong, Longgang, 518119
Shenzhen, Switzerland

(540)

SKYRAIL

(591) Black, white

(531) 27.05.15

(511)

12 – Rolling stock for railways; electric vehicles; locomotives; vehicles for locomotion by land, air, water or rail; motorcycles; cars; funiculars; aeroplanes; boats; civil drones.

(260) AM 2018 95168 A

(800) 1375666

(151) 2017 09 01

(891) 2017 09 01

(731) SHANGHAI TOBACCO GROUP CO. LTD

717 Chang Yang Road, Yangpu District,
Shanghai, China

(540)

FIRAVO

(591) Black, white

(531) 27.05.01

(511)

3 – Ethereal oils; perfumery; aromatics [essential oils]; flavoring essence for tobacco; mint essence [essential oil]; industrial spicery; extracts of flowers [perfumes]; incense; air fragrancing preparations; aromatic [essential oil].

5 – Tobacco-free cigarettes for medical purposes; medicinal tea; appetite suppressants for medical purposes; nutritional supplements; depuratives; mothballs; disinfectant wipes; medicinal health kit; medicinal roots; medicinal herbs.

9 – Car battery chargers, for electronic cigarettes; batteries, for electronic cigarettes; battery chargers, for electronic cigarettes; usb flash drives; digital photo frames; cell phone straps; electronic book readers; battery chargers; glasses-cleaning cloth; usb yarn, for electronic cigarettes.

34 – Electronic cigarettes; chewing tobacco; snuff; cigarettes containing tobacco substitutes, not for medical purposes; nicotine-replacement fluid, for electronic cigarettes; flavorings, other than essential oils, for electronic cigarettes; electronic cigarette filter (e-cigarette parts); atomizer, for electronic cigarettes.

(260) AM 2018 95169 A
 (800) 1375674
 (151) 2017 09 08
 (891) 2017 09 08
 (731) INTELEC HOLDINGS SA
 Av. Samora Machel No. 120, 1° Andar,
 Mozambique
 (540)



(531) 07.01.24; 27.05.10; 29.01.12
 (526) "HOLDINGS"
 (511)
 36 – Services of investment trusts, of holding companies; services of brokers dealing in shares and property.

(260) AM 2018 95170 A
 (800) 1375696
 (151) 2017 08 18
 (891) 2017 08 18
 (731) CAROCELLE SPÓŁKA AKCYJNA
 Słomińskiego 15/509, PL-00-195 Warszawa,
 Poland
 (540)

DELLIGENT

(591) Red and black. Red: letter "D"; black: letters "ELLIGENT" and graphical symbol of arrow.
 (531) 24.15.01; 27.05.01; 29.01.12
 (511)
 5 – Pharmaceuticals and natural remedies, dietetic foods adapted for medical purposes, dietary supplements, nutraceuticals for use as dietary supplements.

(260) AM 2018 95171 A
 (800) 1375707
 (151) 2017 09 13
 (891) 2017 09 13
 (731) Changzhou Trina Solar Energy Co. Ltd
 No. Road, Trina PV Park, Xinbei District
 213031 Changzhou, Jiangsu, China
 (540)

Trinasolar

(591) Bright blue and red. The mark consists of ten letters in the color blue and the dot on the upper part of the third letter in the color red

(531) 27.05.07; 27.05.08; 27.05.10; 27.05.17;
 29.01.04; 29.01.12
 (511)
 9 – Transformers [electricity]; batteries, electric; solar panels for the production of electricity; accumulator jars; accumulator boxes; photovoltaic cells; chargers for electric batteries; solar batteries; accumulators, electric.

(260) AM 2018 95187 A
 (800) 1375712
 (151) 2017 09 15
 (891) 2017 09 15
 (731) UROMED Kurt Drews KG
 Meessen 7, 22113 Oststeinbek, Germany
 (540)

UROAVENUE

(591) Black, white
 (511)
 10 – Medical apparatus and instruments, in particular non-electric urological and surgical apparatus and instruments and parts and fittings therefor, included in this class, in particular guidewires and ureteral catheters.

(260) AM 2018 95188 A
 (800) 1375719
 (151) 2017 07 21
 (891) 2017 07 21
 (731) Joint Stock Company "Krasnyj Ocyabr"
 ul. Malaya Krasnoselskaya, d. 7, str. 24
 RU-107140 Moscow, Russian Federation
 (540)



(591) Black, pink and blue
 (531) 03.04.02; 05.05.04; 08.01.11; 08.01.19;
 08.01.22; 19.03.24; 25.01.01; 29.01.13
 (511)
 30 – Waffles; sweetmeats [candy], namely waffle candies, glazed candies with filling between waffle layers.

(260) AM 2018 95189 A
 (800) 1375720
 (151) 2017 07 21
 (891) 2017 07 21
 (731) Joint Stock Company "Krasnyj Ocyabr"

ul. Malaya Krasnoselskaya, d. 7, str. 24
RU-107140 Moscow, Russian Federation

(540)



(591) White, brown, dark brown, orange,
yellow, light yellow, dark yellow, green, light
green, dark red, black and pink

(531) 03.04.02; 03.04.24; 05.05.04; 05.05.20;
08.01.11; 08.01.19; 08.01.22; 08.01.23;
25.01.01; 29.01.14

(511)

30 – Waffles; sweetmeats [candy], namely waffle
candies, glazed candies with filling between waffle
layers.

(260) AM 2018 95253 A

(800) 1375176

(151) 2017 08 24

(891) 2017 08 24

(731) Obshchestvo s ogranichennoy otvetstvennostyu
"REDZHINA"
Perovskiy proezd, d. 35, str. 17, RU-111024
Moscow, Russian Federation

(540)

EREDA

(591) Black, white

(531) 09.01.07; 25.01.25; 27.05.01

(511)

18 – Pocket wallets; credit card cases [wallets];
business card cases; umbrellas; card cases
[notecases]; hat boxes of leather; boxes of leather or
leatherboard; boxes of vulcanised fibre; purses;
travelling sets [leatherware]; briefcases; haversacks;
leather straps; rucksacks; travelling bags; bags;
suitcases.

25 – Bandanas [neckerchiefs]; underwear; berets;
overalls; boas [necklets]; boxer shorts; breeches for
wear; trousers; brassieres; veils [clothing];
gabardines [clothing]; neckties; leggings [leg
warmers]; gaiters; jerseys [clothing]; vests; sports
jerseys; hosiery; hoods [clothing]; neck scarfs
[mufflers]; kimonos; tights; combinations [clothing];
suits; jackets [clothing]; leggings [trousers]; short-
sleeve shirts; mantillas; coats; furs [clothing];
mittens; muffs [clothing]; fur stoles; socks; clothing;
overcoats; panties; parkas; pelerines; gloves
[clothing]; pajamas (Am.); scarfs; pocket squares;

dresses; headbands [clothing]; garters; ready-made
linings [parts of clothing]; braces for clothing
[suspenders]; ponchos; girdles; money belts
[clothing]; belts [clothing]; jumper dresses; saris;
sarongs; sweaters; togas; knitwear [clothing];
underpants; headgear for wear; aprons [clothing];
tee-shirts; dressing gowns; stockings; caps
[headwear]; sashes for wear; hats; pelisses; skirts.

35 – Import-export agency services; rental of
advertising space; demonstration of goods;
commercial information and advice for consumers
[consumer advice shop]; organization of exhibitions
for commercial or advertising purposes; organization
of fashion shows for promotional purposes;
organization of trade fairs for commercial or
advertising purposes; shop window dressing;
providing business information via a web site;
provision of an on-line marketplace for buyers and
sellers of goods and services; presentation of goods
on communication media, for retail purposes; sales
promotion for others; distribution of samples; on-
line advertising on a computer network; modelling
for advertising or sales promotion; procurement
services for others [purchasing goods and services
for other businesses].

(260) AM 2018 95268 A

(800) 1375854

(151) 2016 12 22

(891) 2016 12 22

(731) mobile.de GmbH

Marktplatz 1 14532 Europarc Dreilinden,
Germany

(540)

MOTOR AGENT

(591) Black and white

(531) 26.05.01; 26.05.22; 26.05.24; 27.05.17;
27.05.24

(511)

9 – Recorded content; databases (electronic); com-
puter database servers; computer databases; directo-
ries recorded on computer media; computer digital
maps; recorded media content [magnetic and electro-
nic]; electronic publications recorded on computer
media; instruction manuals and training manuals in
electronic format; downloadable image files; electro-
nic publications, downloadable; audio visual recor-
dings; computer software; computer programs com-
puter software downloaded from the internet; inter-
faces for computers; computer programs for acces-
sing and using the internet; computer programmes
for use in telecommunications; software for docu-
ment management, for data processing and for da-
tabase management; computer e-commerce softwa-
re; computer software for accessing information
directories that may be downloaded from the global

computer network; computer software for processing market information; computer software to enable the searching of data; search engine software; computer software relating to the handling of financial transactions, computer programmes relating to financial matters and financial management software; computer software for creating searchable databases of information and data; software for enterprise resource planning, inventory management and inventory monitoring; software for managing customer data; content management system software; games software; computer operating systems; electronic blackboards; process controlling software; software for facilitating secure credit card transactions; education software; software applications for portable communications apparatus; web-based applications downloadable to a portable communications apparatus or a computer; computer software and applications for portable communications apparatus and computers for creating, editing, publishing, viewing, searching and saving classified advertisements, in particular for an online vehicle market for the purchase and sale of new and used vehicles, vehicle trailers, motorcycles, building and agricultural machines, containers, boats and other water vehicles, and parts and fittings for vehicles, motorcycles, building and agricultural machines, boats and water vehicles; computer software and applications for portable communications apparatus and computers for creating, editing, publishing, viewing, searching and arranging of automotive vehicle services and of repair services for vehicles, vehicle trailers, motorcycles, building and agricultural machines, containers, boats and other water vehicles; computer software and applications for portable communications apparatus and for computers for publishing, providing, viewing of and searching for news, information, images, videos, surveys and blogs; computer software and applications for portable communications apparatus and for computers for access to and publishing, creating, editing and commenting of and searching for reports in internet forums; computer software and applications for portable communications apparatus and for computers for recording, processing, displaying of and the report on accidents, in particular traffic accidents; computer software and applications for portable communications apparatus and for computers for working on and evaluation of surveys and market studies; insurance comparison software; software for comparing of funds, in particular loans; information technology and audiovisual equipment; communications equipment; computer networking and data communications equipment; apparatus for the transmission of data; point-to-point communications equipment; broadcasting equipment; antennas and aerials as communications apparatus; data storage devices; pre-recorded compact discs, DVDs, HD DVDs, UHD discs and other optical data storage discs; USB flash drives; magnetic data media; rep-

licating apparatus; photocopiers; image scanners; printers; data processing equipment and accessories (electrical and mechanical); electronic agendas; calculators; ticket dispensers; payment terminals, money dispensing and sorting devices; coin-operated mechanisms; peripherals adapted for use with computers; mouse pads; computers and computer hardware; file servers; electronic mail servers; computer components and parts; flash memory card; pocket calculators; visual and photographic devices; radio tuners; car radios; car audio apparatus; display devices, television receivers and film and video devices; image capturing and developing devices; signal cables for IT, AV and telecommunication; magnets, magnetizers and demagnetizers; Cathodic anti-corrosion apparatus, electrolyzers, ionization apparatus not for the treatment of air or water, ozonisers [ozonators]; apparatus, instruments and cables for electricity; apparatus and instruments for accumulating and storing electricity; Batteries for lighting; apparatus and instruments for controlling electricity; photovoltaics; electric and electronic components; electric cables and wires, in particular starter cables for motors and jump leads; electrical circuits and circuit boards; antennas and aerials as components; optical devices, enhancers and correctors; optical enhancers; lasers; optical goods; corrective eyewear; sunglasses; spectacle cases; safety, security, protection and signalling devices; alarms and warning equipment; access control systems; signalling apparatus; vehicle breakdown warning triangles; head guards and eye protection devices; fire extinguishers; fire extinguishers; clothing for protection against accidents; alarm and warning equipment, namely alarms and alarm systems; signalling apparatus, namely vehicle breakdown warning triangles, warning lights for vehicles; protection and safety equipment, namely fire blankets; diving equipment; navigation, guidance, tracking, targeting and map making devices; navigation apparatus for vehicles; measuring, detecting and monitoring instruments, indicators and controllers; electric monitoring apparatus; sensors and detectors; testing and quality control devices; counting, alignment and calibrating instruments; computerized vehicle engine analyzers; diagnostic apparatus, not for medical purposes; controllers (regulators); scientific research and laboratory apparatus, educational apparatus and simulators; vehicle drive training simulators; parts, and fittings for all the aforesaid goods, included in the class.

12 – Vehicles and conveyances; wheeled vehicles; land vehicles and conveyances; road vehicles [for transportation]; automotive vehicles; motorcycles; cars; drone; electric vehicles; unmanned vehicles; trailers [vehicles]; camper vans; camper vans; pedicabs; pedicabs; bicycles; bicycle trailers (riyakah); driverless cars; go-carts; golf cars [vehicles]; child carrying trailers; prams; horse-drawn carriages; mo-

tor homes; caravans; air and space vehicles; water vehicles; parts and fittings for vehicles; parts and fittings for all the aforesaid goods, included in the class.

16 – Works of art and figurines of paper and cardboard, and architects' models; decoration and art materials and media; arts, crafts and modelling equipment; filtering materials of paper; bags and articles for packaging, wrapping and storage of paper, cardboard or plastics; stationery and educational supplies; office requisites, except furniture; writing and stamping implements; correcting and erasing implements; office machines [office requisites]; printing and bookbinding equipment [office requisites]; teaching materials [except apparatus]; photo albums and collectors' albums; glue for stationery or household use; printed matter; transfers [decalcomanias]; tear-off calendars; advent calendars; stickers [stationery], in particular vehicle bumper stickers; newspapers; periodicals; photographs [printed]; books; booklets; brochures; guide books; guide books; computer software operating manuals; forms, printed; paper and cardboard; money holders; disposable paper products; flags of paper; paper pennants; parts and fittings for all the aforesaid goods, included in the class.

25 – Headgear; hats; clothing; motorists' clothing; gloves [clothing]; rainwear; scarfs; neck scarfs [mufflers]; neckties; ascots; ear muffs [clothing]; Tee-shirts; sports jerseys; footwear; parts and fittings for all the aforesaid goods, included in the class.

28 – Sporting articles and equipment; sportballs; frisbee; festive decorations for christmas trees and artificial Christmas trees; fairground and playground apparatus; toys, games, playthings and party favors; racing car games; parlor games; dominoes; board games; playing cards; chess games; puzzles; balls for games; radio-controlled toy vehicles; scale model vehicles; toy model hobby craft kits; toy vehicles; toys adapted for educational purposes, in particular electronic games for the teaching of children; spools for throwing, incorporating coiled string which unwinds and rewinds returning the spool to the hand; kites; play balloons; plush toys; video game apparatus, namely handheld computer games; hand held units for playing video games; parts and fittings for all the aforesaid goods, included in the class.

35 – Advertising, marketing and promotional services; updating of advertising information on a computer data base; database marketing; preparing audio-visual presentations for use in advertising; production of video recordings for advertising purposes; production of corporate videos; banner advertising; arranging and placing of advertisements for others; production of advertising material; advertising services provided via the internet; classified advertising, also through portals and platforms on the inter-

net, in particular for the purchase and sale of new and used vehicles, vehicle trailers, motorcycles, building and agricultural machines, containers, boats and other water vehicles and parts and fittings for vehicles, motorcycles, building and agricultural machines, boats and water vehicles; classified advertising, also through portals and platforms on the internet, in particular for automotive vehicle services and for repair services for vehicles, vehicle trailers, motorcycles, building and agricultural machines, containers, boats and other water vehicles; search engine marketing services; web site traffic optimisation; search engine optimisation; pay per click advertising; advertisements (placing of -); collecting and compilation of directories of goods, services, addresses and branches of trade and the information contained therein; advertising services relating to the sale and purchase of vehicles, vehicle trailers, motorcycles, building and agricultural machines, containers, boats and other water vehicles and parts and fittings for vehicles, motorcycles, building and agricultural machines, boats and water vehicles; advertising services relating to automotive vehicle services and repair services for vehicles, vehicle trailers, motorcycles, building and agricultural machines, containers, boats and other water vehicles; public relations services; product demonstration and product display services; display services for merchandise; presentation of services and sales demonstration [for others]; demonstration of goods and services by electronic means, also for the benefit of the so-called teleshopping and homeshopping services; presentations of companies as well as goods and services on the internet and other analog and digital media [for others]; arranging and conducting trade shows; arranging and conducting of exhibitions for commercial or advertising purposes; conducting, arranging and organisation of events, exhibitions, fairs and shows for commercial, promotional and advertising purposes; loyalty, incentive and bonus program services; provision of advertising space, advertising time and advertising media, in particular for classified advertising on global computer and wireless networks; provision of computerised advertising services; provision of space on web-sites for advertising goods and services; distribution of advertising, marketing and promotional material; direct mail advertising; dissemination of advertisements and commercial announcements, in particular for others via internet and portable communications apparatus; advertising, marketing and promotional consultancy, advisory and assistance services; press advertising consultancy; marketing assistance; commercial trading and consumer information services, namely mediation of trade business for third parties, mediation of agreements regarding the sale and purchase of goods, bidding quotation, price comparison services; consumer consultancy in relation to the selection of goods and services, in particular using test and researching re-

sults and ratings by third parties; auctioneering services, in particular on the internet; rental of vending machines; business contact services; collective buying services; commercial evaluation services; competition arrangements for advertising and commercial purposes; distributorship services; import and export services; ordering services; procurement services for others; subscription services; business intermediary and advisory services in the field of selling products and rendering services; advice and information to consumers regarding after-sales service, user reviews, experience reports, tests, product details, product management and prices of websites for online shopping and online offers; advisory services relating to the purchase of goods; advisory services relating to the purchase of goods on behalf of business; computerised data analysis, data processing, user characteristics analysis, user behavior analysis for consultancy relating to the purchase of goods; online and mail order retail services relating to new and used land and water vehicles, vehicle trailers, motorcycles, vehicle and motorcycle parts, clothing, leather goods, bags, printed matter, pictures, DVDs; negotiation, conclusion and administrative handling of commercial transactions for third parties; provision of business information and relating news in the field of vehicles, the vehicle market, the automotive sector and industry, in particular via internet portals; business assistance, management and administrative services; preparation of audio and/or visual displays for businesses; market reporting services; help in the management of business affairs or commercial functions of an industrial or commercial enterprise; accountancy, book keeping and auditing; financial statement preparation and analysis for businesses; computerised accounting; computerised accounting; computerised auditing; computerised accounting; computerised accounting; computerised accounting; computerised auditing; computerised accounting; provision of reports relating to accounting information; drawing up of statements of accounts; preparation of accounts; accounting; business accounts management; administrative data processing; computerized file management; computerised business information processing services; information services relating to data processing; automated data processing; consultancy relating to data processing; computerized file management; computerized file management; database management, in particular computerized; data processing; data search in computer files for others; on-line data processing services; processing of business survey results; human resources management and recruitment services; industrial management consultation including cost/yield analyses; business advisory and information services; computerised business management [for others]; computerised office management; preparation of documents relating to business; company record keeping [for others]; operation of

businesses [for others]; outsourcing services [business assistance]; administration of business affairs; clerical services; secretarial services; business consultancy and advisory services, in particular in relation to the automotive industry; acquisitions (advice relating to -); business management consulting with relation to strategy, marketing, production, personnel and public relations; establishing a network of business contacts (service to assist in -); arranging of business introductions; professional business consulting; organisational project planning and organisational project management for advertising and presentation of companies on the Internet, on portable communications apparatus and all other kinds of electronic media; rental of office machines; addressing of envelopes; copying services; document preparation; invoicing; business analysis, research and information services; opinion polling; market information services relating to market statistics and sales of market statistics; provision of on-line business and commercial information; information and expert opinions relating to companies and business; provision of statistical information relating to business; analysis of business statistics; benchmarking services for business management purposes; conducting of business appraisals; provision of business information via website; provision of trade-related and commercial information and news in relation to products and services, in particular via an Internet portal; business surveys; provision of computerised business statistics; provision of sales analyses; cost price analysis; provision of user statistics, in particular for advertisements on the internet; provision of analyses of relevance and consequences of advertising; market research; price analysis services; collection and systematization of business data; acquisition of business information relating to company activities; provision of business data; compilation and systematization of information into computer databases; data compilation and data management for others; compilation of statistics; compilation of mailing lists; compilation of directories for publishing on global computer networks or the internet; business information services provided on-line from a computer database or the internet; business statistical information services; economic analysis for business purposes; business analysis services; and rental, hire and leasing in connection with the aforesaid, included in the class; and advice, consultancy and information for the aforesaid, included in the class.

36 – Insurance services; consulting and information concerning insurance; brokerage advisory services relating to insurance; insurance premium rate computing; computerised information services relating to insurance; computerised comparison of insurances, insurance cover and insurance premium rates; provision of insurance premium quotations; insurance and insurance policy brokerage, especially via the internet or portable communication apparatus; insu-

rance brokerage; insurance underwriting and appraisals and assessment for insurance purposes; warranty services; real estate services; rent collection; pawn-brokerage; issuance of prepaid cards and tokens of value; safe deposit services; financial and monetary services, and banking; comparison of finance services, in particular credits, hire-purchase contracts, trade-ins and other finance and funding services; banking and financing services; trusteeship representatives; brokerage of finance services; arranging the provision of finance, credit and finance services; currency trading and exchange services; securities and commodities trading services; loan and credit, and lease-finance services; lease-purchase financing; financing and lease-purchase financing relating to automobiles; debt recovery and factoring services; financial investment; fund investments; financial underwriting and securities issuance (investment banking); financial transfers and transactions, and payment services; cash, check (cheque) and money order services; tax and duty payment services; financial information, data, advice and consultancy services; computerised financial advisory services; financial data base services; financial rating and credit reports; financial appraisal services; fundraising and sponsorship; valuation and financial appraisal services; valuation of vehicles, trailers and motorcycles, building and agricultural machines, containers boats and other water vehicles; and rental, hire and leasing in connection with the aforesaid, included in the class; and advice, consultancy and information for the aforesaid, included in the class.

37 – Building, construction and demolition; ship-building; rental of tools, plant and equipment for construction and demolition; extraction of natural resources; installation, cleaning, repair and maintenance services relating to vehicles and means of transport, in particular motor vehicles, motorcycles, air and spacecraft and water vehicles as well as parts thereof; advisory services relating to the repair, claining, the care and maintenance of motor vehicles, motorcycles, air and spacecraft and water vehicles as well as the repair, cleaning, the care and maintenance of parts thereof; advisory services relating to vehicle maintenance; vehicle repair consultancy; providing information relating to the repair, care or maintenance of motor vehicles, motorcycles, air and space vehicles and water vehicles; providing information relating to the repair of bicycles; providing information relating to the repair or maintenance of railway rolling stock; providing information relating to the rental of car washing apparatus; gasoline refuelling service for motor vehicles; natural gas refuelling service for motor vehicles; service stations for the maintenance of vehicles; service stations for the repair of vehicles; service stations (petrol stations); inspection of automobiles and their parts prior to maintenance and repair; installation of vehicle security devices; mobile vehicle tuning services; vehicle

maintenance; roadside repair of automobiles; arranging of vehicle repairs; maintenance and repair of electric vehicles; repair of trailers; repair services for fork lift trucks; repair of tailboard lifts; rental of vehicle maintenance equipment; vehicle tuning; arranging for the repair of motor land vehicles; arranging for the maintenance of motor land vehicles; arranging for the replacement vehicle windscreens; providing information relating to cleaning, care and maintenance of motor vehicles, motorcycles, air and space vehicles, water vehicles, and relating to repair, cleaning, care and maintenance of parts thereof; alarm, lock and safe installation, maintenance and repair, computer hardware and telecommunication apparatus installation, maintenance and repair; HVAC (heating, ventilation and air conditioning) installation, maintenance and repair, tyre maintenance and repair; rental of cleaning and washing machines and equipment; vehicle service, repair, maintenance and refuelling; glazing, installation, maintenance and repair of glass, windows and blinds; cleaning and care of fabric, textile, leather, fur and goods made thereof; extermination, disinfection and pest control; and rental, hire and leasing in connection with the aforesaid, included in the class; and advice, consultancy and information for the aforesaid, included in the class.

38 – Telecommunication services, in particular computer communication and internet access services; telecommunication services via internet portals; providing access to content, websites and internet portals for the purchase and sale of vehicles, vehicle trailers, motorcycles, building and agricultural machines, containers, boats and other water vehicles and parts and fittings for vehicles, motorcycles, building and agricultural machines, boats and water vehicles; providing access to portals for the purchase and sale of vehicles, vehicle trailers, motorcycles, building and agricultural machines, containers, boats and other water vehicles and parts and fittings for vehicles, motorcycles, building and agricultural machines, boats and water vehicles via portable communications apparatus; providing access to information on the internet about the purchase and sale of vehicles, vehicle trailers, motorcycles, building and agricultural machines, containers, boats and other water vehicles and parts and fittings for vehicles, motorcycles, building and agricultural machines, boats and water vehicles; providing access to contents, websites and internet portals, in particular relating to automotive, motor vehicles, motor vehicle industry, car market, technology, sport and motorised means of transportation; providing of telecommunication services for e-commerce platforms on the internet; providing user access to computer programmes in data networks; providing access to databases on the internet via telecommunication, in particular providing access to online databases for placing goods and services with interactive access

and possibility of immediate ordering; audiovisual and digital communications services; providing access to databases and IT systems; electronic data exchanges services; electronic bulletin board services [telecommunications services]; worldwide computer network access services; providing access to database for the access via internet or via portable communications apparatus; providing telecommunication connections to a global computer network; providing telecommunication connections to databases; providing an electronic mailbox; providing internet chat rooms and online forums; electronic communication by means of chatrooms, chat lines and Internet forums; providing on-line chatrooms and electronic bulletin boards for transmission of messages amongst users; providing online chatrooms for the transmission of messages, comments and multimedia content among users; communication by online blogs; providing internet weblogs; computerised communication services and data transmission; providing access to databases; arranging access to databases on the internet; internet service provider services; electronic transmission of data; electronic transmission of computer programs via the internet; internet based telecommunication services; telecommunication gateway services; information transmission services via digital networks; transmission of information on-line; transmission of messages and images; streaming of audio and video material on the internet; distribution of data or audio visual images via a global computer network or the internet; providing of access to telecommunication warehousing services; electronic mail services; message sending, receiving and forwarding; forwarding all types of messages to internet addresses [web messaging] and to portable communications apparatus; transmission of messages and images; transmission of information by data communications for assisting decision making; news agencies; transmission of database information via telecommunications networks; broadcasting services; broadcasting of programmes via the internet; telephone and smartphone services, namely text messaging services and transmission of information via smartphone; provision and rental of telecommunications facilities and equipment; providing third party users with access to telecommunication infrastructure; rental of access time to a database server; and rental, hire and leasing in connection with the aforesaid, included in the class; and advice, consultancy and information for the aforesaid, included in the class.

41 – Publishing and reporting; provision of electronic publishing and online electronic publications, in particular relating to automotive, vehicles, automotive industry, car market, technology, sport and motorized means of transportation; publication of material which can be accessed from databases or from the internet; providing publications from a global computer network or the internet which may be

browsed; electronic desktop publishing; publication of electronic books and journals on-line; publication and edition of the editorial content of websites accessible via a global computer network; publication and edition of books, magazines and newspapers; publication and edition of electronic publishing products; writing and publishing of texts, other than publicity texts; education, entertainment and sports; sporting and cultural activities; providing a computer game that may be accessed by users in a global computer or telecommunication network and/or the internet; electronic library services for the supply of electronic information (including archive information) in the form of text, audio and/or video information; audiovisual display presentation services for entertainment purposes; provision of on-line entertainment; organization and provision of conferences, seminars, workshops, exhibitions and competitions; organization, administration, provision and events of user and community meeting; gambling; electronic game services provided by means of the internet; photographic reporting and production of documentaries; production of radio and television programmes; audio and video production, and photography; sports and fitness; library services; education and instruction; provision of online information and news relating to vehicles, vehicle trailers, motorcycles, building and agricultural machines, containers, boats and other water vehicles and parts and fittings for vehicles, motorcycles, building and agricultural machines, boats and water vehicles for cultural, educational and entertainment purposes; provision of online information, news, blogs and reports relating to automotive, motor vehicles, motor vehicle industry, motor vehicle market, motor vehicle economy, technology, sport and motorised means of transportation; writing services for blogs; mobile and online library services (including archive library services) with respect to information provided in text, audio and/or video format, particularly regarding supply and demand for goods and services; providing newsletters in the field of automotive, motor-vehicle, motor vehicle industry, motor vehicle market, motor vehicle economy, technology, sport and motorised means of transportation via e-mail; providing on-line videos, not downloadable; coaching; providing computer assisted courses of instruction, computer education training and further education and instructional training; driving instruction; driver safety training; translation and interpretation; and rental, hire and leasing in connection with the aforesaid, included in the class; and advice, consultancy and information for the aforesaid, included in the class.

42 – IT services, namely software development, programming and implementation; programming of software for Internet portals, chatrooms, chat lines and Internet forums; providing temporary use of non-downloadable computer software for use in the creation and publication of on-line journals and

blogs; creation and maintenance of software for blogs; updating and adapting of computer programs according to user requirements; data mining; technical data analysis services; computer services for the analysis of data, in particular relating to purchase intention and purchase decision of consumers and companies; consultancy with regard to webpage design; advisory services relating to the use of computer software; providing computer software from a global computer network [non-downloadable]; provision of on-line support services for computer program users; design, conception, creation, hosting, administration and maintenance of websites for others; maintenance of data bases; design and development of web applications for portable communications apparatus (included in this class); drafting, development, design, administration and hosting of computer software and applications for portable communications apparatus and for computer to create, edit, publish, view, search and save classified advertising, in particular for a vehicle online marketplace for the purchase and sale of new and used vehicles, vehicle trailers, motorcycles, building and agricultural machines, containers, boats and other water vehicles and parts and fittings for vehicles, motorcycles, building and agricultural machines, boats and water vehicles; drafting, development, design, administration and hosting of computer software and applications for portable communications apparatus and for computer to publish, provide, view and search for news, information, pictures, videos, surveys and blogs; drafting, development, design, administration and hosting of computer software and applications for portable communications apparatus and for computer to access, publish, create, edit, comment on and search for contributions in internet forums; drafting, development, design, administration and hosting of computer software and applications for portable communications apparatus and for computer to record, process, display and report on accidents, in particular car accidents; drafting, development, design, administration and hosting of computer software and applications for portable communications apparatus and for computer to conduct and interpret surveys and marketing studies; drafting, development, design, administration and hosting of computer software and applications for portable communications apparatus and for computer to create, edit, publish, view, search and arrange automotive services and repair services relating to vehicles, vehicle trailers, motorcycles, building and agricultural machines, containers, boats and other water vehicles; computer hardware development; hosting services and software as a service and rental of software; cloud computing services and software as a service relating to computer software for enterprise resource planning, inventory management and inventory monitoring; cloud computing services and software as a service relating to computer software

for managing customer data and relating to content management system software; providing an internet platform for the purchase and sale of vehicles, vehicle trailers, motorcycles, building and agricultural machines, containers, boats and other water vehicles and parts and fittings for vehicles, motorcycles, building and agricultural machines, boats and water vehicles; creation and provision of web pages to and for third parties; provision of search engines for the internet and portable communications apparatus and of online searchable and completable data bases, in particular for the search for and the placement of classified advertisements for the purchase and sale of vehicles, vehicle trailers, motorcycles, building and agricultural machines, containers, boats and other water vehicles and parts and fittings for vehicles, motorcycles, building and agricultural machines, boats and water vehicles; provision of search engines for the internet and portable communications apparatus and of online searchable and completable data bases, in particular relating to the issues automotive, motor vehicle, motor vehicle industry, motor vehicle market, motor vehicle economy, technology, sport and motorised means of transportation; cloud computing; data warehousing; application service provider [ASP], namely, hosting computer software applications of others; off-site data backup; hosting of digital content on the internet; server hosting; providing back-up computer programs and facilities; rental of computer hardware and facilities; rental of a database server (to third parties); IT consultancy, advisory and information services; consultancy services for data processing; IT security services in the nature of protection and recovery of computer data; data recovery services; data duplication and conversion services, data coding services; cross-platform conversion of digital content into other forms of digital content; computer analysis and diagnostics; IT services, namely research and development, and implementation of computers and computer systems; computer project management services; data-mining operations; digital watermarking; on-line computer services, namely computer development, leasing, engineering, design, programming and rental services; technology services relation to computers; computer network services; updating of computer software for databases; data migration services; updating of websites, for others; monitoring of computer systems by remote access; scientific and technological services; implementation of and report on technical tests; preparation of technological reports by experts; provision of information and news about technique and design of motor vehicles, in particular via an internet portal; testing, authentication and quality control; website usability testing services; inspection of motor vehicles before transport [for roadworthiness]; inspection of motor vehicles [for roadworthiness]; design services; design services for display systems for promo-

tional and presentation purposes; art work design; advisory and information services relating to design matters; and rental, hire and leasing in connection with the aforesaid, included in the class; and advice, consultancy and information for the aforesaid, included in this class.

45 – Safety, rescue, security and enforcement services; accident reporting; personal and social services, namely astrological and spiritual services; detective services; dating agency services; funerary services; religious services; rental of clothing; child protection services; house guarding services; private investigation services; individual shopping services; lost and found bureau services; networking services; personal letter writing; pet-sitting services; political lobbying services; reminder services; escorting in society [chaperoning]; planning and arranging of wedding ceremonies; legal services; licensing of computer software, computer programs and applications for portable communications apparatus; licensing Industrial property rights; licensing of technology; licensing of databases [legal services]; registration of domain names [legal services]; information services relating to consumer rights and other legal affairs; court reporting; legal information and support services; and rental, hire and leasing in connection with the aforesaid, included in the class; and advice, consultancy and information for the aforesaid, included in the class.

(260) AM 2018 95272 A

(800) 1376826

(151) 2017 09 18

(891) 2017 09 18

(731) GRINDEKS, AS

Krustpils iela 53, LV-1057 Rīga, Latvia

(540)

MITIGEL МИТИГЕЛЬ

(591) Black, white

(511)

3 – Perfumery; body care and beauty care preparations; essential oils; non-medicated cosmetics and non-medicated hair care preparations; cosmetic creams and gels.

(260) AM 2018 95274 A

(800) 1376827

(151) 2017 09 18

(891) 2017 09 18

(731) GRINDEKS, AS

Krustpils iela 53, LV-1057 Rīga, Latvia

(540)

DIMESTIL ДИМЕСТИЛ

(591) Black, white

(511)

3 – Perfumery; body care and beauty care preparations; essential oils; non-medicated cosmetics and non-medicated hair care preparations; cosmetic creams and gels.

(260) AM 2018 95330 A

(800) 1376625

(151) 2017 10 06

(891) 2017 10 06

(731) Apple Inc.

1 Infinite Loop, Cupertino CA 95014, USA

(540)

APPLE PODCASTS

(591) Black, white

(511)

9 – Computer software; computer software for use in reviewing, storing, organizing and playing audio and video content.

(260) AM 2018 95331 A

(800) 1376656

(151) 2017 07 27

(891) 2017 07 27

(731) Soko Štark d.o.o.

Beograd Bulevar Peka Dapčevića 29 11000

Beograd, Serbia

(540)



(591) Magenta, blue, green, white and brown.

(531) 08.01.19; 19.03.03; 27.05.02; 27.05.17; 29.01.15

(511)

30 – Chocolate-coated wafers.

(260) AM 2018 95368 A

(800) 1376657

(151) 2017 07 25

(891) 2017 07 25

(731) Soko Štark d.o.o.

Beograd Bulevar Peka Dapčevića 29,11000
Beograd, Serbia

(540)



(591) Red, green, black, white, yellow and brown.

(531) 03.02.13; 05.01.12; 08.01.19; 27.05.02;
27.05.24; 29.01.15

(511)

30 – Chocolate dessert coated with milk chocolate.

(260) AM 2018 95371 A

(800) 1376760

(151) 2017 06 16

(891) 2017 06 16

(731) Obshchestvo s ogranichennoy
otvetstvennostyu «Estro»
ul. M. Bronnaja, d. 24, str. 1, RU-123001
Moscow, Russian Federation

(540)

NO ONE

(591) Light gray, white.

(531) 27.05.17

(511)

18 – Animal skins; trunks and travelling bags; umbrellas, parasols and walking sticks; whips, harness and saddlery; leather and imitations of leather.

25 – Boots; shoes; caps [headwear]; scarfs; headgear for wear; sashes for wear; hats; outerclothing; dresses; suits; neckties; gloves [clothing]; hosiery; stockings; underwear; clothing of leather; clothing of leather or imitations of leather.

35 – Import-export agency services; business intermediary in the field of selling products; retail and wholesale services.

(260) AM 2018 95372 A

(800) 1376773

(151) 2017 09 13

(891) 2017 09 13

(731) Chengdu Kanghong Pharmaceuticals Group
Co., Ltd
No.36, Shuxi Rd., Jinniu District, Chengdu
Sichuan, China

(540)

KHPG

(591) Black, white

(531) 27.05.01; 27.05.17

(511)

5 – Medicines for human purposes; pharmaceutical preparations; crude drugs; Chinese patent medicine; biochemical medicines; radioactive medicines; gases for medical purposes; disinfectants; solutions for contact lenses; dietetic substances adapted for medical use; food for babies; depuratives; pesticides; medicines for veterinary purposes; disinfectant wipes; dressings, medical; teeth filling materials.

(260) AM 2018 95373 A

(800) 1376778

(151) 2017 09 15

(891) 2017 09 15

(731) Morozov Victor Alexandrovich
Kosmonavtov avenue, 5, block G, apt 40
RU-344092 Rostov-on-Don, Russian
Federation

(540)



(591) White, red and dark yellow.

(531) 05.07.02; 26.01.02; 26.01.16; 26.01.20;
26.01.24; 27.05.24; 29.01.13

(511)

30 – Coffee, tea, cocoa and artificial coffee; rice; tapioca and sago; flour and preparations made from cereals; bread, pastries and confectionery; ice cream; sugar, honey, treacle; yeast, baking-powder; salt; mustard; vinegar, sauces [condiments]; spices; flavorings, other than essential oils, for cakes; flavorings, other than essential oils, for beverages; coffee flavorings; food flavorings, other than essential oils; star aniseed; baozi [stuffed buns]; cereal bars; high-protein cereal bars; pancakes; noodle-based prepared meals; freeze-dried dishes with main ingredient being pasta; freeze-dried dishes with main ingredient being rice; buns; bread rolls;

edible rice paper; edible paper; burritos; vanillin [vanilla substitute]; vareniks [stuffed dumplings]; waffles; vermicelli [noodles]; natural sweeteners; sausage binding materials; binding agents for ice cream; sea water for cooking; seaweed [condiment]; malt biscuits; cloves [spice]; mirror icing [mirror glaze]; cake frosting [icing]; glucose for culinary purposes; gluten additives for culinary purposes; yeast; thickening agents for cooking foodstuffs; leaven; rice-based snack food; cereal-based snack food; artificial coffee; vegetal preparations for use as coffee substitutes; dressings for salad; fruit jellies [confectionery]; candy decorations for cakes; confectionery for decorating Christmas trees; cakes; pastries; peanut confectionery; almond confectionery; pasta; ginger [spice]; frozen yogurt [confectionery ices]; cocoa; capers; caramels [candy]; curry [spice]; ketchup [sauce]; gimbap [Korean rice dish]; quiches; gluten prepared as foodstuff; flour-based dumplings; sweetmeats [candy]; liquorice [confectionery]; peppermint sweets; dulce de leche; cinnamon [spice]; coffee; unroasted coffee; starch for food; crackers; custard; hominy grits; semolina; oatmeal; crushed barley; groats for human food; ice cubes; corn, milled; corn, roasted; meat pies; turmeric; couscous [semolina]; noodles; ice for refreshment; ice, natural or artificial; edible ices; candy; rice cakes; mayonnaise; macarons [pastry]; macaroni; maltose; hominy; piccalilli; marinades; marzipan; honey; royal jelly; bean meal; tapioca flour; potato flour; corn flour; nut flours; flour; wheat flour; soya flour; barley meal; dessert mousses [confectionery]; chocolate mousses; muesli; mint for confectionery; cocoa beverages with milk; coffee beverages with milk; coffee-based beverages; cocoa-based beverages; chamomile-based beverages; tea-based beverages; chocolate beverages with milk; chocolate-based beverages; infusions, not medicinal; crushed oats; husked oats; okonomiyaki [Japanese savory pancakes]; onigiri [rice balls]; nutmegs; chocolate-coated nuts; stick liquorice [confectionery]; pastilles [confectionery]; molasses for food; pâtés en croûte; pelmeni [dumplings stuffed with meat]; pepper; allspice; peppers [seasonings]; pesto [sauce]; cookies; petit-beurre biscuits; bibimbap [rice mixed with vegetables and beef]; pies; pizzas; meat gravies; fondants [confectionery]; popcorn; powders for making ice cream; baking powder; mustard meal; pralines; aromatic preparations for food; condiments; meat tenderizers for household purposes; cereal preparations; oat-based food; propolis; gingerbread; petits fours [cakes]; rice pudding; puddings; cake powder; fruit coulis [sauces]; ravioli; ramen [Japanese noodle-based dish]; chewing gum; relish [condiment]; instant rice; wheat germ for human consumption; spring rolls; sago; palm sugar; sugar; sesame seeds [seasonings]; linseed for culinary purposes [seasoning]; processed

seeds for use as a seasoning; aniseed; agave syrup [natural sweetener]; confectionery; batter mixes for okonomiyaki [Japanese savory pancakes]; baking soda [bicarbonate of soda for cooking purposes]; malt for human consumption; salt for preserving foodstuffs; cooking salt; celery salt; sherbets [ices]; ham glaze; soya sauce; tomato sauce; sauces [condiments]; pasta sauce; spaghetti; seasonings; chocolate-based spreads; chocolate spreads containing nuts; preparations for stiffening whipped cream; rusks; breadcrumbs; sushi; sandwiches; tabbouleh; tacos; tapioca; tarts; dough; pastry dough; almond paste; rice pulp for culinary purposes; cake dough; garden herbs, preserved [seasonings]; chocolate decorations for cakes; vinegar; beer vinegar; ferments for pastes; halvah; bread; unleavened bread; chips [cereal products]; corn flakes; oat flakes; hot dog sandwiches; jiaozi [stuffed dumplings]; chicory [coffee substitute]; tea; iced tea; chutneys [condiments]; minced garlic [condiment]; cheeseburgers [sandwiches]; chow-chow [condiment]; saffron [seasoning]; chocolate; malt extract for food; essences for foodstuffs, except etheric essences and essential oils; husked barley; vanilla flavorings for culinary purposes; cream of tartar for culinary purposes; soya bean paste [condiment]; golden syrup; tortillas; flowers or leaves for use as tea substitutes.

35 – Advertising; business management; business administration; office functions; import-export agency services; commercial information agency services; advertising agency services; cost price analysis; rental of advertising space; business auditing; business intermediary services relating to the matching of potential private investors with entrepreneurs needing funding; employment agency services; computerized file management; book-keeping; invoicing; demonstration of goods; transcription of communications [office functions]; opinion polling; market studies; business information; commercial information and advice for consumers [consumer advice shop]; business investigations; business research; marketing research; personnel recruitment; business management and organization consultancy; business organization consultancy; consultancy regarding public relations communications strategy; business management consultancy; personnel management consultancy; professional business consultancy; consultancy regarding advertising communications strategy; layout services for advertising purposes; marketing; business management of performing artists; business management of sports people; writing of résumés for others; scriptwriting for advertising purposes; news clipping services; updating and maintenance of information in registries; updating and maintenance of data in computer databases; updating of advertising material; word processing; organization of exhibitions for commercial or advertising purposes;

arranging newspaper subscriptions for others; organization of fashion shows for promotional purposes; organization of trade fairs for commercial or advertising purposes; shop window dressing; design of advertising materials; business appraisals; payroll preparation; data search in computer files for others; sponsorship search; business management assistance; commercial or industrial management assistance; commercial intermediation services; providing business information via a web site; provision of commercial and business contact information; provision of an on-line marketplace for buyers and sellers of goods and services; web indexing for commercial or advertising purposes; economic forecasting; auctioneering; retail or wholesale services for pharmaceutical, veterinary and sanitary preparations and medical supplies; sales promotion for others; production of teleshopping programmes; production of advertising films; office machines and equipment rental; rental of advertising time on communication media; publicity material rental; rental of billboards [advertising boards]; rental of vending machines; rental of photocopying machines; publication of publicity texts; radio advertising; distribution of samples; dissemination of advertising matter; direct mail advertising; registration of written communications and data; writing of publicity texts; on-line advertising on a computer network; advertising by mail order; television advertising; document reproduction; compilation of statistics; compilation of information into computer databases; business inquiries; systemization of information into computer databases; advisory services for business management; negotiation of business contracts for others; negotiation and conclusion of commercial transactions for third parties; compiling indexes of information for commercial or advertising purposes; tax preparation; drawing up of statements of accounts; telemarketing services; psychological testing for the selection of personnel; business management of hotels; business project management services for construction projects; commercial administration of the licensing of the goods and services of others; business management of reimbursement programs for others; administration of consumer loyalty programs; administration of frequent flyer programs; administrative processing of purchase orders; public relations; modelling for advertising or sales promotion; typing; appointment reminder services [office functions]; relocation services for businesses; tax filing services; search engine optimization for sales promotion; appointment scheduling services [office functions]; price comparison services; secretarial services; procurement services for others [purchasing goods and services for other businesses]; shorthand; outsourcing services [business assistance]; telephone answering for unavailable subscribers; photocopying services; business efficiency expert services; arran-

ging subscriptions to telecommunication services for others; presentation of goods on communication media, for retail purposes; rental of sales stands; billposting; outsourced administrative management for companies; business management for freelance service providers; web site traffic optimization; pay per click advertising.

(260) AM 2018 95374 A

(800) 1377635

(151) 2017 07 31

(891) 2017 07 31

(731) Otkrytoe aktsionernoe obshchestvo
"Oktyabrskiy zavod suhogo obezhzhennogo
moloka"
ul. Karla Marksa d.30, g.p. Oktyabrskiy
247319 Gomelskaya oblast, Belarus

(540)



(591) White, black, orange and green.

(531) 01.03.01; 03.04.02; 05.01.16; 05.05.20;
06.19.01; 26.02.09; 28.05; 29.01.14

(526) "1973"

(511)

29 – Fatty substances for the manufacture of edible fats; suet for food; edible fats; milk substitutes; yogurt; kephir [milk beverage]; milk shakes; buttercream; margarine; oils for food; butter; milk; albumin milk; condensed milk; powdered milk; milk beverages, milk predominating; milk products; curd; ryazhenka [fermented baked milk]; cream [dairy products]; whipped cream; smetana [sour cream]; whey; cheese; cottage cheese; rennet; milk ferments for culinary purposes.

35 – Demonstration of goods; retail and wholesale services, also online, of the goods mentioned in class.

29 above, including retail shop services; sales promotion for others; procurement services for others [purchasing goods and services for other businesses].

(260) AM 2018 95375 A

(800) 1377651

(151) 2017 09 29

(891) 2017 09 29

(731) Apple Inc.

1 Infinite Loop Cupertino CA 95014, USA

(540)

APPLE

(591) Black and white

(511)

9 – Computers; computer hardware; handheld computers; tablet computers; telecommunications apparatus and instruments; telephones; mobile telephones; smartphones; wireless communication devices for the transmission of voice, data, images, audio, video, and multimedia content; network communication apparatus; handheld digital electronic devices capable of providing access to the Internet and for the sending, receiving, and storing telephone calls, electronic mail, and other digital data; wearable computer hardware; wearable digital electronic devices capable of providing access to the Internet, for sending, receiving and storing of telephone calls, electronic mail, and other digital data; smartwatches; wearable activity trackers; electronic book readers; computer software; computer software for setting up, configuring, operating and controlling computers, computer peripherals, mobile devices, mobile telephones, smartwatches, wearable devices, earphones, headphones, set top boxes, audio and video players and recorders, home theatre systems, and entertainment systems; application development software; computer game software; downloadable pre-recorded audio, video and multimedia content; computer peripheral devices; peripheral devices for computers, mobile telephones, mobile electronic devices, wearable electronic devices, smartwatches, earphones, headphones, set top boxes, and audio and video players and recorders; wearable peripherals for use with computers, mobile telephones, mobile electronic devices, smartwatches, earphones, headphones, set top boxes, and audio and video players and recorders; biometric identification and authentication apparatus; accelerometers; altimeters; distance measuring apparatus; distance recording apparatus; pedometers; monitors, display screens, virtual and augmented reality displays and controllers; optical goods; optical apparatus and instruments; cameras; flashes for cameras; keyboards, mice, mouse pads, printers, disk drives, and hard drives; sound recording and reproducing apparatus; digital audio and video players and recorders; audio speakers; audio amplifiers and receivers; voice recording and voice recognition apparatus; earphones; headphones; microphones; set top boxes; radios; radio transmitters and receivers; global positioning systems (GPS devices); navigational instruments; remote controls for controlling computers, mobile telephones, mobile electronic devices, wearable electronic devices, smartwatches, earphones, headphones, audio and video players and recorders, televisions, set top boxes, speakers, amplifiers, home theatre systems, and entertainment

systems; wearable devices for controlling computers, mobile telephones, mobile electronic devices, smart watches, earphones, headphones, audio and video players and recorders, televisions, set top boxes, speakers, amplifiers, home theatre systems, and entertainment systems; data storage apparatus; batteries; battery chargers; electrical and electronic connectors, couplers, wires, cables, chargers, docks, docking stations, and adapters for use with computers, mobile telephones, handheld computers, computer peripherals, mobile telephones, mobile electronic devices, wearable electronic devices, smartwatches, earphones, headphones, audio and video players and recorders, and set top boxes; interactive touchscreens; interfaces for computers, computer screens, mobile telephones, mobile electronic devices, wearable electronic devices, smartwatches, televisions, set top boxes, and audio and video players and recorders; parts and accessories for computers, computer peripherals, mobile telephones, mobile electronic devices, wearable electronic devices, smartwatches, earphones, headphones, audio and video players and recorders, televisions, and set top boxes; covers, bags, cases, sleeves, straps and lanyards for computers, mobile telephones, mobile electronic devices, wearable electronic devices, smartwatches, earphones, headphones, set top boxes, and audio and video players and recorders; electronic agendas; dictating machines; measuring apparatus; remote controls.

(260) AM 2018 95376 A

(800) 1377756

(151) 2017 09 18

(891) 2017 09 18

(731) XingChao Restaurant Management Co., Ltd
2 Floor, No. 75-77, Hang Zhong Road,
Minhang District Shanghai, China

(540)



(591) Red, yellow and black.

(531) 28.03; 29.01.13

(511)

43 – Accommodation bureau services [hotels, boarding houses]; café services; hotel services; restaurant services; bar services; self-service restaurant services; coffee and tea bar services; holiday camp services [lodging]; providing campground facilities; take-away food and drink services.

(260) AM 2018 95417 A

(800) 1377194

(151) 2017 09 18

(891) 2017 09 18
 (731) Yangquan Zhongjia Abrasives Co. Ltd
 Baiquan Economic Zone, Miaoling,
 Xangquan, Shanxi, China

(540)



(591) Black,white
 (531) 14.07.15; 14.07.16; 27.03.15; 27.05.17
 (511)
 8 – Grindstones [hand tools]; abrading instruments [hand tools]; hand tools, hand operated; bits [hand tools]; spanners [hand tools]; pliers; cutting tools [hand tools]; scraping tools [hand tools]; rams [hand tools]; screwdrivers.

(260) AM 2018 95419 A
 (800) 1377317
 (151) 2017 09 18
 (891) 2017 09 18
 (731) ZHEJIANG YIDUN MECHANICAL &
 ELECTRICAL CO., LTD
 Changhong Industrial District, Zeguo Town,
 Wenling City Zhejiang Province, China

(540)



(591) Black,white
 (531) 26.04.09; 26.15.09; 27.05.01
 (511)
 7 – Cutting machines; hand-held tools, other than hand-operated; motors, other than for land vehicles; dynamos; welding machines, electric; washing apparatus.

(260) AM 2018 95420 A
 (800) 1377328
 (151) 2017 08 16
 (891) 2017 08 16
 (731) ETS ERSOY TURISTIK SERVISLERI
 ANONIM SIRKETI
 Bagdat Cd Göksel Is Merk. No:55/3-5-6-8
 Kızıltoprak Kadıkoy ISTANBUL, Turkey

(540)



(591) White, blue, red, orange.
 (531) 27.05.10; 27.05.19; 29.01.13
 (511)
 39 – Transport; packaging and storage of goods; travel arrangement.

41 – Education; providing of training; entertainment; sporting and cultural activities.

43 – Services for providing food and drink; temporary accommodation.

(260) AM 2018 95421 A
 (800) 1377361
 (151) 2017 09 25
 (891) 2017 09 25
 (731) TONG MING ENTERPRISE CO. LTD
 88 Chang Sheng Rd, E.D.Z. Jiaxing 314003
 Zhejiang, China

(540)



(591) Black,white
 (531) 27.05.01; 27.05.17
 (511)
 6 – Building materials of metal; wire of common metal; washers of metal; rings of metal; nails; screws of metal; buckles of common metal [hardware]; nuts of metal; ironmongery; springs [metal hardware].

(260) AM 2018 95422 A
 (800) 1377373
 (151) 2017 09 13
 (891) 2017 09 13
 (731) Foshan Gaoming Annwa Ceramic Sanitary
 Ware Co., Ltd
 Sanming Road, He Cheng Avenue, Cangjiang
 Industrial Zone, Sanzhou Town, Gaoming
 Area, Foshan City 510000 Guangdong
 Province, China

(540)



(591) Black,white
 (531) 27.05.01; 27.05.17; 28.03
 (526) The third and fourth Chinese words mean "sanitary ware" so the applicant disclaims the exclusive right of the the third and fourth Chinese words.

(511)
 11 – Taps [faucets]; faucets for pipes; mixer taps for water pipes; fountains; pressure water tanks; water-pipes for sanitary installations; water distribution installations; water intake apparatus; water conduits installations; bath tubs; bath tubs for sitz baths; bidets; toilet seats; bath installations; water flushing installations; hydromassage bath apparatus; water closets; wash-hand basins [parts of sanitary installations]; urinals [sanitary fixtures]; floor drain; heating apparatus; oven fittings made of fireclay; lighters.

(260) AM 2018 95423 A
 (800) 1377402
 (151) 2017 05 16
 (891) 2017 05 16
 (731) POLİYA POLİESTER SANAYİ VE
 TİCARET LİMİTED ŞİRKETİ
 Firuzköy Bulvarı No:46, Avcılar, İstanbul,
 Turkey

(540)

poliya

(591) Black,white

(531) 27.05.17

(511)

35 – Advertising, marketing and public relations, organization of exhibitions and trade fairs for commercial or advertising purposes, design of advertising materials, provision of an online marketplace for buyers and sellers of goods and services; office functions, secretarial services, arranging newspaper subscriptions for others, compilation of statistics, rental of office machines, systemization of information into computer databases, telephone answering for unavailable subscribers; business management, business administration and business consultancy, accounting, commercial consultancy services, personnel recruitment, personnel placement agencies, employment agencies, import-export agencies; temporary personnel placement services; auctioneering; the bringing together, for the benefit of others, of a variety of goods, namely, sand, gravel, crushed stone, asphalt, bitumen, cement, gypsum, plaster, concrete, marble blocks for construction, building materials (as finished products) made of concrete, gypsum, clay, potters' clay, stone, marble, wood, plastics and synthetic materials for building, construction, road construction purposes, non-metallic buildings, non-metallic building materials, poles not of metal for power lines, barriers not of metal, natural and synthetic coatings in the form of panels and sheets, being building materials, cardboard coatings for roofing, coating for roofing, doors and windows of wood and synthetic materials, traffic signs not of metal, non-luminous and non-mechanical, for roads, monuments and statuettes of stone, concrete and marble, building glass, enabling customers to conveniently view and purchase those goods, such services may be provided by retail stores, wholesale outlets, by means of electronic media or through mail order catalogues.

(260) AM 2018 95460 A

(800) 1377613

(151) 2017 09 12

(891) 2017 09 12

(731) Myosa Pty Ltd

44 Siganto Dr, HELENSVALE QLD 4212,
 Australia

(540)

MYOVOSA

(591) Black,white

(511)

10 – Orthodontic appliances; orthodontic aids, namely, orthodontic training appliances which assist in straightening teeth, correcting arch development, improving jaw growth and facial development, braces for teeth, dental bite trays, dental plates, teeth retainers; dental apparatus, namely, dental handpieces, dental impression trays, dental inlays; training devices for teeth, tongues and facial muscles in the nature of mouthguards for medical purposes.

41 – Education services including in relation to orthodontic appliances and aids; providing of training; arranging and conducting of conferences, workshops and seminars; education or training advice; instructions services; practical training; providing non-downloadable on-line electronic publications; writing of texts.

44 – Medical services; dentistry; dental clinic services, namely, performing restorative, preventative and cosmetic procedures, oral surgery, and dental implant services; medical clinics; dental assistance, namely, performing restorative, preventative and cosmetic procedures, oral surgery, and dental implant services; orthodontic services.

(260) AM 2018 95461 A

(800) 1377621

(151) 2017 09 12

(891) 2017 09 12

(731) JSC «Dielektric Cable Sistsms»

Bochkin str.,15, RU-170017 Tver, Russian
 Federation

(540)



(591) Red and white.

(531) 26.07.05; 27.05.05; 27.05.17; 29.01.01;
 29.01.12

(511)

6 – Anchors; bolts of metal; eye bolts; screws of metal; nuts of metal; wall plugs of metal; crampons of metal [cramps]; rivets of metal; box fasteners of metal; locks of metal, other than electric; spring locks; closures of metal for containers; latches of metal; buckles of common metal [hardware]; water-pipe valves of metal; drain traps [valves] of metal; elbows of metal for pipes; pillars of metal for building; ferrules of metal; door fittings of metal; buildings of metal; buildings, transportable, of metal; steel buildings; brackets of metal for building; steel sheets; reinforcing materials of metal for pipes; reinforcing materials of metal for building; building materials of metal; refractory construction materials

of metal; pipe muffs of metal; props of metal; branching pipes of metal; iron slabs; steel strip; collars of metal for fastening pipes; winding spools of metal, non-mechanical, for flexible hoses; iron wire; wire of common metal; wire of common metal alloys, except fuse wire; steel wire; springs [metal hardware]; rods of metal for welding; rods of metal for brazing and welding; door handles of metal; junctions of metal for pipes; pipework of metal; penstock pipes of metal; water-pipes of metal; gutter pipes of metal; ducts of metal for ventilating and air-conditioning installations; drain pipes of metal; steel pipes; door stops of metal; stops of metal; flanges of metal [collars]; clips of metal for cables and pipes; washers of metal; boxes of common metal.

(260) AM 2018 95814 A

(800) 1381515

(151) 2017 10 25

(891) 2017 10 25

(731) adp Gauselmann GmbH

Merkur-Allee 1-15, 32339 Espelkamp,
Germany

(540)

Pharos

(591) Black, white

(511)

9 – Computer software; computer and video games software; games software in particular for use on any computer platform, including electronic entertainment and games consoles; computer game programs; video games (software); computer games provided through a global computer network or supplied by means of multi-media electronic broadcast or through telecommunications or electronic transmission or via the Internet; computer games (software), leisure and recreational software, video games and computer software, all being provided in the form of storage media; programs for operating electric and electronic apparatus for games, amusement and/or entertainment purposes; lottery ticket dispensing apparatus, namely automatic lottery machines; software for automatic lottery machines; computer software for computer games on the Internet; online games (software), in particular for online betting games, online prize games, online gambling games, online games of skill and online casino games; computer software in the form of an app for mobile devices and computers; operational computer games software; computer software for managing of games (game collection); collection of video games (software).

(260) AM 2018 95884 A

(800) 1382134

(151) 2017 10 25

(891) 2017 10 25

(731) ROBOPAC S.P.A.

Via Fabrizio da Montebello, 81, 47892
ACQUAVIVA GUALDICCILO,
San Marino

(540)



(591) Blue and red.

(531) 26.07.15; 27.05.17; 29.01.13

(511)

7 – Packing machines; packing installations; bundling machines; canning machines; winding machines; lacing machines; stretch-wrapping machines for applying plastics film to palletised loads; industrial robots; machines for manufacturing packaging materials; bottling machines; packing machines; cartoning machines.

(260) AM 2018 95888 A

(800) 1382207

(151) 2017 08 23

(891) 2017 08 23

(731) IE Aygarayeva Laura Kanatovna

ul. Satpayeva, dom 62. kv. 96, Bostandykskiy
rayon 050057 gorod Almaty, Kazakhstan

(540)



(591) Black, white

(531) 03.03.01; 03.03.17; 24.01.15; 24.09.10;
24.09.11; 27.05.10; 27.05.11

(511)

34 – Tobacco; smokers' articles; matches.

35 – Business management; business administration; office functions.

(260) AM 2018 95889 A

(800) 1382208

(151) 2017 09 14

(891) 2018 09 14

(731) Tovarystvo z obmezhenoiu vidpovidalnistiu
"DELTA MEDICAL"

vul. Chornovola, 43 m. Vyshneve Kyievo-
Sviatoshynskiy r-n Kyivska obl. 08132,
Ukraine

(540)

TURBIOTIC

(591) Black, white

(531) 27.05.17

(511)

3 – Adhesives for cosmetic purposes; after-shave lotions; air fragrancing preparations; almond oil; almond soap; almond milk for cosmetic purposes; aloe vera preparations for cosmetic purposes; amber [perfume]; antistatic preparations for household purposes; astringents for cosmetic purposes; badian essence; balms, other than for medical purposes; bath salts, not for medical purposes; bath preparations, not for medical purposes; bleaching preparations [decolorants] for cosmetic purposes; breath freshening sprays; breath freshening strips; beauty masks; bergamot oil; cakes of soap; cleansing milk for toilet purposes; collagen preparations for cosmetic purposes; cosmetics; cosmetic creams; cosmetic dyes; cosmetics for animals; cosmetic kits; cosmetic pencils; cosmetic preparations for skin care; cosmetic preparations for slimming purposes; cosmetic preparations for baths; cotton wool for cosmetic purposes; cotton sticks for cosmetic purposes; decorative transfers for cosmetic purposes; dental bleaching gels; dentifrices; deodorants for pets; deodorants for human beings or for animals; deodorant soap; eau de Cologne; ethereal essences; ethereal oils; essential oils of cedarwood; fumigation preparations [perfumes]; furbishing preparations; greases for cosmetic purposes; hair colorants; hair lotions; ionone [perfumery]; jasmine oil; potassium hypochloride; lavender water; lavender oil; laundry bleaching preparations; lip glosses; lipsticks; lotions for cosmetic purposes; make-up; make-up preparations; make-up removing preparations; mascara; massage gels, other than for medical purposes; mint for perfumery; mint essence [essential oil]; musk [perfumery]; nail care preparations; neutralizers for permanent waving; oils for cosmetic purposes; oils for perfumes and scents; perfumes; perfumery; petroleum jelly for cosmetic purposes; pomades for cosmetic purposes; rose oil; scented water; scented wood; shaving preparations; cream for whitening the skin; soap; soap for foot perspiration; antiperspirant soap; shampoos; dry shampoos; shampoos for pets [non-medicated grooming preparations]; sunscreen preparations; talcum powder, for toilet use; terpenes [essential oils]; toilet water; tissues impregnated with cosmetic lotions.

5 – Absorbent cotton; acaricides; acetates for pharmaceutical purposes; acids for pharmaceutical purposes; acne treatment preparations; aconitine; adhesive plasters; adhesive tapes for medical purposes; adhesives for dentures; adjuvants for medical purposes; air purifying preparations; air deodorising preparations; albumin dietary supplements; albuminous foodstuffs for medical purposes; albuminous preparations for medical purposes; alcohol for pharmaceutical purposes; aldehydes for pharmaceutical purposes, algicides; alginate dietary supplements; alginates for phar-

maceutical purposes; alkaline iodides for pharmaceutical purposes; alkaloids for medical purposes; alloys of precious metals for dental purposes; almond milk for pharmaceutical purposes; aloe vera preparations for pharmaceutical purposes; aluminium acetate for pharmaceutical purposes; amino acids for medical purposes; amino acids for veterinary purposes; anaesthetics; analgesics; angostura bark for medical purposes; animal washes [insecticides]; anti-uric preparations; antibiotics; anticryptogamic preparations; antioxidant pills; antiparasitic preparations; antiparasitic collars for animals; antiseptic cotton; antiseptics; appetite suppressants for medical purposes; appetite suppressant pills; aseptic cotton; asthmatic tea; babies' napkin-pants; bacterial poisons; bacterial preparations for medical and veterinary use; bacteriological preparations for medical and veterinary use; balms for medical purposes; balsamic preparations for medical purposes; bandages for dressings; barks for pharmaceutical purposes; bath preparations for medical purposes; bath salts for medical purposes; belts for sanitary napkins [towels]; bicarbonate of soda for pharmaceutical purposes; biocides; biological preparations for medical purposes; biological preparations for veterinary purposes; biological tissue cultures for medical purposes; biological tissue cultures for veterinary purposes; bismuth preparations for pharmaceutical purposes; bismuth subnitrate for pharmaceutical purposes; blood plasma; blood for medical purposes; bone cement for surgical and orthopaedic purposes; media for bacteriological cultures; breast-nursing pads; bromine for pharmaceutical purposes; bronchodilating preparations; bunion pads; by-products of the processing of cereals for dietetic or medical purposes; cachets for pharmaceutical purposes; cachou for pharmaceutical purposes; preparations for callouses; calomel [fungicide]; camphor oil for medical purposes; camphor for medical purposes; candy, medicated; candy for medical purposes; capsules for medicines; carbolineum [parasiticide]; casein dietary supplements; castor oil for medical purposes; cattle washes [insecticides]; caustic pencils; caustics for pharmaceutical purposes; cedar wood for use as an insect repellent; cellulose esters for pharmaceutical purposes; cellulose ethers for pharmaceutical purposes; cement for animal hooves; charcoal for pharmaceutical purposes; chemical conductors for electrocardiograph electrodes; chemical contraceptives; chemical preparations for the diagnosis of pregnancy; chemical preparations to treat mildew; chemical preparations to treat wheat smut; chemical preparations for treating phylloxera; chemical preparations for pharmaceutical purposes; chemical preparations for medical purposes; chemical preparations for veterinary purposes; chemical reagents for medical or veterinary purposes; chemico-phar-

rmaceutical preparations; chewing gum for medical purposes; chilblain preparations; chinoline for medical purposes; chloroform; cocaine; cod liver oil; collagen for medical purposes; collodion for pharmaceutical purposes; collyrium; compresses; condurango bark for medical purposes; solutions for contact lenses; contact lens cleaning preparations; cooling sprays for medical purposes; corn rings for the feet; corn remedies; cotton for medical purposes; cotton sticks for medical purposes; cream of tartar for pharmaceutical purposes; creosote for pharmaceutical purposes; croton bark; cultures of microorganisms for medical or veterinary use; curare; decoctions for pharmaceutical purposes; dental abrasives; dental amalgams; dental cements; dental impression materials; dental lacquer; dental mastics; dental amalgams of gold; deodorants, other than for human beings or for animals; deodorants for clothing and textiles; depuratives; preparations for destroying noxious, animals; preparations for destroying dry rot fungus; preparations for destroying mice; detergents for medical purposes; diabetic bread adapted for medical use; diagnostic preparations for medical purposes; diagnostic biomarker reagents for medical purposes; diagnostic preparations for veterinary purposes; diapers for pets; diastase for medical purposes; dietary fibre; dietary supplements for animals; dietetic foods adapted for medical purposes; dietetic beverages adapted for medical purposes; dietetic substances adapted for medical use; digestives for pharmaceutical purposes; digitalin; dill oil for medical purposes; disinfectants for hygiene purposes; disinfectants for chemical toilets; disinfectants; dog washes [insecticides]; douching preparations for medical purposes; dressings, medical; drugs for medical purposes; elixirs [pharmaceutical preparations]; enzyme preparations for medical purposes; enzyme preparations for veterinary purposes; enzyme dietary supplements; enzymes for medical purposes; enzymes for veterinary purposes; ergot for pharmaceutical purposes; esters for pharmaceutical purposes; ethers for pharmaceutical purposes; eucalyptol for pharmaceutical purposes; eucalyptus for pharmaceutical purposes; extracts of hops for pharmaceutical purposes; eyepatches for medical purposes; preparations to facilitate teething; febrifuges; fennel for medical purposes; ferments for pharmaceutical purposes; first-aid boxes, filled; fish meal for pharmaceutical purposes; flour for pharmaceutical purposes; flowers of sulfur for pharmaceutical purposes; fly catching paper; fly catching adhesives; fly destroying preparations; food for babies; formic aldehyde for pharmaceutical purposes; frostbite salve for pharmaceutical purposes; fumigating sticks; fumigation preparations for medical purposes; fungicides; gallic acid for pharmaceutical purposes; gamboge for medical purposes; gases for medical purposes; gauze for

dressings; gelatine for medical purposes; gentian for pharmaceutical purposes; germicides; glucose for medical purposes; glucose dietary supplements; glycerine for medical purposes; glycerophosphates; greases for medical purposes; greases for veterinary purposes; guaiacol for pharmaceutical purposes; gum for medical purposes; gurjun [gurjon, gurjan] balsam for medical purposes; haematogen; haemoglobin; haemorrhoid preparations; haemostatic pencils; herbal teas for medicinal purposes; herbicides; hormones for medical purposes; hydrastine; hydrastinine; hydrated chloral for pharmaceutical purposes; hydrogen peroxide for medical purposes; infant formula; insect repellents; insect repellent incense; insecticides; iodides for pharmaceutical purposes; iodine for pharmaceutical purposes; iodoform; Irish moss for medical purposes; isotopes for medical purposes; jalap; jujube, medicated; lacteal flour for babies; larvae exterminating preparations; laxatives; lead water; lecithin for medical purposes; lecithin dietary supplements; leeches for medical, purposes; lime-based pharmaceutical preparations; liniments; linseed for pharmaceutical purposes; linseed meal for pharmaceutical purposes; linseed dietary supplements; linseed oil dietary supplements; lint for medical purposes; liquorice for pharmaceutical purposes; lotions for pharmaceutical purposes; lotions for veterinary purposes; lupulin for pharmaceutical purposes; magnesia for pharmaceutical purposes; malt for pharmaceutical purposes; malted milk beverages for medical purposes; mangrove bark for pharmaceutical purposes; medical preparations for slimming purposes; medicated eye-washes; medicated animal feed; medicated shampoos for pets; medicated soap; medicinal alcohol; medicinal mud; medicinal infusions; medicinal tea; medicinal oils; medicinal herbs; medicinal roots; medicinal drinks; medicinal hair growth preparations; medicine cases, portable, filled; medicines for alleviating constipation; medicines for dental purposes; medicines for human purposes; medicines for veterinary purposes; melissa water for pharmaceutical purposes; sanitary pads; menthol; mercurial ointments; preparations of microorganisms for medical or veterinary use; milk ferments for pharmaceutical purposes; milk sugar for pharmaceutical purposes; milking grease; mineral waters for medical purposes; mineral water salts; mineral food supplements; mint for pharmaceutical purposes; moleskin for medical purposes; mothproofing preparations; mothproofing paper; moulding wax for dentists; mouthwashes for medical purposes; mud for baths; mustard oil for medical purposes; mustard for pharmaceutical purposes; mustard plasters; myrobalan bark for pharmaceutical purposes; napkins for incontinents; narcotics; nervines; nutritional supplements; nutritive substances for microorganisms; oil of turpentine for pharmaceutical purposes; ointments for

pharmaceutical purposes; opiates; opium; opodeldoc; ophotherapy preparations; oxygen baths; oxygen for medical purposes; pants, absorbent, for incontinents; panty liners [sanitary]; paper for mustard plasters; parasitocides; pastilles for pharmaceutical purposes; pearl powder for medical purposes; pectin for pharmaceutical purposes; pepsins for pharmaceutical purposes; peptones for pharmaceutical purposes; pesticides; petroleum jelly for medical purposes; pharmaceutical preparations; pharmaceutical preparations for treating sunburn; pharmaceutical preparations for skin care; pharmaceutical preparations for treating dandruff; pharmaceuticals; phenol for, pharmaceutical purposes; phosphates for pharmaceutical purposes; poisons; pollen dietary supplements; pomades for medical purposes; porcelain for dental prostheses; potassium salts for medical purposes; poultices; powder of cantharides; propolis for pharmaceutical purposes; propolis dietary supplements; protein dietary supplements; protein supplements for animals; purgatives; pyrethrum powder; quassia for medical purposes; quebracho for medical purposes; quinine for medical purposes; quinquina for medical purposes; radioactive substances for medical purposes; radiological contrast substances for medical purposes; radium for medical purposes; rat poison; reagent paper for medical purposes; reagent paper for veterinary purposes; preparations for reducing sexual activity; remedies for foot perspiration; remedies for perspiration; repellents for dogs; rhubarb roots for pharmaceutical purposes; royal jelly for pharmaceutical purposes; royal jelly dietary supplements; rubber for dental purposes; salts for mineral water baths; salts for medical purposes; sanitary panties; sanitary tampons; sanitary napkins; sarsaparilla for medical purposes; scapulars for surgical purposes; sea water for medicinal bathing; sedatives; semen for artificial insemination; serotherapeutic medicines; serums; personal sexual lubricants; siccatives [drying agents] for medical purposes; slimming pills; slug exterminating preparations; smelling salts; smoking herbs for medical purposes; sodium salts for medical purposes; soil-sterilising preparations; solvents for removing adhesive plasters; soporifics; starch for dietetic or pharmaceutical purposes; stem cells for medical purposes; stem cells for veterinary purposes; sterilising preparations; steroids; stick liquorice for pharmaceutical purposes; strychnine; styptic preparations; sugar for medical purposes; sulfonamides [medicines]; sulfur sticks [disinfectants]; sunburn ointments; suppositories; surgical dressings; surgical implants comprised of living tissues; surgical glues; syrups for pharmaceutical purposes; tanning pills; tartar for pharmaceutical purposes; teeth filling material; therapeutic preparations for the bath; thermal water; thymol for pharmaceutical purposes; tincture of iodine; tinctures for medical purposes;

tissues impregnated with pharmaceutical lotions; tobacco extracts [insecticides]; tobacco-free cigarettes for medical purposes; tonics [medicines]; preparations of trace elements for human and animal use; transplants [living tissues]; preparations for the treatment of burns; turpentine for pharmaceutical purposes; vaccines; vaginal washes for medical purposes; vermifuges; vermin destroying preparations; vesicants; veterinary preparations; vine disease treating chemicals; vitamin preparations; vulnerary sponges; wadding for medical purposes; wart pencils; wheat germ dietary supplements; yeast for pharmaceutical purposes; yeast dietary supplements.

29 – Albumen for culinary purposes; albumin milk; alginates for culinary purposes; almond milk for culinary purposes; aloe vera prepared for human consumption; arrangements of processed fruit; beans, preserved; berries, preserved; bouillon concentrates; candied nuts; cocoa butter for food; coconut oil for food; coconut butter; coconut fat; coconut, desiccated; condensed milk; cranberry sauce [compote]; cream [dairy products]; crystallized fruits; edible fats; fat-containing mixtures for bread slices; fatty substances for the manufacture of edible fats; fish meal for human consumption; fish mousses; fish, tinned [canned (Am.)]; flavoured nuts; frosted fruits; frozen fruits; fruit-based snack food; fruit chips; fruit jellies; fruit peel; fruit, preserved; fruit preserved in alcohol; fruit pulp; fruits, tinned [canned (Am.)]; game, not live; ginger jam; jams; jellies for food; kephir [milk beverage]; lecithin for culinary purposes; marmalade; meat extracts; meat, tinned [canned (Am.)]; milk beverages, milk predominating; milk ferments for culinary purposes; milk products; milk shakes; mushrooms, preserved; nuts, prepared; oils for food; peanut butter; peanut milk for culinary purposes; peas, preserved; pectin for culinary purposes; pollen prepared as foodstuff; preparations for making bouillon; preparations for making soup; protein milk; powdered eggs; powdered milk; rice milk; seaweed extracts for food; seeds, prepared; soya beans, preserved, for food; soya milk; suet for food; vegetable juices for cooking; vegetable mousses; vegetable salads; vegetables, dried; vegetables, preserved; vegetables, tinned [canned (Am.)]; whipped cream; white of eggs; yoghurt; yolk of eggs.

30 – Artificial coffee; baking powder; baking soda [bicarbonate of soda for cooking purposes]; bread; candy; caramels [candy]; cereal bars; cereal-based snack food; cereal preparations; chewing gum; chicory [coffee substitute]; chips [cereal products]; chocolate; chocolate beverages with milk; chocolate-based beverages; cocoa-based beverages; coffee-based beverages; coffee beverages with milk; coffee flavourings; condiments; confectionery; essences for

foodstuffs, except etheric essences and essential oils; ferments for pastes; flavourings, other than essential oils, for beverages; flavourings, other than essential oils, for cakes; flowers or leaves for use as tea substitutes; food flavourings, other than essential oils; frozen yoghurt [confectionery ices]; fruit jellies [confectionery]; fruit coulis [sauces]; glucose for culinary purposes; gluten additives for culinary purposes; gluten prepared as foodstuff; groats for human food; halvah; high-protein cereal bars; honey; infusions, not medicinal; iced tea; linseed for culinary purposes [seasoning]; malt extract for food; malt for human consumption; maltose; meal; mint for confectionery; molasses for food; muesli; natural sweeteners; oat-based food; pastries; peppermint sweets; powders for making ice cream; preparations for stiffening whipped cream; propolis; royal jelly; salt for preserving foodstuffs; sauces [condiments]; seasonings; seaweed [condiment]; spices; starch for food; sugar confectionery; tea; tea-based beverages; thickening agents for cooking foodstuffs; vanilla flavourings for culinary purposes; vegetal preparations for use as coffee substitutes; wheat germ for human consumption.

35 – Retail or wholesale services for pharmaceutical, veterinary and sanitary preparations and medical supplies.

(260) AM 2018 95892 A

(800) 1382229

(151) 2017 10 27

(891) 2017 10 27

(731) BAHRI ATILA

Mimar Kemalettin Mah. Derinkuyu Sok.
No:8 Laleli Fatih Fatih İstanbul, Turkey

(540)

EMPER İÇ GIYİM

(591) Black,white

(531) 27.05.01

(511)

25 – Clothing, including underwear and outer clothing, other than special purpose protective clothing; socks, mufflers [clothing], shawls, bandanas, scarves, belts [clothing]; footwear, shoes, slippers, sandals; headgear, hats, caps with visors, berets, caps [headwear], skull caps.

(260) AM 2018 95893 A

(800) 1382279

(151) 2017 08 11

(891) 2017 08 11

(731) SHIRIN ASAL FOOD INDUSTRIAL
COMPANY

Akhoondi Passage, No 20, Jomhoori St.
Tabriz, Iran (Islamic Republic of)

(540)



(591) Red

(531) 26.04.02; 26.04.09; 26.04.24; 27.05.01;

27.05.24; 28.01

(511)

29 – Dried and cooked fruits and vegetables; jellies, jams, compotes; milk and milk products; canned meat, fish, vegetables and fruits; canned vegetables; canned fish; canned poultry; potato chips; processed dates.

30 – Tea; cocoa; flour and preparations made from cereals; bread; pastry and confectionery; ices; baking powder; ice cream; sauces; waffle; cereals; toffee; candy; cake; chocolate powder; biscuit; cracker, chewing gum; chocolate; spaghetti; pasta.

32 – Mineral and aerated waters; fruit drinks; juices; syrups and other preparations for making beverages.

35 – Advertising; sales promotions at point of purchase or sale, for others; commercial or industrial management assistance for exportation of dried and cooked fruits and vegetables, jellies, jams, compotes, milk and milk products, canned food, canned vegetables, canned fish, canned poultry, chips, date products, tea, cocoa, flour and preparations made from cereals, bread, pastry and confectionery, ices, baking powder, ice cream, sauces, waffle, cereals, toffee, candy, cake, chocolate powder, biscuit, cracker, gum, chocolate, spaghetti, pasta, mineral and aerated waters, fruit drinks, juices, syrups and other preparations for making beverages.

39 – Delivery services of dried and cooked fruits and vegetables, jellies, jams, compotes, milk and milk products, canned food, canned vegetables, canned fish, canned poultry, chips, date products, tea, cocoa, flour and preparations made from cereals, bread, pastry and confectionery, ices, baking powder, ice cream, sauces, waffle, cereals, toffee, candy, cake, chocolate powder, biscuit, cracker, gum, chocolate, spaghetti, pasta, mineral and aerated waters, fruit drinks, juices, syrups and other preparations for making beverages.

INTERNATIONAL TRADEMARKS PROTECTED IN GEORGIA

(260) AM 2018 89313 A
(800) 1316209
(151) 2016 04 29
(181) 2026 04 29
(891) 2016 04 29
(511) 35

(260) AM 2018 90857 A
(800) 1285804
(151) 2015 12 07
(181) 2025 12 07
(891) 2016 06 16
(511) 29

(260) AM 2018 91648 A
(800) 1337279
(151) 2016 10 28
(181) 2026 10 28
(891) 2016 10 28
(511) 18, 25, 28

(260) AM 2018 91697 A
(800) 1036912
(151) 2009 12 10
(181) 2019 12 10
(891) 2016 10 31
(511) 29

(260) AM 2018 91782 A
(800) 1339435
(151) 2016 09 29
(181) 2026 09 29
(891) 2016 09 29
(511) 03

(260) AM 2018 91831 A
(800) 1339716
(151) 2017 01 20
(181) 2027 01 20
(891) 2017 01 20
(511) 05

(260) AM 2018 91906 A
(800) 1340987
(151) 2016 12 28
(181) 2026 12 28

(891) 2016 12 28
(511) 05

(260) AM 2018 92057 A
(800) 1341408
(151) 2016 12 06
(181) 2026 12 06
(891) 2016 12 06
(511) 07

(260) AM 2018 92108 A
(800) 1343127
(151) 2016 07 25
(181) 2026 07 25
(891) 2016 07 25
(511) 12

(260) AM 2018 92144 A
(800) 1342248
(151) 2017 02 17
(181) 2027 02 17
(891) 2017 02 17
(511) 07

(260) AM 2018 92176 A
(800) 1275151
(151) 2015 09 08
(181) 2025 09 08
(891) 2017 04 20
(511) 12

(260) AM 2018 92224 A
(800) 1344513
(151) 2016 12 19
(181) 2026 12 19
(891) 2016 12 19
(511) 09, 10, 11, 21

(260) AM 2018 92225 A
(800) 1343304
(151) 2017 01 23
(181) 2027 01 23
(891) 2017 01 23
(511) 09, 11, 34

(260) AM 2018 92243 A
(800) 1344587
(151) 2017 01 25
(181) 2027 01 25
(891) 2017 01 25
(511) 09, 11, 37

(260) AM 2018 92246 A
(800) 1343542
(151) 2016 12 22
(181) 2026 12 22
(891) 2016 12 22
(511) 03, 05, 10, 16, 21, 24

(260) AM 2018 92257 A
(800) 1343685
(151) 2017 01 27
(181) 2027 01 27
(891) 2017 01 27
(511) 09

(260) AM 2018 92282 A
(800) 1344022
(151) 2016 12 09
(181) 2026 12 09
(891) 2016 12 09
(511) 41

(260) AM 2018 92284 A
(800) 1089194
(151) 2011 07 29
(181) 2021 07 29
(891) 2017 04 24
(511) 31

(260) AM 2018 92298 A
(800) 1344081
(151) 2017 01 25
(181) 2027 01 25
(891) 2017 01 25
(511) 09, 11, 37

(260) AM 2018 92388 A
(800) 1344843
(151) 2017 04 04
(181) 2027 04 04
(891) 2017 04 04
(511) 03, 05

(260) AM 2018 92390 A
(800) 1344643
(151) 2016 08 29

(181) 2026 08 29
(891) 2016 08 29
(511) 25

(260) AM 2018 92394 A
(800) 1344662
(151) 2017 01 17
(181) 2027 01 17
(891) 2017 01 17
(511) 12

(260) AM 2018 92535 A
(800) 1345912
(151) 2017 04 18
(181) 2027 04 18
(891) 2017 04 18
(511) 10, 35, 44

(260) AM 2018 92574 A
(800) 1346199
(151) 2017 02 27
(181) 2027 02 27
(891) 2017 02 27
(511) 30

(260) AM 2018 92663 A
(800) 1348289
(151) 2017 01 31
(181) 2027 01 31
(891) 2017 01 31
(511) 25

(260) AM 2018 92666 A
(800) 1346983
(151) 2016 05 20
(181) 2026 05 20
(891) 2016 05 20
(511) 03, 09, 14, 16, 18, 25, 28, 35, 41

(260) AM 2018 92672 A
(800) 807256
(151) 2003 07 07
(181) 2023 07 07
(891) 2017 03 08
(511) 11

(260) AM 2018 92677 A
(800) 1347040
(151) 2017 02 07
(181) 2027 02 07

(891) 2017 02 07
(511) 09

(891) 2016 12 08
(511) 07, 09, 11, 37

(260) AM 2018 92678 A
(800) 1347052
(151) 2017 02 20
(181) 2027 02 20
(891) 2017 02 20
(511) 34

(260) AM 2018 92688 A
(800) 1347132
(151) 2016 10 24
(181) 2026 10 24
(891) 2016 10 24
(511) 09, 11

(260) AM 2018 92680 A
(800) 1092838
(151) 2011 05 02
(181) 2021 05 02
(891) 2017 04 14
(511) 28

(260) AM 2018 92690 A
(800) 1297050
(151) 2016 02 17
(181) 2026 02 17
(891) 2017 03 09
(511) 17, 35

(260) AM 2018 92681 A
(800) 1137555
(151) 2012 04 27
(181) 2022 04 27
(891) 2017 03 16
(511) 05, 29, 30, 32

(260) AM 2018 92691 A
(800) 1311798
(151) 2016 06 01
(181) 2026 06 01
(891) 2017 03 20
(511) 09

(260) AM 2018 92683 A
(800) 1224421
(151) 2014 06 18
(181) 2024 06 18
(891) 2017 05 18
(511) 03, 25, 28

(260) AM 2018 92748 A
(800) 1347424
(151) 2017 02 02
(181) 2027 02 02
(891) 2017 02 02
(511) 09

(260) AM 2018 92684 A
(800) 1347073
(151) 2016 10 27
(181) 2026 10 27
(891) 2016 10 27
(511) 01, 03, 04, 05, 06, 07, 08, 09, 10, 11, 12, 14,
15, 16, 18, 20, 21, 24, 25, 26, 27, 28, 29, 30,
31, 32, 33, 34, 35, 36, 37, 38, 39, 40, 41, 42,
43, 45

(260) AM 2018 92749 A
(800) 1347455
(151) 2017 03 21
(181) 2027 03 21
(891) 2017 03 21
(511) 30, 31

(260) AM 2018 92685 A
(800) 1261089
(151) 2015 05 19
(181) 2025 05 19
(891) 2017 02 03
(511) 25

(260) AM 2018 92758 A
(800) 1347475
(151) 2016 12 05
(181) 2026 12 05
(891) 2016 12 05
(511) 05, 07, 09, 10, 11, 38, 42

(260) AM 2018 92686 A
(800) 1347116
(151) 2017 12 08
(181) 2016 12 08

(260) AM 2018 92759 A
(800) 1347483
(151) 2017 12 28
(181) 2026 12 28
(891) 2016 12 28
(511) 09, 42

(260) AM 2018 92760 A
(800) 1347485
(151) 2017 02 16
(181) 2027 02 16
(891) 2017 02 16
(511) 09

(260) AM 2018 92761 A
(800) 1347543
(151) 2016 09 30
(181) 2026 09 30
(891) 2016 09 30
(511) 20, 35

(260) AM 2018 92807 A
(800) 1348357
(151) 2016 12 02
(181) 2026 12 02
(891) 2016 12 02
(511) 05, 10, 11

(260) AM 2018 92808 A
(800) 1348358
(151) 2016 12 05
(181) 2026 12 05
(891) 2016 12 05
(511) 05, 07, 09, 10, 11, 38, 42

(260) AM 2018 92810 A
(800) 1348372
(151) 2016 11 19
(181) 2026 11 19
(891) 2016 11 19
(511) 09, 28

(260) AM 2018 92814 A
(800) 1348434
(151) 2017 02 24
(181) 2027 02 24
(891) 2017 02 24
(511) 33

(260) AM 2018 92818 A
(800) 1348508
(151) 2017 03 06
(181) 2027 03 06
(891) 2017 03 06
(511) 03

(260) AM 2018 92831 A
(800) 1348740
(151) 2017 01 24

(181) 2027 01 24
(891) 2017 01 24
(511) 09, 11, 37

(260) AM 2018 92902 A
(800) 1349077
(151) 2016 08 31
(181) 2026 08 31
(891) 2016 08 31
(511) 08

(260) AM 2018 92904 A
(800) 1349079
(151) 2016 11 16
(181) 2026 11 16
(891) 2016 11 16
(511) 05

(260) AM 2018 92911 A
(800) 1350313
(151) 2017 03 01
(181) 2027 03 01
(891) 2017 03 01
(511) 03, 34, 35

(260) AM 2018 92918 A
(800) 1350346
(151) 2017 03 17
(181) 2027 03 17
(891) 2017 03 17
(511) 25

(260) AM 2018 92919 A
(800) 1349929
(151) 2017 12 27
(181) 2026 12 27

(891) 2016 12 27
(511) 30

(260) AM 2018 92929 A
(800) 1350002
(151) 2017 02 03
(181) 2027 02 03
(891) 2017 02 03
(511) 30

(260) AM 2018 92932 A
(800) 1350039
(151) 2017 03 02

(181) 2027 03 02
(891) 2017 03 02
(511) 05

(260) AM 2018 92933 A
(800) 1350040
(151) 2017 03 02
(181) 2027 03 02
(891) 2017 03 02
(511) 05

(260) AM 2018 92934 A
(800) 1350041
(151) 2017 03 02
(181) 2027 03 02
(891) 2017 03 02
(511) 05

(260) AM 2018 92938 A
(800) 1350059
(151) 2017 03 17
(181) 2027 03 17
(891) 2017 03 17
(511) 09

(260) AM 2018 92939 A
(800) 1350065
(151) 2017 03 23
(181) 2027 03 23
(891) 2017 03 23
(511) 09

(260) AM 2018 92940 A
(800) 1350078
(151) 2017 02 28
(181) 2027 02 28
(891) 2017 02 28
(511) 05

(260) AM 2018 92942 A
(800) 1350125
(151) 2017 04 04
(181) 2027 04 04
(891) 2017 04 04
(511) 05

(260) AM 2018 92943 A
(800) 1350126
(151) 2017 04 04
(181) 2027 04 04

(891) 2017 04 04
(511) 05

(260) AM 2018 92946 A
(800) 1350426
(151) 2017 04 28
(181) 2027 04 28
(891) 2017 04 28
(511) 35, 36, 37, 38, 39, 41, 42, 43, 44, 45

(260) AM 2018 92948 A
(800) 1060799
(151) 2010 11 19
(181) 2020 11 19
(891) 2017 05 17
(511) 25

(260) AM 2018 92949 A
(800) 1075993
(151) 2011 04 06
(181) 2021 04 06
(891) 2017 05 19
(511) 25, 41

(260) AM 2018 92951 A
(800) 1147129
(151) 2012 09 19
(181) 2022 09 19
(891) 2017 05 30
(511) 05

(260) AM 2018 92953 A
(800) 1264994
(151) 2014 12 19
(181) 2024 12 19
(891) 2017 05 31
(511) 07, 09, 10, 11, 12, 14, 16, 35, 37, 38, 41,
42, 43, 44, 45

(260) AM 2018 92954 A
(800) 1304967
(151) 2016 04 06
(181) 2026 04 06
(891) 2017 03 03
(511) 29, 30, 31, 35

(260) AM 2018 92955 A
(800) 1330756
(151) 2016 11 17
(181) 2026 11 17

(891) 2017 03 09
(511) 29, 30, 32

(260) AM 2018 92967 A
(800) 1349590
(151) 2017 04 12
(181) 2027 04 12
(891) 2017 04 12
(511) 25

(260) AM 2018 92976 A
(800) 1349775
(151) 2016 11 23
(181) 2026 11 23
(891) 2016 11 23
(511) 09

(260) AM 2018 92979 A
(800) 1349840
(151) 2017 03 13
(181) 2027 03 13
(891) 2017 03 13
(511) 05

(260) AM 2018 92982 A
(800) 1349913
(151) 2017 03 15
(181) 2027 03 15
(891) 2017 03 15
(511) 34

(260) AM 2018 92983 A
(800) 1349922
(151) 2017 03 24
(181) 2027 03 24
(891) 2017 03 24
(511) 05

(260) AM 2018 93001 A
(800) 1350434
(151) 2017 03 14
(181) 2027 03 14
(891) 2017 03 14
(511) 32

(260) AM 2018 93004 A
(800) 1351366
(151) 2017 01 30
(181) 2027 01 30
(891) 2017 01 30
(511) 03, 08

(260) AM 2018 93011 A
(800) 1350638
(151) 2017 02 09
(181) 2027 02 09
(891) 2017 02 09
(511) 16

(260) AM 2018 93012 A
(800) 1350734
(151) 2017 03 28
(181) 2027 03 28
(891) 2017 03 28
(511) 07

(260) AM 2018 93014 A
(800) 1350751
(151) 2017 03 06
(181) 2027 03 06
(891) 2017 03 06
(511) 03, 05

(260) AM 2018 93019 A
(800) 1350822
(151) 2016 09 08
(181) 2026 09 08
(891) 2016 09 08
(511) 06

(260) AM 2018 93028 A
(800) 1351549
(151) 2016 09 23
(181) 2026 09 23
(891) 2016 09 23
(511) 30

(260) AM 2018 93029 A
(800) 1351553
(151) 2016 11 29
(181) 2026 11 29
(891) 2016 11 29
(511) 06, 07, 09, 11, 19, 20, 21, 37, 41, 42

(260) AM 2018 93034 A
(800) 1351623
(151) 2017 03 24
(181) 2027 03 24
(891) 2017 03 24
(511) 03, 05

(260) AM 2018 93037 A
(800) 1351626
(151) 2017 04 12

(181) 2027 04 12
 (891) 2017 04 12
 (511) 11

(891) 2016 03 30
 (511) 07, 11

(260) AM 2018 93038 A
 (800) 1351666
 (151) 2016 11 16
 (181) 2026 11 16
 (891) 2016 11 16
 (511) 05

(260) AM 2018 93113 A
 (800) 1352345
 (151) 2016 11 03
 (181) 2026 11 03
 (891) 2016 11 03
 (511) 09, 28

(260) AM 2018 93039 A
 (800) 1351694
 (151) 2017 04 10
 (181) 2027 04 10
 (891) 2017 04 10
 (511) 14

(260) AM 2018 93114 A
 (800) 1352867
 (151) 2017 04 04
 (181) 2027 04 04
 (891) 2017 04 04
 (511) 41

(260) AM 2018 93041 A
 (800) 806089
 (151) 2003 02 22
 (181) 2023 02 22
 (891) 2017 03 08
 (511) 11

(260) AM 2018 93116 A
 (800) 1352402
 (151) 2017 03 24
 (181) 2027 03 24
 (891) 2017 03 24
 (511) 05

(260) AM 2018 93050 A
 (800) 931360
 (151) 2006 11 10
 (181) 2026 11 10
 (891) 2016 11 11
 (511) 01, 07, 09, 11, 12, 13, 17, 19, 20

(260) AM 2018 93117 A
 (800) 1352418
 (151) 2017 04 11
 (181) 2027 04 11
 (891) 2017 04 11
 (511) 01, 03

(260) AM 2018 93075 A
 (800) 1350938
 (151) 2017 04 12
 (181) 2027 04 12
 (891) 2017 04 12
 (511) 25

(260) AM 2018 93118 A
 (800) 1352429
 (151) 2017 04 28
 (181) 2027 04 28
 (891) 2017 04 28
 (511) 05

(260) AM 2018 93077 A
 (800) 1350987
 (151) 2016 09 28
 (181) 2026 09 28
 (891) 2016 09 28
 (511) 17, 19

(260) AM 2018 93119 A
 (800) 1352466
 (151) 2017 03 04
 (181) 2027 03 04
 (891) 2017 03 04
 (511) 10

(260) AM 2018 93096 A
 (800) 1351234
 (151) 2017 03 30
 (181) 2026 03 30

(260) AM 2018 93120 A
 (800) 1352485
 (151) 2016 12 27
 (181) 2026 12 27
 (891) 2016 12 27
 (511) 18, 25, 35

(260) AM 2018 93121 A
(800) 1352486
(151) 2016 12 06
(181) 2026 12 06
(891) 2016 12 06
(511) 09, 28

(260) AM 2018 93122 A
(800) 1352865
(151) 2017 02 27
(181) 2027 02 27
(891) 2017 02 27
(511) 11

(260) AM 2018 93123 A
(800) 1352487
(151) 2016 12 06
(181) 2026 12 06
(891) 2016 12 06
(511) 09, 28

(260) AM 2018 93124 A
(800) 1352879
(151) 2017 05 01
(181) 2027 05 01
(891) 2017 05 01
(511) 05

(260) AM 2018 93125 A
(800) 1352488
(151) 2016 12 06
(181) 2026 12 06
(891) 2016 12 06
(511) 09, 28

(260) AM 2018 93126 A
(800) 1352912
(151) 2017 05 08
(181) 2027 05 08
(891) 2017 05 08
(511) 09

(260) AM 2018 93127 A
(800) 1352489
(151) 2016 12 06
(181) 2026 12 06
(891) 2017 12 06
(511) 09, 28

(260) AM 2018 93128 A
(800) 1352922
(151) 2017 04 19

(181) 2027 04 19
(891) 2017 04 19
(511) 33

(260) AM 2018 93129 A
(800) 1352923
(151) 2017 04 14
(181) 2027 04 14
(891) 2017 04 14
(511) 05

(260) AM 2018 93130 A
(800) 1352490
(151) 2016 12 06
(181) 2026 12 06
(891) 2016 12 06
(511) 09, 28

(260) AM 2018 93131 A
(800) 1352494
(151) 2017 03 13
(181) 2027 03 13
(891) 2017 03 13
(511) 30

(260) AM 2018 93132 A
(800) 1352957
(151) 2017 05 10
(181) 2027 05 10
(891) 2017 05 10
(511) 25

(260) AM 2018 93133 A
(800) 1352509
(151) 2017 04 18
(181) 2027 04 18
(891) 2017 04 18
(511) 16

(260) AM 2018 93134 A
(800) 1352956
(151) 2017 04 27
(181) 2027 04 27
(891) 2017 04 27
(511) 03

(260) AM 2018 93233 A
(800) 1353543
(151) 2016 12 23
(181) 2026 12 23

(891) 2016 12 23
(511) 38, 41

(260) AM 2018 93416 A
(800) 1355721
(151) 2017 03 10
(181) 2027 03 10
(891) 2017 03 10
(511) 35, 36, 42

(260) AM 2018 93418 A
(800) 1355725
(151) 2017 03 15
(181) 2027 03 15
(891) 2017 03 15
(511) 09, 28

(260) AM 2018 93419 A
(800) 1355728
(151) 2017 03 06
(181) 2027 03 06
(891) 2017 03 06
(511) 03, 05

(260) AM 2018 93420 A
(800) 1355763
(151) 2017 03 06
(181) 2027 03 06
(891) 2017 03 06
(511) 09, 18, 24, 25

(260) AM 2018 93447 A
(800) 1356702
(151) 2017 03 21
(181) 2027 03 21
(891) 2017 03 21
(511) 06, 19, 20, 21, 35

(260) AM 2018 93451 A
(800) 1356775
(151) 2016 12 05
(181) 2026 12 05
(891) 2016 12 05
(511) 01, 05, 29, 30, 32

(260) AM 2018 93598 A
(800) 1357712
(151) 2017 03 24
(181) 2027 03 24
(891) 2017 03 24
(511) 05

(260) AM 2018 93600 A
(800) 1357745
(151) 2017 03 07
(181) 2027 03 07
(891) 2017 03 07
(511) 25

(260) AM 2018 93611 A
(800) 1357753
(151) 2017 03 01
(181) 2027 03 01
(891) 2017 03 01
(511) 03, 05, 10

(260) AM 2018 93612 A
(800) 1357770
(151) 2017 03 22
(181) 2027 03 22
(891) 2017 03 22
(511) 30

APPELLATIONS OF ORIGIN AND GEOGRAPHICAL INDICATION OF GOODS

APPELLATIONS OF ORIGIN OF GOODS FILED IN GEORGIA FOR EXAMINATION UNDER LISBON AGREEMENT, ON THE BASIS OF THE INTERNATIONAL REGISTRATION

The decision can be appealed at the Chamber of Appeal of Sakpatenti within 3 months from the publication or at the Mtskheta District Court Administrative Cases Board (Address: №17, Samkhedro str., Mtskheta), within 1 month after publication.

Number of Identification: 1521
Number of International Registration: 1068
Data of International Registration: 2017 09 04
Application Filing Date: 2018 01 31
Name and Address of Applicant: Farming cooperative of palm growers of Hajiabad
Region of Hajiabad, Iran;
National association of Iranian dates – Hormozgan Province
branch Region of Hajiabad, Iran
Appellation of Origin of Good: Khormay e Piarom e Hajiabad e Iran
The Goods for which the Registration of Appellation of Origin is Required: 31 – Date

Number of Identification: 1522
Number of International Registration: 1069
Data of International Registration: 2017 09 04
Application Filing Date: 2018 01 31
Name and Address of Applicant: Rural Cooperatives Union of South Khorasan Province
Region of South Khorasan, Iran;
Union of Agricultural Cooperatives of barberry growers, gardeners and saffron growers of South Khorasan
Region of South Khorasan, Iran
Appellation of Origin of Good: Annab e Birjand e Iran
The Goods for which the Registration of Appellation of Origin is Required: 31 – Jujube

Number of Identification: 1523
Number of International Registration: 1070
Data of International Registration: 2017 09 04
Application Filing Date: 2018 01 31
Name and Address of Applicant: Rural Cooperatives Union of Sistan and Baluchestan Province
Region of Sistan and Baluchestan, Iran;
Rural Cooperatives Union of Zahedan County
Region of Sistan and Baluchestan, Iran
Appellation of Origin of Good: Khormay e Rabbi e Sistan and o Baluchestan e Iran
The Goods for which the Registration of Appellation of Origin is Required: 31 – Date

Number of Identification: 1524
Number of International Registration: 1071
Data of International Registration: 2017 09 04
Application Filing Date: 2018 01 31
Name and Address of Applicant: Mehr Dashtestan Cooling Company
Region of Dashtestan, Iran;
Dates of south Borazjan Company
Region of Dashtestan, Iran
Appellation of Origin of Good: Khorma e Zahedi e Talaei e Dashtestan e Iran
The Goods for which the Registration of Appellation of Origin is Required: 31 – Date

Number of Identification: 1525
Number of International Registration: 1072
Data of International Registration: 2017 09 04
Application Filing Date: 2018 01 31
Name and Address of Applicant: Exporters Association of Nuts - Khuzestan branch
Region of Khuzestan, Iran;
National Association of Khuzestan dates
Region of Khuzestan, Iran;
Appellation of Origin of Good: Khormay e Stamaran e Khuzestan e Iran
The Goods for which the Registration of Appellation of Origin is Required: 31 – Date

OFFICIAL NOTIFICATION

INVENTIONS

RENEWAL OF PATENT

(21) AP 2015 13835
(11) P 2016 6512 B
(73) Zaur Berishvili
(54) **PLANAR MAGNETRON SPUTTER**
DATE OF PATENT CANCELLATION: 2018 05 28
DATE OF PATENT RENEWAL: 2018 08 10

CANSELLATION OF PATENTS

(21) AP 2004 10247
(11) P 2010 5122 B
(73) Interdigital Technology Corporation
(54) **METHOD AND SYSTEM FOR TRANSFERRING INFORMATION BETWEEN NETWORK
MANAGEMENT ENTITIES OF A WIRELESS COMMUNICATION SYSTEM**
DATE OF PATENT CANCELLATION: 2018 07 14
PATENT RESTORATION IS AVAILABLE: 2019 07 14

(21) AP 2006 10480
(11) P 2011 5302 B
(73) Novartis Ag
(54) **CRYSTALLINE FORMS OF 4-METHYL-N-[3-(4-METHYL-IMIDAZOL-1-YL)-5-
TRIFLUOROMETHYL-PHENYL]-3-(4-PYRIDIN-3-YL-PYRIMIDIN-2-YLAMINO)-BENZAMIDE**
DATE OF PATENT CANCELLATION: 2018 07 18
PATENT RESTORATION IS AVAILABLE: 2019 07 18

(21) AP 2013 13731
(11) P 2016 6586 B
(73) LABORATORI GUIDOTTI S.P.A.
(54) **PEDIATRIC ORAL LIQUID COMPOSITIONS CONTAINING NEPADUTANT**
DATE OF PATENT CANCELLATION: 2018 07 12
PATENT RESTORATION IS AVAILABLE: 2019 07 12

(21) AP 2016 14211
(11) P 2018 6883 B
(73) LEPL Gricultural Research And Research Center
(54) **FRUIT AND VEGETABLE DRYING EQUIPMENT**
DATE OF PATENT CANCELLATION: 2018 07 19
PATENT RESTORATION IS AVAILABLE: 2019 07 19

(21) AP 2000 5456
(11) P 2002 2671 B
(73) Roin Natschkebia
(54) **PLANT MEDICINAL MEANS AND ITS USE**
DATE OF PATENT CANCELLATION: 2018 07 12
PATENT RESTORATION IS AVAILABLE: 2019 07 12

(21) AP 2004 9236
(11) P 2009 4599 B
(73) Interdigital Technology Corporation
(54) **DEVICE FOR TRANSFERRING INFORMATION BETWEEN NETWORK MANAGEMENT ENTITIES OF A WIRELESS COMMUNICATION SYSTEM**
DATE OF PATENT CANCELLATION: 2018 07 14
PATENT RESTORATION IS AVAILABLE: 2019 07 14

(21) AP 2004 9240
(11) P 2010 5135 B
(73) Interdigital Technology Corporation
(54) **METHOD AND DEVICE FOR SIGNALING WLAN NETWORK CONTROL**
DATE OF PATENT CANCELLATION: 2018 07 13
PATENT RESTORATION IS AVAILABLE: 2019 07 13

UTILITY MODELS

RENEWAL OF PATENTS

(21) AU 2016 14127
(11) U 2017 1930 Y
(73) Temur Chakhunashvili;
Teimuraz Rokva;
Jiuli Keadze;
Zinaida Vatsadze
(54) **REACTIVE APPARATUS FOR HIGH AGRESIV SOLUTIONS CHEMICAL PROCESSING**
DATE OF PATENT CANCELLATION: 2018 04 27
MODEL RESTORATION IS AVAILABLE: 2018 08 10

(21) AU 2016 14128
(11) U 2017 1957 Y
(73) Tsiala Gabelia;
Spartak Urotadze;
Leila Japaridze;
Eter Salukvadze;
Givi Chimakadze;
Nana Osipova;
Tamar Kvernadze
(54) **COMPOSITE PREVENTIVE THERAPEUTIC AGENT AT METAL DEFICIENCY ANEMIA IN ANIMALS**
DATE OF PATENT CANCELLATION: 2018 04 27
MODEL RESTORATION IS AVAILABLE: 2018 08 10

CANCELLATION OF PATENTS

(21) AU 2013 13163

(11) U 2014 1810 Y

(73) Gizo Bokeria

(54) **HERBAL INGREDIENTS FOR LIVER DISEASES TREATMENT**

DATE OF PATENT CANCELLATION: 2018 07 15

PATENT RESTORATION IS AVAILABLE: 2019 07 15

(21) AU 2016 14209

(11) U 2017 1932 Y

(73) Omar Marsagishvili

(54) **EQUIPMENT FOR FORMING "KHINKALI"**

DATE OF PATENT CANCELLATION: 2018 07 18

PATENT RESTORATION IS AVAILABLE: 2019 07 18

TRADEMARKS

RENEWAL OF REGISTRATIONS

(111) M 1998 10053 R2

(156) 1998 07 09

(186) 2028 07 09

(732) SUPRA CORPORATION OF JAPAN

PO Box 860, Tokio 100-91, Japan

(111) M 1998 8235 R2

(156) 1998 02 04

(186) 2028 02 04

(732) FCA US LLC

1000 1000 Chrysler Drive, City of Auburn

Hills, State of Michigan 48326, USA

(111) M 1998 10352 R2

(156) 1998 08 19

(186) 2028 08 19

(732) SANOFI

54 rue La Boétie, 75008 Paris, France

(111) M 1998 10400 R2

(156) 1998 08 20

(186) 2028 08 20

(732) Aventisub LLC

3711 Kennett Pike, Suite 200, Greenville,

Delaware 19807, USA

(111) M 1998 10338 R2

(156) 1998 08 19

(186) 2028 08 19

(732) SANOFI

54 rue La Boétie, 75008 Paris, France

(111) M 1998 10311 R2

(156) 1998 08 19

(186) 2028 08 19

(732) SANOFI

54 rue La Boétie, 75008 Paris, France

(111) M 1998 10470 R2

(156) 1998 08 20

(186) 2028 08 20

(732) SANOFI

54 rue La Boétie, 75008 Paris, France

(111) M 1998 10469 R2

(156) 1998 08 20

(186) 2028 08 20

(732) SANOFI

54 rue La Boétie, 75008 Paris, France

(111) M 1998 10418 R2

(156) 1998 08 20

(186) 2028 08 20

(732) A. NATTERMANN & CIE. GmbH

attermannallee 1, 5000 Koln 30

(Bocklemund), Germany

(111) M 1998 10478 R2

(156) 1998 08 20

(186) 2028 08 20

(732) SANOFI

54 rue La Boétie, 75008 Paris, France

(111) M 1998 10615 R2

(156) 1998 08 27

(186) 2028 08 27

(732) Thuraya Telecommunications Company

Etisalat Toweri, Sheikh Rashid Bin saeed Al

Maktoum street, Abu-Dhabi, United Arab

Emirates

(111) M 1998 10135 R2

(156) 1998 07 31

(186) 2028 07 31

(732) ELECTROLUX ITALYA S.P.A.

Corso Lino Zanussi, 30, 33080 Porcia (PN),

Italy

(111) M 1998 10137 R2

(156) 1998 07 31

(186) 2028 07 31

(732) ELECTROLUX ITALYA S.P.A.

Corso Lino Zanussi, 30, 33080 Porcia (PN),

Italy

(111) M 1998 10713 R2

(156) 1998 09 10

(186) 2028 09 10

(732) Zentiva a.s.

Einsteinova 24, Bratislava 851 01, Slovakia

(111) M 1998 10720 R2

(156) 1998 09 10

(186) 2028 09 10

(732) COLGATE-PALMOLIVE COMPANY
300 Park Avenue, New York, NY 10022,
USA

Strawinskylaan 1229, 1077XX Amsterdam,
Netherlands

(111) M 1998 10728 R2
(156) 1998 09 10
(186) 2028 09 10

(732) COLGATE-PALMOLIVE COMPANY
300 Park Avenue, New York, NY 10022,
USA

(111) M 2008 18649 R1
(156) 2008 07 31
(186) 2028 07 31

(732) Kabushiki Kaisha Hitachi Seisakusho
(d.b.a. Hitachi, Ltd.)
6-6, Marunouchi 1-chome, Chiyoda-ku,
Tokio, Japan

(111) M 1998 10733 R2
(156) 1998 09 11
(186) 2028 09 11

(732) COLGATE-PALMOLIVE COMPANY
300 Park Avenue, New York, NY 10022,
USA

(111) M 2008 18650 R1
(156) 2008 07 31
(186) 2028 07 31

(732) Kabushiki Kaisha Hitachi Seisakusho
(d.b.a. Hitachi, Ltd.)
6-6, Marunouchi 1-chome, Chiyoda-ku,
Tokio, Japan

(111) M 1998 10259 R2
(156) 1998 08 17
(186) 2028 08 17

(732) GILMAR S.P.A.
Via Malpaso 723/725, 47842 San Giovanni
in Marignano, Italy

(111) M 1998 10677 R2
(156) 1998 09 10
(186) 2028 09 10

(732) SANOFI
54 rue La Boétie, 75008 Paris, France

(111) M 2008 18584 R1
(156) 2008 07 11
(186) 2028 07 11

(732) TEQUILA CUERVO, S.A. DE C.V.
Avenida Periferico Sur N 8500, Tlaquepaque,
Jalisco, CP 45601, Mexico

(111) M 1998 10678 R2
(156) 1998 09 10
(186) 2028 09 10

(732) SANOFI
54 rue La Boétie, 75008 Paris, France

(111) M 2008 18585 R1
(156) 2008 07 11
(186) 2028 07 11

(732) TEQUILA CUERVO, S.A. DE C.V.
Avenida Periferico Sur N 8500, Tlaquepaque,
Jalisco, CP 45601, Mexico

(111) M 1998 10259 R2
(156) 1998 08 17
(186) 2028 08 17

(732) GILMAR S.P.A.
Via Malpaso 723/725, 47842 San Giovanni
in Marignano, Italy

(111) M 2008 18587 R1
(156) 2008 07 11
(186) 2028 07 11

(732) TEQUILA CUERVO, S.A. DE C.V.
Avenida Periferico Sur N 8500, Tlaquepaque,
Jalisco, CP 45601, Mexico

(111) M 1998 10443 R2
(156) 1998 08 20
(186) 2028 08 20

(732) L' OREAL
4 Rue Royale, 75008 Paris, France

(111) M 2008 18781 R1
(156) 2008 10 16
(186) 2028 10 16

(732) EFES HOLLAND TECHNICAL AND
MANAGEMENT CONSULTANCY B.V.

(111) M 1998 10444 R2
(156) 1998 08 20
(186) 2028 08 20

(732) L' OREAL
4 Rue Royale, 75008 Paris, France

(111) M 1998 10204 R2
(156) 1998 08 05
(186) 2028 08 05
(732) EVERLAST WORLD'S BOXING
HEADQUARTES CORPORATION
1350 Broadway, New York, NY 10018, USA

(111) M 1998 10205 R2
(156) 1998 08 05
(186) 2028 08 05
(732) EVERLAST WORLD'S BOXING
HEADQUARTES CORPORATION
1350 Broadway, New York, NY 10018, USA

CHANGES IN NAMES AND/OR ADDRESSES OF OWNERS

(111) M 2006 16833 R
(732) LTD "AWI LICENSING COMPANY"
1105 North Market Street, Suite 1300,
Wilmington, Delaware 19801, USA
(770) "AWI LICENSING COMPANY"
(a Delaware corporation)
1105 North Market Street, Suite 1300,
Wilmington, Delaware 19801, USA
(580) 2018 07 16

(111) M 1998 9467 R
(732) Pizza Hut International LLC
7100 Corporate Drive, Plano, Texas 75024,
USA
(770) Pizza Hut International LLC
7100 Corporate Drive, Plano, Texas 75024,
USA
(580) 2018 03 13

(111) M 2012 23018 R
(732) Stiefel Laboratories Inc.
Corporation Service Company
251 Little Falls Drive, Wilmington,
Delaware 19808, USA
(770) Stiefel Laboratories Inc.
Corporation Service Company
2711 Sentervil Roudi, Suit 400,
Uilmingtoni, Shtati Delaveri 19801, USA
(580) 2018 07 16

(111) M 2013 23894 R
(732) Stiefel Laboratories Inc.
Corporation Service Company
251 Little Falls Drive, Wilmington,
Delaware 19808, USA
(770) Stiefel Laboratories Inc.
Corporation Service Company
2711 Sentervil Roudi, Suit 400,
Uilmingtoni, Shtati Delaveri 19801, USA
(580) 2018 07 16

CLASSIFICATION INDEXES

INVENTIONS

CONCORDANCE TABLE OF INTERNATIONAL CLASSIFICATION INDEX AND PUBLICATION NUMBERS

INTERNATIONAL CLASSIFICATION INDEXES (51)	NUMBER OF PUBLISHED APPLICATION (10)
A 61 K 9/14; A 61 K 9/20; C 12 Q 1/68; A 61 K 9/28	AP 2018 14304 A
A 61 K 47/26; A 61 K 9/08; A 61 K 9/10; A 61 K 31/444; A 61 K 47/36; A 61 P 27/00	AP 2018 14194 A
C 07 D 401/14; C 07 D 405/14; C 07 D 401/06; A 61 K 31/47; A 61 P 35/00	AP 2018 14347 A

CONCORDANCE TABLE OF PUBLICATION NUMBERS AND INTERNATIONAL CLASSIFICATION INDEX

NUMBER OF PUBLISHED APPLICATION (10)	INTERNATIONAL CLASSIFICATION INDEXES (51)
AP 2018 14194 A	A 61 K 47/26; A 61 K 9/08; A 61 K 9/10; A 61 K 31/444; A 61 K 47/36; A 61 P 27/00
AP 2018 14304 A	A 61 K 9/14; A 61 K 9/20; C 12 Q 1/68; A 61 K 9/28
AP 2018 14347 A	C 07 D 401/14; C 07 D 405/14; C 07 D 401/06; A 61 K 31/47; A 61 P 35/00

CONCORDANCE TABLE OF INTERNATIONAL CLASSIFICATION INDEX, PATENT NUMBERS AND PUBLICATION NUMBERS

INTERNATIONAL CLASSIFICATION INDEX (51)	NUMBER OF PATENT (11)	NUMBER OF PUBLISHED APPLICATION (10)
C 07 D 401/04; B 01 J 31/02; C 07 D 487/04; A 61 K 31/5517; A 61 P 25/02; A 61 P 25/20; C 07 D 61/00	P 2018 6886 B	AP 2018 13945 A
C 07 D 487/04; A 61 K 31/519; A 61 P 1/00; A 61 P 11/00	P 2018 6885 B	AP 2018 13860 A

CONCORDANCE TABLE OF PATENT NUMBERS, PUBLICATION NUMBERS AND INTERNATIONAL CLASSIFICATION INDEX

NUMBER OF PATENT (11)	NUMBER OF PUBLISHED APPLICATION (10)	INTERNATIONAL CLASSIFICATION INDEX (51)
P 2018 6885 B	AP 2018 13860 A	C 07 D 487/04; A 61 K 31/519; A 61 P 1/00; A 61 P 11/00
P 2018 6886 B	AP 2018 13945 A	C 07 D 401/04; B 01 J 31/02; C 07 D 487/04; A 61 K 31/5517; A 61 P 25/02; A 61 P 25/20; C 07 D 61/00

**CONCORDANCE TABLE OF APPLICATION NUMBERS, PUBLICATION NUMBERS
AND PATENTS**

NUMBER OF APPLICATION (21)	NUMBER OF PUBLISHED APPLICATION (10)	NUMBER OF PATENT (11)
AP 2013 013860	AP 2018 13860 A	P 2018 6885 B
AP 2014 013945	AP 2018 13945 A	P 2018 6886 B

UTILITY MODEL

**CONCORDANCE TABLE OF INTERNATIONAL CLASSIFICATION INDEX
AND PUBLICATION NUMBERS**

INTERNATIONAL CLASSIFICATION INDEXES (51)	NUMBER OF PUBLISHED APPLICATION (10)
B 03 B 7/00	AU 2018 14496

**CONCORDANCE TABLE OF PUBLICATION NUMBERS
AND INTERNATIONAL CLASSIFICATION INDEX**

NUMBER OF PUBLISHED APPLICATION (10)	INTERNATIONAL CLASSIFICATION INDEXES (51)
AU 2018 14496	B 03 B 7/00

**CONCORDANCE TABLE OF INTERNATIONAL CLASSIFICATION INDEX,
PATENT NUMBERS AND PUBLICATION NUMBERS**

INTERNATIONAL CLASSIFICATION INDEX (51)	NUMBER OF PATENT (11)	NUMBER OF PUBLISHED APPLICATION (10)
A 61 K 31/045; A 61 K 25/64; A 61 K 36/00	U 2018 1981 Y	AU 2018 14547 U
A 61 K 33/36; A 01 N 59/22; C 01 G 28/00	U 2018 1979 Y	AU 2018 14175 U
C 12 Q 1/68	U 2018 1980 Y	AU 2018 14454 U
C 25 B 11/04	U 2018 1977 Y	AU 2017 13988 U
C 25 B 11/04	U 2018 1978 Y	AU 2017 13989 U
F 26 B 3/00	U 2018 1982 Y	AU 2018 14407 U

**CONCORDANCE TABLE OF PATENT NUMBERS,
PUBLICATION NUMBERS AND INTERNATIONAL CLASSIFICATION INDEX**

NUMBER OF PATENT (11)	NUMBER OF PUBLISHED APPLICATION (10)	INTERNATIONAL CLASSIFICATION INDEX (51)
U 2018 1977 Y	AU 2017 13988 U	C 25 B 11/04
U 2018 1978 Y	AU 2017 13989 U	C 25 B 11/04
U 2018 1979 Y	AU 2018 14175 U	A 61 K 33/36; A 01 N 59/22; C 01 G 28/00
U 2018 1980 Y	AU 2018 14454 U	C 12 Q 1/68
U 2018 1981Y	AU 2018 14547 U	A 61 K 31/045; A 61 K 25/64; A 61 K 36/00
U 2018 1982Y	AU 2018 14407 U	F 26 B 3/00

**CONCORDANCE TABLE OF APPLICATION NUMBERS, PUBLICATION NUMBERS
AND PATENTS**

NUMBER OF APPLICATION (21)	NUMBER OF PUBLISHED APPLICATION (10)	NUMBER OF PATENT (11)
AU 2015 013988	AU 2017 13988 U	U 2018 1977 Y
AU 2015 013989	AU 2017 13989 U	U 2018 1978 Y
AU 2016 014175	AU 2018 14175 U	U 2018 1979 Y
AU 2017 014407	AU 2018 14407 U	U 2018 1982 Y
AU 2017 014454	AU 2018 14454 U	U 2018 1980 Y
AU 2017 014547	AU 2018 14547 U	U 2018 1981Y

DESIGNS

**CONCORDANCE TABLE OF INTERNATIONAL CLASSIFICATION INDEX
AND PUBLICATION NUMBERS**

INTERNATIONAL CLASSIFICATION INDEXES (51)	NUMBER OF PUBLISHED APPLICATION (10)
07-06	AD 2018 1031 S
09-01	AD 2018 1015 S
14-99	AD 2018 1021 S

**CONCORDANCE TABLE OF PUBLICATION NUMBERS
AND INTERNATIONAL CLASSIFICATION INDEX**

NUMBER OF PUBLISHED APPLICATION (10)	INTERNATIONAL CLASSIFICATION INDEXES (51)
AD 2018 1031 S	07-06
AD 2018 1015 S	09-01
AD 2018 1021 S	14-99

**CONCORDANCE TABLE OF INTERNATIONAL CLASSIFICATION INDEX,
PATENT NUMBERS AND PUBLICATION NUMBERS**

INTERNATIONAL CLASSIFICATION INDEX (51)	NUMBER OF PATENT (11)	NUMBER OF PUBLISHED APPLICATION (10)
03-01	D 2018 773 S	AD 2018 998 S
09-01	D 2018 772 S	AD 2018 1007 S

**CONCORDANCE TABLE OF PATENT NUMBERS,
PUBLICATION NUMBERS AND INTERNATIONAL CLASSIFICATION INDEX**

NUMBER OF PATENT (11)	NUMBER OF PUBLISHED APPLICATION (10)	INTERNATIONAL CLASSIFICATION INDEX (51)
D 2018 772 S	AD 2018 1007 S	09-01
D 2018 773 S	AD 2018 998 S	03-01

**CONCORDANCE TABLE OF APPLICATION NUMBERS, PUBLICATION NUMBERS
AND PATENTS**

NUMBER OF APPLICATION (21)	NUMBER OF PUBLISHED APPLICATION (10)	NUMBER OF PATENT (11)
03-01	AD 2018 998 S	D 2018 773 S
09-01	AD 2018 1007 S	D 2018 772 S

**DESIGN REGISTERED ACCORDING TO THE ACCELERATED
PROCEDURE**

**CONCORDANCE TABLE OF INTERNATIONAL CLASSIFICATION INDEX
AND PUBLICATION NUMBERS**

INTERNATIONAL CLASSIFICATION INDEXES (51)	NUMBER OF PUBLISHED APPLICATION (11)
09-01	D 2018 770 S
09-03	D 2018 771 S

**CONCORDANCE TABLE OF PUBLICATION NUMBERS
AND INTERNATIONAL CLASSIFICATION INDEX**

NUMBER OF PUBLISHED APPLICATION (11)	INTERNATIONAL CLASSIFICATION INDEXES (51)
D 2018 770 S	09-01
D 2018 771 S	09-03

CONCORDANCE TABLE OF APPLICATION NUMBERS,
PUBLICATION NUMBERS AND PATENTS

NUMBER OF APPLICATION (21)	NUMBER OF PATENT (11)
AD 2018 1040	D 2018 771 S
AD 2018 1045	D 2018 770 S

TRADEMARKS

CONCORDANCE TABLE OF REGISTRATION NUMBERS, APPLICATION NUMBERS, PUBLICATION NUMBERS AND BULLETIN NUMBERS

NUMBER OF REGISTRATION (111)	NUMBER OF APPLICATIONS (210)	NUMBER OF PUBLISHED APPLICATIONS (260)	NUMBER OF BULLETIN
M 2018 29907 R	AM 98237	–	15(499)2018
M 2018 29908 R	AM 98382	–	15(499)2018
M 2018 29909 R	AM 98383	–	15(499)2018
M 2018 29910 R	AM 98384	–	15(499)2018
M 2018 29911 R	AM 98385	–	15(499)2018
M 2018 29912 R	AM 98386	–	15(499)2018
M 2018 29913 R	AM 98387	–	15(499)2018
M 2018 29914 R	AM 98388	–	15(499)2018
M 2018 29915 R	AM 98394	–	15(499)2018
M 2018 29916 R	AM 98381	–	15(499)2018
M 2018 29917 R	AM 98239	–	15(499)2018
M 2018 29920 R	AM 89219	AM 2016 89219 A	4(488)2018
M 2018 29921 R	AM 89220	AM 2016 89220 A	4(488)2018
M 2018 29922 R	AM 90695	AM 2017 90695 A	21(481)2017
M 2018 29999 R	AM 98182	–	15(499)2018
M 2018 30000 R	AM 98213	–	15(499)2018
M 2018 30001 R	AM 98423	–	15(499)2018
M 2018 30002 R	AM 98218	–	15(499)2018
M 2018 30003 R	AM 98547	–	15(499)2018
M 2018 30004 R	AM 98557	–	15(499)2018
M 2018 30005 R	AM 98662	–	15(499)2018
M 2018 30006 R	AM 98571	–	15(499)2018
M 2018 30007 R	AM 98445	–	15(499)2018
M 2018 30008 R	AM 98763	–	15(499)2018
M 2018 30009 R	AM 98576	–	15(499)2018
M 2018 30010 R	AM 98577	–	15(499)2018
M 2018 30011 R	AM 98578	–	15(499)2018
M 2018 30012 R	AM 98452	–	15(499)2018

CONCORDANCE TABLE OF PUBLICATION NUMBERS
AND APPLICATION NUMBERS

NUMBER OF PUBLISHED APPLICATION (260)	NUMBER OF APPLICATION (210)
AM 2018 92697 A	AM 92697
AM 2018 92700 A	AM 92700
AM 2018 92783 A	AM 92783
AM 2018 93839 A	AM 93839
AM 2018 94977 A	AM 94977
AM 2018 94978 A	AM 94978
AM 2018 95072 A	AM 95072
AM 2018 95073 A	AM 95073
AM 2018 95081A	AM 95081
AM 2018 95095 A	AM 95095
AM 2018 95214 A	AM 95214
AM 2018 95353 A	AM 95353
AM 2018 95406 A	AM 95406
AM 2018 95480 A	AM 95480
AM 2018 95486 A	AM 95486
AM 2018 95551 A	AM 95551
AM 2018 95655 A	AM 95655
AM 2018 95660 A	AM 95660
AM 2018 95920 A	AM 95920
AM 2018 95984 A	AM 95984
AM 2018 95986 A	AM 95986
AM 2018 96005 A	AM 96005
AM 2018 96077 A	AM 96077
AM 2018 96078 A	AM 96078
AM 2018 96117 A	AM 96117
AM 2018 96158A	AM 96158

CONCORDANCE TABLE OF INDEX OF GOODS AND/OR SERVICES
AND APPLICATION NUMBERS

INDEX OF GOODS AND/OR SERVICES (511)	NUMBER OF PUBLISHED APPLICATIONS (26)	1	2
1	2		
1	AM 2018 96078 A	19	AM 2018 96077 A
2	AM 2018 96077 A	19	AM 2018 96078 A
2	AM 2018 96078 A	20	AM 2018 96077 A
3	AM 2018 95406 A	20	AM 2018 96078 A
3	AM 2018 96077 A	21	AM 2018 96077 A
3	AM 2018 96078 A	21	AM 2018 96078 A
4	AM 2018 96077 A	22	AM 2018 96077 A
4	AM 2018 96078 A	22	AM 2018 96078 A
5	AM 2018 92697 A	23	AM 2018 96077 A
5	AM 2018 92700 A	23	AM 2018 96078 A
5	AM 2018 95214 A	24	AM 2018 96077 A
5	AM 2018 95406 A	24	AM 2018 96078 A
5	AM 2018 96078 A	25	AM 2018 95986 A
6	AM 2018 96077 A	25	AM 2018 96077 A
6	AM 2018 96078 A	25	AM 2018 96078 A
7	AM 2018 96077 A	26	AM 2018 96077 A
7	AM 2018 96078 A	26	AM 2018 96078 A
7	AM 2018 96158 A	27	AM 2018 96077 A
8	AM 2018 95081 A	27	AM 2018 96078 A
8	AM 2018 96077 A	28	AM 2018 96077 A
8	AM 2018 96078 A	28	AM 2018 96078 A
9	AM 2018 95095 A	29	AM 2018 96077 A
9	AM 2018 96078 A	29	AM 2018 96078 A
10	AM 2018 96077 A	29	AM 2018 95984 A
10	AM 2018 96078 A	30	AM 2018 93839 A
11	AM 2018 96077 A	30	AM 2018 96078 A
11	AM 2018 96078 A	30	AM 2018 95984 A
11	AM 2018 96158 A	31	AM 2018 96077 A
12	AM 2018 95353 A	31	AM 2018 96078 A
12	AM 2018 95655 A	31	AM 2018 95984 A
12	AM 2018 96078 A	32	AM 2018 96077 A
12	AM 2018 96158 A	32	AM 2018 96078 A
13	AM 2018 96077 A	33	AM 2018 95480 A
13	AM 2018 96078 A	33	AM 2018 95920 A
14	AM 2018 96078 A	33	AM 2018 96077 A
15	AM 2018 96077 A	33	AM 2018 96078 A
15	AM 2018 96078 A	34	AM 2018 92783 A
16	AM 2018 96077 A	34	AM 2018 95486 A
16	AM 2018 96078 A	34	AM 2018 95551 A
17	AM 2018 96077 A	34	AM 2018 96077 A
17	AM 2018 96078 A	34	AM 2018 96078 A
18	AM 2018 96077 A	34	AM 2018 96117 A
18	AM 2018 96078 A	35	AM 2018 94977 A
		35	AM 2018 94978 A
		35	AM 2018 95660 A
		35	AM 2018 96078 A
		35	AM 2018 96158 A
		36	AM 2018 95072 A

1	2
36	AM 2018 96077 A
36	AM 2018 96078 A
37	AM 2018 96078 A
38	AM 2018 96077 A
38	AM 2018 96078 A
39	AM 2018 96077 A
39	AM 2018 96078 A
40	AM 2018 96077 A
40	AM 2018 96078 A
41	AM 2018 96077 A

1	2
41	AM 2018 96078 A
42	AM 2018 96077 A
42	AM 2018 96078 A
43	AM 2018 96077 A
43	AM 2018 96078 A
44	AM 2018 95073 A
44	AM 2018 96078 A
44	AM 2018 96005 A
45	AM 2018 96077 A
45	AM 2018 96078 A

CONCORDANCE TABLE OF INDEX OF GOODS AND/OR SERVICES
AND NUMBERS OF TRADEMARKS REGISTERED ACCORDING
TO THE ACCELERATED PROCEDURE

INDEX OF GOODS AND/OR SERVICES (511)	NUMBERS OF REGISTERED ACCORDING TO THE ACCELERATED PROCEDURE (111)
5	M 2018 30002 R
5	M 2018 30003 R
9	M 2018 30008 R
10	M 2018 29912 R
11	M 2018 29907 R
12	M 2018 29907 R
32	M 2018 30007 R
32	M 2018 29917 R
32	M 2018 29999 R
32	M 2018 30007 R
32	M 2018 30009 R
32	M 2018 30010 R
32	M 2018 30011 R
33	M 2018 30007 R
33	M 2018 30001 R
33	M 2018 30007 R
34	M 2018 29916 R
34	M 2018 29908 R
34	M 2018 29909 R
34	M 2018 29910 R
34	M 2018 29911 R
34	M 2018 29912 R
34	M 2018 29913 R
34	M 2018 29914 R
34	M 2018 30004 R
35	M 2018 30005 R
35	M 2018 30008 R
35	M 2018 29907 R
39	M 2018 30000 R
41	M 2018 30006 R
43	M 2018 29915 R

OFFICIAL BULLETIN OF THE INDUSTRIAL PROPERTY

**INVENTIONS
UTILITY MODELS
DESIGNS
TRADEMARKS**

APPELLATIONS OF ORIGIN AND GEOGRAPHICAL INDICATIONS OF GOODS

15(499)

EDITOR-IN-CHIEF: N. Bebrishvili

EDITOR-TRANSLATOR: E. Gabunia

PROOFREADER: A. Shikhashvili

COMPUTER LAYOUT: M. Ordenidze
K. Svanidze

www.sakpatenti.gov.ge
E-mail: info@sakpatenti.org.ge