

Official Bulletin of the Industrial Property

Inventions

Utility Models

Designs

Trademarks



საქართველოს ინტელექტუალური
საკუთრების ეროვნული ცენტრი

საქპატენტი

SAKPATENTI

NATIONAL INTELLECTUAL PROPERTY
CENTER OF GEORGIA

www.sakpatenti.gov.ge

Date of Publication – 2021 09 10

16(572)

INID CODES FOR IDENTIFICATION OF BIBLIOGRAPHIC DATA

INVENTIONS, UTILITY MODELS

- (10) Number of publication for application, which has been examined
- (11) Number of patent and kind of document
- (21) Serial number of application
- (22) Date of filing of the application
- (23) Date of exhibition or the date of the earlier filing and the number of application, if any
- (24) Date from which patent may have effect
- (31) Number of priority application
- (32) Date of filing of priority application
- (33) Code of the country or regional organization allotting priority application number
- (44) Date of publication of application not granted, but examined and number of bulletin
- (45) Date of publication of registered document
- (51) International Patent Classification Index

- (54) Title of the invention
- (57) Abstract
- (60) Number of examined patent document granted by foreign patent office, date from which patent has effect and country code
- (62) Number of the earlier application and in case of divided application, date of filing an application
- (71) Name, surname and address of applicant (country code)
- (72) Name, surname of inventor (country code)
- (73) Name, surname and address of patent owner (country code)
- (74) Name, surname of representative or patent attorney
- (85) Date of commencement of the national phase of International Application
- (86) Number and date of filing of international application
- (87) Number and date of publication of international application
- (94) Calculated date of expiry of the SPC or the duration of the SPC

DESIGNS

- (10) Number of publication for application
- (11) Number of patent and kind of document or number of registration
- (15) Date of registration/Date of patent renewal
- (18) Expected expiration date of patent or registration
- (21) Serial number of application
- (22) Date of filing of the application
- (23) Date of exhibition or the date of the earlier filing and the number of application, if any
- (24) Date from which patent may have effect
- (28) Number of designs included in the application
- (30) Data relating to priority (number of application, date of filing of application, two-letter code identifying the authority with whom the priority application was made)
- (31) Number of priority application
- (32) Date of filing of priority application
- (33) Code of the country or regional organization allotting priority application number
- (34) Two-letter code according to WIPO St.3 identifying the authority with which the priority application was made
- (44) Date of publication of design and number of bulletin (the first publication)
- (45) Date of publication of design registered by WIPO and number of bulletin

- (51) International Classification for designs (class and subclass of the Locarno Classification)
- (54) Title of the invention
- (55) Reproduction of the design
- (57) Description of characteristic features of the design including indication of colors
- (58) Date of recording of any kind of amendment in the Register
- (62) Number of the earlier application, registration and document number and if available the date of filing an application in case of divided application
- (71) Name, surname and address of applicant (country code)
- (72) Name, surname of creator (country code)
- (73) Name, surname and address of patent owner (country code)
- (74) Name, surname of representative or patent attorney
- (81) Contracting states concerned
 - II designated contracting states according to the 1960 Act
 - III designated contracting states according to the 1999 Act
- (85) Owner's permanent address
- (86) Owner's nationality
- (87) Owner's residence
- (88) State in which the owner has a real and effective industrial or commercial establishment

TRADEMARKS

- (111) - Number of registration
- (151) - Date of registration
- (156) - Date of the renewal
- (181) - Expected expiration date of registration
- (186) - Renewal expiration date of registration
- (141) - Date of cancel of duration of the mark
- (210) - Serial number of application
- (220) - Date of filing of the application
- (230) - Data concerning exhibition
- (260) - Number of application, for which favorable decision of examination about registration has been taken (publication number)
- (310) - Number of the first application
- (320) - Date of filing of the first application
- (330) - Code, identifying national or regional Office where the first application was made
- (511) - International Classification of Goods and Services for the purposes of registration of trade marks and/or list of goods and/or services classified according thereto
- (526) - Disclaimer
- (531) - Description of figurative elements of Trade Marks according to the International Classification of the Figurative Elements of Marks

- (540) - Reproduction of Trade Mark
- (550) - Nature and kind of Trade Mark
- (551) - Indication to the effect that the mark is a collective mark, a certification mark or a guarantee mark
- (554) - Three-dimensional mark
- (580) - Date of recording of any kind changes in respect of applications or registrations
- (591) - Information concerning colors claimed
- (731) - Name and address of the applicant
- (732) - Name and address of the holder of the registration
- (740) - Name and address of the representative
- (750) - Addreses for correspondence
- (770) - Name and address of the previous applicant or holder in case of change in ownership
- (771) - Previous name and address of the applicant or holder in case of change in ownership
- (791) - Name and address of the licensee
- (793) - Indication of conditions and/or restrictions under the license (Type of license, number of license agreement, data of license, data of validity of license)
- (800) - Certain data relating to the international registration of Trade Marks under the Protocol Relating to Madrid Agreement (International registration number
- (852) - Partial cancellation of the list of goods and services
- (891) - Date of subsequent designation

CODES FOR PUBLICATION IN BULLETIN

- (21) AP 0000 000000 - serial number of application for invention
- (10) AP 0000 0000 A - number of published application for invention (first publication)
- (11) P 0000 0000 B - number of patent for invention (second publication)
- (21) API 0000 000000 - number of application for imported patent
- (11) PI 0000 0000 A - number of imported patent (first publication)
- (21) AU 0000 000000 - serial number of application for utility model
- (10) AU 0000 000 U - number of published application for utility model (first publication)
- (11) U 0000 000 Y - number of patent for utility model (second publication)
- (21) AD 0000 000000 - serial number of application for design
- (10) AD 0000 000 S - number of published application for design (first publication)
- (11) D 0000 000 S - registered design

INTERNATIONAL PATENT CLASSIFICATION FOR INVENTIONS AND UTILITY MODELS

- SECTION A - HUMAN NECESSITIES
- SECTION B - PERFORMING OPERATIONS; TRANSPORTING
- SECTION C - CHEMISTRY; METALLURGY
- SECTION D - TEXTILES; PAPER
- SECTION E - FIXED CONSTRUCTIONS
- SECTION F - MECHANICAL ENGINEERING; LIGHTING; HEATING; WEAPONS; BLASTING
- SECTION G - PHYSICS
- SECTION H - ELECTRICITY

-
- M - Trade Mark
 - (210) AM 0000 000000 - Serial number of application;
 - (260) AAM 0000 00000 A - Publication number of application;
 - (111) M 0000 00000 R - Number of registration;
 - (111) MMM0000 00000 Rn - Number of renewals, in which n=1,2,3;
 - (111) M 0000 00000 R(P) - Number of registration under partial assignment of rights
-

Official Bulletin of the Industrial Property

Inventions

Utility Models

Designs

Trademarks

CONTENTS

PUBLISHED TITLES OF PROTECTION	3
INVENTIONS	
▪ APPLICATIONS APPROVED FOR GRANTING PATENT	4
▪ PATENTED INVENTIONS	7
UTILITY MODELS	
▪ APPLICATION APPROVED FOR GRANTING PATENT	8
▪ PATENTED UTILITY MODEL	9
DESIGNS	
▪ APPLICATION APPROVED FOR REGISTRATION	10
▪ REGISTERED DESIGNS	11
▪ DESIGNS, WICH HAVE BEEN REGISTERED WITH THE INTERNATIONAL BUREAU CLAIMING PRIORITY ON THE TERRITORY OF GEORGIA	12
TRADEMARKS	
▪ APPLICATIONS FILED UNDER THE NATIONAL PROCEDURE APPROVED FOR REGISTRATION	47
▪ REGISTERED TRADEMARKS	57
▪ TRADEMARKS REGISTERED ACCORDING TO THE ACCELERATED PROCEDURE	61
▪ INTERNATIONAL TRADEMARKS FOR WHICH A DECISION ON GRANTING PROTECTION IS TAKEN	64
▪ INTERNATIONAL TRADEMARKS PROTECTED IN GEORGIA	92
OFFICIAL NOTIFICATIONS	
INVENTIONS	
▪ EXPIRATION OF PATENT RESTORATION	97
▪ ABOLITION OF PATENTS WITH THE RIGHT TO RESTORE	97
▪ EXPIRATION OF TERM OF RESTORATION OF PATENT	98
UTILITY MODELS	
▪ EXPIRATION OF PATENT RESTORATION	99
▪ ABOLITION OF PATENTS WITH THE RIGHT TO RESTORE	99
▪ EXPIRATION OF TERM OF RESTORATION OF PATENT	100
DESIGNS	
▪ EXTENSION OF REGISTRATION OF DESIGNS	100
▪ CANCELLATION OF REGISTRATIONS OF DESIGNS	101
▪ EXTENSION OF REGISTRATION OF INTERNATIONAL DESIGNS	101
TRADEMARKS	
▪ RENEWAL OF REGISTRATIONS	105
▪ COMPLET TRANSFER OF RIGHTS	106
▪ CHANGES OF NAMES AND/OR ADDRESSES OF OWNER	109
▪ CANCELLATION OF TRADEMARKS REGISTRATIONS	113
▪ REGISTRATION OF LICENSE AGREEMENTS	116
▪ INTERNATIONAL LICENSE AGREEMENTS	117
CLASSIFICATION INDEXES	
INVENTIONS	118
UTILITY MODELS	119
DESIGNS	120
TRADEMARKS	122

PUBLISHED TITLES OF PROTECTION

INVENTIONS

- **APPLICATION APPROVED FOR GRANTING PATENT:**
15318; 15474; 15258; 15347; 12996; 15149; 14863; 15196
- **PATENTED INVENTIONS:**
7289, 7290

UTILITY MODELS

- **APPLICATION APPROVED FOR GRANTING PATENT:**
15417
- **PATENTED UTILITY MODEL:**
2095

DESIGNS

- **APPLICATION APPROVED FOR REGISTRATION:**
1214
- **REGISTERED DESIGNS:**
903, 904
- **DESIGNS, WHICH HAVE BEEN REGISTERED WITH THE INTERNATIONAL BUREAU CLAIMING PRIORITY ON THE TERRITORY OF GEORGIA:**
213688; 211854; 214503; 211855; 214747; 211920; 214874; 412922; 214876; 212043; 214862; 214880

TRADEMARKS

- **APPLICATIONS FILED UNDER THE NATIONAL PROCEDURE APPROVED FOR REGISTRATION:**
98568*, 98569*; 109763; 110482; 110528; 110602; 110749; 111062; 111339; 111412; 111414; 111418-111421; 111428; 111435; 111446; 111497; 111519; 111525; 111526; 111541; 111586; 111587; 111604; 111607; 111610; 111615; 111617; 111693; 111698; 111703; 111705; 111709-111711; 111719; 111724-111726; 111731; 111733; 111740; 111742; 111744-111756; 111845
- **REGISTERED TRADEMARKS:**
34447-34485
- **TRADEMARKS REGISTERED ACCORDING TO THE ACCELERATED PROCEDURE:**
34434-34446
- **INTERNATIONAL TRADEMARKS FOR WHICH A DECISION ON GRANTING PROTECTIONS IS TAKEN:**
108043*; 108453*; 109653*; 110082; 110500-110503; 110552; 110565-110567; 110569; 110572, 110573; 110577; 110597; 110628-110630; 110699, 110700; 110707, 110708; 110713-110715; 110730; 110732; 110828; 110829; 110840; 110844-110849; 110851, 110852; 110895-110897; 110899; 110915; 110917, 110918; 110926; 110929; 110931, 110932; 110982-110984; 111013; 111033; 111035-111039; 111094-111096; 111102-111106; 111137-111142; 111144, 111145
- **INTERNATIONAL TRADEMARKS PROTECTED IN GEORGIA:**
109102; 109169; 109240-109242; 109244, 109245; 109250-109254; 109280, 109281; 109284, 109285; 109311, 109312; 109314-109318; 109320; 109326, 109327; 109331-109335; 109390; 109393, 109394; 109409-109413; 109419, 109420; 109422, 109423; 109425-109427; 109441; 109443; 109485-109490; 109574-109576; 109652; 109654; 109723, 109724

INVENTIONS

APPLICATIONS APPROVED FOR GRANTING PATENT

The decision can be appealed at the Chamber of Appeal of Sakpatenti within 3 months from the publication or at the Mtskheta District Court Administrative Cases Board (Address: №17, Samkhedro St., Mtskheta), within 1 month following the publication.

PART A

A 61

- (10) AP 2021 15318 A (51) Int. Cl. (2006)
A 61 K 39/00
A 61 K 9/16
- (21) AP 2018 15318 (22) 2018 09 11
- (31) 17192260.2
- (32) 2017 09 20
- (33) EP
- (71) Tillotts Pharma AG (CH)
Baslerstrasse 15, Rheinfelden 4310,
Switzerland (CH)
- (72) BRAVO, Roberto (CH);
WETZEL, Carmen (CH);
VARUM, Felipe (CH);
VON ROCHOW, Laetitia (CH)
- (74) Tamar Kochlamazashvili
- (85) 2020 04 16
- (86) PCT/EP2018/074520, 2018 09 11
- (54) PREPARATION OF SOLID DOSAGE
FORMS COMPRISING ANTIBODIES BY
SOLUTION/SUSPENSION LAYERING
- (57) Present invention relates to a method for
preparing immediate and sustained release solid
dosage forms comprising antibodies and functional
fragments thereof.
- Claims: 1 independent
16 dependents
- Fig.: 11

PART B

B 66

- (10) AP 2021 15474 A (51) Int. Cl. (2006)
B 66 D 5/26
- (21) AP 2020 15474 (22) 2020 10 20
- (71) Simon Bitsadze (GE)
Pekini St. 31g, app. 29, 0160, Tbilisi,
Georgia (GE);
Rusudan Bitsadze (GE)
Pekini St. 31g, app. 29, 0160, Tbilisi,
Georgia (GE)

- (72) Simon Bitsadze (GE);
Rusudan Bitsadze (GE)
- (54) MAGNETIC HYDRAULIC PUSHER
HAVING MEMBRANE

(57) A pusher includes a case 1 executed as hydro-cylinders of various diameters connected together; at that, piston 9 rod 10 placed into small diameter hydrocylinder is executed connectable to execution mechanism and electromagnetic anchor 4 placed into large diameter cylinder 3 placed inside of current power electromagnetic reel 2, is hingedly connected to a membrane 6 hinged into the case, and the area above the membrane is connected to the area 9 bellow piston rod with anchor- 11 and core 12 holes; at that, the area above piston rod is connected to the area bellow the membrane with a tube 14 and regulating valve 15, and the area above the membrane is connected to the areas above piston rod and bellow the membrane with one-way valve 13, as well; at that, anchor 4 upper part is ended with interdirect ridges 5 taggable to electromagnetic core.

Claims: 1 independent
Fig.: 2

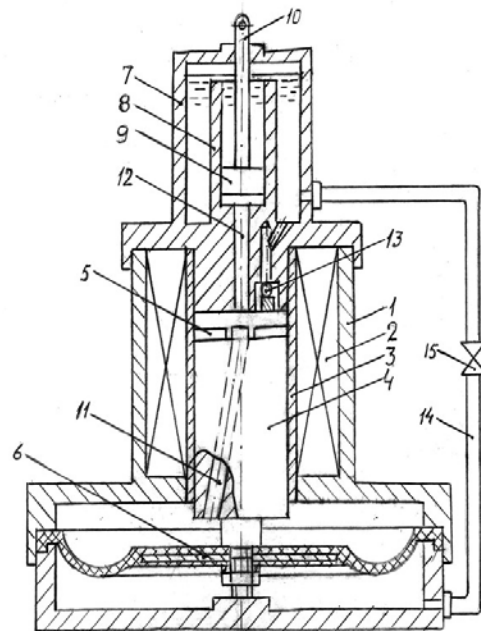

Fig. 1

PART C**C 07**

- (10) AP 2021 15258 A (51) Int. Cl. (2006)
C 07 D 213/75
C 07 D 295/205
- (21) AP 2018 15258 (22) 2018 06 29
(31) 62/527,174; 62/664,363
(32) 2017 06 30; 2018 04 30
(33) US; US
(71) Amgen Inc. (US)
One Amgen Center Drive, Thousand Oaks,
CA 91320-1799, USA (US)
- (72) ROOSEN, Philipp (US);
COSBIE, Andrew (US);
NEERGUNDA, Archana (US);
SHI, Xianqing (US);
WANG, Fang (US);
WU, Zufan (US);
QUAN, Bin, Peter (US);
CAILLE, Sebastien (US);
QUASDORF, Kyle (US);
GUAN, Lianxiu (US)
- (74) Shalva Gvaramadze
(85) 2020 01 14
(86) PCT/US2018/040176, 2018 06 29
- (54) SYNTHESIS OF OMECAMTIV MECARBIL
(57) Present invention relates to novel intermediate compounds – piperazine methyl carboxylate (PMEC) phosphate hydrate, and methyl-4-(2-fluorine-3-nytro benzyl) piperazine-1-carboxylate, intended for omecamtiv mecarbil synthesis, and preparation methods thereof.
Claims: 4 independents
10 dependents
Fig.: 3
-
- (10) AP 2021 15347 A (51) Int. Cl. (2006)
C 07 C 273/04
B 01 D 19/00
B 01 D 5/00
C 07 C 273/14
F 28 D 7/06
F 28 F 21/08
F 28 F 9/02
- (21) AP 2018 15347 (22) 2018 10 26
(31) 17198990.8
(32) 2017 10 27
(33) EP
(71) Stamicarbon B.V. (NL)
Mercator 3, Sittard NL-6135 KW,
Netherlands (NL)
(72) POPA, Dorin (NL)
(74) Liliana Darakhvelidze
(85) 2020 05 25
(86) PCT/NL2018/050711, 2018 10 26

(54) HIGH PRESSURE CARBAMATE CONDENSER

(57) Described are high pressure carbamate condenser, urea plant, and urea production process. High pressure carbamate condenser as described is of shell-and-tube heat exchanger type with tube bundle and has redistribution chamber connected to tubes of the tube bundle and to a duct. The duct extends between redistribution chamber and the shell.

Claims: 3 independents
18 dependents

Fig.: 3

(10) AP 2021 12996 A (51) Int. Cl. (2006)
C 07 D 498/00

(21) AP 2011 12996 (22) 2011 07 12

(31) 61/363,609; 61/419,056

(32) 2010 07 12; 2010 12 02

(33) US; US

(71) Salix Pharmaceuticals LTD (US)
8510 Colonnade Center Dr. Raleigh, North
Carolina 27615 (US)

(72) SELBO, Jon (CN);
TENG, Jing (CN);
KABIR, Mohammed, A. (US);
GOLDEN, Pam (US)

(74) Tamar Kochlamazashvili

(85) 2013 02 11

(86) PCT/US2011/043769, 2011 07 12

(54) FORMULATIONS OF RIFAXIMIN
AND USES THEREOF

(57) Solid dispersion form comprises rifaximin, and one or more polymer selected from the following group: hydroxypropyl methylcellulose phthalate (HPMC-P), and hydroxypropyl methylcellulose acetate succinate (HPMC-AS).

Claims: 8 independents
34 dependents

Fig.: 87

PART E**E 06**

(10) AP 2021 15149 A (51) Int. Cl. (2006)
E 06 B 11/02

(21) AP 2019 15149 (22) 2019 07 22

(71) Avtandil Kistauri (GE)
Vill. Ghulelebi, Tianeti Region, Georgia (GE)

(72) Avtandil Kistauri (GE)

(54) ROLLING GOOR

(57) A door is disclosed, wherein a guide 8 is fixed onto movable part 1 therefor resting and moving on

bearing supports 9 and 10. Executing front support function at its motion between locked and semi-open conditions the pole 6 is mounted thereon movable longitudinal. Accepting support 7 is fixed nearby front edge of opening for pole front (basic) part excepting and fixation. A construction includes managing equipment providing pole 6 basic part immobile disposition in accepting support 7 at door movable 1 part motion between locked and semi-open conditions, and accept and transform its motion into pole 6 motion faster in twice in same direction at the motion thereof.

Claims: 1 independent

Fig.: 3

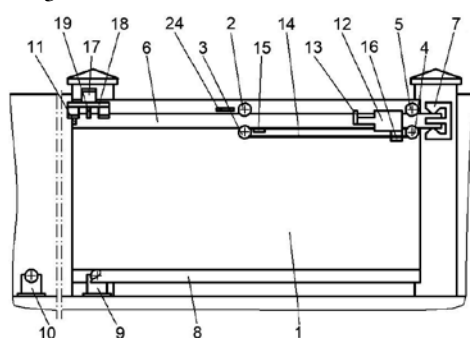

Fig. 1

PART G

G 01

(10) AP 2021 15196 A (51) Int. Cl. (2006)
G 01 N 27/12

(21) AP 2019 15196 (22) 2019 10 15

(71) Georgian Technical University (GE)
M. Kostava St. 77, 0175, Tbilisi, Georgia (GE)

(72) Iuri Khutashvili (GE);
Archil Prangishvili (GE);
Nugzar Iashvili (GE)

(74) Givi Sibashvili

(54) GAS DETECTOR

(57) Gas detector is disclosed, wherein it includes a sensor, semiconductor whereof is one side of semicable, and a resistor is another; a controller, and a transformer as operating amplifier. Range switch is switched parallel of resistor, and managing entrance thereof is connected to another exit of controller.

Claims: 1 independent

1 dependent

Fig.: 2

E 21

(10) AP 2021 14863 A (51) Int. Cl. (2006)
E 21 B 43/295

E 21 B 43/24

(21) AP 2017 14863 (22) 2017 02 07

(31) 62/292,556

(32) 2016 02 08

(33) US

(71) Proton Technologies Inc. (VG)
Wickams Cay I, Rd. Town, Tortola,
British Virgin Islands (VG)

(72) GATES, Ian D. (CA);
WANG, Jingyi (CA)

(74) Shalva Gvaramadze

(85) 2018 08 22

(86) PCT/CA2017/050135, 2017 02 07

(54) IN-SITU PROCESS TO PRODUCE
HYDROGEN FROM UNDERGROUND
HYDROCARBON RESERVOIRS

(57) Hydrocarbon reservoir is treated with heat to induce gasification, water-gas shift, and/or aquathermolysis reactions to generate gases including hydrogen. Hydrogen alone is produced to the surface by using only hydrogen-membranes containing palladium copper or palladium silver alloy, in the production wells.

Claims: 2 independents

7 dependents

Fig.: 24

PATENTED INVENTIONS**PART A****A 61**

- (11) P 2021 7290 B (51) Int. Cl. (2006)
A 61 K 39/395
A 61 K 45/06
C 07 K 16/40
- (10) AP 2021 14848 A (44) 8(564)/2021
(21) AP 2017 14848
(22) 2017 01 05
(24) 2017 01 05
(31) 62/275,025; 62/407,979
(32) 2016 01 05; 2016 10 13
(33) US; US
(86) PCT/US2017/012345, 2017 01 05
(73) University Of Leicester (GB)
University Rd., Leicester, Leicestershire,
LE1 7RF, United Kingdom (GB);
Omeros Corporation (US)
201 Elliott Ave. West, Seattle,
WA 98119, USA (US)
- (72) BRUNSKILL, Nigel, John (GB);
DEMOPULOS, Gregory, A. (US);
DUDLER, Thomas (US);
SCHWAEUBLE, Hans-Wilhelm (GB)
- (74) Tamar Kochlamazashvili
(54) MASP-2 ANTIBODIES FOR INHIBITING
FIBROSIS
-

PART F**F 03**

- (11) P 2021 7289 B (51) Int. Cl. (2006)
F 03 G 7/08
- (10) AP 2021 15188 A (44) 7(563)/2021
(21) AP 2019 15188
(22) 2019 09 27
(24) 2019 09 27
(73) Guram Topuria (GE)
Bakuriani St. 10, 0171, Tbilisi, Georgia (GE)
- (72) Guram Topuria (GE)
(54) MECHANICAL MINI POWER STATION
-

UTILITY MODELS

APPLICATION APPROVED FOR GRANTING PATENT

The decision can be appealed at the Chamber of Appeal of Sakpatenti within 3 months from the publication or at the Mtskheta District Court Administrative Cases Board (Address: №17, Samkhedro St., Mtskheta), within 1 month following the publication.

PART A

A 61

(10) AU 2021 15417 U (51) Int. Cl. (2006)

A 61 B 17/11

(21) AU 2020 15417 (22) 2020 08 21

(71) Mikheil Kotishadze (GE)

Nikea St. Lane II, 6/5, Kutaisi, Georgia (GE)

(72) Mikheil Kotishadze (GE)

(54) VASCULAR TRANSMISSION SYSTEM

(57) A system consists of guide component executed as a fixator and cylindrical arbor pressing down blood vessel 1 onto the fixator including two engaging nodes 2 and 3 executed fixable on relevant ends of blood vessel binder. Each node has cylindrical case, and penetrating hole 4 defined by central axis, engaging nodes are equipped with fixators to be bound together, one wherefrom is executed as stems 5 directed along the axis, and disposed on one of engaging node 2, and another one is executed on another engaging node 3, and it is acceptor and locker 9, each engaging node has blood vessel fixator disposed on each node cylindrical case penetrating hole inner surfaces 4, and is executed as miniature flexible needles 6 inclined relative to cylindrical case geometrical axis, each needle length is less than the sum of adventitial lining thickness and muscular layer.

Claims: 1 independent

3 dependents

Fig.: 5

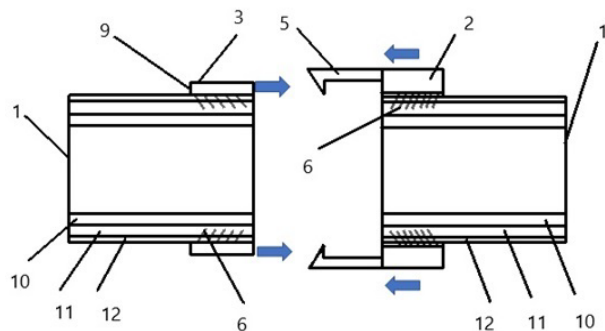

Fig. 4

PATENTED UTILITY MODEL**PART C****C 04**

- (11) U 2021 2095 Y (51) Int. Cl. (2006)
C 04 B 28/36
- (10) AU 2021 15249 U (44) 8(564)/2021
- (21) AU 2019 15249
- (22) 2019 12 24
- (24) 2019 12 24
- (73) Ibragim Zhaksimbetov (KZ)
15th Mkr., H. 80, 130000, Mangystau Region,
Aktau, Kazakhstan (KZ);
Oleg Tashkalov (KZ)
12th Mkr., H. 80, app. 73, 130000, Mangystau
Region, Aktau, Kazakhstan (KZ)
- (72) Ibragim Zhaksimbetov (KZ);
Oleg Tashkalov (KZ)
- (74) Khatuna Imnadze
- (54) METHOD FOR SULFUR CEMENT
PRODUCTION
-

DESIGNS

APPLICATION APPROVED FOR REGISTRATION

The decision can be appealed at the Chamber of Appeal of Sakpatenti within 3 months from the publication or at the Mtskheta District Court Administrative Cases Board (Address: №17, Samkhedro str., Mtskheta), within 1 month following the publication.

- (10) AD 2021 1214 S (51) 09-01
- (21) AD 2021 1214 (22) 2021 04 24
- (28) 2
- (71) LTD "Alazani Winery" (GE)
Demetre Tavaddebuli St. 3, 4800, Kvareli, Georgia (GE)
- (72) Giorgi Zautashvili (GE)
- (74) Giorgi Kartvelishvili (GE)
- (54) BOTTLE
- (55)



1.1



2.1

REGISTERED DESIGNS

(11) D 2021 903 S (51) 06-03
(10) AD 2021 1196 S (44) 2021 05 25 №9
(21) AD 2020 1196
(22) 2020 12 18
(24) 2020 12 18
(28) 1
(18) 2025 12 18
(73) Vardo Makharashvili (GE)
 Vill. Jighaura, 3300, Mtskheta, Georgia (GE)
(72) Vardo Makharashvili (GE)
(54) WOODEN TABLE

(11) D 2021 904 S (51) 24-02
(10) AD 2021 1197 S (44) 2021 05 25 №9
(21) AD 2020 1197
(22) 2020 12 23
(24) 2020 12 23
(28) 1
(18) 2025 12 23
(31) 30-2020-0029223
(32) 2020 06 26
(33) KR
(73) LG CHEM, LTD (KR)
 128, Yeoui-daero, Yeongdeungpo-gu, Seoul,
 07336, Republic of Korea (KR)
(72) LEE, Hye Won (KR)
(74) Tamar Kochlamazashvili (GE)
(54) PLUNGER ROD AND FINGER GRIP FOR
 SYRINGE

DESIGNS, WHICH HAVE BEEN REGISTERED WITH THE INTERNATIONAL BUREAU CLAIMING PRIORITY ON THE TERRITORY OF GEORGIA

The decision can be appealed at the Chamber of Appeal of Sakpatenti within 3 months from the publication or at the Mtskheta District Court Administrative Cases Board (Address: №17, Samkhedro St., Mtskheta), within 1 month following the publication.

- (11) DM/213 688
- (15) 2020 12 11
- (22) 2020 12 11
- (28) 1
- (30) No1: 06.12.2020; 29/737,985; US
- (73) AMBULANT INC.
360 SW Bond St. Ste 310, 97702 Bend, OR (US)
- (85) US
- (86) US
- (87) US
- (88) US
- (89) US
- (81) III. AL, AM, AZ, BA, BG, BN, BW, BX, BZ, CA, CH, DE, DK, EE, EG, EM, ES, FI, FR, GB, GE, GH, HR, HU, IL, IS, JP, KG, KH, KP, KR, LI, LT, LV, MC, MD, ME, MK, MN, MX, NA, NO, OA, OM, PL, RO, RS, RU, RW, SG, SI, SM, SR, ST, SY, TJ, TM, TN, TR, UA, VN, WS
- (72) Joseph Cole MCGOWAN
360 SW Bond St. Ste 310, 97702, Bend, OR (US)
- (74) MASCHOFF BRENNAN/Jason W. Croft
1389 Center Drive, Suite 300, 84098 Park City, UT (US)
- (54) 1. Case for mobile device
- (55)

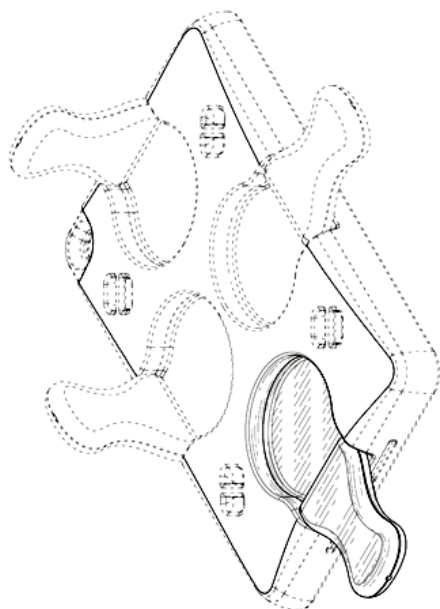

1.1

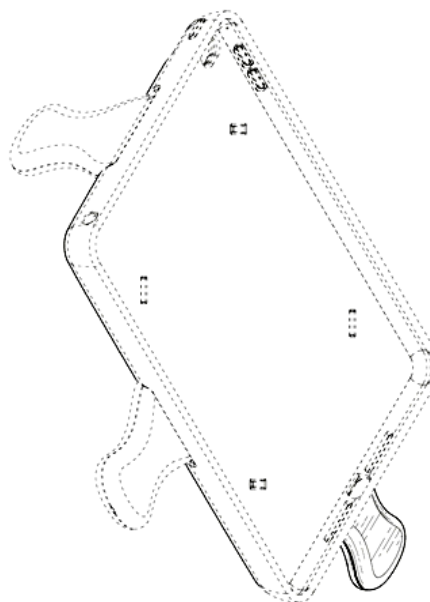

1.2

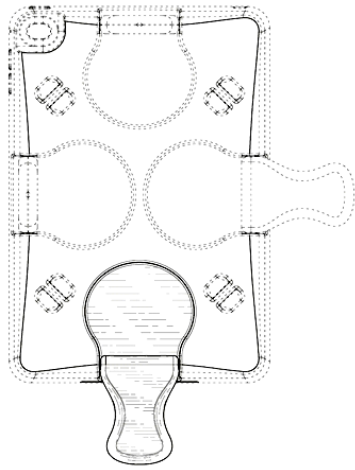

1.3

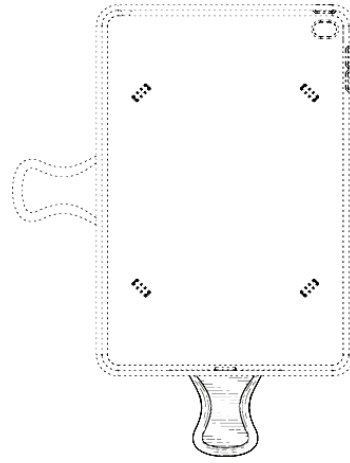

1.4

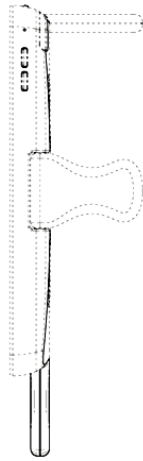

1.5

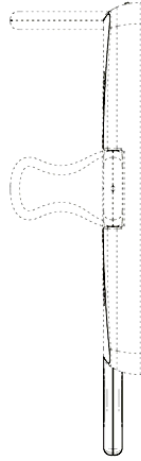

1.6

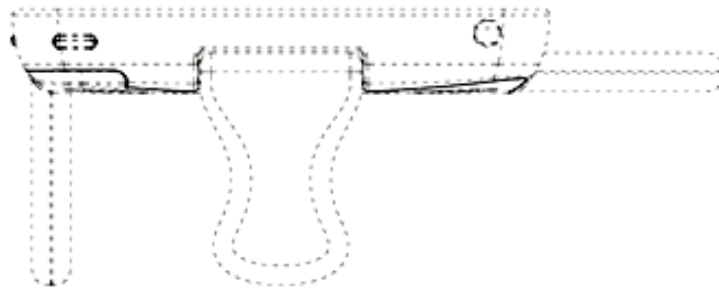

1.7

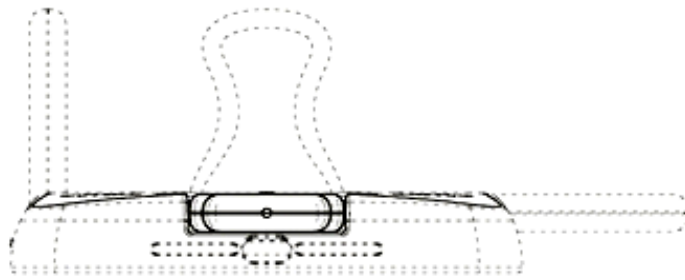

1.8

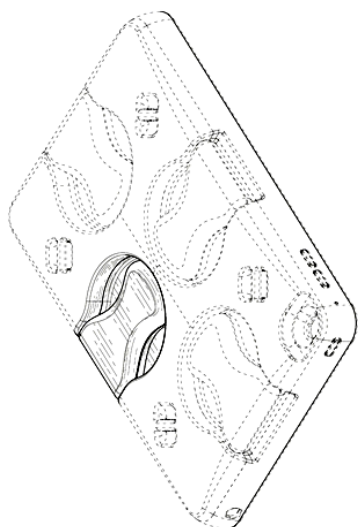

1.9

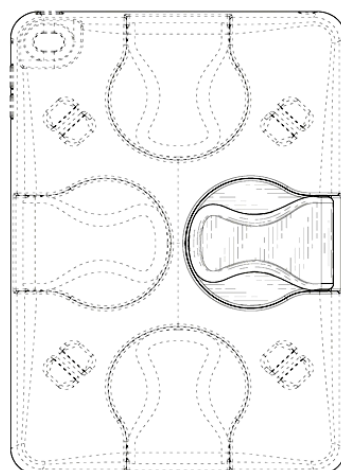

1.10

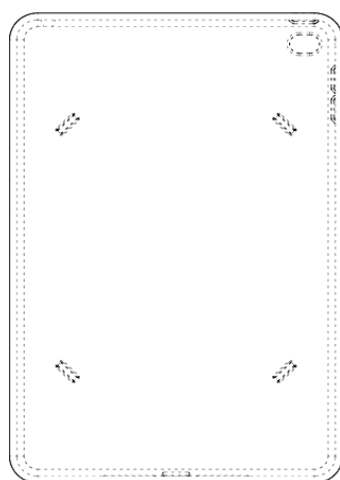

1.11

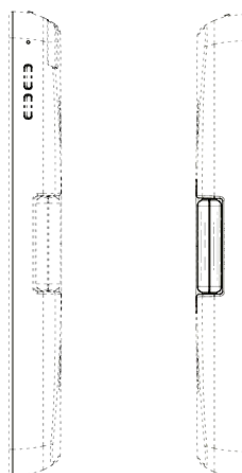

1.12

1.13



1.14



1.15

- (11) DM/211 854 (51) 11-01
 (15) 2020 12 11 (44) 23/2021 (2021 06 11)
 (22) 2020 12 11
 (28) 6
 (73) HARRY WINSTON SA
 Chemin Du Tourbillon 8, 1228 Plan-les-Ouates (CH)
 (85) CH
 (86) CH
 (87) CH
 (88) CH
 (89) CH
 (81) II. MA III. AL, AM, AZ, BA, BZ, CA, CH, EM, GB, GE, KG, LI, MC, MD, ME, MK, MN, NO, OM, SG,
 TN, TR, UA
 (72) 1. Tobias WUEST
 C/o Harry Winston Inc., 718 Fifth Avenue, 10019, New York, N.Y. (US);
 2. Delphine ABDOURAHIM
 C/o Harry Winston Inc., 718 Fifth Avenue, 10019, New York, N.Y. (US);
 3.-4.; 6. Rie YATSUGI-KANG
 C/o Harry Winston Inc., 718 Fifth Avenue, 10019, New York, N.Y. (US);
 5. Dominique RIVIERE
 C/o Harry Winston Inc., 718 Fifth Avenue, 10019, New York, N.Y. (US)
 (74) The Swatch Group AG (The Swatch Group SA) (The Swatch Group Ltd.)
 Faubourg Du Lac 6, 2501 Biel/Bienne (CH)
 (54) 1.-2. Finger ring, 3. Necklace, 4. Pair of earrings, 5. Tiara, 6. Pair of earrings
 (55)



1.1



1.2



1.3



1.4



1.5



1.6



1.7



1.8



2.1



2.2



2.3



2.4





3.7



3.8



4.1



4.2



4.3



4.4



4.5



4.6



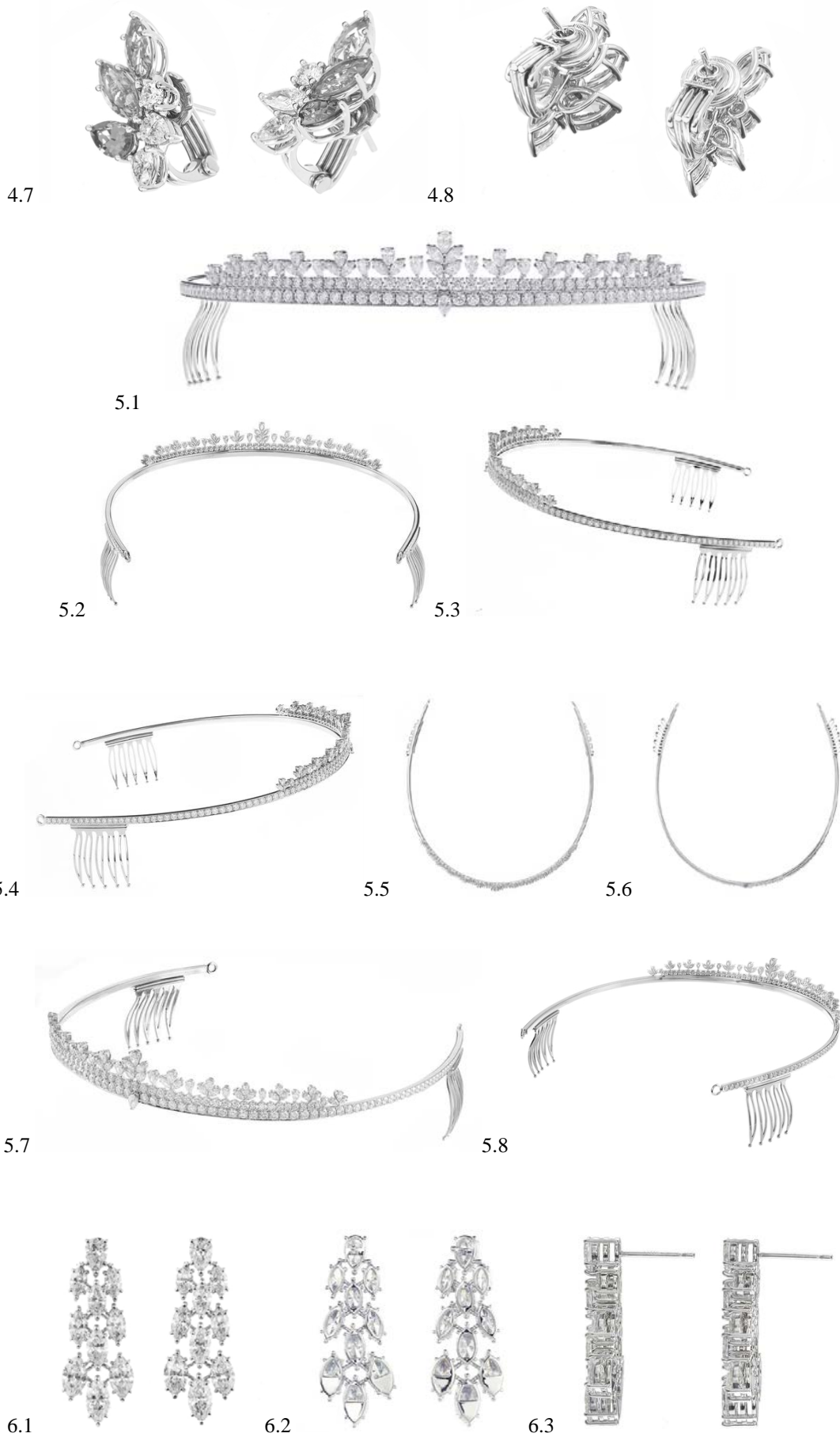



6.4



6.5



6.6



6.7



6.8

- (11) DM/214 503 (51) 12-16
(15) 2020 11 15 (44) 23/2021 (2021 06 11)
(22) 2020 11 15
(28) 3
(73) HOPIUM S.A.S.
54/56 Avenue Hoche, 75008 Paris (FR)
(85) FR
(86) FR
(87) FR
(88) FR
(89) EM
(81) II. BJ, CI, GA, GR, IT, MA, ML, NE, SN III. AL, AM, AZ, BA, BG, BN, BW, BX, BZ, CA, CH, DE, DK, EE, EG, EM, ES, FI, FR, GB, GE, GH, HR, HU, IL, IS, JP, KG, KH, KP, KR, LI, LT, LV, MC, MD, ME, MK, MN, MX, NA, NO, OA, OM, PL, RO, RS, RU, RW, SG, SI, SM, SR, ST, SY, TJ, TM, TN, TR, UA, US, VN, WS
(72) 1 Felix Godard
20 Rue De Princay, 86530, Availles-en-Chatellerault (FR)
(74) MNB Legal Rechtsanwaltsgesellschaft MbH
Prof. Dr. Benjamin F. Schaarschmidt, Kurfürstendamm 226, 10719 Berlin (DE)
(54) 1. Bodywork of a motor-car, 2. Rim for motor vehicles, 3. Motor-car cockpit
(55)

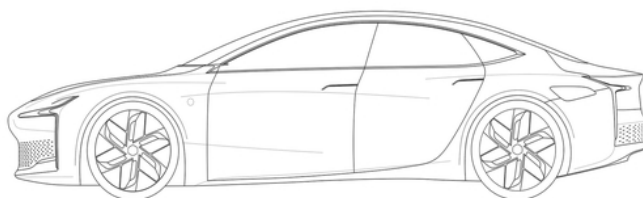

1.1

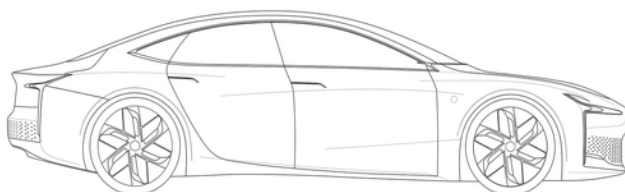

1.2

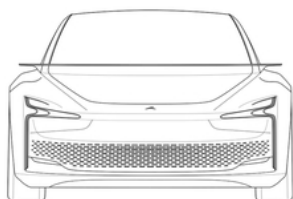

1.3

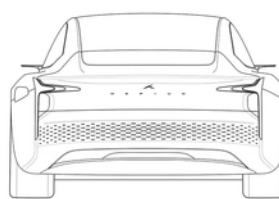

1.4

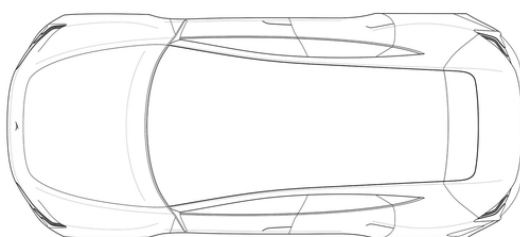

1.5

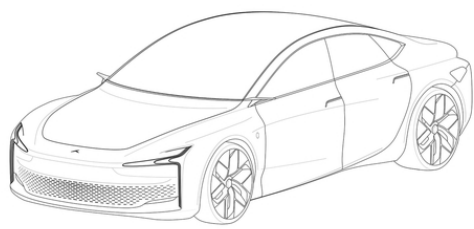

1.6

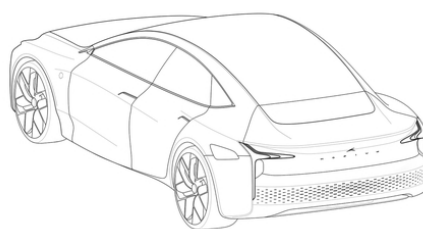

1.7



2.1

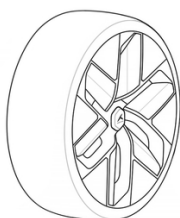

2.2



2.3

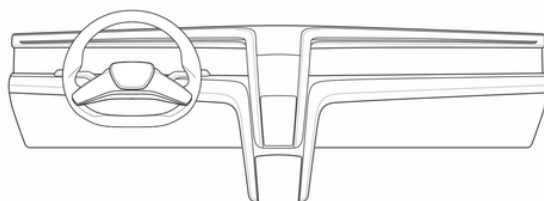

3.1

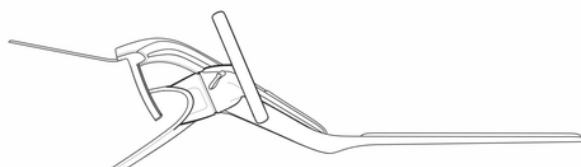

3.2

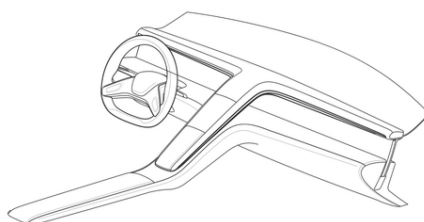

3.3

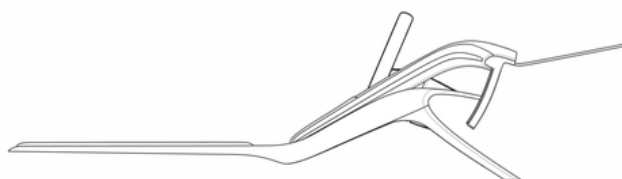

3.4

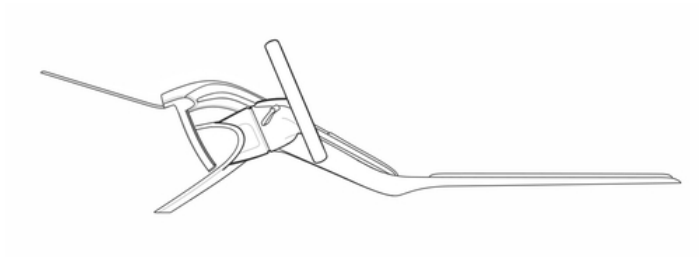

3.5

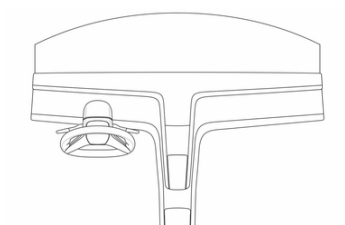

3.6

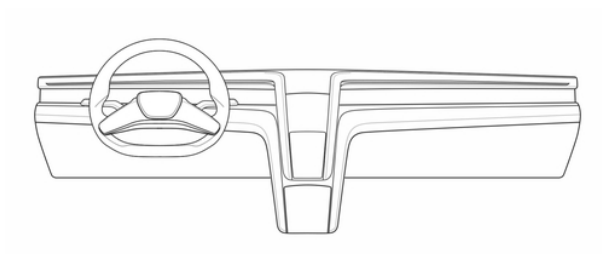

3.7

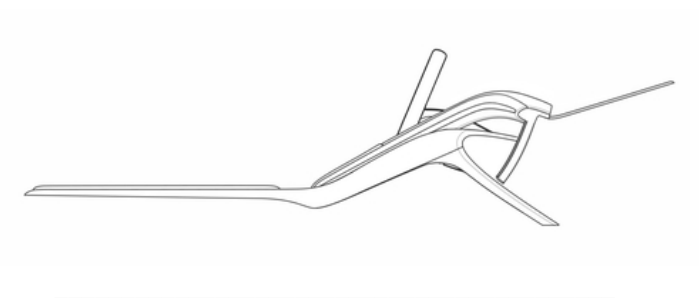

3.8

- (11) DM/211 855 (51) 11-01
 (15) 2020 12 17 (44) 24/2021 (2021 06 18)
 (22) 2020 12 17
 (28) 3
 (73) HARRY WINSTON SA
 Chemin Du Tourbillon 8, 1228 Plan-les-Ouates (CH)
 (85) CH
 (86) CH
 (87) CH
 (88) CH
 (89) CH
 (81) II. MA III. AL, AM, AZ, BA, BZ, CA, CH, EM, GB, GE, KG, LI, MC, MD, ME, MK, MN, NO, OM, SG,
 TN, TR, UA
 (72) 1;3 Rie YATSUGI-KANG
 C/o Harry Winston Inc., 718 Fifth Avenue, 10019, New York, N.Y. (US);
 2. Tobias WUEST
 C/o Harry Winston Inc., 718 Fifth Avenue, 10019, New York, N.Y. (US)
 (74) The Swatch Group AG (The Swatch Group SA) (The Swatch Group Ltd.)
 Faubourg Du Lac 6, 2501 Biel/Bienne (CH)
 (54) 1. Finger ring, 2. Necklace, 3. Pair of earrings
 (55)

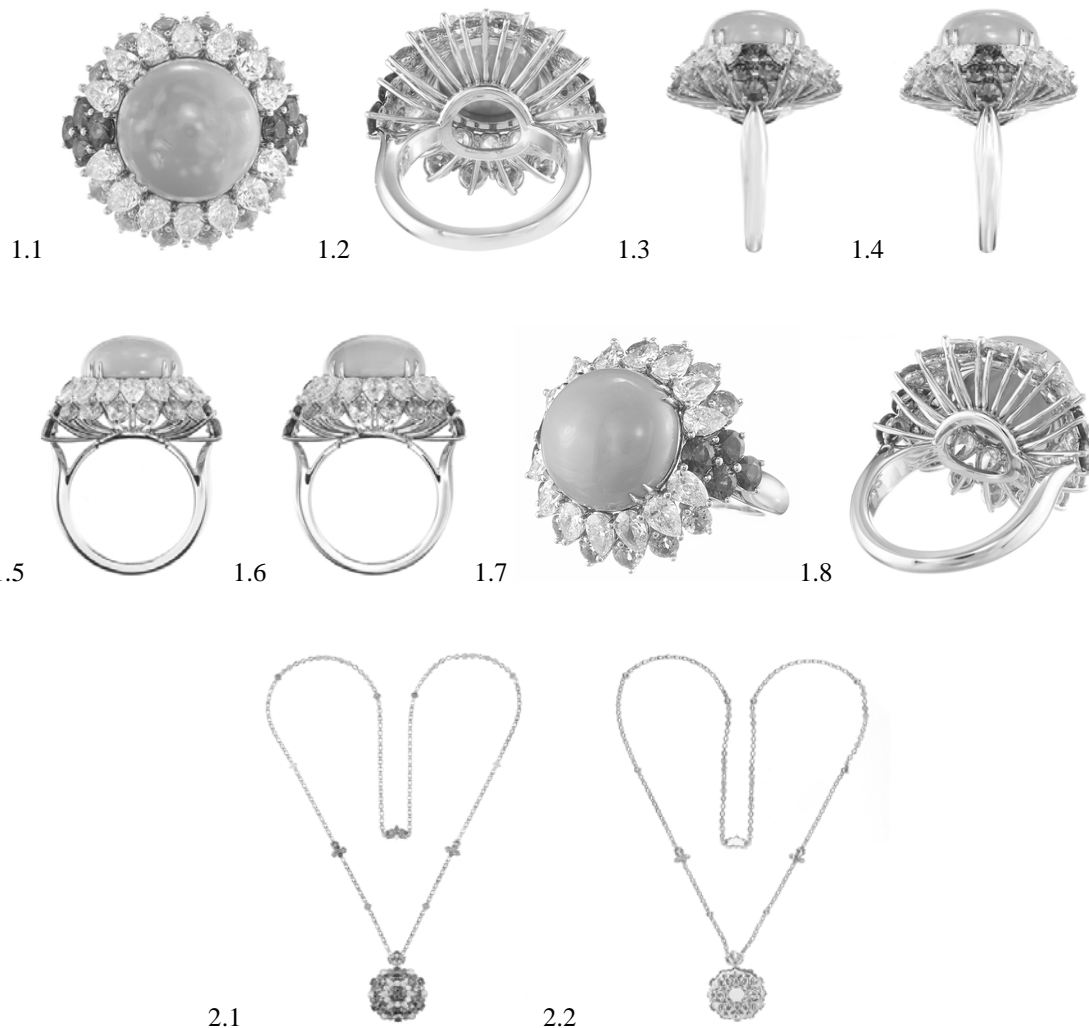



2.3



2.4



2.5



2.6



2.7



2.8



3.1



3.2



3.3



3.4





3.5



3.6



3.7



3.8

(11) DM/214 747 (51) 03-01
(15) 2021 06 10 (44) 25/2021 (2021 06 25)
(22) 2021 06 10
(28) 4
(73) Chanel SARL
Quai Du Général-Guisan 24, 1204 Genève (CH)
(85) CH
(86) CH
(87) CH
(88) CH
(89) CH
(81) II. GR, MA III. AZ, BG, DK, EE, EG, FI, GE, LT, LV, MX, NO, PL, RU, TN, TR, UA
(72) Marianna Nitsch
135 Avenue Du Général De Gaulle, 92521, Neuilly-sur-Seine (FR)
(54) 1.-3. Handbag, 4. Shoulder strap for bags
(55)

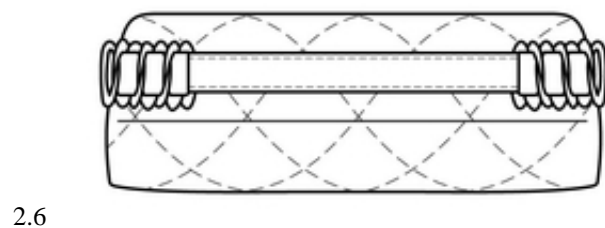
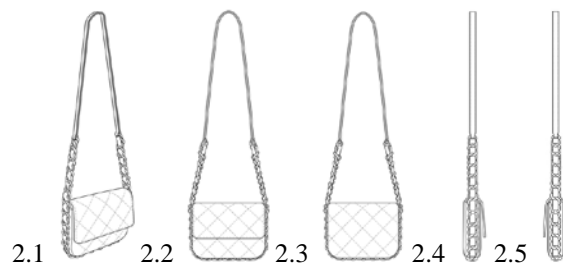
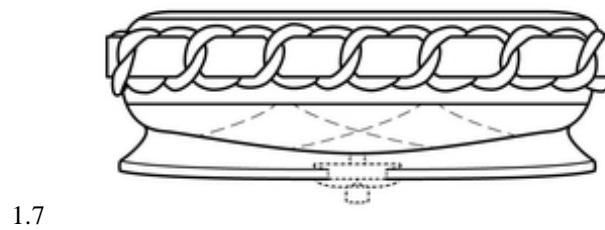
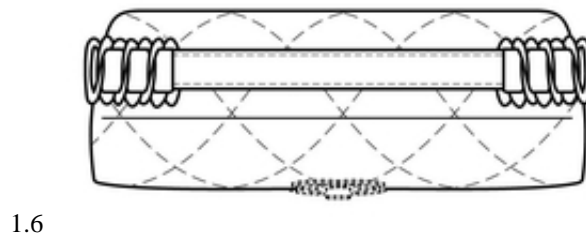
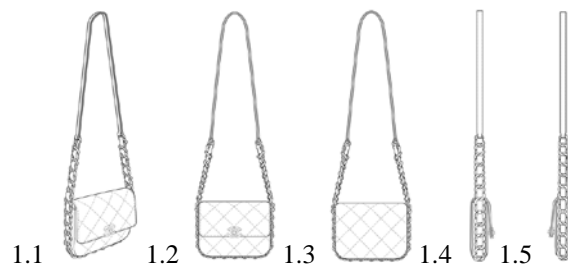

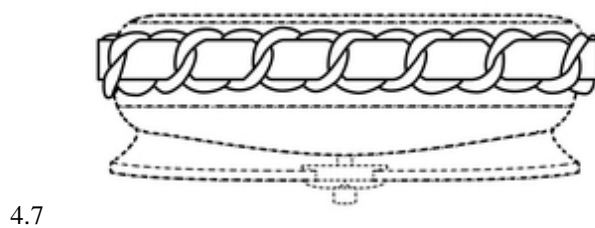
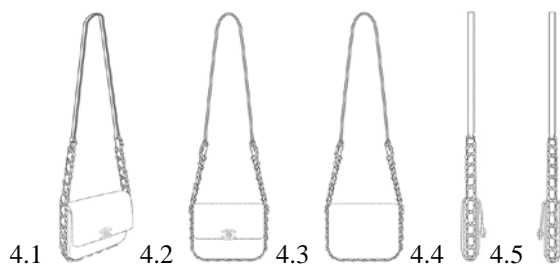
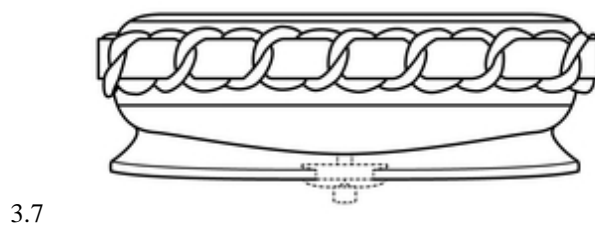
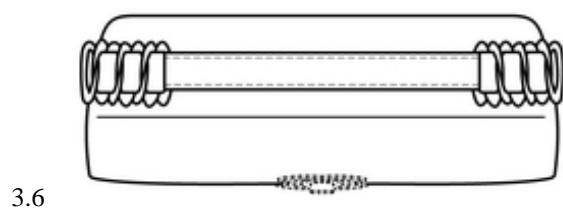
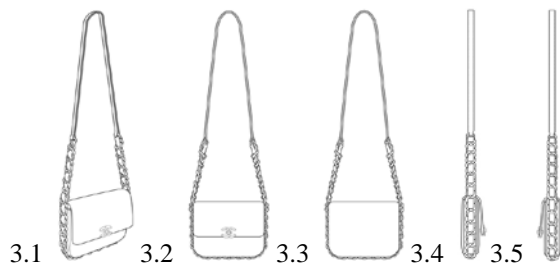
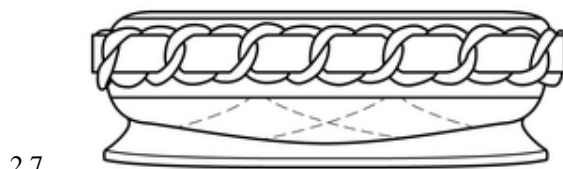

- (11) DM/211 920 (51) 11-01
(15) 2020 12 22 (44) 25/2021 (2021 06 25)
(22) 2020 12 22
(28) 8
(73) HARRY WINSTON SA
Chemin Du Tourbillon 8, 1228 Plan-les-Ouates (CH)
(85) CH
(86) CH
(87) CH
(88) CH
(89) CH
(81) II. MA III. AL, AM, AZ, BA, BZ, CA, CH, EM, GB, GE, KG, LI, MC, MD, ME, MK, MN, NO, OM, SG,
TN, TR, UA
(72) 1; 3-5 Rie YATSUGI-KANG
C/o Harry Winston Inc., 718 Fifth Avenue, 10019, New York, NY (US);
2.-7. Dominique RIVIERE
C/o Harry Winston Inc., 718 Fifth Avenue, 10019, New York, NY (US);
6.; 8. Delphine ABDOURAHIM
C/o Harry Winston Inc., 718 Fifth Avenue, 10019, New York, NY (US)
(74) The Swatch Group AG (The Swatch Group SA) (The Swatch Group Ltd.)
Faubourg Du Lac 6, 2501 Biel/Bienne (CH)
(54) 1. Necklace, 2.-6. Finger ring, 7. Necklace, 8. Pair of earrings
(55)



1.1



1.2



1.3



1.4



1.5



1.6



1.7



1.8

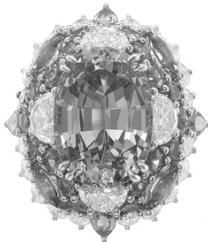

2.1



2.2



2.3



2.4



2.5



2.6



2.7



2.8



3.1



3.2



3.3



3.4

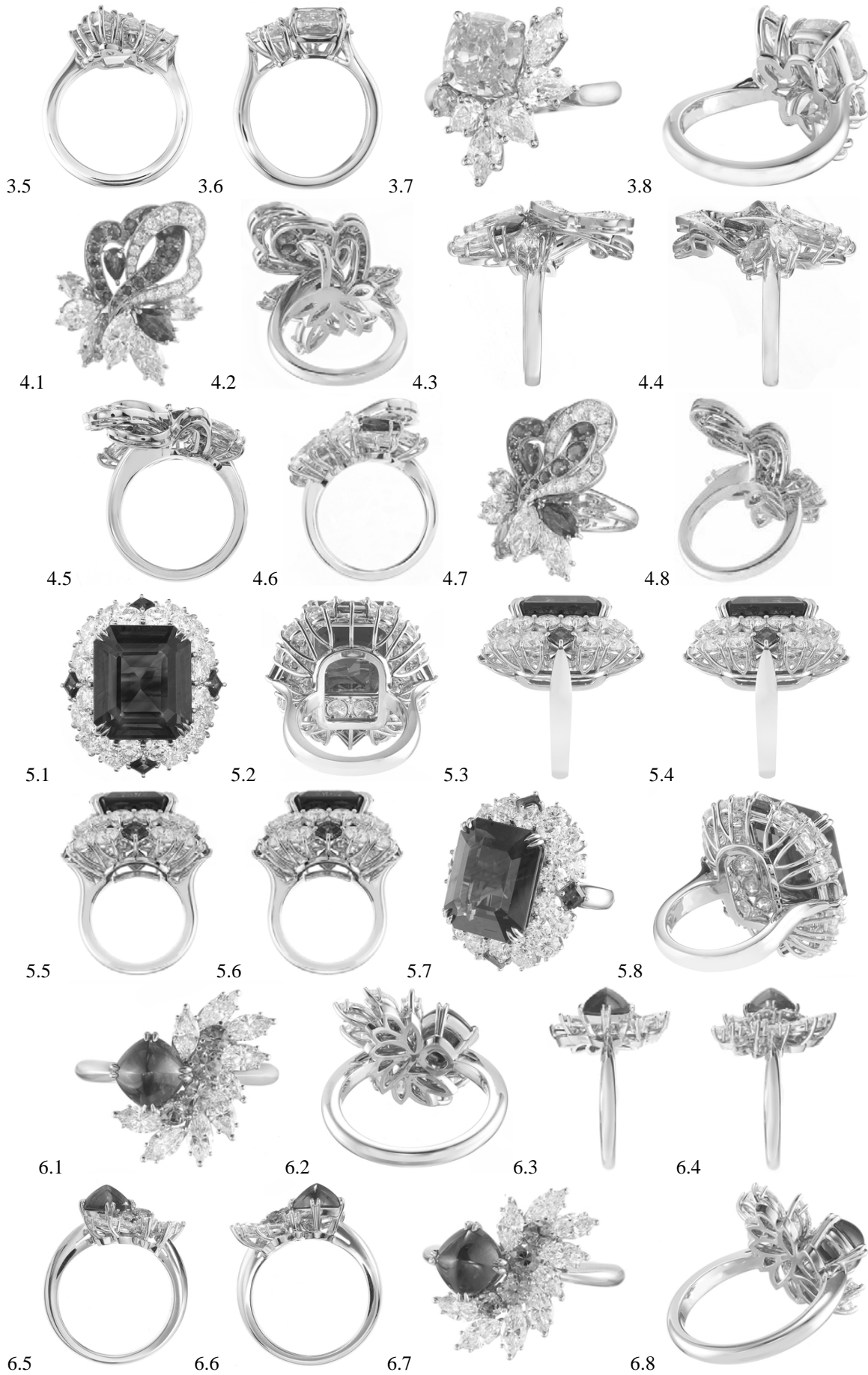



7.1



7.2



7.3



7.4



7.5



7.6



7.7



7.8



8.1



8.2



8.3



8.4



8.5



8.6



8.7



8.8



- (11) DM/214 874 (51) 02-04
 (15) 2021 06 14 (44) 26/2021 (2021 07 02)
 (22) 2021 06 14
 (28) 1
 (73) Valentino S.p.A
 Via Turati 16/18, I-20121 Milano (EM)
 (85) –
 (86) EM, IT
 (87) EM, IT
 (88) EM, IT
 (89) EM
 (81) III. AZ, EM, GB, GE, JP, KG, KR, RU, TJ, TR, UA, US
 (72) Pierpaolo PICCIOLI
 C/o Valentino S.p.A. Via Turati, 16/18, I-20121, Milano (IT)
 (74) Jacobacci & Partners / Matteo Mozz
 Via Senato, 8, I-20121 Milano (IT)
 (54) 1. Shoe
 (55)



- (11) DM/214 922 (51) 02-04
(15) 2021 06 10 (44) 26/2021 (2021 07 02)
(22) 2021 06 10
(28) 2
(73) Valentino S.p.A
Via Turati 16/18, I-20121 Milano (EM)
(85) –
(86) EM, IT
(87) EM, IT
(88) EM, IT
(89) EM
(81) III. AZ, EM, GB, GE, JP, KG, KR, RU, TJ, TR, UA
(72) Pierpaolo PICCIOLI
C/o Valentino S.p.A., Via Turati, 16/18, I-20121, Milano (IT)
(74) Jacobacci & Partners / Salvatore Giovanni Pennacchio
Via Senato, 8, I-20121 Milano (IT)
(54) 1.-2. Shoe
(55)



1.1



1.2



1.3



1.4



1.5



1.6

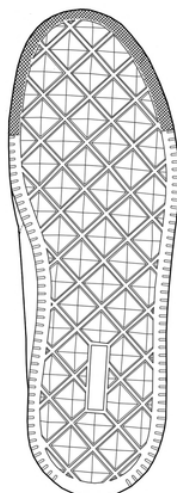

1.7

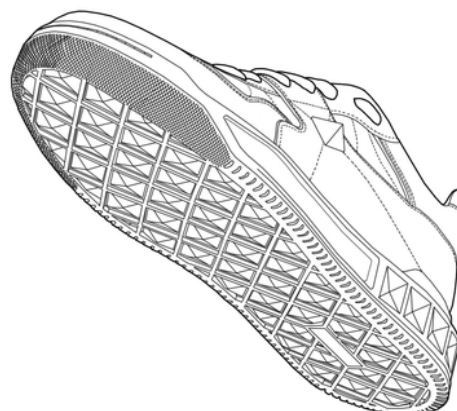

1.8



2.1



2.2



2.3



2.4



2.5

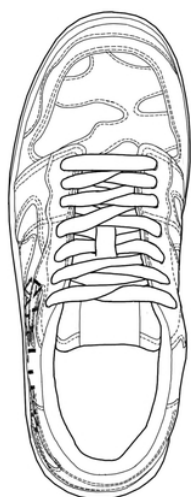

2.6



2.7

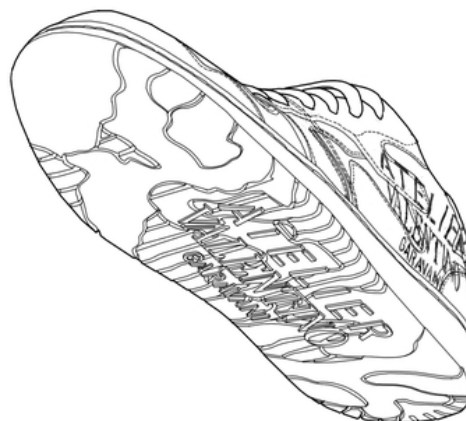

2.8

- (11) DM/214 876
- (15) 2021 06 14
- (22) 2021 06 14
- (28) 2
- (73) Valentino S.p.A
Via Turati 16/18, I-20121 Milano (EM)
- (85) –
- (86) EM, IT
- (87) EM, IT
- (88) EM, IT
- (89) EM
- (81) III. AZ, EM, GB, GE, JP, KG, KR, RU, TJ, TR, UA
- (72) Pierpaolo PICCIOLI
C/o VALENTINO S.p.A. Via Turati, 16/18, I-20121, Milano (IT)
- (74) Jacobacci & Partners / Matteo Mozzi
Via Senato, 8, I-20121 Milano (IT)
- (54) 1. Bag, 2. Bag
- (55)

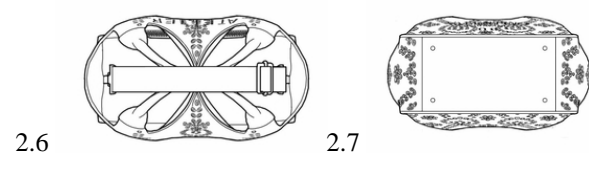
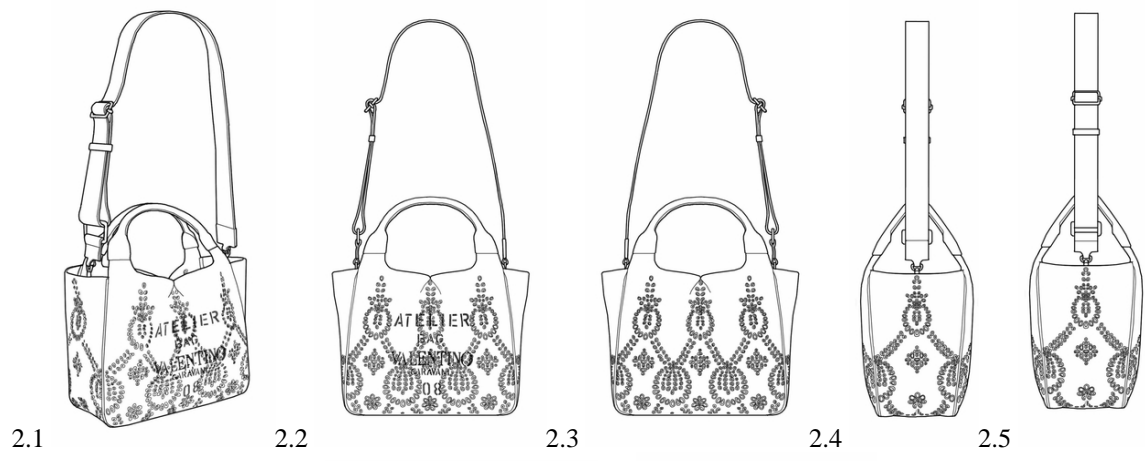
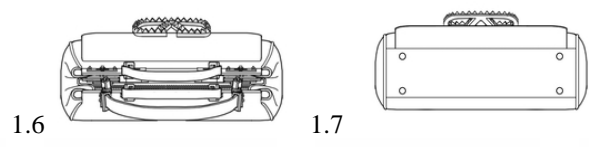
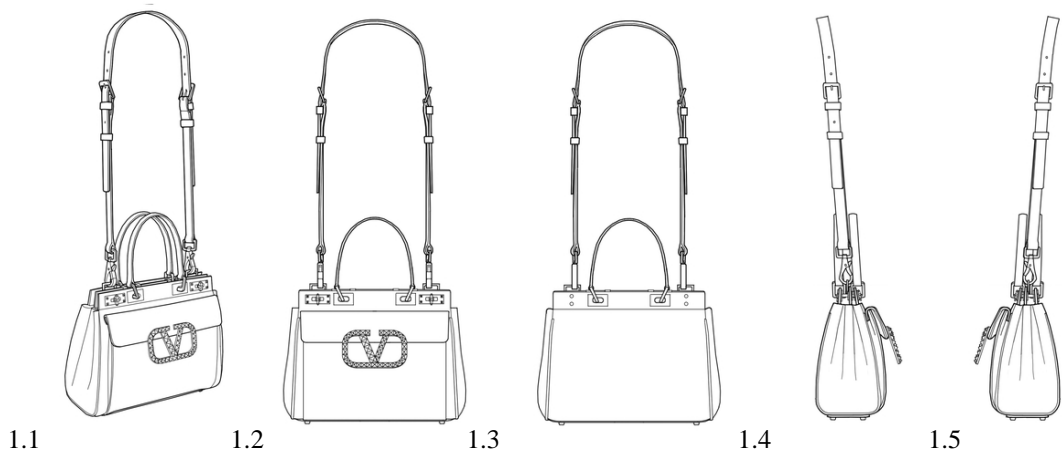

- (11) DM/212 043 (51) 11-01
 (15) 2020 12 28 (44) 26/2021 (2021 07 02)
 (22) 2020 12 28
 (28) 6
 (73) HARRY WINSTON SA
 Chemin Du Tourbillon 8, 1228 Plan-les-Ouates (CH)
 (85) CH
 (86) CH
 (87) CH
 (88) CH
 (89) CH
 (81) IL, MA, III, AL, AM, AZ, BA, BZ, CA, CH, EM, GB, GE, KG, LI, MC, MD, ME, MK, MN, NO, OM, SG,
 TN, TR, UA
 (72) 1.; 3. Rie YATSUGI-KANG
 C/o Harry Winston Inc., 718 Fifth Avenue, 10019, New York (US);
 2. 4 Delphine ABDOURAHIM
 C/o Harry Winston Inc., 718 Fifth Avenue, 10019, New York (US);
 5.-6. Dominique RIVIERE
 C/o Harry Winston Inc., 718 Fifth Avenue, 10019, New York (US)
 (74) The Swatch Group AG (The Swatch Group SA) (The Swatch Group Ltd.)
 Faubourg Du Lac 6, 2501 Biel/Bienne (CH)
 (54) 1. Finger ring, 2. Bracelet, 3. Pair of earrings, 4. Finger ring, 5. Pair of earrings, 6. Pair of earrings
 (55)

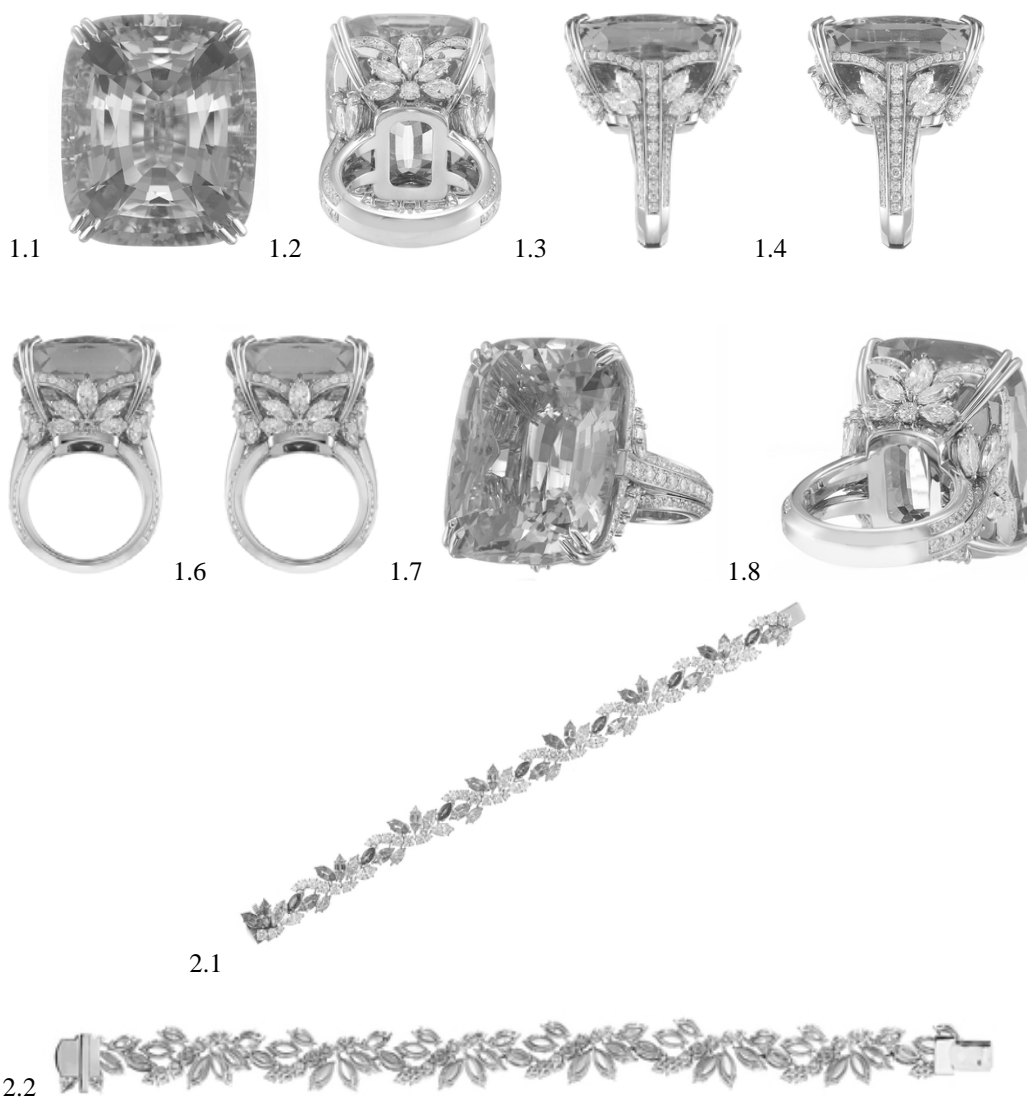





3.5

3.6



3.7

3.8



4.1

4.2

4.3

4.4



4.5

4.6

4.7

4.8



5.1

5.2



5.3

5.4



5.5

5.6

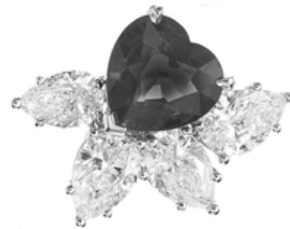

- (11) DM/214 862 (51) 14-03
 (15) 2021 06 18 (44) 26/2021 (2021 07 02)
 (22) 2021 06 18
 (28) 1
 (30) No1: 17.06.2021; 2021/007334; TR
 (73) ARCELIK ANONIM SIRKETI
 Sutluce Mahallesi, Karaagac Caddesi, No: 2-6, Beyoglu, 34445 ISTANBUL (TR)
 (85) TR
 (86) TR
 (87) TR
 (88) TR
 (89) TR
 (81) III. AL, AZ, BA, EM, GE, IL, MK, NO, RS
 (72) CAN ONUR VANCI
 Sutluce Mahallesi, Karaagac Caddesi, No: 2-6 Beyoglu, 34445, ISTANBUL (TR);
 SINAN ANAYURT
 Sutluce Mahallesi, Karaagac Caddesi, No: 2-6 Beyoglu, 34445, ISTANBUL (TR);
 DOGAC SAGIROSMANOGLU
 Sutluce Mahallesi, Karaagac Caddesi, No: 2-6 Beyoglu, 34445, ISTANBUL (TR);
 ASLI OKMEN
 Sutluce Mahallesi, Karaagac Caddesi, No: 2-6 Beyoglu, 34445, ISTANBUL (TR);
 TAMER YUKSEK
 Sutluce Mahallesi, Karaagac Caddesi, No: 2-6 Beyoglu, 34445, ISTANBUL (TR);
 OZLEM KOK GULTEKIN
 Sutluce Mahallesi, Karaagac Caddesi, No: 2-6 Beyoglu, 34445, ISTANBUL (TR);
 NIHAT DURAN
 Sutluce Mahallesi, Karaagac Caddesi, No: 2-6 Beyoglu, 34445, ISTANBUL (TR);
 GIZEM DURAKOGLU EMRE
 Sutluce Mahallesi, Karaagac Caddesi, No: 2-6 Beyoglu, 34445, ISTANBUL (TR)
 (74) ANKARA PATENT BUREAU
 Kavaklidere Mahallesi Bestekar Caddesi No: 10, 06680 ANKARA (TR)
 (54) 1. Remote control
 (55)



1.1

1.2



1.3

1.4

1.5

1.6

1.7

1.8

- (11) DM/214 880 (51) 14-06
 (15) 2021 05 25 (44) 26/2021 (2021 07 02)
 (22) 2021 05 25
 (28) 8
 (30) No1: 27.11.2020; 008286942; EM
 (73) Erwin Müller GmbH
 Breslauer Straße 34-38, 49808 Lingen (Ems) (DE)
 (85) DE
 (86) DE
 (87) DE
 (88) DE
 (89) EM
 (81) II. MA III. AZ, CA, EG, GE, GH, IL, IS, JP, KR, MX, NO, OM, RU, SG, TN, TR, UA, US
 (72) Georg Kaluza
 Emil-Schniewind-Straße 10, 42553, Velbert (DE)
 (74) Kalkoff & Partner Patentanwälte MbB
 Martin-Schmeisser-Weg 3a-3b, 44227 Dortmund (DE)
 (54) 1.-8. Holder for electronic devices
 (55)

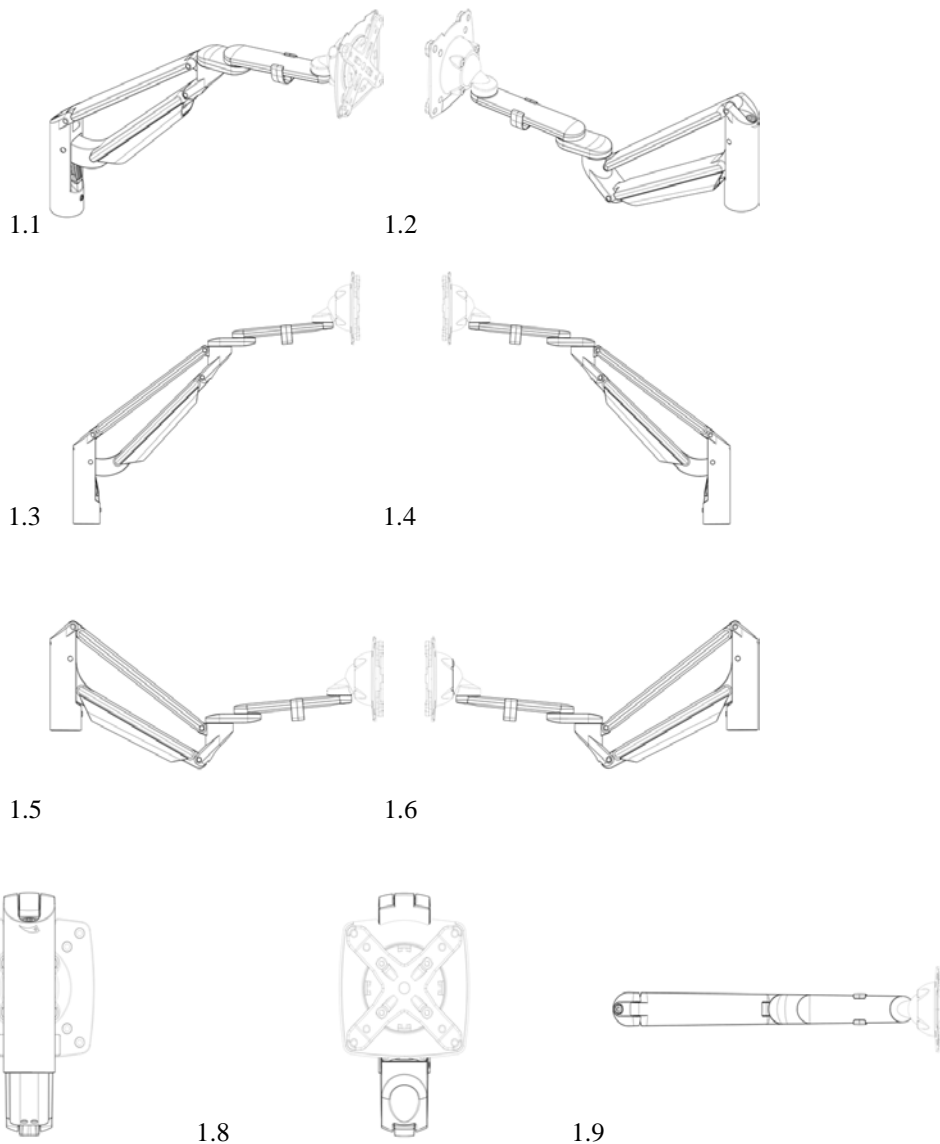

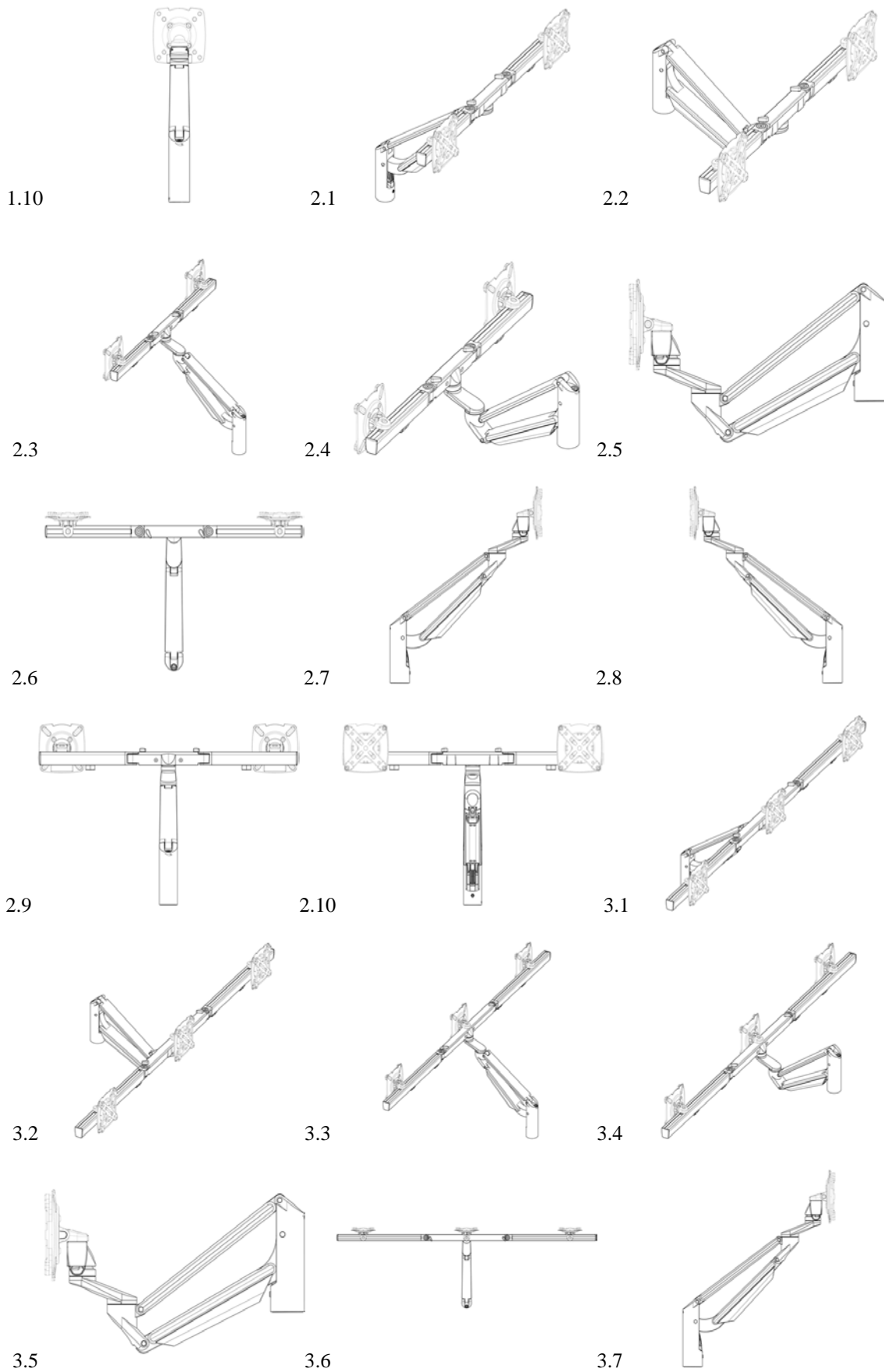

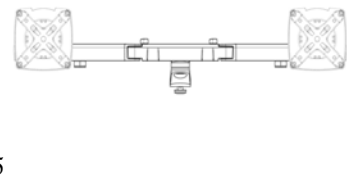
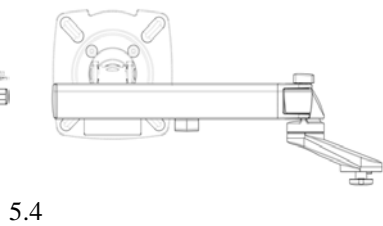
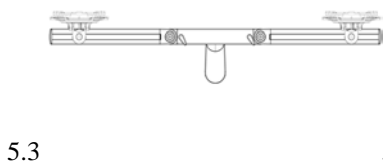
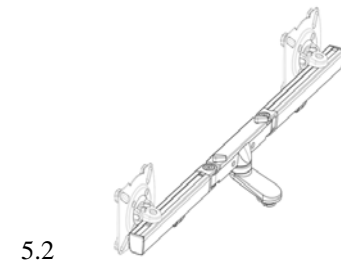
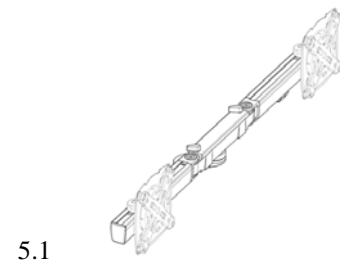
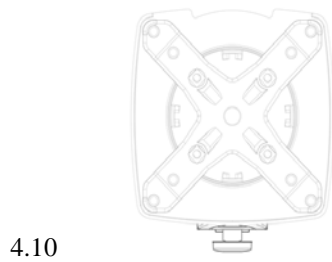
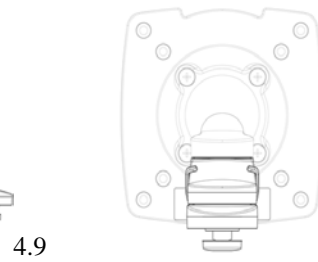
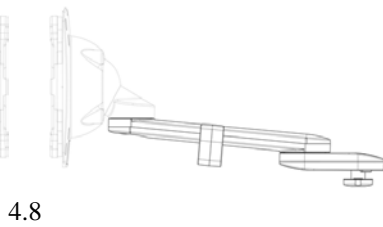
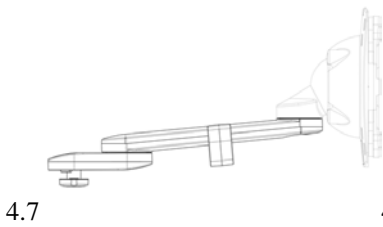
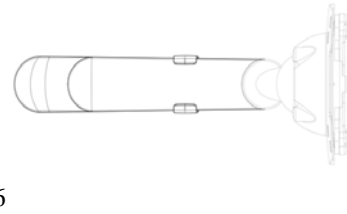
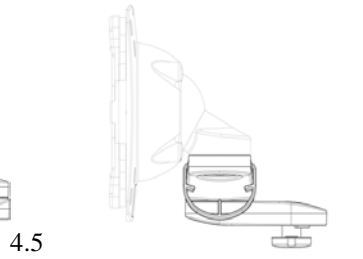
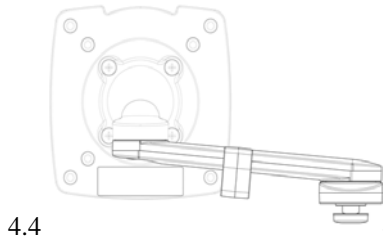
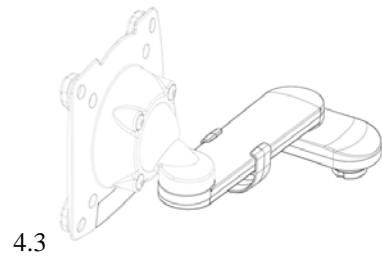
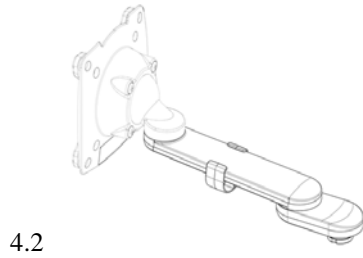
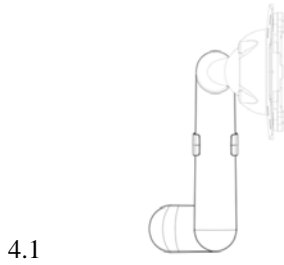
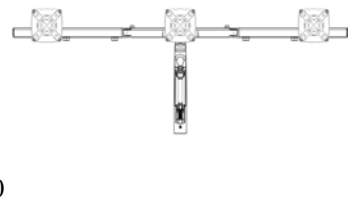
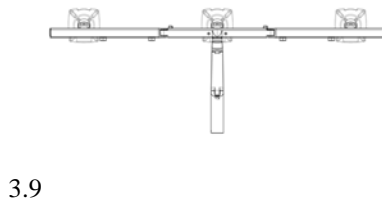
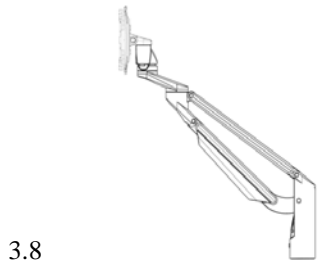

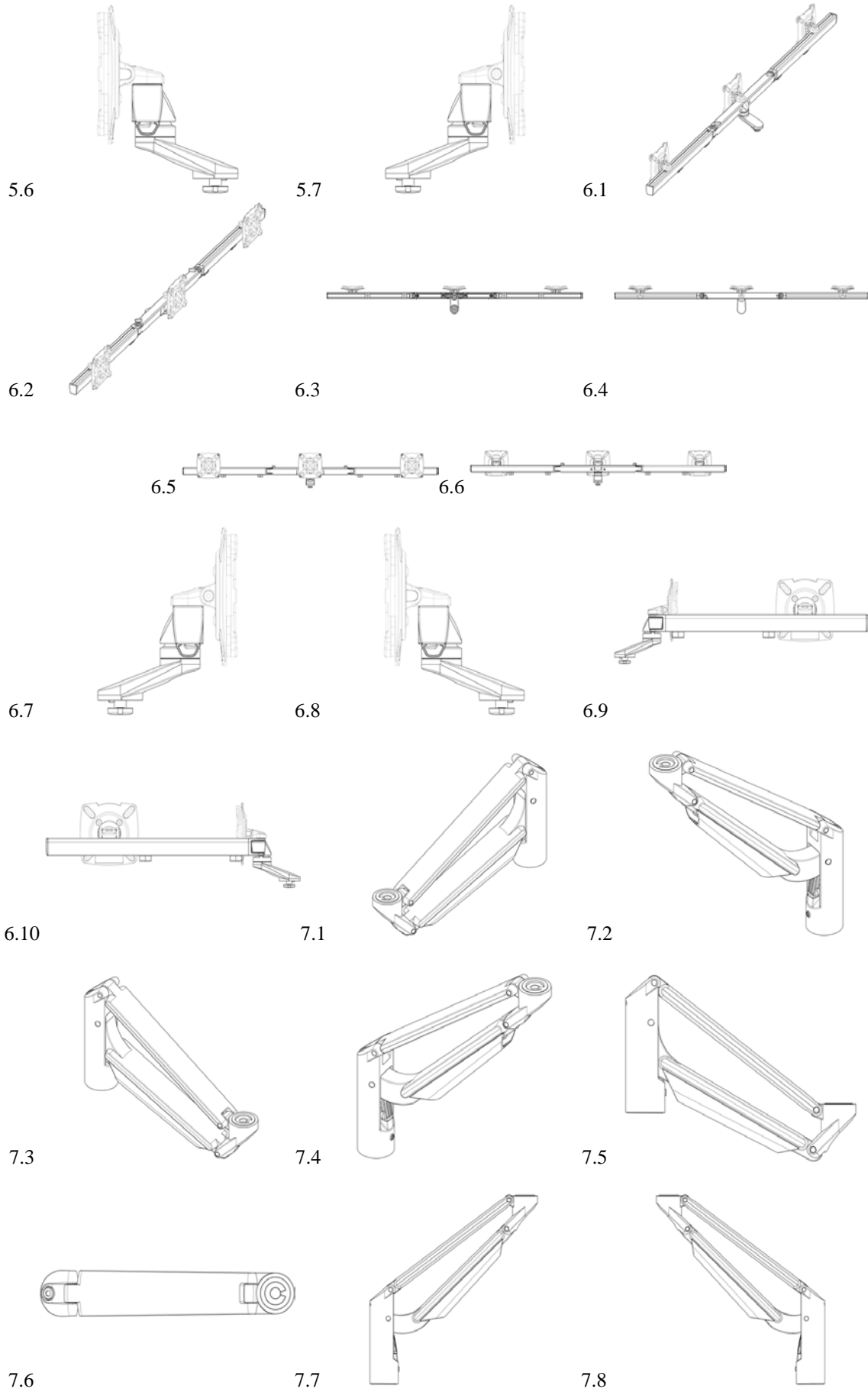

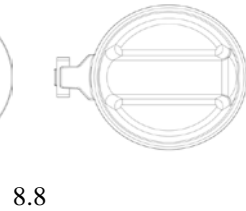
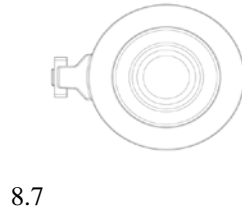
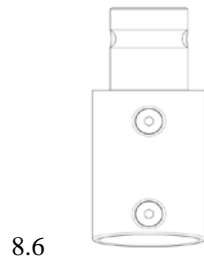
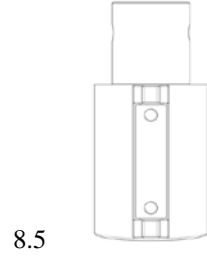
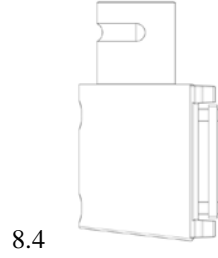
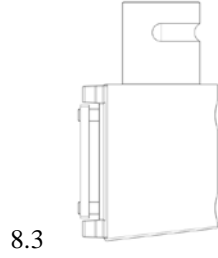
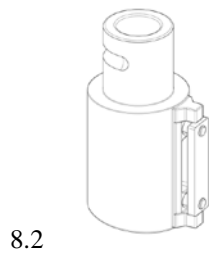
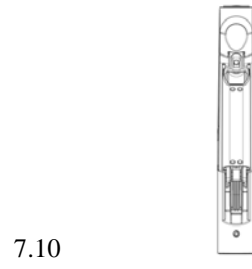
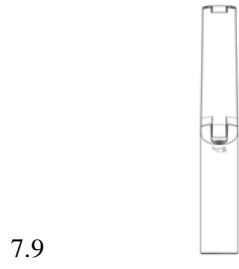

TRADEMARKS

APPLICATIONS FILED UNDER THE NATIONAL PROCEDURE APPROVED FOR REGISTRATION

The decision can be appealed at the Chamber of Appeal of Sakpatenti within 3 months from the publication or at the Mtskheta District Court Administrative Cases Board (Address: №17, Samkhedro St., Mtskheta), within 1 month following the publication.

(260) AM 2021 98568 A*
(210) AM 98568
(220) 2018 07 19
(731) Federal Treasury Enterprise
"Sojuzplodoimport" (FKP "Sojuzplodoimport")
Orlikov lane, bldg.1/11, Moscow, 107139,
Russian Federation
(740) Giorgi Taktakishvili
(540)

СТОЛИЧНАЯ

(591) Black-white
(511) 33

(260) AM 2021 98569 A*
(210) AM 98569
(220) 2018 07 19
(731) Federal Treasury Enterprise
"Sojuzplodoimport" (FKP "Sojuzplodoimport")
Orlikov lane, bldg.1/11, Moscow, 107139,
Russian Federation
(740) Giorgi Taktakishvili
(540)

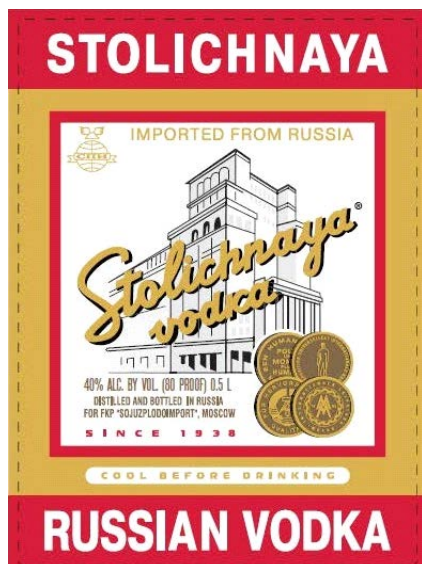

(591) White, black, red, yellow, grey, brown
(531) 01.05.06; 07.01.01; 07.01.08; 24.05.07;
25.01.19; 27.05.01; 27.05.02; 27.05.10;
27.05.19; 27.05.24; 29.01.15
(511) 33

(260) AM 2021 109763 A
(210) AM 109763
(220) 2021 02 16
(731) LTD "Badagoni House"
Adam Mickiewicz St. 29-29a, app. 65, Tbilisi,
Georgia
(740) Tamar Machavariani
(540)



(591) Black-white
(531) 26.04.05; 26.04.22; 26.04.24; 27.05.23;
27.05.24
(511) 33, 43

(260) AM 2021 110482 A
(210) AM 110482
(220) 2020 11 13
(731) LTD "Bio Georgia"
Sopiko Chiaureli St. 16, Tbilisi, Georgia
(540)



(591) Green, white
(531) 05.07.11; 05.07.13; 05.07.14; 26.04.02;
26.04.04; 26.04.07; 26.04.24; 27.05.01;
27.05.10; 27.05.24; 29.01.12
(526) Georgia
(511) 30

(260) AM 2021 110528 A
(210) AM 110528
(220) 2020 11 18
(731) LTD "Aisi"
Odessa St. 30, Saburtalo District,
Tbilisi, Georgia

(740) Nino Mgaloblishvili
(540)



(591) Red, white
(531) 14.05.21; 14.05.23; 26.04.02; 26.04.16;
26.04.22; 26.04.24; 27.05.24; 29.01.12
(526) GEORGIA
(511) 39

(260) AM 2021 110602 A
(210) AM 110602
(220) 2020 11 20
(731) Platinum Wines Sp. z o.o.
Ul. Wolodyjowskiego 70/1, Warszawa, 02-724,
Poland
(740) Nino Bakhtadze
(540)

NANARI PEAK

(591) Black-white
(526) NANARI
(511) 33

(260) AM 2021 110749 A
(210) AM 110749
(220) 2020 12 07
(731) LEPL "Georgian Mediators Association"
Ipolite Khvichia St. 19, app. 12, 0160,
Tbilisi, Georgia
(740) Giorgi Taktakishvili
(540)

**Georgias მედიატორთა
სსმციაცია**

(591) Black-white
(526) Georgia
(511) 45

(260) AM 2021 111062 A
(210) AM 111062
(220) 2020 12 25
(310) 42020518928
(320) 2020 11 27
(330) PH
(731) American-Cigarette Company (Overseas)
Limited
Route de France 17, Boncourt, CH-2926,
Switzerland
(740) Tamar Kochlamazashvili

(540)



(591) Blue, grey, red
(531) 26.04.02, 26.04.12, 26.04.22, 26.04.24,
26.11.12, 27.05.01, 27.05.09, 27.05.10,
29.01.13
(511) 34

(260) AM 2021 111339 A
(210) AM 111339
(220) 2021 01 21
(731) LTD "Multiverse"
M. Kostava St. 59, Tbilisi, Georgia
(540)

MULTIVERSE

(591) Black-white
(531) 27.05.01
(511) 9, 36

(260) AM 2021 111412 A
(210) AM 111412
(220) 2021 01 25
(731) Merck Sharp & Dohme Corp.
One Merck Drive, Whitehouse Station,
New Jersey 08889, USA
(740) Tamaz Shilakadze
(540)

VAXNEUVANCE

(591) Black-white
(511) 5

(260) AM 2021 111414 A
 (210) AM 111414
 (220) 2021 01 25
 (731) Merck Sharp & Dohme Corp.
 One Merck Drive, Whitehouse Station,
 New Jersey 08889, USA

(740) Tamaz Shilakadze
 (540)

VAXPRUMI

(591) Black-white
 (511) 5

(260) AM 2021 111418 A
 (210) AM 111418
 (220) 2021 01 25
 (731) Limited Liability Company "Parapharm"
 U. Sverdalova, Dom 4, 440026, Penza, Russian
 Federation

(740) Shalva Gvaramadze
 (540)



(591) Red, white, grey, yellow, orange, various tones
 of green
 (531) 01.07.06; 26.05.03; 26.05.04; 28.05; 29.01.15
 (511) 5

(260) AM 2021 111419 A
 (210) AM 111419
 (220) 2021 01 25
 (731) Limited Liability Company "Parapharm"
 U. Sverdalova, Dom 4, 440026, Penza, Russian
 Federation

(740) Shalva Gvaramadze
 (540)



ВАЛЕРИАНА
ЭКСТРАСИЛА



(591) Red, black, white, various tones of green
 (531) 26.04.02; 26.04.09; 26.04.10; 26.04.24;
 26.05.03; 26.05.04; 26.11.03; 26.11.06; 28.05;
 29.01.14
 (511) 5

(260) AM 2021 111420 A
 (210) AM 111420
 (220) 2021 01 25
 (731) Limited Liability Company "Parapharm"
 U. Sverdalova, Dom 4, 440026, Penza, Russian
 Federation

(740) Shalva Gvaramadze
 (540)



(591) White, black, F7C8C8 light green,
 various tones of orange
 (531) 26.04.09; 26.04.10; 26.05.03; 26.05.04;
 26.11.03; 26.11.06; 26.11.08; 28.05; 29.01.14
 (511) 5

(260) AM 2021 111421 A
 (210) AM 111421
 (220) 2021 01 25
 (731) Limited Liability Company "Parapharm"
 U. Sverdalova, Dom 4, 440026, Penza, Russian
 Federation

(740) Shalva Gvaramadze
 (540)



(591) White, black, light green, various tones of blue
 (531) 26.04.02; 26.04.09; 26.04.10; 26.04.24;



26.05.02; 26.05.03; 26.05.04; 26.11.03;
26.11.06; 26.11.08; 28.05; 29.01.14
(511) 5

(260) AM 2021 111428 A
(210) AM 111428
(220) 2021 01 26
(731) JSC "Badagoni"
Vill. Zemo Khodasheni, 0910, Akhmeta
Region, Georgia
(740) Tamar Machavariani
(540)

VINELI
ვინელი
ВИНЕЛИ

(591) Black-white
(511) 33

(260) AM 2021 111435 A
(210) AM 111435
(220) 2021 01 27
(731) LLC "Bolero & Company"
Kuchishvili St. 12-14-16, 0179, Tbilisi, Georgia
(540)

ჭიჭიკო
ЧИЧИКО
CHICHIKO

(591) Black-white
(511) 33

(260) AM 2021 111446 A
(210) AM 111446
(220) 2021 01 28
(731) LTD "AT"
Tsikhisdziri St. 40, 0103, Tbilisi, Georgia
(540)



(591) Green, yellow, white
(531) 03.09.01; 25.01.01; 26.04.24; 27.05.01;
27.05.24; 29.01.15
(511) 43

(260) AM 2021 111497 A
(210) AM 111497
(220) 2021 01 29
(731) Giorgi Chiradze
Tiripebi St. 2, app. 20, 0186, Tbilisi,
Georgia
(540)

CLIMB.GE

(591) Black, red
(531) 26.11.08; 27.05.01; 27.05.11; 29.01.12
(511) 28, 35

(260) AM 2021 111519 A
(210) AM 111519
(220) 2021 02 02
(731) LLC "Alcoritale Group"
Giorgi Mdivani St. 3a, Tbilisi, Georgia
(740) Vakhtang Torotadze
(540)



(591) 922E27 Bordeaux, white
(531) 11.03.02; 19.07.01; 27.05.01; 27.05.24;
29.01.12
(511) 32, 33

(260) AM 2021 111525 A
(210) AM 111525
(220) 2021 02 03
(731) Ana Telia
Bakradze St. 11, Tbilisi, Georgia
(540)



(591) Black-white
 (531) 26.01.18; 27.05.01; 27.05.22
 (511) 16, 25, 35, 42

(260) AM 2021 111526 A
 (210) AM 111526
 (220) 2021 02 03
 (731) Ana Telia
 Bakradze St. 11, Tbilisi, Georgia
 (540)



Telianna

(591) Black-white
 (531) 26.01.18; 27.05.01; 27.05.22
 (511) 16, 25, 35, 42

(260) AM 2021 111541 A
 (210) AM 111541
 (220) 2021 02 05
 (731) JSC "Group "Sverdlovelecetro"
 (AO "Group" "Svell")
 U. Chernyakhovskogo 61,
 Ekaterinebourg, RU-620010 Sverdlovskaya
 Oblast, Russian Federation
 (740) Giorgi Taktakishvili
 (540)



(591) Red, black
 (531) 28.05; 29.01.12
 (511) 6, 7, 9, 17, 19, 37, 42

(260) AM 2021 111586 A
 (210) AM 111586
 (220) 2021 02 06
 (731) LLC "Georgian Wine House"
 Vill. Zegaani, 1500, Gurjaani, Georgia
 (740) Sopio Vacheishvili
 (540)

ALEXANDROV

(591) Black-white
 (511) 33

(260) AM 2021 111587 A
 (210) AM 111587
 (220) 2021 02 06
 (731) Foshan Hai Tian Flavoring & Food Company
 Limited
 №16, Wen Sha Road Foshan City, Guangdong
 Province, China
 (740) Giorgi Kartvelishvili
 (540)



(591) White, dark and light grey
 (531) 01.15.05; 07.01.09; 28.03
 (511) 29

(260) AM 2021 111604 A
 (210) AM 111604
 (220) 2021 02 09
 (731) Besik Paichadze
 Bakhtrioni St. 14 b, app. 8, Tbilisi, Georgia
 (740) Shalva Gvaramadze
 (540)



(591) Black-white, yellow
 (531) 27.03.15; 27.05.01; 27.05.10; 27.05.11; 28.19;
 29.01.12
 (511) 30, 33, 35

(260) AM 2021 111607 A
 (210) AM 111607
 (220) 2021 02 10
 (731) House of Prince A/S
 Vester Farimagsgade 19, Copenhagen V,
 DK-1606, Denmark
 (740) Tamar Kotchlamazashvili
 (540)



(591) Black, blue, grey
 (531) 24.09.09; 24.09.11; 26.04.02; 26.04.16;
 26.04.22; 26.04.24; 27.05.01; 27.05.24;
 29.01.13
 (511) 34

(260) AM 2021 111610 A
 (210) AM 111610
 (220) 2021 02 11
 (731) LTD "Real Motors"
 Zurab Chachua St. 49, 0182, Samgori District,
 Tbilisi, Georgia
 (740) Nino Sulikashvili
 (540)



(591) 006BA6 blue, FFB81C yellow, white
 (531) 18.01.21; 26.01.01; 26.01.05; 26.11.08;
 26.11.12; 27.05.11; 27.05.17; 29.01.13
 (511) 7

(260) AM 2021 111615 A
 (210) AM 111615
 (220) 2021 02 11
 (731) Intersun Holding Fzco
 Jebal Ali Free Zone, Dubai, 61051, United Arab
 Emirates
 (740) Mariam Gogitidze
 (540)

Coffee Sens

(591) Black-white
 (511) 30, 35

(260) AM 2021 111617 A
 (210) AM 111617
 (220) 2021 02 11
 (731) Intersun Holding Fzco
 Jebal Ali Free Zone, Dubai, 61051, United Arab
 Emirates
 (740) Mariam Gogitidze
 (540)

Coffee Sense

(591) Black-white
 (511) 30, 35

(260) AM 2021 111693 A
 (210) AM 111693
 (220) 2021 02 12
 (731) LLC "Glamador"
 Budapest St. 11, app. 44, Tbilisi, Georgia
 (740) Levan Nikoladze
 (540)



(591) Black, yellowish-golden
 (531) 04.02.11; 04.02.20; 24.09.09; 26.04.05;
 26.04.14; 26.04.15; 26.04.22; 26.04.24;
 27.05.01; 27.05.24; 29.01.12
 (511) 25

(260) AM 2021 111698 A
 (210) AM 111698
 (220) 2021 02 12
 (731) British American Tobacco (Brands) Inc.
 (a Delaware corporation)
 251 Little Falls Drive, Suite 100, Wilmington,
 Delaware, 19808-1674, USA
 (740) Tamar Kotchlamazashvili
 (540)

LOVE THE NOW

(591) Black-white
 (511) 34

(260) AM 2021 111703 A
 (210) AM 111703
 (220) 2021 02 14
 (731) Rusudan Ghudushauri
 Saakadze St. 167, 0186, Tbilisi, Georgia;
 LTD "Granatappel Road"
 Saakadze St. 167, 0186, Tbilisi,
 Georgia
 (540)



GRANATAPFEL ROAD
 Think Global Go Local
 Georgien

(591) Pomegranate red, white
 (531) 01.15.23; 05.05.20; 26.01.01; 26.01.04;
 26.01.15; 27.05.01; 27.05.10; 29.01.01
 (511) 24, 25, 27, 28, 32, 33, 35, 39, 41, 42

(260) AM 2021 111705 A
 (210) AM 111705
 (220) 2021 02 15
 (731) LTD "Dona 2005"
 Parnavaz Mepe St. 113-121/16,
 Non-residential Area, Batumi,
 Georgia
 (740) Giorgi Taktakishvili

(540)



(591) Black-white
 (531) 03.13.04; 26.04.02; 26.04.09; 26.05.01;
 26.05.15; 26.05.22
 (511) 30, 35, 43

(260) AM 2021 111709 A
 (210) AM 111709
 (220) 2021 02 15
 (731) LLC "Geo Concentrate"
 Tbilisi St. 70, 1400, Gori, Georgia
 (540)

BOSTAN

(591) DC0F14 Red
 (531) 27.05.01; 29.01.01
 (511) 29, 32

(260) AM 2021 111710 A
 (210) AM 111710
 (220) 2021 02 15
 (731) LLC "American Hospital Tbilisi"
 David Kldiashvili St. 15, app. 56, 0112,
 Tbilisi, Georgia

(540)



ამერიკული
 ჰოსპიტალი თბილისი

(591) Red, blue
 (531) 24.13.01; 26.11.03; 26.11.05; 26.11.08;
 29.01.12
 (526) თბილისი
 (511) 35, 36, 37, 39, 40, 41, 42, 43, 44, 45

(260) AM 2021 111711 A
 (210) AM 111711
 (220) 2021 02 15
 (731) LLC "American Hospital Tbilisi"
 David Kldiashvili St. 15, app. 56, 0112,
 Tbilisi, Georgia

(540)



(591) Red, blue
 (531) 24.13.01; 26.11.03; 26.11.05; 26.11.08;
 29.01.12
 (526) Tbilisi
 (511) 35, 36, 37, 39, 40, 41, 42, 43, 44, 45

(260) AM 2021 111719 A
 (210) AM 111719
 (220) 2021 02 16
 (731) LTD "Naqa"
 Beridze St. 6, 0198, Mtatsminda District,
 Tbilisi, Georgia

(540)



(591) White, black, green, red, silver, brown
 (531) 01.15.15; 02.01.11; 08.01.02; 08.01.03;
 08.01.04; 25.01.10; 25.01.15; 27.05.01;
 27.05.02; 27.05.09; 27.05.10; 29.01.15
 (511) 30

(260) AM 2021 111724 A
 (210) AM 111724
 (220) 2021 02 16
 (731) LTD "G-M-P"
 Vill. Ponichala 65, 0165, Tbilisi, Georgia
 (740) Nugzar Ksovreli

(540)



(591) White, red, black
 (531) 01.01.02; 01.01.09; 26.01.01; 26.01.13;
 29.01.13
 (511) 5

(260) AM 2021 111725 A
 (210) AM 111725
 (220) 2021 02 16
 (731) LTD "G-M-P"
 Vill. Ponichala 65, 0165, Tbilisi, Georgia
 (740) Nugzar Ksovreli
 (540)



(591) White, red, black
 (531) 01.01.02; 01.01.09; 26.01.13; 29.01.13
 (511) 5

(260) AM 2021 111726 A
 (210) AM 111726
 (220) 2021 02 16
 (731) LTD "G-M-P"
 Vill. Ponichala 65, 0165, Tbilisi, Georgia
 (740) Nugzar Ksovreli
 (540)



(591) White, red, black
 (531) 01.01.02; 01.01.09; 26.01.13; 29.01.13
 (511) 5

(260) AM 2021 111731 A
 (210) AM 111731
 (220) 2021 02 17
 (731) Merck Sharp & Dohme Corp.
 One Merck Drive, Whitehouse Station,
 New Jersey, 08889, USA
 (740) Tamaz Shilakadze
 (540)

LAGEVRIO

(591) Black-white
 (511) 5

(260) AM 2021 111733 A
 (210) AM 111733
 (220) 2021 02 17
 (731) Izocam Ticaret ve Sanayi Anonim Şirketi
 Altaicheshme Mah. Chamli Soq. Esas Ofisfarq
 №21 Qat: 4-5 Maltefe-Istanbul, Turkey
 (740) Tamaz Shilakadze
 (540)



(591) Yellow, black, white
 (531) 26.11.12; 28.19; 29.01.12
 (511) 1, 16, 17

(260) AM 2021 111740 A
 (210) AM 111740
 (220) 2021 02 18
 (731) Novartis AG
 4002 Basel, Switzerland
 (740) Shalva Gvaramadze
 (540)

NEVANAC

(591) Black-white
 (511) 5

(260) AM 2021 111742 A
 (210) AM 111742
 (220) 2021 02 18
 (731) Novartis AG
 4002 Basel, Switzerland
 (740) Shalva Gvaramadze
 (540)

DUOTRAV

(591) Black-white
 (511) 5

(260) AM 2021 111744 A
 (210) AM 111744
 (220) 2021 02 18
 (731) Novartis AG
 4002 Basel, Switzerland
 (740) Shalva Gvaramadze
 (540)

МАКСИДЕКС

(591) Black-white
 (531) 28.05
 (511) 5

(260) AM 2021 111745 A
 (210) AM 111745
 (220) 2021 02 18
 (731) Novartis AG
 4002 Basel, Switzerland
 (740) Shalva Gvaramadze
 (540)

Макситрол

(591) Black-white
 (531) 28.05
 (511) 5

(260) AM 2021 111746 A
 (210) AM 111746
 (220) 2021 02 18
 (731) Novartis AG
 4002 Basel, Switzerland
 (740) Shalva Gvaramadze
 (540)

Неванак

(591) Black-white
 (531) 28.05
 (511) 5

(260) AM 2021 111747 A
 (210) AM 111747
 (220) 2021 02 18
 (731) Novartis AG
 4002 Basel, Switzerland
 (740) Shalva Gvaramadze
 (540)

ПАТАНОЛ

(591) Black-white
 (531) 28.05
 (511) 5

(260) AM 2021 111748 A
 (210) AM 111748
 (220) 2021 02 18
 (731) Novartis AG
 4002 Basel, Switzerland
 (740) Shalva Gvaramadze
 (540)

ТОБРЕКС

(591) Black-white
 (531) 28.05
 (511) 5

(260) AM 2021 111749 A
 (210) AM 111749
 (220) 2021 02 18
 (731) Novartis AG
 4002 Basel, Switzerland
 (740) Shalva Gvaramadze
 (540)

ВИЗКЬЮ

(591) Black-white
 (531) 28.05
 (511) 5

(260) AM 2021 111750 A
 (210) AM 111750
 (220) 2021 02 18
 (731) Novartis AG
 4002 Basel, Switzerland
 (740) Shalva Gvaramadze
 (540)

ТРАВАТАН

(591) Black-white
 (531) 28.05
 (511) 5

(260) AM 2021 111751 A
 (210) AM 111751
 (220) 2021 02 18
 (731) Novartis AG
 4002 Basel, Switzerland
 (740) Shalva Gvaramadze
 (540)

СИМБРИНЗА

(591) Black-white
 (531) 28.05
 (511) 5

(260) AM 2021 111752 A
 (210) AM 111752
 (220) 2021 02 18
 (731) Novartis AG
 4002 Basel, Switzerland
 (740) Shalva Gvaramadze
 (540)

ТОБРАДЕКС

(591) Black-white
 (531) 28.05
 (511) 5

(260) AM 2021 111753 A
 (210) AM 111753
 (220) 2021 02 18
 (731) Novartis AG
 4002 Basel, Switzerland
 (740) Shalva Gvaramadze
 (540)

АЗАРГА

(591) Black-white
 (531) 28.05
 (511) 5

(260) AM 2021 111754 A
 (210) AM 111754
 (220) 2021 02 18
 (731) Novartis AG
 4002 Basel, Switzerland
 (740) Shalva Gvaramadze
 (540)

БЕТОПТИК

(591) Black-white
 (531) 28.05
 (511) 5

(260) AM 2021 111755 A
 (210) AM 111755
 (220) 2021 02 18
 (731) Novartis AG
 4002 Basel, Switzerland
 (740) Shalva Gvaramadze
 (540)

АЗОПТ

(591) Black-white
 (531) 28.05
 (511) 5

(260) AM 2021 111756 A
 (210) AM 111756
 (220) 2021 02 18
 (731) Novartis AG
 4002 Basel, Switzerland
 (740) Shalva Gvaramadze
 (540)

ДУОТРАВ

(591) Black-white
 (531) 28.05
 (511) 5

(260) AM 2021 111845 A
 (210) AM 111845
 (220) 2021 02 23
 (731) LTD "Naqa"
 Beridze St. 6, Tbilisi, Georgia
 (540)



(591) Brown, reddish-brown, yellow
 (531) 02.01.11; 05.07.02; 05.13.07; 05.13.25;
 08.01.03; 08.01.04; 09.01.07; 19.03.03;
 19.03.05; 19.03.24; 25.01.05; 25.01.09;
 27.05.01; 27.05.10; 29.01.14
 (511) 30

REGISTERED TRADEMARKS

(111) M 2021 34447 R
(151) 2021 09 02
(181) 2031 09 02
(260) AM 2019 105655 A
(220) 2019 11 05

(732) I/E Alekhander Makeev
Zhiuli Shartava Av. 8, Fl. 6, app. 23, 6000,
Batumi, Georgia

(111) M 2021 34448 R
(151) 2021 09 02
(181) 2031 09 02
(260) AM 2020 108943 A
(220) 2020 07 04

(732) David Gabrichidze
Nutsbidze St. 30, 0177, Tbilisi, Georgia

(111) M 2021 34449 R
(151) 2021 09 02
(181) 2031 09 02
(260) AM 2020 109013 A
(220) 2020 07 10

(732) Pediatrica Specialist S.R.L.
Via Nicolodi 28/A, 57121 Livorno (LI), Italy

(111) M 2021 34450 R
(151) 2021 09 02
(181) 2031 09 02
(260) AM 2020 109014 A
(220) 2020 07 10

(732) Pediatrica Specialist S.R.L.
Via Nicolodi 28/A, 57121 Livorno (LI), Italy

(111) M 2021 34451 R
(151) 2021 09 02
(181) 2031 09 02
(260) AM 2020 109015 A
(220) 2020 07 10

(732) Pediatrica Specialist S.R.L.
Via Nicolodi 28/A, 57121 Livorno (LI), Italy

(111) M 2021 34452 R
(151) 2021 09 02
(181) 2031 09 02
(260) AM 2020 109016 A
(220) 2020 07 10

(732) Pediatrica Specialist S.R.L.
Via Nicolodi 28/A, 57121 Livorno (LI), Italy

(111) M 2021 34453 R
(151) 2021 09 02
(181) 2031 09 02
(260) AM 2020 109017 A
(220) 2020 07 10

(732) Pediatrica Specialist S.R.L.
Via Nicolodi 28/A, 57121 Livorno (LI), Italy

(111) M 2021 34454 R
(151) 2021 09 02
(181) 2031 09 02
(260) AM 2020 109018 A
(220) 2020 07 10

(732) Pediatrica Specialist S.R.L.
Via Nicolodi 28/A, 57121 Livorno (LI), Italy

(111) M 2021 34455 R
(151) 2021 09 02
(181) 2031 09 02
(260) AM 2020 109021 A
(220) 2020 07 10

(732) Pediatrica Specialist S.R.L.
Via Nicolodi 28/A, 57121 Livorno (LI), Italy

(111) M 2021 34456 R
(151) 2021 09 02
(181) 2031 09 02
(260) AM 2020 109022 A
(220) 2020 07 10

(732) Pediatrica Specialist S.R.L.
Via Nicolodi 28/A, 57121 Livorno (LI), Italy

(111) M 2021 34457 R
(151) 2021 09 02
(181) 2031 09 02
(260) AM 2020 109023 A
(220) 2020 07 10

(732) Pediatrica Specialist S.R.L.
Via Nicolodi 28/A, 57121 Livorno (LI), Italy

(111) M 2021 34458 R
(151) 2021 09 02
(181) 2031 09 02
(260) AM 2020 109745 A
(220) 2020 09 14

(732) Ahmed Al Bassam Trading Est.
P.O. Box 4215, Khobar, 31952, Saudi Arabia

(111) M 2021 34459 R
(151) 2021 09 02
(181) 2031 09 02
(260) AM 2020 109825 A
(220) 2020 09 21
(732) Caterpillar Inc.
(a Delaware Corporation)
100 NE Adams Street, Peoria, Illinois,
61629, USA

(111) M 2021 34460 R
(151) 2021 09 02
(181) 2031 09 02
(260) AM 2020 109832 A
(220) 2020 09 21
(732) Adami Medienpreis GmbH
Mediencampus Villa Ida,
Menckestraße. N27, 04155, Leipzig, Germany

(111) M 2021 34461 R
(151) 2021 09 02
(181) 2031 09 02
(260) AM 2020 109840 A
(220) 2020 09 23
(732) Enriko Beridze
T. Tabidze St. 10, Dead End I, 0108,
Tbilisi, Georgia

(111) M 2021 34462 R
(151) 2021 09 02
(181) 2031 09 02
(260) AM 2020 109846 A
(220) 2020 09 24
(732) Shalva Khetsuriani
Queen Tamara Av. 17, 0112, Tbilisi, Georgia

(111) M 2021 34463 R
(151) 2021 09 02
(181) 2031 09 02
(260) AM 2020 109848 A
(220) 2020 09 24
(732) LTD "Nikala"
Kheivani 12, St. I, 0114, Krtsanisi District,
Tbilisi, Georgia

(111) M 2021 34464 R
(151) 2021 09 02
(181) 2031 09 02
(260) AM 2020 109911 A
(220) 2020 09 25
(732) LTD "Mill Group"
Beliashvili St., Nearby the Institute of
Morphology, 0159, Tbilisi, Georgia

(111) M 2021 34465 R
(151) 2021 09 02
(181) 2031 09 02
(260) AM 2020 109912 A
(220) 2020 09 25
(732) LTD "Mill Group"
Beliashvili St., Nearby the Institute of
Morphology, 0159, Tbilisi, Georgia

(111) M 2021 34466 R
(151) 2021 09 02
(181) 2031 09 02
(260) AM 2020 109917 A
(220) 2020 09 25
(732) LTD "Legion"
R. Agladze St. 25, Building 1, floor 4,
Didube-Chughureti District, Tbilisi, Georgia

(111) M 2021 34467 R
(151) 2021 09 02
(181) 2031 09 02
(260) AM 2020 109932 A
(220) 2020 09 29
(732) Enriko Beridze
G. Tsitsishvili St. 18, Tbilisi, Georgia

(111) M 2021 34468 R
(151) 2021 09 02
(181) 2031 09 02
(260) AM 2020 109933 A
(220) 2020 09 29
(732) Enriko Beridze
G. Tsitsishvili St. 18, Tbilisi, Georgia

(111) M 2021 34469 R
(151) 2021 09 02
(181) 2031 09 02
(260) AM 2020 109954 A
(220) 2020 10 01
(732) Majid Al Futtain Hypermarkets LLC
5th Floor, MAF Tower 1, Port Saeed, Deira,
United Arab Emirates

(111) M 2021 34470 R
(151) 2021 09 02
(181) 2031 09 02
(260) AM 2020 110023 A
(220) 2020 10 05
(732) Pfizer Inc.
235 East 42nd Street, New York, NY
10017, USA

(111) M 2021 34471 R
(151) 2021 09 02
(181) 2031 09 02
(260) AM 2020 110027 A
(220) 2020 10 05
(732) LTD "Elvisi"
Ir. Abashidze St. 3, app. 11, Tbilisi, Georgia

(111) M 2021 34472 R
(151) 2021 09 02
(181) 2031 09 02
(260) AM 2020 110032 A
(220) 2020 10 06
(732) LTD "Anaseuli Combine"
Vill. Anaseuli, 3500, Ozurgeti Region, Georgia

(111) M 2021 34473 R
(151) 2021 09 02
(181) 2031 09 02
(260) AM 2020 110042 A
(220) 2020 10 08
(732) SPD Swiss Precision Diagnostics GmbH
Route de Saint-Georges 47, Petit-Lancy,
Geneva, 1213, Switzerland

(111) M 2021 34474 R
(151) 2021 09 02
(181) 2031 09 02
(260) AM 2020 110115 A
(220) 2020 10 12
(732) LTD "Krinti"
Madneuli St. 10, Kazreti, Bolnisi, Georgia

(111) M 2021 34475 R
(151) 2021 09 02
(181) 2031 09 02
(260) AM 2020 110116 A
(220) 2020 10 12
(732) LTD "Krinti"
Madneuli St. 10, Kazreti, Bolnisi, Georgia

(111) M 2021 34476 R
(151) 2021 09 02
(181) 2031 09 02
(260) AM 2020 110129 A
(220) 2020 10 14
(732) JSC "Nikora Trade"
Merab Kavtaradze St. 11, 0180, Tbilisi,
Georgia

(111) M 2021 34477 R
(151) 2021 09 02
(181) 2031 09 02
(260) AM 2020 110134 A
(220) 2020 10 15
(732) LLC "Invet Feed"
Tsemi St. 3 (Plot 113), Tbilisi, Georgia

(111) M 2021 34478 R
(151) 2021 09 02
(181) 2031 09 02
(260) AM 2020 110135 A
(220) 2020 10 15
(732) Davit Shlamberidze
Bagebi, corp. 3, app. 67, Tbilisi, Georgia

(111) M 2021 34479 R
(151) 2021 09 02
(181) 2031 09 02
(260) AM 2020 110193 A
(220) 2020 10 16
(732) LTD "Karabadini"
Jansugh Kakhidze St. 9, (Former Krylov St.),
Tbilisi, Georgia

(111) M 2021 34480 R
(151) 2021 09 02
(181) 2031 09 02
(260) AM 2020 110197 A
(220) 2020 10 16
(732) JSC "Nikora Trade"
Merab Kavtaradze St. 11, 0180, Tbilisi,
Georgia

(111) M 2021 34481 R
(151) 2021 09 02
(181) 2031 09 02
(260) AM 2020 110208 A
(220) 2020 10 20
(732) Intellect Products
Sormovlka Exit, House N11, Bld. N2,
Fl. 9, room 5, Moscow, Russian Federation

111) M 2021 34482 R
(151) 2021 09 02
(181) 2031 09 02
(260) AM 2020 110209 A
(220) 2020 10 20
(732) LTD "Karmen"
D. Aghmashenebli St. 34a, 6000, Batumi,
Georgia

(111) M 2021 34483 R
(151) 2021 09 02
(181) 2031 09 02
(260) AM 2020 110224 A
(220) 2020 10 22
(732) Dongfeng Motor Corporation
Special No.1 Dongfeng Road, Wuhan
Economic and Technology Development
Zone, Wuhan, Hubei, China

(111) M 2021 34484 R
(151) 2021 09 02
(181) 2031 09 02
(260) AM 2020 110231 A
(220) 2020 10 22
(732) LTD "Kartveli"
Kakheti Highway 110a, 0151, Tbilisi, Georgia

(111) M 2021 34485 R
(151) 2021 09 02
(181) 2031 09 02
(260) AM 2020 110304 A
(220) 2020 10 29
(732) Novartis AG
4002 Basel, Switzerland

TRADEMARKS REGISTERED ACCORDING TO THE ACCELERATED PROCEDURE

The decision can be appealed at the Chamber of Appeal of Sakpatenti within 3 months from the publication.

(111) M 2021 34434 R
(151) 2021 08 23
(181) 2031 08 23
(210) AM 114323
(220) 2021 08 16
(732) LLC "Namtskhvari/Cookies"
Mikheil Tamarashvili Av. 19a, app. 47,
0177, Tbilisi, Georgia
(540)

საბლე
Sablée

(591) Black-white
(511) 30

(111) M 2021 34435 R
(151) 2021 08 23
(181) 2031 08 23
(210) AM 114231
(220) 2021 08 11
(732) LTD "Askaneli Brothers"
Kakheti Highway 110a, 0198, Isani-Samgori
District, Tbilisi, Georgia
(740) Davit Dzumukashvili
(540)

YESNO

(591) Black-white
(511) 33

(111) M 2021 34436 R
(151) 2021 08 23
(181) 2031 08 23
(210) AM 114232
(220) 2021 08 11
(732) LTD "Askaneli Brothers"
Kakheti Highway 110a, 0198, Isani-Samgori
District, Tbilisi, Georgia
(740) Davit Dzumukashvili
(540)

DM – direct message

(591) Black-white
(511) 33

(111) M 2021 34437 R
(151) 2021 08 24
(181) 2031 08 24
(210) AM 114131
(220) 2021 07 31
(732) LLC "Tsinandali +"
Chirnakhuli St. 5-7, Samgori District, Tbilisi,
Georgia
(740) Vakhtang Torotadze
(540)



(591) 000000 black, BC9B78 beige, 425172
blue
(531) 25.03.01; 25.03.03; 26.04.04; 26.04.05;
26.04.22; 26.04.24; 27.05.01; 27.05.02;
27.05.09; 28.19; 29.01.13
(511) 33

(111) M 2021 34438 R
(151) 2021 08 25
(181) 2031 08 25
(210) AM 114346
(220) 2021 08 19
(732) LTD "Chyren Chamber"
Kobuleti St. 24a, 0179, Tbilisi, Georgia
(540)



CHARMY de ILY

(591) F45702 red, F2E129 yellow, 0A0A09
black, E08A33 orange
(531) 01.01.09; 01.03.01; 01.03.07; 02.09.01;
18.03.01; 29.01.13
(511) 10

(111) M 2021 34439 R
 (151) 2021 08 25
 (181) 2031 08 25
 (210) AM 114345
 (220) 2021 08 19
 (732) JSC "Surf Travel"
 Lekh and Maria Kaczynski St. 1a, 2nd fl.,
 Entr. C, app. N-C101, Batumi, 6010,
 Georgia
 (540)



turketidan.ge

(591) FFFFFFF white, EF862F orange, black
 (531) 04.05.02; 10.03.12; 10.03.13; 24.15.01;
 24.15.11; 24.15.15; 27.05.01; 29.01.13
 (511) 9, 39

(111) M 2021 34441 R
 (151) 2021 09 01
 (181) 2031 09 01
 (210) AM 114316
 (220) 2021 08 15
 (732) Natalia Papashvili
 Galaktion Tabidze St. 7, Tabakhmela, Tbilisi,
 Georgia
 (540)



(591) Lilac, blue, red, black, white
 (531) 02.09.01; 18.01.07; 18.01.08; 18.01.14;
 19.13.22; 26.11.22; 27.05.01; 27.05.09;
 27.05.10; 27.05.11; 29.01.15
 (511) 44

(111) M 2021 34440 R
 (151) 2021 09 01
 (181) 2031 09 01
 (210) AM 114005
 (220) 2021 07 22
 (732) LLC "Georgian Brothers"
 Nutsbidze Plateau, IV mcr., corp. 10b,
 app. 42, 0183, Tbilisi, Georgia
 (740) Khatuna Imnadze
 (540)



(591) Black, white, golden, red
 (531) 03.01.16; 25.01.05; 25.01.25; 26.01.01;
 26.01.15; 26.02.07; 26.02.12; 26.02.24;
 26.13.25; 27.05.01; 27.05.11; 27.05.24; 28.19;
 29.01.14
 (526) GEORGIA
 (511) 32, 33

(111) M 2021 34442 R
 (151) 2021 09 01
 (181) 2031 09 01
 (210) AM 114338
 (220) 2021 08 18
 (732) LTD "Dar Building"
 Mayakoskiy St. 29, Batumi, Georgia
 (740) Vakhtang Torotadze
 (540)

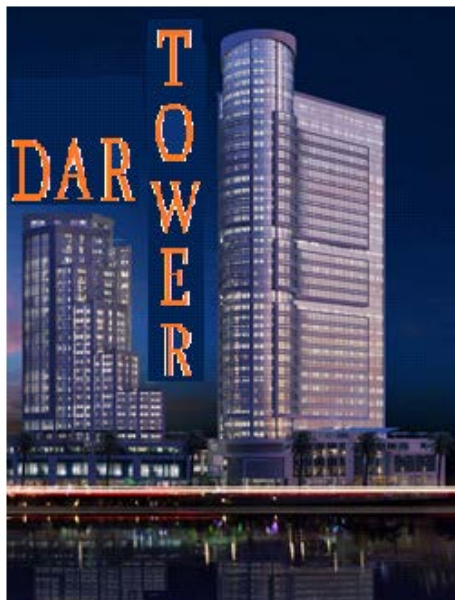

(591) Red, orange, green, lilac, blue, white, black
 (531) 06.03.02; 06.07.01; 06.07.05; 06.07.06;
 27.05.01; 29.01.15
 (511) 36

(111) M 2021 34443 R
 (151) 2021 09 01
 (181) 2031 09 01
 (210) AM 114339
 (220) 2021 08 18
 (732) LTD "Dar Building"
 Mayakoskiy St. 29, Batumi, Georgia
 (740) Vakhtang Torotadze
 (540)



(591) Orange, white, black
 (531) 07.01.24; 15.01.19; 29.01.13
 (511) 36

(111) M 2021 34444 R
 (151) 2021 09 01
 (181) 2031 09 01
 (210) AM 114406
 (220) 2021 08 24
 (732) JSC "Gefa"
 Akaki Belashvili St. 142, 0159, Tbilisi,
 Georgia
 (740) Salome Jeladze
 (540)

Napril-H BENE
Наприл-Н БЕНЕ
ნაპრილ-ნ ბენე

(591) Black-white
 (511) 5

(111) M 2021 34445 R
 (151) 2021 09 02
 (181) 2031 09 02
 (210) AM 114405
 (220) 2021 08 24
 (732) JSC "Gefa"
 Akaki Belashvili St. 142, 0159, Tbilisi,
 Georgia
 (740) Salome Jeladze
 (540)

Diperidin BENE
Диперидин БЕНЕ
დიპერიდინი ბენე

(591) Black-white
 (511) 5

(111) M 2021 34446 R
 (151) 2021 09 02
 (181) 2031 09 02
 (210) AM 114409
 (220) 2021 08 24
 (732) 100 X
 Bogdan Khmelniyskiy St. 8, app. 17, Tbilisi,
 Georgia
 (540)



(591) Lilac, pink and blue gradients
 (531) 27.05.21; 28.05; 29.01.15
 (511) 9

INTERNATIONAL TRADEMARKS FOR WHICH A DECISION ON GRANTING PROTECTIONS IS TAKEN

The decision can be appealed at the Chamber of Appeal of Sakpatenti within 3 months from the publication or at the Mtskheta District Court Administrative Cases Board (Address: №17, Samkhedro St., Mtskheta), within 1 month following the publication.

(260) AM 2021 108043 A*
(800) 1527318
(151) 2019 09 23
(891) 2019 09 23
(731) UAB "VIČIŪŅŲ GRUPĖ"
V. Krėvės pr. 97, LT-50369 Kaunas, Lithuania
(540)



(591) Black, white
(531) 03.06.01; 27.05.02
(511)
29 – sea-cucumbers, not live; clams, not live; black pudding; croquettes; corn dogs; escamoles (edible ant larvae, prepared); tuna, not live.

(260) AM 2021 108453 A*
(800) 1532672
(151) 2020 03 19
(891) 2020 03 19
(731) Tronios Group International B.V.
Bedrijvenpark Twente N 18, NL-7602
Almelo, Netherlands
(540)

AUDIZIO

(591) Black, white
(511)
9 – Apparatus for recording, transmission or reproduction of sound or images; audio sets with or without cd player, bluetooth, mp3; sound mixing apparatus; magnetic data carriers, disc-shaped sound carriers and digital carriers; cd drive; cd mixers; cd players; record players; mp3 players; loudspeakers; passive loudspeakers; active loudspeakers; portable hifi speakers; bluetooth speakers; wifi speakers portable audio equipment; radios; radio and receiving apparatus; headphones; microphones; cabinets and stands for loudspeakers and / or for equipment for sound recording, reproduction and transmission; remote control apparatus; amplifiers; electric cables; couplings, electric; electrical power adaptors; couplers.
35 – Retail and online retail services related to the sale of audio and audiovisual, sound equipment and

instruments, audio sets, bluetooth audio sets, cd players, mp3 players, record players, portable audio equipment, speakers, portable hi-fi speakers, bluetooth speakers, wifi speakers, headphones, microphone, cabling and other audio parts; information and consultancy relating to the aforesaid services; the aforesaid services also include digital media, including the internet.

(260) AM 2021 109653 A*
(800) 1548988
(151) 2020 07 01
(891) 2020 07 01
(731) TCC iTrading Co., Ltd.
NO.1-602 Binhai Wanlong Plaza, East of
Yingbin Avenue, (Central Business District)
Pilot Free, Trade Zone, 300000 Tianjin, China
(540)



(591) Blue, red, orange, gray
(531) 01.01.09; 26.11.12; 27.05.07; 27.05.10;
29.01.14
(511)
42 – Technological research; consultancy in the field of energy-saving.

(260) AM 2021 110082 A
(800) 1554324
(151) 2020 09 15
(891) 2020 09 15
(731) HONOR DEVICE CO., LTD.
Suite 3401, Unit A, Building 6, Shum Yip Sky
Park, No. 8089, Hongli West Road, Xiangmihu
Street, Futian District, Shenzhen, 518040
Guangdong, China
(540)

HONOR MagicBand

(591) Black, white
(531) 27.05.01
(511)
9 – Hand-held electronic dictionaries; fingerprint identifier; human face recognition devices; stored program controlling telephone switching apparatus; ra-

dios; air analysis apparatus; video screens; computer software, recorded; wearable computers; telecommunication apparatus in the form of jewellery; selfie sticks for mobile phones; security surveillance robots; wearable video display monitors; selfie lenses; laboratory robots; teaching robots; USB data lines or data cables; USB data lines or data cables for mobile phones; downloadable mobile phone software applications; holders for mobile phones; touch screens; television apparatus; electric plugs; electric sockets; intercoms; digital door locks; alarm central units; wide area network (WAN) routers; battery chargers for tablet computers; encoded identification bracelets, magnetic; sensors; computer operating programs, recorded; liquid crystal displays (LCD) with large screens; electronic diaries; liquid crystal displays (LCD); video image printers; portable digital electronic scales; wrist-mounted smartphones; television apparatus for vehicles; computer styluses; computer programs, downloadable; computer programs (downloadable software); touch screen pens; 3D spectacles; bags adapted for laptops; smartglasses; smartwatches; smartphones; wearable activity trackers; cases for smartphones; covers for smartphones; protective films adapted for smartphones; digital photo frames; microphones; computer hardware; computer memories; integrated circuit cards (smart cards); transponders; cabinets for loudspeakers; network communication apparatus; modems; sleeves for laptops; electric batteries; chargers for electric batteries; electronic pens; covers for tablet computers; tablet computers; stands adapted for tablet computers; flexible flat panel displays for computers; mobile power source (rechargeable batteries); flat panel displays; laptop computers; pedometers; monitoring apparatus, other than for medical purposes; video monitors; connected bracelets (measuring instruments); computer programs, recorded; computer software applications, downloadable; optical lenses; switchboards; notebook computers; headphones; security tokens (encryption devices); holograms; integrated circuits; electronic chips; thermal imaging cameras; scales with body mass analyzers; personal digital assistants (PDAs); computer software platforms, recorded or downloadable; thin client computers; earphones; virtual reality headsets; digital video recorder for vehicles; set-top boxes; loudspeakers; portable media players; sound transmitting apparatus; camcorders; cameras (photography); computer keyboards; mouse (computer peripheral); gas testing instruments; scales; black boxes (data recorders); interactive touch screen terminals; humanoid robots with artificial intelligence; electronic sheet music, downloadable; smart rings; electric and electronic effects units for musical instruments; digital weather stations; biochips; infrared detectors; electronic key fobs being remote control apparatus; USB wireless routers; network routers; wireless routers.

(260) AM 2021 110500 A
 (800) 772688
 (151) 2001 10 08
 (891) 2020 10 27
 (731) Pivovary Staropramen s.r.o.
 Nádražní 43/84, CZ-150 00 Praha 5,
 Czech Republic
 (540)

Braník

(591) Black, white
 (511)
 32 – Beer.

(260) AM 2021 110501 A
 (800) 1197965
 (151) 2014 03 04
 (891) 2020 10 27
 (731) Pivovary Staropramen s.r.o.
 Nádražní 43/84, CZ-150 00 Praha 5,
 Republic
 (540)

VELVET

(591) Black, white
 (511)
 32 – mineral and aerated waters and other non-alcoholic drinks; fruit drinks and fruit juices; syrups and other preparations for making beverages.

(260) AM 2021 110502 A
 (800) 1406250
 (151) 2018 01 18
 (891) 2020 10 08
 (731) Andronnik Limited Liability Company
 floor 5, building 77, Sacco and Vanzetti street,
 RU-630008 Novosibirsk, Russian Federation
 (540)

ADRIA

(591) Black, white
 (511)
 5 – Eyepatches for medical purposes; eye-washes; contact lens cleaning preparations; collyrium; lead water; solutions for contact lenses.
 9 – Electronic notice boards; interfaces for computers; electronic pens [visual display units]; identity cards, magnetic; video game cartridges; encoded magnetic cards; computer keyboards; electronic agendas; mouse pads; magnetic encoders; compact discs [read-only memory]; computers; laptop computers; notebook computers; contact lenses; correcting lenses [optics]; optical lenses; optical condensers; magnifying glasses [optics]; thread counters; magnets; decorative magnets; mouse [computer peripheral]; mechanisms for coin-operated apparatus; mechanisms for counter-operated apparatus; coin-operated mechanisms for televi-

sion sets; shutter releases [photography]; monitors [computer hardware]; monitors [computer programs]; magnetic data media; optical data media; computer software, recorded; objectives [lenses] [optics]; eye-pieces; lenses for astrophotography; egg-candlers; eyeglass frames; frames for pince-nez; mirrors [optics]; eyeglasses; sunglasses; goggles for sports; pince-nez; electronic pocket translators; transmitters of electronic signals; teaching apparatus; time recording apparatus; optical apparatus and instruments; prisms [optics]; printers for use with computers; telescopic sights for firearms; computer programmes [programs], recorded; computer game software; computer programs [downloadable software]; computer operating programs, recorded; record players; processors [central processing units]; electronic publications, downloadable; spectacle lenses; anti-glare glasses; optical glass; personal stereos; stereoscopes; egg timers [sandglasses]; television apparatus; telescopes; theft prevention installations, electric; downloadable ring tones for mobile phones; downloadable image files; downloadable music files; animated cartoons; filters [photography]; USB flash drives; magic lanterns; optical lamps; signal lanterns; cameras [photography]; containers for contact lenses; eyeglass cases; cases for pince-nez; containers for microscope slides; cases especially made for photographic apparatus and instruments; cell phone straps; cords for pince-nez; tripods for cameras; screens [photography]; workmen's protective face-shields; projection screens.

(260) AM 2021 110503 A
 (800) 1477194
 (151) 2019 05 21
 (891) 2020 09 23
 (731) Open-Type Joint Stock Company
 "ROT FRONT"
 2-oy Novokuznetskiy pereulok, d. 13/15,
 RU-115184 Moscow, Russian Federation

(540)

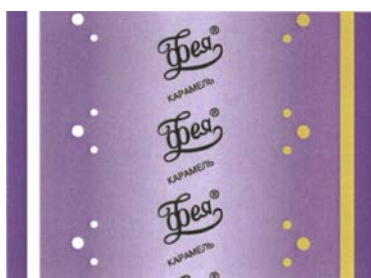

(591) Purple, dark purple, light purple, dark yellow, black and white
 (531) 19.03.24; 25.07.01; 26.01.01; 28.05; 29.01.13
 (526) КАРАМЕЛЬ
 (511)
 30 – Confectionery, namely, caramels [candy].

(260) AM 2021 110552 A
 (800) 1560287
 (151) 2020 07 10
 (891) 2020 07 10
 (731) Autumnpaper Limited
 5th Floor Rear Suite, Oakfield House, 35
 Perrymount Road, Haywards Heath, West
 Sussex RH16 3BW, United Kingdom

(540)

ALEXANDER MCQUEEN

(591) Black, white
 (511)
 4 – Candles; scented candles.

21 – Household or kitchen utensils and containers; cookware and tableware, except forks, knives and spoons; combs and sponges; brushes, except paintbrushes; brush-making materials; articles for cleaning purposes; unworked or semi-worked glass, except building glass; glassware, porcelain and earthenware; cosmetic and toilet utensils; aromatic oil diffusers, other than reed diffusers, electric and non-electric; reed diffusers being devices for diffusing perfumes, sold empty; candle extinguishers; candle snuffers; candle holders.

24 – Textiles; textile articles; upholstery (fabrics); textile piece goods; bed and table covers; household linen; linen cloth; bed linen; bath linen; table linen; table cloths; curtains of textile or plastic; pillow shams; pillow cases; sheets; towels; eiderdowns; duvets; covers for eiderdown and duvets; table runners; table mats; napery; napkins; serviettes; table mats (not of paper); face towels; flannels; tissues (textile); traced cloth for embroidery; tapestry (wall hangings) of textile; rugs (travelling); furniture coverings of plastic; fabrics for textile use; blankets; duvets; coasters; eiderdowns; furniture coverings; handkerchiefs; mattress covers; place mats, (textile), quilts, serviettes (textile).

27 – Carpets, rugs, mats and matting, linoleum and other materials for covering existing floors; wall hangings (non-textile); wallpaper.

(260) AM 2021 110565 A
 (800) 1560693
 (151) 2020 07 21
 (891) 2020 07 21
 (731) Euro Games Technology Ltd.
 4, "Maritsa" Str., "Vranya-Lozen-Triugulnika",
 BG-1151 Sofia, Bulgaria

(540)

Bell Link

(591) Black, white
 (511)
 9 – Software; computer gaming software; computer software packages; computer operating system soft-

ware; computer software, recorded; software drivers; virtual reality software; games software; entertainment software for computer games; computer programs for network management; operating computer software for main frame computers; monitors (computer hardware); computer hardware; apparatus for recording images; monitors (computer programs); computer game programs; computer programs for recorded games; apparatus for recording, transmission or reproduction of sound or images; communications servers [computer hardware]; electronic components for gambling machines; computer application software featuring games and gaming; computer software for the administration of on-line games and gaming; computer hardware for games and gaming; computer hardware and software for gambling, gambling machines, gambling games on the Internet and via telecommunication network.

28 – Gaming machines for gambling; chips for gambling; mah-jong; arcade games; gambling machines operating with coins, notes and cards; games; electronic games; parlor games; gaming chips; gaming tables; slot machines [gaming machines]; LCD game machines; slot machines and gaming devices; coin-operated amusement machines; roulette chips; poker chips; chips and dice [gaming equipment]; gaming equipment for casinos; roulette tables; gaming roulette wheels; casino games; amusement and gambling machines; coin-operated gaming machines and / or electronic coin-operated gaming machines with or without the possibility of gain; boxes for coin-operated machines, slot machines and gaming machines; electronic or electro-technical gaming devices, amusement and gaming machines, including coin-operated machines; housings for coin-operated machines, gaming equipment, gaming machines, machines for gambling; electro-pneumatic and electrical gambling machines (slot machines).

41 – Gambling; entertainment services related to gambling; gaming services for entertainment purposes; casino, gaming and gambling services; training in the development of software systems; provision of equipment for gambling halls; providing casino equipment [gambling]; gaming machine entertainment services; providing casino facilities [gambling]; providing halls with gaming machines; amusement arcade services; games equipment rental; rental of gaming machines; providing amusement arcade services; rental of gaming machines with images of fruits; editing or recording of sounds and images; sound recording and video entertainment services; hire of sound reproducing apparatus; provision of gaming equipment for casinos; providing of casino facilities; online gambling services; provision of casino services; provision of gaming establishments, gaming halls, internet casinos, online gambling services.

(260) AM 2021 110566 A

(800) 1560694

(151) 2020 07 20

(891) 2020 07 20

(731) Euro Games Technology Ltd.

"Maritsa" Str., 4, "Vranya-Lozen-Triugulnika",
BG-1151 Sofia, Bulgaria

(540)



(591) Yellow, gold, red, black, green, orange,
brown and black

(531) 01.15.05; 27.05.04; 29.01.15

(511)

9 – Software; computer gaming software; computer software packages; computer operating system software; computer software, recorded; software drivers; virtual reality software; games software; entertainment software for computer games; computer programs for network management; operating computer software for main frame computers; monitors (computer hardware); computer hardware; apparatus for recording images; monitors (computer programs); computer game programs; computer programs for recorded games; apparatus for recording, transmission or reproduction of sound or images; communications servers [computer hardware]; electronic components for gambling machines; computer application software featuring games and gaming; computer software for the administration of on-line games and gaming; computer hardware for games and gaming; computer hardware and software for gambling, gambling machines, gambling games on the Internet and via telecommunication network.

28 – Gaming machines for gambling; chips for gambling; mah-jong; arcade games; gambling machines operating with coins, notes and cards; games; electronic games; parlor games; gaming chips; gaming tables; slot machines [gaming machines]; LCD game machines; slot machines and gaming devices; coin-operated amusement machines; roulette chips; poker chips; chips and dice [gaming equipment]; gaming equipment for casinos; roulette tables; gaming roulette wheels; casino games; amusement and gambling machines; coin-operated gaming machines and / or electronic coin-operated gaming machines with or without the possibility of gain; boxes for coin-operated machines, slot machines and gaming machines; electronic or electro-technical gaming devices, amusement and gaming machines, including coin-operated machines; housings for coin-operated machines, gaming equipment, gaming machines, machines for gambling; electro-pneumatic and electrical gambling machines (slot machines).

41 – Gambling; entertainment services related to gambling; gaming services for entertainment purposes; casino, gaming and gambling services; training in the development of software systems; provision of equipment for gambling halls; providing casino equipment [gambling]; gaming machine entertainment services; providing casino facilities [gambling]; providing halls with gaming machines; amusement arcade services; games equipment rental; rental of gaming machines; providing amusement arcade services; rental of gaming machines with images of fruits; editing or recording of sounds and images; sound recording and video entertainment services; hire of sound reproducing apparatus; provision of gaming equipment for casinos; providing of casino facilities; online gambling services; provision of casino services; provision of gaming establishments, gaming halls, internet casinos, online gambling services.

(260) AM 2021 110567 A

(800) 1560699

(151) 2020 07 20

(891) 2020 07 20

(731) Euro Games Technology Ltd.

"Maritsa" Str., 4, "Vranya-Lozen-Triugulnika",
BG-1151 Sofia, Bulgaria

(540)



(591) Green, gray, black and white

(531) 26.04.18; 27.05.02; 27.05.10; 29.01.14

(511)

9 – Software; computer gaming software; computer software packages; computer operating system software; computer software, recorded; software drivers; virtual reality software; games software; entertainment software for computer games; computer programs for network management; operating computer software for main frame computers; monitors (computer hardware); computer hardware; apparatus for recording images; monitors (computer programs); computer game programs; computer programs for recorded games; apparatus for recording, transmission or reproduction of sound or images; communications servers [computer hardware]; electronic components for gambling machines; computer application software featuring games and gaming; computer software for the administration of on-line games and gaming; computer hardware for games and gaming; computer hardware and software for gambling, gambling machines, gambling games on the Internet and via telecommunication network.

28 – Gaming machines for gambling; chips for gambling; mah-jong; arcade games; gambling machines

operating with coins, notes and cards; games; electronic games; parlor games; gaming chips; gaming tables; slot machines [gaming machines]; LCD game machines; slot machines and gaming devices; coin-operated amusement machines; roulette chips; poker chips; chips and dice [gaming equipment]; gaming equipment for casinos; roulette tables; gaming roulette wheels; casino games; amusement and gambling machines; coin-operated gaming machines and / or electronic coin-operated gaming machines with or without the possibility of gain; boxes for coin-operated machines, slot machines and gaming machines; electronic or electro-technical gaming devices, amusement and gaming machines, including coin-operated machines; housings for coin-operated machines, gaming equipment, gaming machines, machines for gambling; electro-pneumatic and electrical gambling machines (slot machines).

41 – Gambling; entertainment services related to gambling; gaming services for entertainment purposes; casino, gaming and gambling services; training in the development of software systems; provision of equipment for gambling halls; providing casino equipment [gambling]; gaming machine entertainment services; providing casino facilities [gambling]; providing halls with gaming machines; amusement arcade services; games equipment rental; rental of gaming machines; providing amusement arcade services; rental of gaming machines with images of fruits; editing or recording of sounds and images; sound recording and video entertainment services; hire of sound reproducing apparatus; provision of gaming equipment for casinos; providing of casino facilities; online gambling services; provision of casino services; provision of gaming establishments, gaming halls, internet casinos, online gambling services.

(260) AM 2021 110569 A

(800) 1560729

(151) 2020 05 06

(891) 2020 05 06

(731) AYDIN SEÇGÜ

İkitelli O.S.B. Fatih Sanayi Sitesi,

5A Blok K.4 No.4; Başakşehir – İstanbul, Turkey

(540)



(591) Blue, dark blue, brown, yellow, purple, green, white

(531) 05.03.17; 05.03.20; 26.13.25; 27.05.01;
27.05.09; 27.05.10; 29.01.15

(511)

3 – Bleaching and cleaning preparations, detergents other than for use in manufacturing operations and for medical purposes, laundry bleach, fabric softeners for laundry use, s removers (term considered too vague by the International Bureau – Rule 13 (2) (b) of the Regulations), dishwasher detergents, perfumery; non-medicated cosmetics; fragrances; deodorants for personel use and animals (term considered too vague by the International Bureau – Rule 13 (2) (b) of the Regulations), soaps, dental care preparations; dentifrices, denture polishes, tooth whitening preparations, mouth washes, not for medical purpose abrasive preparations (term considered too vague by the International Bureau – Rule 13 (2) (b) of the Regulations); emery cloth, sandpaper, pumice stome (term considered too vague by the International Bureau – Rule 13 (2) (b) of the Regulations), abrasive pastes, polishi preparations for leather, vinyl, metal and wood (term considered too vague by the International Bureau – Rule 13 (2) (b) of the Regulations), polishes and creams for leather, vinyl, and wood, wax for polishing.

(260) AM 2021 110572 A

(800) 1560762

(151) 2020 06 15

(891) 2020 06 15

(731) Zhydkova Mariia Anatoliivna

pr-t, Heroiv Stalinhrada, 21, korp. 2 kv. 135,
Kyiv 04211, Ukraine

(540)

#ГудНайтШоу

(591) Black, white

(531) 24.17.10; 24.17.14; 24.17.25; 24.17.25; 28.05

(511)

41 – Videotaping; arranging and conducting of congresses; arranging and conducting of concerts; electronic desktop publishing; providing user reviews for entertainment or cultural purposes; providing information in the field of entertainment; providing information relating to recreational activities; providing online videos, not downloadable; providing online electronic publications, not downloadable; providing online music, not downloadable; providing television programs, not downlodable, via video on-demand services; providing films, not downlodable, via video on-demand services; providing user rankings for entertainment or cultural purposes; providing recreation facilities; booking of seats for shows; sound engineering services for events; cinema presentations; microfilming; videotape editing; screenplay writing; songwriting; scriptwriting, other than for advertising purposes; writing of texts; organization of shows [impresario services]; organization of exhibitions for cultural or educational purposes; organization of competitions [education or entertainment]; organization of cosplay

events; party planning [entertainment]; entertainer services; disc jockey services; discotheque services; video editing services for events; layout services other than for advertising purposes; karaoke services; movie studio services; club services [entertainment or education]; nightclub services [entertainment]; orchestra services; news reporters services; lighting technician services for events; recording studio services; holiday camp services [entertainment]; photographic reporting; music composition services; presentation of live performances; presentation of variety shows; presentation of circus performances; online publication of electronic books and journals; publication of books; publication of texts, other than publicity texts; radio entertainment; film directing, other than advertising films; entertainment services; face painting; production of shows; production of music; production of radio and television programmes; film production, other than advertising films; theatre productions; television entertainment; photography.

(260) AM 2021 110573 A

(800) 1560776

(151) 2020 07 15

(891) 2020 07 15

(731) Dimitar Hristov BALEV

Blvd. Vitosha No.137, apt. 17, BG-1408 Sofia,
Bulgaria

(540)

AREON

(591) Black, white

(531) 27.05.01

(511)

3 – Soaps; perfumery; essential oils; aromatics [essential oils]; ionone [perfumery]; extracts of flowers [perfumes]; potpourris [fragrances]; air fragrancng preparations; fragrances for household purposes; fragrances for automobiles; fragrance refills for non-electric room fragrance dispensers; refills for electric room fragrance dispensers; sachets for perfuming linen; scented wood; scented water; joss sticks; air fragrance reed diffusers; tissues impregnated with cosmetic lotions; cloths impregnated with a detergent for cleaning; cloths impregnated with polishing preparations for cleaning; vehicle cleaning preparations; bath salts, not for medical purposes.

5 – Salts for mineral water baths; air purifying preparations; air deodorizers; deodorants for clothing and textiles; air deodorizing preparations; automobile deodorizers; deodorants, other than for human beings or for animals; moist wipes impregnated with a pharmaceutical lotion; disposable sanitizing wipes.

(260) AM 2021 110577 A
 (800) 1561025
 (151) 2020 08 18
 (891) 2020 08 18
 (731) SIMVALIN HOLDINGS LIMITED
 Kritis, 32 PAPACHRISTOFOROU BUILD.,
 4th floor, CY-3087 Limassol, Cyprus
 (540)

PROCEREALS

(591) Black, white
 (511)
 5 – Food for babies; lacteal flour for babies; wheat germ dietary supplements; linseed dietary supplements.
 30 – Cereal bars; high-protein cereal bars; gruel, with a milk base, for food; muesli; chips [cereal products].

(260) AM 2021 110597 A
 (800) 1504449
 (151) 2019 11 08
 (891) 2020 10 10
 (731) GUANGDONG OPPO MOBILE
 TELECOMMUNICATIONS CORP., LTD.
 No.18 Haibin Road, Wusha, Chang'an,
 Dongguan, Guangdong, China
 (540)

Enco

(591) Black, white
 (511)
 9 – Computer programs, recorded; computer game software, downloadable; computer programs, downloadable; interactive touch screen terminals; humanoid robots with artificial intelligence; eyeglasses.

(260) AM 2021 110628 A
 (800) 1561528
 (151) 2020 07 17
 (891) 2020 07 17
 (731) Closed Joint Stock Company "Starodvorskie kolbasy"
 ul. Poliny Osipenko, d. 41, of. 210, RU-600009
 g. Vladimir, Russian Federation
 (540)

Славница

(591) Black, white
 (531) 28.05
 (511)
 29 – Ham; charcuterie; black pudding; sausages; sausages in batter.
 30 – Vareniki [stuffed dumplings]; pelmeni [dumplings stuffed with meat]; pies; ravioli.

(260) AM 2021 110629 A
 (800) 1561533
 (151) 2020 07 21
 (891) 2020 07 21
 (731) Euro Games Technology Ltd.
 "Maritsa" Str., 4, "Vranya-Lozen-Triugulnika",
 BG-1151 Sofia, Bulgaria
 (540)

FLAMING HOT

(591) Black, white
 (511)
 9 – Software; computer gaming software; computer software packages; computer operating system software; computer software, recorded; software drivers; virtual reality software; games software; entertainment software for computer games; computer programs for network management; operating computer software for main frame computers; monitors (computer hardware); computer hardware; apparatus for recording images; monitors (computer programs); computer game programs; computer programs for recorded games; apparatus for recording, transmission or reproduction of sound or images; communications servers [computer hardware]; electronic components for gambling machines; computer application software featuring games and gaming; computer software for the administration of on-line games and gaming; computer hardware for games and gaming; computer hardware and software for gambling, gambling machines, gambling games on the Internet and via telecommunication network.

28 – Gaming machines for gambling; chips for gambling; mah-jong; arcade games; gambling machines operating with coins, notes and cards; games; electronic games; parlor games; gaming chips; gaming tables; slot machines [gaming machines]; LCD game machines; slot machines and gaming devices; coin-operated amusement machines; roulette chips; poker chips; chips and dice [gaming equipment]; gaming equipment for casinos; roulette tables; gaming roulette wheels; casino games; amusement and gambling machines; coin-operated gaming machines and / or electronic coin-operated gaming machines with or without the possibility of gain; boxes for coin-operated machines, slot machines and gaming machines; electronic or electro-technical gaming devices, amusement and gaming machines, including coin-operated machines; housings for coin-operated machines, gaming equipment, gaming machines, machines for gambling; electro-pneumatic and electrical gambling machines (slot machines).

41 – Gambling; entertainment services related to gambling; gaming services for entertainment purposes; casino, gaming and gambling services; training in the development of software systems; provision of equipment for gambling halls; providing casino equipment [gambling]; gaming machine entertainment services;

providing casino facilities [gambling]; providing halls with gaming machines; amusement arcade services; games equipment rental; rental of gaming machines; providing amusement arcade services; rental of gaming machines with images of fruits; editing or recording of sounds and images; sound recording and video entertainment services; hire of sound reproducing apparatus; provision of gaming equipment for casinos; providing of casino facilities; online gambling services; provision of casino services; provision of gaming establishments, gaming halls, internet casinos, online gambling services.

(260) AM 2021 110630 A
 (800) 1561543
 (151) 2020 07 13
 (891) 2020 07 13
 (731) Closed Joint Stock Company "Starodvorskie kolbasy"
 ul. Poliny Osipenko, 41, of. 210, RU-600009
 g. Vladimir, Russian Federation
 (540)



(591) Light gold, gold, beige, burgundy, pink, white and brown
 (531) 06.19.09; 06.19.10; 08.05.03; 24.01.11; 24.01.15; 25.01.19; 26.04.04; 26.04.15; 26.04.18; 28.05; 29.01.13
 (526) R, КОЛБАСА ВАРЕНАЯ, ДОКТОРСКАЯ, the shape of the packaging.
 (511)
 29 – Charcuterie.

(260) AM 2021 110699 A
 (800) 1562647
 (151) 2020 07 16
 (891) 2020 07 16
 (731) Egis Gyógyszergyár Zrt.
 Keresztúri út 30-38., H-1106 Budapest,
 Hungary
 (540)

ORIGODERM

(591) Black, white
 (511)
 3 – Cosmetics and cosmetic preparations.

5 – Human pharmaceutical preparations; medicinal ointments; medicated skin creams; plasters, materials for dressings.

(260) AM 2021 110700 A
 (800) 1562656
 (151) 2020 07 17
 (891) 2020 07 17
 (731) Euro Games Technology Ltd.
 4, "Maritsa" Str., "Vranya-Lozen-Triugulnika",
 BG-1151 Sofia, Bulgaria
 (540)

Frozen Spins

(591) Black, white
 (511)
 9 – Software; computer gaming software; computer software packages; computer operating system software; computer software, recorded; software drivers; virtual reality software; games software; entertainment software for computer games; computer programs for network management; operating computer software for main frame computers; monitors (computer hardware); computer hardware; apparatus for recording images; monitors (computer programs); computer game programs; computer programs for recorded games; apparatus for recording, transmission or reproduction of sound or images; communications servers [computer hardware]; electronic components for gambling machines; computer application software featuring games and gaming; computer software for the administration of on-line games and gaming; computer hardware for games and gaming; hardware and software for gambling, gambling machines, gambling games on the Internet and via telecommunication network.

28 – Gaming machines for gambling; chips for gambling; mah-jong; arcade games; gambling machines operating with coins, notes and cards; games; electronic games; parlor games; gaming chips; gaming tables; slot machines [gaming machines]; LCD game machines; slot machines and gaming devices; coin-operated amusement machines; roulette chips; poker chips; chips and dice [gaming equipment]; equipment for casinos; roulette tables; gaming roulette wheels; casino games; automats and gambling machines; coin-operated machines and / or electronic coin-operated machines with or without the possibility of gain; boxes for coin-operated machines, slot machines and gaming machines; electronic or electrotechnical gaming devices, automats and machines, coin-operated machines; housings for coin-operated machines, gaming equipment, gaming machines, machines for gambling;

electropneumatic and electrical gambling machines (slot machines).

41 – Gambling; services related to gambling; gaming services for entertainment purposes; casino, gaming and gambling services; training in the development of software systems; provision of equipment for gambling halls; providing casino equipment [gambling]; gaming machine entertainment services; providing casino facilities [gambling]; halls with gaming machines; amusement arcade services; games equipment rental; rental of gaming machines; providing amusement arcade services; rental of gaming machines with images of fruits; editing or recording of sounds and images; sound recording and video entertainment services; hire of sound reproducing apparatus; provision of gaming equipment for casinos; providing of casino facilities; online gambling services; casino management services; operation of gaming establishments, gaming halls, internet casinos, online gambling sites.

(260) AM 2021 110707 A
(800) 1562870
(151) 2020 08 24
(891) 2020 08 24
(731) Limited Liability Company "Promishlennik"
Selezneva Str., 201, office 5, Krasnodar,
RU-350058 Krasnodarskiy kray, Russian
Federation

(540)



591) Black and red
(531) 02.01.01; 02.01.16; 09.07.17; 09.07.25;
26.11.08; 28.05; 29.01.12

(511)
6 – Common metals and their alloys; building materials of metal; buildings, transportable, of metal; ironmongery, small items of metal hardware; pipes and tubes of metal; safes [strong boxes]; railway material of metal; materials of metal for funicular railway permanent ways; non-electric cables and wires of common metal; works of art of common metal; ores.

19 – Materials, not of metal, for building and construction; rigid pipes, not of metal, for building; asphalt, pitch and bitumen; buildings, transportable, not of metal; monuments, not of metal.

37 – Construction; repair; installation services.

(260) AM 2021 110708 A
(800) 1562884
(151) 2020 10 29
(891) 2020 10 29
(731) INDUSTRIAS QUIMICAS DEL VALLES,
S.A.
Avda. Rafael Casanova, 81, E-08100
del Valles (Barcelona), Spain

(540)

CUPERTINE

(591) Black, white
(511)
5 – Fungicidal product designed to combat downy mildew of grapevines and in general, all cryptogamic plant pests, consisting of copper sulfate and maneb (manganese ethylene-bis-dithiocarbamate).

(260) AM 2021 110713 A
(800) 1563049
(151) 2020 11 02
(891) 2020 11 02
(731) CAPBRAN HOLDINGS, LLC
11601 Wilshire Blvd., Suite 2300,
Los Angeles CA 90025, USA

(540)

NUTRIBULLET

(591) Black, white
(511)
5 – Dietary food supplements; dietary and nutritional supplements.

(260) AM 2021 110714 A
(800) 1563101
(151) 2020 10 09
(891) 2020 10 09
(731) Yukon Advanced Optics Worldwide, UAB
Ateities g. 21C, LT-06326 Vilnius, Lithuania

(540)



(591) Blue, white
(531) 26.01.01; 26.01.03; 26.01.12; 26.01.24;
26.13.25; 27.05.17; 29.01.12

(511)
9 – Thermal imaging apparatus for night vision; image identifier night vision devices; apparatus providing night vision; night vision goggles; monoculars; binoculars; tripods for binoculars; spotting scopes; hunting binoculars; cases adapted for binoculars; telescopes; rifle scopes; camcorders; thermal imaging cameras; cameras for vehicles; rearview cameras for vehicles; distance measuring apparatus; target sights for guns [electronic]; target sights for guns [laser]; telescopic

bow sights; telescopic sights; riflescopes [telescopic]; gun scopes; optical lens sights; laser range finders; laser measuring systems; laser equipment for non-medical purposes; laser sensors; boresighters [alignment apparatus for firearm sights]; optical sensors; target seekers [optical]; optical apparatus and instruments; target surveillance apparatus [optical]; optical position sensors; optical measurement apparatus; infrared optical apparatus; infrared locating apparatus; infrared thermometers; infrared cameras; infrared detectors; cameras [photography]; digital cameras; multiple purpose cameras; raster image processors; tripods for telescopes; aiming telescopes; docking stations for smartphones; distance sensors; stands for photographic apparatus.

(260) AM 2021 110715 A

(800) 1563130

(151) 2020 07 20

(891) 2020 07 20

(731) Euro Games Technology Ltd.

"Maritsa" Str., 4, "Vranya-Lozen-Triugulnika",
BG-1151 Sofia, Bulgaria

(540)



(591) Green, gray, black and white

(531) 26.04.18; 27.05.02; 27.05.10; 29.01.14

(511)

9 – Software; computer gaming software; computer software packages; computer operating system software; computer software, recorded; software drivers; virtual reality software; games software; entertainment software for computer games; computer programs for network management; operating computer software for main frame computers; monitors (computer hardware); computer hardware; apparatus for recording images; monitors (computer programs); computer game programs; computer programs for recorded games; apparatus for recording, transmission or reproduction of sound or images; communications servers [computer hardware]; electronic components for gambling machines; computer application software featuring games and gaming; computer software for the administration of on-line games and gaming; computer hardware for games and gaming; computer hardware and software for gambling, gambling machines, gambling games on the Internet and via telecommunication network.

28 – Gaming machines for gambling; chips for gambling; mah-jong; arcade games; gambling machines operating with coins, notes and cards; games; electronic games; parlor games; gaming chips; gaming tables; slot machines [gaming machines]; LCD game machines; slot machines and gaming devices; coin-operated

amusement machines; roulette chips; poker chips; chips and dice [gaming equipment]; gaming equipment for casinos; roulette tables; gaming roulette wheels; casino games; amusement and gambling machines; coin-operated gaming machines and / or electronic coin-operated gaming machines with or without the possibility of gain; boxes for coin-operated machines, slot machines and gaming machines; electronic or electro-technical gaming devices, amusement and gaming machines, including coin-operated machines; housings for coin-operated machines, gaming equipment, gaming machines, machines for gambling; electro-pneumatic and electrical gambling machines (slot machines).

41 – Gambling; entertainment services related to gambling; gaming services for entertainment purposes; casino, gaming and gambling services; training in the development of software systems; provision of equipment for gambling halls; providing casino equipment [gambling]; gaming machine entertainment services; providing casino facilities [gambling]; providing halls with gaming machines; amusement arcade services; games equipment rental; rental of gaming machines; providing amusement arcade services; rental of gaming machines with images of fruits; editing or recording of sounds and images; sound recording and video entertainment services; hire of sound reproducing apparatus; provision of gaming equipment for casinos; providing of casino facilities; online gambling services; provision of casino services; provision of gaming establishments, gaming halls, internet casinos, online gambling services.

(260) AM 2021 110730 A

(800) 1563707

(151) 2020 07 23

(891) 2020 07 23

(731) Obshchestvo s ogranichennoy otvetstvennostyu
"Happy Life Solutions"

FEZ Angren, promzona Akhangaran,
g. Akhangaran, Tashkentskaya oblast,
Uzbekistan

(540)



(591) Purple, blue, light purple, white, orange,
light green and turquoise

(531) 26.01.01; 26.04.18; 27.05.01; 29.01.14

(511)

3 – Non-medicated lip protectors; cosmetic creams; cosmetic pads; cosmetics; pre-moistened cosmetic wi-

pes; cloths impregnated with cleaning preparations; feminine hygiene cleansing towelettes; baby powder [toiletries]; shampoos; pre-moistened or impregnated cleansing pads, tissues or wipes; shampoos for babies; baby oils [toiletries]; oils for cosmetic purposes; shower gel; shower gels, creams and oils; soap; liquid soap; body deodorants [perfumery]; deodorants for body care; perfumes and toilet water; baby bubble bath; baby wipes impregnated with cleaning preparations.

5 – Pharmaceutical preparations, sanitary preparations for medical purposes; plasters, materials for dressings; disinfectants; pharmaceuticals.

35 – Retail or wholesale services for pharmaceuticals and sanitary preparations and supplies.

(260) AM 2021 110732 A

(800) 1318466

(151) 2016 06 09

(891) 2020 11 13

(731) VMRay GmbH

Universitaetsstrasse 142, 44799 Bochum,
Germany

(540)

VMRay

(591) Black, white

(511)

9 – Computer antivirus software; computer software downloaded from the internet; recorded computer software; computer application software; recorded computer programs; computer programs [downloadable software]; computer programs for searching the contents of computers and computer networks by remote control; software; computer software to enable the searching of data; computer programmes for data processing; computer software for communicating purposes between microcomputers; computer software for business purposes; utility programs for performing computer system diagnostics; integrated software packages; computer firewall software; computer software downloadable from global computer information networks; downloadable computer utility programs; downloadable computer utility software; downloadable software; downloadable applications for use with mobile devices; computer programmes stored in digital form; programs for computers; simulation software for use in digital computers; software and applications for mobile devices; computer software to maintain and operate computer systems; computer software applications, downloadable; computer software packages.

35 – Computerised data verification; data search in computer files for others.

42 – Updating of computer software; maintenance and updating of computer software; updating of software data bases; updating of memory banks of computer

systems; computer hardware and software consultancy; providing temporary use of non-downloadable software applications accessible via a web site; providing temporary use of web-based software; computer programming and software design; computer software design; software development; development and testing of computing methods, algorithms and software; development and maintenance of computer software; development of software for secure network operations; software development, programming and implementation; design and development of electronic database software; design, development and implementation of software; writing of programs for data processing; creation, maintenance and adaptation of software; computer software research; research in the field of computer programs and software; installation of software; programming of EDP software; repair of software [maintenance, updating]; software as a service [SaaS]; software design and development; software engineering; software engineering services for data processing programs; software creation; rental of software; rental of computer programs; rental of software for data processing; rental of computers and computer software.

(260) AM 2021 110828 A

(800) 1564662

(151) 2020 10 12

(891) 2020 10 12

(731) POLWAX SPÓŁKA AKCYJNA

ul. 3 Maja 101, PL-38-200 JASŁO, Poland

(540)



(591) Blue and dark grey

(531) 26.03.05; 26.03.06; 27.05.04; 27.05.09;

27.05.10; 29.01.12

(511)

1 – Chemicals used in industry; chemical products derived from petroleum; chemicals used in industry; chemical additives for use in industry; sizing preparations; adhesives for use in industry; leather processing chemical preparations; chemicals for use in treating leather; chemical compositions for treating textiles; chemical products for the manufacture of binders; adhesives for use in industry; rubber based adhesives for industrial use; additives (chemical -) for fertilisers; wetting agents for use as adjuvants for plant protection preparations; chemicals used in agriculture, horticulture and forestry; chemical adjuvants for use in agriculture, horticulture and forestry; moulding compounds (foundry -); moulding compounds (foundry -); impregnating chemicals; chemical preparations for waterproofing wood and wood-derivatives; additives (chemical -) for use in the treatment of paper pulp; impregnating agents for paper and packaging of pa-

per; waterproofing preparations [chemical]; chemical auxiliaries for the paper industry; chemical preparations for use in paper making; laminating agents; chemical additives for use in the production of lubricants; chemical substances for use as additives to industrial lubricating greases; stabilising agents for use in food; food-grade wax for the food industry; food-grade paraffin for the food industry.

2 – Anti-corrosive preparations; anti-rust greases; anti-rust oils; anti-corrosive waxes.

4 – Petroleum products derived from crude oil; paraffin; wax, industrial and lubricating oils and greases; lubricating oils [industrial lubricants]; lubricants; fuels and illuminants; candles for lighting; special occasion candles; candles in tins; stearine; paraffins and wax for making candles and grave lights; non-chemical additives for lubricants; wax for use in coating food packaging materials; petroleum jelly for industrial purposes; ceresin.

11 – Candle torches.

35 – Retailing and wholesaling of petroleum products, chemical additives for petroleum products, crude oil products derived from the refining of crude, chemicals used in industry, adhesives used in industry, leather processing chemical preparations, chemicals for use in treating leather, chemical compositions for treating textiles, chemical products for the manufacture of binders, adhesives used in industry, and rubber based adhesives for industrial use; retailing and wholesaling of chemical additives for fertilisers, wetting agents for use as adjuvants for plant protection preparations, chemicals used in agriculture, horticulture and forestry, chemical additives for use in industry, chemical adjuvants for use in forestry, horticulture and agriculture, foundry moulding preparations; retailing and wholesaling of impregnating chemicals, chemical preparations for waterproofing wood and wood-derivatives, chemical additives for use in the treatment of paper pulp, impregnating agents for paper and packaging of paper, preparations for waterproofing (chemicals), chemical auxiliaries for the paper industry, chemical preparations for use in paper making, laminating agents; retailing and wholesaling of chemical additives for use in the production of lubricants, chemical substances for use as additives to industrial lubricating greases, stabilising agents for foodstuffs, food-grade wax for the food industry, food-grade paraffin for the food industry, anti-corrosion preparations, anti-rust greases, anti-rust oils, anti-corrosive waxes; retailing and wholesaling of paraffins, waxes, industrial oils and greases, lubricants, lubricating oils (industrial lubricants), lubricants, fuels and illuminants, candles, grave lights, special occasion candles, candles in tins, stearine, paraffins and wax for making candles and grave lights, non-chemical additives for greases, wax for use in coating foodstuff packaging materials, petroleum jelly for industrial purposes,

ceresin; negotiation of contracts relating to the purchase and sale of goods; business intermediary and advisory services in the field of selling products and rendering services; business administration services for processing sales made on the Internet; electronic commerce services, namely, providing information about products via telecommunication networks for advertising and sales purposes.

(260) AM 2021 110829 A

(800) 1564678

(151) 2020 11 06

(891) 2020 11 06

(731) Apple Inc.

One Apple Park Way, Cupertino CA 95014,
USA

(540)

SF COMPACT

(591) Black, white

(511)

9 – Downloadable computer software for generating, displaying, and printing fonts.

(260) AM 2021 110840 A

(800) 1564824

(151) 2020 07 27

(891) 2020 07 27

(731) "Eurasian Foods Corporation" Joint-Stock
Company

Baizakov str., 69, 050026 Almaty city,
Kazakhstan

(540)

PIZZARELLA

(591) Black, white

(531) 27.05.01

(511)

35 – Advertising; business management services; business administration services; office functions.

43 – Accommodation bureau services [hotels, boarding houses]; rental of temporary accommodation; rental of meeting rooms; tourist home services; hotel reservations; boarding house bookings; temporary accommodation reservations; hotel services; retirement home services; snack-bar services; information and advice in relation to the preparation of meals; café services; cafeteria services; motel services; boarding house services; boarding for animals; rental of cooking apparatus; rental of drinking water dispensers; restaurant services; self-service restaurant services; reception services for temporary accommodation [management of arrivals and departures]; food sculpting; canteen services; decorating of food; cake decorating; holiday camp services [lodging]; bar services; providing campground facilities; personal chef services;

food and drink catering; washoku restaurant services; udon and soba restaurant services.

(260) AM 2021 110844 A

(800) 1042097

(151) 2010 04 14

(891) 2020 11 20

(731) Cargil Tarim ve Gida Sanayi Ticaret A.S.
Barbaros Mah. Kardelen Sokak, Resepsiyon
Lobi Apt. No:2/4-5-6-7, Atasehir, Istanbul,
Turkey

(540)



(591) Black, white

(531) 26.04.18; 27.05.24

(511)

29 – Edible oils and fats.

(260) AM 2021 110845 A

(800) 1149898

(151) 2012 12 26

(891) 2020 11 23

(731) Wu Kuang Jung
No.7 Jhongsing Lane 1, Jhongsing Village,
Hukou Township, Hsinchu County, Taiwan,
China

(540)

GREENTOUR

(591) Black, white

(531) 27.05.01

(511)

12 – Tires for vehicle wheels; tires for automobiles; inner tubes for automobile; solid tires for vehicle wheels; pneumatic tires; tread for tire retreading; tires for bicycles; repair outfits for inner tubes.

(260) AM 2021 110846 A

(800) 1166930

(151) 2012 08 23

(891) 2020 11 17

(731) H&M Hennes & Mauritz AB
SE-106 38 Stockholm, Sweden

(540)



(591) Black, white

(531) 27.05.02; 27.05.23

(511)

3 – Bleaching preparations and other substances for laundry use; cleaning, polishing, scouring and abrasi-ve preparations; soap; perfumes; ethereal oils; cosmetics; hair care preparations; tooth powder; toothpaste; dentifrices.

9 – Scientific, nautical, surveying, photographic, cinematographic, optical, weighing, measuring, signalling, checking (supervision), life-saving and teaching apparatus and instruments; apparatus and instrument for conducting, switching, transforming, accumulating, regulating or controlling electricity; apparatus for recording, transmission or reproduction of sound or images; magnetic data carriers, recording discs; mechanisms for coin-operated apparatus; cash registers, calculating machines, data processing equipment and computers; fire-extinguishing apparatus; eyeglass cases; spectacles (optics); sunglasses; goggles for sports; swimming goggles; eyeglass cords; spectacle frames; spectacle cases; eyeglass chains; electronic publications and documents (downloadable).

14 – Precious metals and their alloys and goods in precious metals or coated therewith, not included in other classes; jewellery; precious stones; watches; chronometric instruments.

16 – Paper; cardboard and goods made from these materials, not included in other classes; printed matter; bookbinding material; photographs; stationery; adhesives for stationery or household purposes; artists' materials; paint brushes; typewriters and office requisites (except furniture); instructional and teaching material (except apparatus); plastic materials for packaging (not included in other classes); printers' type; printing blocks; printed publications; magazines; books.

18 – Leather and imitations of leather, and goods made of these materials and not included in other classes; animal skins, hides; trunks and travelling bags; umbrellas, parasols and walking sticks; whips, harness and saddlery.

25 – Clothing, footwear, headgear.

35 – Advertising; business management; consumer information online; retail services relating to bleaching preparations and other substances for laundry use, cleaning, polishing, scouring and abrasive preparations, soaps, perfumery, essential oils, cosmetics, hair lotions, dentifrices, industrial oils and greases, lubricants, dust absorbing, wetting and binding compositions, fuels (including motor spirit) and illuminants, candles and wicks for lighting, hand tools and implements (hand-operated), articles of cutlery, cutlery, side arms, other than firearms, razors, scientific, nautical, photographic, cinematographic, optical apparatus and instruments, apparatus and instruments for surveying, weighing, measuring, signaling, checking (su-

pervision), life-saving and teaching apparatus and instruments, apparatus and instrument for conducting, switching, transforming, accumulating, regulating or controlling electricity, apparatus for recording, transmission or reproduction of sound or images, magnetic data carriers, recording discs, automatic vending machines and mechanisms for coin-operated apparatus, cash registers, calculating machines, data processing equipment, computers, fire-extinguishing apparatus, eyeglass cases, spectacles (optics), sunglasses, goggles for sports, swimming goggles, eyeglass cords, spectacle frames, spectacle cases, eyeglass chains, precious metals and their alloys and goods in precious metals or coated therewith, jewellery, precious stones, horological and chronometric instruments, paper, cardboard and goods made from these materials, printed matter, bookbinding material, photographs, stationery, adhesives for stationary or household purposes, artists materials, paint brushes, typewriters and office requisites (except furniture), instructional and teaching material (except apparatus), plastic materials for packaging, printing type, printing blocks, printed publications, magazines, books, leather and imitations of leather, and goods made of these materials, animal skins, fur-skins, trunks and travelling bags, umbrellas, parasols and walking sticks, whips, harness and saddler, furniture, mirrors, picture frames, goods of wood, cork, reed, cane, wicker, horn, bone, ivory, whalebone, shell, amber, mother-of-pearl, meerschaum or of substitutes for these materials or of plastics, household or kitchen utensils and containers, combs and sponges, brushes (except paint brushes), brush-making materials, articles for cleaning purpose, steelwool, unworked or semi-worked glass (except glass used in building), glassware, porcelain and earthenware, textiles and textile goods, bed and table covers, clothing, footwear and headgear, lace and embroidery, ribbons and braid, buttons, hooks eyes, pins and needles, artificial flowers, carpets, rugs, mats and matting, linoleum and other materials for covering existing floors, wall hangings (non-textile), games and playthings, gymnastic and sporting articles, decorations for Christmas trees, beer, mineral and aerated waters and other non-alcoholic drinks, fruit drinks and fruits juices, syrups and other preparations for making beverages.

(260) AM 2021 110847 A

(800) 1210900

(151) 2014 04 01

(891) 2020 11 24

(731) TAPI' S.p.A.

Via Cornara Est, 2/F, I-35010 Massanzago
(PD), Italy

(540)

TAPÌ

(591) Black, white

(511)

20 – Synthetic corks, synthetic corks for bottles; furniture, mirrors, picture frames; goods, not included in other classes, of wood, cork, reed, cane, wicker, horn, bone, ivory, whalebone, shell, amber, mother-of-pearl, meerschaum and substitutes for all these materials, or of plastics.

(260) AM 2021 110848 A

(800) 1285463

(151) 2015 11 25

(891) 2020 11 17

(731) Bayer Intellectual Property GmbH
Alfred-Nobel-Str. 10, 40789 Monheim
am Rhein, Germany

(540)

VAYEGO

(591) Black, white

(511)

1 – Chemicals used in agriculture, horticulture and forestry; preparations for treating seeds (included in this class); plant growth regulating preparations; genes of seeds for agricultural production; fertilizers.

5 – Preparations for destroying vermin; fungicides, herbicides.

31 – Agricultural, horticultural and forestry products and grains not included in other classes; seeds.

(260) AM 2021 110849 A

(800) 1428520

(151) 2018 04 30

(891) 2020 07 17

(731) SANDALYECİ DAYANIKLI TÜKETİM,
MALLARI MOBİLYA, SANAYİ VE
TİCARET ANONİM ŞİRKETİ
Yeşillik Caddesi, No:447-457, Karabağlar,
İzmir, Turkey

(540)



(591) Red and white

(531) 26.04.18; 26.04.19; 26.04.24; 27.05.01;
27.05.21; 29.01.01

(511)

20 – Furniture, made of any kind of material; mattresses, pillows, air mattresses and cushions, not for medical purposes, water beds, not for medical purposes; mirrors; beehives, artificial honeycombs and sections

of wood for honeycombs; bouncing chairs for babies, playpens for babies, cradles, infant walkers; display boards, frames for pictures and paintings, identification plates, not of metal; identification tags, not of metal; nameplates, not of metal; identification tags of wood or synthetic materials; packaging containers of wood or plastics, casks for use in transportation or storage, barrels, storage drums, tanks, boxes, storage containers, transportation containers, chests, loading pallets and closures for the aforementioned goods, of wood or plastics; small hardware goods of wood or synthetic materials included in this class, furniture fittings, of wood or synthetic materials; ornaments and decorative goods of wood, cork, reed, cane, wicker, horn, bone, ivory, whalebone, shell, amber, mother-of-pearl, meerschaum, beeswax, plastic or plaster, included in this class, namely figurines, holiday ornaments for walls and sculptures, all made of wood, cork, reed, cane, wicker, horn, bone, ivory, whalebone, shell, amber, mother-of-pearl, meerschaum, beeswax, plastic or plaster; baskets, not of metal; fishing baskets; kennels, nesting boxes and beds for household pets; portable ladders and mobile boarding stairs of wood or synthetic materials; bamboo curtains, roller indoor blinds [for interiors], slatted indoor blinds, bead curtains for decoration, curtain hooks, curtain rings, curtain tie-backs, curtain rods; non-metal wheel chocks; armchairs, office armchairs, sofas, chairs, seats being furniture, tables, coffee tables, dining tables, metal tables, office tables, serving trolleys as furniture.

35 – Advertising, marketing and public relations; organization of exhibitions and trade fairs for commercial or advertising purposes; design of advertising materials; provision of an online marketplace for buyers and sellers of goods and services; office functions; secretarial services; arranging newspaper subscriptions for others; compilation of statistics; rental of office machines; systemization of information into computer databases; telephone answering for unavailable subscribers; business management, business administration and business consultancy; accounting; commercial consultancy services; personnel recruitment, personnel placement, employment agencies, import-export agencies; temporary personnel placement services; auctioneering; the bringing together, for the benefit of others, of furniture, made of any kind of material, mattresses, pillows, air mattresses and cushions, not for medical purposes, water beds, not for medical purposes, mirrors, beehives, artificial honeycombs and sections of wood for honeycombs, bouncing chairs for babies, playpens for babies, cradles, infant walkers, display boards, frames for pictures and paintings, identification plates, not of metal, identification tags, not of metal, nameplates, not of metal, identification tags of wood or synthetic materials, packaging containers of wood or plastics, casks for use in transportation or storage, barrels, storage drums, tanks, bo-

xes, storage containers, transportation containers, chests, loading pallets and closures for the aforementioned goods, of wood or plastics, small hardware goods of wood or synthetic materials, furniture fittings, of wood or synthetic materials, ornaments and decorative goods of wood, cork, reed, cane, wicker, horn, bone, ivory, whalebone, shell, amber, mother-of-pearl, meerschaum, beeswax, plastic or plaster, namely figurines, holiday ornaments for walls and sculptures, all made of wood, cork, reed, cane, wicker, horn, bone, ivory, whalebone, shell, amber, mother-of-pearl, meerschaum, beeswax, plastic or plaster, baskets, not of metal, fishing baskets, kennels, nesting boxes and beds for household pets, portable ladders and mobile boarding stairs of wood or synthetic materials, bamboo curtains, roller indoor blinds [for interiors], slatted indoor blinds, bead curtains for decoration, curtain hooks, curtain rings, curtain tie-backs, curtain rods, non-metal wheel chocks, armchairs, office armchairs, sofas, chairs, seats being furniture, tables, coffee tables, dining tables, metal tables, office tables, serving trolleys as furniture enabling customers to conveniently view and purchase those goods, such services may be provided by retail stores, wholesale outlets, by means of electronic media or through mail order catalogues.

(260) AM 2021 110851 A
 (800) 1479227
 (151) 2018 12 24
 (891) 2020 11 18
 (731) ACQUA DI PARMA S.R.L.
 Via Ripamonti, 99, I-20141 Milano, Italy
 (540)

ACQUA
 DI
 PARMA



(591) Black, white
 (531) 24.01.05; 24.01.09; 24.09.13; 27.05.01
 (511)

3 – Perfumery; eau de Cologne; eau de toilette; essential oils; deodorants for personal use; perfumed skin lotions; perfumed soap; bath salts; bath oils; bath and shower gels; shampoos; cosmetic cream; beauty gels; powders and lotions for face, body and hands; shaving gel; shaving cream; aftershave balm; pre-shave and after-shave lotions; incense; potpourris; room fragrances.

4 – Scented candles; candles.

(260) AM 2021 110852 A

(800) 1492876

(151) 2019 07 09

(891) 2020 11 10

(731) Individual entrepreneur Morgunov Leonid
Grigor'evich

kv. 47, d. 8, ul. Dostoevskogo, RU-630091

Novosibirsk, Russian Federation

(540)

HEALTHBERRY

(591) Black, white

(511)

32 – Aperitifs, non-alcoholic; cocktails, non-alcoholic; essences for making beverages; fruit nectars, non-alcoholic; lemonades; non-alcoholic beverages; non-alcoholic beverages flavored with tea; non-alcoholic fruit extracts; non-alcoholic fruit juice beverages; non-alcoholic preparations for making beverages; smoothies; soft drinks; syrups for beverages; syrups for lemonade; waters [beverages].

(260) AM 2021 110895 A

(800) 1564996

(151) 2020 09 02

(891) 2020 09 02

(731) Belarusian-German Joint Venture "Santa
Bremor" Limited Liability Company

ul. Katin Bor 106, 224025 g. Brest, Belarus

(540)

Yukki

(591) Black, white

(511)

30 – Ice cream; sorbets [ices]; edible ices; frozen yogurt [confectionery ices]; ice lollies; ice cream bars; ice cream bricks; fruit ice cream; ice cream cakes.

(260) AM 2021 110896 A

(800) 1565015

(151) 2020 10 16

(891) 2020 10 16

(731) JUN JAE YUN

103-2103, 27, Wolgye-ro 36-gil, Seongbuk-gu,
Seoul, Republic of Korea

(540)

La'dor

(591) Black, white

(531) 24.17.01; 27.05.01

(511)

35 – Providing business and marketing information; business administration and office work; advertising services; publicity; cost management; wholesale store services featuring pharmaceutical and veterinary preparations; business management of retail outlets; busi-

ness management services relating to franchising; marketing research; providing information on jobs and side-jobs; database management; goods import-export agencies; electronic order processing; on-line ordering services; auctioneering provided on the internet; rental of vending machines; arranging of subscriptions for the publications of others; sales agency services for cereal-based processed products; sales agency services for coffee based beverages; sales agency services for bottled drinking water; sales agency services for confectionery; sales agency services for spices; sales agency services for medical apparatus and instruments; sales agency services for cosmetic preparations; sales agency services for protein for use in the manufacture of cosmetics; sales agency services for preservatives for use in the manufacture of cosmetics; retail store services featuring cosmetic preparations; sales agency services for toilet utensils; sales agency services for cleaning preparations; retail store services featuring soaps for personal use; retail store services featuring toothpaste; sales agency services for dusting apparatus, non-electric; sales agency services for dyestuffs; sales agency services for toilet tissue; sales agency services for pre-moistened cleansing tissues; sales agency services for stationery; sales agency services for furniture; sales agency services for imitation leather; sales agency services for footwear; sales agency services for clothing; sales agency services for plastic film for wrapping food; sales agency services for paper boxes; sales agency services for hot-water heating apparatus; sales agency services for photographic apparatus and instruments; sales agency services for eyewear; sales agency services for life saving apparatus and equipment; sales agency services for bicycles; sales agency services for toys (playthings); sales agency services for gems; sales agency services for woven fabrics; promoting the goods and services by means of operating an on-line comprehensive shopping mall.

(260) AM 2021 110897 A

(800) 1565018

(151) 2020 07 03

(891) 2020 07 03

(731) Individual entrepreneur GANIEV DZHEJHUN
HUDAGULU OGLY

ul. Planernaya, 3, korp. 1. kv. 7, RU-125480
Moscow, Russian Federation

(540)

KEVN

(591) Black, white

(531) 27.05.01

(511)

34 – Flavorings, other than essential oils, for tobacco; flavorings, other than essential oils, for use in electronic cigarettes; gas containers for cigar lighters; ab-

sorbent paper for tobacco pipes; cigarette paper; lighters for smokers; tobacco pouches; books of cigarette papers; matchboxes; humidors; firestones; cigar cutters; cigar holders; cigarette holders; mouthpieces for cigarette holders; tips of yellow amber for cigar and cigarette holders; ashtrays for smokers; spittoons for tobacco users; pipe racks for tobacco pipes; pipe cleaners for tobacco pipes; liquid solutions for use in electronic cigarettes; cigarettes; cigarettes containing tobacco substitutes, not for medical purposes; electronic cigarettes; cigarillos; cigars; tobacco jars; match holders; matches; oral vaporizers for smokers; tobacco; snuffboxes; chewing tobacco; snuff; herbs for smoking; tobacco pipes; pocket machines for rolling cigarettes; cigarette filters; wicks adapted for cigarette lighters; cigarette tips; cigar cases; cigarette cases.

35 – Import-export agency services; demonstration of goods; market studies; providing business information; providing commercial information and advice for consumers in the choice of products and services; marketing; personnel recruitment; business management and organization consultancy; professional business consultancy; targeted marketing; updating and maintenance of data in computer databases; organization of exhibitions for commercial or advertising purposes; arranging of fairs for business and advertising purposes; shop window dressing; design of advertising material (terms too vague in the opinion of the International Bureau – Rule 13 (2) (b) of the Regulations); commercial or industrial management assistance; commercial intermediation services; provision of an online marketplace for buyers and sellers of goods and services; presentation of goods on communication media, for retail purposes; auctioneering; sales promotion for others; rental of sales stands; distribution of samples; dissemination of advertising matter; negotiation of business contracts for others; negotiation and conclusion of commercial transactions for third parties; commercial administration of the licensing of the goods and services of others; administrative processing of purchase orders; market intelligence services; search engine optimization for sales promotion; procurement services for others [purchasing goods and services for other businesses]; outsourcing services [business assistance]; retail or wholesale services for tobacco; on-line ordering services; retail services provided by on-line department stores.

(260) AM 2021 110899 A
(800) 1565077
(151) 2020 07 29
(891) 2020 07 29
(731) SEKTÖR KİMYA DETERJAN SANAYİ VE
TİCARET ANONİM ŞİRKETİ
Büyükayacak Mah., 8 Sokak.No:17 / 1 90,
Selçuklu Konya, Turkey

(540)

Dr. LORY

(591) Red, blue, white
(531) 03.07.15; 03.07.19; 03.07.24; 27.03.03;
27.05.10; 27.05.17; 29.01.13

(511)

3 – Bleaching and cleaning preparations, detergents other than for use in manufacturing operations and for medical purposes, laundry bleach, fabric softeners for laundry use, stain removers, dishwasher detergents; perfumery; non-medicated cosmetics; fragrances; deodorants for personal use and animals; soaps; dental care preparations: dentifrices, denture polishes, tooth whitening preparations, mouth washes, not for medical purposes; abrasive preparations; emery cloth; sandpaper; pumice stone; abrasive pastes; polishing preparations for leather, vinyl, metal and wood, polishes and creams for leather, vinyl, metal and wood, wax for polishing.

(260) AM 2021 110915 A
(800) 1565748
(151) 2020 07 23
(891) 2020 07 23
(731) Egis Gyógyszergyár Zrt.
Keresztúri út 30-38, H-1106 Budapest,
Hungary

(540)

SUPRALLERG

(591) Black, white
(511)
5 – Pharmaceutical preparations for human use; dietic substances adapted for medical use; vitamin compositions, mineral food supplements, dietary supplements.

(260) AM 2021 110917 A
(800) 1565825
(151) 2020 11 13
(891) 2020 11 13
(731) Qingsen Yu
Room 1104, No. 16, Zhile Street, Tianhe
District, Guangzhou City, 510000 Guangdong
Province, China

(540)

youaiyou

(591) Black, white
(531) 27.05.01

(511)
9 – Bags adapted for laptops; mouse [computer peripheral]; wearable activity trackers; subwoofers; headphones; horns for loudspeakers; cabinets for loudspeakers; electric plugs; 3D spectacles.

(260) AM 2021 110918 A
(800) 1565852
(151) 2020 10 12
(891) 2020 10 12
(731) Ningbo Vertak Imp. & Exp. Co., Ltd.
Room 516, Building 5, No. 22, Henghe Road,
Beilun District, Ningbo City Zhejiang
Province, China

(540)



(591) Black, white
(531) 03.13.01; 27.05.02
(511)
7 – Lawnmowers [machines]; Harrows; Weeding machines; Sowers [machines]; Chain saws; Pumps [machines]; Disintegrators; Dust removing installations for cleaning purposes; High pressure washers; Snow ploughs.

(260) AM 2021 110926 A
(800) 1412295
(151) 2018 06 05
(891) 2020 12 01
(731) UNILIN B.V.
Ooigemstraat 3, B-8710 Wielsbeke,
Belgium

(540)

PERGO

(591) Black, white
(511)
19 – Wooden floors; parquet flooring; laminate flooring (not of metal).
27 – Floor coverings; vinyl floor coverings.

(260) AM 2021 110929 A
(800) 1529194
(151) 2020 02 27
(891) 2020 11 30
(731) GFM GmbH Trademarks
An der Ach 3, 82402 Seeshaupt,
Germany

(540)

JADON

(591) Black, white

(511)
25 – Footwear; boots; sandals; shoes; boot uppers; insoles; fittings of metal for footwear; footwear soles; insoles for footwear.

(260) AM 2021 110931 A
(800) 1552943
(151) 2020 08 19
(891) 2020 11 30
(731) GFM GmbH Trademarks
An der Ach 3, 82402 Seeshaupt, Germany
(540)

1461

(591) Black, white
(511)
25 – Footwear; boots; sandals; shoes; boot uppers; inner soles; fittings of metal for footwear; soles for footwear; insoles for footwear.

(260) AM 2021 110932 A
(800) 1553522
(151) 2020 08 19
(891) 2020 11 30
(731) GFM GmbH Trademarks
An der Ach 3, 82402 Seeshaupt, Germany
(540)

1460

(591) Black, white
(511)
25 – Footwear; boots; sandals; shoes; boot uppers; inner soles; fittings of metal for footwear; soles for footwear; insoles for footwear.

(260) AM 2021 110982 A
(800) 1565994
(151) 2020 09 15
(891) 2020 09 15
(731) Tovarystvo z obmezhenoiu vidpovidalnistiu
"MEHATEKS"
pr. Povitroflotskyi, bud. 64 m. Kyiv 03151,
Ukraine
(540)



(591) Black, white
(531) 15.09.02; 27.05.08; 27.05.09; 27.05.10;
27.05.24
(511)
9 – Accumulators, electric; accumulators, electric, for vehicles; acid hydrometers; acidimeters for batteries; accumulator jars; batteries, electric; batteries, electric, for vehicles; battery chargers; chargers for electric ac-

cumulators; accumulator boxes; plates for batteries; grids for batteries.

(260) AM 2021 110983 A

(800) 1565995

(151) 2020 09 15

(891) 2020 09 15

(731) Tovarystvo z obmezhenoiu vidpovidalnistiu "MEHATEKS"
pr. Povitroflotskyi, bud. 64 m. Kyiv 03151,
Ukraine

(540)



(591) Red and white

(531) 15.09.02; 27.05.01; 27.05.08; 27.05.24;
29.01.12

(511)

9 – Accumulators, electric; accumulators, electric, for vehicles; acid hydrometers; acidimeters for batteries; accumulator jars; batteries, electric; batteries, electric, for vehicles; battery chargers; chargers for electric accumulators; accumulator boxes; plates for batteries; grids for batteries.

(260) AM 2021 110984 A

(800) 1566003

(151) 2020 09 30

(891) 2020 09 30

(731) VivaChek Biotech (Hangzhou) Co., Ltd.
Level 2, Block 2, 146 East Chaofeng Road,
Yuhang Economy Development Zone,
Hangzhou, 310000 Zhejiang, China

(540)



(591) Black, white

(531) 26.11.01; 26.11.12

(511)

5 – Biological preparations for medical purposes; chemical preparations for medical purposes; chemical preparations for the diagnosis of pregnancy; diagnostic preparations for medical purposes; chemical preparations for veterinary purposes.

10 – Medical apparatus and instruments; blood testing apparatus; hypodermic syringes; sphygmomanometers; testing apparatus for medical purposes; diagnostic apparatus for medical purposes; surgical apparatus and instruments.

44 – Rest home services; therapy services; medical assistance; dietary and nutritional guidance; services of a psychologist; telemedicine services; nursing, medical; rental of sanitary installations; medical clinic services; health care.

(260) AM 2021 111013 A

(800) 1566646

(151) 2020 09 15

(891) 2020 09 15

(731) Tovarystvo z obmezhenoiu vidpovidalnistiu "MEHATEKS"
pr. Povitroflotskyi, bud. 64, m. Kyiv 03151,
Ukraine

(540)

Стойкие.

(591) Black, white

(531) 15.09.02; 27.05.01; 27.05.08; 28.05

(511)

9 – Accumulators, electric; accumulators, electric, for vehicles; acid hydrometers; acidimeters for batteries; accumulator jars; batteries, electric; batteries, electric, for vehicles; battery chargers; chargers for electric accumulators; accumulator boxes; plates for batteries; grids for batteries.

(260) AM 2021 111033 A

(800) 1567136

(151) 2020 11 24

(891) 2020 11 24

(731) AstraZeneca AB
SE-151 85 Södertälje, Sweden

(540)

AEROSPHERE

(591) Black, white

(511)

10 – Medical devices, namely, inhalers.

(260) AM 2021 111035 A

(800) 1567160

(151) 2020 10 15

(891) 2020 10 15

(731) CHINA ROAD & BRIDGE CORPORATION
Rm.1008, No. 88 C., Andingmenwai Avenue,
Dongcheng District, 100020 Beijing, China

(540)

CRBC

(591) Black, white

(531) 27.05.17

(511)

35 – Import-export agency services; auctioneering; sales promotion for others.

36 – Rental of real estate; real estate agency services; accommodation bureau services; real estate management; rental of apartments; apartment house management; real estate appraisal; real estate brokerage.

37 – Bricklaying; road paving; construction consultancy; masonry; rental of construction equipment; rental of bulldozers; rental of excavators; construction; factory construction; asphaltting; pipeline construction and maintenance; harbour construction; pier breakwater building; underwater construction; underwater repair; sanding; scaffolding; warehouse construction and repair; demolition of buildings; damp-proofing [building]; plastering; plumbing; building insulating.

41 – Educational services; academies [education]; teaching; tuition; educational examination; education information; boarding school education; instruction services; practical training [demonstration].

42 – Construction drafting; design of interior decor; architectural services; research and development of new products for others; scientific research; technological research; urban planning; quality control; engineering; engineering drawing.

(260) AM 2021 111036 A

(800) 1567196

(151) 2020 06 10

(891) 2020 06 10

(731) AGC GLASS EUROPE

Avenue Jean Monnet 4, B-1348 Louvain-la-Neuve, Belgium

(540)

CRYSTALVISION

(591) Black, white

(511)

9 – Glass carrying an electrically conducting layer on one or two faces; flat glass and glass sheets covered with a conducting layer.

19 – Flat glass and glass sheets used in building; clear and extraclear glass sheets used in building; solar control, low emissivity and coated glass sheets used in building; building glass; window glass; multiple glazing (terms too vague in the opinion of the International Bureau – Rule 13 (2) (b) of the Regulations); glazing units; double glazing units; multiple glazing units; non-metallic windows; non-metallic window frames; non-metallic doors and door frames; non-metallic spacers for double-glazing; parts and fittings for the aforementioned goods, not included in other classes.

20 – Furniture; mirrors.

21 – Glassware not included in other classes; unworked or semi-worked glass, except glass used in building; flat glass and glass sheets (except glass used in building); clear and extraclear glass sheets (except

glass used in building); parts and fittings for the aforementioned goods, not included in other classes.

37 – Glazing.

(260) AM 2021 111037 A

(800) 1567204

(151) 2020 09 30

(891) 2020 09 30

(731) GIORGIO ARMANI S.P.A.

Via Borgonuovo, 11, I-20121 MILANO
(Milano), Italy

(540)



(591) Black, white

(531) 27.05.01; 27.05.19

(511)

18 – Luggage and carrying bags.

(260) AM 2021 111038 A

(800) 1567233

(151) 2020 10 29

(891) 2020 10 29

(731) IPSUB HOLDING LIMITED

Riga Feraiou, 7-9 LIZANTIA COURT,
/Office 310, Agioi Omologites, CY-1087
Nicosia, Cyprus

(540)

BK FONBET

(591) Black, white

(511)

35 – Administrative processing of purchase orders; rental of advertising space; advertising and publicity services; advertising and publicity; professional business consultancy; business management consultancy; business management assistance; business management and organization consultancy; business organization consultancy; advisory services for business management; business efficiency expert services; commercial information and advice for consumers [consumer advice shop]; commercial or industrial management assistance; commercial intermediation services; compilation of statistics; compilation of information into computer databases; computerized file management; data search in computer files for others; drawing up of statements of accounts; economic forecasting; invoicing; on-line advertising on computer networks; office machines and equipment rental; outsourcing services [business assistance]; pay per click advertising; personnel management consultancy services; public relations; publicity material rental; search engine optimization; systemization of information in-

to computer databases; telephone answering for unavailable subscribers; updating and maintenance of data in computer databases; web site traffic optimization.

38 – Providing access to databases; communication by computer terminals; computer aided transmission of messages and images; information about telecommunication; rental of modems; providing online forums; transmission of digital files; providing user access to global computer networks; wireless broadcasting.

41 – Providing casino facilities; providing casino facilities [gambling]; providing of casino and gaming facilities; entertainment information; gambling; gambling services; game services provided on-line from a computer network; providing on-line videos, not downloadable; providing on-line electronic publications, not downloadable; operating lotteries; timing of sports events; provision of information relating to jockeys; provision of information relating to sports; provision of information relating to racing; provision of information relating to racehorses; provision of information relating to motor sports; provision of information relating to motor racing; racing information services; handicapping for sporting events; entertainment in the nature of yacht races; entertainment in the nature of golf tournaments; entertainment in the nature of basketball games; entertainment in the nature of baseball games; entertainment in the nature of gymnastic performances; entertainment in the nature of wrestling contests; entertainment in the nature of tennis tournaments; entertainment in the nature of football games; entertainment in the nature of soccer games; entertainment in the nature of boxing contests; entertainment in the nature of automobile races; entertainment in the nature of hockey games; entertainment in the nature of ice hockey games; entertainment in the nature of weight lifting competitions; entertainment in the nature of track and field competitions; entertainment services in the nature of skating events; providing wrestling news and information via a global computer network; sporting results services; betting services; horses (betting on -); casino, gaming and gambling services; dog races; football pools services; wagering services; on-line gaming services; gaming services for entertainment purposes; electronic game services and competitions provided by means of the internet; games equipment rental.

42 – Cloud computing; cloud seeding; computer programming; computer software design; computer software consultancy; rental of computer software; computer system design; computer system analysis; consultancy in the design and development of computer hardware; creating and maintaining web sites for others; data conversion of computer programs and data [not physical conversion]; duplication of computer programs; electronic data storage; hosting computer

sites [web sites]; information technology [it] consultancy; providing information on computer technology and programming via a web site; installation of computer software; maintenance of computer software; monitoring of computer systems by remote access; off-site data backup; recovery of computer data; research and development of new products for others; providing search engines for the internet; server hosting; software as a service [saas]; updating of computer software; rental of web servers; web site design consultancy.

(260) AM 2021 111039 A

(800) 1567262

(151) 2020 11 17

(891) 2020 11 17

(731) Platinum GmbH & CO. KG

Am Ockenheimer Graben 23, 55411 Bingen,
Germany

(540)

Fleischsaftgarung

(591) Black, white

(511)

31 – Animal foodstuffs; foodstuffs for animals, in particular for dogs and cats.

(260) AM 2021 111094 A

(800) 1567410

(151) 2020 09 10

(891) 2020 09 10

(731) Limited liability company "Automobile plant
"GAZ"

Prospect Ilycha, 5, RU-603004 Nizhny
Novgorod, Russian Federation

(540)

ЧАЙКА

(591) Black, white

(531) 28.05

(511)

12 – Vehicles; motor buses; automobiles; engines for land vehicles; couplings for land vehicles; inner tubes for pneumatic tires; suspension shock absorbers for vehicles; shock absorbing springs for vehicles; headrests for vehicle seats; reversing alarms for vehicles; valves for vehicle tires; torsion bars for vehicles; tipping bodies for lorries; mudguards; vehicle wheels; hoods for vehicle engines; crankcases for land vehicle components, other than for engines; safety belts for vehicle seats; hubs for vehicle wheels; vehicle chassis; rudders; vehicle bumpers; hydraulic circuits for vehicles; gearing for land vehicles; clutches for land vehicles; casings for pneumatic tyres; balance weights for vehicle wheels; axles for vehicles; axle journals; windshield wipers; luggage nets for vehicles;

hub caps; brakes for vehicles; bands for wheel hubs; seat covers for vehicles; vehicle running boards; transmissions for land vehicles; propulsion mechanisms for land vehicles; freewheels for land vehicles; windscreens; pneumatic tires; doors for vehicles; vehicle wheel spokes; vehicle suspension springs; rear-view mirrors; rims for vehicle wheels; vehicle seats; undercarriages for vehicles; upholstery for vehicles; windows for vehicles; anti-theft devices for vehicles; automobile tires; automobile bodies; bumpers for automobiles; shock absorbers for automobiles; anti-theft alarms for vehicles; horns for vehicles; brake linings for vehicles; gear boxes for land vehicles; bodies for vehicles; vehicle covers [shaped]; driving chains for land vehicles; transmission chains for land vehicles; torque converters for land vehicles; signal arms for vehicles; reduction gears for land vehicles; brake segments for vehicles; caps for vehicle fuel tanks; connecting rods for land vehicles, other than parts of motors and engines; tailboard lifts [parts of land vehicles]; security harness for vehicle seats; sun-blinds adapted for automobiles; transmission shafts for land vehicles; air bags [safety devices for automobiles]; covers for vehicle steering wheels; spoilers for vehicles; headlight wipers; brake pads for automobiles; spare wheel covers; brake discs for vehicles; cigar lighters for automobiles; engine mounts for land vehicles; vehicle joysticks; ashtrays for automobiles; lug nuts for vehicle wheels; vehicle bonnet pins; cup holders for vehicles; steering wheels for vehicles; side view mirrors for vehicles.

(260) AM 2021 111095 A

(800) 1567484

(151) 2020 11 16

(891) 2020 11 16

(731) Apple Inc.

One Apple Park Way, Cupertino CA 95014,
USA

(540)

 **App Clip**

(591) Black, white

(531) 05.07.13; 05.07.23

(511)

42 – Providing online non-downloadable application development software; providing online non-downloadable computer software development tools; providing online non-downloadable computer software used in developing other software applications; user authentication services using a software application; user authentication services using technology for e-commerce transactions; providing online information relating to computer technology, computer programming, and computer software.

(260) AM 2021 111096 A

(800) 1567498

(151) 2020 11 23

(891) 2020 11 23

(731) KANO LABORATORIES LLC

1000 EAST THOMPSON LANE,
NASHVILLE TN 37211, USA

(540)

KROIL

(591) Black, white

(511)

4 – All-purpose penetrating oil; industrial penetrating oil.

(260) AM 2021 111102 A

(800) 1567664

(151) 2020 11 24

(891) 2020 11 24

(731) SAAME TOOLS (SHANGHAI) IMPORT &
EXPORT CO., LTD.

Floor 2, Building 1, No. 1369 Kangqiao
East Road, Pudong New District, 201315
Shanghai, China

(540)

KENDO

(591) Black, white

(531) 27.05.01; 27.05.17

(511)

6 – Tool boxes of metal, empty; padlocks; steps [ladders] of metal; tool chests of metal, empty; hardware of metal, small; bicycle locks of metal; washers of metal; bolts of metal.

7 – Hand-held tools, other than hand-operated; scissors, electric; electric hand drills; riveting machines; screwdrivers, electric; power-operated rivet guns; nail extractors, electric; grinders being power tools; pneumatic nail guns; hydraulic torque wrenches; saw blades [parts of machines]; electric hand drills, excluding electric coal drills; tools [parts of machines]; grindstones [parts of machines]; blades for metal processing machines; drilling heads [parts of machines]; circular saw blades being parts of machines; reciprocating saws [machines].

8 – Abrading instruments [hand instruments]; frames for handsaws; spanners [hand tools]; handles for hand-operated hand tools; hammers [hand tools]; chisels; taps [hand tools]; pliers; cutting tools [hand tools]; garden tools, hand-operated.

9 – Protective helmets; workmen's protective face-shields; knee-pads for workers; reflective safety vests; acid resistant gloves; slide calipers; rulers [measuring instruments]; safety goggles; tape measures; surveyors' levels.

(260) AM 2021 111103 A
 (800) 1567674
 (151) 2020 10 15
 (891) 2020 10 15
 (731) Premium Beverages International B.V.
 Tweede Weteringplantsoen 21, NL-1017
 ZD Amsterdam, Netherlands

(540)

PURE PIRAÑA

(591) Black, white
 (511)
 33 – Alcoholic beverages, except beers, including so-called hard seltzers.

(260) AM 2021 111104 A
 (800) 1567682
 (151) 2020 11 25
 (891) 2020 11 25
 (731) Enprani Co., Ltd.
 88, Chukhang-daero 296beon-gil, Jung-gu,
 Incheon, Republic of Korea

(540)

HOLIKA HOLIKA

(591) Black, white
 (511)
 3 – Cosmetics; skin lotions; make-up; body lotion; shower gel; shampoo; non-medicated toiletry preparations; cleaning and polishing preparations; nail art stickers; mascara; cosmetics for animals; balms, other than for medical purposes; dentifrices; bleaching preparations and other substances for laundry use; oils for perfumes and scents; beauty masks; mask pack for cosmetic purposes; sunscreen creams for cosmetic use; lipstick.

(260) AM 2021 111105 A
 (800) 1567759
 (151) 2020 10 21
 (891) 2020 10 21
 (731) Jinan G. Weike Science & Technology, Co., Ltd.
 800 meters west of Chunhui Rd and, Kejia Rd,
 Suncun Industrial Area, High-Tech Zone,
 Jinan, 250101 Shandong, China

(540)

G·WEIKE

(591) Black, white
 (531) 27.05.01; 27.05.17
 (511)
 7 – Stands for machines; cutting machines; machine tools; holding devices for machine tools; industrial robots; machine tools for metal processing; cutting machines for metal processing; cutting equipment (machine parts); metalworking machines.

(260) AM 2021 111106 A
 (800) 1567781
 (151) 2020 02 17
 (891) 2020 02 17
 (731) "Amalgame Luxe", Community with limited
 Responsibility
 Hromadyanska Str, 119, of. 109, Mykolayiv
 54017, Ukraine

(540)

SULSENA

(591) Black, white
 (511)
 3 – Abrasives; glass cloth [abrasive cloth]; abrasive paper; breath freshening sprays; diamantine [abrasive]; alum stones [astringents]; amber [perfume]; antiperspirants [toiletries]; antistatic preparations for household purposes; flavorings for beverages [essential oils]; cake flavorings [essential oils]; food flavorings [essential oils]; joss sticks; aromatics [essential oils]; potpourris [fragrances]; balms, other than for medical purposes; basma [cosmetic dye]; bergamot oil; whitening; lip glosses; nail glitter; badian essence; vaginal washes for personal sanitary or deodorant purposes; petroleum jelly for cosmetic purposes; cotton wool for cosmetic purposes; cotton wool impregnated with make-up removing preparations; cotton sticks for cosmetic purposes; bleaching soda; laundry bleach; bleaching preparations [decolorants] for cosmetic purposes; bleaching preparations [decolorants] for household purposes; bleaching preparations and other substances for laundry use; bleaching salts; decorative transfers for cosmetic purposes; shoe wax; mustache wax; depilatory wax; wax for parquet floors; floor wax; volcanic ash for cleaning; astringents for cosmetic purposes; cloths impregnated with a detergent for cleaning; gaultheria oil; dental bleaching gels; heliotropine; geraniol; make-up; lipsticks; deodorants for pets; deodorants for human beings or for animals; detergents, other than for use in manufacturing operations and for medical purposes; scented water; scented wood; extracts of flowers [perfumes]; herbal extracts for cosmetic purposes; ethereal essences; essential oils; essential oils of cedarwood; essential oils of lemon; essential oils of citron; Javelle water; jasmine oil; greases for cosmetic purposes; colorants for toilet purposes; preservatives for leather [polishes]; color-removing preparations; degreasers, other than for use in manufacturing processes; toothpaste; dentifrices; ionone [perfumery]; shaving stones [astringents]; carbides of metal [abrasives]; silicon carbide [abrasive]; adhesives for affixing false eyelashes; adhesives for affixing false hair; adhesives for cosmetic purposes; collagen preparations for cosmetic purposes; hair conditioners; quillaia bark for washing; corundum [abrasive]; cosmetics; eyebrow cosmetics; cosmetics for children; cosmetics for animals; beauty masks; cosmetic preparations for baths; cosmetic preparations for eyelashes; cosmetic preparations for skin care;

cosmetic preparations for slimming purposes; tailors' wax; shoe cream; skin whitening creams; creams for leather; polishing creams; cosmetic creams; starch glaze for laundry purposes; laundry starch; lavender water; lavender oil; incense; hair spray; nail polish; hair lotions; lotions for cosmetic purposes; after-shave lotions; massage gels, other than for medical purposes; massage candles for cosmetic purposes; non-slip wax for floors; almond oil; almond milk for cosmetic purposes; washing soda, for cleaning; soap; deodorant soap; shaving soap; soap for brightening textile; cakes of toilet soap; almond soap; antiperspirant soap; soap for foot perspiration; micellar water; musk [perfumery]; mint for perfumery; mint essence [essential oil]; cosmetic kits; emery; emery cloth; emery paper; nail art stickers; neutralizers for permanent waving; non-medicated cosmetics and toiletry preparations; non-medicated dentifrices; non-medicated soaps; fumigation preparations [perfumes]; eau de Cologne; eyebrow pencils; cosmetic pencils; oils for toilet purposes, oils for perfumes and scents; oils for cosmetic purposes; oils for cleaning purposes; oil of turpentine for degreasing; mouth washes, not for medical purposes; bases for flower perfumes; drying agents for dishwashing machines; cleansing milk for toilet purposes; cleansers for intimate personal hygiene purposes, non medicated; scouring solutions; perfumery; perfumery, essential oils; perfumery, essential oils, non-medicated cosmetics, non-medicated hair lotions; toiletry preparations; perfumes; perfumery, essential oils, cosmetics, hair lotions; pastes for razor strops; gel eye patches for cosmetic purposes; pumice stone; hydrogen peroxide for cosmetic purposes; polishing wax; polishing paper; polishing rouge; polishing stones; polishing preparations; shoe polish; polish for furniture and flooring; pomades for cosmetic purposes; fabric softeners for laundry use; laundry blueing; laundry preparations; air fragrancing preparations; bath preparations, not for medical purposes; leather bleaching preparations; floor wax removers [scouring preparations]; rust removing preparations; varnish-removing preparations; paint stripping preparations; descaling preparations for household purposes; stain removers; lacquer-removing preparations; hair straightening preparations; shaving preparations; depilatory preparations; nail care preparations; hair waving preparations; laundry soaking preparations; sun-tanning preparations [cosmetics]; make-up removing preparations; make-up preparations; laundry glaze; preparations to make the leaves of plants shiny; shining preparations [polish]; breath freshening preparations for personal hygiene; denture polishes; preparations for unblocking drain pipes; smoothing preparations [starching]; dry-cleaning preparations; preparations for cleaning dentures; wallpaper cleaning preparations; aloe vera preparations for cosmetic purposes; air fragrance reed diffusers; make-up powder; nail varnish removers; windshield cleaning liquids; non-slip liquids for floors; eye-washes, not for

medical purposes; saflor; sachets for perfuming linen; tissues impregnated with cosmetic lotions; tissues impregnated with make-up removing preparations; turpentine for degreasing; teeth whitening strips; breath freshening strips; soda lye; bath salts, not for medical purposes; sunscreen preparations; douching preparations for personal sanitary or deodorant purposes [toiletries]; canned pressurized air for cleaning and dusting purposes; talcum powder, for toilet use; terpenes [essential oils]; tripoli stone for polishing; rose oil; toilet water; mascara; beard dyes; hair dyes; liquid latex body paint for cosmetic purposes; body paint for cosmetic purposes; cosmetic dyes; phytocosmetic preparations; lipstick cases; color-brightening chemicals for household purposes [laundry]; henna [cosmetic dye]; cleaning chalk; cleaning, polishing, scouring and abrasive preparations; cleaning preparations; chemical cleaning preparations for household purposes; shampoos; shampoos for pets [non-medicated grooming preparations]; shampoos for animals [non-medicated grooming preparations]; dry shampoos; cobblers' wax; shoemakers' wax; sandpaper; abrasive cloth; smoothing stones; grinding preparations; false eyelashes; false nails.

5 – Adjuvants for medical purposes; cooling sprays for medical purposes; acaricides; aconitine; alkaloids for medical purposes; albumin dietary supplements; alginates for pharmaceutical purposes; alginate dietary supplements; algicides; aldehydes for pharmaceutical purposes; amino acids for veterinary purposes; amino acids for medical purposes; analgesics; anaesthetics; antibiotics; vermifuges; anti-uric preparations; antiseptics; first-aid boxes, filled; aluminium acetate for pharmaceutical purposes; acetates for pharmaceutical purposes; germicides; bacterial preparations for medical and veterinary use; bacteriological preparations for medical and veterinary use; balms for medical purposes; balsamic preparations for medical purposes; royal jelly for pharmaceutical purposes; tobacco-free cigarettes for medical purposes; bandages for dressings; bicarbonate of soda for pharmaceutical purposes; albuminous preparations for medical purposes; albuminous foodstuffs for medical purposes; biological preparations for veterinary purposes; biological preparations for medical purposes; biocides; bismuth subnitrate for pharmaceutical purposes; linseed meal for pharmaceutical purposes; flour for pharmaceutical purposes; bromine for pharmaceutical purposes; bronchodilating preparations; vaginal washes for medical purposes; petroleum jelly for medical purposes; vaccines; absorbent cotton; antiseptic cotton; aseptic cotton; cotton for medical purposes; wadding for medical purposes; cotton sticks for medical purposes; veterinary preparations; tartar for pharmaceutical purposes; decoctions for pharmaceutical purposes; vitamin preparations; mineral waters for medical purposes; hydrated chloral for pharmaceutical purposes; dietary fiber; charcoal for pharmaceutical purposes; astrin-

gents for medical purposes; gases for medical purposes; gallic acid for pharmaceutical purposes; guaiacol for pharmaceutical purposes; sexual stimulant gels; hematogen; hemoglobin; hemostatic pencils; herbicides; sanitary preparations for medical purposes; sanitary tampons; hydrastine; hydrastinine; mustard for pharmaceutical purposes; mustard oil for medical purposes; mustard plasters; glycerine for medical purposes; glycerophosphates; glucose for medical purposes; homogenized food adapted for medical purposes; hormones for medical purposes; mud for baths; medicinal mud; vulnerary sponges; rubber for dental purposes; gamboge for medical purposes; gurjun balsam for medical purposes; disinfectants; disinfectants for chemical toilets; disinfectants for hygiene purposes; deodorants for clothing and textiles; deodorants, other than for human beings or for animals; cedar wood for use as an insect repellent; detergents for medical purposes; digitalin; infant formula; diagnostic preparations for veterinary purposes; diagnostic preparations for medical purposes; diastase for medical purposes; dietary supplements for human beings and animals; dietary supplements for animals; royal jelly dietary supplements; glucose dietary supplements; pollen dietary supplements; dietary supplements with a cosmetic effect; linseed dietary supplements; linseed oil dietary supplements; acai powder dietary supplements; propolis dietary supplements; wheat germ dietary supplements; dietetic beverages adapted for medical purposes; dietetic food and substances adapted for medical or veterinary use, food for babies; dietetic substances adapted for medical use; dietetic foods adapted for medical purposes; yeast for pharmaceutical purposes; yeast dietary supplements; eucalyptus for pharmaceutical purposes; eucalyptol for pharmaceutical purposes; plant extracts for pharmaceutical purposes; extracts of hops for pharmaceutical purposes; herbal extracts for medical purposes; elixirs [pharmaceutical preparations]; enzymes for veterinary purposes; enzymes for medical purposes; enzyme dietary supplements; enzyme preparations for medical purposes; esters for pharmaceutical purposes; cellulose esters for pharmaceutical purposes; ethers for pharmaceutical purposes; cellulose ethers for pharmaceutical purposes; febrifuges; gelatine for medical purposes; milking grease; greases for veterinary purposes; greases for medical purposes; nicotine gum for use as an aid to stop smoking; chewing gum for medical purposes; nervines; bunion pads; isotopes for medical purposes; immunostimulants; reagent paper for medical or veterinary purposes; reagent paper for veterinary purposes; reagent paper for medical purposes; insecticides; Irish moss for medical purposes; alkaline iodides for pharmaceutical purposes; iodides for pharmaceutical purposes; iodine for pharmaceutical purposes; iodoform; casein dietary supplements; calomel [fungicide]; gum for medical purposes; camphor for medical purposes; camphor oil for medical purposes; capsules for medicines; carbolineum [parasiticide]; caustics for

pharmaceutical purposes; caustic pencils; cachou for pharmaceutical purposes; quassia for medical purposes; quebracho for medical purposes; oxygen for medical purposes; acids for pharmaceutical purposes; oxygen baths; bone cement for surgical and orthopaedic purposes; fly glue; adhesive tapes for medical purposes; adhesives for dentures; cocaine; collagen for medical purposes; collodion for pharmaceutical purposes; compresses; chemical contraceptives; angostura bark for medical purposes; condurango bark for medical purposes; croton bark; mangrove bark for pharmaceutical purposes; myrobalan bark for pharmaceutical purposes; barks for pharmaceutical purposes; quinquina for medical purposes; rhubarb roots for pharmaceutical purposes; lint for medical purposes; collyrium; cream of tartar for pharmaceutical purposes; creosote for pharmaceutical purposes; blood for medical purposes; depuratives; styptic preparations; dill oil for medical purposes; starch for dietetic or pharmaceutical purposes; biological tissue cultures for veterinary purposes; biological tissue cultures for medical purposes; cultures of microorganisms for medical or veterinary use; curare; dental lacquer; breast-nursing pads; lactose for pharmaceutical purposes; adhesive plasters; lecithin for medical purposes; lecithin dietary supplements; fly catching paper; medicines for alleviating constipation; medicines for human purposes; medicines for veterinary purposes; drugs for medical purposes; medicines for dental purposes; medicinal roots; medicated animal feed; medicinal tea; corn remedies; remedies for perspiration; remedies for foot perspiration; medicated toothpaste; medicated dentifrices; medicated hair lotions; medicated after-shave lotions; medicinal drinks; medicinal infusions; medicinal oils; medicated toiletry preparations; medicinal hair growth preparations; medicated eye-washes; medicinal herbs; liniments; liquorice for pharmaceutical purposes; lotions for veterinary purposes; lotions for pharmaceutical purposes; personal sexual lubricants; lupulin for pharmaceutical purposes; magnesia for pharmaceutical purposes; sunburn ointments; ointments for pharmaceutical purposes; frostbite salve for pharmaceutical purposes; gauze for dressings; massage candles for therapeutic purposes; dental impression materials; teeth filling material; material for dental fillings and dental impressions; medicinal alcohol; medicine cases, portable, filled; medical preparations for slimming purposes; melissa water for pharmaceutical purposes; menthol; almond milk for pharmaceutical purposes; antibacterial handwashes; dog washes [insecticides]; animal washes [insecticides]; cattle washes [insecticides]; insecticidal veterinary washes; antibacterial soap; disinfectant soap; medicated soap; mineral food supplements; molding wax for dentists; moleskin for medical purposes; powdered milk for babies; lacteal flour for babies; milk ferments for pharmaceutical purposes; sea water for medicinal bathing; mint for pharmaceutical purposes; vitamin supplement patches; nicotine patches for use as aids to

stop smoking; scapulars for surgical purposes; vesicants; narcotics; linseed for pharmaceutical purposes; tincture of iodine; tinctures for medical purposes; nutraceutical preparations for therapeutic or medical purposes; fumigating sticks; fumigation preparations for medical purposes; cachets for pharmaceutical purposes; wart pencils; oil of turpentine for pharmaceutical purposes; opiates; opium; opodeldoc; mouthwashes for medical purposes; rat poison; poisons; bacterial poisons; stick liquorice for pharmaceutical purposes; paper for mustard plasters; mothproofing paper; parasiticides; pastilles for pharmaceutical purposes; pectin for pharmaceutical purposes; pepsins for pharmaceutical purposes; peptones for pharmaceutical purposes; dressings, medical; hydrogen peroxide for medical purposes; pearl powder for medical purposes; pesticides; antioxidant pills; tanning pills; appetite suppressant pills; slimming pills; babies' diapers; diapers for pets; diapers for incontinence; babies' diaper-pants; blood plasma; plasters, materials for dressings; by-products of the processing of cereals for dietetic or medical purposes; eyepatches for medical purposes; nutritional supplements; nutritive substances for microorganisms; media for bacteriological cultures; pomades for medical purposes; powder of cantharides; pyrethrum powder; porcelain for dental prostheses; laxatives; bismuth preparations for pharmaceutical purposes; hemorrhoid preparations; preparations for callouses; chilblain preparations; pre-filled syringes for medical purposes; bath preparations for medical purposes; air deodorising preparations; mothproofing preparations; preparations for reducing sexual activity; preparations for destroying dry rot fungus; larvae exterminating preparations; preparations for destroying mice; fly destroying preparations; slug exterminating preparations; preparations for destroying noxious animals; vermin destroying preparations; acne treatment preparations; preparations for the treatment of burns; lice treatment preparations [pediculicides]; ootherapy preparations; air purifying preparations; appetite suppressants for medical purposes; sterilising preparations; soil-sterilising preparations; contact lens cleaning preparations; aloe vera preparations for pharmaceutical purposes; preparations of trace elements for human and animal use; preparations of microorganisms for medical or veterinary use; preparations to facilitate teething; poultices; chemical conductors for electrocardiograph electrodes; food for babies; sanitary towels; purgatives; propolis for pharmaceutical purposes; protein dietary supplements; protein supplements for animals; asthmatic tea; corn rings for the feet; antiparasitic collars for animals; antiparasitic preparations; anticryptogamic preparations; leeches for medical purposes; radium for medical purposes; radioactive substances for medical purposes; diagnostic biomarker reagents for medical purposes; radiological contrast substances for medical purposes; insect repellents; insect repellent incense; repellents for dogs; digestives for pharmaceutical purposes; fish

meal for pharmaceutical purposes; cod liver oil; castor oil for medical purposes; ergot for pharmaceutical purposes; solutions for contact lenses; solvents for removing adhesive plasters; mercurial ointments; sarsaparilla for medical purposes; lead water; sedatives; tissues impregnated with pharmaceutical lotions; serotherapeutic medicines; siccatives [drying agents] for medical purposes; serums; syrups for pharmaceutical purposes; sulfur sticks [disinfectants]; turpentine for pharmaceutical purposes; soporifics; salts for mineral water baths; bath salts for medical purposes; smelling salts; potassium salts for medical purposes; mineral water salts; salts for medical purposes; sodium salts for medical purposes; malt for pharmaceutical purposes; malted milk beverages for medical purposes; semen for artificial insemination; alcohol for pharmaceutical purposes; alloys of precious metals for dental purposes; douching preparations for medical purposes; steroids; stem cells for veterinary purposes; stem cells for medical purposes; dental abrasives; dental amalgams; dental amalgams of gold; dental mastics; dental cements; strychnine; freeze-dried meat adapted for medical purposes; freeze-dried food adapted for medical purposes; sulfonamides [medicines]; suppositories; therapeutic preparations for the bath; thermal water; thymol for pharmaceutical purposes; gentian for pharmaceutical purposes; tonics [medicines]; smoking herbs for medical purposes; herbal teas for medicinal purposes; transplants [living tissues]; pants, absorbent, for incontinence; sanitary panties; tobacco extracts [insecticides]; preparations (Terms too vague in the opinion of the International Bureau – Rule 13 (2) (b) of the Regulations); pharmaceutical preparations for treating dandruff; pharmaceutical preparations for skin care; pharmaceutical preparations for treating sunburn; lime-based pharmaceutical preparations; pharmaceuticals; phenol for pharmaceutical purposes; fennel for medical purposes; ferments for pharmaceutical purposes; enzyme preparations for veterinary purposes; phytotherapy preparations for medical purposes; formic aldehyde for pharmaceutical purposes; phosphates for pharmaceutical purposes; fungicides; fungicides, herbicides; chemico-pharmaceutical preparations; chemical preparations for the diagnosis of pregnancy; chemical preparations for treating wheat blight; chemical preparations for treating phylloxera; chemical preparations for treating diseases affecting vine plants; chemical preparations for treating diseases affecting cereal plants; chemical preparations for treating mildew; chemical preparations for veterinary purposes; chemical preparations for medical purposes; chemical preparations for pharmaceutical purposes; chemical reagents for medical or veterinary purposes; quinine for medical purposes; chinoline for medical purposes; surgical implants comprised of living tissues; surgical glues; surgical dressings; diabetic bread adapted for medical use; chloroform; flowers of sulfur for pharmaceutical purposes; cement for animal hooves; medicated sweets; crystallized rock sugar for me-

dical purposes; sugar for medical purposes; medicated shampoos for pets; insecticidal animal shampoos; medicated shampoos; pediculicidal shampoos; medicated dry shampoos; panty liners [sanitary]; jujube, medicated; jalap.

(260) AM 2021 111137 A
 (800) 1445254
 (151) 2018 12 13
 (891) 2020 11 06
 (731) NOVARTIS AG
 CH-4002 Basel, Switzerland
 (540)

VIJOICE

(591) Black, white
 (511)
 5 – Pharmaceutical preparations.

(260) AM 2021 111138 A
 (800) 1494099
 (151) 2019 08 13
 (891) 2020 12 15
 (731) Friend Factory AB
 Åsögatan 140, SE-116 24 Stockholm,
 Sweden
 (540)

Frever

(591) Black, white
 (511)
 9 – Computer gaming software; downloadable electronic game programs; virtual reality game software; augmented reality game software.

41 – Interactive entertainment services; interactive computer game services; online interactive entertainment; game services provided by means of communications by computer terminals or mobile telephone; games services provided via computer networks and global communication networks; online game services through mobile devices; game services provided online from a computer network; on-line gaming services; video game entertainment services.

(260) AM 2021 111139 A
 (800) 1515315
 (151) 2019 12 06
 (891) 2020 12 14
 (731) Adecco Group AG
 Bellerivestrasse 30, CH-8008 Zürich,
 Switzerland
 (540)

LHH

(591) Violet (Pantone 2617)
 (531) 27.05.01; 29.01.05
 (511)
 35 – Consulting services in the fields of recruitment and outsourcing of personnel.

41 – Consulting services in the fields of careers and career guidance; educational events in the fields of recruitment, careers, career guidance and outsourcing of personnel.

(260) AM 2021 111140 A
 (800) 1521851
 (151) 2020 02 14
 (891) 2020 12 15
 (731) Universal Biosensors Pty Ltd
 1 Corporate Avenue, ROWVILLE VIC 3178,
 Australia
 (540)

SENTIA

(591) Black, white, brown
 (531) 26.13.25; 27.05.01; 29.01.13
 (511)
 5 – Medical consumables, namely, disposable strips for measuring the properties of bodily fluids (including blood, urine, saliva and mucous) and liquid control reagents; medical diagnostic test strips.

9 – Scientific apparatus and instruments for measuring and testing bodily fluids (including blood, urine, saliva and mucous), food and beverage samples, and agricultural samples; electrochemical testing and measuring apparatus and instruments; electrochemical testing and measuring apparatus and instruments containing computer hardware and software for use in measuring and testing of human and animal bodily fluids, food and beverage samples, and agricultural samples.

10 – Medical diagnostic devices for measuring the properties of bodily fluids (including blood, urine, saliva and mucous); veterinary apparatus and instruments for measuring the properties of bodily fluids.

(260) AM 2021 111141 A
 (800) 1525712A
 (151) 2020 02 26
 (891) 2020 12 15
 (731) Gallaher Limited
 Members Hill, Brooklands Road Weybridge,
 Surrey KT13 0QU, United Kingdom
 (540)

LD

(591) Black, white

(511)
34 – Manufactured tobacco, unmanufactured tobacco; smoking substances for non-medical and non-therapeutic purposes sold separately or mixed with tobacco; snuff; smokers' articles included in this class; cigarette paper, cigarette tubes; matches.

chemical and microbial preparations for the treatment of seeds.

5 – Preparations for destroying vermin; preparations for weed and pest control, insecticides, herbicides, fungicides, molluscicides, rodenticides, pesticides.

(260) AM 2021 111142 A
(800) 1527557
(151) 2020 03 03
(891) 2020 12 17
(731) Gilead Sciences Ireland UC
IDA Business and Technology Park,
Carrigtohill, Co. Cork, Ireland

(540)

SUNLENCA

(591) Black, white
(511)
5 – Pharmaceutical preparations.

(260) AM 2021 111144 A
(800) 1557596
(151) 2020 09 15
(891) 2020 12 14
(731) GLOBACHEM
Lichtenberglaan 2019, B-3800 Sint-Truiden,
Belgium

(540)

POMAX

(591) Black, white
(511)
5 – Fungicides for the treatment of fruit and fruit-bearing plants.

(260) AM 2021 111145 A
(800) 1561770
(151) 2020 10 05
(891) 2020 12 16
(731) Nichino Europe Co., Ltd.
5 Pioneer Court, Vision Park, Histon,
CAMBRIDGE CB24 9PT, United Kingdom

(540)

ENVISOFT

(591) Black, white
(511)
1 – Chemicals used in agriculture, horticulture and forestry and amenity situations; manures; adjuvants, surfactants, water conditioning agents, soil conditioning agents, plant nutrients, fertilizers, minerals, trace elements and preparations used for stimulating or regulating plant growth, or as a pre-harvest aid or as a water conditioner in agriculture, horticulture, forestry or amenity situations; biofertilisers for seed treatment,

INTERNATIONAL TRADEMARKS PROTECTED IN GEORGIA

(260) AM 2021 109102 A
(800) 1482569
(151) 2019 06 03
(181) 2029 06 03
(891) 2020 06 19
(511) 09

(260) AM 2021 109169 A
(800) 1541809
(151) 2020 05 15
(181) 2030 05 15
(891) 2020 05 15
(511) 09

(260) AM 2021 109240 A
(800) 1542608
(151) 2020 06 23
(181) 2030 06 23
(891) 2020 06 23
(511) 29, 30

(260) AM 2021 109241 A
(800) 1542614
(151) 2020 04 20
(181) 2030 04 20
(891) 2020 04 20
(511) 33

(260) AM 2021 109242 A
(800) 1542634
(151) 2020 05 29
(181) 2030 05 29
(891) 2020 05 29
(511) 09

(260) AM 2021 109244 A
(800) 1542679
(151) 2020 04 16
(181) 2030 04 16
(891) 2020 04 16
(511) 11, 21

(260) AM 2021 109245 A
(800) 1542686
(151) 2020 01 10
(181) 2030 01 10
(891) 2020 01 10
(511) 18, 25

(260) AM 2021 109250 A
(800) 1542842
(151) 2020 06 19
(181) 2030 06 19
(891) 2020 06 19
(511) 34

(260) AM 2021 109251 A
(800) 1542928
(151) 2020 06 05
(181) 2030 06 05
(891) 2020 06 05
(511) 01, 17

(260) AM 2021 109252 A
(800) 1542972
(151) 2020 06 12
(181) 2030 06 12
(891) 2020 06 12
(511) 09

(260) AM 2021 109253 A
(800) 1542990
(151) 2020 06 02
(181) 2030 06 02
(891) 2020 06 02
(511) 30

(260) AM 2021 109254 A
(800) 1543023
(151) 2020 05 08
(181) 2030 05 08
(891) 2020 05 08
(511) 16, 35, 41

(260) AM 2021 109280 A
(800) 1047200
(151) 2010 06 14
(181) 2030 06 14
(891) 2020 07 14
(511) 01, 02, 06, 17, 19, 20

(260) AM 2021 109281 A
(800) 1207296
(151) 2014 03 21
(181) 2024 03 21
(891) 2020 05 28
(511) 05

(260) AM 2021 109284 A
(800) 1444364
(151) 2018 11 20
(181) 2028 11 20
(891) 2020 07 14
(511) 02

(260) AM 2021 109317 A
(800) 1544146
(151) 2020 06 08
(181) 2030 06 08
(891) 2020 06 08
(511) 34

(260) AM 2021 109285 A
(800) 1506154
(151) 2019 02 14
(181) 2029 02 14
(891) 2020 01 28
(511) 24, 27, 35

(260) AM 2021 109318 A
(800) 1544184
(151) 2020 03 09
(181) 2030 03 09
(891) 2020 03 09
(511) 01, 03, 10, 16, 20, 21, 42

(260) AM 2021 109311 A
(800) 1543829
(151) 2020 06 26
(181) 2030 06 26
(891) 2020 06 26
(511) 05

(260) AM 2021 109320 A
(800) 1544199
(151) 2020 06 08
(181) 2030 06 08
(891) 2020 06 08
(511) 34

(260) AM 2021 109312 A
(800) 1543919
(151) 2020 06 23
(181) 2030 06 23
(891) 2020 06 23
(511) 30

(260) AM 2021 109326 A
(800) 1544462
(151) 2020 07 03
(181) 2030 07 03
(891) 2020 07 03
(511) 29, 30, 32

(260) AM 2021 109314 A
(800) 1543929
(151) 2020 02 26
(181) 2030 02 26
(891) 2020 02 26
(511) 39, 41, 43

(260) AM 2021 109327 A
(800) 1544487
(151) 2020 03 20
(181) 2030 03 20
(891) 2020 03 20
(511) 09, 28

(260) AM 2021 109315 A
(800) 1544101
(151) 2020 03 03
(181) 2030 03 03
(891) 2020 03 03
(511) 03, 05, 10, 14, 18, 35, 44

(260) AM 2021 109331 A
(800) 1544532
(151) 2020 03 12
(181) 2030 03 12
(891) 2020 03 12
(511) 09, 28

(260) AM 2021 109316 A
(800) 1544132
(151) 2020 07 08
(181) 2030 07 08
(891) 2020 07 08
(511) 39

(260) AM 2021 109332 A
(800) 1544554
(151) 2020 03 20
(181) 2030 03 20
(891) 2020 03 20
(511) 09, 28

(260) AM 2021 109333 A
(800) 1544592
(151) 2020 05 19
(181) 2030 05 19
(891) 2020 05 19
(511) 05

(260) AM 2021 109410 A
(800) 1545573
(151) 2020 06 16
(181) 2030 06 16
(891) 2020 06 16
(511) 07, 08, 09

(260) AM 2021 109334 A
(800) 1544633
(151) 2020 05 28
(181) 2030 05 28
(891) 2020 05 28
(511) 09

(260) AM 2021 109411 A
(800) 1545589
(151) 2020 07 03
(181) 2030 07 03
(891) 2020 07 03
(511) 38

(260) AM 2021 109335 A
(800) 1544676
(151) 2020 06 04
(181) 2030 06 04
(891) 2020 06 04
(511) 01, 04, 35, 37, 41

(260) AM 2021 109412 A
(800) 1545633
(151) 2020 04 28
(181) 2030 04 28
(891) 2020 04 28
(511) 12

(260) AM 2021 109390 A
(800) 1544943
(151) 2020 01 10
(181) 2030 01 10
(891) 2020 01 10
(511) 18, 25

(260) AM 2021 109413 A
(800) 1545699
(151) 2020 03 05
(181) 2030 03 05
(891) 2020 03 05
(511) 17

(260) AM 2021 109393 A
(800) 1544979
(151) 2020 06 12
(181) 2030 06 12
(891) 2020 06 12
(511) 07

(260) AM 2021 109419 A
(800) 1545842
(151) 2020 06 08
(181) 2030 06 08
(891) 2020 06 08
(511) 35, 36, 41, 42, 45

(260) AM 2021 109394 A
(800) 1545014
(151) 2020 06 26
(181) 2030 06 26
(891) 2020 06 26
(511) 05

(260) AM 2021 109420 A
(800) 1545846
(151) 2020 05 15
(181) 2030 05 15
(891) 2020 05 15
(511) 42

(260) AM 2021 109409 A
(800) 1545550
(151) 2020 07 08
(181) 2030 07 08
(891) 2020 07 08
(511) 05, 16, 44

(260) AM 2021 109422 A
(800) 1545879
(151) 2020 06 03
(181) 2030 06 03
(891) 2020 06 03
(511) 29, 30

(260) AM 2021 109423 A
(800) 1545900
(151) 2020 04 29
(181) 2030 04 29
(891) 2020 04 29
(511) 07, 12

(260) AM 2021 109425 A
(800) 1115187
(151) 2012 03 20
(181) 2022 03 20
(891) 2020 06 19
(511) 09, 38, 42

(260) AM 2021 109426 A
(800) 1353922
(151) 2017 01 11
(181) 2027 01 11
(891) 2020 07 03
(511) 18, 25, 35

(260) AM 2021 109427 A
(800) 1500803
(151) 2019 09 02
(181) 2029 09 02
(891) 2020 07 29
(511) 32

(260) AM 2021 109441 A
(800) 1545952
(151) 2020 06 04
(181) 2030 06 04
(891) 2020 06 04
(511) 29

(260) AM 2021 109443 A
(800) 1545971
(151) 2020 02 12
(181) 2030 02 12
(891) 2020 02 12
(511) 41, 42

(260) AM 2021 109485 A
(800) 1546894
(151) 2020 06 10
(181) 2030 06 10
(891) 2020 06 10
(511) 18, 22, 25

(260) AM 2021 109486 A
(800) 1546902
(151) 2019 02 22
(181) 2029 02 22
(891) 2019 02 22
(511) 09

(260) AM 2021 109487 A
(800) 1546925
(151) 2020 07 16
(181) 2030 07 16
(891) 2020 07 16
(511) 30, 35

(260) AM 2021 109488 A
(800) 1546931
(151) 2020 07 16
(181) 2030 07 16
(891) 2020 07 16
(511) 30, 35

(260) AM 2021 109489 A
(800) 1546938
(151) 2020 07 16
(181) 2030 07 16
(891) 2020 07 16
(511) 30, 35

(260) AM 2021 109490 A
(800) 1546944
(151) 2020 04 23
(181) 2030 04 23
(891) 2020 04 23
(511) 06, 09, 17, 20, 35, 37, 39

(260) AM 2021 109574 A
(800) 1268182
(151) 2015 06 15
(181) 2025 06 15
(891) 2020 08 07
(511) 09, 16, 34

(260) AM 2021 109575 A
(800) 1268623
(151) 2015 06 15
(181) 2025 06 15
(891) 2020 08 07
(511) 09, 16, 34

(260) AM 2021 109576 A
(800) 1268974
(151) 2015 06 30
(181) 2025 06 30
(891) 2020 07 21
(511) 05, 29, 30, 35

(260) AM 2021 109652 A
(800) 1548910
(151) 2020 04 10
(181) 2030 04 10
(891) 2020 04 10
(511) 01, 04, 09, 16, 35, 36, 37, 42

(260) AM 2021 109654 A
(800) 1181026
(151) 2013 07 22
(181) 2023 07 22
(891) 2020 08 20
(511) 01, 16, 17, 19

(260) AM 2021 109723 A
(800) 1304126
(151) 2016 02 24
(181) 2026 02 24
(891) 2020 07 20
(511) 30

(260) AM 2021 109724 A
(800) 1304309
(151) 2016 05 02
(181) 2026 05 02
(891) 2020 07 29
(511) 09

OFFICIAL NOTIFICATIONS
INVENTIONS
EXPIRATION OF PATENT RESTORATION

(21) AP 2013 13601
(11) P 2016 6547 B
(73) Officine Maccaferri S.P.A.
(54) GABION
DATE OF CANCELLATION OF PATENT: 2021 03 07
THE TERM OF RESTORATION OF PATENT: 2021 09 10

ABOLITION OF PATENTS WITH THE RIGHT TO RESTORE

(21) AP 2007 10228
(11) P 2009 4695 B
(73) Nana Tsiklauri
(54) ALCOHOLIC BEVERAGE
DATE OF CANCELLATION OF PATENT: 2021 08 14
THE TERM OF RESTORATION OF PATENT: 2022 08 14

(21) AP 2014 13553
(11) P 2016 6584 B
(73) Zaur Dzneladze
(54) METHOD FOR IODIZED CONCENTRATE PRODUCTION
DATE OF CANCELLATION OF PATENT: 2021 08 18
THE TERM OF RESTORATION OF PATENT: 2022 08 18

(21) AP 2014 13559
(11) P 2016 6511 B
(73) Aleksandre Kvernadze
(54) DEVICE FOR DISTILLING VODKA
DATE OF CANCELLATION OF PATENT: 2021 08 25
THE TERM OF RESTORATION OF PATENT: 2022 08 25

(21) AP 2004 9292
(11) P 2008 4469 B
(73) Perma-Fix Environmental Services Inc.;
SBR Technologies Inc.
(54) METHOD FOR TREATMENT OF CHEMICAL AGENT HYDROLYSATES
DATE OF CANCELLATION OF PATENT: 2021 08 16
THE TERM OF RESTORATION OF PATENT: 2022 08 16

EXPIRATION OF TERM OF RESTORATION OF PATENTS

(21) AP 2006 10576
(11) P 2010 5134 B
(73) The Trustees of Columbia University In The City of New York
(54) AGENTS FOR PREVENTING AND TREATING DISORDERS INVOLVING MODULATION OF THE RYR RECEPTORS
DATE OF CANCELLATION OF PATENT: 2020 08 17
THE TERM OF RESTORATION OF PATENT VALIDITY HAS EXPIRED: 2021 08 17

(21) AP 2011 12341
(11) P 2013 5990 B
(73) Vladimer Loladze;
Shak Bananidze;
Giorgi Loladze;
Nino Mskhiladze;
Vakhtang Pirmiashvili;
Vakhtang Loladze
(54) POLYLAYER, MULTIFUNCTION ENVELOPE
DATE OF CANCELLATION OF PATENT: 2020 08 18
THE TERM OF RESTORATION OF PATENT VALIDITY HAS EXPIRED: 2021 08 18

(21) AP 2010 12624
(11) P 2014 6113 B
(73) Syngenta Participations AG
(54) MICROBIOCIDAL HETEROCYCLES
DATE OF CANCELLATION OF PATENT: 2020 08 06
THE TERM OF RESTORATION OF PATENT VALIDITY HAS EXPIRED: 2021 08 06

(21) AP 2010 12671
(11) P 2014 6200 B
(73) Heat On-the-Fly LLC
(54) WATER HEATING APPARATUS FOR CONTINUOUS HEATED WATER FLOW AND METHOD FOR USE IN HYDRAULIC FRACTURING
DATE OF CANCELLATION OF PATENT: 2020 08 17
THE TERM OF RESTORATION OF PATENT VALIDITY HAS EXPIRED: 2021 08 17

(21) AP 2011 13171
(11) P 2015 6364 B
(73) Wuhan Kaidi Engineering Technology Research Institute Co. LTD
(54) METHOD AND DEVICE FOR PREPARING HIGH TEMPERATURE WATER VAPOR RICH IN ACTIVE PARTICLES USING PLASMA
DATE OF CANCELLATION OF PATENT: 2020 08 11
THE TERM OF RESTORATION OF PATENT VALIDITY HAS EXPIRED: 2021 08 11

(21) AP 2014 14098
(11) P 2018 6834 B
(73) Roberto Pisano
(54) METAL PALLET WITH ASSEMBLABLE COMPONENTS
DATE OF CANCELLATION OF PATENT: 2020 08 19
THE TERM OF RESTORATION OF PATENT VALIDITY HAS EXPIRED: 2021 08 19

(21) AP 2014 14099
(11) P 2019 7033 B
(73) Macrogenix Inc.
(54) BI-SPECIFIC MONOVALENT DIABODIES THAT ARE CAPABLE OF BINDING TO GPA33 AND CD3,
AND USES THEREOF
DATE OF CANCELLATION OF PATENT: 2020 08 20
THE TERM OF RESTORATION OF PATENT VALIDITY HAS EXPIRED: 2021 08 20

UTILITY MODELS EXPIRATION OF PATENT RESTORATION

(21) AU 2015 13910
(11) U 2017 1927 Y
(73) Nugzar Robitashvili
(54) CARDBOARD FAT-AND WATERPROOF CONTAINER FOR FOODSTUFF
DATE OF CANCELLATION OF PATENT: 2021 08 12
THE TERM OF RESTORATION OF PATENT: 2021 09 10

ABOLITION OF PATENTS WITH THE RIGHT TO RESTORE

(21) AU 2013 13201
(11) U 2014 1815 Y
(73) Archil Ghaghanidze;
Shalva Kandelaki;
Dimitri Lominadze
(54) METHOD OF QUICKLY IGNITING AND SMOOTHLY BURNING COAL BRIQUETTE PRODUCTION
DATE OF CANCELLATION OF PATENT: 2021 08 21
THE TERM OF RESTORATION OF PATENT: 2022 08 21

(21) AU 2015 13910
(11) U 2017 1927 Y
(73) Nugzar Robitashvili
(54) CARDBOARD FAT-AND WATERPROOF CONTAINER FOR FOODSTUFF
DATE OF CANCELLATION OF PATENT: 2021 08 12
THE TERM OF RESTORATION OF PATENT: 2023 08 12

(21) AU 2017 14570
(11) U 2018 1990 Y
(73) Taras Gabison
C. Eliava's House Institute of Bacteriophage, Microbiology and Virology
(54) METHOD FOR BACTERIOPHAGE DRUGS PREPARATION TO USE THEREIN VETERINARY
MEDICINE
DATE OF CANCELLATION OF PATENT: 2021 08 16
THE TERM OF RESTORATION OF PATENT: 2022 08 16

EXPIRATION OF TERM OF RESTORATION OF PATENT

(21) AU 2017 14575
(11) U 2018 1986 Y
(73) Elguja Shengelia
(54) METHOD FOR ART EDITION PRODUCTION
DATE OF CANCELLATION OF PATENT: 2020 08 18
THE TERM OF RESTORATION OF PATENT VALIDITY HAS EXPIRED: 2021 08 18

DESIGNS

EXTENSION OF REGISTRATION OF DESIGNS

(11) D 2007 295 S
(73) Orion Corporation (KR)
30-10 Munbae-Dong, Yongsan-Ku, Seoul, Korea (KR)
(54) CONFECTIONERY
(28) 1
(24) 2006 09 29
(18) 2026 09 29
(58) 2021 08 25

(11) D 2007 296 S
(73) Orion Corporation (KR)
30-10 Munbae-Dong, Yongsan-Ku, Seoul, Korea (KR)
(54) PACKING BOX FOR CONFECTIONERY
(28) 1
(24) 2006 09 29
(18) 2026 09 29
(58) 2021 08 25

(11) D 2007 297 S
(73) Orion Corporation (KR)
30-10 Munbae-Dong, Yongsan-Ku, Seoul, Korea (KR)
(54) PACKING BOX FOR CONFECTIONERY
(28) 1
(24) 2006 09 29
(18) 2026 09 29
(58) 2021 08 25

(11) D 2007 298 S
(73) Orion Corporation (KR)
30-10 Munbae-Dong, Yongsan-Ku, Seoul, Korea (KR))
(54) PACKING BOX FOR CONFECTIONERY
(28) 1
(24) 2006 09 29
(18) 2026 09 29
(58) 2021 08 25

CANCELLATION OF REGISTRATION OF DESIGNS

(11) D 2012 489 S
(73) Limited Liability Company "Lukoil" (RU)
Sretenskiy Boulevard 11, 101000, Moscow, Russian Federation (RU)
(54) SET OF COMPANY AND SPECIAL CLOTHES FOR PETROL STATIONS STAFF OF GROUP "LUKOIL"
ORGANIZATIONS
(18) 2021 02 16
(58) 2021 08 31

(11) D 2016 663 S
(73) Gocha Pipia (GE)
Budapest St. 11, app. 55, 0160, Tbilisi, Georgia (GE)
(54) DECORATIVE BEVERAGE VESSEL WITH TAP
(18) 2021 02 03
(58) 2021 08 31

(11) D 2016 694 S
(73) Nika Alavidze (GE)
Lado Meskhishvili St., III lane 18, 4600, Kutaisi, Georgia (GE)
(54) STREET LIGHTS
(18) 2021 02 24
(58) 2021 09 02

EXTENSION OF REGISTRATION OF INTERNATIONAL DESIGNS

(11) DM/68098
(73) MONTRES TUDOR SA
Rue François-Dussaud 3, CH-1211 Genève 26 (CH)
(15) 2006 08 23
(24) 2006 08 23
(18) 2026 08 23
(28) 5
(28') 5
(54) 1. Watch bezel, 2. watch middle, 3. watch middle with watch bezel, 4.-5. watch bezels

(11) DM/68117
(73) BRAUN GMBH
Frankfurter Strasse 145, 61476 Kronberg (DE)
(15) 2006 08 31
(24) 2006 08 31
(18) 2026 08 31
(28) 4
(28') 4
(54) Cleaning device for an electric shaver, Combination of an electric shaver and a cleaning device, Electric shaver, Shaving part for shaver

(11) DM/73936
(73) MAKEL ELEKTRIK MALZEMELERI SANAYI VE TICARET ANONIM SIRKETI
Istiklal Mahallesi Maresal, Fevzi Cakmak Caddesi No:38, KIRAC ESENYURT-ISTANBUL (TR)
(15) 2010 05 26
(24) 2010 05 26
(18) 2025 05 26
(28) 3
(28') 3
(54) Commutator, Electric switch, Grounded electric socket

(11) DM/88452
(73) ETA SA MANUFACTURE HORLOGÈRE SUISSE
Schild-Rust-Strasse 17, CH-2540 Grenchen (CH)
(15) 2015 12 02
(24) 2015 12 02
(18) 2025 12 02
(28) 1
(28') 1
(54) Timepiece movement part

(11) DM/88461
(73) HARRY WINSTON SA
Chemin du Tourbillon 8, CH-1228 Plan-les-Ouates (CH)
(15) 2015 12 07
(24) 2015 12 07
(18) 2025 12 07
(28) 1
(28') 1
(54) Pendant

(11) DM/88472
(73) ETA SA MANUFACTURE HORLOGÈRE SUISSE
Schild-Rust-Strasse 17, CH-2540 Grenchen (CH)
(15) 2015 12 08
(24) 2015 12 08
(18) 2025 12 08
(28) 2
(28') 2
(54) Wristwatches

(11) DM/88502
(73) RADO UHREN AG (RADO WATCH CO. LTD.)(MONTRES RADO SA)
Bielstrasse 45, CH-2543 Lengnau (CH)
(15) 2015 12 08
(24) 2015 12 08
(18) 2025 12 08
(28) 5
(28') 4
(54) Dials, Watch cases with bracelets

(11) DM/88591
(73) MONTRES JAQUET DROZ SA (MONTRES JAQUET DROZ AG) (MONTRES JAQUET DROZ LTD.)
Allée du Tourbillon 2, CH-2300 La Chaux-de-Fonds (CH)
(15) 2015 12 10
(24) 2015 12 10
(18) 2025 12 10
(28) 3
(28') 3
(54) Dials,Oscillating weight

(11) DM/88674
(73) HARRY WINSTON SA
Chemin du Tourbillon 8, CH-1228 Plan-les-Ouates (CH)
(15) 2015 12 17
(24) 2015 12 17
(18) 2025 12 17
(28) 1
(28') 1
(54) Necklace

(11) DM/88771
(73) BAYADERA MANAGEMENT LIMITED
Karpenisiou, 30, P.C., CY-1660 Nicosia (CY)
(15) 2015 10 07
(24) 2015 10 07
(18) 2025 10 07
(28) 1
(28') 1
(54) Bottle

(11) DM/89044
(73) Hamilton International Ag (Hamilton International Sa) (Hamilton International LTD)
Mattenstrasse 149, CH-2503 Biel/Bienne (CH)
(15) 2015 12 24
(24) 2015 12 24
(18) 2025 12 24
(28) 15
(28') 15
(54) 1.-2. Watch cases, 3. Dial, 4. Watch case, 5. Watch element, 6. Bracelet, 7. Watch, 8. Watch case, 9. Watch, 10. Dial, 11. Watch case, 12. Watch, 13. Dial, 14. Watch, 15. Dial,

(11) DM/91315
(73) EVELINE COSMETICS S.A. S.K.
ul. Żytunia 19, PL-05-506 Lesznowola (PL)
(15) 2016 01 27
(24) 2016 01 27
(18) 2026 01 27
(28) 6
(28') 6
(54) Ornamentation for packaging containers,Tubes [packaging containers]

(11) DM/92010

(73) SAVERGLASS

3 rue de la Gare, F-60960 FEUQUIERES (FR)

(15) 2016 07 08

(24) 2016 07 08

(18) 2026 07 08

(28) 3

(28') 3

(54) Bottles

TRADEMARKS

RENEWAL OF REGISTRATIONS

<p>(111) M 2001 14003 R2 (156) 2001 09 11 (186) 2031 09 11 (732) "Hellenic Fuels and Lubricants Single Member Industrial and Ommercial Societe Anonyme" also trading as "Eko Abee" 8A Cheimarras street, 151 25 Marousi, Greece</p>	<p>2-chome, Kokurakita-ku, Kitakyushu-shi, Fukuoka-Ken, Japan</p>
<p>(111) M 2001 14086 R2 (156) 2001 10 18 (186) 2031 10 18 (732) Nexen Tire Corporation 355, Chungnyeol-ro, Yangsan-si, Gyeongsangnam-do, Republic of Korea</p>	<p>(111) M 2011 21649 R1 (156) 2011 07 22 (186) 2031 07 22 (732) LTD "Glavspirtprom" Z. Paliashvili St. 26, 0179, Tbilisi, Georgia</p>
<p>(111) M 2002 14437 R2 (156) 2002 05 01 (186) 2032 05 01 (732) Jo Malone Inc. (a Delaware Corporation) 767 Fifth Avenue, New York, New York 10153, USA</p>	<p>(111) M 2011 21672 R1 (156) 2011 08 04 (186) 2031 08 04 (732) PartnerRe LTD Wellesley House, 90 Pitts Bay Road, Pembroke, HM08, Bermuda</p>
<p>(111) M 2002 14438 R2 (156) 2002 05 01 (186) 2032 05 01 (732) Jo Malone Inc. (a Delaware Corporation) 767 Fifth Avenue, New York, New York 10153, USA</p>	<p>(111) M 2012 22310 R1 (156) 2012 02 23 (186) 2032 02 23 (732) PPC Marketing LTD Texas Limited Partnership (Having Pilgrim's Pride Corporation, a Daleware Corporation, as its General Partner) 1770 Promontory Circle, Greeley, Colorado 80634, USA</p>
<p>(111) M 2011 21964 R1 (156) 2011 11 16 (186) 2031 11 16 (732) Brown-Forman Finland LTD Porkkalankatu 24, 00180 helsinki, Finland</p>	<p>(111) M 2012 22311 R1 (156) 2012 02 23 (186) 2032 02 23 (732) PPC Marketing LTD Texas Limited Partnership (Having Pilgrim's Pride Corporation, a Daleware Corporation, as its General Partner) 1770 Promontory Circle, Greeley, Colorado 80634, USA</p>
<p>(111) M 2011 21691 R1 (156) 2011 08 23 (186) 2031 08 23 (732) LTD "Globalpharm" Tamar Mepe Av. 7/13, 0112, Tbilisi, Georgia</p>	<p>(111) M 2011 21815 R1 (156) 2011 09 29 (186) 2031 09 29 (732) Swiss Pharma International AG Lindenstrasse 22, 8008 Zurich, Switzerland</p>
<p>(111) M 2011 21782 R1 (156) 2011 09 19 (186) 2031 09 19 (732) Toto LTD a Japanese Corporation 1-1, Nakashima</p>	<p>(111) M 2011 21729 R1 (156) 2011 08 23 (186) 2031 08 23 (732) Compagnie Gervais Danone (a France Corporation)</p>

17, Boulevard Haussmann, 75009 Paris,
France

(111) M 2011 21778 R1
(156) 2011 09 16
(186) 2031 09 16
(732) KRKA, Tovarna Zdravil, D.D., Novo Mesto
Smarjeska Cesta 6, 8501 Novo mesto,
Slovenia

(111) M 2011 22092 R1
(156) 2011 12 14
(186) 2031 12 14
(732) Toto LTD
a Japanese Corporation
1-1, Nakashima 2-chome, Kokurakita-ku,
Kitakyushu-shi, Fukuoka-Ken, Japan

COMPLETE TRANSFER OF RIGHTS

(111) M 2019 31749 R
(732) Predo Sağlık Ürünleri Sanayi ve
Ticaret Anonim Şirketi
2. Organize Sanayi Bölgesi Batı 4, Nolu Cadde
№2, Başpınar Şehitkamil, Gaziantep, Turkey
(770) Shovgi Aivazovi
Vill. Kirach-Muganlo, Marneuli, Georgia
(580) 2021 07 27

(111) M 1996 1848 R
(732) Wella Operations US, LLC
4500 Park Granada, Suite 100, Calabasas
CA 91302, USA
(770) Noxell Corporation
11050 York Road, Hunt Valley,
Maryland 21030-2098, USA
(580) 2021 08 02

(111) M 2002 14782 R
(732) Wella International Operations Switzerland
Sàrl
Chemin Louis-Hubert 1, 1213 Petit-Lancy,
Switzerland
(770) HFC Prestige International Operations
Switzerland Sarl
Chemin Louis-Hubert 1, 1213 Petit-Lancy,
Switzerland
(580) 2021 08 02

(111) M 2002 14782 R
(732) HFC Prestige International Operations
Switzerland Sarl
Chemin Louis-Hubert 1, 1213 Petit-Lancy,
Switzerland
(770) HFC Prestige International Holding
Switzerland Sàrl
Chemin Louis-Hubert 1-3, 1213 Petit-Lancy,
Switzerland
(580) 2021 08 02

(111) M 2006 16696 R
(732) Wella Operations US, LLC
4500 Park Granada, Suite 100, Calabasas
91302, USA
(770) OPI Products Inc.
a Delaware Corporation
13034 Saticoy Street, North Hollywood,
California 91605, USA
(580) 2021 08 02

(111) M 2006 17131 R
(732) Abbott Products Operations AG
Hegenheimermattweg 127, 4123 Allschwil,
Switzerland
(770) Gerd Petrik
Via Collina 43, 6612 Ascona, Switzerland
(580) 2021 08 05

(111) M 2007 17425 R
(732) Hyundai Heavy Industries Holdings Co., LTD
75, Yulgok-Ro, Jongno-Gu, Seoul,
Republic of Korea
(770) Hyundai Corporation
226, Shinmunro-1ka, Jongno-gu, Seoul,
of Korea
(580) 2021 07 23

(111) M 1997 4384 R
(732) Abbott Products Operations AG
Hegenheimermattweg 127, 4123 Allschwil,
Switzerland
(770) Gerd Petrik
Via Collina 43, 6612 Ascona, Switzerland
(580) 2021 08 05

(111) M 1996 1608 R
(732) Abbott Products Operations AG
Hegenheimermattweg 127, 4123 Allschwil,
Switzerland
(770) Gerd Petrik
Via Collina 43, CH 6612 Ascona,
Switzerland
(580) 2021 08 05

(111) M 2009 19281 R
(732) Wella International Operations Switzerland
Sàrl
Chemin Louis-Hubert 1, 1213 Petit-Lancy,
Switzerland
(770) HFC Prestige International Operations
Switzerland Sarl
Chemin Louis-Hubert 1-3, 1213 Petit-Lancy,
Switzerland
(580) 2021 08 02

(111) M 2009 19281 R
(732) HFC Prestige International Operations
Switzerland Sarl
Chemin Louis-Hubert 1-3, 1213 Petit-Lancy
Switzerland
(770) HFC Prestige International Holding
Switzerland Sàrl
Chemin Louis-Hubert 1-3, 1213 Petit-Lancy,
Switzerland
(580) 2021 08 02

(111) M 2010 21045 R
(732) Wella Operations US, LLC
4500 Park Granada, Suite 100, Calabasas
CA 91302, USA
(770) Noxell Corporation

11050 York Road, Hunt Valley, Maryland
21030-2098, USA
(580) 2021 08 02

(111) M 1997 6859 R
(732) HFC Prestige International Operations
Switzerland Sarl
Chemin Louis-Hubert 1-3, 1213 Petit-Lancy,
Switzerland
(770) HFC Prestige International Holding
Switzerland Sàrl
Chemin Louis-Hubert 1-3, 1213 Petit-Lancy,
Switzerland
(580) 2021 08 02

(111) M 1997 6859 R
(732) Wella International Operations Switzerland
Sàrl
Chemin Louis-Hubert 1, 1213 Petit-Lancy,
Switzerland
(770) HFC Prestige International Operations
Switzerland Sarl
Chemin Louis-Hubert 1-3, 1213 Petit-Lancy,
Switzerland
(580) 2021 08 02

(111) M 1997 6864 R
(732) HFC Prestige International Operations
Switzerland Sarl
Chemin Louis-Hubert 1-3, 1213 Petit-Lancy,
Switzerland
(770) International Holding Switzerland Sàrl
Chemin Louis-Hubert 1-3, 1213 Petit-Lancy
Switzerland
(580) 2021 08 02

(111) M 1997 6864 R
(732) Wella International Operations Switzerland
Sàrl
Chemin Louis-Hubert 1, 1213 Petit-Lancy,
Switzerland
(770) HFC Prestige International Operations
Switzerland Sarl

Chemin Louis-Hubert 1-3, 1213 Petit-Lancy,
Switzerland
(580) 2021 08 02

(111) M 1997 6866 R
(732) HFC Prestige International Operations
Switzerland Sarl
Chemin Louis-Hubert 1-3, 1213 Petit-Lancy,
Switzerland
(770) HFC Prestige International Holding
Switzerland Sàrl

Chemin Louis-Hubert 1-3, 1213 Petit-Lancy,
Switzerland
(580) 2021 08 02

(111) M 1997 6866 R
(732) Wella International Operations Switzerland
Sàrl
Chemin Louis-Hubert 1, 1213 Petit-Lancy,
Switzerland
(770) HFC Prestige International Operations
Switzerland Sarl
Chemin Louis-Hubert 1-3, 1213 Petit-Lancy,
Switzerland
(580) 2021 08 02

(111) M 1997 6867 R
(732) Wella International Operations Switzerland
Sàrl
Chemin Louis-Hubert 1, 1213 Petit-Lancy,
Switzerland
(770) HFC Prestige International Operations
Switzerland Sarl
Chemin Louis-Hubert 1-3, 1213 Petit-Lancy,
Switzerland
(580) 2021 08 02

(111) M 1997 6867 R
(732) HFC Prestige International Operations
Switzerland Sarl
Chemin Louis-Hubert 1-3, 1213 Petit-Lancy,
Switzerland
(770) HFC Prestige International Holding
Switzerland Sàrl
Chemin Louis-Hubert 1-3, 1213 Petit-Lancy,
Switzerland
(580) 2021 08 02

(111) M 1997 6869 R
(732) Wella International Operations Switzerland
Sàrl
Chemin Louis-Hubert 1, 1213 Petit-Lancy,
Switzerland
(770) HFC Prestige International Operations
Switzerland Sarl
Chemin Louis-Hubert 1-3, 1213 Petit-Lancy,
Switzerland
(580) 2021 08 02

(111) M 1997 6869 R
(732) HFC Prestige International Operations
Switzerland Sarl
Chemin Louis-Hubert 1-3, 1213 Petit-Lancy,
Switzerland
(770) HFC Prestige International Holding
Switzerland Sàrl

Chemin Louis-Hubert 1-3, 1213 Petit-Lancy,
Switzerland
(580) 2021 08 02

(111) M 1997 6870 R
(732) Wella International Operations Switzerland
Sàrl
Chemin Louis-Hubert 1, 1213 Petit-Lancy,
Switzerland
(770) HFC Prestige International Operations
Switzerland Sarl
Chemin Louis-Hubert 1-3, 1213 Petit-Lancy,
Switzerland
(580) 2021 08 02

(111) M 1997 6870 R
(732) HFC Prestige International Operations
Switzerland Sarl
Chemin Louis-Hubert 1-3, 1213 Petit-Lancy,
Switzerland
(770) HFC Prestige International Holding
Switzerland Sàrl
Chemin Louis-Hubert 1-3, 1213 Petit-Lancy,
Switzerland
(580) 2021 08 02

(111) M 1997 5904 R
(732) Wella International Operations Switzerland
Sàrl
Chemin Louis-Hubert 1, 1213 Petit-Lancy,
Switzerland
(770) HFC Prestige International Operations
Switzerland Sarl
Chemin Louis-Hubert 1-3, 1213 Petit-Lancy,
Switzerland
(580) 2021 08 02

(111) M 1997 5904 R
(732) HFC Prestige International Operations
Switzerland Sarl
Chemin Louis-Hubert 1-3, 1213 Petit-Lancy,
Switzerland
(770) HFC Prestige International Holding
Switzerland Sàrl
Chemin Louis-Hubert 1-3, 1213 Petit-Lancy,
Switzerland
(580) 2021 08 02

(111) M 2013 24115 R
(732) Limited Liability Company "Russkaya
Kosmetika"
St. Vokzalnaya, 53, lit.C, office 2 RU-143005
Odintsovo, Moscow region, Russian
Federation

(770) Gaudal Limited
35 Thekla Lysioti Street, Eagle Star House,
6th Floor, 3030 Limassol, Cyprus
(580) 2021 07 26

(111) M 2013 24116 R
(732) Limited Liability Company "Russkaya
Kosmetika"
St. Vokzalnaya 53, Litera C, office 2,
RU-143005, Odintsovo, Moscow region,
Russian Federation

(770) Gaudal Limited
35 Thekla Lysioti Street, Eagle Star House,
6th Floor, 3030 Limassol, Cyprus
(580) 2021 07 26

(111) M 2016 26732 R
(732) L'Oreal
14, Rue Royale, 75008 Paris, France
(770) Azzaro Mugler Beauté
14, Rue Royale, 75008 Paris, France
(580) 2021 07 16

(111) M 2016 27633 R
(732) Tovarischestvo S Ogranichenoi
Otvetstvenostiu "Winalco Group"
ul. Griboedova 91A, Alma-Ata, Kazakhstan
(770) Irakli Kobidze
Mikheil Bukhaidze St. 7, Tbilisi, Georgia
(580) 2021 07 08

(111) M 2018 30067 R
(732) LLC "My Republic"
Pokhodny Lane 14, floor/premises/office
5/II/№5, RU-125373, Moscow, Russian
Federation
(770) Limited Liability Company "Plast Tim"
Panino St. 7, Vyazma, Vyazma District,
Smolensk region, 215113, Russian Federation
(580) 2021 08 05

(111) M 2018 30068 R
(732) LLC "My Republic"
Pokhodny Lane 14, floor/premises/office
5/II/№5, RU-125373, Moscow, Russian
Federation
(770) Limited Liability Company "Plast Tim"
Panino St. 7, Vyazma, Vyazma District,
Smolensk region, 215113, Russian Federation
(580) 2021 08 05

CHANGES OF NAMES AND/OR ADDRESS OF OWNERS

-
- (111) M 2020 32217 R
(732) Rakuten Group Inc.
1-14-1 Tamagawa, Setagaya-ku,
Tokyo, 158-0094, Japan
(770) Rakuten Inc.
1-14-1 Tamagawa, Setagaya-ku, Tokyo,
158-0094, Japan
(580) 2021 07 30
-
- (111) M 2020 32218 R
(732) Rakuten Group Inc.
1-14-1 Tamagawa, Setagaya-ku, Tokyo,
158-0094, Japan
(770) Rakuten Inc.
1-14-1 Tamagawa, Setagaya-ku, Tokyo,
158-0094, Japan
(580) 2021 07 30
-
- (111) M 2020 32219 R
(732) Rakuten Group Inc.
1-14-1 Tamagawa, Setagaya-ku, Tokyo,
158-0094, Japan
(770) Rakuten Inc.
1-14-1 Tamagawa, Setagaya-ku, Tokyo,
158-0094, Japan
(580) 2021 07 30
-
- (111) M 2020 33073 R
(732) Rakuten Group Inc.
1-14-1 Tamagawa, Setagaya-ku, Tokyo,
158-0094, Japan
(770) Rakuten Inc.
1-14-1 Tamagawa, Setagaya-ku, Tokyo,
158-0094, Japan
(580) 2021 07 31
-
- (111) M 2021 34109 R
(732) LTD "Kerki"
Vill. Dzentsmani, 6100, Keda, Georgia
(770) LTD "Agro Network"
Gorgasali St./S. Khimshiashvili St. 111/13(15)
/S. Khimshiashvili St. 15, app. 5, 6000,
Batumi, Georgia
(580) 2021 08 17
-
- (111) M 1997 6993 R
(732) L3Harris Technologies Inc.
1025 West Nasa Blvd., Melbourne, Florida
32919, USA
(770) Harris Corporation
a Delaware Corporation
1025 West NASA Blvd., Melbourne, Florida
32919, USA
(580) 2021 07 27
-
- (111) M 1998 10381 R
(732) American-Cigarette Company (Overseas)
Limited
Route de France 17, 2926 Boncourt,
Switzerland
(770) American-Cigarette Company (Overseas)
Limited
Zählerweg 4, CH-6300 Zug, Switzerland
(580) 2021 08 06
-
- (111) M 1999 11831 R
(732) Novo Nordisk Health Care AG
The Circle 32/38, CH-8058 Zürich,
Switzerland
(770) Novo Nordisk Health Care AG
Thurgauerstrasse 36/38, CH-8050 Zürich,
Switzerland
(580) 2021 08 13
-
- (111) M 2001 14086 R
(732) Nexen Tire Corporation
355, Chungnyeol-ro, Yangsan-si,
Gyeongsangnam-do, Republic of Korea
(770) Nexen Tire Corporation
30, Yusan-Dong, Yangsan City,
Kyongsangnam-Do, Republic of Korea
(580) 2021 08 11
-
- (111) M 2003 15376 R
(732) Betek Boya ve Kimya Sanayi A.S.
Zümrütevler Mahallesi Ural Sokak No:38
Maltepe 34852 Stamboli, Turkey
(770) Betek Boya ve Kimya Sanayi A.S.
Ankara Asfalti, Huseyin Celik Sok. N9
Kozyatagi 81090 Bostanci Istanbul, Turkey
(580) 2021 07 09
-
- (111) M 2011 21815 R
(732) Swiss Pharma International AG
Lindenstrasse 22, 8008 Zurich, Switzerland
(770) Swiss Pharma International AG
Waldmannstrasse 8, 8001 Zurich, Switzerland
(580) 2021 08 16
-

(111) M 2012 23048 R
(732) New Balance Athletics Inc.
100 Guest Street, Boston, MA 02135, USA
(770) New Balance Athletic Shoe Inc.
20 Guest Street, Boston, MA 02135, USA
(580) 2021 07 14

(111) M 1997 5224 R
(732) Novo Nordisk Health Care AG
The Circle 32/38, CH-8058 Zürich,
Switzerland
(770) Novo Nordisk Health Care AG
Thurgauerstrasse 36/38, CH-8050 Zürich,
Switzerland
(580) 2021 08 13

(111) M 1999 11622 R
(732) Novo Nordisk Health Care AG
The Circle 32/38, CH-8058 Zürich,
Switzerland
(770) Novo Nordisk Health Care AG
Thurgauerstrasse 36/38, CH-8050 Zürich,
Switzerland
(580) 2021 08 13

(111) M 1999 11631 R
(732) Novo Nordisk Health Care AG
The Circle 32/38, CH-8058 Zürich,
Switzerland
(770) Novo Nordisk Health Care AG
Thurgauerstrasse 36/38, CH-8050 Zürich,
Switzerland
(580) 2021 08 13

(111) M 1996 1569 R
(732) Novo Nordisk Health Care AG
The Circle 32/38, CH-8058 Zürich,
Switzerland
(770) Novo Nordisk Health Care AG
Thurgauerstrasse 36/38, CH-8050 Zürich,
Switzerland
(580) 2021 08 13

(111) M 1996 1564 R
(732) Novo Nordisk Health Care AG
The Circle 32/38, CH-8058 Zürich,
Switzerland
(770) Novo Nordisk Health Care AG
Thurgauerstrasse 36/38, CH-8050 Zürich,
Switzerland
(580) 2021 08 13

(111) M 1996 1563 R
(732) Novo Nordisk Health Care AG
The Circle 32/38, CH-8058 Zürich,
Switzerland
(770) Novo Nordisk Health Care AG
Thurgauerstrasse 36/38, CH-8050 Zürich,
Switzerland
(580) 2021 08 13

(111) M 2016 26732 R
(732) Azzaro Mugler Beauté
14, Rue Royale, 75008 PARIS, France
(770) Clarins Fragrance Group.
9, rue du Commandant Pilot, 92200
NEUILLY SUR SEINE, France
(580) 2021 07 16

(111) M 2016 26885 R
(732) Hankook & Company Co., LTD
286, Pangyo-ro, Bundang-gu, Seongnam -si,
Gyeonggi-do, Republic of Korea
(770) Hankook Tire Worldwide Co., LTD
133, Teheran-ro (Yeoksam-dong), Gangnam-
gu, Seoul, 135-723, Republic of Korea
(580) 2021 08 13

(111) M 2015 26426 R
(732) Hankook & Company Co. LTD
286, Pangyo-ro, Bundang-gu, Seongnam-si,
Gyeonggi-do, Republic of Korea
(770) Hankook Tire Worldwide Co. LTD
133, Teheran-ro (Yeoksam-dong), Gangnam-
gu, Seoul, 135-723, Republic of Korea
(580) 2021 08 13

(111) M 2015 26427 R
(732) Hankook & Company Co. LTD
286, Pangyo-ro, Bundang-gu, Seongnam-si,
Gyeonggi-do, Republic of Korea
(770) Hankook Tire Worldwide Co. LTD
133, Teheran-ro (Yeoksam-dong), Gangnam-
gu, Seoul, 135-723, Republic of Korea
(580) 2021 08 13

(111) M 2015 26428 R
(732) Hankook & Company Co. LTD
286, Pangyo-ro, Bundang-gu, Seongnam-si,
Gyeonggi-do, Republic of Korea
(770) Hankook Tire Worldwide Co. LTD
133, Teheran-ro (Yeoksam-dong), Gangnam-
gu, Seoul, 135-723, Republic of Korea
(580) 2021 08 13

(111) M 2015 26429 R
(732) Hankook & Company Co. LTD
286, Pangyo-ro, Bundang-gu, Seongnam-si,
Gyeonggi-do, Republic of Korea
(770) Hankook Tire Worldwide Co. LTD
133, Teheran-ro (Yeoksam-dong), Gangnam-
gu, Seoul, 135-723, Republic of Korea
(580) 2021 08 13

(111) M 2018 29539 R
(732) JSC "Kolkhika"
Sanapiro St. 10, 0108, Old Tbilisi District,
Tbilisi, Georgia
(770) LLC "Iverta"
Sanapiro St. 10, 0108, Old Tbilisi District,
Tbilisi, Georgia
(580) 2021 08 10

(111) M 2016 26975 R
(732) American-Cigarette Company (Overseas)
Limited
Route de France 17, 2926 Boncourt,
Switzerland
(770) American-Cigarette Company (Overseas)
Limited
Zaehlerweg 4, Zug CH 6300, Switzerland
(580) 2021 08 06

(111) M 2016 27079 R
(732) Hp Hewlett Packard Group LLC
10300 Energy Drive, Spring, Texas
77389, USA
(770) Hp Hewlett Packard Group LLC
11445 Compaq Center Drive West, Houston,
Texas 77070, USA
(580) 2021 08 11

(111) M 2017 28735 R
(732) Hp Hewlett Packard Group LLC
10300 Energy Drive, Spring, Texas
77389, USA
(770) Hp Hewlett Packard Group LLC
11445 Compaq Center Drive West, Houston,
Texas 77070, USA
(580) 2021 08 11

(111) M 2016 27698 R
(732) Hp Hewlett Packard Group LLC
10300 Energy Drive, Spring, Texas
77389, USA
(770) Hp Hewlett Packard Group LLC
11445 Compaq Center Drive West, Houston,
Texas 77070, USA
(580) 2021 08 11

(111) M 2017 28741 R
(732) LTD "Genuin Breving Company"
Il. Chavchavadze Av. 75, corp. 3a, app. 19,
0179, Vake District, Tbilisi, Georgia
(770) LLC "Georgian Beverage Company"
Il. Chavchavadze Av. 75, corp. 3a, app. 19,
0179, Vake District, Tbilisi, Georgia
(580) 2021 07 12

CANCELLATION OF TRADEMARKS REGISTRATION

(111) M 2001 13746 R
(151) 2001 02 20
(732) Penhaligon's Limited
a U.K. Corporation
Unit 5-7, Blenheim Court, Brewery Road,
N7 9NY London, United Kingdom
(141) 2021 09 01

(111) M 2001 13728 R
(151) 2001 02 20
(732) Net2Phone Inc. (Corporation of Delaware)
171 Main Street, Hackensack,
New Jersey 07601, USA
(141) 2021 09 01

(111) M 2001 13724 R
(151) 2001 02 20
(732) European Tobacco Inc.
Palm Chambers 3, Road Town, Tortola,
Virgin Islands (British)
(141) 2021 09 01

(111) M 2001 13737 R
(151) 2001 02 20
(732) Eli Lilly and Company
Lilly Corporate Center, Indianapolis, Indiana,
USA
(141) 2021 09 01

(111) M 2001 13763 R
(151) 2001 02 22
(732) Fox Media LLC
10201 West Pico Boulevard, Los-Angeles,
CA 90035, USA
(141) 2021 09 01

(111) M 2001 13769 R
(151) 2001 02 22
(732) Philip Morris Brands Sarl
Quai Jeanrenaud 3, 2000 Neuchâtel,
Switzerland
(141) 2021 09 01

(111) M 2001 13781 R
(151) 2001 02 22
(732) Bayer Intellectual Property GmbH
Alfred-Nobel-Strasse 10, 40789 Monheim
am Rhein, Germany
(141) 2021 09 01

(111) M 2010 20831 R
(151) 2010 10 20
(732) LLC "GD Alco"
M. Aleksidze St. 8, 0193, Tbilisi, Georgia
(141) 2021 08 27
Grounds: The Law of Georgia 20th Paragraph
4 of the article

(111) M 2011 21192 R
(151) 2011 02 25
(732) LLC "G-P-C-Pharmacy"
M. Tsinamdzghvrishvili St. 106, 0164, Tbilisi,
Georgia;
JSC "G P C"
Marjanishvili St. 26, 0164, Tbilisi, Georgia
(141) 2021 09 02

(111) M 2011 21193 R
(151) 2011 02 25
(732) LLC "G-P-C-Pharmacy"
M. Tsinamdzghvrishvili St. 106, 0164, Tbilisi,
Georgia;
JSC "G P C"
Marjanishvili St. 26, 0164, Tbilisi, Georgia
(141) 2021 09 02

(111) M 2011 21171 R
(151) 2011 02 24
(732) LLC "Georgian Dishes"
Aerodrome Settlement St. 7, app. 6, 0182,
Tbilisi Georgia;
Nana Lomtadze
V. Kupradze St. 52, 4600, Kutaisi, Georgia
(141) 2021 09 01

(111) M 2011 21173 R
(151) 2011 02 24
(732) Sanofi İlaç Sanayi ve Ticaret Anonim
Şirketi
Esentepe Mah. Büyükdere Cad. No: 193
Kat: 4, Şişli, Istanbul, Turkey
(141) 2021 09 01

(111) M 2011 21160 R
(151) 2011 02 14
(732) Swiss Pharma International AG
Waldmannstrasse 8, 8001 Zurich,
Switzerland
(141) 2021 08 23

(111) M 2011 21161 R
 (151) 2011 02 14
 (732) Swiss Pharma International AG
 Waldmannstrasse 8, 8001 Zurich,
 Switzerland
 (141) 2021 08 23

(111) M 2011 21162 R
 (151) 2011 02 14
 (732) PT Djarum
 Dl. Jend. A Yani N28, Kudus, 59317,
 Indonesia
 (141) 2021 08 23

(111) M 2011 21163 R
 (151) 2011 02 14
 (732) PT Djarum
 Dl. Jend. A Yani N28, Kudus, 59317,
 Indonesia
 (141) 2021 08 23

(111) M 2011 21164 R
 (151) 2011 02 14
 (732) PT Djarum
 Dl. Jend. A Yani N28, Kudus, 59317,
 Indonesia
 (141) 2021 08 23

(111) M 2011 21174 R
 (151) 2011 02 24
 (732) LTD "M.C.I. Project"
 Leonidze St. 1, 0105, Tbilisi, Georgia
 (141) 2021 09 01

(111) M 2011 21176 R
 (151) 2011 02 24
 (732) LLC "Globalpharm"
 Tamar Mepe Av. 7/13, 0112, Tbilisi, Georgia
 (141) 2021 09 01

(111) M 2011 21179 R
 (151) 2011 02 24
 (732) LLC "Globalpharm"
 Tamar Mepe Av. 7/13, 0112, Tbilisi, Georgia
 (141) 2021 09 01

(111) M 2011 21180 R
 (151) 2011 02 24
 (732) LLC "Globalpharm"
 Tamar Mepe Av. 7/13, 0112, Tbilisi, Georgia
 (141) 2021 09 01

(111) M 2011 21181 R
 (151) 2011 02 24
 (732) LLC "Globalpharm"
 Tamar Mepe Av. 7/13, 0112, Tbilisi,
 Georgia
 (141) 2021 09 01

(111) M 2011 21183 R
 (151) 2011 02 24
 (732) Solomon Ioramashvili
 Griboedov St. 3, 0108, Tbilisi,
 Georgia
 (141) 2021 09 01

(111) M 2011 21184 R
 (151) 2011 02 24
 (732) Solomon Ioramashvili
 Griboedov St. 3, 0108, Tbilisi,
 Georgia
 (141) 2021 09 01

(111) M 2011 21185 R
 (151) 2011 02 24
 (732) Marks and Spencer PLC
 Waterside House, 35 North Wharf Road,
 London W2 1NW, United Kingdom
 (141) 2021 09 01

(111) M 2011 21186 R
 (151) 2011 02 24
 (732) Marks and Spencer PLC
 Waterside House, 35 North Wharf Road,
 London W2 1NW, United Kingdom
 (141) 2021 09 01

(111) M 2011 21195 R
 (151) 2011 02 25
 (732) The Coca-Cola Company
 One Coca-Cola Plaza, Atlanta, Georgia
 30313, USA
 (141) 2021 09 02

(111) M 2011 21198 R
 (151) 2011 02 25
 (732) PTC Therapeutics Inc.
 (Delaware Corporation)
 100 Corporate Court, South Plainfield,
 jersey 07080, USA
 (141) 2021 09 02

(111) M 2011 21206 R
(151) 2011 02 25
(732) Gallaher Limited
Members Hill, Brooklands Road, Weybridge,
Surrey, KT13 0QU, United Kingdom
(141) 2021 09 02

(111) M 2011 21189 R
(151) 2011 02 24
(732) LTD "Ameriteki"
Ak. Shanidze St. 21, 0179, Tbilisi, Georgia
(141) 2021 09 01

(111) M 2011 21208 R
(151) 2011 02 25
(732) LLC "Geocell"
Gotua St. 3, Right Riverside of Mtkvari,
0160, Tbilisi, Georgia
(141) 2021 09 02

(111) M 2011 21209 R
(151) 2011 02 25
(732) LLC "Geocell"
Gotua St. 3, Right Riverside of Mtkvari,
0160, Tbilisi, Georgia
(141) 2021 09 02
Grund: Registration action extraordinary
extension

(111) M 2011 21210 R
(151) 2011 02 25
(732) LLC "Geocell"
Gotua St. 3, Right Riverside of Mtkvari,
0160, Tbilisi, Georgia
(141) 2021 09 02

(111) M 2011 21211 R
(151) 2011 02 25
(732) LLC "Geocell"
Gotua St. 3, Right Riverside of Mtkvari,
0160, Tbilisi, Georgia
(141) 2021 09 02

(111) M 2011 21212 R
(151) 2011 02 25
(732) LLC "Geocell"
Gotua St. 3, Right Riverside of Mtkvari,
0160, Tbilisi, Georgia
(141) 2021 09 02

(111) M 2011 21213 R
(151) 2011 02 25
(732) LLC "Geocell"
Gotua St. 3, Right Riverside of Mtkvari,
0160, Tbilisi, Georgia
(141) 2021 09 02

(111) M 2011 21214 R
(151) 2011 02 25
(732) LLC "Geocell"
Gotua St. 3, Right Riverside of Mtkvari,
0160, Tbilisi, Georgia
(141) 2021 09 02

(111) M 2011 21215 R
(151) 2011 02 25
(732) LLC "Geocell"
Gotua St. 3, Right Riverside of Mtkvari,
0160, Tbilisi, Georgia
(141) 2021 09 02

(111) M 2011 21216 R
(151) 2011 02 25
(732) LLC "Geocell"
Gotua St. 3, Right Riverside of Mtkvari,
0160, Tbilisi, Georgia
(141) 2021 09 02

(111) M 2011 21217 R
(151) 2011 02 25
(732) LLC "Geocell"
Gotua St. 3, Right Riverside of Mtkvari,
0160, Tbilisi, Georgia
(141) 2021 09 02

(111) M 2011 21218 R
(151) 2011 02 25
(732) LLC "Geocell"
Gotua St. 3, Right Riverside of Mtkvari,
0160, Tbilisi, Georgia
(141) 2021 09 02

(111) M 2011 21219 R
(151) 2011 02 25
(732) LLC "Geocell"
Gotua St. 3, Right Riverside of Mtkvari,
0160, Tbilisi, Georgia
(141) 2021 09 02

(111) M 2011 21220 R
(151) 2011 02 25
(732) LLC "Geocell"
Gotua St. 3, Right Riverside of Mtkvari,
0160, Tbilisi, Georgia
(141) 2021 09 02

(111) M 2011 22110 R
(151) 2011 12 19
(732) LLC "GD Alco"
M. Aleksidze St. 8, 0193, Tbilisi, Georgia
(141) 2021 08 27
Grounds: The Law of Georgia 20th Paragraph
4 of the article

REGISTRATION OF LICENSE AGREEMENTS

(111) M 2019 31041 R
(732) LTD "Georgian Cosmetics"
Vazha-Pshavela Av., Vii qurt., corp. 5b,
app. 8, 0186, Tbilisi, Georgia
(791) LTD "Dariachang"
Ateni St. 16, app. 67, Vake District, Tbilisi,
Georgia
(793) №1646
16 07 2021-For a period of validity of the mark
Special
Class – 3

(111) M 2021 34187 R
(732) LTD "Savane"
Shrosha St. 8-10, app. 25, Vake District,
Tbilisi, Georgia
(791) LTD "Georgian Wine Junith"
A. Eristavi-Khoshtaria St. 18, b. 5, Mtatsminda
District, Tbilisi, Georgia
(793) №1647
19 07 2021- For a period of validity of the mark
Simple
Class – 33, 43

(111) M 2011 22149 R
(732) BR IP Holder LLC
130 Royall Street, Suite 300, P.O. Box 9141,
Canton, Massachusetts 02021, USA
(791) Baskin-Robbins Franchising LLC
P.O. Box 9141, Canton MA 02021, USA
(793) №1318
17 07 2015 – 17 07 2030- Simple
Class – 30, 32, 43

(111) M 2011 22149 R
(732) BR IP Holder LLC
130 Royall Street, Suite 300, P.O. Box 9141,
Canton, Massachusetts 02021, USA
(791) Baskin-Robbins Franchising LLC
P.O. Box 9141, Canton MA 02021, USA
(793) №1322
17 07 2015-17 07 2030- Simple
30, 32, 43

(111) M 2012 23133 R
(732) LTD "Tobi"
Rustaveli Av. 40-40, 0108, Tbilisi, Georgia
(791) JSC "Tbilisi Tobacco"
Giorgi Nadareishvili St. 7, Isani District,
Tbilisi, Georgia
(793) №1648
15-07-2021-16-07-2031-Special
Class – 34

INTERNATIONAL LICENSE AGREEMENTS

(800) 1438380
(732) DD IP Holder LLC
P.O. Box 9141, Canton MA 02021, USA
(791) Dunkin' Donuts Franchising LLC
P.O. Box 9141, Canton MA 02021, USA
(793) №1654
Simple
04 03 2021 - 05 03 2071
Class – 29, 30, 32, 43

(800) 1438380
(732) DD IP Holder LLC
P.O. Box 9141, Canton MA 02021, USA
(791) Dunkin' Donuts Franchising LLC
P.O. Box 9141, Canton MA 02021, USA
(793) №1652
Simple
04 03 2021 - 05 03 2071
Class – 29, 30, 32, 43

(800) 1439413
(732) DD IP Holder LLC
P.O. Box 9141, Canton MA 02021, USA
(791) Dunkin' Donuts Franchising LLC
P.O. Box 9141, Canton MA 02021, USA
(793) №1653
Simple
04 03 2021 - 05 03 2071
Class – 29, 30, 32, 43

(800) 1439413
(732) DD IP Holder LLC
P.O. Box 9141, Canton MA 02021, USA
(791) Dunkin' Donuts Franchising LLC
P.O. Box 9141, Canton MA 02021, USA
(793) №1649
Simple
04 03 2021 - 05 03 2071
Class – 29, 30, 32, 43

(800) 1400643
(732) DD IP Holder LLC
P.O. Box 9141, Canton MA 02021, USA
(791) Dunkin' Donuts Franchising LLC
P.O. Box 9141, Canton MA 02021, USA
(793) №1650
Simple
04 03 2021 - 05 03 2071
Class – 29, 30, 32, 43

(800) 1400643
(732) DD IP Holder LLC
P.O. Box 9141, Canton MA 02021, USA
(791) Dunkin' Donuts Franchising LLC
P.O. Box 9141, Canton MA 02021, USA
(793) №1655
Simple
04 03 2021 - 05 03 2071
Class – 29, 30, 32, 43

(800) 1403126
(732) DD IP Holder LLC
P.O. Box 9141, Canton MA 02021, USA
(791) Dunkin' Donuts Franchising LLC
P.O. Box 9141, Canton MA 02021, USA
(793) №1651
Simple
04 03 2021 - 05 03 2071
Class – 29, 30, 32, 43

(800) 1403126
(732) DD IP Holder LLC
P.O. Box 9141, Canton MA 02021, USA
(791) Dunkin' Donuts Franchising LLC
P.O. Box 9141, Canton MA 02021, USA
(793) №1656
Simple
04 03 2021 - 05 03 2071
Class – 29, 30, 32, 43

CLASSIFICATION INDEXES

INVENTIONS

CONCORDANCE TABLE OF INTERNATIONAL CLASSIFICATION INDEX AND PUBLICATION NUMBERS

INTERNATIONAL CLASSIFICATION INDEXES (51)	NUMBER OF PUBLISHED APPLICATION (10)
A 61 K 39/00; A 61 K 9/16	AP 2021 15318 A
B 66 D 5/26	AP 2021 15474 A
C 07 D 213/75; C 07 D 295/205	AP 2021 15258 A
C 07 C 273/04; B 01 D 19/00; B 01 D 5/00; C 07 C 273/14; F 28 D 7/06; F 28 F 21/08; F 28 F 9/02	AP 2021 15347 A
C 07 D 498/00	AP 2021 12996 A
E 06 B 11/02	AP 2021 15149 A
E 21 B 43/295; E 21 B 43/24	AP 2021 14863 A
G 01 N 27/12	AP 2021 15196 A

CONCORDANCE TABLE OF PUBLICATION NUMBERS AND INTERNATIONAL CLASSIFICATION INDEX

NUMBER OF PUBLISHED APPLICATION (10)	INTERNATIONAL CLASSIFICATION INDEXES (51)
AP 2021 12996 A	C 07 D 498/00
AP 2021 14863 A	E 21 B 43/295; E 21 B 43/24
AP 2021 15149 A	E 06 B 11/02
AP 2021 15196 A	G 01 N 27/12
AP 2021 15258 A	C 07 D 213/75; C 07 D 295/205
AP 2021 15318 A	A 61 K 39/00; A 61 K 9/16
AP 2021 15347 A	C 07 C 273/04; B 01 D 19/00; B 01 D 5/00; C 07 C 273/14; F 28 D 7/06; F 28 F 21/08; F 28 F 9/02
AP 2021 15474 A	B 66 D 5/26

CONCORDANCE TABLE OF INTERNATIONAL CLASSIFICATION INDEX, PATENT NUMBERS AND PUBLICATION NUMBERS

INTERNATIONAL CLASSIFICATION INDEX (51)	NUMBER OF PATENT (11)	NUMBER OF PUBLISHED APPLICATION (10)
A 61 K 39/395; A 61 K 45/06; C 07 K 16/40	P 2021 7290 B	AP 2021 14848 A
F 03 G 7/08	P 2021 7289 B	AP 2021 15188 A

**CONCORDANCE TABLE OF PATENT NUMBERS,
PUBLICATION NUMBERS AND INTERNATIONAL CLASSIFICATION INDEX**

NUMBER OF PATENT (11)	NUMBER OF PUBLISHED APPLICATION (10)	INTERNATIONAL CLASSIFICATION INDEX (51)
P 2021 7289 B	AP 2021 15188 A	F 03 G 7/08
P 2021 7290 B	AP 2021 14848 A	A 61 K 39/395; A 61 K 45/06; C 07 K 16/40

**CONCORDANCE TABLE OF APPLICATION NUMBERS,
PUBLICATION NUMBERS AND PATENTS**

NUMBER OF APPLICATION (21)	NUMBER OF PUBLISHED APPLICATION (10)	NUMBER OF PATENT (11)
AP 2017 14848	AP 2021 14848 A	P 2021 7290 B
AP 2019 15188	AP 2021 15188 A	P 2021 7289 B

UTILITY MODELS

INTERNATIONAL CLASSIFICATION INDEXES (51)	NUMBER OF PUBLISHED APPLICATION (10)
A 61 B 17/11	AU 2021 15417 U

**CONCORDANCE TABLE OF PUBLICATION NUMBERS
AND INTERNATIONAL CLASSIFICATION INDEX**

NUMBER OF PUBLISHED APPLICATION (10)	INTERNATIONAL CLASSIFICATION INDEXES (51)
AU 2021 15417 U	A 61 B 17/11

**CONCORDANCE TABLE OF INTERNATIONAL CLASSIFICATION INDEX,
PATENT NUMBERS AND PUBLICATION NUMBERS**

INTERNATIONAL CLASSIFICATION INDEX (51)	NUMBER OF PATENT (11)	NUMBER OF PUBLISHED APPLICATION (10)
C 04 B 28/36	U 2021 2095 Y	AU 2021 15249 U

**CONCORDANCE TABLE OF PATENT NUMBERS,
PUBLICATION NUMBERS AND INTERNATIONAL CLASSIFICATION INDEX**

NUMBER OF PATENT (11)	NUMBER OF PUBLISHED APPLICATION (10)	INTERNATIONAL CLASSIFICATION INDEX (51)
U 2021 2095 Y	AU 2021 15249 U	C 04 B 28/36

**CONCORDANCE TABLE OF APPLICATION NUMBERS,
PUBLICATION NUMBERS AND PATENTS**

NUMBER OF APPLICATION (21)	NUMBER OF PUBLISHED APPLICATION (10)	NUMBER OF PATENT (11)
AU 2019 15249	AU 2021 15249 U	U 2021 2095 Y

DESIGNS

**CONCORDANCE TABLE OF INTERNATIONAL CLASSIFICATION INDEX
AND PUBLICATION NUMBERS**

INTERNATIONAL CLASSIFICATION INDEXES (51)	NUMBER OF PUBLISHED APPLICATION (10)
09-01	AD 2021 1214 S

**CONCORDANCE TABLE OF PUBLICATION NUMBERS
AND INTERNATIONAL CLASSIFICATION INDEX**

NUMBER OF PUBLISHED APPLICATION (10)	INTERNATIONAL CLASSIFICATION INDEXES (51)
AD 2021 1214 S	09-01

**CONCORDANCE TABLE OF INTERNATIONAL CLASSIFICATION INDEX,
NUMBERS OF REGISTRATION AND PUBLICATION NUMBERS**

INTERNATIONAL CLASSIFICATION INDEX (51)	NUMBER OF REGISTRATION (11)	NUMBER OF PUBLISHED APPLICATION (10)
06-03	D 2021 903 S	AD 2021 1196 S
24-02	D 2021 904 S	AD 2021 1197 S

CONCORDANCE TABLE OF NUMBERS OF REGISTRATION,
PUBLICATION NUMBERS AND INTERNATIONAL CLASSIFICATION INDEX

NUMBER OF REGISTRATION (11)	NUMBER OF PUBLISHED APPLICATION (10)	INTERNATIONAL CLASSIFICATION INDEX (51)
D 2021 903 S	AD 2021 1196 S	06-03
D 2021 904 S	AD 2021 1197 S	24-02

CONCORDANCE TABLE OF APPLICATION NUMBERS,
PUBLICATION NUMBERS AND NUMBERS OF REGISTRATION

NUMBER OF APPLICATION (21)	NUMBER OF PUBLISHED APPLICATION (10)	NUMBER OF REGISTRATION (11)
AD 2020 1196	AD 2021 1196 S	D 2021 903 S
AD 2020 1197	AD 2021 1197 S	D 2021 904 S

TRADEMARKS

CONCORDANCE TABLE OF REGISTRATION NUMBERS, APPLICATION NUMBERS, PUBLICATION NUMBERS AND BULLETIN NUMBERS

NUMBER OF REGISTRATION (111)	NUMBER OF APPLICATIONS (210)	NUMBER OF PUBLISHED APPLICATIONS (260)	NUMBER OF BULLETIN
1	2	3	4
M 2021 34434 R	AM 114323	–	16(572)2021
M 2021 34435 R	AM 114231	–	16(572)2021
M 2021 34436 R	AM 114232	–	16(572)2021
M 2021 34437 R	AM 114131	–	16(572)2021
M 2021 34438 R	AM 114346	–	16(572)2021
M 2021 34439 R	AM 114345	–	16(572)2021
M 2021 34440 R	AM 114005	–	16(572)2021
M 2021 34441 R	AM 114316	–	16(572)2021
M 2021 34442 R	AM 114338	–	16(572)2021
M 2021 34443 R	AM 114339	–	16(572)2021
M 2021 34444 R	AM 114406	–	16(572)2021
M 2021 34445 R	AM 114405	–	16(572)2021
M 2021 34446 R	AM 114409	–	16(572)2021
M 2021 34447 R	AM 105655	AM 2021 105655 A	8(564)2021
M 2021 34448 R	AM 108943	AM 2021 108943 A	2(558)2021
M 2021 34449 R	AM 109013	AM 2021 109013 A	3(559)2021
M 2021 34450 R	AM 109014	AM 2021 109014 A	3(559)2021
M 2021 34451 R	AM 109015	AM 2021 109015 A	3(559)2021
M 2021 34452 R	AM 109016	AM 2021 109016 A	3(559)2021
M 2021 34453 R	AM 109017	AM 2021 109017 A	3(559)2021
M 2021 34454 R	AM 109018	AM 2021 109018 A	3(559)2021
M 2021 34455 R	AM 109021	AM 2021 109021 A	3(559)2021
M 2021 34456 R	AM 109022	AM 2021 109022 A	3(559)2021
M 2021 34457 R	AM 109023	AM 2021 109023 A	3(559)2021
M 2021 34458 R	AM 109745	AM 2021 109745 A	6(562)2021
M 2021 34459 R	AM 109825	AM 2021 109825 A	8(564)2021
M 2021 34460 R	AM 109832	AM 2021 109832 A	8(564)2021
M 2021 34461 R	AM 109840	AM 2021 109840 A	8(564)2021
M 2021 34462 R	AM 109846	AM 2021 109846 A	8(564)2021
M 2021 34463 R	AM 109848	AM 2021 109848 A	7(563)2021
M 2021 34464 R	AM 109911	AM 2021 109911 A	8(564)2021
M 2021 34465 R	AM 109912	AM 2021 109912 A	8(564)2021
M 2021 34466 R	AM 109917	AM 2021 109917 A	7(563)2021
M 2021 34467 R	AM 109932	AM 2021 109932 A	8(564)2021
M 2021 34468 R	AM 109933	AM 2021 109933 A	8(564)2021
M 2021 34469 R	AM 109954	AM 2021 109954 A	7(563)2021
M 2021 34470 R	AM 110023	AM 2021 110023 A	8(564)2021
M 2021 34471 R	AM 110027	AM 2021 110027 A	8(564)2021
M 2021 34472 R	AM 110032	AM 2021 110032 A	8(564)2021
M 2021 34473 R	AM 110042	AM 2021 110042 A	8(564)2021
M 2021 34474 R	AM 110115	AM 2021 110115 A	8(564)2021
M 2021 34475 R	AM 110116	AM 2021 110116 A	8(564)2021
M 2021 34476 R	AM 110129	AM 2021 110129 A	8(564)2021
M 2021 34477 R	AM 110134	AM 2021 110134 A	9(565)2021
M 2021 34478 R	AM 110135	AM 2021 110135 A	8(564)2021
M 2021 34479 R	AM 110193	AM 2021 110193 A	8(564)2021

1	2	3	4
M 2021 34480 R	AM 110197	AM 2021 110197 A	8(564)2021
M 2021 34481 R	AM 110208	AM 2021 110208 A	8(564)2021
M 2021 34482 R	AM 110209	AM 2021 110209 A	9(565)2021
M 2021 34483 R	AM 110224	AM 2021 110224 A	9(565)2021
M 2021 34484 R	AM 110231	AM 2021 110231 A	8(564)2021
M 2021 34485 R	AM 110304	AM 2021 110304 A	9(565)2021

**CONCORDANCE TABLE OF PUBLICATION NUMBERS
AND APPLICATION NUMBERS**

NUMBER OF PUBLISHED APPLICATION (260)	NUMBER OF APPLICATION (210)	1	2
		1	2
AM 2021 98568 A*	AM 98568	AM 2021 111615 A	AM 111615
AM 2021 98569 A*	AM 98569	AM 2021 111617 A	AM 111617
AM 2021 109763 A	AM 109763	AM 2021 111693 A	AM 111693
AM 2021 110482 A	AM 110482	AM 2021 111698 A	AM 111698
AM 2021 110528 A	AM 110528	AM 2021 111703 A	AM 111703
AM 2021 110602 A	AM 110602	AM 2021 111705 A	AM 111705
AM 2021 110749 A	AM 110749	AM 2021 111709 A	AM 111709
AM 2021 111062 A	AM 111062	AM 2021 111710 A	AM 111710
AM 2021 111339 A	AM 111339	AM 2021 111711 A	AM 111711
AM 2021 111412 A	AM 111412	AM 2021 111719 A	AM 111719
AM 2021 111414 A	AM 111414	AM 2021 111724 A	AM 111724
AM 2021 111418 A	AM 111418	AM 2021 111725 A	AM 111725
AM 2021 111419 A	AM 111419	AM 2021 111726 A	AM 111726
AM 2021 111420 A	AM 111420	AM 2021 111731 A	AM 111731
AM 2021 111421 A	AM 111421	AM 2021 111733 A	AM 111733
AM 2021 111428 A	AM 111428	AM 2021 111740 A	AM 111740
AM 2021 111435 A	AM 111435	AM 2021 111742 A	AM 111742
AM 2021 111446 A	AM 111446	AM 2021 111744 A	AM 111744
AM 2021 111497 A	AM 111497	AM 2021 111745 A	AM 111745
AM 2021 111519 A	AM 111519	AM 2021 111746 A	AM 111746
AM 2021 111525 A	AM 111525	AM 2021 111747 A	AM 111747
AM 2021 111526 A	AM 111526	AM 2021 111748 A	AM 111748
AM 2021 111541 A	AM 111541	AM 2021 111749 A	AM 111749
AM 2021 111586 A	AM 111586	AM 2021 111750 A	AM 111750
AM 2021 111587 A	AM 111587	AM 2021 111751 A	AM 111751
AM 2021 111604 A	AM 111604	AM 2021 111752 A	AM 111752
AM 2021 111607 A	AM 111607	AM 2021 111753 A	AM 111753
AM 2021 111610 A	AM 111610	AM 2021 111754 A	AM 111754
		AM 2021 111755 A	AM 111755
		AM 2021 111756 A	AM 111756
		AM 2021 111845 A	AM 111845

CONCORDANCE TABLE OF INDEX OF GOODS AND/OR SERVICES
AND APPLICATION NUMBERS

INDEX OF GOODS AND/OR SERVICES (511)	NUMBER OF PUBLISHED APPLICATIONS (260)	1	2
1	2		
1	AM 2021 111733 A	30	AM 2021 111604 A
5	AM 2021 111412 A	30	AM 2021 111615 A
5	AM 2021 111414 A	30	AM 2021 111617 A
5	AM 2021 111418 A	30	AM 2021 111705 A
5	AM 2021 111419 A	30	AM 2021 111719 A
5	AM 2021 111420 A	30	AM 2021 111845 A
5	AM 2021 111421 A	32	AM 2021 111519 A
5	AM 2021 111724 A	32	AM 2021 111703 A
5	AM 2021 111725 A	32	AM 2021 111709 A
5	AM 2021 111726 A	33	AM 2021 98568 A*
5	AM 2021 111731 A	33	AM 2021 98569 A*
5	AM 2021 111740 A	33	AM 2021 109763 A
5	AM 2021 111742 A	33	AM 2021 110602 A
5	AM 2021 111744 A	33	AM 2021 111428 A
5	AM 2021 111745 A	33	AM 2021 111435 A
5	AM 2021 111746 A	33	AM 2021 111519 A
5	AM 2021 111747 A	33	AM 2021 111586 A
5	AM 2021 111748 A	33	AM 2021 111604 A
5	AM 2021 111749 A	33	AM 2021 111703 A
5	AM 2021 111750 A	34	AM 2021 111062 A
5	AM 2021 111751 A	34	AM 2021 111607 A
5	AM 2021 111752 A	34	AM 2021 111698 A
5	AM 2021 111753 A	35	AM 2021 111497 A
5	AM 2021 111754 A	35	AM 2021 111525 A
5	AM 2021 111755 A	35	AM 2021 111526 A
5	AM 2021 111756 A	35	AM 2021 111604 A
6	AM 2021 111541 A	35	AM 2021 111615 A
7	AM 2021 111541 A	35	AM 2021 111617 A
7	AM 2021 111610 A	35	AM 2021 111703 A
9	AM 2021 111339 A	35	AM 2021 111705 A
9	AM 2021 111541 A	35	AM 2021 111710 A
16	AM 2021 111525 A	36	AM 2021 111339 A
16	AM 2021 111526 A	36	AM 2021 111710 A
16	AM 2021 111733 A	36	AM 2021 111711 A
17	AM 2021 111541 A	37	AM 2021 111541 A
17	AM 2021 111733 A	37	AM 2021 111710 A
19	AM 2021 111541 A	37	AM 2021 111711 A
24	AM 2021 111703 A	39	AM 2021 110528 A
25	AM 2021 111525 A	39	AM 2021 111703 A
25	AM 2021 111526 A	39	AM 2021 111710 A
25	AM 2021 111693 A	39	AM 2021 111711 A
25	AM 2021 111703 A	40	AM 2021 111710 A
27	AM 2021 111703 A	40	AM 2021 111711 A
28	AM 2021 111497 A	41	AM 2021 111703 A
28	AM 2021 111703 A	41	AM 2021 111710 A
29	AM 2021 111587 A	41	AM 2021 111711 A
29	AM 2021 111709 A	42	AM 2021 111525 A
30	AM 2021 110482 A	42	AM 2021 111526 A
		42	AM 2021 111541 A
		42	AM 2021 111703 A
		42	AM 2021 111710 A

1	2
42	AM 2021 111711 A
43	AM 2021 109763 A
43	AM 2021 111446 A
43	AM 2021 111705 A
43	AM 2021 111710 A
43	AM 2021 111711 A

1	2
44	AM 2021 111710 A
44	AM 2021 111711 A
45	AM 2021 110749 A
45	AM 2021 111710 A
45	AM 2021 111711 A

**CONCORDANCE TABLE OF INDEX OF GOODS AND/OR SERVICES
AND NUMBERS OF TRADEMARKS REGISTERED ACCORDING
TO THE ACCELERATED PROCEDURE**

INDEX OF GOODS AND/OR SERVICES (511)	NUMBERS OF REGISTERED ACCORDING TO THE ACCELERATED PROCEDURE (111)
5	M 2021 34444 R
5	M 2021 34445 R
9	M 2021 34439 R
9	M 2021 34446 R
10	M 2021 34438 R
30	M 2021 34434 R
32	M 2021 34440 R
33	M 2021 34435 R
33	M 2021 34436 R
33	M 2021 34437 R
33	M 2021 34440 R
36	M 2021 34442 R
36	M 2021 34443 R
39	M 2021 34439 R
43	M 2021 34434 R
44	M 2021 34441 R

OFFICIAL BULLETIN OF THE INDUSTRIAL PROPERTY

**INVENTIONS
UTILITY MODELS
DESIGNS
TRADEMARKS**

16(572)

EDITOR-IN-CHIEF: N. Bebrishvili

EDITOR-TRANSLATOR: E. Gabunia

PROOFREADER: A. Shikhashvili

COMPUTER LAYOUT: M. Ordenidze
K. Svanidze

www.sakpatenti.gov.ge

E-mail: info@sakpatenti.org.ge