



# Official Bulletin of the Industrial Property

Inventions

Designs

Trademarks

Appellations of Origin of Goods



საქართველოს ინტელექტუალური  
საკუთრების ეროვნული ცენტრი  
**საქპატენტი**  
**SAKPATENTI**  
NATIONAL INTELLECTUAL PROPERTY  
CENTER OF GEORGIA  
[www.sakpatenti.gov.ge](http://www.sakpatenti.gov.ge)

**16(619)**

# INID CODES FOR IDENTIFICATION OF BIBLIOGRAPHIC DATA

## INVENTIONS, UTILITY MODELS

- (10) Number of publication of examined application/  
Application publication number\*\*\*
- (11) Patent number/ Patent number\*\*\*  
Registered utility model number\*\*\*
- (21) Application number
- (22) Date of filing of the application
- (23) Date of exhibition priority
- (24) Date from which patent may have effect
- (31) Number of priority application
- (32) Date of filing of priority application
- (33) Code of the country or regional organization allotting application number
- (43) Date of publication of application, number of bulletin\*\*\*
- (44) Date of publication of examined application, on which no grant has taken place and number of bulletin
- (45) Date of publication of patent/ Date of publication of patent\*\*\*  
Date of publication of registered utility model\*\*\*
- (51) International Patent Classification Index
- (54) Title of the invention/title of the utility model
- (57) Abstract
- (60) Number of examined patent document granted by foreign patent office, date from which patent has effect and country code
- (62) Number and filing date of the earlier application in case of a divisional application
- (71) Name and address of applicant (country code)
- (72) Name of inventor (country code)
- (73) Name and address of patent owner/patent owner\*\*\*/ registered utility model owner\*\*\* (country code)
- (74) Name of representative or patent attorney
- (85) Date of commencement of the national phase of international application (PCT)
- (86) Number and date of filing of international application (PCT)
- (87) Number and date of publication of international application (PCT)
- (94) Calculated date of expiry of the SPC or the duration of the SPC

## DESIGNS

- (10) Number of publication for application
- (11) Number of patent and kind of document or number of registration
- (15) Date of registration/Date of patent renewal
- (18) Expected expiration date of patent or registration
- (21) Serial number of application
- (22) Date of filing of the application
- (23) Date of exhibition or the date of the earlier filing and the number of application, if any
- (24) Date from which patent may have effect
- (28) Number of designs included in the application
- (30) Data relating to priority (number of application, date of filing of application, two-letter code identifying the authority with whom the priority application was made)
- (31) Number of priority application
- (32) Date of filing of priority application
- (33) Code of the country or regional organization allotting priority application number
- (34) Two-letter code according to WIPO St.3 identifying the authority with which the priority application was made
- (44) Date of publication of design and number of bulletin (the first publication)
- (45) Date of publication of design registered by WIPO and number of bulletin
- (51) International Classification for designs (class and subclass of the Locarno Classification)
- (54) Title of the invention
- (55) Reproduction of the design
- (57) Description of characteristic features of the design including indication of colors
- (58) Date of recording of any kind of amendment in the Register
- (62) Number of the earlier application, registration and document number and if available the date of filing an application in case of divided application
- (71) Name, surname and address of applicant (country code)
- (72) Name, surname of creator (country code)
- (73) Name, surname and address of patent owner (country code)
- (74) Name, surname of representative or patent attorney
- (81) Contracting states concerned  
II designated contracting states according to the 1960 Act  
III designated contracting states according to the 1999 Act
- (85) Owner's permanent address
- (86) Owner's nationality
- (87) Owner's residence
- (88) State in which the owner has a real and effective industrial or commercial establishment

## TRADEMARKS

- (111) – Number of registration
- (151) – Date of registration
- (156) – Date of the renewal
- (181) – Expected expiration date of registration
- (186) – Renewal expiration date of registration
- (141) – Date of cancel of duration of the mark
- (210) – Serial number of application
- (220) – Date of filing of the application
- (230) – Data concerning exhibition
- (260) – Number of application, for which favorable decision of examination about registration has been taken (publication number)
- (310) – Number of the first application
- (320) – Date of filing of the first application
- (330) – Code, identifying national or regional Office where the first application was made
- (511) – International Classification of Goods and Services for the purposes of registration of trade marks and/or list of goods and/or services classified according thereto
- (526) – Disclaimer
- (531) – Description of figurative elements of Trade Marks according to the International Classification of the Figurative Elements of Marks
- (540) – Reproduction of Trade Mark
- (550) – Nature and kind of Trade Mark
- (551) – Indication to the effect that the mark is a collective mark, a certification mark or a guarantee mark
- (554) – Three-dimensional mark
- (580) – Date of recording of any kind changes in respect of applications or registrations
- (591) – Information concerning colors claimed
- (731) – Name and address of the applicant
- (732) – Name and address of the holder of the registration
- (740) – Name and address of the representative
- (750) – Addreses for correspondence
- (770) – Name and address of the previous applicant or holder in case of change in ownership
- (771) – Previous name and address of the applicant or holder in case of change in ownership
- (791) – Name and address of the licensee
- (793) – Indication of conditions and/or restrictions under the license (Type of license, number of license agreement, data of license, data of validity of license)
- (800) – Certain data relating to the international registration of Trade Marks under the Protocol Relating to Madrid Agreement (International registration number
- (852) – Partial cancellation of the list of goods and services
- (891) – Date of subsequent designation

## CODES FOR PUBLICATION IN BULLETIN

- (21) AP 0000 000000 – number of application for invention
- (10) AP 0000 0000 A – number of publication of application for invention
- (11) P 0000 0000 B – number of patent for invention/ patent number\*\*\*
- (21) API 0000 000000 – number of application for imported patent
- (11) PI 0000 0000 A – number of imported patent
- (21) AU 0000 000000 – number of application for utility model
- (10) AU 0000 000 U – number of publication of application for utility model
- (11) U 0000 000 Y – number of patent for utility model/ registered utility model number\*\*\*
- (21) AD 0000 000000 – serial number of application for design
- (10) AD 0000 000 S – number of published application for design (first publication)
- (11) D 0000 000 S – registered design

## INTERNATIONAL PATENT CLASSIFICATION FOR INVENTIONS AND UTILITY MODELS

- SECTION A – HUMAN NECESSITIES
- SECTION B – PERFORMING OPERATIONS; TRANSPORTING
- SECTION C – CHEMISTRY; METALLURGY
- SECTION D – TEXTILES; PAPER
- SECTION E – FIXED CONSTRUCTIONS
- SECTION F – MECHANICAL ENGINEERING; LIGHTING; HEATING; WEAPONS; BLASTING
- SECTION G – PHYSICS
- SECTION H – ELECTRICITY

\* Number of application published after the decision of Appellation Chamber of SAKPATENTI

\*\* Number of application published after Court decision

\*\*\* Materials published according to the amendments of May 16, 2023 (No. 2883-XI0b-X03) to the Patent Law of Georgia

- M – Trade Mark
- (210) AM 0000 000000 – Serial number of application;
- (260) AAM 0000 00000 A – Publication number of application;
- (111) M 0000 00000 R – Number of registration;
- (111) MMM0000 00000 Rn – Number of renewals, in which n=1,2,3;
- (111) M 0000 00000 R(P) – Number of registration under partial assignment of rights

# Official Bulletin of the Industrial Property

Inventions

Designs

Trademarks

Appellations of Origin of Goods

# CONTENT

<b>PUBLISHED TITLES OF PROTECTION</b> .....	3
<b>INVENTIONS</b>	
▪ APPLICATIONS APPROVED FOR GRANTING PATENT .....	4
▪ PATENTED INVENTIONS .....	5
▪ APPLICATION*** .....	7
<b>DESIGNS</b>	
▪ APPLICATION APPROVED FOR REGISTRATION .....	8
▪ REGISTERED DESIGN .....	9
▪ DESIGN REGISTERED ACCORDING TO THE ACCELERATED PROCEDURE .....	10
▪ DESIGNS, WHICH HAVE BEEN REGISTERED WITH THE INTERNATIONAL BUREAU CLAIMING PRIORITY ON THE TERRITORY OF GEORGIA .....	11
<b>TRADEMARKS</b>	
▪ APPLICATIONS FILED UNDER THE NATIONAL PROCEDURE APPROVED FOR REGISTRATION .....	26
▪ REGISTERED TRADEMARKS .....	30
▪ TRADEMARKS REGISTERED ACCORDING TO THE ACCELERATED PROCEDURE .....	32
▪ INTERNATIONAL TRADEMARKS FOR WHICH A DECISION ON GRANTING PROTECTION IS TAKEN .....	34
▪ INTERNATIONAL TRADEMARKS PROTECTED IN GEORGIA .....	112
<b>APPELLATIONS OF ORIGIN OF GOODS</b>	
APPELLATIONS OF ORIGIN OF GOODS FILED IN GEORGIA FOR EXAMINATION UNDER LISBON AGREEMENT, ON THE BASIS OF THE INTERNATIONAL REGISTRATION .....	115
<b>OFFICIAL NOTIFICATION</b>	
<b>INVENTIONS</b>	
▪ RESTORATION OF PATENTS .....	116
▪ LAPSE OF PATENTS WITH THE RIGHT TO RESTORE .....	116
▪ EXPIRATION OF PATENTS RESTORATION TERM .....	120
▪ CHANGES OF NAME AND/OR ADDRESS OF PATENT OWNERS .....	122
<b>UTILITY MODELS</b>	
▪ RESTORATION OF PATENTS .....	127
▪ LAPSE OF PATENTS WITH THE RIGHT TO RESTORE .....	127
▪ EXPIRATION OF PATENTS RESTORATION TERM .....	128
<b>DESIGNS</b>	
CANCELLATION OF DESIGNS REGISTRATION .....	129
<b>TRADEMARKS</b>	
▪ EXTENSION OF TERM OF TRADEMARKS REGISTRATION .....	130
▪ COMPLETE TRANSFER OF RIGHTS .....	134
▪ CHANGES OF NAME AND/OR ADDRESS OF TRADEMARKS OWNERS .....	135
▪ CANCELLATION OF TRADEMARKS REGISTRATION .....	137
<b>CLASSIFICATION INDEXES</b>	
INVENTIONS .....	138
DESIGNS .....	140
TRADEMARKS .....	142

## **PUBLISHED TITLES OF PROTECTION**

### **INVENTIONS**

- **APPLICATION APPROVED FOR GRANTING PATENT:**  
15865
- **PATENTED INVENTIONS:**  
7529-7533
- **APPLICATION<sup>\*\*\*</sup> :**  
16300

### **DESIGNS**

- **APPLICATION APPROVED FOR REGISTRATION:**  
1307
- **REGISTERED DESIGN:**  
976
- **DESIGN REGISTERED ACCORDING TO THE ACCELERATED PROCEDURE:**  
977
- **DESIGNS, WHICH HAVE BEEN REGISTERED WITH THE INTERNATIONAL BUREAU CLAIMING PRIORITY ON THE TERRITORY OF GEORGIA:**  
228998; 225751; 229350, 229351; 229353; 229687-229689; 229742

### **TRADEMARKS**

- **APPLICATIONS FILED UNDER THE NATIONAL PROCEDURE APPROVED FOR REGISTRATION:**  
112294, 112295; 120614; 120631; 120698; 120717; 120811; 120817; 120822; 120848; 120945; 120960, 120961; 121040; 121052; 121129; 121142; 121155; 121242; 121307; 121503; 121524
- **REGISTERED TRADEMARKS:**  
37179, 37180; 37186-37203
- **TRADEMARKS REGISTERED ACCORDING TO THE ACCELERATED PROCEDURE:**  
37181-37185; 37204-37206
- **INTERNATIONAL TRADEMARKS FOR WHICH A DECISION ON GRANTING PROTECTIONS IS TAKEN:**  
119510; 120261; 120263, 120264; 120295-120299; 120378-120387; 120397; 120429; 120432; 120454-120462; 120470-120474; 120480-120482; 120485; 120487-120491; 120493, 120494; 120539; 120542; 120544; 120548; 120558; 120577-120582; 120589; 120591-120594; 120634-120638; 120671-120674; 120676; 120691, 120692; 120696, 120697; 120739; 120755; 120783; 120790; 120809, 120810; 120863, 120864; 120866; 120886-120888; 120905-120908; 120929, 120930; 120932, 120933; 121034, 121035; 121037-121039, 121055-121061; 121068-121070; 121072; 121110; 121249
- **INTERNATIONAL TRADEMARKS PROTECTED IN GEORGIA:**  
115552; 116022; 116474; 116877; 118702; 118891, 118892; 118955-118957; 118973, 118974; 118985; 118987-118990; 119030-119034; 119135-119142; 119265; 119410-119413; 119417-119419

### **APPELLATIONS OF ORIGIN OF GOODS**

3523-3525

# INVENTIONS

## APPLICATION APPROVED FOR GRANTING PATENT

The decision can be appealed at the Chamber of Appeal of Sakpatenti within 3 months from the publication or at the Mtskheta District Court Administrative Cases Board (Address: №17, Samkhedro St., Mtskheta), within 1 month following the publication.

### PART A

#### A 61

- (10) AP 2023 15865 A (51) Int. Cl. (2006)  
A 61 K 31/428  
A 61 K 31/404  
A 61 K 31/538  
A 61 K 31/4155  
A 61 K 31/55  
A 61 K 31/437  
A 61 K 31/5025  
A 61 K 31/4439  
A 61 K 31/4709  
A 61 K 31/427  
A 61 P 37/02  
A 61 P 35/00  
A 61 P 37/00  
C 07 D 487/04  
C 07 D 471/04  
C 07 D 417/14
- (21) AP 2020 15865 (22) 2020 07 28  
(31) 19188749.6  
(32) 2019 07 29  
(33) EP  
(71) Les Laboratoires Servier (FR)  
35, rue de Verdun, 92284 Suresnes Cedex,  
France (FR);  
Vernalis (R&D) Limited (GB)  
Granta Park, Cambridge, CB21 6GB, UK (GB)
- (72) NOVAK, Tibor (HU);  
DAVIDSON, James Edward Paul (GB);  
PACZAL, Attila (HU);  
STARCK, Jérôme-Benoit (FR);  
KOTSCHY, András (HU);  
MURRAY, James Brooke (GB);  
BEDFORD, Simon (GB);  
CHANRION, Maïa (FR);  
COLLAND, Frédéric (FR);  
DODSWORTH, Mark Philip (GB);  
HERNER, András (HU);  
MARAGNO, Ana Leticia (FR);  
SANDERS, Emma (GB);  
TIMÁRI, Mátyás Pál (HU);  
WEBB, Paul (GB)
- (74) Tamaz Shilakadze  
(85) 2022 01 28  
(86) PCT/EP2020/071181, 2020 07 28

(54) 6,7-DIHYDRO-5H-PYRIDO[2,3-C]PYRIDAZINE DERIVATIVES AND RELATED COMPOUNDS AS BCL-XL PROTEIN INHIBITORS AND PRO-APOPTOTIC AGENTS FOR TREATING CANCER

(57) Present invention relates to 6,7-dihydro-5H-pyrido[2,3-c]pyridazine, 1,2,3,4-tetrahydroquinoline, 1H-indole, 3,4-dihydro-2H-1,4-benzoxazine, 1H-pyrrolo[2,3-b]pyridin-1-yl, 7H-pyrrolo[2,3-c]pyridazine, 5H,6H,7H,8H,9H-pyridazino[3,4-b]azepine derivatives of formula (IA),

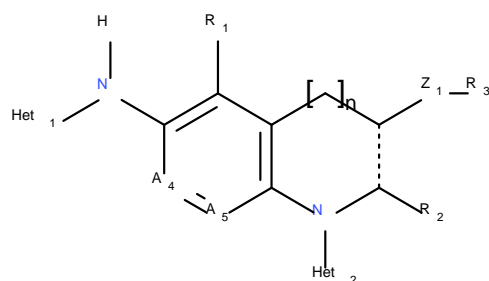

(IA)

pharmaceutical compositions containing them, and their usage as pro-apoptotic agents for the treatment of cancer, and immune and autoimmune diseases.

Claims: 11 independents

26 dependents

Fig.: 2

## PATENTED INVENTIONS

### PART A

#### A 23

- (11) P 2023 7533 B (51) Int. Cl. (2006)  
A 23 C 23/00
- (10) AP 2023 16008 A (44) 6(609)/2023  
(21) AP 2022 16008  
(22) 2022 07 18  
(24) 2022 07 18  
(73) Maria Silagadze (GE)  
26 May St. 45, 4600, Kutaisi, Georgia (GE);  
Nato Burjaliani (GE)  
Z. Chavchavadze St. 48/27, 4600, Kutaisi,  
Georgia (GE);  
Giorgi Pkhakadze (GE)  
26 May St. 45, 4600, Kutaisi, Georgia (GE);  
Gulnara Khetsuriani (GE)  
Rustaveli Ave. 120a, ap. 42, 4600, Kutaisi,  
Georgia (GE);  
Andria Ghvinepadze (GE)  
Kazbegi St. 28, 4600, Kutaisi, Georgia (GE);  
Khatia Khvadagiani (GE)  
Rezo Tabukashvili St. 183/76, 4600, Kutaisi,  
Georgia (GE)
- (72) Maria Silagadze (GE);  
Nato Burjaliani (GE);  
Giorgi Pkhakadze (GE);  
Gulnara Khetsuriani (GE);  
Andria Ghvinepadze (GE);  
Khatia Khvadagiani (GE)
- (54) PROPHYLACTIC CHEESE PRODUCT  
FOR ANTIANEMIC DIET

#### A 61

- (11) P 2023 7531 B (51) Int. Cl. (2006)  
A 61 K 31/53  
A 61 P 35/00  
C 07 D 487/04
- (10) AP 2023 15724 A (44) 9(612)/2023  
(21) AP 2020 15724  
(22) 2020 01 27  
(24) 2020 01 27  
(31) 19154781.9  
(32) 2019 01 31  
(33) EP  
(86) PCT/EP2020/051884, 2020 01 27  
(73) Bayer Pharma Aktiengesellschaft (DE)  
Müllerstraße 178, Berlin, 13353,  
Germany (DE);

- Bayer Aktiengesellschaft (DE)  
Kaiser-Wilhelm-Allee 1, Leverkusen, 51373,  
Germany (DE)
- (72) GRIES, Jörg (DE);  
PLATZEK, Johannes (DE);  
HÄSELHOFF, Claus-Christian (DE);  
LOVIS, Kai (DE)
- (74) Giorgi Kartvelishvili
- (54) MONOHYDRATE OF ROGARATINIB  
HYDROCHLORIDE AND SOLID  
STATES THEREOF

- (11) P 2023 7532 B (51) Int. Cl. (2006)  
A 61 K 31/7048  
A 61 K 9/14  
A 61 K 9/00  
A 61 P 9/14
- (10) AP 2023 15564 A (44) 9(612)/2023  
(21) AP 2019 15564  
(22) 2019 07 19  
(24) 2019 07 19  
(31) 18/56769  
(32) 2018 07 20  
(33) FR  
(86) PCT/EP2019/069498, 2019 07 19  
(73) Les Laboratoires Servier (FR)  
35, rue de Verdun, 92284, Suresnes, France  
(FR)
- (72) MARSAS, Stéphanie (FR);  
PEAN, Jean-Manuel (FR)
- (74) Tamaz Shilakadze
- (54) PHARMACEUTICAL COMPOSITION  
IN FORM OF CHEWABLE TABLET  
OF DIOSMIN OR OF FLAVONOID  
MOIETY

**PART C**

(54) METHOD FOR HYDROMETALLURGI-  
CAL PROCESSING OF MANGANESE ORE  
ENRICHMENT WASTE

---

**C 07**

- (11) P 2023 7530 B (51) Int. Cl. (2006)  
C 07 D 295/205  
C 07 D 213/75
- (10) AP 2023 15463 A (44) 9(612)/2023
- (21) AP 2018 15463
- (22) 2018 06 29
- (24) 2018 06 29
- (62) AP 2018 15258 2018 06 29
- (31) 62/527,174; 62/664,363
- (32) 2017 06 30; 2018 04 30
- (33) US; US
- (86) PCT/US2018/040176 , 2018 06 29
- (73) Amgen Inc. (US)  
One Amgen Center Drive, Thousand Oaks, CA  
91320-1799, USA (US)
- (72) ROOSEN, Philipp (US);  
COSBIE, Andrew (US);  
NEERGUNDA, Archana (US);  
SHI, Xianqing (US);  
WANG, Fang (US);  
WU, Zufan (US);  
QUAN, Bin, Peter (US);  
CAILLE, Sebastien (US);  
QUASDORF, Kyle (US);  
GUAN, Lianxiu (US)
- (74) Shalva Gvaramadze
- (54) NEW INTERMEDIATES FOR OMECA-  
MTIV MECARBIL SYNTHESIS AND  
METHODS FOR PREPARATION  
THEREOF
- 

**C 22**

- (11) P 2023 7529 B (51) Int. Cl. (2006)  
C 22 B 47/00  
C 22 B 3/08
- (10) AP 2023 15638 A (44) 8(611)/2023
- (21) AP 2021 15638
- (22) 2021 05 24
- (24) 2021 05 24
- (73) Giorgi Sakhvadze (GE)  
Sayat-Nova St. 1, 0105, Tbilisi, Georgia (GE);  
Davit Sakhvadze (GE)  
Sayat-Nova St. 1, 0105, Tbilisi, Georgia (GE);  
Gigo Jandieri (GE)  
Vazisubani, I m/r, bld. 3, ap. 36, 0152, Tbilisi,  
Georgia (GE)
- (72) Giorgi Sakhvadze (GE);  
Davit Sakhvadze (GE);  
Gigo Jandieri (GE)
- (74) Giorgi Sakhvadze
-



---

**APPLICATION\*\*\*****PART E****E 21**

- (10) AP 2023 16300 A (51) E 21 B 43/295  
E 21 B 43/24  
E 21 B 43/243
- (43) 2023 08 25 №16
- (21) AP 2021 16300 (22) 2021 12 14
- (31) 63/127,754
- (32) 2020 12 18
- (33) US
- (71) Proton Technologies Inc. (CA)  
#300, 140 - 8 Ave SW, Calgary AB T2P 1B3,  
Canada (CA)
- (72) STREM, Grant D. (CA);  
GATES, Ian D. (CA);  
WANG, Jingyi (CA)
- (74) Shalva Gvaramadze
- (85) 2023 07 17
- (86) PCT/CA2021/051803, 2021 12 14
- (54) METHODS FOR REPURPOSING THERMAL  
HYDROCARBON RECOVERY OPERATIONS  
FOR SYNTHESIS GAS PRODUCTION
- (57) The methods for repurposing thermal hydrocarbon recovery operations where the reservoir, which has been previously treated with steam for hydrocarbon mobilization, is further treated with an oxidizer to induce one or more of thermal cracking (thermolysis), gasification, water-gas shift, and aquathermolysis reactions to generate synthesis gas within the reservoir, which synthesis gas or its constituent components can then be produced to surface.
-

---

# DESIGNS

## APPLICATION APPROVED FOR REGISTRATION

The decision can be appealed at the Chamber of Appeal of Sakpatenti within 3 months from the publication or at the Mtskheta District Court Administrative Cases Board (Address: №17, Samkhedro str., Mtskheta), within 1 month following the publication.

(10) AD 2023 1307 S (51) 02-02

(21) AD 2023 1307 (22) 2023 04 25

(28) 1

(71) Nana Avaliani (GE)

Temka, III m/r, Nishnianidze St. 35, ap. 15, 0197, Tbilisi, Georgia (GE)

(72) Nana Avaliani (GE)

(54) JEANS WITH DOUBLE FOLDS

(55)



1.1



1.2



1.3

## REGISTERED DESIGN

- (11) D 2023 976 S      (51) 08-05  
(10) AD 2023 1287 S    (44) 2023 05 10 №9  
(21) AD 2022 1287  
(22) 2022 12 08  
(24) 2022 12 08  
(28) 4  
(18) 2027 12 08  
(73) OLEJNIK, Jacek Lech (PL)  
51-217 Ramiszow 36 C, Poland (PL)  
(72) OLEJNIK, Jacek Lech (PL)  
(74) Shalva Gvaramadze (GE)  
(54) 1.-4. SPATULA [HAND TOOL FOR  
SURFACE TREATMENT]
-

## DESIGN REGISTERED ACCORDING TO THE ACCELERATED PROCEDURE

The decision can be appealed at the Chamber of Appeal of Sakpatenti within 3 months from the publication.

(11) D 2023 977 S (51) 20-01  
(21) AD 2023 1327 (22) 2023 07 20

(24) 2023 07 20

(28) 2

(18) 2028 07 20

(73) Nino Neilson (GE)

Tchabua Amirejibi Highway 1b, ap. 44, 0162, Tbilisi, Georgia (GE)

(72) Nino Neilson (GE)

(74) Davit Dzamukashvili (GE)

(54) 1.-2. DISPENSER WITH STAND

(55)

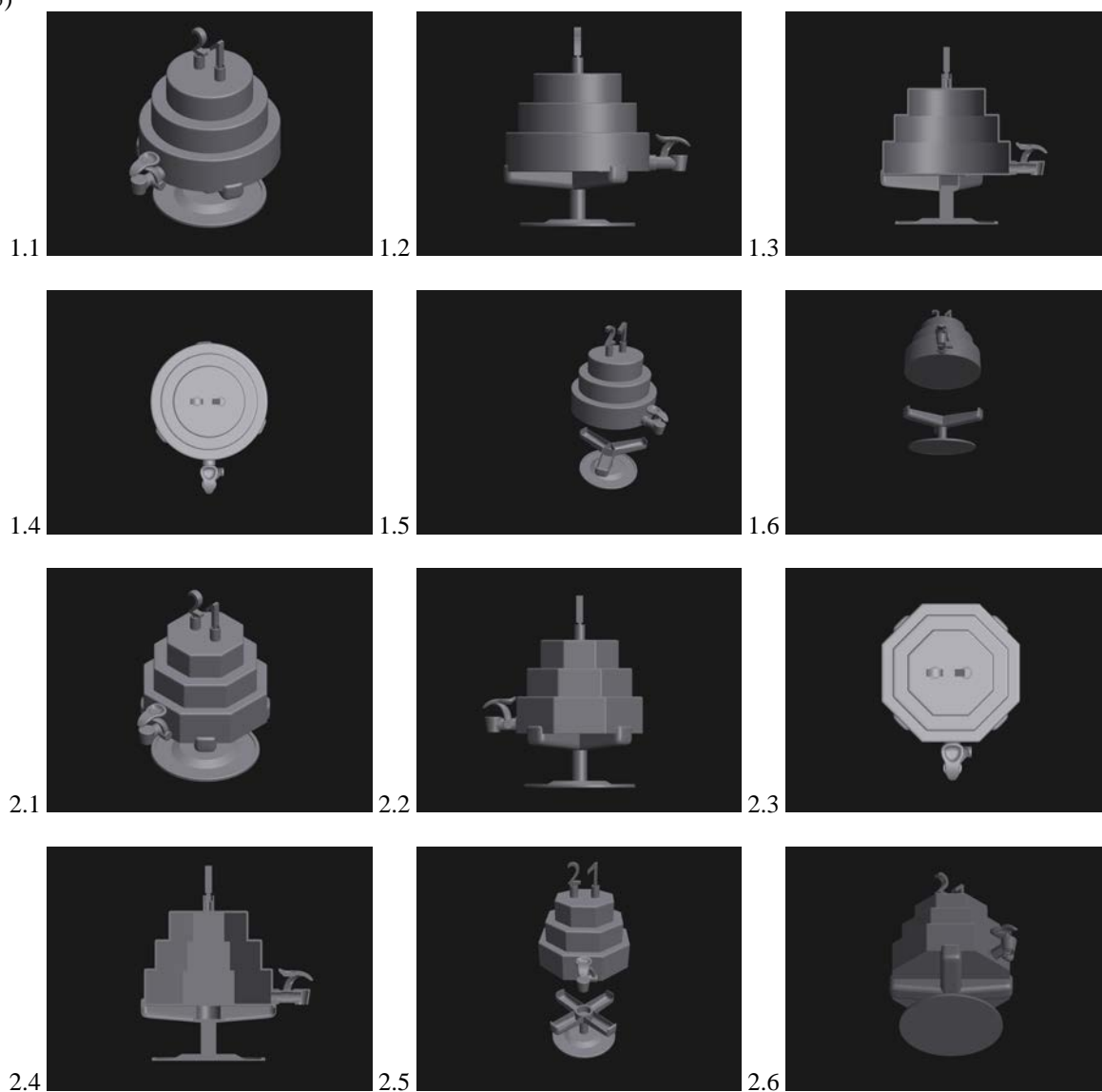

**DESIGNS, WHICH HAVE BEEN REGISTERED WITH THE INTERNATIONAL BUREAU CLAIMING PRIORITY ON THE TERRITORY OF GEORGIA**

The decision can be appealed at the Chamber of Appeal of Sakpatenti within 3 months from the publication or at the Mtskheta District Court Administrative Cases Board (Address: №17, Samkhedro St., Mtskheta), within 1 month following the publication.

- (11) DM/228 998 (51) 07-02  
(15) 2023 05 09 (44) 21/2023 (2023 05 26)  
(22) 2023 05 09  
(28) 1  
(73) Silverline Endustri ve Ticaret Anonim Sirketi  
Organize Sanayi B. Ankara Asfalti Uzeri Y/ Merzifon Amasya (Tr)  
(85) TR  
(86) TR  
(87) TR  
(88) TR  
(89) TR  
(81) III. GE, TR, EM, AZ, TM  
(72) Cihan PEÇENEK  
İspirli Canip sokak Albayrak apt. No:30 D:4 İçerenköy Ataşehir İstanbul, İstanbul (TR)  
(74) Ankara Patent Bureau  
Mustafa Kemal Mahallesi Dumlupınar Bulvarı Eskişehir Yolu 9.km No:274/7 B Blok  
14. Kat No:161 Çankaya Ankara (TR)  
(46) 2023 06 26  
(54) 1. BAKING SHEET BASE  
(55)

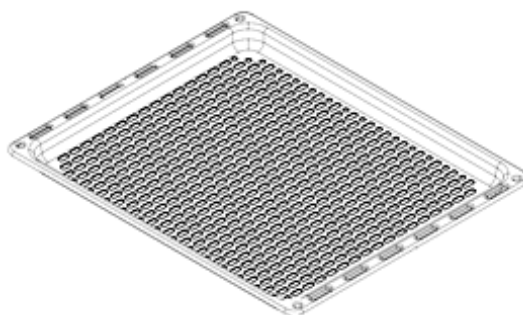

1.1

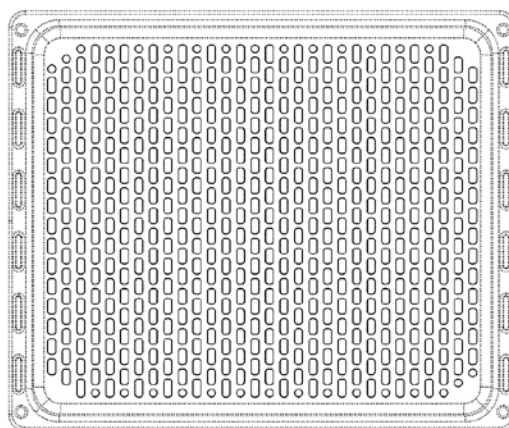

1.2

- (11) DM/225 751 (51) 11-01  
 (15) 2022 11 28 (44) 22/2023 (2023 06 02)  
 (22) 2022 11 28  
 (28) 3  
 (73) Harry Winston SA  
 Chemin Du Tourbillon 8, 1228 Plan-les-Ouates (CH)  
 (85) CH  
 (86) CH  
 (87) CH  
 (88) CH  
 (89) CH  
 (81) III. KG, LI, CA, GE, MK, OM, TR, BA, MN, NO, CH, EM, AL, UA, AM, MA, SG, MC, MD, ME, BZ,  
 AZ, TN, GB  
 (72) 1 Christina YANG  
 C/o Harry Winston Inc. 718 Fifth Avenue, 10019, New York (US);  
 2-3 Rie YATSUGI-KANG  
 C/o Harry Winston Inc. 718 Fifth Avenue, 10019, New York (US)  
 (74) The Swatch Group AG (The Swatch Group SA) (The Swatch Group Ltd.)  
 Faubourg Du Lac 6, 2501 Biel/Bienne (CH)  
 (46) 2023 06 02  
 (54) 1. PAIR OF EARRINGS, 2. FINGER RING, 3. BROOCH  
 (55)



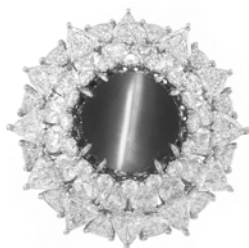

2.1



2.2



2.3



2.4



2.5



2.6



2.7



2.8



3.1



3.2



3.3



3.4



3.5



3.6



3.7



3.8

---



(11) DM/229 350 (51) 10-07  
 (15) 2023 05 31 (44) 24/2023 (2023 06 16)

(22) 2023 05 31

(28) 1

(30) No1: 14.03.2023; 2023-00140; CH

(73) Rolex SA  
 rue François-Dussaud 3-5-7, 1211 Genève 26 (CH)

(85) CH

(86) CH

(87) CH

(88) CH

(89) CH

(81) III. GE, CA, OM, NO, RS, RW, MU, EM, AM, BW, TJ, MD, VN, TN, SR, MN, JP, KR, UA, OA, MA, ME, AZ, SM, KG, WS, LI, MK, BA, EG, JM, RU, IS, BY, GB, KH, TR, ST, GH, IL, KP, MX, AL, BN, NA, SG, MC, BZ, TM

(72) Giovanni SICILIANO  
 9, Chemin Docteur-Adolphe Pasteur, 1209, Genève (CH)

(74) Bugnion S.A.  
 10, route de Florissant, Case Postale 375, 1211 Genève 12 (CH)

(46) 2023 06 16

(54) 1. WATCH BEZEL

(55)

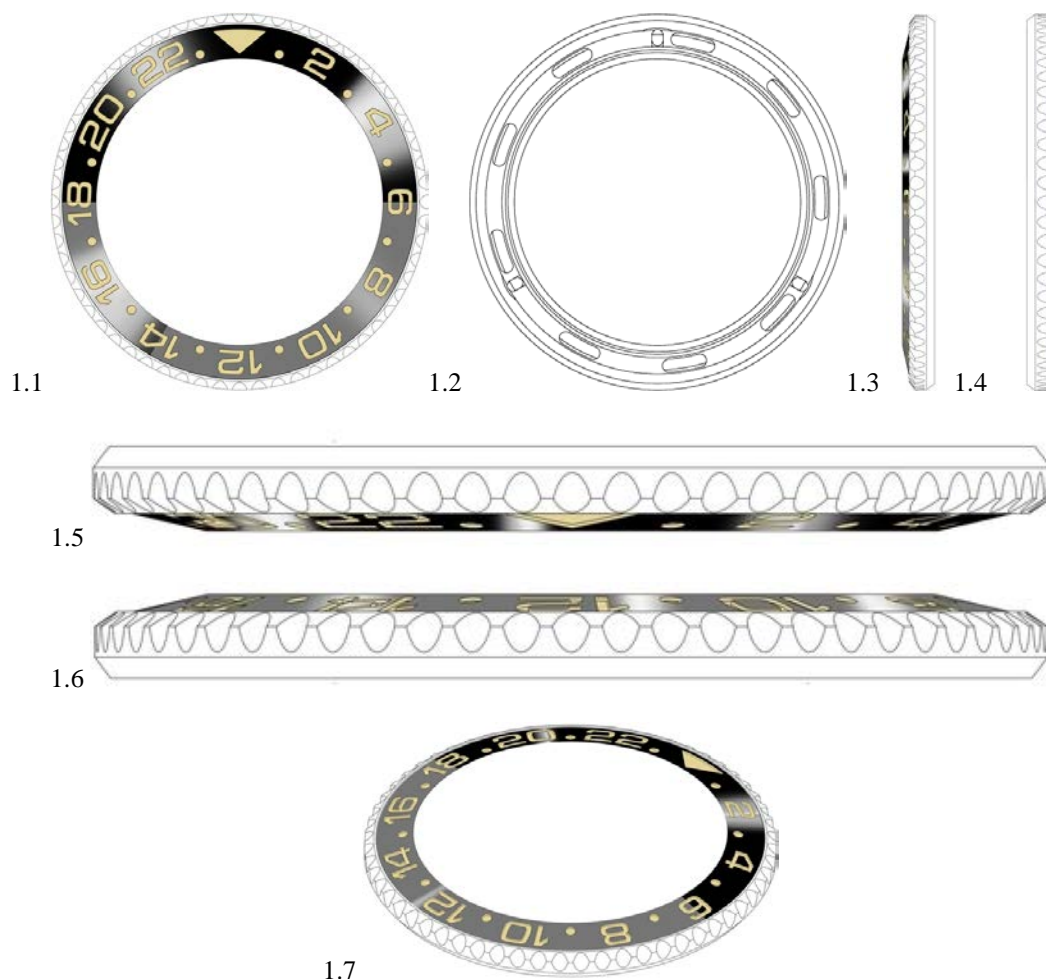

- (11) DM/229 351 (51) 10-07
- (15) 2023 05 17 (44) 24/2023 (2023 06 16)
- (22) 2023 05 17
- (28) 1
- (30) No1: 14.03.2023; 2023-00143; CH
- (73) Rolex SA  
rue François-Dussaud 3-5-7, 1211 Genève 26 (CH)
- (85) CH
- (86) CH
- (87) CH
- (88) CH
- (89) CH
- (81) III. GE, OM, CA, NO, RS, RW, MU, EM, AM, BW, TJ, MD, VN, TN, SR, MN, JP, KR, UA, OA, MA, ME, AZ, SM, KG, WS, LI, MK, BA, EG, JM, RU, IS, BY, GB, KH, TR, ST, GH, IL, KP, MX, AL, BN, NA, SG, MC, BZ, TM
- (72) Michele LA MAZZA  
rue du Ronzier 13, 1260, Nyon (CH)
- (74) Bugnion S.A.  
10, route de Florissant, Case Postale 375, 1211 Genève 12 (CH)
- (46) 2023 06 16
- (54) I. WATCH DIAL
- (55)



(11) DM/229 353 (51) 10-07  
 (15) 2023 05 17 (44) 24/2023 (2023 06 16)  
 (22) 2023 05 17

(28) 1  
 (30) No1: 14.03.2023; 2023-00142; CH

(73) Rolex SA  
 rue François-Dussaud 3-5-7, 1211 Genève 26 (CH)

(85) CH

(86) CH

(87) CH

(88) CH

(89) CH

(81) III. GE, OM, CA, NO, RS, RW, MU, EM, AM, BW, TJ, MD, VN, TN, SR, MN, JP, KR, UA, OA, MA, ME, AZ, SM, KG, WS, LI, MK, BA, EG, JM, RU, IS, BY, GB, KH, TR, ST, GH, IL, KP, MX, AL, BN, NA, SG, MC, BZ, TM

(72) Michele LA MAZZA  
 rue du Ronzier 13, 1260, Nyon (CH)

(74) Bugnion S.A.  
 10, route de Florissant, Case Postale 375, 1211 Genève 12 (CH)

(46) 2023 06 16

(54) 1. WATCH DIAL

(55)

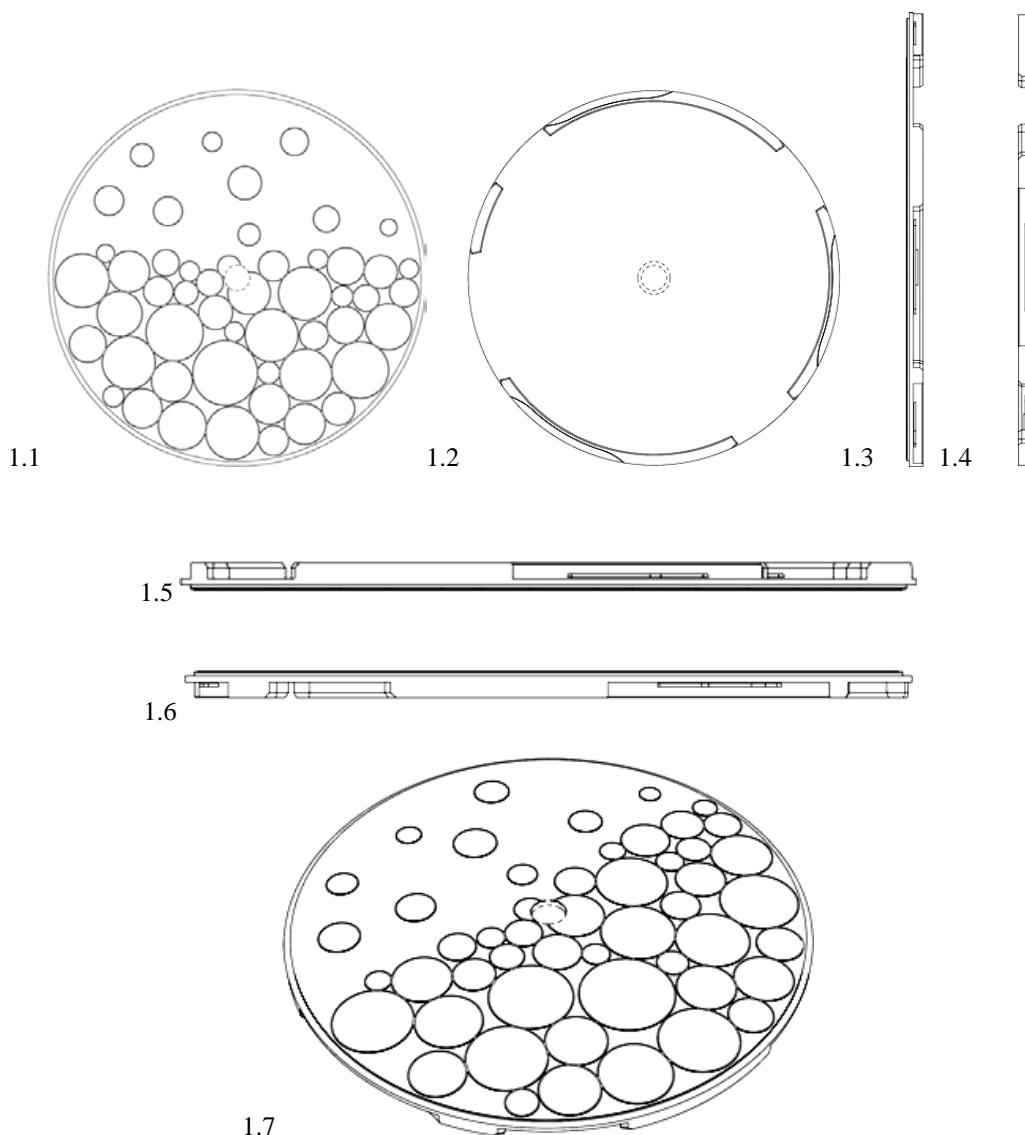

- (11) DM/229 687                      (51) 25-03
- (15) 2023 04 12                      (44) 25/2023 (2023 06 23)
- (22) 2023 04 12
- (28) 2
- (30) No1: 28.02.2023; 2023300788414; CN; No2: 28.02.2023; 2023300788414; CN
- (73) Foshan Alpicool Technology Co.,Ltd.  
       No. 4-5, Xinye 3rd Road, Lingang Pioneer Park, Shunjiang Community, Beijiao Town, Shunde District,  
       528000 Foshan, Guangdong (CN)
- (85) CN
- (86) CN
- (87) CN
- (88) CN
- (89) CN
- (81) III. KG, WS, LI, OM, CA, GE, MK, BA, NO, RS, EG, RU, JM, RW, SY, IS, AM, BW, TJ, BY, MD, VN, TN,  
       KH, TR, SR, GH, MN, ST, IL, CH, JP, KR, MX, BN, UA, OA, NA, SG, MA, BX, MC, BZ, ME, TM, AZ, SM
- (72) Tongying Wang  
       No. 4-5, Xinye 3rd Road, Lingang Pioneer Park, Shunjiang Community, Beijiao Town, Shunde Distric,  
       Foshan, Guangdong (CN);  
       Shengming He  
       No. 4-5, Xinye 3rd Road, Lingang Pioneer Park, Shunjiang Community, Beijiao Town, Shunde Distric,  
       528000, Foshan, Guangdong (CN)
- (46) 2023 06 23
- (54) 1.-2. PREFABRICATED HOUSE
- (55)

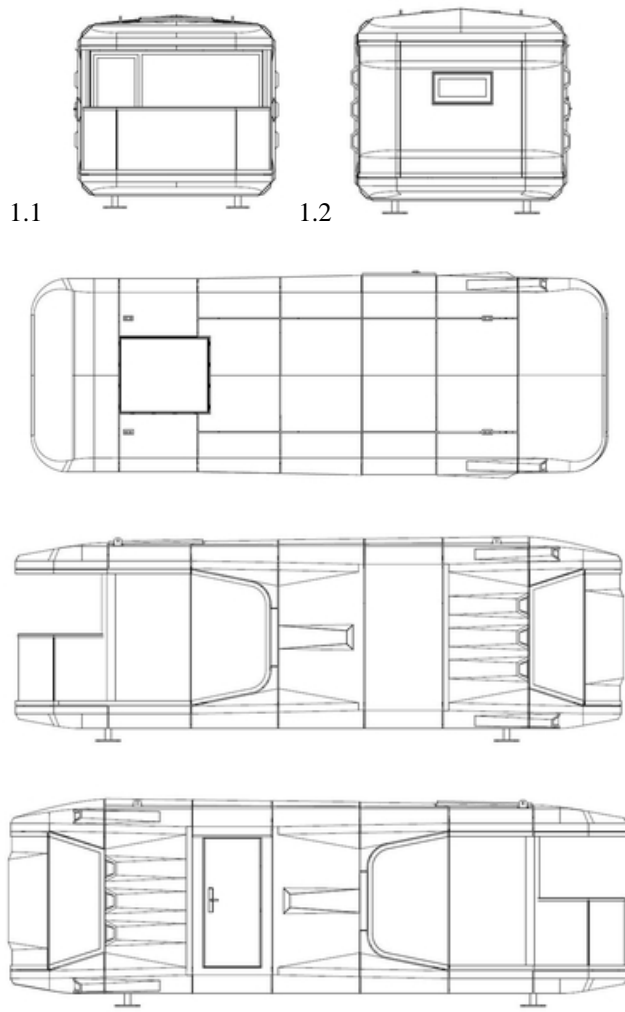

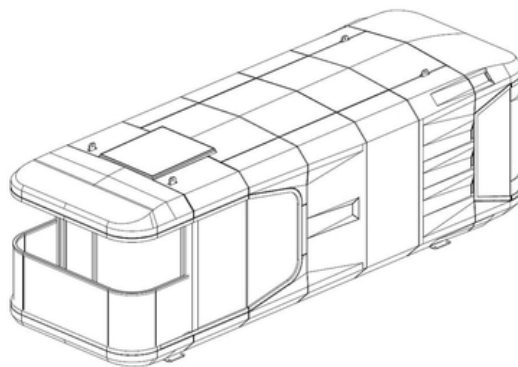

1.6



2.1



2.2

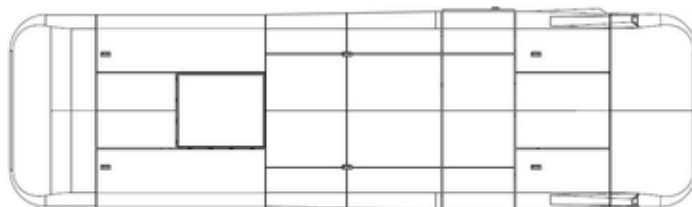

2.3

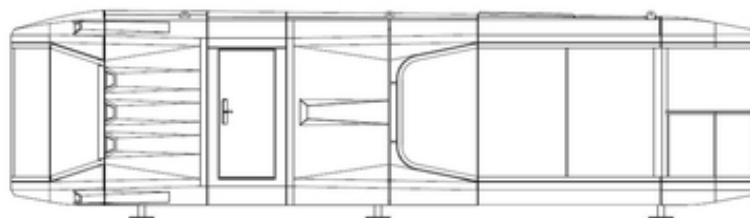

2.4

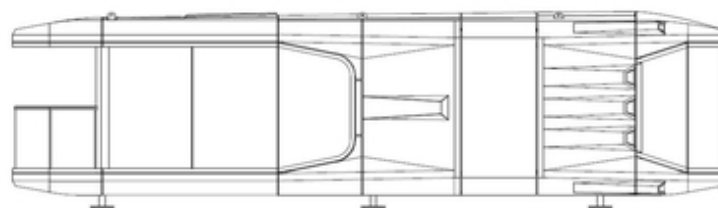

2.5

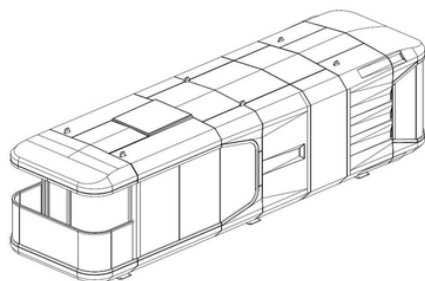

2.6

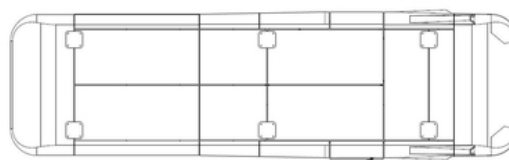

2.7

- (11) DM/229 688                      (51) 25-03
- (15) 2023 04 12                      (44) 25/2023 (2023 06 23)
- (22) 2023 04 12
- (28) 2
- (73) Foshan Alpicool Technology Co., Ltd.  
       No. 4-5, Xinye 3rd Road, Lingang Pioneer Park, Shunjiang Community, Beijiao Town, Shunde District,  
       528000 Foshan, Guangdong (CN)
- (85) CN
- (86) CN
- (87) CN
- (88) CN
- (89) CN
- (81) III. WS, LI, OM, MK, GE, BA, EG, JM, RW, SY, IS, AM, BW, BY, MD, VN, TN, KH, SR, GH, ST, MX,  
       UA, BN, OA, NA, SG, MA, BX, MC, BZ, ME, AZ, SM
- (72) Pizhi Zhao  
       No. 4-5, Xinye 3rd Road, Lingang Pioneer Park, Shunjiang Community, Beijiao Town, Shunde District,  
       528000, Foshan, Guangdong (CN);  
       Junjie Qin  
       No. 4-5, Xinye 3rd Road, Lingang Pioneer Park, Shunjiang Community, Beijiao Town, Shunde District,  
       528000, Foshan, Guangdong (CN)
- (46) 2023 06 23
- (54) 1.-2. PREFABRICATED HOUSE
- (55)

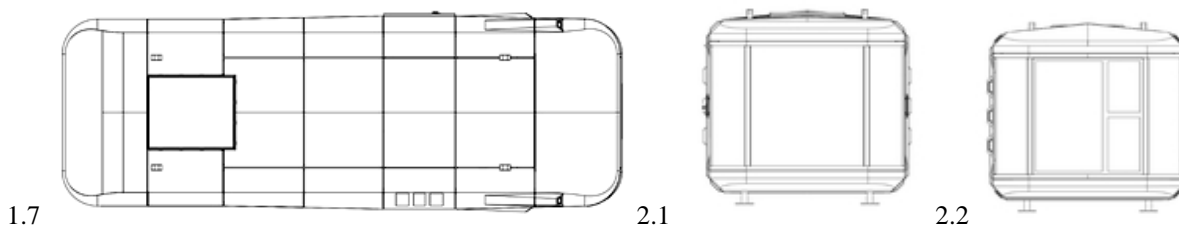
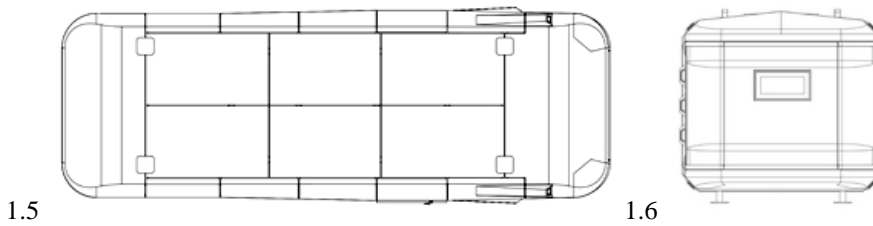
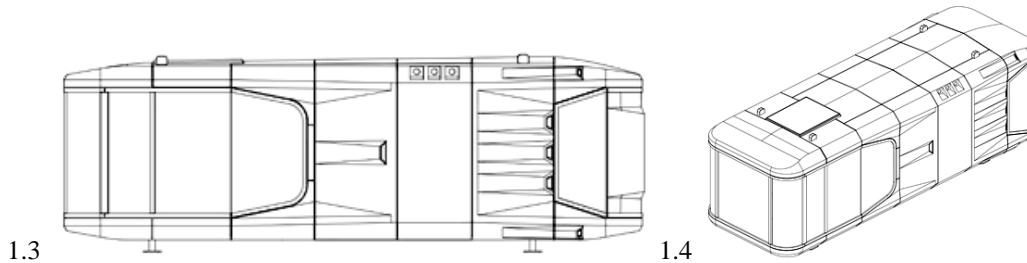
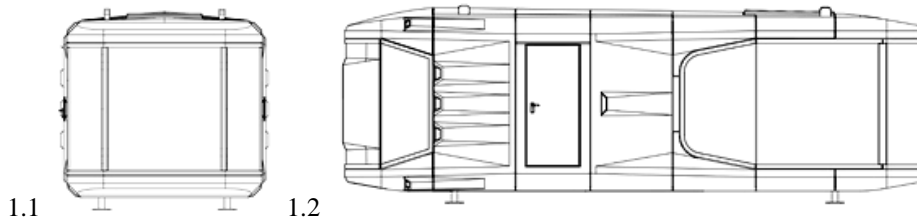

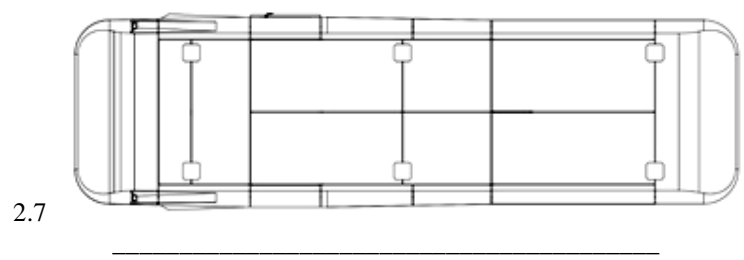
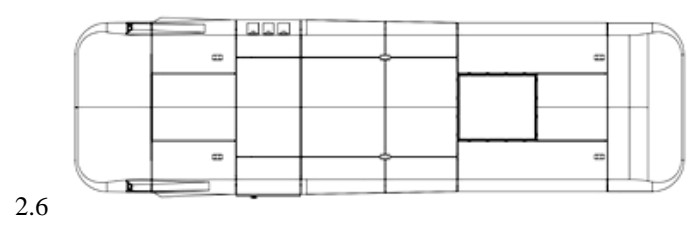
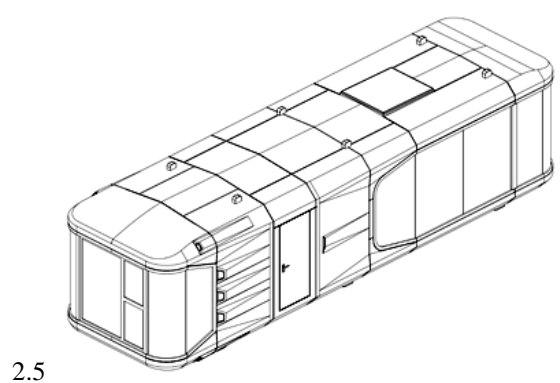
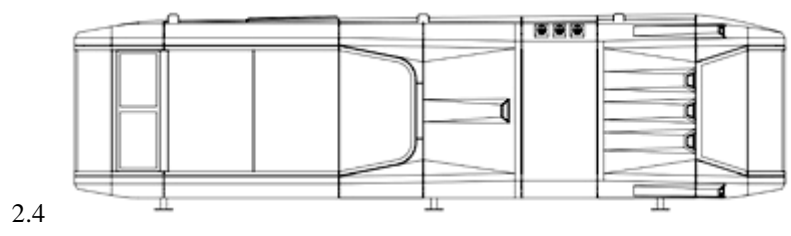
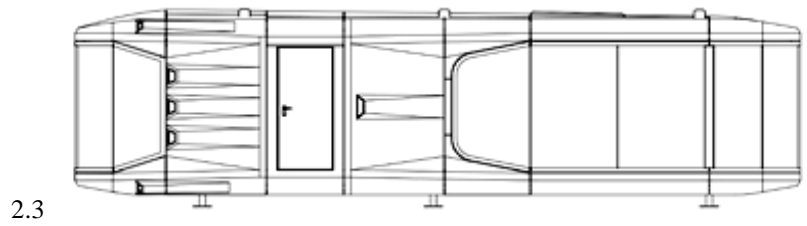

- (11) DM/229 689                   (51) 25-03
- (15) 2023 04 12                   (44) 25/2023 (2023 06 23)
- (22) 2023 04 12
- (28) 2
- (73) Foshan Alpicool Technology Co., Ltd.  
No. 4-5, Xinye 3rd Road, Lingang Pioneer Park, Shunjiang Community, Beijiao Town, Shunde District,  
528000 Foshan, Guangdong (CN)
- (85) CN
- (86) CN
- (87) CN
- (88) CN
- (89) CN
- (81) III. WS, LI, OM, MK, GE, CA, BA, RS, EG, JM, RW, SY, IS, AM, BW, MD, BY, VN, TN, KH, SR, GH,  
MN, ST, MX, UA, BN, OA, NA, SG, MA, MC, BX, ME, BZ, AZ, TM, SM
- (72) Pizhi Zhao  
No. 4-5, Xinye 3rd Road, Lingang Pioneer Park, Shunjiang Community, Beijiao Town, Shunde District,  
528000, Foshan, Guangdong (CN);  
Junjie Qin  
No. 4-5, Xinye 3rd Road, Lingang Pioneer Park, Shunjiang Community, Beijiao Town, Shunde District,  
528000, Foshan, Guangdong (CN)
- (46) 2023 06 23
- (54) 1.-2. PREFABRICATED HOUSE
- (55)

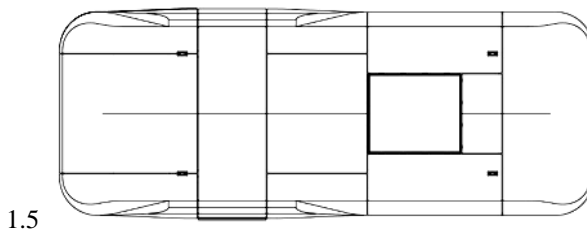
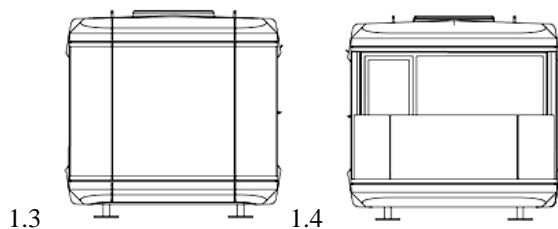
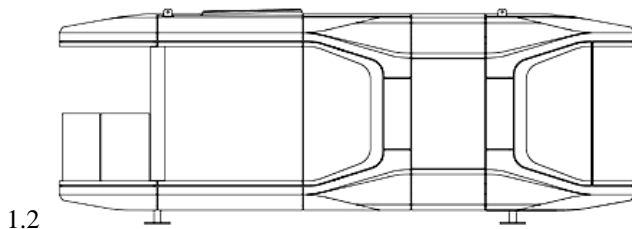
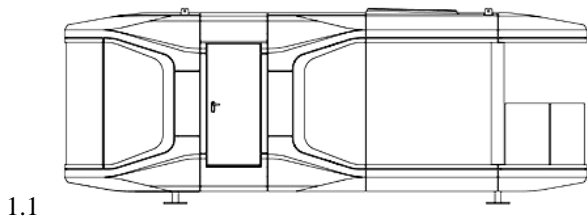



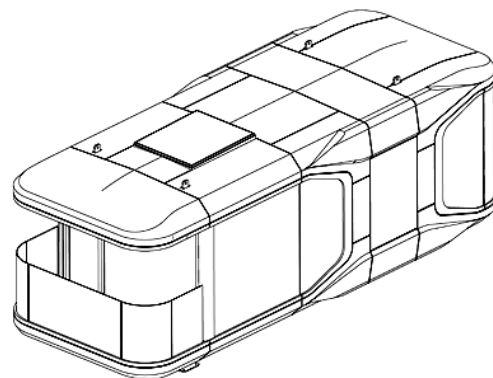

1.6

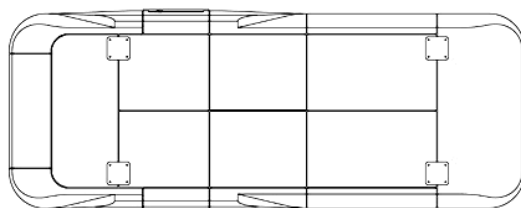

1.7

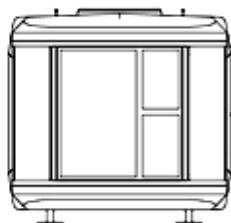

2.1

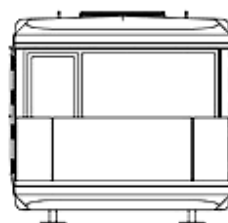

2.2

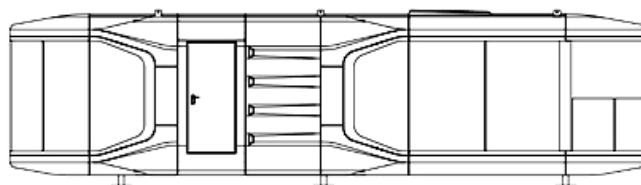

2.3

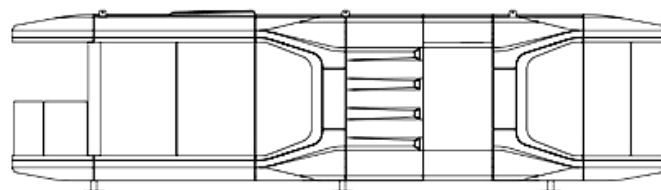

2.4

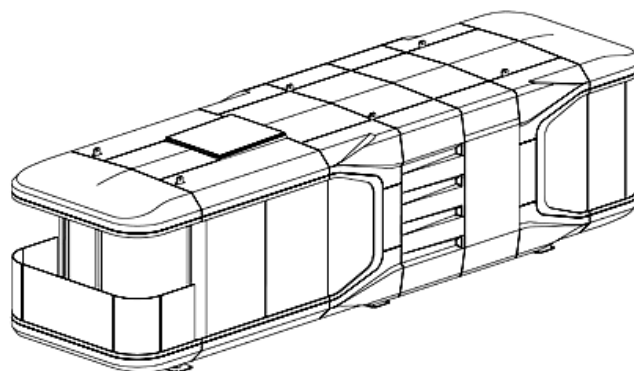

2.5

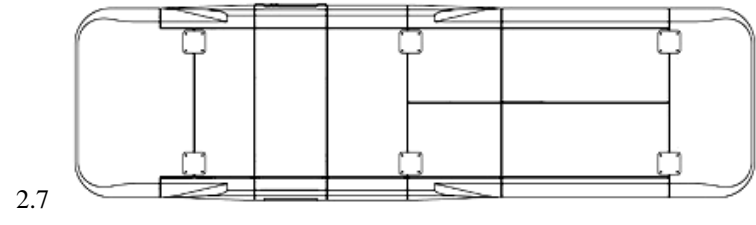
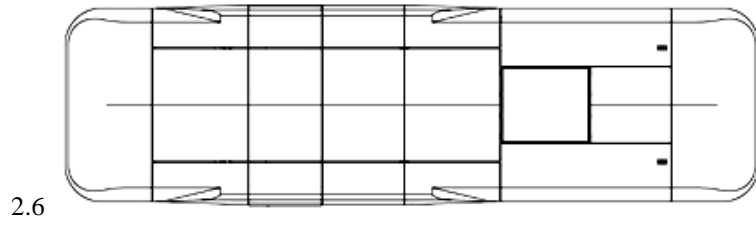

- (11) DM/229 742 (51) 10-07  
 (15) 2023 06 16 (44) 26/2023 (2023 06 30)  
 (22) 2023 06 16  
 (28) 1  
 (30) No1: 20.03.2022; 2023-00168; CH  
 (73) Rolex SA  
 rue François-Dussaud 3-5-7, 1211 Genève 26 (CH)  
 (85) CH  
 (86) CH  
 (87) CH  
 (88) CH  
 (89) CH  
 (81) III. GE, CA, OM, NO, RS, RW, SY, MU, EM, AM, BW, TJ, MD, VN, TN, SR, MN, JP, KR, UA, OA, MA,  
 ME, AZ, SM, WS, KG, LI, MK, BA, EG, JM, RU, IS, BY, GB, KH, TR, GH, ST, IL, KP, MX, AL, BN, NA,  
 SG, MC, BZ, TM  
 (72) Giovanni SICILIANO  
 9, Chemin Docteur-Adolphe Pasteur, 1209, Genève (CH)  
 (74) Bugnion SA  
 10, route de Florissant, Case Postale 375, 1211 Genève 12 (CH)  
 (46) 2023 06 30  
 (54) 1. WATCH DIAL  
 (55)



1.1

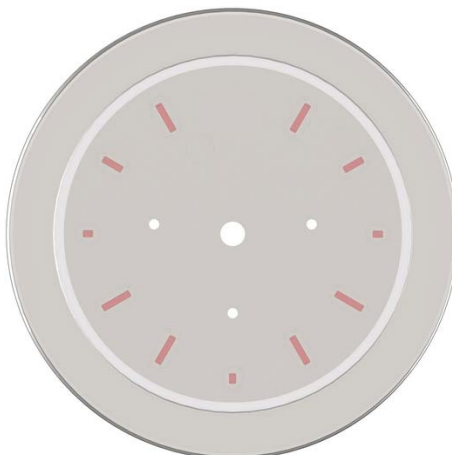

1.2



1.3

1.4



1.5



1.6



1.7

---

# TRADEMARKS

## APPLICATIONS FILED UNDER THE NATIONAL PROCEDURE APPROVED FOR REGISTRATION

The decision can be appealed at the Chamber of Appeal of Sakpatenti within 3 months from the publication or at the Mtskheta District Court Administrative Cases Board (Address: №17, Samkhedro St., Mtskheta), within 1 month following the publication.

(260) AM 2023 112294 A  
(210) AM 112294  
(220) 2021 03 24  
(731) LLC "Ice-Co Company"  
Abovyan St. 7, 0105, Tbilisi, Georgia  
(740) Giorgi Taktakishvili  
(540)

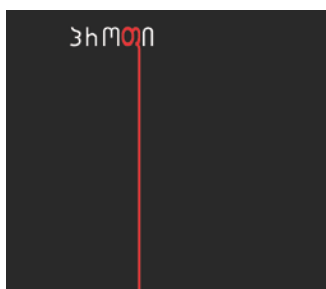

(591) Red, black, white  
(531) 26.04.22; 26.04.24; 28.19; 29.01.13  
(511) 3

---

(260) AM 2023 112295 A  
(210) AM 112295  
(220) 2021 03 24  
(731) LLC "Ice-Co Company"  
Abovyan St. 7, 0105, Tbilisi, Georgia  
(740) Giorgi Taktakishvili  
(540)



(591) Black-white  
(531) 18.01.09; 28.19  
(511) 3

---

(260) AM 2023 120614 A  
(210) AM 120614  
(220) 2022 12 05  
(731) Hill's Pet Nutrition, Inc.  
A Delaware Corporation  
400 SW Eighth Avenue, Topeka, Kansas,  
66603, USA  
(740) Tamaz Shilakadze

(540)



(591) Black, white, red, blue  
(531) 26.04.09; 26.11.02; 26.11.05; 26.11.12;  
27.05.01; 27.05.17; 29.01.14  
(511) 31

---

(260) AM 2023 120631 A  
(210) AM 120631  
(220) 2022 12 08  
(731) British American Tobacco (Brands) Limited  
Globe House, 4 Temple Place, London, WC2R  
2PG, United Kingdom  
(740) Tamar Kotchlamazashvili  
(540)



(591) Black-white  
(531) 26.01.12; 26.01.22; 27.05.01  
(511) 34

---

(260) AM 2023 120698 A  
(210) AM 120698  
(220) 2022 12 09  
(731) LTD "Radius"  
Nikoloz Berdzenishvili St. 4, Entrance Hall 2,  
floor 5, ap. 27, 0179, Vake District, Tbilisi,  
Georgia

(540)

**OTIUM**  
**ოტიუმი**

(591) Black-white  
 (511) 35, 36, 37

(260) AM 2023 120717 A  
 (210) AM 120717  
 (220) 2022 12 13  
 (731) The William Carter Company  
 3438 Peachtree Road NE, Suite 1800, Atlanta,  
 GA 30326, USA  
 (740) Giorgi Taktakishvili  
 (540)

**SWEET REWARDS**

(591) Black-white  
 (511) 35

(260) AM 2023 120811 A  
 (210) AM 120811  
 (220) 2022 12 16  
 (731) LTD "Ana"  
 Vill. Dighomi, I. Sheklashvili I Lane, House 3,  
 Saburtalo District, Tbilisi, Georgia  
 (540)



(591) Red, yellow, green, orange  
 (531) 05.05.16; 27.05.01; 29.01.14  
 (511) 31, 35, 44

(260) AM 2023 120817 A  
 (210) AM 120817  
 (220) 2022 12 19  
 (731) Tornike Meshveliani  
 Freedom St. 24, Zahesi, Tbilisi, Georgia  
 (540)



(591) White, sky-blue, black

(531) 10.03.10; 10.03.11; 10.03.12; 10.03.13;  
 27.05.01; 27.05.10; 29.01.13  
 (511) 35

(260) AM 2023 120822 A  
 (210) AM 120822  
 (220) 2022 12 19  
 (731) Ruslan Bokelovadze  
 Patsaev Av. 18, ap. 1, Moscow Region,  
 Dolgoprudniy Settlement, Russian Federation  
 (740) Shalva Giorgadze  
 (540)



(591) Black-white  
 (531) 03.01.08; 11.03.02; 27.05.01  
 (511) 1, 30, 31, 32, 33, 35, 39, 40, 41, 43, 44

(260) AM 2023 120848 A  
 (210) AM 120848  
 (220) 2022 12 21  
 (731) Western Union Holdings Inc.  
 7001 East Belleview Avenue, Denver, Colorado  
 80237, USA  
 (740) Pavle Meipariani  
 (540)

**WESTERN UNION**

(591) Black-white  
 (511) 36

(260) AM 2023 120945 A  
 (210) AM 120945  
 (220) 2022 12 27  
 (731) Tornike Chomakhidze  
 Vazha-Pshavela Av., II qu., bld. 3, ap. 43, 0186,  
 Tbilisi, Georgia  
 (540)



(591) Golden, white, black  
 (531) 26.01.01; 26.01.03; 26.01.18; 26.01.21;  
 26.11.12; 27.05.02; 29.01.13  
 (511) 35, 41, 43

(260) AM 2023 120960 A  
 (210) AM 120960  
 (220) 2022 12 29  
 (731) Bifinity UAB (Lithuania)  
 Lvivo g. 25-104, LT-09320 Vilnius, Lithuania  
 (740) Tamaz Shilakadze  
 (540)

**BIFINITY**

(591) Black-white  
 (511) 9, 35, 36, 41, 42

(260) AM 2023 120961 A  
 (210) AM 120961  
 (220) 2022 12 29  
 (731) Bifinity UAB (Lithuania)  
 Lvivo g. 25-104, LT-09320 Vilnius, Lithuania  
 (740) Tamaz Shilakadze  
 (540)



(591) Black-white  
 (531) 26.01.02; 26.01.06  
 (511) 9, 35, 36, 41, 42

(260) AM 2023 121040 A  
 (210) AM 121040  
 (220) 2022 12 30  
 (731) Seara Alimentos LTDA.  
 Av. Marginal Direita do Tietê, 500 – Bloco II –  
 Subsolo – Sala 13, Vila Jaguará 05118-100  
 São Paulo – SP, Brazil  
 (740) Tamaz Shilakadze  
 (540)

**MABELLA**

(591) Black-white  
 (511) 29

(260) AM 2023 121052 A  
 (210) AM 121052  
 (220) 2023 01 05  
 (310) 018729071  
 (320) 2022 07 05  
 (330) EUIPO  
 (731) NR Class 3, LLC  
 300 West 23rd Street, PH-B, New York New  
 York 10011, USA  
 (740) Liliana Darakhvelidze  
 (540)

**ALL OF ME**

(591) Black-white  
 (511) 3

(260) AM 2023 121129 A  
 (210) AM 121129  
 (220) 2023 01 10  
 (731) Alikutty Thaikadappuram Hamza Koya  
 Thaikadappuram  
 Alkhail Gate 1-5(608), Alquoz Industrial Area  
 №02, Dubai, 28005, United Arab Emirates  
 (740) Nino Gazdeliani  
 (540)



**Newcastle**

(591) Black-white  
 (531) 24.01.11; 24.01.15; 27.05.04  
 (511) 34

(260) AM 2023 121142 A  
 (210) AM 121142  
 (220) 2023 01 11  
 (731) Sayali Musaeva  
 Vill. Nazarlo, 1322, Gardabani, Georgia  
 (540)



(591) Light green, dark green, white  
 (531) 03.01.15; 27.05.01; 29.01.03  
 (511) 10, 12, 18, 20, 24, 25, 26, 35

(260) AM 2023 121155 A  
 (210) AM 121155  
 (220) 2023 01 12  
 (731) Basilur Tea Exports (PVT) LTD.  
 (A Limited Liability Company Incorporated  
 Under the Laws of Sri Lanka)  
 143/6, Weediyabandara Mawatha, Kelanimulla,  
 Angoda, Sri Lanka  
 (740) Giorgi Kartvelishvili  
 (540)



(591) White, blue, dark blue, dark brown, brown, red

(531) 03.02.03; 24.01.03; 24.01.05; 24.01.15;  
24.09.02; 24.09.10; 26.04.02; 26.04.22;  
26.04.24; 26.11.08; 29.01.14  
(511) 30

(260) AM 2023 121242 A  
(210) AM 121242  
(220) 2023 01 18  
(731) LTD "G M Pharmaceuticals"  
Rustavi Highway 52, 0114, Tbilisi, Georgia  
(740) Nugzar Ksovrelidze  
(540)

აპიკვისი  
АПИКВИС  
Ariquis

(591) Black-white  
(511) 5

(260) AM 2023 121307 A  
(210) AM 121307  
(220) 2023 01 20  
(731) LTD "KTW Development"  
Sulkhan Tsintsadze St. 12, Area 3-6, 0160,  
Tbilisi Georgia  
(540)

  
DEVELOPMENT

(591) Black-white  
(531) 26.04.04; 26.04.09; 26.04.18; 26.04.24;  
26.11.09; 27.05.01  
(511) 36

(260) AM 2023 121503 A  
(210) AM 121503  
(220) 2023 02 03  
(731) Al Muqarram Insulation Material Industry LLC  
Industrial Area 15, Sharjah, PO Box 24756,  
United Arab Emirates  
(740) Giorgi Kartvelishvili  
(540)



(591) Blue, white, light grey  
(531) 03.09.04; 24.01.09; 24.01.15; 26.05.01;  
26.05.15; 26.05.22; 26.05.24; 27.05.01;  
27.05.24; 29.01.12  
(511) 1, 2, 17

(260) AM 2023 121524 A  
(210) AM 121524  
(220) 2023 02 07  
(731) Davit Shamiladze  
Mehmed Abashidze St. 56, ap. 19, Batumi,  
Georgia  
(740) Giorgi Taktakishvili  
(540)



(591) Red, yellow, green, pink, lilac, orange, green,  
blue, black  
(531) 10.03.10; 10.03.11; 10.03.13; 19.07.01;  
26.04.05; 26.04.22; 26.04.24; 27.05.01;  
27.05.24; 29.01.15  
(511) 35

---

**REGISTERED TRADEMARKS**

(111) M 2023 37179 R  
(151) 2023 08 04  
(181) 2033 08 04  
(260) AM 2022 119179 A  
(220) 2022 08 26  
(732) RCN Televisión S.A.  
Av. De Las Americas No. 65- 82, Bogota D.C.,  
Colombia

---

(111) M 2023 37180 R  
(151) 2023 08 04  
(181) 2033 08 04  
(260) AM 2022 119180 A  
(220) 2022 08 26  
(732) RCN Televisión S.A.  
Av. De Las Americas No. 65- 82, Bogota D.C.,  
Colombia

---

(111) M 2023 37186 R  
(151) 2023 08 15  
(181) 2033 08 15  
(260) AM 2022 119700 A  
(220) 2022 10 05  
(732) Utex Industries Inc.  
10810 Katy Freeway, Suite 100, Houston,  
Texas, 77043, USA

---

(111) M 2023 37187 R  
(151) 2023 08 15  
(181) 2033 08 15  
(260) AM 2022 119698 A  
(220) 2022 10 05  
(732) Utex Industries Inc.  
10810 Katy Freeway, Suite 100, Houston,  
Texas, 77043, USA

---

(111) M 2023 37188 R  
(151) 2023 08 15  
(181) 2033 08 15  
(260) AM 2022 119678 A  
(220) 2022 09 30  
(732) LLC "Geo Olimp"  
Rapiel Eristavi St. 16, Tbilisi, Georgia

---

(111) M 2023 37189 R  
(151) 2023 08 15  
(181) 2033 08 15  
(260) AM 2022 119677 A  
(220) 2022 09 30  
(732) LLC "Geo Olimp"  
Rapiel Eristavi St. 16, Tbilisi, Georgia

---

(111) M 2023 37190 R  
(151) 2023 08 15  
(181) 2033 08 15  
(260) AM 2022 119609 A  
(220) 2022 09 28  
(732) LLC "Pay Unicard"  
Vazha-Pshavela Av. 71, fl. 3, 0180, Tbilisi,  
Georgia

---

(111) M 2023 37191 R  
(151) 2023 08 15  
(181) 2033 08 15  
(260) AM 2022 119603 A  
(220) 2022 09 27  
(732) LLC "Pay Unicard"  
Vazha-Pshavela Av. 71, fl. 3, 0180, Tbilisi,  
Georgia

---

(111) M 2023 37192 R  
(151) 2023 08 15  
(181) 2033 08 15  
(260) AM 2022 119602 A  
(220) 2022 09 27  
(732) LLC "Pay Unicard"  
Vazha-Pshavela Av. 71, floor 3, 0180, Tbilisi,  
Georgia

---

(111) M 2023 37193 R  
(151) 2023 08 15  
(181) 2033 08 15  
(260) AM 2022 119601 A  
(220) 2022 09 27  
(732) LLC "Pay Unicard"  
Vazha-Pshavela Av. 71, floor 3, 0180, Tbilisi,  
Georgia

---

(111) M 2023 37194 R  
(151) 2023 08 15  
(181) 2033 08 15  
(260) AM 2022 119600 A  
(220) 2022 09 27  
(732) LLC "Pay Unicard"  
Vazha-Pshavela Av. 71, fl. 3, 0180, Tbilisi,  
Georgia

---

(111) M 2023 37195 R  
(151) 2023 08 15  
(181) 2033 08 15  
(260) AM 2022 119599 A  
(220) 2022 09 27  
(732) LLC "Pay Unicard"

---



---

Vazha-Pshavela Av. 71, fl. 3, 0180, Tbilisi,  
Georgia

---

(111) M 2023 37196 R  
(151) 2023 08 15  
(181) 2033 08 15  
(260) AM 2022 119499 A  
(220) 2022 09 21  
(732) Unitek International Group Limited  
Flat/Room 02, 16/F Enterprise Square III, 39  
Wang Chiu Road, Kowloon Bay, Kowloon,  
Hong Kong

---

(111) M 2023 37197 R  
(151) 2023 08 15  
(181) 2033 08 15  
(260) AM 2022 119364 A  
(220) 2022 09 14  
(732) The News Hub Limited  
Office at 10th Floor, Building 7 Chiswick Park,  
566 Chiswick High Road, London, W4 5YG,  
United Kingdom

---

(111) M 2023 37198 R  
(151) 2023 08 15  
(181) 2033 08 15  
(260) AM 2022 119355 A  
(220) 2022 09 12  
(732) LLC "May 2020"  
Vill. Natakhtari, next to the Main Channel,  
729, 3300, Mtskheta Region, Mtskheta,  
Georgia

---

(111) M 2023 37199 R  
(151) 2023 08 15  
(181) 2033 08 15  
(260) AM 2022 119288 A  
(220) 2022 09 07  
(732) Zaza Datukishvili  
17 Shindiseli Heroi St. 4, Tbilisi, Georgia

---

(111) M 2023 37200 R  
(151) 2023 08 15  
(181) 2033 08 15  
(260) AM 2022 119211 A  
(220) 2022 09 01  
(732) LTD "LB Capital"  
Iliia Chavchavadze Av. 34, shop 12A,  
0107, Tbilisi, Georgia

---

(111) M 2023 37201 R  
(151) 2023 08 15  
(181) 2033 08 15  
(260) AM 2022 118861 A  
(220) 2022 08 04  
(732) Philip Morris Products S.A.  
Quai Jeanrenaud 3, 2000 Neuchâtel,  
Switzerland

---

(111) M 2023 37202 R  
(151) 2023 08 15  
(181) 2033 08 15  
(260) AM 2022 118860 A  
(220) 2022 08 04  
(732) Philip Morris Products S.A.  
Quai Jeanrenaud 3, 2000 Neuchâtel,  
Switzerland

---

(111) M 2023 37203 R  
(151) 2023 08 15  
(181) 2033 08 15  
(260) AM 2022 118314 A  
(220) 2022 06 30  
(732) FremantleMedia Limited  
1 Stephen Street, London W1T 1AL, United  
Kingdom

---

## TRADEMARKS REGISTERED ACCORDING TO THE ACCELERATED PROCEDURE

The decision can be appealed at the Chamber of Appeal of Sakpatenti within 3 months from the publication.

(111) M 2023 37181 R  
(151) 2023 08 08  
(181) 2033 08 08  
(210) AM 124217  
(220) 2023 08 04  
(732) LTD "Sabue Vineyards"  
Vill. Sabue, Kvareli Region, Georgia  
(540)



(591) Black, yellow, white, gradation of light and dark tones of brown  
(531) 03.07.05; 03.07.16; 29.01.13  
(511) 29, 30, 32, 33, 35

(111) M 2023 37182 R  
(151) 2023 08 08  
(181) 2033 08 08  
(210) AM 124054  
(220) 2023 07 27  
(732) LLC "IT Garage"  
Merab Aleksidze St. 12, floor 3, office 12,  
0193, Saburtalo District, Tbilisi, Georgia  
(740) Tamar Kotchlamazashvili  
(540)

# Garage IT

(591) Black-white  
(511) 35, 38, 42, 45

(111) M 2023 37183 R  
(151) 2023 08 08  
(181) 2033 08 08  
(210) AM 124068  
(220) 2023 07 28  
(732) LTD "Madli"  
Vill. Kvemo Lisi, Mtskheta, Georgia

(540)



(591) Black-white  
(531) 26.04.02; 26.04.05; 26.04.22; 27.05.09;  
27.05.10; 27.05.17  
(511) 32

(111) M 2023 37184 R  
(151) 2023 08 08  
(181) 2033 08 08  
(210) AM 123929  
(220) 2023 07 20  
(732) LTD "Daily"  
Varketili Farm Settlement, Ahmed Melashvili  
St. 2, Tbilisi, Georgia  
(540)



(591) Red, dark red, white  
(531) 02.09.01; 24.17.20; 27.05.21; 28.19; 29.01.12  
(511) 35

(111) M 2023 37185 R  
(151) 2023 08 08  
(181) 2033 08 08  
(210) AM 123658  
(220) 2023 07 13  
(732) Shamsu Tatarkhanov  
Mani-Sheikh St. S. 13, Chechen Republic,  
Argun, Russian Federation  
(740) Shalva Giorgadze

(540)

**COFFEE SOUL**<sup>®</sup>

SPECIALTY COFFEE COMPANY

(591) Black-white

(531) 27.05.01; 27.05.10

(511) 30, 32, 43

(111) M 2023 37204 R

(151) 2023 08 17

(181) 2033 08 17

(210) AM 124227

(220) 2023 08 07

(732) LTD "Sabue Vineyards"

Vill. Sabue, Kvareli Region, Georgia

(540)



(591) Black-white

(531) 03.07.05; 03.07.16

(511) 29, 30, 32, 33, 35

(111) M 2023 37205 R

(151) 2023 08 17

(181) 2033 08 17

(210) AM 123623

(220) 2023 07 12

(732) City Market 2023

Mukhiani, IV "A" m/r, bld. 4, ap. 29, Gldani

District, Tbilisi, Georgia

(540)



საქართველის • City Market

(591) Black, yellowish orange, white, green, sky-blue, red, lilac

(531) 07.01.06; 18.01.19; 26.04.09; 29.01.15

(511) 35

(111) M 2023 37206 R

(151) 2023 08 17

(181) 2033 08 17

(210) AM 124221

(220) 2023 08 04

(732) JSC "K. Eristavi National Center of

Experimental and Clinical Surgery"

Konstantine Chachava St. 7, Didube District,

Tbilisi, Georgia

(740) Shalva Gvaramadze

(540)



(591) White, different tones of green

(531) 02.09.01; 27.05.17; 29.01.12

(511) 9, 42

## INTERNATIONAL TRADEMARKS FOR WHICH A DECISION ON GRANTING PROTECTIONS IS TAKEN

The decision can be appealed at the Chamber of Appeal of Sakpatenti within 3 months from the publication or at the Mtskheta District Court Administrative Cases Board (Address: №17, Samkhedro St., Mtskheta), within 1 month following the publication.

(260) AM 2023 119510 A

(800) 1684162

(151) 2022 07 07

(891) 2022 07 07

(731) KAYALARNOROO BOYA SANAYI VE  
TICARET ANONIM SIRKETI  
Kimya San.O.S.B, Tem Yan Yol, N4 M.Aras  
B. 48, Tuzla, Istanbul, Türkiye

(540)

**GENÇ NOROO**

(591) Light blue, brown

(531) 26.11.01; 26.11.08; 27.05.01; 27.05.09;  
27.05.11; 29.01.13

(511)

2 – Paints; lacquers; coatings [paints]; preservatives against rust; anti rust preparations; paints for industrial equipment; paint for industrial equipment and machinery; colorants, paints and dyes for general industrial use; coating composition in the nature of paint for industrial applications; protective coatings, namely, anti-tarnishing preparations for surfaces including windows; decorative spray coatings; water-based roof coatings; paints for automobiles; automotive paints; floor paints; paint for use in the manufacture of automobiles; epoxy coating for use on concrete industrial floors; epoxy resin coatings.

(260) AM 2023 120261 A

(800) 1694062

(151) 2022 09 09

(891) 2022 09 09

(731) Obschestvo s ogranichennoi otvetstvennostju  
"Set data-tsentrovo "Selektel"  
Tsvetochnaya Street, 21, liter A, RU-196084  
Saint Petersburg, Russian Federation

(540)



(591) Light blue, gray-blue, blue, black and white

(531) 04.05.05; 29.01.13

(554) Three Dimensional

(511)

9 – 3D spectacles; aerials; holograms; floppy disks; phonograph records; disks, magnetic; optical discs; electronic notice boards; interfaces for computers; coaxial cables; fibre optic cables; cables, electric; calculating machines; pocket calculators; identity cards, magnetic; video game cartridges; memory cards for video game machines; encoded magnetic cards; electronic book readers; electronic agendas; mouse pads; compact discs [audio-video]; compact discs [read-only memory]; computers; laptop computers; tablet computers; notebook computers; decorative magnets; monitors [computer hardware]; monitors [computer programs]; headphones; magnetic data media; optical data media; electronic sheet music, downloadable; computer software, recorded; computer hardware; sunglasses; goggles for sports; radio pagers; computer software applications, downloadable; computer programs, recorded; computer game software, downloadable; computer operating programs, recorded; electronic publications, downloadable; integrated circuit cards [smart cards]; smart glasses; smartphones; smartwatches; bags adapted for laptops; downloadable ring tones for mobile phones; downloadable image files; downloadable music files; animated cartoons; USB flash drives; covers for tablet computers; covers for smartphones; cell phone straps.

16 – Fountain pens; albums; almanacs; posters; banners of paper; tickets; forms, printed; announcement cards [stationery]; note books; pads [stationery]; drawing pads; spiral notebooks; pamphlets; booklets; wrapping paper; paper; newsletters; signboards of paper or cardboard; bunting of paper; newspapers; magazines [periodicals]; bookmarks; periodicals; printed publications; graphic representations; calendars; pencils; pencil lead holders; pictures; transfers [decalcomanias]; catalogues; books; comic books; envelopes [stationery]; boxes of paper or cardboard; printed coupons; flyers; bags [envelopes, pouches] of paper or plastics, for packaging; stickers [stationery]; passport holders; musical greeting cards; greeting cards; postcards; conical paper bags; folders for papers; desk mats; writing cases [sets]; office requisites, except furniture; writing materials; writing instruments; printed matter; prospectuses; writing or drawing books; bottle wrappers of paper or cardboard; manuals [handbooks]; flags of paper; stencils; stamps [seals]; shields [paper seals]; labels of paper or cardboard.

8 – Playing cards.

38 – Wireless broadcasting; electronic bulletin board services [telecommunications services]; providing information about wireless communication; providing user access to global computer networks; providing access to databases; providing internet chatrooms; providing telecommunications connections to a global computer network; message sending; computer aided transmission of messages and images; transmission of digital files; providing online forums; rental of access time to global computer networks; rental of telecommunication equipment; communications by fibre optic networks; communications by computer terminals; telecommunications routing and junction services; streaming of data.

41 – Academies [education]; publication of books; layout services, other than for advertising purposes; virtual reality game services provided on-line from a computer network; practical training [demonstration]; providing recreation facilities; arranging and conducting of conferences; arranging and conducting of workshops [training]; arranging and conducting of seminars; organization of competitions [education or entertainment]; organization of lotteries; vocational guidance [education or training advice]; providing online videos, not downloadable; providing online music, not downloadable; educational examination; electronic desktop publishing; online publication of electronic books and journals; publication of texts, other than publicity texts; entertainment services; tutoring; arranging and conducting of training; providing online electronic publications, not downloadable.

42 – Computer system analysis; recovery of computer data; computer virus protection services; installation of computer software; computer security consultancy; information technology [IT] consultancy; consultancy in the design and development of computer hardware; computer software consultancy; data security consultancy; updating of computer software; monitoring of computer systems to detect breakdowns; monitoring of computer systems for detecting unauthorized access or data breach; monitoring of computer systems by remote access; software as a service [SaaS]; maintenance of computer software; providing information relating to computer technology and programming via a website; providing search engines for the internet; conversion of computer programs and data, other than physical conversion; computer system design; rental of web servers; computer rental; rental of computer software; hosting computer sites [web sites]; creating and maintaining websites for others; computer programming; technical writing; copying of computer programs; off-site data backup; telecommunications technology consultancy; data encryption services; electronic data storage; computer software design.

(260) AM 2023 120263 A  
(800) 1694070  
(151) 2022 09 19  
(891) 2022 09 19  
(731) Kia Corporation  
12, Heolleung-ro, Seocho-gu, Seoul 06797,  
Republic of Korea  
(540)

**Kia**

(591) Black, white  
(511)  
39 – Emergency automobile towing; leasing of rental car; providing transportation information; providing information relating to car transport; car rental; tracking of automobile fleets using electronic navigation and locating devices [transport information]; towing and transportation of cars as part of vehicle breakdown services; car sharing services; transport; carpooling services; providing information via the Internet relating to the leasing of automobiles; rental of safety seats for children, for vehicles; rental of vehicle roof racks; rental of airplanes; renting of vehicles; providing information relating to air transport; providing information relating to vehicle driving services; reservation services for vehicle rental; car rental, garage and parking space rental; providing information relating to vehicle parking services; reservation of parking spaces; transportation of passengers and passengers' luggage; providing information about transport services; logistics services consisting of the storage, transportation and delivery of goods; transport, delivery, packaging, and storage of goods; providing road and traffic information; inspection of vehicles before transport; storage of energy and fuels; depot services for the storage of vehicles; rental of wheelchairs; travel consultancy; providing information relating to travel and sightseeing travel tours; booking agency services for travel; travel reservation; travel reservation and travel information services; conducting of sightseeing travel tours by automobiles; physical storage of electronically stored data, documents, digital photographs, music, images, video, and computer games; storage, distribution and supply of energy and fuel; storage and distribution of electricity; providing information relating to the distribution of electricity.

(260) AM 2023 120264 A  
(800) 1694107  
(151) 2022 06 10  
(891) 2022 06 10  
(731) CEADESIGN SRL  
VIA BRENTA, 8, I-36020 POVE DEL  
GRAPPA (VI), Italy  
(540)

**CEA**

(591) Black, white  
 (531) 27.05.01; 27.05.01; 27.05.19; 27.05.23  
 (511)

11 – Sanitary and bathroom installations and plumbing fixtures; spouts for washbasin, bidets and bathtubs; flow restrictors for bathroom and shower spouts; shower spouts; hand-showers and brackets therefor being parts of sanitary installations; plumbing fixtures, namely, shower sprayers and brackets; mixers for washbasins, bidets, showers and bathtubs water supply; thermostatic mixing valves for faucets; electronic mixing valves for faucets; mixers for kitchens water supply; faucet sprayers for sanitary ware; toilet flushes; plumbing fittings, namely, waste drains; taps; plumbing fittings, namely traps; toilet cisterns; plumbing fittings for domestic tubs and bathrooms; spouts for outdoor showers; ceiling fans; fans; fans with lighting; fans with air purification system; electric towel warmers; washbasins; water closets; toilet bowls; showers; showerheads; all the aforementioned goods being intended for domestic use, swimming pool showers and garden taps, not for use in industrial plants, nor for purification, nor sanitation, nor treatment of water or food products, nor for refrigeration, compression or drying, nor for agricultural use or for animal breeding.

(260) AM 2023 120295 A  
 (800) 1695033  
 (151) 2022 08 05  
 (891) 2022 08 05  
 (731) NOVARTIS AG  
 CH-4002 Basel, Switzerland  
 (540)



(591) Dark blue, light blue and magenta  
 (531) 01.15.15; 26.13.25; 29.01.14  
 (511)  
 5 – Pharmaceutical preparations.

(260) AM 2023 120296 A  
 (800) 1695047  
 (151) 2022 06 10  
 (891) 2022 06 10  
 (731) WYCON S.p.A.  
 Piazza IV Novembre n.4, I-20124 Milano,  
 Italy

(540)



(591) Black, white  
 (531) 27.05.24  
 (511)

3 – Scented water; nail art stickers; adhesives for cosmetic purposes; adhesives for affixing false hair; aromatics [essential oils]; lipstick cases; shower and bath foam; hair conditioners; bases for flower perfumes; joss sticks; cotton swabs for cosmetic purposes; pre-moistened or impregnated cleansing pads, tissues or wipes; glitter for cosmetic purposes; massage candles for cosmetic purposes; depilatory wax; shoe wax; polishing wax; false eyelashes; make-up powder; hair dyes; colorants for toilet purposes; cosmetics; cosmetics for animals; cosmetics for children; cosmetic creams; creams, oils, lotions, sprays, pencils and balms for cosmetic purposes; bleaching preparations [decolorants] for cosmetic purposes; dentifrices; deodorants for human beings or for animals; detergents for household purposes; cleansers for intimate personal hygiene purposes, non medicated; air fragrance reed diffusers; eau de parfum; skin exfoliants; eyeliner; blusher; tissues impregnated with essential oils, for cosmetic use; foundation; fragrances and perfumery; moisturizing gels [cosmetic]; greases for cosmetic purposes; henna [cosmetic dye]; incense; hair spray; cleansing milk; beauty lotions; after-shave lotions; hair lotions; lotions for cosmetic purposes; lip glosses; mascara; beauty masks; make-up pencils; eyeliner pencils; eye pencils; cosmetic pencils; decorative transfers for cosmetic purposes; cosmetic kits; oils for toilet purposes; essential oils; oils for cosmetic purposes; eyeshadow; cotton wool for cosmetic purposes; pumice stone; alum stones [astringents]; cosmetic face powder; potpourris [fragrances]; sun-tanning preparations [cosmetics]; cosmetic preparations for baths; toiletry preparations; cleaning and polishing preparations; breath freshening preparations for personal hygiene; beauty care preparations; make-up preparations for the face and body; pre-shave and after-shave preparations; cosmetic and beauty preparations; cosmetics and toiletries; cosmetic preparations for skin care; sachets for perfuming linen; make-up removing preparations; perfumes; air fragrancing preparations; lipsticks; cosmetic bath salts; tissues impregnated with make-up removing preparations; feminine hygiene cleansing towelettes; shaving soap; cakes of toilet soap; soap; deodorant soap; shampoos; dry shampoos; stain removers; nail varnish; nail varnish removers; make-up.

35 – Purchasing of goods and services for other businesses; shop window dressing; commercial administration of the licensing of the goods and services of ot-

hers; administration of consumer loyalty programs; providing assistance in the field of product commercialization; assistance in product commercialization within the framework of a franchise contract; business management assistance; provision of an online marketplace for buyers and sellers of goods and services; organization of trade fairs for commercial or advertising purposes; organization of fashion shows for promotional purposes; arranging and conducting of advertising events; search engine optimization for sales promotion; presentation of goods on communication media, for retail purposes; demonstration of goods and services by electronic means; sales promotion for others; advertising; bringing together, for the benefit of others, of a variety of goods, excluding the transport thereof, enabling customers to conveniently view and purchase those goods; modelling for advertising or sales promotion; mail order retail services for clothing and clothing accessories; mail order retail services for beauty preparations; mail order retail services for perfumes and soaps; mail order retail services for make-up; mail order retail services for cosmetics; retail or wholesale services for bedding; retail or wholesale services for bags; retail or wholesale services for clothing; retail or wholesale services for footwear; retail or wholesale services for candles; retail or wholesale services for headwear; retail or wholesale services for food and drink; retail or wholesale services for cosmetics; retail or wholesale services for bathing suits; retail or wholesale services for jewelry and watches; retail or wholesale services for eyewear; retail or wholesale services for make-up brushes, combs, cosmetics and make-up holders; retail or wholesale services for perfumes; retail or wholesale services for make-up; online retail store services featuring cosmetics and beauty products; mail order retail services for clothing accessories; on-line marketing.

(260) AM 2023 120297 A

(800) 1695050

(151) 2022 07 11

(891) 2022 07 11

(731) Euro Games Technology Ltd.

4, "Maritsa" Str., "Vranya-Lozen-Triugulnika",  
BG-1151 Sofia, Bulgaria

(540)



(591) Yellow, orange, red, green, black, pink and purple

(531) 05.05.20; 24.17.02; 26.11.13; 27.05.01;  
27.05.02; 27.05.03; 27.05.04; 27.05.09;  
27.05.10; 29.01.15

(511)

9 – Software; computer gaming software; computer software packages; computer operating system software; computer software, recorded; software drivers; virtual reality software; games software; entertain-

ment software for computer games; computer programs for network management; operating computer software for main frame computers; monitors (computer hardware); computer hardware; apparatus for recording images; monitors (computer programs); computer game programs; computer programs for recorded games; apparatus for recording, transmission or reproduction of sound or images; communications servers [computer hardware]; electronic components for gambling machines; computer application software featuring games and gaming; computer software for the administration of on-line games and gaming; computer hardware for games and gaming; hardware and software for gambling, gambling machines, gambling games on the Internet and via telecommunication network.

28 – Gaming machines for gambling; chips for gambling; mah-jong; arcade games; gambling machines operating with coins, notes and cards; games; electronic games; parlor games; gaming chips; gaming tables; slot machines [gaming machines]; LCD game machines; slot machines and gaming devices; coin-operated amusement machines; roulette chips; poker chips; chips and dice [gaming equipment]; gaming equipment for casinos; roulette tables; gaming roulette wheels; casino games; gambling machines and amusement machines, automatic and coin-operated; coin-operated amusement machines and/or electronic coin-operated amusement machines with or without the possibility of gain; boxes for coin-operated machines, slot machines and gaming machines; electronic or electrotechnical amusement machines and apparatus, gaming machines, coin-operated entertainment machines; housings for coin-operated machines, gaming equipment, gaming machines, machines for gambling; electropneumatic and electrical gambling machines (slot machines).

41 – Gambling; entertainment services related to gambling; gaming services for entertainment purposes; casino, gaming and gambling services; training in the development of software systems; provision of gaming equipment for gambling halls; providing casino equipment [gambling]; gaming machine entertainment services; providing casino facilities [gambling]; gaming hall services; amusement arcade services; games equipment rental; rental of gaming machines; providing amusement arcade services; rental of gaming machines with images of fruits; editing or recording of sounds and images; sound recording and video entertainment services; hire of sound reproducing apparatus; provision of gaming equipment for casinos; providing of casino facilities; online gambling services; casino, gaming and gambling services; provision of gaming facilities, gaming hall facilities, Internet casinos and online gambling services.

(260) AM 2023 120298 A  
 (800) 1695100  
 (151) 2022 10 09  
 (891) 2022 10 09  
 (731) Danas Consultants Limited  
 Omirou, 64, Imperium Tower, CY-3096  
 Limassol, Cyprus  
 (540)

## NOVIKOV

(591) Black, white  
 (511)  
 43 – Services for providing food and drink; snack-bar services; café services; cafeteria services; restaurant services; self-service restaurant services; canteen services in enterprises and educational institutions; bar services; food and drink catering; information and advice in relation to the preparation of meals; udon and soba restaurant services.

(260) AM 2023 120299 A  
 (800) 1695129  
 (151) 2022 07 18  
 (891) 2022 07 18  
 (731) C F E B SISLEY  
 3 avenue de Friedland, F-75008 Paris, France  
 (540)

## N E U R | A É

(591) Black, white  
 (531) 26.11.01; 26.11.05; 26.11.07; 27.05.01  
 (511)  
 3 – Cosmetics and skin care products; face and body care serums and cosmetics for body and face care in the nature of roll-ons; scrubs and skin cleansers; dermatological creams other than for medical use, non-medicinal balms; cosmetic preparations for baths; make-up and make-up removing products and preparations; nail care products; deodorants for personal use [perfumery]; cosmetic sun protection products, lotions and preparations; cosmetic preparations for slimming; firming creams; hair lotions; hair balms and masks; deodorants and antiperspirants; body gels [cosmetics], for muscles and joints, perfumery products, air fragrancing preparations, incense; soaps; soaps other than for personal use; bath soaps; beauty soap; soaps for personal use; cosmetic soaps; cakes of toilet soap, toilet soaps; essential oils; essential oil-based creams for aromatherapy use; essences, oils and gels for cosmetic use; aromatherapy preparations; oils for cosmetic use; oils for perfumes and scents; non-medicated dissolvable products for the face and body in the nature of compressed tablets, ampoules, drops, inhalation and roll-ons; non-medicated toilet preparations; skin care preparations and beauty care cosmetics.  
 5 – Pharmaceutical products; sanitary products for medical purposes; vitamins and vitamin preparations;

food supplements in the nature of beverages, powders, drops, capsules, tablets, compressed tablets, lozenges or ampoules, dietary supplements for medical use consisting of amino acids, minerals and/or trace elements, dietetic substances for medical use consisting of vitamins, minerals, amino acids and trace elements, antioxidants used as food supplements, medicinal plants and herbs, plant and herb extracts for medicinal use, herbal and plant preparations for medicinal use, medicinal herbal teas, medicinal tea, slimming tea for medical use, appetite suppressants for medical use; food supplements for dietetic use; food supplements with cosmetic effect; pharmaceutical and medical preparations for body, skin and hair treatment, care, cleansing, soothing, disinfection, revitalization and relaxation; disinfectants; antibacterial products for washing hands; bath preparations for medical use; massage candles for therapeutic use; phytotherapy preparations for pharmaceutical use.

44 – Beauty care services; skin care centers; consultancy services relating to cosmetics; massage services; hairdressing salons; beauty salons; sauna services; provision of spa facilities; balneotherapy, physiotherapy and aromatherapy services; Turkish bath services; cosmetic testing; advice with respect to personal wellness; providing information and recommendations with respect to massage, essential oil wraps, diet, nutrition and naturopathy; service provision and advice with respect to massage, essential oil wraps, diet, nutrition and naturopathy; phytotherapy focused care services; providing facilities in the field of cosmetics, massage, naturopathy, balneotherapy, physiotherapy, aromatherapy and phytotherapy.

(260) AM 2023 120378 A  
 (800) 1695791  
 (151) 2022 09 02  
 (891) 2022 09 02  
 (731) Junhua WANG  
 No. 91, Building 23, No. 128 Yard,  
 Changjiang Middle Road, Erqi District,  
 Zhengzhou, Henan, China  
 (540)

## BUBU

(591) Black, white  
 (531) 27.05.01  
 (511)  
 25 – Tops [clothing]; underwear; trousers; shoes; hats; hosiery; dance clothing; scarfs; girdles; children's clothing.



(260) AM 2023 120379 A  
 (800) 1695792  
 (151) 2022 10 16  
 (891) 2022 10 16  
 (731) Grailed, LLC  
 131 Spring Street, Floor 6, New York  
 NY 10013, USA

(540)

**GRAILED**

(591) Black, white  
 (511)  
 35 – Operating online marketplaces for sellers and buyers of goods.

(260) AM 2023 120380 A  
 (800) 1695867  
 (151) 2022 07 30  
 (891) 2022 07 30  
 (731) IceWarp Ltd.  
 Georgiou Gennadiou 43; CY-3041 Limassol,  
 Cyprus

(540)



(591) Pantone 7456 C, Pantone 7439 C, Pantone 7682 C, Pantone 272 C, Pantone 7670 C, Pantone 660 C and Pantone Cool Gray 11 C

(531) 26.13.25; 29.01.13

(511)

9 – Recorded content; computer software; application software; downloadable applications for use with mobile devices; downloadable cloud computing software; computer software, recorded; computer programs [downloadable software]; computer software applications, downloadable; computer programs for project management; software for processing images, graphics and text; instant messaging software; telecommunications software; computer software for document management; computer software for database management; electronic mail and messaging software; software for online messaging; recorded computer software for business management; computer operating systems; computer programs for editing images, sound and video; computer programs for connecting remotely to computers or computer networks; computer software for use in providing multiple user access to a global computer information network; data management software; downloadable computer software for the transmission of data and information; interfaces for computers; downloadable cloud-based software; downloadable mobile applications; computer software for word processing; computer software platforms; computer software platforms for use in integrating email, calendars, contacts, instant messaging history, email encryption and email translations; computer software platforms for use in synchronizing email, appointments, contacts, tasks, notes, distribution lists

and public folders by an email and scheduling software; computer software platforms for use in synchronizing files with a cloud-based drive; computer software for use in creating, viewing and editing documents in conjunction with email, calendar and contacts lists; computer software for use in instant messaging, sharing files, scheduling appointments and organizing web conferences; computer software programs for spreadsheet management; computer software to enable teleconferencing, videoconferencing and videophone services; computer software platform for use in synchronizing emails, appointments, contacts, tasks, notes, distribution lists and public folders using email and scheduling software.

38 – Transmission of electronic mail; providing online chatrooms for social networking; providing online forums; transmission of digital files; computer-aided transmission of messages and images; electronic bulletin board services [telecommunications services]; streaming of data; electronic transmission of mail and messages; electronic exchange of data stored in databases accessible via telecommunication networks; electronic transmission of messages; electronic transmission of data; communication by electronic mail systems; communications services provided over the Internet; computer communications services for the transmission of information; electronic mail; electronic messaging; electronic mail and mailbox services; instant messaging services; electronic transmission of e-mail; voice over Internet Protocol [VoIP] services; videoconferencing services; call recording services.

42 – Cloud computing; server hosting; rental of computer software; rental of web servers; software as a service [SaaS]; electronic data storage; off-site data backup; electronic storage of documents; hosting online web facilities for others; hosting platforms on the Internet; providing temporary use of on-line non-downloadable operating software for accessing and using a cloud computing network; providing temporary use of on-line non-downloadable software for importing and managing data; providing temporary use of non-downloadable software applications accessible via a web site; rental of computer software and programs; electronic storage services for archiving databases; providing temporary use of on-line non-downloadable software for transmission of information; rental of operating software for accessing and using a cloud computing network; rental of memory space on servers for hosting electronic bulletin boards; providing online non-downloadable software for word processing; rental of software for data processing; rental of software for importing and managing data; rental of database management software; hosting web sites; remote computer backup services; rental of application software; rental of operating software for computer networks and servers; providing temporary use of on-line non-downloadable software for database management; providing temporary use of web-based app-

lications; electronic storage services for archiving electronic data; file sharing services, namely hosting a website featuring technology enabling users to upload and download electronic files; providing temporary use of on-line non-downloadable cloud computing software for use in electronic storage of data.

(260) AM 2023 120381 A

(800) 1695884

(151) 2022 06 29

(891) 2022 06 29

(731) CAHILL SOFTWARE LIMITED

Block 3 Harcourt Centre, Harcourt Road,  
Dublin 02A339, Ireland

(540)

**AZYRA** 

(591) Blue, red, green, white

(531) 20.05.07; 26.04.02; 26.04.09; 27.05.01;  
29.01.13

(511)

9 – Computer software; computer software programmes for business and public service administration and accounting.

42 – Hosting of computer software applications for others; hosting of computer software applications for remote users who access the applications via communications of any form including dialup lines, leased lines, the internet, virtual private networks, satellite links, or similar forms of communication; provision of non-downloadable software being software as a service (SaaS); providing application software for cloud computing services.

(260) AM 2023 120382 A

(800) 1695894

(151) 2022 09 06

(891) 2022 09 06

(731) VENATURA SAĞLIK ÜRÜNLERİ TİCARET  
VE SANAYİ ANONİM ŞİRKETİ

HUZUR MAH. AZERBAYCAN, CAD. B 4  
B 467, Sarıyer, İstanbul, Türkiye

(540)

**VeNatura** 

(591) Green, dark green, white

(531) 05.03.14; 27.05.01; 29.01.13

(511)

5 – Pharmaceuticals, medical preparations; sanitary preparations for medical purposes; dietetic food and substances adapted for medical use; dietary supplements for human beings.

35 – Retail or wholesale services for pharmaceutical, sanitary preparations and medical supplies; retail

services in relation to dietary supplements; wholesale services in relation to dietary supplements; on-line retail store services featuring dietary supplements; on-line wholesale store services featuring dietary supplements.

(260) AM 2023 120383 A

(800) 1695909

(151) 2022 09 06

(891) 2022 09 06

(731) VEFA İLAÇ SANAYİ VE TİCARET  
ANONİM ŞİRKETİ

BEYLİKDÜZÜ OSB MAH. 2 CAD. 3 2,  
Beylikdüzü, İstanbul, Türkiye

(540)

**Ursovef**

(591) Black, white

(531) 27.05.17

(511)

5 – Pharmaceuticals, medical preparations.

(260) AM 2023 120384 A

(800) 1695960

(151) 2022 09 13

(891) 2022 09 13

(731) ANN-MAX S.R.L.

VIA BACCELLIERA 2, I-41126 MODENA  
(MO), Italy

(540)

**MARIA BELLENTANI**

(591) Black, white

(511)

25 – Ladies' clothing; menswear; childrenswear; bathing suits; shoes; clothing; footwear [excluding orthopedic footwear]; headgear; sportswear; stockings; belts [clothing]; kerchiefs [clothing]; neck scarves [mufflers]; foulards [clothing articles]; shawls; underwear, nightwear; gloves [clothing].

(260) AM 2023 120385 A

(800) 1696015

(151) 2022 02 06

(891) 2022 02 06

(731) DSM GRUP DANIŞMANLIK İLETİŞİM VE  
SATIŞ TİCARET A.Ş.

Maslak Mahallesi Büyükdere Caddesi,  
(Spine Plaza) No:243, İç Kapı No:19  
Sarıyer, İstanbul, Türkiye

(540)

**Trendyol Glam**

(591) Black, white

(531) 27.05.01

(511)

3 – Adhesives for cosmetic purposes; after-shave lotions; air fragrance reed diffusers; air fragrancing preparations; antiperspirant soap; antiperspirants [toiletries]; antistatic preparations for household purposes; aromatics [essential oils]; astringents for cosmetic purposes; baby wipes impregnated with cleaning preparations; balms, other than for medical purposes; bath preparations, not for medical purposes; bath salts, not for medical purposes; beard dyes; beauty masks; bleaching preparations [decolorants] for cosmetic purposes; bleaching preparations [decolorants] for household purposes; body glitter; body paint for cosmetic purposes; breath freshening preparations for personal hygiene; cake flavourings [essential oils]; chemical cleaning preparations for household purposes; cleaning chalk; cleaning preparations; cloths impregnated with a detergent for cleaning; colorants for toilet purposes; colour-brightening chemicals for household purposes [laundry]; colour-removing preparations; colour run prevention laundry sheets; cosmetic dyes; cosmetic creams; cosmetic kits; cosmetic pencils; cosmetic preparations for baths; cosmetic preparations for eyelashes; cosmetic preparations for skin care; cosmetic preparations for slimming purposes; cosmetics; cosmetics for animals; cosmetics for children; cotton swabs for cosmetic purposes; cotton wool for cosmetic purposes; cotton wool impregnated with make-up removing preparations; creams for leather; decorative transfers for cosmetic purposes; degreasers, other than for use in manufacturing processes; dental bleaching gels; dentifrices; denture polishes; deodorants for human beings or for animals; depilatory preparations; depilatory wax; detergents, other than for use in manufacturing operations and for medical purposes; douching preparations for personal sanitary or deodorant purposes [toiletries]; dry-cleaning preparations; dry shampoos; eau de Cologne; emery cloth; emery paper; essential oils; eyebrow cosmetics; eyebrow pencils; eye-washes, not for medical purposes; fabric softeners for laundry use; false eyelashes; false nails; flavourings for beverages [essential oils]; floor wax; floor wax removers [scouring preparations]; food flavourings [essential oils]; fumigation preparations [perfumes]; gel eye patches for cosmetic purposes; grinding preparations; hair conditioners; hair dyes; hair lotions; hair spray; hair straightening preparations; hair waving preparations; henna [cosmetic dye]; herbal extracts for cosmetic purposes; hydrogen peroxide for cosmetic purposes; incense; laundry preparations; lip glosses; lipstick cases; lipsticks; lotions for cosmetic purposes; make-up; make-up powder; make-up preparations; make-up removing preparations; mascara; massage candles for cosmetic purposes; massage gels, other than for medical purposes; micellar water; moustache wax; mouthwashes, not for medical purposes; nail art stickers; nail care preparations; nail glitter; nail varnish; nail varnish removers; oils for perfumes and scents; paint stripping preparations;

perfumery; perfumes; petroleum jelly for cosmetic purposes; polish for furniture and flooring; polishing creams; polishing paper; polishing preparations; polishing rouge; polishing stones; polishing wax; potpourris [fragrances]; pomades for cosmetic purposes; preparations for cleaning dentures; preparations for unblocking drain pipes; pumice stone; sandpaper; scented water; scented wood; scouring solutions; shampoos; shampoos for animals [non-medicated grooming preparations]; shampoos for pets [non-medicated grooming preparations]; shaving preparations; shaving soap; shaving stones [astringents]; shoe cream; shoe polish; shoe wax; skin whitening creams; smoothing preparations [starching]; soaps; soap for brightening textile; soap for foot perspiration; stain removers; starch glaze for laundry purposes; talcum powder, for toilet use; tissues impregnated with cosmetic lotions; tissues impregnated with make-up removing preparations; toiletry preparations; toilet water; toothpaste; washing soda, for cleaning.

18 – Goods made of leather, imitations of leather or other materials namely key holders being key cases, wallets, purses, bags, straps, boxes, key cases, trunks [luggage], suitcases; umbrellas, parasols, walking sticks; carrying bags; sports bags; backpacks; backpacks for carrying infants; bags [envelopes, pouches] of leather, for packaging; bags for campers; bags for carrying animals; bags for carrying pets; bags for climbers; beach bags; belt pouches; briefcases; cases of leather or leatherboard; clothing for pets; coin pouches; collars for animals; cosmetic bags sold empty; cosmetic cases, empty; costumes for animals; covers for animals; credit card cases and holders [leatherware]; document cases; garment bags for travel; harness fittings; harness for animals; harness straps; hiking sticks; labels of leather; luggage tags; saddlery; slings for carrying infants.

25 – Clothing, footwear and headwear for human beings namely clothing; outer clothing; waterproof clothing; overalls; overcoats; paper clothing; parkas; pelisses; pelisses; petticoats; pockets for clothing; ponchos; rash guards; ready-made clothing; shirt fronts; shirts; shirt yokes; short-sleeve shirts; coats; collars [clothing]; combinations [clothing]; suits; dresses; dressing gowns; dress shields; sweaters; aprons [clothing]; jackets [clothing]; clothing of imitations of leather; clothing of leather; liveries; maniples; mantillas; masquerade costumes; leggings [leg warmers]; leggings [trousers]; leotards; tee-shirts; tights; trousers; trouser straps; uniforms; vests, babies' pants [underwear]; bibs, not of paper; layettes [clothing]; bathing caps; bathing suits; bathing trunks; bath robes; bath sandals; bath slippers; beach clothes; beach shoes; wet suits for water-skiing; cyclists' clothing jackets [clothing]; jerseys [clothing]; judo uniforms; jumper dresses; karate uniforms; kimonos; knitwear [clothing]; fishing vests; furs [clothing]; fur stoles; clothing containing slimming substances; clothing for

gymnastics; clothing incorporating LEDs; motorists' clothing; belts [clothing]; money belts [clothing]; headwear; berets; caps being headwear; hats; headbands [clothing]; headscarves; hoods [clothing]; visors being headwear; ear muffs [clothing]; cuffs; detachable collars; gloves [clothing]; mittens; muffs [clothing]; neck gaiters; neckties; paper hats [clothing]; shower caps; ready-made linings [parts of clothing]; saris; sarongs; sashes for wear; scarfs; shawls; veils [clothing]; togas; turbans; bandanas [neckerchiefs]; ascots; bodices [lingerie]; camisoles; corselets; corsets [underclothing]; garters; girdles; boxer shorts; braces for clothing [suspenders]; gaiters; pyjamas; panties; brassieres; underpants; underwear; sweat-absorbent underwear; hosiery; stockings; stocking suspenders; footwear; shoes; footwear uppers; boots; boots for sports; boot uppers; sandals; football boots; foot muffs, not electrically heated; gymnastic shoes; half-boots; heelpieces for footwear; heelpieces for stockings; heel protectors for shoes; heels; inner soles; galoshes; breeches for wear; non-slipping devices for footwear; ski boots; ski gloves; skirts; shorts; skull caps; sleep masks; slippers; slips [underclothing]; socks; sock suspenders; soles for footwear; sports jerseys; sports shoes; sports singlets.

35 – Advertising; business management; business administration; office functions; organization, operation and supervision of loyalty and incentive schemes; advertising services provided via the Internet; production of television and radio advertisements; accountancy; auctioneering; trade fairs; opinion polling; data processing; provision of business information; advertising agency services; advertising services provided for others; database management; compilation of information into computer databases; business consulting services; business consulting services in the field of web based events, conferences, training programs, learning programs, and seminars; business consulting services in the field of delivering web-based knowledge; business consulting services in the field of online collaboration and collaboration technologies; business consulting services in the fields of sales and marketing; business project management services; business project management services relating to development, set up, staging, production, recording, monitoring and follow-up for web based events, conferences, training programs, learning programs, and seminars; market research and business consulting services; business consultancy services relating to facilitating the transaction of business via local and global computer networks by locating and providing referrals for the delivery of a wide variety of business and consumer products and services; dissemination of business information of goods and services of others via local and global computer networks; business consultancy services relating to providing a web site on a global computer network by which third parties can offer and source goods and services, place, determine the status of and fulfil trade leads and orders, enter in-

to contracts and transact business; providing computerized online ordering services; advertising of goods and services of others via local and global computer networks; international import and export agency services; rental of advertising space on communication media; online trading services relating to electronic auctioneering and providing online business evaluation relating thereto; providing a directory of third party web sites to facilitate business transactions; business consultancy services relating to operating an electronic marketplace for the buyers and sellers of goods and/or services on a global computer network; business assistance relating to facilitating business transaction via local and global computer networks; corporate management consultancy services; marketing and promotion services; publication of publicity materials; marketing of vacant premises; dissemination of advertising materials, updating of advertising materials, compilation of advertisements for use as web pages on the Internet; rental of advertising space; computer data processing; sales, business and promotional information services; telephone answering (for unavailable subscribers); telephone answering (for others); auctioneering provided on the Internet; personnel management; provision of sales, business, advertising and promotional information through a global computer network and via the Internet; presentation of goods on communication media for retail purposes; retail and wholesale of cosmetics, perfumery, toiletries, dentifrices, soaps, detergents, deodorants for personal use and household use, bleaching and cleaning preparations, dental care preparations, dentifrices, mouth washes, polishing preparations, candles, wax, pharmaceuticals, veterinary and medical preparations, disinfectants, dietary supplements, baby food, herbs and herbal beverages, sanitary preparations, sanitary diapers, sanitary pads, goods and materials of common metal used for storage, wrapping, packaging and sheltering purposes, containers of metal (storage, transport), metal boxes, packaging containers of metal, aluminium foil, storage containers of metal, metal containers for the transportation of goods, ladders of metal, ironmongery, small hardware of metal, safes of metal, machines, machine tools and industrial robots for processing and shaping wood, metals, glass, plastics and minerals, 3D printers, electric kitchen machines for chopping, grinding, crushing, mixing and mincing foodstuff, washing machines, laundry washing machines, dishwashers, spin driers (not heated), electric cleaning machines for cleaning floors, carpets or floorings, vacuum cleaners and parts thereof, forks, spoons, knives and non-electric cutters, slicers, peelers for kitchen use, including those made of precious metals, tools and apparatus for personal beauty care use: tools and apparatus for shaving, epilation, manicure and pedicure, electric hand implements for straightening and curling hair, scissors, handoperated hand tools for the repair of machines, apparatus and vehicles and for use in construc-

tion, agriculture, horticulture and forestry, electric or non-electric irons, steam irons, thermometers, microscopes, magnifying glasses, apparatus for recording, transmission or reproduction of sound or images, cameras, photographic cameras, television apparatus, video recorders, CD and DVD players and recorders, MP3 players, computers, desktop computers, tablet computers, microphones, loudspeakers, earphones, telecommunications apparatus, apparatus for the reproduction of sound or images, computer peripheral devices, cell phones, covers for cell phones, telephone apparatus, computer printers, scanners as data processing equipment, photocopiers, magnetic and optic data carriers and computer software and programmes recorded thereto, downloadable and recordable electronic publications, encoded magnetic and optic cards, photocells, optical sensors, counters, clothing for protection against accidents, irradiation and fire, safety vests and life-saving apparatus and equipment, eyeglasses, sunglasses, optical lenses and cases, containers, parts and components thereof, decorative magnets, metronomes, medical orthopaedic articles, corsets for medical purposes, orthopaedic shoes, elastic bandages and supportive bandages, condoms, babies' bottles, babies' pacifiers, teats, teeters for babies, lighting installations, hair driers, hand drying apparatus, water softening apparatus, electric bed warmers and electric blankets, not for medical use, electric pillow warmers, electric or nonelectric foot warmers, hot water bottles, pasteurizers and sterilizers, motorcycles, mopeds, vehicle seats, head-rests for vehicle seats, safety seats for children, for vehicles, seat covers for vehicles, vehicle covers, sun-blinds adapted for vehicles, wipers for vehicles, baby carriages, wheelchairs, pushchairs, shopping carts, shopping trolleys, fireworks, sprays for personal defence, jewellery, watches, statuettes and figurines of precious metal, clocks, watches, parts thereof, chronometers, music instruments, their cases, paper and cardboard, paper and cardboard for packaging and wrapping purposes, cardboard boxes, paper towels, toilet paper, paper napkins, plastic materials for packaging and wrapping purposes, printed publications, printed matter, books, magazines, newspapers, bill books, printed dispatch notes, printed vouchers, calendars, posters, photographs [printed], paintings, stickers [stationery], postage stamps, stationery, office stationery, instructional and teaching material [except furniture and apparatus], writing and drawing implements, artists' materials, paper products for stationery purposes, adhesives for stationery purposes, pens, pencils, erasers, adhesive tapes for stationery purposes, cardboard cartons [artists' materials], writing paper, copying paper, paper rolls for cash registers, drawing materials, chalkboards, painting pencils, watercolours [paintings], stationery, instructional and teaching material, writing and drawing implements, artists' materials, paper products for stationery purposes, adhesives for stationery purposes, pens, pencils, erasers, adhesive tapes for

stationery purposes, cardboard cartons [artists' materials], writing paper, copying paper, paper rolls for cash registers, drawing materials, chalkboards, painting pencils, watercolours [paintings], paint roller, paint brushes, rosaries, goods made of leather, imitations of leather or other materials designed for carrying items, bags, wallets, straps, boxes and trunks made of leather or stout leather, key cases, trunks [luggage], suitcases, umbrellas, parasols, walking sticks, monuments and statuettes of stone, concrete and marble, furniture, mattresses, pillows, air mattresses and cushions, sleeping bags for camping, water beds, mirrors, bouncing chairs for babies, playpens for babies, cradles, infant walkers, display boards, frames for pictures and paintings, identification plates, identification tags, nameplates, identification labels made of wood or synthetic materials, packaging containers of wood or plastics, storage containers, chests, ornaments and decorative goods of wood, cork, reed, cane, wicker, horn, bone, ivory, whalebone, shell, amber, mother-of-pearl, meerschaum, beeswax, plastic or plaster, figurines, holiday ornaments for walls and sculptures, baskets, kennels, nesting boxes and beds for household pets, cages for household pets, indoor aquariums, vivarium and indoor terrariums for animals and plant cultivation, bamboo curtains, roller indoor blinds [for interiors], slatted indoor blinds, strip curtains, bead curtains for decoration, curtain hooks, curtain rings, curtain tie-backs, curtain rods, hand-operated non-electric cleaning instruments and appliances, brushes, other than paintbrushes, sponges for cleaning, steel wool for cleaning, cloths of textile for cleaning, gloves for dishwashing, non-electric polishing machines for household purposes, brooms for carpets, mops, tooth brushes, shaving brushes, hair brushes, non-electric household or kitchen utensils, service dishes, pots and pans, bottle openers, flower pots, drinking straws, non-electric cooking utensils, ironing boards and shaped covers therefor, drying racks for washing, clothes drying hangers, ornaments and decorative goods of glass, porcelain, earthenware or clay, statues, figurines and vases, perfume burners, perfume sprayers, perfume vaporizers, electric or non-electric make-up removing appliances, powder puffs, toilet cases, plant watering devices and containers, ropes, strings, hammocks, tents, bags of textile, yarns, threads, textile goods for household use, curtains, bed covers, sheets (textile), pillowcases, blankets, quilts, towels, flags, labels, blankets, clothing, headgear, footwear, swimwear, scarves, hats, caps, Laces and embroidery, guipures, festoons, ribbons (haberdashery), ribbons and braid, fastening tapes for clothing, cords for clothing, letters and numerals for marking linen, embroidered emblems, badges for wear, not of precious metal, shoulder pads for clothing, buttons for clothing, fasteners for clothing, eyelets for clothing, zippers, buckles for shoes and belts, fasteners, shoe and belt buckles, pins, other than jewellery, adhesive patches for decoration of textile articles, laces, need-

les, sewing needles, needles for sewing machines, needles for knitting and embroidery, boxes for needles, needle cushions, artificial flowers, artificial fruits, hair pins, hair buckles, hair bands, decorative articles for the hair, wigs, hair extensions, electric or non-electric hair curlers, carpets, rugs, mats, wallpaper, wall hangings, games, toys, gymnastic and sporting articles, fishing tackle, artificial fishing bait, decoys for hunting and fishing, Christmas trees of artificial material, ornaments for Christmas trees, artificial snow, rattles (playthings), novelties for parties, paper party hats, foodstuff, beverages, matches, tobacco and tobacco products enabling customers to conveniently view and purchase those goods, such services may be provided by retail stores, wholesale outlets, through vending machines, mail order catalogues or by means of electronic media, for example, through web sites or television shopping programmes.

(260) AM 2023 120386 A

(800) 1696016

(151) 2022 02 06

(891) 2022 02 06

(731) DSM GRUP DANIŞMANLIK İLETİŞİM VE SATIŞ TİCARET A.Ş.

Maslak Mahallesi Büyükdere Caddesi,

(Spine Plaza) No:243, İç Kapı No:19

Sarıyer, İstanbul, Türkiye

(540)

## Trendyol Ecofriendly

(591) Black, white

(531) 27.05.01

(511)

25 – Clothing, footwear and headwear for human beings namely clothing; outer clothing; waterproof clothing; overalls; overcoats; paper clothing; parkas; pelerines; pelisses; petticoats; pockets for clothing; ponchos; rash guards; ready-made clothing; shirt fronts; shirts; shirt yokes; short-sleeve shirts; coats; collars [clothing]; combinations [clothing]; suits; dresses; dressing gowns; dress shields; sweaters; aprons [clothing]; jackets [clothing]; clothing of imitations of leather; clothing of leather; liveries; maniples; mantillas; masquerade costumes; leggings [leg warmers]; leggings [trousers]; leotards; tee-shirts; tights; trousers; trouser straps; uniforms; vests, babies' pants [underwear]; bibs, not of paper; layettes [clothing]; bathing caps; bathing suits; bathing trunks; bath robes; bath sandals; bath slippers; beach clothes; beach shoes; wet suits for water-skiing; cyclists' clothing jackets [clothing]; jerseys [clothing]; judo uniforms; jumper dresses; karate uniforms; kimonos; knitwear [clothing]; fishing vests; furs [clothing]; fur stoles; clothing containing slimming substances; clothing for gymnastics; clothing incorporating LEDs; motorists' clothing; belts [clothing]; money belts [clothing]; headwear; berets; caps being headwear; hats; headbands

[clothing]; headscarves; hoods [clothing]; visors being headwear; ear muffs [clothing]; cuffs; detachable collars; gloves [clothing]; mittens; muffs [clothing]; neck gaiters; neckties; paper hats [clothing]; shower caps; ready-made linings [parts of clothing]; saris; sarongs; sashes for wear; scarfs; shawls; veils [clothing]; togas; turbans; bandanas [neckerchiefs]; ascots; bodices [lingerie]; camisoles; corselets; corsets [underclothing]; garters; girdles; boxer shorts; braces for clothing [suspenders]; gaiters; pyjamas; panties; brassieres; underpants; underwear; sweat-absorbent underwear; hosiery; stockings; stocking suspenders; footwear; shoes; footwear uppers; boots; boots for sports; boot uppers; sandals; football boots; foot muffs, not electrically heated; gymnastic shoes; half-boots; heelpieces for footwear; heelpieces for stockings; heel protectors for shoes; heels; inner soles; galoshes; breeches for wear; non-slipping devices for footwear; ski boots; ski gloves; skirts; shorts; skull caps; sleep masks; slippers; slips [underclothing]; socks; sock suspenders; soles for footwear; sports jerseys; sports shoes; sports singlets.

35 – Advertising; business management; business administration; office functions; organization, operation and supervision of loyalty and incentive schemes; advertising services provided via the Internet; production of television and radio advertisements; accountancy; auctioneering; trade fairs; opinion polling; data processing; provision of business information; advertising agency services; advertising services provided for others; database management; compilation of information into computer databases; business consulting services; business consulting services in the field of web based events, conferences, training programs, learning programs, and seminars; business consulting services in the field of delivering web-based knowledge; business consulting services in the field of online collaboration and collaboration technologies; business consulting services in the fields of sales and marketing; business project management services; business project management services relating to development, set up; staging, production, recording, monitoring and follow-up for web based events, conferences, training programs, learning programs, and seminars; market research and business consulting services; business consultancy services relating to facilitating the transaction of business via local and global computer networks by locating and providing referrals for the delivery of a wide variety of business and consumer products and services; dissemination of business information of goods and services of others via local and global computer networks; business consultancy services relating to providing a web site on a global computer network by which third parties can offer and source goods and services, place, determine the status of and fulfil trade leads and orders, enter into contracts and transact business; providing computerized online ordering services; advertising of goods and services of others via local and global computer

networks; international import and export agency services; rental of advertising space on communication media; online trading services relating to electronic auctioneering and providing online business evaluation relating thereto; providing a directory of third party web sites to facilitate business transactions; business consultancy services relating to operating an electronic marketplace for the buyers and sellers of goods and/or services on a global computer network; business assistance relating to facilitating business transaction via local and global computer networks; corporate management consultancy services; marketing and promotion services; publication of publicity materials; marketing of vacant premises; dissemination of advertising materials, updating of advertising materials, compilation of advertisements for use as web pages on the Internet; rental of advertising space; computer data processing; sales, business and promotional information services; telephone answering (for unavailable subscribers); telephone answering (for others); auctioneering provided on the Internet; personnel management; provision of sales, business, advertising and promotional information through a global computer network and via the Internet; presentation of goods on communication media for retail purposes; retail and wholesale of cosmetics, perfumery, toiletries, dentifrices, soaps, detergents, deodorants for personal use and household use, bleaching and cleaning preparations, dental care preparations, dentifrices, mouth washes, polishing preparations, candles, wax, pharmaceuticals, veterinary and medical preparations, disinfectants, dietary supplements, baby food, herbs and herbal beverages, sanitary preparations, sanitary diapers, sanitary pads, goods and materials of common metal used for storage, wrapping, packaging and sheltering purposes, containers of metal (storage, transport), metal boxes, packaging containers of metal, aluminium foil, storage containers of metal, metal containers for the transportation of goods, ladders of metal, ironmongery, small hardware of metal, safes of metal, machines, machine tools and industrial robots for processing and shaping wood, metals, glass, plastics and minerals, 3D printers, electric kitchen machines for chopping, grinding, crushing, mixing and mincing foodstuff, washing machines, laundry washing machines, dishwashers, spin driers (not heated), electric cleaning machines for cleaning floors, carpets or floorings, vacuum cleaners and parts thereof, forks, spoons, knives and non-electric cutters, slicers, peelers for kitchen use, including those made of precious metals, tools and apparatus for personal beauty care use, tools and apparatus for shaving, epilation, manicure and pedicure, electric hand implements for straightening and curling hair, scissors, hand-operated hand tools for the repair of machines, apparatus and vehicles and for use in construction, agriculture, horticulture and forestry, electric or non-electric irons, steam irons, thermometers, microscopes, magnifying glasses, apparatus for recording, transmission or

reproduction of sound or images, cameras, photographic cameras, television apparatus, video recorders, CD and DVD players and recorders, MP3 players, computers, desktop computers, tablet computers, microphones, loudspeakers, earphones, telecommunications apparatus, apparatus for the reproduction of sound or images, computer peripheral devices, cell phones, covers for cell phones, telephone apparatus, computer printers, scanners as data processing equipment, photocopiers, magnetic and optic data carriers and computer software and programmes recorded thereto, downloadable and recordable electronic publications, encoded magnetic and optic cards, photocells, optical sensors, counters, clothing for protection against accidents, irradiation and fire, safety vests and life-saving apparatus and equipment, eyeglasses, sunglasses, optical lenses and cases, containers, parts and components thereof, decorative magnets, metronomes, medical orthopaedic articles, corsets for medical purposes, orthopaedic shoes, elastic bandages and supportive bandages, condoms, babies' bottles, babies' pacifiers, teats, teeters for babies, lighting installations, hair driers, hand drying apparatus, water softening apparatus, electric bed warmers and electric blankets, not for medical use, electric pillow warmers, electric or non-electric foot warmers, hot water bottles, pasteurizers and sterilizers, motorcycles, mopeds, vehicle seats, head-rests for vehicle seats, safety seats for children, for vehicles, seat covers for vehicles, vehicle covers, sun-blinds adapted for vehicles, wipers for vehicles, baby carriages, wheelchairs, pushchairs, shopping carts, shopping trolleys, fireworks, sprays for personal defence, jewellery, watches, statuettes and figurines of precious metal, clocks, watches, parts thereof, chronometers, music instruments, their cases, paper and cardboard, paper and cardboard for packaging and wrapping purposes, cardboard boxes, paper towels, toilet paper, paper napkins, plastic materials for packaging and wrapping purposes, printed publications, printed matter, books, magazines, newspapers, bill books, printed dispatch notes, printed vouchers, calendars, posters, photographs [printed], paintings, stickers [stationery], postage stamps, stationery, office stationery, instructional and teaching material [except furniture and apparatus], writing and drawing implements, artists' materials, paper products for stationery purposes, adhesives for stationery purposes, pens, pencils, erasers, adhesive tapes for stationery purposes, cardboard cartons [artists' materials], writing paper, copying paper, paper rolls for cash registers, drawing materials, chalkboards, painting pencils, watercolours [paintings], stationery, instructional and teaching material, writing and drawing implements, artists' materials, paper products for stationery purposes, adhesives for stationery purposes, pens, pencils, erasers, adhesive tapes for stationery purposes, cardboard cartons [artists' materials], writing paper, copying paper, paper rolls for cash registers, drawing materials, chalkboards, painting pencils, watercolours

[paintings], pint roller, paint brushes, rosaries, goods made of leather, imitations of leather or other materials designed for carrying items, bags, wallets, straps, boxes and trunks made of leather or stout leather, key cases, trunks [luggage], suitcases, umbrellas, parasols, walking sticks, monuments and statuettes of stone, concrete and marble, furniture, mattresses, pillows, air mattresses and cushions, sleeping bags for camping, water beds, mirrors, bouncing chairs for babies, playpens for babies, cradles, infant walkers, display boards, frames for pictures and paintings, identification plates, identification tags, nameplates, identification labels made of wood or synthetic materials, packaging containers of wood or plastics, storage containers, chests, ornaments and decorative goods of wood, cork, reed, cane, wicker, horn, bone, ivory, whalebone, shell, amber, mother-of-pearl, meerschaum, beeswax, plastic or plaster, figurines, holiday ornaments for walls and sculptures, baskets, kennels, nesting boxes and beds for household pets, cages for household pets, indoor aquariums, vivarium and indoor terrariums for animals and plant cultivation, bamboo curtains, roller indoor blinds [for interiors], slatted indoor blinds, strip curtains, bead curtains for decoration, curtain hooks, curtain rings, curtain tie-backs, curtain rods, hand-operated non-electric cleaning instruments and appliances, brushes, other than paintbrushes, sponges for cleaning, steel wool for cleaning, cloths of textile for cleaning, gloves for dishwashing, non-electric polishing machines for household purposes, brooms for carpets, mops, tooth brushes, shaving brushes, hair brushes, non-electric household or kitchen utensils, service dishes, pots and pans, bottle openers, flower pots, drinking straws, non-electric cooking utensils, ironing boards and shaped covers therefor, drying racks for washing, clothes drying hangers, ornaments and decorative goods of glass, porcelain, earthenware or clay, statues, figurines and vases, perfume burners, perfume sprayers, perfume vaporizers, electric or non-electric make-up removing appliances, powder puffs, toilet cases, plant watering devices and containers, ropes, strings, hammocks, tents, bags of textile, yarns, threads, textile goods for household use, curtains, bed covers, sheets (textile), pillowcases, blankets, quilts, towels, flags, labels, blankets, clothing, headgear, footwear, swimwear, scarves, hats, caps, laces and embroidery, guipures, festoons, ribbons (haberdashery), ribbons and braid, fastening tapes for clothing, cords for clothing, letters and numerals for marking linen, embroidered emblems, badges for wear, not of precious metal, shoulder pads for clothing, buttons for clothing, fasteners for clothing, eyelets for clothing, zippers, buckles for shoes and belts, fasteners, shoe and belt buckles, pins, other than jewellery, adhesive patches for decoration of textile articles, laces, needles, sewing needles, needles for sewing machines, needles for knitting and embroidery, boxes for needles, needle cushions, artificial flowers, artificial fruits, hair pins, hair buckles, hair bands,

decorative articles for the hair, wigs, hair extensions, electric or non-electric hair curlers, carpets, rugs, mats, wallpaper, wall hangings, games, toys, gymnastic and sporting articles, fishing tackle, artificial fishing bait, decoys for hunting and fishing, Christmas trees of artificial material, ornaments for Christmas trees, artificial snow, rattles (playthings), novelties for parties, paper party hats, foodstuff, beverages, matches, tobacco and tobacco products enabling customers to conveniently view and purchase those goods, such services may be provided by retail stores, wholesale outlets, through vending machines, mail order catalogues or by means of electronic media, for example, through web sites or television shopping programmes.

(260) AM 2023 120387 A

(800) 1696031

(151) 2022 08 17

(891) 2022 08 17

(731) YENİ MAĞAZACILIK ANONİM ŞİRKETİ  
BURHANİYE MAH. NAGEHAN SK. 4 B 1,  
Üsküdar, İstanbul, Türkiye

(540)



(591) Turquoise, white, black and yellow

(531) 24.17.05; 26.04.04; 26.04.17; 26.04.18;  
27.05.24; 27.07.24; 29.01.13

(511)

35 – Advertising, marketing and public relations; organization of exhibitions and trade fairs for commercial or advertising purposes; office functions; secretarial services; arranging newspaper subscriptions for others; compilation of statistics; rental of office machines; systemization of information into computer databases; telephone answering for unavailable subscribers; business management, business administration and business consultancy; accounting; commercial consultancy services; personnel recruitment, personnel placement, employment agencies, import-export agencies; temporary personnel placement services; auctioneering; the bringing together, for the benefit of others, of a variety of goods, namely chemicals used in industry, science, photography, agriculture, horticulture and forestry, manures and soils, unprocessed artificial resins and unprocessed plastics, fire extinguishing compositions, adhesives not for medical, household and stationery purposes, paints, varnishes, lacquers, preservatives against rust, preservatives against deterioration of wood, thinners and binders for paints, pigments, preservatives for metals, shoe dyes,



printing dyes and ink, toners (including filled toner cartridges), colorants for food, pharmaceuticals and beverages, raw natural resins, metals in foil and powder form for painters, decorators, printers and artists, bleaching and cleaning preparations, detergents other than for use in manufacturing operations and for medical purposes, laundry bleach, fabric softeners for laundry use, stain removers, dishwasher detergents, perfumery, cosmetics, fragrances, deodorants for personal use and animals, dental care preparations namely dentifrices, denture polishes, tooth whitening preparations, mouth washes, not for medical purposes, abrasive preparations, emery cloth, sandpaper, pumice stone, abrasive pastes, polishing preparations for leather, vinyl, metal and wood, polishes and creams for leather, vinyl, metal and wood, wax for polishing, industrial oils and greases, cutting fluids, dust absorbing, wetting and binding compositions, solid fuels, coal, firewood, liquid and gas fuels, petrol, diesel oil, liquified petroleum gas, natural gas, fuel oil and their non-chemical additives, candles, wicks, semi-finished wax, wax and paraffin for lighting purposes, pharmaceutical and veterinary preparations for medical purposes, chemical preparations for medical and veterinary purposes, chemical reagents for pharmaceutical and veterinary purposes, dietary supplements for pharmaceutical and veterinary purposes, dietary supplements, nutritional supplements, medical preparations for slimming purposes, food for babies, herbs and herbal beverages adapted for medicinal purposes, dental preparations and articles, teeth filling material, dental impression material, dental adhesives and material for repairing teeth, sanitary preparations for medical use, hygienic pads, hygienic tampons, plasters, materials for dressings, diapers, including those made of paper and textiles, preparations for destroying vermin, fungicides, pharmaceutical and veterinary, deodorants, other than for human beings or for animals, air deodorising preparations, disinfectants, antiseptics, detergents for medical purposes, ores of non-precious metal, common metals and their alloys and semi-finished products made of these materials, goods and materials of common metal used for storage, wrapping, packaging and sheltering purposes, containers of metal (storage, transport), buildings of metal, frames of metal for building, poles of metal for building, metal boxes, packaging containers of metal, aluminium foil, fences made of metal, guard barriers of metal, metal tubes, storage containers of metal, metal containers for the transportation of goods, ladders of metal, goods of common metal for filtering and sifting purposes, doors, windows, shutters, jalousies and their cases and fittings of metal, non-electric cables and wires of metal, ironmongery, small hardware of metal, ventilation ducts, vents, vent covers, pipes, chimney caps, manhole covers, grilles of metal for ventilation, heating, sewage, telephone, underground electricity and air conditioning installations, metal panels or boards (non-luminous and non-mechanical) used for

signalling, route showing, publicity purposes, signboards of metal, advertisement columns of metal, signaling panels of metal, non-luminous and non-mechanical traffic signs of metal, pipes of metal for transportation of liquids and gas, drilling pipes of metal and their metal fittings, valves of metal, couplings of metal for pipes, elbows of metal for pipes, clips of metal for pipes, connectors of metal for pipes, safes (strong boxes) of metal, metal railway materials, metal rails, metal railway ties, railway switches, bollards of metal, floating docks of metal, mooring buoys of metal, anchors, metal moulds for casting, other than machine parts, works of art made of common metals or their alloys, metal closures, bottle caps of metal, metal poles, metal pallets and metal ropes for lifting, loading and transportation purposes, metal hangers, ties, straps, tapes and bands used for load-lifting and load-carrying, wheel chocks made primarily of metal, machines, machine tools and industrial robots for processing and shaping wood, metals, glass, plastics and minerals, 3D printers, construction machines and robotic mechanisms (machines) for use in construction, bulldozers, diggers (machines), excavators, road construction and road paving machines, drilling machines, rock drilling machines, road sweeping machines, lifting, loading and transmission machines and robotic mechanisms (machines) for lifting, loading and transmission purposes, elevators, escalators and cranes, machines and robotic mechanisms (machines) for use in agriculture and animal breeding, machines and robotic mechanisms (machines) for processing cereals, fruits, vegetables and food, engines and motors, other than for land vehicles, parts and fittings therefor, hydraulic and pneumatic controls for engines and motors, brakes other than for vehicles, brake linings for engines, crankshafts, gearboxes, other than for land vehicles, gearboxes, cylinders for engines, pistons for engines, turbines, not for land vehicles, filters for engines and motors, oil, air and fuel filters for land vehicle engines, exhausts for land vehicle engines, exhaust manifolds for land vehicle engines, engine cylinders for land vehicles, engine cylinder heads for land vehicles, pistons for land vehicle engines, carburetors for land vehicles, fuel conversion apparatus for land vehicle engines, injectors for land vehicle engines, fuel economisers for land vehicle engines, pumps for land vehicle engines, valves for land vehicle engines, starter motors for land vehicles, dynamos for land vehicle engines, sparking plugs for land vehicle engines, bearings (parts of machines), roller or ball bearings, machines for mounting and detaching tires, alternators, current generators, electric generators, current generators operated with solar energy, painting machines, automatic spray guns for paint, electric, hydraulic and pneumatic punching machines and guns, electric adhesive tape dispensers (machines), electric guns for compressed gas or liquid spraying machines, electric hand drills, electric hand saws, electric jigsaw machines, spiral machines, compressed

air machines, compressors (machines), vehicle washing installations, robotic mechanisms (machines) with the abovementioned functions, electric and gas-operated welding apparatus, electric arc welding apparatus, electric soldering apparatus, electric arc cutting apparatus, electrodes for welding machines, industrial robots (machines) with the abovementioned functions, printing machines, packaging machines, filling, plugging and sealing machines, labellers (machines), sorting machines, industrial robots (machines) with the abovementioned functions, electric packing machines for plugging and sealing of plastics, machines for textile processing, sewing machines, industrial robots (machines) with the abovementioned functions, pumps other than parts of machines or engines, fuel dispensing pumps for service stations, self-regulating fuel pumps, electric kitchen machines for chopping, grinding, crushing, mixing and mincing foodstuff, washing machines, laundry washing machines, dishwashers, spin driers (not heated), electric cleaning machines for cleaning floors, carpets or floorings, vacuum cleaners and parts thereof, automatic vending machines, galvanizing and electroplating machines, electric door openers and closers, joints (parts of engines), forks, spoons, knives and non-electric cutters, slicers, peelers for kitchen use, including those made of precious metals, side arms and blades (weapons), tools and apparatus for personal beauty care use, tools and apparatus for shaving, epilation, manicure and pedicure, electric hand implements for straightening and curling hair, scissors, hand-operated [non-electric] hand tools for the repair of machines, apparatus and vehicles and for use in construction, agriculture, horticulture and forestry, none of them being power tools, electric or non-electric irons, steam irons, measurement apparatus and equipment including those for scientific, nautical, topographic, meteorologic, industrial and laboratory purposes, thermometers, not for medical purposes, barometers, ammeters, voltmeters, hygrometers, testing apparatus not for medical purposes, telescopes, periscopes, directional compasses, speed indicators, laboratory apparatus, microscopes, magnifying glasses, stills, ovens and furnaces for laboratory experiments, apparatus for recording, transmission or reproduction of sound or images, cameras, photographic cameras, television apparatus, video recorders, CD and DVD players and recorders, MP3 players, computers, desktop computers, tablet computers, microphones, loudspeakers, earphones, telecommunications apparatus, apparatus for the reproduction of sound or images, computer peripheral devices, cell phones, covers for cell phones, telephone apparatus, computer printers, scanners [data processing equipment], photocopiers, magnetic and optic data carriers and computer software and programmes recorded thereto, downloadable and recordable electronic publications, encoded magnetic and optic cards, antennas, satellite antennas, amplifiers for antennas, parts of the aforementioned goods,

ticket dispensers, automatic teller machines (ATM), electronic components used in the electronic parts of machines and apparatus, semi-conductors, electronic circuits, integrated circuits, chips [integrated circuits], diodes, transistors [electronic], magnetic heads for electronic apparatus, electronic locks, photocells, remote control apparatus for opening and closing doors, optical sensors, counters and quantity indicators for measuring the quantity of consumption, automatic time switches, clothing for protection against accidents, irradiation and fire, safety vests and life-saving apparatus and equipment, eyeglasses, sunglasses, optical lenses and cases, containers, parts and components thereof, apparatus and instruments for conducting, transforming, accumulating or controlling electricity, electric plugs, junction boxes [electricity], electric switches, circuit breakers, fuses, lighting ballasts, battery starter cables, electrical circuit boards, electric resistances, electric sockets, transformers [electricity], electrical adapters, battery chargers, electric door bells, electric and electronic cables, batteries, electric accumulators, alarms and anti-theft alarms, other than for vehicles, electric bells, signalling apparatus and instruments, luminous or mechanical signs for traffic use, fire extinguishing apparatus, fire engines, fire hose and fire hose nozzles, radar apparatus, sonars, night vision apparatus and instruments, decorative magnets, metronomes, surgical, medical, dental and veterinary apparatus and instruments, furniture especially made for medical purposes, artificial limbs and prostheses, medical orthopaedic articles, corsets for medical purposes, orthopaedic shoes, elastic bandages and supportive bandages, surgical gowns and surgical sterile sheets, adult sexual aids, condoms, babies' bottles, babies' pacifiers, teats, teethers for babies, lighting installations, lights for vehicles and interior-exterior spaces, heating installations using solid, liquid or gas fuels or electricity, central heating boilers, boilers for heating installations, radiators [heating], heat exchangers, not parts of machines, stoves, kitchen stoves, solar thermal collectors [heating], steam, gas and fog generators, steam boilers, other than parts of machines, acetylene generators, oxygen generators, nitrogen generators, installations for air-conditioning and ventilating, cooling installations and freezers, electric and gas-powered devices, installations and apparatus for cooking, drying and boiling; cookers, electric cooking pots, electric water heaters, barbecues, electric laundry driers, hair driers, hand drying apparatus, sanitary installations, taps [faucets], shower installations, toilets [water-closets], shower and bathing cubicles, bath tubs, toilet seats, sinks, wash-hand basins [parts of sanitary installations], water softening apparatus, water purification apparatus, water purification installations, waste water purification installations, electric bed warmers and electric blankets, not for medical use, electric pillow warmers, electric or non-electric footwarmers, hot water bottles, filters for aquariums and aquarium filtration apparatus, industrial type ins-

tallations for cooking, drying and cooling purposes, pasteurizers and sterilizers, motor land vehicles, motorcycles, mopeds, engines and motors for land vehicles, clutches for land vehicles, transmissions, transmission belts and transmission chains for land vehicles, gearing for land vehicles, brakes, brake discs and brake linings for land vehicles, vehicle chassis, automobile bonnets, vehicle suspension springs, shock absorbers for automobiles, gearboxes for land vehicles, steering wheels for vehicles, rims for vehicle wheels, bicycles and their bodies, handlebars and mudguards for bicycles, vehicle bodies, tipping bodies for trucks, trailers for tractors, frigorific bodies for land vehicles, trailer hitches for vehicles, vehicle seats, head-rests for vehicle seats, safety seats for children, for vehicles, seat covers for vehicles, vehicle covers (shaped), sun-blinds adapted for vehicles, direction signals and anus for direction signals for vehicles, windscreen wipers and wiper arms for vehicles, inner and outer tires for vehicle wheels, tubeless tires, tire-fixing sets comprised of tire patches and tire valves for vehicles, windows for vehicles, safety windows for vehicles, rear-view mirrors and wing mirrors for vehicles, anti-skid chains for vehicles, luggage carriers for vehicles, bicycle and ski carriers for cars, saddles for bicycles or motorcycles, air pumps for vehicles, for inflating tires, anti-theft alarms for vehicles, horns for vehicles, safety belts for vehicle seats, air bags (safety devices for automobiles), baby carriages, wheelchairs, push-chairs, wheelbarrows, shopping carts, single or multi-wheeled wheelbarrows, shopping trolleys, grocery carts, handling carts, rail vehicles, locomotives, trains, trams, waggons, cable cars, chairlifts, vehicles for locomotion by water and their parts, other than their motors and engines, vehicles for locomotion by air and their parts, other than their motors and engines, firearms, air pistols (weapons), spring-loaded firearms, adapted cases and shoulder straps therefor, heavy weapons, mortars and rockets, fireworks, sprays for personal defence purposes, jewellery, imitation jewellery, gold, precious stones and jewellery made thereof, cufflinks, tie pins, statuettes and figurines of precious metal, clocks, watches and chronometrical instruments, chronometers and their parts, watch straps, musical instruments and cases for musical instruments, paper and cardboard, paper and cardboard for packaging and wrapping purposes, cardboard boxes, paper towels, toilet paper, paper napkins, plastic materials for packaging and wrapping purposes, printing blocks and types, bookbinding material, printed publications, printed matter, books, magazines, newspapers, bill books, printed dispatch notes, printed vouchers, calendars, posters, photographs [printed], paintings, stickers [stationery], postage stamps, stationery, office stationery, instructional and teaching material [except furniture and apparatus], writing and drawing implements, artists' materials, paper products for stationery purposes, adhesives for stationery purposes, pens, pencils, erasers, adhesive tapes for stationery

purposes, cardboard cartons [artists' materials], writing paper, copying paper, paper rolls for cash registers, drawing materials, chalkboards, painting pencils, watercolors [paintings], office requisites, paint rollers and paintbrushes for painting, rosaries, rubber, gutta-percha, gum, asbestos, mica and semi-finished synthetic goods made from these materials in the form of powder, bars, panels and foils, insulation, stopping and sealing materials, insulation paints, insulation fabrics, insulating tape and band, insulation covers for industrial machinery, joint sealant compounds for joints, gaskets, O-rings for scaling purposes, flexible pipes made from rubber and plastic, hoses made of plastic and rubber, including those used for vehicles, junctions for pipes of plastic and rubber, pipe jackets of plastic and rubber, hoses of textile material, junctions for pipes, not of metal, pipe jackets, not of metal, connecting hose for vehicle radiators, unworked or semi-worked leather and animal skins, imitations of leather, stout leather, leather used for linings, goods made of leather, imitations of leather or other materials, designed for carrying items, bags, wallets, boxes and trunks made of leather or stout leather, keycases, trunks [luggage], suitcases, umbrellas, parasols, sun umbrellas, walking sticks, whips, harness, saddlery, stirrups, straps of leather (saddlery), sand, gravel, crushed stone, asphalt, bitumen, cement, gypsum, plaster, concrete, marble blocks for construction, building materials (as finished products) made of concrete, gypsum, clay, potters' clay, stone, marble, wood, plastics and synthetic materials for building, construction, road construction purposes, non-metallic buildings, non-metallic building materials, poles not of metal for power lines, barriers not of metal, natural and synthetic coatings in the form of panels and sheets, being building materials, bitumen cardboard coatings for roofing, bitumen coating for roofing, doors and windows of wood and synthetic materials, traffic signs not of metal, non-luminous and non-mechanical, for roads, monuments and statuettes of stone, concrete and marble, building glass, prefabricated swimming pools not of metal (structures), aquarium sand, furniture, made of any kind of material, mattresses, pillows, air mattresses and cushions, not for medical purposes, sleeping bags for camping, water beds, not for medical purposes, mirrors, beehives, artificial honeycombs and sections of wood for honeycombs, bouncing chairs for babies, playpens for babies, cradles, infant walkers, display boards, frames for pictures and paintings, identification plates, identification tags, nameplates, identification labels made of wood or synthetic materials, packaging containers of wood or plastics, casks for use in transportation or storage, barrels, storage drums, tanks, boxes, storage containers, transportation containers, chests, loading pallets and closures for the aforementioned goods, of wood or plastics, small hardware goods of wood or synthetic materials, furniture fittings, of wood or synthetic materials, opening and closing mechanisms of wood or

synthetic materials, ornaments and decorative goods of wood, cork, reed, cane, wicker, horn, bone, ivory, whalebone, shell, amber, mother-of-pearl, meerschaum, beeswax, plastic or plaster namely figurines, holiday ornaments for walls and sculptures, baskets, fishing baskets, kennels, nesting boxes and beds for household pets, portable ladders and mobile boarding stairs of wood or synthetic materials, bamboo curtains, roller indoor blinds [for interiors], slatted indoor blinds, strip curtains, bead curtains for decoration, curtain hooks, curtain rings, curtain tie-backs, curtain rods, non-metal wheel chocks, hand-operated non-electric cleaning instruments and appliances, brushes, other than paintbrushes, steel chips for cleaning, sponges for cleaning, steel wool for cleaning, cloths of textile for cleaning, gloves for dishwashing, non-electric polishing machines for household purposes, brooms for carpets, mops, toothbrushes, electric toothbrushes, dental floss, shaving brushes, hair brushes, combs, non-electric household or kitchen utensils [other than forks, knives, spoons], services [dishes], pots and pans, bottle openers, flower pots, drinking straws, non-electric cooking utensils, ironing boards and shaped covers therefor, drying racks for washing, clothes drying hangers, cages for household pets, indoor aquariums, vivariums and indoor terrariums for animals and plant cultivation, ornaments and decorative goods of glass, porcelain, earthenware or clay namely statues, figurines and vases, mouse traps, insect traps, electric devices for attracting and killing flies and insects, fly catchers, fly swatters, perfume burners, perfume sprayers, perfume vaporizers, electric or non-electric make-up removing appliances, powder puffs, toilet cases, nozzles for sprinkler hose, nozzles for watering cans, watering devices, garden watering cans, unworked or semi-worked glass, except building glass, mosaics of glass and powdered glass for decoration, except for building, glass wool other than for insulation or textile use, ropes, strings, rope ladders, hammocks, fishing nets, tents, awnings, tarpaulins, sails, vehicle covers, not fitted, bags of textile, for packaging, padding and stuffing materials, except of rubber and plastics, including those of wool and cotton, textile fibers, raw spun fiber, glass fibers for textile use, yarns and threads for textile use, threads and yarns for sewing, embroidery and knitting, thread, elastic yarns and threads for textile use, woven or non-woven textile fabrics, textile goods for household use, curtains, bed covers, sheets (textile), pillowcases, blankets, quilts, towels, flags, pennants, labels of textile, swaddling blankets, clothing, including underwear and outerclothing, other than special purpose protective clothing, socks, mufflers [clothing], shawls, bandanas, scarves, belts [clothing], footwear, shoes, slippers, sandals, headgear, hats, caps with visors, berets, caps [headwear], skull caps, laces and embroidery, guipures, festoons, ribbons (haberdashery), ribbons and braid, fastening tapes for clothing, cords for clothing, letters and numerals for marking linen, em-

broidered emblems, badges for wear, not of precious metal, shoulder pads for clothing, buttons for clothing, fasteners for clothing, eyelets for clothing, zippers, buckles for shoes and belts, fasteners, shoe and belt buckles, pins, other than jewellery, adhesive patches for decoration of textile articles, laces, needles, sewing needles, needles for sewing machines, needles for knitting and embroidery, boxes for needles, needle cushions, artificial flowers, artificial fruits, hair pins, hair buckles, hair bands, decorative articles for the hair, not made of precious metal, wigs, hair extensions, electric or non-electric hair curlers, other than hand implements, carpets, rugs, mats, prayer rugs, linoleum, artificial turf, linoleum for covering floors, gymnasium mats, wallpaper, wall hangings not of textile, games and toys, arcade video game machines, game apparatus and machines for use with an external display screen and monitor, including those coin-operated, toys for animals, toys for outdoor playgrounds, parks and game parks, gymnastic and sporting articles, fishing tackle, artificial fishing bait, decoys for hunting and fishing, Christmas trees of artificial material, ornaments for Christmas trees, artificial snow for Christmas trees, rattles (playthings), novelties for parties, dances (party favors), paper party hats, meal, fish, poultry and game, processed meat products, dried pulses, soups, bouillon, processed olives, olive paste, milk and milk products, butter, edible oils, dried, preserved, frozen, cooked, smoked or salted fruits and vegetables, tomato paste, prepared nuts and dried fruits as snacks, hazelnut spreads and peanut butter, tahini (sesame seed paste), eggs and powdered eggs, potato chips, coffee, cocoa, coffee or cocoa based beverages, chocolate based beverages, pasta, stuffed dumplings, noodles, pastries and bakery products based on flour, desserts based on flour and chocolate, bread, simit [Turkish ring-shaped bagel covered with sesame seeds], poğaç [Turkish bagel], pita, sandwiches, katmer [Turkish pastry], pies, cakes, baklava [Turkish dessert based on dough coated with syrup], kadayıf [Turkish dessert based on dough], desserts based on dough coated with syrup, puddings, custard, kazandibi [Turkish pudding], rice pudding, keşkül [Turkish pudding], honey, bee glue for human consumption, propolis for food purposes, condiments for foodstuff, vanilla (flavoring), spices, sauces (condiments), tomato sauce, yeast, baking powder, flour, semolina, starch for food, sugar, cube sugar, powdered sugar, tea, ice tea, confectionery, chocolate, biscuits, crackers, wafers, chewing gums, ice-cream, edible ices, salt, cereal-based snack food, popcorn, crushed oats, corn chips, breakfast cereals, processed wheat for human consumption, crushed barley for human consumption, processed oats for human consumption, processed rye for human consumption, rice, molasses for food, agricultural and horticultural products, seeds, forestry products, live animals, fertilized eggs for hatching, plants, dried plants for decoration, fresh garden herbs, dried garden herbs for decoration, animal

foodstuffs, mall not for human consumption, beers, preparations for making beer, mineral water, spring water, table water, soda water, fruit and vegetable juices, fruit and vegetable concentrates and extracts for making beverages, non-alcoholic soft drinks, energy drinks, alcoholic beverages (except beers), wines, raki [traditional Turkish alcoholic drink], whisky, liqueurs, alcoholic cocktails, tobacco, chewing tobacco, cigarettes, cigars, smokers' articles including those made of precious metals, pipes, mouthpieces for cigars and cigarettes, ashtrays, tobacco boxes, pocket apparatus for rolling cigarettes, cigarette paper, tobacco pipes, firestones, lighters for smokers, matches, enabling customers to conveniently view and purchase those goods, such services may be provided by retail stores, wholesale outlets, by means of electronic media or through mail order catalogues.

36 – Insurance services; financial and monetary affairs; real estate brokers, real estate agencies and real estate management; customs brokerage services.

(260) AM 2023 120397 A  
(800) 1696161  
(151) 2022 08 29  
(891) 2022 08 29  
(731) "HAYR YEV VORDI YEREMYANNER"  
LLC  
Yervand Kochar Street 27/25, Yerevan,  
Armenia

(540)



(591) Black, white  
(531) 11.01.09; 26.04.09; 26.04.16; 26.04.18;  
27.05.01; 28.05; 28.19

(511)

43 – Services for providing food and drink; temporary accommodation.

(260) AM 2023 120429 A  
(800) 1599502  
(151) 2021 04 15  
(891) 2022 09 15  
(731) SOLEPHARM PHARMACEUTICALS, SIA  
Alkšņu iela 4, Jaunmārupe, LV-2166  
Mārupes novads, Latvia

(540)

**SOLVITALE**

(591) Black, white

(511)

5 – Pharmaceutical and veterinary preparations.

(260) AM 2023 120432 A  
(800) 1679810  
(151) 2022 06 24  
(891) 2022 09 28  
(731) Kurchyna Olena Henadiivna  
vul. Drahomyrova, 18A, kv. 35, m. Kyiv 01014,  
Ukraine

(540)

**ÉLAN**

(591) Black, white

(531) 27.05.01

(511)

3 – Beard dyes; hair colorants; hair dyes; colorants for toilet purposes; lip glosses; cotton wool for cosmetic purposes; bleaching preparations [decolorants] for cosmetic purposes; make-up; lipsticks; cosmetics; eyebrow cosmetics; cosmetic preparations for eyelashes; beauty masks; cosmetic kits; cosmetic preparations for skin care; cosmetic creams; lotions for cosmetic purposes; eyebrow pencils; cosmetic pencils; pomades for cosmetic purposes; make-up preparations; make-up removing preparations; tissues impregnated with cosmetic lotions.

(260) AM 2023 120454 A  
(800) 1697078  
(151) 2022 09 21  
(891) 2022 09 21  
(731) SHENZHEN SIKENAI INDUSTRIAL CO.,  
LIMITED  
2 / F and 3 / F, No. 5, Qiushuiling Industrial  
Zone, E'gongling Community, Pinghu Street,  
Longgang District, Shenzhen City,  
Guangdong Province, China

(540)



(591) Black, white

(531) 26.04.04; 26.04.18; 27.05.01

(511)

9 – USB flash drives; liquid crystal display [LCD] screens; protective films adapted for mobile telephone screens; covers for smartphones; headphones; cases for smartphones; electrical plugs and sockets; power banks; battery chargers; batteries.

(260) AM 2023 120455 A  
 (800) 1697176  
 (151) 2022 10 25  
 (891) 2022 10 25  
 (731) SUSHI JIRO IP PTY LTD  
 Level 7, SE 1 520 Collins St, Melbourne  
 VIC 3000, Australia

(540)  

(591) Blue  
 (531) 03.09.01; 03.09.24; 27.03.01; 27.03.03;  
 27.05.02; 28.03; 29.01.12

(511)  
 43 – Cafe services; cafes; take away food services; advisory services relating to catering; booking of catering services; business catering services; catering services; catering services for the provision of coffee for offices; charitable services, namely providing food and drink catering; contract catering services; food and drink catering; hotel catering services; mobile catering services; office catering services for the provision of coffee; provision of self catering holiday accommodation; booking of restaurant places; booking of restaurant seats; inn keeping (bar, restaurant and accommodation); provision of information relating to restaurants; provision of restaurant booking or reservations from customer loyalty and frequent buyer schemes; rental of cooking equipment for restaurants; restaurant booking or reservation services provided in relation to a customer loyalty or frequent buyer scheme; restaurant booking or reservation services provided in relation to a frequent flyer scheme; restaurant booking or reservation services provided in relation to frequent flyer schemes; restaurant reservation services; restaurant services; restaurant services for the provision of fast food; restaurants; salad bar restaurant services; self-service restaurants; theatre restaurants (provision of food and drink); udon and soba restaurant services; washoku restaurant services; food cooking services; consultancy services relating to food preparation; food preparation; internet cafe services (provision of food and drink prepared for consumption); preparation of food and drink; preparation of take-away and fast food; provision of information relating to the preparation of food and drink; takeaway food and drink services.

(260) AM 2023 120456 A  
 (800) 1697182  
 (151) 2022 06 20  
 (891) 2022 06 20  
 (731) Euro Games Technology Ltd.  
 4, "Maritsa" Str., "Vranya-Lozen-Triugulnika",  
 BG-1151 Sofia, Bulgaria

(540)



(591) Yellow, brown and red  
 (531) 27.05.01; 27.05.03; 27.05.09; 27.05.17;  
 27.07.03; 27.07.11; 27.07.17; 29.01.13

(511)  
 9 – Apparatus for recording, transmission or reproduction of sound or image, computer software /recorded/, monitors /computer hardware/.

28 – Games that are not included in other classes, gaming machines operating with coins, banknotes and cards; gaming machines for gambling.

(260) AM 2023 120457 A  
 (800) 1697256  
 (151) 2022 10 18  
 (891) 2022 10 18  
 (731) Cornerman Productions, LLC  
 130 South La Brea Avenue, Los Angeles  
 CA 90026, USA

(540)

## SUSHI CLUB

(591) Black, white  
 (511)

25 – Clothing, namely, hats, jackets, pants, shirts, shorts, tops, bottoms, footwear and sweatshirts.

(260) AM 2023 120458 A  
 (800) 1697322  
 (151) 2022 10 09  
 (891) 2022 10 09  
 (731) Obshchestvo s ogranichennoy otvetstvennostju  
 "Globus"  
 Promyshlenny passage, 7B, Novoulyanovsk,  
 RU-433300 Ulyanovsk region, Russian  
 Federation

(540)



(591) White, blue, brown, yellow and dark yellow  
 (531) 26.13.01; 28.05; 29.01.13

(511)  
 30 – Food flavourings, other than essential oils; cereal bars; high-protein cereal bars; pancakes; noodle-based

prepared meals; buns; bread rolls; pains au chocolat; waffles; vermicelli; malt biscuits; mirror icing [mirror glaze]; cake frosting [icing]; croûtons; leaven; rice-based snack food; cereal-based snack food; fruit jellies [confectionery]; candy decorations for cakes; confectionery for decorating Christmas trees; cakes; Danish pastries; pastries; peanut confectionery; almond confectionery; confectionery; fruit confectionery; frozen yogurt [confectionery ices]; cocoa; caramels [sweets]; sweets; liquorice [confectionery]; peppermint sweets; dulce de leche; crackers; custard; crème brûlée; croissants; groats for human food; macaroons [pastries]; marzipan; ice cream; chocolate mousses; muesli; cocoa beverages with milk; coffee beverages with milk; coffee-based beverages; cocoa-based beverages; tea beverages with milk; chocolate beverages with milk; chocolate-based beverages; nougat; lozenges [confectionery]; biscuits; coconut macaroons; petit-beurre biscuits; pies; fondants [confectionery]; pralines; cereal preparations; profiteroles; gingerbread; petits fours; puddings; sorbets [ices]; chocolate-based spreads; chocolate spreads containing nuts; dough; pastry dough; cake batter; chocolate decorations for cakes; halvah; bread; chips [cereal products]; corn flakes; oat flakes; chocolate.

(260) AM 2023 120459 A

(800) 1697341

(151) 2022 05 26

(891) 2022 05 26

(731) Bitcoin Association for BSV

Grafenauweg 6, CH-6300 Zug, Switzerland

(540)

## Teranode

(591) Black, white

(511)

9 – Computer software; application software; computer software packages; software platforms; application software for mobile telephones; downloadable computer software; software development tools; software for encryption; database management software; computer platforms in the form of recorded or downloadable software; downloadable computer software for use as a digital wallet; downloadable ewallets; downloadable multimedia files; downloadable video recordings; downloadable image files; electronic publications; downloadable cryptographic keys for receiving and spending cryptocurrency; downloadable educational course materials; project management software; downloadable podcasts.

41 – Teaching; Organization and conducting of educational conferences; organization of business conferences; arranging, coordination and organization of seminars; arranging and conducting of conferences, congresses and symposiums; provision of training courses; arranging and coordination of training courses; organization and conducting of teaching courses;

organization and conducting of training workshops; arranging, coordination and organization of workshops; training; business training services; organization of educational events; provision of educational material; publication of educational materials; publication of multimedia material online; production and rental of educational and instructional materials; publication of texts, other than publicity texts; publication of brochures; publication by electronic means; arranging and coordination of lectures; production of podcasts; production of video recordings; organization of exhibitions for training purposes; organization of shows for educational purposes.

42 – Software design and development not applicable to the treatment of materials, in particular to metal treatment, and not applicable to material analysis and chemical-physical analysis and examination; Development of computer platforms; programming of software for Internet platforms; design, development and implementation of software not applicable to the treatment of materials, in particular to metal treatment, and not applicable to material analysis and chemical-physical analysis and examination; Blockchain as a Service [BaaS]; information technology consulting not applicable to the treatment of materials, in particular to metal treatment, and not applicable to material analysis and chemical-physical analysis and examination; computer software maintenance; scientific and technological services not applicable to the treatment of materials, in particular to metal treatment, and not applicable to material analysis and chemical-physical analysis and examination; information technology [IT] consultancy not applicable to the treatment of materials, in particular to metal treatment, and not applicable to material analysis and chemical-physical analysis and examination; development of new technology for others not applicable to the treatment of materials, in particular to metal treatment, and not applicable to material analysis and chemical-physical analysis and examination; product development consultation not applicable to the treatment of materials, in particular to metal treatment, and not applicable to material analysis and chemical-physical analysis and examination; product research and development not applicable to the treatment of materials, in particular to metal treatment, and not applicable to material analysis and chemical-physical analysis and examination; software technical support services not applicable to the treatment of materials, in particular to metal treatment, and not applicable to material analysis and chemical-physical analysis and examination; computer security services for protection against illegal network access; data authentication via blockchain; providing temporary use of non-downloadable software applications accessible via a web site; security services for computer networks, computer access and computerized transactions; encryption, decryption and authentication of information, messages and data.

(260) AM 2023 120460 A  
 (800) 1697357  
 (151) 2022 09 22  
 (891) 2022 09 22  
 (731) TÜRKİYE TURİZM TANITIM VE  
 GELİŞTİRME AJANSI  
 Esentepe Mahallesi, Büyükdere Caddesi,  
 Astoria 127 B 71 Şişli, İstanbul, Türkiye  
 (540)



(591) Turquoise blue and Green  
 (531) 05.03.13; 05.03.15; 24.03.07; 24.03.14;  
 24.03.18; 26.01.04; 26.01.15; 27.05.10;  
 29.01.12

(511)  
 35 – Advertising, marketing and public relations; or-  
 ganization of exhibitions and trade fairs for commer-  
 cial or advertising purposes; development of adverti-  
 sing concepts; provision of an online marketplace for  
 buyers and sellers of goods and services.

39 – Land, water and air transport services; rental of  
 land, water or air vehicles; arranging of travel tours;  
 travel reservation; issuing of tickets for travel; courier  
 services (messages or merchandise).

41 – Arranging and conducting of conferences, con-  
 gresses and seminars; sporting and cultural activities;  
 entertainment; ticket reservation and booking services  
 for entertainment, sporting and cultural events, in-  
 cluding ticket reservation and booking services for the-  
 atres, cinemas, museums and concerts; publication  
 and editing of printed matter, including magazines,  
 books, newspapers, other than publicity texts; electro-  
 nic publication services.

(260) AM 2023 120461 A  
 (800) 1697369  
 (151) 2022 06 02  
 (891) 2022 06 02  
 (731) "Lex Tobacco Company" LLC  
 Kurghinyan street 13, apt. 32, Malatia-Sebastia,  
 0068 Yerevan, Armenia  
 (540)

**ALMAZ**

(591) Black, white  
 (511)  
 34 – Tobacco, whether manufactured or unmanufactu-  
 red; smoking tobacco; pipe tobacco; hand rolling to-  
 bacco; chewing tobacco; snus; cigarettes; electronic

cigarettes; cigars; cigarillos; snuff; smokers' articles  
 included in this class; cigarette papers; cigarette tubes.

(260) AM 2023 120462 A  
 (800) 1697447  
 (151) 2022 06 28  
 (891) 2022 06 28  
 (731) Guangzhou Aopiya Leather Industrial LLC  
 No. 1, Shitang Village, Xinya Street, Huadu  
 District, Guangzhou City, 510623 Guangdong  
 Province, China

(540)

**BAGCO**

(591) Black, white  
 (531) 27.05.01  
 (511)  
 18 – Trimmings of leather for furniture; umbrellas.

(260) AM 2023 120470 A  
 (800) 1697529  
 (151) 2022 10 21  
 (891) 2022 10 21  
 (731) Island Slipper Factory, Limited  
 98-711 Kuahao Place, Pearl City HI 96782,  
 USA

(540)

**ISLAND SLIPPER**

(591) Black, white  
 (511)  
 25 – Footwear; hats; sandals; beach footwear; beach  
 shoes; flip-flops for use as footwear; footwear for  
 men; footwear for women; slippers; thong footwear; t-  
 shirts.

35 – Retail clothing stores; retail stores featuring slip-  
 pers, sandals, flip flops, beach shoes, beach footwear,  
 footwear, and thong footwear; on-line retail store  
 services featuring slippers, sandals, flip flops, beach  
 shoes, beach footwear, footwear, and thong footwear

(260) AM 2023 120471 A  
 (800) 1697545  
 (151) 2022 09 28  
 (891) 2022 09 28  
 (731) BERKO İLAÇ VE KİMYA SANAYİ A.Ş.  
 YENİŞEHİR MAH. ÖZGÜR SK. 16 1,  
 Ataşehir, İstanbul, Türkiye

(540)

**Berko Beraxin**

(591) Black and white.  
 (531) 27.05.01  
 (511)  
 5 – Pharmaceutical and veterinary preparations for  
 medical purposes; chemical preparations for medical



and veterinary purposes, chemical reagents for pharmaceutical and veterinary purposes; medicated cosmetics; dietary supplements for pharmaceutical and veterinary purposes; dietary supplements; nutritional supplements; medical preparations for slimming purposes; food for babies; herbs and herbal beverages adapted for medicinal purposes; dental preparations and articles: teeth filling material, dental impression material, dental adhesives and material for repairing teeth; sanitary preparations for medical use: hygienic pads, hygienic tampons; plasters, materials for dressings, diapers made of paper and textiles for babies, adults and pets; preparations for destroying vermin; herbicides, fungicides, preparations for destroying rodents; deodorants, other than for human beings or for animals; air purifying preparations; air deodorising preparations; disinfectants; antiseptics; detergents for medical purposes; medicated soaps; disinfectant soaps; antibacterial hand lotions.

(260) AM 2023 120472 A

(800) 1697561

(151) 2022 09 22

(891) 2022 09 22

(731) CAREX BİTKİSEL ÜRÜNLER VE  
KOZMETİK SANAYİ TİCARET LİMİTED  
ŞİRKETİ  
FATİH SULTAN MEHMET MAH.,  
POLİGON CAD. 8 B 33, Ümraniye, İstanbul,  
Türkiye

(540)

**CELENES**

(591) Black, white

(511)

3 – Cleaning, polishing, scouring and abrasive preparations, soaps, perfumery, essential oils, cosmetics, hair lotions, dentifrices.

(260) AM 2023 120473 A

(800) 1697586

(151) 2022 09 30

(891) 2022 09 30

(731) KOSAN KOZMETİK SANAYİ VE TİCARET  
ANONİM ŞİRKETİ  
ACIBADEM MAH. ÇEÇEN SK., AKASYA  
A KULE KENT ETABI 25 A 1, Üsküdar,  
İstanbul, Türkiye

(540)



(591) Black, white

(531) 27.05.01; 27.05.21

(511)

3 – Bleaching and cleaning preparations, detergents other than for use in manufacturing operations and for medical purposes, laundry bleach, fabric softeners for laundry use, stain removers, dishwasher detergents; perfumery; non-medicated cosmetics; fragrances; deodorants for personal use and animals; soaps; dental care preparations; dentifrices, denture polishes, tooth whitening preparations, mouth washes, not for medical purposes; abrasive preparations; emery cloth; sandpaper; pumice stone; abrasive pastes; polishing preparations for leather, vinyl, metal and wood, polishes and creams for leather, vinyl, metal and wood, wax for polishing.

(260) AM 2023 120474 A

(800) 1697636

(151) 2022 06 21

(891) 2022 06 21

(731) Brun Oleksii Mykolaiovych  
vul. Liapunova, 16, kv. 91, Kharkiv 61000,  
Ukraine

(540)



**STAR  
DRINK**

(591) Black, white

(531) 01.01.02; 01.01.10; 01.01.25; 25.01.10;  
27.05.01; 27.05.17

(511)

43 – Accommodation bureau services [hotels, boarding houses]; bar services; boarding for animals; boarding house bookings; boarding house services; café services; cafeteria services; cake decorating; providing campground facilities; canteen services; rental of chairs, tables, table linen, glassware; rental of cooking apparatus; day-nursery [crèche] services; decorating of food; rental of drinking water dispensers; food and drink catering; food sculpting; holiday camp services [lodging]; hookah lounge services; hotel accommodation services; hotel reservations; information and advice in relation to the preparation of meals; rental of lighting apparatus; rental of meeting rooms; motel services; personal chef services; reception services for temporary accommodation [management of arrivals and departures]; restaurant services; retirement home services; self-service restaurant services; snack-bar services; rental of temporary accommodation; temporary accommodation reservations; rental of tents; tourist home services; rental of transportable build-

dings; udon and soba restaurant services; washoku restaurant services.

---

(260) AM 2023 120480 A

(800) 1697806

(151) 2022 07 14

(891) 2022 07 14

(731) Blockchain Game Partners, Inc.

680 S Cache Street, Suite 100, Jackson  
WY 83001, USA

(540)

## **INTO THE GALAVERSE**

(591) Black, white

(511)

41 – Arranging and conducting online and in person educational talks, speeches, demonstrations, seminars, workshops, exhibitions, conferences and networking opportunities in the field of computer games, gaming, finance, blockchain, virtual currency, NFTs and digital tokens; entertainment services, namely, providing online photographic, audio, video and prose presentations featuring educational conferences, live and videotaped talks on the subjects of computer games, gaming, finance, blockchain, virtual currency, NFTs and digital tokens; entertainment services in the nature of organizing and conducting computer game contests, computer game tournaments; entertainment exhibitions, competitions and events rendered live at indoor and outdoor venues and through the Internet; entertainment services, namely, organizing exhibits composed of interactive displays, participatory activities and contests centered around computer gaming; entertainment services, namely, live performances by video game players; entertainment services, namely, providing online non-downloadable videos featuring games being played by others; providing online gaming via a web-based system and online portal for gamers; providing online news, educational information, and commentary in the fields of computer games, gaming, computer and video game players, finance, blockchain, virtual currency, NFTs, and digital tokens; online publication of journals, namely, blogs featuring computer games, gaming, finance, blockchain, virtual currency, NFTs, and digital tokens.

42 – Providing online multimedia virtual computer environments through cloud computing in which users can interact for entertainment purposes.

---

(260) AM 2023 120481 A

(800) 1697807

(151) 2022 07 14

(891) 2022 07 14

(731) Blockchain Game Partners, Inc.

680 S Cache Street, Suite 100, Jackson  
WY 83001, USA

(540)

## **GALAVERSE**

(591) Black, white

(511)

41 – Arranging and conducting online and in person educational talks, speeches, demonstrations, seminars, workshops, exhibitions, conferences and networking opportunities in the field of computer games, gaming, finance, blockchain, virtual currency, NFTs and digital tokens; entertainment services, namely, providing online photographic, audio, video and prose presentations featuring educational conferences, live and videotaped talks on the subjects of computer games, gaming, finance, blockchain, virtual currency, NFTs and digital tokens; entertainment services in the nature of organizing and conducting computer game contests, computer game tournaments; entertainment exhibitions, competitions and events rendered live at indoor and outdoor venues and through the Internet; entertainment services, namely, organizing exhibits composed of interactive displays, participatory activities and contests centered around computer gaming; entertainment services, namely, live performances by video game players; entertainment services, namely, providing online non-downloadable videos featuring games being played by others; providing online gaming via a web-based system and online portal for gamers; providing online news, educational information, and commentary in the fields of computer games, gaming, computer and video game players, finance, blockchain, virtual currency, NFTs, and digital tokens; online publication of journals, namely, blogs featuring computer games, gaming, finance, blockchain, virtual currency, NFTs, and digital tokens.

42 – Providing online multimedia virtual computer environments through cloud computing in which users can interact for entertainment purposes.

---

(260) AM 2023 120482 A

(800) 1697842

(151) 2022 05 13

(891) 2022 05 13

(731) MAZARS

Avenue du Boulevard 21, box 8, B-1210  
Saint-Josse-ten-Noode, Belgium

(540)

## **MAZARS**

(591) Black, white

(511)

9 – Computer software; electronic publications; non-printed publications; downloadable publications; apparatus, instruments and media for the recording, storage, carriage, manipulation, transmission, reproduction, and retrieval of data, signals, information, code, images, text, video, sound and audio; CD-ROMs; DVDs; downloadable audio, visual and audiovisual

materials; interactive computer software; encoded identity cards; computer software for collecting and managing data, performing analyses, conducting studies, and creating and generating reports in the fields of information technology, human resources, accounting, auditing, management, business, law and tax; downloadable applications for mobile telephones in the fields of accounting, auditing, management, business, law and tax; downloadable electronic publications; downloadable electronic publications in the field of finance, business and consulting.

16 – Printed matter; stationery; printed publications; paper and cardboard; blank note cards; memo pads; headed notepaper; books; manuals; newspapers; newsletters; printed reports; catalogues; magazines; periodicals; photographs; instructional and teaching materials; publications, namely, educational books, printed lessons and lectures, and newsletters, reports and brochures, all in the fields of information technology, human resources, accounting, auditing, management, business, law and tax.

35 – Advertising; commercial business management; management administration of commercial undertakings; office functions; accounting; bookkeeping; accounting services with respect to mergers and acquisitions; registered auditor services; tax preparation; advisory services relating to the automation of tax functions; business management consulting services in the field of information; assistance related to salary statements; preparation of payrolls [for others]; consulting services with respect to employee remuneration; human resources management; personnel recruitment services; personnel placement services; personnel management services; consultancy and advisory services relating to personnel management; services provided by consultants regarding human resources; planning services for companies; business management assistance for industrial or commercial companies; consultancy and advisory services relating to business management; business auditing services; business management and consultancy in connection with fraud detection and prevention, with compliance with anti-corruption laws and provisions by companies and businesses; business management and consultancy in connection with ensuring that businesses comply with human rights, legislation and requirements with respect to fraud and anti-corruption; business management and consultancy in the field of social media; business management and consultancy in connection with customer engagement, satisfaction and loyalty; business management and consultancy in connection with inclusiveness and diversity; business management and consultancy in connection with employee satisfaction and engagement; business management consulting services in the field of information technology; business performance improvement services; business appraisal services; financial auditing; negotiation and conclusion of commercial transactions for

others; advisory services relating to commercial transactions; advice services relating to business mergers and acquisitions; business due diligence services; consultancy regarding advertising communications strategy; consultancy regarding public relations communication strategies; compilation of information into computer databases; marketing analysis services; market studies; economic forecasting analysis for business purposes; market forecasting; statistical analysis and reporting; computer file management; collection and transcription of administration, business, financial and other data; data processing; business risk assessment services; risk assessment with respect to business organization; analysis of business trends; analysis of marketing trends; business change management services; business management and organization consultancy; advice on corporate organization and management; preparation of economic reports; organization of exhibitions for commercial or advertising purposes; business appraisals; business strategy services; business planning and business continuity consulting; business intelligence services.

36 – Insurance services; financial affairs; monetary affairs; real estate affairs; financial advice and consultancy services; financial services provided via the internet; provision of financial information; financial information for investors; advisory services relating to corporate finance; financing services for companies; consultancy with respect to corporate tax, international tax and employment tax; tax investigation services; financial project management; all the aforesaid services also provided via the internet or other interactive electronic platforms; asset management services for companies and businesses; actuarial services; fiscal expert services; financial risk assessment services; financial assessment of company credit; financial evaluations; financial rating and credit reports; preparing and analyzing financial reports; financial benchmarking services; conducting financial feasibility studies; financial investigation services; consultation and advisory services relating to the improvement of financial performance through financial solutions and efficiency; trusteeship; financial advisory services relating to insolvency; business liquidation services (financial); fund management; consulting services relating to financial risk management; information, advice, and support services relating to any of the aforementioned services.

41 – Training; conference services; conducting live and on-line classes, seminars, conferences, and workshops in the fields of accounting, auditing, law, tax, business, information management, information technology, computers, management training, financial planning and investment strategies; publishing of periodicals and works via internet; organization and conducting of congresses, conferences and colloquiums; publication of texts other than advertising texts; training and educational consultancy in the professio-

nal field; information, advisory and consultancy services relating to all the above services.

42 – Scientific and technological services as well as research and design services relating thereto; industrial analysis and research services; design and development of computer hardware and software; software consultancy services; installation and maintenance of computer software; consultancy relating to computers; providing information in the fields of information technology, computers and computer systems; research and development with respect to environmental sustainability as regards requirements and laws that companies and businesses must comply with; environmental consulting services for companies; environmental risk assessment; risk assessment in the field of computer security; development of data bases; preparation of reports with respect to technologies; advice relating to computer security; software as a service (SaaS); Platform as a Service (PaaS); infrastructure as a Service (IaaS); providing temporary use of online non-downloadable software for use in processing, generating, tracking, calculating, measuring, reporting, and analysing information and reports in the fields of accounting, finance, financial management, economics, law, taxation, tax preparation and planning, auditing, business and business management; technical data analysis services; data mining; IT project management; research, information, consultancy and advisory services in relation to technological innovations, disruptive technologies and FinTech, including social media, cryptocurrencies, mobile payments, cybersecurity, e-commerce, distributed ledger technology, blockchain, machine learning, artificial intelligence, internet of things (IoT), smart data discovery, and prescriptive analytics; data security services; IT security services in the nature of protection and recovery of computer data; risk management consultancy [IT]; consulting services relating to digital transformation; services related to the computerized automation of processes; IT services for data protection.

45 – Legal services; legal advice; regulatory compliance consulting services; litigation, mediation and arbitration services; legal document preparation services; legal research services; legal advice in the field of taxes; licensing of computer software (legal services); licensing of databases; review of standards and practices so as to ensure compliance with laws and regulations; providing expert legal opinions; consultation in relation to data protection compliance.

(260) AM 2023 120485 A

(800) 1295997

(151) 2016 02 11

(891) 2022 10 30

(731) PORCELANITE, S.L.

Camino Foyes Ferraes, partida Torreta,  
E-12110 ALCORA, Castellón, Spain

(540)

## PORCELANITEDOS

(591) Black, white

(511)

19 – Wall tiles, floor tiles, wall lining and floor paving materials made of ceramic materials, of sandstone and porcelain.

(260) AM 2023 120487 A

(800) 1607950

(151) 2021 04 15

(891) 2022 11 02

(731) CAGS TOBACCO TUTUN VE TUTUN  
MAMULLERI SANAYI VE TICARET  
ANONIM SIRKETI

Maslak Mah., Sogutozu Sk., Agaoglu Maslak  
1453, T4 Blok No:20U/B124, Sariyer, Istanbul,  
Türkiye

(540)



YoungMaster

(591) Black, white

(531) 02.01.01; 16.01.14; 16.03.13

(511)

34 – Tobacco; chewing tobacco; hookah tobacco; cigarettes; cigars; cigarette cases; tobacco pipes; cigar holders; cigarette holders; smokers' mouthpieces for cigarettes, cigars, cigarette holders and cigar holders; cigarette rolling papers; ashtrays for smokers; humidors; pocket machines for rolling cigarettes; cigarette paper; firestones; lighters for smokers; matches.

(260) AM 2023 120488 A

(800) 1619465

(151) 2021 02 16

(891) 2022 07 22

(731) LOEWE IP HOLDING LIMITED

Arch. Makariou & Kalogration, 4 Nicolaides  
Sea View City, Flat/Office 903-904 Block A-B,  
CY-6016 Larnaca, Cyprus

(540)

## LOEWE

(591) Black, white

(511)

9 – Imaging devices for scientific purposes; biochips; microscopes; apparatus and instruments for microscopy; science sets for children being instructional apparatus; science sets for children being teaching apparatus; optical frequency metrology devices; instrumen-

tation simulators; teaching apparatus; audiovisual teaching apparatus; teaching apparatus and instruments; scientific apparatus and instruments; apparatus and instruments for accumulating and storing electricity; apparatus and instruments for controlling electricity; electric and electronic components; photovoltaics; uninterruptable power supply apparatus; electricity mains apparatus; regulated power supply apparatus; dc/ac converters; mains power units (electric -); power-line transmission apparatus; uninterruptible power supply apparatus [battery]; ac/dc converters; media content; software; recorded data files; pre-recorded compact discs; pre-recorded cassettes; data carriers containing stored typographic typefaces; computer digital maps; directories [electric or electronic]; data recorded electronically; telephone ring tones [downloadable]; holograms; downloadable ring tones for mobile phones; magnetic recordings; recorded data [magnetic]; pre-recorded compact discs featuring games; recording substrates [optical]; optical disc recordings; recorded tapes; prerecorded magnetic data carriers; pre-programmed discs; sensors and detectors; controllers (regulators); monitoring instruments; electricity indicators; switchboard indicating lamps; traffic sign recognition apparatus and instruments; load indicators; image analyzers; diagnostic apparatus, not for medical purposes; digital indicators; torque transducers; electric power analyzers; electronic colour analyzers; electronic control instruments; electro-optic transducers; high frequency transducers; wireless controllers to remotely monitor and control the function and status of other electrical, electronic, and mechanical devices or systems; wireless controllers to remotely monitor and control the function and status of security systems; checking (supervision) apparatus and instruments; luminous indicators; linear transducers; logic probes; piezoelectrical transducers; autonomous driving control systems for vehicles; spectrum analyzers, other than for medical use; ultrasonic transducers; universal disturbance analyzers; load cells; heat sensing identification indicators; gps receivers; cases for satellite navigation devices; vehicle tracking systems; vehicle tracking apparatus; global positioning system [gps] apparatus; global positioning systems for use with bicycles; global positioning instruments; interactive computer software that provides navigational and travel information; directional compasses; personnel tracking devices; satellite navigational system for bicycles; sensors for determining position; gps transmitters; display devices, television receivers and film and video devices; audio devices and radio receivers; image capturing and developing devices; 3d spectacles; 3d spectacles for television receivers; covers for digital media players; covers for portable media players; playing devices for sound and image carriers; cases adapted for dvd players; containers for films; bags for cameras and photographic equipment; audiovisual apparatus; recording devices for sound and image carriers; tape players; tape dri-

ves; sound filters made of cloth, for radio apparatus; compact disc players; cd rom drives; digital audio servers; digital video players; digital video servers; docking stations for mp3 players; docking stations for smartphones; docking stations for digital music players; dvd recorders; dvd players; wireless audio and video receivers; motion-activated cameras; electric cables for the transmission of sounds and images; audio- and video-receivers; endoscopic equipment for industrial purposes; cases for digital media players; lens cases; cases for portable media players; fm transmitters; remote controls for televisions; remote controls for radios; remote controls for stereos; motion-picture cameras for self-developing film; cables for transmitting and receiving cable television signals; receivers for receiving cable television; multiframe view cameras; karaoke equipment; pairable wireless speakers; laser pointers; luminous pointers; mp4 players; magnetic tape drives; multi-camera systems for vehicles; multifunctional remote controls; optical finders; head cleaning tapes [recording]; magnetic tape cleaners; vibration dampeners for electronic audio equipment; sync generators; tablet monitors; portable dvd players; audiovisual teaching apparatus; video imaging systems; head cleaning tapes for video recorder; video servers; signal cables for it, av and telecommunication; data processing equipment and accessories (electrical and mechanical); calculators; covers for personal digital assistants [pdas]; computers being artificial intelligence apparatus; audio digitisers; image analyzers; image setting apparatus; image stabilisers; image synthesizers; compact disc recorders; cd burners; cd-rom writers; chromatogram analyzers for scientific or laboratory use; computerized vehicle engine analyzers; computerised personal organisers; computer interface apparatus; data exit terminals; data exchange units; data entry terminals; data terminals; data gloves; data processors; data conversion apparatus; storage apparatus for computer data; data processing equipment; data processing terminals; data processing apparatus; real-time data processing apparatus; programming units (electric -); electric power analyzers; electronic data processing equipment; electronic colour analyzers; programming units (electronic -); electronic calculators; electronic spell-checkers; electronic control systems; electronic currency converters; hand-held electronic dictionaries; electronic word processors; electronic desk calculators; cases for pdas; cases for pocket calculators; invoicing machines; hand scanner; fluorescence analyzers; peripheral devices for data reproduction; instruments for analysing photographs; cards containing microprocessors; couplers [data processing equipment]; optical character readers; readers [data processing equipment]; magnetic coded card readers; optical disc players; magnetic strip readers; storage apparatus for computer programs; memory card readers; programmable logic controllers; vocoders; voice recognisers; voice processing systems; speech processing equip-

ment; bar code terminals; bar code readers; electronic pocket translators; word processing apparatus; tape recorders; audio processing apparatus; usb port cards; usb card readers; universal disturbance analyzers; multichannel analyzers; virtual reality headsets; computer central processing units; translation apparatus; point-to-point communications equipment; broadcasting equipment; acoustic couplers; alarm signalling transmitters; amplitude modulation tuners; mounting fittings for radios; connectors for telecommunication apparatus; indicator lights [for telecommunication apparatus]; audio transmitter units; automatic switching apparatus [for telecommunication]; automatic telephone dialers; automatic telegraph apparatus; automatic dialling apparatus; apparatus for the transmission of images; satellite earth stations; broadband installations; dab radios; demodulators; digital transmitters; digital telecommunications apparatus; wire communication apparatus; wireless high frequency transmission instruments; fibre optic telecommunications apparatus; telegraphic transmitting apparatus; open-wire transmission apparatus; frequency modulation apparatus; frequency scanners; frequency modulators; radio-frequency receivers; high-frequency apparatus; radio-frequency transmitter; interactive computer software enabling exchange of information; wireless communication devices for voice, data, or image transmission; tone pads; coding modulators; microwave communications apparatus; microwave filters; solar powered radios; listening devices for monitoring babies; mobile radio receiving apparatus; mobile data receivers; mobile radio transmitting apparatus; radio frequency repeaters; radio frequency amplifiers; low noise converters; noise filters; noise suppression apparatus; transmitter receivers; transmitters; transmitters [telecommunication]; transmitters for the transmission of electric signals; transmitters for the transmission of electronic signals; transmitters of electronic signals; sim cards; transmitters for use in emergency communications; fuses [for telecommunication apparatus]; signal attenuation apparatus; signal tuners; signal converters; signal transmitters; signal couplers; signal splitters; signal processing apparatus; signal delay apparatus; signal transmission apparatus; speed repeaters; vocoders; voice recognisers; speech synthesizers; voice operated coders; voice response equipment; voice processing systems; stereo receivers; synchronous data units; parts and fittings for communications apparatus; telecommunication apparatus; video transmitters; guided wave intercoms; duplexers; two-way radios; artificial intelligence apparatus; audio digitisers; computer interface apparatus; data exchange units; data entry terminals; data terminals; storage apparatus for computer data; data conversion apparatus; data processing equipment; data processing apparatus; digitiser pads; real-time data processing apparatus; programming units (electric -); electric power analyzers; electronic data processing equipment; electronic coding apparatus; electronic control systems for machi-

nes; programming units (electronic -); electronic spell-checkers; electronic control systems; optical disc players; air analysis apparatus; mathematical instruments; hand-held electronic dictionaries; electronic word processors; electronic desk calculators; cases for pdas; cases for pocket calculators; cards containing microprocessors; measuring transducers; metric converters; optical disk drives; personal digital assistants; photometric analyzers [other than for medical use]; physical analysing apparatus [other than for medical use]; scanners [data processing equipment]; storage apparatus for computer programs; memory card readers; programmable logic controllers; spectrum analyzers, other than for medical use; vocoders; voice recognisers; character recognition apparatus; point-to-point communications equipment; broadcasting equipment; acoustic couplers; alarm signalling transmitters; amplitude modulation tuners; mounting fittings for radios; connectors for telecommunication apparatus; indicator lights [for telecommunication apparatus]; audio transmitter units; adapters for connecting telephones to hearing aids; stands adapted for mobile phones; carriers adapted for mobile phones; phone covers [specifically adapted]; answering machines; facsimile transmitting and receiving apparatus; dashboard mounts for mobile phones; audio conference apparatus; telephone recorders; car telephone installations; car telephones; in-car telephone handset cradles; phototelegraphy apparatus; video telephones; smart bracelets; digital telephone switching apparatus; digital cellular phones; digital phones; display modules for mobile phones; displays for mobile phones; displays for smartphones; display screen protectors in the nature of films for mobile phones; mobile phone docking stations; hands free kits for phones; hands-free holders for cell phones; hands-free microphones for cell phones; speakerphones; radiotelephony sets; radiotelegraphy sets; mobile telephone batteries; cell phones; mobile telephones for use in vehicles; mobile telephone cases made of leather or imitations of leather; cell phones having large keys and numbers that assist users having impaired vision or dexterity; mobile telephone covers made of cloth or textile materials; network junction points for telephone exchange networks; devices for hands-free use of mobile phones; holders adapted for mobile phones; headsets for mobile telephones; cell phone covers; covers for smartphones; covers for telephone receivers; Internet phones; flip covers for mobile phones; encoded telephone cards; telephone headsets; leather cases for mobile phones; leather cases for smartphones; local mobile telephone systems; manual telegraph apparatus; microphones [for telecommunication apparatus]; solar powered telephones; mobile telephone apparatus with built-in facsimile systems; mobile or portable fax machines; paging equipment; pagers; radio pagers; private branch exchanges; point-to-point receivers; point-to-point transmitters; radiotelephones; auxiliary batteries for mobile phones; auxiliary speakers for

mobile phones; cell phone straps; satellite telephones; cases for smartphones; wireless headsets for smartphones; cordless telephones; liquid crystal protective films for smartphones; selfie sticks used as smartphone accessories; selfie sticks [hand-held monopods]; smartbands; flip covers for smart phones; smartphones; smartphones in the shape of a watch; smartwatches; keyboards for mobile phones; telephone adapters; telephone connecting cords; telephone connectors; telephone sets with screen and keyboard; telephones incorporating intercommunication systems; telephone terminals; telephone intercom apparatus; telephone receivers; telephone earpieces; telephone transmitters; telephone concentrators; telephone switchboards; phone plugs; phone extension jacks; phone extension leads; telegraphs [apparatus]; portable fax machines; wearable smart phones; walkie-talkies; beeper carrying cases; smart wristbands that communicate data to smartphones; video communications apparatus; video conferencing apparatus; video door telephone apparatus; video intercom apparatus; voip phones; intercommunication apparatus; intercoms; audio books; electronic databases recorded on computer media; electronic publications recorded on computer media; books recorded on tape; series of musical sound recordings; books recorded on disc; typeface fonts recorded on magnetic media; digital books downloadable from the internet; disc storage containers; instruction manuals in electronic format; downloadable digital music provided from a computer database or the Internet; prerecorded cd-roms; prerecorded cd-is; prerecorded music videos; recorded discs bearing images; recorded tape cassettes; pre-recorded video compact discs; prerecorded videodiscs; e-books; electronic publications, downloadable; downloadable printable planners and organizers; downloadable publications; downloadable video recordings; downloadable video recordings featuring music; downloadable digital music provided from MP3 Internet web sites; downloadable electronic books; downloadable templates for designing audiovisual presentations; holographic images; talking books; interactive dvds; compact discs featuring music; pre-recorded dvds featuring music; prerecorded video tapes featuring music; optical discs featuring music; pre-recorded dvds featuring games; multimedia software recorded on cd-rom; multi-media recordings; musical sound recordings; musical recordings in the form of discs; downloadable music files; musical video recordings; training manuals in the form of a computer program; audio visual recordings; audio recordings; usb web keys; usb web keys for automatically launching pre-programmed website urls; video recordings; audio/visual and photographic devices; display devices, television receivers and film and video devices; audio devices and radio receivers; image capturing and developing devices; head-mounted video display apparatus; display screen filters adapted for use with televisions; racks adapted to house video apparatus; bags adapted to car-

ry video apparatus; wall mountings adapted for television monitors; vehicle autonomous driving systems featuring interactive displays; anti-glare filters for televisions; apparatus for the processing of images; car televisions; monitors; video mixers; apparatus for the reproduction of images; visual monitoring apparatus; screen filters for computers and televisions; anti-glare filters for televisions and computer monitors; wide-aspect ratio monitors; electronic book readers; electronic paper (display devices); camera monopods; luminous electric signs; television recorders; television decoders; television receiving dishes; television receivers; DMB (digital multimedia broadcasting) televisions; television standards converters; electric and electronic video surveillance installations; electroluminescent display panels; electric luminescent display panels; electronic displays; electronic notice boards; electronic advertising displays; electronic visual display units; memo boards [electronic]; electronic panels for displaying messages; electronic digital signboards; electronic numeric displays; electrophoretic displays; colour monitors; colour video processors; tv sets; recorded content; devices for treatment using electricity; information technology and audiovisual equipment; magnets, magnetizers and demagnetizers; measuring, detecting and monitoring instruments, indicators and controllers; navigation, guidance, tracking, targeting and map making devices; optical devices, enhancers and correctors; safety, security, protection and signalling devices; computer components and parts; wristband computer devices; cases adapted for netbook computers; cases adapted for notebook computers; cloud servers; computers; work stations [computer apparatus]; computers for use in data management; computers for use with bicycles; computer docking station; computer touchscreens; work stations [computers]; programming units (computer -); computer hardware for use in computer-assisted software engineering; computer hardware for the dissemination of positioning data; computer hardware for the transmission of positioning data; communications computers; communications servers [computer hardware]; sleeves for laptops; laptop computers; bags adapted for laptops; microchips [computer hardware]; leather cases for tablet computers; computer servers; covers for tablet computers; file servers; computer database servers; smartglasses; digital tablets; laptop docking stations; tablet docking stations; electronic mail servers; electronic notebooks; cases for tablet computers; stands for computer equipment; graphics tablets; palmtop computers; interactive computer systems; internet servers; intranet servers; flip covers for tablet computers; tablet computers; pocket computers for note-taking; thin client computers; wearable computers; handheld personal computers; transmitting and receiving apparatus for radio broadcasting; transmitting and receiving apparatus for television broadcasting; transmitting apparatus for television broadcasting; video streaming devices; firmware for com-

puter peripherals; oscilloscopes; testing apparatus for electronic equipment; generators (signal -); computer component testing and calibrating equipment; semiconductor testing apparatus; smoke alarm testers; resistance testing apparatus.

12 – Vehicles and conveyances; land vehicles and conveyances; small wagons for transporting children; handling carts; automatic guided vehicles; drone; electric vehicles; self-propelled electric vehicle; vehicles adapted for the disabled; parts and fittings for vehicles; anti-theft, security and safety devices and equipment for vehicles; pushchair covers and hoods; cushions adapted for use in vehicles; vehicles; passenger motor vehicles; mobility conveyances; powered stand up wheelchairs; mobility scooters; pushchairs for pets; automotive vehicles.

(260) AM 2023 120489 A

(800) 1620746

(151) 2021 05 10

(891) 2022 10 11

(731) Güntner Group Europe GmbH

Hans-Güntner-Str. 2, 82256 Fürstfeldbruck,  
Germany

(540)

**GÜNTNER**

(591) Black, white

(511)

7 – Condensing installations, namely, air condensers, air cooled condensers, axial fan condensers, steam condensers, refrigeration condensers; steam engines; pumps (machine or engine parts, machinery), pumps for heating installations, pumps for cooling installations, vacuum pumps, centrifugal pumps, lubricating pumps, refrigerant recovery pumps; regulators [parts of machines]; heat exchangers [parts of machines]; compressors, in particular refrigerant compressors for heating installations; refrigerant compressors for cooling installations, compressors for refrigerators, compressors for recovering and recycling refrigerant gases; heat sinks for use in machines; radiators [cooling] for motors and engines.

9 – Apparatus and instruments for conducting, switching, transforming, accumulating, regulating and controlling the distribution of electricity; apparatus and instruments for regulating and controlling pressure, temperature, fan speed, noise or water; electronic control circuits for electric fans; electronic control circuits for electric valves; computer software and computer programs; computer application software for use in implementing the Internet of Things [IoT]; sensory software, electrical connecting plugs; plasma display apparatus; electric installations for the remote control of industrial operations; sensors, namely coolant-temperature sensors, pressure sensors, sensors for use in the control of engines, electronic control sensors for motors; refrigerant meters; refrigerant scales; electric

cal and thermal controls; programmable controllers; wireless controllers to remotely monitor and control the function and status of other electrical, electronic, and mechanical devices or systems; central processing unit coolers; electronic process control units, namely industrial process control hardware and software for cooling and heating processes; climate control digital thermostats; diagnostic, monitoring, heat regulating and testing apparatus, not for medical purposes; all the aforesaid goods in particular in relation to refrigeration, cooling, air conditioning, purifying, heat and heat exchanger technology.

11 – Apparatus for heating, steam generating, refrigerating, drying, ventilating and water supply purposes; heat exchangers not being parts of machines, in particular lamellar heat exchangers, plate heat exchangers, tubular heat exchangers; fittings for heat exchangers; cooling installations and machines, in particular oil coolers, air coolers, glycol dry coolers, water dry coolers, water cooling towers; refrigerant condensers; freezers; shock frosters; dry cooling apparatus for cooling media; refrigerating machines; refrigerating containers; chilling chambers, coolers for furnaces; refrigeration units; refrigerating apparatus, appliances and installations; ice machines and apparatus; freezing machines; cooling installations for liquids; driers for refrigeration systems; chiller units being parts of water cooling installations; cooler pipes; finned tubes; heating and cooling apparatus and equipment for waste heat recovery; installations for the cooling of air; air conditioning fans; filters for air conditioning; air conditioning and parts of air conditioning systems; ventilating installations; ventilator frames; air conditioning panels for use in walk-in coolers; air heating apparatus; evaporators, in particular industrial high-performance evaporators, shell tube evaporators and heat pump evaporators; heating installations; gas boilers; gas condensers, others than parts of machines; condenser tubes; air heaters; level controlling valves in tanks; regulating and safety accessories for water apparatus; heat regenerators; heat accumulators; electric radiators, heat pumps, heat sinks for use in cooling apparatus; heat sinks for use in ventilating apparatus; heat sinks for use in heating apparatus; air purifying apparatus and machines, air filtering installations and apparatus, germicidal lamps for purifying air and water filtering installations; air filters for industrial and household use; water distribution installations; parts of the all above goods included in this class.

35 – Collective buying services, commercial evaluation services, auctioneering, commercial information agency services, import-export agency services, online information and ordering services in the field of refrigeration, cooling, air conditioning, purifying, heat and heat exchanger technology; retailing and wholesaling, mail order services and online retail and wholesale services in the field of refrigeration, cooling, air conditioning, purifying, heat and heat exchanger tech-



nology, in particular in relation to condensing installations, condensers, pumps, compressors, heat exchangers, heat sinks, radiators, software, control systems, sensors, monitoring, test and heat regulating systems, refrigerating apparatus, machines and installations, cooling apparatus and machines, heating apparatus and installations, air conditioning apparatus and installations, air purifying installations, water distribution installations and water cooling towers and in relation to parts of these goods; consultancy in the field of procuring goods and services in the field of refrigeration, cooling, air conditioning, purifying, heat and heat exchanger technology; providing of business and commercial information and consultancy for consumers in the field of refrigeration, cooling, air conditioning, purifying, heat and heat exchanger technology.

37 – Installation, cleaning, repair, general overhaul and maintenance in relation to refrigerating apparatus and installations, cooling equipment and machines, refrigerating machines, heat exchangers, heating apparatus, pumps, condensers, condensing installations, air conditioning apparatus and installations, air filtering and purifying installations, water distribution installations and water cooling towers and parts of these goods; construction management services; interference suppression in electric apparatus and in air conditioning installations and apparatus; construction consultancy; advisory services and rental of objects in connection with the providing of the aforesaid services, included in this class; all aforesaid services in particular in relation to refrigeration, cooling, air conditioning, purifying, heat and heat exchanger technology; all aforesaid services not in relation to apparatus and machines for the manufacture or processing of food.

40 – Recycling, in particular of heat exchangers; rental of cooling apparatus, refrigerating apparatus and installations, cooling machines, refrigerating machines, heat exchangers, heating apparatus, pumps specially adapted for heating or cooling installations, condensers as a part of heating installations, condensing installations, air conditioning apparatus and installations, air filtering and purifying installations, water distribution installations specially designed or adapted as a part of heating or cooling apparatus and installations and water cooling towers as a part of heating or cooling apparatus and installations.

42 – Scientific and technological services; industrial analysis and research services; material testing, technical testing, in particular technical testing of heat exchangers for reusability, corrosion, material fatigue, wear, fracturing and leak tightness; technical testing and measurement services in relation to performance and energy consumption of heat exchangers; design, development, planning and civil engineering services; research and development of installations, technological processes and products; architectural and urban planning services and correspondent consultancy ser-

vices; design and development of computer software; IT services, namely development, programming and implementation of software; cloud computing; hosting of computer sites (websites); software as a service (SaaS); monitoring of computer systems by remote access; testing, authentication and quality control; technological consultancy; providing technical advice relating to energy-saving measures; consultancy relating to energy use and energy efficiency; advisory services relating to industrial engineering; all aforesaid services in particular in relation to refrigeration, cooling, air conditioning, purifying, heat and heat exchanger technology; all aforesaid services not in relation to apparatus and machines for the manufacture or processing of food.

(260) AM 2023 120490 A

(800) 1659051

(151) 2021 12 29

(891) 2022 10 14

(731) Tovarishchestvo s ogranichennoy otvetstvennostyu "Global Beverages"  
Prospekt Al Farabi, 116/23, 6, Medeuskiy raion,  
050023 Almaty, Kazakhstan

(540)

## POLUS

(591) Black, white

(511)

33 – Aperitifs; arak; baijiu [Chinese alcoholic beverage]; brandy; wine; wine from grape pomace; whiskey; vodka; anise vodka; cherry vodka; gin; digestives [liqueurs and spirits]; cocktails; curacao; anise liqueur; liqueurs; mixed alcoholic beverages, with the exception of beer-based beverages; alcoholic drinks, except beer; alcoholic beverages containing fruits; alcoholic drinks; distilled alcoholic drinks; honey drink [mead]; mint tincture; bitter tinctures; nira [alcoholic beverage based on sugar cane]; rum; sake; pear cider; ciders; rice alcohol; alcohol extracts; fruit alcohol extracts; alcohol essences.

(260) AM 2023 120491 A

(800) 1662406

(151) 2022 03 17

(891) 2022 09 14

(731) SAMSUNG ELECTRONICS CO., LTD.  
129, Samsung-ro, Yeongtong-gu, Suwon-si,  
Gyeonggi-do, Republic of Korea

(540)

## SpaceMax

(591) Black, white

(511)

7 – Electric washing machines; washing machines for household purposes.

11 – Laundry driers, electric; refrigerators; refrigerators for household purposes.

(260) AM 2023 120493 A

(800) 1680208

(151) 2022 05 23

(891) 2022 10 03

(731) BESCHIERU Nichita

Str. Nicolae Milescu, MD-2075 Spătarul nr. 23,  
ap. 79, Republic of Moldova

(540)

## ARMSTRONG

(591) Black, white

(511)

33 – Alcoholic beverages, except beers; alcoholic preparations for making beverages.

(260) AM 2023 120494 A

(800) 1693417

(151) 2022 06 08

(891) 2022 11 05

(731) ARAZ SUPERMARKET LIMITED

LIABILITY COMPANY

House 137, Mardanov Gardashlari, Nasimi  
district, AZ-1078 Baku city, Azerbaijan

(540)



(591) Orange, green and white

(531) 01.15.15; 26.11.06; 26.11.08; 27.03.12;  
27.05.09; 27.05.11; 27.05.17; 29.01.12

(526) Supermarket

(511)

35 – Advertising and retail sale services of meat, fish, poultry and game, meat extracts, preserved, dried and cooked fruits and vegetables, jellies, jams, compotes, eggs, milk and milk products, oils and fats for food, coffee, tea, cocoa and substitutes therefor, rice, tapioca (manioca) and sago, flour and preparations made from cereals, pastries and confectionery, ice cream, sugar, honey, treacle, yeast, baking-powder, salt, mustard, vinegar, seasonings, spices, ice, raw and unprocessed agricultural, horticultural and forestry products, raw and unprocessed grains and seeds, fresh fruits and vegetables, natural plants and flowers, food-stuffs for animals, malt.

39 – Transport, packaging and storage of meat, fish, poultry and game, meat extracts, preserved, dried and cooked fruits and vegetables, jellies, jams, compotes, eggs, milk and milk products, oils and fats for food, coffee, tea, cocoa and substitutes therefor, rice, tapioca (manioca) and sago, flour and preparations made from cereals, pastries and confectionery, ice cream, sugar, honey, treacle, yeast, baking-powder, salt, mustard, vinegar, seasonings, spices, ice, raw and unprocessed agricultural, horticultural and forestry products, raw and unprocessed grains and seeds, fresh

fruits and vegetables, natural plants and flowers, food-stuffs for animals, malt.

(260) AM 2023 120539 A

(800) 1698088

(151) 2022 08 18

(891) 2022 08 18

(731) "Medical center "M.T.K." Limited liability  
Company

Mykola Amosov str., 10, Kyiv 03680, Ukraine

(540)

## ТІБОП-І

(591) Black, white

(531) 24.17.01; 28.05

(511)

5 – Pharmaceuticals and veterinary preparations; sanitary preparations for medical purposes; dietetic food and substances adapted for medical use; food for babies; plasters, materials for dressings; material for dental fillings and dental impressions; disinfectants; vermin destroying preparations; fungicides, herbicides.

(260) AM 2023 120542 A

(800) 1698121

(151) 2022 09 27

(891) 2022 09 27

(731) GMM S.p.A.

Via Nuova 155/B, I-28883 Gravelona Toce,  
Italy

(540)

## CEMAR

(591) Black, white

(511)

7 – Mechanical saws for stone materials and artificially reconstructed plates machines powered with abrasive tools for stone materials and artificially reconstructed plates; block cutter machines with blades for stone materials and artificially reconstructed plates; block cutter machines with threads for stone materials and artificially reconstructed plates; single-head industrial cleaning machines [polishers] for stone materials and artificially reconstructed plates; flat polishers for stone materials and artificially reconstructed plates; flat calibrating machines for stone materials and artificially reconstructed plates; vertical and horizontal spine polishers for stone materials and artificially reconstructed plates; straight and inclined chamfering machines for stone materials and artificially reconstructed plates; cutting tables for stone materials and artificially reconstructed plates; lathes [machine tools] for stone materials and artificially reconstructed plates; equipment for moving and handling for stone materials and artificially reconstructed plates; industrial robots for handling workpieces for stone materials and artificially reconstructed plates; materials handling conveyors for stone materials and artificially re-

constructed plates; grippers [machines] for stone materials and artificially reconstructed plates; grippers for cranes; collets [parts of machines] and suction cups [parts of machines] for stone materials and artificially reconstructed plates; waterjet cutting machines for stone materials and artificially reconstructed plates; cutting centres [machines] for stone materials and artificially reconstructed plates; cross-cutting stations for stone materials and artificially reconstructed plates; chamfering machines for stone materials and artificially reconstructed plates; calibrating machines for stone materials and artificially reconstructed plates; multi-spindle machines for stone materials and artificially reconstructed plates; contour grinding machines for stone materials and artificially reconstructed plates.

(260) AM 2023 120544 A  
 (800) 1698246  
 (151) 2022 09 20  
 (891) 2022 09 20  
 (731) Philip Morris Products S.A.  
 Quai Jeanrenaud 3, CH-2000 Neuchâtel,  
 Switzerland

(540)

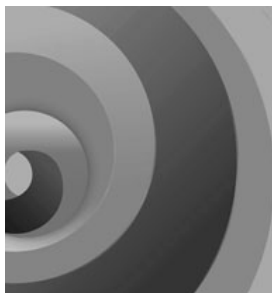

(591) Black, white  
 (531) 01.15.23; 26.01.05  
 (511)

34 – Wired vaporizers for electronic cigarettes and electronic smoking devices; tobacco, raw or manufactured; tobacco products, including cigars, cigarettes, cigarillos, tobacco for roll-your-own cigarettes, pipe tobacco, chewing tobacco, snuff tobacco, kretek; snus; tobacco substitutes (not for medical purposes); smokers' articles, namely cigarette paper and tubes, cigarette filters, tobacco tins, cigarette cases and ashtrays, pipes, pocket apparatus for rolling cigarettes, lighters; matches; tobacco sticks, tobacco products for the purpose of being heated, electronic devices and their parts for the purpose of heating cigarettes or tobacco in order to release nicotine-containing aerosols for inhalation; liquid nicotine solutions for use in electronic cigarettes; electronic smoking devices; electronic cigarettes; electronic cigarettes as substitutes for traditional cigarettes; electronic devices for the inhalation of nicotine-containing aerosols; oral vaporizing devices for smokers, tobacco products and tobacco substitutes; smokers' articles for electronic cigarettes; parts and fittings for the aforesaid products included in this

class; devices for extinguishing heated cigarettes and cigars as well as heated tobacco sticks; electronic rechargeable cigarette cases.

(260) AM 2023 120548 A  
 (800) 1698292  
 (151) 2022 08 03  
 (891) 2022 08 03  
 (731) SANOFI  
 46 avenue de la Grande Armée, F-75017  
 Paris, France

(540)

## **At Sanofi, we chase miracles of science to improve people's lives**

(591) Black, white  
 (511)

1 – Chemical products used for manufacture of pharmaceutical and cosmetic preparations and substances.

3 – Non-medicated preparations for skin hygiene, care and maintenance; personal hygiene products; cosmetic products; soaps; dentifrices.

5 – Pharmaceutical and veterinary products sold on prescription or over the counter; sanitary products for medicine; dietetic substances for medical use; chemical preparations for medical or pharmaceutical use; vaccines; food for babies; plasters, materials for dressings; materials for dental fillings and dental impressions; disinfectants; vitamins, vitamin-based preparations, dietetic substances for medical use; natural dietetic foods and remedies based on medicinal plants for medical or veterinary use; beverages and foodstuffs for medicinal use; food supplements and additives for medicinal use; mineral food supplements for medicinal use; nutritional supplements, plant-based preparations for medicinal use; food supplements containing proteins, carbohydrates, lipids and/or fibers, or micronutrients such as vitamins and/or minerals, amino acids and/or fatty acids, for medical use; plant-based products and plant extracts for medicinal use; preparations for making dietetic or medicated beverages; medicinal preparations; chemical preparations for medicinal use; substances for medicinal use; medicated candy and confectionery for medicinal use; pharmacological preparations for skin care.

9 – Contact lenses; spectacles and optical glasses; software in the field of health; video and audio cassettes, CD-ROMs in the field of health, medical imaging software; software as a medical device [SaMD], downloadable; software and applications for mobile devices; software for Web applications only for information and advisory purposes in the field of health; software for Web applications, for sending, receiving and storing digital data, solely for use in the field of health.

10 – Surgical, medical, dental and veterinary apparatus and instruments; artificial limbs, eyes and teeth; orthopedic articles; suture materials; medical imaging apparatus; X-ray apparatus for medical use.

35 – Business consultancy services; consultation services, namely, providing consumer information relating to goods and services; advertising and marketing services; distribution services, namely, delivery of goods and information about pharmaceutical products for advertising purposes; commercial business management and administration in the field of health; distribution of printed promotional material in the field of health; promotion and public awareness campaign services in the field of health; advice on communication strategy (advertising and public relations); advertising services for promoting public awareness concerning health issues.

38 – Telecommunication services and particularly transmission of information by radio, telephone, television and computer terminals on Internet sites concerning health care; transmission of information on behalf of third parties in the field of health; communication of information intended for patients or healthcare professionals via computers, the Internet, television and radio; providing online chat rooms and electronic bulletin boards for transmission of messages among computer users concerning healthcare, pharmaceutical products and medical and pharmaceutical developments.

41 – Education and training in the field of health; organization of seminars, conferences and congresses in the field of health; publishing of magazines, books and guides and dissemination of digital media for information and training in the field of health.

42 – Scientific and technological services namely chemical research, biological and pharmaceutical research, design and development of software and databases, in the field of health; clinical studies; scientific information services by providing scientific data.

44 – Medical services; veterinary services; hygienic and beauty care, consulting relating to pharmacy and health; providing information with respect to health; providing medical and scientific information; providing medical information on any medium, including online via the Internet and social networks.

---

(260) AM 2023 120558 A  
 (800) 1698744  
 (151) 2022 10 06  
 (891) 2022 10 06  
 (731) VIENNA INSURANCE GROUP AG Wiener  
 Versicherung Gruppe  
 Schottenring 30, Wien, A-1010 Österreich,  
 Austria

(540)

**VIENNA-LIFE**  

---

  
**VIENNA INSURANCE GROUP**

(591) Blue, red and black  
 (531) 27.05.09; 27.05.10; 27.05.11; 29.01.13  
 (511)

36 – Insurance; financial affairs; monetary affairs; real estate affairs.

---

(260) AM 2023 120577 A  
 (800) 1071145  
 (151) 2010 11 23  
 (891) 2022 11 14  
 (731) Evonik Operations GmbH  
 Rellinghauser Str. 1 – 11, 45128 Essen,  
 Germany

(540)

**AEROPERL**

(591) Black, white  
 (511)

1 – Finely divided silica for industrial use, in particular as a filler for natural and synthetic rubbers, as a thickening agent for liquid systems, as a free-flow additive; carrier and adsorber for catalysts, for use in cosmetics, pharmaceuticals, in medical and biotechnological applications.

---

(260) AM 2023 120578 A  
 (800) 1074887  
 (151) 2011 02 22  
 (891) 2022 11 14  
 (731) Evonik Operations GmbH  
 Rellinghauser Str. 1 – 11, 45128 Essen,  
 Germany

(540)

**AERODISP**

(591) Black, white  
 (511)

1 – Chemicals used in industry, science and photography, as well as in agriculture, horticulture and forestry, silica acid, aluminium oxide, aluminium silicate, titan dioxide, zircon oxide, silicon, silicates, silica for industrial use, in particular as a filler for natural and synthetic rubbers, as a thickening agent for liquid systems, as a free-flow additive; carrier and absorber for catalysts, silica for use in the chemical, textile, pharmaceutical, cosmetic, paint, ceramic and plastics industry and in medical and biotechnological applications, silica for use in the manufacture of paper, cardboard and goods made from these materials, unprocessed artificial resins, unprocessed plastics; manures; fire extinguishing compositions; tempering and solde-

ring preparations; chemical substances for preserving foodstuffs; tanning substances; adhesives used in industry.

2 – Paints, varnishes, lacquers, pigments, paint dispersions, coatings, thickeners for paints, toner cartridges, filled, for printers and photocopiers, printing ink, toners for photocopiers; preservatives against rust and against deterioration of wood; colorants; mordants; raw natural resins; metals in foil and powder form for painters, decorators, printers and artists.

(260) AM 2023 120579 A

(800) 1223108

(151) 2014 06 24

(891) 2022 11 16

(731) BORDOGNA TRADING S.R.L.

Via Camillo Golgi 9/11, I-25036 Palazzolo  
Sull'Oglio, Brescia, Italy

(540)

**Bordogna**  
group  
CASSEFORTI

(591) Black, white

(531) 27.05.10

(511)

6 – Safes [strong boxes]; safety cashboxes; locks of metal; armour plating; keys; fireproof cabinets and safes.

9 – Electric and electronic locks; electric and electronic locking mechanisms for safes.

(260) AM 2023 120580 A

(800) 1364251

(151) 2017 03 16

(891) 2022 11 09

(731) Red Bull GmbH

Am Brunnen 1, A-5330 Fuschl am See, Austria

(540)

**Red Bull**  

(591) Red and gold

(531) 01.03.01; 01.03.08; 03.04.04; 03.04.23;  
03.04.24; 27.05.01; 29.01.12

(511)

25 – Clothing; Tee-shirts; blouses; sweaters; anoraks; jackets [clothing]; coats; dresses; knitwear [clothing]; aprons [clothing]; trousers; shorts; skirts; tops; braces for clothing [suspenders]; corselets and corsets [underclothing]; belts [clothing]; money belts [clothing]; sun visors; sports wear; clothing of leather; outerclothing; socks; uniforms; clothing for gymnastics; cyc-

lists' clothing; motorists' clothing; footwear; sandals; slippers; sports boots and shoes; football boots and studs; ski boots; non-slipping devices for footwear; headgear for wear; caps [headwear]; hats; headbands [clothing]; bandanas.

28 – Games and playthings; dolls; plush toys; puppets; toy pistols; play balloons; playing cards; bingo cards; practical jokes [novelties]; confetti; appliances for gymnastic; gymnastic and sporting articles not included in other classes; skis; snowboards; ice skates and snowshoes; machines for physical exercises; stationary exercise bicycles; trampolines; targets, electronic and non-electronic; tennis equipment; tennis nets and tennis ball throwing apparatus; angling equipment; artificial fishing baits; fish hooks; bags specially adapted for use with sports equipment; bags especially designed for skis and surfboards; cricket bags; golf bags; tennis bags; ski bindings; edges of skis; sole coverings for skis; snowboard bindings; balls for games; dumb-bells; shotputs; discs for sports; javelins; rackets; bats for games; cricket bats; golf clubs and hockey sticks; roller skates; in-line roller skates; indoor football tables; tables for table tennis; billiard tables; decorations for Christmas trees, except illumination articles and confectionery; snow globes; gaming machines for gambling; apparatus for games; video game machines; arcade video game machines; amusement machines automatic and coin-operated; slot machines [gaming machines]; hand-held video games; hand-held computer games; scale model vehicles; radio-controlled toy vehicles; toy vehicles; scooters [toys]; fencing weapons; bows for archery; nets for sports; fishing tackle; landing nets for anglers; swimming webs [flippers]; swimming belts and water wings; paragliders; hang gliders; skateboards; surf boards; body boards; windsurfing boards; harness for sailboards; masts for sailboards; protective paddings [parts of sports suits].

30 – Coffee; tea; cocoa; sugar; rice; tapioca; sago; artificial coffee; flour and preparations made from cereals; bread; pastry and confectionery; ices (ice cream); honey; treacle; yeast; baking-powder; salt; edible salt; mustard; vinegar; sauces (condiments); dressings for salad; spices; ice; coffee, tea, cocoa and chocolate drinks; iced tea; coffee and cocoa preparations for making alcoholic and non-alcoholic beverages; cereals for human consumption, including oat flakes and other cereal flakes; flavorings, other than essential oils; sweets; candy; fruit gums; chocolate; chocolate products; pralines with liqueur fillings; chocolate mixtures containing alcohol; chewing gums; fruit and muesli bars.

32 – Non-alcoholic beverages; soft drinks; energy drinks; whey beverages; refreshing drinks; hypertonic and hypotonic drinks (for use and/or as required by athletes); isotonic beverages; beer; malt beer; wheat beer; porter; ale; stout and lager; mineral water [beverages]; table waters and aerated waters; fruit beve-

rages and fruit juices; non-alcoholic vegetable or fruit juice beverages and non-alcoholic fruit extracts; syrups and other preparations for making beverages and syrups for lemonade; pastilles and powders for effervescent beverages; non-alcoholic aperitifs and cocktails; sherbets [beverages]; smoothies.

33 – Alcoholic beverages (except beers); hot and mixed alcoholic drinks; alcoholic energy drinks; mulled wine; distilled beverages; pre-mixed alcoholic beverages, other than beer-based; alcoholic beverages containing fruit and alcoholic fruit extracts; wine; cider; spirits [beverages] and liqueurs, including gin, rum, vodka, whisky, brandy; alcoholic essences and extracts for making beverages; cocktails and aperitifs; bitters.

34 – Tobacco; smoking tobacco; snuff and chewing tobacco; cigars; cigarillos and cigarettes; smokers' articles; tobacco jars and pouches; cigar and cigarette holders; cigar and cigarette cases; ashtrays for smokers; humidors; pipe racks and cleaners for tobacco pipes; cigar cutters; tobacco pipes; lighters for smokers; pocket machines for rolling cigarettes; cigarette paper; cigarette tips; cigarette filters; matches; electronic cigarettes.

41 – Education; teaching; tuition; academies [education]; recreational parks and amusement parks; providing of training, including practical training [demonstration]; entertainment; presentation of live performances; radio, music, cinema and television entertainment; circuses; sporting and cultural activities; racing and sport teams management, in particular in the motorsport sector (entertainment, education, coaching); sports facility services for racing and sport teams, in particular in the motorsport sector; providing sports facilities for racing and sport teams, in particular in the motorsport sector; organization of sports competitions; night clubs and discotheque services; organization of exhibitions for cultural, sporting or educational purposes; rental of videotapes, motion pictures, games equipment and sound recordings; cinema, movie and video film production, other than advertising films; videotaping and microfilming; publication of books, texts (other than publicity texts), electronic books and journals on-line; electronic desktop publishing; providing on-line electronic publications, not downloadable; game services provided on-line from a computer network; providing karaoke services; music composition and production services; layout services, other than for advertising purposes; animal training; health club services [health and fitness training]; library services; operating lotteries; language interpreter services; arranging and conducting of seminars, symposiums, congresses, contests and concerts; dubbing; gambling; photography; recording studio and television studio services; rental of sports grounds and stadium facilities; subtitling.

43 – Services for providing food and drink; bar services; cafes; cafeterias; canteens; snack bars; restaurants; self-service restaurants; food and drink catering; temporary accommodation; hotels; boarding houses; holiday camp services [lodging], tourist homes and motels; temporary accommodation reservations; boarding for animals; rental of transportable buildings, bars and tents; rental of chairs, tables, table linen, glass ware, cooking apparatus and bar equipment.

(260) AM 2023 120581 A

(800) 1555121

(151) 2020 08 12

(891) 2022 09 21

(731) Joint-stock company "AKKOND"

Skladskoy proezd, d. 16, Cheboksary,

RU-428022 Chuvash republic, Russian

Federation

(540)



(591) Red, dark red, yellow, white, beige, brown and cream

(531) 05.05.01; 05.07.06; 08.01.19; 28.05; 29.01.15

(526) Realistic image of the candy and the kernel of whole almonds

(511)

30 – Candies.

(260) AM 2023 120582 A

(800) 1566947A

(151) 2020 07 29

(891) 2022 11 01

(731) Salesforce, Inc.

Salesforce Tower, 415 Mission Street, 3rd

Floor, San Francisco CA 94105, USA

(540)

**SLACK**

(591) Black, white

(511)

9 – Downloadable mobile application featuring software for use in group communication, namely, postings, memoranda and instant messaging, file sharing, calendar synchronization, and automated integrations with external service providers; downloadable computer software for sending messages via the Internet and for audio and video chat and conferencing; downloadable computer software for uploading, downloading, sharing and archiving images, messages, audio, video, data and text content and files, for creating customized personal profiles and for providing search engines for use in group communication and collaboration

platforms for businesses; downloadable computer software for integrating third party software applications; downloadable e-books, handbooks, and reports in the field of group communication, group collaboration, business communications and networking, and business application development; downloadable application programming interface (API) software for developing and customizing business computer software applications; downloadable computer software for data analytics for use in the field of group communication and collaboration for businesses; downloadable application with a searchable database featuring employee, office, team, organization, and project profiles and information; downloadable computer search engine software.

41 – Arranging and conducting business conferences in the field of group communication and collaboration for businesses and in the field of business application development; arranging and conducting educational conferences in the fields of group communication and collaboration and in the field of business application development; conducting seminars, workshops, and computer application training in the fields of group communication and collaboration for businesses and in the field of business application development; online publication of journals or diaries [blog services] and non-downloadable publications in the form of articles in the field of communication, collaboration, business communications and networking, and business application development, via a website.

42 – Platform as a service (PAAS) featuring computer software platforms for use in group communication, namely, postings, memoranda and instant messaging, file sharing, calendar synchronization, and automated integrations with external service providers; computer services, namely, creating virtual communities to organize groups, participate in discussions, get feedback from their peers, and engage in social networking and business collaboration and communication; file sharing services, namely, providing online facilities for others featuring technology enabling users to upload and download electronic files; Software as a service (SAAS) featuring software for uploading, downloading, sharing and archiving images, messages, audio, video, data and text content and files, for creating customized personal profiles, and for providing search engines for use in group communication and collaboration platforms for businesses; Software as a service (SAAS) featuring software for integrating third party software applications; Software as a service (SAAS) featuring application programming interface (API) software for developing and customizing business computer software applications; computer technical support services, namely, help desk services and troubleshooting computer software and computer hardware technology problems; computer technology consultancy in the field of group communication and collaboration for businesses and in the field of business

software application development; Software as a service (SAAS) featuring software for data analytics in the field of group communication and collaboration for businesses; Software as a service (SaaS) services featuring non-downloadable software for database management in the field of employee, office, team, organization, and project profiles and information; Software as a Service (SaaS) featuring online non-downloadable computer search engine software; Software as a service (SAAS) services featuring software for information sharing; design, development, implementation, customization, and configuration of computer software for others; data services, namely, migrating data and applications from one platform to another; data services in the nature of hosting of software as a service (SAAS), namely, providing software for use by others for automated integrations with external service providers and data sources.

---

(260) AM 2023 120589 A  
 (800) 1686227  
 (151) 2022 08 22  
 (891) 2022 11 09  
 (731) Aimbridge Parent, Inc.  
 5301 Headquarters Drive, Plano TX 75024,  
 USA

(540)

**Aimbridge**

(591) Black, white  
 (531) 27.05.01; 27.05.19  
 (511)

35 – Hotel management for others; business management of hotels; managing and operating hotels and resorts for others; preparation of financial reports for others for business or commercial purposes; employment staffing consultation services; franchise services, namely, offering business management assistance in the establishment and operation of hotels and resorts; business management advisory services relating to franchising; business management consulting, strategic business planning, and business management advisory services; market analysis; preparing financial reports for others; concept and brand development consulting for corporate and individual clients.

36 – Capital management services, namely, project budget oversight in the field of property renovation; franchising services, namely, providing financial information and advice regarding the establishment and/or operation of hotels and resorts; receivership of non-performing hotels and resorts; receivership services for non-performing hotels and resorts.

37 – Construction, maintenance, and renovation of property; renovation of hotel and resort properties; advisory and consulting services in the field of renovation and property repositioning.

---

(260) AM 2023 120591 A  
 (800) 1692738  
 (151) 2022 08 22  
 (891) 2022 11 09  
 (731) Aimbridge Parent, Inc.  
 5301 Headquarters Drive, Plano TX 75024,  
 USA

(540)



(591) The color(s) black and blue is/are claimed as a feature of the mark

(531) 27.05.01; 27.05.19; 29.01.12  
 (511)

35 – Hotel management for others; business management of hotels; managing and operating hotels and resorts for others; preparation of financial reports for others for business or commercial purposes; employment staffing consultation services; franchise services, namely, offering business management assistance in the establishment and operation of hotels and resorts; business management advisory services relating to franchising; business management consulting, strategic business planning, and business management advisory services; market analysis; preparing financial reports for others; business consulting services relating to concept and brand creation for corporate and individual clients.

36 – Capital management services, namely, project budget oversight in the field of property renovation; franchising services, namely, providing financial information and advice regarding the establishment and/or operation of hotels and resorts; receivership of non-performing hotels and resorts; receivership services for non-performing hotels and resorts.

37 – Construction, maintenance, and renovation of property; renovation of hotel and resort properties; advisory and consulting services in the field of renovation and property repositioning.

(260) AM 2023 120592 A  
 (800) 1694255  
 (151) 2022 09 28  
 (891) 2022 11 10  
 (731) URSA Salgótarján Glass Wool Close Co., Ltd.  
 Szépvölgyi út 41, 2/2, H-1037 Budapest,  
 Hungary

(540)



(591) Black, white  
 (511)

17 – Insulating, soundproofing and stopping materials; fabrics, felts, webs, plates, panels and sheets for use as insulation material; rubber or plastics for padding and stuffing; mineral wool, glass wool, stone wool, rock wool, slag wool and fiber glass for thermal

or acoustic insulation; glass fibers for insulation; slag wool, glass wool blankets and panels for building insulation; wood fiber, plastic insulation materials, especially foamed plastic materials; insulation boards, made from polystyrene, especially made from extruded polystyrene; XPS (extruded polystyrene) material for packing and stuffing; XPS (extruded polystyrene) panels for insulation; plastic film, other than for packaging purposes; substances for insulating buildings against moisture; sealant compounds for joints; insulating paper, insulating tape and band, rubber, gutta-percha, gum, asbestos, mica; plastics in extruded form for use in manufacture; packing materials, joint packaging for flexible pipes, not of metal; membranes and insulating materials for air tightness and vapor barriers (membrane for moisture protection); vapor barriers; insulating adhesives for sealing and/or attaching or linking membranes of air tightness and/or vapor barriers (for moisture protection) to anything that has to pass through like carpentry, timber studs, tubes, chimney, parts used for ventilation, ducts; insulating adhesives, especially in the form of tapes to be used in combination with insulating material, like mineral wool and XPS (extruded polystyrene); adhesive tapes for industrial purposes; insulating material for buildings and glass mineral wool for insulation purposes together with the respective fixing material for fastening the insulation material and mineral wool for the building, namely warm frame construction, cold frame construction, wall/floor junction timber floor, cavity batts made of mineral fibers, pitched roof insulation, roof junctions for separating wall / attic space, roof junctions for separating wall / room in the roof.

19 – Building materials (non-metallic), including panels and sheets of mineral fibers (especially fiber glass) for buildings; ducts for air conditioning, not of metal; self-bearing duct designs made from mineral wool especially glass fiber panels used for HVAC (heating, ventilation and air conditioning); mineral wool panels with woven or non-woven facings or coverings; non-metallic rigid pipes for building; asphalt, pitch and bitumen; non-metallic transportable buildings; monuments, not of metal, waterproofing claddings.

(260) AM 2023 120593 A  
 (800) 1694458  
 (151) 2022 09 28  
 (891) 2022 11 10  
 (731) URSA Salgótarján Glass Wool Close Co., Ltd.  
 Szépvölgyi út 41, 2/2, H-1037 Budapest,  
 Hungary

(540)



(591) Black, white  
 (531) 27.05; 27.05.01; 27.05.17



(511)

17 – Insulating, soundproofing and stopping materials; fabrics, felts, webs, plates, panels and sheets for use as insulation material; rubber or plastics for padding and stuffing; mineral wool, glass wool, stone wool, rock wool, slag wool and fiber glass for thermal or acoustic insulation; glass fibers for insulation; slag wool, glass wool blankets and panels for building insulation; wood fiber, plastic insulation materials, especially foamed plastic materials; insulation boards, made from polystyrene, especially made from extruded polystyrene; XPS (extruded polystyrene) material for packing and stuffing; XPS (extruded polystyrene) panels for insulation; plastic film, other than for packaging purposes; substances for insulating buildings against moisture; sealant compounds for joints; insulating paper, insulating tape and band, rubber, gutta-percha, gum, asbestos, mica; plastics in extruded form for use in manufacture; packing materials, joint packaging for flexible pipes, not of metal; membranes and insulating materials for air tightness and vapor barriers (membrane for moisture protection); vapor barriers; insulating adhesives for sealing and/or attaching or linking membranes of air tightness and/or vapor barriers (for moisture protection) to anything that has to pass through like carpentry, timber studs, tubes, chimney, parts used for ventilation, ducts; insulating adhesives, especially in the form of tapes to be used in combination with insulating material, like mineral wool and XPS (extruded polystyrene); adhesive tapes for industrial purposes; insulating material for buildings and glass mineral wool for insulation purposes together with the respective fixing material for fastening the insulation material and mineral wool for the building, namely warm frame construction, cold frame construction, wall/floor junction timber floor, cavity batts made of mineral fibers, pitched roof insulation, roof junctions for separating wall / attic space, roof junctions for separating wall / room in the roof.

19 – Building materials (non-metallic), including panels and sheets of mineral fibers (especially fiber glass) for buildings; ducts for air conditioning, not of metal; self-bearing duct designs made from mineral wool especially glass fiber panels used for HVAC (heating, ventilation and air conditioning); mineral wool panels with woven or non-woven facings or coverings; non-metallic rigid pipes for building; asphalt, pitch and bitumen; non-metallic transportable buildings; monuments, not of metal, waterproofing claddings.

(260) AM 2023 120594 A

(800) 1694463

(151) 2022 09 28

(891) 2022 11 10

(731) URSA Salgótarján Glass Wool Close Co., Ltd.  
Szépvölgyi út 41, 2/2, H-1037 Budapest,  
Hungary

(540)



(591) Blue, red

(531) 03.01.14; 03.01.24; 27.05.01; 27.05.17;  
29.01.12

(511)

17 – Insulating, soundproofing and stopping materials; fabrics, felts, webs, plates, panels and sheets for use as insulation material; rubber or plastics for padding and stuffing; mineral wool, glass wool, stone wool, rock wool, slag wool and fiber glass for thermal or acoustic insulation; glass fibers for insulation; slag wool, glass wool blankets and panels for building insulation; wood fiber, plastic insulation materials, especially foamed plastic materials; insulation boards, made from polystyrene, especially made from extruded polystyrene; XPS (extruded polystyrene) material for packing and stuffing; XPS (extruded polystyrene) panels for insulation; plastic film, other than for packaging purposes; substances for insulating buildings against moisture; sealant compounds for joints; insulating paper, insulating tape and band, rubber, gutta-percha, gum, asbestos, mica; plastics in extruded form for use in manufacture; packing materials, joint packaging for flexible pipes, not of metal; membranes and insulating materials for air tightness and vapor barriers (membrane for moisture protection); vapor barriers; insulating adhesives for sealing and/or attaching or linking membranes of air tightness and/or vapor barriers (for moisture protection) to anything that has to pass through like carpentry, timber studs, tubes, chimney, parts used for ventilation, ducts; insulating adhesives, especially in the form of tapes to be used in combination with insulating material, like mineral wool and XPS (extruded polystyrene); adhesive tapes for industrial purposes; insulating material for buildings and glass mineral wool for insulation purposes together with the respective fixing material for fastening the insulation material and mineral wool for the building, namely warm frame construction, cold frame construction, wall/floor junction timber floor, cavity batts made of mineral fibers, pitched roof insulation, roof junctions for separating wall / attic space, roof junctions for separating wall / room in the roof.

19 – Building materials (non-metallic), including panels and sheets of mineral fibers (especially fiber glass) for buildings; ducts for air conditioning, not of metal; self-bearing duct designs made from mineral wool especially glass fiber panels used for HVAC (heating, ventilation and air conditioning); mineral wool panels with woven or non-woven facings or coverings; non-metallic rigid pipes for building; asphalt, pitch and bitumen; non-metallic transportable buildings; monuments, not of metal, waterproofing claddings.

dings; monuments, not of metal, waterproofing claddings.

(260) AM 2023 120634 A

(800) 1699644

(151) 2022 09 19

(891) 2022 09 19

(731) LIMITED LIABILITY COMPANY

"AQUANT"

Pokhodny pr., 14, floor/premises/office

5/II/No.5, RU-125373 Moscow, Russian

Federation

(540)



(591) Black and grey

(531) 24.15.02; 24.15.07; 24.15.13; 27.05.01;  
27.05.08

(511)

16 – Fountain pens; aquarelles; albums; almanacs; document laminators for office use; mimeograph apparatus and machines; atlases; banknotes; souvenir banknotes; banners of paper; paper bows, other than haberdashery or hair decorations; name badges [office requisites]; table linen of paper; tickets; baggage claim check tags of paper; forms, printed; announcement cards [stationery]; glitter for stationery purposes; note books; pads [stationery]; drawing pads; wristbands for the retention of writing instruments; pamphlets; booklets; paper; paper sheets [stationery]; waxed paper; baking paper; paper for medical examination tables; origami folding paper; plantable seed paper [stationery]; paper for recording machines; paper for radiograms; papers for painting and calligraphy; electrocardiograph paper; drawer liners of paper, perfumed or not; wood pulp paper; carbon paper; copying paper [stationery]; parchment paper; writing paper; rice paper; luminous paper; toilet paper; wrapping paper; filter paper; wash; blotters; newsletters; rollers for typewriters; house painters' rollers; composing sticks; adhesives [glues] for stationery or household purposes; modelling wax, not for dental purposes; signboards of paper or cardboard; sewing patterns; bunting of paper; newspapers; electrotypes; hectographs; modelling clay; polymer modelling clay; terrestrial globes; drawing sets; engravings; slate pencils; pencil leads; document holders [stationery]; pencil holders; chalk holders; holders for cheque books; holders for stamps [seals]; page holders; name badge holders [office requisites]; diagrams; table runners of paper; engraving plates; writing slates; blackboards; magnetic boards being office requisites; galley racks [printing]; drawing boards; advertisement boards of paper or card-

board; duplicators; punches [office requisites]; cream containers of paper; correcting fluids [office requisites]; magazines [periodicals]; money clips; clips for name badge holders [office requisites]; tags for index cards; pen clips; bookmarks; etching needles; tracing needles for drawing purposes; periodicals; printed publications; paper shredders for office use; graphic representations; credit card imprinters, non-electric; paper creasers [office requisites]; graining combs; drawing instruments; calendars; tracing paper; tracing cloth; tracing patterns; gums [adhesives] for stationery or household purposes; lithographic stones; ink stones [ink reservoirs]; pencils; pencil lead holders; charcoal pencils; pictures; transfers [decalcomanias]; paintings [pictures], framed or unframed; colouring pictures; cardboard; wood pulp board [stationery]; hat boxes of cardboard; cards; index cards [stationery]; geographical maps; paper tapes and cards for the recordal of computer programmes; trading cards, other than for games; perforated cards for Jacquard looms; catalogues; spools for inking ribbons; flower-pot covers of paper; paintbrushes; painters' brushes; writing brushes; typewriter keys; glue for stationery or household purposes; isinglass for stationery or household purposes; gluten [glue] for stationery or household purposes; starch paste [adhesive] for stationery or household purposes; printing blocks; books; colouring books; manifolds [stationery]; comic books; drawing pins; mats of paper for beer glasses; cigar bands; envelopes [stationery]; boxes of paper or cardboard; cases for stamps [seals]; paint boxes for use in schools; printed coupons; stencils [stationery]; French curves; paper ribbons, other than haberdashery or hair decorations; gummed tape [stationery]; typewriter ribbons; barcode ribbons; adhesive tapes for stationery or household purposes; correcting tapes [office requisites]; inking ribbons; self-adhesive tapes for stationery or household purposes; square rulers for drawing; drawing rulers; flyers; absorbent sheets of paper or plastic for foodstuff packaging; humidity control sheets of paper or plastic for foodstuff packaging; viscose sheets for wrapping; sheets of reclaimed cellulose for wrapping; plastic bubble packs for wrapping or packaging; steel letters; type [numerals and letters]; lithographs; letter trays; paint trays; architects' models; postage stamps; plastics for modelling; graphic prints; modelling materials; teaching materials [except apparatus]; sealing compounds for stationery purposes; padding materials of paper or cardboard; bookbinding material; packing [cushioning, stuffing] materials of paper or cardboard; packaging material made of starches; filtering materials of paper; dish mats of paper; addressing machines; pencil sharpening machines, electric or non-electric; bookbinding apparatus and machines [office equipment]; typewriters, electric or non-electric; franking machines for office use; chalk for lithography; writing chalk; tailors' chalk; marking chalk; spray chalk; bags [envelopes, pouches] of paper or plastics, for packaging; garbage bags of paper

or of plastics; plastic bags for pet waste disposal; painters' easels; hand-rests for painters; printing sets, portable [office requisites]; bibs of paper; bibs, sleeved, of paper; floor decals; stickers [stationery]; fingerstalls for office use; writing cases [stationery]; cords for bookbinding; paper knives [letter openers]; printed sheet music; numbering apparatus; bottle envelopes of paper or cardboard; sealing wafers; covers [stationery]; passport holders; protective covers for books; plastic cling film, extensible, for palletization; embroidery designs [patterns]; handwriting specimens for copying; oleographs; musical greeting cards; greeting cards; postcards; etchings; conical paper bags; paper bags for use in the sterilization of medical instruments; bags for microwave cooking; palettes for painters; ink sticks; pantographs [drawing instruments]; loose-leaf binders; files [office requisites]; folders for papers; papier mâché; pastels [crayons]; modelling paste; pen cases; mezuzah parchments; pen wipers; office perforators; pens [office requisites]; nibs of gold; nibs; steel pens; drawing pens; song books; seals [stamps]; sealing stamps; posters; clipboards; address plates for addressing machines; handkerchiefs of paper; plastic film for wrapping; transparencies [stationery]; desk mats; trays for sorting and counting money; coasters of paper; bookends; stamp stands; stands for pens and pencils; photograph stands; obliterating stamps; inking pads; stamp pads; binding strips [bookbinding]; face towels of paper; towels of paper; inking sheets for document reproducing machines; inking sheets for duplicators; cloth for bookbinding; gummed cloth for stationery purposes; printers' blankets, not of textile; portraits; paperweights; writing cases [sets]; inkstands; office requisites, except furniture; writing materials; writing instruments; drawing materials; school supplies [stationery]; adhesive tape dispensers [office requisites]; hand labelling appliances; printed matter; lithographic works of art; prospectuses; printed timetables; ledgers [books]; printers' reglets; indexes; paper cutters [office requisites]; rubber erasers; elastic bands for offices; T-squares for drawing; graphic reproductions; retractable reels for name badge holders [office requisites]; penholders; marking pens [stationery]; tissues of paper for removing make-up; paper wipes for cleaning; dental tray covers of paper; place mats of paper; tablemats of paper; tablecloths of paper; paper clasps; document files [stationery]; scrapers [erasers] for offices; paper-clips; clips for offices; erasing products; biological samples for use in microscopy [teaching materials]; histological sections for teaching purposes; steatite [tailor's chalk]; writing board erasers; composing frames [printing]; carrier bags of paper or plastic; sealing wax; arithmetical tables; placards of paper or cardboard; writing or drawing books; fabrics for bookbinding; stationery; pencil sharpeners, electric or non-electric; stencil plates; stencils for decorating food and beverages; cardboard tubes; Indian inks; moisteners [office requisites]; moisteners for gummed

surfaces [office requisites]; squares for drawing; chart pointers, non-electronic; bottle wrappers of paper or cardboard; envelope sealing machines for offices; sealing machines for offices; vignetting apparatus; apparatus for mounting photographs; stapling presses [office requisites]; manuals [handbooks]; figurines of papier mâché; paper coffee filters; flags of paper; flip charts; silver paper; moulds for modelling clays [artists' materials]; photo-engravings; photographs [printed]; mezuzah cases; stencil cases; canvas for painting; chromolithographs [chromos]; animation cels; compasses for drawing; numbers [type]; artists' water-colour saucers; ink; correcting ink [heliography]; inkwells; blueprints; stencils; erasing shields; balls for ball-point pens; desktop cabinets for stationery [office requisites]; printing type; address stamps; stamps [seals]; shields [paper seals]; prints [engravings]; labels of paper or cardboard.

20 – Picture frame brackets; recycling bins, not of metal; bottles [containers], not of metal, for compressed gas or liquid air; bamboo, unworked or semi-worked; bumper guards for cots, other than bed linen; reels, not of metal, non-mechanical, for flexible hoses; sew-on tags of plastic or rubber for clothing; pulleys of plastics for blinds; bolts, not of metal; casks of wood for decanting wine; mooring buoys, not of metal; casks, not of metal; barrels, not of metal; identification bracelets, not of metal; sideboards; busts of wood, wax, plaster or plastic; costume stands; bolsters; fans for personal use, non-electric; work benches; vice benches [furniture]; valet stands; coatstands; coat hangers; shoulder poles [yokes]; screws, not of metal; display stands; showcases [furniture]; newspaper display stands; jewellery organizer displays; removable covers for sinks; collars, not of metal, for fastening pipes; comb foundations for beehives; signboards of wood or plastics; loading gauge rods, not of metal, for railway wagons; nuts, not of metal; covers for clothing [wardrobe]; shoe pegs, not of metal; nesting boxes; coffins; doors for furniture; curtain holders, not of textile material; dowels, not of metal; divans; towel dispensers, fixed, not of metal; door closers, not of metal, non-electric; kennels for household pets; birdhouses; keyboards for hanging keys; display boards; plugs [dowels], not of metal; containers, not of metal, for liquid fuel; troughs, not of metal, for mixing mortar; oil drainage containers, not of metal; packaging containers of plastic; indoor window blinds [furniture]; indoor window blinds of paper; indoor window blinds of woven wood; indoor window blinds of textile; flower-stands [furniture]; curtain tie-backs; clips, not of metal, for cables and pipes; binding screws, not of metal, for cables; clips of plastic for sealing bags; rivets, not of metal; imitation tortoiseshell; locks, not of metal, for vehicles; padlocks, other than electronic, not of metal; locks, other than electric, not of metal; bead curtains for decoration; door bolts, not of metal; bottle closures, not of metal; closures, not of metal, for containers; latches, not of metal; mirrors [looking

glasses]; hand-held mirrors [toilet mirrors]; number-plates, not of metal; scratching posts for cats; animal claws; animal hooves; coral; meerschaum; whalebone, unworked or semi-worked; stag antlers; tortoiseshell; horn, unworked or semi-worked; animal horns; rattan; corozo; plaited straw, except matting; wickerwork; hampers [baskets] for the transport of items; works of art of wood, wax, plaster or plastic; cabinet work; reeds [plaiting materials]; settees; jerrycans, not of metal; curtain rods; index cabinets [furniture]; reels of wood for yarn, silk, cord; drain traps [valves] of plastic; water-pipe valves of plastic; valves, not of metal, other than parts of machines; staves of wood; plastic keys; plastic key cards, not encoded and not magnetic; mats for infant playpens; reusable baby changing mats; sleeping pads; mats, removable, for sinks; saw horses; bed casters, not of metal; furniture casters, not of metal; brush mountings; chopping blocks [tables]; wind chimes [decoration]; door bells, not of metal, non-electric; bottle caps, not of metal; bassinets; tent pegs, not of metal; curtain rings; split rings, not of metal, for keys; chests of drawers; console tables; waste dumpsters, not of metal, other than for medical use; containers, not of metal [storage, transport]; floating containers, not of metal; lecterns; dog kennels; bakers' bread baskets; baskets, not of metal; Moses baskets; bottle casings of wood; tool boxes, not of metal, empty; taps, not of metal, for casks; arm-chairs; hairdressers' chairs; deck chairs; beds; hospital beds; waterbeds, not for medical purposes; bedsteads of wood; air beds, not for medical purposes; cots for babies; edgings of plastic for furniture; brackets, not of metal, for furniture; screw tops, not of metal, for bottles; table tops; sash fasteners, not of metal, for windows; coathooks, not of metal; curtain hooks; clothes hooks, not of metal; bag hangers, not of metal; beds for household pets; nesting boxes for household pets; ladders of wood or plastics; playpens for babies; tailors' dummies; mattresses; air mattresses, not for medical purposes; camping mattresses; furniture; furniture of metal; inflatable furniture; office furniture; school furniture; mobiles [decoration]; door knockers, not of metal; shoe dowels, not of metal; curtain rails; runners, not of metal, for sliding doors; legs for furniture; feet for furniture; house numbers, not of metal, non-luminous; cask hoops, not of metal; door stops, not of metal or rubber; window stops, not of metal or rubber; hanging closet organizers; mouldings for picture frames; bed bases; plastic ramps for use with vehicles; furniture partitions of wood; freestanding partitions [furniture]; mother-of-pearl, unworked or semi-worked; ambroid plates; loading pallets, not of metal; handling pallets, not of metal; transport pallets, not of metal; mirror tiles; head-rests [furniture]; trays, not of metal; stakes, not of metal, for plants or trees; trestles [furniture]; magazine racks; book rests [furniture]; stands for calculating machines; pet cushions; pillows; cushions; cushions for lining pet crates; head support cushions for babies; anti-roll cushions

for babies; air cushions, not for medical purposes; air pillows, not for medical purposes; head positioning pillows for babies; racks [furniture]; library shelves; shelves for file cabinets; furniture shelves; plate racks [furniture]; shelves for storage; wood ribbon; straw edgings; towel stands [furniture]; hat stands; bathtub grab bars, not of metal; cask stands, not of metal; inflatable publicity objects; counters [tables]; bedding, except linen; corks for bottles; corks; stoppers, not of glass, metal or rubber; sealing caps, not of metal; stair rods; flower-pot pedestals; standing desks; embroidery frames; dispensers for dog waste bags, fixed, not of metal; drawer organizers; shells; picture frames; sections of wood for beehives; crucifixes of wood, wax, plaster or plastic, other than jewellery; containers, not of metal, for compressed gas or liquid air; reservoirs, not of metal nor of masonry; fodder racks; curtain rollers; door handles, not of metal; knobs, not of metal; fishing baskets; writing desks; bath seats for babies; seats of metal; benches [furniture]; vats, not of metal; honeycombs; sofas; plugs, not of metal; statues of wood, wax, plaster or plastic; oyster shells; silvered glass [mirrors]; shelving units; ambroid bars; umbrella stands; gun racks; trolleys for computers [furniture]; lap desks; dressing tables; washstands [furniture]; tables; typing desks; massage tables; tables of metal; wall-mounted baby changing platforms; saw benches [furniture]; desks; portable desks; tea trolleys; dinner wagons [furniture]; drafting tables; steps [ladders], not of metal; step stools, not of metal; chairs [seats]; high chairs for babies; shower chairs; chests, not of metal; placards of wood or plastics; nameplates, not of metal; stools; bathroom stools; footstools; crates; trolleys [furniture]; straw plaits; mobile boarding stairs, not of metal, for passengers; straw mattresses; decorations of plastic for foodstuffs; beehives; bathroom vanities [furniture]; door fasteners, not of metal; window fasteners, not of metal; funerary urns; window closers, not of metal, non-electric; door openers, not of metal, non-electric; window openers, not of metal, non-electric; winding spools, not of metal, non-mechanical, for flexible hoses; figurines of wood, wax, plaster or plastic; hand-held flagpoles, not of metal; door fittings, not of metal; coffin fittings, not of metal; bed fittings, not of metal; furniture fittings, not of metal; window fittings, not of metal; infant walkers; garment covers [storage]; covers specially made for handling and transport of bottles, not of metal, for compressed gas; stuffed animals; stuffed birds; hinges, not of metal; chaise longues; poles, not of metal; screens [furniture]; luggage lockers; filing cabinets; medicine cabinets; lockers [furniture]; meat safes; bookcases; kitchen dressers [furniture]; wardrobes; cupboards; window pulleys, not of metal; bamboo curtains; slatted indoor blinds; sneeze guards; screens for fireplaces [furniture]; labels of plastic; yellow amber; drawers for furniture; chests for toys; tool chests, not of metal, empty; boxes of wood or

plastic; letter boxes, not of metal or masonry; bottle racks.

21 – Autoclaves, non-electric, for cooking; indoor aquaria; wine aerators; buckets; automatic opening and closing trash cans; cookie jars; candle jars [holders]; china ornaments; dishes; vegetable dishes; saucers; boxes for sweets; bottles; demijohns; busts of porcelain, ceramic, earthenware, terra-cotta or glass; vases; epergnes; fruit bowls; inflatable bath tubs for babies; bird baths; baby baths, portable; plungers for clearing blocked drains; waffle irons, non-electric; diaper disposal pails; ice buckets; mop wringer buckets; buckets made of woven fabrics; whisks, non-electric, for household purposes; cooking skewers of metal; towel rails and rings; clothing stretchers; barbecue forks; serving forks; hair brushes; horsehair for brush-making; funnels; pie funnels; candle warmers, electric and non-electric; carpet beaters [hand instruments]; signboards of porcelain or glass; candle extinguishers; heads for electric toothbrushes; flower pots; chamber pots; glue-pots; cruets; decanters; large-toothed combs for the hair; combs for animals; tea cosies; abrasive sponges for scrubbing the skin; bath sponges; make-up sponges; sponges for household purposes; sponge holders; stands for portable baby baths; toothpick holders; soap holders; table napkin holders; holders for flowers and plants [flower arranging]; tea bag rests; shaving brush stands; toilet paper holders; toilet paper dispensers; soap dispensers; plug-in diffusers for mosquito repellents; aromatic oil diffusers, other than reed diffusers, electric and non-electric; ironing boards; cutting boards for the kitchen; bread boards; washing boards; crushers for kitchen use, non-electric; strainers for household purposes; smoke absorbers for household purposes; containers for household or kitchen use; kitchen containers; glass jars [carboys]; heat-insulated containers; heat-insulated containers for beverages; thermally insulated containers for food; glass flasks [containers]; closures for pot lids; chamois leather for cleaning; toothpicks; ceramics for household purposes; majolica; works of art of porcelain, ceramic, earthenware, terra-cotta or glass; kitchen grinders, non-electric; cleaning instruments, hand-operated; cabarets [trays]; stew-pans; couscous cooking pots, non-electric; cooking pots, non-electric; flower-pot covers, not of paper; shaving brushes; make-up brushes; cages for household pets; birdcages; cages for collecting insects; baking mats; ladles for serving wine; polishing leather; hot pots, not electrically heated; glass bulbs [receptacles]; shoe trees; napkin rings; poultry rings; rings for birds; disposable aluminium foil containers for household purposes; coin banks; piggy banks; bread baskets for household purposes; baskets for household purposes; waste paper baskets; feeding troughs; pet feeding bowls, automatic; mangers for animals; lunch boxes; insect collectors' boxes; tea caddies; washtubs; earthenware saucepans; mess-tins; cauldrons; coffee percolators, non-electric; coffeepots, non-electric; coffee

grinders, hand-operated; mugs; beer mugs; tankards; rat traps; pot lids; aquarium hoods; butter-dish covers; dish covers; cheese-dish covers; reusable silicone food covers; buttonhooks; reusable ice cubes; jugs; perfume burners; watering cans; fly traps; insect traps; ice cream scoops; mixing spoons [kitchen utensils]; basting spoons [cooking utensils]; serving spoons; pie servers; spatulas for kitchen use; valet trays [receptacles for small objects] for household purposes; litter boxes for pets; butter dishes; material for brush-making; polishing materials for making shiny, except preparations, paper and stone; tablemats, not of paper or textile; noodle machines, hand-operated; lint removers, electric or non-electric; pasta makers, hand-operated; polishing apparatus and machines, for household purposes, non-electric; pepper mills, hand-operated; mills for household purposes, hand-operated; feather-dusters; brooms; isothermic bags; decorating bags for confectioners; cooking mesh bags, other than for microwaves; bowls [basins]; pet feeding bowls; soup bowls; mosaics of glass, not for building; dishcloths; saucepan scourers of metal; soap boxes; mouse traps; meat grinders, non-electric; cooking pot sets; nozzles for watering cans; pouring spouts; wine pourers; cake decorating tips and tubes; nozzles for watering hose; fitted picnic baskets, including dishes; toilet cases; floss for dental purposes; fibreglass thread, other than for textile use; cookie [biscuit] cutters; pastry cutters; sprinklers; syringes for watering flowers and plants; egg yolk separators; cotton waste for cleaning; wool waste for cleaning; cleaning tow; cold packs for chilling food and beverages; chopsticks; cocktail stirrers; food steamers, non-electric; pepper pots; abrasive mitts for scrubbing the skin; oven mitts; animal grooming gloves; gloves for household purposes; car washing mitts; polishing gloves; gardening gloves; pestles for kitchen use; droppers for household purposes; wine-tasting pipettes; droppers for cosmetic purposes; plates for diffusing aromatic oil; plates to prevent milk boiling over; dripping pans; trays for household purposes; trays of paper, for household purposes; lazy susans; heaters for feeding bottles, non-electric; candelabra [candlesticks]; trivets [table utensils]; coasters, not of paper or textile; grill supports; menu card holders; knife rests for the table; mats, not of paper or textile, for beer glasses; flat-iron stands; egg cups; abrasive pads for kitchen purposes; scouring pads; drinking troughs; serving ladles; powdered glass for decoration; pottery; pots; vessels for making ices and ice cream, non electric; painted glassware; tableware, other than knives, forks and spoons; porcelain ware; earthenware; crystal [glassware]; cosmetic utensils; trouser presses; tortilla presses, non-electric [kitchen utensils]; tube squeezers for household purposes; fruit presses, non-electric; deodorizing apparatus for personal use; cruet sets for oil and vinegar; make-up removing appliances; spice sets; apparatus for wax-polishing, non-electric; bottle openers, electric and non-electric; glove stretchers; boot

jacks; crumb trays; tie presses; potholders; clothes-  
pegs; glass stoppers; roaster pans; powder compacts,  
empty; perfume vaporizers; powder puffs; dusting  
apparatus, non-electric; foam toe separators for use in  
pedicures; combs; electric combs; grills [cooking uten-  
sils]; sifters [household utensils]; drinking horns;  
shoe horns; candle drip rings; broom handles; salad  
bowls; place mats, not of paper or textile; beverage  
urns, non-electric; sugar bowls; beaters, non-electric;  
egg separators, non-electric, for household purposes;  
services [dishes]; coffee services [tableware]; liqueur  
sets; tea services [tableware]; sieves [household uten-  
sils]; cinder sifters [household utensils]; tea strainers;  
siphon bottles for carbonated water; rolling pins, do-  
mestic; frying pans; squeegees [cleaning instruments];  
steel wool for cleaning; currycombs; smart medicine  
bottles, sold empty; blenders, non-electric, for house-  
hold purposes; scoops for household purposes; straws  
for drinking; salt cellars; drinking vessels; refrigerat-  
ing bottles; bulb basters; cups of paper or plastic; gla-  
sses [receptacles]; drinking glasses; statues of porce-  
lain, ceramic, earthenware, terra-cotta or glass; figur-  
ines of porcelain, ceramic, earthenware, terra-cotta or  
glass; glass for vehicle windows [semi-finished pro-  
duct]; fused silica [semi-worked product], other than  
for building; plate glass [raw material]; opal glass;  
glass, unworked or semi-worked, except building  
glass; opaline glass; glass incorporating fine electrical  
conductors; enamelled glass, not for building; glass  
wool, other than for insulation; vitreous silica fibres,  
other than for textile use; fibreglass, other than for  
insulation or textile use; mortars for kitchen use; por-  
table cool boxes, non-electric; soup tureens; drying  
racks for laundry; rotary washing lines; tajines, non-  
electric; basins [receptacles]; table plates; paper pla-  
tes; disposable table plates; graters for kitchen use;  
insulating flasks; indoor terrariums [plant cultivation];  
indoor terrariums [vivariums]; roller tubes for peeling  
garlic; cloth for washing floors; polishing cloths;  
cloths for cleaning; dusting cloths [rags]; furniture  
dusters; wax-polishing appliances, non-electric, for  
shoes; water apparatus for cleaning teeth and gums;  
electric devices for attracting and killing insects; wa-  
tering devices; ultrasonic pest repellers; utensils for  
household purposes; kitchen utensils; cooking uten-  
sils, non-electric; figurines of porcelain, ceramic, ear-  
thenware, terracotta or glass for cakes; coffee filters,  
non-electric; flasks; water flossers; hip flasks; drin-  
king bottles for sports; boot trees; moulds [kitchen  
utensils]; egg poachers; cake moulds; baking cases of  
paper; baking cases of silicone; ice cube moulds; coo-  
kery moulds; deep fryers, non-electric; comb cases;  
bread bins; fly swatters; teapots; kettles, non-electric;  
cups; garlic presses [kitchen utensils]; ironing board  
covers, shaped; tea infusers; decorative glass spheres;  
mops; mop wringers; cocktail shakers; cosmetic spa-  
tulas; cosmetic stamps, sold empty; corkscrews, elec-  
tric and non-electric; animal bristles [brushware]; pig  
bristles for brush-making; brushes; sound wave vibra-

tion hairbrushes; dishwashing brushes; ski wax brus-  
hes; brushes for cleaning tanks and containers; lamp-  
glass brushes; horse brushes; scrubbing brushes; to-  
othbrushes; toothbrushes, electric; basting brushes;  
carpet sweepers; shoe brushes; tar-brushes, long han-  
dled; toilet brushes; electric brushes, except parts of  
machines; eyebrow brushes; nail brushes; eyelash  
brushes; barbecue tongs; nutcrackers; ice tongs; salad  
tongs; sugar tongs; decanter tags; nest eggs, artificial;  
boxes for dispensing paper towels; dustbins; window-  
boxes; boxes of glass.

28 – Arcade video game machines; video game ma-  
chines; gaming machines for gambling; amusement  
machines, automatic and coin-operated; toy vehicles;  
swimming pools [play articles]; trampolines; novelty  
toys for parties; scratch cards for playing lottery ga-  
mes; golf bag tags; starting blocks for sports; bodybo-  
ards; boomerangs; dolls' feeding bottles; tricycles for  
infants [toys]; stationary exercise bicycles; external  
cooling fans for game consoles; creels [fishing traps];  
shuttlecocks; spinning tops [toys]; dumb-bells; gyros-  
copes and flight stabilizers for model aircraft; jigsaw  
puzzles; clay pigeons [targets]; punching bags; bite  
sensors [fishing tackle]; hang gliders; joysticks for  
video games; flying discs [toys]; discuses for sports;  
dolls' houses; playhouses for children; dominoes; swi-  
mming kickboards; paddleboards; surfboards; spring  
boards [sports articles]; skateboards; sailboards; ches-  
sboards; draughtboards; drones [toys]; darts; Christ-  
mas trees of synthetic material; cups for dice; swim-  
ming jackets; ascenders [mountaineering equipment];  
kites; needles for pumps for inflating balls for games;  
toys; toys for pets; stuffed toys; inflatable games for  
swimming pools; plush toys; toy mobiles; novelty to-  
ys for playing jokes; fidget toys; games; portable ga-  
mes and toys incorporating telecommunication functi-  
ons; card games; trading card games; table-top games;  
board games; portable games with liquid crystal dis-  
plays; ring games; building games; toy imitation cos-  
metics; swimming pool air floats; kaleidoscopes; bla-  
dders of balls for games; rosin used by athletes; edges  
of skis; trading cards for games; bingo cards; playing  
cards; fairground ride apparatus; reels for fishing; roc-  
king horses; swings; yoga swings; skittles; skittles  
[games]; billiard cues; golf clubs; hockey sticks; baby  
gyms; seal skins [coverings for skis]; bells for Christ-  
mas trees; dolls' rooms; controllers for game conso-  
les; controllers for toys; cone markers for sports; con-  
fetti; ice skates; roller skates; in-line roller skates;  
dice; electric muscle stimulation bodysuits for sports;  
paintball guns [sports apparatus]; ski bindings; dolls'  
beds; roulette wheels; fish hooks; building blocks [to-  
ys]; dolls; ball-jointed dolls [BJD]; flippers for diving;  
flippers for swimming; swimming webs; rhythmic gy-  
mnastics ribbons; fishing lines; gut for fishing; bows  
for archery; skis; waterskis; roller skis; mah-jong;  
hunting game calls; puppets; masks [playthings]; car-  
nival masks; theatrical masks; fencing masks; toy  
dough; toy putty; matryoshka dolls; masts for sailbo-

ards; ball pitching machines; teddy bears; chalk for billiard cues; targets; electronic targets; toy models; scale model kits [toys]; scale model vehicles; kite reels; balls for games; artificial fishing bait; billiard table cushions; knee guards [sports articles]; billiard cue tips; elbow guards [sports articles]; backgammon games; ball inflators; climbers' harness; hoops for exercise incorporating measuring sensors; dolls' clothes; fencing weapons; play tents; ski sticks for roller skis; ski sticks; twirling batons; toy glow stick bracelets for parties; paragliders; pachinkos; baseball gloves; boxing gloves; golf gloves; gloves for games; batting gloves [accessories for games]; fencing gauntlets; playground sandboxes; piñatas; toy pistols; toy air pistols; percussion caps [toys]; caps for pistols [toys]; screen protectors made of polyethylene terephthalate [PET] specially adapted for hand-held game consoles; rattles [playthings]; horseshoe games; candle holders for Christmas trees; Christmas tree stands; sole coverings for skis; water wings; floats for fishing; swimming belts; adhesive abdominal exercise belts, electric, for muscle stimulation; waist trimmer exercise belts; decoys for hunting or fishing; scent lures for hunting or fishing; archery implements; soap bubbles [toys]; divot repair tools [golf accessories]; billiard markers; video game consoles; hand-held consoles for playing video games; protective paddings [parts of sports suits]; rackets; protective cups for sports; surfboard leashes; harness for sailboards; weight lifting belts [sports articles]; toy robots; sling shots [sports articles]; rollers for stationary exercise bicycles; harpoon guns [sports articles]; plush toys with attached comfort blanket; scooters [toys]; sleds [sports articles]; bob-sleighs; skeleton sleds; butterfly nets; landing nets for anglers; nets for sports; tennis nets; bite indicators [fishing tackle]; slot machines [gaming machines]; appliances for gymnastics; quoits; bar-bells; fishing tackle; artificial snow for Christmas trees; snowshoes; snowboards; remote-controlled toy vehicles; clay pigeon traps; billiard tables; coin-operated billiard tables; tables for table tennis; strings for rackets; gut for rackets; golf bags, with or without wheels; cricket bags; golf bag trolleys; slides [playthings]; body-building apparatus; machines for physical exercises; men's athletic supporters [sports articles]; rods for fishing; ornaments for Christmas trees, except lights, candles and confectionery; tennis ball throwing apparatus; conjuring apparatus; apparatus for games; bowling apparatus and machinery; exercise weights; toy figures; action figures; counters [discs] for games; chips for gambling; foosball tables; party poppers [party novelties]; hand clappers [noisemaker toys]; Christmas crackers [party novelties]; bags especially designed for surfboards; bags especially designed for skis; marbles for games; billiard balls; party balloons; bowling balls; balls for playing bowls; paintballs [ammunition for paintball guns] [sports apparatus]; snow globes; chess games; draughts [games]; poles for pole vaulting; paper party hats; shin guards [sports

articles]; camouflage screens [sports articles]; chest expanders [exercisers].

(260) AM 2023 120635 A

(800) 1699655

(151) 2022 09 02

(891) 2022 09 02

(731) Euro Games Technology Ltd.

"Maritsa" Str. 4, "Vranya-Lozen-Triugulnika",  
BG-1151 Sofia, Bulgaria

(540)

## Shining Hot

(591) Black, white

(511)

9 – Operating computer software for main frame computers; monitors (computer hardware); computer hardware; apparatus for recording images; monitors (computer programs); computer game programs; computer programs for recorded games; apparatus for recording, transmission or reproduction of sound or images; communications servers [computer hardware]; electronic components for gambling machines; computer application software featuring games and gaming; computer software for the administration of on-line games and gaming; computer hardware for games and gaming; computer hardware and software for gambling, gambling machines, gambling games on the Internet and via telecommunication network; computer systems; computer operating system software; computer terminals; interactive terminals; multimedia terminals; electronic terminals for generating lottery tickets; interactive touch screen terminals; computer touchscreens; electronic display panels; liquid crystal display screens; digital signage display panels; multimedia software; multimedia apparatus and instruments; interactive multimedia software for playing games; computer screens; LCD large-screen displays; liquid crystal displays [LCDs] for home theaters; media streaming software; computer application software for streaming audio-visual media content via the Internet; software; computer gaming software; computer software packages; computer operating system software; computer software, recorded; software drivers; virtual reality software; games software; entertainment software for computer games; computer programs for network management; electronic lottery tickets; computer software platforms; operating systems; interactive computer systems; operating system programs; computer game software for use with on-line interactive games; games software for use with video game consoles.

28 – Gaming machines for gambling; chips for gambling; mah-jong; arcade games, gambling machines operating with coins, notes and cards; games; electronic games; parlor games; gaming chips; gaming tables; slot machines [gaming machines]; LCD game machines; slot machines and gaming devices; coin-operated

rated amusement machines; roulette chips; poker chips; chips and dice [gaming equipment]; equipment for casinos; roulette tables; gaming roulette wheels; casino games; automats and gambling machines; coin-operated machines and/or electronic coin-operated machines with or without the possibility of gain; boxes for coin-operated machines, slot machines and gaming machines; electronic or electrotechnical gaming devices, automats and machines, coin-operated machines; housings for coin-operated machines, gaming equipment, gaming machines, machines for gambling; electropneumatic and electrical gambling machines (slot machines) lottery wheels; electronic targets for games and sports; video game consoles.

41 – Gambling; services related to gambling; gaming services for entertainment purposes; casino, gaming and gambling services; training in the development of software systems; provision of gaming equipment for gambling halls; providing casino equipment [gambling]; gaming machine entertainment services; providing casino facilities [gambling]; amusement arcade services; games equipment rental; rental of gaming machines; providing amusement arcade services; rental of gaming machines with images of fruits; editing or recording of sounds and images; sound recording and video entertainment services; hire of sound reproducing apparatus; provision of gaming equipment for casinos; providing of casino facilities; online gambling services; casino management services; operation of gaming establishments, gaming halls, Internet casinos, online gambling sites; organization of lotteries; operating of lotteries; provision of games by means of a computer based system; online interactive entertainment; on-line casino services; online game services through mobile devices; providing online entertainment in the nature of game tournaments; providing on-line information in the field of computer gaming entertainment; sports betting services; online sports betting services; providing on-line computer games and games of chance, in particular use of non-downloadable game software; rental of video game consoles.

(260) AM 2023 120636 A

(800) 1699658

(151) 2022 07 21

(891) 2022 07 21

(731) WENLING AWT MACHINERY CO., LTD.

East of Xincheng Avenue, Qiaowu Village,  
Zeguo Town, Wenling, Taizhou City, 317523  
Zhejiang Province, China

(540)

# Azzuno

(591) Black, white

(531) 27.05.17

(511)

7 – Industrial robots; hydraulic turbines; stone-working machines; shredders [machines] for industrial use; drilling machines; pumps [machines]; electric welding apparatus; electric hammers; jacks [machines]; lawnmowers [machines].

9 – Rulers [measuring instruments]; signal lanterns; protection devices for personal use against accidents; battery chargers; solderers' helmets; face recognition equipment; gloves for protection against accidents; automatic measuring instruments; protective masks, not for medical purposes; remote control apparatus.

(260) AM 2023 120637 A

(800) 1699685

(151) 2022 07 29

(891) 2022 07 29

(731) Euro Games Technology Ltd.

"Maritsa" Str. 4, "Vranya-Lozen-Triugulnika",  
BG-1151 Sofia, Bulgaria

(540)

## 40 Super Flaming

(591) Black, white

(511)

9 – Software; computer gaming software; computer software packages; computer operating system software; computer software, recorded; software drivers; virtual reality software; games software; entertainment software for computer games; computer programs for network management; operating computer software for main frame computers; monitors (computer hardware); computer hardware; apparatus for recording images; monitors (computer programs); computer game programs; computer programs for recorded games; apparatus for recording, transmission or reproduction of sound or images; communications servers [computer hardware]; electronic components for gambling machines; computer application software featuring games and gaming; computer software for the administration of on-line games and gaming; computer hardware for games and gaming; hardware and software for gambling, gambling machines, gambling games on the Internet and via telecommunication network.

28 – Gaming machines for gambling; chips for gambling; mah-jong; arcade games; gambling machines operating with coins, notes and cards; games; electronic games; parlor games; gaming chips; gaming tables; slot machines [gaming machines]; LCD game machines; slot machines and gaming devices; coin-operated amusement machines; roulette chips; poker chips; chips and dice [gaming equipment]; gaming equipment for casinos; roulette tables; gaming roulette wheels; casino games; gambling machines and amusement machines, automatic and coin-operated; coin-operated amusement machines and/or electronic coin-operated amusement machines with or without the



possibility of gain; boxes for coin-operated machines, slot machines and gaming machines; electronic or electrotechnical amusement machines and apparatus, gaming machines, coin-operated entertainment machines; housings for coin-operated machines, gaming equipment, gaming machines, machines for gambling; electropneumatic and electrical gambling machines (slot machines).

41 – Gambling; entertainment services related to gambling; gaming services for entertainment purposes; casino, gaming and gambling services; training in the development of software systems; provision of gaming equipment for gambling halls; providing casino equipment [gambling]; gaming machine entertainment services; providing casino facilities [gambling]; gaming hall services; games equipment rental; rental of gaming machines; providing amusement arcade services; rental of gaming machines with images of fruits; editing or recording of sounds and images; sound recording and video entertainment services; hire of sound reproducing apparatus; provision of gaming equipment for casinos; providing of casino facilities; online gambling services; casino services; provision of gaming facilities and gaming hall facilities, internet casinos and online gambling services; providing online games and games of chance, in particular using non-downloadable gaming software.

(260) AM 2023 120638 A  
(800) 1699710  
(151) 2022 11 02  
(891) 2022 11 02  
(731) Edgewell Personal Care Brands, LLC  
6 Research Drive, Shelton CT 06484, USA  
(540)

## HAWAIIAN TROPIC

(591) Black, white  
(511)  
3 – Sunscreen preparations; sun-tanning preparations; sunless tanning preparations, namely, cosmetic tanning preparations; body butter; moisturizers; non-medicated skin care preparations; lip balm.

(260) AM 2023 120671 A  
(800) 1700348  
(151) 2022 07 29  
(891) 2022 07 29  
(731) KERAKOLL S.P.A  
VIA DELL'ARTIGIANATO 9, I-41049  
SASSUOLO (MO), Italy  
(540)

## FUGABELLA

(591) Black, white

(511)  
1 – Chemical additives for grouting materials used for laying floorings and coverings of ceramic tiles and/or natural stone.

(260) AM 2023 120672 A  
(800) 1700365  
(151) 2022 11 10  
(891) 2022 11 10  
(731) HYUNDAI MOTOR COMPANY  
12, Heolleung-ro, Seocho-gu, Seoul 06797,  
Republic of Korea  
(540)



(591) Dark blue  
(531) 24.11.18; 24.11.25; 26.01.02; 26.01.03;  
26.01.18; 27.05.01; 27.05.21; 29.01.04

(511)  
28 – Toys for pets; ornaments for Christmas trees, except illumination articles and confectionery; toys (playthings); toy cars; dolls; toys; scale model vehicles; toy vehicles; toy aircraft; toy robots; drones [toys]; remote controls for operating scale model vehicles; electric ride-on toy cars for children or infants; toys designed to be attached to car seats; games and playthings; portable games and toys incorporating telecommunication functions; games; video game apparatus; machines for physical exercises; bags specially adapted for sports equipment; gymnastic and sporting articles; golf bags.

(260) AM 2023 120673 A  
(800) 1700429  
(151) 2022 07 29  
(891) 2022 07 29  
(731) Euro Games Technology Ltd.  
4, "Maritsa" Str., "Vranya-Lozen-Triugulnika",  
BG-1151 Sofia, Bulgaria  
(540)

## Mighty God of the Seas

(591) Black, white  
(511)  
9 – Operating computer software for main frame computers; monitors (computer hardware); computer hardware; apparatus for recording images; monitors (computer programs); computer game programs; recorded computer game programs; apparatus for recording, transmission or reproduction of sound or images; communications servers (computer hardware); electronic components for gambling machines; computer application software featuring games and gaming;

computer software for the administration of on-line games and gaming; computer hardware for games and gaming; computer hardware for games and gambling on the Internet and via telecommunication network; downloadable computer game software for gambling machines on the Internet and via telecommunication network; computer systems; computer operating system software; computer terminals; interactive terminals; multimedia terminals; electronic terminals for generating lottery tickets; interactive touch screen terminals; computer touchscreens; electronic display panels; liquid crystal display screens; digital signage display panels; multimedia software; multimedia apparatus and instruments; interactive multimedia software for playing games; computer screens; led large-screen displays; liquid crystal displays [lcds] for home theatres; media streaming software; computer application software for streaming audio-visual media content via the Internet; software; computer gaming software; computer software packages; computer operating system software; computer software, recorded; software drivers; virtual reality software; games software; entertainment software for computer games; computer programs for network management; electronic lottery tickets; computer software platforms; operating systems; interactive computer systems; operating system programs; computer game software for use with on-line interactive games.

28 – Gaming machines for gambling; chips for gambling; mah-jong; arcade games; gambling machines operating with coins, notes and cards; games; electronic games; parlor games; gaming chips; gaming tables; slot machines [gaming machines]; LCD game machines; slot machines and gaming devices; coin-operated amusement machines; roulette chips; poker chips; chips and dice [gaming equipment]; gaming equipment for casinos; roulette tables; gaming roulette wheels; casino games; automats and gambling machines; coin-operated amusement machines and/or electronic coin-operated amusement machines with or without the possibility of gain; boxes for coin-operated amusement machines, slot machines and gaming machines; electronic or electrotechnical amusement machines and apparatus, gaming machines, coin-operated entertainment machines; housings for coin-operated amusement machines, gaming equipment, gaming machines, machines for gambling; electropneumatic and electrical gambling machines (slot machines); lottery games; electronic targets for games and sports.

41 – Gambling; entertainment services related to gambling; gaming services for entertainment purposes; casino, gaming and gambling services; training in the development of software systems; provision of gaming equipment for gambling halls; providing casino equipment [gambling]; gaming machine entertainment services; providing casino facilities [gambling]; gaming hall services; games equipment rental; rental of

gaming machines; providing amusement arcade services; rental of gaming machines with images of fruits; editing or recording of sounds and images; sound recording and video entertainment services; hire of sound reproducing apparatus; provision of gaming equipment for casinos; providing of casino facilities; online gambling services; casino services; provision of gaming facilities and gaming hall facilities, Internet casinos and online gambling services; lottery services; organization of lotteries; provision of games by means of a computer based system; online interactive entertainment; on-line casino services; online game services through mobile devices; providing online entertainment in the nature of game tournaments; providing on-line information in the field of computer gaming entertainment; sports betting services; online sports betting services; providing online games and games of chance, in particular using non-downloadable gaming software.

---

(260) AM 2023 120674 A

(800) 1700480

(151) 2022 08 11

(891) 2022 08 11

(731) Doka GmbH

Josef-Umdasch-Platz 1, A-3300 Amstetten,  
Austria

(540)

## FRAMI

(591) Black, white

(511)

6 – Formwork and parts therefor for concrete construction, especially wall forms and formwork shuttering; formwork and support structures and components thereof for formwork for use in concrete construction, in particular adjustable footholds and supporting heads; tension jacks, anchors, consoles, wedges, tapers, nuts, anchor plates, bolts, connectors, tubing, rails of metal, fittings of metal for building, all the aforesaid good being of metal or predominantly of metal.

19 – Formwork and parts therefor for concrete construction, in particular shuttering boards; all the aforesaid goods being not of metal or predominantly not of metal, all the aforesaid goods, of the following materials: mainly of wood, another material being wood, combinations of the aforesaid goods, including in connection with metal.

---

(260) AM 2023 120676 A

(800) 1700581

(151) 2022 06 20

(891) 2022 06 20

(731) MUSTANG – Bekleidungswerke GmbH + Co. KG  
Karl-Kurz-Straße 44/1, 74523 Schwäbisch  
Hall, Germany

(540)



(591) Black, white

(531) 03.03.01; 03.03.24

(511)

3 – Soap; perfumery, essential oils, cosmetics, hair lotions; dentifrices; deodorising preparations for personal use (perfumery); room sprays as fragrance sprays.

9 – Spectacles, sunglasses.

14 – Goods in precious metals and/or their alloys and coated therewith, namely works of art, ornaments, key rings [split rings with trinket or decorative fob], jewellery charms and decorative articles [trinkets or jewellery] for personal use; jewellery; paste jewellery, clocks, wrist watches, pocket watches.

18 – Goods made from leather and imitation leather, namely bags and other, small leather goods and containers not specifically designed for the objects to be carried, namely purses, pocket wallets, key bags, labels of leather, cases (for storing spectacles and/or keys), purses, luggage tags, cosmetic purses, toiletry bags; handbags, shopping bags, sport bags and packs, briefcases, school knapsacks, rucksacks, trunks and travelling bags, travelling bags; umbrellas and parasols.

24 – Textiles, fabrics, curtains of textile or plastic, household linen, table and bed linen; bed and table covers; handkerchiefs of textile; fabric of imitation animal skins; non-woven fabrics; towels and face towels of textile.

25 – Clothing, in particular trousers, denim jeans, shirts and blouses, skirts and dresses, shorts, Tee-shirts, tops, sweaters, sweat shirts, parkas, coats, jackets [clothing], scarves, pyjamas, nighties, dressing gowns, bathrobes, foundation garments and undergarments, corsets [underclothing], socks, stockings; sportswear, workwear, clothing for children, clothing of leather; belts, suspenders, headgear, footwear, shoes, sports shoes.

35 – Advertising, marketing, public relations and promotional services, business management, business administration, office functions; the bringing together, for the benefit of others, of a variety of goods (excluding the transport thereof), namely, the bringing together, but not transporting, in relation to the following goods, namely, clothing and clothing accessories, shoes, headgear, handbags and leather goods including small leather goods, namely, pouches, wallets, key cases, key tags, labels of leather, purses, luggage tags, toiletry pouches, toilet bags and cases (for

storing glasses and/or keys), perfumery and cosmetology, sporting articles, costume jewellery and time instruments, sunglasses and other fashion items and lifestyle goods, namely, textiles, fabrics, curtains, window shades, household linen, bed linen and table linen, bed and table cloths, handkerchiefs of textile, textile imitations of leather, cloths made of non-woven materials, hand towels and facecloths of textile, for purposes of the aforesaid services, enabling customers to conveniently view and purchase those goods from a retail store, by catalogue and electronic media; presentation of goods for sales purposes, enabling customers to compare and purchase those goods; procurement services for others [purchasing goods and services for other businesses]; management services for retailing, mail order and/or online businesses; business information, advisory and consultancy, in relation to the following fields, namely, retail shops, especially, sale, demonstration of goods and business plans; import-export agency services; franchise management in connection with the operation or management of commercial enterprises.

(260) AM 2023 120691 A

(800) 1262011

(151) 2015 05 01

(891) 2022 11 18

(731) DYSON TECHNOLOGY LIMITED  
TETBURY HILL, MALMESBURY,  
WILTSHIRE SN16 0RP, United Kingdom

(540)



(591) Black, white

(531) 27.05.01; 27.05.17

(511)

7 – Floor cleaning apparatus and machines; vacuum cleaners; carpet shampooers; floor polishers; hard floor cleaners; dry cleaning apparatus for floors and carpets; apparatus and machines for applying cleaning preparations to floors and carpets; steam cleaners; handheld vacuum cleaners; stick vacs; cordless vacuum cleaners; wet and dry cleaning machines; robotic vacuum cleaners; floor tools for vacuum cleaners; accessories for vacuum cleaners and other cleaning machines; attachments for vacuum cleaners; separators; separation apparatus for use in vacuum cleaners and other cleaning apparatus; apparatus for separating particles from an airflow; motors (other than for land vehicles); electric motors for use in domestic appliances; switched reluctance motors; navigation systems for use in robotic vacuum cleaners; garden vacuums; electric blenders; food processors; electric crushers and grinders; electric whisks; lawn mowers; parts and fittings for all the aforesaid goods.

9 – Batteries; rechargeable batteries; battery chargers; batteries, electric batteries, rechargeable batteries, battery chargers, all for domestic appliances; batteries, electric batteries, rechargeable batteries, battery chargers, all for cordless, handheld or robotic vacuum cleaners; batteries, electric batteries, rechargeable batteries, battery chargers, all for fans, fan heaters, purifiers, humidifiers, hair dryers, hair styling apparatus or lighting apparatus; computer software for use in appliances and machines; computer application software for computers, mobile phones and hand-held devices for the control of electrical appliances; computer software for use in environmental monitoring, control, and automation systems; vision systems; computer games software; parts and fittings for the aforesaid goods.

11 – Drying apparatus; hand dryers; hand drying apparatus for washrooms; hand and face dryers; electric hand dryers; over sink hand dryers; taps incorporating hand drying apparatus; faucets incorporating hand drying apparatus; wash hand basins; sinks; taps; faucets; filters, being parts of drying apparatus, hand dryers, hand and face dryers or electric hand dryers; water heaters; water filtering apparatus; water purifying apparatus; water mineralisers; electric kettles; microwave ovens; toasters; coffee makers; espresso machines; hair dryers; fans; electric fans; ceiling fans; free-standing fans; wall-mounted fans; electric fans for personal use; electric fans incorporating lighting apparatus; air cooling apparatus; air conditioning apparatus; air conditioners; air conditioners for vehicles; air sterilisers; air purifiers; air deodorising apparatus; air freshening apparatus; electrostatic air filters; humidifiers; dehumidifiers; extractor fans; extractor hoods; heat exchangers, not being parts of machines; heating apparatus; electric heaters; electric fans having combined heating and cooling capabilities; electric heaters having combined heating and cooling capabilities; air curtains; air washers; window fans; ventilation installations for vehicles; filters, being parts of household or industrial installations; lighting apparatus; electric lights; ceiling lights; desk lights; floor lights; spotlights; lighting units; lighting fittings; uplighters; downlighters; lamps; LED lighting apparatus; reflectors, diffusers and lenses for lights and lamps; aforesaid goods.

37 – Installation, maintenance, servicing and repair of household appliances; installation, maintenance, servicing and repair of vacuum cleaners and other cleaning apparatus; installation, maintenance, servicing and repair of hand drying apparatus; installation, maintenance, servicing and repair of air conditioning apparatus, fans, fan heaters, purifiers, humidifiers, ceiling fans and hair dryers; installation, maintenance, servicing and repair of lighting apparatus and installations; rental and leasing of vacuum cleaners and hand dryers.

(260) AM 2023 120692 A  
 (800) 1262119  
 (151) 2015 05 01  
 (891) 2022 11 18  
 (731) DYSON TECHNOLOGY LIMITED  
 TETBURY HILL, MALMESBURY,  
 WILTSHIRE SN16 0RP, United Kingdom  
 (540)

## DYSON

(591) Black, white  
 (511)

7 – Floor cleaning apparatus and machines; vacuum cleaners; carpet shampooers; floor polishers; hard floor cleaners; dry cleaning apparatus for floors and carpets; apparatus and machines for applying cleaning preparations to floors and carpets; steam cleaners; handheld vacuum cleaners; stick vacs; cordless vacuum cleaners; wet and dry cleaning machines; robotic vacuum cleaners; floor tools for vacuum cleaners; accessories for vacuum cleaners and other cleaning machines; attachments for vacuum cleaners; separators; separation apparatus for use in vacuum cleaners and other cleaning apparatus; apparatus for separating particles from an airflow; motors (other than for land vehicles); electric motors for use in domestic appliances; switched reluctance motors; navigation systems for use in robotic vacuum cleaners; garden vacuums; electric blenders; food processors; electric crushers and grinders; electric whisks; lawn mowers; parts and fittings for all the aforesaid goods.

9 – Batteries; rechargeable batteries; battery chargers; batteries, electric batteries, rechargeable batteries, battery chargers, all for domestic appliances; batteries, electric batteries, rechargeable batteries, battery chargers, all for cordless, handheld or robotic vacuum cleaners; batteries, electric batteries, rechargeable batteries, battery chargers, all for fans, fan heaters, purifiers, humidifiers, hair dryers, hair styling apparatus or lighting apparatus; computer software for use in appliances and machines; computer application software for computers, mobile phones and hand-held devices for the control of electrical appliances; computer software for use in environmental monitoring, control, and automation systems; vision systems; computer games software; parts and fittings for the aforesaid goods.

11 – Drying apparatus; hand dryers; hand drying apparatus for washrooms; hand and face dryers; electric hand dryers; over sink hand dryers; taps incorporating hand drying apparatus; faucets incorporating hand drying apparatus; wash hand basins; sinks; taps; faucets; filters, being parts of drying apparatus, hand dryers, hand and face dryers or electric hand dryers; water heaters; water filtering apparatus; water purifying apparatus; water mineralisers; electric kettles; microwave ovens; toasters; coffee makers; espresso machines; hair dryers; fans; electric fans; ceiling fans; free-standing fans; wall-mounted fans; electric fans

for personal use; electric fans incorporating lighting apparatus; air cooling apparatus; air conditioning apparatus; air conditioners; air conditioners for vehicles; air sterilisers; air purifiers; air deodorising apparatus; air freshening apparatus; electrostatic air filters; humidifiers; dehumidifiers; extractor fans; extractor hoods; heat exchangers, not being parts of machines; heating apparatus; electric heaters; electric fans having combined heating and cooling capabilities; electric heaters having combined heating and cooling capabilities; air curtains; air washers; window fans; ventilation installations for vehicles; filters, being parts of household or industrial installations; lighting apparatus; electric lights; ceiling lights; desk lights; floor lights; spotlights; lighting units; lighting fittings; uplighters; downlighters; lamps; LED lighting apparatus; reflectors, diffusers and lenses for lights and lamps; aforesaid goods.

37 – Installation, maintenance, servicing and repair of household appliances; installation, maintenance, servicing and repair of vacuum cleaners and other cleaning apparatus; installation, maintenance, servicing and repair of hand drying apparatus; installation, maintenance, servicing and repair of air conditioning apparatus, fans, fan heaters, purifiers, humidifiers, ceiling fans and hair dryers; installation, maintenance, servicing and repair of lighting apparatus and installations; rental and leasing of vacuum cleaners and hand dryers.

(260) AM 2023 120696 A

(800) 1665292

(151) 2021 11 08

(891) 2022 11 18

(731) Dyson Technology Limited  
Tetbury Hill, Malmesbury, Wiltshire  
SN16 0RP, United Kingdom

(540)



(591) Black, white

(531) 27.05.01; 27.05.17

(511)

3 – Cleaning preparations for household purposes; cleaning preparations for floors, carpets, upholstery and fabrics; stain removal preparations for carpets and fabrics; preparations for removing dirt and odours from floors, carpets, upholstery and fabrics; floor shampoos; floor wax; floor polishing preparations; scale removing preparations for household purposes; toiletries for care and cleaning of hair; hair spray; hair lotions; hair straightening preparations; hair conditioners; hair waving and hair setting preparations; hair mousse; hair styling and moulding products; hair gel; hair wax; neutralisers for permanent waving; hair curling preparations; hair texturisers; sunscreen prepara-

tions; sun-tanning preparations; breath freshening preparations for personal hygiene; breath freshening sprays; breath freshening strips; dental bleaching gels; teeth whitening strips; non-medicated mouthwash; non-medicated toothpaste.

8 – Hair styling apparatus; electrical appliances for styling hair; apparatus and devices for curling hair; electrical irons for styling hair; electric hair curling irons; electric hair straightening irons; electric apparatus for hair curling; electric apparatus for hair crimping; electric apparatus for hair cutting; electric apparatus for hair trimming; hand tools and implements for hair; heated hair curling devices; hand tools and implements for curling, cutting, crimping, straightening, styling, trimming or waving hair; hair tongs; hair styling attachments for all the aforesaid goods; cases, boxes, bags and stands specially adapted for all for the aforesaid goods; parts, fittings and accessories all for the aforesaid goods.

9 – Electronic devices for recording, organizing, transmitting, manipulating, reviewing, sending, receiving, playing, and displaying text, data, audio, image, video and digital files; portable electronic devices for recording, organizing, transmitting, manipulating, reviewing, receiving, playing, and displaying text, data, audio, image, video and digital files; wearable electronic devices for recording, organizing, transmitting, manipulating, reviewing, receiving, playing, and displaying text, data, audio, image, video and digital files; audio apparatus; digital audio players; earphones; headphones; wireless earphones; wireless headphones; noise cancelling headphones; headphones for use with air purification apparatus; headphones with integrated air purification apparatus; headphones for use with air filtration apparatus; headphones with integrated air filtration apparatus; headphones for use with respiratory masks, other than for artificial respiration; headphones with integrated respiratory masks, other than for artificial respiration; protective masks; breathing masks; respiratory masks, other than for artificial respiration; respiratory mask filters [non-medical]; anti-pollution masks for respiratory protection; filters for respiratory masks; visors for delivering purified air, being parts of respiratory masks; apparatus for voice recording, voice command, and voice recognition; microphones; remote controls for controlling computers, mobile telephones, mobile electronic devices, wearable electronic devices, smart watches, audio and video players and recorders, televisions, speakers, home automation systems, home theatre systems, and entertainment systems; wearable devices in the nature of headphones and earphones with remote controls for controlling computers, mobile telephones, mobile electronic devices, smart watches, audio and video players and recorders, televisions, speakers, home automation systems, home theatre systems, and entertainment systems; smart watches; wearable electronic sensors; environmental monitoring sensors; air quality

sensors; wearable activity trackers; wearable electronic sensors for gathering a user's biometric data, body movement data, heart rate data, respiration rate data, and environmental data; wearable devices in the nature of headphones and earphones for gathering a user's biometric data, body movement data, heart rate data, respiration rate data, and environmental data; electronic connectors, couplers, chargers, docks, docking stations, and adapters, all being for use with all of the aforesaid goods; cases for earphones, headphones, smart watches, and respiratory masks; covers and sleeves for earphones, headphones, smart watches, and respiratory masks; computer software, downloadable software and mobile software applications; computer software for use in appliances and machines; computer software, downloadable software and mobile software applications for the control of electrical appliances; computer software, downloadable software and mobile software applications for use in environmental monitoring, analysis, control, and automation systems; computer software, downloadable software and mobile software applications for controlling, analysing and monitoring home automation systems; computer software, downloadable software and mobile software applications for controlling and monitoring the functions of air purification apparatus; computer software, downloadable software and mobile software applications for air quality analysis; computer software, downloadable software and mobile software applications for controlling and monitoring the functions of personal air purification apparatus; computer software, downloadable software and mobile software applications for controlling and monitoring the functions of respiratory masks, other than for artificial respiration; computer software, downloadable software and mobile software applications for enabling the sharing and transmission of data and information between devices for the purposes of facilitating environmental monitoring, control, analysis, visualisation, scheduling and automation; computer software, downloadable software and mobile software applications for enabling the sharing and transmission of data and information between devices for the purposes of monitoring, controlling, analysing, visualising, scheduling and automation of electrical appliances; computer software, downloadable software and mobile software applications for operating an online shop; computer software, downloadable software and mobile software applications for processing electronic purchases, payments and transactions; computer software, downloadable software and mobile software applications for enabling the local storage and connectivity to cloud-based software and data; computer software, downloadable software and mobile software applications for data visualisation, analysis and reporting; computer software, downloadable software and mobile software applications for accessing, browsing, searching, monitoring, tracking, saving and sharing information; computer software,

downloadable software and mobile software applications for social networking; computer software, downloadable software and mobile software applications for accessing, browsing, searching, saving, and sharing information from online databases; computer software, downloadable software and mobile software applications for providing product support and trouble-shooting information; computer software, downloadable software and mobile software applications for accessing virtual assistant capabilities; computer software, downloadable software and mobile software applications for personal information management; computer software, downloadable software and mobile software applications for communication, messaging and alerting; batteries; rechargeable batteries; battery chargers; batteries, electric batteries, rechargeable batteries, battery chargers, all for portable electronic devices; batteries, electric batteries, rechargeable batteries, battery chargers, all for wearable electronic devices; batteries, electric batteries, rechargeable batteries, battery chargers, all for domestic appliances; batteries, electric batteries, rechargeable batteries, battery chargers, all for cordless, handheld or robotic vacuum cleaners; batteries, electric batteries, rechargeable batteries, battery chargers, all for fans, fan heaters, purifiers, humidifiers, hair dryers, hair styling apparatus, hair straighteners, headphones, smart watches, electric toothbrushes or lighting apparatus; vision systems; computer games; parts and fittings for the aforesaid goods.

21 – Brushes; floor brushes; dusting brushes; hair brushes; brooms; mops; electric brushes; electric hair brushes; electric rotary hair brushes; electric hot styling brushes; electric heated hair brushes; combs; large-toothed combs; electric combs; electric toothbrushes; heads for electric toothbrushes; floss for dental purposes; soap dispensers; cases, boxes, bags, and stands specially adapted for all the aforesaid goods; parts, fittings and accessories for the aforesaid goods.

---

(260) AM 2023 120697 A  
 (800) 1665295  
 (151) 2021 11 08  
 (891) 2022 11 18  
 (731) Dyson Technology Limited  
 Tetbury Hill, Malmesbury, Wiltshire  
 SN16 0RP, United Kingdom  
 (540)

**DYSON**

(591) Black, white  
 (511)  
 3 – Cleaning preparations for household purposes; cleaning preparations for floors, carpets, upholstery and fabrics; stain removal preparations for carpets and fabrics; preparations for removing dirt and odours from floors, carpets, upholstery and fabrics; floor shampoos; floor wax; floor polishing preparations;

scale removing preparations for household purposes; toiletries for care and cleaning of hair; hair spray; hair lotions; hair straightening preparations; hair conditioners; hair waving and hair setting preparations; hair mousse; hair styling and moulding products; hair gel; hair wax; neutralisers for permanent waving; hair curling preparations; hair texturisers; sunscreen preparations; sun-tanning preparations; breath freshening preparations for personal hygiene; breath freshening sprays; breath freshening strips; dental bleaching gels; teeth whitening strips; non-medicated mouthwash; non-medicated toothpaste.

8 – Hair styling apparatus; electrical appliances for styling hair; apparatus and devices for curling hair; electrical irons for styling hair; electric hair curling irons; electric hair straightening irons; electric apparatus for hair curling; electric apparatus for hair crimping; electric apparatus for hair cutting; electric apparatus for hair trimming; hand tools and implements for hair; heated hair curling devices; hand tools and implements for curling, cutting, crimping, straightening, styling, trimming or waving hair; hair tongs; hair styling attachments for all the aforesaid goods; cases, boxes, bags and stands specially adapted for all for the aforesaid goods; parts, fittings and accessories all for the aforesaid goods.

9 – Electronic devices for recording, organizing, transmitting, manipulating, reviewing, sending, receiving, playing, and displaying text, data, audio, image, video and digital files; portable electronic devices for recording, organizing, transmitting, manipulating, reviewing, receiving, playing, and displaying text, data, audio, image, video and digital files; wearable electronic devices for recording, organizing, transmitting, manipulating, reviewing, receiving, playing, and displaying text, data, audio, image, video and digital files; audio apparatus; digital audio players; earphones; headphones; wireless earphones; wireless headphones; noise cancelling headphones; headphones for use with air purification apparatus; headphones with integrated air purification apparatus; headphones for use with air filtration apparatus; headphones with integrated air filtration apparatus; headphones for use with respiratory masks, other than for artificial respiration; headphones with integrated respiratory masks, other than for artificial respiration; protective masks; breathing masks; respiratory masks, other than for artificial respiration; respiratory mask filters [non-medical]; anti-pollution masks for respiratory protection; filters for respiratory masks; visors for delivering purified air, being parts of respiratory masks; apparatus for voice recording, voice command, and voice recognition; microphones; remote controls for controlling computers, mobile telephones, mobile electronic devices, wearable electronic devices, smart watches, audio and video players and recorders, televisions, speakers, home automation systems, home theatre systems, and entertainment systems; wearable devices in the nature

of headphones and earphones with remote controls for controlling computers, mobile telephones, mobile electronic devices, smart watches, audio and video players and recorders, televisions, speakers, home automation systems, home theatre systems, and entertainment systems; smart watches; wearable electronic sensors; environmental monitoring sensors; air quality sensors; wearable activity trackers; wearable electronic sensors for gathering a user's biometric data, body movement data, heart rate data, respiration rate data, and environmental data; wearable devices in the nature of headphones and earphones for gathering a user's biometric data, body movement data, heart rate data, respiration rate data, and environmental data; electronic connectors, couplers, chargers, docks, docking stations, and adapters, all being for use with all of the aforesaid goods; cases for earphones, headphones, smart watches, and respiratory masks; covers and sleeves for earphones, headphones, smart watches, and respiratory masks; computer software, downloadable software and mobile software applications; computer software for use in appliances and machines; computer software, downloadable software and mobile software applications for the control of electrical appliances; computer software, downloadable software and mobile software applications for use in environmental monitoring, analysis, control, and automation systems; computer software, downloadable software and mobile software applications for controlling, analysing and monitoring home automation systems; computer software, downloadable software and mobile software applications for controlling and monitoring the functions of air purification apparatus; computer software, downloadable software and mobile software applications for air quality analysis; computer software, downloadable software and mobile software applications for controlling and monitoring the functions of personal air purification apparatus; computer software, downloadable software and mobile software applications for controlling and monitoring the functions of respiratory masks, other than for artificial respiration; computer software, downloadable software and mobile software applications for enabling the sharing and transmission of data and information between devices for the purposes of facilitating environmental monitoring, control, analysis, visualisation, scheduling and automation; computer software, downloadable software and mobile software applications for enabling the sharing and transmission of data and information between devices for the purposes of monitoring, controlling, analysing, visualising, scheduling and automation of electrical appliances; computer software, downloadable software and mobile software applications for operating an online shop; computer software, downloadable software and mobile software applications for processing electronic purchases, payments and transactions; computer software, downloadable software and mobile software applications for enabling the local storage and con-

nectivity to cloud-based software and data; computer software, downloadable software and mobile software applications for data visualisation, analysis and reporting; computer software, downloadable software and mobile software applications for accessing, browsing, searching, monitoring, tracking, saving and sharing information; computer software, downloadable software and mobile software applications for social networking; computer software, downloadable software and mobile software applications for accessing, browsing, searching, saving, and sharing information from online databases; computer software, downloadable software and mobile software applications for providing product support and trouble-shooting information; computer software, downloadable software and mobile software applications for accessing virtual assistant capabilities; computer software, downloadable software and mobile software applications for personal information management; computer software, downloadable software and mobile software applications for communication, messaging and alerting; batteries; rechargeable batteries; battery chargers; batteries, electric batteries, rechargeable batteries, battery chargers, all for portable electronic devices; batteries, electric batteries, rechargeable batteries, battery chargers, all for wearable electronic devices; batteries, electric batteries, rechargeable batteries, battery chargers, all for domestic appliances; batteries, electric batteries, rechargeable batteries, battery chargers, all for cordless, handheld or robotic vacuum cleaners; batteries, electric batteries, rechargeable batteries, battery chargers, all for fans, fan heaters, purifiers, humidifiers, hair dryers, hair styling apparatus, hair straighteners, headphones, smart watches, electric toothbrushes or lighting apparatus; vision systems; computer games; parts and fittings for the aforesaid goods.

21 – Brushes; floor brushes; dusting brushes; hair brushes; brooms; mops; electric brushes; electric hair brushes; electric rotary hair brushes; electric hot styling brushes; electric heated hair brushes; combs; large-toothed combs; electric combs; electric toothbrushes; heads for electric toothbrushes; floss for dental purposes; soap dispensers; cases, boxes, bags, and stands specially adapted for all the aforesaid goods; parts, fittings and accessories for the aforesaid goods.

(260) AM 2023 120739 A

(800) 1701021

(151) 2022 09 30

(891) 2022 09 30

(731) ASSE KOZMETİK SANAYİ VE DIŞ  
TİCARET LİMİTED ŞİRKETİ  
MURATBEY MERKEZ MAH., ERİKLİ SK.  
3 1, ÇATALCA, İSTANBUL, Türkiye

(540)

**ASSE**

(591) Black, white

(511)

3 – Bleaching and cleaning preparations, detergents other than for use in manufacturing operations and for medical purposes, laundry bleach, fabric softeners for laundry use, stain removers, dishwasher detergents; perfumery; non-medicated cosmetics; fragrances; deodorants for personal use and animals; soaps; dental care preparations: dentifrices, denture polishes, tooth whitening preparations, mouth washes, not for medical purposes; abrasive preparations; emery cloth; sandpaper; pumice stone; abrasive pastes; polishing preparations for leather, vinyl, metal and wood, polishes and creams for leather, vinyl, metal and wood, wax for polishing.

(260) AM 2023 120755 A

(800) 1701302

(151) 2022 10 17

(891) 2022 10 17

(731) "Limonad" Limited Liability Company  
ul. Very Horuzhej, 22-12, 220123 Minsk,  
Belarus

(540)

**Manifesto**

(591) Black, white

(511)

34 – Tobacco and tobacco substitutes; cigarettes and cigars; electronic cigarettes and oral vaporizers for smokers; smokers' articles; matches.

35 – Advertising; shop window dressing; presentation of goods on all communication media, for retail purposes; demonstration of goods; organization of exhibitions for commercial or advertising purposes; organization of trade fairs; import-export agency services; marketing; auctioneering; sales promotion for others; promotion of goods and services through sponsorship of sports events; procurement services for others [purchasing goods and services for other businesses]; providing commercial information and advice for consumers in the choice of products and services; wholesale and retail services for tobacco and tobacco substitutes, cigarettes and cigars, electronic cigarettes and oral vaporizers for smokers, smokers' articles and matches, including through vending machines, mail order catalogues or by means of electronic media and web sites.

(260) AM 2023 120783 A

(800) 1701827

(151) 2022 09 19

(891) 2022 09 19

(731) JOINT STOCK COMPANY "ALIUM"  
territory Quarter A, 2, Obolensk settlement,  
Serpukhov, RU-142279 Moscow region,  
Russian Federation



(540)

# НеобуТИН

(591) Black, white

(531) 28.05

(511)

5 – Acaricides; aconitine; alkaloids for medical purposes; algicides; aldehydes for pharmaceutical purposes; dental amalgams of gold; dental amalgams; amino acids for veterinary purposes; amino acids for medical purposes; antibiotics; aluminium acetate for pharmaceutical purposes; acetates for pharmaceutical purposes; germicides; balms for medical purposes; bandages for dressings; biocides; bromine for pharmaceutical purposes; paper for mustard plasters; fly catching paper; mothproofing paper; petroleum jelly for medical purposes; vaccines; oxygen baths; aseptic cotton; absorbent cotton; wadding for medical purposes; dietetic substances adapted for medical use; radiological contrast substances for medical purposes; nutritive substances for microorganisms; radioactive substances for medical purposes; bismuth subnitrate for pharmaceutical purposes; melissa water for pharmaceutical purposes; seawater for medicinal bathing; mineral waters for medical purposes; thermal water; dietary fibre; moulding wax for dentists; gases for medical purposes; guaiacol for pharmaceutical purposes; haematogen; haemoglobin; hydrastine; hydrastinine; glycerine for medical purposes; glycerophosphates; glucose for medical purposes; gentian for pharmaceutical purposes; hormones for medical purposes; mustard for pharmaceutical purposes; mustard plasters; mud for baths; medicinal mud; gamboge for medical purposes; gurjun balsam for medical purposes; deodorants, other than for human beings or for animals; deodorants for clothing and textiles; diastase for medical purposes; digitalin; yeast for pharmaceutical purposes; gelatine for medical purposes; cod liver oil; isotopes for medical purposes; insecticides; iodine for pharmaceutical purposes; iodides for pharmaceutical purposes; alkaline iodides for pharmaceutical purposes; iodoform; calomel [fungicide]; cream of tartar for pharmaceutical purposes; tartar for pharmaceutical purposes; camphor for medical purposes; capsules for medicines; cachets for pharmaceutical purposes; haemostatic pencils; wart pencils; caustic pencils; carbolineum [parasiticide]; caustics for pharmaceutical purposes; cachou for pharmaceutical purposes; quassia for medical purposes; quebracho for medical purposes; oxygen for medical purposes; gallic acid for pharmaceutical purposes; acids for pharmaceutical purposes; adhesives for dentures; cocaine for medical purposes; collodion for pharmaceutical purposes; corn rings for the feet; medicated sweets; barks for pharmaceutical purposes; cedar wood for use as an insect repellent; croton bark; mangrove bark for pharmaceutical purposes; myrobalan bark for pharmaceutical purposes; quinquina for medical purposes; medicinal roots; rhubarb roots for pharmaceutical purposes; lint for medical purposes;

starch for dietetic or pharmaceutical purposes; creosote for pharmaceutical purposes; blood for medical purposes; cultures of microorganisms for medical or veterinary use; curare; dental lacquer; liquorice for pharmaceutical purposes; milk sugar for pharmaceutical purposes; adhesive plasters; medicines for alleviating constipation; lecithin for medical purposes; lotions for veterinary purposes; lotions for pharmaceutical purposes; lupulin for pharmaceutical purposes; magnesia for pharmaceutical purposes; liniments; ointments for pharmaceutical purposes; sunburn ointments; mercurial ointments; frostbite salve for pharmaceutical purposes; gauze for dressings; medicinal oils; mustard oil for medical purposes; camphor oil for medical purposes; castor oil for medical purposes; oil of turpentine for pharmaceutical purposes; dill oil for medical purposes; dental mastics; dental abrasives; dental impression materials; teeth filling material; dressings, medical; surgical dressings; drugs for medical purposes; medicines for veterinary purposes; serotherapeutic medicines; medicines for human purposes; medicines for dental purposes; menthol; medicinal drinks; moleskin for medical purposes; almond milk for pharmaceutical purposes; royal jelly for pharmaceutical purposes; milk ferments for pharmaceutical purposes; Irish moss for medical purposes; flour for pharmaceutical purposes; linseed meal for pharmaceutical purposes; fish meal for pharmaceutical purposes; fly glue; mint for pharmaceutical purposes; dietetic beverages adapted for medical purposes; malted milk beverages for medical purposes; narcotics; medicinal infusions; tincture of iodine; eucalyptol for pharmaceutical purposes; tinctures for medical purposes; opium; opodeldoc; decoctions for pharmaceutical purposes; antiparasitic collars for animals; stick liquorice for pharmaceutical purposes; sulfur sticks [disinfectants]; pectin for pharmaceutical purposes; pepsins for pharmaceutical purposes; peptones for pharmaceutical purposes; hydrogen peroxide for medical purposes; leeches for medical purposes; blood plasma; eyepatches for medical purposes; poultices; compresses; scapulars for surgical purposes; bunion pads; breast-nursing pads; pomades for medical purposes; powder of cantarides; pyrethrum powder; anti-uric preparations; bacterial preparations for medical and veterinary use; bacteriological preparations for medical and veterinary use; balsamic preparations for medical purposes; albuminous preparations for medical purposes; biological preparations for veterinary purposes; biological preparations for medical purposes; veterinary preparations; bismuth preparations for pharmaceutical purposes; vitamin preparations; diagnostic preparations for medical purposes; therapeutic preparations for the bath; haemorrhoid preparations; preparations for callouses; preparations to facilitate teething; preparations for the treatment of burns; fumigation preparations for medical purposes; ootherapy preparations; air deodorizing preparations; air purifying preparations; bronchodilating preparations; sterilizing preparations;

soil-sterilizing preparations; corn remedies; pharmaceutical preparations for treating dandruff; preparations for destroying noxious animals; herbicides; preparations for destroying dry rot fungus; larvae exterminating preparations; fly destroying preparations; preparations for destroying mice; slug exterminating preparations; parasiticides; pharmaceutical preparations for skin care; contact lens cleaning preparations; lime-based pharmaceutical preparations; opiates; anticryptogamic preparations; preparations of trace elements for human and animal use; sulfonamides [medicines]; pharmaceutical preparations; enzyme preparations for veterinary purposes; enzyme preparations for medical purposes; chemico-pharmaceutical preparations; chemical preparations for veterinary purposes; chemical preparations for the diagnosis of pregnancy; chemical preparations for medical purposes; chemical preparations for treating diseases affecting vine plants; chemical preparations for treating mildew; chemical preparations for treating phyloxera; chemical preparations for pharmaceutical purposes; chilblain preparations; mothproofing preparations; collyrium; lead water; chemical conductors for electrocardiograph electrodes; albuminous foodstuffs for medical purposes; dietetic foods adapted for medical purposes; by-products of the processing of cereals for medical purposes; sanitary towels; panty liners [sanitary]; radium for medical purposes; hydrated chloral for pharmaceutical purposes; solvents for removing adhesive plasters; vaginal washes for medical purposes; solutions for contact lenses; chemical reagents for medical or veterinary purposes; gum for medical purposes; rubber for dental purposes; chewing gum for medical purposes; insect repellent incense; insect repellents; repellents for dogs; tissues impregnated with pharmaceutical lotions; sarsaparilla for medical purposes; sugar for medical purposes; asthmatic tea; fumigating sticks; linseed for pharmaceutical purposes; tobacco-free cigarettes for medical purposes; siccatives [drying agents] for medical purposes; syrups for pharmaceutical purposes; turpentine for pharmaceutical purposes; milking grease; greases for veterinary purposes; greases for medical purposes; soporifics; bicarbonate of soda for pharmaceutical purposes; salts for mineral water baths; bath salts for medical purposes; salts for medical purposes; potassium salts for medical purposes; sodium salts for medical purposes; smelling salts; mineral water salts; malt for pharmaceutical purposes; semen for artificial insemination; medicinal alcohol; alloys of precious metals for dental purposes; ergot for pharmaceutical purposes; adjuvants for medical purposes; astringents for medical purposes; vermifuges; disinfectants for hygiene purposes; disinfectants for chemical toilets; appetite suppressants for medical purposes; mouthwashes for medical purposes; febrifuges; depuratives; animal washes [insecticides]; detergents for medical purposes; cattle washes [insecticides]; dog washes [insecticides]; vesicants; headache relief sticks; remedies for

perspiration; remedies for foot perspiration; chemical contraceptives; antiparasitic preparations; laxatives; tonics [medicines]; nervines; digestives for pharmaceutical purposes; bouillons for bacteriological cultures; steroids; strychnine; serums; sanitary tampons; vulnerary sponges; thymol for pharmaceutical purposes; smoking herbs for medical purposes; medicinal herbs; tranquilizers; surgical implants comprised of living tissues; sanitary panties; charcoal for pharmaceutical purposes; fennel for medical purposes; porcelain for dental prostheses; phenol for pharmaceutical purposes; enzymes for veterinary purposes; enzymes for medical purposes; ferments for pharmaceutical purposes; formic aldehyde for pharmaceutical purposes; phosphates for pharmaceutical purposes; fungicides; quinine for medical purposes; chinoline for medical purposes; diabetic bread adapted for medical use; chloroform; flowers of sulfur for pharmaceutical purposes; cement for animal hooves; bone cement for surgical and orthopaedic purposes; dental cements; herbal teas for medicinal purposes; eucalyptus for pharmaceutical purposes; tobacco extracts [insecticides]; extracts of hops for pharmaceutical purposes; elixirs [pharmaceutical preparations]; ethers for pharmaceutical purposes; esters for pharmaceutical purposes; cellulose esters for pharmaceutical purposes; rat poison; poisons; bacterial poisons; jalap; hygienic bandages; nutritional supplements; additives to fodder for medical purposes; mineral dietary supplements; pastilles for pharmaceutical purposes; adhesive tapes for medical purposes; angostura bark for medical purposes; condurango bark for medical purposes; dog lotions; anti-horsefly oils; lacteal flour for babies; medicine cases, portable, filled; pants, absorbent, for incontinence; pills for pharmaceutical purposes; plasters for medical purposes; belts for sanitary napkins [towels]; bath preparations for medical purposes; medicinal hair growth preparations; pharmaceutical preparations for treating sunburn; chemical preparations for treating wheat blight; food for babies; sanitary napkins; suppositories; anaesthetics; antiseptics; analgesic preparations; medical preparations for slimming purposes; sal ammoniac lozenges; surgical tissues; cellulose ethers for pharmaceutical purposes; jujube, medicated.

35 – Arranging subscriptions to telecommunication services for others; import-export agency services; commercial information agency services; advertising agency services; cost price analysis; rental of advertising space; financial auditing; business auditing; employment agency services; computerized file management; invoicing; demonstration of goods; transcription of communications [office functions]; opinion polling; market studies; business investigations; marketing research; personnel recruitment; business management and organization consultancy; business organization consultancy; business management consultancy; professional business consultancy; layout services for advertising purposes; business management of

performing artists; news clipping services; updating of advertising material; word processing; secretarial services; shorthand; organization of exhibitions for commercial or advertising purposes; arranging newspaper subscriptions for others; organization of trade fairs for commercial or advertising purposes; shop window dressing; business appraisals; payroll preparation; data search in computer files for others; sponsorship search; business management assistance; commercial or industrial management assistance; presentation of goods on communication media, for retail purposes; economic forecasting; auctioneering; office machines and equipment rental; rental of advertising time on communication media; publicity material rental; rental of vending machines; rental of photocopying machines; publication of publicity texts; typing; radio advertising; bill-posting; distribution of samples; dissemination of advertising matter; advertising; online advertising on a computer network; advertising by mail order; television advertising; compilation of statistics; business inquiries; systemization of information into computer databases; tax preparation; drawing up of statements of accounts; psychological testing for the selection of personnel; business management of hotels; commercial administration of the licensing of the goods and services of others; administrative processing of purchase orders; public relations; modelling for advertising or sales promotion; administrative services for the relocation of businesses; price comparison services; procurement services for others [purchasing goods and services for other businesses]; outsourcing services [business assistance]; telephone answering for unavailable subscribers; photocopying services; book-keeping; providing business information; providing commercial information and advice for consumers in the choice of products and services; promoting the goods of others; reproduction of documents; compilation of information into computer databases; business efficiency expert services.

---

(260) AM 2023 120790 A

(800) 1701946

(151) 2022 11 05

(891) 2022 11 05

(731) Apple Inc.

One Apple Park Way, Cupertino CA 95014,  
USA

(540)

## FREEFORM

(591) Black, white

(511)

9 – Downloadable computer software for facilitating realtime collaboration, for jointly creating, sharing, viewing, displaying, editing, annotating, storing, and distributing photos, images, graphics, documents, presentations, data, videos, and multimedia content, and for communicating via text and video regarding the collaboration process and jointly-created content;

downloadable computer software for creating, sharing, viewing, displaying, editing, annotating, storing, and distributing photos, images, graphics, documents, presentations, data, videos, and multimedia content; downloadable computer programs for word processing.

---

(260) AM 2023 120809 A

(800) 1629652

(151) 2021 10 26

(891) 2022 08 12

(731) GENEVERSE ENERGY INC.

48531 Warm Springs Blvd, Ste 413,  
Fremont CA 94539, USA

(540)

## GENEVERSE

(591) Black, white

(511)

9 – Batteries; rechargeable batteries; supercapacitors for energy storage; portable charging devices in the nature of rechargeable electric batteries; solar-powered battery chargers; battery charge devices; battery packs; inverters; electric cables and wires; wireless chargers; lithium iron phosphate batteries; lithium phosphate batteries; photovoltaic cells; solar cells; solar panels for production of electricity; battery monitors; battery testers; carrying cases, holders, protective cases and stands featuring power supply connectors, adaptors, speakers and battery charging devices, specially adapted for use with handheld digital electronic devices, namely, cell phones, MP3 players, personal digital assistants; recorded and downloadable computer application software for controlling or managing battery power supplies; downloadable and recorded computer application software for controlling and managing solar panels; downloadable and recorded computer application software for managing solar panels, charging stations, batteries, and power supplies; downloadable and recorded computer application software for controlling and managing electronic devices; electronic devices for home and office use, namely, computers, electric meters, electric charging station, circuit breaker, electric control panels.

---

(260) AM 2023 120810 A

(800) 1660288

(151) 2021 12 27

(891) 2022 09 23

(731) Doubleeagle Industry (China) Limited

Xingda Industrial Park, Chenghai District,  
Shantou City, Guangdong Province, China

(540)



(591) Black, white

(531) 27.05.01; 27.05.09; 27.05.17

(511)  
28 – Christmas trees (ornaments for -), except illumination articles and confectionery; building blocks [toys]; fishing tackle; machines for physical exercises; smart toys; games; toys; chess; building blocks, large size; playing balls.

(260) AM 2023 120863 A  
(800) 1702369  
(151) 2022 11 17  
(891) 2022 11 17  
(731) Evonik Operations GmbH  
Rellinghauser Str. 1 – 11, 45128 Essen,  
Germany

(540)

**ZEOFREE**

(591) Black, white  
(511)  
1 – Silicon dioxide used as an anti-caking agent and carrier in the food, animal feed, and pesticide industries; as a rheology control agent and abrasive in the dentifrice industry; as a de-foamer in the paper and paint industries.

(260) AM 2023 120864 A  
(800) 1702419  
(151) 2022 07 18  
(891) 2022 07 18  
(731) EcoFlow Inc.  
Floor 1, Building E, Factory Building, Jiehe  
Industrial City, Shuitian Community, Shiyan  
Street, Baoan District, Shenzhen, 518000  
Guangdong, China

(540)

**ECOFLOW**

(591) Black, white  
(531) 27.05.01  
(511)  
9 – Downloadable application software for mobile phones; face recognition devices; sound recording carriers; electric sockets with moveable sockets; electronic numeric displays; remote control apparatus; batteries, electric, for vehicles; batteries, electric; mobile power supply [rechargeable batteries].

11 – Refrigerating apparatus and machines; air cooling apparatus; drying apparatus and installations; air-conditioning apparatus and installations; refrigerators; air purifying apparatus and machines; lighting apparatus and installations; watering installations, automatic; disinfectant apparatus; cooking utensils, electric; radiators, electric; ice machines and apparatus; ice-making machines; air filtering installations; ventilation [air-conditioning] installations and apparatus; all the aforesaid goods not for use in laboratories.

(260) AM 2023 120866 A  
(800) 1702441  
(151) 2022 10 05  
(891) 2022 10 05  
(731) COMPAGNIE LAITIERE EUROPEENNE  
F-50890 CONDE-SUR-VIRE, France  
(540)



(591) Gold gradient, red, blue, green, brown  
(531) 03.04.01; 03.04.02; 06.19.11; 07.05.02;  
24.17.25; 25.01.15; 25.03.01; 25.03.03;  
29.01.14

(511)  
29 – Edible oils and fats; dairy products and substitutes; cheeses; butter; flavored beverages with milk; milk-based beverages; yogurt-based beverages; milk; processed fruits, mushrooms, vegetables, nuts and legumes; jellies, jams, compotes, fruit and vegetable spreads; prepared nuts; dried nuts; fruit-based fillings for cakes and pies; fruit-based fillings for fruit pies; fruit jellies; legume-based spreads; hazelnut-based spreads; fruit pulps; edible fats; vegetable fats for food; vegetable fats for cooking; oils for food; cream [dairy product]; milk desserts; dairy-based desserts; yogurt-based desserts; canned vegetables; canned cut fruits; mixed vegetables; dried fruit mixes; snack mixes consisting of prepared fruits and prepared nuts; yogurt; vegetable spreads; vegetable yogurt; alternative cheese based on vegetable fat (cheese substitutes); milk beverages containing fruit; dairy products and substitutes made with rice, soya, almond, oat, coconuts and nuts; rice milk (milk substitute); soy milk (milk substitute); almond milk; coconut milk; dairy beverages containing rice, soy, almond, oat, coconut and nuts; yogurt based on rice, soy, almond, oat, coconut and nuts (dairy product substitutes); cream (dairy product) containing rice, soy, almond, oat, coconut and nuts; pudding-type yogurts based on rice, soy, almond, oat, coconut and nuts (dairy product substitutes); desserts based on milk substitutes; vegetable cream (dairy product substitutes); vegetable butter; ultra-fresh margarine; alternative yogurt based on vegetable fat (dairy product substitutes); alternative cream based on vegetable fat (dairy product substitutes); alternative butter based on vegetable fat; preserved soybeans for food; prepared sunflower seeds; prepared seeds; linseed oil for food.

30 – Coffee, teas, cocoa and their substitutes; milk-based chocolate beverages; chocolate-based beverages; chocolate; chocolate beverage with milk; ice, ice creams, frozen yogurts and sherbets; ice cream based on dairy products; ice cream; ice cream [desserts]; fruit ice creams; frozen desserts made with milk products;

vegan edible ice; ice for refreshment; edible ices; pastries, cakes, tarts, cookies and biscuits; foodstuffs containing cocoa [as the main component]; cocoa-based foods; dairy-based confectionery; chocolate-based confectionery for non-medical use; chocolate decorations for confectionery articles; chocolate-based spreads; chocolate spreads containing nuts; prepared foodstuffs in the form of sauces; pizza crusts; savory pastries; sweet or savory pies; sugar, natural sweeteners, sweet fillings and coatings, apicultural products; sweet fillings and toppings; syrups and molasses; sugar-based foods for dessert preparation; food products based on sugar for sweetening desserts; natural sweeteners; pastries; fresh pastries; dough [pastry]; prepared desserts [pastries]; cakes; edible ices made with rice, soya, almond, oat, coconuts and nuts; ice cream substitutes based on rice, soy, almond, oat, coconut and nuts; frozen yogurt substitutes based on rice, soy, almond, oat, coconut and nuts (edible ices); pastries based on rice, soy, almonds, oats, coconut and hazelnuts; confectionery based on rice, soy, almonds, oats, coconut and hazelnuts; oat-based food; dessert in the nature of mousses based on rice, soy, almonds, oats, coconut and hazelnuts.

(260) AM 2023 120886 A

(800) 1702911

(151) 2022 01 20

(891) 2022 01 20

(731) MS Partners Ltd.

73, Patriarh Evtimii Blvd., floor 1, BG-1463

Sofia, Bulgaria

(540)

## Burning Wheels

(591) Black, white

(511)

9 – 3D spectacles; DVD players; USB flash drives; fire escapes; solenoid valves [electromagnetic switches]; automatic indicators of low pressure in vehicle tyres; aerometers; asbestos screens for firemen; asbestos clothing for protection against fire; asbestos gloves for protection against accidents; azimuth instruments; actinometers; accelerometers; electric batteries; batteries, electric, for vehicles; acoustic alarms; acoustic couplers; acoustic conduits; horns for loudspeakers; alarm bells, electric; alarms; alidades; height gauges; ammeters; anemometers; animated cartoons; anodes; anode batteries; aerials; anticathodes; air analysis apparatus; food analysis apparatus; apparatus to check franking; intercommunication apparatus; apparatus for fermentation [laboratory apparatus]; glazing apparatus for photographic prints; global positioning system [GPS] apparatus; breathing apparatus for underwater swimming; breathing apparatus, except for artificial respiration; distance recording apparatus; pressure gauges; speed measuring apparatus [photography]; distance measuring apparatus; appliances for

measuring the thickness of leather; testing apparatus not for medical purposes; ionization apparatus not for the treatment of air or water; boiler control instruments; speed checking apparatus for vehicles; egg-candlers; magnetic resonance imaging [MRI] apparatus, not for medical purposes; monitoring apparatus, other than for medical purposes; apparatus to check stamping mail; X-ray photographs, other than for medical purposes; teleprompters; satellite navigational apparatus; apparatus and installations for the production of X-rays, not for medical purposes; weighing apparatus and instruments; apertometers [optics]; audio- and video-receivers; audiovisual teaching apparatus; audio interfaces; audio mixers; acidimeters for batteries; rods for water diviners; automated teller machines [ATM]; barometers; batteries, electric; batteries for electronic cigarettes; baby monitors; baby scales; video baby monitors; radiotelephones; betatrons; ticket dispensers; binoculars; biometric identity cards; biometric passports; biochips; coils, electric; locks, electric; bullet-proof waistcoats; bullet-proof clothing; counters; thread counters; money counting and sorting machines; push buttons for bells; vacuum gauges; washing trays [photography]; variometers; balancing apparatus; scales with body mass analysers; spectacle chains; wind socks for indicating wind direction; video screens; camcorders; video recorders; video projectors; video telephones; viewfinders, photographic; screw-tapping gauges; viscosimeters; loudspeakers; high-frequency apparatus; divers' masks; naval signalling apparatus; solderers' helmets; voltmeters; time recording apparatus; cell phone straps; wavemeters; gasometers [measuring instruments]; discharge tubes, electric, other than for lighting; galvanometers; surveying apparatus and instruments; surveying instruments; record players; phonograph records; downloadable graphics for mobile phones; encoded identification bracelets, magnetic; lightning conductors; graduated glassware; telemeters; flowmeters; decompression chambers; decorative magnets; densimeters; stills for laboratory experiments; distillation apparatus for scientific purposes; infrared detection apparatus; counterfeit coin detectors; smoke detectors; pocket calculators; joysticks for use with computers, other than for video games; juke boxes for computers; diagnostic apparatus, not for medical purposes; transparencies [photography]; diaphragms [photography]; diaphragms for scientific apparatus; climate control digital thermostats; digital photo frames; dictating machines; dynamometers; disks, magnetic; disk drives for computers; diffraction apparatus [microscopy]; respiratory masks, other than for artificial respiration; DNA chips; dosimeters; intercoms; choking coils [impedance]; carpenters' rules; holders for electric coils; carriers for dark plates [photography]; equalizers [audio apparatus]; electric and electronic effects units for musical instruments; electrified fences; electrified rails for mounting spot lights; electrical adapters; electric door bells; electric apparatus for commutation;

electric installations for the remote control of industrial operations; electric wire harnesses for automobiles; electronic key fobs being remote control apparatus; fuses; electric sockets; flashing lights [luminous signals]; electric plugs; electro-dynamic apparatus for the remote control of signals; electro-dynamic apparatus for the remote control of railway points; electricity conduits; electrolyzers [electrolytic cells]; electronic pocket translators; electronic tags for goods; electronic interactive whiteboards; thermionic valves; vacuum tubes [radio]; electronic collars to train animals; electronic sheet music, downloadable; electronic pens [visual display units]; downloadable e-wallets; electronic publications, downloadable; light-emitting electronic pointers; electronic access control systems for interlocking doors; electronic notice boards; electronic numeric displays; electronic notepads; downloadable emoticons for mobile phones; epidiascopes; test tubes; ergometers; temperature indicator labels, not for medical purposes; sound locating instruments; security tokens [encryption devices]; mercury levels; life saving apparatus and equipment; juke boxes, musical; coin-operated mechanisms for television sets; ignition batteries; igniting apparatus, electric, for igniting at a distance; charging stations for electric vehicles; chargers; chargers for electronic cigarettes; shutters [photography]; saccharometers; head protection; protective suits for aviators; protective masks; protective masks; protection masks; protective films adapted for smartphones; workmen's protective face-shields; protection devices for personal use against accidents; protection devices against X-rays, not for medical purposes; protective films adapted for computer screens; sound reproduction apparatus; sound recording apparatus; recording discs; sound recording strips; sound recording carriers; sounding apparatus and machines; sounding leads; sound transmitting apparatus; bells [warning devices]; signs, luminous; buzzers; needles for record players; identification threads for electric wires; identification sheaths for electric wires; measures; measuring glassware; surveying chains; measuring apparatus; gauges; measuring devices, electric; satellite finder meters; data processing apparatus; inverters [electricity]; water level indicators; quantity indicators; electric loss indicators; pressure indicators; inductors [electricity]; incubators for bacteria culture; theft prevention installations, electric; gas testing instruments; observation instruments; levelling instruments; instruments containing eyepieces; material testing instruments and machines; printed circuit boards; interactive touch screen terminals; interfaces for computers; infrared detectors; starter cables for motors; cables, electric; wire (electric -); electrical cables; ducts [electricity]; calibrating rings; calorimeters; sleeves for laptops; covers for glasses; covers for personal digital assistants [PDAs]; cases for smartphones; covers for tablet computers; rearview cameras for vehicles; weight measuring instruments; bathroom scales; covers for electric outlets; ca-

pillary tubes; memory cards for video game machines; integrated circuit cards [smart cards]; video game cartridges; ink cartridges, unfilled, for printers and photocopiers; cassette players; riding helmets; cash registers; padlocks, electronic; cathodes; cathodic anti-corrosion apparatus; mileage recorders for vehicles; cinematographic cameras; cinematographic film, exposed; oxygen transvasing apparatus; mobile telephones; coaxial cables; encoded key cards; encoded magnetic cards; body harnesses for support when lifting loads; weight belts for divers; collectors, electric; compact disc players; compact discs [audio-video]; compact discs [read-only memory]; comparators; directional compasses; compasses for measuring; computers; computer software, recorded; computer programs, recorded; pre-recorded software; computer screen saver software, recorded or downloadable; computer hardware; notebook computers; computer keypads; computer peripheral devices; computer programs, downloadable; computer software platforms, recorded or downloadable; computer software applications, downloadable; commutators; converters, electric; condensers [capacitors]; contacts, electric; contact lenses; traffic cones; nautical apparatus and instruments; correcting lenses [optics]; cosmographic instruments; diving suits; pedometers; downloadable cryptographic keys for receiving and spending cryptocurrency; galena crystals [detectors]; circular slide rules; battery boxes; cases for loudspeakers; cases especially made for photographic apparatus and instruments; laboratory trays; ovens for laboratory experiments; laboratory robots; laboratory pipettes; laboratory centrifuges; logs [measuring instruments]; lasers not for medical purposes; lactometers; darkroom lamps [photography]; camera flashes; video cassettes; head cleaning tapes [recording]; lenses for astrophotography; spectacle lenses; close-up lenses; square rulers for measuring; squares for measuring; identity cards, magnetic; slide-rules; sounding lines; magnifying glasses [optics]; magic lanterns; electromagnetic coils; magnetic encoders; magnetic tapes; magnetic tape units for computers; magnetic data media; magnetic wires; tape recorders; crash test dummies; resuscitation mannequins [teaching apparatus]; pressure measuring apparatus; marking gauges [joinery]; mathematical instruments; masts for wireless aerials; dosage dispensers; invoicing machines; mechanical signs; beacons, luminous; megaphones; copper wire, insulated; diaphragms [acoustics]; tone arms for record players; plane tables [surveying instruments]; measuring spoons; metal detectors for industrial or military purposes; materials for electricity mains [wires, cables]; meteorological balloons; meteorological instruments; metronomes; mechanisms for counter-operated apparatus; coin-operated mechanisms; micrometers; micrometer screws for optical instruments; microprocessors; microscopes; microtomes; microphones; mouse [computer peripheral]; trackballs [computer peripherals]; modems; parking meters; monitors [computer hardware]; moni-

tors [computer programs]; apparatus for editing cinematographic film; marine compasses; weighbridges; nets for protection against accidents; downloadable music files; navigation apparatus for vehicles [on-board computers]; navigational instruments; kneepads for workers; neon signs; levels [instruments for determining the horizontal]; levelling staffs [surveying instruments]; calipers; sheaths for electric cables; safety restraints, other than for vehicle seats and sports equipment; objectives [lenses] [optics]; selfie lenses; furniture especially made for laboratories; clothing for protection against accidents, irradiation and fire; clothing for protection against fire; clothing especially made for laboratories; marking buoys; revolution counters; footwear for protection against accidents, irradiation and fire; teaching apparatus; teaching robots; mirrors [optics]; mirrors for inspecting work; limiters [electricity]; ozonisers [ozonators]; octants; eyepieces; ohmmeters; computer operating programs, recorded; optical apparatus and instruments; optical fibres [light conducting filaments]; optical discs; optical cables; optical condensers; optical lanterns; optical lenses; telescopic sights for artillery; sighting telescopes for firearms; optical data media; optical glass; optical character readers; organic light-emitting diodes [OLED]; oscillographs; plumb bobs; reflective articles for wear, for the prevention of accidents; spectacles; sunglasses; goggles for sports; optical goods; radio pagers; periscopes; personal digital assistants [PDAs]; punched card machines for offices; piezoelectric sensors; droppers for measuring, other than for medical or household purposes; pyrometers; planimeters; plates for batteries; wafers for integrated circuits; plotters; grids for batteries; step-up transformers; mouse pads; wrist rests for use with computers; ear pads for headphones; fire alarms; fire boats; fire beaters; fire hose; fire extinguishing apparatus; extinguishers; fire blankets; semi-conductors; polarimeters; wearable video display monitors; wearable computers; portable media players; walkie-talkies; personal stereos; wearable activity trackers; retorts' stands; cleaning apparatus for sound recording discs; cleaning apparatus for phonograph records; reducers [electricity]; switches, electric; switchboxes [electricity]; plugboards; transmitters of electronic signals; transmitters [telecommunication]; teeth protectors; spark-guards; protective helmets for sports; safety nets; safety tarpaulins; vehicle breakdown warning triangles; burglar alarms; telerupters; precision balances; precision measuring apparatus; prisms [optics]; headgear being protective helmets; ticket printers; printers for use with computers; hemline markers; pressure indicator plugs for valves; conductors, electric; projection apparatus; slide projectors; projection screens; head guards for sports; mouth guards for sports; visors for helmets; anti-glare glasses; fire pumps; sprinkler systems for fire protection; road signs, luminous or mechanical; radar apparatus; radiological apparatus for industrial purposes; radiology screens for industrial purposes;

radio receivers; vehicle radios; radiotelegraphy sets; radiotelephony sets; branch boxes [electricity]; demagnetizing apparatus for magnetic tapes; distribution consoles [electricity]; distribution boxes [electricity]; distribution boards [electricity]; gasoline gauges; spectacle frames; frames for photographic transparencies; screens for photoengraving; stage lighting regulators; voltage surge protectors; voltage regulators for vehicles; light dimmers [regulators], electric; speed regulators for record players; regulating apparatus, electric; cell switches [electricity]; film cutting apparatus; resistances, electric; time switches, automatic; relays, electric; X-ray apparatus not for medical purposes; X-ray tubes not for medical purposes; X-ray films, exposed; rheostats; respirators for filtering air; retorts; refractometers; refractors; security surveillance robots; telepresence robots; downloadable ring tones for mobile phones; spools [photography]; armatures [electricity]; gloves for divers; gloves for protection against accidents; gloves for protection against X-rays for industrial purposes; hand-held electronic dictionaries; balances [steelyards]; flashlights [photography]; photometers; reflective safety vests; screens [photography]; light-emitting diodes [LED]; quantum dot light-emitting diodes [QLED]; traffic-light apparatus [signalling devices]; whistle alarms; dog whistles; connected bracelets [measuring instruments]; sextants; parking sensors for vehicles; data gloves; fog signals, non-explosive; signals, luminous or mechanical; animal signalling rattles for directing livestock; signalling whistles; signalling panels, luminous or mechanical; signal bells; rescue laser signalling flares; signal lanterns; sirens; scanners [data processing equipment]; speed indicators; headphones; earpieces for remote communication; solar batteries; solar panels for the production of electricity; smartglasses; smart rings; smartphones; smartwatches; abacuses; calculators; salinometers; sonars; probes for scientific purposes; computer game software, recorded; computer game software, downloadable; downloadable computer game software; life belts; life-saving capsules for natural disasters; lifeboats; survival blankets; life jackets; rescue flares, non-explosive and non-pyrotechnic; life-saving rafts; spectrograph apparatus; spectroscopes; alcoholmeters; sports whistles; satellites for scientific purposes; lighting ballasts; stereoscopes; stereoscopic apparatus; selfie sticks [hand-held monopods]; tripods for cameras; stands adapted for laptops; fuse wire; needles for surveying compasses; stroboscopes; fire hose nozzles; subwoofers; sulfimeters; drying apparatus for photographic prints; drainers for use in photography; drying racks [photography]; spherometers; battery jars; containers for contact lenses; containers for microscope slides; couplings, electric; couplers [data processing equipment]; connections for electric lines; wire connectors [electricity]; connectors [electricity]; junction boxes [electricity]; junction sleeves for electric cables; control panels [electricity]; tablet computers; taximeters; ear plugs for divers; ta-

chometers; weights; television apparatus; telegraphs [apparatus]; telegraph wires; telecommunication apparatus in the form of jewellery; range finders; telescopes; teleprinters; telephone receivers; telephone apparatus; telephone transmitters; telephone wires; answering machines; temperature indicators; theodolites; terminals [electricity]; credit card terminals; thermal imaging cameras; thermometers, not for medical purposes; thermostats; thermostats for vehicles; thermo-hygrometers; crucibles [laboratory]; T-squares for measuring; current rectifiers; heat regulating apparatus; totalizers; transistors [electronic]; transponders; protractors [measuring instruments]; transformers [electricity]; simulators for the steering and control of vehicles; resuscitation training simulators; triodes; pitot tubes; darkrooms [photography]; thin client computers; wah-wah pedals; enlarging apparatus [photography]; steering apparatus, automatic, for vehicles; nanoparticle size analysers; ring sizers; finger sizers; acid hydrometers; height measuring instruments; marine depth finders; slope indicators; densitometers; apparatus and instruments for astronomy; urinometers; amplifiers; particle accelerators; railway traffic safety appliances; voting machines; remote control apparatus; computer memory devices; egg timers [sandglasses]; anti-interference devices [electricity]; devices for the projection of virtual keyboards; apparatus for changing record player needles; hands-free kits for telephones; facsimile transmission machines; apparatus and instruments for physics; films, exposed; filters for respiratory masks; filters for ultraviolet rays, for photography; filters for use in photography; floppy disks; fluorescent screens; cameras [photography]; photovoltaic cells; racks (photographic -); photocopiers; phototelegraphy apparatus; hairdressing training heads [teaching apparatus]; heliographic apparatus; hygrometers; hydrometers; chemistry apparatus and instruments; holograms; chromatography apparatus for laboratory use; chronographs [time recording apparatus]; humanoid robots with artificial intelligence for use in scientific research; processors [central processing units]; centering apparatus for photographic transparencies; cyclotrons; digital signs; digital weather stations; bags adapted for laptops; time clocks [time recording devices]; black boxes [data recorders]; frequency meters; electronic book readers; readers [data processing equipment]; bar code readers; petri dishes; chips [integrated circuits]; dressmakers' measures; virtual reality headsets; snorkels; spectacle cords; peepholes [magnifying lenses] for doors; letter scales; nose clips for divers and swimmers.

28 – Climbers' harness; fidget toys; apparatus for games; tennis ball throwing apparatus; conjuring apparatus; clay pigeon traps; arcade video game machines; party balloons; trampettes; baseball gloves; dolls' feeding bottles; billiard markers; billiard tables; coin-operated billiard tables; billiard balls; billiard cues; bob-sleighs; bodyboards; punching bags; boxing gloves; bowling apparatus and machinery; boomerangs;

rackets; strings for rackets; gut for fishing; surf skis; creels [fishing traps]; rods for fishing; fairground ride apparatus; billiard cue tips; chest expanders [exercisers]; clay pigeons [targets]; Christmas crackers [party novelties]; draughts; darts; hang gliders; percussion caps [toys]; rocking horses; playhouses for children; joysticks for video games; controllers for game consoles; discs for sports; controllers for toys; radio-controlled toy vehicles; dominoes; drones [toys]; rattles [playthings]; exercise weights; paddleboards; checkerboards; draughtboards; electronic targets; golf bag tags; counters [discs] for games; gyroscopes and flight stabilizers for model aircraft; novelty toys for parties; dice; protective films adapted for screens for portable games; protective cups for sports; needles for pumps for inflating balls for games; ninepins; amusement machines, automatic and coin-operated; gaming machines for gambling; toys; toy air pistols; children's playthings; toys for pets; soap bubbles [toys]; toy imitation cosmetics; masks [playthings]; toy figures; games; horseshoe games; table-top games; snow for Christmas trees (artificial -); artificial fishing bait; sole coverings for skis; divot repair tools [golf accessories]; kaleidoscopes; surfboard covers; bells for Christmas trees; caps for pistols [toys]; playing cards; skittles [games]; bowls [games]; shin guards [sports articles]; weight lifting belts [sports articles]; Christmas trees of synthetic material; trading cards for games; roulette wheels; rollers for stationary exercise bicycles; golf bag trolleys; toy cars; rosin used by athletes; video game consoles; confetti; lines for fishing; tennis racket strings; dolls; puppets; ice skates; dolls' rooms; dolls' beds; rhythmic gymnastics ribbons; flying discs [toys]; bows for archery; swings; yoga swings; mah-jong; reels for fishing; kite reels; toy models; models being toys; skeleton sleds; teddy bears; tables for table tennis; fencing masks; camouflage screens [sports articles]; matryoshka dolls; masts for sailboards; video output game machines; ball pitching machines; stuffed toys; scent lures for hunting or fishing; targets; toy mobiles; toy dough; butterfly nets; nets for sports; tennis nets; paintballs [ammunition for paintball guns] [sports apparatus]; inflatable games for swimming pools; swimming pool air floats; knee guards [sports articles]; elbow guards [sports articles]; edges of skis; dolls' clothes; quoits; ring games; fencing weapons; play tents; paragliders; party poppers [party novelties]; pachinkos; piñatas; paintball guns [sports apparatus]; toy pistols; floats for fishing; flippers for swimming; flippers for diving; toy putty; bladders of balls for games; bite indicators [fishing tackle]; pools (swimming -) [play articles]; swimming jackets; plush toys; plush toys with attached comfort blanket; swimming kickboards; pumps specially adapted for use with balls for games; flotation apparatus for swimming; swimming rings; sling shots [sports articles]; paddings (protective -) [parts of sports suits]; portable games and toys incorporating telecommunication functions; portable games with liquid crystal displays;



hunting lures; decoys for hunting or fishing; archery implements; waist trimmer exercise belts; men's athletic supporters [sports articles]; poles for pole vaulting; dumb-bells; spinning tops [toys]; jigsaw puzzles; slides [playthings]; bats for games; surfboard leashes; ski bindings; harness for sailboards; body-training apparatus; fish hooks; landing nets for anglers; fishing equipment; toy robots; in-line roller skates; roller skates; roller skis; batting gloves [accessories for games]; golf gloves; gloves for games; fencing gauntlets; webbed gloves for swimming; hand-held consoles for playing video games; parlour games; ascenders [mountaineering equipment]; candle holders for Christmas trees; scale model kits [toys]; skateboards; skis; scratch cards for playing lottery games; slot machines [gaming machines]; snowshoes; snow globes; ski boards; starting blocks for sports; stationary exercise bicycles; golf clubs; Christmas tree skirts; building games; building blocks [toys]; sailboards; ornaments for Christmas trees, except lights, candles and confectionery; backgammon games; bingo cards; theatrical masks; chalk for billiard cues; shuttlecocks; playing balls; balls for games; marbles for games; spring boards [sports articles]; tricycles for infants [toys]; scooters [toys]; seal skins [coverings for skis]; scale model vehicles; billiard table cushions; body-building apparatus; appliances for gymnastics; machines for physical exercises; foosball tables; guns (harpoon -) [sports articles]; paper party hats; kites; hockey sticks; golf bags, with or without wheels; cricket bags; cups for dice; chips for gambling; bite sensors [fishing tackle]; chessboards; chess games; novelty toys for playing jokes; sleighs [sports articles]; sleds [sports articles]; twirling batons; ski sticks for roller skis; ski sticks.

41 – Ticket agency services [entertainment]; academies [education]; holiday camp services [entertainment]; presentation of variety shows; videotaping; gymnastic instruction; discotheque services; providing online electronic publications, not downloadable; animal training; sign language interpretation; nursery schools; correspondence courses; recording studio services; zoological garden services; publication of books; calligraphy services; club services [entertainment or education]; music composition services; electronic publishing services; cultural, educational or entertainment services provided by art galleries; micro-filming; videotape editing; teaching; educational services provided by special needs assistants; educational services provided by schools; training; aikido instruction; judo instruction; sado instruction [tea ceremony instruction]; training services provided via simulators; dubbing; online publication of electronic books and journals; arranging and conducting of colloquiums; arranging and conducting of congresses; arranging and conducting of conferences; arranging and conducting of concerts; arranging and conducting of workshops [training]; arranging and conducting of seminars; arranging and conducting of in-person educational forums; arranging and conducting of symposiums; orga-

nization of balls; organization of exhibitions for cultural or educational purposes; organization of competitions [education or entertainment]; organization of lotteries; arranging of beauty contests; organization of cosplay entertainment events; organization of fashion shows for entertainment purposes; organization of shows [impresario services]; party planning [entertainment]; organization of sports competitions; orchestra services; providing casino facilities [gambling]; providing museum facilities [presentation, exhibitions]; sport camp services; providing golf facilities; providing recreation facilities; arcade game services; rental of lighting apparatus for theatrical sets or television studios; rental of audio equipment; rental of video cameras; rental of videotapes; rental of video cassette recorders; rental of skin diving equipment; rental of indoor aquaria; rental of sound recordings; toy rental; rental of cinematographic apparatus; rental of motion pictures; games equipment rental; rental of artwork; rental of radio and television sets; rental of training simulators; rental of sports grounds; rental of sports equipment, except vehicles; lease of scenery; rental of stadium facilities; rental of tennis courts; songwriting; screenplay writing; scriptwriting, other than for advertising purposes; writing of texts; mobile library services; modelling for artists; practical training [demonstration]; translation and interpretation; know-how transfer [training]; presentation of live performances; cinema presentations; education information; entertainment information; information services relating to recreation; providing user rankings for entertainment or cultural purposes; providing online videos, not downloadable; providing online music, not downloadable; providing user reviews for entertainment or cultural purposes; providing television programmes, not downloadable, via video-on-demand services; providing films, not downloadable, via video-on-demand services; educational examination; educational examination for users to qualify to pilot drones; conducting fitness classes; conducting guided tours; conducting guided climbing tours; film showings; production of music; production of radio and television programmes; film production, other than advertising films; vocational retraining; vocational guidance [education or training advice]; publication of texts, other than publicity texts; radio entertainment; entertainment services; karaoke services; film distribution; film directing, other than advertising films; booking of seats for shows; religious education; news reporters services; health club services [health and fitness training]; subtitling; theatre productions; television entertainment; sound engineering services for events; layout services, other than for advertising purposes; entertainer services; disc jockey services; lending library services; movie studio services; personal trainer services [fitness training]; nightclub services [entertainment]; coaching [training]; amusement park services; game services provided online from a computer network; video editing services for events;

physical fitness assessment services for training purposes; face painting; gambling services; lighting technician services for events; tutoring; language interpreter services; boarding school education; physical education; photography; photographic reporting; timing of sports events; presentation of circus performances; production of shows.

---

(260) AM 2023 120887 A

(800) 1702914

(151) 2022 03 15

(891) 2022 03 15

(731) Yuga Labs, Inc.

1430 S. Dixie Hwy, Ste. 105 1075, Coral

Gables FL 33146, USA

(540)

## Meebits

(591) Black, white

(511)

9 – Downloadable software for viewing crypto-collectibles, non-fungible tokens and other application tokens; downloadable software for use in electronically trading, storing, sending, receiving, accepting and transmitting crypto-collectibles, non-fungible tokens and other application tokens; downloadable software for use in electronically trading, storing, sending, receiving, accepting and transmitting digital currency, and managing digital currency payment and exchange transactions; downloadable software for processing transactions related to crypto-collectibles, non-fungible tokens and other application tokens; downloadable authentication software for communications with computers and computer networks; downloadable digital files authenticated by non-fungible tokens (NFTs).

25 – Apparel, namely, hats, t-shirts, and sweatshirts.

41 – Entertainment services in the nature of animated and/or television programs; entertainment services in the nature of production of animated television programs; entertainment services in the nature of animated motion picture theatrical films.

42 – Platform as a service (PaaS) featuring software platforms for providing access to crypto-collectibles, non-fungible tokens and other application tokens; platform as a service (PaaS) featuring software platforms for downloading software, data, and image files from the Internet; providing temporary use of online non-downloadable software for use in electronically trading, storing, sending, receiving, accepting and transmitting digital currency, crypto-collectibles, non-fungible tokens and other application tokens, and managing digital transactions; software as a service (SaaS) and platform as a service (PaaS) featuring software for use in connection with providing a digital platform for navigating digital art, crypto-collectibles, non-fungible tokens and other application tokens, and non-fungible token marketplaces and auctions; software as

a service (SaaS) and platform as a service (PaaS) featuring software for use in connection with providing information for digital art, crypto-collectibles, non-fungible tokens and other application tokens; providing online non-downloadable software for providing access to crypto-collectibles, non-fungible tokens and other application tokens.

---

(260) AM 2023 120888 A

(800) 1702915

(151) 2022 03 15

(891) 2022 03 15

(731) Yuga Labs, Inc.

1430 S. Dixie Hwy, Ste. 105 1075, Coral

Gables FL 33146, USA

(540)

## CryptoPunks

(591) Black, white

(511)

9 – Downloadable software for viewing crypto-collectibles, non-fungible tokens and other application tokens; downloadable software for use in electronically trading, storing, sending, receiving, accepting and transmitting crypto-collectibles, non-fungible tokens and other application tokens; downloadable software for use in electronically trading, storing, sending, receiving, accepting and transmitting digital currency, and managing digital currency payment and exchange transactions; downloadable software for processing transactions related to crypto-collectibles, non-fungible tokens and other application tokens; downloadable authentication software for communications with computers and computer networks; downloadable digital files authenticated by non-fungible tokens (NFTs).

25 – Apparel, namely, hats, t-shirts, and sweatshirts.

41 – Entertainment services in the nature of animated and/or television programs; entertainment services in the nature of production of animated television programs; entertainment services in the nature of animated motion picture theatrical films.

42 – Platform as a service (PaaS) featuring software platforms for providing access to crypto-collectibles, non-fungible tokens and other application tokens; platform as a service (PaaS) featuring software platforms for downloading software, data, and image files from the Internet; providing temporary use of online non-downloadable software for use in electronically trading, storing, sending, receiving, accepting and transmitting digital currency, crypto-collectibles, non-fungible tokens and other application tokens, and managing digital transactions; software as a service (SaaS) and platform as a service (PaaS) featuring software for use in connection with providing a digital platform for navigating digital art, crypto-collectibles, non-fungible tokens and other application tokens, and non-fungible token marketplaces and auctions; soft-

ware as a service (SaaS) and platform as a service (PaaS) featuring software for use in connection with providing information for digital art, crypto-collectibles, non-fungible tokens and other application tokens; providing online non-downloadable software for providing access to crypto-collectibles, non-fungible tokens and other application tokens.

(260) AM 2023 120905 A

(800) 1703303

(151) 2022 11 13

(891) 2022 11 13

(731) JOINT STOCK COMPANY "FATS AND OIL INTEGRATED WORKS"

UL. TITOVA 27, EKATERINBURG,  
RU-620085 SVERDLOVSKAYA OBLAST,  
Russian Federation

(540)



(591) Black, white, gray, orange, yellow, brown, dark-brown, light-brown, red, light-red, dark-red, green, light-green, dark-green, beige

(531) 01.15.11; 02.09.01; 05.09.17; 05.09.22;  
08.05.02; 08.07.11; 08.07.17; 08.07.25;  
11.03.11; 11.03.20; 28.05; 29.01.15

(511)

30 – Mayonnaise; mayonnaise sauce.

(260) AM 2023 120906 A

(800) 1703304

(151) 2022 11 13

(891) 2022 11 13

(731) JOINT STOCK COMPANY "FATS AND OIL INTEGRATED WORKS"

UL. TITOVA 27, EKATERINBURG,  
RU-620085 SVERDLOVSKAYA OBLAST,  
Russian Federation

(540)



(591) Black, white, gray, orange, brown, dark-brown, light-brown, red, light-red, pink, lilac, green, light-green, dark-green, beige

(531) 02.09.01; 05.09.06; 05.09.15; 08.07.17;  
08.07.25; 11.03.11; 11.03.20; 28.05; 29.01.15

(511)

30 – Mayonnaise; mayonnaise sauce.

(260) AM 2023 120907 A

(800) 1703305

(151) 2022 11 13

(891) 2022 11 13

(731) JOINT STOCK COMPANY "FATS AND OIL INTEGRATED WORKS"

UL. TITOVA 27, EKATERINBURG,  
RU-620085 SVERDLOVSKAYA OBLAST,  
Russian Federation

(540)



(591) Black, white, gray, orange, light-orange, brown, dark-brown, light-brown, lilac, violet, green, light-green, dark-green, beige

(531) 02.09.01; 05.09.06; 05.09.12; 08.07.17;  
11.03.11; 11.03.20; 28.05; 29.01.15

(511)

30 – Mayonnaise; mayonnaise sauce.

(260) AM 2023 120908 A

(800) 1703306

(151) 2022 11 13

(891) 2022 11 13

(731) JOINT STOCK COMPANY "FATS AND OIL INTEGRATED WORKS"

UL. TITOVA 27, EKATERINBURG,  
RU-620085 SVERDLOVSKAYA OBLAST,  
Russian Federation

(540)



- (591) Black, white, gray, orange, light-orange, brown, dark-brown, light-brown, red, light-red, green, light-green, dark-green, beige, yellow  
 (531) 01.15.11; 02.09.01; 08.01.01; 08.01.04; 08.07.10; 08.07.17; 11.03.11; 11.03.20; 28.05; 29.01.15  
 (511)  
 30 – Mayonnaise; mayonnaise sauce.

(260) AM 2023 120929 A

(800) 1472039

(151) 2019 04 16

(891) 2022 11 10

- (731) HGS KAHVE AMBALAJ GIDA İNŞAAT SANAYİ VE TİCARET LİMİTED ŞİRKETİ  
 Hacı Yusuf Mescid Mahallesi, Firdevs Caddesi, Yeni Şekerciler Sitesi, 10551 Sokak, No:14, Karatay, Konya, Türkiye

(540)



- (591) Red, yellow and white  
 (531) 01.01.05; 01.01.10; 01.11.08; 05.03.13; 25.07.01; 26.01.04; 26.04.16; 27.05.01; 27.05.17; 29.01.14  
 (526) Kahve  
 (511)  
 30 – Coffee, cocoa; coffee or cocoa based beverages, chocolate based beverages.

(260) AM 2023 120930 A

(800) 1582031

(151) 2020 12 02

(891) 2022 12 06

- (731) PIRELLI & C. S.p.A.  
 Viale Piero e Alberto Pirelli 25, I-20126 Milano, Italy

(540)



- (591) Black, white  
 (531) 27.05.02  
 (511)  
 9 – Scientific, research, navigation, surveying, photographic, cinematographic, audiovisual, optical, weighing, measuring, signalling, detecting, testing, inspecting, life-saving and teaching apparatus and instru-

ments; apparatus and instruments for conducting, switching, transforming, accumulating, regulating or controlling the distribution or use of electricity; apparatus and instruments for recording, transmitting, reproducing or processing sound, images or data; recorded and downloadable media, computer software, blank digital or analogue recording and storage media; mechanisms for coin-operated apparatus; cash registers, calculating devices; computers and computer peripheral devices; diving suits, divers' masks, ear plugs for divers, nose clips for divers and swimmers, gloves for divers, breathing apparatus for underwater swimming; fire-extinguishing apparatus; USB Flash drives; video game software; video game programs; electronic game software; spectacles smart glasses; sunglasses; protecting helmets; sports helmets; protective clothing; protective footwear; apparatus and devices for personal protection against accidents, irradiation and fire; downloadable multimedia files and downloadable data files; magnetic data carriers; recording discs; computers; computer programs; computer peripherals; mouse, mouse pads; mobile telephones; smartphones; telephone apparatus; apparatus for communication; electronic publications; smartwatches; wearable digital electronic devices for the sensing, recording, storing, sending and receiving of text, data, audio, image and video files across communications networks, including devices that communicate with smartphones; personal digital assistants; sound recording and sound reproducing apparatus, and computer software for use in creating and designing web sites; computer software; electronic apparatus for monitoring, processing, displaying, storing and transmitting data relating to a user's physical activity, compliance with health and fitness programs, geolocation, direction, distance, altitude, speed, steps taken, activity level, calories burned, navigational information, weather information and biometric data; calculating devices; measuring, detecting and monitoring instruments; automatic indicators of low pressure in vehicle tires and controllers; data transmission networks; apparatus for data transmission; data transfer units; electronic monitoring instruments, other than for medical use; data processing apparatus; electronic sensors; tire monitoring apparatus; tire pressure sensors; magnetic, smart, microprocessor cards of subscription and payment related to the rental of bicycles and push scooters; smart bracelets; smart necklaces; application software for smart phone; downloadable smart phone application [software]; mobile computers; mobile phones; application software for mobile phones; protective cases for mobile phones; computer hardware; software; helmets; amplifiers for musical instruments; computer programs for generating music; covers for music storage devices; digital music, downloadable; downloadable music files; headphones; tyre pressure gauges; tyre tread depth gauges; tyre balancing machines for land vehicles; automatic indicators of low pressure in tyres; remotely deployable spike strips

used to stop cars by puncturing tyres; digital signs; signs, luminous; protective masks; battery; electric batteries; power banks.

12 – Vehicles; apparatus for locomotion by land, air or water; air vehicles; armored vehicles; axles for vehicles; bodies for vehicles; brakes for vehicles; caissons [vehicles]; doors for vehicles; electric vehicles, electric cars, electric motorcycles, electric bicycles; hoods for vehicles; horns for vehicles; refrigerated vehicles; sleighs [vehicles]; space vehicles; spoilers for vehicles; trailers [vehicles]; undercarriages for vehicles; upholstery for vehicles; vans [vehicles]; vehicle bumpers; vehicle chassis; vehicle joysticks; vehicle seats; vehicle wheels; water vehicles; windows for vehicles; air cushion vehicles; air pumps [vehicle accessories]; anti-dazzle devices for vehicles; anti-glare devices for vehicles; anti-theft alarms for vehicles; anti-theft devices for vehicles; balance weights for vehicle wheels; brake discs for vehicles; brake linings for vehicles; brake segments for vehicles; brake shoes for vehicles; caps for vehicle fuel tanks; casters for carts [vehicles]; casters for trolleys [vehicles]; clutches for land vehicles; concrete mixing vehicles; couplings for land vehicles; covers for vehicle steering wheels; cup holders for vehicles; driving chains for land vehicles; driving motors for land vehicles; engine mounts for land vehicles; engines for land vehicles; freewheels for land vehicles; gear boxes for land vehicles; gearing for land vehicles; golf cars [vehicles]; golf carts [vehicles]; head-rests for vehicle seats; hoods for vehicle engines; hubs for vehicle wheels; hydraulic circuits for vehicles; jet engines for land vehicles; luggage carriers for vehicles; luggage nets for vehicles; lug nuts for vehicle wheels; military vehicles for transport; motors, electric, for land vehicles; motors for land vehicles; propulsion mechanisms for land vehicles; push scooters [vehicles]; reduction gears for land vehicles; reversing alarms for vehicles; rims for vehicle wheels; safety belts for vehicle seats; safety seats for children, for vehicles; seat covers for vehicles; security harness for vehicle seats; shock absorbing springs for vehicles; side view mirrors for vehicles; signal arms for vehicles; sleeping berths for vehicles; solid tyres for vehicle wheels; steering wheels for vehicles; suspension shock absorbers for vehicles; tires for vehicle wheels; torque converters for land vehicles; torsion bars for vehicles; trailer hitches for vehicles; transmission chains for land vehicles; transmissions for land vehicles; transmission shafts for land vehicles; treads for vehicles [roller belts]; treads for vehicles [tractor type]; turbines for land vehicles; tyres for vehicle wheels; valves for vehicle tires; valves for vehicle tyres; vehicle bonnet pins; vehicle covers [shaped]; vehicle hood pins; vehicle running boards; vehicle suspension springs; vehicle wheel hubs; vehicle wheel rims; vehicle wheel spokes; autonomous underwater vehicles for seabed inspections; non-skid devices for vehicle tyres; remotely operated vehicles for underwater inspections; crankcases for

land vehicle components, other than for engines; elevating tailgates [parts of land vehicles]; power tailgates [parts of land vehicles]; remote control vehicles, other than toys; tailboard lifts [parts of land vehicles]; vehicles for locomotion by land, air, water or rail; connecting rods for land vehicles, other than parts of motors and engines; automobile tyres; bicycle tyres; pneumatic tyres; spikes for tyres; casings for pneumatic tyres; flanges for railway wheel tyres; inner tubes for bicycle tyres; inner tubes for pneumatic tyres; pumps for bicycle tyres; spare tyre covers; treads for retreading tyres; tubeless tyres for bicycles; tyre mousse inserts; tyres for snow ploughs; panniers adapted for bicycles; bicycles; motorcycles; casings for pneumatic tyres; ski carriers for cars; boats; inflatable boats.

14 – Precious metals and their alloys; jewelry, precious and semi-precious stones; horological and chronometric instruments; watches and clocks; chronographs and chronometers; earrings; rings; necklaces; bracelets; ornamental pins made of precious metal; shoe ornaments of precious metal; boxes of precious metal; pins; tie clips; cuff links; watch straps; watch bands; key rings; key fobs.

16 – Paper and cardboard; printed matter; bookbinding material; photographs; stationery and office requisites, except furniture; adhesives for stationery or household purposes; drawing materials and materials for artists; paintbrushes; instructional and teaching materials; plastic sheets, films and bags for wrapping and packaging; printers' type, printing blocks; stationery; articles of paper or cardboard, namely, boxes, bags, envelopes and pouches for packaging; wrapping paper; writing instruments; pouches for writing instruments; cases for writing instruments; inks and ink refills for writing instruments; desk sets; writing books; calendars, note books, indexes, covers [stationery], files [office requisites], announcement cards [stationery]; writing paper, envelopes, index cards [stationery]; business cards; writing pads; writing instrument holders; paperweights; diaries, cover for diaries, replacement papers for diaries; inkwells; check book holders, passport holders; document holders and cases; albums; bookends; money clips; writing cases (sets); atlases, geographical maps; printed publications; specialist books; magazines; printed advertising articles and printed advertising materials; photographs [printed]; flags of paper; books; catalogs; adhesive labels of paper; posters.

17 – Unprocessed and semi-processed rubber, gutta-percha, gum, asbestos, mica and substitutes for all these materials; plastics and resins in extruded form for use in manufacture; packing, stopping and insulating materials; flexible pipes, tubes and hoses, not of metal; sealing, packing and insulating materials; flexible hoses [not made from metal]; flexible pipes, tubes, hoses and fittings therefor [including valves], and fittings for rigid pipes, all non-metallic; seals, rubber

sealants and insulation fillers; insulation and barrier materials; acoustic insulation articles and materials; flexible hose connections [not made from metal]; casings of rubber for hoses; insulators for cables [not made from metal]; rubber compensators; line seals; sealing gaiters, sealing rings, diaphragms [not included in other classes]; natural rubber [liquid]; sub-ballast mats made from rubber and rubber substitutes for vibration and shock damping in track construction; oil-absorbent mats made of rubber and rubber substitutes; rubber valves; soft top, door, window, engine compartment seals; plastic sheeting [except for packaging purposes], including sheeting for sealing and insulating purposes, roof and pond liners; rubber for retreading tires; adhesive tapes, strips, bands and films, other than stationary; decorative plastics films being semi-finished products; rubber solutions; torsional vibration dampers made of rubber; brake hoses; cooling, heating, brake, fuel, charge air, oil, hydraulic hoses as vehicle components; rubber material for recapping tyres; plastic fibres for use in the manufacture of tyre cord; synthetic rubber.

18 – Leather and imitations of leather; animal skins and hides; luggage and carrying bags; umbrellas and parasols; walking sticks; whips, harness and saddlery; collars, leashes and clothing for animals; handbags; traveling bags; briefcases; leather briefcases; leather credit card holders; wallets; pocket wallets; leather document briefcases; key-cases of leather and skins; purses; suitcases; cosmetic bags sold empty; bags; evening and shoulder bags for ladies; leather shopping bags; school bags; garment bags for travel; suit carriers for travel; shoe bags for travel; beach bags; diaper bags; backpacks; Boston bags; traveling trunks; duffel bags; overnight bags; carry-on bags; satchels; vanity cases (not fitted); hides; cases and boxes made of leather; bags made of leather for packaging; leather straps; umbrellas; leather leashes; saddlery; parasols; walking sticks; trunks (luggage); luggage included in this class; bags included in this class, in particular sports bags and briefcases; purses; key cases; suitcases with wheels; leather, unworked or semi-worked; imitation leather; fur.

25 – Clothing, footwear, headwear; coats; jackets; trousers; skirts; tops; raincoats; overcoats; belts; braces for clothing; suits; stuff jackets; jumpers; jeans; dresses; cloaks; parkas; shirts; T-shirts; underwear; baby-dolls being nightwear; bathrobes; bathing costumes; negligee; swim suits; dressing gowns; shawls; neckerchiefs; scarves; ties; neckties; sweat shirts; under shirts; polo shirts; body suits; shorts; combinations [clothing]; wedding dresses; stockings; socks; shoes; slippers; overshoes; galoshes; wooden clog; soles for footwear; footwear upper; boots; ski boots; snow boots; half boots; esparto shoes or sandals; sandals; bath sandals; gloves; mittens; hats and caps; visors (headwear); ski clothing; ski hats; ski jackets; ski gloves;

ski pants; salopettes; silk scarves; ski suits; wet suits for water-skiing; veils [clothing]; soccer bibs; replica soccer shirts, shorts and socks; baseball uniforms; golf shirts; track jackets; running shoes; shell jackets; golf clothing, other than gloves; motorists' clothing; cyclists' clothing.

28 – Games, toys and playthings; video game apparatus; gymnastic and sporting articles; decorations for Christmas trees; sporting articles and equipment, gymnastic articles; ornaments for Christmas trees, except illumination articles and confectionery; artificial Christmas trees; fairground and playground apparatus; toys, games; scale model kits [toys]; stuffed toys; automatic amusement machines (coin-operated machines), arcade video game machines; video game machines; scale model vehicles; toy vehicles; scooters (toys for children); scale model automobiles; toy automobiles; radio-controlled toy vehicles; balls for games; board games; playing cards; playing balls; appliances for gymnastics; plastic race tracks; gloves for games; skis; ski sticks; surf skis; ski sticks for roller skis; ski bindings; bags especially designed for skis and surfboards; sailboards; soccer balls; football tables; golf bag carts; golf bags, with or without wheels; golf gloves; golf clubs; golf balls; scale model kits (toys); skateboards; tennis balls; tennis rackets; cases for tennis balls; video game machines; electronic games.

35 – Advertising; business management; business administration; office functions; providing commercial information and advice in relation to the tyre industry; commercial services for facilitating and organising the maintenance and repair of tyres and repair of cars; tracking and monitoring vehicles for commercial purposes; business consultancy relating to the management of tyres; data management services; inventory management services; compilation of information in computer databases; compilation and systematization of information in databanks relating to vehicle driving performance, tyre performance and tyre management; customer loyalty services and customer club services, for commercial, promotional and/or advertising purposes; providing of information and consultancy relating to the management of pneumatic tyres and vehicle fleets; retail and wholesale services and on line retail and wholesale services concerning motor vehicles and their parts and accessories, motors and engines for land vehicles, vehicle tires for vehicle wheels; retail store, wholesale store, on line retail and wholesale service all related to automotive parts and accessories, horological and chronometric instruments, watches, key rings, clothing and related accessories, namely, shirts, skirts, dresses, pants, jackets, coats, suits, leggings, sweaters, belts, scarves, gloves, footwear, sunglasses, eyeglass frames, eyeglass cases, contact lens cases, umbrellas, electronics and accessories, namely, car chargers, AC adaptors/travel chargers, hands-free kits comprised of an earphone-type

speaker, a microphone and a jack to plug into the phone and cradle units that plug into a car cigarette lighter, batteries, wireless headsets, wireless speakers, protective flip covers, cellular phones, leather cases, vinyl cases, plastic cases and replacement housings for cellular telephones, shoes, sports equipment, bracelets, printed matter, namely, photographs, stationery, calendars, post cards, posters, printed advertising boards, printed art reproductions, writing materials in the nature of writing instruments, cases, bags, furniture, household goods, handbags, wallets, credit card cases, leather key chains, luggage tags, luggage, tote bags, briefcases, document cases, toiletry cases sold empty; demonstration of general consumer merchandise; organization of exhibitions and trade fairs for business or advertising purposes; online retail store services featuring automotive parts and accessories, horological and chronometric instruments, watches, key rings, clothing and related accessories, clothing, namely, shirts, skirts, dresses, pants, jackets, coats, suits, leggings, sweaters, belts, scarves, gloves, footwear, sunglasses, eyeglass frames, eyeglass cases, contact lens cases, umbrellas, electronics and accessories, namely, car chargers, AC adaptors/travel chargers, hands-free kits comprised of an earphone-type speaker, a microphone and a jack to plug into the phone and cradle units that plug into a car cigarette lighter, batteries, wireless headsets, wireless speakers, protective flip covers, cellular phones, leather cases, vinyl cases, plastic cases and replacement housings for cellular telephones, shoes, sports equipment, bracelets, printed matter, namely, photographs, stationery, calendars, post cards, posters, printed advertising boards, printed ad reproductions, writing materials in the nature of writing instruments, cases, bags, furniture, household goods, handbags, wallets, credit card cases, leather key chains, luggage tags, luggage, tote bags, briefcases, document cases, toiletry cases sold empty, cosmetic bags sold empty; business administration and organizational management of vehicle fleets for others; commercial information and advice for consumers (consumer advice shop); administrative processing of purchase orders; consultancy and assistance relating to business organization and management of retail and business companies; advertising; business management; business administration; office work; business management consultancy, radio and television advertising, organization of trade fairs for commercial or advertising purposes in the automotive field; collecting and arranging of relevant business press articles; presentation of goods on communication media, for retail purposes; public relations; auctioneering; sales promotion for others; administrative processing of purchase orders; business auditing; sponsorship search; retail services provided by tyre stores; fuel management consulting services in the field of motor vehicles; fleet business management consulting services; monitoring services for business purposes to ascertain vehicle location, maintenance,

use, safety and performance via a global computer information network and other computer and electronic communication networks; providing information services for business purposes in the field of vehicle location, maintenance, use, safety and performance to vehicle fleet operators.

37 – Construction services; installation and repair services; mining extraction, oil and gas drilling; maintenance and repair of vehicles and the components and fittings thereof; maintenance, repair, retreading and changing of vehicle tyres; installation, maintenance, repair and changing of electric and electronic equipment, instruments and apparatus for vehicles; services for drivers and managers of vehicle fleets, information and consultancy in relation to vehicle maintenance and repair; maintenance, repair, retreading, re-cutting, fitting, removing and replacement of pneumatic tyres and inner tubes for pneumatic tyres; wheel balancing; services relating to the inspection of cars, namely checking the technical state of cars; emergency motor vehicle recovery, including services relating to pneumatic tyres for motor vehicles; vehicle inspection, namely technical verification of tyre condition; vehicle battery charging; charging of electric vehicles; vehicle breakdown repair services; vulcanization of tires [repair]; information and advice services for drivers and vehicle fleet managers related to vehicle maintenance and repair.

41 – Education, providing of training, entertainment, sporting and cultural activities; timing of sports events; providing on-line electronic publications, not downloadable; entertainment information; rental of sports equipment, except vehicles; organization of sports competitions; arranging and conducting of conferences, congresses, seminars, symposiums, workshops [training] all in the automotive and cultural fields; providing museum faculties [presentation, exhibitions]; services of schools [education]; provision of training; providing computer assisted courses of instruction; training related to industrial electric and electronic systems; training related to tire pressure sensors; training related to tire pressure gauges; training related to electronic instruments for measuring, detecting and monitoring in the automotive industry; library services; art exhibition services; educational services, namely conducting lectures in the field of art; electronic publication; publication services; editorial consultation; publication and edition of books; publication of manuals; publication of booklets; publication of journals; publication of magazines; publication of printed matter and printed publications; publication of calendars; publication of posters; publication of printed matter; publication of calendars of events; publication of directories relating to tourism; entertainment services, namely, arranging, organizing, conducting or presenting music concerts, lectures, exhibitions and social entertainment events; publication of books, catalogs, booklets and guides; entertainment

through films, television and performances and shows; production of films, video films, radio and television programs.

42 – Scientific and technological services and related research and design services; analysis and industrial research services; design and development of hardware and software; computer rental; software updating; surveying; preparation of construction plans; chemical analysis; water analysis; computer systems analysis; architecture; authentication of works of art; materials testing; architectural consultancy; energy economics consultancy; software consultancy; consultancy in the design and development of computers; consultancy for the design of websites; quality control; technical control for vehicles; creation and management of websites for third parties; interior decoration; digitisation of documents (scanning); industrial drawings; software development (design); geological examinations; provision of scientific information and consultancy in relation to carbon dioxide emissions; provision of search engines for the internet; engineering; software installation; monitoring of computer systems through remote access; expert opinions (engineering work); urban planning; design of computer systems; computer programming; clinical trials; textile trials; data recovery in computer databases; research and development of new products for third parties; geological research; research in chemistry; research in physics; research on environmental protection; research in mechanics; scientific research; technical research; server hosting (services offered by the provider for the publication of websites on its servers); analysis services for oilfield research; meteorological information services; chemistry services; information technology (IT) consultancy services; graphic arts designer services; packaging designer services; scientific laboratory services; virus protection services; software services (SaaS); stylism (industrial aesthetics); technical project studies; calibration (measurement); energy verification; industrial analysis and research services relating to automobile tyres; research and development services relating to automobile tyre; providing temporary use of web-based software; providing temporary use of web-based applications; providing temporary use of on-line non-downloadable software for inventory management; hosting of databases; programming of software for database management; programming of software for inventory management; providing computer programs for measuring data of vehicle running motion; designing, programming or maintenance of computer programs for measuring data of vehicle running motion; cloud computing featuring software; vehicle roadworthiness testing; research and development of new products for others.

(260) AM 2023 120932 A

(800) 1607549

(151) 2021 06 07

(891) 2022 11 23

(731) MGI TECH CO., LTD.

Main Building and Second Floor, of No. 11 Building, Beishan Industrial Zone, Yantian District, Shenzhen, 518083 Guangdong, China

(540)



(591) Black, white

(531) 01.13.15; 27.03.02; 27.05.01; 27.05.09;

27.05.17

(511)

9 – Computer programs, recorded; laboratory apparatus and instruments, namely, gene analyzers for genome information; gene amplification instrument; laboratory equipment, namely, protein sequence analysis apparatus; nucleic acid sequencers used for analyzing nucleic acids in scientific research; automatic chromatographic apparatus for laboratory use; apparatus and measuring instruments for physical and chemical test and composition analysis; diagnostic apparatus, not for medical purposes; data processing apparatus; clothing for protection against accidents, irradiation and fire.

10 – Apparatus for DNA and RNA testing for medical purposes; body composition monitors; apparatus for the regeneration of stem cells for medical purposes; analysers for bacterial identification for medical purposes; medical apparatus and instruments; testing apparatus for medical purposes; apparatus and instruments for radioisotope therapy; tomographs for medical purposes; radiotherapy apparatus; body fat monitors.

(260) AM 2023 120933 A

(800) 1662939

(151) 2022 01 31

(891) 2022 11 15

(731) SHALASHNYY SERGEY IGOREVICH

Yuzhnaya St., 19, office 18, Krasnodar, RU-350007 Krasnodarsky kray, Russian Federation

(540)



(591) Black, white

(531) 27.05.01

(511)

35 – Advertising agency services; business intermediary services relating to the matching of potential private investors with entrepreneurs needing funding;



employment agency services; computerized file management; opinion polling; market studies; business information; business investigations; business research; marketing research; personnel recruitment; consultancy regarding advertising communication strategies; consultancy regarding public relations communication strategies; business management and organization consultancy; business organization consultancy; business management consultancy; personnel management consultancy; professional business consultancy; layout services for advertising purposes; marketing; marketing in the framework of software publishing; targeted marketing; writing of curriculum vitae for others; scriptwriting for advertising purposes; organization of exhibitions for commercial or advertising purposes; organization of trade fairs for commercial or advertising purposes; business management assistance; commercial or industrial management assistance; commercial intermediation services; providing business information via a website; providing commercial and business contact information; provision of an online marketplace for buyers and sellers of goods and services in the field of education, competitions and employment; web indexing for commercial or advertising purposes in the field of education, competitions and employment; media relations services; sales promotion for others in the field of education, competitions and employment; production of advertising films; rental of advertising time on communication media; dissemination of advertising matter; direct mail advertising; advertising; online advertising on a computer network; outdoor advertising; advertising by mail order; television advertising; document reproduction; compilation of statistics; business inquiries; systemization of information into computer databases; advisory services relating to business management; corporate communications services; negotiation of business contracts for others; negotiation and conclusion of commercial transactions for third parties; psychological testing for the selection of personnel; interim business management; outsourced administrative management for companies; administration of consumer loyalty programs; public relations; market intelligence services; website traffic optimization; search engine optimization for sales promotion; business efficiency expert services.

41 – Academies [education]; videotaping; production of music; discotheque services; publication of books; providing information in the field of education; providing information relating to recreational activities; entertainment information; nightclub services [entertainment]; layout services, other than for advertising purposes; videotape editing; production of radio and television programmes; screenplay writing; correspondence courses; practical training [demonstration]; training services provided via simulators; organization of exhibitions for cultural and educational purposes; providing recreation facilities; arranging and conducting of colloquiums; arranging and conducting of con-

gresses; arranging and conducting of conferences; arranging and conducting of concerts; arranging and conducting of workshops [training]; organization of in-person educational forums; arranging and conducting of seminars; arranging and conducting of symposiums; organization of competitions [education or entertainment]; arranging of beauty contests; organization of cosplay entertainment events; organization of lotteries; organization of fashion shows for entertainment purposes; organization of shows [impresario services]; organization of sports competitions; vocational guidance [education or training advice]; sign language interpretation; know-how transfer [training]; television entertainment; mobile library services; vocational retraining; providing online videos, not downloadable; providing online music, not downloadable; providing television programmes, not downloadable, via video-on-demand services; providing films, not downloadable, via video-on-demand services; providing online electronic publications, not downloadable; educational examination; production of motion films, other than advertising films; online publication of electronic books and journals; publication of texts, other than publicity texts; radio entertainment; guests entertainment; entertainment services; writing of texts; film directing, other than advertising films; party planning [entertainment]; subtitling; tutoring; video editing services for events; disc jockey services; sound engineering services for events; game services provided online from a computer network; club services; cultural, educational or entertainment services provided by art galleries; teaching; educational services provided by special needs assistants; educational services provided by schools; translation; scriptwriting, other than for advertising purposes; ticket agency services [entertainment]; educational examination for users to qualify to pilot drones; coaching [training]; lighting technician services for events; sport camp services; recording studio services; nursery schools; photography; photographic reporting; timing of sports events; boarding school education; production of shows.

42 – Computer system analysis; energy auditing; recovery of computer data; business card design; graphic design of promotional materials; interior design; industrial design; graphic arts design; installation of computer software; meteorological information; clinical trials; material testing; textile testing; bacteriological research; biological research; geological research; research in the field of environmental protection; cosmetic research; mechanical research; research in the field of welding; research in the field of building construction; research in the field of telecommunications technology; research in the field of physics; chemical research; research and development of new products for others; medical research; scientific and technological research relating to patent mapping; scientific and technological research in the field of natural disasters; scientific research; analysis for oil-

field exploitation; underwater exploration; technological research; website design consultancy; computer security consultancy; information technology [IT] consultancy; consultancy in the design and development of computer hardware; architectural consultancy; computer software consultancy; data security consultancy; technological consultancy; updating of computer software; monitoring of computer systems to detect breakdowns; monitoring of computer systems for detecting unauthorized access or data breach; monitoring of computer systems by remote access; software as a service [SaaS]; maintenance of computer software; digitization of documents [scanning]; conversion of data or documents from physical to electronic media; providing information relating to computer technology and programming via a website; providing scientific information, advice and consultancy relating to carbon offsetting; providing search engines for the internet; platform as a service [PaaS]; conversion of computer programs and data, other than physical conversion; conducting technical project studies; computer system design; rental of web servers; computer rental; rental of computer software; hosting computer websites; server hosting; development of computer platforms; computer software design; creating and designing website-based indexes of information for others [information technology services]; creating and maintaining websites for others; computer programming; technical writing; copying of computer programs; providing virtual computer systems through cloud computing; information technology services provided on an outsourcing basis; chemistry services; packaging design; off-site data backup; consultancy services in the field of information technology; telecommunications technology consultancy; scientific laboratory services; data encryption services; electronic data storage.

(260) AM 2023 121034 A  
 (800) 1543506  
 (151) 2020 05 22  
 (891) 2022 11 14  
 (731) AstraZeneca AB  
 SE-151 85 Södertälje, Sweden  
 (540)



(591) Black, white  
 (531) 25.03.03; 26.01.06  
 (511)  
 5 – Pharmaceutical preparations and substances for human use only.

(260) AM 2023 121035 A  
 (800) 1580256  
 (151) 2021 01 13  
 (891) 2022 12 09  
 (731) NIHON NOHYAKU CO., LTD.  
 19-8, Kyobashi 1-chome, Chuo-ku, Tokyo  
 104-8386, Japan  
 (540)



(591) Black, white  
 (531) 06.01.02; 06.01.04; 26.01.02; 26.01.03;  
 26.01.16; 26.01.24; 26.13; 26.13.25  
 (511)  
 1 – Agricultural chemicals, except fungicides, herbicides, insecticides and parasiticides; plant growth regulating preparations.  
 5 – Pesticides; insecticides; fungicides; herbicides; miticides; acaricides.

(260) AM 2023 121037 A  
 (800) 1692670  
 (151) 2022 05 30  
 (891) 2022 11 16  
 (731) SAINT-GOBAIN WEBER  
 2-4 rue Marco Polo, F-94370 SUCY-EN-BRIE,  
 France  
 (540)



(591) Yellow and black  
 (531) 26.03.04; 27.05.01; 29.01.12  
 (511)  
 1 – Chemical products for the building industry and for public works; admixtures and additives for concrete, plasters and mortars; adhesives for use in industry, including adhesives and glues for laying building materials; unprocessed artificial resins; glaziers' putties; silicones; chemical preparations for waterproofing masonry, cement except for paints.  
 2 – Paints (non-insulating); paint additives in the form of shades of color; pigments; varnishes (other than insulators); lacquers (paints); coatings (paints); anti-rust preparations for preservation; products for the protection of building materials, namely anti-corrosive preparations, coating preparations having water repellent properties (paints); mastic (natural resin).  
 3 – Cleaning, polishing, degreasing and abrasive preparations; cleaning products and scouring solutions for use in the building and public works industry.

9 – Software and software applications for computers and portable telephones enabling users to download information relating to construction products and their environmental impact; software applications enabling scanning of construction product packaging; downloadable electronic publications; downloadable computer software applications.

17 – Packing, stopping and insulating materials; materials for heat insulation, particularly reinforcing fabrics; materials for sound insulation; materials, plates, panels, strips and material for insulation; sealant compounds for joints; grouting coatings; sealing membranes and strips; adhesive bands not for medical, stationery or household use; insulating paints; polyurethane foam; insulating foam for building and construction; sealing compounds; caulking sealants; adhesive jointing sealants; fiberglass fabrics for insulation.

19 – Non-metallic construction materials; mortars for construction; concrete; cement; lime; plaster; gypsum (building material); coatings (building materials); aggregates; asphalt; bitumen; bituminous preparations for building; panels, not of metal, for building; fiberglass fabrics for construction; linings not of metal [building]; artificial stones and bricks.

35 – Commercial intermediary services in the field of construction, namely intermediation with building and construction professionals; demonstration of goods and presentation of goods on all communication media for sale thereof; dissemination of advertising material (leaflets, prospectuses, printed matter, samples); advertising in the field of construction; commercial information and inquiries relating to building materials and their implementation; organization of exhibitions for commercial or advertising purposes; website traffic optimization; referencing of web sites for commercial or advertising purposes; services for organizing and managing consumer loyalty programs.

37 – Information with respect to construction and to construction and insulating materials; rental of construction and construction-site tools, equipment and machines; construction; mixing, pumping and pouring of fluid floor mortars (construction work); renovation and maintenance of buildings; building insulation; cleaning of buildings [interior]; demolition of buildings; removal of debris from buildings and constructions.

39 – Transport and storage of waste; collection and pick-up of industrial waste; supply, transportation, delivery of construction and insulation materials.

40 – Waste treatment (transformation); recycling of waste; upcycling (waste recycling); information and consultancy with respect to waste treatment and upcycling; recycling of debris from buildings and constructions; treatment of construction materials and insulation; custom assembly of materials for third parties.

41 – Provision of non-downloadable online electronic publications; training services; organization of competitions (education or entertainment) and lotteries; organization and conducting of colloquiums, conferences, seminars or congresses.

---

(260) AM 2023 121038 A

(800) 1696158

(151) 2022 08 22

(891) 2022 11 18

(731) Aimbridge Parent, Inc.

5301 Headquarters Drive, Plano TX 75024,  
USA

(540)

## AIMBRIDGE

(591) Black, white

(511)

35 – Hotel management for others; business management of hotels; managing and operating hotels and resorts for others; employment staffing consultation services; franchise services, namely, offering business management assistance in the establishment and operation of hotels and resorts; business management advisory services relating to franchising; business management consulting, strategic business planning, and business management advisory services; market analysis; concept and brand development consulting for corporate and individual clients.

36 – Capital management services, namely, project budget oversight in the field of property renovation; franchising services, namely, providing financial information and advice regarding the establishment and/or operation of hotels and resorts; receivership of non-performing hotels and resorts; receivership services for non-performing hotels and resorts; preparation of financial reports for others for business or commercial purposes; preparing financial reports for others.

37 – Construction, maintenance, and renovation of property; renovation of hotel and resort properties; advisory and consulting services in the field of renovation and property repositioning.

---

(260) AM 2023 121039 A

(800) 1698364

(151) 2022 10 17

(891) 2022 12 12

(731) Orveon Global Ltd.

The Adelphi, 1-11 John Adam St., Floor 10,  
London WC2N 6HT, United Kingdom

(540)

## ORVEON

(591) Black, white

(511)

3 – Cosmetics; non-medicated skin care preparations, namely, creams, lotions, gels, toners, cleaners and peels; skin lotions.

35 – Provision of an online marketplace for buyers and sellers of goods and services; presentation of goods on communication media, for retail purposes; research on the market of cosmetics, perfumes and beauty products.

---

(260) AM 2023 121055 A

(800) 1705393

(151) 2022 09 15

(891) 2022 09 15

(731) Clinical Services Corporate Operations, Inc.  
271 Waverly Oaks Rd. Suite 208, Waltham  
MA 02452, USA

(540)

## ALLUCENT

(591) Black, white

(511)

9 – Downloadable computer application software for use in connection with the collection, tracking, retrieval, validation, summarization, statistical analysis and presentation of data used in the areas of medical research and product regulatory approval, environmental health, health care, and in relation to the design, research, development, and testing of new medical products and devices; downloadable computer application software for providing telehealth, telemedicine, remote care and virtual health care services to patients; downloadable computer application software for use in connection with collection, tracking, retrieval, validation, summarization, statistical analysis and presentation of remotely gathered patient-generated health data for use in clinical studies.

35 – Providing statistical information and analysis resulting from clinical trials in the fields of pharmaceuticals, biotechnology, medical devices and diagnostics; providing data processing, project management and cost management services for preclinical and clinical trials in the fields of pharmaceuticals, biotechnology, medical devices and diagnostics; designing laboratory research, namely, managing and monitoring preclinical and clinical trials; data management, namely, abstraction and collection of medical data from clinical tests for business purposes; market research and business marketing consulting services in the pharmaceutical, biotechnology, medical device, and diagnostics industries.

38 – Providing access to online database for controlling and managing electronic health records and patient health and medical information, for communications between patients and their health care providers, and for medical practice management.

41 – Training and development in the field of conducting clinical trials, namely, conducting tutorials, seminars and workshops in the field of clinical trials; training in the field of computer software support, namely, conducting tutorials, seminars and workshops in the field of software support.

42 – Scientific research for others conducted using databases for collection of patient-generated health data; cloud computing featuring software that allows users to collect, review, analyze and report on clinical research; technical support services, namely, installation and remote administration of software, and troubleshooting of software problems and hosted software applications, all for use in connection with medical research and product regulatory approval, environmental health, health care, and in relation to the design, research, development, and testing of new medical products and devices; cloud computing featuring software for providing telehealth, telemedicine, remote care and virtual health care services to patients; cloud computing featuring software that allows users to collect, track, retrieve, validate, summarize, statistically analyze and present data used in the areas of medical research and product regulatory approval, environmental health, health care, and in relation to the design, research, development, and testing of new medical products and devices; cloud computing featuring software to aggregate, integrate, transfer and manage data generated from home health and remote monitoring devices and applications and health-related smart-phone applications; cloud computing featuring software that provides integrated workflows, analytics, visualizations, and reporting features to deliver, process, analyze, elevate, and display patient-generated health data; cloud computing featuring software that integrates remotely collected health data into databases, systems, platforms, applications, and software that inform clinical research, remote monitoring, and care management; providing a web-based portal for study sponsors and contract research organizations (CROs) to build programs, enroll members, automate actions, and visualize/analyze data in connection with clinical studies; technical consulting services, namely, evaluating the safety of pharmaceutical, medical, cosmetic and consumer devices and products in clinical development or in commercial production.

45 – Development of regulatory compliance strategies in the field of medical research, namely, regulatory compliance in drug, biologic, cosmetic and medical device development.

---

(260) AM 2023 121056 A

(800) 1705430

(151) 2022 02 17

(891) 2022 02 17

(731) Limited liability company "TIMOSHA"

Energetikov str., 42, lit. 1-1B, floor/room 3/8,

---

Dzerzhinskiy city, RU-140091 Moscow  
region, Russian Federation

(540)

**АЗОВЧАНКА**

(591) Black, white

(531) 28.05

(511)

16 – Drawing pads; calendars; forms, printed; waxed paper; announcement cards [stationery]; seals [stamps]; cards; manuals [handbooks]; booklets; spiral notebooks; gummed tape [stationery]; newspapers; bags for microwave cooking; sheets of reclaimed cellulose for wrapping; newsletters; pamphlets; magazines [periodicals]; tablemats of paper; humidity control sheets of paper or plastic for foodstuff packaging; graphic representations; catalogues; printing sets, portable [office requisites]; books; wrapping paper; absorbent sheets of paper or plastic for foodstuff packaging; bottle envelopes of paper or cardboard; bags [envelopes, pouches] of paper or plastics, for packaging; conical paper bags; place mats of paper; bottle wrappers of paper or cardboard; table napkins of paper; filter paper; plastic film for wrapping; envelopes [stationery]; cardboard; printed publications; paper sheets [stationery]; printed matter; photographs [printed]; cardboard or paper boxes; folders for papers; labels of paper or cardboard.

29 – Buttercream; almonds, ground; truffles, preserved; curd; sunflower seeds, prepared; salted fish; fish fillet; sauerkraut; fish roe, processed; pollen prepared as foodstuff; yolk of eggs; rice milk [milk substitute]; condensed milk; vegetable juices for cooking; soya beans, preserved, for food; aloe vera prepared for human consumption; tripe; preparations for making bouillon; toasted laver; kephir; sausages; spiny lobsters, not live; fish, tinned; edible birds' nests; coconut butter; albumin milk; isinglass for food; tahini [sesame seed paste]; pork; onions, preserved; fish, not live; ajvar being preserved peppers; fruit peel; cottonseed oils for culinary purposes; black pudding; fish meal for human consumption; milk shakes; vegetable salads; tomato juice for cooking; suet for food; soya milk being milk substitute; milk beverages, milk predominating; oysters, not live; animal marrow for food; crystallized fruits; jellies for food; peanuts, prepared; vegetables, preserved; anchovy, not live; broth; fruit jellies; poultry, not live; cream [dairy products]; rennet; soups; jams; alginates for culinary purposes; vegetables, tinned; coconut fat; vegetable soup preparations; frozen fruits; koumiss; albumen for culinary purposes; apple purée; compotes; seeds, prepared; nuts, prepared; crustaceans, not live; preserved garlic; charcuterie; artichokes, preserved; raisins; clams, not live; cranberry compote; meat jellies; meat, preserved; cocoa butter; sausages in batter; oils for food; prawns, not live; powdered eggs; shellfish, not live; salmon, not live; milk products; milk; fruit-based snack food; coconut, desiccated; fruit salads; marmalade; rape oil

for food; cheese; fruit pulp; sea-cucumbers, not live; tofu; milk ferments for culinary purposes; fruit, stewed; mushrooms, preserved; non-alcoholic eggnog; palm oil for food; shrimps, not live; sunflower oil for food; salted meats; fruit preserved in alcohol; vegetables, dried; fish mousses; beans, preserved; broth concentrates; coconut oil for food; low-fat potato crisps; lard; gherkins; meat; food products made from fish; ham; ginger jam; eggs; fat-containing mixtures for bread slices; game, not live; mussels, not live; tomato purée; bone oil for food; vegetable mousses; white of eggs; liver pâté; seaweed extracts for food; sesame oil for food; pickles; preparations for making soup; hummus [chickpea paste]; lobsters, not live; whipped cream; fish, preserved; dates; fruit, preserved; gelatin; snail eggs for consumption; olive oil for food; vegetable marrow paste; fatty substances for the manufacture of edible fats; pectin for culinary purposes; lecithin for culinary purposes; ryazhenka being fermented baked milk; caviar; fruits, tinned; sardines, not live; palm kernel oil for food; silkworm chrysalis for human consumption; maize oil for food; almond milk for culinary purposes; edible fats; liver; herrings, not live; margarine; lentils, preserved; butter; kimchi; peanut milk for culinary purposes; croquettes; vegetables, cooked; meat extracts; whey; potato flakes; smetana; crayfish, not live; peas, preserved; potato fritters; potato crisps; yogurt; aubergine paste; meat, tinned; bacon; tuna, not live; tomato puree; peanut butter; olives, preserved; vegetable oils; potato chips; fruit chips.

30 – Biscuits; waffles; cakes; peanut confectionery; almond confectionery; caramels; sweets; crackers; fruit jellies [confectionery]; flour; pastilles [confectionery]; cookies; pies; fondants [confectionery]; cereal preparations; pastries; food products containing starch (terms too vague in the opinion of the International Bureau – Rule 13 (2) (b) of the Regulations); gingerbread; tarts; halva; marinades; liquorice [confectionery]; mint for confectionery; lozenges [confectionery]; bean meal; allspice; natural sweeteners; oat flakes; corn, milled; corn flakes; edible ices; pizzas; pastry dough; frozen yogurt [confectionery ices]; mayonnaise; bread rolls; potato flour; peppermint sweets; custard; seawater for cooking; soya bean paste [seasoning]; meat pies; popcorn; capers; rice pudding; oatmeal; tabbouleh; sugar; bread; garden herbs, preserved [seasonings]; starch for food; iced tea; pesto [sauce]; pasta; breadcrumbs; pasta sauce; salt for preserving foodstuffs; husked barley; vermicelli; cake batter; corn, roasted; leaven; dessert mousses [confectionery]; cake powder; pepper; soya flour; cake frosting [icing]; hominy; baking soda [bicarbonate of soda for cooking purposes]; hominy grits; unleavened bread; chocolate-based beverages; maltose; spaghetti; pancakes; petits fours; meat gravies; spices; chocolate beverages with milk; dough; crushed oats; chips [cereal products]; cereal bars; rice cakes; royal jelly; cooking salt; thickening agents for cooking foodstuffs; wheat

flour; aromatic preparations for food; malt extract for food; pâtés en croûte; beer vinegar; fruit coulis [sauces]; confectionery for decorating Christmas trees; mustard meal; ham glaze; golden syrup; essences for foodstuffs, except etheric essences and essential oils; minced garlic [condiment]; coffee-based beverages; food flavourings, other than essential oils; chocolate decorations for cakes; cinnamon [spice]; molasses for food; linseed for culinary purposes [seasoning]; vanilla [flavoring]; ice cream; baking powder; cereal-based snack food; saffron [seasoning]; sausage binding materials; puddings; coffee substitutes; dressings for salad; condiments; tapioca; flavourings, other than essential oils, for beverages; chow-chow [condiment]; stick liquorice [confectionery]; nut flours; seaweed [condiment]; noodles; ice, natural or artificial; celery salt; propolis; curry [spice]; cloves [spice]; chocolate-coated nuts; chocolate mousses; powders for making ice cream; vegetal preparations for use as coffee substitutes; candy decorations for cakes; sorbets [ices]; coffee flavourings; binding agents for ice cream; spring rolls; tacos; malt biscuits; infusions, not medicinal; chewing gum; lollipops [confectionery]; aniseed; buns; noodle-based prepared meals; meat tenderizers for household purposes; gluten additives for culinary purposes; macarons [pastries]; cocoa-based beverages; tea; semolina; seasonings; groats for human food; tortillas; ketchup [sauce]; flowers or leaves for use as tea substitutes; gluten prepared as foodstuff; ice for refreshment; corn flour; sauces [condiments]; preparations for stiffening whipped cream; sandwiches; tea-based beverages; yeast; husked oats; wheat germ for human consumption; cheeseburgers [sandwiches]; honey; cocoa beverages with milk; tapioca flour; ravioli; marzipan; nutmegs; vareniki [stuffed dumplings]; macaroni; glucose for culinary purposes; coffee beverages with milk; tomato sauce; turmeric; cream of tartar for culinary purposes; barley meal; ginger [spice]; rice; crushed barley; high-protein cereal bars; vinegar; peppers [seasonings]; oat-based food; unroasted coffee; flavourings, other than essential oils, for cakes; sago; palm sugar; mustard; malt for human consumption; sushi; chutneys [condiments]; coffee; pralines; cocoa; almond paste; rice-based snack food; petit-beurre biscuits; chocolate; caramels [candy]; relish [condiment]; couscous; quiches; ferments for pastes; muesli; star aniseed; pelmeni; vanillin [vanilla substitute]; soya sauce; chicory [coffee substitute]; piccalilli.

(260) AM 2023 121057 A  
(800) 1705488  
(151) 2022 11 04  
(891) 2022 11 04  
(731) Richter Gedeon Nyrt.  
Gyömrői út 19-21, H-1103 Budapest, Hungary  
(540)

## TANDARUM

(591) Black, white  
(511)  
5 – Pharmaceutical preparations.

(260) AM 2023 121058 A  
(800) 1705489  
(151) 2022 11 04  
(891) 2022 11 04  
(731) Richter Gedeon Nyrt.  
Gyömrői út 19-21, H-1103 Budapest, Hungary  
(540)

## STERVALT

(591) Black, white  
(511)  
5 – Pharmaceutical preparations.

(260) AM 2023 121059 A  
(800) 1705490  
(151) 2022 11 04  
(891) 2022 11 04  
(731) Richter Gedeon Nyrt.  
Gyömrői út 19-21, H-1103 Budapest, Hungary  
(540)

## SYRUVIN

(591) Black, white  
(511)  
5 – Pharmaceutical preparations.

(260) AM 2023 121060 A  
(800) 1705491  
(151) 2022 11 04  
(891) 2022 11 04  
(731) Richter Gedeon Nyrt.  
Gyömrői út 19-21, H-1103 Budapest, Hungary  
(540)

## URADOMIN

(591) Black, white  
(511)  
5 – Pharmaceutical preparations.

(260) AM 2023 121061 A  
(800) 1705492  
(151) 2022 11 04  
(891) 2022 11 04  
(731) Richter Gedeon Nyrt.  
Gyömrői út 19-21, H-1103 Budapest, Hungary  
(540)

## VODARELON

(591) Black, white  
(511)  
5 – Pharmaceutical preparations.

(260) AM 2023 121068 A  
 (800) 1705593  
 (151) 2022 10 28  
 (891) 2022 10 28  
 (731) Alpen Pharma AG  
 Finkenhübelweg 16, CH-3012 Bern,  
 Switzerland  
 (540)

## AP878

(591) Black, white  
 (511)  
 5 – Pharmaceutical products, medicines for human medicine; oils for medical and pharmaceutical use.

(260) AM 2023 121069 A  
 (800) 1705716  
 (151) 2022 11 02  
 (891) 2022 11 02  
 (731) Montres Tudor SA  
 Rue François-Dussaud 3, CH-1211 Genève 26,  
 Switzerland  
 (540)

## BLACK BAY 58

(591) Black, white  
 (511)  
 14 – Timepieces, namely, watches, wrist-watches, component parts for timepieces and accessories for timepieces not included in other classes, clocks and other chronometric instruments, chronometers, chronographs (timepieces), watch bands, dials (timepieces), boxes and cases for timepieces and jewelry, watch movements and their parts; jewelry; precious stones and semi-precious stones; precious metals and alloys thereof; pins (jewelry).

(260) AM 2023 121070 A  
 (800) 1705722  
 (151) 2022 07 25  
 (891) 2022 07 25  
 (731) Euro Games Technology Ltd.  
 4, "Maritsa" Str., "Vranya-Lozen-Triugulnika",  
 BG-1151 Sofia, Bulgaria  
 (540)



(591) Yellow, orange, red, pink, purple, blue and light blue  
 (531) 05.05.20; 17.02.02; 27.05.01; 27.05.03;  
 27.05.07; 27.07.03; 29.01.15

(511)  
 9 – Software; computer gaming software; computer software packages; computer operating system software; computer software, recorded; software drivers; virtual reality software; games software; entertainment software for computer games; computer programs for network management; operating computer software for main frame computers; monitors (computer hardware); computer hardware; apparatus for recording images; monitors (computer programs); computer game programs; computer programs for recorded games; apparatus for recording, transmission or reproduction of sound or images; communications servers [computer hardware]; electronic components for gambling machines; computer application software featuring games and gaming; computer software for the administration of on-line games and gaming; computer hardware for games and gaming; hardware and software for gambling, gambling machines, gambling games on the Internet and via telecommunication network.

28 – Gaming machines for gambling; chips for gambling; mah-jong; arcade games; gambling machines operating with coins, notes and cards; games; electronic games; parlor games; gaming chips; gaming tables; slot machines [gaming machines]; LCD game machines; slot machines and gaming devices; coin-operated amusement machines; roulette chips; poker chips; chips and dice [gaming equipment]; gaming equipment for casinos; roulette tables; gaming roulette wheels; casino games; gambling machines and amusement machines, automatic and coin-operated; coin-operated amusement machines and/or electronic coin-operated amusement machines with or without the possibility of gain; boxes for coin-operated machines, slot machines and gaming machines; electronic or electrotechnical amusement machines and apparatus, gaming machines, coin-operated entertainment machines; housings for coin-operated machines, gaming equipment, gaming machines, machines for gambling; electropneumatic and electrical gambling machines (slot machines).

41 – Gambling; entertainment services related to gambling; gaming services for entertainment purposes; casino, gaming and gambling services; training in the development of software systems; provision of gaming equipment for gambling halls; providing casino equipment [gambling]; gaming machine entertainment services; providing casino facilities [gambling]; gaming hall services; amusement arcade services; games equipment rental; rental of gaming machines; providing amusement arcade services; rental of gaming machines with images of fruits; editing or recording of sounds and images; sound recording and video entertainment services; hire of sound reproducing apparatus; provision of gaming equipment for casinos; providing of casino facilities; online gambling services; casino, gaming and gambling services; provision

of gaming facilities, gaming hall facilities, Internet casinos and online gambling services; providing on-line games and games of chance.

(260) AM 2023 121072 A

(800) 1705859

(151) 2022 06 28

(891) 2022 06 28

(731) WORLD MEDICINE İLAÇ SAN. VE TİC. A.Ş.

15 TEMMUZ MAH. CAMİ YOLU CAD.,

NO:50 Bağcılar, İstanbul, Türkiye

(540)



(591) Navy blue and white

(531) 26.01.18; 26.07.04; 27.05.24; 29.01.12

(526) MEDICINE Pharmaceutical Company

(511)

5 – Pharmaceutical and veterinary preparations for medical purposes; chemical preparations for medical and veterinary purposes, chemical reagents for pharmaceutical and veterinary purposes; medicated cosmetics, dietary supplements for pharmaceutical and veterinary purposes; dietary supplements; nutritional supplements; medical preparations for slimming purposes; food for babies; herbs and herbal beverages adapted for medicinal purposes, dental preparations and articles: teeth filling material, dental impression material, dental adhesives and material for repairing teeth, sanitary preparations for medical use; hygienic pads; hygienic tampons; plasters; materials for dressings; diapers made of paper and textiles for babies, adults and pets, preparations for destroying vermin; herbicides, fungicides, preparations for destroying rodents, deodorants, other than for human beings or for animals; air purifying preparations; air deodorising preparations, disinfectants; antiseptics; detergents for medical purposes; medicated soaps; disinfectant soaps; antibacterial hand lotions.

10 – Surgical, medical, dental and veterinary apparatus and instruments; furniture especially made for medical purposes, artificial limbs and prostheses, medical orthopaedic articles: corsets for medical purposes, orthopaedic shoes, elastic bandages and supportive bandages, surgical gowns and surgical sterile sheets, adult sexual aids, condoms, babies' bottles, babies' pacifiers, teats, teethers for babies, bracelets and rings for medical purposes, anti-rheumatism bracelets, anti-rheumatism rings.

35 – Advertising, marketing and public relations, organization of exhibitions and trade fairs for commercial or advertising purposes, development of internet advertising concepts, provision of an online market-

place for buyers and sellers of goods and services, office functions, secretarial services, arranging newspaper subscriptions for others, compilation of statistics, rental of office machines, systemization of information into computer databases, telephone answering for unavailable subscribers, business management, business administration and business consultancy, accounting, commercial consultancy services, personnel recruitment, personnel placement, employment agencies, import-export agencies, temporary personnel placement services, auctioneering, the bringing together, for the benefit of others, of a variety of goods, namely, pharmaceutical and veterinary preparations for medical purposes, chemical preparations for medical and veterinary purposes, chemical reagents for pharmaceutical and veterinary purposes, medicated cosmetics, dietary supplements for pharmaceutical and veterinary purposes, dietary supplements, nutritional supplements, medical preparations for slimming purposes, food for babies, herbs and herbal beverages adapted for medicinal purposes, dental preparations and articles: teeth filling material, dental impression material, dental adhesives and material for repairing teeth, sanitary preparations for medical use, hygienic pads, hygienic tampons, plasters, materials for dressings, diapers made of paper and textiles for babies, adults and pets, preparations for destroying vermin, herbicides, fungicides, preparations for destroying rodents, deodorants, other than for human beings or for animals, air purifying preparations, air deodorising preparations, disinfectants, antiseptics, detergents for medical purposes, medicated soaps, disinfectant soaps, antibacterial hand lotions, surgical, medical, dental and veterinary apparatus and instruments, furniture especially made for medical purposes, artificial limbs and prostheses, medical orthopaedic articles: corsets for medical purposes, orthopaedic shoes, elastic bandages and supportive bandages, surgical gowns and surgical sterile sheets, adult sexual aids, condoms, babies' bottles, babies' pacifiers, teats, teethers for babies, bracelets and rings for medical purposes, anti-rheumatism bracelets, anti-rheumatism rings, paper and cardboard, paper and cardboard for packaging and wrapping purposes, cardboard boxes, paper towels, toilet paper, paper napkins, plastic materials for packaging and wrapping purposes, printing blocks and types, bookbinding material, printed publications, printed matter, books, magazines, newspapers, bill books, printed dispatch notes, printed vouchers, calendars, posters, photographs [printed], paintings, stickers [stationery], postage stamps, stationery, office stationery, instructional and teaching material [except furniture and apparatus], writing and drawing implements, artists' materials, paper products for stationery purposes, adhesives for stationery purposes, pens, pencils, erasers, adhesive tapes for stationery purposes, cardboard cartons [artists' materials], writing paper, copying paper, paper rolls for cash registers, drawing materials, chalkboards, painting pencils, water-



colors [paintings], office requisites, paint rollers and paintbrushes for painting, clothing, including underwear and outer clothing, other than special purpose protective clothing, socks, mufflers [clothing], shawls, bandanas, scarves, belts [clothing], footwear, shoes, slippers, sandals, headgear, hats, caps with visors, berets, caps [headwear], skull caps, meat, fish, poultry and game, processed meat products, dried pulses, soups, bouillon, processed olives, olive paste, milks of animal origin, milks of herbal origin, milk products, butter, edible oils, dried, preserved, frozen, cooked, smoked or salted fruits and vegetables, tomato paste, prepared nuts and dried fruits as snacks, hazelnut spreads and peanut butter, tahini (sesame seed paste), eggs and powdered eggs, potato chips, coffee, cocoa, coffee or cocoa based beverages, chocolate based beverages, pasta, stuffed dumplings, noodles, pastries and bakery products based on flour, desserts based on flour and chocolate, bread, simit [turkish ring-shaped bagel covered with sesame seeds], poğaç [turkish bagel], pita, sandwiches, katmer [turkish pastry], pies, cakes, baklava [turkish dessert based on dough coated with syrup], kadayıf [turkish dessert based on dough], desserts based on dough coated with syrup, puddings, custard, kazandibi [turkish pudding], rice pudding, keşkül [turkish pudding], honey, bee glue for human consumption, propolis for food purposes, condiments for foodstuff, vanilla (flavoring), spices, sauces (condiments), tomato sauce, yeast, baking powder, flour, semolina, starch for food, sugar, cube sugar, powdered sugar, tea, ice tea, confectionery, chocolate, biscuits, crackers, wafers, chewing gums, ice-cream, edible ices, salt, cereal-based snack food, popcorn, crushed oats, corn chips, breakfast cereals, processed wheat for human consumption, crushed barley for human consumption, processed oats for human consumption, processed rye for human consumption, rice, molasses for food, agricultural and horticultural products not included in other classes, seeds, forestry products not included in other classes, live animals, fertilized eggs for hatching, plants, dried plants for decoration, fresh garden herbs, dried garden herbs for decoration, animal foodstuffs, malt not for human consumption, sanded paper [litter] for pets, cat litters, enabling customers to conveniently view and purchase those goods, such services may be provided by retail stores, wholesale outlets, by means of electronic media or through mail order catalogues.

36 – Insurance services, financial and monetary affairs, real estate brokers, real estate agencies and real estate management, customs brokerage services.

39 – Land, water and air transport services, rental of land, water or air vehicles, arranging of tours, travel reservation, issuing of tickets for travel, courier services (messages or merchandise), car parking, garage rental, boat storage, transport by pipeline, electricity distribution, water supplying, rescue operations for vehicles and goods, storage, wrapping and packaging

of goods, transport and storage of trash, transport and storage of waste.

44 – Medical services, beauty care services, veterinary services, animal husbandry, animal breeding, shoeing horses [farrier services], agriculture, horticulture and forestry services, landscape design services, medical advisory services in the field of personnel health.

---

(260) AM 2023 121110 A  
 (800) 1019862  
 (151) 2009 10 30  
 (891) 2022 12 17  
 (731) Audio Design Lautsprecher Vertriebs GmbH  
 Am Breilingsweg 3, 76709 Kronau, Germany  
 (540)



(591) Black, white  
 (531) 27.03.01; 27.05.22  
 (511)  
 9 – Electric measuring, signalling and checking (supervision) apparatus and instruments, electronic apparatus for entertainment, in particular apparatus for receiving, recording, transmission and reproduction of sound and images, including amplifiers adapted and designed for motor vehicles, headphones, loudspeakers; loudspeaker cabinets and hi-fi systems, including public address systems for discotheques, shopping centres, shopping malls and communal buildings or building sites.

---

(260) AM 2023 121249 A  
 (800) 1707843  
 (151) 2022 11 15  
 (891) 2022 11 15  
 (731) Richter Gedeon Nyrt.  
 Gyömrői út 19-21., H-1103 Budapest, Hungary  
 (540)

УРАДОМИН

(591) Black, white  
 (531) 28.05  
 (511)  
 5 – Pharmaceutical preparations.

---

**INTERNATIONAL TRADEMARKS PROTECTED IN GEORGIA**

(260) AM 2023 115552 A  
(800) 1627971  
(151) 2021 09 10  
(181) 2031 09 10  
(891) 2021 09 10  
(511) 03, 03, 05, 10

---

(260) AM 2023 118955 A  
(800) 1676868  
(151) 2022 05 17  
(181) 2032 05 17  
(891) 2022 05 17  
(511) 05

---

(260) AM 2023 116022 A  
(800) 1635881  
(151) 2021 09 16  
(181) 2031 09 16  
(891) 2021 09 16  
(511) 05

---

(260) AM 2023 118956 A  
(800) 1676879  
(151) 2022 06 15  
(181) 2032 06 15  
(891) 2022 06 15  
(511) 29, 30, 32

---

(260) AM 2023 116474 A  
(800) 1641904  
(151) 2021 10 15  
(181) 2031 10 15  
(891) 2021 10 15  
(511) 25

---

(260) AM 2023 118957 A  
(800) 1676898  
(151) 2022 06 29  
(181) 2032 06 29  
(891) 2022 06 29  
(511) 09, 35

---

(260) AM 2023 116877 A  
(800) 1647473  
(151) 2021 09 14  
(181) 2031 09 14  
(891) 2021 09 14  
(511) 39

---

(260) AM 2023 118973 A  
(800) 1677537  
(151) 2022 04 05  
(181) 2032 04 05  
(891) 2022 04 05  
(511) 28

---

(260) AM 2023 118702 A  
(800) 1673766  
(151) 2022 02 28  
(181) 2032 02 28  
(891) 2022 02 28  
(511) 20

---

(260) AM 2023 118974 A  
(800) 1677599  
(151) 2022 02 24  
(181) 2032 02 24  
(891) 2022 02 24  
(511) 03

---

(260) AM 2023 118891 A  
(800) 1676193  
(151) 2022 04 28  
(181) 2032 04 28  
(891) 2022 04 28  
(511) 09

---

(260) AM 2023 118985 A  
(800) 1677792  
(151) 2022 07 14  
(181) 2032 07 14  
(891) 2022 07 14  
(511) 01, 31

---

(260) AM 2023 118892 A  
(800) 1676239  
(151) 2022 07 06  
(181) 2032 07 06  
(891) 2022 07 06  
(511) 03

---

(260) AM 2023 118987 A  
(800) 1374322  
(151) 2017 05 26  
(181) 2027 05 26  
(891) 2022 07 21  
(511) 05, 30

---

---

(260) AM 2023 118988 A  
(800) 1496809  
(151) 2019 09 03  
(181) 2029 09 03  
(891) 2022 07 18  
(511) 05, 35, 36

---

---

(260) AM 2023 119034 A  
(800) 1678057  
(151) 2022 05 24  
(181) 2032 05 24  
(891) 2022 05 24  
(511) 05

---

---

(260) AM 2023 118989 A  
(800) 1617337  
(151) 2021 09 13  
(181) 2031 09 13  
(891) 2022 07 26  
(511) 30

---

---

(260) AM 2023 119135 A  
(800) 1679051  
(151) 2022 06 30  
(181) 2032 06 30  
(891) 2022 06 30  
(511) 01, 05

---

---

(260) AM 2023 118990 A  
(800) 1617339  
(151) 2021 09 13  
(181) 2031 09 13  
(891) 2022 07 26  
(511) 30

---

---

(260) AM 2023 119136 A  
(800) 1679061  
(151) 2022 06 10  
(181) 2032 06 10  
(891) 2022 06 10  
(511) 11, 30, 35, 43

---

---

(260) AM 2023 119030 A  
(800) 1677966  
(151) 2022 06 15  
(181) 2032 06 15  
(891) 2022 06 15  
(511) 03

---

---

(260) AM 2023 119137 A  
(800) 1679075  
(151) 2022 06 07  
(181) 2032 06 07  
(891) 2022 06 07  
(511) 34

---

---

(260) AM 2023 119031 A  
(800) 1678012  
(151) 2022 06 30  
(181) 2032 06 30  
(891) 2022 06 30  
(511) 41

---

---

(260) AM 2023 119138 A  
(800) 1679084  
(151) 2022 05 04  
(181) 2032 05 04  
(891) 2022 05 04  
(511) 05

---

---

(260) AM 2023 119032 A  
(800) 1678029  
(151) 2022 02 17  
(181) 2032 02 17  
(891) 2022 02 17  
(511) 29, 30, 32

---

---

(260) AM 2023 119139 A  
(800) 1679131  
(151) 2022 04 20  
(181) 2032 04 20  
(891) 2022 04 20  
(511) 09

---

---

(260) AM 2023 119033 A  
(800) 1678033  
(151) 2022 07 04  
(181) 2032 07 04  
(891) 2022 07 04  
(511) 35, 36, 37, 39, 40, 41, 42

---

---

(260) AM 2023 119140 A  
(800) 1679134  
(151) 2022 06 07  
(181) 2032 06 07  
(891) 2022 06 07  
(511) 09, 14

---

(260) AM 2023 119141 A  
(800) 1679153  
(151) 2022 04 28  
(181) 2032 04 28  
(891) 2022 04 28  
(511) 09, 28, 41

---

(260) AM 2023 119417 A  
(800) 1683381  
(151) 2021 11 15  
(181) 2031 11 15  
(891) 2021 11 15  
(511) 38, 41

---

(260) AM 2023 119142 A  
(800) 1679165  
(151) 2022 06 16  
(181) 2032 06 16  
(891) 2022 06 16  
(511) 12

---

(260) AM 2023 119418 A  
(800) 1683396  
(151) 2022 05 29  
(181) 2032 05 29  
(891) 2022 05 29  
(511) 10

---

(260) AM 2023 119265 A  
(800) 1673609  
(151) 2022 02 23  
(181) 2032 02 23  
(891) 2022 07 11  
(511) 03, 05, 10, 35, 41

---

(260) AM 2023 119419 A  
(800) 1683414  
(151) 2022 07 22  
(181) 2032 07 22  
(891) 2022 07 22  
(511) 25, 35

---

(260) AM 2023 119410 A  
(800) 1683022  
(151) 2022 08 12  
(181) 2032 08 12  
(891) 2022 08 12  
(511) 05

---

(260) AM 2023 119411 A  
(800) 1683114  
(151) 2021 10 11  
(181) 2031 10 11  
(891) 2021 10 11  
(511) 04, 07, 09, 12, 14, 16, 18, 25, 26, 28, 35,  
37, 39, 41

---

(260) AM 2023 119412 A  
(800) 1683150  
(151) 2022 07 30  
(181) 2032 07 30  
(891) 2022 07 30  
(511) 32, 33

---

(260) AM 2023 119413 A  
(800) 1683165  
(151) 2022 08 11  
(181) 2032 08 11  
(891) 2022 08 11  
(511) 34

---

---

## APPELLATIONS OF ORIGIN OF GOODS

### APPELLATIONS OF ORIGIN OF GOODS FILED IN GEORGIA FOR EXAMINATION UNDER LISBON AGREEMENT, ON THE BASIS OF THE INTERNATIONAL REGISTRATION

The decision can be appealed at the Chamber of Appeal of Sakpatenti within 3 months from the publication or at the Mtskheta District Court Administrative Cases Board (Address: №17, Samkhedro St., Mtskheta), within 1 month following the publication.

(210) 3523  
(800) 1273  
(151) 2022 03 07  
(731) Garlic And Summer Agricultural Cooperative Company of Hamedan City  
Hamedan Province, Iran  
(540) IRAN'S HAMEDAN GARLIC  
(511)  
31 – Garlic.

ناری ا ن ادمه ریس

---

(210) 3524  
(800) 1274  
(151) 2023 03 15  
(731) Handicrafts Union of Isfahan City Isfahan City, Iran  
(540) KALAMKARI OF ISFAHAN  
(511)  
24 – Kalamkari

ناهفصا یراکم لق

---

(210) 3525  
(800) 1279  
(151) 2021 12 08  
(731) Iran Carpet Company  
Josheghan County, Kashan City, Isfahan Province, Iran;  
Kashan Handmade Carpet Sellers Union  
Josheghan County, Kashan City, Isfahan Province, Iran;  
Kashan Handmade Carpet Weavers Union  
Josheghan County, Kashan City, Isfahan Province, Iran;  
Kashan Rural Handmade Carpet Manufacturers Cooperative  
Josheghan County, Kashan City, Isfahan Province, Iran  
(540) JOSHEGHAN HANDMADE CARPET

ناقش و ج ت ف ا ب ت س د ش ر ف

(511)  
27 – Handmade carpet.

---

---

**OFFICIAL NOTIFICATIONS  
INVENTIONS  
RESTORATION OF PATENTS**

(21) AP 2014 14061  
(11) P 2017 6763 B  
(73) Ditesan LTD.  
(54) GENETICALLY STABLE ONCOLYTIC RNA VIRUS, METHOD OF MANUFACTURING AND USE THEREOF  
DATE OF PATENT LAPSE: 2023 07 16  
DATE OF PATENT RESTORATION: 2023 08 25

---

(21) AP 2017 14472  
(11) P 2019 6967 B  
(73) Tatiana Gegechkori;  
Grigor Mamniashvili;  
Sarkis Markaryan;  
Tsisana Gavasheli  
(54) SYNERGETIC DEVICE AND METHOD FOR WATER PURIFICATION  
DATE OF PATENT LAPSE: 2023 04 11  
DATE OF PATENT RESTORATION: 2023 08 25

---

**LAPSE OF PATENTS WITH THE RIGHT TO RESTORE**

(21) AP 2009 11397  
(11) P 2011 5308 B  
(73) LTD "Pharma Start"  
(54) MEDICINAL MEANS TRIMETAZIDINE DIHYDROCHLORIDE IN THE FORM OF MATRIX TABLETS WITH THE PROLONGED ACTION (VARIANTS) AND METHODS FOR ITS RECEPTION (VARIANTS)  
DATE OF PATENT LAPSE: 2023 07 31  
PATENT RESTORATION TERM: 2024 07 31

---

(21) AP 2008 11722  
(11) P 2012 5539 B  
(73) Ipsen Consumer Healthcare  
(54) FLAVOURED CLAY-BASED THERAPEUTIC COMPOSITION  
DATE OF PATENT LAPSE: 2023 08 12  
PATENT RESTORATION TERM: 2024 08 12

---

(21) AP 2010 12705  
(11) P 2014 6192 B  
(73) Cent & Cent Gmbh & CO KG  
(54) METAL FIBER HAVING A CHAMFER IN FIBER EDGE EXTENDING IN LONGITUDINAL DIRECTION OF FIBER  
DATE OF PATENT LAPSE: 2023 07 07  
PATENT RESTORATION TERM: 2024 07 07

---

(21) AP 2012 13400  
(11) P 2016 6531 B  
(73) Vertex Pharmaceuticals Incorporated  
(54) INHIBITORS OF INFLUENZA VIRUSES REPLICATION  
DATE OF PATENT LAPSE: 2023 08 01  
PATENT RESTORATION TERM: 2024 08 01

---

(21) AP 2012 13685  
(11) P 2017 6698 B  
(73) Vertex Pharmaceuticals Incorporated  
(54) INHIBITORS OF INFLUENZA VIRUSES REPLICATION  
DATE OF PATENT LAPSE: 2023 08 01  
PATENT RESTORATION TERM: 2024 08 01

---

(21) AP 2014 14061  
(11) P 2017 6763 B  
(73) Ditesan LTD.  
(54) GENETICALLY STABLE ONCOLYTIC RNA VIRUS, METHOD OF MANUFACTURING AND USE THEREOF  
DATE OF PATENT LAPSE: 2023 07 16  
PATENT RESTORATION TERM: 2025 07 16

---

(21) AP 2014 14071  
(11) P 2018 6860 B  
(73) Red Leaf Resources Inc.  
(54) COMPOSITE FEEDSTOCK FOR RECOVERY OF HYDROCARBONS FROM HYDROCARBONACEOUS MATERIAL  
DATE OF PATENT LAPSE: 2023 07 28  
PATENT RESTORATION TERM: 2024 07 28

---

(21) AP 2016 14218  
(11) P 2018 6822 B  
(73) Tamar Barbakadze;  
Salome Barbakadze  
(54) TOOTH IMPLANT  
DATE OF PATENT LAPSE: 2023 07 22  
PATENT RESTORATION TERM: 2024 07 22

---

(21) AP 2016 14238  
(11) P 2018 6861 B  
(73) Maia Gorgodze  
(54) WALL HEAT-INSULATING BLOCK  
DATE OF PATENT LAPSE: 2023 08 09  
PATENT RESTORATION TERM: 2024 08 09

---

(21) AP 2016 14240  
(11) P 2019 6955 B  
(73) Zurab Aslamazashvili;  
Giorgi Oniashvili;  
Garegin Zakharov;  
Giorgi Tavadze

(54) METHOD FOR PREPARATION OF COMPOSITE MATERIAL STABLE AT DYNAMIC LOAD OF HIGH INTENSIVITY

DATE OF PATENT LAPSE: 2023 08 10

PATENT RESTORATION TERM: 2024 08 10

---

(21) AP 2015 14394

(11) P 2018 6925 B

(73) Research Triangle Institute

(54) HIGH EFFICIENCY NEUTRON CAPTURE PRODUCTS PRODUCTION

DATE OF PATENT LAPSE: 2023 08 06

PATENT RESTORATION TERM: 2024 08 06

---

(21) AP 2016 14686

(11) P 2020 7069 B

(73) Mayr-Melnhof Karton AG

(54) MULTI-LAYER CARDBOARD MATERIAL AND METHOD FOR PRODUCING A MULTI-LAYER CARDBOARD MATERIAL

DATE OF PATENT LAPSE: 2023 07 15

PATENT RESTORATION TERM: 2024 07 15

---

(21) AP 2018 14846

(11) P 2020 7135 B

(73) LEPL "Shota Rustaveli National Science Foundation of Georgia";

Teona Ghvinianidze;

Papuna Chikovani;

Temur Ghvinianidze;

Akaki Tsereteli State University

(54) ANTIOXIDANT FOOD CONCENTRATE

DATE OF PATENT LAPSE: 2023 08 01

PATENT RESTORATION TERM: 2024 08 01

---

(21) AP 2017 15006

(11) P 2021 7301 B

(73) Novartis AG;

Les Laboratoires Servier

(54) COMBINATION OF BCL-2 INHIBITOR AND MCL-1 INHIBITOR, USES AND PHARMACEUTICAL COMPOSITIONS THEREOF

DATE OF PATENT LAPSE: 2023 07 21

PATENT RESTORATION TERM: 2024 07 21

---

(21) AP 2019 15125

(11) P 2021 7255 B

(73) Razhden Skhvitaridze;

Elena Shapakidze;

Merab Abazadze;

Ioseb Gejadze;

Malkhaz Turdzeladze;

Shalva Verulava;

LEPL "National Bureau of Forensic Expertise named after Levan Samkharauli";

Georgian Technical University;

Named After Ivane Javakhishvili Tbilisi State University;

LEPL "Shota Rustaveli National Scientific Foundation"



(54) PREPARATION METHOD FOR EXPANDED CLAY WITH SHALE BROUGHT BY THE RIVER  
DURUJI AND ACCUMULATED IN THE RIVER-BED NEARBY CITY KVARELI  
DATE OF PATENT LAPSE: 2023 07 03  
PATENT RESTORATION TERM: 2024 07 03

---

(21) AP 2019 15137  
(11) P 2020 7203 B  
(73) Ramaz Gakhikidze  
Lia Kvarayskhelia  
(54) BIOINSECTICIDE REPELLENT (SYNONYMS: BIOPHAR, ANTIPHAR, BIORAL)  
DATE OF PATENT LAPSE: 2023 07 15  
PATENT RESTORATION TERM: 2024 07 15

---

(21) AP 2021 15687  
(11) P 2022 7416 B  
(73) Vladimer Miruashvili;  
Aleksandre Kharibegashvili;  
Malkhaz Miruashvili;  
Mindia Miruashvili;  
Svimon Okhanashvili;  
Manana Kevlishvili;  
Levan Shavadze;  
Mzia Ghagholishvili;  
Telavi State University  
(54) ANTI-HAIL DEVICE FOR PLANTS  
DATE OF PATENT LAPSE: 2023 07 07  
PATENT RESTORATION TERM: 2024 07 07

---

(21) AP 2021 15711  
(11) P 2023 7475 B  
(73) Zaali Patckoria  
(54) DISINFECTION ROBOT WITH AIR HUMIDIFIER AND OZONATOR  
DATE OF PATENT LAPSE: 2023 08 02  
PATENT RESTORATION TERM: 2024 08 02

---

(21) AP 2021 15794  
(11) P 2023 7515 B  
(73) Pfizer Inc.  
(54) NITRILE-CONTAINING ANTIVIRAL COMPOUNDS  
DATE OF PATENT LAPSE: 2023 08 06  
PATENT RESTORATION TERM: 2024 08 06

---

## EXPIRATION OF PATENTS RESTORATION TERM

(21) AP 2009 12122  
(11) P 2013 5920 B  
(73) Pierre Fabre Dermo-Cosmetique  
(54) KIT FOR ONYCHOMYCOSIS TREATMENT  
DATE OF PATENT LAPSE: 2022 07 31  
DATE OF EXPIRATION OF PATENT RESTORATION TERM: 2023 07 31

---

(21) AP 2011 12288  
(11) P 2012 5654 B  
(73) Anzor Chachua  
(54) AIRLINE SERVICE COMPLEX  
DATE OF PATENT LAPSE: 2022 07 08  
DATE OF EXPIRATION OF PATENT RESTORATION TERM: 2023 07 08

---

(21) AP 2010 12614  
(11) P 2016 6419 B  
(73) Geox S.P.A.  
(54) VAPOR-PERMEABLE SHOE  
DATE OF PATENT LAPSE: 2022 08 04  
DATE OF EXPIRATION OF PATENT RESTORATION TERM: 2023 08 04

---

(21) AP 2010 12630  
(11) P 2016 6420 B  
(73) Geox S.P.A.  
(54) INSERT FOR VAPOR-PERMEABLE AND WATERPROOF SOLES  
DATE OF PATENT LAPSE: 2022 08 04  
DATE OF EXPIRATION OF PATENT RESTORATION TERM: 2023 08 04

---

(21) AP 2013 13165  
(11) P 2017 6634 B  
(73) Giorgi Tumanishvili;  
Tengiz Nadiradze;  
Giorgi Tumanishvil  
(54) CARRIAGE WHEELPAIR  
DATE OF PATENT LAPSE: 2022 07 18  
DATE OF EXPIRATION OF PATENT RESTORATION TERM: 2023 07 18

---

(21) AP 2014 13542  
(11) P 2017 6658 B  
(73) Eter Kemertelidze;  
Mariam Benidze;  
Aleksandre Skhirtladze  
(54) METHOD FOR RECEIVING PLANT GROWTH-PROMOTING FACTOR "ALEXIN"  
DATE OF PATENT LAPSE: 2022 08 05  
DATE OF EXPIRATION OF PATENT RESTORATION TERM: 2023 08 05

---

(21) AP 2015 14426  
(11) P 2019 6987 B  
(73) Alliance Magnésium  
(54) HYDROMETALLURGICAL PROCESS TO PRODUCE PURE MAGNESIUM METAL AND VARIOUS BY-PRODUCTS  
DATE OF PATENT LAPSE: 2022 07 17  
DATE OF EXPIRATION OF PATENT RESTORATION TERM: 2023 07 17

---

(21) AP 2015 14478  
(11) P 2019 7004 B  
(73) Ioulia Tseti  
(54) IRON (III) HYDROXIDE COMPLEXES WITH ACTIVATED GLUCOSE SYRUPS AND PROCESS FOR PREPARING SAME  
DATE OF PATENT LAPSE: 2022 07 28  
DATE OF EXPIRATION OF PATENT RESTORATION TERM: 2023 07 28

---

(21) AP 2016 14730  
(11) P 2020 7071 B  
(73) Sergey Dmitrievich Filipov  
(54) HYDROGEN-ENRICHED WATER WITH INCREASED ANTIOXIDANT ACTIVITY AND PREPARATION METHODS THEREOF  
DATE OF PATENT LAPSE: 2022 08 08  
DATE OF EXPIRATION OF PATENT RESTORATION TERM: 2023 08 08

---

(21) AP 2018 14849  
(11) P 2020 7123 B  
(73) LTD "Composite Materials Scientific-Industrial Union"  
(54) METHOD FOR CLADDING OF NANOSTRUCTURAL POWDER MATERIALS AND THEIR MIXTURE  
DATE OF PATENT LAPSE: 2022 08 03  
DATE OF EXPIRATION OF PATENT RESTORATION TERM: 2023 08 03

---

(21) AP 2018 14850  
(11) P 2020 7115 B  
(73) LTD "Composite Materials Scientific-Industrial Union"  
(54) METHOD FOR OBTAINING METALLIC COPPER FROM INDUSTRIAL WASTEWATER  
DATE OF PATENT LAPSE: 2022 08 03  
DATE OF EXPIRATION OF PATENT RESTORATION TERM: 2023 08 03

---

(21) AP 2004 9208  
(11) P 2007 4277 B  
(73) JSC "Grindex"  
(54) MELDONIUM SALTS, METHOD OF THEIR PREPARATION AND PHARMACEUTICAL COMPOSITION ON THEIR BASIS  
DATE OF PATENT LAPSE: 2022 07 15  
DATE OF EXPIRATION OF PATENT RESTORATION TERM: 2023 07 15

---

## CHANGES OF NAME AND/OR ADDRESS OF PATENTOWNERS

(21) AP 2008 11622

(11) P 2012 5702 B

(54) BENZIMIDAZOLE DERIVATIVES

NAME AND ADDRESS OF NEW PATENT OWNER: Pfizer Inc. (US)

66 Hudson Boulevard East, New York, N.Y. 10001-2192,  
USA (US)

NAME AND ADDRESS OF FORMER PATENT OWNER: Pfizer Inc. (US)

235 East 42nd Street, New York, New York 10017,  
USA (US)

DATE OF REGISTRATION: 2023 08 04

---

(21) AP 2009 12121

(11) P 2013 5803 B

(54) DIOXA-BICYCLO[3.2.1.]OCTANE-2,3,4-TRIOL DERIVATIVES

NAME AND ADDRESS OF NEW PATENT OWNER: Pfizer Inc. (US)

66 Hudson Boulevard East, New York, N.Y. 10001-2192,  
USA (US)

NAME AND ADDRESS OF FORMER PATENT OWNER: Pfizer Inc. (US)

235 East 42nd Street, New York, New York 10017,  
USA (US)

DATE OF REGISTRATION: 2023 08 04

---

(21) AP 2010 12727

(11) P 2014 6104 B

(54) DIOXA-BICYCLO[3.2.1.]OCTANE-2,3,4-TRIOL DERIVATIVES

NAME AND ADDRESS OF NEW PATENT OWNER: Pfizer Inc. (US)

66 Hudson Boulevard East, New York, N.Y. 10001-2192,  
USA (US)

NAME AND ADDRESS OF FORMER PATENT OWNER: Pfizer Inc. (US)

235 East 42nd Street, New York, New York 10017,  
USA (US)

DATE OF REGISTRATION: 2023 08 04

---

(21) AP 2013 13564

(11) P 2016 6560 B

(54) MACROCYCLIC DERIVATIVES FOR THE TREATMENT OF PROLIFERATIVE DISEASES

NAME AND ADDRESS OF NEW PATENT OWNER: Pfizer Inc. (US)

66 Hudson Boulevard East, New York, N.Y. 10001-2192,  
USA (US)

NAME AND ADDRESS OF FORMER PATENT OWNER: Pfizer Inc. (US)

235 East 42nd Street, New York, New York 10017,  
USA (US)

DATE OF REGISTRATION: 2023 08 04

---

(21) AP 2014 13916

(11) P 2017 6600 B

(54) PYRROLO [2, 3 -D]PYRIMIDINE DERIVATIVES AS INHIBITORS OF JANUS- RELATED KINASES  
(JAK)

NAME AND ADDRESS OF NEW PATENT OWNER: Pfizer Inc. (US)

66 Hudson Boulevard East, New York, N.Y. 10001-2192,  
USA (US)

NAME AND ADDRESS OF FORMER PATENT OWNER: Pfizer Inc. (US)  
235 East 42nd Street, New York, New York 10017,  
USA (US)

DATE OF REGISTRATION: 2023 08 04

---

(21) AP 2014 14164  
(11) P 2018 6840 B  
(54) PYRROLO [2,3-D] PYRIMIDINYL, PYRROLO [2,3-B] PYRAZINYL AND PYRROLO [2,3-D]  
PYRIDINYL ACRYLAMIDES

NAME AND ADDRESS OF NEW PATENT OWNER: Pfizer Inc. (US)  
66 Hudson Boulevard East, New York, N.Y. 10001-2192,  
USA (US)

NAME AND ADDRESS OF FORMER PATENT OWNER: Pfizer Inc. (US)  
235 East 42nd Street, New York, New York 10017,  
USA (US)

DATE OF REGISTRATION: 2023 08 04

---

(21) AP 2015 14288  
(11) P 2018 6887 B  
(54) BICYCLIC-FUSED HETEROARYL OR ARYL COMPOUNDS AND THEIR USE AS IRAK4  
INHIBITORS

NAME AND ADDRESS OF NEW PATENT OWNER: Pfizer Inc. (US)  
66 Hudson Boulevard East, New York, N.Y. 10001-2192,  
USA (US)

NAME AND ADDRESS OF FORMER PATENT OWNER: Pfizer Inc. (US)  
235 East 42nd Street, New York, New York 10017,  
USA (US)

DATE OF REGISTRATION: 2023 08 04

---

(21) AP 2015 14347  
(11) P 2018 6933 B  
(54) SUBSTITUTED DIHYDROISOQUINOLINE COMPOUNDS

NAME AND ADDRESS OF NEW PATENT OWNER: Pfizer Inc. (US)  
66 Hudson Boulevard East, New York, N.Y. 10001-2192,  
USA (US)

NAME AND ADDRESS OF FORMER PATENT OWNER: Pfizer Inc. (US)  
235 East 42nd Street, New York, New York 10017,  
USA (US)

DATE OF REGISTRATION: 2023 08 04

---

(21) AP 2017 14948  
(11) P 2021 7211 B  
(54) SUBSTITUTED CARBONUCLEOSIDE DERIVATIVES USEFUL AS ANTICANCER AGENTS

NAME AND ADDRESS OF NEW PATENT OWNER: Pfizer Inc. (US)  
66 Hudson Boulevard East, New York, N.Y. 10001-2192,  
USA (US)

NAME AND ADDRESS OF FORMER PATENT OWNER: Pfizer Inc. (US)  
235 East 42nd Street, New York, New York 10017,  
USA (US)

DATE OF REGISTRATION: 2023 08 04

---

(21) AP 2017 14998

(11) P 2021 7234 B

(54) PYRIDOPYRIMIDINONE CDK2/4/6 INHIBITORS

NAME AND ADDRESS OF NEW PATENT OWNER: Pfizer Inc. (US)

66 Hudson Boulevard East, New York, N.Y. 10001-2192,  
USA (US)

NAME AND ADDRESS OF FORMER PATENT OWNER: Pfizer Inc. (US)

235 East 42nd Street, New York, New York 10017,  
USA (US)

DATE OF REGISTRATION: 2023 08 04

---

(21) AP 2017 15005

(11) P 2020 7159 B

(54) DIACYLGLYCEROL ACYLTRANSFERASE 2 INHIBITORS

NAME AND ADDRESS OF NEW PATENT OWNER: Pfizer Inc. (US)

66 Hudson Boulevard East, New York, N.Y. 10001-2192,  
USA (US)

NAME AND ADDRESS OF FORMER PATENT OWNER: Pfizer Inc. (US)

235 East 42nd Street, New York, New York 10017,  
USA (US)

DATE OF REGISTRATION: 2023 08 04

---

(21) AP 2017 15110

(11) P 2021 7265 B

(54) GLP-1 RECEPTOR AGONISTS AND USES THEREOF

NAME AND ADDRESS OF NEW PATENT OWNER: Pfizer Inc. (US)

66 Hudson Boulevard East, New York, N.Y. 10001-2192,  
USA (US)

NAME AND ADDRESS OF FORMER PATENT OWNER: Pfizer Inc. (US)

235 East 42nd Street, New York, New York 10017,  
USA (US)

DATE OF REGISTRATION: 2023 08 04

---

(21) AP 2019 15475

(11) P 2022 7433 B

(54) 2-AMINO-PYRIDINE OR 2-AMINO-PYRIMIDINE DERIVATIVES AS CYCLIN DEPENDENT KINASE  
INHIBITORS

NAME AND ADDRESS OF NEW PATENT OWNER: Pfizer Inc. (US)

66 Hudson Boulevard East, New York, N.Y. 10001-2192,  
USA (US)

NAME AND ADDRESS OF FORMER PATENT OWNER: Pfizer Inc. (US)

235 East 42nd Street, New York, New York 10017,  
USA (US)

DATE OF REGISTRATION: 2023 08 04

---

(21) AP 2019 15517

(11) P 2023 7453 B

(54) GLP-1 RECEPTOR AGONISTS AND USES THEREOF

NAME AND ADDRESS OF NEW PATENT OWNER: Pfizer Inc. (US)

66 Hudson Boulevard East, New York, N.Y. 10001-2192,  
USA (US)

NAME AND ADDRESS OF FORMER PATENT OWNER: Pfizer Inc. (US)

235 East 42nd Street, New York, New York 10017,  
USA (US)

DATE OF REGISTRATION: 2023 08 04

---

(21) AP 2019 15588

(11) P 2023 7476 B

(54) N-SUBSTITUTED-DIOXOCYCLOBUTENYLAMINO-3-HYDROXYPICOLINAMIDES USEFUL AS CCR6 INHIBITORS

NAME AND ADDRESS OF NEW PATENT OWNER: Pfizer Inc. (US)

66 Hudson Boulevard East, New York, N.Y. 10001-2192,  
USA (US)

NAME AND ADDRESS OF FORMER PATENT OWNER: Pfizer Inc. (US)

235 East 42nd Street, New York, New York 10017,  
USA (US)

DATE OF REGISTRATION: 2023 08 04

---

(21) AP 2019 15599

(11) P 2022 7442 B

(54) BORON CONTAINING PDE4 INHIBITORS

NAME AND ADDRESS OF NEW PATENT OWNER: Pfizer Inc. (US)

66 Hudson Boulevard East, New York, N.Y. 10001-2192,  
USA (US)

NAME AND ADDRESS OF FORMER PATENT OWNER: Pfizer Inc. (US)

235 East 42nd Street, New York, New York 10017,  
USA (US)

DATE OF REGISTRATION: 2023 08 04

---

(21) AP 2019 15630

(11) P 2022 7434 B

(54) 2,3-DIHYDRO-1H-PYRROLO[3,4-C]PYRIDIN-1-ONE DERIVATIVES AS HPK1 INHIBITORS FOR THE TREATMENT OF CANCER

NAME AND ADDRESS OF NEW PATENT OWNER: Pfizer Inc. (US)

66 Hudson Boulevard East, New York, N.Y. 10001-2192,  
USA (US)

NAME AND ADDRESS OF FORMER PATENT OWNER: Pfizer Inc. (US)

235 East 42nd Street, New York, New York 10017,  
USA (US)

DATE OF REGISTRATION: 2023 08 04

---

(21) AP 2020 15709

(11) P 2022 7451 B

(54) 3-CARBONYLAMINO-5-CYCLOPENTYL-1H-PYRAZOLE COMPOUNDS HAVING INHIBITORY ACTIVITY ON CDK2

NAME AND ADDRESS OF NEW PATENT OWNER: Pfizer Inc. (US)

66 Hudson Boulevard East, New York, N.Y. 10001-2192,  
USA (US)

NAME AND ADDRESS OF FORMER PATENT OWNER: Pfizer Inc. (US)

235 East 42nd Street, New York, New York 10017,  
USA (US)

DATE OF REGISTRATION: 2023 08 04

---

(21) AP 2021 15794

(11) P 2023 7515 B

(54) NITRILE-CONTAINING ANTIVIRAL COMPOUNDS

NAME AND ADDRESS OF NEW PATENT OWNER: Pfizer Inc. (US)

66 Hudson Boulevard East, New York, N.Y. 10001-2192,  
USA (US)

NAME AND ADDRESS OF FORMER PATENT OWNER: Pfizer Inc. (US)

235 East 42nd Street, New York, New York 10017,  
USA (US)

DATE OF REGISTRATION: 2023 08 04

---

(21) AP 2003 8328

(11) P 2006 3909 B

(54) 2-(PYRIDIN-2-YLAMINO)-PYRIDO[2,3d] PYRIMIDIN-7-ONES

NAME AND ADDRESS OF NEW PATENT OWNER: Warner-Lambert Company LLC (US)

66 Hudson Boulevard East, New York, N.Y. 10001-2192,  
USA (US)

NAME AND ADDRESS OF FORMER PATENT OWNER: Warner-Lambert Company LLC (US)

235 East 42nd Street, New York, New York 10017,  
USA (US)

DATE OF REGISTRATION: 2023 08 04

---

(21) AP 2005 9887

(11) P 2010 4906 B

(54) ENANTIOMERICALLY PURE AMINOHETEROARYL COMPOUNDS AS PROTEIN KINASE  
INHIBITORS

NAME AND ADDRESS OF NEW PATENT OWNER: Pfizer Inc. (US)

66 Hudson Boulevard East, New York, N.Y. 10001-2192,  
USA (US)

NAME AND ADDRESS OF FORMER PATENT OWNER: Pfizer Inc. (US)

235 East 42nd Street, New York, New York 10017,  
USA (US)

DATE OF REGISTRATION: 2023 08 04

---

(21) AP 2005 9888

(11) P 2009 4845 B

(54) PYRAZOLE-SUBSTITUTED AMINOHETEROARYL COMPOUNDS AS PROTEIN KINASE  
INHIBITORS

NAME AND ADDRESS OF NEW PATENT OWNER: Pfizer Inc. (US)

66 Hudson Boulevard East, New York, N.Y. 10001-2192,  
USA (US)

NAME AND ADDRESS OF FORMER PATENT OWNER: Pfizer Inc. (US)

235 East 42nd Street, New York, New York 10017,  
USA (US)

DATE OF REGISTRATION: 2023 08 04

---



## UTILITY MODELS RESTORATION OF PATENTS

(21) AU 2017 14497  
(11) U 2021 2079 Y  
(73) Anzor Kuparadze  
(54) METHOD FOR BIODIESEL PRODUCTION  
DATE OF PATENT LAPSE: 2023 05 19  
DATE OF PATENT RESTORATION:2023 08 25

---

(21) AU 2019 15167  
(11) U 2021 2067 Y  
(73) Tamaz Nadirashvili;  
    Mariam Lomtadze  
(54) METHOD FOR WALL BUILDING MATERIAL PRODUCTON WITH STUBBLE  
DATE OF PATENT LAPSE: 2023 08 08  
DATE OF PATENT RESTORATION:2023 08 25

---

## LAPSE OF PATENTS WITH THE RIGHT TO RESTORE

(21) AU 2019 15127  
(11) U 2021 2073 Y  
(73) Elena Shapakidze;  
    Razden Skhvitaridze;  
    Isolda Kamushadze;  
    Lamara Gabunia;  
    Ioseb Gejadze;  
    Marine Nadirashvili;  
    Vera Maisuradze;  
    Tamar Petriashvili;  
    Iv. Javakhishvili Named Tbilisi State University;  
    Shota Rustaveli National Scientific Foundation  
(54) METHOD FOR CEMENT POZZOLANIC ADDITIVE PRODUCTION  
DATE OF PATENT LAPSE: 2023 07 04  
PATENT RESTORATION TERM: 2024 07 04

---

(21) AU 2019 15167  
(11) U 2021 2067 Y  
(73) Tamaz Nadirashvili;  
    Mariam Lomtadze  
(54) METHOD FOR WALL BUILDING MATERIAL PRODUCTON WITH STUBBLE  
DATE OF PATENT LAPSE: 2023 08 08  
PATENT RESTORATION TERM: 2025 08 08

---

(21) AU 2021 15699  
(11) U 2022 2119 Y  
(73) Revaz Giorganashvili;;  
    Zezva Jaiani  
(54) VEHICLE INTERNAL COMBUSTION ENGINE EXHAUST GASES DISPOSAL DEVICE

DATE OF PATENT LAPSE: 2023 07 19  
PATENT RESTORATION TERM: 2024 07 19

---

(21) AU 2021 15708  
(11) U 2022 2136 Y  
(73) LTD "Bluelight"  
(54) ULTRAVIOLET RADIATION STERILIZATION DEVICE  
DATE OF PATENT LAPSE: 2023 07 27  
PATENT RESTORATION TERM: 2024 07 27

---

## EXPIRATION OF PATENTS RESTORATION TERM

(21) AU 2015 13890  
(11) U 2016 1912 Y  
(73) Konstantine Maghradze;  
Nugzar Joglidze  
(54) COMPOSITION FOR BAKERY FOR PANCREATIC DIABETIC DIETARY MEAL  
DATE OF PATENT LAPSE: 2022 07 17  
DATE OF EXPIRATION OF PATENT RESTORATION TERM: 2023 07 17

---

(21) AU 2018 15238  
(11) U 2020 2056 Y  
(73) Obshchestvo s Ogranichennoy Otvetstvennostyu "DzhetLab"  
(54) PACKAGE FOR THE TRANSPORTATION OF BOTTLE  
DATE OF PATENT LAPSE: 2022 07 24  
DATE OF EXPIRATION OF PATENT RESTORATION TERM: 2023 07 24

---

(21) AU 2020 15386  
(11) U 2021 2082 Y  
(73) Salome Vadatchkoria;  
Nino Vadatchkoria  
(54) POLYLACTIC ACID – POLYLACTIDE (PLA) AND USAGE OF POLYMERS THEREWITH  
NOVEL DESTINATION  
DATE OF PATENT LAPSE: 2022 07 10  
DATE OF EXPIRATION OF PATENT RESTORATION TERM: 2023 07 10

---

(21) AU 2020 15406  
(11) U 2021 2084 Y  
(73) Nona Dadvani  
(54) VINEYARD POLE  
DATE OF PATENT LAPSE: 2022 08 09  
DATE OF EXPIRATION OF PATENT RESTORATION TERM: 2023 08 09

---

## DESIGNS

### CANCELLATION OF DESIGNS REGISTRATION

(11) D 2018 747 S  
(73) "Grand Kendi" LLC (AM)  
31 Masis St., 0061, Yerevan, Armenia (AM)  
(54) PACKING BOX  
(18) 2023 01 30  
(58) 2023 08 14

---

(11) D 2018 748 S  
(73) "Grand Kendi" LLC (AM)  
31 Masis St., 0061, Yerevan, Armenia (AM)  
(54) PACKING BOX  
(18) 2023 01 30  
(58) 2023 08 14

---

(11) D 2018 782 S  
(73) Tamar Zautashvili (GE)  
Titsian Tabidze St. 39, ap. 18, 0162, Tbilisi, Georgia (GE)  
(54) Earring  
(18) 2023 01 31  
(58) 2023 08 17

---

(11) D 2018 783 S  
(73) Tamar Zautashvili (GE)  
Titsian Tabidze St. 39, ap. 18, 0162, Tbilisi, Georgia (GE)  
(54) Cap  
(18) 2023 01 31  
(58) 2023 08 17

---

**TRADEMARKS****EXTENSION OF TERMS OF TRADEMARKS REGISTRATION**

(111) M 2003 14956 R2  
(151) 2003 01 30  
(186) 2033 01 30  
(732) Tamaz Shilakadze  
Bakhtrioni St. 6, ap. 24, 0160, Tbilisi,  
Georgia

---

(111) M 2003 14957 R2  
(151) 2003 01 30  
(186) 2033 01 30  
(732) Tamaz Shilakadze  
Bakhtrioni St. 6, ap. 24, 0160, Tbilisi,  
Georgia

---

(111) M 2003 14955 R2  
(151) 2003 01 30  
(186) 2033 01 30  
(732) Tamaz Shilakadze  
Bakhtrioni St. 6, ap. 24, 0160, Tbilisi,  
Georgia

---

(111) M 2003 15171 R2  
(151) 2003 06 27  
(186) 2033 06 27  
(732) Deere & Company  
One John Deere Place, Moline, Illinois 61265,  
USA

---

(111) M 2003 15172 R2  
(151) 2003 06 27  
(186) 2033 06 27  
(732) Deere & Company  
One John Deere Place, Moline, Illinois 61265,  
USA

---

(111) M 2003 15068 R2  
(151) 2003 03 28  
(186) 2033 03 28  
(732) JSC "Lomisi"  
Sanapiro St. 1, 0600, Borough Akhalgori,  
Georgia

---

(111) M 2003 15193 R2  
(151) 2003 06 27  
(186) 2033 06 27  
(732) Wyeth LLC  
66 Hudson Boulevard East, New York,  
NY 10001-2192, USA

---

(111) M 2003 15194 R2  
(151) 2003 06 27  
(186) 2033 06 27  
(732) KG Mobility Corp.  
455-12 (Chilgoe-dong), Dongsak-ro,  
Pyeongtaek-si, Gyeonggi-do, Republic of  
Korea

---

(111) M 2003 15237 R2  
(151) 2003 09 08  
(186) 2033 09 08  
(732) Henkel AG & Co. KgaA  
Henkelstrasse 67, 40589 Dusseldorf, Germany

---

(111) M 2003 15234 R2  
(151) 2003 08 14  
(186) 2033 08 14  
(732) Nintendo Co., LTD  
11-1, Hokotate-cho, Kamitoba, Minami-ku,  
Kyoto-shi, Kyoto, Japan

---

(111) M 2003 15295 R2  
(151) 2003 10 15  
(186) 2033 10 15  
(732) Warsteiner Brauerei Haus Cramer KG  
Domring, 59581 Warstein, Germany

---

(111) M 2004 15495 R2  
(151) 2004 04 16  
(186) 2034 04 16  
(732) LLC "Ascaneli Brothers"  
Kakheti Highway 110a, 0198, Tbilisi,  
Georgia

---

(111) M 2004 15496 R2  
(151) 2004 04 16  
(186) 2034 04 16  
(732) LLC "Ascaneli Brothers"  
Kakheti Highway 110a, 0198, Tbilisi,  
Georgia

---

(111) M 2004 15497 R2  
(151) 2004 04 16  
(186) 2034 04 16  
(732) LLC "Ascaneli Brothers"  
Kakheti Highway 110a, 0198, Tbilisi,  
Georgia

---

(111) M 2004 15498 R2  
(151) 2004 04 16  
(186) 2034 04 16  
(732) LLC "Ascaneli Brothers"  
Kakheti Highway 110a, 0198, Tbilisi,  
Georgia

---

(111) M 2004 15564 R2  
(151) 2004 06 15  
(186) 2034 06 15  
(732) Nissin Foods Holdings Co., LTD  
1-1 Nishinakajima 4-chome, Yodogawa-ku,  
Osaka, Japan

---

(111) M 2013 23844 R1  
(151) 2013 07 19  
(186) 2033 07 19  
(732) JSC "Liberty Bank"  
Ilia Chavchavadze Av. 74, 0162, Tbilisi,  
Georgia

---

(111) M 2013 23315 R1  
(151) 2013 02 12  
(186) 2033 02 12  
(732) Clarios Technology and Recycling GmbH  
Am Leineufer 51, 30419 Hannover,  
Germany

---

(111) M 2013 23845 R1  
(151) 2013 07 19  
(186) 2033 07 19  
(732) JSC "Liberty Bank"  
Ilia Chavchavadze Av. 74, 0162, Tbilisi,  
Georgia

---

(111) M 2013 23718 R1  
(151) 2013 06 07  
(186) 2033 06 07  
(732) Payless ShoeSource Worldwide Inc.  
Jayhawk Towers, 700 Southwest Jackson  
Street, Suite 202, Topeka, Kansas 66603, USA

---

(111) M 2013 24066 R1  
(151) 2013 09 30  
(186) 2033 09 30  
(732) Kingston Technology Corporation  
17600 Newhope Street, Fountain Valley,  
California 92708, USA

---

(111) M 2013 24328 R1  
(151) 2013 12 13  
(186) 2033 12 13  
(732) KT & G Corporation  
100, Pyeongchon-dong Daedeok-gu, Taejeon  
306-712, Republic of Korea

---

(111) M 2013 23799 R1  
(151) 2013 06 25  
(186) 2033 06 25  
(732) Discovery Communications LLC  
230 Park Avenue South, New York,  
NY 10003, USA

---

(111) M 2013 23536 R1  
(151) 2013 03 27  
(186) 2033 03 27  
(732) International Company Limited Liability  
Company "EFKO Food Products"  
Oktyabrskaya St. 8, office 304, 236006,  
Kaliningrad, Kaliningrad Region, Russian  
Federation

---

(111) M 2013 23537 R1  
(151) 2013 03 27  
(186) 2033 03 27  
(732) Obshchestvo s Ogranichennoy Otvetstven-  
nostiu "Koordiniroiushchi Raspredelitelni  
Tsentr "Efko-Kaskad"  
Ul. Frunze, dom 4, Aleseevka, 309850,  
Belgorodskaya Oblast, Russian Federation

---

(111) M 2013 23967 R1  
(151) 2013 09 02  
(186) 2033 09 02  
(732) Wolverine Outdoors Inc.  
(a Michigan Corporation)  
9341 Courtland Drive NE, Rockford, Michigan  
49351, USA

---

(111) M 2013 23890 R1  
(151) 2013 08 14  
(186) 2033 08 14  
(732) HBI Branded Apparel Enterprises LLC  
1000 East Hanes Mill Road, Winston-Salem,  
North Carolina 27105, USA

---

(111) M 2013 23813 R1  
(151) 2013 06 25  
(186) 2033 06 25  
(732) Accor Management Canada Inc.  
155 Wellington Street West, Toronto, Ontario,  
M5V 0C3, Canada

---

(111) M 2013 23971 R1  
(151) 2013 09 02  
(186) 2033 09 02  
(732) Egis Gyógyszergyár ZRT (shortly: Egis ZRT)  
30-38, Keresztúri út., H-1106, Budapest,  
Hungary

---

(111) M 2013 23915 R1  
(151) 2013 08 14  
(186) 2033 08 14  
(732) LG Household & Health Care LTD.  
58, Saemunan-ro, Jongno-gu, Seoul, Republic  
of Korea

---

(111) M 2013 23928 R1  
(151) 2013 08 14  
(186) 2033 08 14  
(732) Abdi İbrahim İlaç Sanayi ve Ticaret Anonim  
Şirketi  
Reşitpaşa Mahallesi Eski Büyükdere Caddesi  
No: 4, 34467 Maslak-Sarıyer-İstanbul, Türkiye

---

(111) M 2013 24087 R1  
(151) 2013 09 30  
(186) 2033 09 30  
(732) Compagnie Generale des Etablissements  
Michelin  
23, Place des Carmes-Déchaux, 63000  
Clermont-Ferrand, France

---

(111) M 2013 24057 R1  
(151) 2013 09 17  
(186) 2033 09 17  
(732) JSC "Liberty Bank"  
Ilia Chavchavadze Av. 74, 0162, Tbilisi,  
Georgia

---

(111) M 2013 23945 R1  
(151) 2013 08 14  
(186) 2033 08 14  
(732) Adamed Pharma S.A.  
Pieńków, Ul. Mariana Adamkiewiczza  
6A 05-152 Czostów, Poland

---

(111) M 2013 23946 R1  
(151) 2013 08 14  
(186) 2033 08 14  
(732) Adamed Pharma S.A.  
Pieńków, Ul. Mariana Adamkiewiczza  
6A 05-152 Czostów, Poland

---

(111) M 2013 23947 R1  
(151) 2013 08 14  
(186) 2033 08 14  
(732) Adamed Pharma S.A.  
Pieńków, Ul. Mariana Adamkiewiczza  
6A 05-152 Czostów, Poland

---

(111) M 2013 24161 R1  
(151) 2013 10 17  
(186) 2033 10 17  
(732) Roraj Trade LLC  
a New York Limited Liability Company  
c/o Holland & Knight LLP 400, South Hope  
Street, 8th Floor Los Angeles, California  
90071-2801, USA

---

(111) M 2013 24059 R1  
(151) 2013 09 17  
(186) 2033 09 17  
(732) Société Air france  
45, rue de Paris 95747 Roissy-Charles-De-  
Gaulee, France

---

(111) M 2013 24112 R1  
(151) 2013 09 30  
(186) 2033 09 30  
(732) Colgate - Palmolive Company, a Delaware  
Corporation  
300 Park Avenue, New York, New York  
10022, USA

---

(111) M 2013 23950 R1  
(151) 2013 08 14  
(186) 2033 08 14  
(732) LEPL "House of Justice"  
Sanapiro St. 2, 0105, Tbilisi, Georgia

---

(111) M 2013 23951 R1  
(151) 2013 08 14  
(186) 2033 08 14  
(732) LEPL "House of Justice"  
Sanapiro St. 2, 0105, Tbilisi, Georgia

---

(111) M 2013 23952 R1  
(151) 2013 08 14  
(186) 2033 08 14  
(732) LEPL "House of Justice"  
Sanapiro St. 2, 0105, Tbilisi, Georgia

---

(111) M 2013 23953 R1  
(151) 2013 08 14  
(186) 2033 08 14  
(732) LEPL "House of Justice"  
Sanapiro St. 2, 0105, Tbilisi, Georgia

---

(111) M 2013 24396 R1  
(151) 2013 12 30  
(186) 2033 12 30  
(732) JSC "Lomisi"  
Vill. Natakhtari, 3308, Mtskheta Region,  
Georgia

---

(111) M 2013 24397 R1  
(151) 2013 12 30  
(186) 2033 12 30  
(732) JSC "Lomisi"  
Vill. Natakhtari, 3308, Mtskheta Region,  
Georgia

---

(111) M 2014 24890 R1  
(151) 2014 06 13  
(186) 2034 06 13  
(732) LEPL "National Wine Agency"  
Marshall Gelovani Av. 6, 0159, Tbilisi,  
Georgia

---

(111) M 2013 23547 R1  
(151) 2013 03 28  
(186) 2033 03 28  
(732) LTD "Harili"  
Tsabadze St. 19, 0179, Tbilisi, Georgia

---

(111) M 2014 24750 R1  
(151) 2014 05 07  
(186) 2034 05 07  
(732) JSC "Sarajishvili"  
Sarajishvili Av. 4, 0153, Tbilisi, Georgia

---

(111) M 2014 24772 R1  
(151) 2014 05 07  
(186) 2034 05 07  
(732) LYD "Nova"  
Dighomi, II qu. 9a, ap. 13, 0119, Didube-  
Chughureti Dstrict, Tbilisi, Georgia

---

(111) M 2014 24693 R1  
(151) 2014 04 15  
(186) 2034 04 15  
(732) Giorgi Talakhadze  
Saakadze St. 2, 1200, Borjomi, Georgia

---

(111) M 2013 23771 R1  
(151) 2013 06 11  
(186) 2033 06 11  
(732) Carrefour  
93 Avenue de Paris, F-91300 MASSY, France

---

(111) M 2013 23772 R1  
(151) 2013 06 11  
(186) 2033 06 11  
(732) Carrefour  
93 Avenue de Paris, F-91300 MASSY, France

---

(111) M 2014 24947 R1  
(151) 2014 07 07  
(186) 2034 07 07  
(732) LLC "Socar Georgia Petroleum"  
300 Aragveli St. 24, 0144, Tbilisi, Georgia

---

(111) M 2014 24948 R1  
(151) 2014 07 07  
(186) 2034 07 07  
(732) LLC "Socar Georgia Petroleum"  
300 Aragveli St. 24, 0144, Tbilisi, Georgia

---

## COMPLETE TRANSFER OF RIGHTS

(111) M 2020 32443 R  
(732) Mylan Inc.  
1000 Mylan Blvd Canonsburg, PA 15317,  
USA  
(770) Mylan Institutional Inc  
1718 Northrock Court Rockford, Illinois  
61103, USA  
(580) 2023 07 24

---

(111) M 2020 32449 R  
(732) Mylan Inc.  
1000 Mylan Blvd Canonsburg, PA 15317,  
USA  
(770) Mylan Institutional Inc.  
1718 Northrock Court Rockford, Illinois  
61103, USA  
(580) 2023 07 24

---

(111) M 2021 34396 R  
(732) Obshchestvo s Ogranichennoy Otvetstven-  
nostyu "Retail Logistics"  
Ul. Trudovaya, Dom 10, Skl. 3, Litera 1b,  
Pomeshchenie II, D.p. Rodniki, Ramenskiy  
Raion, 140143, Moskovskaya Obl., Russian  
Federation  
(770) Obshchestvo s Ogranichennoi Otvetstven-  
nostiu "Intellect Produkts"  
Sormovskiy Per., Dom 11, Stroenie 2, etazh 9,  
komnata 5, Moscow, Russian Federation  
(580) 2023 06 12

---

(111) M 2021 34481 R  
(732) Obshchestvo s Ogranichennoy Otvetstven-  
nostyu "Retail Logistics"  
Ul. Trudovaya, Dom 10, Skl. 3, Litera 1b,  
Pomeshchenie II, D.p. Rodniki, Ramenskiy  
Raion, 140143, Moskovskaya Obl., Russian  
Federation  
(770) Obshchestvo s Ogranichennoi Otvetstven-  
nostiu "Intellect Produkts"  
Sormovskiy Per., Dom 11, Stroenie 2, etazh 9,  
komnata 5, Moscow, Russian Federation  
(580) 2023 06 12

---

(111) M 2022 36086 R  
(732) Tamar Gogolashvili  
Kirimi St. 7, 0101, Tbilisi, Georgia  
(770) Onway LLC  
Kirimi St. 7, 0101, Tbilisi, Georgia  
(580) 2023 07 31

---

(111) M 2003 15007 R  
(732) Wilmar Trading (China) Pte. LTD.  
28 Biopolis Road, Singapore 138568,  
Singapore  
(770) Wilmar International Limited  
56 Neil Road, Singapore 088830, Singapore  
(580) 2023 07 06

---

(111) M 1997 7294 R  
(732) Toyobo MC Corporation  
Osaka Umeda Twin Towers South,  
Osaka Umeda 13-1, Umeda 1-chome,  
Kita-ku, Osaka-shi, Osaka 530-0001, Japan  
(770) Toyobo CO., LTD.  
13-1, Umeda 1-chome, Kita-ku, Osaka-  
shi, Osaka 530-0001, Japan  
(580) 2023 07 05

---

(111) M 2013 24184 R  
(732) Champion Glory Limited  
38/f., OnE Kowloon, 1 Wang Yuen Street,  
Kowloon Bay, Hong Kong  
(770) Glorious Sun Licensing (L) Limited  
Lot 2 & 3, Level 3, Wisma Lazenda, Jalan  
Kemajuan, 87000 Wilayah Persekutuan  
Labuan, East Malaysia, Malaysia  
(580) 2023 08 01

---

(111) M 2014 25100 R  
(732) LLC "Mira Global One"  
N. Kipshidze St. 20, ap. 4, Vake District,  
Tbilisi Georgia  
(770) Nugzar Shvelidze  
Kipshidze St. 20, 0162, Tbilisi, Georgia  
(580) 2023 07 24

---

(111) M 2017 29007 R  
(732) Mylan Inc.  
1000 Mylan Blvd Canonsburg, PA 15317,  
USA  
(770) Mylan Institutional Inc.  
1718 Northrock Court Rockford, Illinois  
61103, USA  
(580) 2023 07 24

---

(111) M 1998 9621 R  
(732) Fasbra SE  
Deichmannweg 9, 45359, Essen, Germany  
(770) Salamander GmbH  
Zur Schlenkhecke 4, 40764 Langenfeld,  
Germany

---



(580) 2023 08 01

---

(111) M 2019 31850 R

(732) Mylan Inc.

1000 Mylan Blvd Canonsburg, PA 15317,  
USA

(770) Mylan Institutional Inc.

1718 Northrock Court Rockford, Illinois  
61103, USA

(580) 2023 07 24

---

## CHANGES OF NAME AND/OR ADDRESS OF TRADEMARKS OWNERS

(111) M 2022 35466 R

(732) Niterra Co., LTD.

1-1-1, Higashisakura, Higashi-ku, Nagoya-shi,  
Japan

(770) NGK Spark Plug Co., LTD.

1-1-1, Higashisakura, Higashi-ku, Nagoya-shi,  
Japan

(580) 2023 07 19

---

(111) M 2022 35467 R

(732) Niterra Co., LTD.

1-1-1, Higashisakura, Higashi-ku, Nagoya-shi,  
Japan

(770) NGK Spark Plug Co., LTD.

1-1-1, Higashisakura, Higashi-ku, Nagoya-shi,  
Japan

(580) 2023 07 19

---

(111) M 2023 36978 R

(732) Limited Liability Company "PRime Expedition  
Company"

1st Vyazovsky Ave., 4, p. 19, 109428  
Moscow, Russian Federation

(770) Obshchestvo s Ogranichenoy Otvetstven-  
nostyu "First Expedition Company"

1-y Viazovsky pr., 4, str. 19, 109428, Moscow,  
Russian Federation

(580) 2023 07 24

---

(111) M 2004 15774 R

(732) Mondelez Hellas Snacks Production  
S.M.S.A.

12th km National Road Athens-Lamia, 14452,  
Metamorfossis, Attica, Greece

(770) Chipita Global Societe Anonyme

(Chipita global S.A.)

12th km National Road Athens-Lamia,  
14452, Metamorfossis, Attica, Greece

(580) 2023 07 26

---

(111) M 2004 15775 R

(732) Mondelez Hellas Snacks Production S.M.S.A.

12th km National Road Athens-Lamia,  
14452, Metamorfossis, Attica, Greece

(770) Chipita Global Societe Anonyme

(Chipita Global S.A.)

12th km National Road Athens-Lamia,  
14452, Metamorfossis, Attica, Greece

(580) 2023 07 26

---

(111) M 2005 16298 R

(732) Guangxi Golden Throat Co., LTD

N28, Fengxiang Road, Liuzhou City,  
Guangxi 545001, China

(770) Guangxi Golden Throat Co., LTD

N28, Yuejin Road, Liuzhou City, Guangxi  
545001, China

(580) 2023 06 29

---

(111) M 2007 17602 R

(732) JSC "Badagoni"

Vill. Zemo Khodasheni, 0910, Akhmeta  
Region, Georgia

(770) LLC "Badagoni"

Vill. Zemo Khodasheni, 0910, Akhmeta  
Region, Georgia

(580) 2023 07 18

---

(111) M 2009 19207 R  
(732) Betek Boya Ve Kimya Sanayi Anonim  
Şirketi  
Gebze Organize Sanayi Bölgesi, Tembelova  
Alanı 3200 Sok. No:3206, Gebze, Kocaeli,  
Türkiye  
(770) Betek Boya Ve Kimya Sanayi Anonim  
Şirketi  
Kaynarca, Kavakpınar Mh. Tandoğan Cad.  
Kocamezarlık Karşısı, Pendik-Istanbul,  
Türkiye  
(580) 2023 08 04

---

(111) M 2013 24133 R  
(732) Syngenta Limited  
Jealott's Hill International Research  
Centre, Bracknell, Berkshire, RG42 6EY,  
United Kingdom  
(770) Syngenta Limited  
Syngenta European Regional Centre,  
Priestley Road, Surrey Research Park,  
Guildford, Surrey GU2 7YH, United  
Kingdom  
(580) 2023 07 12

---

(111) M 2013 23799 R  
(732) Discovery Communications LLC  
230 Park Avenue South, New York,  
NY 10003, USA  
(770) Discovery Communications LLC  
8403 Colesville Road, Silver Spring, Maryland  
20910, USA  
(580) 2023 06 22

---

(111) M 2013 23536 R  
(732) International Company Obshchestvo s  
Ogranichennoy Otvetstvennostyu "EFKO  
Product Nutrition"  
Ul Oktyabrskaya, dom 8, office 304,  
Kaliningrad, Kaliningradskaya Oblast, 236006,  
Russian Federation  
(770) EFKO Foods PLK  
Boumpoulina St. 11, fl. 1, 1060, Nicosia,  
Cyprus  
(580) 2023 06 27

---

(111) M 2013 24087 R  
(732) Compagnie Generale des Etablissements  
Michelin  
23, Place des Carmes-Déchaux, 63000  
Clermont-Ferrand, France  
(770) Compagnie Generale des Etablissements  
Michelin  
12, cours Sablon, 63000, Clermont-Ferrand,  
France

(580) 2023 07 13

---

(111) M 2018 30222 R  
(732) Betek Boya ve Kimya Sanayi Anonim  
Şirketi  
Gebze Organize Sanayi Bölgesi, Tembelova  
Alanı 3200 Sok. No:3206, Gebze, Kocaeli,  
Türkiye  
(770) Betek Boya ve Kimya Sanayi Anonim  
Şirketi  
Kaynarca, Kavakpınar Mah. Tandoğan Cad.  
Kocamezarlık Karşısı Pendik - Istanbul,  
Türkiye  
(580) 2023 08 04

---

(111) M 2018 29976 R  
(732) Betek Boya ve Kimya Sanayi Anonim  
Şirketi  
Gebze Organize Sanayi Bölgesi, Tembelova  
Alanı 3200 Sok. No:3206, Gebze, Kocaeli,  
Türkiye  
(770) Betek Boya ve Kimya Sanayi Anonim  
Şirketi  
Kaynarca, Kavakpınar Mah. Tandoğan Cad.  
Kocamezarlık Karşısı Pendik - Istanbul,  
Türkiye  
(580) 2023 08 04

---

(111) M 2018 29977 R  
(732) Betek Boya ve Kimya Sanayi Anonim  
Şirketi  
Gebze Organize Sanayi Bölgesi, Tembelova  
Alanı 3200 Sok. No:3206, Gebze, Kocaeli,  
Türkiye  
(770) Betek Boya ve Kimya Sanayi Anonim  
Şirketi  
Kaynarca, Kavakpınar Mah. Tandoğan Cad.  
Kocamezarlık Karşısı Pendik - Istanbul,  
Türkiye  
(580) 2023 08 04

---

## CANCELLATION OF TRADEMARKS REGISTRATION

(111) M 2013 23251 R  
(151) 2013 01 09  
(732) National Olympic Committee of Georgia  
Machabeli St. 11, 0105, Tbilisi, Georgia  
(141) 2023 08 17

---

(111) M 2013 23307 R  
(151) 2013 02 01  
(732) Dedika Bulia  
Ir. Abashidze St. 14, 0179, Tbilisi, Georgia  
(141) 2023 08 14

---

# CLASSIFICATION INDEXES

## INVENTIONS

### CONCORDANCE TABLE OF INTERNATIONAL CLASSIFICATION INDEX AND PUBLICATION NUMBERS

INTERNATIONAL CLASSIFICATION INDEXES (51)	NUMBER OF PUBLISHED APPLICATION (10)
A 61 K 31/428; A 61 K 31/404; A 61 K 31/538; A 61 K 31/4155; A 61 K 31/55; A 61 K 31/437; A 61 K 31/5025; A 61 K 31/4439; A 61 K 31/4709; A 61 K 31/427; A 61 P 37/02; A 61 P 35/00; A 61 P 37/00; C 07 D 487/04; C 07 D 471/04; C 07 D 417/14	AP 2023 15865 A

### CONCORDANCE TABLE OF PUBLICATION NUMBERS AND INTERNATIONAL CLASSIFICATION INDEX

NUMBER OF PUBLISHED APPLICATION (10)	INTERNATIONAL CLASSIFICATION INDEXES (51)
AP 2023 15865 A	A 61 K 31/428; A 61 K 31/404; A 61 K 31/538; A 61 K 31/4155; A 61 K 31/55; A 61 K 31/437; A 61 K 31/5025; A 61 K 31/4439; A 61 K 31/4709; A 61 K 31/427; A 61 P 37/02; A 61 P 35/00; A 61 P 37/00; C 07 D 487/04; C 07 D 471/04; C 07 D 417/14

### CONCORDANCE TABLE OF INTERNATIONAL CLASSIFICATION INDEX, PATENT NUMBERS AND PUBLICATION NUMBERS

INTERNATIONAL CLASSIFICATION INDEX (51)	NUMBER OF PATENT (11)	NUMBER OF PUBLISHED APPLICATION (10)
A 23 C 23/00	P 2023 7533 B	AP 2023 16008 A
A 61 K 31/53; A 61 P 35/00; C 07 D 487/04	P 2023 7531 B	AP 2023 15724 A
A 61 K 31/7048; A 61 K 9/14; A 61 K 9/00; A 61 P 9/14	P 2023 7532 B	AP 2023 15564 A
C 07 D 295/205; C 07 D 213/75	P 2023 7530 B	AP 2023 15463 A
C 22 B 47/00; C 22 B 3/08	P 2023 7529 B	AP 2023 15638 A

**CONCORDANCE TABLE OF PATENT NUMBERS,  
PUBLICATION NUMBERS AND INTERNATIONAL CLASSIFICATION INDEX**

NUMBER OF PATENT (11)	NUMBER OF PUBLISHED APPLICATION (10)	INTERNATIONAL CLASSIFICATION INDEX (51)
P 2023 7529 B	AP 2023 15638 A	C 22 B 47/00; C 22 B 3/08
P 2023 7530 B	AP 2023 15463 A	C 07 D 295/205; C 07 D 213/75
P 2023 7531 B	AP 2023 15724 A	A 61 K 31/53; A 61 P 35/00; C 07 D 487/04
P 2023 7532 B	AP 2023 15564 A	A 61 K 31/7048; A 61 K 9/14; A 61 K 9/00; A 61 P 9/14
P 2023 7533 B	AP 2023 16008 A	A 23 C 23/00

**CONCORDANCE TABLE OF APPLICATION NUMBERS,  
PUBLICATION NUMBERS AND PATENTS**

NUMBER OF APPLICATION (21)	NUMBER OF PUBLISHED APPLICATION (10)	NUMBER OF PATENT (11)
AP 2018 15463	AP 2023 15463 A	P 2023 7530 B
AP 2019 15564	AP 2023 15564 A	P 2023 7532 B
AP 2021 15638	AP 2023 15638 A	P 2023 7529 B
AP 2020 15724	AP 2023 15724 A	P 2023 7531 B
AP 2022 16008	AP 2023 16008 A	P 2023 7533 B

**APPLICATION\*\*\***

**CONCORDANCE TABLE OF INTERNATIONAL CLASSIFICATION INDEX  
AND PUBLICATION NUMBERS**

INTERNATIONAL CLASSIFICATION INDEXES (51)	NUMBER OF PUBLISHED APPLICATION (10)
E 21 B 43/24; E 21 B 43/243	AP 2023 16300 A

**CONCORDANCE TABLE OF PUBLICATION NUMBERS  
AND INTERNATIONAL CLASSIFICATION INDEX**

NUMBER OF PUBLISHED APPLICATION (10)	INTERNATIONAL CLASSIFICATION INDEXES (51)
AP 2023 16300 A	E 21 B 43/24; E 21 B 43/243

**DESIGNS****CONCORDANCE TABLE OF INTERNATIONAL CLASSIFICATION INDEX  
AND PUBLICATION NUMBERS**

INTERNATIONAL CLASSIFICATION INDEXES (51)	NUMBER OF PUBLISHED APPLICATION (10)
02-02	AD 2023 1307 S

**CONCORDANCE TABLE OF PUBLICATION NUMBERS  
AND INTERNATIONAL CLASSIFICATION INDEX**

NUMBER OF PUBLISHED APPLICATION (10)	INTERNATIONAL CLASSIFICATION INDEXES (51)
AD 2023 1307 S	02-02

**CONCORDANCE TABLE OF INTERNATIONAL CLASSIFICATION INDEX,  
NUMBERS OF REGISTRATION AND PUBLICATION NUMBERS**

INTERNATIONAL CLASSIFICATION INDEX (51)	NUMBER OF REGISTRATION (11)	NUMBER OF PUBLISHED APPLICATION (10)
08-05	D 2023 976 S	AD 2023 1287 S

**CONCORDANCE TABLE OF NUMBERS OF REGISTRATION,  
PUBLICATION NUMBERS AND INTERNATIONAL CLASSIFICATION INDEX**

NUMBER OF REGISTRATION (11)	NUMBER OF PUBLISHED APPLICATION (10)	INTERNATIONAL CLASSIFICATION INDEX (51)
D 2023 976 S	AD 2023 1287 S	08-05

**CONCORDANCE TABLE OF APPLICATION NUMBERS,  
PUBLICATION NUMBERS AND NUMBERS OF REGISTRATION**

NUMBER OF APPLICATION (21)	NUMBER OF PUBLISHED APPLICATION (10)	NUMBER OF REGISTRATION (11)
AD 2022 1287	AD 2023 1287 S	D 2023 976 S

DESIGN REGISTERED ACCORDING TO THE ACCELERATED  
PROCEDURE

CONCORDANCE TABLE OF INTERNATIONAL CLASSIFICATION INDEX  
AND PUBLICATION NUMBERS

INTERNATIONAL CLASSIFICATION INDEXES (51)	NUMBER OF REGISTRATION (11)
20-01	D 2023 977 S

CONCORDANCE TABLE OF PUBLICATION NUMBERS  
AND INTERNATIONAL CLASSIFICATION INDEX

NUMBER OF REGISTRATION (11)	INTERNATIONAL CLASSIFICATION INDEXES (51)
D 2023 977 S	20-01

CONCORDANCE TABLE OF APPLICATION NUMBERS,  
PUBLICATION NUMBERS AND PATENTS

NUMBER OF APPLICATION (21)	NUMBER OF REGISTRATION (11)
AD 2023 1327	D 2023 977 S

## TRADEMARKS

### CONCORDANCE TABLE OF REGISTRATION NUMBERS, APPLICATION NUMBERS, PUBLICATION NUMBERS AND BULLETIN NUMBERS

NUMBER OF REGISTRATION (111)	NUMBER OF APPLICATIONS (210)	NUMBER OF PUBLISHED APPLICATIONS (260)	NUMBER OF BULLETIN
M 2023 37179 R	AM 119179	AM 2023 119179 A	7(610)2023
M 2023 37180 R	AM 119180	AM 2023 119180 A	7(610)2023
M 2023 37181 R	AM 124217	–	16(619)2023
M 2023 37182 R	AM 124054	–	16(619)2023
M 2023 37183 R	AM 124068	–	16(619)2023
M 2023 37184 R	AM 123929	–	16(619)2023
M 2023 37185 R	AM 123658	–	16(619)2023
M 2023 37186 R	AM 119700	AM 2023 119700 A	8(611)2023
M 2023 37187 R	AM 119698	AM 2023 119698 A	8(611)2023
M 2023 37188 R	AM 119678	AM 2023 119678 A	8(611)2023
M 2023 37189 R	AM 119677	AM 2023 119677 A	8(611)2023
M 2023 37190 R	AM 119609	AM 2023 119609 A	8(611)2023
M 2023 37191 R	AM 119603	AM 2023 119603 A	8(611)2023
M 2023 37192 R	AM 119602	AM 2023 119602 A	8(611)2023
M 2023 37193 R	AM 119601	AM 2023 119601 A	8(611)2023
M 2023 37194 R	AM 119600	AM 2023 119600 A	8(611)2023
M 2023 37195 R	AM 119599	AM 2023 119599 A	8(611)2023
M 2023 37196 R	AM 119499	AM 2023 119499 A	8(611)2023
M 2023 37197 R	AM 119364	AM 2023 119364 A	7(610)2023
M 2023 37198 R	AM 119355	AM 2023 119355 A	8(611)2023
M 2023 37199 R	AM 119288	AM 2023 119288 A	8(611)2023
M 2023 37200 R	AM 119211	AM 2023 119211 A	6(609)2023
M 2023 37201 R	AM 118861	AM 2023 118861 A	4(607)2023
M 2023 37202 R	AM 118860	AM 2023 118860 A	4(607)2023
M 2023 37203 R	AM 118314	AM 2023 118314 A	4(607)2023
M 2023 37204 R	AM 124227	–	16(619)2023
M 2023 37205 R	AM 123623	–	16(619)2023
M 2023 37206 R	AM 124221	–	16(619)2023



**CONCORDANCE TABLE OF PUBLICATION NUMBERS  
AND APPLICATION NUMBERS**

NUMBER OF PUBLISHED APPLICATION (260)	NUMBER OF APPLICATION (210)	1	2
1	2		
AM 2023 112294 A	AM 112294	AM 2023 120848 A	AM 120848
AM 2023 112295 A	AM 112295	AM 2023 120945 A	AM 120945
AM 2023 120614 A	AM 120614	AM 2023 120960 A	AM 120960
AM 2023 120631 A	AM 120631	AM 2023 120961 A	AM 120961
AM 2023 120698 A	AM 120698	AM 2023 121040 A	AM 121040
AM 2023 120717 A	AM 120717	AM 2023 121052 A	AM 121052
AM 2023 120811 A	AM 120811	AM 2023 121129 A	AM 121129
AM 2023 120817 A	AM 120817	AM 2023 121142 A	AM 121142
AM 2023 120822 A	AM 120822	AM 2023 121155 A	AM 121155
		AM 2023 121242 A	AM 121242
		AM 2023 121307 A	AM 121307
		AM 2023 121503 A	AM 121503
		AM 2023 121524 A	AM 121524

**CONCORDANCE TABLE OF INDEX OF GOODS AND/OR SERVICES  
AND APPLICATION NUMBERS**

INDEX OF GOODS AND/OR SERVICES (511)	NUMBER OF PUBLISHED APPLICATIONS (260)	1	2
1	2		
1	AM 2023 120822 A	34	AM 2023 121129 A
1	AM 2023 121503 A	35	AM 2023 120698 A
2	AM 2023 121503 A	35	AM 2023 120717 A
3	AM 2023 112294 A	35	AM 2023 120811 A
3	AM 2023 112295 A	35	AM 2023 120817 A
3	AM 2023 121052 A	35	AM 2023 120822 A
5	AM 2023 121242 A	35	AM 2023 120945 A
9	AM 2023 120960 A	35	AM 2023 120960 A
9	AM 2023 120961 A	35	AM 2023 120961 A
10	AM 2023 121142 A	35	AM 2023 121142 A
12	AM 2023 121142 A	35	AM 2023 121524 A
17	AM 2023 121503 A	36	AM 2023 120698 A
18	AM 2023 121142 A	36	AM 2023 120848 A
20	AM 2023 121142 A	36	AM 2023 120960 A
24	AM 2023 121142 A	36	AM 2023 120961 A
25	AM 2023 121142 A	36	AM 2023 121307 A
26	AM 2023 121142 A	36	AM 2023 120698 A
29	AM 2023 121040 A	37	AM 2023 120698 A
30	AM 2023 120822 A	39	AM 2023 120822 A
30	AM 2023 121155 A	40	AM 2023 120822 A
31	AM 2023 120614 A	41	AM 2023 120822 A
31	AM 2023 120811 A	41	AM 2023 120945 A
31	AM 2023 120822 A	41	AM 2023 120960 A
32	AM 2023 120822 A	41	AM 2023 120961 A
33	AM 2023 120822 A	42	AM 2023 120960 A
34	AM 2023 120631 A	42	AM 2023 120961 A
		43	AM 2023 120822 A
		43	AM 2023 120945 A
		44	AM 2023 120811 A
		44	AM 2023 120822 A

---

CONCORDANCE TABLE OF INDEX OF GOODS AND/OR SERVICES  
AND NUMBERS OF TRADEMARKS REGISTERED ACCORDING  
TO THE ACCELERATED PROCEDURE

INDEX OF GOODS AND/OR SERVICES (511)	NUMBERS OF REGISTERED ACCORDING TO THE ACCELERATED PROCEDURE (111)
9	M 2023 37206 R
29	M 2023 37181 R
29	M 2023 37204 R
30	M 2023 37181 R
30	M 2023 37185 R
30	M 2023 37204 R
32	M 2023 37181 R
32	M 2023 37183 R
32	M 2023 37185 R
32	M 2023 37204 R
33	M 2023 37181 R
33	M 2023 37204 R
35	M 2023 37181 R
35	M 2023 37182 R
35	M 2023 37184 R
35	M 2023 37204 R
35	M 2023 37205 R
38	M 2023 37182 R
42	M 2023 37182 R
42	M 2023 37206 R
43	M 2023 37185 R
45	M 2023 37182 R

# OFFICIAL BULLETIN OF THE INDUSTRIAL PROPERTY

INVENTIONS

DESIGNS

TRADEMARKS

APPELLATIONS OF ORIGIN OF GOODS

## 16(619)

EDITOR-IN-CHIEF: N. Bebrishvili

EDITOR-TRANSLATOR: E. Gabunia

PROOFREADER: E. Gabunia

COMPUTER LAYOUT: M. Ordenidze  
K. Svanidze

ISSN 2720-8486

[info@sakpatenti.gov.ge](mailto:info@sakpatenti.gov.ge)  
[www.sakpatenti.gov.ge](http://www.sakpatenti.gov.ge)