



**NATIONAL INTELLECTUAL PROPERTY CENTER OF GEORGIA
SAKPATENTI**

**OFFICIAL BULLETIN
OF THE INDUSTRIAL PROPERTY**

17(501)

**2018
TBILISI**

INID CODES FOR IDENTIFICATION OF BIBLIOGRAPHIC DATA

INVENTIONS, UTILITY MODELS

- (10) Number of publication for application, which has been examined
- (11) Number of patent and kind of document
- (21) Serial number of application
- (22) Date of filing of the application
- (23) Date of exhibition or the date of the earlier filing and the number of application, if any
- (24) Date from which patent may have effect
- (31) Number of priority application
- (32) Date of filing of priority application
- (33) Code of the country or regional organization allotting priority application number
- (44) Date of publication of application not granted, but examined and number of bulletin
- (45) Date of publication of registered document
- (51) International Patent Classification Index
- (54) Title of the invention
- (57) Abstract
- (60) Number of examined patent document granted by foreign patent office, date from which patent has effect and country code
- (62) Number of the earlier application and in case of divided application, date of filing an application
- (71) Name, surname and address of applicant (country code)
- (72) Name, surname of inventor (country code)
- (73) Name, surname and address of patent owner (country code)
- (74) Name, surname of representative or patent attorney
- (85) Date of commencement of the national phase of International Application
- (86) Number and date of filing of international application
- (87) Number and date of publication of international application

DESIGNS

- (10) Number of publication for application
- (11) Number of patent and kind of document or number of registration
- (15) Date of registration/Date of patent renewal
- (18) Expected expiration date of patent or registration
- (21) Serial number of application
- (22) Date of filing of the application
- (23) Date of exhibition or the date of the earlier filing and the number of application, if any
- (24) Date from which patent may have effect
- (28) Number of designs included in the application
- (30) Data relating to priority (number of application, date of filing of application, two-letter code identifying the authority with whom the priority application was made)
- (31) Number of priority application
- (32) Date of filing of priority application
- (33) Code of the country or regional organization allotting priority application number
- (34) Two-letter code according to WIPO St.3 identifying the authority with which the priority application was made
- (44) Date of publication of design and number of bulletin (the first publication)
- (45) Date of publication of design registered by WIPO and number of bulletin
- (51) International Classification for designs (class and subclass of the Locarno Classification)
- (54) Title of the invention
- (55) Reproduction of the design
- (57) Description of characteristic features of the design including indication of colors
- (58) Date of recording of any kind of amendment in the Register
- (62) Number of the earlier application, registration and document number and if available the date of filing an application in case of divided application
- (71) Name, surname and address of applicant (country code)
- (72) Name, surname of creator (country code)
- (73) Name, surname and address of patent owner (country code)
- (74) Name, surname of representative or patent attorney
- (81) Contracting states concerned
 - II designated contracting states according to the 1960 Act
 - III designated contracting states according to the 1999 Act
- (85) Owner's permanent address
- (86) Owner's nationality
- (87) Owner's residence
- (88) State in which the owner has a real and effective industrial or commercial establishment

TRADEMARKS

- (111) – Number of registration
- (151) – Date of registration
- (156) – Date of the renewal
- (181) – Expected expiration date of registration
- (186) – Renewal expiration date of registration
- (141) – Date of cancel of duration of the mark
- (210) – Serial number of application
- (220) – Date of filing of the application
- (230) – Date concerning exhibition
- (260) – Number of application, for which favorable decision of examination about registration has been taken (publication number)
- (310) – Number of the first application
- (320) – Date of filing of the first application
- (330) – Code, identifying national or regional Office where the first application was made
- (511) – International Classification of Goods and Services for the purposes of registration of trade marks and/or list of goods and/or services classified according thereto
- (531) – Description of figurative elements of Trade Marks according to the International Classification of the Figurative Elements of Marks
- (540) – Reproduction of Trade Mark
- (550) – Nature and kind of Trade Mark
- (580) – Date of recording of any kind changes in respect of applications or registrations
- (591) – Information concerning colors claimed
- (731) – Name and address of the applicant
- (732) – Name and address of the holder of the registration
- (740) – Name and address of the representative
- (750) – Address for correspondence
- (770) – Name and address of the previous applicant or holder in case of change in ownership
- (771) – Previous name and address of the applicant or holder in case of change in ownership
- (791) – Name and address of the licensee
- (793) – Indication of conditions and/or restrictions under the license (Type of license, number of license agreement, data of license, data of validity of license)
- (800) – Certain data relating to the international registration of Trade Marks under the Protocol Relating to Madrid Agreement (International registration number)

CODES FOR PUBLICATION IN BULLETIN

- (21) AP 0000 000000 – serial number of application for invention
- (10) AP 0000 0000 A – number of published application for invention (first publication)
- (11) P 0000 0000 B – number of patent for invention (second publication)
- (21) API 0000 000000 – number of application for imported patent
- (11) PI 0000 0000 A – number of imported patent (first publication)
- (21) AU 0000 000000 – serial number of application for utility model
- (10) AU 0000 000 U – number of published application for utility model (first publication)
- (11) U 0000 000 Y – number of patent for utility model (second publication)
- (21) AD 0000 000000 – serial number of application for design
- (10) AD 0000 000 S – number of published application for design (first publication)
- (11) D 0000 000 S – number of patent for design (second publication)

INTERNATIONAL PATENT CLASSIFICATION FOR INVENTIONS AND UTILITY MODELS

- SECTION A – HUMAN NECESSITIES
- SECTION B – PERFORMING OPERATIONS; TRANSPORTING
- SECTION C – CHEMISTRY; METALLURGY
- SECTION D – TEXTILES; PAPER
- SECTION E – FIXED CONSTRUCTIONS
- SECTION F – MECHANICAL ENGINEERING; LIGHTING; HEATING; WEAPONS; BLASTING
- SECTION G – PHYSICS
- SECTION H – ELECTRICITY

-
- M – Trade Mark
 - (210) AM 0000 000000 – Serial number of application;
 - (260) AAM 0000 00000 A – Publication number of application;
 - (111) M 0000 00000 R – Number of registration;
 - (111) MMM0000 00000 Rn – Number of renewals, in which n=1,2,3;
 - (111) M 0000 00000 R(P) – Number of registration under partial assignment of rights
-

LIST OF CODES, IN ALPHABETIC SEQUENCE, AND THE CORRESPONDING (SHORT) NAMES OF STATES, OTHER ENTITIES AND INTERGOVERNMENTAL ORGANIZATIONS
(WIPO STANDARD ST.3)

AD	Andorra				
AE	United Arab Emirates				
AF	Afghanistan				
AG	Antigua and Barbuda				
AI	Anguilla				
AL	Albania				
AM	Armenia				
AN	Netherlands Antilles				
AO	Angola				
AP	African Regional Intellectual Property Organization (ARIPO)				
AR	Argentina				
AT	Austria				
AU	Australia				
AW	Aruba				
AZ	Azerbaijan				
BA	Bosnia and Herzegovina				
BB	Barbados				
BD	Bangladesh				
BE	Belgium				
BF	Burkina Faso				
BG	Bulgaria				
BH	Bahrain				
BI	Burundi				
BJ	Benin				
BM	Bermuda				
BN	Brunei Darussalam				
BO	Bolivia				
BR	Brazil				
BS	Bahamas				
BT	Bhutan				
BV	Bouvet Island				
BW	Botswana				
BX	Benelux Office for Intellectual Property (BOIP)				
BY	Belarus				
BZ	Belize				
CA	Canada				
CD	Democratic Republic of the Congo				
CF	Central African Republic				
CG	Congo				
CH	Switzerland				
CI	Cote d'Ivoire				
CK	Cook Islands				
CL	Chile				
CM	Cameroon				
CN	China				
CO	Colombia				
CR	Costa Rica				
CU	Cuba				
CV	Cape Verde				
CY	Cyprus				
CZ	Czech Republic				
DE	Germany				
DJ	Djibouti				
DM	Dominica				
DO	Dominican Republic				
DZ	Algeria				
EA	Eurasian Patent Organization (EAPO)				
EC	Ecuador				
EE	Estonia				
EG	Egypt				
EH	Western Sahara				
EM	Office for Harmonization in the Internal Market (Trademarks and Designs)(OHIM)				
EP	European Patent Office (EPO)				
ER	Eritrea				
ES	Spain				
ET	Ethiopia				
FI	Finland				
FJ	Fiji				
FK	Falkland Islands (Malvinas)				
FO	Faroe Islands				
FR	France				
GA	Gabon				
GB	United Kingdom				
GC	Patent Office of the Cooperation Council for the Arab States of the Gulf (GCC)				
GD	Grenada				
GG	Guernsey				
GH	Ghana				
GI	Gibraltar				
GT	Guatemala				
GW	Guinea- Bissau				
GY	Guyana				
HK	The Hong Kong Special Administrative Region of the People's Republic of China				
HN	Honduras				
HR	Croatia				
HT	Haiti				
HU	Hungary				
IB	International Bureau of the World Intellectual Property Organization (WIPO)				
ID	Indonesia				
IE	Ireland				
IL	Israel				
IM	Isle of Man				
IN	India				
IQ	Iraq				
ID	Indonesia				
IE	Ireland				
IL	Israel				
IM	Isle of Man				
IN	India				
IQ	Iraq				
IR	Iran (Islamic Republic of)				
IS	Iceland				
IT	Italy				
JE	Jersey				
JM	Jamaica				
JO	Jordan				
JP	Japan				
KE	Kenya				
KG	Kyrgyzstan				
KH	Cambodia				
KI	Kiribati				
KM	Saint Kitts and Nevis				
KP	Democratic People's Republic of Korea				
KR	Republic of Korea				
KW	Kuwait				
KY	Cayman Islands				
KZ	Kazakhstan				
LA	Lao People's Democratic Republic				
LB	Lebanon				
LC	Saint Lucia				
LI	Liechtenstein				
LK	Sri Lanka				
LR	Liberia				
LS	Lesotho				
LT	Lithuania				
LU	Luxembourg				
LV	Latvia				
LY	Libyan Arab Jamahiriya				
MA	Morocco				
MC	Monaco				
MD	Republic of Moldova				
ME	Montenegro				
MG	Madagascar				
MK	The former Yugoslav Republic of Macedonia				
ML	Mali				
MM	Myanmar				
MN	Mongolia				
MO	Macao				
MP	Northern Mariana Islands				
MR	Mauritania				
MS	Montserrat				
MT	Malta				
MU	Mauritius				
MV	Maldives				
MW	Malawi				
MX	Mexico				
MY	Malaysia				
MZ	Mozambique				
NA	Namibia				
NE	Niger				
NG	Nigeria				
NI	Nicaragua				
NL	Netherlands				
NO	Norway				
NP	Nepal				
NR	Nauru				
NZ	New Zealand				
OA	African Intellectual Property Organization (OAPI)				
OM	Oman				
PA	Panama				
PE	Peru				
PG	Papua New Guinea				
PH	Philippines				
PK	Pakistan				
PL	Poland				
PT	Portugal				
PW	Palau				
PY	Paraguay				
QA	Qatar				
QZ	Community Plant Variety Office (European Community) (CPVO)				
RO	Romania				
RS	Serbia				
RU	Russian Federation				
RW	Rwanda				
SA	Saudi Arabia				
SB	Solomon Islands				
SC	Seychelles				
SD	Sudan				
SG	Singapore				
SH	Saint Helena				
SI	Slovenia				
SK	Slovakia				
SL	Sierra Leone				
SM	San Marino				
SN	Senegal				
SO	Somalia				
SR	Suriname				
ST	Sao Tome and Principe				
SV	El Salvador				
SY	Syrian Arab Republic				
SZ	Swaziland				
TC	Turks and Caicos Islands				
TD	Chad				
TG	Togo				
TH	Thailand				
TJ	Tajikistan				
TL	Timor-Leste				
TM	Turkmenistan				
TN	Tunisia				
TO	Tonga				
TR	Turkey				
SE	Sweden				
TT	Trinidad and Tobago				
TV	Tuvalu				
TW	Taiwan, Province of China				
TZ	United Republic of Tanzania				
UA	Ukraine				
UG	Uganda				
US	United States of America				
UY	Uruguay				
UZ	Uzbekistan				
VA	Holy See				
VC	Saint Vincent and the Grenadines				
VE	Venezuela				
VG	Virgin Islands (British)				
VN	Viet Nam				
VU	Vanuatu				
WO	World Intellectual Property Organization (WIPO)				
WS	Samoa				
XN	Nordic Patent Institute (NPI)				
YE	Yemen				
ZA	South Africa				
ZM	Zambia				
ZW	Zimbabwe				

**NATIONAL INTELLECTUAL PROPERTY CENTER OF GEORGIA
SAKPATENTI**

**OFFICIAL BULLETIN
OF THE INDUSTRIAL PROPERTY**

17(501)

INVENTIONS

DESIGNS

TRADEMARKS

**APPELLATIONS OF ORIGIN AND GEOGRAPHICAL
INDICATIONS OF GOODS**

DATE OF PUBLICATION

2018 09 10

CONTENTS

PUBLISHED TITLES OF PROTECTION	3
INVENTIONS	
▪ APPLICATIONS APPROVED FOR GRANTING PATENTS	4
▪ PATENTED INVENTIONS	6
DESIGNS	
▪ APPLICATIONS APPROVED FOR REGISTRATION	8
▪ DESIGNS, WHICH HAVE BEEN REGISTERED WITH THE INTERNATIONAL BUREAU CLAIMING PRIORITY ON THE TERRITORY OF GEORGIA	11
TRADEMARKS	
▪ APPLICATIONS FILED UNDER THE NATIONAL PROCEDURE APPROVED FOR REGISTRATION	34
▪ REGISTERED TRADEMARKS	38
▪ TRADEMARKS REGISTERED ACCORDING TO THE ACCELERATED PROCEDURE	42
▪ INTERNATIONAL TRADEMARKS FOR WHICH A DECISION ON GRANTING PROTECTION IS TAKEN	44
▪ INTERNATIONAL TRADEMARKS PROTECTED IN GEORGIA	164
APPELLATIONS OF ORIGIN AND GEOGRAPHICAL INDICATIONS OF GOODS	
▪ APPELLATIONS OF ORIGIN OF GOODS FILED IN GEORGIA FOR EXAMINATION UNDER LISBON AGREEMENT, ON THE BASIS OF THE INTERNATIONAL REGISTRATION	171
OFFICIAL NOTIFICATIONS	
TRADEMARKS	
▪ RENEWAL OF REGISTRATIONS	172
▪ TRANSFER OF RIGHT	175
▪ CHANGES IN NAMES AND/OR ADDRESSES OF OWNERS	177
▪ INVALIDATION OF TRADEMARK REGISTRATIONS	179
▪ CHANGE OF THE LIST OF GOODS AND/OR SERVICES OF TRADEMARKS	207
▪ CANCELING OF TRADEMARK REGISTRATION	208
CLASSIFICATION INDEXES	
INVENTIONS	209
DESIGNS	210
TRADEMARKS	211

PUBLISHED TITLES OF PROTECTION

INVENTIONS

- **APPLICATIONS APPROVED FOR GRANTING PATENT:**
14459; 14140; 13483
- **PATENTED INVENTIONS:**
6890-6894

DESIGNS

- **APPLICATION APPROVED FOR REGISTRATION:**
1020
- **DESIGNS WHICH HAVE BEEN REGISTERED WITH THE INTERNATIONAL BUREAU CLAIMING PRIORITY ON THE TERRITORY OF GEORGIA:**
99038; 99091; 99109; 99118; 98287; 101607; 101617; 101720; 99471

TRADEMARKS

- **APPLICATIONS FILED UNDER THE NATIONAL PROCEDURE APPROVED FOR REGISTRATION:**
91291-91293; 92105; 93349*; 95689; 95713-95715; 95758; 95801; 95830; 95987; 96115; 96154, 96155; 96240; 96307, 96308; 96313; 96485; 96545
- **REGISTERED TRADEMARKS:**
30095-30134
- **TRADEMARKS REGISTERED ACCORDING TO THE ACCELERATED PROCEDURE:**
30089-30094
- **INTERNATIONAL TRADEMARKS FOR WHICH A DECISION ON GRANTING PROTECTIONS IS TAKEN:**
89297*; 91912; 92171*; 92247; 92273; 92564; 92824; 93023; 93176; 93178; 93293; 93295; 93362; 93400; 93595, 93596; 93649; 93739; 93741; 93788; 93791, 93792; 93947; 93969; 94150; 94235; 94253; 94422, 94523; 94607; 94611; 94614; 94617; 94619-94621; 94631; 94649; 94651; 94731; 94736; 94757; 94781-94784; 94803, 94804; 94808-94811; 94813; 94815; 94817; 94842; 94887; 94890; 94930; 94957, 94958; 94960, 94961; 94963; 94991, 94992; 94996; 94999; 95002; 95024, 95025; 95040-95043; 95063; 95083; 95086; 95090; 95104, 95105; 95111, 95112; 95115-95117; 95153-95156; 95158-95164; 95190, 95191; 95193-95196; 95225, 95226; 95228-95230; 95232-95234; 95237; 95240-95242; 95254-95258; 95260, 95261; 95265; 95281; 95284, 95285; 95287; 95289; 95291; 95293; 95296-95299; 95301; 95305; 95311; 95313; 95315, 95316; 95321- 95324; 95326; 95329; 95369; 95377-95386; 95424-95426; 95430; 95434-95439; 95477, 95478; 95484; 95500-95504; 95506; 95508; 95510; 95512; 95537; 95591-95595; 95620-95627; 95629; 95701; 95703; 95712; 95720; 95722; 95735-95739; 95741, 95742; 95744; 95813; 95822; 95827; 96268
- **INTERNATIONAL TRADEMARKS PROTECTED IN GEORGIA:**
89751; 91121; 91143; 91728; 92633; 92649; 92658; 92661; 92667; 92693; 92821; 92901; 92906, 92907; 92917; 92920; 92944; 92984; 93010; 93033; 93159; 93164; 93171; 93249, 93250; 93252; 93265; 93269, 93270; 93288-93292; 93297-93299, 93301-93303; 93305; 93307, 93308; 93310; 93313, 93314; 93322; 93348; 93356; 93360, 93361; 93371; 93388; 93401-93404; 93406, 93407; 93452-93460; 93462, 93463; 93466, 93467; 93469; 93471, 93472; 93482; 93490; 93494; 93503; 93511; 93546, 93547; 93578; 93580, 93581; 93583; 93586, 93587; 93589; 93591-93594; 93625; 93830; 93981

APPELLATIONS OF ORIGIN AND GEOGRAPHICAL INDICATIONS OF GOODS

- **APPELLATIONS OF ORIGIN OF GOODS FILED IN GEORGIA FOR EXAMINATION UNDER LISBON AGREEMENT, ON THE BASIS OF THE INTERNATIONAL REGISTRATION:**
1518-1520

INVENTIONS

APPLICATIONS APPROVED FOR GRANTING PATENTS

The decision can be appealed at the Chamber of Appeal of Sakpatenti within 3 months from the publication or at the Mtskheta District Court Administrative Cases Board (Address: №17, Samkhedro str., Mtskheta), within 1 month following the publication.

PART A

A 01

(10) AP 2018 14459 A (51) Int. Cl. (2006)

A 01 N 43/40

(21) AP 2015 014459 (22) 2015 08 28

(31) 62/045,976

(32) 2014 09 04

(33) US

(71) HELSINN HEALTHCARE SA (CH)

Via Pian Scairolo 9 CH-6912 Lugano/
Pazzallo (CH)

(72) MANN, William (US);

FRIEND, John (US);

POLVINO, William (US);

ALLEN, Suzan (US);

LU, Ming (US);

DUUS, Elizabeth (US);

GIORGINO, Ruben (CH);

BARONI, Enrico (IT)

(74) Shalva Gvaramadze

(85) 2017 03 31

(86) PCT/US2015/047435, 2015 08 28

(54) **MEDICAL TREATMENTS BASED
ON ANAMORELIN**

(57) Anamorelin is used at cachexia treatment of patient having malignant neoplasm.

Claims: 8 independent

15 dependent

Fig.: 13

A 61

(10) AP 2018 14140 A (51) Int. Cl. (2006)

A 61C 8/00

(21) AP 2016 014140 (22) 2016 05 11

(71) Sergey Manukov (GE)

Sakanelas q. 37, 0108, Tbilisi (GE)

(72) Sergey Manukov (GE)

(74) Karina Manukova

(54) **INTACT OR DOUBLE PARTIAL
COMBINED CRYSTAL OR AXIAL
STOMATOLOGICAL IMPLANT, AND
SYSTEM OF DOUBLE OR ONE STAGE**

BICORTICAL TOOTH IMPLANTS OF UPPER JAW OF SECOND TYPE BONE FOR PREMOLARS AND MOLARS AREA

(57) Intact or double partial combined crystal or axial stomatological implant includes a case with neck; one end of case has truncated conic shaped crown part or abutment, and another part thereof has: a top, apical part having shape of two conjugate hemispheres. Case one part includes a ring, a rim or a neck, and another part approximately relative thereto has conic right carving, from another side approximately relative to case neck. The implant has right or left carving; at that, apical surface of all rings and threads is parabolic-shaped in the section.

Claims: 2 independent

11 dependent

Fig.: 10

(10) AP 2018 13483 A (51) Int. Cl. (2006)

A 61 K 31/706

A 61 P 35/00

A 61 P 35/02

(21) AP 2012 013483 (22) 2012 11 02

(31) 61/555,049

(32) 2011 11 03

(33) US

(71) MILLENNIUM PHARMACEUTICALS,
INC. (US)

40 Landsdowne Street, Cambridge,
MA 02139 (US)

(72) SMITH, Peter G. (US)

(74) Tamaz Shilakadze

(85) 2014 05 29

(86) PCT/US2012/063382, 2012 11 02

(54) **ADMINISTRATION D'UN**

**INHIBITEUR D'ENZYME ACTIVANT
NEDD8 ET AGENT D'HYPOMÉTHY-
LATION**

(57) Present invention relates to cancer treating methods in patients wherefor such treatment is prescribed. The methods include to introduce NAE inhibitor or pharmaceutically acceptable salts thereof, e.g. ((1S,2S,4R) - 4 - (4-((1S)-2,3-dihydro-1H-inden-1-ylamino)-7H-pyrrolo[2,3 d]pyrimidin 7-yl)- 2- hydroxycyclopentyl) methyl sulfamate (MLN4924) or {(1S,2S,4R) - 4 - [(6-{{[(1R,2S)-5-chloro-2-methoxy-2,3-dihydro-1H-inden-1-yl] ami-

no }pyrimidin-4-yl)oxy]-2-hydroxycyclopentyl}-
methyl sulfamate (I-216), in patient, and
hypomethylating agent or pharmaceutically
acceptable salts thereof, such as azacitidine or
decitabine.

Claims: 3 independent

21 dependent

Fig.: 5

BROWN, Jason W. (US);
HITCHCOCK, Stephen (US);
KIKUCHI, Shota (US);
LAM, Betty (US);
MONENSCHHEIN, Holger (US);
REICHARD, Holly (US);
SUN, Huikai (US)

(74) Aleksandre Gegechkori

(54) **PYRAZINES MODULATORS OF GPR6**

C 22

(11) P 2018 6894 B (51) Int. Cl. (2006)

C 22 C 5/04

B 01 J 23/40

(10) AP 2018 14324 A (44) 10(494)/2018

(21) AP 2015 014324

(22) 2015 08 13

(24) 2015 08 13

(31) 2014134348

(32) 2014 08 21

(33) RU

(86) PCT/RU2015/000509, 2015 08 13

(73) OJSC "KRASNOYARSKIY ZAVOD
TSVETNYKH METALLOV IMENI
V.N. GULIDOVA" (RU)

Transportnyi proezd, 1 Krasnoyarsk,
660027 (RU)

(72) EFIMOV, Waleriy Nikolaevich (RU);

MAMONOV, Sergey Nikolaevich (RU)

(74) Larisa Amirkhanyan

(54) **PLATINUM-BASED ALLOY FOR
CATALYST GAUZES**

DESIGNS

APPLICATION APPROVED FOR REGISTRATION

The decision can be appealed at the Chamber of Appeal of Sakpatenti within 3 months from the publication or at the Mtskheta District Court Administrative Cases Board (Address: №17, Samkhedro str., Mtskheta), within 1 month following the publication.

(10) AD 2018 1020 S

(51) 31-00

(21) AD 2018 1020

(22) 2018 02 08

(28) 4

(31) 29/614,321; 29/614,321; 29/614,321; 29/614,321

(32) 2017 08 17; 2017 08 17; 2017 08 17; 2017 08 17

(33) US; US; US; US

(71) CAPBRAN HOLDINGS, LLC (US)

11601 Wilshire blvd. Suite 2300, Los Angeles, CA 90025 (US)

(72) Colin Sapphire (US)

(74) Shalva Gvaramadze (GE)

(54) **1. BLENDER, 2. BLENDER CASE 3. BLENDER CUTTERS HOLDER, 4. BLENDER CONTAINER**

(55)

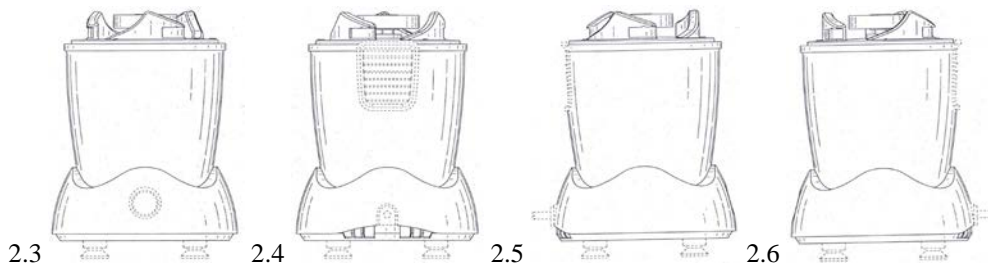
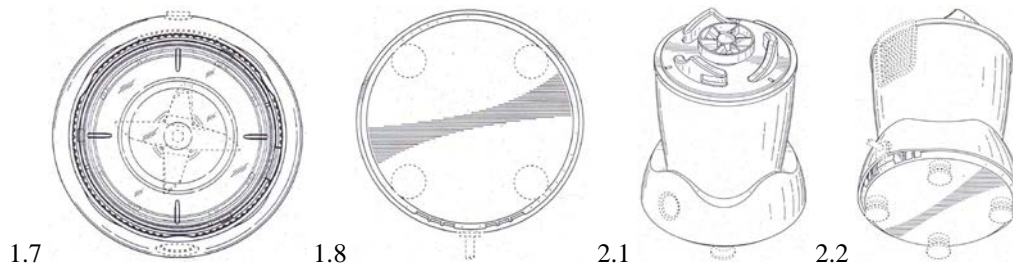
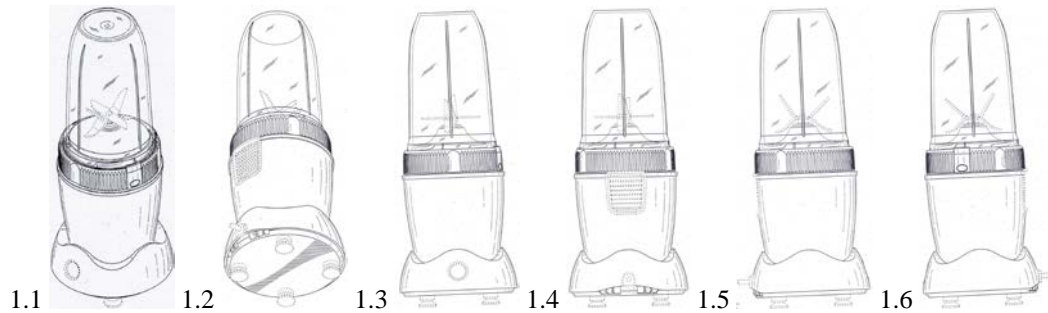

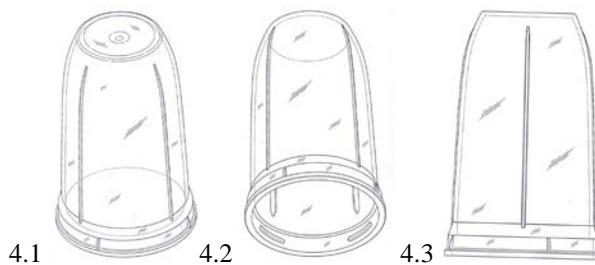
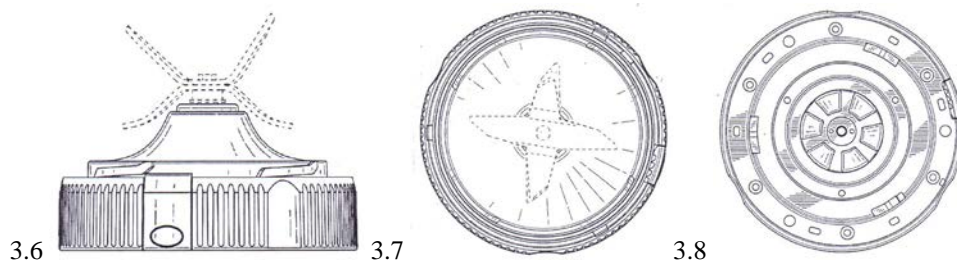
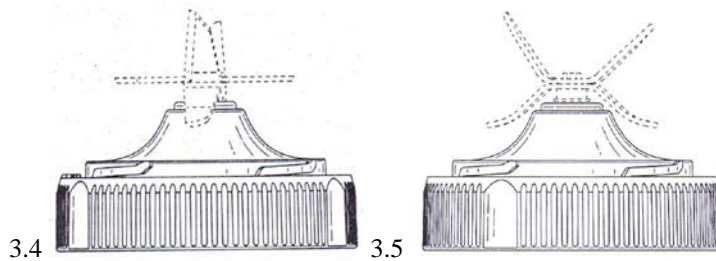
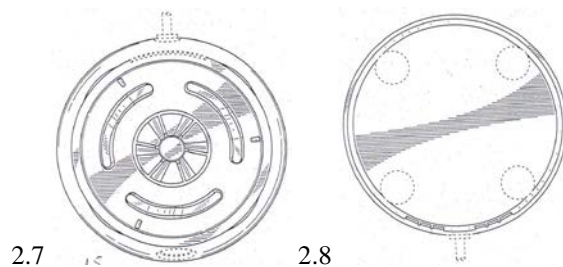

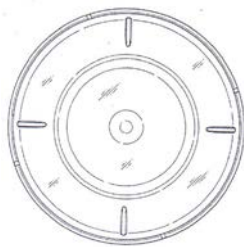

4.4

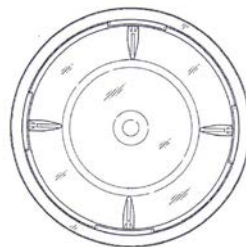

4.5

DESIGNS, WHICH HAVE BEEN REGISTERED WITH THE INTERNATIONAL BUREAU CLAIMING PRIORITY ON THE TERRITORY OF GEORGIA

The decision can be appealed at the Chamber of Appeal of Sakpatenti within 3 months from the publication or at the Mtskheta District Court Administrative Cases Board (Address: №17, Samkhedro Str., Mtskheta), within 1 month following the publication.

- (11) **DM/099038** (51) **10-07**
 (15) 2017 12 18 (45) 2018/24 (2018 06 22)
 (22) 2017 12 18
 (28) 5
 (73) MONTRES JAQUET DROZ SA (MONTRES JAQUET DROZ AG) (MONTRES JAQUET DROZ LTD)
 Allée du Tourbillon 2, CH-2300 La Chaux-de-Fonds (CH)
 (85) CH
 (86) CH
 (87) CH
 (88) CH
 (89) CH
 (81) II. BZ, MA III. AL, AM, AZ, BA, CH, EM, GE, KG, LI, MC, MD, ME, MK, MN, NO, OM, SG, TN,
 TR, UA
 (72) Christian Lattmann
 Chemin du Château-Neuf 17, CH-1125 Monnaz, Suisse;
 Le Ngoc Thanh
 1 rue du Clos de la Fontaine, F-25500 Le Belieu, France
 (54) 1.-2. Dials; 3. Oscillating weight; 4. Dial; 5. Oscillating weight
 (55)



1.6



2.1



2.2



2.3



2.4



2.6

2.5



3.1



3.2



3.3



3.4



3.5



3.6



3.7



3.8



4.1



4.2



4.3



4.4



4.6

4.5



5.1



5.2

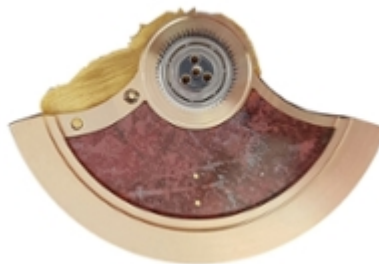

5.3



5.4



5.5



5.6



5.7



5.8

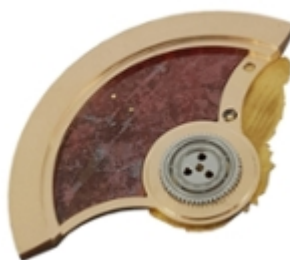

(11) DM/099091

(15) 2017 12 20

(22) 2017 12 20

(28) 1

(73) BLANCPAIN SA

Le Rocher 12, CH-1348 LE BRASSUS (CH)

(85) CH

(86) CH

(87) CH

(88) CH

(89) CH

(81) IL, BZ, MA III, AL, AM, AZ, BA, CH, EM, GE, KG, LI, MC, MD, ME, MK, MN, NO, OM, SG, TN, TR, UA

(72) Patrice NANGA

Avenue Dapples 26, CH-1006 Lausanne, Suisse;

Fabien HENRIET

57A Impasse de la Colombière, F-74200 Marin, France

(54) 1. Dial

(55)

1.1

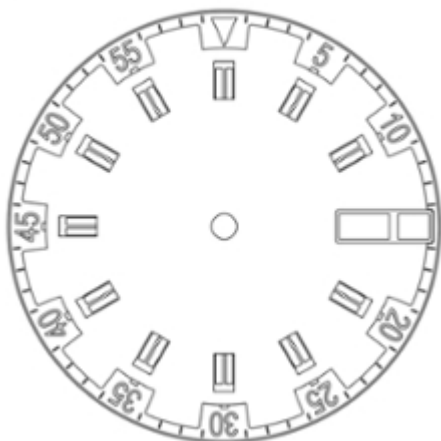

1.2



(11) DM/099109

(51) 10-02

(15) 2017 12 21

(45) 2018/24 (2018 06 22)

(22) 2017 12 21

(28) 7

(73) MONTRES BREGUET S.A.

Place de la Tour 23, CH-1344 L'ABBAYE (CH)

(85) CH

(86) CH

(87) CH

(88) CH

(89) CH

(81) II. BZ, MA III. AL, AM, AZ, BA, CH, EM, GE, KG, LI, MC, MD, ME, MK, MN, NO, OM, SG, TN, TR, UA

(72) Vincent LAUCELLA

Route de France 38, CH-1348 Le Brassus, Suisse

(54) 1.-7. Watches

(55)

1.1



1.2

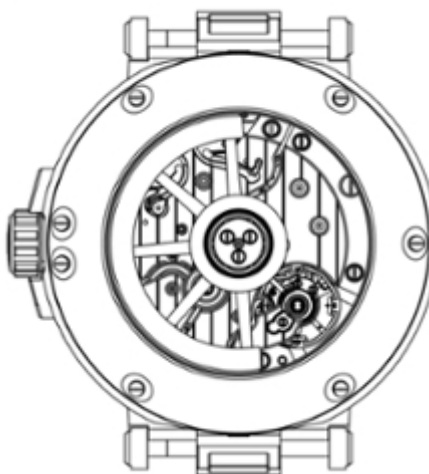

1.3



1.4



1.5

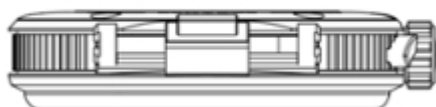

1.6



1.7

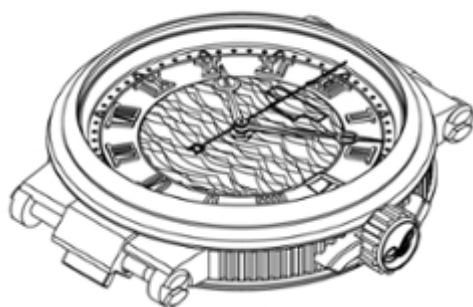

1.8



2.1



2.2

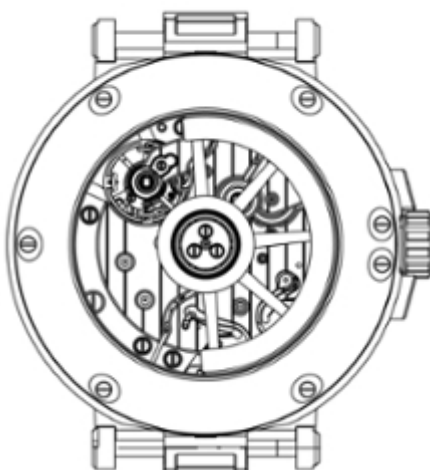

2.3



2.4



2.5

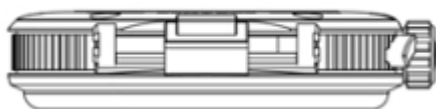

2.6



2.7



2.8



3.1



3.2



3.3



3.4

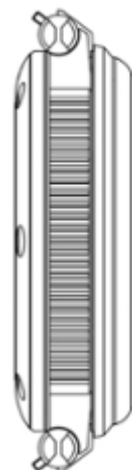

3.5

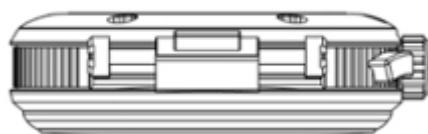

3.6

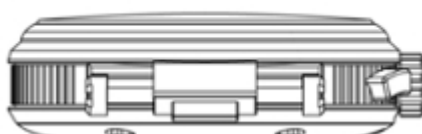

3.7



3.8



4.1



4.2



4.3

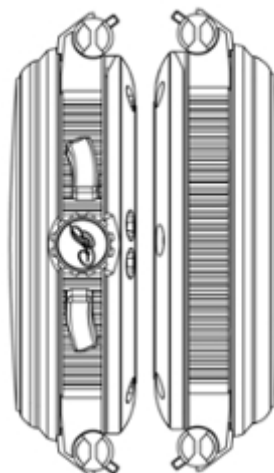

4.4

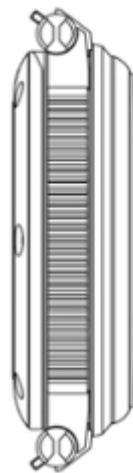

4.5

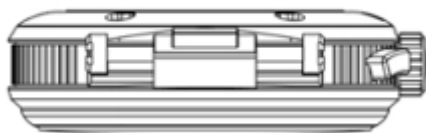

4.6



4.7



4.8



5.1



5.2

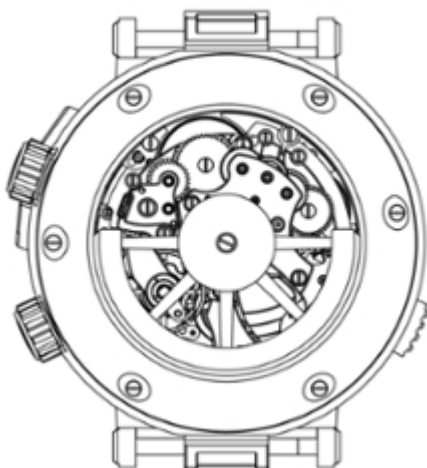

5.3

5.4

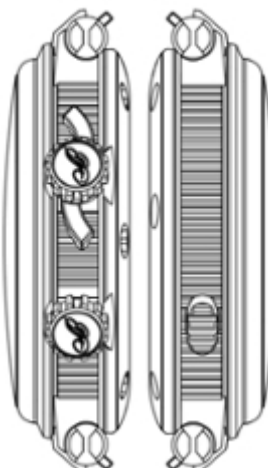

5.5

5.6

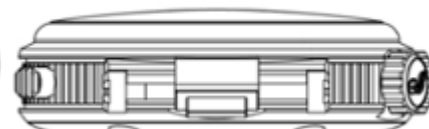
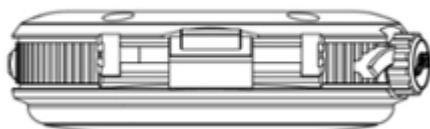

5.7

5.8



6.1

6.2

6.3

6.4

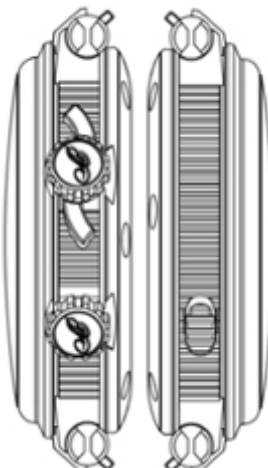
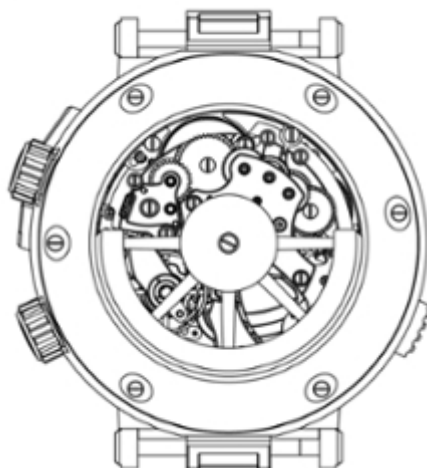

6.5

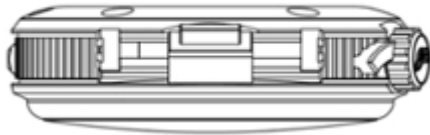

6.6

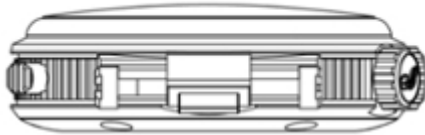

6.7



6.8

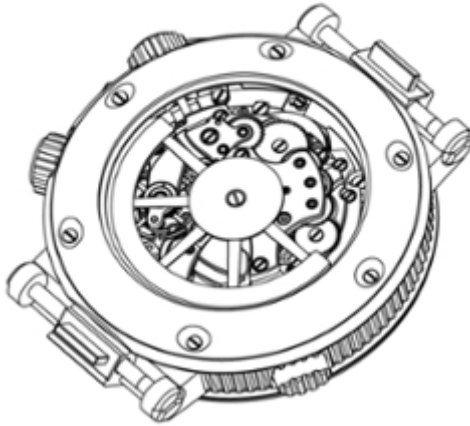

7.1



7.2



7.3



7.4

7.5



7.6

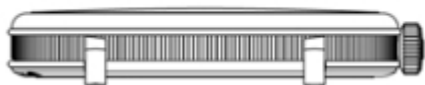

7.7



7.8



(11) DM/099118

(15) 2017 12 21

(22) 2017 12 21

(28) 2

(73) MONTRES BREGUET S.A.

Place de la Tour 23, CH-1344 L'ABBAYE (CH)

(85) CH

(86) CH

(87) CH

(88) CH

(89) CH

(81) IL, BZ, MA III, AL, AM, AZ, BA, CH, EM, GE, KG, LI, MC, MD, ME, MK, MN, NO, OM, SG, TN, TR, UA

(72) Vincent LAUCELLA

Route de France 38, CH-1348 Le Brassus, Suisse

(54) 1.-2. Watch bracelets

(55)

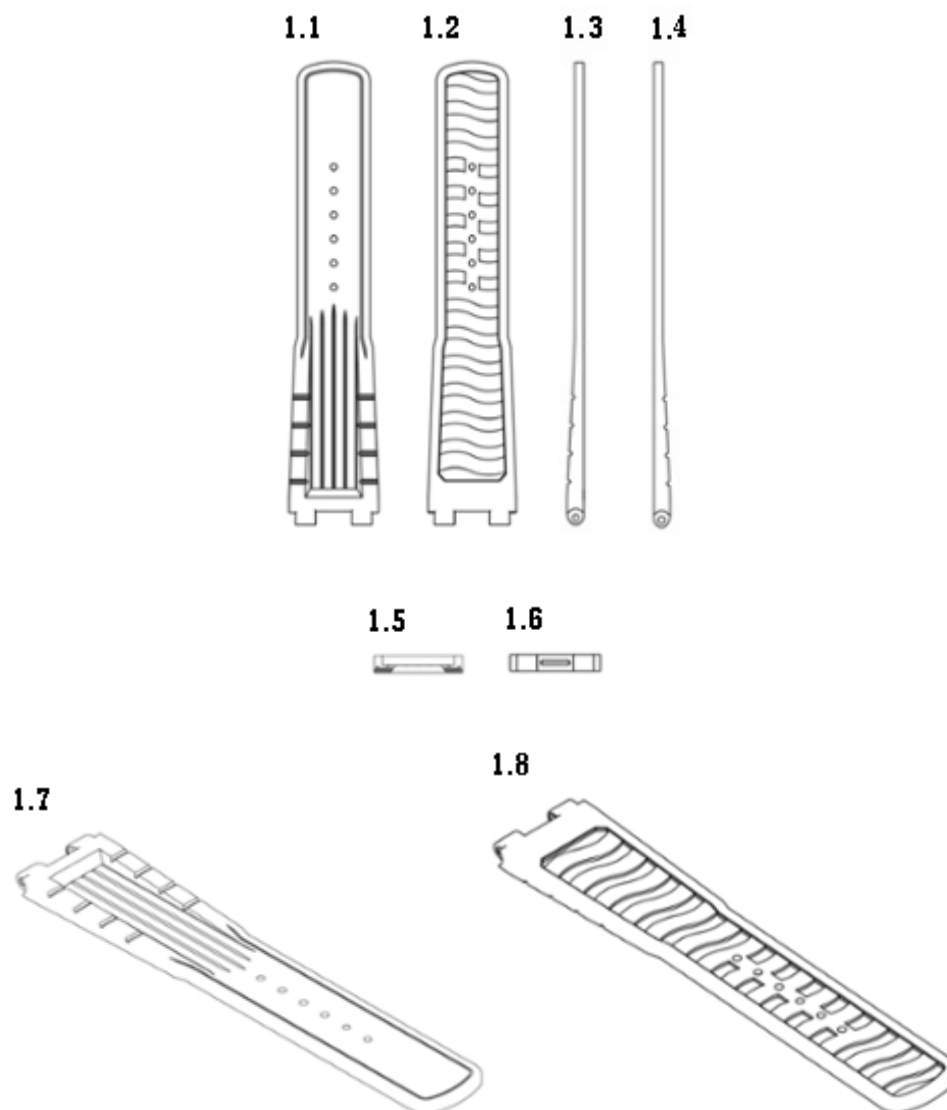

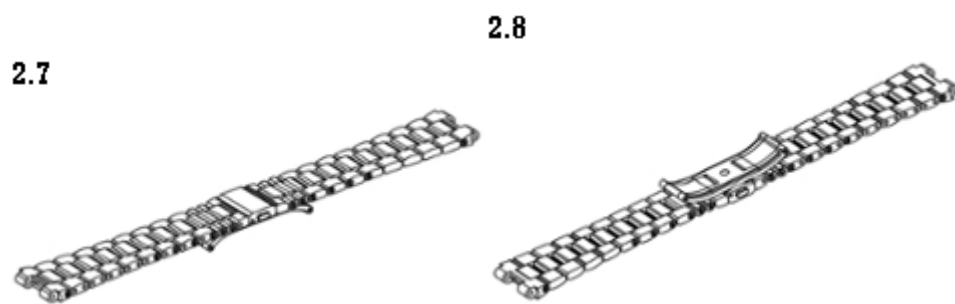
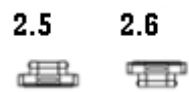
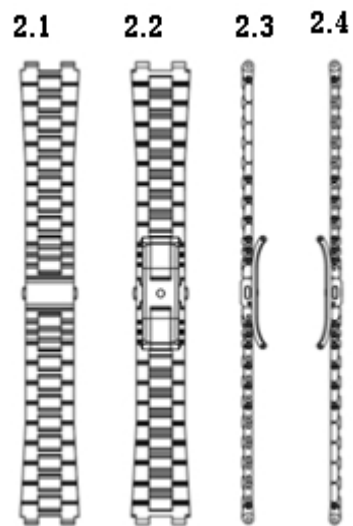

(11) DM/098287**(51) 10-07**

(15) 2017 10 25

(45) 2018/25 (2018 06 29)

(22) 2017 10 25

(28) 1

(73) SWATCH AG (SWATCH SA) (SWATCH LTD.)

Jakob-Stämpfli-Strasse 94, CH-2502 Biel/Bienne (CH)

(85) CH

(86) CH

(87) CH

(88) CH

(89) CH

(81) II. BZ, MA III. AL, AM, AZ, BA, CH, EM, GE, KG, LI, MD, ME, MK, MN, OM, SG, TN, TR

(72) Per BOLMSTRAND

Hjortronvägen 9, SE-16859 Bromma, Suède;

Thomas SCHAAD

Rödabergsgatan 8, SE-11133 Stockholm, Suède

(54) 1. Watch case

(55)

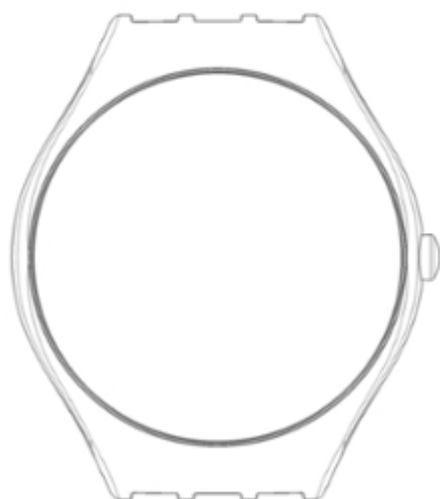
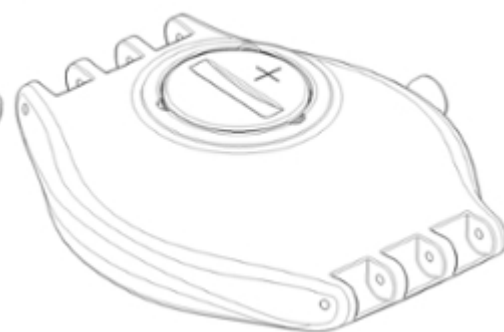
1.1**1.2****1.3****1.4****1.5****1.6****1.7****1.8**

(11) DM/101607

(15) 2018 02 20

(22) 2018 02 20

(28) 3

(30) No. 1: 22.08.2017; 004159507-0001; EM; No. 3: 22.08.2017; 004159507-0002; EM; No. 2: 22.08.2017; 004159507-0003; EM

(73) KAZAR FOOTWEAR SPÓŁKA Z OGRANICZONĄ ODPOWIEDZIALNOŚCIĄ

Lwowska 154, PL-37-700 Przemyśl (PL)

(85) –

(86) PL, EM

(87) PL, EM

(88) PL, EM

(89) PL

(81) III. AL, AM, AZ, BA, CH, EG, GE, IS, JP, KG, LI, MD, ME, MK, NO, RS, SG, SY, TM, TN, UA, US

(72) Lorenzo Rocco

Via Tutoli No. 16, 83030 Pietradefusi Avellino, Italy

(54) 1. Surface pattern; 2. Ornamentation; 3. Surface pattern

(55)

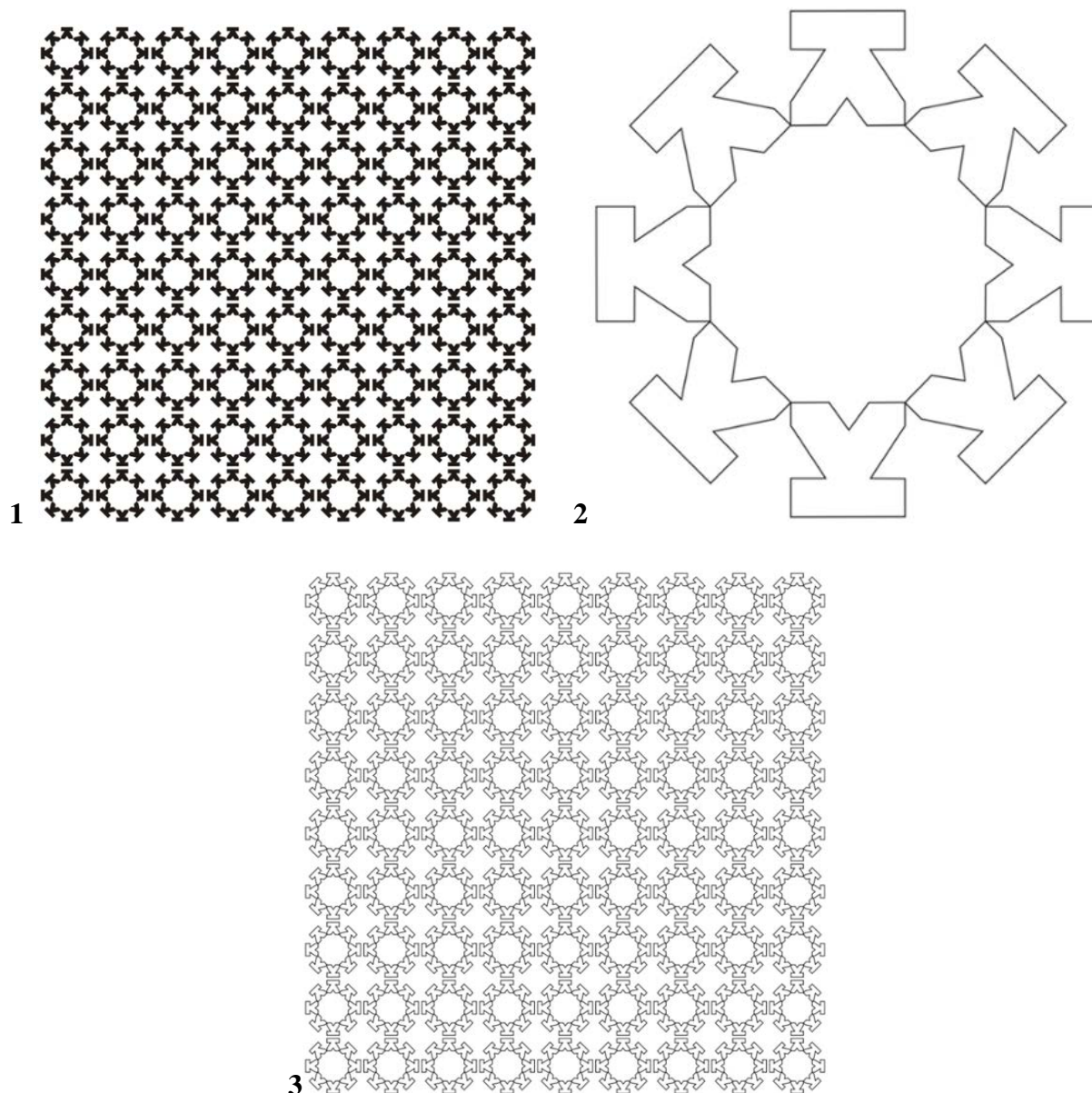

(11) DM/101617

(15) 2018 05 17

(22) 2018 05 17

(28) 2

(73) VALENTINO S.P.A.

Via Turati, 16/18, I-20121 Milano (IT)

(85) –

(86) EM, IT

(87) EM, IT

(88) EM, IT

(89) EM

(81) III. AZ, EM, GE, JP, KG, KR, RU, TJ, TR, UA

(72) SASSI Stefano

c/o VALENTINO S.p.A., Via Turati, 16/18, I-20121 Milano, Italy

(54) 1.-2. Shoes

(55)

(51) 02-04

(45) 2018/25 (2018 06 29)

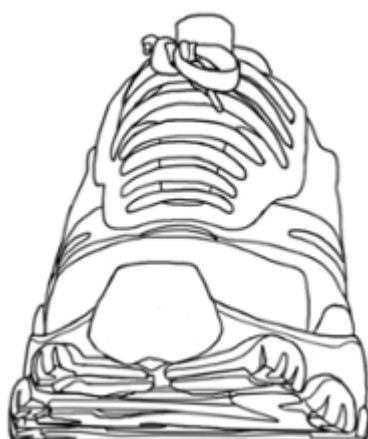
1.1**1.2****1.3**

1.4



1.5



1.6

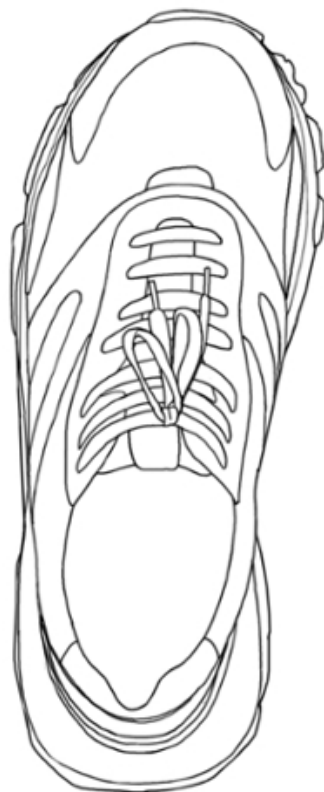

1.7



1.8



2.1



2.2



2.3



2.4



2.5



2.6

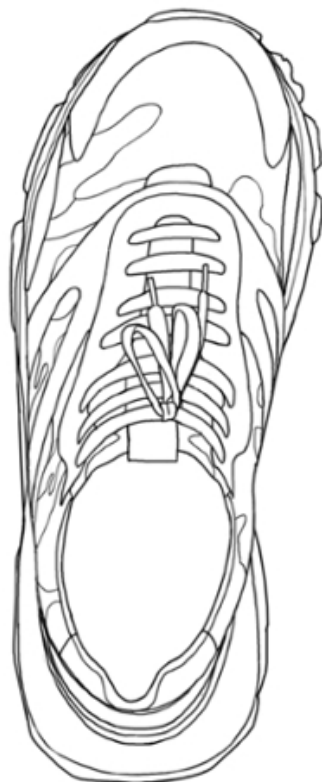

2.7



(11) DM/101720

(51) 21-01

(15) 2018 05 15

(45) 2018/26 (2018 07 06)

(22) 2018 05 15

(28) 1

(30) No. 1: 16.11.2017; 6022166; GB

(73) STEVEN DANIELS

32 Toucan Street, Trowbridge BA14 7FY (GB)

(85) EM

(86) EM

(87) EM

(88) EM

(89) EM

(81) III. AL, AM, AZ, BA, BN, BW, CH, EG, EM, GE, GH, IS, JP, KG, KH, KP, KR, LI, MC, MD, ME, MK, MN, NA, OA, OM, RS, RU, RW, SG, SI, ST, SY, TJ, TM, TN, TR, UA, US

(72) STEVEN DANIELS

32 TOUCAN STREET, BA14 7FY TROWBRIDGE, United Kingdom;

TIMOTHY ALAN BIRD

31 MATRAVERS CLOSE, BA13 3NS WESRTBURY, United Kingdom

(54) 1. Set of game pieces

(55)

1.1



1.2



1.3

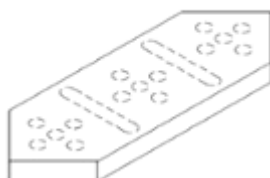

1.4



1.5



1.6



1.7



(11) DM/099471

(51) 10-07

(15) 2018 01 05

(45) 2018/27 (2018 07 13)

(22) 2018 01 05

(28) 5

(73) HARRY WINSTON SA

Chemin du Tourbillon 8, CH-1228 Plan-les-Ouates (CH)

(85) CH

(86) CH

(87) CH

(88) CH

(89) CH

(81) II. BZ, MA III. AL, AM, AZ, BA, CH, EM, GE, KG, LI, MC, MD, ME, MK, MN, NO, OM, SG, TN, TR, UA

(72) Faubourg

du Lac 6, CH-2501 Biel/Bienne

(54) 1.-4. Cadrans; 5. Masse oscillante

(55)

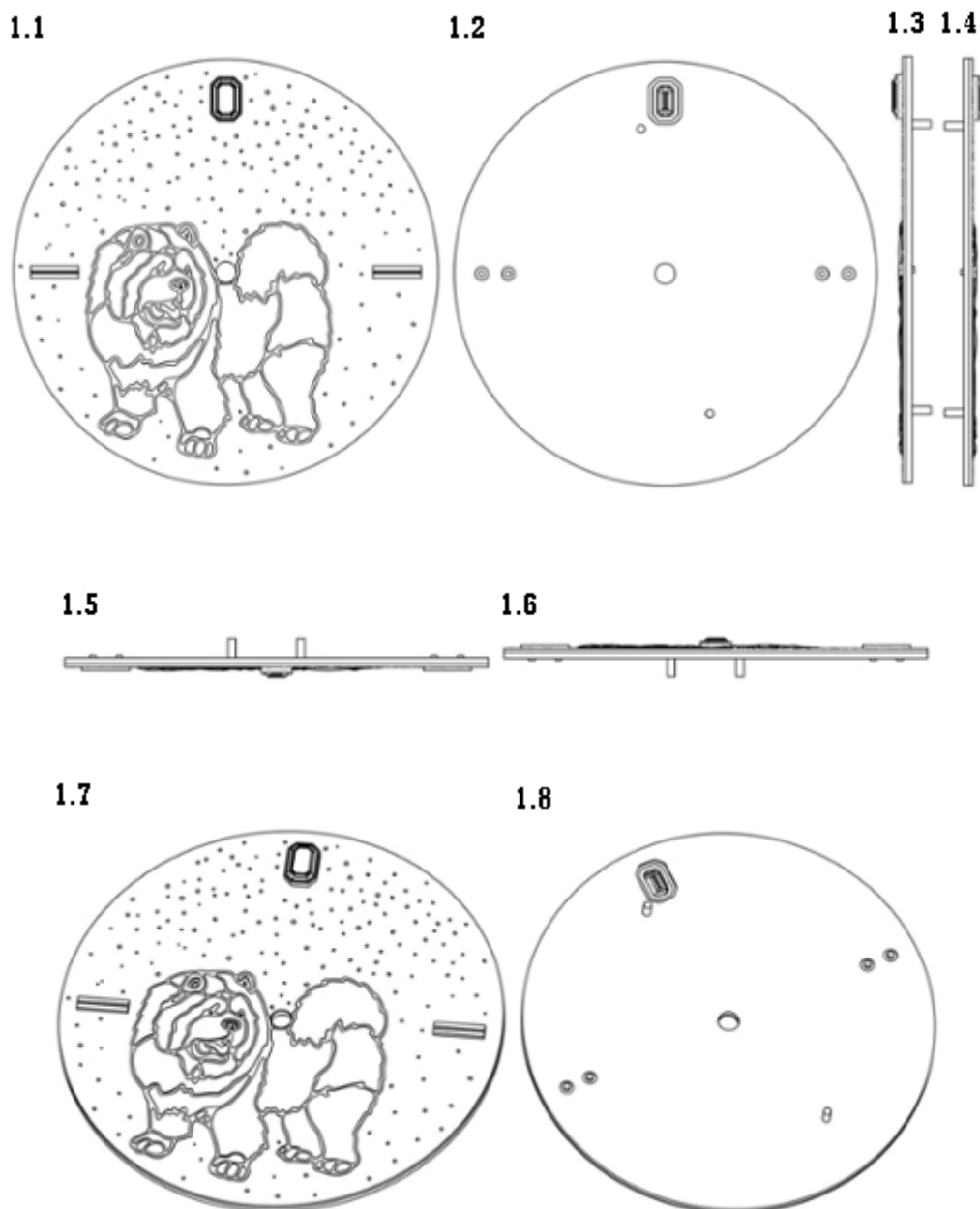

2.1



2.2



2.3 2.4



2.5



2.6



2.7



2.8

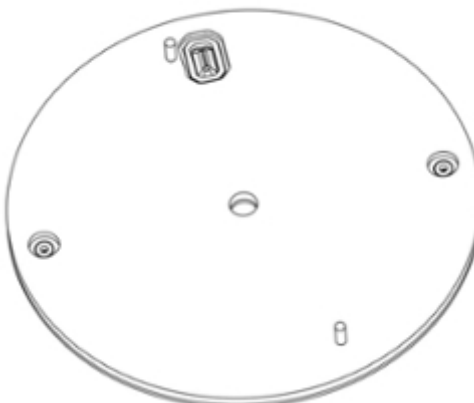

3.1

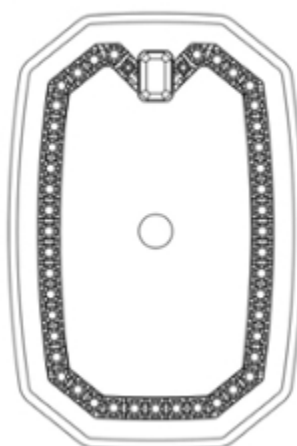

3.2

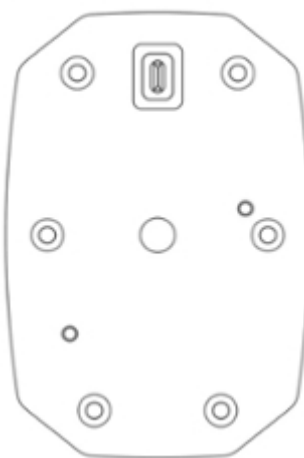

3.3

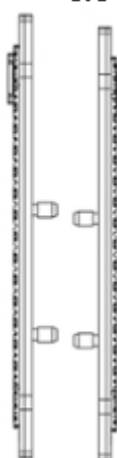

3.4

3.5



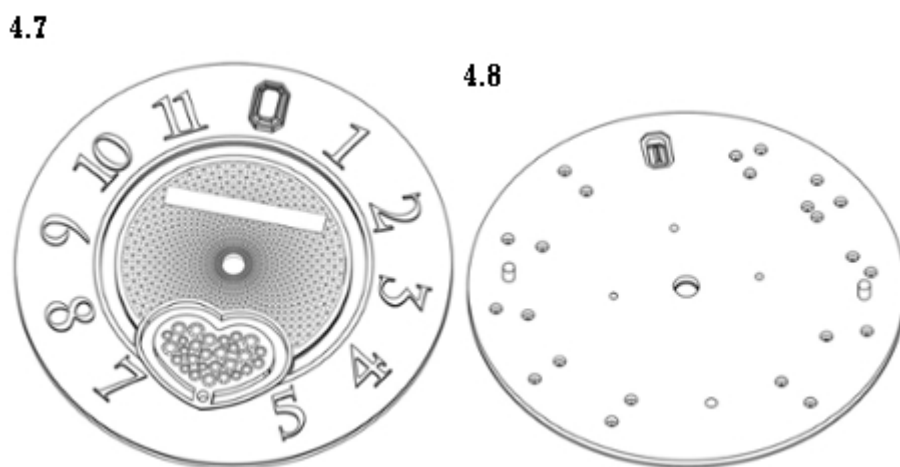
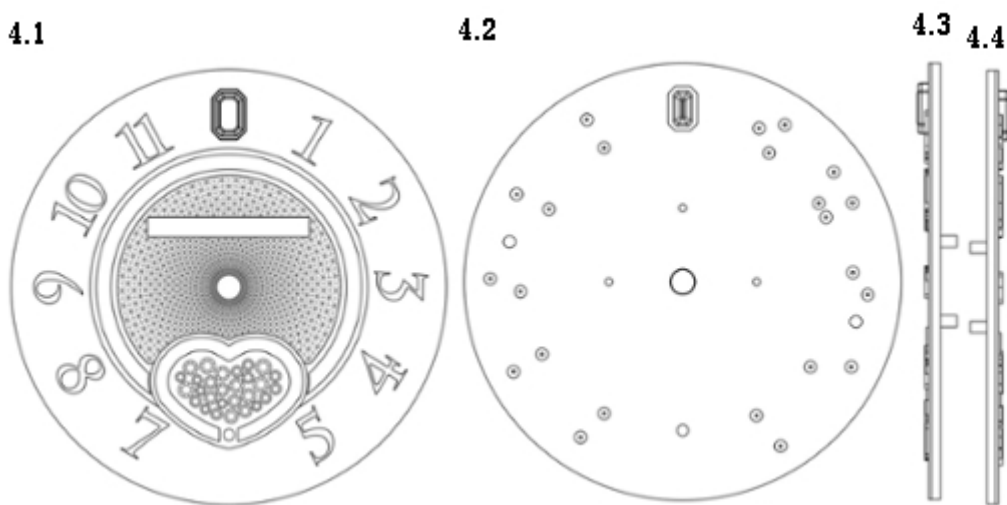
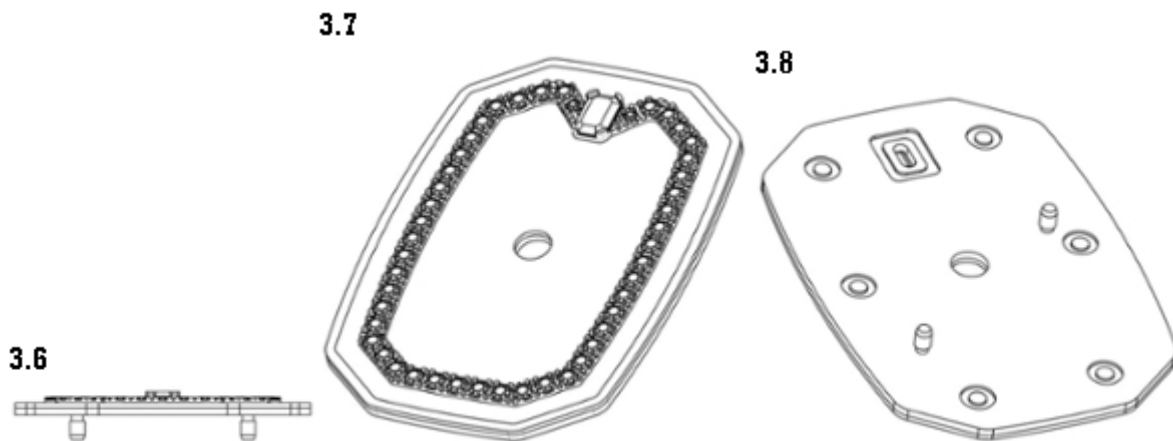

5.1



5.2



5.3 5.4



5.5



5.6



5.7



5.8



TRADEMARKS

APPLICATIONS FILED UNDER THE NATIONAL PROCEDURE APPROVED FOR REGISTRATION

The decision can be appealed at the Chamber of Appeal of Sakpatenti within 3 months from the publication or at the Mtskheta District Court Administrative Cases Board (Address: №17, Samkhedro St., Mtskheta), within 1 month following the publication.

(260) AM 2018 91291 A
(210) AM 91291
(220) 2017 03 20
(731) Bosnalijeki D.d, Pharmaceutical end
Chemical Industry JSC
7100 Saraevo, Zhukicheva 53, Bosnia and
Herzegovina
(740) Davit Zurabishvili
(540)

LYSOBACT SPRAY

(511) 5

(260) AM 2018 91292 A
(210) AM 91292
(220) 2017 03 20
(731) Bosnalijeki D.d, Pharmaceutical end
Chemical Industry JSC
7100 Saraevo, Zhukicheva 53, Bosnia and
Herzegovina
(740) Davit Zurabishvili
(540)

**LYSOBACT
COMPLETE SPRAY**

(511) 5

(260) AM 2018 91293 A
(210) AM 91293
(220) 2017 03 20
(731) Bosnalijeki D.d, Pharmaceutical end
Chemical Industry JSC
7100 Saraevo, Zhukicheva 53, Bosnia and
Herzegovina
(740) Davit Zurabishvili
(540)

LYSOBACT DUO

(511) 5

(260) AM 2018 92105 A
(210) AM 92105
(220) 2017 05 15
(731) LTD "MIRIDA"

Sushovskiy Val 3/5, Moscow, Russian
Federation
(740) Natalia Pirtskhalava
(540)

**წმინდა თამარ მეფის
პანთეონი**

(526) თამარ მეფე
(511) 16

(260) AM 2018 93349 A*
(210) AM 93349
(220) 2017 07 14
(731) Zorluteks Tekstil Ticaret
Ve Sanayi Anonim Şirketi
Leventi 199 Biuiuqdere Jadesi No: 199 34394
Shishli, Stamboli, Turkey
(740) Tamaz Shilakadze
(540)



(591) Red, white, grey
(531) 24.07.01; 24.07.23; 26.04.06; 26.04.24;
27.05.24;
29.01.13
(511) 21

(260) AM 2018 95689 A
(210) AM 95689
(220) 2017 12 28
(731) Shenzhen Times Innovation Technology Co.,
Ltd
Room 03, 6/F, Building 3, WINLEAD,
Fada Road, Bantian Street, Longgang District,
Shenzhen City, Guangdong Province, China
(540)

Baseus

(591) Black-white
(531) 27.05.01; 27.05.17
(511) 9, 35

(260) AM 2018 95713 A
 (210) AM 95713
 (220) 2017 12 29
 (731) Kraft Foods Schweiz Holding GmbH
 Chollerstrasse 4, Zug 6301, Switzerland
 (740) Giorgi Taktakishvili
 (540)

MILKA CHOCO COOKIE

(591) Black-white
 (511) 30

(260) AM 2018 95714 A
 (210) AM 95714
 (220) 2017 12 29
 (731) Kraft Foods Schweiz Holding GmbH
 Chollerstrasse 4, Zug 6301, Switzerland
 (740) Giorgi Taktakishvili
 (540)

MILKA SOFT & CHOC

(591) Black-white
 (511) 30

(260) AM 2018 95715 A
 (210) AM 95715
 (220) 2017 12 29
 (731) Kraft Foods Schweiz Holding GmbH
 Chollerstrasse 4, Zug 6301, Switzerland
 (740) Giorgi Taktakishvili
 (540)

MILKA CHOCO COW

(591) Black-white
 (511) 30

(260) AM 2018 95758 A
 (210) AM 95758
 (220) 2018 01 04
 (731) NSAR GENERAL TRADING LLC
 P.O. Box 171611, Dubai, United Arab
 Emirates
 (740) Vakhtang Torotadze
 (540)



(591) Red, blue, grey, white
 (531) 03.01.02; 03.01.20; 03.01.22; 24.01.15;
 25.01.05; 27.05.17; 29.01.14
 (511) 34

(260) AM 2018 95801 A
 (210) AM 95801
 (220) 2018 01 05
 (731) LTD "MIRA-HOTELS"
 Kipshidzis q. 20, b. 4, 0162, Tbilisi,
 Georgia
 (740) Giorgi Taktakishvili
 (540)

The Collection Hotel

(591) Black-white
 (511) 43

(260) AM 2018 95830 A
 (210) AM 95830
 (220) 2018 01 05
 (731) Al - Safeh Restaurant
 Ze Hashimit Kingdom Of Jordan, Amman, Jordan
 Televijn Imploii'z Hausing, Iasmin Eria, Kuaider
 Khraisat Str., Bldg. 25, P.o. Boqs 568 Amani 11941,
 Jordan
 (740) Merab Kvimsadze
 (540)



(591) Black, red, white
 (531) 08.01.06; 24.01.15; 27.05.17; 27.05.24;
 29.01.13
 (511) 43

(260) AM 2018 95987 A
 (210) AM 95987
 (220) 2018 01 16
 (731) LTD "La-Gvini"
 Al. Kazbegis gamz. 11a, b. 42, 0177,
 Tbilisi, Georgia
 (540)

villa godoly

ვილა გოდოლი

(591) Black-white
 (511) 43

(260) AM 2018 96115 A
 (210) AM 96115
 (220) 2018 01 25

(731) LTD "WINE ARTS"
I. Chavchavadzis gamz. 16, b. 10, 0179,
Tbilisi, Georgia
(740) Ivane Martiashvili
(540)

ეთნო
Ethno

(591) Black-white
(511) 30, 32, 33, 35, 41, 43

(260) AM 2018 96154 A
(210) AM 96154
(220) 2018 01 29
(731) Mindshare Media UK Limited
Central St Giles, 1 St Giles High Street,
London WC2H 8AR, United Kingdom
(740) Tamaz Shilakadze
(540)

MINDSHARE

(591) Black-white
(511) 35

(260) AM 2018 96155 A
(210) AM 96155
(220) 2018 01 29
(731) Wavemaker Global Limited
18 Sea Containers, Upper Ground, London
SE1 9E, United Kingdom
(740) Tamaz Shilakadze
(540)

WAVEMAKER

(591) Black-white
(511) 35

(260) AM 2018 96240 A
(210) AM 96240
(220) 2018 02 05
(731) LTD "L + COMPANY"
D. Bakradzis q. 6, 0119, Tbilisi, Georgia
(540)



(591) Blue, white, red, brown
(531) 19.03.24; 28.05; 29.01.14
(511) 34

(260) AM 2018 96307 A
(210) AM 96307
(220) 2018 02 12
(731) Gela Mikadze
Lalionis shesakhvevi 5, 0101, Tbilisi,
Georgia
(540)

Noir Cafe

(591) Black-white
(511) 43

(260) AM 2018 96308 A
(210) AM 96308
(220) 2018 02 12
(731) LTD "SVI"
M. Kostavas q. 75, b. 31, 0171, Tbilisi,
Georgia
(540)

ჟუჟუნა
Jujuna
Жужуна

(591) Black-white
(511) 30, 32, 33, 43

(260) AM 2018 96313 A
(210) AM 96313
(220) 2018 02 13
(731) LTD "გლორია LLC GLORIA"
V. Gorgaslis q. 3, 0105, Tbilisi,
Georgia
(540)



THE
GRAND GLORIA
HOTEL

(591) Black, golden
(531) 26.01.11; 26.01.18; 27.01.06; 27.05.10;
27.05.11;
29.01.12
(511) 43

(260) AM 2018 96485 A
(210) AM 96485
(220) 2018 02 21
(731) Intersun Holding FZCO
P.O. Box 61051 Jebel Ali Free Zone, Dubai,
United Arab Emirates
(740) Tamar Kochlamazashvili
(540)



(591) Red, yellow
(531) 26.11.13; 26.13.25; 28.05
(511) 30, 35

(260) AM 2018 96545 A
(210) AM 96545
(220) 2018 02 26
(731) Hankook Tire Worldwide Co., Ltd
647-15, Yoksam-dong, Kangnam-gu, Seoul,
Republic of Korea
(740) Merab Kvimsadze
(540)

 **HANKOOK** Tire & Technology

(591) Black-white
(531) 26.13.25; 27.05.10
(511) 12

REGISTERED TRADEMARKS

(111) M 2018 30095 R
(151) 2018 09 05
(181) 2028 09 05
(260) AM 2016 88989 A
(220) 2016 10 13
(732) JSC "TERMA"

Budapeshtis q. 10, 1 sart., 0160, Tbilisi,
Georgia

(111) M 2018 30096 R
(151) 2018 09 05
(181) 2028 09 05
(260) AM 2016 89904 A
(220) 2016 12 12
(732) AVAYA INC.

4655 Great America Parkway, Santa Clara,
California 95054, USA

(111) M 2018 30097 R
(151) 2018 09 05
(181) 2028 09 05
(260) AM 2017 91092 A
(220) 2017 03 01
(732) SHARINOV EVGENI PAVLOVICH

Slobozhanskiy prospekt, dom 1, kv. 178,
Dnepr, Ukraina

(111) M 2018 30098 R
(151) 2018 09 05
(181) 2028 09 05
(260) AM 2017 91846 A
(220) 2017 04 26
(732) LTD "FIERNA"

L. Gotuas q. 12, 0160, Tbilisi, Georgia

(111) M 2018 30099 R
(151) 2018 09 05
(181) 2028 09 05
(260) AM 2017 91847 A
(220) 2017 04 26
(732) LTD "FIERNA"

L. Gotuas q. 12, 0160, Tbilisi, Georgia

(111) M 2018 30100 R
(151) 2018 09 05
(181) 2028 09 05
(260) AM 2017 91848 A
(220) 2017 04 26
(732) LTD "FIERNA"

L. Gotuas q. 12, 0160, Tbilisi, Georgia

(111) M 2018 30101 R
(151) 2018 09 05
(181) 2028 09 05
(260) AM 2017 91851 A
(220) 2017 04 26
(732) LTD "FIERNA"

L. Gotuas q. 12, 0160, Tbilisi, Georgia

(111) M 2018 30102 R
(151) 2018 09 05
(181) 2028 09 05
(260) AM 2017 91865 A
(220) 2017 04 27
(732)) JSC "TIERRAS DE ARMENIA"

1st Blind Alley, M. Khorenatsi Street,
Building 8, Apartment A2, Yerevan, Armenia

(111) M 2018 30103 R
(151) 2018 09 05
(181) 2028 09 05
(260) AM 2017 91957 A
(220) 2017 05 03
(732) YONGKANG XULANG INDUSTRY AND

TRADE CO., LTD
No.216 Meilong Roud, Khicheng, Iongkang,
Jejiang, China

(111) M 2018 30104 R
(151) 2018 09 05
(181) 2028 09 05
(260) AM 2017 92189 A
(220) 2017 05 18
(732) LTD "ORION GROUP"

I. Chavchavadzis gamz. 75, b. 53, 0162, Tbilisi,
Georgia

(111) M 2018 30105 R
(151) 2018 09 05
(181) 2028 09 05
(260) AM 2017 92190 A
(220) 2017 05 18
(732) LTD "ORION GROUP"

I. Chavchavadzis gamz. 75, b. 53, 0162, Tbilisi,
Georgia

(111) M 2018 30106 R
(151) 2018 09 05
(181) 2028 09 05
(260) AM 2017 92213 A
(220) 2017 05 18

(732) HARRINGTON DEVELOPMENT INC.
Elvira Mendesis Striti, Valarino Bldg,
3th fl., Panama, Panamis Respublika,
Panama

Elvira Mendez Street, Vallarino Bldg, 3-rd
Floor, Panama, Republic of Panama

(111) M 2018 30107 R
(151) 2018 09 05
(181) 2028 09 05
(260) AM 2017 92608 A
(220) 2017 06 07
(732) LTD "JEMI"
Sop. Karajala, 2200, Telavi, Georgia

(111) M 2018 30113 R
(151) 2018 09 05
(181) 2028 09 05
(260) AM 2017 92850 A
(220) 2017 06 20
(732) HARRINGTON DEVELOPMENT INC.
Elvira Mendez Street, Vallarino Bldg, 3-rd
Floor, Panama, Republic of Panama

(111) M 2018 30108 R
(151) 2018 09 05
(181) 2028 09 05
(260) AM 2017 92617 A
(220) 2017 06 08
(732) TAIZHOU HAPPY WATER PUMP CO., LTD
DaYangCheng Industry Area, Daxi, Wenling
City, Zhejiang Province, China

(111) M 2018 30114 R
(151) 2018 09 05
(181) 2028 09 05
(260) AM 2017 93106 A
(220) 2017 07 04
(732) POTOMAC TOBACCO COMPANY LTD
Mill Mall, Suite 6, Wickhams Cay, Road
Town, Tortola, Virgin Islands (British)

(111) M 2018 30109 R
(151) 2018 09 05
(181) 2028 09 05
(260) AM 2017 92752 A
(220) 2017 06 12
(732) MAHDI GODRATI Asl
Kipshidzis q. 3b, I sadarbazo, sart. 6, b. 19,
0162, Tbilisi, Georgia

(111) M 2018 30115 R
(151) 2018 09 05
(181) 2028 09 05
(260) AM 2017 93294 A
(220) 2017 07 11
(732) CELGENE CORPORATION
86 Morris Avenue, Summit, New Jersey
07901, USA

(111) M 2018 30110 R
(151) 2018 09 05
(181) 2028 09 05
(260) AM 2017 92765 A
(220) 2017 06 13
(732) SOPIO JINTCHARADZE
Sop. Legva, 6200, Kobuleti, Georgia

(111) M 2018 30116 R
(151) 2018 09 05
(181) 2028 09 05
(260) AM 2017 93315 A
(220) 2017 07 12
(732) OTAR KATCHKATCHASHVILI
Sop. Arali, Adigeni, Adigenis r-ni, Georgia

(111) M 2018 30111 R
(151) 2018 09 05
(181) 2028 09 05
(260) AM 2017 92793 A
(220) 2017 06 15
(732) SOPHARMA AD
16, Oulitsa "Iliensko chaussee", BG-1220
Sofia, Bulgaria

(111) M 2018 30117 R
(151) 2018 09 05
(181) 2028 09 05
(260) AM 2017 93328 A
(220) 2017 07 13
(732) LALI KHORKHELI
Kikodzis q. 9, b. 21, 0105, Tbilisi, Georgia

(111) M 2018 30112 R
(151) 2018 09 05
(181) 2028 09 05
(260) AM 2017 92848 A
(220) 2017 06 20
(732) HARRINGTON DEVELOPMENT INC.

(111) M 2018 30118 R
(151) 2018 09 05
(181) 2028 09 05
(260) AM 2017 93499 A
(220) 2017 07 26
(732) JSC "INSURANCE GROUP OF GEORGIA"
Marijanis q. 4, 0186, Tbilisi, Georgia

(111) M 2018 30119 R
(151) 2018 09 05
(181) 2028 09 05
(260) AM 2017 93500 A
(220) 2017 07 26
(732) JSC "INSURANCE GROUP OF GEORGIA"
Marijanis q. 4, 0186, Tbilisi, Georgia

(111) M 2018 30120 R
(151) 2018 09 05
(181) 2028 09 05
(260) AM 2017 93627 A
(220) 2017 08 04
(732) BUDGET RENT A CAR SYSTEM INC.
6 Sylvan Way, Parsippany, New Jersey
07054, USA

(111) M 2018 30121 R
(151) 2018 09 05
(181) 2028 09 05
(260) AM 2017 93629 A
(220) 2017 08 04
(732) BUDGET RENT A CAR SYSTEM INC.
6 Sylvan Way, Parsippany, New Jersey
07054, USA

(111) M 2018 30122 R
(151) 2018 09 05
(181) 2028 09 05
(260) AM 2017 93691 A
(220) 2017 08 08
(732) LEPL Millennium Challenge Account –
Georgia (MCA-Georgia)
Kostavas q. 5, 0108, Tbilisi, Georgia

(111) M 2018 30123 R
(151) 2018 09 05
(181) 2028 09 05
(260) AM 2017 93811 A
(220) 2017 08 18
(732) INTERNATIONAL LIMITED
36 Robinson Road # 04-01 City House,
Singapore 068877, Singapore

(111) M 2018 30124 R
(151) 2018 09 05
(181) 2028 09 05
(260) AM 2017 93846 A
(220) 2017 08 22
(732) GIORGI IUKURIDZE
19, Gukovskogo Str., flat 6, Odesa, Ukraine

(111) M 2018 30125 R
(151) 2018 09 05
(181) 2028 09 05
(260) AM 2017 93852 A
(220) 2017 08 23
(732) TAMAR AMASHUKELI
I. Chavchavadzis gamz. 11a, 0179, Tbilisi,
Georgia

(111) M 2018 30126 R
(151) 2018 09 05
(181) 2028 09 05
(260) AM 2017 93913 A
(220) 2017 08 29
(732) ASSUTA MEDICAL CENTERS LTD.
Habarzel St.. 20, Tel-Aviv-Yafo, Israel

(111) M 2018 30127 R
(151) 2018 09 05
(181) 2028 09 05
(260) AM 2017 94053 A
(220) 2017 09 05
(732) JSC "TBILVINO"
Sarajishvilis gam 2, 0153, Tbilisi, Georgia

(111) M 2018 30128 R
(151) 2018 09 05
(181) 2028 09 05
(260) AM 2017 94309 A
(220) 2017 09 25
(732) LTD "PARK GIDA"
S. Khutsubani, me-5 ubani q. 46a, 6200,
Kobuleti, Georgia

(111) M 201 30129 R
(151) 2018 09 05
(181) 2028 09 05
(260) AM 2017 94312 A
(220) 2017 09 26
(732) BRITISH AMERIKEN TOBAKO (BREND)
INC.
251 Little Falls Drive, Suite 100, DE
19808-1674, Wilmington, USA

(111) M 2018 30130 R
(151) 2018 09 05
(181) 2028 09 05
(260) AM 2017 94348 A
(220) 2017 09 28
(732) LIA TKEMALADZE
Tashkentis q. 31, 0160, Tbilisi, Georgia;
NANA TOPURIA-NAKAIDZE
Paliashvilis q. 72, b. 30, 0179, Tbilisi, Georgia;
TARASI GABISONIA

I. Chavchavadzis gamz. 39b, 0162, Tbilisi,
Georgia;
INGA GIORGADZE
I. Nikoladzis q. 7, 0179, Tbilisi, Georgia;
LEPL G. Eliava Institute of Bacteriophage,
Microbiology and Virusology
Gotuas q. 3, 0160, Tbilisi, Georgia

(260) AM 2017 94358 A
(220) 2017 09 29
(732) LTD "VIP TRANS"
Z. Paliashvilis q. 21, 0186, Akhaltsikhe,
Georgia

(111) M 2018 30131 R
(151) 2018 09 05
(181) 2028 09 05
(260) AM 2017 94349 A
(220) 2017 09 28
(732) LIA TKEMALADZE
Tashkentis q. 31, 0160, Tbilisi, Georgia;
NANA TOPURIA-NAKAIDZE
Paliashvilis q. 72, b. 30, 0179, Tbilisi, Georgia;
TARASI GABISONIA
I. Chavchavadzis gamz. 39b, 0162, Tbilisi,
Georgia;
INGA GIORGADZE
I. Nikoladzis q. 7, 0179, Tbilisi, Georgia;
LEPL G. Eliava Institute of Bacteriophage,
Microbiology and Virusology
Gotuas q. 3, 0160, Tbilisi, Georgia

(111) M 2018 30132 R
(151) 2018 09 05
(181) 2028 09 05
(260) AM 2017 94350 A
(220) 2017 09 28
(732) LIA TKEMALADZE
Tashkentis q. 31, 0160, Tbilisi, Georgia;
NANA TOPURIA-NAKAIDZE
Paliashvilis q. 72, b. 30, 0179, Tbilisi, Georgia;
TARASI GABISONIA
I. Chavchavadzis gamz. 39b, 0162, Tbilisi,
Georgia;
INGA GIORGADZE
I. Nikoladzis q. 7, 0179, Tbilisi, Georgia;
LEPL G. Eliava Institute of Bacteriophage,
Microbiology and Virusology
Gotuas q. 3, 0160, Tbilisi, Georgia

(111) M 2018 30133 R
(151) 2018 09 05
(181) 2028 09 05
(260) AM 2017 94356 A
(220) 2017 09 29
(732) REIMA OY
Karhumaentie 3, 01530 Vantaa, Finland

(111) M 2018 30134 R
(151) 2018 09 05
(181) 2028 09 05

TRADEMARKS REGISTERED ACCORDING TO THE ACCELERATED PROCEDURE

The decision can be appealed at the Chamber of Appeal of Sakpatenti within 3 months from the publication.

(111) M 2018 30089 R
(151) 2018 08 24
(181) 2028 08 24
(210) AM 98969
(220) 2018 08 13
(732) LTD "CITY LOFT"
26 Maisis sakh. moedani,
0171, Tbilisi, Georgia
(740) Giorgi Taktakishvili
(540)

ავიატორი
Aviator

(591) Black-white
(511) 41

(111) M 2018 30090 R
(151) 2018 08 29
(181) 2028 08 29
(210) AM 98970
(220) 2018 08 13
(732) LTD "EPOCH"
Sop. Akhalsheni, Khelvachauris r-ni,
6000, Batumi, Georgia
(540)



(591) Black, yellow
(531) 01.03.01; 01.03.13; 01.03.16; 27.05.01;
27.05.09; 27.05.19; 29.01.12
(511) 43

(111) M 2018 30091 R
(151) 2018 08 31
(181) 2028 08 31
(210) AM 99055
(220) 2018 08 20
(732) Davit Jobava
Moskovis gamz. 38, b. 113, 0137,
Tbilisi, Georgia
(740) Levan Nanobashvili

(540)

ბობომ ობენე

(591) Black
(511) 33

(111) M 2018 30092 R
(151) 2018 08 31
(181) 2028 08 31
(210) AM 98976
(220) 2018 08 14
(732) LTD "REPUBLIC"
Akhvledianis q. 26, Orkhevis dasakhlebs
Tbilisi, Georgia
(540)

რანონა

(511) 29, 30, 32

(111) M 2018 30093 R
(151) 2018 09 03
(181) 2028 09 03
(210) AM 99085
(220) 2018 08 24
(732) LTD "SMARTSOFT"
Vazisubani, IV mkr., kvart. I, korp. 3,
b. 8, 0152, Tbilisi, Georgia
(540)

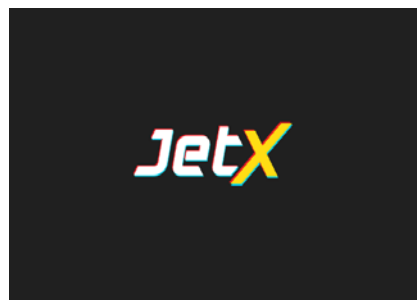

(591) White, black, yellow
(531) 26.04.02; 26.04.22; 26.04.24; 27.05.01;
27.05.24; 29.01.13
(511) 9, 41

(111) M 2018 30094 R
(151) 2018 09 03
(181) 2028 09 03
(210) AM 99052

(220) 2018 08 20

(732) LTD "MAKNATUNA"

Gugunavas q. 13 (nakv. N4-3/2), 4600,
Kutaisi, Georgia

(540)

ბუნკოპ



(591) Pink, blue, green, blue, red, purple, yellow,
black, brown, white

(531) 03.07.06; 03.07.24; 03.07.25; 29.01.15

(511) 29, 30

INTERNATIONAL TRADEMARKS FOR WHICH A DECISION ON GRANTING PROTECTIONS IS TAKEN

The decision can be appealed at the Chamber of Appeal of Sakpatenti within 3 months from the publication or at the Mtskheta District Court Administrative Cases Board (Address: №17, Samkhedro str., Mtskheta), within 1 month following the publication.

(260) AM 2018 89297 A*

(800) 1315806

(151) 2016 08 29

(891) 2016 08 29

(731) HARRY WINSTON, INC.

718 Fifth Avenue New York, NY 10019,

USA

(540)

HARRY WINSTON EMERALD COLLECTION

(511)

14 – Precious metals and their alloys and goods made of these materials or coated therewith included in this class; jewelry, jewelry caskets, jewelry cases, precious stones; timepieces and chronometric instruments, chronometers, chronographs, clocks, watches, wristwatches, wall clocks, alarm clocks, watch chains, presentation cases for timepieces, cases for timepieces.

(260) AM 2018 91912 A

(800) 1340015

(151) 2016 11 14

(891) 2016 11 14

(731) XIAOMI SINGAPORE PTE. LTD.

12 Marina View #23-01 Asia Square

Tower 2 Singapore 018961, Singapore

(540)

MIHOME

(591) Black and white

(511)

7 – Agitators; mixers (machines); dishwashers; grinding machines; electric blenders; electric kitchen machines; electric fruit presses for household use; soybean reaping cutters (machines); industrial washing machines; washing machines for household purposes; washing machines incorporating drying facilities; ironing machines; industrial robots; knives (parts of machines); knife blades for electric knives; knife sharpeners (electric); mills (machines); Industrial cleaning machines; electric cleaning machines; carpet cleaning machines; apparatus for the removal of dust from buildings; electric dust removing (cleaning) apparatus; dust removing installations for cleaning purposes; dust separators; dust filters and bags for vacuum cleaners; air filters being parts of engines; machines for manufacturing air filter ele-

ments; filters (parts of machines or engines); apparatus (machines) for filtering; filter presses; filters for industrial purposes; central vacuum cleaning apparatus.

9 – Computer storage apparatus; computer apparatus; computer programmes (programs), recorded; keyboards; computer operating programs, recorded; computer peripheral equipment; computer software; computer software (recorded); monitors (computer hardware); computer monitoring apparatus; computer monitoring instruments; computer mouse; data processing equipment; optical data media; optical disks; central processing units; scanners (data processing equipment); electronic cards; notebook computers; electronic publications (downloadable); computer programs (downloadable software); computer game software; downloadable ring tones for mobile phones; downloadable music files; downloadable image files; USB flash drives; portable computers; counters; time recording apparatus; electronic timers; detectors; photocopiers (photographic, electrostatic, thermic); mobile or portable fax machine; fax devices; scales; measuring apparatus and instruments; gauges; electronic bulletin board apparatus; telephone handsets; apparatus for navigation; navigational instruments; radiotelegraphy sets; telegraphic apparatus; radio apparatus; radio receivers; radio control units; radios; telephones; video phones; satellite navigational apparatus; hands free kits for phones; global positioning system (GPS) apparatus; mobile phones for use in vehicles; cell phones; telephone sets; tape recorders; audio amplifiers; video receivers; headsets for telephones; headsets for use with computers; wireless headsets for smartphones; anti-dust headsets; loud speakers; apparatus for sound transmission; sound recording devices; recording devices for sound and image carriers; time clocks (time recording devices); speakers (audio equipment); cameras; portable media players; video recording apparatus; video cameras; cameras (photography); slide projectors; photographic projectors for slides; photographic slides; slide framing apparatus; slide projection lenses; slide film mounts; pressure gauges; dynamometers; optical instruments, other than for medical use; stereoscopes; video monitors; remote control apparatus; electronic measuring devices for telephone lines; automatic test instruments for monitoring telephone lines; electric wires; silicon wafers; semi-conductors; sensor apparatus, other than for medical use; electric control appara-

tus; electrical anti-theft devices, other than for vehicles; anti-theft warning devices; burglar alarms; optical glasses; glasses adapted to protect the eyes; sunglasses; batteries; battery chargers; vehicle batteries; animated cartoons; regulated power supply apparatus; on-off sensors; light regulators (dimmers), electric; plugs, sockets and other contacts (electric connections); temperature indicators; electric sensors; meters; instruments for measuring pressure; simulators for driving or control of vehicles.

11 – Electric lamps; lighting lamps; lighting apparatus and installations; lighting devices for showcases; lampshades; flashlights; safety lamps; lighting installations for air vehicles; vehicle lighting apparatus; motor vehicle lamps; lamps; electric cookers; cooking apparatus and installations; electric pressure cookers; electric kettles; water heaters; freezers; refrigerators; refrigeration installations; refrigeration units; refrigerator deodorizing units; pocket torches, electric; toasters; air purification apparatus; air conditioning apparatus; air filtration installations; air cooling apparatus; air dryers; air-conditioning fans; clothes dryers; dryers for the hands using a warm air drying stream; drying apparatus; electric heaters; water filter apparatus; gas purification apparatus; ionizers for the treatment of air or water; machines for the processing (purification) of sewage; apparatus for water purification; fabric steamers; heaters for heating irons; ventilating fans; axial fans; air humidifier; electric heating apparatus; automatic faucets; water distributing apparatus (automatic); water installations (automatic); automatic flushing installations for urinals; toilet stool units with a washing water squirter; toilets with washing functions; automatic watering installations; bathroom fixtures; bathroom installations; bath fittings; portable electric heater; lighters; electric hair dryers; drying apparatus and installations.

42 – Technical research; biotechnology research; research and development of new products for others; scientific research and development; scientific laboratory services; quality control; building and structural inspection services (engineering, quality assessment, and surveying services); calibration (measuring); measurement services; meteorological information; material testing; mechanical research; Industrial design; packaging design; interior design; fashion design; computer programming; computer software consultancy; updating of computer software; providing information, including online, about design and development of computer hardware and software; rental and maintenance of computer software; rental of computer hardware; rental of computers; recovery of computer data; development of computer system; advisory services relating to computer system analysis; computer systems integration services; computer systems design; copying of computer software; conversion of data or documents

from physical to electronic media; creating and maintaining web sites for others; installation of computer software; rental of web servers; rental of a database server (to third parties); computer virus protection services; provision of Internet search engines; digitization of documents (scanning); monitoring of computer systems by remote access; product quality evaluation; quality control of goods; graphic art design.

(260) AM 2018 92171 A*
 (800) 1157474
 (151) 2013 03 11
 (891) 2016 12 22
 (731) DELIA COSMETICS Sp. z o.o.
 ul. Lesna 5 PL-95-030 Rzgów,
 Poland
 (540)

Cameleo

(591) Black, white
 (531) 27.05.01
 (511)
 3 – perfumery, essential oils, cosmetics, hair lotions.

(260) AM 2018 92247 A
 (800) 1343989
 (151) 2016 07 12
 (891) 2016 07 12
 (731) EP INFRASTRUCTURE, A.S.
 Pařížská 130/26, CZ-110 00 Praha 1, Czech
 Republic
 (540)

EP Infrastructure

(591) Red and black
 (531) 27.05.10; 29.01.12
 (511)
 4 – Electricity, electrical energy, including electricity and electrical energy generated from renewable sources; coal; natural gas; none of these products being meant to the nuclear energy industry.

9 – Power installations (other than generators) for distributing electricity, gas and fluids; switchboxes (electricity); distribution boxes (electricity); switches; electricity conduits; none of these products being meant to the nuclear energy industry.

35 – Purchase and sale of energy; import and export of electricity, gas, coal, solid, liquid and gaseous fuels; procurement and intermediary activities in the field of a trade with energy (electricity, heat, hot water, steam); none of these services being meant to the nuclear energy industry.

36 – Financial services relating to the brokerage of energy and fuels; none of these services being meant to the nuclear energy industry.

37 – Extraction and mining services; installation services, in particular maintenance, repair, construction, restoration and refurbishment of electrical equipment and distribution of electricity; none of these services being meant to the nuclear energy industry.

39 – Storage, distribution, transport and supply of electricity, natural gas, heat, water, energy, fuels and illuminating materials; none of these services being meant to the nuclear energy industry.

40 – Production, of energy (electricity, heat, hot water, steam), treatment of the aforesaid substances; consultancy in the field of the aforesaid services; energy supply services included in this class, namely the production of electricity and gas, processing and treatment of gas, natural resources and fuels for the production of energy, electricity, heat, water and steam; energy generation consultancy; none of these services being meant to the nuclear energy industry.

(260) AM 2018 92273 A

(800) 1343990

(151) 2017 05 12

(891) 2016 07 12

(731) EP POWER EUROPE, A.S.

Biskupský dvůr 2095/8, CZ-110 00 Praha 1,
Czech Republic

(540)

EP Power Europe

(591) Red and black

(531) 27.05.10; 29.01.12

(511)

4 – Electricity, electrical energy, including electricity and electrical energy generated from renewable sources; coal; natural gas; none of these products being meant to the nuclear energy industry.

9 – Power installations (other than generators) for distributing electricity, gas and fluids; switchboxes (electricity); distribution boxes (electricity); switches; electricity conduits; none of these products being meant to the nuclear energy industry.

35 – Purchase and sale of energy; import and export of electricity, gas, coal, solid, liquid and gaseous fuels; none of these services being meant to the nuclear energy industry.

36 – Financial services relating to the brokerage of energy and fuels; none of these services being meant to the nuclear energy industry.

37 – Extraction and mining services; installation services, in particular maintenance, repair, construction, restoration and refurbishment of electrical equip-

ment and distribution of electricity; none of these services being meant to the nuclear energy industry.

39 – Storage, distribution, transport and supply of electricity, natural gas, heat, water, energy, fuels and illuminating materials; none of these services being meant to the nuclear energy industry.

40 – Production of energy (electricity, heat, hot water, steam), treatment of the aforesaid substances; energy supply services included in this class, namely the production of electricity and gas, processing and treatment of gas, natural resources and fuels for the production of energy, electricity, heat, water and steam; consultancy in the field of the aforesaid services; energy generation consultancy; none of these services being meant to the nuclear energy industry.

(260) AM 2018 92564 A

(800) 1346029

(151) 2016 11 14

(891) 2016 11 14

(731) ILKO ILAC SANAYI VE TICARET

ANONIM SIRKETI

Veysel Karani Mah. Colakoglu Sok. No:10,
Kat:7-8-9, Sancaktepe ISTANBUL, Turkey

(540)



(591) Black and blue

(531) 02.05.01; 02.05.02; 02.09.01; 09.07.01;
09.07.25; 26.11.13; 27.03.01; 27.03.02;
29.01.12

(511)

5 – Pharmaceutical and veterinary preparations for medical purposes; chemical preparations for medical and veterinary purposes, chemical reagents for pharmaceutical and veterinary purposes; dietary supplements for pharmaceutical and veterinary purposes; dietary supplements; nutritional supplements; medical preparations for slimming purposes; food for babies; herbs and herbal beverages adapted for medicinal purposes; dental preparations and articles: teeth filling material, dental impression material, dental adhesives and material for repairing teeth; sanitary preparations for medical use; hygienic pads; hygienic tampons; plasters; materials for dressings; diapers, including those made of paper and textiles; preparations for destroying vermin; fungicides, herbicides; deodorants, other than for human beings or for animals; air deodorising preparations; disinfectants; antiseptics; detergents for medical purposes.

10 – Surgical, medical, dental and veterinary apparatus and instruments; furniture especially made for medical purposes; artificial limbs and prostheses; medical orthopaedic articles: corsets for medical

purposes, orthopedic shoes, elastic and support bandages; adult sexual aids; condoms; babies' bottles; babies' pacifiers; teats; teethingers for babies.

44 – Medical services; beauty care services; medical advisory services in the field of personnel health.

(260) AM 2018 92824 A

(800) 1348618

(151) 2017 02 28

(891) 2017 02 28

(731) INVICTA GROUP

Zone Industrielle, Lieudit la Gravette
F-08350 DONCHERY, France

(540)

DEVILLE

(591) Black and white

(531) 27.05.05; 27.05.17

(511)

11 – Apparatus for heating, steam generating, cooking and drying; cooking apparatus and installations; cooking apparatus; kilns; cookers (cooking stoves); bread baking ovens; apparatus for grilling and roasting; barbecues; grills [cooking appliances]; hot plates; roasting spits; plate warmers; cooking rings; hot water bottles; stoves; bakers' ovens; heating apparatus; heating apparatus for solid, liquid or gaseous fuels; heating plates; stoves (heating apparatus); radiators; central heating radiators; solar thermal collectors (heating); boilers other than parts of machines; heating boilers; gas boilers; flues for heating boilers; hot water heating installations; electric heating apparatus; water heaters; boilers; heat accumulators; steam accumulators; domestic fireplaces; furnace grates; fire bars; chimney flues; structural plates for ovens; oven fittings made of fire clay; automatic ash conveyor installations; hearth ash pans; hearths; brackets for gas burners; acetylene burners; gas burners; alcohol burners, petrol burners; incandescent burners; friction lighters for igniting gas; fountains.

(260) AM 2018 93023 A

(800) 1350931

(151) 2017 01 10

(891) 2017 01 10

(731) ASTON MARTIN LAGONDA LIMITED

Banbury Road, Gaydon Warwick CV35
0DB, United Kingdom

(540)

AMR

(591) Black and white

(511)

7 – Radiator grills of metal for vehicles; radiator grills of non-metallic materials for vehicles.

(260) AM 2018 93176 A

(800) 1352295

(151) 2017 04 13

(891) 2017 04 13

(731) Obschestvo s ogranichennoy otvetstvennostyu
"LABORATORIYA SOVREMENNOGO
ZDOROVYA"

ul. Khimzavodskaya, 11/20, Berdsk
RU-633004 Novosibirskaya oblast', Russian
Federation

(540)

VITAMAMA

(591) Black and white

(531) 27.05.17

(511)

3 – Almond milk for cosmetic purposes; aloe vera preparations for cosmetic purposes; antistatic preparations for household purposes; balms, other than for medical purposes; beauty masks; breath freshening sprays; cleaning preparations; cleansing milk for toilet purposes; cosmetics; cosmetic creams; cosmetic kits; cosmetic pencils; cosmetic preparations for baths; cosmetic preparations for skin care; cotton wool for cosmetic purposes; decorative transfers for cosmetic purposes; degreasers, other than for use in manufacturing processes; dentifrices; detergents, other than for use in manufacturing operations and for medical purposes; essential oils; eyebrow cosmetics; fabric softeners for laundry use; greases for cosmetic purposes; hair lotions; laundry bleaching preparations; laundry preparations; laundry soaking preparations; lip glosses; lipsticks; lotions for cosmetic purposes; massage gels, other than for medical purposes; mouthwashes, not for medical purposes; oils for cosmetic purposes; perfumery; perfumes; petroleum jelly for cosmetic purposes; pomades for cosmetic purposes; potpourris [fragrances]; sachets for perfuming linen; shampoos; soap; stain removers; starch glaze for laundry purposes; sunscreen preparations; sun-tanning preparations [cosmetics]; tissues impregnated with cosmetic lotions; toilet water.

5 – Albumin dietary supplements; albuminous foodstuffs for medical purposes; albuminous preparations for medical purposes; almond milk for pharmaceutical purposes; aloe vera preparations for pharmaceutical purposes; antioxidant pills; balms for medical purposes; biocides; by-products of the processing of cereals for dietetic or medical purposes; casein dietary supplements; cod liver oil; decoctions for pharmaceutical purposes; dietetic beverages adapted for medical purposes; dietary fiber; dietetic foods adapted for medical use; digestives for pharmaceutical purposes; enzyme dietary supplements; flour for pharmaceutical purposes; food for babies; glucose dietary supplements; hematogen; lacteal flour for babies; liniments; linseed oil dietary supplements; lotions for pharmaceutical purposes; medicinal herbs; medicinal

infusions; medicinal oils; medicinal roots; medicinal tea; milk ferments for pharmaceutical purposes; mineral food supplements; nervines; nutritional supplements; pearl powder for medical purposes; pharmaceutical preparations for skin care; pollen dietary supplements; preparations of trace elements for human and animal use; propolis dietary supplements; propolis for pharmaceutical purposes; protein dietary supplements; royal jelly dietary supplements; royal jelly for pharmaceutical purposes; serums; sugar for medical purposes; tonics [medicines]; vitamin preparations; wheat germ dietary supplements.

29 – Apple purée; bouillon; bouillon concentrates; buttercream; charcuterie; cheese; compotes; cranberry sauce [compote]; crystallized fruits; edible fats; fat-containing mixtures for bread slices; fish-based foodstuffs; fish, not live; fish mousses; fish, preserved; fish, tinned; frozen fruits; fruit-based snack food; fruit chips; fruit jellies; fruit, preserved; fruit pulp; fruit salads; fruit, stewed; fruits, tinned; jams; jellies for food; liver pâté; liver; marmalade; meat; meat extracts; meat jellies; meat, preserved; meat, tinned; milk beverages, milk predominating; milk; milk products; milk shakes; nuts, prepared; oils for food; potato chips; potato flakes; poultry, not live; preparations for making bouillon; preparations for making soup; salted meats; sausages; seaweed extracts for food; seeds, prepared; soups; soya milk; tofu; tripe; vegetable juices for cooking; vegetable mousses; vegetable salads; vegetables, cooked; vegetables, dried; vegetables, preserved; vegetables, tinned; whey; white of eggs; yogurt.

30 – Bread; cakes; cereal bars; cereal-based snack food; cereal preparations; chewing gum; chips [cereal products]; chocolate; chocolate beverages with milk; chocolate-based beverages; chocolate mousses; cocoa; cocoa-based beverages; cocoa beverages with milk; condiments; confectionery; cookies; crackers; dessert mousses [confectionery]; edible ices; flour; fondants [confectionery]; frozen yogurt [confectionery ices]; fruit jellies [confectionery]; fruit coulis [sauces]; gingerbread; golden syrup; groats for human food; halvah; honey; husked oats; husked barley; ice cream; infusions, not medicinal; malt biscuits; malt for human consumption; molasses for food; muesli; noodle-based prepared meals; oat-based food; oat flakes; pancakes; pastilles [confectionery]; pasta; pastries; pies; popcorn; pralines; propolis; puddings; rice; rice-based snack food; royal jelly; rusks; sandwiches; sauces [condiments]; sherbets [ices]; spices; sweetmeats [candy]; tarts; tea; tea-based beverages; waffles; wheat germ for human consumption.

32 – Aerated water; aloe vera drinks, non-alcoholic; aperitifs, non-alcoholic; cocktails, non-alcoholic; fruit juices; isotonic beverages; essences for making beverages; kvass [non-alcoholic beverage]; lemonades; non-alcoholic beverages; non-alcoholic fruit

extracts; non-alcoholic fruit juice beverages; non-alcoholic honey-based beverages; mineral water [beverages]; powders for effervescent beverages; preparations for making beverages; smoothies; syrups for lemonade; syrups for beverages; vegetable juices [beverages]; waters [beverages]; whey beverages.

(260) AM 2018 93178 A

(800) 645215

(151) 1995 10 16

(891) 2017 05 08

(731) Vandemoortele Lipids, naamloze

Vennootschap

Moutstraat 64, B-9000 Gent, Belgium

(540)

OPAL

(591) Black, white

(511)

29 – Edible oils and fats.

(260) AM 2018 93293 A

(800) 1354287

(151) 2017 02 02

(891) 2017 02 02

(731) UAB "ATLANTIC DUTY FREE"

Mokyklos g. 1, Mokolu k. LT-68461

Marijampoles sav, Lithuania

(540)

SHABBAT

(591) Black, white

(511)

29 – Fish, seafood and molluscs; meat; dairy products and dairy substitutes; processed fruits, fungi and vegetables (including nuts and pulses); birds eggs and egg products; oils and fats; pre-packaged dinners consisting primarily of seafood; antipasto salads; stewed apples; eggplant paste; casseroles [food]; shepherd's pie; banana chips; organic nut and seed-based snack bars; bisques; stock; ox bone based broth (seolleongtang); broth [soup]; stock cubes; caesar salad; caponata; chicharron; chile con queso; chili con carne; chop suey; dahls; dairy puddings; artificial milk based desserts; desserts made from milk products; chowder; dairy-based dips; prepared meals consisting substantially of seafood; prepared meals consisting principally of game; instant soup; fish in olive oil; fish and chips; dips; dolmas; condensed tomatoes; soups containing steamed eggs; stews; roast beef flavoured extract; faggots [food]; falafel; cooked dish consisting primarily of chicken and ginseng (samgyetang); cooked dish consisting primarily of soybean paste and tofu (doenjang-jjigae); cooked dish consisting primarily of rich soybean paste and tofu (cheonggukjang-jjigae); cooked dish consisting primarily of fermented vegetable, pork and tofu (kimchi-jjigae); cooked dish consisting

primarily of stir-fried chicken and fermented hot pepper paste (dak-galbi); cooked dish consisting primarily of stired-fried beef and fermented soy sauce (sogalbi); prepared meals made from meat [meat predominating]; prepared meals made from poultry [poultry predominating]; prepared meals containing [principally] eggs; prepared dishes consisting principally of meat; prepared meals containing [principally] chicken; prepared meals containing [principally] bacon; cooked meat dishes; cooked truffles; frozen cooked fish; stock in the form of granules; chilled dairy desserts; steamed cakes of smashed fish and yam (hampen); fish stock; fish crackers; fish cakes; fish jellies; fish croquettes; steamed or toasted cakes of fish paste (kamaboko); fish sausages; beef bouillon; broth concentrates; meatballs; prepared meat dishes; fruit desserts; fruit-based snack food; chicken salad; frozen french fries; frozen pre-packaged entrees consisting primarily of seafood; chile rellenos; filled potato skins; stuffed olives; bombay mix; instant stew; instant miso soup; custard style yoghurts; yoghurt desserts; chilled meals made from fish; potato fritters; bottled vegetables; vegetable-based entrees; vegetable-based snack foods; vegetable stock; prepared vegetable dishes; vegetable chips; salted nuts; gumbo; scotch eggs; corned beef hash; prepared dishes consisting primarily of fishcakes, vegetables, boiled eggs, and broth (oden); frozen prepared meals consisting principally of vegetables; chicken croquettes; chicken stock; chicken balls; legume salads; soy-based snack foods; meat boiled down in soy sauce (tsukudani meat); bologna; matzo ball soup; powdered milk for food purposes; mixes for making soup; mixes for making broths; vegetable soup preparations; veal stock; potato chips; potato flakes; potato-based gnocchi; potato dumplings; potato pancakes; potato fritters; mashed potato; potato salad; potato snacks; radish cubed kimchi (kkakdugi); consommes; mincemeat made from fruits; stuffed cabbage rolls; coconut shrimp; canned pork and beans; soups; croquettes; beef jerky; sugar-coated fruits on a stick; nut-based snack foods; nut-based food bars; spiced nuts; prepared nuts; olives stuffed with feta cheese in sunflower oil; olives stuffed with red peppers; olives stuffed with red peppers and almonds; olives stuffed with almonds; olives stuffed with pesto in sunflower oil; omelets; breaded and fried jalapeno peppers; vegetable marrow paste; pollen prepared as foodstuff; french fries; quenelles; rhubarb in syrup; beef stew; hash brown potatoes; rosti [fried grated potato cakes]; roast chestnuts; roasted nuts; potato-based salads; potato-based snack foods; snack foods based on nuts; meat-based snack foods; tofu-based snacks; snack foods based on vegetables; snack foods based on legumes; soy chips; soy burger patties; puffed pork rind; potato sticks; canned soups; meat extracts for soups; soup concentrates; soup pastes; soup (preparations for making -); soup powders; soup cubes; teriyaki chicken; frozen appe-

tizers consisting primarily of chicken; frozen appetizers consisting primarily of seafood; tofu; tofu burger patties; vegetable burgers; vegetarian sausages; clam juice; hazelnuts, prepared; prepared snails [escargot]; yuca chips; tzatziki; prepared salads; preparations for making bouillon; onion rings; stock [prepared]; soya [prepared]; edible birds' nests; ready cooked meals consisting wholly or substantially wholly of meat; ready cooked meals consisting wholly or substantially wholly of game; ready cooked meals consisting wholly or substantially wholly of poultry; pre-cooked miso soup; pre-cooked soup; pre-cooked curry stew; pre-packaged dinners consisting primarily of game; cooked meals consisting principally of fish; chilled foods consisting predominantly of fish; prepared meals consisting primarily of meat substitutes; white pudding; sausages in batter; spicy beef broth (yukgaejang).

30 – Chocolate and desserts; ice, ice creams, frozen yogurts and sorbets; coffee, teas and cocoa and substitutes therefor; salts, seasonings, flavourings and condiments; sugars, natural sweeteners, sweet coatings and fillings, bee products; pineapple fritters; french toast, flavoured popcorn; snack food products consisting of cereal products; snack food products made from potato flours; snack foods prepared from maize; snacks manufactured from muesli; banana fritters; baozi [stuffed buns]; flaky pastry containing ham; pretzels; brioche; bean jam buns; frankfurter sandwiches; buckwheat jelly (memilmuk); burritos; calzones; chalapas; cheeseburgers [sandwiches]; chimichanga; chinese steamed dumplings (shumai, cooked); grain-based chips; crisps made of cereals; chow mein; chow mein [noodle-based dishes]; crackers made of prepared cereals; crackers flavoured with meat; crackers flavoured with vegetables; crackers flavoured with herbs; crackers flavoured with cheese; crackers flavoured with spices; crepes; egg pies; empanadas; enchiladas; chocolate-based ready-to-eat food bars; tortillas for making fajitas; pastries consisting of vegetables and fish; rice-based prepared meals; prepared meals in the form of pizzas; prepared meals containing [principally] pasta; pies containing meat; meat pies; meat pies [prepared]; fresh pies; fresh pizza; fresh sausage rolls; stir fried rice cake [topokki]; egg rolls; spring rolls; prawn crackers; fried corn; chilled pizzas; frozen pastry stuffed with meat; frozen pastry stuffed with vegetables; filled baguettes; pasta containing stuffings; chinese stuffed dumplings (gyoza, cooked); filled bread rolls; vegetable pies; pellet-shaped rice crackers (arare); rice based dishes; meals consisting primarily of pasta; corn kernels being toasted; toasted sandwiches; toasted cheese sandwich; toasted cheese sandwich with ham; chips [cereal products]; cereal-based snack food; gimhap [korean rice dish]; mincemeat pies; flapjacks; hamburgers being cooked and contained in a bread roll; hamburgers contained in bread rolls; hot sausage and ketchup in cut open bre-

ad rolls; millet cakes; hot dog sandwiches; snack food products made from cereal flour; snack foods made from corn; snack foods made from corn and in the form of puffs; snack foods made from corn and in the form of rings; puffed corn snacks; cereal snack foods flavoured with cheese; jiaozi [stuffed dumplings]; canapes; caramel coated popcorn with candied nuts; kimchi pancakes (kimchijeon); sticky rice cakes (chapssaltteock); shrimp dumplings; preserved pizzas; korean-style pasta soups (sujebi); glutinous pounded rice cake coated with bean powder (injeolmi); stir-fried noodles with vegetables (japchae); cheese curls [snacks]; macaroni with cheese; pumpkin porridge (hobak-juk); lasagne; seaweed flavoured corn chips; maize, roasted; corn chips; vegetable flavoured corn chips; macaroni salad; microwave popcorn; sandwiches containing fish fillet; sandwiches containing meat; steamed buns stuffed with minced meat (niku-manjuh); caramel coated popcorn; crackers filled with cheese; mung bean pancakes (bindaetteok); nachos; ready-made dishes containing pasta; noodle-based prepared meals; canned pasta foods; pasta salad; okonomiyaki [japanese savory pancakes]; pasta dishes; pastries consisting of vegetables and meat; pastries consisting of vegetables and poultry; pies; pies containing fish; pies containing poultry; pies containing vegetables; pies containing game; pies [sweet or savoury]; stir-fried rice; pancakes; green onion pancake [pajeon]; prepared savory foodstuffs made from potato flour; savory pastries; pizza crust; pizza bases; prepared pizza meals; pizza; pizzas [prepared]; candy coated popcorn; pot pies; puffed cheese balls [corn snacks]; popcorn; quesadillas; quiches; ramen [japanese noodle-based dish]; ravioli; ravioli [prepared]; rice mixed with vegetables and beef [bibimbap]; rice crisps; prepared rice dishes; rice dumplings; rice dumplings dressed with sweet bean jam (ankoro); rice crackers; rice cakes; rice biscuits; rice salad; rice-based snack food; risotto; salted tarts; samosas; sandwiches; sandwiches containing fish; sandwiches containing chicken; sandwiches containing minced beef; sandwiches containing salad; pork pies; rice crackers [senbei]; sesame snacks; snack foods made from wheat; snack food products made from cereal starch; snack food products made from maize flour; snack food products made from rusk flour; snack foods made of whole wheat; cheese flavoured puffed corn snacks; pre-baked pizzas crusts; meals consisting primarily of rice; snack foods consisting principally of bread; pre-packaged lunches consisting primarily of rice, and also including meat, fish or vegetables; snack foods consisting principally of extruded cereals; prepared meals containing [principally] rice; wonton chips; wontons; soft pretzels; wholewheat crisps; poultry and game meat pies; wrap [sandwich]; sausage rolls; prepared foodstuffs in the form of sauces; pasta-based prepared meals; onion biscuits.

31 – Foodstuffs and fodder for animals; agricultural and aquacultural crops, horticulture and forestry products; live animals, organisms for breeding.

32 – Beer and brewery products; non-alcoholic beverages; preparations for making beverages.

33 – Alcoholic beverages (except beer); preparations for making alcoholic beverages.

(260) AM 2018 93295 A

(800) 1354590

(151) 2016 11 22

(891) 2016 11 22

(731) ZORLUTEKS TEKSTIL TICARET VE SANAYI ANONİM ŞİRKETİ

Levent 199, Büyükdere Caddesi No:199, Şişli, TR-34394 İstanbul, Turkey

(540)



(591) Black, white

(531) 05.03.04; 27.05.10

(511)

23 – Yarns and threads for textile use, threads and yarns for sewing, embroidery and knitting, thread, elastic yarns and threads for textile use.

24 – Fabric for clothing, upholstery fabrics, all kinds of lining, buckram, curtains, tulle, tulle curtain, household linen, table covers, bed covers, set of bedding, chair cover, sheets (textile), piques, pillow cases, quilt cases, armchair covers, table cloths of textile, refrigerator and television cover, fabric napkins, quilts, coverlets, blankets, bath mitts, bath towels, washcloths, hand and face towels, beach towels, flags made of fabric, banners, labels, labels of fabric.

26 – Laces and embroidery (appliques), point lace, festoons, hair bands and ribbons, braids, buttons, hook and eye, zippers for clothing, shoe and belt buckles, rivet buttons, heat adhesive patches, laces, shoulder pads for clothing, letter-shaped or number-shaped fabric appliques [haberdashery].

(260) AM 2018 93339 A

(800) 1355852

(151) 2017 04 07

(891) 2017 04 07

(731) AKTSIONERNOIE OBSHCHESTVO GRUPPA SVERDLOVELEKTRO

ul. Cherniakhovskogo, 61, Ekaterinburg,

RU-620010 Sverdlovskaya Oblast, Russian Federation

(540)

SVEL

(591) Black, white

(531) 27.05.17

(511)

6 – Poles of metal for power lines; brackets of metal for building; props of metal; masts of metal; staircases of metal; railings of metal.

7 – Expansion tanks [parts of machines]; housings [parts of machines]; stators [parts of machines]; brushes [parts of machines]; generators of electricity; dynamos; alternators; electric motors for machines; steam engine boilers; boiler tubes [parts of machines]; turbines, other than for land vehicles.

17 – Dielectrics [insulators]; insulators; insulators for electric mains.

19 – Brackets, not of metal, for building; staircases, not of metal; rails, not of metal; poles, not of metal, for power lines.

37 – Installation, repair and maintenance of machinery; construction; construction consultancy; building construction supervision; construction information; repair information.

42 – Construction drafting; technical research; material testing, including testing of insulating oil for transformers; engineering; computer software design; quality control; surveying; consultancy in the field of energy-saving; scientific laboratory services; scientific research; technological consultancy; technical writing; computer-aided industrial testing.

(260) AM 2018 93362 A

(800) 960497

(151) 2007 09 17

(891) 2017 04 05

(731) Aktsionernoe Obchtchestvo "NARODNY SBREGATELNY BANK KAZAKHSTANA"
Al-Farabi Ave., 40, 050059 Almaty
(A26M3K5), Kazakhstan

(540)

HALYK

(591) Black, white

(531) 27.05.17

(511)

9 – Computer programs and software, magnetic and optical data media, including bank cards.

38 – Telecommunications.

41 – Training.

(260) AM 2018 93400 A

(800) 1355113

(151) 2017 03 27

(891) 2017 03 27

(731) JOSÉ EISENBERG

24, Avenue Princesse Grace, Monte-Carlo
MC-98000 Monaco, Monaco

(540)

EMED

(591) Black and white

(511)

3 – Bleaching preparations and other substances for laundry use; cleaning, polishing, degreasing and abrasive preparations; soaps, shower gels, bath gels, shower creams, bath creams, shampoos; perfumery, perfumes, fragrances, deodorants [perfumery] for cosmetic use; essential oils; cosmetics, cosmetic preparations for slimming, beauty masks, skin whitening creams, make-up removing products, oils for cosmetic use; cosmetic skin-tanning preparations; make-up products, lipsticks, lip gloss, pencils for cosmetic use, make-up, mascaras, nail polish, make-up powders, make-up foundation; hair lotions; hair sprays; dentifrices.

(260) AM 2018 93595 A

(800) 1357653

(151) 2017 01 26

(891) 2017 01 26

(731) QMARO LIMITED

Nicu Georgiu, 6, BLOCK C, 7th floor,
Office 703 CY-1095 Nicosia, Cyprus

(540)

FINME

(591) Black, white

(531) 27.05.17

(511)

35 – Providing business information via a web site; provision of an on-line marketplace for buyers and sellers of goods and services; web indexing for commercial or advertising purposes; commercial intermediation services; layout services for advertising purposes; commercial information and advice for consumers [consumer advice shop]; price comparison services; presentation of goods on communication media, for retail purposes; commercial intermediation services.

36 – Instalment loans; brokerage; credit bureau services; banking; real estate appraisal; mutual funds; capital investment; surety services; exchanging money; safe deposit services; loans [financing]; factoring; financing services; financial management; pawnbrokerage; financial analysis; antique appraisal; art appraisal; financial consultancy; processing of

credit card payments; processing of debit card payments; electronic funds transfer; financial information; jewellery appraisal; numismatic appraisal; stamp appraisal; deposits of valuables; financial sponsorship; online banking; lending against security.

38 – Electronic bulletin board services [telecommunications services].

(260) AM 2018 93596 A

(800) 1357659

(151) 2017 01 27

(891) 2017 01 27

(731) Obshchestvo s ogranichennoy otvetstvennostyu "SATIUS"
pr-kt Andropova, 38, korp.3, etazh 2 of. 192
RU-115487 Moskva, Russian Federation

(540)

ВЕЗИКАТЕСТ

(591) Black, white

(531) 28.05

(511)

5 – Diagnostic biomarker reagents for medical purposes; pharmaceuticals, medical and veterinary preparations; contrasting agents for diagnostic ultrasound imaging; antibodies for medical purposes; diagnostic substances for medical purposes; diagnostic reagents and contrast media for medical purposes; test strips for measuring blood glucose levels; diagnostic preparations for medical purposes; biochemical preparations for medical purposes; radiopharmaceutical preparations for diagnostic purposes; in vitro diagnostic preparations for medical purposes; diagnostic reagents for medical purposes; biological and chemical reagents for medical or veterinary purposes; diagnostic test reagents for medical purposes; reagents for medical purposes; biological reagents for veterinary purposes; biological reagents for medical purposes; clinical diagnostic reagents; chemical reagents for medical or veterinary purposes; therapeutic drugs and agents.

10 – Surgical, medical and dental apparatus; testing apparatus for medical purposes.

(260) AM 2018 93649 A

(800) 1323526

(151) 2016 04 27

(891) 2017 05 11

(731) VOROLA FINANCIAL LTD.
33 Porter Road, P.O. Box 3169 PMB 103,
Road Town Tortola, Virgin Islands (British)

(540)

Francesco Bella

(591) Black, white

(531) 27.05.01

(511)

14 – Agates; diamonds; amulets [jewellery, jewelry (Am.)]; anchors [clock- and watchmaking]; barrels [clock- and watchmaking]; bracelets [jewellery, jewelry (Am.)]; watch bands; charms [jewellery, jewelry (Am.)]; key rings [trinkets or fobs]; brooches [jewellery, jewelry (Am.)]; alarm clocks; pins [jewellery, jewelry (Am.)]; ornamental pins; tie pins; beads for making jewelry; pearls made of ambroid [pressed amber]; jet, unwrought or semi-wrought; pearls [jewellery, jewelry (Am.)]; copper tokens; tie clips; cuff links; badges of precious metal; gold, unwrought or beaten; ivory jewelry; works of art of precious metal; jewelry; jewelry of yellow amber; iridium; precious stones; semi-precious stones; spun silver [silver wire]; necklaces [jewellery, jewelry (Am.)]; rings [jewellery, jewelry (Am.)]; boxes of precious metal; watch cases [parts of watches]; clock cases; pendulums [clock- and watchmaking]; medals; lockets [jewellery, jewelry (Am.)]; precious metals, unwrought or semi-wrought; movements for clocks and watches; clockworks; coins; gold thread [jewellery, jewelry (Am.)]; threads of precious metal [jewellery, jewelry (Am.)]; silver thread [jewellery, jewelry (Am.)]; olivine [gems]; osmium; palladium; platinum [metal]; chronometric instruments; watch springs; rhodium; ruthenium; stopwatches; silver, unwrought or beaten; earrings; ingots of precious metals; alloys of precious metal; statues of precious metal; figurines [statuettes] of precious metal; watch glasses; paste jewellery [costume jewelry (Am.)]; clock hands [clock and watch making]; ornaments [jewellery, jewelry (Am.)]; shoe ornaments of precious metal; hat ornaments of precious metal; ornaments of jet; cases for watches [presentation]; cases for clock- and watchmaking; chronographs [watches]; chronometers; chronoscopes; chains [jewellery, jewelry (Am.)]; watch chains; dials [clock- and watchmaking]; atomic clocks; watches; sundials; clocks and watches, electric; control clocks [master clocks]; clocks; wristwatches; jewelry boxes; spinel [precious stones].

18 – Mountaineering sticks; pocket wallets; business card cases; card cases [notecases]; reins; harness fittings; parts of rubber for stirrups; chamois leather, other than for cleaning purposes; umbrellas; parasols; saddlery; frames for umbrellas or parasols; handbag frames; cases of leather or leatherboard; valves of leather; whips; imitation leather; leather, unworked or semi-worked; leatherboard; casings, of leather, for springs; umbrella rings; hat boxes of leather; boxes of leather or leatherboard; boxes of vulcanised fibre; chain mesh purses; purses; fastenings for saddles; butts [parts of hides]; saddle trees; bags [envelopes, pouches] of leather, for packaging; moleskin [imitation of leather]; travelling sets [leatherware]; knee-pads for horses; muzzles; halters; vanity cases, not fitted; leather thread; furniture co-

verings of leather; gut for making sausages; clothing for pets; trimmings of leather for furniture; collars for animals; music cases; slings for carrying infants; goldbeaters' skin; cat o' nine tails; leather leashes; pads for horse saddles; horseshoes; girths of leather; horse blankets; shoulder belts [straps] of leather; briefcases; traces [harness]; fur; haversacks; leather straps; straps for soldiers' equipment; harness straps; straps for skates; straps of leather [saddlery]; chin straps, of leather; stirrup leathers; umbrella handles; walking stick handles; suitcase handles; rucksacks; travelling bags; riding saddles; net bags for shopping; umbrella or parasol ribs; stirrups; bags; bags for climbers; sling bags for carrying infants; garment bags for travel; valises; handbags; tool bags of leather, empty; beach bags; bags for sports; bags for campers; shopping bags; wheeled shopping bags; school satchels; pouch baby carriers; travelling trunks; nose bags [feed bags]; bridoons; walking sticks; umbrella sticks; walking stick seats; bits for animals [harness]; bridles [harness]; harness for animals; key cases; horse collars; trunks [luggage]; suitcases; attaché cases; covers for horse saddles; umbrella covers; kid; curried skins; animal skins; cattle skins; leather laces; blinkers [harness]; game bags [hunting accessories].

25 – Wimples; bandanas [neckerchiefs]; underwear; sweat-absorbent underwear; berets; overalls; boas [necklets]; teddies [undergarments]; half-boots; ski boots; boots for sports; breeches for wear; trousers; football boots; brassieres; detachable collars; collars [clothing]; pelerines; shirt yokes; veils [clothing]; gabardines [clothing]; galoshes; neckties; ascots; leggings [leg warmers]; gaiters; boot uppers; corselets; jerseys [clothing]; vests; sports jerseys; hosiery; heels; hoods [clothing]; hat frames [skeletons]; pockets for clothing; neck scarfs [mufflers]; visors [headwear]; cap peaks; tights; slips [undergarments]; combinations [clothing]; wet suits for water-skiing; bodices [lingerie]; corsets [underclothing]; suits; bathing suits; masquerade costumes; beach clothes; jackets [clothing]; stuff jackets [clothing]; fishing vests; leggings [trousers]; liveries; camisoles; cuffs; short-sleeve shirts; mantillas; coats; sleep masks; furs [clothing]; mittens; miters [hats]; muffs [clothing]; footmuffs, not electrically heated; heelpieces for footwear; bibs, not of paper; fur stoles; ear muffs [clothing]; socks; beach shoes; sports shoes; footwear; paper clothing; outerclothing; ready-made clothing; motorists' clothing; cyclists' clothing; clothing for gymnastics; clothing of imitations of leather; clothing of leather; uniforms; clothing; fittings of metal for footwear; maniples; overcoats; parkas; gloves [clothing]; ski gloves; pajamas (Am.); bathing trunks; shirt fronts; scarfs; pocket squares; dresses; waterproof clothing; headbands [clothing]; garters; sock suspenders; stocking suspenders; ready-made linings [parts of clothing]; dress shields; soles for footwear; braces for clothing [suspenders]; lace boots;

ponchos; girdles; belts [clothing]; money belts [clothing]; layettes [clothing]; non-slipping devices for footwear; heelpieces for stockings; welts for footwear; chasubles; shirts; wooden shoes; sandals; bath sandals; boots; sarongs; jumper dresses; saris; sweaters; footwear uppers; inner soles; bath slippers; togas; knitwear [clothing]; underpants; gymnastic shoes; slippers; shoes; skull caps; turbans; headgear for wear; aprons [clothing]; tee-shirts; dressing gowns; bath robes; top hats; tips for footwear; stockings; sweat-absorbent stockings; shawls; caps [headwear]; paper hats [clothing]; shower caps; bathing caps; sashes for wear; studs for football boots; hats; babies' pants [clothing]; trouser straps; pelisses; esparto shoes or sandals; skirts; petticoats; skorts.

(260) AM 2018 93739 A

(800) 1359200

(151) 2017 04 21

(891) 2027 04 21

(731) Eagle Investment SICAV plc, acting on behalf of ITT FUND
Alpine House, Naxxar Road SGN 9032 San Gwann, Malta

(540)

NEOS

(591) Black and white

(511)

28 – Apparatus for games; lottery wheels; slot machines; automatic gaming machines; coin-operated amusement machines; bill-operated gaming equipment; LCD game machines; counters for games; board games; amusement apparatus for use in arcades.

41 – Gambling; operating lotteries; prize draws (lotteries); organising and conducting lotteries; games equipment rental; leasing of casino games; providing of casino and gambling facilities; casino, gaming and gambling services; providing amusement arcade services; video arcade services; gaming machine entertainment services.

(260) AM 2018 93741 A

(800) 1359893

(151) 2016 11 30

(891) 2016 11 30

(731) AICON CAFÈ SRL

Via Francesco Caracciolo, 15, I-80122
NAPOLI, Italy

(540)



(591) Black, white

(531) 02.09.01; 26.04.02; 26.04.04; 26.04.05;
26.04.22; 26.04.24; 27.05.10; 27.05.24

(511)

11 – Espresso coffee machines (electric), electric coffee toasters, electric coffee makers.

30 – Roasted coffee, coffee powder, coffee beans, coffee bags, coffee capsules, coffee flavourings, coffee essences, coffee extracts, mixtures of coffee, artificial coffee, prepared coffee beverages, coffee-based beverages; tea, cocoa; cocoa-based beverages, chocolate-based beverages, tea-based beverages; rice; tapioca and sago; flour and preparations made from cereals; bread, pastries and confectionery; edible ices; sugar, honey, treacle; yeast, baking-powder; salt; mustard; vinegar, sauces [condiments]; spices; ice.

(260) AM 2018 93788 A

(800) 1359422

(151) 2016 11 01

(891) 2016 11 01

(731) VINZERHOME

Mishugi Str., 2, nonresidential premise
No.418 Kyiv 02140, Ukraine

(540)

VINZERHOME

(591) Black, white

(531) 27.05.10; 27.05.17

(511)

8 – Hand tools and implements [hand-operated]; levers; table forks; oyster openers; spoons; fleshing knives [hand tools]; meat choppers [hand tools]; mincing knives [hand tools]; knives; scaling knives; vegetable choppers; vegetable knives; vegetable shredders; vegetable slicers; silver plate [knives, forks and spoons]; table cutlery [knives, forks and spoons]; nippers; pincers, tongs; nutcrackers, not of precious metal.

16 – Paper, cardboard and goods made from these materials, not included in other classes, particularly, boxes of cardboard or paper; paper bags and containers; packing materials of paper or cardboard; paper for wrapping; bottle envelopes of cardboard or paper; wrappers of cardboard or paper for dishes; packing paper; signboards of paper or cardboard; printed matter, particularly; forms, printed; pamphlets; booklets; printed publications, almanacs; newsletters; calendars; catalogues; posters; prospectuses; flyers; ledgers [books]; stickers [stationery]; pictures; index cards [stationery]; charts; seals [stamps]; address stamps; adhesive bands for stationery or household purposes; plastic materials for packaging, particularly; sheets of plastic for packaging; bags for wrapping and packaging; sheets of reclaimed ce-

llulose for wrapping; bags [envelopes, pouches] of paper or plastics, for packaging.

21 – Household or kitchen utensils and containers; waffle irons, non-electric; buckets, pails; containers for household or kitchen use, not of precious metal; beaters, non-electric; candle extinguishers, not of precious metal; whisks, non-electric, for household purposes; kitchen grinders, non-electric, for household purposes; coffeepots, non-electric, not of precious metal; coffee grinders, hand-operated; coffee services [tableware], not of precious metal; coffee percolators, non-electric; coffee filters, non-electric; stew-pans; mugs, not of precious metal; cooking pot sets; kitchen containers, not of precious metal; blenders, non-electric, for household purposes; coolers [ice pails], ice buckets, ice pails; spatulas [kitchen utensils]; pie servers; tart scoops; butter dishes; menu card holders; basins [bowls]; mills for domestic purposes, hand-operated; butter-dish covers; covers for dishes, dish covers; heat-insulated containers for beverages; spice sets; services [dishes], not of precious metal; knife rests for the table; dustbins, garbage cans, refuse bins, trash cans; ladles, for kitchen use; pepper mills, hand-operated; pepper pots, not of precious metal; cookie jars; trivets [table utensils]; egg cups; egg cups, not of precious metal; hand-operated mills for domestic purposes; cocktail shakers; griddles [cooking utensils], grills [cooking utensils]; salad bowls, not of precious metal; candelabra [candlesticks], candlesticks, not of precious metal; frying pans; autoclaves [pressure cookers], non-electric; deep fryers, non-electric; fruit presses, non-electric, for household purposes; tableware, other than knives, forks and spoons, not of precious metal; table plates, not of precious metal; heat-insulated containers; thermally insulated containers for food; trays for domestic purposes, not of precious metal; molds [kitchen utensils], moulds [kitchen utensils]; ice cube molds [moulds]; strainers for household purposes; strainers, not of precious metal; boxes for sweetmeats, candy boxes, not of precious metal; tea balls, tea infusers, not of precious metal; teapots, not of precious metal; tea services [tableware], not of precious metal; tea strainers, not of precious metal; drinking glasses, goblets, mugs, not of precious metal; cups, not of precious metal.

35 – Advertising; business management; business administration; office functions; business management assistance; price quotations for goods, revealing the commodity prices, demand and-supply for the goods; cost price analysis and market research services; collection of market research information relating to dishes and electric devices for household purposes; administration of business affairs; the bringing together, for the benefit of others, of a variety of goods (excluding the transport thereof), particularly, the devices for household purposes, household and kitchen utensils and containers (not of pre-

cious metal), cooking equipment, electrical appliances for household purposes, table cutlery, enabling customers to conveniently view and purchase those goods; such services may be provided by retail stores, wholesale outlets, through mail order catalogues or by means of electronic media, for example, through web sites or television shopping programmes; demonstration of goods; distribution of samples; office services; sales promotion for others; business management services relating to franchising.

(260) AM 2018 93791 A

(800) 1359464

(151) 2017 03 16

(891) 2017 03 16

(731) YONGGAO CO., LTD.

No.2, Daixi Road, Huangyan Economic Development Zone, Taizhou City, Zhejiang Province, China

(540)



(591) Black, white

(531) 27.05.17; 27.05.23

(511)

17 – Seals; reinforcing materials, not of metal, for pipes; pipe jackets, not of metal; pipe muffers, not of metal; junctions, not of metal, for pipes; plastic pipes for use in manufacturing; plastic boards for use in manufacturing; plastic poles for use in manufacturing; plastic strips for use in manufacturing; watering hoses.

19 – Drain traps [valves], not of metal or plastic; doors and windows of plastic; plastic pipes for building; plastic boards for construction; plastic poles for construction; plastic strips for construction; pipework, not of metal; laths, not of metal; water-pipes, not of metal; building materials, not of metal.

20 – Valves, not of metal, other than parts of machines; drain traps (valves) of plastic; drain valves of plastic; water-pipe valves of plastic; nonmetallic ball valves; plastic trough for cables and wires; sealing caps, not of metal; screws, not of metal.

(260) AM 2018 93792 A

(800) 1359468

(151) 2017 02 22

(891) 2017 02 22

(731) Araik KHACHATRIAN

Pr. 40-richchia Zhovtnia, 46/1, kv. 37 Kyiv 03039, Ukraine

(540)



(591) Black, white

(531) 27.05.17

(511)

4 – Fuel and illuminants; anthracite; biomass fuel; wood briquettes; combustible briquettes; lignite; kerosene; firewood; charcoal (fuel); ethanol (fuel); coal; coal dust (fuel); coal briquettes; firelighters; fuel with an alcoholic base; petrol; paper spills for lighting; alcohol (fuel); wood spills for lighting; tinder.

8 – Table forks; table knives; table spoons; oyster openers; ceramic knives; fire irons; mincing knives (hand tools); can openers, non-electric; pizza cutters, non-electric; cleavers; penknives; cutlery; vegetable slicers; vegetable choppers; cheese slicers, non-electric; silver plate (knives, forks and spoons); table cutlery (knives, forks and spoons); egg slicers, non-electric.

11 – Apparatus for heating and cooking; kitchen ranges [ovens]; furnaces, other than for laboratory use; hearths; rotisseries; roasting spits; lava rocks for use in barbecue grills; cooking utensils, electric; cooking rings; cookers; barbecues; plate warmers; roasting jacks; oil burners; heated display cabinets; refrigerators; alcohol burners; fruit roasters; beverage cooling apparatus.

29 – Meat, fish, poultry and game; meat extracts; preserved, frozen, dried and cooked fruits and vegetables; jellies, jams, compotes; eggs; milk and milk products; edible oils and fats; ajvar (preserved peppers); aloe vera prepared for human consumption; albumin milk; alginates for culinary purposes; anchovy, not live; peanuts, prepared; peanut butter; peanut milk for culinary purposes; artichokes preserved; bacon; albumen for culinary purposes; white of eggs; beans, preserved; bulgogi (Korean beef dish); bouillon; broth; bouillon concentrates; marmalade; cream (dairy products); toasted laver; flavored nuts; nuts, prepared; peas, preserved; mushrooms, preserved; hummus (chickpea paste); potato fritters; jams; non-alcoholic eggnog; seaweed extracts for food; gelatine; meat jellies; bone oil, edible; lard; suet for food; fatty substances for the manufacture of edible fats; fat-containing mixtures for bread slices; yolk of eggs; cranberry sauce (compote); salted fish; candied nuts; whipped cream; condensed milk; caviar; eggplant paste; vegetable marrow paste; fish roe, prepared; ginger jam; yogurt; sauerkraut; potato flakes; potato chips; kephir (milk beverage); curd; kimchi (fermented vegetable dish); isinglass for food; clams, not live; charcuterie; coconut oil for food; coconut butter; coconut fat; coconut, desiccated; milk shakes; arrangements of processed fruit; shrimps, not live; prawns, not live; black pudding (blood sausage); croquettes; corn oil for food; koumiss (milk beverage); sesame oil for food; spiny lobsters, not live; lecithin for culinary purposes; flaxseed oil for culinary purposes; margarine.

rine; butter; cocoa butter for food; buttercream; almonds, ground; almond milk for culinary purposes; mussels, not live; powdered milk; milk beverages, milk predominating; shellfish, not live; sea cucumbers, not live; vegetable mousses; fish mousses; meat, tinned (canned); meat, preserved; seeds, prepared; sunflower seeds, prepared; vegetables, tinned (canned); vegetable salads; vegetable juices for cooking; vegetable soup preparations; vegetables, cooked; gherkins; olives, preserved; olive oil for food; lobsters, not live; herrings, not live; palm oil for food; palm kernel oil for food; liver pate; pectin for culinary purposes; liver; pollen prepared as foodstuff; prostokvasha (soured milk); poultry, not live; crayfish, not live; crustaceans, not live; fish, preserved; salmon, not live; fish meal for human consumption; fish fillets; fish, tinned (canned); rice milk for use as a milk substitute; colza oil for food; raisins; ryazhenka (fermented baked milk); sardines, not live; pork; cheese; whey; rennet; preparations for making bouillon; smetana (sour cream); soya milk (milk substitute); tofu; soya beans, preserved, for food; salted meats; pickles; sunflower oil for food; sausages; sausages in batter; lentils, preserved; preparations for making soup; soups; tahini (sesame seed paste); animal marrow for food; tripe; tomato paste; tomato purée; tomato juice for cooking; truffles, preserved; tuna, not live; oysters, not live; milk ferments for culinary purposes; dates; crystallized fruits; fruit preserved in alcohol; fruit peel; fruit pulp; fruit jellies; fruit-based snack food; fruit, stewed; fruits, tinned (canned); fruit chips; fruit salads; hazelnuts, prepared; fish-based foodstuffs; edible birds' nests; onions, preserved; preserved garlic; low-fat potato chips; ham; silkworm chrysalis for human consumption; apple purée; berries, preserved; powdered eggs; snail eggs for consumption; yakitori.

35 – Advertising; business management; business administration; office functions; administrative processing of purchase orders; administration of consumer loyalty programs; administration of frequent flyer programs; cost price analysis; business auditing; auctioneering; outsourced administrative management for companies; book-keeping; web indexing for commercial or advertising purposes; market studies; opinion polling; invoicing; arranging newspaper subscriptions for others; arranging subscriptions to telecommunication services for others; payroll preparation; tax preparation; demonstration of goods; business inquiries; business management assistance; commercial or industrial management assistance; advisory services for business management; business research; economic forecasting; providing business information via a web site; compilation of information into computer databases; compilation of statistics; business information; business management of performing artists; business management for freelance service providers; business management of hotels; business management of sports people; busi-

ness management of reimbursement programs for others; commercial information and advice for consumers (consumer advice shop); commercial administration of the licensing of the goods and services of others; computerized file management; personnel management consultancy; business management consultancy; business organization consultancy; marketing; marketing research; typing; provision of commercial and business contact information; provision of an on-line marketplace for buyers and sellers of goods and services; writing of resumes for others; writing of publicity texts; scriptwriting for advertising purposes; word processing; updating of advertising material; updating and maintenance of data in computer databases; web site traffic optimization; organization of exhibitions for commercial or advertising purposes; organization of fashion shows for promotional purposes; organization of trade fairs for commercial or advertising purposes; rental of advertising space; shop window dressing; business appraisals; personnel recruitment; business management and organization consultancy; commercial information agency services; employment agency services; business efficiency expert services; outsourcing services (business assistance); business project management services for construction projects; commercial intermediation services; layout services for advertising purposes; appointment reminder services (office functions); news clipping services; price comparison services; procurement services for others (purchasing goods and services for other businesses); relocation services for businesses; photocopying services; appointment scheduling services (office functions); tax filing services; import-export agency services; modelling for advertising or sales promotion; advertising agency services; secretarial services; public relations; retail or wholesale services for pharmaceutical, veterinary and sanitary preparations and medical supplies; data search in computer files for others; sponsorship search; search engine optimization for sales promotion; presentation of goods on communication media, for retail purposes; telephone answering for unavailable subscribers; rental of billboards (advertising boards); office machines and equipment rental; publicity material rental; rental of advertising time on communication media; rental of vending machines; rental of sales stands; rental of photocopying machines; direct mail advertising; psychological testing for the selection of personnel; publication of publicity texts; radio advertising; pay per click advertising; bill-posting; advertising by mail order; on-line advertising on a computer network; document reproduction; distribution of samples; dissemination of advertising matter; design of advertising materials; business investigations; systemization of information into computer databases; drawing up of statements of accounts; sales promotion for others; production of advertising films; shorthand; transcription of communications

(office functions); television advertising; telemarketing services; negotiation and conclusion of commercial transactions for third parties; professional business consultancy; the bringing together, for the benefit of others, of a variety of goods (excluding the transport thereof), enabling customers to conveniently view and purchase those goods in retail stores, wholesale outlets, through mail order catalogues or by means of electronic media, for example, through web sites or television shopping programmes.

41 – Education; providing of training; entertainment services; sporting and cultural activities; academies (education); teaching; videotaping; arranging and conducting of congresses; arranging and conducting of colloquiums; arranging and conducting of conferences; arranging and conducting of concerts; arranging and conducting of in-person educational forums; arranging and conducting of workshops (training); arranging and conducting of seminars; arranging and conducting of symposiums; arranging of beauty contests; electronic desktop publishing; educational examination; providing on-line videos, not downloadable; providing on-line electronic publications, not downloadable; providing on-line music, not downloadable; providing recreation facilities; correspondence courses; recreation information; education information; entertainment information; tutoring; scriptwriting, other than for advertising purposes; writing of texts; organization of balls; organization of shows (impresario services); organization of exhibitions for cultural or educational purposes; organization of competitions (education or entertainment); organization of lotteries; organization of fashion shows for entertainment purposes; organization of sports competitions; party planning (entertainment); entertainer services; disc jockey services; discotheque services; coaching (training); karaoke services; club services (entertainment or education); nightclub services (entertainment); orchestra services; amusement park services; sport camp services; holiday camp services (entertainment); photographic reporting; educational services provided by schools; practical training (demonstration); presentation of live performances; presentation of variety shows; presentation of circus performances; rental of audio equipment; rental of show scenery; vocational retraining; vocational guidance (education or training advice); on-line publication of electronic books and journals; publication of books; publication of texts, other than publicity texts; production of shows.

43 – Providing campground facilities; food and drink catering; rental of meeting rooms; bar services; hotel services; canteen services; café services; cafeteria services; motel services; boarding house services; restaurant services; self-service restaurant services; snack-bar services; holiday camp services (lodging); tourist home services; rental of drinking water dispensers; rental of tents; rental of cooking appara-

tus; rental of lighting apparatus; rental of transportable buildings; rental of chairs, tables, table linen, glassware; food sculpting.

(260) AM 2018 93947 A

(800) 1361306

(151) 2017 04 19

(891) 2017 04 19

(731) NIO CO., LTD.

Suite 115, 569 Anchi Road, Anting Town,
Jiading District, 201805 Shanghai (China),
China

(540)

NIO  **蔚来**

(591) Black, white

(531) 26.02.07; 26.13.25; 28.03

(511)

9 – Computer programs [downloadable software]; batteries, electric, for vehicles; accumulators, electric; chargers for electric batteries; navigation apparatus for vehicles [on-board computers]; breakdown warning triangles; automatic indicators of low pressure in vehicle tires [tyres]; portable media players; anti-dazzle shades; theft prevention installations, electric.

(260) AM 2018 93969 A

(800) 1361522

(151) 2017 06 19

(891) 2017 06 19

(731) TEKSÜT SÜT MAMÜLLERİ SANAYİ VE
TİCARET ANONİM ŞİRKETİ

Hasanbey Mahallesi Köyalti Sokak No:14/A
Gönen Balıkesir, Turkey

(540)

İyi Olan Tektir!

(591) Green, dark green and white

(531) 25.05.02; 26.04.04; 27.05.24; 29.01.12

(511)

29 – Milk and milk products (including butter).

(260) AM 2018 94150 A

(800) 1363502

(151) 2016 12 29

(891) 2016 12 29

(731) EGT REFRAKTER GEREÇLER ENDÜSTRİ VE TİCARET LİMİTED ŞİRKETİ
Organize Sanayi Bölgesi, Tevfik Ziyaeddin Caddesi, 7. Sokak, No:8 Selçuklu Konya, Turkey

(540)



(591) Red and white

(531) 26.11.03; 26.11.08; 27.05.11; 27.05.17; 29.01.01

(511)

19 – Mortar for building, refractory construction materials, not of metal; refractory mortar; concrete, refractory concrete.

(260) AM 2018 94235 A

(800) 1365265

(151) 2017 04 07

(891) 2017 04 07

(731) Eagle Investment SICAV plc, acting on behalf of ITT FUND
Alpine House, Naxxar Road, SGN 9032 San Gwann, Malta

(540)

Dice 81

(591) Black, white

(511)

9 – Games software; software programs for video games; interactive video game programs; software cartridges for computer games; software cartridges for video games; software; educational software; application software; community software; computer telephony software; interactive computer software; communication software; programs for computers; electronic components for gambling machines; games cartridges for use with electronic games apparatus; juke boxes; automated teller machines.

28 – Games; sports games; manipulative games; mechanical games; musical games; electronic games; parlor games; board games; quiz games; apparatus for games; arcade games; skill and action games; electronic hand-held game units; handheld computer games; lottery wheels; lottery tickets; slot machines; automatic gaming machines; coin-operated amusement machines; bill-operated gaming equipment; LCD game machines; counters for games; amusement apparatus for use in arcades.

41 – Gambling; operating lotteries; prize draws; organising and conducting lotteries; games equipment rental; casino services; leasing of casino games; pro-

viding of casino and gaming facilities; casino, gaming and gambling services; providing amusement arcade services; video arcade services.

(260) AM 2018 94253 A

(800) 1365073

(151) 2017 02 07

(891) 2017 02 07

(731) Zakrytoe aktsionernoe obshchestvo "DS Controlz"
ul. Nekhinskaya, 61 RU-173021 Veliky Novgorod, Russian Federation

(540)



(591) Red, blue and white

(531) 14.03.20; 27.05.08; 29.01.13

(511)

6 – Fittings of metal for compressed air ducts; bottles [metal containers] for compressed gas or liquid air; valves of metal, other than parts of machines; water-pipe valves of metal; drain traps [valves] of metal; cast steel; containers of metal for compressed gas or liquid air; reservoirs of metal; tanks of metal; pipework of metal; penstock pipes of metal; water-pipes of metal; pipes of metal; tubes of metal; steel pipes; steel tubes; clips of metal for cables and pipes; balls of steel.

7 – Fittings for engine boilers; valves [parts of machines]; clack valves [parts of machines]; pressure reducers [parts of machines]; taps [parts of machines, engines or motors]; pistons [parts of machines or engines]; stuffing boxes [parts of machines]; control mechanisms for machines, engines or motors; filters [parts of machines or engines]; driving chains, other than for land vehicles; cylinders for machines; pneumatic jacks; motors, electric, other than for land vehicles.

9 – Fittings for engine boilers; valves [parts of machines]; clack valves [parts of machines]; pressure reducers [parts of machines]; taps [parts of machines, engines or motors]; pistons [parts of machines or engines]; stuffing boxes [parts of machines]; control mechanisms for machines, engines or motors; filters [parts of machines or engines]; driving chains, other than for land vehicles; cylinders for machines; pneumatic jacks; motors, electric, other than for land vehicles.

11 – Structural plates for ovens; framework of metal for ovens; air valves for steam heating installations; level controlling valves in tanks; thermostatic valves [parts of heating installations]; taps [cocks, spigots] [faucets (Am.)] for pipes; faucets for pipes (Am.); pipe line cocks [spigots]; taps [faucets]; air purifying apparatus and machines; safety accessories for water

or gas apparatus and pipes; regulating and safety accessories for gas apparatus; regulating accessories for water or gas apparatus and pipes; regulating and safety accessories for water apparatus; regulating and safety accessories for gas pipes; air filtering installations; cooling installations and machines; water supply installations; dampers [heating].

35 – Marketing studies; business investigations; marketing research; commercial intermediation services; sales promotion for others; dissemination of advertising matter; compilation of statistics; procurement services for others [purchasing goods and services for other businesses].

(260) AM 2018 94422 A

(800) 1366804

(151) 2017 08 11

(891) 2017 08 11

(731) FITTEAM Global LLC

4440 PGA BLVD STE 600, Palm Beach
Gardens FL 33410, USA

(540)

FITTEAM Global

(591) Black, white

(526) Global

(511)

5 – Dietary supplements.

(260) AM 2018 94523 A

(800) 1367963

(151) 2017 08 04

(891) 2017 08 04

(731) Araik KHACHATRIAN

Pr. 40-richchia Zhovtnia, 46/1, kv. 37 Kyiv
03039, Ukraine

(540)

JUMBO GRILL

(591) Black and white

(531) 27.05.17

(511)

41 – Education; providing of training; entertainment services; sporting and cultural activities; academics (education); teaching; videotaping; arranging and conducting of congresses; arranging and conducting of colloquiums; arranging and conducting of conferences; arranging and conducting of concerts; arranging and conducting of in-person educational forums; arranging and conducting of workshops (training); arranging and conducting of seminars; arranging and conducting of symposiums; arranging of beauty contests; electronic desktop publishing; educational examination; providing on-line videos, not downloadable; providing on-line electronic publications, not downloadable; providing on-line music, not downloadable; providing recreation facilities;

correspondence courses; recreation information; education information; entertainment information; tutoring; scriptwriting, other than for advertising purposes; writing of texts; organization of balls; organization of shows (impresario services); organization of exhibitions for cultural or educational purposes; organization of competitions (education or entertainment); organization of lotteries; organization of fashion shows for entertainment purposes; organization of sports competitions; party planning (entertainment); entertainer services; disc jockey services; discotheque services; coaching (training); karaoke services; club services (entertainment or education); nightclub services (entertainment); orchestra services; amusement park services; sport camp services; holiday camp services (entertainment); photographic reporting; educational services provided by schools; practical training (demonstration); presentation of live performances; presentation of variety shows; presentation of circus performances; rental of audio equipment; rental of show scenery; vocational retraining; vocational guidance (education or training advice); on-line publication of electronic books and journals; publication of books; publication of texts, other than publicity texts; production of shows.

43 – Providing campground facilities; food and drink catering; rental of meeting rooms; bar services; hotel services; canteen services; café services; cafeteria services; motel services; boarding house services; restaurant services; self-service restaurant services; snack-bar services; holiday camp services (lodging); tourist home services; rental of drinking water dispensers; rental of tents; rental of cooking apparatus; rental of lighting apparatus; rental of transportable buildings; rental of chairs, tables, table linen, glassware; food sculpting.

(260) AM 2018 94607 A

(800) 1369809

(151) 2017 07 25

(891) 2017 07 25

(731) PIERRE FABRE MEDICAMENT

45 place Abel Gance, F-92100 BOULOGNE
BILLANCOURT, France

(540)

CICALIUM

(591) Black, white

(511)

3 – Products for oral and dental hygiene for cosmetic use.

5 – Orthodontic wax; products for oral and dental cleaning and the care for medical use.

21 – Toothbrushes; dental floss; interdental brushes; dental sticks.

(260) AM 2018 94611 A

(800) 1369815

(151) 2017 08 01

(891) 2017 08 01

(731) CHAUX ET ENDUITS DE SAINT ASTIER

Lieudit la Jarthe, F-24110 SAINT-ASTIER,
France

(540)

TERECHAUX

(591) Black, white

(511)

19 – Natural lime for whitewash coatings; building materials, not of metal; hydraulic lime.

(260) AM 2018 94614 A

(800) 1369841

(151) 2017 07 25

(891) 2017 07 25

(731) AVON PRODUCTS, INC.

601 Midland Avenue, Rye, NY 10580, USA

(540)



(591) Black, white

(531) 01.15.23; 26.04.01; 26.04.03; 26.04.12;

26.13.25; 27.05.08; 27.05.17; 27.05.21

(511)

18 – Bags, hand bags, clutch bags, tote bags, cases, holdalls, luggage tags of leather, suitcases, trunks, travelling bags; toiletry bags, make-up bags; backpacks; athletic bags, beach bags, duffel bags, gym bags, shopping bags; credit card cases; purses, pocket wallets; umbrellas.

25 – Clothing; underclothing; lingerie; clothing for children; hosiery, socks, tights, vests; sweaters, tank tops, dresses, skirts, trousers, sweat pants, sweat shirts, track suits, shirts, blouses, shorts, socks, t-shirts, headgear; swimwear and beachwear; pyjamas, nightdresses; jackets; bath robes, bath sandals and bath slippers; gloves, mittens; headgear, baseball caps, visors, hats; scarves; belts; footwear; slippers, boots and shoes, women's shoes, flip flops.

(260) AM 2018 94617 A

(800) 1369851

(151) 2017 07 06

(891) 2017 07 06

(731) FUJIAN JINLU DAILY CHEMICALS,
CO., LTD.

Dongxi Industrial Zone, Honglai, Nan'an,
362300 Fujian, China

(540)



(591) Black, white

(531) 03.04.07; 03.04.22; 26.13.25; 26.15.07;

27.05.02; 28.03

(511)

5 – Disinfectants; radioactivity drug; contact lens cleaning solutions; media for bacteriological cultures; dietetic foods adapted for medical purposes; air deodorising preparations; pesticides; mosquito-repellent incense; fly destroying preparations; insect repellent incense; insect repellents; mothballs; paper impregnated with disinfectants.

(260) AM 2018 94619 A

(800) 1369219

(151) 2017 07 14

(891) 2017 07 14

(731) "SOUTHERN JUICE COMPANY" Limited

Pobedy st., 132, RU-352630 Belorechensk,
Krasnodar region, Russian Federation

(540)

Родной

(591) Black and white

(511)

32 – Aperitifs, non-alcoholic; lithia water; seltzer water; soda water; waters [beverages]; aerated water; mineral water [beverages]; table waters; lemonades; non-alcoholic fruit juice beverages; fruit nectars, non-alcoholic; smoothies; tomato juice [beverage]; cider, non-alcoholic; vegetable juices [beverages]; fruit juices; sherbets [beverages]; non-alcoholic fruit extracts.

(260) AM 2018 94620 A

(800) 1369888

(151) 2017 03 01

(891) 2017 03 01

(731) MONTEFARMACO OTC S.P.A.

Via IV Novembre, 92, I-20021 Bollate (MI),
Italy

(540)

IRIDINA

(591) Black, white

(511)

3 – Colour cosmetics for the eyes; eye compresses for cosmetic purposes; solutions for cleaning spectacle lenses.

5 – Ophthalmic preparations for medical purposes, including in the form of gels and sprays; eyewash; eye drops; artificial tears; dietary supplements for sight and eye health; disinfectants for contact lenses.

(260) AM 2018 94621 A

(800) 1369254

(151) 2016 11 14

(891) 2016 11 14

(731) Huvepharma EOOD

Nikolay Haitov Str. 3A, 5th floor BG-1113

Sofia, Bulgaria

(540)

AMPHEN

(591) Black and white

(511)

5 – Veterinary preparations; antibiotics for veterinary use; medicines for veterinary purposes; nutritional additives to foodstuffs for animals, for medical purposes.

(260) AM 2018 94631 A

(800) 1370023

(151) 2017 01 11

(891) 2017 01 11

(731) CHINA COSCO SHIPPING

CORPORATION LIMITED

628, MINSHENG ROAD, SHANGHAI

PILOT FREE TRADE ZONE, SHANGHAI,

China

(540)



(591) Black, white

(531) 26.01.06; 26.01.21; 27.05.10; 27.05.15; 27.05.17

(526) SHIPPING

(511)

6 – Buildings, transportable, of metal; loading pallets of metal; containers of metal for storage and transport of goods; storage containers of metal; floating docks of metal, for mooring boats; anchors; floating containers of me.

12 – Hydroplanes; vehicle chassis; boats; ships' hulls; ships; yachts; davits for boats; barges; funnels for ships; spars for ships.

36 – Insurance underwriting; insurance brokerage; financing, services; banking; capital investment; art

appraisal; real estate management; financial customs brokerage services; surety services; charitable fund raising; trusteeship; lending against security; marine insurance underwriting.

37 – Construction consultancy, namely providing information related to marine construction and construction of offshore rigs and ships; construction, namely construction of offshore rigs and ships; underwater construction; harbour construction; drilling of wells; machinery installation, maintenance and repair, namely installation, maintenance and repair of offshore rigs and ships, construction, installation, relating to offshore and marine vessels, ships and structures; vehicle repair services; shipbuilding; rust-proofing; maintenance and repair of storage containers; underwater repair.

39 – Transport; transport brokerage; transport of travelers; wrapping of goods; piloting; boat rental; shipbrokerage; air transport; vehicle rental; warehousing; rental of storage containers; operating canal locks; courier services for messages or merchandise; arranging of travel tours; transport by pipeline; transportation logistics; lighterage services; stevedoring; river transport; marine transport; car transport; freight; hauling; pleasure boat transport; freight, namely shipping of goods; boat transport; barge transport; railway truck rental.

(260) AM 2018 94649 A

(800) 1369599

(151) 2017 09 07

(891) 2017 09 07

(731) BEATS ELECTRONICS, LLC

8600 Hayden Place Culver City CA 90232, USA

(540)

BEATS STUDIO

(591) Black and white

(511)

9 – Headphones.

(260) AM 2018 94651 A

(800) 1369638

(151) 2017 05 17

(891) 2017 05 17

(731) MAISON DE FLEURS LIMITED

C/o Mark Davies & Associates Ltd, 25 Southampton Buildings, Chancery Lane London WC2A 1AL, United Kingdom

(540)

The logo for Maison de Fleurs is a highly stylized, cursive script. The words "Maison de Fleurs" are written in a fluid, elegant hand, with the letters overlapping and flowing together.

(591) Black and white
 (531) 27.05.01; 27.05.19
 (511)

3 – Bleaching preparations and other substances for laundry use; cleaning, polishing, scouring and abrasive preparations; soaps; perfumery, essential oils, cosmetics, hair lotions; dentifrices; abrasive paper; abrasives; adhesives for affixing false eyelashes; adhesives for affixing false hair; adhesives for cosmetic purposes; after-shave lotions; air fragrancings preparations; almond milk for cosmetic purposes; almond oil; almond soap; aloe vera preparations for cosmetic purposes; alum stones [astringents]; amber [perfume]; ammonia [volatile alkali] [detergent]; antiperspirant soap; antiperspirants [toiletries]; antistatic preparations for household purposes; aromatics [essential oils]; astringents for cosmetic purposes; badian essence; balms other than for medical purposes; bases for flower perfumes; bath salts, not for medical purposes; beard dyes; beauty masks; bergamot oil; bleaching preparations [decolorants] for cosmetic purposes; bleaching salts; bleaching soda; breath freshening sprays; breath freshening strips; cake flavourings [essential oils]; cakes of soap; canned pressurized air for cleaning and dusting purposes; carbides of metal [abrasives]; cleaning chalk; cleaning preparations; cleansing milk for toilet purposes; cloths impregnated with a detergent for cleaning; cobblers' wax; color-brightening chemicals for household purposes [laundry]; color-removing preparations; colorants for toilet purposes; corundum [abrasive]; cosmetic creams; cosmetic dyes; cosmetic kits; cosmetic pencils; cosmetic preparations for baths; cosmetic preparations for eyelashes; cosmetic preparations for skin care; cosmetic preparations for slimming purposes; cosmetics; cosmetics for animals; cotton sticks for cosmetic purposes; cotton wool for cosmetic purposes; decorative transfers for cosmetic purposes; degreasers other than for use in manufacturing processes; dental bleaching gels; dentifrices; denture polishes; deodorant soap; deodorants for human beings or for animals; deodorants for pets; depilatories; depilatory wax; detergents other than for use in manufacturing operations and for medical purposes; diamantine [abrasive]; douching preparations for personal sanitary or deodorant purposes [toiletries]; dry-cleaning preparations; dry shampoos; drying agents for dishwashing machines; eau de cologne; emery; emery cloth; emery paper; essential oils of cedarwood; essential oils of citron; essential oils of lemon; ethereal essences; ethereal oils; extracts of flowers [perfumes]; eyebrow cosmetics; eyebrow pencils; fabric softeners for laundry use; false eyelashes; false nails; flavorings for beverages [essential oils]; floor wax; floor wax removers [scouring preparations]; fumigation preparations [perfumes]; refurbishing preparations; gaultheria oil; geraniol; glass cloth; greases for cosmetic purposes; grinding preparations; hair dyes; hair lotions; hair spray;

hair waving preparations; heliotropine; henna [cosmetic dye]; hydrogen peroxide for cosmetic purposes; incense; ionone [perfumery]; jasmine oil; javelle water; joss sticks; lacquer-removing preparations; laundry bleach; laundry blueing; laundry glaze; laundry preparations; laundry soaking preparations; laundry starch; laundry wax; lavender oil; lavender water; leather bleaching preparations; leather preservatives [polishes]; lip glosses; lipsticks; lotions for cosmetic purposes; make-up; make-up powder; make-up preparations; make-up removing preparations; mascara; massage gels other than for medical purposes; mint essence [essential oil]; mint for perfumery; mouth washes, not for medical purposes; musk [perfumery]; mustache wax; nail art stickers; nail care preparations; nail polish; neutralizers for permanent waving; non-slipping liquids for floors; non-slipping wax for floors; oil of turpentine for degreasing; oils for cleaning purposes; oils for cosmetic purposes; oils for perfumes and scents; oils for toilet purposes; paint stripping preparations; pastes for razor strops; perfumery; perfumes; petroleum jelly for cosmetic purposes; polish for furniture and flooring; polishing creams; polishing paper; polishing preparations; polishing rouge; polishing stones; polishing wax; pomades for cosmetic purposes; potpourris [fragrances]; preparations for cleaning dentures; preparations for unblocking drain pipes; preparations to make shiny the leaves of plants; pumice stone; quillaia bark for washing; rose oil; rust removing preparations; sachets for perfuming linen; safrol; sandcloth; sandpaper; scale removing preparations for household purposes; scented water; scented wood; scouring solutions; shampoos; shampoos for pets; shaving preparations; shaving soap; shaving stones [astringents]; shining preparations [polish]; shoe cream; shoe polish; shoe wax; shoemakers' wax; silicon carbide [abrasive]; skin whitening creams; smoothing preparations [starching]; smoothing stones; soap; soap for brightening textile; soap for foot perspiration; soda lye; stain removers; starch glaze for laundry purposes; sun-tanning preparations [cosmetics]; sunscreen preparations; tailors' wax; talcum powder, for toilet use; terpenes [essential oils]; tissues impregnated with cosmetic lotions; toilet water; toiletries; tripoli stone for polishing; turpentine, for degreasing; varnish-removing preparations; volcanic ash for cleaning; wallpaper cleaning preparations; washing soda, for cleaning; waxes for leather; whitening; windscreen cleaning liquids.

4 – Industrial oils and greases; lubricants; dust absorbing, wetting and binding compositions; fuels (including motor spirit) and illuminants; candles and wicks for lighting; additives, non-chemical, to motor fuel; alcohol [fuel]; anthracite; beeswax; belting wax; benzene fuel; blocks of peat [fuel]; bone oil for industrial purposes; carburants; carnauba wax; castor oil for technical purposes; ceresine; charcoal [fuel]; christmas tree candles; coal; coal briquettes; coal

dust [fuel]; coal naphtha; coal tar oil; coke; combustible briquettes; cutting fluids; dust binding compositions for sweeping; dust laying compositions; dust removing preparations; electrical energy; ethanol [fuel]; firelighters; firewood; fish oil, not edible; fuel; fuel gas; fuel oil; fuel with an alcoholic base; gas for lighting; gas oil; gasoline; grease for arms [weapons]; grease for belts; grease for boots; grease for leather; illuminating grease; illuminating wax; industrial grease; industrial oil; industrial wax; kerosene; lamp wicks; lanolin; lighting fuel; lignite; lignoin; lubricants; lubricating graphite; lubricating grease; lubricating oil; mazut; methylated spirit; mineral fuel; moistening oil; motor oil; naphtha; nightlights [candles]; non-slipping preparations for belts; oil for the preservation of leather; oil for the preservation of masonry; oil-gas; oils for paints; oils for releasing form work [building]; oleine; ozocerite [ozokerite]; paper spills for lighting; paraffin; peat [fuel]; perfumed candles; petrol; petroleum ether; petroleum jelly for industrial purposes; petroleum, raw or refined; preservatives for leather [oils and greases]; producer gas; rape oil for industrial purposes; solidified gas [fuel]; soya bean oil preparations for non-stick treatment of cooking utensils; stearine; sunflower oil for industrial purposes; tallow; tapers; textile oil; tinder; vaporized fuel mixtures; wax [raw material]; wicks for candles; wood briquettes; wood spills for lighting; wax for skis; xylene fuel.

21 – Household or kitchen utensils and containers; combs and sponges; brushes (except paint brushes); brush-making materials; articles for cleaning purposes; steelwool; unworked or semi-worked glass (except glass used in building); glassware, porcelain and earthenware not included in other classes; abrasive pads for kitchen purposes; abrasive sponges for scrubbing the skin; aerosol dispensers, not for medical purposes; animal bristles [brushware]; apparatus for wax-polishing, non-electric; aquarium hoods; autoclaves [pressure cookers], non-electric; baby baths, portable; baking mats; basins [bowls]; basins [receptacles]; baskets for domestic use; basting spoons, for kitchen use; beaters, non-electric; beer mugs; bird baths; birdcages; blenders, non-electric, for household purposes; boot jacks; boot trees [stretchers]; bottle gourds; bottle openers; bottles; boxes for dispensing paper towels; boxes of glass; bread baskets, domestic; bread bins; bread boards; brooms; brush goods; brushes; brushes for cleaning tanks and containers; brushes for footwear; buckets made of woven fabrics; buckskin for cleaning; busts of porcelain, ceramic, earthenware or glass; butter-dish covers; butter dishes; buttonhooks; cabarets [trays]; cages for household pets; cake molds [moulds]; candle extinguishers; candle rings; candlesticks; candy boxes; carboys; carpet beaters, not being machines; carpet sweepers; cauldrons; ceramics for household purposes; chamber pots; cheese-dish covers; china ornaments; chopsticks; cinder sifters

[household utensils]; cleaning instruments, hand-operated; cleaning tow; closures for pot lids; cloth for washing floors; clothes-pegs; clothes racks, for drying; clothing stretchers; coasters, not of paper and other than table linen; cocktail stirrers; coffee filters, non-electric; coffee grinders, hand-operated; coffee percolators, non-electric; coffee services [tableware]; coffeepots, non-electric; comb cases; combs; combs for animals; confectioners' decorating bags [pastry bags]; containers for household or kitchen use; cookery molds [moulds]; cookie [biscuit] cutters; cookie jars; cooking pins of metal; cooking pot sets; cooking pots; cooking utensils, non-electric; corkscrews; cosmetic utensils; cotton waste for cleaning; crockery; cruet sets for oil and vinegar; cruets; crumb trays; crystal [glassware]; cups; cups of paper or plastic; currycombs; cutting boards for the kitchen; decanters; deep fryers, non-electric; deodorising apparatus for personal use; dish covers; dishes; dish-washing brushes; disposable table plates; drinking glasses; drinking horns; drinking straws; drinking troughs; drinking vessels; drying racks for washing; dustbins; dusting apparatus, non-electric; dusting cloths [rags]; earthenware saucepans; egg cups; electric brushes, except parts of machines; electric combs; electric devices for attracting and killing insects; enamelled glass; epergnes; eyebrow brushes; feather-dusters; feeding troughs; fiberglass other than for insulation or textile use; fiberglass thread, not for textile use; fitted picnic baskets, including dishes; flasks; flat-iron stands; floss for dental purposes; flower-pot covers, not of paper; flower baskets, bowls, vases, holders and containers, flower pots; fly swatters; food cooling devices, containing heat exchange fluids, for household purposes; fruit cups; fruit presses, non-electric, for household purposes; frying pans; funnels; furniture dusters; fused silica [semi-worked product], other than for building; gardening gloves; garlic presses [kitchen utensils]; glass bowls; glass bulbs [receptacles]; glass caps; glass flasks [containers]; glass for vehicle windows [semi-finished product]; glass incorporating fine electrical conductors; glass jars [carboys]; glass [receptacles]; glass, unworked or semi-worked, except building glass; glass wool other than for insulation; glove stretchers; gloves for household purposes; glue-pots; graters [household utensils]; grill supports; grills [cooking utensils]; hair for brushes; heat-insulated containers; heat insulated containers for beverages; heaters for feeding bottles, non-electric; holders for flowers and plants [flower arranging]; horse brushes; hot pots, not electrically heated; ice cube molds; ice pails; indoor aquaria; indoor terrariums [plant cultivation]; indoor terrariums [vivariums]; insect traps; ironing board covers, shaped; ironing boards; isothermic bags; jugs; kettles, non-electric; kitchen containers; kitchen mixers, non-electric; kitchen utensils; knife rests for the table; lamp-glass brushes; large-toothed combs for the

hair; lazy susans; liqueur sets; litter trays for pets; lunch boxes; majolica; make-up removing appliances; manglers for animals; material for brush-making; menu card holders; mess-tins; mills for domestic purposes, hand-operated; mixing spoons [kitchen utensils]; molds [kitchen utensils]; mop wringers; mops; mosaics of glass, not for building; mouse traps; mugs; nail brushes; napkin holders; napkin rings; nest eggs, artificial; non-electric portable cold-boxes; noodle machines, hand-operated; nozzles for sprinkler hose; opal glass; opaline glass; pails; painted glassware; paper plates; pastry cutters; pepper mills, hand-operated; pepper pots; perfume burners; perfume sprayers; pie servers; pig bristles; piggy banks; plate glass [raw material]; plates to prevent milk boiling over; plungers for clearing blocked drains; polishing apparatus and machines, for household purposes, non-electric; polishing gloves; polishing leather; polishing materials for making shiny, except preparations, paper and stone; porcelain ware; pot lids; pots; pottery; poultry rings; powder compacts; powder puffs; powdered glass for decoration; rags for cleaning; rat traps; refrigerating bottles; rings for birds; rolling pins, domestic; roses for watering cans; salad bowls; salt cellars; saucepan scourers of metal; saucers; scoops [tableware]; scouring pads; scrubbing brushes; services [dishes]; shakers; shaving brush stands; shaving brushes; shoe horns; shoe trees [stretchers]; sieves [household utensils]; sifters [household utensils]; signboards of porcelain or glass; siphons for carbonated water; smoke absorbers for household purposes; soap boxes; soap dispensers; soap holders; soup bowls; spatulas [kitchen utensils]; spice sets; sponge holders; sponges for household purposes; spouts; sprinklers; statues of porcelain, ceramic, earthenware or glass; statuettes of porcelain, ceramic, earthenware or glass; steel wool for cleaning; stew-pans; strainers; strainers for household purposes; sugar bowls; syringes for watering flowers and plants; table plates; tableware, other than knives, forks and spoons; tankards; tar-brushes, long handled; tea balls; tea caddies; tea cosies; tea services [tableware]; tea strainers; teapots; thermally insulated containers for food; tie presses; toilet brushes; toilet cases; toilet paper dispensers; toilet paper holders; toilet sponges; toilet utensils; toothbrushes; toothbrushes, electric; toothpick holders; toothpicks; towel rails and rings; trays for domestic purposes; trays for domestic purposes, of paper; trivets [table utensils]; trouser presses; urns; utensils for household purposes; vacuum bottles; vases; vegetable dishes; vessels of metal for making ices and iced drinks; vitreous silica fibers [fibres], not for textile use; waffle irons, non-electric; washing boards; wash-tubs; waste paper baskets; water apparatus for cleaning teeth and gums; watering cans; watering devices; wax-polishing appliances, non-electric, for shoes; whisks, non-electric, for household purposes; window-boxes; wine tasters [siphons]; wool waste

for cleaning; works of art of porcelain, ceramic, earthenware or glass.

26 – Lace and embroidery, ribbons and braid; buttons, hooks and eyes, pins and needles; artificial flowers; appliqués [haberdashery]; artificial flowers; artificial fruit; artificial garlands; artificial plants; badges for wear, not of precious metal; barrettes [hair-slides]; beads other than for making jewelry; belt clasp; binding needles; birds' feathers [clothing accessories]; blouse fasteners; bobbins for retaining embroidery floss or wool [not parts of machines]; bodkins; bows for the hair; boxes for needles; braids; brassards; brooches [clothing accessories]; buckles [clothing accessories]; buttons; chenille [passementerie]; collar supports; competitors' numbers; cords for clothing; cords for rimming, for clothing; corset busks; darning lasts; darning needles; dress fastenings; edgings for clothing; elastic ribbons; embroidering crochet hooks; embroidery; expanding bands for holding sleeves; eyelets for clothing; false beards; false hair; false hems; false moustaches; fastenings for braces; feathers [clothing accessories]; festoons [embroidery]; frills for clothing; frills [lace-work]; fringes; gold embroidery; haberdashery, except thread; hair bands; hair coloring caps; hair curlers, other than hand implements; hair curling papers; hair curling pins; hair extensions; hair grips [slides]; hair nets; hair ornaments; hair pins; hat ornaments, not of precious metal; heat adhesive patches for decoration of textile articles [haberdashery]; heat adhesive patches for repairing textile articles; hook and pile fastening tapes; hooks for corsets; hooks [haberdashery]; human hair; knitting needles; lace for edgings; letters for marking linen; mica spangles; monogram tabs for marking linen; needle cases; needle cushions; needles; needles for wool combing machines; numerals for marking linen; ornamental novelty badges [buttons]; orsedew [trimmings for clothing]; ostrich feathers [clothing accessories]; passementerie; picot [lace]; pin cushions; pins, other than jewellery [jewelry]; plaited hair; prize ribbons; ribbons [haberdashery]; rosettes [haberdashery]; rug hooks; saddlers' needles; sewing boxes; sewing needles; sewing thimbles; shoe buckles; shoe eyelets; shoe fasteners; shoe hooks; shoe laces; shoe ornaments, not of precious metal; shoemakers' needles; shoulder pads for clothing; shuttles for making fishing nets; silk flowers; silver embroidery; skirt flounces; snap fasteners; spangles for clothing; tapes for curtain headings; tassels [haberdashery]; top-knots [pompoms]; toupees; trimmings for clothing; trouser clips for cyclists; wigs; woollen laces; wreaths of artificial flowers; zippers; zippers for bags.

28 – Games and playthings; gymnastic and sporting articles not included in other classes; decorations for Christmas trees; air pistols [toys]; amusement machines, automatic and coin-operated; apparatus for

games; appliances for gymnastics; arcade video game machines; archery implements; artificial fishing bait; artificial snow for Christmas trees; ascenders [mountaineering equipment]; backgammon games; bags especially designed for skis and surfboards; balls for games; bar-bells; baseball gloves; batting gloves [accessories for games]; bells for Christmas trees; billiard balls; billiard cue tips; billiard cues; billiard markers; billiard table cushions; billiard tables; bingo cards; bite indicators [fishing tackle]; bite sensors [fishing tackle]; bladders of balls for games; board games; bob-sleighs; body boards; body-building apparatus; bowling apparatus and machinery; bows for archery; boxing gloves; building blocks [toys]; building games; butterfly nets; camouflage screens [sports articles]; candle holders for Christmas trees; caps for pistols [toys]; chalk for billiard cues; checkerboards; checkers [games]; chess games; chessboards; chips for gambling; Christmas tree stands; Christmas trees of synthetic material; clay pigeon traps; clay pigeons [targets]; climbers' harness; coin-operated billiard tables; confetti; conjuring apparatus; controllers for game consoles; coques [toy fireworks]; counters [discs] for games; creels [fishing traps]; cricket bags; cups for dice; darts; toys used as decorations during Easter and Christmas; detonating caps [toys]; dice; discuses for sports; divot repair tools [golf accessories]; dolls; dolls' beds; dolls' clothes; dolls' feeding bottles; dolls' houses; dolls' rooms; dominoes; edges of skis; elbow guards [sports articles]; electronic targets; exercisers [expanders]; fairground ride apparatus; fencing gloves; fencing masks; fencing weapons; fish hooks; fishing tackle; flippers for swimming; floats for fishing; flying discs [toys]; games; gaming machines for gambling; gloves for games; golf bags, with or without wheels; golf clubs; golf gloves; gut for fishing; gut for rackets; hang gliders; harness for sailboards; harpoon guns [sports articles]; hockey sticks; horseshoe games; hunting game calls; ice skates; in-line roller skates; jigsaw puzzles; kaleidoscopes; kite reels; kites; knee guards [sports articles]; landing nets for anglers; lines for fishing; lures for hunting or fishing; machines for physical exercises; mah-jong; marbles for games; masts for sailboards; men's athletic supporters [sports articles]; mobiles [toys]; nets for sports; ninepins; novelties for parties, dances [party favors, favours]; ornaments for Christmas trees, except illumination articles and confectionery; pachinkos; paintball guns [sports apparatus]; paintballs [ammunition for paintball guns] [sports apparatus]; paper party hats; paragliders; parlor games; piñatas; play balloons; playing balls; playing cards; plush toys; poles for pole vaulting; portable games with liquid crystal displays; practical jokes [novelties]; protective paddings [parts of sports suits]; punching bags; puppets; quoits; rackets; radio-controlled toy vehicles; rattles [playthings]; reels for fishing; ring games; rocking horses; rods for fishing;

roller skates; rollers for stationary exercise bicycles; rosin used by athletes; roulette wheels; sailboards; scale model kits [toys]; scale model vehicles; scent lures for hunting or fishing; scooters [toys]; scratch cards for playing lottery games; seal skins [coverings for skis]; shin guards [sports articles]; shuttlecocks; skateboards; skating boots with skates attached; ski bindings; skis; skittles; sleighs [sports articles]; slides [playthings]; sling shots [sports articles]; slot machines [gaming machines]; snow globes; snowboards; snowshoes; soap bubbles [toys]; sole coverings for skis; spinning tops [toys]; spring boards [sports articles]; starting blocks for sports; stationary exercise bicycles; strings for rackets; stuffed toys; surf boards; surf skis; surfboard leashes; swimming belts; swimming jackets; swimming kick boards; swimming pools [play articles]; swings; tables for indoor football; tables for table tennis; targets; teddy bears; tennis ball throwing apparatus; tennis nets; theatrical masks; toy masks; toy pistols; toy vehicles; toys; toys for domestic pets; trampolines; twirling batons; video game machines; water wings; waterskis; weight lifting belts [sports articles].

31 – Grains and agricultural, horticultural and forestry products not included in other classes; live animals; fresh fruits and vegetables; seeds; natural plants and flowers; foodstuffs for animals; malt; algae for human or animal consumption; algarovilla for animal consumption; almonds [fruits]; aloe vera plants; animal fattening preparations; animal foodstuffs; aromatic sand for pets [litter]; bagasses of cane [raw material]; barley; beans, fresh; beet; berries, fresh fruits; beverages for pets; bird food; bran; bran mash for animal consumption; bred stock; bulbs; bushes; cereal seeds, unprocessed; chestnuts, fresh; chicory roots; chicory [salad]; christmas trees; citrus fruit; cocoa beans, raw; coconut shell; coconuts; colanuts; copra; crayfish, live; crustaceans, live; cucumbers, fresh; cuttle bone for birds; distillery waste for animal consumption; dog biscuits; draff; edible chews for animals; eggs for hatching, fertilised; fish, live; fish meal for animal consumption; fish spawn; fishing bait, live; flax meal [fodder]; flowers, dried, for decoration; flowers; flower bulbs; flower seeds; wreaths of natural flowers; bouquet of fresh flowers; dried flowers for decoration; flowers, natural; fodder; fruit, fresh; garden herbs, fresh; grains [cereals]; grains for animal consumption; grapes, fresh; groats for poultry; hay; hazelnuts; hop cones; hops; juniper berries; leeks, fresh; lemons, fresh; lentils, fresh; lettuce, fresh; lime for animal forage; linseed for animal consumption; linseed meal for animal consumption; litter peat; live animals; lobsters, live; locust beans; maize; maize cake for cattle; malt for brewing and distilling; marc; marrows; mash for fattening livestock; meal for animals; menagerie animals; mushroom spawn for propagation; mushrooms, fresh; mussels, live; nettles; nuts [fruits]; oats; oil cake; olives, fresh; onions, fresh vegetables; oranges; oysters,

live; palm trees; palms [leaves of the palm tree]; peanut cake for animals; peanut meal for animals; peanuts, fresh; peas, fresh; peppers [plants]; pet food; pine cones; plant seeds; plants; plants, dried, for decoration; pollen [raw material]; potatoes, fresh; poultry, live; preparations for egg laying poultry; products for animal litter; rape cake for cattle; raw barks; residual products of cereals for animal consumption; residue in a still after distillation; rhubarb; rice meal for forage; rice, unprocessed; roots for food; rose bushes; rough cork; rye; salt for cattle; sanded paper for pets [litter]; sea-cucumbers, live; seed germ for botanical purposes; seedlings; sesame; shellfish, live; silkworm eggs; silkworms; sod; spinach, fresh; spiny lobsters, live; stall food for animals; straw [forage]; straw litter; straw mulch; strengthening animal forage; sugarcane; trees; truffles, fresh; trunks of trees; undressed timber; unsawn timber; vegetables, fresh; vine plants; wheat; wheat germ for animal consumption; wood chips for the manufacture of wood pulp; wreaths of natural flowers; yeast for animal consumption.

35 – Advertising; business management; business administration; office functions; accounting; administrative processing of purchase orders; advertising by mail order; advisory services for business management; arranging newspaper subscriptions for others; arranging subscriptions to telecommunication services for others; auctioneering; bill-posting; business appraisals; business auditing; business efficiency expert services; business information; business inquiries; business investigations; business management and organization consultancy; business management assistance; business management consultancy; business management of hotels; business management of performing artists; business management of sports people; business organization consultancy; business research; commercial administration of the licensing of the goods and services of others; commercial information agencies; commercial information and advice for consumers [consumer advice shop]; commercial or industrial management assistance; compilation of information into computer databases; compilation of statistics; computerized file management; cost price analysis; data search in computer files for others; demonstration of goods; direct mail advertising; dissemination of advertising matter; distribution of samples; document reproduction; drawing up of statements of accounts; economic forecasting; employment agencies; import-export agencies; invoicing; layout services for advertising purposes; marketing; marketing research; marketing studies; modelling for advertising or sales promotion; news clipping services; office machines and equipment rental; on-line advertising on a computer network; opinion polling; organization of exhibitions for commercial or advertising purposes; organization of fashion shows for promotional purposes; organization of trade fairs for commercial or

advertising purposes; outsourcing services [business assistance]; payroll preparation; personnel management consultancy; personnel recruitment; photocopying services; presentation of goods on communication media, for retail purposes; price comparison services; procurement services for others [purchasing goods and services for other businesses]; production of advertising films; professional business consultancy; psychological testing for the selection of personnel; public relations; publication of publicity texts; publicity; publicity agencies; advertising services, namely preparation of publicity materials; publicity material rental; radio advertising; relocation services for businesses; rental of advertising space; rental of advertising time on communication media; rental of photocopying machines; rental of vending machines; retail or wholesale services for cosmetics, perfumes, candles, decorations, artificial flowers, flowers, games, and oils; sales promotion for others; secretarial services; shop window dressing; shorthand; sponsorship search; systemization of information into computer databases; tax preparation; telemarketing services; telephone answering for unavailable subscribers; television advertising; transcription; typing; updating of advertising material; word processing; writing of publicity texts.

44 – Medical services; veterinary services; hygienic and beauty care for human beings or animals; agriculture, horticulture and forestry services; aerial and surface spreading of fertilizers and other agricultural chemicals; alternative medicine services; animal breeding; animal grooming; aquaculture services; aromatherapy services; artificial insemination services; beauty salons; blood bank services; chiropractics; dentistry; farming equipment rental; flower arranging; flower arrangement design services; floral design; gardening; hair implantation; hairdressing salons; health care; health centers; health counseling; health spa services; horticulture; hospices; hospitals; in vitro fertilization services; landscape design; landscape gardening; lawn care; manicuring; massage; medical assistance; medical clinic services; medical equipment rental; midwife services; nursing homes; nursing, medical; opticians' services; pet grooming; pharmacists' services to make up prescriptions; pharmacy advice; physiotherapy; plant nurseries; plastic surgery; public baths for hygiene purposes; rehabilitation for substance abuse patients; rental of sanitation facilities; rest homes; sanatoriums; sauna services; services of a psychologist; solarium services; speech therapy services; tattooing; telemedicine services; therapy services; tree planting for carbon offsetting purposes; tree surgery; Turkish baths; vermin exterminating for agriculture, horticulture and forestry; veterinary assistance; visagists' services; weed killing; wreath making.

(260) AM 2018 94731 A
 (800) 1371180
 (151) 2017 03 16
 (891) 2017 03 16
 (731) TURNER NETWORK TELEVISION, INC.
 1050 Techwood Drive, Atlanta GA 30318
 (US), USA

(540)

MONSTERS OF GOD

(591) Black, white

(511)

9 – Audio visual recordings in all media, featuring entertainment in the nature of an on-going television series in the field of comedy, action, drama and adventure (terms considered too vague by the International Bureau – rule 13(2)(b) of the Common Regulations); downloadable television programming featuring comedy, action, drama and adventure distributed via the internet and wireless communications (terms considered too vague by the International Bureau – rule 13(2)(b) of the Common Regulations).

41 – Entertainment services, namely, a multimedia program series featuring comedy, action, drama and adventure distributed via various platforms across multiple forms of transmission media; providing on-line computer games.

(260) AM 2018 94736 A
 (800) 1371263
 (151) 2017 08 08
 (891) 2017 08 08
 (731) KRYOLAN GmbH Chemische Fabrik
 Papierstrasse 10, 13409 Berlin, Germany
 (540)

Kalide

(591) Black, white

(511)

44 – Visagist's services, beauty salon services.

(260) AM 2018 94757 A
 (800) 1356991
 (151) 2017 02 09
 (891) 2027 08 22
 (731) ADP GAUSELMANN GMBH
 Merkur-Allee 1-15, 32339 Espelkamp,
 Germany
 (540)

Over the Top

(591) Black, white

(511)

9 – Computer software; computer game software; games software for use with any computer-based platforms, including consumer electronics and game consoles; game program for computers; programs

for operating electric and electronic apparatus for games, amusement and/or entertainment purposes; electronic terminals for generating lottery tickets; computer software for computer games on the internet; online games (software); computer software in the form of an application for mobile devices and computers; computer software for casino and amusement arcade games, for gaming machines, slot machines or video lottery gaming machines or games of chance via the internet.

(260) AM 2018 94781 A
 (800) 1371101
 (151) 2017 09 11
 (891) 2017 09 11
 (731) SOCIEDAD ANONIMA DAMM
 Roselló, 515 E-08025 Barcelona, Spain
 (540)

MALQUERIDA

(591) Black and white

(511)

32 – Non-alcoholic beverages; hop extracts for use in the preparation of beverages; malt syrup for making beverages; beer wort; malt wort; hop extracts for making beers; essences for making beverages; extracts for making beverages; beer; malt beer; non-alcoholic beer; low-alcohol beers; mineral-enriched beers; lagers; lager shandy; beer-based cocktails; porter (beer); stout.

(260) AM 2018 94782 A
 (800) 1371113
 (151) 2016 12 07
 (891) 2016 12 07
 (731) MEHMET ERDAL
 Beşelsiz Mah. No. 41 TR-10512 Istanbul,
 Turkey
 (540)



(591) Red and white
 (531) 26.04.02; 26.04.24; 26.11.03; 26.11.08;
 27.05.10; 27.05.11; 27.05.17; 27.05.22;
 27.05.24; 29.01.12

(526) R

(511)

35 – The bringing together, for the benefit of others, of a variety of goods, namely bleaching and cleaning preparations, detergents other than for use in manufacturing operations and for medical purposes, la-

undry bleach, fabric softeners for laundry use, stain removers, dishwasher detergents, perfumery, cosmetics, fragrances, deodorants for personal use and animals, soaps, measurement apparatus and equipment including those for scientific, nautical, topographic, meteorologic, industrial and laboratory purposes, thermometers, not for medical purposes, barometers, ammeters, voltmeters, hygrometers, testing apparatus not for medical purposes, telescopes, periscopes, directional compasses, speed indicators, laboratory apparatus, microscopes, magnifying glasses, stills, ovens and furnaces for laboratory experiments, apparatus for recording, transmission or reproduction of sound or images, cameras, photographic cameras, television apparatus, video recorders, CD and DVD players and recorders, MP3 players, computers, desktop computers, tablet computers, microphones, loudspeakers, earphones, telecommunications apparatus, apparatus for the reproduction of sound or images, computer peripheral devices, cell phones, covers for cell phones, telephone apparatus, computer printers, scanners [data processing equipment], photocopiers, magnetic and optic data carriers and computer software and programmes recorded thereto, downloadable and recordable electronic publications, encoded magnetic and optic cards, antennas, satellite antennas, amplifiers for antennas, parts of the aforementioned goods, ticket dispensers, automatic teller machines (ATM), electronic components used in the electronic parts of machines and apparatus, semi-conductors, electronic circuits, integrated circuits, chips [integrated circuits], diodes, transistors [electronic], magnetic heads for electronic apparatus, electronic locks, photocells, remote control apparatus for opening and closing doors, optical sensors, counters and quantity indicators for measuring the quantity of consumption, automatic time switches, clothing for protection against accidents, irradiation and fire, safety vests and life-saving apparatus and equipment, eyeglasses, sunglasses, optical lenses and cases, containers, parts and components thereof, apparatus and instruments for conducting, transforming, accumulating or controlling electricity, electric plugs, junction boxes [electricity], electric switches, circuit breakers, fuses, lighting ballasts, battery starter cables, electrical circuit boards, electric resistances, electric sockets, transformers [electricity], electrical adapters, battery chargers, electric door bells, electric and electronic cables, batteries, electric accumulators, alarms and anti-theft alarms, other than for vehicles, electric bells, signalling apparatus and instruments, luminous or mechanical signs for traffic use, fire extinguishing apparatus, fire engines, fire hose and fire hose nozzles, radar apparatus, sonars, night vision apparatus and instruments, decorative magnets, metronomes, jewellery, imitation jewellery, gold, precious stones and jewellery made thereof, cufflinks, tie pins, statuettes and figurines of precious metal, clocks, watches and chronometrical

instruments, chronometers and their parts, watch straps, unworked or semi-worked leather and animal skins, imitations of leather, stout leather, leather used for linings, goods made of leather, imitations of leather or other materials, designed for carrying items, included in this class, bags, wallets, boxes and trunks made of leather or stout leather, key cases, trunks [luggage], suitcases, umbrellas, parasols, sun umbrellas, walking sticks, whips, harness, saddlery, stirrups, straps of leather (saddler), woven or non-woven textile fabrics, textile goods for household use, not included in other classes, curtains, bed covers, sheets (textile), pillowcases, blankets, quilts, towels, flags, pennants, labels of textile, swaddling blankets, games and toys, arcade video game machines, game apparatus and machines for use with an external display screen and monitor, including those coin-operated, toys for animals, toys for outdoor playgrounds, parks and game parks, gymnastic and sporting articles not included in other classes, fishing tackle, artificial fishing bait, decoys for hunting and fishing, Christmas trees of artificial material, ornaments for Christmas trees, artificial snow for Christmas trees, rattles (playthings), novelties for parties, dances (party favors), paper party hats enabling customers to conveniently view and purchase those goods, such services may be provided by retail stores, wholesale outlets, by means of electronic media or through mail order catalogues.

(260) AM 2018 94783 A

(800) 1371119

(151) 2017 02 13

(891) 2017 02 13

(731) XIAOMI INC.

Floor 13, Rainbow City Shopping Mall
II of China Resources, NO. 68, Qinghe
Middle Street, Haidian District Beijing,
China

(540)



(591) Black and white

(531) 27.05.01; 27.05.23

(511)

9 – Computers; cellular phones; headphones; cameras [photography]; surveying apparatus and instruments; stereoscopes; chips [integrated circuits]; sensors; video screens; remote control apparatus; theft prevention installations, electric; chargers for electric batteries; wires, electric; pedometers.

(260) AM 2018 94784 A

(800) 1371169

(151) 2017 04 06

(891) 2017 04 06

(731) ALIYEV ANAR SEFER
M. Rezulzadeh 15, ap. 79, Binagadi district
AZ-1117 Baku, Azerbaijan

(540)



(591) Red, black, blue, green, yellow
(531) 20.01.05; 20.01.09; 26.04.02; 26.04.04;
26.04.06; 27.05.03; 29.01.15

(511)

2 – Paints, varnishes, lacquers; preservatives against rust and against deterioration of wood; colorants; mordants; raw natural resins; metals in foil and powder form for use in painting, decorating, printing and art.

19 – Building materials [non-metallic]; non-metallic rigid pipes for building; asphalt, pitch and bitumen; non-metallic transportable buildings; monuments, not of metal.

35 – Advertising; business management; business administration; office functions.

(260) AM 2018 94803 A

(800) 1370134

(151) 2017 01 05

(891) 2017 01 05

(731) Kraft Foods Belgium Intellectual Property BVBA (SPRL), besloten vennootschap met beperkte aansprakelijkheid
Brusselsesteenweg 450 B-1500 Halle,
Belgium

(540)



(591) Blue, white and yellow.
(531) 26.04.03; 26.04.19; 27.05.02; 27.05.17;
29.01.14

(511)

29 – Preserved and/or cooked fruit and vegetables; dried fruits; compotes, jellies and jams; savoury or sweet cocktail snacks, especially prepared from plain or flavoured potatoes; cocktail snacks made of charcuterie.

30 – Rice, puffed rice; tapioca; flour; sweet or savoury tarts and pies; pizzas, pasta (plain or flavoured and/or filled); prepared meals, totally or partially made of cake paste; breads, toast, rusks; biscuits (sweet or savoury); wafers, cakes, pastries, all these goods being plain and/or topped and/or filled and/or flavoured; confectionery; salt (plain or flavoured); mustard, vinegar, sauces (condiments), spices.

(260) AM 2018 94804 A

(800) 1370143

(151) 2017 04 17

(891) 2017 04 17

(731) FUTURE ENTERPRISES PTE. LTD.

31 Harrison Road, #08-01, Food Empire
Business Suites, Singapore (369649),
Singapore

(540)

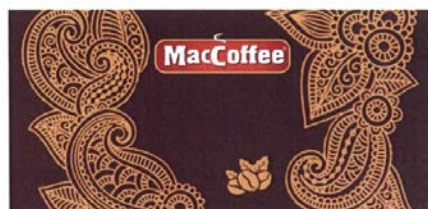

(591) Red, dark red, light-red, yellow, white,
golden, olive, brown, light-brown, grey, black

(531) 05.03.13; 05.03.16; 05.07.01; 05.13.25;
29.01.13

(511)

30 – Coffee flavoring; coffee substitutes; vegetal preparations for use as coffee substitutes; roasted coffee beans; sugar-coated coffee beans; coffee; decaffeinated coffee; ground coffee; instant coffee; iced coffee; unroasted coffee; coffee beverages with milk; coffee-based beverages; mixtures of coffee and chicory [coffee substitute]; coffee extracts.

(260) AM 2018 94808 A

(800) 1370248

(151) 2017 06 20

(891) 2017 06 20

(731) COOPERSURGICAL, INC.

95 Corporate Drive Trumbull CT 06611, USA

(540)

COOPERFERTILITY

(591) Black, white

(511)

1 – Reagent kits comprising generic DNA circle, DNA primers, polymerase and buffers for use in biotechnology fields; chemicals for use in science, being diagnostics for scientific research use, namely, stain used for determining the morphology of sperm and other cells found in semen samples from humans and animals; chemicals used in industry and science, namely, growth media for cell cultures and reagents.

10 – Medical equipment, namely, vitrification carriers; medical devices, namely, devices used in the cryopreservation of biological specimens; medical equipment, namely, a vitrification device for embryos and blastocytes; cryopreservation device for biological cells for use for in vitro fertilization; medical device for use for in vitro fertilization; catheters; biological cell sampling needle; medical apparatus and instruments used for the vitrification and/or cryopreservation of biological cells; medical apparatus for vitrification, cryopreservation, and cryostorage of cells, namely, vessels and canes for the collection, vitrification, cryostorage, and warming of cells; medical instruments for use in the manipulation and transfer of cells during assisted reproduction technology medical procedures.

(260) AM 2018 94809 A

(800) 1370277

(151) 2017 03 01

(891) 2017 03 01

(731) XANTIS PHARMA LIMITED

Lemesou, 5, EUROSURE TOWER 1st floor,
Flat/Office 101 CY-2112 Nicosia, Cyprus

(540)

SANORIN AQUA NATURA

(591) Black, white

(511)

3 – Cosmetics; toiletries; balms, other than for medical purposes; petroleum jelly for cosmetic purposes; cosmetic creams; lotions for cosmetic purposes; beauty masks; oils for cosmetic purposes; essential oils for cosmetic purposes; oils for cleaning purposes; soap; mouthwashes, not for medical purposes; cosmetic preparations for baths; bath salts, not for medical purposes; cosmetic preparations for skin care; cosmetic preparations containing sea-salt.

5 – Pharmaceuticals; medicinal preparations; drugs for medical purposes; sanitary preparations for medical purposes; nutritional supplements for humans; disinfectants; anti-infectives; anti-inflammatories; analgesics; anaesthetics; antibiotics; antiseptics; hormones for medical purposes; medicinal oils; germicides; tonics for medical purposes; febrifuges; preparations of trace elements for human use; nutritional supplements; dietary supplements for medical use; mineral food supplements; albumin dietary supplements; enzyme dietary supplements; vitamin preparations; bacterial preparations for medical use; bacteriological preparations for medical use; enzyme preparations for medical purposes; candy, medicated; jujube, medicated; pastilles for pharmaceutical purposes; syrups for pharmaceutical purposes; medicinal drinks; elixirs [pharmaceutical preparations]; medicinal infusions; tinctures for medical purposes; medicinal tea; liniments; ointments for pharmaceutical purposes; petroleum jelly for medical purposes;

mineral waters for medical purposes; salts for medical purposes; mineral water salts; smelling salts; thermal water; sea water for medical purposes; plant extracts for pharmaceutical purposes; pharmaceutical preparations for skin care; pharmaceutical preparations for mouth and throat care; pharmaceutical preparations for nasal cavity care; gargles for medical purposes; nasal sprays for medical purposes; medicated throat sprays; pharmaceutical preparations for nasal rinsing; pharmaceutical preparations for treatment of otolaryngologic diseases; pharmaceutical preparations containing sea-salt; medicated eyewashes; bronchodilating preparations; cooling sprays for medical purposes; disinfectant soap; medicated soap.

10 – Medical apparatus and instruments; medical devices, namely appliances for otolaryngologic care and for treatment of otolaryngologic diseases; appliances for nasal rinsing; nasal aspirators; esthetic massage apparatus; spoons for administering medicine; cushions for medical purposes; tongue scrapers; ear picks; inhalers; ultraviolet ray lamps for medical purposes; hearing protectors; physiotherapy apparatus.

(260) AM 2018 94810 A

(800) 1370304

(151) 2017 08 09

(891) 2017 08 09

(731) MPSYSTEM Spółka z ograniczoną

Odpowiedzialnością

ul. Wielopolska 23 lok. 2 PL-39-200 Dębica,
Poland

(540)

CREALAT

(591) Black, white

(511)

1 – Supports for catalysts; preparations of microorganisms, other than for medical and veterinary use; milk ferments for industrial purposes; cultures of microorganisms for industrial purposes; milk ferments [bacteria preparations] used in making foodstuffs; preservatives for maintaining the viability of microorganisms in cultures [scientific]; bacteria [other than for medical or veterinary purposes]; polymerisation catalysts; catalysts for use in biochemical processes; fermentation extracts for industrial purposes; homogeneous catalysts; milk ferments for chemical purposes; catalysts for chemical and biochemical processes; lactic acid polymers; bacteria for use in food manufacture; chemical products derived from milk; lactic cultures for the food industry; chemical substances for use in preventing the coagulation of albumin in milk; fermentation extract; probiotic bacteria for the food industry; chemicals for use in fermenting; biochemical catalysts; preservatives for maintaining the viability of microorganisms in cultures [industrial]; enzymes for use in fermenta-

tion; bacteriological cultures [other than for medical and veterinary use]; additives (chemical -) for use in fermentation; cultures, other than for medical or veterinary use; milk ferments for the food industry; catalysts for hardening purposes; catalysts; bacterial cultures for addition to food products; proteins for use in fermentation technology; biological preparation for use in cell cultures other than for medical or veterinary use; synthetic catalysts.

35 – Retail services in relation to enzymes for use in fermentation; retail services in relation to lactic cultures for the food industry; wholesale services in relation to bacteria for use in food manufacture; retail services in relation to preservatives for maintaining the viability of micro-organisms in cultures [scientific]; wholesale services in relation to preservatives for maintaining the viability of micro-organisms in cultures [scientific]; retail services in relation to supports for catalysts; wholesale services in relation to catalysts; retail services in relation to bacteriological cultures [other than for medical and veterinary use]; retail services in relation to cultures, other than for medical or veterinary use; wholesale services in relation to milk ferments for the food industry; retail services in relation to catalysts; wholesale services in relation to chemicals for use in fermenting; retail services in relation to lactic acid polymers; retail services in relation to proteins for use in fermentation technology; retail services in relation to homogeneous catalysts; wholesale services in relation to polymerisation catalysts; retail services in relation to chemical substances for use in preventing the coagulation of albumin in milk; wholesale services in relation to additives (chemical -) for use in fermentation; retail services in relation to catalysts for hardening purposes; retail services in relation to biological preparation for use in cell cultures other than for medical or veterinary use; wholesale services in relation to biochemical catalysts; retail services in relation to fermentation extract; wholesale services in relation to supports for catalysts; wholesale services in relation to fermentation extract; wholesale services in relation to biological preparation for use in cell cultures other than for medical or veterinary use; wholesale services in relation to milk ferments [bacteria preparations] used in making foodstuffs; retail services in relation to polymerisation catalysts; retail services in relation to synthetic catalysts; wholesale services in relation to chemical substances for use in preventing the coagulation of albumin in milk; wholesale services in relation to cultures of microorganisms for industrial purposes; retail services in relation to fermentation extracts for industrial purposes; retail services in relation to catalysts for use in biochemical processes; wholesale services in relation to synthetic catalysts; retail services in relation to milk ferments for chemical purposes; wholesale services in relation to cultures, other than for medical or veterinary use; wholesale services in relation to pro-

teins for use in fermentation technology; wholesale services in relation to catalysts for hardening purposes; wholesale services in relation to milk ferments for chemical purposes; retail services in relation to milk ferments for industrial purposes; retail services in relation to chemicals for use in fermenting; wholesale services in relation to bacteria [other than for medical or veterinary purposes]; retail services in relation to bacterial cultures for addition to food products; wholesale services in relation to probiotic bacteria for the food industry; retail services in relation to preservatives for maintaining the viability of micro-organisms in cultures [industrial]; wholesale services in relation to lactic cultures for the food industry; wholesale services in relation to milk ferments for industrial purposes; retail services in relation to cultures of microorganisms for industrial purposes; wholesale services in relation to chemical products derived from milk; retail services in relation to additives (chemical -) for use in fermentation; retail services in relation to milk ferments [bacteria preparations] used in making foodstuffs; wholesale services in relation to bacterial cultures for addition to food products; retail services in relation to preparations of microorganisms, other than for medical and veterinary use; wholesale services in relation to preparations of microorganisms, other than for medical and veterinary use; retail services in relation to probiotic bacteria for the food industry; wholesale services in relation to fermentation extracts for industrial purposes; retail services in relation to bacteria [other than for medical or veterinary purposes]; wholesale services in relation to bacteriological cultures [other than for medical and veterinary use]; retail services in relation to milk ferments for the food industry; wholesale services in relation to preservatives for maintaining the viability of micro-organisms in cultures [industrial]; retail services in relation to bacteria for use in food manufacture; wholesale services in relation to catalysts for chemical and biochemical processes; wholesale services in relation to homogeneous catalysts; wholesale services in relation to lactic acid polymers; wholesale services in relation to catalysts for use in biochemical processes; retail services in relation to catalysts for chemical and biochemical processes; retail services in relation to biochemical catalysts; retail services in relation to chemical products derived from milk.

(260) AM 2018 94811 A

(800) 1370355

(151) 2017 07 14

(891) 2017 07 14

(731) Kutteneuler Mineralölhandels- und Tankstellenbetriebsgesellschaft mit beschränkter Haftung
Dieselstr. 10 50996 Köln,
Germany

(540)



(591) Blue, red and white.

(531) 03.01.01; 03.01.16; 26.01.15; 26.11.12;
27.05.01; 27.05.11; 27.05.17; 27.05.24;
29.01.13

(511)

1 – Chemicals used in industry, science and photography, as well as in agriculture, horticulture and forestry; chemical additives for fuels, motor fuels and motor spirits; chemical additives for oils; chemical additives for fuels; anti-knock substances for internal combustion engines; engine-decarbonising chemicals; transmission fluids; power steering fluids; anti-freeze; antifreeze for motor vehicle radiators; chemical deicers and de-icing preparations; fluids for hydraulic circuits; chemical coolants and chemical cooling additives; coolants for vehicle engines; tensio-active agents; oil-purifying chemicals; chemical agents, preparations and plastics for absorbing oil; chemical rubber care preparations; anti-boil preparations for engine coolants; tire repairing compositions; detergent additives to gasoline [petrol]; automobile body fillers; combusting preparations (chemical additives to motor fuel); fire extinguishing compositions; fireproofing preparations; adhesives for use in industry; heat exchanger fluids; coolants; brake fluid.

4 – Mineral oils; industrial oils and greases; lubricants; dust absorbing, wetting and binding compositions; fuels (including motor spirit) and illuminants; non-chemical additives for fuels, motor fuels and motor spirits; non-chemical additives for oils; lubricants, namely motor oils, automotive engine oils, cylinder oils, lubricants being gear oils, lubricating grease, lubricating oils; liquid and gaseous fuels; fuels, in particular liquid and gaseous fuels for internal combustion engines and components thereof; electrical energy; fuel oils, heating oils; granular absorbent compositions for binding materials spilled on floors.

35 – Retail services in the fields of chemicals, coating preparations, pharmaceuticals, cosmetics and household goods, fuels, motor fuels and motor spirits; retail services via the internet in the fields of chemicals, coating preparations, pharmaceuticals, cosmetics and household goods, fuels, motor fuels and motor spirits; wholesale services in the fields of chemicals, coating preparations, pharmaceuticals, cosmetics and household goods, fuels, motor fuels and motor spirits; wholesale services via the internet in the fields of chemicals, coating preparations, pharmaceuticals, cosmetics and household goods, fuels, motor fuels and motor spirits; online mail order retail services and mail order retail services via catalogues

in the fields of chemicals, coating preparations, pharmaceuticals, cosmetics and household goods, fuels, motor fuels and motor spirits; retail services in the fields of chemicals and chemical preparations for operating and for maintenance of vehicles, mineral oils, industrial oils and greases, lubricants and lubricating agents, liquid and gaseous fuels, fuel oils, heating oils, fuels (including motor spirit); retail services in the fields of motor fuels, motor spirits and illuminants, additives for fuels, additives for motor fuels, additives for motor spirits, additives for oils, additives for coolants, additives for vehicle fuels, additives for liquid fuels, additives for fuel oils and additives for heating oils; retail services via the internet in the fields of chemicals and chemical preparations for operating and for maintenance of vehicles, mineral oils, industrial oils and greases, lubricants and lubricating agents, liquid and gaseous fuels, fuel oils, heating oils, fuels (including motor spirit); retail services via the internet in the fields of motor fuels, motor spirits and illuminants, additives for fuels, additives for motor fuels, additives for motor spirits, additives for oils, additives for coolants, additives for vehicle fuels, additives for liquid fuels, additives for fuel oils and additives for heating oils; wholesale services in the fields of chemicals and chemical preparations for operating and for maintenance of vehicles, mineral oils, industrial oils and greases, lubricants and lubricating agents, liquid and gaseous fuels, fuel oils, heating oils, fuels (including motor spirit); wholesale services in the fields of motor fuels, motor spirits and illuminants, additives for fuels, additives for motor fuels, additives for motor spirits, additives for oils, additives for coolants, additives for vehicle fuels, additives for liquid fuels, additives for fuel oils and additives for heating oils; wholesale services via the internet in the fields of chemicals and chemical preparations for operating and for maintenance of vehicles, mineral oils, industrial oils and greases, lubricants and lubricating agents, liquid and gaseous fuels, fuel oils, heating oils, fuels (including motor spirit); wholesale services via the internet in the fields of motor fuels, motor spirits and illuminants, additives for fuels, additives for motor fuels, additives for motor spirits, additives for oils, additives for coolants, additives for vehicle fuels, additives for liquid fuels, additives for fuel oils and additives for heating oils; online mail order retail services and mail order retail services via catalogues in the fields of chemicals and chemical preparations for operating and for maintenance of vehicles, mineral oils, industrial oils and greases, lubricants and lubricating agents, liquid and gaseous fuels, fuel oils, heating oils, fuels (including motor spirit); online mail order retail services and mail order retail services via catalogues in the fields of motor fuels, motor spirits and illuminants, additives for fuels, additives for motor fuels, additives for motor spirits, additives for oils, additives for coolants, additives for vehicle fu-

els, additives for liquid fuels, additives for fuel oils and additives for heating oils.

(260) AM 2018 94813 A

(800) 1370387

(151) 2017 02 24

(891) 2017 02 24

(731) RATING ASSOCIATION LEADER OF THE YEAR

Scheuchzerstrasse 17, CH-8006 Zürich,
Switzerland

(540)



(591) Black, white

(531) 01.01.01; 01.01.05; 03.07.17; 26.01.21

(511)

35 – Advertising; business management; business administration; office functions; administration of consumer loyalty programs; cost price analysis; business auditing; audio, video and photo advertising; banner internet advertising; negotiation of business contracts for others; market studies; opinion polling; demonstration of goods; business inquiries; business management assistance; advertising of the services of other vendors, and the bringing together, for the benefit of others, of a variety of services, enabling customers to conveniently view and purchase those services; business research; economic forecasting; providing business information via a web site; compilation of information into computer databases; compilation of statistics; production of videos and video clips for commercial or advertising purposes; information and analytical services in the field of statistical rating; business information; commercial information and advice for consumers (consumer advice shop); consultancy regarding public relations communications strategy; consultancy regarding advertising communications strategy; business organization consultancy; marketing; marketing research; provision of commercial and business contact information; provision of an on-line marketplace for buyers and sellers of goods and services; providing of advertising and information services for awarding enterprises-leaders of ratings from other businesses; providing of services concerning data compilation and processing and rating compilation from various businesses; rental of advertising time on communication media; writing of publicity texts; scriptwriting for advertising purposes; processing and placement of advertising and information materials in electronic catalogues; word processing; updating, correc-

ting and development of advertising materials; updating and maintenance of data in computer databases; updating and maintenance of information in registries; organization and conducting of exhibitions and trade fairs for commercial or advertising purposes, including via the Internet; organization and conducting of various events, sales promotions, campaigns, surveys, promotional events, promotional offers, media events, competitions, festivals and presentations for commercial or advertising purposes; organization and conducting of competitions among enterprises and business people for advertising purposes; rental of advertising space; business appraisals; business intermediary services relating to the matching of potential private investors with entrepreneurs needing funding; commercial information agency services; business efficiency expert services; intermediary services relating to placing advertisements on communication media; outsourcing services (business assistance); commercial intermediation services; layout services for advertising purposes; price comparison services; advertising and information support services of various events, competitions, award ceremonies; public relations; data search in computer files for others; sponsorship search; search engine optimization for sales promotion; presentation of goods on communication media, for retail purposes; rental of billboards (advertising boards); publicity material rental; rental of advertising time on communication media; rental of sales stands; publication of publicity texts; radio advertising; registration of written communications and data; advertising and information services; bill-posting; on-line advertising on a computer network; placing advertisements on the Internet on web pages and web sites in relation to list of provided services which allow all concerned parties to order services from web pages and web sites on the Internet, as well as to receive necessary information about provided services; distribution of samples; dissemination of advertising matter, including different advertising and printed and souvenir products; design of advertising materials; business investigations; systemization of information into computer databases; compiling indexes of information for commercial or advertising purposes; sales promotion for others; production of advertising films, commercials and presentations; television advertising; telemarketing services; negotiation and conclusion of commercial transactions for third parties.

41 – Education; providing of training; entertainment services; sporting and cultural activities; videotaping and photography of various events; arranging and conducting of congresses, colloquiums, symposiums, conferences, forums, discussions, lectures, trainings and seminars; arranging and conducting of award ceremonies; electronic desktop publishing; providing rooms for festive and entertainment events; recording on magnetic and optical data media; providing on-line videos, not downloadable;

providing on-line electronic publications, not downloadable; providing television programs, not downloadable, via video-on-demand transmission services; booking of seats for shows, award ceremonies, entertainment and festive events, competitions; audio recording; filming of video clips, other than advertising video clips; information relating to conducting of entertainment competitions and award ceremonies and various events within the framework of these competitions and ceremonies; booking of seats for entertainment events, provision of recreation facilities; scriptwriting, other than for advertising purposes; writing of texts; organization of shows (impresario services); organization of exhibitions for cultural or educational purposes, including via the Internet; organization of lotteries; arranging and conducting of various entertainment events, including award ceremonies, parades, holidays, education or entertainment competitions, guessing games, festivals, fireworks, shows, anniversary celebrations, festivities; arranging and conducting of presentations, other than advertising presentations; arranging and conducting of receptions, press briefings, roundtable discussions, press conferences, interviews; arranging and conducting of professional events, other than advertising professional events, within the framework of competitions and award ceremonies; party planning (entertainment); entertainer and actor services; layout services, other than for advertising purposes; television, radio commenting and commenting of various events on the Internet; language interpreter services; orchestra services; translation; news reporters services; photographic reporting; practical training (demonstration); conducting of workshops; rental of audio equipment; rental of show scenery; rental of video cameras; rental of videotapes; rental of sound recordings; rental of lighting apparatus for theatrical sets or television studios; rental of artwork; rental of stage scenery; vocational retraining; vocational guidance (education or training advice); on-line publication of electronic books and journals; on-line publication of electronic scientific and research periodicals; publication of books; publication of texts, other than publicity texts; production of shows; production of radio and television programmes; photography; photographic reporting.

(260) AM 2018 94815 A
(800) 1370437
(151) 2017 08 04
(891) 2017 08 04
(731) CASTER

99 rue du Faubourg Saint Honoré, F-75008
PARIS, France

(540)

PHYTO LE SALON

(591) Black, white

(531) 27.05.05

(511)

44 – Skin care services (beauty and hygiene care); beauty salon services; hairdressing salon services.

(260) AM 2018 94817 A

(800) 1370544

(151) 2017 08 11

(891) 2017 08 11

(731) ORIGINAL BUFF, S.A.

França,16, E-08700 IGUALADA
(BARCELONA), Spain

(540)

BUFF

(591) Black, white

(511)

25 – Ready-made clothing for external and internal use; handkerchiefs (not included in other classes), caps, footwear (except orthopedic footwear) and headgear; excluding goods made of buffalo skin.

(260) AM 2018 94842 A

(800) 1059042

(151) 2010 09 08

(891) 2017 10 11

(731) Otkrytoe aktsionernoe obshchestvo

"NIZHEGORODSKY MASLO-ZHIROVOY
KOMBINAT"

11, sh. Zhirkombinata RU-603950 g. Nizhny
Novgorod, Russian Federation

(540)

VANDA

(591) Black, white

(511)

3 – soaps; perfumery, essential oils, cosmetics, hair lotions; dentifrices.

(260) AM 2018 94887 A

(800) 1371799

(151) 2017 05 25

(891) 2017 05 25

(731) OPENMARK LIMITED

19 Waterfront Drive, PO Box 3540 Road
Town, Tortola 1110, Virgin Islands (British)

(540)



MULTILOCK

(591) Black and white

(531) 05.03.13; 05.03.14; 27.05.01

(511)
34 – Loose, rolling and pipe tobacco; raw tobacco; tobacco; cigarette tobacco; cigarettes, cigars, cigarillos and other ready-for-use smoking articles; filter-tipped cigarettes; cigarettes containing tobacco substitutes; lighters for smokers; electronic cigarette boxes; cigarette tubes; tobacco pouches; tobacco containers and humidors; ashtrays; cigar cutters; pipe knives; cigarette cutters; smokers' articles of precious metal; smokers' articles, not of precious metal; cigarette filters; cigarette tips; tobacco filters; cigar filters; cigarette paper.

(260) AM 2018 94890 A
(800) 1371866
(151) 2017 09 18
(891) 2017 09 18
(731) FRANZ HAAS
Via Villa, 6, I-39040 MONTAGNA
(Bolzano), Italy

(540)

FRANZ HAAS

(591) Black, white
(511)
33 – Alcoholic beverages (except beers); wines; sparkling wines.

(260) AM 2018 94930 A
(800) 1373321
(151) 2017 08 28
(891) 2017 08 28
(731) WORLD TRIATHLON CORPORATION
3407 W. Dr. Martin Luther King Jr. Blvd,
Suite 100 Tampa FL 33607, USA

(540)



(591) Black and white
(531) 02.01.23; 27.03.01; 27.03.02; 27.05.01
(511)

25 – Clothing for men, women and youths namely, fleece sweat shirts, sweat pants, sweat shorts, and fleece jackets; sport shirts, sport shorts, t-shirts, hats, caps, swimwear, running shorts, pants and shirts, bicycling shorts, pants, shirts and jackets, outerwear coats and jackets, socks, gloves and footwear.

41 – Entertainment services, namely, presentation of athletic events consisting of running, swimming and biking contests.

(260) AM 2018 94957 A
(800) 151605
(151) 1951 02 01
(891) 2017 10 12
(731) SANOFI-AVENTIS DEUTSCHLAND
GMBH
Brüningstrasse 50 65926 Frankfurt am Main,
Germany

(540)

FESTAL

(591) Black and white
(511)
5 – Medicines for humans and animals, chemical products for medical and sanitary use, pharmaceutical drugs and preparations, plasters, surgical dressings, pesticides and herbicides, disinfectants.

(260) AM 2018 94958 A
(800) 219151
(151) 1959 04 20
(891) 2018 10 17
(731) H. WILHELM SCHAUMANN GMBH
An der Mühlenau 4 25421 Pinneberg,
Germany

(540)

„Ovital“

(591) Black and white
(511)
31 – Fodder, mixed grains.

(260) AM 2018 94960 A
(800) 1372715
(151) 2017 07 25
(891) 2017 07 25
(731) PIERRE FABRE MEDICAMENT
45 place Abel Gance F-92100 BOULOGNE
BILLANCOURT, France

(540)

PERIOBLOCK

(591) Black, white
(531) 27.05.05
(511)
3 – Dentifrices, oral-dental gel; oral-and-dental hygiene products for cosmetic use.
5 – Orthodontic wax; oral-and-dental hygiene and care products for medical use.
21 – Toothbrushes; dental floss; interdental brushes; dental sticks.

(260) AM 2018 94961 A
(800) 1372763
(151) 2017 09 14
(891) 2017 09 14

(731) GENERAL FRUIT – S.R.L.

Via John Fitzgerald Kennedy, 4, I-24060

VILLONGO (BG), Italy

(540)

NATURERA POLOT 1882

(591) Black, white

(511)

30 – Coffee, tea, cocoa, sugar, rice, tapioca, sago, artificial coffee; flour and preparations made from cereals, bread, pastry and confectionery, edible ices; honey, treacle; yeast, baking-powder; salt, mustard; vinegar, sauces (condiments, except lemon juice); spices; ice; preparations for making beverages [tea based]; flavouring syrups; chocolate syrup; table syrup; topping syrup; syrup for food; chocolate syrups for the preparation of chocolate based beverages; glucose syrups for food; cake mixes; preparations for making waffles; aromatic preparations for pastries; preparations for making ice cream; aromatic preparations for herbal teas; preparations for chocolate beverages flavoured with mocha; preparations for making cocoa, coffee and chocolate-based beverages; herbal preparations for making beverages; powders for producing cakes and ice creams; cake decorations; chocolate creams; bavarian creams; cocoa based creams in the form of spreads; instant dessert puddings; pancake syrup; batter for making pancakes; custard-based fillings; chocolate-based fillings; cake decorations; frappes; flavourings for making milkshakes; sorbets; sauces for ice cream; frosting mixes; yoghurt (frozen -) [confectionery ices]; preparations for use in the manufacture of ice cream; sorbets [water ices]; sorbet mixes [ices]; mixtures for making water ices; natural flavourings for use in ice cream; sherbets [ices]; fruit jellies [confectionery]; savory food flavourings for food [other than essential oils]; cookies; cakes; flavourings for cakes; flavourings for foods; flavourings made from fruits; flavourings for beverages; condiments; sauces; custard; custard powder; custard mixes; custard-based fillings for cakes and pies.

32 – Beers; mineral and sparkling waters and other non-alcoholic drinks, except soft drinks and non-alcoholic wines; fruit drinks and fruit juices, except lemon juice and fresh lemon juice; syrups and other preparations for making beverages; syrups for making flavoured mineral waters; syrups for making non-alcoholic beverages; fruit juice concentrates; concentrates for use in the preparation of soft drinks; concentrates for making fruit drinks; powders for the preparation of beverages; cocktails, non-alcoholic; non-alcoholic fruit cocktails; non-alcoholic cocktail bases; fruit smoothies; part frozen slush drinks; sorbets in the form of beverages; mixes for making sorbet beverages; non-alcoholic fruit extracts used in the preparation of beverages; energy drinks; isotonic drinks.

(260) AM 2018 94963 A

(800) 1372802

(151) 2017 08 15

(891) 2017 08 15

(731) Shenzhen Hongfeng Century Technology LTD

3/F, Building C, No. 2 Road 1 Shangxue Industrial Area, Bantian Street, Longgang District, Shenzhen 518001 Guangdong, China

(540)



(591) Black and red.

(531) 26.01.18; 27.05.08; 27.05.17; 27.05.21; 29.01.13

(511)

9 – Transmitters of electronic signals; camcorders; video recorders; cameras [photography]; speed measuring apparatus [photography]; cell phone straps; sunglasses; electronic agendas; chargers for electric batteries.

(260) AM 2018 94991 A

(800) 1372860

(151) 2017 02 22

(891) 2017 02 22

(731) FIRST SOLAR, INC.

350 West Washington Street, Suite 600, Tempe AZ 85281, USA

(540)



(591) Black, white

(531) 26.01.01; 26.01.24; 26.11.02; 26.11.13; 27.05.01

(526) Solar

(511)

9 – Photovoltaic modules, namely, an assembly of photovoltaic cells.

37 – Construction services, namely, construction of photovoltaic arrays, systems and subsystems; installation of solar panels and solar power systems; providing information in the field of construction of solar panels and solar power systems.

42 – Design of power plants; design of solar photovoltaic systems; technical research in the field of energy production and energy saving; technical planning of photovoltaic installations and solar energy systems; quality control of solar panels; quality control of the layout, construction and operation of solar panels and photovoltaic arrays; planning and techni-

cal design of photovoltaic arrays, systems and subsystems.

(260) AM 2018 94992 A

(800) 1372861

(151) 2017 02 22

(891) 2017 02 22

(731) FIRST SOLAR, INC.

350 West Washington Street, Suite

600 Tempe AZ 85281, USA

(540)

FIRST SOLAR

(591) Black, white

(531) 27.05.01

(526) SOLAR

(511)

9 – Photovoltaic modules, namely, an assembly of photovoltaic cells.

37 – Construction services, namely, construction of photovoltaic arrays, systems and subsystems; installation of solar panels and solar power systems; providing information in the field of construction of solar panels and solar power systems.

42 – Design of power plants; design of solar photovoltaic systems; technical research in the field of energy production and energy saving; technical planning of photovoltaic installations and solar energy systems; quality control of solar panels; quality control of the layout, construction and operation of solar panels and photovoltaic arrays; planning and technical design of photovoltaic arrays, systems and subsystems.

(260) AM 2018 94996 A

(800) 1372980

(151) 2017 07 25

(891) 2017 07 25

(731) STAROFSERVICE

58 rue Lambrechts, F-92400 Courbevoie,

France

(540)

StarOfService

(591) Blue (HEX:#4A86F8).

(531) 01.01.02; 01.01.15; 27.05.05; 29.01.04

(511)

35 – Advertising; online advertising on a computer network; dissemination of ads; rental of advertising space; creation and updating of advertising media; promotion and merchandising; business management and organization consultancy; consulting services in the field of commercial strategy; office functions; company audits [commercial analyses]; commercial intermediary services [caretaking]; advertising servi-

ces on the Internet for third parties; sales promotion for others; merchandising services aimed at persuading consumers to buy third-party goods; commercial networking services for service providers and customers by means of Internet sites and application software; company prospecting and research services and business information on services of all types and, in particular, in the fields of personal services, sports, wellbeing, consulting, DIY, construction and repair of all kinds, entertainment, events, training and teaching; business assistance and information relating to service providers for others in any field; provision of business information; computerized file management services; data search in computer files for others; collection, compilation, systematization of data and information in a computer database; creation of information directories (compilation of data for third parties); none of the aforesaid services in connection with personnel (technical) in the fields of oil, gas and electricity, in the infrastructure and processing industry and all related markets.

42 – Design, development, maintenance and updating of computer programs, downloadable software and applications for mobile media, phones and tablets; design, development, maintenance and updating of systems for the input, analysis, extraction, processing, management, display and storage of data and computer files; design, development, maintenance and updating of computer databases; analysis and retrieval of information and data in a computer database.

(260) AM 2018 94999 A

(800) 1373141

(151) 2017 08 01

(891) 2017 08 01

(731) NARDI S.P.A

Via delle Stangà, 14, I-36072 Chiampo VI,

Italy

(540)

NARDI

(591) Black, white

(531) 27.05.17

(511)

20 – Garden furniture; outdoor furniture; chaise longues; chairs; armchairs; tables.

(260) AM 2018 95002 A

(800) 1373247

(151) 2017 06 14

(891) 2017 06 14

(731) VITTMO Trend

Str. Grivitei nr. 151, Brăila, Județ Braila,

Romania

(540)



(591) Black and gold

(531) 26.01.03; 26.01.18; 26.04.01; 26.04.08;
26.04.10; 26.04.18; 26.04.24; 29.01.12

(511)

14 – Ornaments, made of or coated with precious or semi-precious metals or stones, or imitations thereof; ornamental hat pins; decorative pins of precious metal; model animals [ornaments] coated with precious metal; action figures (decorative -) of precious metal; ornamental figurines made of precious metal; ornaments of jet; scale models [ornaments] of precious metal; ornaments [statues] made of precious metal; dress ornaments in the nature of jewellery; clothing ornaments of precious metals; commemorative shields of precious metal; ornamental sculptures made of precious metal; statues and figurines, made of or coated with precious or semi-precious metals or stones, or imitations thereof; busts of precious metal; model figures [ornaments] coated with precious metal; model animals [ornaments] made of precious metal; figurines for ornamental purposes of precious stones; figurines made from gold; figurines made of imitation gold; figurines of precious stones; figurines coated with precious metal; figurines made from silver; miniature figurines [coated with precious metal]; sculptures of precious metal; statuettes made of semi-precious metals; statuettes made of semi-precious stones; figures of precious metal; statuettes of precious metal and their alloys; desktop statuary made of precious metal; figurines [statuettes] of precious metal; statues of precious metal of religious icons; statues of precious metal and their alloys; silver alloys; iridium alloys; osmium alloys; palladium alloys; rhodium alloys; ruthenium alloys; decorative articles [trinkets or jewellery] for personal use; trinkets coated with precious metal; identification bracelets [jewelry]; copper tokens; prize cups of precious metals; decorative boxes made of precious metal; boxes of precious metal; commemorative boxes of precious metal; trinkets of bronze; metal tokens used for mass transit; gold bullion; misbaha [prayer beads]; coins; non-monetary coins; commemorative coins; collectible coins; gold bullion coins; meditation beads; rosaries; objet d'art made of precious stones; silver objets d'art; objet d'art of enamelled silver; objet d'art of enamelled gold; works of art of precious metal; commemorative shields; grave markers of precious metal; identity plates of precious metal; fancy keyrings of precious metals; monetary

coin sets for collecting purposes; trophies made of precious metal alloys; trophies made of precious metals; trophies coated with precious metal alloys; trophies coated with precious metals; commemorative statuary cups made of precious metal; jewellery; jewellery findings; jewelry pins for use on hats; tie pins; lapel pins [jewellery]; lapel pins of precious metals [jewellery]; fitted covers for jewelry rings to protect against impact, abrasion, and damage to the ring' band and stones; agate as jewellery; clips of silver [jewellery]; tie clips of precious metal; amulets [jewellery]; jewellery containing gold; articles of jewellery with ornamental stones; articles of jewellery made from rope chain; articles of jewellery coated with precious metals; articles of jewellery made of precious metal alloys; semi-precious articles of bijouterie; jewellery, clocks and watches; gold thread [jewellery]; flexible wire bands for wear as a bracelet; sterling silver jewellery; cloisonné jewellery; jewellery made of bronze; jewellery made of crystal; jewellery made of precious metals; jewellery fashioned of cultured pearls; jewellery fashioned of semi-precious stones; jewellery made of plastics; jewellery made of glass; jewellery incorporating diamonds; jewellery incorporating precious stones; body jewellery; women's jewelry; ivory jewellery; corporate recognition jewelry; gold jewellery; pewter jewellery; jewellery made of crystal coated with precious metals; jewellery made of semi-precious materials; jewellery fashioned from non-precious metals; jewellery made of precious stones; platinum jewelry; enamelled jewellery; jewellery made from silver; jewellery being articles of precious metals; custom jewelry; pet jewelry; jewelry for the head; children's jewelry; facial jewellery; jewellery for personal adornment; personal jewellery; jewellery coated with precious metal alloys; precious jewellery; jewellery being articles of precious stones; jewellery in the form of beads; jewellery, including imitation jewellery and plastic jewellery; jewel pendants; ornamental pins; pins [jewellery]; decorative brooches [jewellery]; gold plated brooches [jewellery]; bracelets; bracelets [jewellery]; wooden bead bracelets; silver bracelets; gold bracelets; friendship bracelets; bracelets of precious metal; bracelets made of embroidered textile [jewellery]; charity bracelets; ankle bracelets; silver-plated bracelets; gold plated bracelets; bracelets and watches combined; cuff links; cuff links made of gold; cuff links made of imitation gold; cuff links made of precious metals with semi-precious stones; cuff links made of silver plate; cuff links coated with precious metals; cuff links made of precious metals with precious stones; cuff links and tie clips; cuff links of precious metal; cuff links made of porcelain; cabochons; cabochons for making jewellery; cameos [jewelry]; earrings; drop earrings; silver earrings; gold earrings; earrings of precious metal; body-piercing studs; pierced earrings; silver-plated earrings; gold plated earrings; hoop earrings;

jewellery of yellow amber; jewelry clips for adapting pierced earrings to clip-on earrings; scarf clips being jewelry; necklaces [jewellery]; necklaces of precious metal; bib necklaces; crosses [jewellery]; decorative cuff link covers; diadems; threads of precious metal [jewellery]; gems; imitation jewellery ornaments; rings [jewellery]; rings [jewellery] made of non-precious metal; rings [jewellery] made of precious metal; signet rings; silver rings; collets being parts of jewellery; engagement rings; friendship rings; gold rings; platinum rings; body-piercing rings; silver-plated rings; gold plated rings; rings coated with precious metals; cloisonne pins; lapel badges of precious metal; ornamental lapel pins; decorative pins [jewellery]; badges of precious metal; metal badges for wear [precious metal]; jade [jewellery]; chains [jewellery]; silver necklaces; gold necklaces; jewellery chain of precious metal for anklets; jewellery chain of precious metal for necklaces; jewel chains; tie chains of precious metal; chains of precious metals; jewellery chain of precious metal for bracelets; silver-plated necklaces; gold-plated necklaces; rope chain [jewellery] made of common metal; rope chain made of precious metal; gold chains; square gold chain; jewellery rope chain for bracelets; jewellery rope chain for necklaces; jewellery rope chain for anklets; jewelry guard chains; gold plated chains; medals; commemorative medals; medals made of precious metals; gold medals; medals coated with precious metals; medallions; lockets [jewellery]; medallions made of non-precious metals; medallions made of precious metals; hat jewellery; ear ornaments in the nature of jewellery; shoe jewellery; ornaments of precious metal in the nature of jewelry; pendants; pearls [jewellery]; parts and fittings for jewellery; precious stones; synthetic stones [jewellery]; eternity rings; chain mesh of precious metals [jewellery]; chain mesh of semi-precious metals; ornaments [jewellery, jewelry (Am.)]; charms [jewellery] of common metals; bracelet charms; necklace charms; wedding rings; clasps for jewellery; closures for necklaces; paste jewellery; jewellery boxes and watch boxes; clock cases being parts of clocks; watch cases [parts of watches]; cases for clock- and watchmaking; jewellery boxes; jewelry boxes not of metal; presentation boxes for horological articles; jewelry cases [caskets or boxes]; jewelry cases not of precious metal; jewel cases of precious metal; jewelry boxes, not of precious metal; jewelry boxes of metal; cases [fitted] for horological articles; presentation cases for horological articles; presentation boxes for jewellery; cases for watches [presentation]; wooden jewellery boxes; cases of precious metals for horological articles; leather jewelry boxes; small jewellery boxes of precious metals; small jewelry boxes, not of precious metal; musical jewelry boxes; boxes for tie-pins; jewel cases; cases [fitted] for jewels; jewelry boxes of precious metal; boxes for cufflinks; cases [fitted] for

clocks; cases for watches and clocks; cases for chronometric instruments; cases for horological chronometric instruments; jewellery rolls; jewelry rolls for storage; watch pouches; jewelry organizer rolls for travel; stands for clocks; ring holders of precious metal; fitted jewelry pouches; key rings and key chains, and charms therefor; charms for key rings; key fobs of imitation leather; leather key fobs; key fobs of common metal; key fobs of precious metals; metal key fobs; key fobs [rings] coated with precious metal; key chains as jewellery [trinkets or fobs]; key fobs, not of metal; key charms coated with precious metals; key rings [trinkets or fobs] of precious metal; key rings [split rings with trinket or decorative fob]; split rings of precious metal for keys; key rings and key chains; time instruments; fittings for watches; clock hands; watch hands; anchors [clock- and watchmaking]; apparatus for timing sports events; chronometric apparatus and instruments; watch springs; horological articles; pendulums [clock- and watchmaking]; watch fobs; watches; watch bands; metal expanding watch bracelets; metal watch bands; dials [clock- and watchmaking]; clock dials; watch dials; sundials; barrels [clock- and watchmaking]; buckles for watchstraps; chronometers; atomic clocks; clocks incorporating radios; travel clocks; small clocks; clocks and watches; clocks and parts therefor; automatic watches; watches containing a game function; watches containing an electronic game function; watches incorporating a telecommunication function; clocks incorporating ceramics; quartz watches; watches bearing insignia; watches with the function of wireless communication; pendant watches; watches incorporating a memory function; desk clocks; pocket watches; stopwatches; women's watches; table clocks; wristwatches with GPS apparatus; wristwatches with pedometers; silver watches; watches made of precious metals or coated therewith; platinum watches; dress watches; watches for outdoor use; time clocks [master clocks] for controlling other clocks; mantle clocks; alarm clocks; electronic alarm clocks; digital clocks; digital clocks incorporating radios; digital clocks being electronically controlled; digital watches with automatic timers; watches made of gold; watches made of rolled gold; watches made of precious metals; clocks and watches, electric; industrial clocks; mechanical watches; mechanical watches with automatic winding; mechanical watches with manual winding; watches for nurses; automobile clocks; clocks for world time zones; divers' watches; watches made of plated gold; sports watches; miniature clocks; clocks and watches for pigeon-fanciers; watch crowns; chronographs [watches]; chronographs for use as watches; chronographs for use as timepieces; ship's chronometers; watch straps made of metal or leather or plastic; watch straps of nylon; watchstraps made of leather; watch straps of synthetic material; watch straps of plastic; non-leather watch straps; watch straps of polyvinyl chloride;

clock cases; escapements; digital time indicators having temperature displays; horological instruments having quartz movements; horological instruments made of gold; apparatus for sports timing [stopwatches]; watch chains; clock and watch hands; electronically operated movements for watches; clockworks; watch movements; watch winders; floor clocks; oscillators for watches; mechanical watch oscillators; oscillators for timepieces; oscillators for clocks; pendants for watch chains; grandfather clocks; parts for clockworks; parts for clocks; parts and fittings for chronometric instruments; parts and fittings for horological instruments; control clocks [master clocks]; timekeeping systems for sports; watch glasses; watch clasps; gemstones, pearls and precious metals, and imitations thereof; agates; agate [unwrought]; unwrought silver alloys; precious metal alloys [other than for use in dentistry]; platinum alloys; gold alloys; alloys of precious metal; silver; silver, unwrought or beaten; unwrought silver; silver and its alloys; semi-finished articles of precious metals for use in the manufacture of jewellery; semi-finished articles of precious stones for use in the manufacture of jewellery; gold; gold, unwrought or beaten; chalcedony; pearls made of ambroid [pressed amber]; diamond [unwrought]; diamonds; cut diamonds; spun silver [silver wire]; silver thread [jewellery]; wire thread of precious metal; metal wire [precious metal]; natural gem stones; precious and semi-precious gems; imitation jet; imitation gold; imitation pearls; imitation precious stones; iridium; iridium and its alloys; jades; jet; jet, unwrought or semi-wrought; silver ingots; gold ingots; ingots of precious metals; platinum ingots; silver alloy ingots; gold alloy ingots; platinum alloy ingots; silver bullion; marcassites; precious metals; precious metals, unwrought or semi-wrought; processed or semi-processed precious metals; semi-worked precious metals; beads for making jewellery; opal; osmium; osmium and its alloys; palladium; palladium and its alloys; olivine [gems]; pearl; cultured pearls; natural pearls; artificial stones [precious or semi-precious]; unwrought precious stones; unwrought and semi-wrought precious stones and their imitations; semi-wrought precious stones and their imitations; synthetic precious stones; semi-precious stones; platinum [metal]; platinum and its alloys; rhodium; rhodium and its alloys; ruby; ruthenium; ruthenium and its alloys; sapphires; sardonyx [unwrought]; emeralds; spinel [precious stones]; topaz; cubic zirconia.

35 – Business analysis, research and information services; collection and systematization of business data; business records management; financial records management; statistical analysis and reporting; collection of data; compilation of statistics [for business or commercial purposes]; collection of commercial information; collecting information for business; collection of statistics for business; computerised compilation of stock control records; computeri-

sed compilation of customer indexes; computerised compilation of order lists; compilation of indexed addresses; compilation of business directories for publishing on the internet; compilation of online business directories; compilation of data into computer databases; compilation of business directories; compilation of mathematical data; data compilation for others; compilation of statistical information; compilation of statistical data for use in scientific research; compiling indexes of information for commercial or advertising purposes; compilation of statistical data relating to medical research; compilation of lists of prospective customers; compilation of mailing lists; compilation of direct mailing lists; compilation of commercial registers; compilation of directories for publication on the internet; compilation of directories for publishing on global computer networks or the internet; compilation of business statistics and commercial information; compilation of statistics relating to advertising; compilation of statistics relating to health care utilization; compilation of business statistics; compilation and systemization of written communications and data; compilation and systemization of information used in electronic transmissions; compilation of statistical data relating to business; compilation of statistical models for the provision of market dynamics information; compilation of registers relating to exporters; compilation of registers relating to importers; compilation and systemization of information into computer databases; compilation of statistics; consultancy relating to the preparation of business statistics; collection and systematization of information into computer databases; preparation of business statistical data; drawing up of business statistical information; acquisition of commercial information; acquisition of business information relating to company activities; acquisition of business information relating to company status; obtaining business statistics [for others]; computerised business information retrieval; records management services, namely, document indexing for others; computerised point-of-sale data collection services for retailers; services comprising the composition of statistical data; computerised business information processing services; services comprising the transcription of statistical data; services comprising the recording of statistical data; systemization of information into computer databases; market studies; analysis of market research data; analysis of market research data and statistics; analysis of advertising response; consumer response analysis; analysis of advertising response and market research; analysis of the public awareness of advertising; analysis of market research statistics; market survey analysis; analysis relating to marketing; market analysis; advertising analysis; grain market analysis; real estate marketing analysis; market analysis and research; audience rating determination for radio and television broadcasts; computerised market research; mar-

ket research for compiling information on viewers of television; market research for compiling information on readers of publications; market research for advertising; business and market research; advertising research; research and analysis in the field of market manipulation; consumer research; market research and marketing studies; market research by means of a computer data base; collection of information relating to market research; market research consultancy; dissemination of data relating to advertising; conducting of marketing studies; preparation of public opinion surveys; preparation of marketing surveys; evaluating the impact of advertising on audiences; statistical evaluations of marketing data; provision of market research information; interpretation of market research data; interviewing for qualitative market research; interviewing for market research purposes; investigations of marketing strategy; preparation of market analysis reports; marketing forecasting; market canvassing; market analysis reports; conducting of market studies involving opinion polling; computerized market research services; marketing research and analysis; market analysis services relating to the availability of antiques; market analysis services relating to the availability of goods; market analysis services relating to the sale of antiques; market analysis services relating to the sale of goods; research services relating to advertising and marketing; market research services for publishers; market research services regarding customer loyalty; market research services regarding internet usage habits; research services relating to advertising; market research data collection services; advisory services relating to market research; consumer market information services; planning services for marketing studies; market research data retrieval services; market research services relating to broadcast media; market assessment services; opinion polling; market surveys conducted by telephone; marketing research in the fields of cosmetics, perfumery and beauty products; pricing surveys; market opinion polling studies; corporate image studies; profit surveys; market study and analysis of market studies; updating of business information on a computer data base; commercial information agency services; commercial information agencies [provides business information, e.g., marketing or demographic data]; business analysis; business analysis of markets; analysis of company behaviour; assessment analysis relating to business management; analysis of business information; cost price analysis; business profit analysis; analysis of business management systems; analysis of business statistics; cost benefit analysis; cost price analysis regarding waste disposal, removal, handling and recycling; economic forecasting analysis for business purposes; price analysis services; economic analysis for business purposes; strategic business analysis; business surveys; assistance, advisory services and consultancy with regard to bu-

business analysis; computerised business research; research of business information; business research and surveys; market research and business analyses; business research for new businesses; business research; acquisition (business -) searches; information and data compiling and analyzing relating to business management; compilation and provision of trade and business price and statistical information; consultancy relating to business analysis; goods or services price quotations; company information (searches relating to -); developing and coordinating volunteer projects for charitable organisations; dissemination of data relating to business; dissemination of commercial information; dissemination of business information; conducting of business research; conducting of internal business communication surveys; conducting of business appraisals; preparation of business surveys; preparing business reports; conducting of business feasibility studies; business appraisals; business appraisals and evaluations in business matters; benchmarking (evaluation of business organisation practices); evaluation of business opportunities; evaluations relating to business management in commercial enterprises; evaluations relating to business management in industrial enterprises; evaluations relating to business management in professional enterprises; evaluations relating to commercial matters; expert evaluations and reports relating to business matters; provision of sales analyses; provision of business data; provision of business and commercial information; providing commercial information to consumers; providing commercial information relating to companies; provision of commercial information from online databases; providing business information, also via internet, the cable network or other forms of data transfer; provision of business information via global computer networks; providing business information by way of computer terminals; provision of business information relating to the agricultural industry; provision of computerised business management information; provision of information relating to data processing; provision of information concerning commercial sales; providing information about commercial business and commercial information via the global computer network; provision of business information; providing business information via a web site; providing business information in the field of social media; provision of business information relating to franchising; providing consumer product information via the internet; provision of business information relating to joint ventures; provision of on-line business and commercial information; providing hotel rate comparison information; provision of commercial business information by means of a computer database; provision of business management information; provision of business statistical information relating to medical matters; provision of statistical information relating to business; providing informa-

tion in the field of time management; provision of information relating to commerce; provision of information and advice to consumers regarding the selection of products and items to be purchased; provision of computerised business statistics; provision of computerised data relating to business; provision of commercial information; provision of computerised information relating to business records; providing consumer product information relating to software; providing an on-line commercial information directory on the internet; computer assisted business information; business information for enterprises (provision of -); business information; information or enquiries on business and marketing; information in business matters; information and expert opinions relating to companies and business; business investigations; providing business information directory services, via a global computer network; preparation of market reports and studies; preparation and compilation of business and commercial reports and information; economic forecasting; economic forecasting and analysis; design of public opinion surveys; market reports and studies; conducting online business management research surveys; writing of business project studies; health care cost review; business information agency services; business data analysis services; business analysis services; business management analysis; statistical analysis and reporting services for business purposes; business research and advisory services; business research and information services; cost assessment services; benchmarking services for business management purposes; outsourcing services in the field of business analytics; providing online commercial directory information services; services for provision of foreign trade information; information services relating to business matters; information services relating to businesses; information and advisory services relating to tax preparation; commercial information services; computerised business information services; business information services provided on-line from a computer database or the internet; business information services provided online from a global computer network or the internet; commercial information services provided by access to a computer database; commercial information services relating to wine; commercial information services, via the internet; computerised information services to business opportunities appraisals; market information services relating to index levels; market information services relating to trade reports; market information services relating to market statistics; economic information services for business purposes; business statistical information services; news clipping services; surveys for business purposes; commercial information research studies; project studies for businesses; economic studies for business purposes; business efficiency studies; business statistical studies; business assistance, management and administrative services;

human resources management and recruitment services; personnel management for advertising purposes; business management services provided by theatrical agencies; employment agency services; model recruitment agencies; work analysis to determine worker skill sets and other worker requirements; assistance relating to recruitment and placement of staff; personnel management assistance; auditioning of performing artists [selection of personnel]; collection of personnel information; recruitment consultants in the financial services field; employment counselling; employment agency services relating to the support for employees with regard to business matters; personnel management consultancy; career planning consultancy; job placement consultancy; personnel placement consultancy; consultancy relating to the selection of personnel; consultancy relating to business management; professional consultancy relating to personnel management; recruitment consultancy for legal secretaries; recruitment consultancy for lawyers; consultancy of personnel recruitment; human resources consultancy; business organisation and management consultancy in the field of personnel management; employment consultancy; personnel management and employment consultancy; personnel consultancy; business recruitment consultancy; providing information relating to the recruitment of graduates; evaluation of personnel requirements; provision of advice relating to the recruitment of graduates; providing information relating to employment recruitment; provision of information relating to recruitment; providing information relating to employee relocation services; providing employment information; providing employment information via a global computer network; providing recruitment information via a global computer network; provision of administrative staff; provision of commission sales staff; providing temporary office support staff; provision of sales staff; matching skilled volunteers with non-profit organisations; employee leasing; personnel management of marketing personnel; personnel management of sales personnel; personnel management; human resources management; organising and conducting job fairs; planning of staff placement; placement of staff; placement of permanent personnel; placement of design staff; personnel placement and recruitment; personnel placement; personnel recruitment advertising; employment agency services, namely provision of nominee company directors; conducting employee incentive award programs; personnel recruitment; recruitment of high-level management personnel; recruitment of flight personnel; recruitment of executive staff; recruitment of airport ground staff; recruitment of temporary personnel; recruiting of office support staff; recruitment of computer staff; recruitment of airline personnel; permanent staff recruitment; recruitment of temporary technical personnel; job and personnel placement; personnel relocation;

selection of executive personnel; personnel selection using psychological testing; personnel selection [for others]; administrative services relating to the relocation of personnel; job agency services for medical personnel; job agency services for para-medical personnel; clerical employment agency services; employment agency services relating to au pairs; employment agency services provided for nannies; employment agency services, namely the provision of staff for the manning of show houses; employment agency services relating to nurses; employment agency services relating to bilingual staff; employment agency services relating to placement of medical and nursing personnel; personnel recruitment agency services relating to the electronics industry; employment agency services for temporary work assignments; modeling agency services; modelling agency services relating to sales promotions; modelling agency services for advertising purposes; employment agency services for personnel in general office positions; employment agency services for people skilled in the use of computers; secretarial employment services; employment outplacement services; employment counselling and consultancy services; business advisory services provided to determine pay and grading structures; business advisory services to determine pay and grading structures by job evaluation; career placement consulting services; advisory services relating to personnel placement; employment consultancy services relating to data processing personnel; consultancy and advisory services relating to personnel management; consultancy and advisory services relating to personnel placement; consultancy and advisory services relating to personnel recruitment; executive search and placement services; executive search and selection services; employee records management services; employment management services for film television technicians; headhunting services; information services relating to jobs and career opportunities; personnel recruitment agency services; interviewing services [for personnel recruitment]; publicity personnel management services; modelling for advertising or sales promotion; personnel services; career advisory services (other than education and training advice); employment placement services for personal assistants; employment placement services for butlers; employment placement services for housekeepers; executive placement services; nanny placement services; internship placement services; temporary personnel services; job matching services; personnel recruitment services and employment agencies; recruitment services for sales and marketing personnel; office support staff recruitment services; employment booking services for performing artists; employment booking services for film television technicians; employee relocation services; talent agency services [business management of performing artists]; career networking services; professional recruit-

ment services; testing to determine job competency; testing to determine professional competency; testing to determine employment skills; psychometric testing for the selection of personnel; personality testing for recruitment purposes; psychological testing for the selection of personnel; serving as a human resources department for others; preparation of résumés for others; administrative data processing; management and compilation of computerised databases; collating of data in computer databases; compilation of information into computerised registers; compilation and input of information into computer databases; compilation and systematisation of information in databanks; compilation of information into computer databases; consultancy relating to data processing; data search in computer files for others; business file management; computerized file management; data entry and data processing; automated data processing; data processing; computerised data processing; data processing for the collection of data for business purposes; data processing for businesses; electronic data processing; processing of business survey results; administrative services relating to credit card registration; advisory services relating to data processing; advisory services relating to electronic data processing; business consultancy services relating to data processing; data management services; information services relating to data processing; data processing services in the field of healthcare; data processing services in the field of transportation; data processing services in the field of payroll; data retrieval services; automobile registration services; administrative services relating to credit card registration; on-line data processing services; computerised data verification; data processing verification; business consultancy and advisory services; providing assistance in the field of business management; providing assistance in the field of business organisation; assistance and advice regarding business management; assistance and advice regarding business organization; assistance and consultancy relating to business management and organisation; assistance and advice regarding business organisation and management; assistance, advisory services and consultancy with regard to business organization; assistance, advisory services and consultancy with regard to business planning; advisory services for business management; business advice relating to restaurant franchising; business acquisitions (advice relating to -); providing advice relating to the organisation and management of businesses; business advice relating to franchising; business advice relating to disposals; business advice and consultancy relating to franchising; business consultancy relating to the administration of information technology; business appraisal consultancy; business management consultancy; corporate image development consultation; corporate management consultancy; business advice relating to marketing management consulta-

tions; business acquisitions consultation; advice relating to the business management of health clubs; business research consulting; advice relating to barter trade; advising commercial enterprises in the conduct of their business; advising industrial enterprises in the conduct of their business; business advice in the running of establishments as franchises; consultancy relating to the establishment and running of businesses; consultancy relating to business efficiency; business merger consultation; consultancy relating to business document management; business management consultancy, also via the internet; advice relating to the business management of fitness clubs; risk management consultancy [business]; advice relating to the business operation of health clubs; business organization consultancy; consultancy regarding business organisation and business economics; business organization and operation consultancy; consultancy regarding the organization or managing of a trade company; advice relating to the organisation and management of business; consulting in sales techniques and sales programmes; advice relating to the sale of businesses; professional business consultation relating to the operation of businesses; professional business consultation relating to the setting up of businesses; professional consultancy relating to business management; business advice, inquiries or information; business management advice relating to manufacturing business; business management consultancy in the field of executive and leadership development; business consulting; business consultancy to firms; business consultancy to individuals; business advice relating to strategic marketing; business consultancy, in the field of transport and delivery; business advice relating to growth financing; business advice relating to financial re-organisation; advice in the field of business management and marketing; business management and organization consultancy; counselling on business matters; business efficiency advice; management advice; business management consultancy in the field of transport and delivery; business organization advice; business planning consultancy; business planning and business continuity consulting; advice and information concerning commercial business management; consultations relating to business disposals; development of marketing strategies and concepts; providing business management start-up support for other businesses; providing advice relating to sales methods and techniques; business management and enterprise organization consultancy; business organization and management consultancy including personnel management; business management advisory services relating to franchising; business advisory services relating to the establishment and operation of franchises; assistance and consultancy services in the field of business management of companies in the energy sector; assistance, advisory services and consultancy with regard to busi-

ness management; advisory services relating to business administration; advisory services relating to business analysis; advisory services relating to business organisation and management; business management advisory services related to franchising; advisory and consultancy services relating to import-export agencies; advisory services (business -) relating to the establishment of franchises; advisory services (business -) relating to the exploitation of inventions; advisory services (business -) relating to the management of businesses; advisory services (business -) relating to the management of public sector businesses; advisory services (business -) relating to the operation of franchises; business advisory services relating to the running of sandwich bars; business advisory services relating to the running of restaurants; business advisory services relating to the selection of computers; business advisory services relating to the setting up of sandwich bars; business advisory services relating to the setting up of restaurants; business advisory services relating to product manufacturing; business advisory services relating to the establishment of motor dealership; business advisory services relating to product development; business advisory services relating to the use of computers; business advisory services relating to business liquidations; business consulting services in the agriculture field; business consultancy services relating to disaster planning and recovery; advisory services for preparing and carrying out commercial transactions; consultancy services relating to the administration and management of hotels; foreign trade consultancy services; business management consulting services in the field of information technology; advisory services relating to business management and business operations; advisory services relating to business risk management; advisory services relating to business planning; consultancy services regarding business strategies; advisory services relating to the corporate structure of businesses; business administration consultancy; business advisory services relating to franchising of a motor dealership; business consultancy services relating to management of fund raising campaigns; business consultancy services relating to the supply of quality management systems; business consultancy services relating to insolvency; business advisory services relating to company performance; business consultancy services relating to manufacturing; business management advisory services relating to commercial enterprises; business management advisory services relating to industrial enterprises; business management consultancy via the internet; consultancy and advisory services in the field of business strategy; business management consultancy and advisory services; market reporting services; clerical services; updating and maintenance of data in computer databases; filing documents or magnetic-tapes [office functions]; payroll assistance;

water meter reading for billing purposes; gas meter reading for billing purposes; utility meter reading for billing purposes; electricity meter reading for billing purposes; addressing of envelopes; appointment scheduling services [office functions] for others; computerised inventory control; data-based stock control; copying of documents for others; stenographic transcription services; invoicing; telephone billing; medical billing; billing; provision of clerical assistance; provision of initial company secretarial services on company formation; inventory management of parts and components for manufacturers and suppliers; computerised stock management; initiating telephone calls for others; office functions, namely inserting printed matter into envelopes; stock-taking; inventorying merchandise; keypunching [office functions]; preparation of documents relating to taxation; computerised inventory preparation; preparation of inventories; processing telephone inquiries regarding advertised goods and services; computerized word processing; processing warranty registration documents for others; word processing; reproduction of records [paper]; document reproduction; document reproduction [photocopying services]; reproduction of files [paper]; reproduction of drawings; office administration services [for others]; clerical services for the taking of sales orders; administrative services relating to the management of legal dockets; electronic stock management services; office management services [for others]; typing agency services; payroll advisory services; copying services; typing; medical billing services for doctors; medical billing services for hospitals; business invoicing services; billing services in the field of energy; billing services in the field of healthcare; photocopying services; stock control services; computerized stock management services; inventory management services; appointment reminder services [office functions]; payroll processing services [for others]; word processing and typing services; appointment scheduling services [office functions]; document reproduction services; secretarial services; shorthand secretarial services; secretarial services provided by hotels; company office secretarial services; clerical services for the handling of enquiries; clerical services for making appointments; business secretarial services; secretarial and clerical services; shorthand; conference call transcription services; bill-posting services; shareholder record keeping services; mail sorting, handling and receiving; transcription of recorded communications; data transcription; transcription of messages; transcription of communications [office functions]; stenographic transcription; xerography; key return registration; registration and transcription of written communications; preparation of invoices; preparation of mailing lists; computerised payroll preparation; preparation of payrolls [for others]; payroll preparation; maintenance of registers [for others]; maintenance of asset re-

gisters [for others]; maintenance of personnel records [for others]; maintaining personal medical history records and files; maintaining files and records concerning the medical condition of individuals; maintaining a registry of professional vocational evaluators; maintaining a registry of information; maintaining a registry of animal breeds; maintaining a registry of dog breeds; maintaining a registry of certified aerospace technicians; maintaining a registry of certified medical technical professionals; rental of office machines; rental of electronic point of sale (ePOS) equipment; rental of photocopying machines; leasing of typewriters; office machines and equipment rental; rental of typewriters and copying machines; business acquisitions; updating and maintenance of information in registries; business management of actors; business management of airports; business management of insurance agencies and brokers on an outsourcing basis; business management of entertainers; business management of authors and writers; veterinary practice business management; business management of conference centers; business management of swimming pool complexes; business management of resort hotels; business management of musical performers; business management of models; business management of musicians; business management of an airline company; business management of car parking facilities; business management of retail outlets; business management of wholesale outlets; business management of restaurants; business management of hospitals; business management of professional athletes; business management of theaters; administration of preferred provider plans; business management; business management for freelance service providers; management of business offices for others; administration of employee welfare benefit plans; administration of employee benefit plans; administration of employee pension plans; administration of prepaid health care plans; administration of patient reimbursement programs; administration of cultural and educational exchange programs; administering medication reimbursement programs and services; administering pharmacy reimbursement programs and services; administration of business payroll for others; administration relating to marketing; administration relating to business appraisal; administration relating to sales methods; administration relating to business planning; administration (business -) relating to statistical methods; business administration; administration of business affairs; administration of foreign business affairs; administration of the business affairs of retail stores; business management for a trade company and for a service company; business administration in the field of transport and delivery; administration of the business affairs of franchises; management of telephone call centers for other; commercial administration of the licensing of the

goods and services of others; business administration of employee share schemes; reception services for visitors in buildings; business management of hotels; business management for shops; operation of commercial businesses [for others]; business management of petrol stations [for others]; management administration of commercial undertakings; relocation services for businesses; business assistance relating to the formation of commercial undertakings; business assistance relating to the establishment of franchises; business assistance relating to franchising; commercial assistance in business management; management assistance for industrial organisations; business management assistance in the operation of restaurants; business management assistance in the establishment and operation of restaurants; assistance to management in commercial enterprises in respect of advertising; assistance to industrial or commercial enterprises in the running of their business; assistance to industrial enterprises in the conduct of their business; operational business assistance to enterprises; assistance to commercial enterprises in the management of their business; assistance in business management within the framework of a franchise contract; assistance relating to business organisation; assistance with business planning; business administration assistance; business management assistance in the field of franchising; business management assistance for industrial or commercial companies; business assistance; business management assistance; providing assistance in the management of business activities; providing assistance in the management of franchised businesses; providing assistance in the management of industrial or commercial enterprises; providing assistance in the field of business management and planning; corporate management assistance; help in the management of business affairs or commercial functions of an industrial or commercial enterprise; assistance in franchised commercial business management; management assistance to commercial companies; commercial or industrial management assistance; management and operation assistance to commercial businesses; management assistance; management assistance in the establishment of commercial undertakings; management assistance in business affairs; management advice relating to the placing of staff; management advice relating to the recruitment of staff; consultancy relating to search engine optimisation; industrial management consultation including cost/yield analyses; business relocation consulting; business inquiries; development of hospital management systems; writing of business project reports; business records keeping; company record-keeping; company record keeping [for others]; efficiency experts; operation of businesses [for others]; provision of assistance [business] in the operation of franchises; providing administrative assistance to pharmacies for managing drug inventories; provision of assistance [business]

in the establishment of franchises; provision of business assistance; providing transportation documentation for others [administrative services]; provision of commercial and business contact information; provision of business and commercial contact information via the internet; providing academic course administration services for academic institutions; outsource service provider in the field of customer relationship management; medical cost management; administrative management of health care clinics; administrative management of hospitals; business consultation and management regarding marketing activities; business consultation and management regarding launching of new products; outsourced administrative management for companies; management of a retail enterprise for others; business management of reimbursement programmes for others; information about sales methods; computerised office management; restaurant management for others; hotel management for others; commercial management; business management of performing artists; transportation fleet (business management of -) [for others]; vehicle fleet (business management of a -) [for others]; business management of sports people; business management in the field of transport and delivery; management of health care clinics for others; management of an airline company; computerised business management [for others]; business management of sporting facilities [for others]; business project management; management of business projects [for others]; hospital management; company management, including consultancy in demographic matters; business administration and management; business process management and consulting; negotiation of business contracts for others; negotiation of commercial transactions for performing artists; negotiation of commercial transactions for third parties; operation of a telephone switchboard for others; arranging of presentations for business purposes; arranging of business introductions; business management organisation; business organisation; organisation for a third party of telephone welcoming services and of telephone receptionist services; business meeting planning; planning concerning business management, namely, searching for partners for amalgamations and business take-overs as well as for business establishments; strategic business planning; business management planning; business planning services; business succession planning; providing market intelligence services; preparation of project studies relating to business matters; business process re-engineering; administrative services relating to hospital referrals; administrative services relating to customs clearance; administrative services relating to referrals for insurance agents; administrative services relating to referrals for general building contractors; chamber of commerce services for the promotion of commerce; chamber of commerce services for the promotion of businesses; airport adminis-

tration services; business management services provided by theatrical agencies; business administration services for the processing of sales made on a global computer network; business management services relating to the acquisition of businesses; business management services relating to the development of businesses; business administration services in the field of healthcare; business administration services in the field of transportation; business administration services for processing sales made on the internet; business services relating to the establishment of businesses; agency services for arranging business introductions; company office secretarial services; business networking services; consultancy services relating to the management of telephone call centers; business project management services for construction projects; business risk assessment services; business examinations services; business expertise services; business efficiency expert services; outsourcing services [business assistance]; outsourcing services in the nature of arranging service contracts for others; outsourcing services in the field of business operations; office functions services; supply chain management services; booking agent services for models; business advisory and information services; commercial intermediation services; business risk management services; hotel management service [for others]; management of professional athletes; telephone answering and message handling services; telephone answering for unavailable subscribers; business representative services; telephone answering [for others]; business strategy services; medical transcription services; telephone welcoming services for third parties; services rendered by a franchisor, namely, assistance in the running or management of industrial or commercial enterprises; business services relating to the arrangement of joint ventures; business strategy development services; business strategy and planning services; business merger services; business intelligence services; business supervision; business management supervision; supervision of businesses on behalf of others; sales volume tracking for others; vehicular registration and title transfer; registration of written communications and data; preparation of documents relating to business; preparation of audio and/or visual displays for businesses; preparation of economic reports; preparation of annual returns for business undertakings; retail services connected with the sale of clothing and clothing accessories; retail services in relation to computer hardware; retail services in relation to building materials; retail services connected with stationery; retail services in relation to computer software; mail order retail services connected with clothing accessories; shop retail services connected with carpets; wholesale services in relation to computer hardware; wholesale services in relation to computer software; mail order retail services for clothing; mail order retail services for cosmetics; re-

tail services in relation to horticulture equipment; retail services in relation to mobile phones; online retail services relating to luggage; online retail services relating to clothing; online retail services relating to jewelry; online retail services relating to handbags; online retail services relating to toys; online retail services relating to cosmetics; retail services via catalogues related to beer; retail services via catalogues related to alcoholic beverages (except beer); retail services via catalogues related to non-alcoholic drinks; retail services via catalogues related to foodstuffs; mail order retail services related to beer; mail order retail services related to alcoholic beverages (except beer); mail order retail services related to non-alcoholic beverages; mail order retail services related to foodstuffs; retail services via global computer networks related to beer; retail services via global computer networks related to alcoholic beverages (except beer); retail services via global computer networks related to non-alcoholic beverages; retail services via global computer networks related to foodstuffs; retail services relating to automobile accessories; retail services relating to sporting goods; retail services relating to furs; retail services relating to fake furs; retail services relating to delicatessen products; retail services relating to candy; retail services relating to flowers; retail services relating to fruit; retail services relating to automobile parts; retail services connected with the sale of furniture; retail or wholesale services for pharmaceutical, veterinary and sanitary preparations and medical supplies; retail services relating to food; retail store services in the field of clothing; retail services in relation to medical apparatus; retail services in relation to veterinary apparatus; retail services in relation to weapons; retail services in relation to headgear; retail services in relation to cleaning articles; retail services in relation to sewing articles; retail services in relation to metal hardware; retail services in relation to gardening articles; retail services in relation to furnishings; retail services in relation to saddlery; retail services in relation to sporting articles; retail services in relation to articles for use with tobacco; retail services in relation to veterinary articles; retail services in relation to bedding for animals; retail services in relation to luggage; retail services in relation to beer; retail services in relation to jewellery; retail services in relation to alcoholic beverages (except beer); retail services in relation to non-alcoholic beverages; retail services in relation to cocoa; retail services in relation to coffee; retail services in relation to wearable computers; retail services in relation to teas; retail services in relation to smartwatches; retail services in relation to chocolate; retail services in relation to fuels; retail services in relation to recorded content; retail services in relation to festive decorations; retail services in relation to desserts; retail services in relation to navigation devices; retail services in relation to

hearing protection devices; retail services in relation to meats; retail services in relation to audio-visual equipment; retail services in relation to sun tanning appliances; retail services in relation to freezing equipment; retail services in relation to food cooking equipment; retail services in relation to lighting; retail services in relation to refrigerating equipment; retail services in relation to cooling equipment; retail services in relation to diving equipment; retail services in relation to information technology equipment; retail services in relation to heating equipment; retail services in relation to physical therapy equipment; retail services in relation to sanitation equipment; retail services in relation to sporting equipment; retail services in relation to threads; retail services in relation to yarns; retail services in relation to downloadable music files; retail services in relation to seafood; retail services in relation to fodder for animals; retail services in relation to bags; retail services in relation to frozen yogurts; retail services in relation to water supply equipment; retail services in relation to sanitary installations; retail services in relation to beauty implements for animals; retail services in relation to beauty implements for humans; retail services in relation to hygienic implements for animals; retail services in relation to hygienic implements for humans; retail services in relation to time instruments; retail services in relation to hand-operated implements for construction; retail services in relation to medical instruments; retail services in relation to musical instruments; retail services in relation to veterinary instruments; retail services in relation to games; retail services in relation to toys; retail services in relation to lubricants; retail services in relation to works of art; retail services in relation to art materials; retail services in relation to litter for animals; retail services in relation to educational supplies; retail services in relation to fabrics; retail services in relation to printed matter; retail services in relation to furniture; retail services in relation to stationery supplies; retail services in relation to dietetic preparations; retail services in relation to cleaning preparations; retail services in relation to animal grooming preparations; retail services in relation to preparations for making beverages; retail services in relation to preparations for making alcoholic beverages; retail services in relation to veterinary preparations; retail services in relation to foodstuffs; retail services in relation to chemicals for use in agriculture; retail services in relation to chemicals for use in horticulture; retail services in relation to chemicals for use in forestry; retail services in relation to baked goods; retail services in relation to confectionery; retail services in relation to toiletries; retail services in relation to disposable paper products; retail services in relation to horticulture products; retail services in relation to dairy products; retail services in relation to downloadable electronic publications; retail services in relation to heaters; retail ser-

vices in relation to sex aids; retail services in relation to dietary supplements; retail services in relation to cutlery; retail services in relation to smartphones; retail services in relation to tobacco; retail services in relation to umbrellas; retail services in relation to hand-operated tools for construction; retail services in relation to cookware; retail services in relation to agricultural equipment; retail services in relation to construction equipment; retail services in relation to earthmoving equipment; retail services in relation to vehicles; retail services in relation to tableware; retail services in relation to clothing; retail services in relation to floor coverings; retail services in relation to wall coverings; retail services in relation to footwear; retail services in relation to ice creams; retail services in relation to sorbets; wholesale services in relation to horticulture equipment; wholesale services relating to automobile accessories; wholesale services relating to sporting goods; wholesale services relating to furs; wholesale services relating to fake furs; wholesale services relating to candy; wholesale services relating to flowers; wholesale services relating to automobile parts; wholesale services in relation to medical apparatus; wholesale services in relation to veterinary apparatus; wholesale services in relation to weapons; wholesale services in relation to headgear; wholesale services in relation to cleaning articles; wholesale services in relation to sewing articles; wholesale services in relation to metal hardware; wholesale services in relation to furnishings; wholesale services in relation to saddlery; wholesale services in relation to sporting articles; wholesale services in relation to articles for use with tobacco; wholesale services in relation to veterinary articles; wholesale services in relation to bedding for animals; wholesale services in relation to luggage; wholesale services in relation to beer; wholesale services in relation to jewellery; wholesale services in relation to alcoholic beverages (except beer); wholesale services in relation to non-alcoholic beverages; wholesale services in relation to cocoa; wholesale services in relation to coffee; wholesale services in relation to teas; wholesale services in relation to chocolate; wholesale services in relation to fuels; wholesale services in relation to kitchen knives; wholesale services in relation to festive decorations; wholesale services in relation to desserts; wholesale services in relation to navigation devices; wholesale services in relation to meats; wholesale services in relation to audio-visual equipment; wholesale services in relation to water supply equipment; wholesale services in relation to freezing equipment; wholesale services in relation to food cooking equipment; wholesale services in relation to lighting; wholesale services in relation to refrigerating equipment; wholesale services in relation to cooling equipment; wholesale services in relation to information technology equipment; wholesale services in relation to heating equipment; wholesale services in relation to

sanitation equipment; wholesale services in relation to sporting equipment; wholesale services in relation to threads; wholesale services in relation to yarns; wholesale services in relation to seafood; wholesale services in relation to fodder for animals; wholesale services in relation to bags; wholesale services in relation to frozen yogurts; wholesale services in relation to sanitary installations; wholesale services in relation to beauty implements for animals; wholesale services in relation to beauty implements for humans; wholesale services in relation to hygienic implements for animals; wholesale services in relation to hygienic implements for humans; wholesale services in relation to hand-operated implements for construction; wholesale services in relation to medical instruments; wholesale services in relation to veterinary instruments; wholesale services in relation to games; wholesale services in relation to toys; wholesale services in relation to lubricants; wholesale services in relation to works of art; wholesale services in relation to art materials; wholesale services in relation to educational supplies; wholesale services in relation to fabrics; wholesale services in relation to printed matter; wholesale services in relation to furniture; wholesale services in relation to stationery supplies; wholesale services in relation to dietetic preparations; wholesale services in relation to cleaning preparations; wholesale services in relation to fragrancings preparations; wholesale services in relation to animal grooming preparations; wholesale services in relation to preparations for making beverages; wholesale services in relation to preparations for making alcoholic beverages; wholesale services in relation to veterinary preparations; wholesale services in relation to veterinary preparations and articles; wholesale services in relation to foodstuffs; wholesale services in relation to chemicals for use in agriculture; wholesale services in relation to chemicals for use in horticulture; wholesale services in relation to chemicals for use in forestry; wholesale services in relation to baked goods; wholesale services in relation to confectionery; wholesale services in relation to litter for animals; wholesale services in relation to toiletries; wholesale services in relation to disposable paper products; wholesale services in relation to horticulture products; wholesale services in relation to dairy products; wholesale services in relation to heaters; wholesale services in relation to dietary supplements; wholesale services in relation to cutlery; wholesale services in relation to tobacco; wholesale services in relation to umbrellas; wholesale services in relation to hand-operated tools for construction; wholesale services in relation to cookware; wholesale services in relation to agricultural equipment; wholesale services in relation to construction equipment; wholesale services in relation to earth-moving equipment; wholesale services in relation to vehicles; wholesale services in relation to tableware; wholesale services in relation to clothing; wholesale

services in relation to floor coverings; wholesale services in relation to wall coverings; wholesale services in relation to footwear; wholesale services in relation to ice creams; wholesale services in relation to sorbets; online retail store services relating to clothing; online retail store services relating to cosmetic and beauty products; rental of sales stands; auctioneering services; carrying out auction sales; providing on-line auction services; auctioning via telecommunication networks; telephone and television auctions; on-line auction bidding for others; organisation of internet auctions; conducting interactive virtual auctions; arranging of auctions; arranging and conducting of real estate auctions; arranging and conducting of internet auctions; arranging and conducting of auctions and reverse auctions via mobile telephones; arranging and conducting of auctions and reverse auctions via computer and telecommunication networks; arranging and conducting of telephone auctions; arranging and conducting of television auctions; arranging and conducting auctions; on-line trading services in which seller posts products to be auctioned and bidding is done via the internet; auction and reverse auction services; auctioneering services provided via telecommunication networks; on-line auctioneering services via the internet; auctioning of vehicles; auctioneering of property; auctioneering provided on the internet; auctioneering services relating to agriculture; rental of vending machines; rental of coin-operated vending machines; rental of card-operated vending machines; subscription to a television channel; subscription to an information media package; subscriptions to electronic journals; subscriptions to telecommunications database services; newspaper subscriptions; procurement of goods on behalf of other businesses; purchasing of goods and services for other businesses; administration of newspaper subscription [for others]; sales administration; import-export agency services; import-export agencies in the field of energy; compilation and systemization of data relating to name and address based lists; computerised stock ordering; providing consumer product advice; providing consumer product advice relating to laptops; providing consumer product advice relating to cosmetics; consultancy relating to costing of sales orders; bidding quotation; price comparison rating of accommodations; providing information via the internet relating to the sale of automobiles; providing consumer information relating to goods and services; providing consumer product advice relating to software; providing consumer product information; providing consumer product information relating to cosmetics; provision of online price comparison services; provision of an on-line marketplace for buyers and sellers of goods and services; providing consumer product information relating to food or drink products; providing consumer product information relating to laptops; foreign trade information and consultation;

commercial information and advice for consumers [consumer advice shop]; mediation of trade business for third parties; procurement of contracts [for others]; arranging of contracts for the purchase and sale of goods and services, for others; arranging of contracts for others for the buying and selling of goods; arranging of contracts, for others, for the providing of services; arranging the buying of goods for others; mediation of agreements regarding the sale and purchase of goods; mediation of contracts for purchase and sale of products; arranging of buying and selling contracts for third parties; arranging of commercial and business contacts; management on behalf of industrial and commercial enterprises in terms of supplying them with office requisites; mediation and conclusion of commercial transactions for others; negotiation of contracts with health care payors; negotiation of contracts relating to the purchase and sale of goods; negotiation and conclusion of commercial transactions for third parties; negotiation and conclusion of commercial transactions for third parties via telecommunication systems; procurement of contracts for others relating to the sale of goods; procurement of contracts for the purchase and sale of goods and services; arranging subscriptions to information media; arranging subscriptions to media packages; arranging subscriptions to internet services; arranging subscriptions to telephone services; arranging subscriptions to a television channel; arranging subscriptions to electronic journals; arranging of collective buying; arranging business introductions relating to the buying and selling of products; arranging commercial transactions, for others, via online shops; arranging of trading transactions and commercial contracts; arranging and conducting of flea markets; arranging and conducting sales events for livestock; arranging and conducting sales events for cattle; arranging and conducting sales events for others of livestock and registered and commercial cattle; arranging of contractual [trade] services with third parties; arranging newspaper subscriptions; administrative processing of warranty claims; administrative processing of computerized purchase orders; administrative processing of purchase orders placed by telephone or computer; administrative processing of purchase orders; electronic order processing; administrative processing and organising of mail order services; administrative processing of purchase orders within the framework of services provided by mail-order companies; production of teleshopping programmes; advertising of the services of other vendors, enabling customers to conveniently view and compare the services of those vendors; arranging subscriptions to information packages; subscriptions (arranging of -) to books, reviews, newspapers or comic books; subscriptions (arranging -) to a telematics, telephone or computer service [internet]; the bringing together, for the benefit of others, of a variety of insurance services,

enabling consumers to conveniently compare and purchase those services; the bringing together, for the benefit of others, of a variety of telecommunication services, enabling consumers to conveniently compare and purchase those services; administrative services relating to dental health insurance; administrative services relating to the referral of clients to lawyers; administrative services relating to the referral of patients; administrative services relating to warranty claims processing; administrative services relating to employee stock plans; export agency services; import agency services; arranging subscriptions of the online publications of others; arranging newspaper subscriptions for others; coupon procurement services for others; literary agency services consisting of the negotiation of contracts; procurement services for others relating to office requisites; alcoholic beverage procurement services for others [purchasing goods for other businesses]; procurement services for others [purchasing goods and services for other businesses]; ordering services for third parties; wholesale ordering services; on-line ordering services in the field of restaurant take-out and delivery; automatic re-ordering service for business; online ordering services; computerized on-line ordering services; electronic commerce services, namely, providing information about products via telecommunication networks for advertising and sales purposes; price comparison services; energy price comparison services; advisory services relating to commercial transactions; advisory and consultancy services relating to the procurement of goods for others; advisory services relating to the purchase of goods on behalf of business; advisory services relating to the purchase of goods on behalf of others; advisory services relating to the ordering of stationery; consultancy services relating to the procurement of goods and services; outsourcing services in the nature of arranging procurement of goods for others; sales management services; import and export services; commercial information and advice services for consumers in the field of beauty products; commercial information and advice services for consumers in the field of cosmetic products; commercial information and advice services for consumers in the field of make-up products; business intermediary services relating to the matching of potential private investors with entrepreneurs needing funding; intermediary services relating to the rental of advertising time and space; intermediary services relating to advertising; purchasing agency services; business intermediary and advisory services in the field of selling products and rendering services; telephone order-taking services for others; telemarketing services; export promotion services; arranging of subscriptions for the publications of others; arranging subscriptions to telecommunication services for others; procuring of contracts for the purchase and sale of goods; advertising, marketing

and promotional services; distribution of advertising, marketing and promotional material; dissemination of advertisements; dissemination of advertising matter; dissemination of advertisements via the internet; dissemination of advertising via online communications networks; dissemination of advertising, marketing and publicity materials; dissemination of advertising matter online; dissemination of advertising for others; dissemination of advertising for others via an on-line communications network on the internet; dissemination of advertising matter by mail; dissemination of advertising and promotional materials; distribution of advertisements and commercial announcements; dissemination of advertising material [leaflets, brochure and printed matter]; dissemination of advertising for others via the internet; distribution of advertising announcements; distribution of samples; distribution of advertising material by post; distribution of advertising material; distribution of publicity materials (flyers, prospectuses, brochures, samples, particularly for catalogue long distance sales) whether cross border or not; distribution of advertising mail and of advertising supplements attached to regular editions; distribution of samples for publicity purposes; distribution of prospectuses for advertising purposes; distribution of prospectuses and samples for advertising purposes; distribution of publicity texts; distribution of promotional matter; distribution of printed promotional material by post; distribution of flyers, brochures, printed matter and samples for advertising purposes; distribution of products for advertising purposes; distribution of prospectuses and samples; handbill distribution; distribution and dissemination of advertising materials [leaflets, prospectuses, printed material, samples]; arranging the distribution of advertising samples; arranging the distribution of advertising samples in response to telephone enquiries; arranging the distribution of advertising literature in response to telephone enquiries; promoting the sale of goods and services of others through the distribution of printed material and promotional contests; promoting the goods and services of others through the distribution of discount cards; marketing the goods and services of others by distributing coupons; street dissemination of advertising materials; direct mail advertising; direct mail advertising to attract new customers and to maintain the existing customer base; advertising by mail order; dissemination of advertising matter; direct mail advertising services provided by letter-shops; product demonstration and window display arrangement services; shop window dressing; sales demonstration [for others]; arranging of demonstrations for advertising purposes; arranging of displays for commercial purposes; arranging of displays for advertising purposes; organisation and conducting of product presentations; preparation and presentation of audio visual displays for advertising purposes; presentation of goods and services; demonstration of

goods and services by electronic means, also for the benefit of the so-called teleshopping and homeshopping services; demonstration of photographic equipment [for advertising purposes]; demonstration of goods; presentation of financial products on communication media, for retail purposes; demonstration of goods for promotional purposes; presentation of goods on communication media, for retail purposes; retail shop window display arrangement services; window dressing services for advertising purposes; window dressing and display arrangement services; display services for merchandise; business merchandising display services; product demonstration services in shop windows by live models; advertising services by means of balloon displays; advertising, marketing and promotional consultancy, advisory and assistance services; providing assistance in the field of business promotion; marketing assistance; providing advice relating to the analysis of consumer buying habits; providing advice relating to the analysis of consumer buying habits; providing advice relating to the marketing of chemical products; consultancy regarding advertising communications strategy; consultations relating to business advertising; advice concerning chemical product marketing; advice relating to marketing management; consultancy relating to the organisation of promotional campaigns for business; consultations relating to business promotion; advisory services relating to sales promotion; press advertising consultancy; professional consultancy relating to marketing; consultancy relating to advertising and promotion services; consultancy relating to demographics for marketing purposes; direct marketing consulting; advertising and marketing consultancy; providing marketing consulting in the field of social media; provision of marketing advisory services for manufacturers; provision of information and advisory services relating to e-commerce; organisation of promotions using audiovisual media; marketing advice; advisory services relating to promotional activities; advisory services relating to corporate identity; marketing consulting; consultancy relating to advertising; advisory services relating to publicity for franchisees; business advice relating to marketing; business consultancy services relating to the marketing of fund raising campaigns; business consultancy services relating to the promotion of fund raising campaigns; consultancy services in the field of affiliate marketing; consulting services in the field of internet marketing; market segmentation consultation; advertising services to promote public awareness of nephrotic syndrome and focal segmental glomerulosclerosis [fsgs]; advertising services relating to clothing; loyalty, incentive and bonus program services; administration of loyalty rewards programs featuring trading stamps; administration of sales promotion incentive programs; administration of customer loyalty and incentive schemes; administration of sales and promotional incen-

tive schemes; administration of consumer loyalty programs; management of hotel incentive programs of others; administration of loyalty programs involving discounts or incentives; administration of frequent flyer programs; administration of a discount program for enabling participants to obtain discounts on goods and services through use of a discount membership card; organisational consultancy regarding customer loyalty programmes; management of customer loyalty, incentive or promotional schemes; administration of loyalty and incentive schemes; organisation of customer loyalty programs for commercial, promotional or advertising purposes; organisation and management of customer loyalty programs; organisation and management of business incentive and loyalty schemes; organisation, operation and supervision of an incentive scheme; organisation, operation and supervision of customer loyalty schemes; organisation, operation and supervision of loyalty schemes and incentive schemes; organization, operation and supervision of sales and promotional incentive schemes; sales promotion through customer loyalty programs; promoting the goods and services of others through the administration of sales and promotional incentive schemes involving trading stamps; promoting the sale of goods and services of others by awarding purchase points for credit card use; sales promotion for others provided through the distribution and the administration of privileged user cards; administrative loyalty card services; customer club services, for commercial, promotional and/or advertising purposes; customer loyalty services for commercial, promotional and/or advertising purposes; loyalty scheme services; public relations services; assistance to management in commercial enterprises in respect of public relations; consultancy regarding public relations communications strategy; public relations consultancy; conducting studies in the field of public relations; commercial lobbying services; public relations studies; organization of trade shows and exhibitions for commercial purposes; exhibitions (conducting -) for business purposes; conducting, arranging and organizing trade shows and trade fairs for commercial and advertising purposes; organisation of events for commercial and advertising purposes; organization of events, exhibitions, fairs and shows for commercial, promotional and advertising purposes; conducting of trade shows; organisation of exhibitions for business or commerce; organisation of exhibitions of flowers and plants for commercial or advertising purposes; arranging of exhibitions for business purposes; organization of exhibitions for commercial or advertising purposes; exhibitions (conducting -) for advertising purposes; organisation of exhibitions and events for commercial or advertising purposes; organisation of exhibitions and trade fairs for business and promotional purposes; organisation of fashion shows for commercial purposes; arranging of trade

fairs; arranging and conducting of commercial exhibitions; arranging and conducting of art exhibitions for commercial or advertising purposes; arranging and conducting of exhibitions for business purposes; organisation and holding of fairs for commercial or advertising purposes; arranging and conducting trade shows; arranging of exhibitions for advertising purposes; organization of fashion shows for promotional purposes; organization of trade fairs for commercial or advertising purposes; arranging and conducting of fairs and exhibitions for business purposes; arranging and conducting of fairs and exhibitions for advertising purposes; planning and conducting of trade fairs, exhibitions and presentations for economic or advertising purposes; fashion show exhibitions for commercial purposes; promotion of fairs for trade purposes; promoting and conducting trade shows; conducting trade shows in the field of automobiles; shows (conducting business -); conducting virtual trade show exhibitions online; trade show management services; provision of advertising space, time and media; provision of computerised advertising services; provision of advertising space; provision of advertising space by electronic means and global information networks; provision of space on web-sites for advertising goods and services; provision of advertising space on electronic media; provision of advertising space on a global computer network; providing and rental of advertising space on the internet; providing advertising space in periodicals, newspapers and magazines; arranging for the provision of advertising space in newspapers; rental of billboards [advertising boards]; rental of advertisement billboards; rental of digital billboards; rental of advertising space; leasing of advertising space on trains; rental of advertising space on-line; rental of advertising space on the internet; rental of advertising space on the internet for employment advertising; leasing of advertising space on pamphlets; leasing of advertising space on railway properties; rental of advertisement space and advertising material; rental of advertising time in cinemas; rental of advertising time on communication media; advertising services, especially in the field of telematic and telephone networks; updating of advertising information on a computer data base; administration of incentive award programs to promote the sale of the goods and services of others; bill-posting; displaying advertisements for others; advertising agency services; classified advertising; business assistance relating to business image; assistance in product commercialization, within the framework of a franchise contract; business assistance relating to corporate identity; providing assistance in the field of product commercialization; management assistance for promoting business; market campaigns; collection of information relating to advertising; compilation of advertisements; compilation of advertisements for use as web pages on the internet; compilation of ad-

vertisements for use on the internet; compilation, production and dissemination of advertising matter; design of advertising brochures; design of advertising flyers; design of advertising logos; design of advertising materials; sponsorship search consultancy services; copywriting; copywriting for advertising and promotional purposes; preparation of publicity materials; sponsorship search; developing promotional campaigns for business; development of promotional campaigns; development of marketing strategies and concepts; development and implementation of marketing strategies for others; issuing and updating of advertising texts; statistical evaluations of marketing data; arranging and conducting of trade show exhibitions; providing searchable online advertising guides; provision of information relating to marketing; providing marketing information via websites; providing business marketing information; provision of information relating to advertising; provision of models for advertising; providing a searchable online advertising guide featuring the goods and services of other on-line vendors on the internet; web indexing for commercial or advertising purposes; arranging advertising contracts for others; arranging advertising and promotional contracts for others; mediation of advertising; arranging of advertising in cinemas; promotional management of celebrities; promotional management for sports personalities; affiliate marketing; trade marketing [other than selling]; database marketing; product marketing; marketing the goods and services of others; referral marketing; direct marketing; financial marketing; real estate marketing; internet marketing; event marketing; marketing by telephone; promotional marketing; product sampling; negotiation of advertising contracts; search engine optimisation; search engine optimization for sales promotion; web site traffic optimization; arranging of product launches; arranging of presentations for advertising purposes; organisation of trade fairs for advertising purposes; arranging and conducting of marketing events; arranging and conducting marketing promotional events for others; arranging and placing of advertisements; arranging and conducting of promotional events; arranging and conducting of advertising events; arranging of competitions for advertising purposes; arrangement of advertising; prize draws (organising of -) for promotional purposes; planning of marketing strategies; advertisements (placing of -); placing advertisements for others; preparation of custom advertisements for others; preparation of advertising campaigns; preparation of publicity documents; preparation of mailing lists for direct mail advertising services [other than selling]; preparing promotional and merchandising material for others; preparation of publicity publications; preparing and placing outdoor advertisements for others; preparing and placing advertisements for others; preparation and realization of media and advertising plans and

concepts; preparing audio-visual presentations for use in advertising; presentation of companies on the internet and other media; presentation of companies and their goods and services on the internet; production of television and radio advertisements; production of advertising films; production of infomercials; production of visual advertising matter; production of advertising matter and commercials; production of advertising material; production of cinema commercials; production of radio advertisements; production of sound recordings for marketing purposes; production of sound recordings for advertising purposes; production and distribution of radio and television commercials; design of marketing surveys; promotion [advertising] of concerts; promotion [advertising] of travel; promoting the sale of fashion goods through promotional articles in magazines; promoting the sale of goods and services of others through promotional events; sales promotion for others through trading stamp schemes; sales promotion using audiovisual media; computerised business promotion; promoting the goods and services of others via computer and communication networks; promotion of sports competitions and events; promotion of musical concerts; promotion of special events; promoting the goods and services of others via a global computer network; promoting the goods and services of others through advertisements on internet websites; promoting the goods and services of others by means of a preferred customer program; promoting the goods and services of others through discount card programs; promoting the goods and services of others by means of a loyalty rewards card scheme; promoting the goods and services of others; promotion of goods and services through sponsorship of sports events; promotion of goods and services through sponsorship of international sports events; promotion of insurance services, on behalf of third parties; promotion of financial and insurance services, on behalf of third parties; on-line promotion of computer networks and websites; promotion, advertising and marketing of on-line websites; promotion [advertising] of business; business promotion; promoting the designs of others by means of providing online portfolios via a website; promoting the music of others by means of providing online portfolios via a website; promoting the artwork of others by means of providing online portfolios via a website; promoting the goods and services of others over the internet; promoting the goods and services of others by arranging for sponsors to affiliate their goods and services with sporting activities; promoting the goods and services of others by arranging for sponsors to affiliate their goods and services with sports competitions; promoting the goods and services of others by arranging for sponsors to affiliate their goods and services with awards programs; promoting a series of films for others; promoting the sale of the services [on behalf

of others] by arranging advertisements; sales promotion; sales promotions at point of purchase or sale, for others; sales promotion for others; publication of printed matter for advertising purposes; publication of printed matter for advertising purposes in electronic form; publication of advertising literature; publication of publicity materials; publication of publicity materials on-line; publication of publicity materials and texts; publication of publicity texts; electronic publication of printed matter for advertising purposes; issuing of publicity leaflets; advertising; response advertising; advertising the goods and services of online vendors via a searchable online guide; on-line advertising on a computer network; advertisement for others on the internet; advertising of the goods of other vendors, enabling customers to conveniently view and compare the goods of those vendors; advertising of cinemas; advertising of commercial or residential real estate; advertising of business web sites; advertisement for others on the internet; advertising automobiles for sale by means of the internet; banner advertising; advertising via electronic media and specifically the internet; electronic billboard advertising; advertisement via mobile phone networks; advertising through all public communication means; advertising by transmission of on-line publicity for third parties through electronic communications networks; promotional advertising for exploration projects; promotional advertising relating to philosophical instruction; radio and television advertising; radio advertising; advertising relating to pharmaceutical products and in-vivo imaging products; television advertising; cinema advertising; advertising in the field of tourism and travel; advertising in the popular and professional press; magazine advertising; advertising in periodicals, brochures and newspapers; advertising relating to transport and delivery; advertising and marketing; advertisement and publicity services by television, radio, mail; advertising, including promotion of products and services of third parties through sponsoring arrangements and licence agreements relating to international sports' events; advertising, including on-line advertising on a computer network; advertising particularly services for the promotion of goods; updating of advertising material; preparing advertisements for others; preparation of publicity leaflets; preparation of advertising material; production of video recordings for advertising purposes; producing promotional videotapes, video discs, and audio visual recordings; scriptwriting for advertising purposes; writing of publicity texts; reproduction of advertising material; information, advisory and consultancy services relating to business management provided online or via the Internet; marketing agency services; agency services for promoting sports personalities; online advertising network matching services for connecting advertisers to websites; brand creation services; brand creation ser-

vices (advertising and promotion); media buying services; brand evaluation services; graphic advertising services; corporate identity services; information services relating to advertising; product launch services; layout services for advertising purposes; marketing; business marketing services; marketing services provided by means of digital networks; telephone marketing services [not selling]; search engine marketing services; promotional marketing services using audiovisual media; marketing services in the field of travel; marketing services in the field of restaurants; marketing services in the field of dentistry; merchandising; planning services for advertising; brand positioning services; services with regard to product presentation to the public; promotion services; business promotion services provided by telex; business promotion services provided by telephone; business promotion services provided by audio/visual means; publicity and sales promotion services; business advertising services relating to franchising; advertising services by means of sandwich board; digital advertising services; advertising services provided by a radio and television advertising agency; advertising services provided for florists; advertising services provided via the internet; advertising services provided via a data base; advertising services of a radio and television advertising agency; advertising services to promote public awareness of the benefits of shopping locally; advertising for others; advertising services relating to in vivo imaging apparatus; advertising services for architects; advertising services relating to jewelry; advertising services relating to the commercialization of new products; advertising services for the literary industry; promoting services for baseball game; advertising services relating to cosmetics; advertising services relating to in vivo imaging products; advertising services relating to perfumery; advertising services relating to pharmaceutical products; advertising services for promoting the brokerage of stocks and other securities; advertising services for the promotion of beverages; advertising services for the promotion of e-commerce; advertising services to promote public awareness of medical conditions; advertising services to promote public awareness of environmental issues and initiatives; advertising services to promote the sale of beverages; advertising services relating to the sale of goods; advertising services by means of television screen based text; advertising services relating to the motor vehicle industry; advertising services relating to the marine and maritime industry; advertising services relating to the travel industries; advertising services relating to public works; advertising services relating to pharmaceuticals for the treatment of diabetes; advertising services relating to the transport industries; advertising services relating to financial services; advertising services relating to the sale of motor vehicles; advertising services relating to

real property; press advertising services; advertising and marketing services provided by means of blogging; advertising and promotion services and related consulting; advertising and marketing services provided by means of social media; advertising and marketing services provided via communications channels; advertising, promotional and public relations services; publicity services; editing of publicity texts; brand strategy services; trade promotional services; promotional services provided by telephone; advertising services to create corporate and brand identity; advertising services relating to books; advertising services relating to hotels; advertising services relating to data bases; advertising services relating to financial investment; advertising services relating to the recruitment of personnel; advertising services relating to the sale of personal property; advertising services relating to newspapers; pay per click advertising; advertising services relating to the provision of business; brand testing; publicity material rental; rental of all publicity and marketing presentation materials; rental of signs for advertising purposes; preparation of marketing plans; provision of marketing reports; preparation of advertisements; preparation of trade publicity texts.

(260) AM 2018 95024 A

(800) 1374531

(151) 2017 06 22

(891) 2017 06 22

(731) Concern "NICMAS"

prosp. Kurskyi, 6 m. Sumy 40020, Ukraine

(540)

NICMAS

(591) Black and white

(531) 27.05.01

(511)

1 – Chemicals for use in industry, science and photography, as well as in agriculture, horticulture and forestry; nitrogen; argon; helium; oxygen; methane; carbonic hydrates; carbon dioxide for industrial purposes; unprocessed artificial resins, unprocessed plastics; fertilizers; fire extinguishing compositions; tempering and soldering preparations; chemical substances for preserving foodstuffs.

4 – Industrial oils and greases; lubricants; dust absorbing, wetting and binding compositions; fuels, including motor spirit, and illuminants.

6 – Common metals and their alloys; building materials of metal; buildings, transportable, of metal; railway material of metal; metal blanks, wire; non-electric cables and wires of common metal; hardware of metal, small; pipes and tubes of metal; safes (strong boxes); ores of metal.

7 – Drilling machines; vacuum pumps (machines); centrifugal pumps; exhaust manifold for engines; ex-

hausts for motors and engines; clack valves (parts of machines); centrifugal machines; water separators; water heaters (parts of machines); suction machines for industrial purposes; blowing machines for the compression, exhaustion and transport of gases; gasifier; elevator chains (parts of machines); elevator belts; electromechanical machines for chemical industry; welding machines, electric; joints (parts of engines); shaft couplings (machines); injectors for engines; crankcases for machines, motors and engines; hydraulic controls for machines, motors and engines; control mechanisms for machines, engines or motors; pneumatic controls for machines, motors and engines; grease rings (parts of machines); piston segments; valves (parts of machines); pressure reducers (parts of machines); crank shafts; stationary, mobile, self-propelled compressors (machines); compressors for refrigerators; compressed air pumps; hoists; shovels, mechanical; blades (parts of machines); grease boxes (parts of machines); lubricators (parts of machines); butter machines; clutches, other than for land vehicles; superchargers; anti-pollution devices for motors and engine; transmission shafts, other than for land vehicles; transmission chains, other than for land vehicles; air condensers; pistons for engines; pistons for cylinders; membrane, adsorption, cryogenic mobile units (machines), including nitrogen, oxygen, hydrocarbon units for receiving compressed gas; radiators (cooling) for motors and engines; regulators (parts of machines); speed governors for machines, engines and motors; pressure regulators (parts of machines); reduction gears, other than for land vehicles; receivers (parts of machines); separators; stationery, mobile, transportable, self-powered compressor stations; heat exchangers (parts of machines); turbines, other than for land vehicles; wind turbines; turbocompressors; filters (parts of machines or engines); filters for cleaning cooling air, for engines; centrifugal machines; cylinders for motors and engines; cylinders for machines; renewal parts for aforementioned machines and goods.

35 – Advertising; business management; business administration; office functions; organization of exhibitions and trade fairs for commercial or advertising purposes; demonstration of goods; provision of commercial information; sales promotion for others.

36 – Insurance services; financial affairs; monetary affairs; real estate affairs; rental of real estate; real estate brokerage.

37 – Construction; repair of installations, machines, engines, machine tools; installation services; rebuilding machines, installations, engines, machine tools that have been worn or partially destroyed.

42 – Scientific and technological services and research and design relating thereto; industrial analysis and research, design and development services; construction drafting; conducting technical project stu-

dies; material testing; industrial design; technical research; physics (research); mechanical research; research in the field of environmental protection; engineering; surveying; calibration (measuring); computer system analysis; consultancy in the field of energy-saving; surveying; scientific and technological services and research and design in the field of energy technology, including preparation of energy consumption balance sheet of industrial enterprises, development of projects on energy supply of technological equipment and improvement of industrial power systems of industrial enterprises, design of production lines, industrial processes of enterprises concerning energy supply, design of power generating units; quality control; industrial analysis and research services relating to boiler, turbine, compressor, electrical equipment and water preparation equipment, gas cleaning and cooling systems, aeration and air conditioning systems, technological support air systems for production.

(260) AM 2018 95025 A

(800) 1374547

(151) 2017 07 03

(891) 2017 07 03

(731) Limited Liability Company
Mail.Ru.

Leningradsky pr-kt, d. 39, str. 79 RU-125167
Moscow, Russian Federation

(540)



(591) Orange, yellow, orange-yellow, gray, light gray and dark gray

(531) 24.17.04; 27.05.03; 28.05; 29.01.12

(511)

9 – Accumulators, electric; ammeters; remote control apparatus; electro-dynamic apparatus for the remote control of signals; monitoring apparatus, electric; Global Positioning System [GPS] apparatus; electric apparatus for commutation; anode batteries; galvanic batteries; solar batteries; solar panels for the production of electricity; batteries, electric; computer memory devices; circuit closers; voltmeters; switchboxes [electricity]; current rectifiers; heliographic apparatus; detectors; floppy disks; disks, magnetic; disk drives for computers; juke boxes for computers; DNA chips; interfaces for computers; cables, electric; computer keyboards; solenoid valves [electromagnetic switches]; wire connectors [electricity]; magnetic encoders; compact discs [audio-video]; compact discs [read-only memory]; computers; laptop computers; notebook computers; condensers [capacitors]; contacts, electric; distribution

boxes [electricity]; junction boxes [electricity]; gale-na crystals [detectors]; head cleaning tapes [recording]; magnetic tapes; electricity conduits; magnets; decorative magnets; materials for electricity mains [wires, cables]; microprocessors; modems; monitors [computer hardware]; monitors [computer programs]; magnetic data media; optical data media; computer software, recorded; wrist rests for use with computers; wafers for integrated circuits; computer software applications, downloadable; printers for use with computers; computer programmes [programs], recorded; computer game software; computer programs [downloadable software]; computer operating programs, recorded; processors [central processing units]; scanners [data processing equipment]; integrated circuit cards [smart cards]; connections for electric lines; couplings, electric; resistances, electric; integrated circuits; printed circuits; counters; revolution counters; transformers [electricity]; step-up transformers; electric loss indicators; electric installations for the remote control of industrial operations; tape recorders; data processing apparatus; battery chargers; computer peripheral devices; demagnetizing apparatus for magnetic tapes; readers [data processing equipment]; downloadable image files; downloadable music files; USB flash drives; frequency meters; chips [integrated circuits]; cell phone straps; distribution boards [electricity]; projection screens; ducts [electricity].

38 – News agency services; wireless broadcasting; television broadcasting; cable television broadcasting; electronic bulletin board services [telecommunications services]; information about telecommunication; providing user access to global computer networks; providing access to databases; providing internet chatrooms; providing telecommunications connections to a global computer network; providing telecommunication channels for teleshopping services; video-on-demand transmission; transmission of greeting cards online; message sending; computer aided transmission of messages and images; transmission of telegrams; transmission of digital files; providing online forums; videoconferencing services; rental of message sending apparatus; rental of access time to global computer networks; rental of modems; rental of telecommunication equipment; rental of telephones; rental of facsimile apparatus; radio broadcasting; radio communications; transmission of electronic mail; communications by fiber optic networks; communications by cellular phones; communications by computer terminals; satellite transmission; communications by telegrams; communications by telephone; facsimile transmission; paging services [radio, telephone or other means of electronic communication]; teleconferencing services; telex services; voice mail services; telecommunications routing and junction services; streaming of data; telegraph services; telephone services.

41 – Modelling for artists; academies [education]; rental of indoor aquaria; rental of artwork; rental of sports grounds; rental of tennis courts; lending library services; booking of seats for shows; videotaping; physical education; production of music; discotheque services; animal training; dubbing; gambling services; publication of books; education information; recreation information; entertainment information; movie studio services; health club services [health and fitness training]; nightclub services [entertainment]; layout services, other than for advertising purposes; microfilming; videotape editing; production of radio and television programmes; screenplay writing; game services provided on-line from a computer network; providing on-line electronic publications, not downloadable; religious education; aikido instruction; gymnastic instruction; correspondence courses; practical training [demonstration]; training services provided via simulators; organization of balls; organization of exhibitions for cultural or educational purposes; providing recreation facilities; arranging and conducting of colloquiums; arranging and conducting of congresses; arranging and conducting of conferences; arranging and conducting of concerts; arranging and conducting of workshops [training]; arranging and conducting of in-person educational forums; arranging and conducting of seminars; arranging and conducting of symposiums; organization of competitions [education or entertainment]; arranging of beauty contests; organization of lotteries; organization of fashion shows for entertainment purposes; organization of shows [impresario services]; organization of sports competitions; vocational guidance [education or training advice]; amusement park services; sign language interpretation; television entertainment; mobile library services; vocational retraining; providing on-line videos, not downloadable; providing on-line music, not downloadable; providing television programs, not downloadable, via video-on-demand transmission services; providing films, not downloadable, via video-on-demand transmission services; providing golf facilities; providing sports facilities; providing amusement arcade services; cinema presentations; presentation of circus performances; presentation of variety shows; presentation of live performances; theatre productions; conducting fitness classes; educational examination; film production, other than advertising films; rental of audio equipment; rental of video cameras; rental of video cassette recorders; rental of videotapes; rental of show scenery; rental of sound recordings; toy rental; rental of cinematographic apparatus; rental of motion pictures; games equipment rental; rental of stadium facilities; rental of lighting apparatus for theatrical sets or television studios; rental of radio and television sets; rental of skin diving equipment; rental of sports equipment, except vehicles; rental of stage scenery; electronic desktop publishing; on-line publication of electronic books

and journals; publication of texts, other than publicity texts; radio entertainment; entertainer services; entertainment services; writing of texts; sado instruction [tea ceremony instruction]; zoological garden services; news reporters services; party planning [entertainment]; music composition services; subtitling; tutoring; holiday camp services [entertainment]; conducting guided tours; disc jockey services; personal trainer services [fitness training]; providing casino facilities [gambling]; calligraphy services; karaoke services; club services [entertainment or education]; songwriting; providing museum facilities [presentation, exhibitions]; teaching; educational services provided by schools; orchestra services; translation; scriptwriting, other than for advertising purposes; ticket agency services [entertainment]; coaching [training]; sport camp services; recording studio services; language interpreter services; nursery schools; photography; photographic reporting; timing of sports events; boarding school education; production of shows.

42 – Computer system analysis; energy auditing; recovery of computer data; computer virus protection services; engineering; installation of computer software; meteorological information; material testing; research in the field of environmental protection; research and development of new products for others; scientific research; technical research; information technology [IT] consultancy; consultancy in the design and development of computer hardware; computer software consultancy; technological consultancy; quality control; updating of computer software; monitoring of computer systems by remote access; software as a service [SaaS]; maintenance of computer software; digitization of documents [scanning]; conversion of data or documents from physical to electronic media; providing information on computer technology and programming via a web site; provision of scientific information, advice and consultancy in relation to carbon offsetting; providing search engines for the internet; conversion of computer programs and data, other than physical conversion; conducting technical project studies; computer system design; rental of web servers; computer rental; rental of computer software; hosting computer sites [web sites]; duplication of computer programs; construction drafting; computer software design; server hosting; consultancy in the field of energy-saving; creating and maintaining web sites for others; computer programming; cloud computing; outsource service providers in the field of information technology; computer technology consultancy; telecommunications technology consultancy; styling [industrial design]; electronic data storage; surveying.

45 – Marriage agency services; leasing of internet domain names; intellectual property consultancy; monitoring intellectual property rights for legal ad-

visory purposes; licensing of intellectual property; licensing of computer software [legal services]; missing person investigations; registration of domain names [legal services]; personal letter writing; personal background investigations; escorting in society [chaperoning]; copyright management; legal administration of licences; dating services; on-line social networking services.

(260) AM 2018 95040 A

(800) 1374562

(151) 2017 08 23

(891) 2017 08 23

(731) GRINDEKS, AS

Krustpils iela 53 LV-1057 Rīga, Latvia

(540)

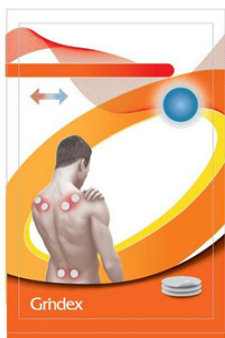

(591) Red, orange, yellow, brown, beige, blue, grey, black and white

(531) 02.01.01; 02.01.08; 19.13.15; 19.13.21; 24.15.02; 26.01.02; 26.01.04; 26.11.06; 26.11.08; 26.11.13; 26.15.01; 29.01.15

(511)

3 – Cosmetics; cosmetic patches; cosmetic patches for skin care of the body.

5 – Pharmaceutical preparations; plasters for medical use; medical plasters; anti-inflammatory analgesic plasters.

(260) AM 2018 95041 A

(800) 1374563

(151) 2017 08 23

(891) 2017 08 23

(731) GRINDEKS, AS

Krustpils iela 53 LV-1057 Rīga, Latvia

(540)

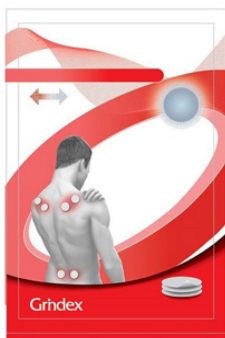

(591) Red, pink, light blue, grey, black and white

(531) 02.01.01; 02.01.08; 19.13.21; 24.15.02; 26.01.02; 26.01.04; 26.11.02; 26.11.06; 26.11.08; 26.11.13; 26.15.01; 29.01.15

(511)

3 – Cosmetics; cosmetic patches; cosmetic patches for skin care of the body.

5 – Pharmaceutical preparations; plasters for medical use; medical plasters; anti-inflammatory analgesic plasters.

(260) AM 2018 95042 A

(800) 1374597

(151) 2017 09 01

(891) 2017 09 01

(731) QIBU CORPORATION LIMITED

No.3 Chiyan Road, Qiaoxiang Industry Zone, Youzhu, Qingtian County Zhejiang, China

(540)

ABC KIDS

(591) Black and white

(531) 27.05.01; 27.05.17

(511)

25 – Clothing; children's clothing; layettes [clothing]; shoes; hats; hosiery; gloves [clothing]; scarfs; girdles; swimsuits.

(260) AM 2018 95043 A

(800) 1374624

(151) 2017 08 01

(891) 2017 08 01

(731) L&O HUNTING GROUP GMBH

Ziegelstadel 1 88316 Isny, Germany

(540)

Integral

(591) Black and white

(511)

13 – Firearms; ammunition; accessories, namely gun bags, rifle cases, cartridge belts, gun slings, cartridge pouches.

(260) AM 2018 95063 A

(800) 1350303

(151) 2017 01 17

(891) 2017 09 01

(731) ADP GAUSELMANN GMBH

Merkur-Allee 1-15 32339 Espelkamp, Germany

(540)

CENTURIO

(591) Black and white

(511)

9 – Scientific, nautical, surveying, photographic, cinematographic, optical, weighing, measuring, signalling, checking (supervision), life-saving and teaching apparatus and instruments; apparatus and instruments for conducting, switching, transforming, accumulating, regulating or controlling electricity; apparatus for recording, transmission or reproduction of sound or images; magnetic data carriers, recording discs; compact discs, DVDs and other digital recording media; cash registers, calculating machines, data processing equipment, computers; computer software; fire-extinguishing apparatus; musical jukeboxes and parts for the aforesaid automatic machines; automatic cash dispensers, automatic money counting and money changing machines; coin-operated mechanisms; computer and video games software; games software for use on any computer platform, including electronic entertainment and games consoles; computer game programs; computer games; video games (software); computer games, leisure and recreational software, video games and computer software, all being provided in the form of storage media; programs for operating electric and electronic apparatus for games, amusement and/or entertainment purposes; automatic lottery machines; computer software in the form of an app for mobile devices and computers; calculating apparatus in coin-operated machines and parts for the aforesaid goods; apparatus for recording, transmission, processing or reproduction of data, including sound or images, including parts for all the aforesaid goods, except radio sets, television receivers, hi-fi systems, video recorders, telephone apparatus, fax machines and telephone answering machines; computer hardware and software for casino and amusement arcade games, for gaming machines or slot machines, video lottery gaming machines; electric, electronic, optical or automatic apparatus, for identifying data carriers, identity cards and credit cards, bank notes and coins; electric, electronic or optical alarm and monitoring installations, including video cameras and apparatus for image transmission and image processing; data processing apparatus and computers, including data processing apparatus and computers being components for data networks and parts facilitating data network communications; electric wiring harnesses; circuit boards, printed circuit boards (electronic components) and combinations thereof, being assemblies and parts for apparatus, included in this class; protective clothing for protection against accident or injury and protective helmets.

(260) AM 2018 95083 A

(800) 1373646

(151) 2017 09 26

(891) 2017 09 26

(731) JOH. WILH. VON EICKEN GMBH

Drechslerstrasse 1-3, 23556 Lübeck, Germany

(540)

PIPERS BARSDORF'S CAPTAIN BEST

(591) Black, white

(531) 27.05.01

(511)

34 – Tobacco and tobacco products (including substitutes); cigarettes, cigars, cigarillos and other ready-for-use smoking articles; pipe tobacco.

(260) AM 2018 95086 A

(800) 1373759

(151) 2017 09 11

(891) 2017 09 11

(731) APPLE INC.

One Apple Park Way Cupertino CA 95014, USA

(540)

SUPER RETINA

(591) Black, white

(511)

9 – Computers; electronic display screens and electronic display interfaces; handheld mobile digital devices used as a telephone, handheld computer, media player, and personal digital assistant and used to access the Internet, electronic mail, and digital audio, video, and data; smartphones; smartwatches; wearable computers; wearable computer peripherals.

(260) AM 2018 95090 A

(800) 1373888

(151) 2017 07 24

(891) 2017 07 24

(731) Aktsionernoe obshchestvo "ESSEN PRODUCTION AG"

Avtozavodsky district, New Passage 3, of. 95, RU-445037 Tolyatti, Samara Region, Russian Federation

(540)



(591) yellow, violet
 (531) 19.03.24; 25.01.15; 26.11.03; 26.11.08; 28.05;
 29.01.12
 (511)
 30 – Sweetmeats [candy].

(260) AM 2018 95104 A
 (800) 1374098
 (151) 2017 08 30
 (891) 2017 08 30
 (731) FERRERO S.P.A.
 Piazzale Pietro Ferrero,1, I-12051 ALBA,
 CUNEO, Italy
 (540)



(591) Black, red-orange, blue, light blue, yellow,
 ocher, red, light green, dark green, pink and
 fuscia
 (531) 27.05.02; 27.05.17; 29.01.15
 (511)
 28 – Games and playthings; gymnastic and sporting
 articles; decorations for Christmas trees; swings; sli-
 des [playthings]; scooters [toys]; playing cards; pina-
 tas; swimming pools [play articles].
 30 – Pastries; confectionery; cookies; wafers; cocoa;
 cocoa-based products; chocolate; chocolate pro-
 ducts; ice cream.

(260) AM 2018 95105 A
 (800) 1374157
 (151) 2017 08 29
 (891) 2017 08 29
 (731) LABORATOIRE FRANCAIS DU
 FRACTIONNEMENT ET DES
 BIOTECHNOLOGIES
 3 avenue des Tropiques, F-91940 LES ULIS,
 France
 (540)



(591) Black, white
 (531) 27.05.17; 27.05.23
 (511)
 5 – Pharmaceutical and veterinary products and pre-
 parations; medicines; diagnostic products for medi-
 cal and veterinary use.
 9 – Scientific apparatus and instruments; downloa-
 dable electronic and digital publications in the field
 of health; downloadable instructional and teaching
 material, in the field of health; electronic reports fea-

turing results from clinical trials and studies in the
 field of health; recorded software, including softwa-
 re for medical information, educational and commer-
 cial activities; software for Websites, Intranet and
 the Internet; downloadable computer software app-
 lications in the field of health.

10 – Medical, veterinary, surgical apparatus and ins-
 truments; apparatus for analysis and diagnosis in the
 medical field; medical devices.

35 – Retail sale of pharmaceutical preparations and
 products, medical devices; wholesale of pharmaceu-
 tical preparations and products, medical devices; im-
 port and export of pharmaceutical preparations and
 products, medical devices; commercial representta-
 tion; sales promotion.

41 – Editing and publishing of texts other than ad-
 vertising texts in the field of health; education, trai-
 ning and instruction in the field of health; organiza-
 tion and conducting of seminars, symposiums, con-
 gresses, conferences, meetings, educational courses,
 workshops, in the field of health.

42 – Scientific and technological services as well as
 research and design services relating thereto; Indus-
 trial analysis and research services; technological
 platform for scientific research in the field of health;
 scientific studies; research and development of new
 products (for others); scientific research for medical
 purposes; cellular and molecular biology research;
 testing on pharmaceutical products; clinical trials;
 engineering; advice and assistance in all the
 aforesaid fields.

44 – Medical analysis relating to human blood plas-
 ma; sampling, collection and preservation (storage)
 of human blood plasma; advice and information on
 health.

(260) AM 2018 95111 A
 (800) 1374183
 (151) 2017 04 21
 (891) 2017 04 21
 (731) LOTTO SPORT ITALIA S.P.A.
 Via Montebelluna, 5/7 I-31040
 TREVIGNANO (TV), Italy
 (540)

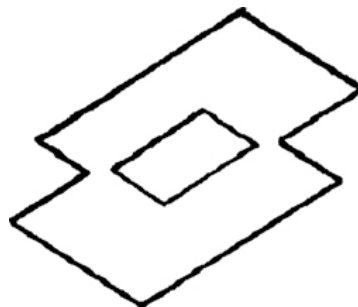

(591) Black, white
 (531) 26.04.03; 26.04.04; 26.04.09

(511)

3 – Perfumery, essential oils, cosmetics, hair lotions; dentifrices; after-shave lotions; almond milk for cosmetic purposes; almond oil; almond soap; amber [perfume]; antiperspirant soap; antiperspirants [toiletries]; aromatics [essential oils]; astringents for cosmetic purposes; badian essence; bath salts, not for medical purposes; cosmetic preparations for bath; beauty masks; bergamot oil; boot cream; non-medicated bar soap; essential oils of cedar wood; cleansing milk for toilet purposes; colorants for cosmetic purposes; cosmetic kits; cotton sticks for cosmetic purposes; cotton wool for cosmetic purposes; cosmetic creams; preservative creams for leather; degreasers other than for use in manufacturing processes; deodorant soap; deodorants for personal use; depilatory preparations; detergents other than for use in manufacturing operations and for medical purposes; cosmetic dyes; eau de Cologne; emery; ethereal essences; extracts of flowers [perfumes]; bases for flower perfumes; gaultheria oil; geraniol; incense; ionone [perfumery]; jasmine oil; lavender oil; lavender water; essential oils of lemon; lipsticks; lotions for cosmetic purposes; make-up sets; make-up powder; make-up preparations for the face and the body; make-up removing preparations; mascara; mint essence [essential oil]; mint for perfumery; mouth washes, not for medical purposes; musk [perfumery]; mustache wax; non-medicated nail care preparations; oils for cosmetic purposes; oils for perfumes; oils for toilet purposes; cosmetic pencils; eyebrow pencils; perfumes; petroleum jelly for cosmetic purposes; pomades for cosmetic purposes; rose oil for cosmetic purposes; scented water; shampoos; shaving preparations; shaving soap; shoe polish; shoe wax; shoemakers' wax; cosmetic preparations for skin care; skin whitening creams; bath soaps in liquid, solid or gel form; soap for foot perspiration; sunscreen preparations; sun-tanning preparations [cosmetics]; talcum powder, for toilet use; tissues impregnated with cosmetic lotions; toilet water; non-medicated toiletry preparations; decorative transfers for cosmetic purposes; depilatory wax.

9 – Optical, measuring and life-saving apparatus and instruments; protective eyewear; footwear for protection against accidents, radiation and fire; motorcyclists' helmets; life belts, life jackets; anti-dazzle shades; anti-glare visors; clothing especially made for laboratories; clothing for protection against accidents, irradiation and fire; clothing for protection against fire; eyeglass cases; eyeglass chains; eyeglass cords; eyeglass frames; eyeglasses; gloves for protection against accidents; riding helmets; kneepads for workers; pince-nez; pince-nez cords; protection devices for personal use against accidents; protective helmets; protective helmets for sports; protective masks; safety restraints, other than for vehicle seats and sports equipment; shoes for protection against accidents, irradiation and fire; spectacle

glasses; time clocks [time recording devices]; time recording apparatus; workmen's protective face-shields.

35 – Sale by retail, wholesale, online and by mail order of clothing, sportswear, footwear, sports footwear, headgear, belts, perfumery, cosmetics, soaps, watches, spectacles, sunglasses, sports glasses, spectacle frames, spectacle cases, protective and safety clothing and footwear, protective helmets for sports, luggage, rucksacks, bags, holdalls for sports, bags for sporting articles, goods made from paper, stationery, gymnastic and sporting articles, footballs, shin pads, knee pads, gloves for sports, household and kitchen utensils and containers, woven and textile products, household linen, bedlinen, blankets, table linens.

(260) AM 2018 95112 A

(800) 1374216

(151) 2017 08 08

(891) 2017 08 08

(731) CHINA OCEANWIDE HOLDINGS GROUP COMPANY LIMITED

23rd Floor, Tower C, Minsheng Financial Center, No.28 Jianguomennei Avenue, Dongcheng District Beijing, China

(540)

泛海集团
OCEANWIDE GROUP

(591) Blue (C: 100% M: 50% Y: 25% K: 25%).

(531) 27.05.01; 28.03; 29.01.04

(526) group

(511)

4 – Petroleum, raw or refined; gasoline; petrol; coke; paraffin; candles, tapers; dust binding compositions for sweeping.

6 – Steel alloys; water-pipe valves of metal; doors of metal; steel wire; pegs of metal; door knockers of metal; padlocks; loading pallets of metal; statues of common metal.

16 – Paper; carbon paper; cards, charts; pictures; boxes of paper or cardboard; paper knives [cutters] [office requisites], paper cutters [office requisites], paper knives [office requisites]; stationery; blackboards; architects' models.

35 – Advertising agency services, publicity agency services; import-export agency services; relocation services for businesses; office machines and equipment rental; drawing up of statements of accounts.

36 – Rental of offices [real estate]; surety services; insurance brokerage; financial analysis; jewellery [jewelry (Am.)] appraisal, jewellery appraisal, jewel-

ry appraisal; rental of real estate; trusteeship, fiduciary; lending against security; antique appraisal.

39 – Transport; boat transport; car transport; car rental; courier services [messages or merchandise]; arranging of travel tours; delivery of goods by mail order; rental of motor racing cars; travel reservation.

41 – Academies [education]; arranging and conducting of conferences; mobile library services, book-mobile services; publication of books; entertainer services; modelling for artists; religious education; organization of shows [impresario services]; rental of audio equipment; film production, other than advertising films; photography.

42 – Scientific research; engineering; construction drafting; design of interior decor; computer programming; authenticating works of art.

43 – Restaurant services; accommodation bureau services [hotels, boarding houses]; cafe services; cafeteria services; canteen services; hotel services; bar services; rental of meeting rooms.

44 – Beauty salon services; gardening; Turkish bath services; sauna services; plant nursery services; flower arranging; lawn care; tree surgery; weed killing; landscape design.

(260) AM 2018 95115 A

(800) 1374230

(151) 2016 12 27

(891) 2016 12 27

(731) KARACA ZÜCCACIYE TİCARET VE
SANAYİ ANONİM ŞİRKETİ
Yakuplu Merkez Mah. Birlik, Cad. No:24
Büyükcemece İstanbul, Turkey

(540)

Fine Pearl

(591) Red

(531) 29.01.01

(511)

8 – Forks, spoons, knives and non-electric cutters, slicers, peelers for kitchen use, including those made of precious metals; side arms and blades (weapons); tools and apparatus included in this class for personal beauty care use: tools and apparatus included in this class for shaving, epilation, manicure and pedicure, electric hand implements for straightening and curling hair, scissors; hand-operated [non-electric] hand tools included in this class for the repair of machines, apparatus and vehicles and for use in construction, agriculture, horticultural and forestry, none of them being power tools; electric or non-electric irons; steam irons.

11 – Lighting installations; lights for vehicles and interior-exterior spaces; heating installations using solid, liquid or gas fuels or electricity, central hea-

ting boilers, boilers for heating installations, radiators [heating], heat exchangers, not parts of machines, stoves, kitchen stoves, solar thermal collectors [heating]; steam and fog generators, steam boilers, other than parts of machines, acetylene generators, oxygen generators, nitrogen generators; installations for air-conditioning and ventilating; cooling installations and freezers; electric and gas-powered devices, installations and apparatus for cooking, drying and boiling: cookers, electric cooking pots, electric water heaters, barbecues, electric laundry driers; hair driers; hand drying apparatus; sanitary installations, taps [faucets], shower installations, toilets [water-closets], shower cubicles, bath tubs, toilet seats, sinks, wash-hand basins [parts of sanitary installations]; water softening apparatus; water purification apparatus; water purification installations; waste water purification installations; electric bed warmers and electric blankets, not for medical use; electric pillow warmers; electric or non-electric footwarmers; hot water bottles; filters for aquariums and aquarium filtration apparatus; industrial type installations for cooking, drying and cooling purposes; pasteurizers and sterilizers.

21 – Hand-operated non-electric cleaning instruments and appliances, brushes, other than paintbrushes, steel chips for cleaning, sponges for cleaning, steel wool for cleaning, cloths of textile for cleaning, gloves for dishwashing, non-electric polishing machines for household purposes, brooms for carpets, mops; toothbrushes, electric toothbrushes, dental floss, shaving brushes, hair brushes, combs; non-electric household or kitchen utensils, included in this class, [other than forks, knives, spoons], services [dishes], pots and pans, bottle openers, flower pots, drinking straws, non-electric cooking utensils; ironing boards and shaped covers therefor, drying racks for washing, clothes drying hangers; cages for household pets, indoor aquariums, vivariums and indoor terrariums for animals and plant cultivation; ornaments and decorative goods of glass, porcelain or earthenware, included in this class, namely statues, figurines and vases, all made of glass, porcelain or earthenware; mouse traps, insect traps, electric devices for attracting and killing flies and insects, fly catchers, fly swatters; perfume burners, perfume sprayers, perfume vaporizers, electric or non-electric make-up removing appliances, powder puffs, toilet cases; nozzles for sprinkler hose, nozzles for watering cans, watering devices, garden watering cans; unworked or semi-worked glass, except building glass, mosaics of glass and powdered glass for decoration, except for building, glass wool other than for insulation or textile use.

(260) AM 2018 95116 A

(800) 1374282

(151) 2017 03 08

(891) 2017 03 08
 (731) FURNA AYAKKABI SANAYİ TİCARET
 LİMİTED ŞİRKETİ
 Mehmet Nesih Özmen Mah. Zakkum Sok.
 Timaş Hani, No:6 K:3 Güngören İstanbul,
 Turkey

(540)



SASHA LOTTINI

(591) Black, white

(531) 05.13.08; 24.17.09; 27.05.17

(511)

25 – Clothing, including underwear and outerclot-
 hing, other than special purpose protective clothing;
 socks, mufflers [clothing], shawls, bandanas, scar-
 ves, belts [clothing], footwear, shoes, slippers, san-
 dals, headgear, hats, caps with visors, berets, caps
 [headwear], skull caps.

35 – Advertising, marketing and public relations, or-
 ganization of exhibitions and trade fairs for commer-
 cial or advertising purposes, office functions, secre-
 tarial services, arranging newspaper subscriptions
 for others, compilation of statistics, rental of office
 machines, systemization of information into compu-
 ter databases, telephone answering for unavailable
 subscribers, business management, business admi-
 nistration and business consultancy, accounting, co-
 mmercial consultancy services, personnel recruit-
 ment, personnel placement, employment agencies,
 import-export agencies, temporary personnel place-
 ment services, auctioneering, the bringing together,
 for the benefit of others, of unworked or semi-wor-
 ked leather and animal skins, imitations of leather,
 stout leather, leather used for linings, goods made of
 leather, imitations of leather or other materials, na-
 mely caryying cases, bags, wallets, boxes and trunks
 made of leather or stout leather, keycases, trunks
 [luggage], suitcases, umbrellas, parasols, sun umbre-
 llas, walking sticks, whips, harness, saddlery, stir-
 rups, straps of leather (saddlery) clothing, including
 underwear and outerclotting, other than special pur-
 pose protective clothing, socks, mufflers [clothing],
 shawls, bandanas, scarves, belts [clothing], footwear,
 shoes, slippers, sandals, headgear, hats, caps with
 visors, berets, caps [headwear], skull caps enabling
 customers to conveniently view and purchase those
 goods, such services may be provided by retail stor-
 es, wholesale outlets, by means of electronic media
 or through mail order catalogues.

(260) AM 2018 95117 A

(800) 1374283

(151) 2017 04 19

(891) 2017 04 19

(731) TEXMART INTERNET PAZARLAMA
 ANONİM SİRKETİ
 Çobançesme Mh. Kimiz Sk. No:40/21
 Yenibosna Bahçelievler İstanbul, Turkey

(540)

texmart

(591) Black, white

(511)

35 – Advertising; business management; business
 administration; the bringing together, for the benefit
 of others, precious metals and their alloys, jewellery,
 precious and semi- precious stones, horological and
 chronometric instruments, unworked or semi-wor-
 ked leather and animal skins, imitations of leather,
 stout leather, leather used for linings, goods made of
 leather, imitations of leather or other materials desig-
 ned for carrying items, namely, bags, all purpose
 carrying bags, all purpose sport bags, articles of lug-
 gage being bags, baggage, briefcases, valises, back-
 packs, suitcases and trunks, purses, wallets, key ca-
 ses, umbrellas, parasols, sun umbrellas, walking
 sticks, whips, harness, saddlery, stirrups, straps of
 leather (saddlery), woven or non-woven textile fab-
 rics, textile goods for household use, curtains, bed
 covers, sheets (textile), pillowcases, blankets, quilts,
 towels, flags, pennants, labels of textile, swaddling
 blankets, clothing, including underwear and outer
 clothing, other than special purpose protective clot-
 hing, socks, mufflers [clothing], shawls, bandanas,
 scarves, bells [clothing], footwear, shoes, slippers,
 sandals, headgear, hats, caps with visors, berets, caps
 [headwear], skull caps, enabling customers to conve-
 niently view and purchase those goods, such services
 may be provided by retail stores, wholesale outlets,
 through mail order catalogues or by means of el-
 ectronic media, for example, through web sites or
 television shopping programmes.

(260) AM 2018 95153 A

(800) 1375359

(151) 2017 08 01

(891) 2017 08 01

(731) S.C. JOHNSON & SON, INC

1525 Howe Street, Racine Wisconsin WI

53403-2236, USA

(540)

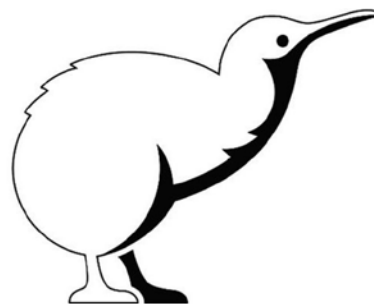

(591) Black, white

(531) 03.07.18

(511)

1 – Waterproofing chemical products for footwear, leather or textiles; adhesives (adhesive materials) for repairing footwear, rainwear and other surfaces of leather, rubber, nylon, plastic, canvas, linen or vinyl; chemical compositions for softening, stretching footwear.

2 – Colorants, dyes, mordants and inks for footwear and goods of leather.

3 – Cleaning, polishing, degreasing and abrasive preparations; color polishes, creams and waxes for footwear and goods of leather; preservatives for leather (polishes); dry chemical preparations in the form of tablets for cleaning and other preparations for cleaning leather, suede, vinyl, plastic and products made of these materials; preparations for erasing, masking scuff marks on leather and vinyl products; oil for the protection of feet against fissures, cracks (not for medical use); polishes and creams for footwear and goods of leather, including for covering, masking scuff marks; preservatives for footwear and goods of leather (polishes); wipes (tissues) impregnated with preparations for shining, waxing, polishing.

5 – Anti-fungal preparation for feet in spray form; deodorants for footwear.

21 – Shoe horns and shoe trees (stretchers); polishing cloths and sponges; cloths for shining, waxing, polishing; shoe brushes.

25 – Non-slipping devices for footwear; anti-skid soles and insoles for footwear; soles, inner soles and pads (soles) for footwear; heels and heelpieces for footwear; heel plates for footwear, heel pads for footwear, heels and stocking protectors (socks) for stockings and tights; socks, stockings and tights.

26 – Shoe laces.

(260) AM 2018 95154 A

(800) 1375363

(151) 2017 08 31

(891) 2017 08 31

(731) PHILIP MORRIS PRODUCTS S.A.

Quai Jeanrenaud 3 CH-2000 Neuchâtel,
Switzerland

(540)

EZE

(591) Black, white

(511)

9 – Batteries for electronic cigarettes; batteries for electronic devices that are used for heating tobacco, chargers for electronic devices that are used for heating tobacco; USB chargers for electronic devices

that are used for heating tobacco; car chargers for electronic cigarettes; car chargers for devices that are used for heating tobacco; battery chargers for electronic cigarettes.

11 – Electronic vaporizers except electronic cigarettes; apparatus for heating liquids; apparatus for generating vapor.

34 – Wired vaporizers for electronic cigarettes and electronic smoking devices; tobacco, raw or manufactured; tobacco products, including cigars, cigarettes, cigarillos, tobacco for roll-your-own cigarettes, pipe tobacco, chewing tobacco, snuff tobacco, kretek; snus; tobacco substitutes (not for medical purposes); smokers' articles, including cigarette paper and tubes, cigarette filters, tobacco tins, cigarette cases and ashtrays, pipes, pocket apparatus for rolling cigarettes, lighters; matches; tobacco sticks, tobacco products for the purpose of being heated, electronic devices and their parts for the purpose of heating cigarettes or tobacco in order to release nicotine-containing aerosol for inhalation; liquid nicotine solutions for use in electronic cigarettes; electronic smoking devices; electronic cigarettes; electronic cigarettes as substitute for traditional cigarettes; electronic devices for the inhalation of nicotine containing aerosol; oral vaporizing devices for use by smokers, tobacco products and tobacco substitutes; smokers' articles for electronic cigarettes; parts and fittings for the aforesaid products included in this class; devices for extinguishing heated cigarettes and cigars as well as heated tobacco sticks; electronic rechargeable cigarette cases.

(260) AM 2018 95155 A

(800) 1375364

(151) 2017 08 31

(891) 2017 08 31

(731) PHILIP MORRIS PRODUCTS S.A.

Quai Jeanrenaud 3, CH-2000 Neuchâtel,
Switzerland

(540)



(591) Black, white

(531) 26.11.08; 27.01.01

(511)

9 – Batteries for electronic cigarettes; batteries for electronic devices that are used for heating tobacco, chargers for electronic devices that are used for heating tobacco; USB chargers for electronic devices that are used for heating tobacco; car chargers for electronic cigarettes; car chargers for devices that are used for heating tobacco; battery chargers for electronic cigarettes.

11 – Electronic vaporizers except electronic cigarettes; apparatus for heating liquids; apparatus for generating vapor.

34 – Wired vaporizers for electronic cigarettes and electronic smoking devices; tobacco, raw or manufactured; tobacco products, including cigars, cigarettes, cigarillos, tobacco for roll-your-own cigarettes, pipe tobacco, chewing tobacco, snuff tobacco, kretek; snus; tobacco substitutes (not for medical purposes); smokers' articles, including cigarette paper and tubes, cigarette filters, tobacco tins, cigarette cases and ashtrays, pipes, pocket apparatus for rolling cigarettes, lighters; matches; tobacco sticks, tobacco products for the purpose of being heated, electronic devices and their parts for the purpose of heating cigarettes or tobacco in order to release nicotine-containing aerosol for inhalation; liquid nicotine solutions for use in electronic cigarettes; electronic smoking devices; electronic cigarettes; electronic cigarettes as substitute for traditional cigarettes; electronic devices for the inhalation of nicotine-containing aerosol; oral vaporizing devices for use by smokers, tobacco products and tobacco substitutes; smokers' articles for electronic cigarettes; parts and fittings for the aforesaid products included in this class; devices for extinguishing heated cigarettes and cigars as well as heated tobacco sticks; electronic rechargeable cigarette cases.

(260) AM 2018 95156 A
(800) 1375365
(151) 2017 08 31
(891) 2017 08 31
(731) PHILIP MORRIS PRODUCTS S.A.
Quai Jeanrenaud 3 CH-2000 Neuchâtel,
Switzerland

(540)



(591) Black, white
(531) 26.11.08; 27.01.01
(511)

9 – Batteries for electronic cigarettes; batteries for electronic devices that are used for heating tobacco, chargers for electronic devices that are used for heating tobacco; USB chargers for electronic devices that are used for heating tobacco; car chargers for electronic cigarettes; car chargers for devices that are used for heating tobacco; battery chargers for electronic cigarettes.

11 – Electronic vaporizers except electronic cigarettes; apparatus for heating liquids; apparatus for generating vapor.

34 – Wired vaporizers for electronic cigarettes and electronic smoking devices; tobacco, raw or manufactured; tobacco products, including cigars, cigarettes, cigarillos, tobacco for roll-your-own cigarettes, pipe tobacco, chewing tobacco, snuff tobacco, kretek; snus; tobacco substitutes (not for medical purposes); smokers' articles, including cigarette paper and tubes, cigarette filters, tobacco tins, cigarette cases and ashtrays, pipes, pocket apparatus for rolling cigarettes, lighters; matches; tobacco sticks, tobacco products for the purpose of being heated, electronic devices and their parts for the purpose of heating cigarettes or tobacco in order to release nicotine-containing aerosol for inhalation; liquid nicotine solutions for use in electronic cigarettes; electronic smoking devices; electronic cigarettes; electronic cigarettes as substitute for traditional cigarettes; electronic devices for the inhalation of nicotine-containing aerosol; oral vaporizing devices for use by smokers, tobacco products and tobacco substitutes; smokers' articles for electronic cigarettes; parts and fittings for the aforesaid products included in this class; devices for extinguishing heated cigarettes and cigars as well as heated tobacco sticks; electronic rechargeable cigarette cases.

(260) AM 2018 95158 A
(800) 1375368
(151) 2017 09 11
(891) 2017 09 11
(731) STRATPHARMA AG
Centralbahnplatz 8, CH-4051 Basel,
Switzerland
(540)

STRATACEL

(591) Black, white
(511)
5 – Pharmaceutical preparations for skin care.

(260) AM 2018 95159 A
(800) 1375425
(151) 2017 02 07
(891) 2017 02 07
(731) HUNAN SUNNY HYDRO-POWER
EQUIPMENT CORPORATION
Shanli Industry Park, Daxing West Road,
Jinshi Town, Xinning County, Shaoyang
City, 422799 Hunan Province, China
(540)



(591) Black, white
(531) 25.05.01; 26.01.16; 26.11.13; 26.13.25; 28.03

(511)
7 – Hydraulic generator and motors; hydraulic turbines; waterpower dynamical facility (term considered too vague by the International Bureau – rule 13(2)(b) of the Common Regulations).

(260) AM 2018 95160 A
(800) 1375478
(151) 2017 05 19
(891) 2017 05 19
(731) MERCK KGAA
Frankfurter Str. 250, 64293 Darmstadt,
Germany

(540)

ADVEVA

(591) Black, white
(511)
9 – Scientific, measuring, signaling and control apparatus and instruments; computer software; mobile medical apps and web applications (software) to support patients with chronic diseases; mobile medical apps; computer software platforms; digital telephone platforms; information software platforms on the Internet; electronic publications.

16 – Paper, paperboard; printed matter; photographs; stationery and office requisites, except furniture; instructional and teaching materials.

38 – Providing access to platforms and portals on the Internet; electronic communication by means of chatrooms, chat lines and Internet forums.

41 – Education, teaching and training; publishing of medical publications; providing of electronic publications (not downloadable); conducting courses, seminars and workshops; organization and conducting of conferences, congresses and symposiums; publishing of medical magazines, books and manuals.

44 – Medical services; health and beauty care for people; medical consultancy and care services; information and advice on health.

(260) AM 2018 95161 A
(800) 1375486
(151) 2017 04 10
(891) 2017 04 10
(731) ELENA ANATOLYEVNA FEDOROVA
Pulkovskoe sh., d. 13, korp. 2, kv. 45,
RU-196240 Saint-Petersburg, Russian
Federation

(540)



(591) Black, white
(531) 03.07.16; 03.07.17
(511)
18 – Pocket wallets; purses; leather straps; rucksacks; handbags; bags for sports; bags for campers; shopping bags.

25 – Clothing, footwear, headgear, including underwear; trousers; neckties; gaiters; sports jerseys; hosiery; tights; suits; jackets [clothing]; leggings [trousers]; mittens; socks; sports shoes; overcoats; dresses; sweaters; shirts; underpants; tee-shirts; dressing gowns; caps [headwear]; skirts.

(260) AM 2018 95162 A
(800) 1375487
(151) 2017 05 04
(891) 2017 05 04
(731) VERWOOD TRADING LIMITED
Poseidonos 1, Ledra Business Centre, Egkomi,
CY-2406 Nicosia, Cyprus

(540)

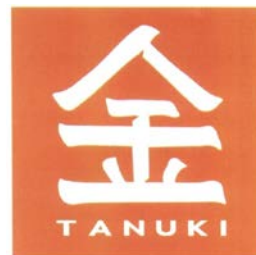

(591) Orange, white.
(531) 26.04.24; 27.05.24; 28.03; 29.01.12
(511)

35 – Procurement services for others [purchasing goods and services for other businesses]; business management assistance in the operation of restaurants.

41 – Entertainer services rendered in restaurants; production of shows; nightclubs; discotheque services.

43 – Restaurants; self-service restaurants; cafes; snack-bars; bars.

(260) AM 2018 95163 A
(800) 1375540
(151) 2017 07 11
(891) 2017 07 11
(731) STADA Arzneimittel AG
Stadastraße 2-18, 61118 Bad Vilbel, Germany

(540)



(591) Red (Pantone Rubin Red) and white.

(531) 26.11.12; 29.01.01

(511)

3 – Laundry detergent; bleach; cleaning preparations; polish; degreaser; abrasives; soaps; perfumery; essential oils; preparations for body and beauty care; hair lotions; dentifrice.

5 – Pharmaceutical products; veterinary preparations; sanitary preparations for medical purposes; dietetic foods and substances adapted for medical or veterinary purposes; food for babies; nutritional supplements for humans; food supplements for animals; adhesive band for medical use; dressings; tooth fillings; impression materials for dental purposes; disinfectants; preparations for destroying vermin; fungicides; herbicides.

10 – Surgical, medical, dental or veterinary instruments and appliances; diagnostic apparatus for medical purposes; artificial limbs; artificial eyes; artificial teeth; orthopedic appliances; surgical suture.

35 – Advertising; business management; business administration; office functions; wholesale and retail services relating to washing and bleaching preparations, cleaning, polishing, scouring and abrasive preparations, soaps, perfumery, essential oils, cosmetics, hair lotions, dentifrices, pharmaceutical and veterinary preparations, sanitary preparations for medical purposes, medicines, dietary foods and products for medical or veterinary purposes, food for babies, food supplements for humans and animals, diagnostic preparations for medical purposes, plasters, materials for dressings, tooth fillings and dental impression materials for dental purposes, disinfectants, preparations for destroying vermin, fungicides, herbicides, surgical, medical, dental and veterinary instruments and apparatus, diagnostic apparatus for medical purposes, artificial limbs, eyes and teeth, orthopedic articles, suture materials, printed matter, instructional and teaching materials [except apparatus].

(260) AM 2018 95164 A

(800) 1375613

(151) 2017 08 30

(891) 2017 08 30

(731) CELGENE CORPORATION

86 Morris Avenue, Summit NJ 07901, USA

(540)

IMID FOUNDATION

(591) Black, white

(511)

5 – Pharmaceutical preparations for use in the treatment of cancer and immune related diseases; pharmaceutical preparations, namely, cytokine inhibitory drugs; pharmaceutical preparations that modulate the immune system.

42 – Development and testing services in the fields of biotechnology, chemistry and pharmaceuticals; scientific study and research in the fields of the prevention, treatment and management of illness, health care delivery and the scientific aspects of health care policy, health care cost management and financing as these fields impact on quality of health care; research in the fields of chemicals and pharmaceuticals; research and testing services in the fields of chemicals and pharmaceuticals; research and development of new products for others in the fields of chemicals and pharmaceuticals; providing clinical laboratory testing services for medical and scientific research and development purposes, namely, pharmacogenetic testing, predictive medical testing, personalized medical testing, gene sequencing-based testing and genotyping based on the assessment, development and application of genomic discoveries in the pharmaceutical, informatics and clinical diagnostic industries; scientific research services; scientific research, namely, development of pharmaceuticals or diagnostic methods for others.

44 – Providing on-line information in the field of diagnosis and treatment of cancer; providing information relating to diagnosis and treatment of cancer, via an on-line computer database; provision of information about the diagnosis and treatment of cancer, via websites; providing medical and pharmaceutical information services; providing medical information and pharmaceutical information services, namely, providing information relating to diagnostic, prophylactic and therapeutic properties of pharmaceuticals; providing medical information, via an interactive website that enables users to enter, access, track, monitor and generate health and medical information and reports; providing pharmacogenetic testing, predictive medical testing, personalized medical testing, gene sequencing-based testing and genotyping, all for medical diagnostic and treatment purposes, based on the assessment, development and application of genomic discoveries in the pharmaceutical, informatics and clinical diagnostic industries.

(260) AM 2018 95190 A

(800) 1375750

(151) 2017 10 01

(891) 2017 10 01

(731) AGILENT TECHNOLOGIES, INC.

5301 Stevens Creek Boulevard, Santa Clara
CA 95051, USA

(540)

AGILENT

(591) Black, white

(511)

44 – Medical services in the nature of medical analysis and diagnosis; genetic analysis and reporting services for medical purposes; nucleic acid sequencing

and analysis services for medical purposes; genome sequencing and analysis services for medical purposes; DNA screening for medical purposes; providing information in the field of DNA sequencing and genomics for medical purposes; consultation in the field of medicine, health and pharmaceuticals; medical testing for diagnostic purposes in the field of human cancer; DNA and polynucleic acid testing services for medical diagnostic services; conducting medical tests to diagnose diseases.

(260) AM 2018 95191 A
 (800) 1375765
 (151) 2017 10 03
 (891) 2017 10 03
 (731) RCHAIN COOPERATIVE
 12345 Lake City Way NE, N2032 Seattle
 WA 98125, USA
 (540)

RCHAIN

(591) Black, white
 (511)
 42 – Design and development of computer software for decentralized computing using blockchain technology.

(260) AM 2018 95193 A
 (800) 1160961
 (151) 2013 03 21
 (891) 2017 10 31
 (731) CASEN RECORDATI, S.L.
 Autovía Logroño, Km. 13,30, E-50180
 UTEBO (Zaragoza), Spain
 (540)

PAIDOLAX

(591) Black, white
 (511)
 5 – Pharmaceutical, veterinary and sanitary products; dietetic substances adapted for medical use, food for babies; plasters, materials for dressings; material for dental fillings and dental impressions; disinfectants; pesticides; fungicides, herbicides.

10 – Pharmaceutical, veterinary and sanitary products; dietetic substances adapted for medical use, food for babies; plasters, materials for dressings; material for dental fillings and dental impressions; disinfectants; pesticides; fungicides, herbicides.

(260) AM 2018 95194 A
 (800) 1174547
 (151) 2013 08 07
 (891) 2017 10 20
 (731) YIWU LIMA KNITTING CO., LTD.
 No.256 Zhuyang Road, Niansanli Industrial

Park, Yiwu, 322000 Zhejiang, China
 (540)

LIMAX

(591) Black, white
 (531) 27.05.01; 27.05.17
 (511)
 25 – Clothing; underwear; layette; bathing suits; shoes; hats; hosiery; gloves [clothing]; scarfs; leather belts [clothing].

(260) AM 2018 95195 A
 (800) 1179434
 (151) 2013 09 13
 (891) 2017 10 30
 (731) CHUGAI SEIYAKU KABUSHUKI KAISHA
 5-1, Ukima 5-chome, Kita-ku, Tokyo, Japan
 (540)

ENSPRYNG

(591) Black, white
 (511)
 5 – Pharmaceuticals.

(260) AM 2018 95196 A
 (800) 1199746
 (151) 2014 01 23
 (891) 2017 09 07
 (731) MITSUI CHEMICALS AGRO, INC.
 1-19-1, Nihonbashi, Chuo-ku, Tokyo
 103-0027, Japan
 (540)

STARKLE

(591) Black, white
 (511)
 5 – Preparations for killing weeds and destroying vermin; insecticides; pesticides; vermicides; fungicides; herbicides; germicides.

(260) AM 2018 95225 A
 (800) 1374808
 (151) 2017 09 18
 (891) 2017 09 18
 (731) APPLE INC.
 One Apple Park Way, Cupertino CA 95014,
 USA
 (540)

Super Retina

(591) Black, white
 (511)
 9 – Computers; electronic display screens and electronic display interfaces; handheld mobile digital devices used as a telephone, handheld computer, media player, and personal digital assistant and used to access the Internet, electronic mail, and digital audio,

video, and data; smartphones; smartwatches; wearable computers; wearable computer peripherals.

(260) AM 2018 95226 A

(800) 1374846

(151) 2017 07 10

(891) 2017 07 10

(731) LODESTAR ANSTALT

Lova-Center, P.O. Box 1150 FL-9490

Vaduz, Liechtenstein

(540)

METAL GURU

(591) Black, white

(511)

9 – Scientific, nautical, surveying, photographic, cinematographic, optical, weighing, measuring, signalling, checking (supervision), life-saving and teaching apparatus and instruments; apparatus and instruments for conducting, switching, transforming, accumulating, regulating or controlling electricity; apparatus for recording, transmission or reproduction of sound or images; magnetic data carriers, recording discs; mechanisms for coin-operated apparatus; cash registers, calculating machines, data processing equipment and computers; fire-extinguishing apparatus.

14 – Precious metals and their alloys and watches made of precious metals or coated therewith; jewellery, precious stones; horological and chronometric instruments.

32 – Beers; mineral and aerated waters and other non-alcoholic drinks; fruit drinks and fruit juices; syrups and other preparations for making beverages.

(260) AM 2018 95228 A

(800) 1374850

(151) 2017 09 15

(891) 2017 09 15

(731) APPLE INC.

One Apple Park Way, Cupertino CA 95014,

USA

(540)



Clips

(591) White, blue, and purple

(531) 16.03.01; 16.03.11; 26.01.16; 26.04.01;

26.04.04; 26.04.10; 29.01.13

(511)

9 – Computer software for use in creating, editing, importing, exporting, and sharing video and multimedia content, adding animation, graphics, music, sound effects, and special effects to video and multimedia content, and posting video and multimedia content to websites and social media platforms.

(260) AM 2018 95229 A

(800) 1374974

(151) 2017 06 14

(891) 2016 06 14

(731) LIXIL Group Corporation

2-1-1, Ojima, Koto-ku, Tokyo 136-8535,

Japan

(540)

(591) red

(531) 27.05.01; 27.05.17; 29.01.01

(511)

6 – Metal materials for building or construction; sashes of metal; doors of metal; curtain walls of metal; shutters of metal; siding materials of metal; bicycle parking installations of metal; prefabricated building assembly kits of metal; metal hardware (not including "security locks, keys for locks, ring of metal for keys and padlocks"); security locks; keys for locks; rings of metal for keys; padlocks; metal hardware; drain outlet of metal for construction purposes; wire nets and gauzes; metal nameplates and door nameplates; metal stepladders and ladders; letter boxes of metal; hat-hanging hooks of metal; water tanks of metal for household purposes; towel dispensers of metal; metal joinery fittings; safes; transportable greenhouses of metal for household use; sculptures of metal; outdoor blinds of metal; metal fittings for parking bicycles; metal installations for parking bicycles; shoe dowels of metal; shoe pegs of metal; hobnails of metal.

9 – Mechanisms for coin-operated car parking gates; power locks for motor vehicles; fire extinguishers; fire hoses; fire hose nozzles; sprinkler systems for fire protection; fire alarms; gas alarms; anti-theft warning apparatus; crime prevention alarm apparatus and devices for residential use; alarms; measuring or testing machines and instruments; power distribution or control machines and apparatus; rotary converters; phase modifiers; solar batteries; batteries and cells; telecommunication machines and apparatus; electronic machines (not including geiger counters, high frequency apparatus for welding, cyclotrons (not for medical purposes), industrial x-ray machines and apparatus (not for medical use), Industrial betatrons (not for medical use), magnetic prospecting machines, magnetic object detectors, seismic

exploration machines and apparatus, hydrophone machines and apparatus, echo sounders, ultrasonic flaw detectors, ultrasonic sensors, electronic door closing control systems and electron microscopes); electron tubes; semi-conductor elements; electronic circuits (not including those recorded with computer programs); computer programs; geiger counters; cyclotrons (not for medical purposes); industrial x-ray machines and apparatus (not for medical use); industrial betatrons (not for medical use); magnetic prospecting machines; magnetic object detectors; seismic exploration machines and apparatus; hydrophone machines and apparatus; echo sounders; ultrasonic flaw detectors; ultrasonic sensors; electronic door closing control systems; electron microscopes; electronic machines, apparatus and their parts; dust masks; gas masks; welding masks; gloves for protection against accidents; electronic publications; optical glass; electric buzzers; electronic lock assemblies; electric locks.

11 – Toilet bowls and seats sold as a unit; prefabricated bathroom installations for sanitary purposes; cooking apparatus and installations for commercial use; industrial dish drying machines for industrial purposes; dish disinfectant apparatus for industrial purposes; tap water faucets; level controlling valves for tanks; pipe line cocks; flushing apparatus for toilets, namely level controlling valves being parts for sanitary installations; waste water treatment tanks (for industrial purposes); septic tanks (for industrial purposes); garbage incinerators for industrial purposes; garbage incinerators for household purposes; garbage incinerators; solar water heaters; electric lamps and other lighting apparatus; household electrothermic appliances (other than for beauty or sanitary purposes); household electrothermic appliances for beauty or sanitary purposes; hand drying apparatus for washrooms; household electrothermic appliances; washers for water taps; gas water heaters (for household purposes); non-electric cooking heaters (for household purposes); kitchen worktops with integrated sinks; kitchen sinks; kitchen worktops with integrated sinks for kitchen unit; kitchen sinks for kitchen unit; household tap-water filters; waste water treatment tanks for household purposes; septic tanks for household purposes; toilet stool units with a washing water squirter; disinfectant dispensers for toilets; toilet bowls; toilet seats for use with Japanese style toilet bowls; toilet stool units with an automatic washing water squirter (put-in type); bath fittings; shower heads; bath tubs; stoves for household purposes (non-electric); charcoal heating apparatus for household purposes (hibachi).

19 – Ceramic building materials, bricks and refractory products; ceramic tiles; building materials made of linoleum for fixing to existing walls or floors; plastic building materials; synthetic building materials; asphalt, and asphalt building or construction

materials; rubber building or construction materials; plaster (for building purposes); lime building or construction materials; building or construction materials of plaster; rockslide retention nets of textile (construction materials); shutters of non combustible woven fabric; building materials made of non combustible woven fabric; bicycle parking installations, not of metal; buildings, not of metal; cement and its products; siding materials of ceramic based cement; building timber; building stone; building glass; letter boxes of masonry; joinery fittings (not of metal); transportable greenhouses (not of metal) for household use; stone sculptures; concrete sculptures; marble sculptures; building boards and glass powder for building purposes; plaster boards; slag; non-metallic minerals for building or construction; bicycle parking apparatus, not of metal.

20 – Curtain fittings; metal-substitute plastic fasteners; nails, wedges, nuts, screws, tacks, bolts, rivets and casters (not of metal); washers (not of metal, not of rubber or vulcanized fiber); locks (non-electric, not of metal); nameplates and door nameplates (not of metal); step ladders and ladders (not of metal); letter boxes (not of metal or masonry); hat hooks (not of metal); water tanks for household purposes (not of metal or masonry); towel dispensers (not of metal); furniture; indoor window blinds (shade) (furniture); blinds of reed, rattan or bamboo (sudare); bead curtains for decoration; window shades; benches; plaster sculptures; plastic sculptures; wooden sculptures; wind chimes; shoe dowels, not of metal; shoe pegs, not of metal; hobnails, not of metal.

22 – Cotton waddings for clothes; hammocks; cotton batting for futon; knitted cords; sanada-himo (Japanese-style cords); starched cords; twisted cords; cordage; netting (not of metal); industrial packaging containers of textile; elastic bands for binding; tarpaulins (not for ships); tents (not for camping); awnings.

35 – Advertising and publicity services; information services relating to advertising; provision of space on the internet home pages for advertising goods and services; arranging and conducting of merchandising display in the showrooms and business administration services for merchandising exhibitions and displays; providing information about promoting sweepstakes for advertising or sales promotion; promoting the goods and services of others through the administration of sales and promotional incentive schemes involving trading stamps; issue, administration and redemption of trading stamps, coupons, loyalty rewards card and privileged user cards and providing information thereof; issue, administration and redemption of coupons or points for promoting and marketing the goods and services and providing information thereof; providing information via the internet about accumulation, tabulation, administration and redemption of points for promoting and

marketing the goods and services; issue and redemption of privilege points (stored and managed as electronic data) for promoting and marketing the goods and services; business management analysis or business consultancy; marketing research or analysis; providing information concerning commercial sales; business management of hotels; promoting the goods of others; business merchandising exhibitions and display services; telemarketing; providing information about retail premises; providing information about commercial transaction performances; providing business information; business information for enterprises; providing commercial information; providing economic information; arranging and brokerage of contracts for the buying and selling of goods; providing information about executives in a corporation and personnel; preparation of financial statements; employment agencies; import-export agencies; shorthand services; transcription; document reproduction; office functions, namely filing, in particular documents or magnetic tape; compilation of information into computer databases; providing business assistance to others in the operation of data processing apparatus namely, computers, typewriters, telex machines and other similar office machines; reception services for visitors in buildings; telephone receptionist services; initiating telephone calls for others; telephone receptionist services; telephone operator services [office functions]; publicity material rental; rental of typewriters, copying machines and word processors; retail services or wholesale services for woven fabrics and beddings; retail services or wholesale services for clothing; retail services or wholesale services for footwear (other than special footwear for sports); retail services or wholesale services for bags and pouches; retail services or wholesale services for personal articles; retail services or wholesale services for foods and beverages; retail services or wholesale services for holders for beverage can or bottle for automobiles; retail services or wholesale services for coin cases used inside an automobile; retail services or wholesale services for parts and fittings of automobiles; retail services or wholesale services for parts and fittings of two-wheeled motor vehicles; retail services or wholesale services for unicycles, bicycles and their parts and fittings; retail services or wholesale services for vessels and their parts and fittings; retail services or wholesale services for baby strollers, baby carriage (prams), sleighs and sleds (vehicles), wheelbarrows; retail services or wholesale services for adhesive rubber patches for repairing tubes or tires; retail services or wholesale services for primers and glazing putty for the painting and repair of automobile; retail services or wholesale services for chemical filling agents for repairing automobiles; retail services or wholesale services for paints for repairing automobiles; retail services or wholesale services for car decoration; retail services or wholesale servi-

ces for furniture; retail services or wholesale services for joinery fittings; retail services or wholesale services for tatami mats; retail services or wholesale services for floor coverings, window shades, indoor window blinds (shade) (furniture), curtains, table clothes (not of paper), wall hangings; retail services or wholesale services for flower vases, flower bowls and wind chimes; retail services or wholesale services for oriental single panel standing partition (tsu-itate), oriental folding partition screens (byobu); retail services or wholesale services for metal indoor ornaments; retail services or wholesale services for indoor ornaments of precious metal; retail services or wholesale services for indoor ornaments of wood, bamboo, porcelain, plastic, terra-cotta or glass; retail services or wholesale services for tarpaulins (not for ships), tents (not for camping), sunshades, Japanese reed screens (yoshizu); retail services or wholesale services for benches; retail services or wholesale services for stone lanterns; retail services or wholesale services for upright signboards and advertisement display boards; retail services or wholesale services for transportable greenhouses for household use; retail services or wholesale services for artificial turf; retail services or wholesale services for metal outdoor ornaments; retail services or wholesale services for outdoor ornaments of precious metal; retail services or wholesale services for outdoor ornaments of wood, bamboo, porcelain, stone, cement, plastic, terracotta, plaster or glass; retail services or wholesale services for arch trellis for outdoor decoration; retail services or wholesale services for ritual equipment; retail services or wholesale services for electrical machinery and apparatuses; retail services or wholesale services for edge tools (hand tools), hand tools, hardware; retail services or wholesale services for kitchen equipment, cleaning tools and washing utensils; retail services or wholesale services for bath fittings; retail services or wholesale services for nameplates and door nameplates; retail services or wholesale services for banners and flags, flagpoles; retail services or wholesale services for Chinese lanterns; retail services or wholesale services for gas lamps, oil lamps, lamp chimneys; retail services or wholesale services for candles; retail services or wholesale services for candle extinguishers, candle holders; retail services or wholesale services for warming pans (non-electric), pocket warmers (non-electric), hot water bottles (for warming one's feet in bed); retail services or wholesale services for apparatus for catching small animals or insects such as rat; retail services or wholesale services for step ladders and ladders; retail services or wholesale services for letter boxes; retail services or wholesale services for hat hooks; retail services or wholesale services for coat hangers; retail services or wholesale services for clothes brushes; retail services or wholesale services for electric lint removers; retail services or wholesale services for lint removers (non-

electric); retail services or wholesale services for hygienic hand towels of paper, towels of paper, table napkins of paper, hand towels of paper, handkerchiefs of paper; retail services or wholesale services for toilet stool units with a washing water squirter, disinfectant dispensers for toilets, toilet bowls, seating for use with Japanese style toilet bowls, chamber pots, toilet paper holders, toilet seat covers of textile, urinals (for medical purposes), bed pans; retail services or wholesale services for towel dispensers, boxes of metal for dispensing paper towels, soap dispensers; retail services or wholesale services for shopping baskets; retail services or wholesale services for piggy banks; retail services or wholesale services for heating or cooling packs filled with chemical substances ready to react when required; retail services or wholesale services for hanging boards (Japanese style pegboards using positional hooks); retail services or wholesale services for tool boxes; retail services or wholesale services for condensation-absorbing tapes; retail services or wholesale services for garbage incinerators for household purposes; retail services or wholesale services for water tanks for household purposes; retail services or wholesale services for needle-threaders, dressmakers' chalk sharpeners, paper patterns, tailors' chalk, embroidery frames, flat-iron-stands, tailors' sprayers, ironing boards (kotedai), marking boards for use with an impress blades (hera-dai), knitting sticks, sewing boxes, dressmakers' impressing blades, sewing thimbles, pin and needle cushions, needle cases; retail services or wholesale services for haberdashery, except thread; retail services or wholesale services for threads and yarns (for textile use); retail services or wholesale services for tapes (semifinished) and ribbons; retail services or wholesale services for knitted fabric; retail services or wholesale services for felt and non-woven textile fabrics; retail services or wholesale services for vinyl coated cloth; retail services or wholesale services for tufts and tassels (semi-finished); retail services or wholesale services for rubber cords and laces, leather straps, knitted cords and braids, twist braids, braids, cordage; retail services or wholesale services for netting (not of metal or asbestos); retail services or wholesale services for wire gauzes; retail services or wholesale services for artificial flowers (other than "artificial garlands and wreaths"); retail services or wholesale services for mannequins, costume display stands; retail services or wholesale services for pharmaceutical, veterinary and sanitary preparations; retail services or wholesale services for cosmetics, toiletries, dentifrices, soaps and detergents; retail services or wholesale services for chemicals for repairing automobile, and other chemicals; retail services or wholesale services for pastes and other adhesives; retail services or wholesale services for perfume and flavour materials; retail services or wholesale services for incenses and fragrances; retail ser-

vices or wholesale services for shoe black (shoe polish); retail services or wholesale services for polishing preparations; retail services or wholesale services for apparatus for therapeutic Shiatsu massage, and other medical machines and apparatus; retail services or wholesale services for agricultural machines, implements and supplies; retail services or wholesale services for lawn mowers, hedge trimmers, burners for agricultural harvesters; retail services or wholesale services for plastic sheeting for agricultural purposes; retail services or wholesale services for compost manufacturing machines for household use (non-electric); retail services or wholesale services for flowers (natural) and trees; retail services or wholesale services for flower pots, planters, dishes for flower pot, stakes for plants or trees, watering cans, water jugs for gardening; retail services or wholesale services for hand tools, bladed or pointed hand tools for horticulture, cultivation containers for domestic horticultural purposes, plastic films for horticultural purposes; retail services or wholesale services for hoses for water sprinkler; retail services or wholesale services for hose reels; retail services or wholesale services for nozzles for water sprinkler hose; retail services or wholesale services for sprinklers; retail services or wholesale services for sprayers for gardening and their parts and fittings; retail services or wholesale services for sprayers for disinfectant, insecticide, deodorizer (excluding those for agricultural use); retail services or wholesale services for plastic tanks for liquid such as water, drinking water, lamp oil and the like; retail services or wholesale services for oil fuel lubrication pumps for household use, water supply pumps and other pumps (not for specified purposes); retail services or wholesale services for fuel; retail services or wholesale services for printed matter; retail services or wholesale services for paper and stationery; retail services or wholesale services for paintings and calligraphic works, and picture frames; retail services or wholesale services for sculptures; retail services or wholesale services for insect collecting implements; retail services or wholesale services for printing inks (other than "mimeographing inks"); retail services or wholesale services for adhesive tape dispensers, automatic stamping machines, addressing machines, ink ribbons, automatic stamp affixing machines, electric staplers for offices, envelope sealing machines for offices, stamp obliterating machines, drawing instruments, typewriters, cash registers, coin counting or sorting machines, electric sign boards for displaying target figures, current outputs or the like, photo-copying machines, drawing or drafting instruments and apparatus, time and date stamping machines, time clocks (time recording devices), punched card office machines, voting machines, billing machines, postage stamp checking apparatus, check-writers, mimeographs, paper shredders (for office use), franking machines (stamping machines), lami-

nators for household or office use, rotary duplicators; retail services or wholesale services for sports goods; retail services or wholesale services for toys, dolls, game machines and apparatus; retail services or wholesale services for wax for skis; retail services or wholesale services for fishing tackle and fishing baits; retail services or wholesale services for apparatus for arcade games adapted for use with an external display screen or monitor and amusement machines and apparatus for use in amusement parks (other than arcade video game machines); retail services or wholesale services for musical instruments and records; retail services or wholesale services for recorded video discs and video tapes, photograph stands; retail services or wholesale services for photographic machines and apparatus, photographic supplies, and optical apparatus and instruments; retail services or wholesale services for laboratory apparatus and instruments; retail services or wholesale services for measuring or testing machines and instruments; retail services or wholesale services for clocks, watches and spectacles (eyeglasses and goggles); retail services or wholesale services for tobaccos and smokers' articles; retail services or wholesale services for matches; retail services or wholesale services for stained-glass windows and other building materials; retail services or wholesale services for ceramic glazings; retail services or wholesale services for pigments; retail services or wholesale services for paints; retail services or wholesale services for dyestuffs; retail services or wholesale services for semi-wrought precious stones and their imitations; retail services or wholesale services for pet animals, pet insects, aquarium fishes; retail services or wholesale services for pet food, feed for insects, bait for aquarium fishes; retail services or wholesale services for clothing, ornaments, collars, harness, lead, blankets, towels for domestic pets; retail services or wholesale services for storage bags for pet animal supplies; retail services or wholesale services for carry bags for pet animal transportation; retail services or wholesale services for furniture, houses, gauges, bird cages, mattresses, pillows, carpets, cushions for pets; retail services or wholesale services for storage furniture for pet animal supplies; retail services or wholesale services for toys and feeding vessels for pets; retail services or wholesale services for deodorizing sheets for pet animal toilet and deodorizing sand for pet animal toilet; retail services or wholesale services for indoor aquarium and their fittings; retail services or wholesale services for metalworking machines and tools; retail services or wholesale services for construction machines and apparatus and loading-unloading machines and apparatus; retail services or wholesale services for chemical processing machines and apparatus; retail services or wholesale services for knitting machines and other textile machines and apparatus; retail services or wholesale services for sewing ma-

chines; retail services or wholesale services for lumbering, woodworking, or veneer or plywood making machines and apparatus; retail services or wholesale services for printing or bookbinding machines and apparatus; retail services or wholesale services for leather tanning machines; retail services or wholesale services for painting machines and apparatus; retail services or wholesale services for kiln for calcination of crockery, pottery, cloisonné or clay for household use; retail services or wholesale services for burners for clay calcination for household use; retail services or wholesale services for kiln for calcination of crockery, pottery, cloisonné or clay for industrial use; retail services or wholesale services for burners for clay calcination for industrial use; retail services or wholesale services for power-operated potters' wheels; retail services or wholesale services for plastic processing machines and apparatus; retail services or wholesale services for machines and apparatus for manufacturing rubber goods; retail services or wholesale services for stone working machines and apparatus; retail services or wholesale services for non-electric prime movers, not for land vehicles; retail services or wholesale services for non-electric prime movers for land vehicles (not including "their parts"); retail services or wholesale services for pneumatic or hydraulic machines and instruments; retail services or wholesale services for airconditioning apparatus (for industrial purposes); retail services or wholesale services for freezing machines and apparatus; retail services or wholesale services for vending machines; retail services or wholesale services for cooking equipment and electric blenders for industrial purposes; retail services or wholesale services for vacuum cleaners and dust collectors for industrial purposes; retail services or wholesale services for fire extinguishers; retail services or wholesale services for fire alarms, gas alarms, anti-theft warning apparatus, crime-prevention alarms; retail services or wholesale services for protective helmets; retail services or wholesale services for vehicle breakdown warning triangles; retail services or wholesale services for curtain drawing devices electrically operated; retail services or wholesale services for bicycle parking apparatus; retail services or wholesale services for solar water heaters; retail services or wholesale services for water purifying apparatus; retail services or wholesale services for machine elements (not for land vehicles); retail services or wholesale services for machine elements for land vehicles; retail services or wholesale services for paper (for wrapping); retail services or wholesale services for elastic bands for offices, elastic bands for binding; retail services or wholesale services for industrial packaging containers of metal (not including "metal stoppers, lids and caps"); retail services or wholesale services for industrial packaging containers of glass (not including "glass stoppers, lids and covers"); retail services or wholesale services

for industrial packaging containers of wood (not including "corks nor wooden stoppers, lids and covers"); retail services or wholesale services for containers of paper, for packaging; retail services or wholesale services for industrial packaging containers of textile; retail services or wholesale services for industrial packaging containers of bamboo; retail services or wholesale services for industrial packaging containers of straw; retail services or wholesale services for industrial packaging containers of rubber; retail services or wholesale services for Industrial packaging containers of ceramics; retail services or wholesale services for industrial packaging containers of leather; retail services or wholesale services for industrial packaging containers of plastics (not including "plastic stoppers, lids, covers and bottles"); retail services or wholesale services for metal stoppers for industrial packaging containers, metal lids and caps (for industrial packaging containers), rubber stoppers (for industrial packaging containers), rubber lids and caps (for industrial packaging containers), cork stoppers (for industrial packaging containers), plastic stoppers (for industrial packaging containers), plastic lids and caps (for industrial packaging containers), wooden stoppers (for industrial packaging containers), wooden lids and caps (for industrial packaging containers), glass stoppers (for industrial packaging containers), glass lids and covers (for industrial packaging containers); retail services or wholesale services for industrial oil; retail services or wholesale services for waxes (raw material); retail services or wholesale services for irons and steels; retail services or wholesale services for nonferrous metals and their alloys, and precious metals; retail services or wholesale services for ores of metal, non-metallic minerals; retail services or wholesale services for plastic semi-worked products (for use as material); retail services or wholesale services for rubber (raw or semi-worked); retail services or wholesale services for leather and fur (unworked or semiworked); retail services or wholesale services for urushi tree seeds, Japanese food wrapping sheets of wood as materials (kyogi), ferns (unworked or partly worked material), bamboo (unworked or partly worked material), bamboo skins (unworked or partly worked material), vines, rattan (unworked or partly worked material), tree barks, rice straw, straw of wheat, barley or oats, rushes (raw or partly worked material), sedges (unworked or partly worked material), onigaya hay (raw or partly worked material), vegetable aggregate for plaster (susa), reeds (raw or partly worked material), sawdust, kapok, rice hulls, wood shavings, wax waste for stuffing, ragleaf, wood wool (wooden excelsior); retail services or wholesale services for tusks (raw or partly worked material), whalebones, shells and crusts, artificial horns, ivory (unworked or partly worked material), animal horns, animal teeth, tortoiseshells (unworked or partly worked material), animal bone (un-

worked or partly worked material), coral (unworked or partly worked), pig bristles (hog bristles for brushes), cattle hair (not for textile use, not for brushes), human hair (not for textile use, not for brushes), raccoon dog hair (not for textile use, not for brushes), pig bristles (not for textile use, not for brushes), horsehair (not for textile use, not for brushes), feathers and downs; retail services or wholesale services for nonmetallic mineral materials (unworked or partly worked); retail services or wholesale services for toilet seats for nursing care; retail services or wholesale services for toilet bowls and bodily waste treatment apparatus for nursing care and parts and fittings therefor; retail services or wholesale services for bathing aids for nursing care; retail services or wholesale services for portable bath tubs for nursing care; retail services or wholesale services for hoisting device for lifts for nursing care; retail services or wholesale services for wheelchairs for nursing care, lifts for nursing care, apparatus for postural change for nursing care, toilet bowls for nursing care, walkers frames for nursing care, walking sticks for nursing care, bath tubs for nursing care, wandering detectors for nursing care and other apparatus and instruments for nursing care, apparatus and instruments for nursing care and welfare.

36 – Acceptance of deposits (including substitute bond issuance) and acceptance of fixed interval installment deposits; loans (financing) and discount of bills; domestic exchange settlement; liability guarantee and acceptance of bills; securities lending; acquisition and transfer of monetary claims; safekeeping of valuables including securities and precious metals (safe deposit services); money exchange (exchanging money); trusteeship of financial futures contracts; trusteeship of money, securities, monetary claims, personal property, land, rights on land fixtures, surface rights or lease on land; agencies for bond subscriptions; foreign exchange transactions; letter-of-credit related services; brokerage of credit purchase; issue of tokens of value; agencies for collecting gas or electric power utility payments; consigned collection of securities index futures; trading of securities options; trading of overseas market securities futures; agencies for brokerage of securities, securities index futures, securities options, and overseas market securities futures; agencies for brokerage of entrusting agents with on-commission trading in domestic markets of securities, securities index futures and securities options; agencies for brokerage of entrusting agents with oncommission trading in overseas markets of securities, and securities index futures; agencies for brokerage of forward agreement of securities, for forward agreement of securities index futures, for forward agreement of securities options, spot and forward transaction of securities index futures; brokerage for securities liquidation; securities underwriting; securities offering; brokerage services relating to securities subscription or

offering; providing stock market information; subscription or offering of beneficiary certificate of investment trust; mutual funds; agencies for payment of earnings, repayment, partial cancellation of contract regarding beneficiary certificate of securities investment trust; management of investment trust; provision of information on investment trust; real estate investment trust services; provision of information on real estate investment trust; life insurance brokerage; life insurance underwriting; agencies for non-life insurance; claim adjustment for non-life insurance; non-life insurance underwriting; insurance premium rate computing; management of buildings; agency services for the leasing or rental of buildings; leasing or renting of buildings; purchase and sale of buildings; agency services for the purchase or sale of buildings; real estate appraisal; land management; agency services for the leasing or rental of land; leasing of land; purchase and sale of land; agency services for the purchase or sales of land; providing information on buildings or land (real estate affairs).

37 – Constructions; provision of construction information; construction consultancy; building construction supervision; operation and maintenance of building equipment; repair of bicycles; repair or maintenance of automobiles; repair or maintenance of two-wheeled motor vehicles; repair or maintenance of fire alarms; repair or maintenance of crimeprevention alarm apparatus for home, gas alarm, anti-theft warning apparatus and other alarms; repair or maintenance of electronic machines and apparatus; repair or maintenance of telephone apparatus; repair of radio receivers or television receivers; repair or maintenance of telecommunication machines and apparatus (other than telephone apparatus, radio receivers and television receivers); repair or maintenance of telecommunication machines and apparatus; repair or maintenance of consumer electric appliances; repair or maintenance of electric lighting apparatus; repair or maintenance of electric motors; repair or maintenance of power distribution or control machines and apparatus; repair or maintenance of power generators; repair or maintenance of measuring and testing machines and instruments; repair or maintenance of mechanical parking systems; repair or maintenance of bicycle parking apparatus; repair or maintenance of cooking equipment for industrial purposes; repair or maintenance of dishwashers for industrial purposes; furniture restoration; repair of shutters, doors and sashes; repair of joinery fittings; setup or repair of locks; setup or repair of electric locks and electronic locks; repair or maintenance of gas water heaters; repair or maintenance of non-electric cooking heaters; repair or maintenance of cooking pots and pans; repair or maintenance of kitchen worktops and kitchen sinks; repair or maintenance of bath fittings; repair of toilet stool units with a washing water squirts; repair of tatami mats; chimney

sweeping; cleaning of building exterior surfaces; window cleaning; carpet and rug cleaning; floor polishing; bathtub and bath boiler cleaning.

42 – Architectural design; surveying; geological surveys or research; designing of machines, apparatus, instruments (including their parts) or systems composed of such machines, apparatus and instruments; designing (other than for advertising purposes); computer software design, computer programming, or maintenance of computer software; research on building construction or city planning; testing or research on prevention of pollution; testing or research on electricity; testing or research on civil engineering; rental of computers; providing computer programs on data networks.

44 – Providing bath houses; garden tree planting; garden or flower bed care; fertilizer spreading; weed killing; vermin exterminating (for agriculture, horticulture or forestry); massage and therapeutic Shiatsu massage; chiropractics; moxibustion; treatment for joint dislocation, sprain, bone fractures or the like [judo-seifuku]; acupuncture; providing medical information; physical examination; dietary and nutritional guidance; animal breeding; veterinary services; animal grooming; nursing care; providing of care and nursing care facilities for elderly or handicapped persons; rental of potted plants; farming equipment rental; rental of medical apparatus and instruments; rental of lawnmowers; rental of chamber pots.

(260) AM 2018 95230 A

(800) 1374884

(151) 2017 09 05

(891) 2017 09 05

(731) ACTELION PHARMACEUTICALS LTD
LEGAL DEPARTMENT
Gewerbstrasse 16, CH-4123 Allschwil,
Switzerland

(540)

OCYNTIO

(591) Black, white

(511)

5 – Pharmaceutical preparations.

(260) AM 2018 95232 A

(800) 1374886

(151) 2017 09 06

(891) 2017 09 06

(731) SOCIÉTÉ DES PRODUITS NESTLÉ S.A.
CH-1800 Vevey, Switzerland

(540)

ПЕРЛ

(591) Black, white

(531) 28.05
(511)
31 – Foodstuffs for animals.

(260) AM 2018 95233 A
(800) 1374908
(151) 2017 09 25
(891) 2017 09 25
(731) ADP GAUSELMANN GMBH
Merkur-Allee 1-15, 32339 Espelkamp,
Germany
(540)

Pizza Express

(591) Black, white
(511)
9 – Computer software; computer and video games software; games software in particular for use on any computer platform, including electronic entertainment and games consoles; computer game programs; video games (software); computer games provided through a global computer network or supplied by means of multi-media electronic broadcast or through telecommunications or electronic transmission or via the internet; computer games, leisure and recreational software, video games and computer software, all being provided in the form of storage media; programs for operating electric and electronic apparatus for games, amusement and/or entertainment purposes; automatic lottery machines; computer software for computer games on the internet; online games (software), in particular for online betting games, online prize games, online gambling games, online games of skill and online casino games; computer software in the form of an app for mobile devices and computers; operational computer games software; computer software for managing of games (game collection); collection of video games.

(260) AM 2018 95234 A
(800) 1374934
(151) 2017 06 22
(891) 2017 06 22
(731) ALTESSE
Valamas, F-07310 SAINT-MARTIN-DE-
ALAMAS, France
(540)

Les Georgettes • by Altesse •

(591) Black, white
(531) 24.17.02; 27.05.01; 27.05.15
(511)
14 – Precious metals and their alloys; works of art of precious metal; jewelry cases [caskets]; boxes of precious metal; jewelry; jewelry; fashion jewelry; medals; precious stones; key rings [trinkets or fobs];

timepieces and chronometric instruments; cases or presentation cases for timepieces; cases; bracelets; chains; springs or glasses for watches.

18 – Leather and imitations of leather; purses (coin purses); card cases (notecases); diary holders; briefcases; purses; briefcases; document bags and briefcases; music cases; satchels; clutch bags (leather goods); handbags; backpacks; wheeled shopping bags; traveling bags; beach bags; school bags; shopping bags; key cases; vanity cases; traveling sets; traveling trunks; trunks [luggage]; suitcases and small cases; wallets.

(260) AM 2018 95237 A
(800) 1374953
(151) 2017 10 05
(891) 2017 10 05
(731) THE FROZEN BEAN
8351 Elm Ave # 103, Rancho Cucamonga
CA 91730, USA
(540)

The Frozen Bean

(591) Black, white
(526) Frozen
(511)
29 – Dairy-based powders for making dairy-based food beverages and shakes.

(260) AM 2018 95240 A
(800) 1374968
(151) 2017 09 25
(891) 2017 09 25
(731) ADP GAUSELMANN GMBH
Merkur-Allee 1-15,32339 Espelkamp,
Germany
(540)

Zipper

(591) Black, white
(511)
9 – Computer software; computer and video games software; games software in particular for use on any computer platform, including electronic entertainment and games consoles; computer game programs; video games (software); computer games provided through a global computer network or supplied by means of multi-media electronic broadcast or through telecommunications or electronic transmission or via the internet; computer games, leisure and recreational software, video games and computer software, all being provided in the form of storage media; programs for operating electric and electronic apparatus for games, amusement and/or entertainment purposes; automatic lottery machines; computer software for computer games on the internet; online games (software), in particular for online betting

games, online prize games, online gambling games, online games of skill and online casino games; computer software in the form of an app for mobile devices and computers; operational computer games software ; computer software for managing of games (game collection); collection of video games.

(260) AM 2018 95241 A

(800) 1374979

(151) 2017 04 25

(891) 2017 04 25

(731) PAKTEN SAĞLIK ÜRÜNLERİ SANAYİ VE TİCARET ANONİM ŞİRKETİ
2. Organize Sanayi Bölgesi, Nolu Cadde, No:9
TR-83221 Şehitkamil – Gaziantep, Turkey

(540)

PAKTEN CLING

(591) Black, white

(531) 27.05.01

(511)

3 – Bleaching and cleaning preparations, detergents other than for use in manufacturing operations and for medical purposes, laundry bleach, fabric softeners for laundry use, stain removers, dishwasher detergents; perfumery; cosmetics (except medicated cosmetics); fragrances; deodorants for personal use and animals; soaps (except medicated soap); dental care preparations, dentifrices, denture polishes, tooth whitening preparations, mouth washes, not for medical purposes; abrasive preparations; emery cloth; sandpaper; pumice stone; abrasive pastes; polishing preparations for leather, vinyl, metal and wood, polishes and creams for leather, vinyl, metal and wood, wax for polishing.

(260) AM 2018 95242 A

(800) 1374980

(151) 2017 05 09

(891) 2017 05 09

(731) EGIS GYÓGYSZERGYÁR ZRT.
Keresztúri út 30-38, H-1106 Budapest,
Hungary

(540)

XIREVIMA

(591) Black, white

(511)

5 – Pharmaceutical preparations for human use.

(260) AM 2018 95254 A

(800) 1375190

(151) 2017 10 19

(891) 2017 10 19

(731) REFORMED SPIRITS COMPANY LTD
535 King's Road, London SW10 OSZ,
United Kingdom

(540)

MARTIN MILLER'S

(591) Black, white

(511)

33 – Gin.

(260) AM 2018 95255 A

(800) 1375192

(151) 2017 09 29

(891) 2017 09 29

(731) INDUSTRIAS QUIMICAS VIRGEN DE LA SALUD, S. L. (INQUIVISA, S. L.)
POLIGONO INDUSTRIAL LA CAPELLA-
NIA, PARCELA 39 E-30600 ARCHENA
(MURCIA), Spain

(540)

LA SALUD

(591) Black, white

(511)

3 – Bleaching preparations and other substances for laundry use; cleaning, polishing, degreasing and abrasive preparations; soaps; dentifrices; perfumery products; essential oils; cosmetics; hair lotions.

(260) AM 2018 95256 A

(800) 1375282

(151) 2017 06 29

(891) 2017 06 29

(731) HUAWEI TECHNOLOGIES CO., LTD.
Administration Building Huawei Technolo-
gies Co., Ltd., Bantian, Longgang District
Shenzhen, China

(540)



(591) Black, white

(531) 03.07.17; 10.03.07

(511)

9 – Black boxes (data recorders); interactive touch screen terminals; humanoid robots with artificial intelligence; electronic sheet music, downloadable; smart rings; recorded computer programmes (programs); protective films adapted for smartphones; audio interfaces; electric and electronic effects units for musical instruments; equalizers (audio apparatus); virtual reality headsets; automobile data recorders; set-top boxes; headphones; digital weather stations; biochips; infrared detectors; electronic key fobs being remote control apparatus; charging stations for electric vehicles; batteries for electronic cigarettes; security tokens (encryption devices); downloadable mobile phone software applications; fin-

gerprint identifiers; human face recognition devices; scales with body mass analyzers; baby scales; bathroom scales; thermal imaging cameras; subwoofers; audio mixers; needles for surveying compasses; pressure indicators; thermo-hygrometers; safety restraints, other than for vehicle seats and sports equipment; respiratory masks, other than for artificial respiration; electronic access control systems for interlocking doors.

(260) AM 2018 95257 A

(800) 1375294

(151) 2017 09 20

(891) 2017 09 20

(731) RICHTER GEDEON NYRT.

Gyömrői út 19-21 H-1103 Budapest, Hungary

(540)

ESCUPA

(591) Black, white

(511)

5 – Pharmaceutical preparations.

(260) AM 2018 95258 A

(800) 1375301

(151) 2017 04 08

(891) 2017 04 08

(731) PERIMETERS MEDIA PRIVATE LIMITED

7514, sector – d, pocket – 7, vasant kunj
new delhi – 110070, India

(540)

SEVEN

(591) Black, white

(531) 27.05.01; 27.05.17

(511)

35 – Advertising, business management, business administration, office functions.

(260) AM 2018 95260 A

(800) 1375307

(151) 2017 04 14

(891) 2017 04 14

(731) FERRERO S.P.A.

Piazzale Pietro Ferrero, 1 I-12051 ALBA
(CUENO), Italy

(540)



(591) White, red-orange and black.

(531) 01.15.15; 02.09.01; 26.11.13; 27.05.17;
29.01.13

(511)

28 – Games and playthings; gymnastic and sporting articles; decorations for Christmas trees.

30 – Pastry; confectionery; chocolate; chocolate products; cereal-based snacks; cream filled sponge cakes; biscuits; cakes; sweet baked products; wafers; cocoa based spread creams; chocolate-based beverages; cocoa-based beverages; ice cream.

41 – Teaching; providing of training; entertainment services; sporting and cultural activities; organization of games and competitions; organization and provision of games and competitions via the Internet.

(260) AM 2018 95261 A

(800) 1375314

(151) 2017 06 08

(891) 2017 06 08

(731) HAZUKI COMPANY KABUSHIKI

KAISHA

10-1, Roppongi 6-chome, Minato-ku, Tokyo,
Japan

(540)

Hazuki Loupe

(591) Black, white

(511)

9 – Magnifying glasses; spectacles-type magnifying glasses.

(260) AM 2018 95265 A

(800) 1375826

(151) 2017 05 11

(891) 2017 05 11

(731) AISINO CORPORATION

No.18A, Xingshikou Road, Haidian District
100195 Beijing, China

(540)

Aisino

(591) Black and white

(531) 27.05.01; 27.05.17

(511)

2 – Dyes; pigments; food colorants; printing ink; paints; waterproof powder (paint); paint thinner; lacquers; preservative oil for wood; mastic [natural resin].

16 – Paper; copying paper [stationery]; toilet paper; cardboard; printed matter; printed publications; picture poster; boxes of cardboard or paper; document laminators for office use; office requisites, except furniture; ink; numbering apparatus; writing instruments; gums [adhesives] for stationery or household purposes; drawing instruments; drawing materials; duplicators; teaching materials [except apparatus]; architects' models.

35 – Advertising; commercial administration of the licensing of the goods and services of others; business information; import-export agency services; personnel management consultancy; relocation services for businesses; compilation of information into computer databases; systemization of information into computer databases; office machines and equipment rental; administrative processing of purchase orders; business auditing; rental of vending machines.

36 – Insurance underwriting; capital investment; tax auditing service; art appraisal; accommodation bureau services [apartments]; brokerage; surety services; charitable fund raising; trusteeship; pawnbrokerage.

37 – Construction information; mining extraction; kitchen equipment installation; interference suppression in electrical apparatus; installation and repair of medical equipment; photographic apparatus repair; rustproofing; retreading of tires [tyres].

38 – Television broadcasting; message sending; communications by telephone; electronic mail; computer aided transmission of messages and images; teleconferencing services; satellite transmission; providing telecommunications connections to a global computer network; communications by computer terminals; providing access to databases; rental of message sending apparatus.

39 – Transport; marine transport; salvaging; car transport; piloting; car parking; carting; storage; rental of diving suits; distribution of energy; operating canal locks; courier services [messages or merchandise]; arranging of tours; launching of satellites for others.

41 – Teaching; teaching; arranging and conducting of colloquiums; lending library services; publication of books; production of shows; holiday camp services [entertainment]; health club services; zoological gardens; operating lotteries.

42 – Research and development of new products for others; certificate of quality system; surveying; chemical research; biological research; meteorological information; material testing; physics [research]; industrial design; architectural services; dress designing; computer programming; consultancy services in the field of design, selection, implementation and use of computer hardware; recovery of computer data; computer system analysis; creating and maintaining web sites for others; data conversion of computer programs and data [not physical conversion]; computer rental; providing search engines for the Internet; computer virus protection services; computer software consultancy; installation of computer software; conversion of data or documents from physical to electronic media; maintenance of computer software; rental of computer software; updating

of computer software; authenticating works of art; invisible asset evaluation.

(260) AM 2018 95281 A

(800) 1376882

(151) 2017 10 11

(891) 2017 10 11

(731) JÜRGEN HRUSCHKA

Kunigundenstr. 49, 80805 Munich,
Germany

(540)

Racuda

(591) Black, white

(511)

12 – Vehicles, in particular motor vehicles and electric vehicles; apparatus for locomotion by land, air or water; engines for land vehicles; parts for motor vehicles and electric vehicles, as far as included in this class.

(260) AM 2018 95284 A

(800) 1376976

(151) 2017 05 24

(891) 2017 05 24

(731) ORGANİKA KİMYA KOZMETİK VE
AMBALAJ SANAYİ TİCARET LİMİTE D
ŞİRKETİ

Ortaköy Mah. Tibet Sokak, No:6/A Selimpaşa
Silivri, İstanbul, Turkey

(540)

VASSO®

(591) Black, white

(531) 27.05.01; 27.05.19

(526) R

(511)

3 – Perfumes; eau de Cologne, colognes, lotions for cosmetic purposes, essential oils, deodorants for personal use, after-shave lotions, antiperspirant deodorants and lotions, cosmetics namely, nail polishes, lipsticks, mascaras, creams for cosmetic, hair care cream, hair dyes, hair gel, body gel, hair spray, petroleum jelly for cosmetic purposes, hair wax, shampoos, hair waving preparations, eyebrow pencils (eyeliner), lip-liners, eye shadows, rouges, skin care creams, moisturizing cream and lotions liquid make-up, powder for make-up; nail varnish remover; nail care products, nail hardening and nourishing preparations, shaving preparations, shaving soaps; after-shave soaps, after-shave creams, shower gel, depilatory preparations for cosmetic purposes, hennas; cosmetic preparations for slimming purposes; cosmetic soaps and soaps namely, soaps for personal use, tooth care preparations namely toothpastes, dentifrices; mouthwashes, not for medical purposes.

(260) AM 2018 95285 A
 (800) 1376977
 (151) 2017 06 02
 (891) 2017 06 02
 (731) RUSOH, INC.

3925 North Hastings Way, Eau Claire WI
 547033703, USA

(540)

RUSOH

(591) Black, white
 (531) 27.05.05; 27.05.17
 (511)

1 – Fire extinguishing compositions; kits for reloading fire extinguishers comprising fire extinguishing preparations, carbon dioxide (CO₂) filled cartridges, reloading cartridge filled with monoammonium phosphate extinguishing agents and other dry chemical fire extinguishing preparations.

9 – Fire-extinguishing apparatus; fire extinguishers.

41 – Fire safety training services.

(260) AM 2018 95287 A
 (800) 1377002
 (151) 2017 06 08
 (891) 2017 06 08
 (731) KEMA d.o.o.

Puconci 393, SI-9201 Puconci, Slovenia

(540)

LINEA

(591) Black, white
 (511)

1 – Adhesives for ceramic tiles, marble, facade elements, clinker, siporex, styropor, polystyrene and for insulating boards and panels; additives for concrete and cement mortar, not included in other classes.

19 – Non-metallic building materials; mortar; coatings (building materials), plaster; levelling compounds (building materials).

(260) AM 2018 95289 A
 (800) 875403
 (151) 2005 12 19
 (891) 2017 10 06
 (731) UŽDAROJI AKCINĖ BENDROVĖ

"DAISENA"

Taikos pr. 161, LT-52102 Kaunas, Lithuania

(540)



(591) Black, white

(531) 01.15.11; 27.05.02; 27.05.03
 (511)

30 – Coffee, tea, coffee substitutes, unroasted coffee, coffee-based beverages.

(260) AM 2018 95291 A
 (800) 951061
 (151) 2007 12 04
 (891) 2017 09 20

(731) STRAUSS COFFEE B.V.

Prof. J.H. Bavincklaan 2, NL-1183 AT
 Amstelveen, Netherlands

(540)



(591) Black, white and light brown.

(531) 05.07.01; 25.01.05; 26.11.08; 27.05.02;
 29.01.13

(511)

30 – Coffee; coffee-based beverages; coffee beverages with milk.

(260) AM 2018 95293 A
 (800) 1048944
 (151) 2010 08 19
 (891) 2017 09 18
 (731) ORAC NV

Biekorfstraat 32, B-8400 Oostende, Belgium

(540)

DUROPOLYMER

(591) Black, white

(511)

19 – Framework and other shaped building components not of metal, for decorative purposes, including wall framing, ceiling framing, plinths, rosettes, consoles, cornices, pillars, pilasters, columns, capitals, door panels, wall panels, wall claddings, door frames, window frames, arches, arcades, baseboards, niches.

20 – Wall furniture; furniture framing; mirrors; socles (furniture).

37 – Installation and repair work, both in connection with framework and other shaped building components not of metal, for decorative purposes, including wall framing, ceiling furniture, plinths, rosettes, consoles, cornices, pillars, pilasters, columns, capitals, door panels, wall panels, wall claddings, door frames, window frames, arches, arcades, baseboards, niches.

(260) AM 2018 95296 A
 (800) 1204647
 (151) 2013 12 27
 (891) 2017 09 28
 (731) QUESOS VEGA SOTUELAMOS, SL
 Finca Sotuelamos, Pedania de Sotuelamos,
 E-02610 El Bonillo, Albacete, Spain
 (540)



(591) Black and gold. Black background with characters depicted in gold.
 (531) 26.04.22; 26.04.24; 27.05.24; 29.01.12
 (511)
 29 – Cheese with appellation of origin Manchego.

(260) AM 2018 95297 A
 (800) 1242163
 (151) 2014 08 26
 (891) 2017 01 02
 (731) KALE OTO RADYATÖR SANAYİ VE
 TİCARET ANONİM ŞİRKETİ
 Sanayi Mahallesi, Turan Caddesi No:6, 4.
 Levent – İSTANBUL, Turkey
 (540)



(531) 15.09.25; 27.05.10
 (511)
 7 – Radiators for vehicles, fans for motors and engines.

(260) AM 2018 95298 A
 (800) 1331847
 (151) 2016 05 23
 (891) 2017 08 22
 (731) Viktor Petrovych Slobodianiuk
 vul. Zhovtneva., 2, smt. Rudnytsia,
 Pishchanskyi r-n, Vinnyts'ka obl. 24723,
 Ukraine
 (540)



(591) Black and yellow.
 (531) 01.01.12; 01.15.07; 27.07.17; 29.01.13
 (511)
 6 – Aluminium wire; anchors; anchor plates; framework of metal for building; hardware of metal, small; sleeves [metal hardware]; nuts of metal; wire of common metal; wire of common metal alloys,

except fuse wire; soldering wire of metal; powder wire for welding; wire cloth; iron wire; pillars of metal for buildings; sheets and plates of metal; copper wire, not insulated; rods of metal for welding; rods of metal for brazing; rods of metal for brazing and welding; alloys of common metal; buildings, transportable, of metal; silver solder; steel wire; steel buildings; brazing alloys; nails.

7 – Machine tools; die-cutting and tapping machines; threading machines; finishing machines; metal drawing machines; electric welding apparatus; electrodes for welding machines; electric arc welding apparatus; electric arc cutting apparatus; labellers [machines]; welding machines, electric; soldering apparatus, gas-operated; metalworking machines; soldering irons, gas-operated; soldering irons, electric; soldering apparatus, electric; soldering blow pipes, gas-operated; cutters [machines]; milling machines.

35 – Market studies; demonstration of goods; commercial information and advice for consumers [consumer advice shop]; marketing research; provision of an on-line marketplace for buyers and sellers of goods and services; organization of exhibitions for commercial or advertising purposes; presentation of goods on communication media, for retail purposes; provision of an on-line marketplace that allows customers to browse, order and buy conveniently the goods and to order services on the web pages and web sites, and also receive necessary information about the provided goods and services; the bringing together, for the benefit of others, of a variety of goods (excluding the transport thereof), enabling customers to conveniently view and purchase those goods from a retail and wholesale stores; distribution of samples, dissemination of advertising matter; design of advertising materials; sales promotion for others; telemarketing services.

(260) AM 2018 95299 A
 (800) 1337114
 (151) 2016 05 20
 (891) 2017 09 28
 (731) HITACHI KOKI CO., LTD.
 15-1, Konan 2-chome, Minato-ku, Tokyo
 108-6020, Japan
 (540)

HIKOKI

(591) Black, white
 (511)
 7 – Agitators; apparatus for machining; aprons [parts of machines]; atomizers [machines]; bellows [machines]; bending machines; blade sharpening [stropping] machines; blades [parts of machines] for metalworking, mining, construction, chemical processing, food or beverage processing, lumbering, woodworking, veneer or plywood making, stone working

[machines]; blowing engines; blowing machines; brushes [parts of machines]; brushes, electrically operated; centrifugal machines; centrifugal pumps; centrifuges [machines]; chain saws; chisels for machines; chucks [parts of machines]; cleaning appliances utilizing steam; clippers [machines]; coal-cutting machines; compressed air machines; compressed air pumps; compressors [machines]; compressors for refrigerators; concrete mixers [machines]; crushing machines; cultivators [machines]; current generators; cutting machines; die-cutting and tapping machines; die-stamping machines; diggers [machines]; disintegrators; ditchers [ploughs]; drill chucks [parts of machines]; drilling bits [parts of machines]; drilling heads [parts of machines]; drilling machines; dynamos; earth moving machines; electric arc cutting apparatus; electric arc welding apparatus, electric hammers; electric hand drills; electric welding apparatus; embossing machines; emergency power generators; engines for boats; engines, other than for land vehicles; engraving machines; excavators; finishing machines; food preparation machines, electro-mechanical; foundry machines; generators of electricity; glue guns, electric; electric grinders and crushers for household purposes; grinding machines; guns [tools using explosives]; hand-held tools, other than hand-operated; harrows; hemming machines; high pressure washers; igniting devices for internal combustion engines; igniting magnetos; knives for mowing machines; lathes [machine tools]; machine wheel work; electric machines and apparatus for cleaning; electric machines and apparatus for polishing; meat choppers [machines]; meat mincers [machines]; milling machines; mine borers; molding machines; mortising machines; motorized cultivators; motors for boats; motors, other than for land vehicles; mowing and reaping machines; mufflers for motors and engines; nail extractors, electric; nail pullers, electric; nut-tapping machines; paring machines; peeling machines; planing machines; pneumatic hammers; power hammers; presses [machines for industrial purposes]; pumps [machines]; pumps [parts of machines, engines or motors]; rammers [machines]; rams [machines]; saws [machines]; scissors, electric; sharpening machines; sharpening wheels [parts of machines]; shears, electric; shredders [machines] for industrial use; snow ploughs; spraying machines; threading machines; trimming machines; turbocompressors; vacuum cleaner bags; vacuum cleaner hoses; vacuum pumps, washing apparatus; metalworking machines and tools; mining machines and apparatus; construction machines and apparatus; loading-unloading machines and apparatus; industrial fishing machines; chemical processing machines and apparatus; textile machines and apparatus; food or beverage processing machines and apparatus; lumbering, woodworking, or veneer or plywood making machines and apparatus; pulp making, papermaking or paper-working machines and apparatus; agricul-

tural machines, agricultural implements other than hand-operated; plastic processing machines and apparatus; machines and apparatus for manufacturing rubber goods; stone working machines and apparatus; non-electric prime movers, not for land vehicles, and parts of non-electric prime movers; pneumatic or hydraulic machines and instruments; washing machines [laundry]; vehicle washing installations; food mixing machines for commercial use; food peeling machines for commercial use; food cutting, chopping and slicing machines for commercial use; dishwashers; machines and apparatus for wax-polishing, electric; vacuum cleaners; machine elements [not for land vehicles]; lawnmowers; waste crushing machines; starters for motors and engines; AC motors and DC motors [not including those for land vehicles but including "parts" for any AC motors and DC motors]; AC generators; DC generators; electric food blenders for household purposes; dynamo brushes.

8 – Abrading instruments [hand instruments]; bits [hand tools]; bits [parts of hand tools]; blade sharpening instruments; blades for planes; cutting tools [hand tools]; drills; files [tools]; gimlets [hand tools]; gouges [hand tools]; grindstones [hand tools]; hollowing bits [parts of hand tools]; hoop cutters [hand tools]; non-electric caulking guns; saws [hand tools]; stamping-out tools [hand tools]; whetstones; wrenches [hand tools]; electric razors and electric hair clippers; bladed or pointed hand tools; hand tools.

9 – Electric accumulators; electric batteries; battery boxes; battery chargers; condensers [capacitors] for telecommunication machines and electronic machines; radios; sound reproduction apparatus; laboratory apparatus and instruments; solar batteries; batteries and cells; electric wires and cables; telecommunication machines and apparatus; electronic machines, apparatus and their parts; gloves for protection against accidents; spectacles [eyeglasses and goggles].

(260) AM 2018 95301 A

(800) 1376227

(151) 2017 08 28

(891) 2017 08 28

(731) GEELY HOLDING GROUP CO., LTD.

Zhong-Xing Road, Bin-Jiang District,
Hangzhou Zhejiang, China

(540)



(591) Black and white

(531) 05.03.04; 26.01.04; 26.01.15; 26.01.21
(511)
12 – Automobiles; cars; motors for land vehicles; vehicle wheels; vehicle bumpers; automobile tires (tyres).

37 – Motor vehicle maintenance and repair; vehicle lubrication; vehicle cleaning; anti-rust treatment for vehicles; vehicle service stations [refuelling and maintenance]; airplane maintenance and repair; retreading of tires [tyres]; vulcanization of tires [repair].

(260) AM 2018 95305 A
(800) 1376244
(151) 2017 08 08
(891) 2017 08 08
(731) "GRAND MASTER" LLC
Masis Industrial Hub, Gortsaranain street,
8 Area 0801 Ararat marz, Armenia

(540)

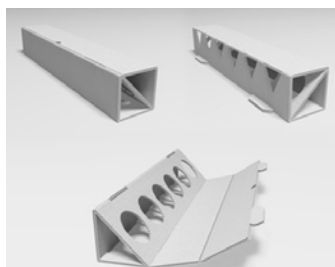

(591) Black and white
(531) 19.03.24
(554) Three-dimensional
(511)
16 – Boxes of cardboard.

21 – Food containers.

29 – Eggs.

(260) AM 2018 95311 A
(800) 1376331
(151) 2017 08 31
(891) 2017 08 31
(731) JANSSEN PHARMACEUTICA NV
Turnhoutseweg 30, B-2340 BEERSE,
Belgium

(540)

СИЛА МЯГКОСТИ

(591) Black, white
(511)
3 – Cosmetic products for the care and cleansing of skin and hair.

(260) AM 2018 95313 A
(800) 1376374
(151) 2017 10 11

(891) 2017 10 11
(731) OLAM INTERNATIONAL LIMITED
7 Straits View, #20-01 Marina One East
Tower, Singapore 018936, Singapore

(540)

SESAMEZZE

(591) Black, white

(531) 27.05.17

(511)

29 – Prepared sesame seeds; sesame oils; tahini [sesame seed paste].

30 – Sesame seeds [seasonings]; sweetmeat made of sesame oil; table salt mixed with sesame seeds.

31 – Edible sesame seeds (unprocessed).

(260) AM 2018 95315 A
(800) 1376451
(151) 2017 09 12
(891) 2017 09 12
(731) ISIS PHARMA GmbH
Bahnhofstrasse 12, CH-3900 BRIG,
Switzerland

(540)

GENESKIN

(591) Black, white

(531) 27.05.17

(511)

3 – Cosmetics for the skin; skin care and treatment preparations; moisturizers, emollients, scrubs, masks, lotions, creams for the skin; milks for skin care; skin cleansers and toners; skin make-up; skin care oils other than for medical use; cosmetic preparations for protecting the skin from sunstroke and the effects of aging; skin care compounds other than for medical use; anti-wrinkle products for skin care; anti-aging skin care preparations; anti-aging moisturizers for cosmetic use.

(260) AM 2018 95316 A
(800) 1376463
(151) 2017 08 31
(891) 2017 08 31
(731) WALDMANN, DANIEL
AGIOU ANDREOU STR. 223, Columbia
Plaza, TOWNHOUSE 5, CY-3036
LIMASSOL, Cyprus

(540)

PAUL GARNIER

(591) Black, white

(511)

14 – Precious metals and their alloys; jewelry, precious and semi-precious stones; timepieces and chronometric instruments.

18 – Leather and imitations of leather; animal skins; luggage and transport bags; umbrellas and parasols; walking sticks; whips, harness and saddlery; collars, leashes and clothing for animals.

25 – Clothing, footwear, headgear.

(260) AM 2018 95321 A

(800) 1376468

(151) 2017 09 05

(891) 2017 09 05

(731) ACTELION PHARMACEUTICALS LTD

LEGAL DEPARTMENT

Gewerbstrasse 16, CH-4123 Allschwil,
Switzerland

(540)

VEVLANY

(591) Black, white

(511)

5 – Pharmaceutical preparations.

(260) AM 2018 95322 A

(800) 1376469

(151) 2017 09 05

(891) 2017 09 05

(731) ACTELION PHARMACEUTICALS LTD

LEGAL DEPARTMENT

Gewerbstrasse 16, CH-4123 Allschwil,
Switzerland

(540)

VIVLANY

(591) Black, white

(511)

5 – Pharmaceutical preparations.

(260) AM 2018 95323 A

(800) 1376519

(151) 2017 10 10

(891) 2017 10 10

(731) TENX PTE. LTD.

8 Eu Tong Sen Street, #24-89/90 The
Central Singapore 059818, Singapore

(540)

TENX

(591) Black, white

(511)

9 – Money counting and sorting machines; data processing apparatus; computer programmes [programs], recorded; computer operating programs, recorded; computer peripheral devices; computer software, recorded; encoded magnetic cards; magnetic data media; magnetic encoders; readers [data processing equipment]; safety restraints, other than for vehicle seats and sports equipment; scanners [data

processing equipment]; diagnostic apparatus, not for medical purposes; integrated circuit cards [smart cards]; electronic publications, downloadable; computer programs [downloadable software]; automated teller machines [ATM]; encoded identification bracelets, magnetic; computer software applications, downloadable; encoded key cards; security tokens [encryption devices].

35 – Compilation of information into computer databases; systemization of information into computer databases; commercial intermediation services; providing business information via a web site.

36 – Brokerage; financial customs brokerage services; exchanging money; clearing, financial; clearing-houses, financial; loans [financing]; financing services; financial management; savings bank services; processing of credit card payments; processing of debit card payments; electronic funds transfer; financial information; issuance of tokens of value; deposits of valuables; issuance of credit cards; retirement payment services; online banking; lending against security; provident fund services; providing financial information via a web site; financial management of reimbursement payments for others; investment of funds; stocks and bonds brokerage; providing rebates at participating establishments of others through use of a membership card.

42 – Computer programming; computer software design; updating of computer software; research and development of new products for others; computer system analysis; computer system design; conversion of data or documents from physical to electronic media; conversion of computer programs and data, other than physical conversion; monitoring of computer systems by remote access; providing information on computer technology and programming via a web site; outsource service providers in the field of information technology; data encryption services; electronic monitoring of credit card activity to detect fraud via the Internet.

(260) AM 2018 95324 A

(800) 1376523

(151) 2017 09 13

(891) 2017 09 13

(731) FOSHAN LEHUA HENGYE SANITARY

CO., LTD

No. 3 South Area of Manjiang Industry
District, Nanshan Town, Sanshui District,
Foshan City 528100 Guangdong Province,
China

(540)

ARROW 箭牌

(591) Black, white

(531) 27.05.01; 28.03

(511)
19 – Bricks; non-metal tiles; terrazzo; non-metal wall tiles for building; ceramic tiles; glass mosaics.

(260) AM 2018 95326 A

(800) 1376558

(151) 2016 10 04

(891) 2016 10 04

(731) GUMENIUK MYKOLA IVANOVYCH
vul. Klinichna, 23-25, kv. 173 Kyiv 03110,
Ukraine

(540)

INFULGAN

(591) Black, white

(531) 27.05.01

(511)

5 – Acaricides; aconitine; alkaloids for medical purposes; alginates for pharmaceutical purposes; algicides; aldehydes for pharmaceutical purposes; dental amalgams of gold; dental amalgams; amino acids for veterinary purposes; amino acids for medical purposes; analgesics; anaesthetics; antibiotics; antiseptics; medicine cases, portable, filled; first-aid boxes, filled; aluminium acetate for pharmaceutical purposes; acetates for pharmaceutical purposes; germicides; balms for medical purposes; bandages for dressings; diagnostic biomarker reagents for medical purposes; biocides; bracelets for medical purposes; anti-rheumatism bracelets; bromine for pharmaceutical purposes; paper for mustard plasters; fly catching paper; reagent paper for medical or veterinary purposes; mothproofing paper; petroleum jelly for medical purposes; vaccines; oxygen baths; antiseptic cotton; aseptic cotton; absorbent cotton; wadding for medical purposes; cotton for medical purposes; dietetic substances adapted for medical use; radiological contrast substances for medical purposes; nutritive substances for microorganisms; radioactive substances for medical purposes; bismuth subnitrate for pharmaceutical purposes; melissa water for pharmaceutical purposes; sea water for medicinal bathing; mineral waters for medical purposes; thermal water; dietary fiber; molding wax for dentists; gases for medical purposes; guaiacol for pharmaceutical purposes; hematogen; hemoglobin; hydrastine; hydrastinine; glycerine for medical purposes; glycerophosphates; glucose for medical purposes; gentian for pharmaceutical purposes; hormones for medical purposes; mustard for pharmaceutical purposes; mustard plasters; mud for baths; medicinal mud; gamboge for medical purposes; gurgun [gurjon, gurjan] balsam for medical purposes; air deodorising preparations; deodorants, other than for human beings or for animals; deodorants for clothing and textiles; diastase for medical purposes; digitalin; mineral food supplements; nutritional supplements; albumin dietary supplements; dietary supplements for animals;

yeast dietary supplements; alginate dietary supplements; glucose dietary supplements; casein dietary supplements; lecithin dietary supplements; linseed oil dietary supplements; propolis dietary supplements; protein dietary supplements; protein supplements for animals; royal jelly dietary supplements; pollen dietary supplements; wheat germ dietary supplements; linseed dietary supplements; enzyme dietary supplements; yeast for pharmaceutical purposes; gelatine for medical purposes; cod liver oil; isotopes for medical purposes; insecticides; iodine for pharmaceutical purposes; iodides for pharmaceutical purposes; alkaline iodides for pharmaceutical purposes; iodoform; calomel; cream of tartar for pharmaceutical purposes; tartar for pharmaceutical purposes; camphor for medical purposes; capsules for medicines; cachets for pharmaceutical purposes; hemostatic pencils; wart pencils; caustic pencils; headache pencils; carbolineum [parasiticide]; caustics for pharmaceutical purposes; cachou for pharmaceutical purposes; quassia for medical purposes; quebracho for medical purposes; oxygen for medical purposes; gallic acid for pharmaceutical purposes; acids for pharmaceutical purposes; adhesives for dentures; adhesive tapes for medical purposes; surgical glues; stem cells for veterinary purposes; stem cells for medical purposes; cocaine; collagen for medical purposes; collodion for pharmaceutical purposes; corn rings for the feet; anti-rheumatism rings; candy, medicated; angostura bark for medical purposes; barks for pharmaceutical purposes; cedar wood for use as an insect repellent; condurango bark for medical purposes; croton bark; mangrove bark for pharmaceutical purposes; myrobalan bark for pharmaceutical purposes; quinquina for medical purposes; medicated animal feed; medicinal roots; rhubarb roots for pharmaceutical purposes; lint for medical purposes; starch for dietetic or pharmaceutical purposes; creosote for pharmaceutical purposes; blood for medical purposes; cultures of microorganisms for medical or veterinary use; curare; dental lacquer; liquorice for pharmaceutical purposes; lactose for pharmaceutical purposes; candy for medical purposes; adhesive plasters; medicines for alleviating constipation; lecithin for medical purposes; lotions for veterinary purposes; dog lotions; lotions for pharmaceutical purposes; lozenges for pharmaceutical purposes/pastilles for pharmaceutical purposes; personal sexual lubricants; lupulin for pharmaceutical purposes; magnesia for pharmaceutical purposes; liniments; ointments for pharmaceutical purposes; sunburn ointments; frostbite salve for pharmaceutical purposes; mercurial ointments; gauze for dressings; medicinal oils; mustard oil for medical purposes; camphor oil for medical purposes; castor oil for medical purposes; oil of turpentine for pharmaceutical purposes; dill oil for medical purposes; dental mastics; dental abrasives; dental impression materials; teeth filling material; dressings, medical; surgical dressings;

drugs for medical purposes; medicines for veterinary purposes; serotherapeutic medicines; medicines for human purposes; medicines for dental purposes; menthol; medicinal drinks; moleskin for medical purposes; milk of almonds for pharmaceutical purposes; powdered milk for babies; royal jelly for pharmaceutical purposes; milk ferments for pharmaceutical purposes; Irish moss for medical purposes; flour for pharmaceutical purposes; linseed meal for pharmaceutical purposes; fish meal for pharmaceutical purposes; fly glue; mint for pharmaceutical purposes; dietetic beverages adapted for medical purposes; malted milk beverages for medical purposes; narcotics; medicinal infusions; tincture of iodine; eucalyptol for pharmaceutical purposes; tinctures for medical purposes; opium; opodeldoc; decoctions for pharmaceutical purposes; antiparasitic collars for animals; cotton sticks for medical purposes; stick liquorice for pharmaceutical purposes; sulfur sticks [disinfectants]; pectin for pharmaceutical purposes; diagnostic preparations for veterinary purposes; pepsins for pharmaceutical purposes; peptones for pharmaceutical purposes; hydrogen peroxide for medical purposes; pesticides; food for babies; leeches for medical purposes; blood plasma; eyepatches for medical purposes; poultices; compresses; scapulars for surgical purposes; babies' diapers [napkins]; diapers for pets; diapers for incontinents; breast-nursing pads; bunion pads; pomades for medical purposes; powder of cantharides; pyrethrum powder; belts for sanitary napkins [towels]; anti-uric preparations; bacterial preparations for medical and veterinary use; bacteriological preparations for medical and veterinary use; balsamic preparations for medical purposes; albuminous preparations for medical purposes; biological preparations for veterinary purposes; biological preparations for medical purposes; veterinary preparations; bismuth preparations for pharmaceutical purposes; vitamin preparations; diagnostic preparations for medical purposes; bath preparations for medical purposes; therapeutic preparations for the bath; hemorrhoid preparations; preparations for callouses; acne treatment preparations; preparations to facilitate teething; preparations for the treatment of burns; fumigation preparations for medical purposes; opotherapy preparations; air purifying preparations; eye-washes; bronchodilating preparations; preparations for reducing sexual activity; sterilising preparations; soil-sterilising preparations; corn remedies; pharmaceutical preparations for treating dandruff; preparations for destroying noxious animals; herbicides; preparations for destroying dry rot fungus; larvae exterminating preparations; fly destroying preparations; preparations for destroying mice; slug exterminating preparations; vermin destroying preparations; pharmaceutical preparations for skin care; contact lens cleaning preparations; lime-based pharmaceutical preparations; preparations of microorganisms for medical or veterinary use; chilblain prepa-

rations; medicinal hair growth preparations; opiates; mothproofing preparations; anticryptogamic preparations; aloe vera preparations for pharmaceutical purposes; preparations of trace elements for human and animal use; sulfonamides [medicines]; pharmaceutical preparations; pharmaceutical preparations for treating sunburn; enzyme preparations for veterinary purposes; enzyme preparations for medical purposes; chemico-pharmaceutical preparations; chemical preparations for veterinary purposes; chemical preparations for the diagnosis of pregnancy; chemical preparations for medical purposes; chemical preparations to treat wheat blight [smut]; vine disease treating chemicals; chemical preparations to treat mildew; chemical preparations for treating phyloxera; chemical preparations for pharmaceutical purposes; collyrium; lead water; chemical conductors for electrocardiograph electrodes; albuminous foodstuffs for medical purposes; dietetic foods adapted for medical purposes; by-products of the processing of cereals for dietetic or medical purposes; pharmaceuticals; sanitary towels; sanitary pads; panty liners [sanitary]; propolis for pharmaceutical purposes; pearl powder for medical purposes; radium for medical purposes; solvents for removing adhesive plasters; hydrated chloral for pharmaceutical purposes; vaginal washes; solutions for contact lenses; chemical reagents for medical or veterinary purposes; gum for medical purposes; rubber for dental purposes; chewing gum for medical purposes; insect repellents; insect repellent incense; repellents for dogs; tissues impregnated with pharmaceutical lotions; sarsaparilla for medical purposes; sugar for medical purposes; asthmatic tea; fumigating sticks; suppositories; linseed for pharmaceutical purposes; tobacco-free cigarettes for medical purposes; milking grease; turpentine for pharmaceutical purposes; siccatives [drying agents] for medical purposes; syrups for pharmaceutical purposes; greases for veterinary purposes; greases for medical purposes; lacteal flour for babies; infant formula; soporifics; bicarbonate of soda for pharmaceutical purposes; mineral water salts; bath salts for medical purposes; salts for mineral water baths; salts for medical purposes; potassium salts for medical purposes; sodium salts for medical purposes; smelling salts; malt for pharmaceutical purposes; semen for artificial insemination; alcohol for pharmaceutical purposes; medicinal alcohol; alloys of precious metals for dental purposes; ergot for pharmaceutical purposes; cooling sprays for medical purposes; adjuvants for medical purposes; styptic preparations; vermifuges; disinfectants; disinfectants for hygiene purposes; disinfectants for chemical toilets; douching preparations for medical purposes; appetite suppressants for medical purposes; medical preparations for slimming purposes; parasiticides; mouthwashes for medical purposes; febrifuges; depuratives; animal washes; detergents for medical purposes; cattle washes; dog was-

hes; vesicants; purgatives; chemical contraceptives; antiparasitic preparations; remedies for perspiration; remedies for foot perspiration; sedatives; laxatives; digestives for pharmaceutical purposes; tonics [medicines]; nervines; media for bacteriological cultures; steroids; strychnine; serums; antioxidant pills; tanning pills; appetite suppressant pills; slimming pills; jujube, medicated; sanitary tampons; vulnerary sponges; thymol for pharmaceutical purposes; biological tissue cultures for veterinary purposes; biological tissue cultures for medical purposes; smoking herbs for medical purposes; medicinal herbs; transplants [living tissues]; surgical implants comprised of living tissues; pants, absorbent, for incontinents; sanitary panties; babies' napkin-pants [diaper-pants]; charcoal for pharmaceutical purposes; fennel for medical purposes; porcelain for dental prostheses; phenol for pharmaceutical purposes; enzymes for veterinary purposes; enzymes for medical purposes; ferments for pharmaceutical purposes; formic aldehyde for pharmaceutical purposes; phosphates for pharmaceutical purposes; fungicides; quinine for medical purposes; chinoline for medical purposes; diabetic bread adapted for medical use; chloroform; flowers of sulfur for pharmaceutical purposes; cement for animal hooves; bone cement for surgical and orthopaedic purposes; dental cements; medicinal tea; herbal teas for medicinal purposes; eucalyptus for pharmaceutical purposes; plant extracts for pharmaceutical purposes; tobacco extracts [insecticides]; extracts of hops for pharmaceutical purposes; elixirs [pharmaceutical preparations]; ethers for pharmaceutical purposes; esters for pharmaceutical purposes; cellulose esters for pharmaceutical purposes; cellulose ethers for pharmaceutical purposes; rat poison; poisons; bacterial poisons; jalap.

(260) AM 2018 95329 A
 (800) 1376603
 (151) 2017 08 29
 (891) 2017 08 29
 (731) Otkrytoe aktsionernoe obshchestvo
 "NIZHEGORODSKY MASLO-ZHIROVOY
 KOMBINAT"
 sh. Zhirkombinata, 11, RU-603950 g. Nizhny
 Novgorod, Russian Federation

(540)

Мамы доверяют

(591) Black, white
 (511)

3 – Petroleum jelly for cosmetic purposes; cotton sticks for cosmetic purposes; cotton wool for cosmetic purposes; sachets for perfuming linen; laundry wax; dentifrices; cosmetic creams; skin whitening creams; creams for leather; lotions for cosmetic purposes; beauty masks; oils for perfumes and scents; oils for cosmetic purposes; oils for toilet purposes; essential oils; essential oils of cedarwood; essential

oils of lemon; oils for cleaning purposes; bergamot oil; gaultheria oil; jasmine oil; lavender oil; almond oil; rose oil; oil of turpentine for degreasing; soap; deodorant soap; shaving soap; soap for brightening textile; cakes of toilet soap; antiperspirant soap; soap for foot perspiration; almond soap; cosmetic kits; toiletries; cosmetic preparations for baths; mouth washes, not for medical purposes; bleaching preparations and other substances for laundry use; laundry bleach; smoothing preparations [starching]; starch glaze for laundry purposes; laundry soaking preparations; cleaning, polishing, scouring and abrasive preparations; fabric softeners for laundry use; dry-cleaning preparations; color- [colour-] brightening chemicals for household purposes [laundry]; tissues impregnated with cosmetic lotions; cosmetics; sun-tanning preparations [cosmetics]; cosmetic preparations for skin care; antiperspirants [toiletries]; detergents, other than for use in manufacturing operations and for medical purposes; degreasers, other than for use in manufacturing processes; bath salts, not for medical purposes; bleaching salts; talcum powder, for toilet use; hair shampoos; hair lotions; aromatics [essential oils].

5 – Disinfectant soap; medicated soap.

(260) AM 2018 95369 A
 (800) 1376756
 (151) 2017 07 09
 (891) 2017 07 09
 (731) 24/7 APPS LTD.
 P.O.B. 134, Berotaim, 4285000 Emek Hefer,
 Israel
 (540)

ITUBE

(591) Black, white
 (511)

9 – Computer software for storage and playback of customized music playlist; downloadable application software for mobile phones, portable media players and handheld computers, namely, software for use in downloading and streaming audio materials.

(260) AM 2018 95377 A
 (800) 1377760
 (151) 2017 10 01
 (891) 2017 10 01
 (731) HEIFER PROJECT INTERNATIONAL, INC.
 One World Way Little Rock AR 72202, USA
 (540)



(591) Black and white
 (531) 03.04.01; 03.04.22; 03.04.24
 (511)
 36 – Charitable fundraising services.

41 – Educational services, namely, conducting classes, seminars and individual instruction in environmental training, namely, agriculture or animal husbandry.

(260) AM 2018 95378 A
 (800) 1377775
 (151) 2017 05 29
 (891) 2017 05 29
 (731) SPORT VISION D.O.O.
 Milentija Popovića 5v 11070 Novi Beograd,
 Serbia

(540)



(591) Black and white
 (531) 26.04.02; 26.04.09; 26.04.18; 26.04.24;
 27.05.21; 27.05.24

(511)
 18 – Animal skins; imitation leather; attaché cases; purses; vanity cases, not fitted; trunks and suitcases; traveling trunks; shoulder belts [straps] of leather; haversacks; bags, namely overnight bags, leather bags; overnight bags; clutch bags; sports bags; all-purpose carrying bags for use by campers; rucksacks for use by campers and climbers; sports bags; all-purpose carrying bags for use by climbers; backpacks; handbags; card-holders that are wallets; key cases; credit card cases [wallets]; wallets; school satchels; umbrellas and parasols.

24 – Gauze [cloth]; damask; pillow shams; fabric table runners and textile table cloths; elastic fabrics for clothing and elastic yarn mixed fabrics; textile labels; curtains of textile or plastic; shrouds; pillow-cases; buckram; linen cloths; handkerchiefs of textile; cloth, namely mattress covers; cloth, namely linen fabrics; place mats of textile; cotton fabrics; calico; furniture coverings of plastic; bath linen except clothing; textile linings, namely linings of textile for clothing; linen lining fabric for footwear; bed linen; covers for cushions; bed covers; silk fabrics; textiles, namely textile table mats and textile bathroom towels; household linen; fabrics for footwear; table linen not of paper; flannel [fabric]; sheets; table covers, namely table covers not of paper.

25 – Clothing, namely pants, stockings [clothing]; tops [clothing], shirts, dresses, underwear and socks, footwear, headgear, namely hats, caps; baseball caps; sun visor caps.

28 – Games, namely table games and action games; toys; namely action figures [toys]; construction toys

and fantasy characters as toys; quoits; bowling apparatus and machinery; tennis ball throwing apparatus; game articles, namely swimming pools, baseball gloves; billiard tables; billiard cues; bobsleighs; boxing gloves; punching bags; rowing boards in the form of paddle boards; sailboards; swimming kick boards; snowboards; surfboards; discuses for sports; drones [toys]; kites; masts for sailboards; ice skates; gut for fishing; snowshoes; billiard balls; play balls; bows for archery; fencing masks; ball-pitching machines; machines for physical exercises, namely elliptical ball-throwing machines, rowing machines and exercise machines; poles for pole vaulting; sole coverings for skis; swimming jackets; paragliders; flippers for swimmers; climbing harnesses; sports articles, namely weightlifting belts [sports articles]; swimming belts; sports articles, namely sling shots [sports articles]; fishing tackle; in-line roller skates; roller skates; golf gloves; games accessories, namely softball gloves; fencing gauntlets; sports articles, namely sleds for use downhill in amusement rides; skateboards; ski bindings; skis; skating boots with skates attached; body-building apparatus; starting blocks for sports; tables for table tennis; barbells; dumbbells; tennis nets; golf bags, with or without wheels; cricket bags; roulette wheels; sports articles, namely diving equipment in the form of spear fishing harp guns; hockey sticks; golf clubs; rackets, namely tennis rackets; squash rackets; badminton rackets; rods for fishing; sports articles, namely elbow guards; sports articles, namely knee pads; sports articles, namely shin guards; decorations for Christmas trees excluding electric Christmas lights and confectionery.

(260) AM 2018 95379 A
 (800) 1377809
 (151) 2017 08 03
 (891) 2017 08 03
 (731) VLAKTOR TRADING LIMITED
 Zinonos Kitieos, 8, Kato Lakatamia, 2322,
 Nicosia, Cyprus
 (540)



(591) Grey, green, yellow, brown, white, black.

(531) 19.07.01; 29.01.13
 (554) Three-dimensional
 (526) VODKA Original Recipe
 (511)
 33 – Vodka.

(260) AM 2018 95380 A
 (800) 1377814
 (151) 2016 12 28
 (891) 2016 12 28
 (731) HONDA MOTOR CO., LTD.
 1-1, Minami-Aoyama 2-chome, Minato-ku
 Tokyo 107-8556, Japan
 (540)



(591) Black and white
 (531) 26.04.02; 26.04.04; 26.04.18; 27.05.21
 (511)

1 – Unprocessed plastics [plastics in primary form]; unprocessed plastics in all forms; straw pulp; esparto pulp; kraft pulp [sulphate pulp]; chemiground wood pulp; chemi-mechanical pulp; thermomechanical pulp; chemical pulps; semichemical pulp; cellulose pulp; soda pulp; rag pulp; rayon pulp; sulphite pulp; sulfite pulp; paper pulp; recycled paper pulp; groundwood pulp; wood pulp; wood pulp for manufacturing purposes; dissolving pulp; bast pulp; special fine groundwood pulp; ordinary groundwood pulp; chemical agents for hardening wood; chemical agents for use in metal cutting; chemical agents for acid removal in industrial manufacturing applications; chemical agents for carbon dioxide sequestration; chemical agents for coating textiles, furs, leather, non-woven and woven fabrics; chemical agents for impregnating cut Christmas trees to preserve freshness; chemical agents for impregnating cut flowers to preserve freshness; chemical agents for impregnating textiles, furs, leather, non-woven and woven fabrics; chemical agents for manufacturing dyestuffs; chemical agents for removing acid in industrial manufacturing applications; chemical agents for the flame-retardant coating of textiles; chemical agents for the treatment of bilge water; surface-active chemical agents; chemical additives for fuel [chemical]; chemicals; plant growth regulating preparations; glue and adhesives, other than for office or household purposes; higher fatty acids; actinium; americium; antimony; ytterbium; yttrium; uranium; erbium; gadolinium; gallium; californium; curium; samarium; dysprosium; silicon [metal element]; me-

rcury; scandium; strontium; caesium; cesium; cerium; selenium; bismuth; thallium; thulium; technetium; terbium; tellurium; thorium; neodymium; neptunium; berkelium; barium; fermium; praseodymium; francium; plutonium; protactinium; promethium; holmium; europium; radium; lanthanum; lithium; rubidium; rhenium; radium for scientific purposes; fissionable chemical elements; cassiopium [lutetium]; rare earth metals; fissionable material for nuclear energy; polonium; lutetium [cassiopium]; mischmetal; rare earths; sulfur [non-metallic minerals]; sulphur [non-metallic minerals]; foundry sand; kaolin; China clay; China slip; calcined kaolin for industrial purposes; talc; rock salt; diatomaceous earth; kieselgur; diatomite; acid clay; barytes (barite, heavy spar); saltpeter [salpetre]; graphite for industrial purposes; artificial graphite for industrial purposes; artificial graphite for secondary cell batteries; natural graphite; natural graphite for industrial purposes; graphite in raw or semi-finished form for use in manufacture; dolomite; dolomite for industrial purposes; cryolite; bentonite; bauxite; fluorite [fluorspar]; magnesite; alunite; rock phosphate; kainite; olivine [silicate mineral]; spinel [oxide mineral]; talc [magnesium silicate]; titanite; witherite; loam; huntite; hydromagnesite; kieserite; mineral substances used to oxidize impurities and regulate temperatures in glass production furnaces; siliceous ooze; flour and starch for industrial purposes; fertilizers; fertilising preparations; manures; chemical compositions for developing, printing and enlarging photographs; chemical compositions for use in developing photographs; reagent paper; chemical test paper; artificial sweeteners [chemical preparations]; ceramic glazings; wallpaper removing preparations.

2 – Paints; coatings [paints]; coating compositions in the nature of paint; anti-rust greases; dyestuffs; dyes; pigments; printing ink; printing compositions [ink]; printers' pastes [ink]; colors for painting pictures; nonferrous metals in foil or powder form for painters, decorators, printers and artists; precious metals in foil or powder form for painters, decorators, printers and artists; Canada balsam [raw natural resin]; copal; sandarac; shellac; pine oil; dammar; mordants; mastic; pine gum; wood preservatives.

3 – Soaps and detergents; soap products; polishing preparations; paint stripping preparations; paint removing compositions; perfume and flavour extracts; cosmetics; cosmetic preparations; cosmetic kits; adhesives for affixing false hair; false nails; false eyelashes; artificial eyelashes; adhesives for affixing false eyelashes; dentifrices; anti-static preparations for household purposes; de-greasing preparations for household purposes; degreasers other than for use in manufacturing processes; rust removing preparations; stain removing benzene; fabric softeners for laundry use; laundry fabric conditioner; laundry starch; starch for laundry purposes; laundry bleach; ble-

aching preparations for laundry use; laundry bleaching preparations; seaweed gelatine for laundry use [funori]; abrasive paper [sandpaper]; abrasive cloth; abrasive sand; artificial pumice stone; pumice stone; pumice stones for personal use; polishing paper; shoe and boot cream; shoe black [shoe polish]; breath freshening preparations; breath fresheners; deodorants for animals.

4 – Mineral oils and greases for industrial purposes [not for fuel]; non-mineral oils for industrial purposes [not for fuel]; industrial oil; non-mineral oils and greases for industrial purposes [not for fuel]; fuels; waxes [raw material]; grease for shoes and boots; solid lubricants; solid lubricants for industrial purposes; leather preserving oil and grease; lamp wicks; candles; candles for night lights; nightlights [candles].

5 – Babies' diapers of paper; pharmaceutical preparations; reagent paper for medical purposes; dental materials; dietary supplements for humans; dietetic beverages adapted for medical purposes; dietetic food adapted for medical purposes; beverages for babies; food for babies; dietary supplements for animals; semen for artificial insemination.

6 – Metal keys for locks; keys; rings of metal for keys; liquefied gas storage tanks of metal; metal nameplates and door nameplates; tool boxes of metal (empty); upright signboards of metal; metal carabiners; sculptures of metal; sculptures of common metal; iron and steel; metal materials for building or construction; prefabricated building assembly kits of metal; prefabricated sectional poultry houses of metal; metal moulds for forming cement products; metal junctions for pipes; metal pipe couplings; metal pipe joints; pipe couplings of metal; metal flanges; metallic flanges; metal keys for machines; metal cotter pins; beacons of metal [non-luminous]; containers of metal for transport; wire ropes; wire nets and gauzes; chicken wire; wire gauze; wire mesh; industrial packaging containers of metal [not including "metal stoppers, lids and caps"]; transportable greenhouses of metal for household use.

7 – Loading-unloading machines and apparatus; non-electric prime movers, not for land vehicles; pneumatic or hydraulic machines and instruments; agricultural machines, agricultural implements other than hand-operated; starters for motors and engines; AC motors and DC motors [not including those for land vehicles but including "parts" for any AC motors and DC motors]; AC generators [alternators]; alternators; DC generators; direct current generators; lawnmowers; dethatchers [machines]; dishwashers; painting machines and apparatus; vehicle washing installations; vehicle washing machines; washing installations for vehicles; waste compacting machines and apparatus; waste crushing machines; machine elements [not for land vehicles]; metalworking ma-

chines and tools; mining machines and apparatus; construction machines and apparatus; chemical processing machines and apparatus; textile machines and apparatus; food or beverage processing machines and apparatus; lumbering, woodworking, or veneer or plywood making machines and apparatus; pulp making, papermaking or paper-working machines and apparatus; printing or bookbinding machines and apparatus; packaging or wrapping machines and apparatus; plastic processing machines and apparatus; semiconductor manufacturing machines and systems; rubber manufacturing machines; stone working machines and apparatus; parts of non-electric prime movers for land vehicles; industrial fishing machines; sewing machines; sewing machinery; glassware manufacturing machines and apparatus; shoe making machines; leather tanning machines; tobacco processing machines; adhesive tape dispensing machines; automatic stamping machines; mechanical parking systems; repairing or fixing machines and apparatus; machines and apparatus for wax-polishing, electric; washing machines [laundry]; electric washing machines; vacuum cleaners; sweepers, electric; electric vacuum cleaners; dynamo brushes; electric food blenders [for household purposes]; curtain drawing devices electrically operated; power-operated potters' wheels; potters' wheels; fuel dispensing machines for service stations; vending machines; distribution machines, automatic; automatic vending machines; arc welding machines; electric metal cutting machines (by arc, gas or plasma); electric welding apparatus; welding torches, electric; electric door openers; boilers for non-electric prime movers and engines; power sprayers for disinfecting insecticides and deodorants [not for agricultural purposes]; 3D printers.

8 – Hand tools; bladed or pointed hand tools; edge tools [hand tools]; hoes [hand-held]; digging forks [spading forks]; lawn rakes [hand-held ones only]; braiders [hand-held ones only]; lasts for shoe-making [hand-held ones only]; electric razors and electric hair clippers; shaving cases; pedicure sets; manicure sets; non-electric planes for flaking dried bonito blocks [katsuo-bushi planes]; sugar tongs; can openers [non-electric]; nut crackers not of precious metal; spoons; forks [cutlery]; flat irons, non-electric; needle-threaders; dressmakers' chalk sharpeners; diving knives; diving knife holders; ice axes; insecticide atomizers [hand tools]; insecticide sprayers [hand tools]; insecticide vaporizers [hand tools]; fire pans for carrying live charcoal [juno]; palette knives; fire tongs; tweezers; electric flat irons; nut crackers of precious metal; bludgeons.

9 – Electronic machines, apparatus and their parts; telecommunication machines and apparatus; electrical communication machines and instruments; telecommunication devices and apparatus; telecommunication apparatus and instruments; telecommuni-

cations equipment; batteries and cells; electrical cells and batteries; power distribution or control machines and apparatus; electric wires and cables; electric conductors; electric or magnetic meters and testers; measuring or testing machines and instruments; simulators for the steering and control of vehicles; vehicle drive training simulators; vehicle driving simulators for training purposes; simulators for driving or control of vehicles; protective helmets; safety helmets; crash helmets; exposed cinematographic films; exposed slide films; slide film mounts; recorded video discs and video tapes; blueprint apparatus; blueprinting machines; laboratory apparatus and instruments; tilting heads [for cameras]; cameras; cameras [photography]; tripods for cameras; camera shutters; shutters [photography]; lens filters for cameras; filters [photography]; camera lenses; range finders [for cameras]; photo-developing, printing, enlarging or finishing machines and apparatus; bellows for cameras; spools for cameras; spools [photography]; slide projectors; transparency projection apparatus; self-timers [for cameras]; photographic flash units [for cameras]; flash lamps [for cameras]; photographic viewfinders; viewfinders [for cameras]; lens hoods [for cameras]; flash guns [for cameras]; film magazines for cameras; shutter releases [for cameras]; shutter releases [photography]; exposure meters [light meters]; carriers for dark plates [photography]; darkroom lamps [photography]; darkrooms [photography]; diaphragms [photography]; drying racks [photography]; enlarging apparatus [photography]; flash-bulbs [photography]; flashlights [photography]; screens [photography]; speed measuring apparatus [photography]; washing trays [photography]; photographic equipment; photographic apparatus and instruments; cinematographic machines and apparatus; cinematographic apparatus and instruments; optical machines and apparatus; spectacles [eyeglasses and goggles]; eyewear; eyeglasses; optical glass; life saving apparatus and equipment; phonograph records; ozonisers [ozonators]; electrolyzers [electrolytic cells]; sports training simulators; rotary converters; phase modifiers; electric buzzers; buzzers, electric; railway signal apparatus, luminous or mechanical; railway signals; vehicle breakdown warning triangles; luminous or mechanical road signs; road signs, luminous or mechanical; fire alarms; gas alarms; gas leak alarms; gloves for protection against accidents; fire extinguishers; fire extinguishing apparatus; fire hose nozzles; fire engines; fire trucks; fire boats; sprinkler systems for fire protection; anti-theft warning apparatus; burglar alarms; fireproof garments; dust masks; dust protective masks; gas masks; magnetic cores; resistance wires; cathodes; anodes; cathodic anti-corrosion apparatus; electrodes for laboratory research; fuel cell electrodes; collectors, electric; anticathodes; welding masks; mechanisms for coin-operated car parking gates; cash registers; calculating scales; sliderules;

coin counting or sorting machines; electric sign boards for displaying target figures, current outputs or the like; photocopying machines; photocopying apparatus; manual calculating machines; mathematical instruments; time and date stamping machines; time clocks [time recording devices]; computers; electronic calculators; punched card office machines; voting machines; billing machines; postage stamp checking apparatus; weight belts [for scuba diving]; air tanks [for scuba diving]; breathing apparatus for underwater swimming; decompression chambers; diving helmets; rebreathers for diving; underwater breathing apparatus; regulators [for scuba diving]; egg-candlers; metronomes; electronic key holders; readers and encoders; electronic keys; ear plugs for divers; electronic navigational and positioning apparatus and instruments; navigational instruments; navigation apparatus for vehicles [on-board computers]; computer software; helmets for motorcyclists; socks, electrically heated.

10 – Contraceptives, non-chemical; contraceptive devices; contraceptive apparatus; artificial tympanic membranes; prosthetics or filling materials [not for dental use]; ear plugs for sleeping; ear plugs for soundproofing; ear plugs for protection against noise; medical apparatus and instruments [other than walking aids, crutches]; gloves for medical purposes; gloves for use in hospitals; ear plugs for swimming.

11 – Electric lamps and other lighting apparatus; gas water heaters [for household purposes]; gas-fired water heaters; freezing machines and apparatus; heat exchangers [for chemical processing]; air-conditioning apparatus [for industrial purposes]; solar water heaters; water purifying apparatus; water purification units; electrically heated carpets for household purposes; electric cooking pots for household purposes; electric coffee makers for household purposes; electric coffee machines for household purposes; Japanese electric leg-warming apparatus for household purposes [electric Kotatsu]; electric cooking stoves for household purposes; laundry dryers, electric, for household purposes; clothes drying machines, electric, for household purposes; electric humidifiers for household purposes; electric air purifiers for household purposes; electric dehumidifiers for household purposes; electric fans for household purposes; electric fans for personal use; electric water ionizers for household purposes; electric futon driers for household purposes; electric hot plates for household purposes; electric space cooling apparatus for household purposes; electric range hoods [extractor hoods] for household purposes; electric water purifiers for household purposes; water purifiers for household purposes, electric; electric radiant heaters for household purposes; electric footwarmers for personal use; electric toasters for household purposes; electric bread toasters for household purposes;

automatic bread-making machines for household purposes; Japanese hand warming apparatus for household purposes [electric Hibachi]; electric sleeping mattresses for household purposes; electric therm pots for household purposes; electric kettles for household purposes; blankets, electric, for household purposes; electric blankets for household purposes; electric refrigerators for household purposes; electric freezers for household purposes; electromagnetic induction cookers for household purposes; electric cooking ovens for household purposes; microwave ovens [cooking apparatus] for household purposes; microwave ovens for household purposes; electric cooking ovens for household purposes; electric bath-water purifying apparatus for household purposes; steam sterilizers for household purposes; electric shoe dryers for household purposes; electric egg steamers for household purposes; electrically heated carpets; heating pads [cushions], electric, not for medical purposes; blankets, electric, not for medical purposes; electric space heating apparatus for household purposes; heating cushions [pads], electric, not for medical purposes; footmuffs, electrically heated; immersion heaters; heaters, electric, for feeding bottles; facial equipment using ultrasonic waves for household purposes; hair dryers [for household purposes]; household tap-water filters; water purifiers for household use; water purifying apparatus for household purposes; waste water treatment tanks [for industrial purposes]; garbage incinerators; standing paper lanterns [andon]; freestanding paper lanterns; lamps of glass; oil lamps; portable paper lanterns [chochin]; Chinese lanterns; lamp chimneys; industrial furnaces; nuclear reactors [atomic piles]; atomic piles; Japanese charcoal heaters for household purposes [hibachi]; boilers, other than parts of machines; boilers [other than parts of non-electric prime movers, engines]; kitchen worktops with integrated sinks; kitchen sinks; sinks; gas cooking ovens [for household purposes]; Japanese kitchen furnaces for household purposes [Kamado]; Japanese charcoal cooking stoves for household purposes [Shichirin]; oil cooking stoves for household purposes; non-electric baking ovens for household purposes; non-electric barbecue grills for household purposes; deep fryers for commercial use; industrial deep fryers; dish drying machines for commercial use; industrial dish drying machines; rice cookers for commercial use; industrial rice cookers; electric cooking pots for commercial use; roasters for commercial use; electric roasters for industrial purposes; cooking ovens for commercial use; commercial cooking ovens; industrial cooking ovens; ice chests (for household purposes, non-portable); ice boxes; ice chests; non-portable ice chests for household purposes; non-portable ice chests for household use; ice-cooling refrigerators [for household purposes]; forage drying apparatus; milk sterilizers; drying apparatus [for chemical processing]; desiccating apparatus; recupera-

tors [for chemical processing]; steamers [for chemical processing]; evaporators [for chemical processing]; distillers [for chemical processing]; distillation apparatus; toilet bowls and seats sold as a unit; toilets [water-closets]; prefabricated bathrooms sold as a unit; towel steamers for hair salons; hair drying machines for beauty salon use; hair dryers for use in beauty salons; hair steamers for beauty salon use; hair steamers for use in beauty salons; shampoo basins for barbers' shop use; bath fittings; washers for water taps; tap water faucets; level controlling valves for tanks; level controlling valves in tanks; pipe line cocks [spigots]; waste water treatment tanks for household purposes; septic tanks for household purposes; septic tanks [for industrial purposes]; toilet stool units with a washing water squirter; disinfectant dispensers for toilets; toilet bowls; seatings for use with Japanese style toilet bowls; warming pans [non-electric]; pocket warmers [nonelectric]; Japanese pocket warmers filled with fuel; hot water bottles [for warming one's feet in bed]; non-electric hot water bottles; hot water bottles; ventilators for toilets, non-electric; fire hydrants.

12 – Vessels and their parts and fittings; aircraft and their parts and fittings; automobiles and their parts and fittings; two-wheeled motor vehicles, bicycles and their parts and fittings; three-wheeled electric vehicles and their parts and fittings; baby carriage [prams]; wheelchairs; rickshaws; sleighs [vehicles]; trolleys; hand trucks; trolleys [mobile carts]; wheel barrows; carts; horse drawn carriages; bicycle trailers [riyakah]; aerial conveyors; car dampers; mine-car pushers; mine-car pullers; traction engine; internal combustion engines for land vehicles; gasoline engines for land vehicles; diesel engines for land vehicles; diesel motors for land vehicles; kerosene engines for land vehicles; steam engines for land vehicles; steam engines for railway rolling stock, automobiles and motorcycles; jet engines for land vehicles; turbojet engines for land vehicles; ramjet engines for land vehicles; turboprop engines for land vehicles; turbines for land vehicles; steam turbines for land vehicles; air turbines for land vehicles; gas turbines for land vehicles; automobile engines; motorcycle engines; motors for bicycles; bicycle motors; propulsion mechanisms for land vehicles; engine mounts for land vehicles; engines for land vehicles; driving motors for land vehicles; motors for land vehicles; jet engines for land vehicles; machine elements for land vehicles; AC motors or DC motors for land vehicles [not including "their parts"]; adhesive rubber patches for repairing tubes or tires; anti-theft alarms for vehicles; cigar lighters for automobiles; railway rolling stock and their parts and fittings; parachutes; space vehicles.

13 – Firearms; ammunition for firearms; ammunition; gunpowder; blasting powder; blasting explosives; pyrotechnic products and their peripherals.

14 – Personal ornaments [other than "cuff links"]; clocks and watches; trophies [prize cups]; commemorative shields; keyrings [trinkets or fobs]; key chains [trinkets or fobs]; precious metals; jewel cases of precious metal; unwrought and semi-wrought precious stones and their imitations; precious stones and their imitations, unwrought and semi-wrought; non-monetary coins; collectible coins; monetary coin sets for collecting purposes; watches for sporting use; sports watches; wrist watches; Omamori [lucky charms].

15 – Tuning apparatus for musical instruments; tuners for musical instruments.

16 – Paper and cardboard; containers of paper, for packaging; industrial packaging containers of paper; food wrapping plastic film for household use; garbage bags of paper [for household purposes]; garbage bags of plastics [for household purposes]; hygienic hand towels of paper; paper patterns; towels of paper; paper towels; paper washcloths; tablecloths of paper; paper tablecloths; table napkins of paper; paper serviettes; hand towels of paper; paper hand-towels; banners of paper; flags of paper; paper bunting; handkerchiefs of paper; tailors' chalk; baggage tags; printed matter; paintings and calligraphic works; photographs; photographic prints; photographs [printed]; photograph stands; stationery; pastes and other adhesives for stationery or household purposes; addressing machines; printers' reglets [interline leads]; printers' reglets; ink ribbons; printing type; letters [type]; printer's type; type [numerals and letters]; typeface; hectographs; automatic stamp affixing machines; electric staplers for offices; envelope sealing machines for offices; sealing machines for offices; stamp obliterating machines; stamp cancelling machines; drawing instruments; drafting instruments; decorators' paintbrushes; typewriters; office check writing machines; mimeographs; relief duplicators; paper shredders [for office use]; sealing wax; marking templates; franking machines for office use; franking machines [postage meters]; postage meters for office use; rotary duplicators; stickers [stationery]; printed paper for lot, other than toy; printed lottery tickets [other than toys]; cardboard for keeping shape of socks; old banknotes, other than those for use as currency; rulers [for stationery and office use]; writing implements [writing instruments]; writing materials; writing utensils; books; omikuji [sacred lots] [printed strips of paper used for fortune telling].

17 – Gaskets; junctions for pipes [not of metal]; non-metal pipe couplings and joints; pipe couplings and joints, not of metal; pipe couplings, not of metal; pipe joints, not of metal; joint packings; graphite packing for gaskets; graphite packing for pumps; graphite packing for valves; joint packings for pipes; waterproof packings; floating anti-pollution barriers; synthetic fibers, not for textile use; regenerated fi-

bers, not for textile use; semi-synthetic fibers, not for textile use; plastic fibers [fibres], not for textile use; plastic fibers, not for use in textiles; aramid fibers for use in the manufacture of elevator cables; aramid fibers, not for textile use; plastic fibers for use in the manufacture of tire cord; rock wool; slag wool; rubber thread and covered rubber yarn, not for textile use; regenerated fiber thread and yarn, not for textile use; industrial packaging containers of rubber; plastic sheeting for agricultural purposes; rubber [raw or semi-worked]; soundproofing materials of rock wool [not for building purposes]; asbestos yarn.

18 – Purses of precious metal; wallets of precious metal; purses made of precious metal; bags; folding briefcases; shoulder bags; gladstone bags; Japanese wicker trunks (kori); wicker trunks [kori]; briefcases; book bags; suitcases; carry-on bags; trunks; handbags; schoolchildren's backpacks; randsels [Japanese school satchels]; rucksacks; backpacks [rucksacks]; pouches; charm bags [omamori-ire]; card cases [notecases]; card wallets; shopping bags [including "wheeled shopping bags"]; purses; key cases; key wallets; money pouches; wallets; commutation-ticket holders; business card cases; name card cases; vanity cases [not fitted]; unfitted vanity cases; vanity cases sold empty; umbrellas and their parts; leather and fur (unworked or semi-worked); handbag frames; purse frames; purse frames [handbags]; walking sticks; canes; walking staffs; walking sticks; handles for canes and walking sticks; metal parts of canes and walking sticks; saddlery; clothing for domestic pets; industrial packaging containers of leather; leather cloth.

19 – Man-made garden ponds [structures, not of metal]; ceramic building materials, bricks and refractory products; building materials made of linoleum for fixing to existing walls or floors; plastic building materials; building materials of synthetics; asphalt, and asphalt building or construction materials; rubber building or construction materials; plaster [for building purposes]; lime building or construction materials; building or construction materials of plaster; rockslide retention nets of textiles [construction materials]; buildings, not of metal; erosion control mats integrating plant seeds; plastic security windows allowing communication; road and field marking sheets and strips; cement and its products; building timber; building stone; poultry houses, not of metal; moulds for forming cement products [not of metal]; beacons [not of metal, non-luminous]; stone lanterns [garden ornaments of stone]; transportable greenhouses [not of metal] for household use; non-metal transportable greenhouses for household use; boards and powder of inorganic fiber; plaster boards; plasterboard; slag.

20 – Paper blinds; furniture; industrial packaging containers of wood, bamboo or plastics; loading pallets [not of metal]; handling pallets, not of metal;

pallets, not of metal; wind chimes; indoor textile window blinds; reservoirs [not of metal or masonry]; storage tanks, not of metal or masonry; tanks, not of metal nor of masonry; valves of plastics [not including machine elements]; valves of plastic, other than machine parts; curtain fittings; metal-substitute plastic fasteners; nails, wedges, nuts, screws, tacks, bolts, rivets and casters [not of metal]; washers [not of metal, not of rubber or vulcanized fiber]; locks [non-electric, not of metal]; Buddhist mortuary tablets [Ihai]; household shinto altars [Kamidana]; Shintoist family altars [Kamidana]; funerary urns; Shintoist upright tubular vases for Sakaki tree twigs [Sakaki-tate]; offering stands for Shintoism [Sanboh]; Buddhist prayer beads [Juzu]; coffin fittings; ritual flower stands; caskets; coffins; funerary caskets; coffin fittings, not of metal; Buddhist family altars [Butsudan]; Shintoist sake-offering porcelain bottles [Heiji]; portable shrines for Shintoism [Mikoshi]; water-offering porcelain pots for Shintoism [Mizutama]; hollow wood blocks for beating when reciting Buddhist sutra [Mokugyo]; Buddhist hanging lanterns [Rinto]; beehives [hive boxes or honeycombs]; cushions [furniture]; cushions in the nature of furniture; Japanese floor cushions [zabuton]; pillows; mattresses; mattress cushions; futon mattresses; beds for household pets; advertising balloons; inflatable publicity objects; dog kennels; hand-held flat fans; hand-held supermarket shopping baskets, not of metal; picture frames; water tanks for household purposes [not of metal or masonry]; step ladders and ladders [not of metal]; tool boxes [not of metal]; tool boxes, not of metal [furniture]; nesting boxes for small birds; embroidery frames and hoops; stakes for plants or trees; artificial model food samples; blinds of reed, rattan or bamboo [sudare]; sleeping bags [for camping]; hand-held folding fans; bead curtains for decoration; decorative bead curtains; towel dispensers [not of metal]; oriental single panel standing partition [tsutate]; nameplates and door nameplates [not of metal]; flagpoles; hanging boards [Japanese style pegboards using positional hooks]; oriental folding partition screens [byoubu]; benches; hat hooks [not of metal]; mannequins; straw plaits; upright signboards of wood or plastics; letter boxes [not of metal or masonry]; cradles; infant walkers; costume display stands; hairdresser's chairs; barbers' chairs; plaster sculptures; plastic sculptures; sculptures of plastic; wooden sculptures; wood carvings; reeds [raw or partly worked material]; reed, raw or partly worked; rushes [raw or partly worked material]; onigaya hay [raw or partly worked material]; Japanese food wrapping sheets of wood as materials [kyogi]; ferns [unworked or partly worked material]; sedges [unworked or partly worked material]; vegetable aggregate for plaster [susa]; bamboo [unworked or partly worked material]; bamboo; bamboo skins [unworked or partly worked material]; vines; rattan [unworked or partly worked ma-

terial]; straw of wheat, barley or oats; tree barks; rice straw; tusks [raw or partly worked material]; whale-bones; shells; shells [unworked or partly worked material]; coral [unworked or partly worked]; artificial horns; ivory [unworked or partly worked material]; animal horns; animal teeth; tortoiseshells [unworked or partly worked material]; animal bone [unworked or partly worked material]; meerschaum [raw or partly worked material]; yellow amber; containers for transport [not of metal]; light-up frame in a shape of box for decoration purposes; bathroom stools.

21 – Tanks [indoor aquaria] and their fittings; unworked or semi-worked glass [not for building]; cooking pots and pans [non-electric]; coffee-makers [non-electric, not of precious metal]; non-electric coffee urns, not of precious metal; Japanese cast iron kettles, non-electric [tetsubin]; kettles [non-electric]; tea kettles; tableware, other than knives, forks and spoons, not of precious metal; dishware, not of precious metal; ice pails; whisks [non-electric]; beaters, non-electric; cooking skewers; portable coldboxes [non-electric]; cooking strainers; strainers; pepper pots, not of precious metal; sugar basins, not of precious metal; salt shakers, not of precious metal; egg cups, not of precious metal; napkin holders, not of precious metal; napkin rings not of precious metals; cabarets [trays], not of precious metal; toothpick holders, not of precious metal; kitchen containers for rice; salad bowls, not of precious metal; colanders; shakers; Japanese style cooked rice scoops [shamoji]; rice paddles [cooked rice serving scoops]; hand-operated coffee grinders and pepper mills; cooking funnels; funnels; food preserving jars of glass; drinking flasks [for travellers]; canteens; drinking flasks; water bottles sold empty; surikogi [wooden cooking pestles]; suribachi [articles of earthenware for household use]; Japanese style personal dining trays or stands [zen]; bottle openers, non-electric; cooking graters; tart scoops; hot pads [trivets]; chopsticks; chopstick cases; ladles and dippers for kitchen use; cooking sieves and sifters; chopping boards for kitchen use; carving boards; chopping boards; cutting boards; knife boards; vacuum bottles [insulated flasks]; insulated jars; insulating flasks; insulating jars; vacuum flasks; rolling pins [for cooking purposes]; cooking grills; toothpicks; lemon squeezers; waffle irons [non-electric]; cleaning tools and washing utensils; gloves for household purposes; household gloves for general use; cosmetic and toilet utensils; dental floss [floss for dental purposes]; dental flossers; floss for dental purposes; tub brushes; metal brushes; brushes for pipes; industrial brushes; ship-scrubbing brushes; pig bristles for brushes; clothes brushes; shoe brushes; shoe horns; shoe shine cloths; cloths for polishing shoes; shoe shine sponges and cloths; shoe-trees [stretchers]; industrial packaging containers of glass or porcelain; mangers for animals; feeding troughs; poultry rings;

ironing boards; flat-iron stands; feeding vessels for pets; brushes for pets; pet brushes; flower pots; planters [pots]; hydroponic plant pots for home gardening; cinder sifters for household purposes; boxes of metal for dispensing paper towels; empty spray bottles for tailoring; bootjacks; ironing boards [kotedai]; bird cages; bird baths; bird baths, not being structures; watering cans; chamber pots; coal scuttles; soap dispensers; money boxes, not of metal; non-metal piggy banks; toilet paper holder; toilet roll holders; toilet tissue holders; mouse and rat traps; fly swatters; hera-dai [fabric marking boards]; stirrers for hot bathtub water[yukakibo]; bathroom pails; candle extinguishers, not of precious metal; candle snuffers, not of precious metal; candle holders, not of precious metal; flower vases, not of precious metal; vases, not of precious metal; upright signboards of glass or ceramics; perfume burners; incense burners; portable cooking kits for outdoor use; flower bowls, not of precious metal; gotoku [trivets for Japanese charcoal heaters for household purposes]; Japanese charcoal extinguishers [hikeshi-tsubo]; tableware, other than knives, forks and spoons, of precious metal; pepper pots of precious metal; sugar bowls of precious metal; salt shakers of precious metal; egg cups of precious metal; napkin holders of precious metal; napkin rings of precious metal; cabarets [trays] of precious metal; toothpick holders of precious metal; flower vases of precious metal; flower bowls of precious metal; candle extinguishers of precious metal; candle holders of precious metal; powder compacts of precious metal; drinking straws; trays, not of metal, for household purposes; polishing cloth; cold packs used to keep food and drink cold; cold packs for chilling food and beverages; reusable ice cubes.

22 – Raw textile fibers; textile fibers; netting [not of metal]; industrial packaging containers of textile; industrial packaging containers of straw; elastic bands for binding; tarpaulins [not for ships]; tarpaulins, not for use with vehicles; tents [not for camping]; sawdust; kapok; wood shavings; wood wool [wooden excelsior]; rice hulls; wax waste for stuffing; feathers and downs.

23 – Threads and yarns.

24 – Woven fabrics; knitted fabrics; felt and non-woven textile fabrics; oilcloth; gummed waterproof cloth; vinyl coated cloth; rubberized cloth; filtering materials of textile; woven textile goods for personal use; table napkins of textile; serviettes of textile; dish towels for drying; tea towels; mosquito nets; bedsheets; futon quilts; quilt covers for futon; futon ticks [unstuffed futon]; pillowcases [pillow slips]; pillow covers; blankets; seat covers of textile; wall hangings of textile; curtains; shower curtains; shower room curtains; table cloths [not of paper]; draperies [thick drop curtains]; toilet seat covers of textile; fitted toilet seat covers of textile; shrouds

[sheets for wrapping corpses]; shrouds for dressing a corpse for funeral [kyokatabira kimono]; black-and-white striped curtains; red-and-white striped curtains; labels of cloth; billiard cloth [baize]; banners and flags [not of paper].

25 – Clothing; ready-made clothing; garters; sock suspenders; suspenders [braces]; braces for clothing [suspenders]; trouser straps; waistbands; belts for clothing; belts made of leather; footwear [other than special footwear for sports]; masquerade costumes; clothes for sports; special footwear for sports; boots for sport; wetsuits; motorcyclists' clothing; boots for motorcycling; motorcycle gloves; sports caps and hats.

26 – Knitted raschel lace fabrics; embroidery lace fabrics; braids; tapes [haberdashery]; tassels [semi-finished]; ribbons; buttons and the like; needles; hosiery loom needles; knitting sticks; sewing boxes; dressmakers' impressing blades; sewing thimbles; pin and needle cushions; boxes, not of precious metal, for needles; eyelets for clothing; insignias for wear [not of precious metal]; badges for wear [not of precious metal]; buckles for clothing [clothing buckles]; clothing buckles; brooches for clothing; armband for holding sleeves; special sash clips for obi [obi-dome]; bonnet pins [not of precious metal]; ornamental adhesive patches for jackets; brassards; hair ornaments; false beards; false moustaches; hair curlers, non-electric; hair rollers, non-electric; shoe ornaments, not of precious metal; shoe eyelets; shoe laces; laces for footwear; metal fasteners for shoes and boots; metal fasteners for footwear; artificial flowers; artificial flower arrangements; shuttles for making fishing nets; electric hair curlers; boxes of precious metal for needles.

27 – Carpets for automobiles; automobile carpets; floor coverings; artificial turf; artificial lawn; wall hangings [not of textile]; non-textile wall hangings; tatami mats and the like; bath mats for wash places; gymnastic mats; exercise mats; wallpaper; wall coverings.

28 – Amusement machines and apparatus for use in amusement parks; handheld home video game consoles; playing cards; toys; dolls; sports equipment; fishing tackle; toys for domestic pets; slot machines [amusement machines]; slot machines [gaming machines]; inflatable swimming floats; swimming flutter boards; game machines and apparatus; go games; go board games; Japanese chess [shogi games]; dice; Japanese dice games [sugoroku]; sugoroku board games; dice cups; cups for dice; Chinese checkers games; Chinese checkers [games]; chess games; chess sets; checkers [checker sets]; checkers games; conjuring apparatus; apparatus for performing magic tricks; dominoes; mah-jong; mah jong games; billiard equipment; toys for domestic pets; wax for skis.

29 – Edible oils and fats; milk products; meat for human consumption [fresh, chilled or frozen]; meat; fresh, chilled or frozen edible aquatic animals (not live); seafood, not live; processed meat products; charcuterie; processed seafood products; fish products prepared for human consumption; processed fish products for human consumption; processed seafood; preserved pulses; processed vegetables and fruits; eggs; processed eggs; pre-cooked curry stew, stew and soup mixes; side-dish made of fermented soybean (name-mono); dried flakes of laver for sprinkling on rice in hot water [ochazuke-nori]; furikake [dried flakes of fish, meat, vegetables or seaweed]; fried tofu pieces [abura-age]; freeze-dried tofu pieces [kohri-dofu]; jelly made from devils' tongue root [konnyaku]; soya milk [milk substitute]; tofu; bean curd; fermented soybeans [natto]; formed textured vegetable protein for use as a meat substitute; unformed textured vegetable protein for use as a meat extender; frozen fruits; frozen vegetables.

30 – Seasonings [other than spices]; spices; coffee; coffee [roasted, powdered, granulated, or in drinks]; prepared coffee and coffee-based beverages; cocoa; cocoa [roasted, powdered, granulated, or in drinks]; prepared cocoa and cocoa-based beverages; unroasted coffee beans; unroasted coffee; tea; aromatic preparations for food [not from "essential oils"]; husked rice; rice; husked barley; flour; gluten for food; cereal preparations; processed cereals; processed grains; sandwiches; sushi; pizzas; fresh pizza; boxed lunches consisting of rice, with added meat, fish or vegetables; pre-packaged lunches consisting primarily of rice, and also including meat, fish or vegetables; meat pies; ravioli; confectionery; pastries; bread and buns; instant confectionery mixes; ice cream mixes; sorbet mixes [ices]; almond paste; yeast powder; koji [fermented malted rice]; yeast; baking powder; ice; water ice; binding agents for ice cream; binding agents for ice cream [edible ices]; meat tenderizers for household purposes; preparations for stiffening whipped cream; by-product of rice for food [sake lees]; Chinese stuffed dumplings [gyoza, cooked]; Chinese steamed dumplings [shumai, cooked]; fried balls of batter mix with small pieces of octopus [takoyaki]; steamed buns stuffed with minced meat (niku-manjuh); hamburgers [sandwiches]; hamburger sandwiches; hot dogs [sandwiches]; hot dog sandwiches; edible paper of gold; tea leaves [unprocessed].

31 – Edible seaweeds; unprocessed sugar crops; malt [not for food]; animal foodstuffs; animal feed; fodder; foodstuffs for animals; forage; seeds and bulbs; trees; live trees; grasses [plants]; turf [natural]; dried flowers; seedlings; saplings; flowers [natural]; potted dwarfed trees [bonsai]; live mammals, fish [not for food], birds and insects; silkworm eggs; cocoons for silkworm breeding; cocoons for egg production; eggs for hatching; urushi tree seeds.

32 – Beer; carbonated drinks [refreshing beverages]; soft drinks; fruit beverages and fruit juices; fruit drinks; vegetable juices [beverage]; whey beverages; extracts of hops for making beer.

33 – Japanese liquors [in general]; whisky; vodka; gin; brandy; rum; liquors; alcoholic fruit beverages; fruit wine; Chinese liquors [in general]; flavored liquors.

34 – Smokers' articles of precious metal; tobacco; smokers' articles, not of precious metal; matches; cigarette paper; cigarette-rolling papers.

35 – Advertising; advertising services; publicity; promoting the goods and services of others through the administration of sales and promotional incentive schemes involving trading stamps; business management analysis; business consultancy services; market canvassing; market canvassing services; market research; market research services; market research studies; market surveys; provision of information concerning commercial sales; business management of hotels; administrative hotel management; business management of hotels for others; preparation of financial statements; financial statement preparation; drawing up of statements of accounts; employment agencies; employment agency services; job placement; job placement services; staff placement services; auctioneering; auction services; conducting of auction sales; import-export agencies; import-export agency services; arranging newspaper subscriptions; arranging newspaper subscriptions for others; newspaper subscriptions; copying of documents; document copying; document copying services; document reproduction [photocopying services]; shorthand; shorthand secretarial services; shorthand services; providing business assistance to others in the operation of data processing apparatus namely, computers, typewriters, telex machines and other similar office machines; transcription; transcription services; office functions, namely filing, in particular documents or magnetic tape; reception services for visitors in buildings; publicity material rental; leasing of marketing materials; leasing of publicity and marketing materials; rental of publicity and marketing materials; rental of typewriters, copying machines and word processors; providing employment information; rental of vending machines; retail services for automobiles; retail services for electrical machinery and apparatuses; retail services for polishing preparations; retail services for mineral oils and greases for industrial purposes [not for fuel], non-mineral oils for industrial purposes [not for fuel], and industrial oils; retail services for floor coverings; providing information on newspaper articles; retail services or wholesale services for a variety of goods in each field of clothing, foods and beverages, and livingware, carrying all goods together; retail services or wholesale services for edible seaweeds; retail services or wholesale services for laver; retail services

or wholesale services for sugar crops; retail or wholesale services for tea leaves; retail services or wholesale services for malt; retail services or wholesale services for dietary supplements for humans; retail services or wholesale services for dietetic beverages adapted for medical purposes; retail services or wholesale services for dietetic food adapted for medical purposes; retail services or wholesale services for beverages for babies and food for babies; retail services or wholesale services for breath freshening preparations and deodorants for pets; retail services or wholesale services for pharmaceutical preparations and reagent paper for medical purposes; retail services or wholesale services for contraceptives; retail services or wholesale services for dental materials, artificial tympanic membranes, and prosthetics or fillings materials [not for dental use]; retail services or wholesale services for ear plugs [including ear plugs for infants]; retail services or wholesale services for ear plugs for sleeping during traveling; retail or wholesale services for poultry cages of metal and poultry houses, not of metal; retail or wholesale services for dietary supplements for animals; retail or wholesale services for animal foodstuffs; retail or wholesale services for seeds and bulbs; retail services or wholesale services for flowers[natural] and trees; retail services or wholesale services for metal materials for building or construction; retail services or wholesale services for flooring of ceramic; retail services or wholesale services for asphalt building or construction materials; retail services or wholesale services for rubber building or construction materials; retail services or wholesale services for plastic building materials; retail services or wholesale services for building materials of synthetic resins; retail services or wholesale services for transportable simplified house; retail services or wholesale services for erosion control mats integrating plants seeds; retail services or wholesale services for plastic security windows allowing communication; retail services or wholesale services for road and field marking sheets and strips; retail services or wholesale services for cement; retail services or wholesale services for building timber; retail services or wholesale services for building stone; retail services or wholesale services for pet animals.

36 – Issuing credit cards; guarantee and surety services for credit card users; brokerage services for issuing credit cards; providing information relating to credit card charges; brokerage for hire-purchase; brokerage services relating to hire-purchase; processing of installment sale payments; cash payment balance inquiry services and bank account balance inquiry services; monetary liability guarantee services; arranging of loans; financing and loan services; financing services; loan financing; loans [financing]; collection of debts; debt collection; debt collection agency services; debt collection services; money exchange [exchanging money]; currency exchange;

currency exchange services; exchanging money; monetary exchange; monetary exchange services; money exchange services; life insurance brokerage; life insurance underwriting; life insurance services; life insurance underwriting services; agencies for non-life insurance; claim adjustment for non-life insurance; non-life insurance underwriting; casualty insurance underwriting; insurance premium rate computing; management of buildings; agency services for the leasing or rental of buildings; leasing or renting of buildings; rental of buildings; purchase and sale of buildings; agency services for the purchase or sale of buildings; real estate appraisal and valuation; ad valorem appraisals of real estate; land management; real estate management services relating to land; agency services for the leasing or rental of land; leasing of land; land leasing; purchase and sale of land; agency services for the purchase or sales of land; providing information on buildings or land [real estate affairs]; providing real estate information; providing real estate information relating to property and land; financial assessment of company credit; business credit reporting services; charitable fund raising; charitable fund raising services; collection of charitable donations and charitable fund raising, for others; collection of monetary donations for charitable purposes; organization of charitable collections; acceptance of deposits [including substitute bond issuance] and acceptance of fixed interval installment deposits; discount of bills; domestic exchange settlement; acceptance of bills; securities lending; acquisition and transfer of monetary claims; safekeeping of valuables including securities and precious metals [safe deposit services]; safe deposit services; trusteeship of financial futures contracts; trusteeship of money, securities, monetary claims, personal property, land, rights on land fixtures, surface rights or lease on land; agencies for bond subscriptions; foreign exchange transactions; monetary exchange operations; foreign exchange trading; foreign exchange bureau; conducting foreign exchange transactions for others; letter-of-credit related services; agencies for collecting gas or electric power utility payments; buying and selling of securities; trading of securities index futures; trading of securities options and overseas market securities futures; agencies for brokerage of securities, securities index futures, securities options, and overseas market securities futures; agencies for brokerage of entrusting agents with on-commission trading in domestic markets of securities, securities index futures and securities options; agencies for brokerage of entrusting agents with on-commission trading in overseas markets of securities and securities index futures; securities underwriting; securities offering; brokerage services relating to securities subscription or offering; providing stock market information; stock exchange quotations; agencies for commodity futures trading; agencies for trading of commodity futures;

antique appraisal; art appraisal; precious stone appraisal; appraisal of precious stones; issue of tokens of value; tokens of value (issue of -); used automobiles appraisal; advisory services relating to tax planning; tax payment processing services; rental of paper money and coin counting or processing machines; rental of cash dispensers or automated-teller machines.

37 – Repair or maintenance of automobiles; repair or maintenance of two-wheeled motor vehicles; repair or maintenance of chemical processing machines and apparatus; repair or maintenance of non-electric prime movers, not for land vehicles; repair or maintenance of pneumatic or hydraulic machines and instruments; repair or maintenance of plowing machines and implements [other than "hand-held tools"]; repair or maintenance of cultivating machines and implements; repair or maintenance of harvesting machines and implements; repair or maintenance of starters for motors and engines; repair or maintenance of AC motors and DC motors [not including those for land vehicles]; repair or maintenance of AC generators [alternators] and DC generators; repair or maintenance of lawnmowers; repair or maintenance of vessels; aircraft repair or maintenance; repair of bicycles; bicycle repair; repair or maintenance of water purifying apparatus; repair or maintenance of electric lighting apparatus; repair or maintenance of measuring and testing machines and instruments; repair or maintenance of air-conditioning apparatus [for industrial purposes]; repair or maintenance of telecommunication machines and apparatus; repair or maintenance of computers, including electronic circuits and magnetic disks recorded with computer programs, central processing units and other peripheral apparatus; repair or maintenance of painting machines and apparatus; repair or maintenance of vehicle washing installations; repair or maintenance of burners; burner maintenance or repair; repair or maintenance of waste compacting machines and apparatus; repair or maintenance of waste crushing machines and apparatus; repair or maintenance of power distribution or control machines and apparatus; repair or maintenance of pumps; pump repair or maintenance; repair or maintenance of amusement machines and apparatus; rental of car-washing apparatus; general building construction works; dredging; construction and maintenance services relating to civil engineering; road paving; laying of paving; masonry; glass installation services; steel structure construction works; plastering; carpentry; carpentry services; tile laying, bricklaying or block laying; joinery; building reinforcing; painting; painting services; scaffolding; construction services in the nature of earthworks; construction services using concrete; upholstery; installation of metal sheets; building damp-proofing; roofing services; plumbing; machinery installation; drilling of wells; water well drilling; electrical installation services;

telecommunication wiring; thermal insulating for buildings; operation of building equipment; repair or maintenance of chick brooders; repair or maintenance of egg incubators; repair or maintenance of medical apparatus and instruments; repair or maintenance of medical machines and apparatus; repair or maintenance of printing or bookbinding machines and apparatus; repair or maintenance of movie projectors; repair or maintenance of photographic machines and apparatus; repair or maintenance of elevators [lifts]; repair or maintenance of fire alarms; repair or maintenance of gasoline station equipment; repair or maintenance of glassware manufacturing machines and apparatus; repair or maintenance of mechanical parking systems; repair or maintenance of milk filtering machines; repair or maintenance of milking machines; repair or maintenance of industrial dishwashers; repair or maintenance of industrial dish washing machines; repair or maintenance of electric washing machines for industrial purposes; repair or maintenance of industrial washing machines; repair or maintenance of shoe making machines and instruments; repair or maintenance of plant fiber processing machines and implements; repair or maintenance of fodder presses; repair or maintenance of fodder cutting machines; repair or maintenance of fodder cutters; repair or maintenance of fodder mixing machines; repair or maintenance of fodder mixers; repair or maintenance of cake-fodder crushing machines; repair or maintenance of fodder mills; repair or maintenance of industrial furnaces; repair or maintenance of mining machines and apparatus; repair or maintenance of sericultural machines and implements; repair or maintenance of vending machines; repair or maintenance of firearms; repair or maintenance of machines and apparatus for processing foods or beverages; repair or maintenance of office machines and equipment; repair or maintenance of office machines and apparatus; repair or maintenance of machines and apparatus for lumbering, wood-working, or veneer or plywood making; repair or maintenance of textile machines and apparatus; repair or maintenance of divers' apparatus; repair or maintenance of diving machines and apparatus; repair or maintenance of tobacco processing machines; repair or maintenance of boilers; repair or maintenance of freezing machines and apparatus; repair or maintenance of reservoirs; repair or maintenance of storage tanks; repair or maintenance of construction machines and apparatus; repair or maintenance of construction equipment; repair or maintenance of machines and apparatus for pulp-making, papermaking or paper-working; repair or maintenance of apparatus and instruments for use in beauty salons or barbers' shops; repair or maintenance of machines and apparatus for use in beauty salons or barbers' shops; repair or maintenance of packaging or wrapping machines and apparatus; repair or maintenance of packing or wrapping machines and apparatus; re-

pair or maintenance of sewing machines; repair or maintenance of consumer electric appliances; repair or maintenance of consumer electrical appliances; repair or maintenance of laboratory apparatus and instruments; repair of sports equipment; repair of toys or dolls; furniture restoration; repair of furniture; umbrella repair; repair or maintenance of gas water heaters; repair of non-electric cooking heaters; repair or maintenance of cooking pots and pans; repair or maintenance of musical instruments; repair of bags or pouches; safe maintenance or repair; shoe repair; setup or repair of locks; repair of toilet stool units with a washing water squirts; repair of toilet stool units with a washing water squirter; repair or maintenance of fishing tackle; clock and watch repair or maintenance; sharpening of scissors and kitchen knives; repair of billiard equipment; repair of billiard equipment and providing information relating thereto; repair of game machines and apparatus; repair of personal ornaments; repair of spectacles; repair or maintenance of bath fittings; repair or maintenance of bathtubs; fur care and repair; laundering; laundry services; washing; pressing of clothing; repair of tatami mats; clothing repair [mending clothing]; repair or maintenance of futon; chimney sweeping; cleaning of building exterior surfaces; window cleaning; carpet and rug cleaning; floor polishing; septic tank cleaning; reservoirs cleaning; storage tank cleaning; cleaning of storage tanks; street cleaning; bathtub and bath boiler cleaning; disinfecting of telephone hand-sets; vermin exterminating [other than for agriculture, horticulture or forestry]; rental of electric washing machines; rental of laundry washing machines; rental of construction machines and apparatus; rental of floor cleaning machines; rental of mops; rental of mining machines and apparatus; construction consultancy; repair or maintenance of railway rolling stock; repair or maintenance of fishing machines and instruments; repair or maintenance of metalworking machines and tools; repair or maintenance of rubber-goods manufacturing machines and apparatus; repair or maintenance of integrated circuits manufacturing machines and systems; repair or maintenance of semiconductor manufacturing machines and systems; repair or maintenance of plastic processing machines and apparatus; repair or maintenance of power-driven floor cleaning machines; repair or maintenance of water pollution control equipment; repair or maintenance of chemical plants; repair or maintenance of nuclear power plants; repair or maintenance of signboards; sterilization of medical apparatus and instruments; rental of drainage pumps; repair and maintenance of 3D printers; rental of dish drying machines for restaurants; rental of dish washing machines for industrial purposes.

38 – Communications by computer terminals; communications by electronic computer terminals; rental of telecommunication equipment including telepho-

nes and facsimile apparatus; leasing of telephone sets, facsimile and other communication equipment; rental of telephone sets, facsimile and other communication equipment; mobile telephone communication; telex services; telex transmission; telex transmission services; transmission of telexes; communications by telegrams; communications by telegraph; sending of telegrams; telegram transmission; telegraph services; transmission of telegrams; communications by telephone; telephone communications; telephone services; facsimile transmission; facsimile communication; communications by facsimile; television broadcasting; transmission of television programs; cable television broadcasting; radio broadcasting; transmission of radio programs; news agencies; news agency services.

39 – Railway transport; transport by rail; car transport; marine transport; boat transport; ocean shipping services; ship transport; vessel transport; air transport; air freight shipping services; air transport services; air transportation; transport by air; packaging of goods; packaging services; packing of cargo; packing of goods; cargo unloading; cargo handling; loading and unloading of goods; freight brokerage; rental of motor vehicles; leasing of three-wheeled vehicle; rental of three-wheeled vehicle; car rental; leasing of automobiles; rental of warehouse space; parking services; car park services; car parking; parking garage services; parking lot services; provision of parking spaces; vehicle parking services; provision of travel information, including provision of information about points of interest and historic sites; conducting of travel for package holidays; travel arrangement and reservation services [excluding those for lodging]; rental of wheelchairs; rental of bicycles; bicycle rental; rental of vessels; boat rental; rental of ships; rental of watercraft; airport services; electricity distribution; temporary safekeeping of personal belongings; brokerage for selling, purchasing or chartering of vessels; refloating of ships; ship piloting; piloting; escorting of travel tours; warehousing services; gas supplying [distribution]; gas supply services [distribution]; distribution of gas; water supplying [distribution]; water supply and distribution services; water supply; heat supplying [distribution]; heat supply services [distribution]; distribution of heat; providing vessel mooring facilities; provision of berthing facilities; rental of aircraft; aircraft rental; airplane rental; leasing of aircraft; rental of airplanes; rental of containers; rental of pallets; rental of packaging or wrapping machines and apparatus; provision of road and traffic information; vehicle-driving services; removal services; operating parking lots; rental of mechanical parking systems; rental of freezers for household purposes; rental of refrigerator-freezers for household purposes; correspondence delivery services; rental of aircraft engines; rental of freezing machines and apparatus; ren-

tal of gasoline station equipment (not for repair and maintenance of automobiles).

40 – Rental of waste compacting machines and apparatus; rental of waste crushing machines and apparatus; collection, sorting of domestic waste and trash; collection, sorting of industrial waste and trash; rental of air-conditioning apparatus [for industrial purposes]; rental of space cooling apparatus; treatment or processing of cloth, clothing or fur [including drying]; tailoring or dressmaking; sewing; custom tailoring services; custom tailoring or dressmaking; custom tailoring; embroidery [embroidering]; embroidery services; embroidering; paper treating and working; processing of rubber; processing of plastics; food processing; stone treating; ceramic processing; electro-plating; millworking; annealing; metal tempering; hot dipping; taxidermy; wood-working; processing of cinematographic films; photographic enlarging; photographic printing; photographic film development; processing of photographic films; bookbinding; disposal of domestic waste and trash; disposal of industrial waste and trash; recycling of waste; recycling; recycling of rubbish; recycling of trash; photogravure; rental of chemical processing machines and apparatus; rental of glassware manufacturing machines and apparatus; rental of metal treating machines and tools; rental of shoe making machines; rental of machines for making shoes; rental of machines and apparatus for film development, photograph printing, photograph enlargement or photograph finishing; rental of machines and apparatus for processing foods or beverages; rental of machines and apparatus for lumbering, wood-working, or veneering or plywood making; rental of bookbinding machines and apparatus; rental of textile machines and apparatus; rental of machines and apparatus for treating textiles; rental of tobacco processing machines; rental of machines and apparatus for pulp-making, papermaking or paper-working; offset printing; photogravure printing; screen printing; lithographic printing; letterpress printing; rental of knitting machines; rental of sewing machines; rental of typographic presses; radiation area decontamination services; processing of bamboo, tree barks, rattan, vines or other mineral vegetable materials [other than processing of ingredients]; processing of artificial limbs or artificial teeth [including processing of medical materials]; water treating; water treatment services; nuclear fuel reprocessing; reprocessing of nuclear fuels; engraving of sealing stamps; rental of water purifying apparatus; leasing of water purification equipment; rental of water treatment equipment; providing material treatment information; material treatment information; rental of boilers; rental of 3D printers.

41 – Educational and instruction services relating to arts, crafts, sports or general knowledge; animal training; plant exhibitions; gardens for public admis-

sion; caves for public admission; animal exhibitions; services of reference libraries for literature and documentary records; reference libraries of literature and documentary records; art exhibitions; art exhibition services; arranging and planning of movies, shows, plays or musical performances; movie theatre presentations or movie film production and distribution; presentation of live show performances; live entertainment; presentation of live performances; direction or presentation of plays; presentation of musical performances; musical performances; musical entertainment services; production of radio or television programs; organization, arranging and conducting of professional golf tournaments or competitions; organization, arranging and conducting of soccer games; organization, arranging and conducting of sumo wrestling competitions; organization, arranging and conducting of boxing matches; organization, arranging and conducting of baseball games; organization, arranging and conducting of horse races; organization, arranging and conducting of bicycle races; organization, arranging and conducting of boat races; organization, arranging and conducting of auto races; organization, arranging and conducting of motorcycle races; operating lotteries; operating of lotteries; providing audio or video studio services; providing audio or video studios; providing sports facilities; providing amusement facilities; booking of seats for shows; rental of movie projectors and their accessories; rental of cine-films; rental of toys; toy rental; rental of musical instruments; rental of ski equipment; rental of skis; rental of skin-diving equipment; rental of television sets; book rental; rental of radio sets; rental of radios; rental of records or sound-recorded magnetic tapes; rental of image-recorded magnetic tapes; rental of amusement machines and apparatus; rental of game machines and apparatus; rental of cameras; rental of optical machines and apparatus; photography; language interpretation; language interpreter services; interpreter services; translation; arranging, conducting and organization of seminars; publication of books; book publishing; publishing services; production of videotape film in the field of education, culture, entertainment or sports [not for movies or television programs and not for advertising or publicity]; directing of radio and television programs; operation of video and audio equipment for production of radio and television programs; organization of entertainment events excluding movies, shows, plays, musical performances, sports, horse races, bicycle races, boat races and auto races; providing facilities for movies, shows, plays, music or educational training; rental of reversal film; rental of paintings and calligraphic works.

42 – Providing meteorological information; meteorological information; providing weather information; designing of machines, apparatus, instruments [including their parts] or systems composed of such

machines, apparatus and instruments; design services; technological advice relating to computers, automobiles and industrial machines; computer software design, computer programming, or maintenance of computer software; testing or research on machines, apparatus and instruments; research on building construction or city planning; research relating to building construction or city planning; testing or research on prevention of pollution; testing or research on electricity; testing or research on civil engineering; rental of measuring apparatus; leasing of measuring apparatus; rental of computers, including electronic circuits, magnetic disks, magnetic tapes all recorded with computer programs, central processing units and other peripheral apparatus; rental of laboratory apparatus and instruments; leasing of laboratory apparatus; leasing of laboratory apparatus and instruments; testing, inspection or research on agriculture, livestock breeding or fisheries; architectural design; architectural design services; architectural services; architectural services for the design of buildings; surveying; geological surveys or research; testing, inspection or research of pharmaceuticals, cosmetics or foodstuffs; rental of technical drawing instruments; providing information on donation of human corpses for medical education; arranging of donation of human corpses for medical education.

43 – Providing temporary accommodation; accommodation bureaux [brokering reservations for hotels, boarding houses or the like]; providing foods and beverages; food preparation services; preparation of food and beverages; providing food and drink; services for providing food and drink; serving of food and drink; take-away food and drink services; rental of conference rooms; providing conference rooms; rental of meeting rooms; rental of furniture; rental of wall hangings for commercial use; rental of floor coverings; rental of towels for commercial use; rental of futon and quilts; preschooler and infant care at daycare centers; day-nursery [creche] services; creche services; rental of curtains; rental of facilities for exhibitions; providing facilities for exhibitions; rental of kitchen worktops; rental of cooking equipment for industrial purposes.

44 – Provision of bath houses; provision of medical information; geriatric nursing; rental of fishing equipment and instruments; rental of ultrasonic diagnostic apparatus; rental of combine harvesters; rental of lawnmowers; beauty salons; beautician services; beauticians' services; beauty care services; beauty salon services; beauty therapy; beauty treatment services; cosmetician services; barbershops; hair salon services; barber shop services; barbers' services; garden or flower bed care; garden tree planting; fertilizer spreading; spreading of fertilizers; weed killing; weed control; vermin exterminating [for agriculture, horticulture or forestry]; massage and therapeutic shiatsu massage; moxibustion; moxibustion therapy;

treatment for dislocated joints, sprain, bone fractures or the like [judo-seifuku]; acupuncture; acupuncture services; medical services; medical clinics; medical clinic services; medical care; hospital services; physical examination; physical examination services; medical testing services for fitness evaluation; medical testing for fitness evaluation; medical examination services; health clinic services; dentistry; dentistry services; dental clinic services; preparation and dispensing of medications; dispensing of pharmaceuticals; dietary and nutritional guidance; nutritional and dietetic consultancy; services rendered by a dietician; medical services for cattle; rental of potted plants; rental of apparatus and instruments for use in beauty salons or barbers' shops; rental of kitchen sinks.

45 – Clothing rental; rental of clothing; rental of fire alarms; rental of fire extinguishers; marriage partner introduction or dating services; matchmaking services; providing and conducting civil marriage ceremonies; funeral service undertaking; funerary undertaking; conducting funeral ceremonies; providing grave spaces or charnel houses; agencies for copyright licensing; copyright licensing agency services; security guarding for facilities; personal body guarding; investigation or surveillance services for checking background profiles; rental of altars; rental of safes; information relating to fashion coordination services for individuals; legal services for procedures relating to industrial property rights; provision of expert legal opinions; providing information on legal procedures relating to lawsuits or other legal issues; legal services provided in relation to lawsuits; legal services; legal services relating to company registration; legal services relating to social insurance claims; fortune-telling; forecasting services in the nature of fortune-telling; non-therapeutic counselling services rendered to meet the needs of individuals; personal services rendered by others to meet the needs of individuals; rental of personal ornaments for wearing.

(260) AM 2018 95381 A

(800) 1377835

(151) 2017 09 25

(891) 2017 09 25

(731) BLUE LAKE STAR SHIPPING LTD

171, Old Bakery Street Valletta VLT 1455,
Malta

(540)



(591) Light green, blue, red and white.

(531) 26.13.25; 29.01.14

(511)
39 – Transport; transportation and delivery of goods; arrangement of transportation; arranging the shipping of goods; distribution [transport] of goods by sea; carting of goods; distribution services; forwarding agency services; chartering of transport.

(260) AM 2018 95382 A
(800) 1377858
(151) 2017 09 20
(891) 2017 09 20
(731) RICHTER GEDEON NYRT.
Gyömrői út 19-21 H-1103 Budapest, Hungary
(540)

POSTIUPA

(591) Black and white
(511)
5 – Pharmaceutical preparations.

(260) AM 2018 95383 A
(800) 1377899
(151) 2017 06 24
(891) 2017 06 24
(731) MYM ENDÜSTRİ SANAYİ VE TİCARET
ANONİM ŞİRKETİ
Yıldırım Beyazıt Mah. Yıldız Sk. No:9/A
Çerkezköy Çerkezköy-Tekirdağ, Turkey
(540)



(591) Claret red
(531) 14.05.01; 14.05.02; 24.09.09; 24.09.11;
26.01.16; 27.05.17; 29.01.01
(511)

7 – Machines and robotic mechanisms (machines) for use in agriculture and animal breeding, machines and robotic mechanisms (machines) for processing cereals, fruits, vegetables and food; engines and motors, other than for land vehicles, parts and fittings therefor; hydraulic and pneumatic controls for engines and motors, brakes other than for vehicles, brake linings for engines, crankshafts, gearboxes, other than for land vehicles, gearboxes, cylinders for engines, pistons for engines, turbines, not for land vehicles, filters for engines and motors, oil, air and fuel filters for land vehicle engines, exhausts for land vehicle engines, exhaust manifolds for land vehicle engines, engine cylinders for land vehicles, engine cylinder heads for land vehicles, pistons for land vehicle engines, carburetors for land vehicles, fuel conversion apparatus for land vehicle engines, injectors for land vehicle engines, fuel economisers for land vehicle engines, pumps for land vehicle engines, valves for land vehicle engines, starter motors for land

vehicles, dynamos for land vehicle engines, sparking plugs for land vehicle engines; bearings (parts of machines), roller or ball bearings; current generators; compressed air machines, compressors (machines); gaskets for engines and motors.

12 – Motor land vehicles, motorcycles, mopeds; engines and motors for land vehicles; clutches for land vehicles; transmissions, transmission belts and transmission chains for land vehicles; gearing for land vehicles; brakes, brake discs and brake linings for land vehicles; vehicle chassis, automobile bonnets, vehicle suspension springs, shock absorbers for automobiles, gearboxes for land vehicles, steering wheels for vehicles, rims for vehicle wheels.

(260) AM 2018 95384 A
(800) 1377922
(151) 2017 09 20
(891) 2017 09 20
(731) RICHTER GEDEON NYRT.
Gyömrői út 19-21 H-1103 Budapest, Hungary
(540)

POSTUPA

(591) Black and white
(511)
5 – Pharmaceutical preparations.

(260) AM 2018 95385 A
(800) 1377923
(151) 2017 09 20
(891) 2017 09 20
(731) RICHTER GEDEON NYRT.
Gyömrői út 19-21 H-1103 Budapest, Hungary
(540)

POSTINUPA

(591) Black and white
(511)
5 – Pharmaceutical preparations.

(260) AM 2018 95386 A
(800) 1377939
(151) 2017 11 26
(891) 2017 11 26
(731) Zakrytoe aktsionernoe obshchestvo
"RENNА-HOLDING"
ul. Privolnaya, 25, RU-109145 Moscow,
Russian Federation
(540)

MOLONEZ

(591) Black and white
(511)
29 – Yogurt; kefir [milk beverage]; milk shakes; buttercream; kumys [milk beverage]; margarine; edible

oils and fats; edible oils; sunflower oil for food; butter; milk and milk products; albumin milk; condensed milk; powdered milk; milk beverages, milk predominating; prostokvasha [soured milk]; ryazhenka [fermented baked milk]; cream [dairy products]; whipped cream; smetana [sour cream]; whey; cheese; milk ferments for culinary purposes; rennet.

30 – Mustard; dressings for salad; frozen yogurt [confectionery ices]; ketchup [sauce]; mayonnaise; marinades; ice cream; meat tenderizers, for household purposes; sorbets [ices]; soya sauce; tomato sauce; sauces [condiments]; pasta sauce; vinegar; condiments; pastry and confectionery.

(260) AM 2018 95424 A

(800) 1377410

(151) 2017 03 07

(891) 2017 03 07

(731) SALZGITTER MANNESMANN GMBH

Eisenhüttenstraße 99,38239 Salzgitter,
Germany

(540)

Mannesmann

(591) Black, white

(511)

6 – Metal hardware; building and construction materials and elements of metal; unprocessed and semi-processed materials of metal; doors and windows of metal; structures and transportable buildings of metal; transport and packaging containers of metal; tubes of metal; steel strip; clamps of metal; sheets of metal; rings of metal; mouldings of metal; bolt of metal.

7 – Machines and machine tools for treatment of materials and for manufacturing; agricultural machines, earthmoving, construction, oil and gas extraction and mining equipment; transporting machines; parts and accessories for all the aforesaid goods, included in this class.

40 – Custom manufacture and assembly services; treatment and conversion of metal; rental of objects in connection with the providing of the aforesaid services, included in this class; consultancy and information in relation to the aforesaid services, included in this class; printing.

(260) AM 2018 95425 A

(800) 1377423

(151) 2017 09 18

(891) 2017 09 18

(731) LIN CHENYAO

No.43, Xinhua Road, Siming District, Xiamen
City, Fujian Province, China

(540)



(591) Black, white

(531) 21.03.21; 26.01.12; 28.03

(511)

25 – Clothing; layettes [clothing]; bathing suits/swimsuits; football shoes/football boots; raincoat (including rain hat, shawl, cloak); girdles; hats; hosiery; gloves [clothing]; neckties.

(260) AM 2018 95426 A

(800) 1377429

(151) 2017 09 28

(891) 2017 09 28

(731) ASLI KÜNTEŞ

Kobakçaköyü Güvencilik İstasyonu Mevkii
2. Paf. 126-127-128 Par, Turkey

(540)

(591) Black, white

(531) 26.11.08; 27.05.11

(511)

3 – Bleaching and cleaning preparations, detergents other than for use in manufacturing operations and for medical purposes, laundry bleach, fabric softeners for laundry use, stain removers, dishwasher detergents, perfumery; non-medicated cosmetics; fragrances; deodorants for personal use and animals; soaps, dental care preparations: dentifrices, denture polishes, tooth whitening preparations, mouth washes, not for medical purposes, abrasive preparations; emery cloth; sandpaper; pumice stone; abrasive pastes, polishing preparations for leather, vinyl, metal and wood, polishes and creams for leather, vinyl, metal and wood, wax for polishing.

(260) AM 2018 95430 A

(800) 1377433

(151) 2017 10 19

(891) 2017 10 19

(731) AS HESBURGER

Uusaru 3, Saue city, EE-76505 Harju county,
Estonia

(540)

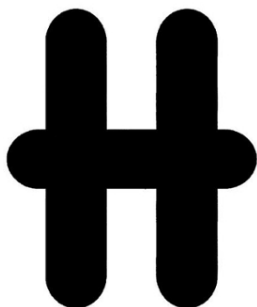

(591) Black, white

(531) 27.05.21

(511)

43 – Services for providing food and drink; temporary accommodation.

(260) AM 2018 95434 A

(800) 1377474

(151) 2017 06 20

(891) 2017 06 20

(731) FUJIFILM Europe GmbH

Heesenstrasse 31, 40549 Düsseldorf, Germany

(540)

SHACOLLA

(591) Black, white

(511)

16 – Self-adhesive boards of foam for mounting pictures, self-adhesive wall decorations, adhesive wall decorations, adhesive plastic film used for mounting images, adhesive corners for photographs, adhesive corners for photographs, paper picture mounts, photo albums and collectors' albums, mounting photographs (apparatus for -); photograph holders.

20 – Fastening materials, not of metal (terms considered too vague by the International Bureau – rule 13.2.b) of the Common Regulations), decorations of foam (terms considered too vague by the International Bureau – rule 13.2.b) of the Common Regulations), photograph and picture frames.

(260) AM 2018 95435 A

(800) 1377476

(151) 2017 05 16

(891) 2017 05 16

(731) "EUROPE" LTD.

Zarya 1 str. BG-6300 Haskovo, Bulgaria

(540)



(591) Black, white

(531) 27.05.02; 27.05.10; 27.05.17; 27.05.21

(511)

18 – Duffel bags; bags for sports; garment carriers; work bags; hiking bags; beach bags; briefcases [leather goods]; evening handbags; evening purses (handbags); handbags; travel baggage; travelling sets; vanity cases; cosmetic purses; ladies' handbags; bags for campers; sports packs; game bags [hunting accessories]; textile shopping bags; beach bags; travelling sets [leatherware]; shopping bags made of skin; bags for climbers; bags for umbrellas; gentlemen's handbags; evening handbags; belt bags and hip bags; gym bags; game bags [hunting accessories]; trunks and suitcases; briefcases [leather goods]; flexible bags for garments; flight bags; bags for sports clothing; boot bags; ladies' handbags; pouch baby carriers; all-purpose athletic bags; shopping bags; canvas bags; hipsacks; shoe bags; attache cases made of leather; garment bags for travel made of leather; bags made of imitation leather; all-purpose carrying bags; travel bags made of plastic materials; vanity cases, not fitted; carriers for suits, shirts and dresses; general purpose sport trolley bags; luggage, bags, wallets and other carriers.

(260) AM 2018 95436 A

(800) 1377490

(151) 2017 09 26

(891) 2017 09 26

(731) UAB "MV GROUP ASSET

MANAGEMENT"

J. Jasinskio g. 16F, LT-03163 Vilnius,

Lithuania

(540)

KETEVAN

(591) Black, white

(511)

33 – Alcoholic beverages, except beer; wine; brandy; spirits (beverages).

(260) AM 2018 95437 A

(800) 1377497

(151) 2017 09 14

(891) 2017 09 14

(731) ARISTON THERMO S.p.A.

Viale Aristide Merloni, 45, I-60044

FABRIANO (ANCONA, Italy

(540)

LYDOS

(591) Black, white

(511)

11 – Heaters for baths, water heaters, heating boilers, heating installations, hot water heating and gas central heating installations, boilers, heat pumps, air conditioners, solar-powered heating installations and

apparatus, burners for heating installations, kettles, geothermal heating installations, cooling installations, air conditioning installations.

(260) AM 2018 95438 A
 (800) 1377504
 (151) 2017 11 01
 (891) 2017 11 01
 (731) HANES INNERWEAR AUSTRALIA PTY LTD
 L1, 115 Cotham Rd, KEW VIC 3101,
 Australia
 (540)

BONDS

(591) Black, white
 (511)
 25 – Clothing; footwear; headgear.

(260) AM 2018 95439 A
 (800) 1377507
 (151) 2016 09 29
 (891) 2016 09 29
 (731) ÇAĞLAYAN KİMYA VE İNŞAAT
 SANAYİ TİCARET ANONİM ŞİRKETİ
 3. Organize Sanayi Bölgesi, T. Ziyaettin
 Caddesi, 8. Sokak, No:29, Selçuklu Konya,
 Turkey
 (540)

şef universal

(591) Black, white
 (531) 27.05.02
 (526) "universal"
 (511)
 3 – Bleaching and cleaning preparations, detergents other than for use in manufacturing operations and for medical purposes; laundry bleach, fabric softeners for laundry use, stain removers, dishwasher detergents; laundry starch; glass cleaners; perfumery; cosmetics; fragrances; deodorants for personal use and animals; essential oils; eau de Cologne; rose oil; aftershave lotions; antiperspirants; nail polish; lipsticks; mascara; beauty creams; hair dyes; eyeliners; shampoos; cosmetic hair care preparations; eyebrow pencils; blush pencils; cosmetic preparations for protecting the skin from the sun's rays; make-up powder; foundation; nail polish; nail polish and nail polish remover; make-up preparations; nail care preparations; pre-shave and aftershave preparations; shaving soap; shave creams; shower gel; petroleum jelly for cosmetic purposes; wax for removing body hair; henna for cosmetic purposes; tanning creams; cotton wool for cosmetic purposes; cotton pads for removing make-up; cleaning pads impregnated with cosmetics; cotton sticks for cosmetic purposes; co-

ton pads for removing make-up; tissues impregnated with cosmetic lotions; soaps; disinfectant soaps; cosmetic soaps; perfumed soaps; soaps for personal use; dental care preparations, dentifrices, denture polishes, tooth whitening preparations, mouth washes, not for medical purposes; liquid dentifrices; mouthwashes, not for medical purposes; abrasive preparations; emery cloth; sandpaper; pumice stone; abrasive pastes; polishing preparations for leather, vinyl, metal and wood, polishes and creams for leather, vinyl, metal and wood, wax for polishing.

(260) AM 2018 95477 A
 (800) 1379123
 (151) 2017 10 18
 (891) 2017 10 18
 (731) POWER SOURCE INDUSTRIES CO., LTD.
 61 Yudong 1st Road, Dongcheng, Yangdong,
 Yangjiang Guangdong, China
 (540)

NexTool

(591) Black and white
 (531) 27.05.17
 (511)
 6 – Props of metal; hardware of metal, small; hooks [metal hardware]; cattle chains; split rings of common metal for keys; sealing caps of metal; tool boxes of metal, empty; buckles of common metal [hardware].
 8 – Blade sharpening instruments; manicure implements; cleavers; scissors; knives; tongs; penknives; sword scabbards; table cutlery [knives, forks and spoons]; garden tools, hand-operated.
 9 – Signalling whistles; life saving apparatus and equipment; batteries, electric; railway traffic safety appliances; flashing lights [luminous signals]; protection devices for personal use against accidents; acoustic [sound] alarms; signal lanterns; chargers for electric batteries; sirens.
 13 – Gun cases; cartridge pouches; sprays for personal defense purposes; tear-gas weapons; flare pistols; sighting mirrors for guns and rifles; rifle cases; shoulder straps for weapons.
 16 – Stationery; nibs; office perforators; writing instruments; drawing instruments; money clips; penholders.
 21 – Bottle openers, electric and non-electric; cruets; cups; kitchen utensils; corkscrews, electric and non-electric; chopsticks; cooking utensils, non-electric; mixing spoons [kitchen utensils].

(260) AM 2018 95478 A

(800) 1379124

(151) 2017 10 10

(891) 2017 10 10

(731) ELENA VLADIMIROVNA TALAGAEVA
kv.143, d. 3, Kommunisticheskaya St,
Ramenskoye, RU-140002 Moskovskaya
oblast, Russian Federation

(540)

Бархатные губки

(591) Black and white

(531) 28.05

(511)

3 – Lip glosses; petroleum jelly for cosmetic purposes; cotton wool for cosmetic purposes; scented water; lavender water; toilet water; depilatory wax; waxes for leather; creams for leather; massage gels, other than for medical purposes; deodorants for human beings or for animals; perfumes; perfumery; eyebrow pencils; cosmetic pencils; cosmetic dyes; cosmetic creams; cream for whitening the skin; hair spray; nail polish; hair lotions; after-shave lotions; beauty masks; oils for perfumes and scents; oils for cosmetic purposes; almond milk for cosmetic purposes; cleansing milk for toilet purposes; soap; deodorant soap; shaving soap; cakes of toilet soap; cosmetic kits; false nails; eau de Cologne; cotton sticks for cosmetic purposes; dentifrices; lipsticks; pomades for cosmetic purposes; shaving preparations; cosmetic preparations for baths; toiletries; douching preparations for personal sanitary or deodorant purposes [toiletries]; nail care preparations; aloe vera preparations for cosmetic purposes; sunscreen preparations; make-up powder; false eyelashes; eyebrow cosmetics; hair colorants; cosmetic preparations for skin care; cosmetics; henna [cosmetic dye]; shampoos.

35 – Demonstration of goods; organization of exhibitions for commercial or advertising purposes; presentation of goods on communication media, for retail purposes; sales promotion for others; advertising; procurement services for others [purchasing goods and services for other businesses].

(260) AM 2018 95484 A

(800) 1379181

(151) 2017 01 18

(891) 2017 01 18

(731) IVOCLAR VIVADENT AG
Bendererstrasse 2 FL-9494 Schaan,
Liechtenstein

(540)

PM3

(591) Black and white

(511)

3 – Dental materials for the bleaching of teeth.

5 – Materials for use in dentistry; materials and auxiliary materials for the manufacture of dental impressions, models, crowns, bridges, inlays, prostheses, artificial teeth; materials for the characterization of teeth; materials for polishing teeth; dental waxes; dental filling materials; materials for relining teeth; materials for root canal filling; core build-up materials for use in dentistry; luting materials; materials for pulp protection and root treatment; materials for cavity treatment; materials for dentin wound and pulp treatment; materials used for acid etching and for the caries prophylaxis; dental adhesive agents; protective varnishes for teeth; drying and degreasing materials for the use in dentistry; materials for cosmetic restoration of damaged teeth; diagnostic substances for medical use; dental composites; dental cements; saliva diagnostic agents, preparations and substances for medical use; disinfectants; preparations for the hygiene of teeth and oral cavity; medical mouthwash; dental materials for the treatment of caries and periodontitis; color stains for use in dentistry; precious metal alloys and non-precious metal alloys for dental use; precious metals and non-precious metals for dental use; investment materials for dental use; dental adhesives; materials for repairing damaged teeth; metal primers; prefabricated parts for crowns, bridges, and pontics; fiber-reinforced resin for the manufacture of crowns, bridges, and pontics; fissure sealants; mixing capsules for dental materials; materials for the detection of plaque; dental ceramic layering; ingots made of resin, metal, or ceramic for the manufacture of dental crowns, bridges, inlays, prostheses, artificial teeth; opaquers being dental lacquers.

9 – Software for dental use; scanners, apparatus for the processing of images, and devices for CAD-CAM-processing.

10 – Apparatus, devices, tools, and instruments for dental use, in this class; impression devices for dental use; registration devices for dental use; articulators for dental use; mixing devices for dental use; blasting devices for dental use; dosing instruments and apparatus for dental use; milling, grinding, and drilling instruments for dental use; artificial teeth and veneers; dental plates; dental crowns and bridges; syringes; shade guides; dental matrices; dental strips; apparatus and instruments for the caries prophylaxis and for the treatment of periodontitis; polishing instruments (terms considered too vague by the International Bureau – Rule 13 (2) (b) of the Common Regulations); ceramic mixing plates, for dental use; tooth pins for medical use; medical dressings, coverings and applicators; milling and grinding machines for dental use and parts thereof; milling machines and grinding machines for dental use for the treatment of ceramics, metal and plastic materials, and parts thereof; milling and grinding tools for dental use as machine tools, and parts thereof;

holding devices for machine tools and piece holders for milling and grinding machines for dental use.

11 – Dental furnaces.

38 – Providing access to databases.

42 – Cloud computing services.

(260) AM 2018 95500 A

(800) 926441

(151) 2007 04 23

(891) 2017 11 16

(731) ICEWARP LTD.

Georgiou Gennadiou 43 CY-3041 Limassol, Cyprus

(540)

IceWarp

(591) Black and white

(531) 27.05.10; 27.05.17

(511)

9 – Software for electronic communication.

(260) AM 2018 95501 A

(800) 926793

(151) 2006 07 17

(891) 2017 10 12

(731) BEURER GMBH

Söflinger Str. 218 89077 Ulm, Germany

(540)

Beurer

(591) Black and white

(511)

9 – Scientific, nautical, surveying, photographic, cinematographic, optical, weighing, measuring, signalling, checking (supervision), life-saving and teaching apparatus and instruments; apparatus and instruments for conducting, switching, transforming, accumulating, regulating or controlling electricity; apparatus for recording, transmission or reproduction of sound or images; magnetic data carriers, recording discs; automatic vending machines and mechanisms for coin-operated apparatus; cash registers, calculating machines, data processing equipment and computers; fire-extinguishing apparatus.

10 – Surgical, medical, dental and veterinary apparatus and instruments, artificial limbs, eyes and teeth; orthopedic articles; suture materials.

11 – Apparatus for lighting, heating, steam generating, cooking, refrigerating, drying, ventilating.

(260) AM 2018 95502 A

(800) 977578

(151) 2008 07 24

(891) 2017 01 02

(731) KALE OTO RADYATÖR SANAYİ VE TİCARET ANONİM ŞİRKETİ
Sanayi Mahallesi, Turan Caddesi No:6 4.
Levent – İSTANBUL, Turkey

(540)



(591) Blue

(531) 15.09.25; 29.01.04

(511)

7 – Radiators for vehicles, fans for motors and engines.

(260) AM 2018 95503 A

(800) 1014716

(151) 2009 09 01

(891) 2017 10 27

(731) Otkrytoe aktsionernoe obshchestvo
"GRODNENSKAYA TABACHNAYA
FABRIKA "NEMAN"
18, ul. Ordzhonikidze 230071 Grodno,
Belarus

(540)



(591) Black and white

(531) 04.03.01; 24.01.19; 25.01.01; 25.05.01;
27.05.01; 27.05.10

(511)

34 – Tobacco; smokers' articles; matches.

(260) AM 2018 95504 A

(800) 1176269

(151) 2013 08 27

(891) 2017 10 12

(731) BEURER GMBH

Söflinger Str. 218 89077 Ulm, Germany

(540)

Beurer

(591) Black and white

(511)

8 – Hand tools and implements (hand-operated); razors; manicure and pedicure implements; depilation appliances, electric and non-electric; pincers; polishing irons (glazing tools).

(260) AM 2018 95506 A

(800) 1228803

(151) 2014 08 27

(891) 2017 11 10

(731) SAĞLIKLI GIDA ÜRÜNLERİ SANAYİ VE TİCARET A.Ş.

Celaliye Mahallesi Bağlarbasi Caddesi No:55
B. Cekmece Istanbul, Turkey

(540)



(591) Black, white and red

(531) 14.07.02; 14.07.03; 23.01.01; 24.01.05;
24.01.15; 24.01.17; 25.01.19; 26.11.02;
26.11.14; 27.05.01; 27.05.25; 29.01.13

(526) ENERGY DRINK

(511)

32 – Energy drinks.

(260) AM 2018 95508 A

(800) 1284510

(151) 2015 11 06

(891) 2017 09 26

(731) Ravishankar Ramanayakanpet Venkatratnam "SRI SRI RAVI SHANKAR"

199 A Cross, 11th Main, 4th Block, Jayanagar,
Bangalore, Karnataka 560041, India

(540)

TLEX

(591) Black and white

(511)

41 – Educational services, namely, conducting workshops and corporate training in the field of leadership development and stress management and distribution of course material in connection therewith; training services in the field of leadership development and stress management.

(260) AM 2018 95510 A

(800) 1313134

(151) 2016 02 24

(891) 2017 11 16

(731) ROCHE DIAGNOSTICS GMBH

Sandhofer Strasse 116 68305 Mannheim,
Germany

(540)

AVENIO

(591) Black and white

(511)

1 – Chemical, biological and biochemical preparations for scientific and research purposes; in vitro diagnostic reagents for use in industry and science; chemical additives, enzymes, reagents, organisms and proteins for use in science, research and industry; control solutions for calibrating and monitoring the accuracy and function of instruments and test results; chemical reagents for cell separation, labelling reagents; reagents for the processing, separation, isolation, enrichment, depletion, detection, screening, cultivation, analysis and counting of biological material; reagents featuring magnetic beads, namely, magnetic immunoassay, for scientific and research purposes; monoclonal antibody reagents for scientific purposes; chemical reagents for diagnostic tests and test kits for the determination of genetic information for scientific or research purposes; assays and reagents for use in genetic research; assays and reagents for scientific or medical research use; reagents and nucleotides for nucleic acid sequencing for scientific or research purposes.

5 – Chemical, biological and biochemical preparations for medical purposes; in vitro diagnostic reagents for clinical or medical use; in vitro diagnostic agents, namely, reagents and control solutions for analysis of biological samples for medical diagnostic purposes; chemical reagents for testing body fluids to determine fetal chromosomal abnormalities; chemical reagents and test kits for medical, clinical and diagnostic purposes in the fields of DNA sequencing and genetics; diagnostic test kits consisting primarily of reagents for nucleic acid detection and analysis.

9 – Scientific instruments and apparatus; laboratory devices for use in research, science and industry; laboratory instruments, namely, devices for analysis of nucleic acids and for DNA sequencing; nucleic acid sequencers; imaging devices and analyzers;

apparatus for preparation, amplification, mixing, hybridization, incubation, and washing of scientific samples; sample loaders and bar code readers for automated laboratory apparatus; genotyping and gene expression microarrays, associated mapping files and associated kits for analyzing nucleic acids for scientific, pharmaceutical and medical research purposes; software for scientific, pharmaceutical and medical research purposes; computer systems and software for collecting, storing, analyzing and reporting biological information, and for sample tracking and managing projects, laboratory workflow and data, for use in the fields of scientific, diagnostic and clinical research and for clinical diagnostic purposes; software for use in analyzing, managing and visualizing DNA sequencing data; all the aforesaid goods are not intended for use in the field of health and longterm care, in particular for the planning and documentation of treatment services and nursing care.

10 – Surgical and medical apparatus and instruments; medical apparatus and instruments for medical and diagnostic purposes; diagnostic and analytical apparatus for medical purposes; medical equipment, namely, devices for analyzing nucleic acids and for DNA sequencing for the purpose of rendering medical treatment and diagnosis.

42 – Scientific research and consultancy services related thereto; scientific research and consultancy services related thereto in the fields of genome sequence analysis and reporting; medical research services; providing DNA screening for scientific research purposes; providing diagnostic services for others in the fields of science and research related thereto; consulting services in the field of cloud computing in the fields of life science; technical support services, namely, infrastructure management services for monitoring, administration and management of cloud computing IT and application systems in the fields of life science; computer services, namely, cloud hosting provider services for storing, analyzing and sharing data in the fields of life science; providing online non-downloadable software for the custom design and ordering of assays and reagents; design and development of laboratory instruments and computer systems for use in science and clinical research; consultancy, information and advisory services in the field of analysis of biomolecules.

(260) AM 2018 95512 A

(800) 1371752

(151) 2017 07 12

(891) 2017 10 26

(731) Limited Liability Company "ORIMI"

1-st Microrayon Street, 15/4 plot, Sverdlov factory settlement, Vsevolozhsk district,

RU-188682 Leningrad oblast, Russian Federation

(540)



(591) red, brown, white, yellow, orange, purple, beige, green

(531) 08.07.17; 08.07.25; 11.01.02; 25.01.15; 25.05.02; 29.01.15

(511)

30 – Tea, including instant tea, flavored tea, tea with fruits, herbal and other flavors, tea-based beverages; tea made from herbs and flowers other than for medicinal use; iced tea.

(260) AM 2018 95537 A

(800) 1378087

(151) 2017 09 29

(891) 2017 09 29

(731) APPLE INC.

One Apple Park Way, Cupertino CA 95014, USA

(540)



(591) Black, white

(531) 05.07.13

(511)

9 – Computers; computer hardware; handheld computers; tablet computers; telecommunications apparatus and instruments; telephones; mobile telephones; smartphones; wireless communication devices for the transmission of voice, data, images, audio, vi-

deo, and multimedia content; network communication apparatus; handheld digital electronic devices capable of providing access to the Internet and for the sending, receiving, and storing telephone calls, electronic mail, and other digital data; wearable computer hardware; wearable digital electronic devices capable of providing access to the Internet, for sending, receiving and storing of telephone calls, electronic mail, and other digital data; smartwatches; wearable activity trackers; electronic book readers; computer software; computer software for setting up, configuring, operating and controlling computers, computer peripherals, mobile devices, mobile telephones, smartwatches, wearable devices, earphones, headphones, set top boxes, audio and video players and recorders, home theatre systems, and entertainment systems; application development software; computer game software; downloadable pre-recorded audio, video and multimedia content; computer peripheral devices; peripheral devices for computers, mobile telephones, mobile electronic devices, wearable electronic devices, smartwatches, earphones, headphones, set top boxes, and audio and video players and recorders; wearable peripherals for use with computers, mobile telephones, mobile electronic devices, smartwatches, earphones, headphones, set top boxes, and audio and video players and recorders; biometric identification and authentication apparatus; accelerometers; altimeters; distance measuring apparatus; distance recording apparatus; pedometers; monitors, display screens, virtual and augmented reality displays and controllers; optical goods; optical apparatus and instruments; cameras; flashes for cameras; keyboards, mice, mouse pads, printers, disk drives, and hard drives; sound recording and reproducing apparatus; digital audio and video players and recorders; audio speakers; audio amplifiers and receivers; voice recording and voice recognition apparatus; earphones; headphones; microphones; set top boxes; radios; radio transmitters and receivers; global positioning systems (GPS devices); navigational instruments; remote controls for controlling computers, mobile telephones, mobile electronic devices, wearable electronic devices, smartwatches, earphones, headphones, audio and video players and recorders, televisions, set top boxes, speakers, amplifiers, home theatre systems, and entertainment systems; wearable devices for controlling computers, mobile telephones, mobile electronic devices, smart watches, earphones, headphones, audio and video players and recorders, televisions, set top boxes, speakers, amplifiers, home theatre systems, and entertainment systems; data storage apparatus; batteries; battery chargers; electrical and electronic connectors, couplers, wires, cables, chargers, docks, docking stations, and adapters for use with computers, mobile telephones, handheld computers, computer peripherals, mobile telephones, mobile electronic devices, wearable el-

ectronic devices, smartwatches, earphones, headphones, audio and video players and recorders, and set top boxes; interactive touchscreens; interfaces for computers, computer screens, mobile telephones, mobile electronic devices, wearable electronic devices, smartwatches, televisions, set top boxes, and audio and video players and recorders; parts and accessories for computers, computer peripherals, mobile telephones, mobile electronic devices, wearable electronic devices, smartwatches, earphones, headphones, audio and video players and recorders, televisions, and set top boxes; covers, bags, cases, sleeves, straps and lanyards for computers, mobile telephones, mobile electronic devices, wearable electronic devices, smartwatches, earphones, headphones, set top boxes, and audio and video players and recorders; electronic agendas; dictating machines; measuring apparatus; remote controls.

(260) AM 2018 95591 A

(800) 1378230

(151) 2017 09 15

(891) 2017 09 15

(731) MOROZOV VICTOR ALEXANDROVICH
Kosmonavtov avenue, 5, block G, apt 40
RU-344092 Rostov-on-Don, Russian
Federation

(540)



(591) light blue, light pink, brownish beige and dark brownish beige.

(531) 03.05.09; 03.05.25; 05.07.02; 29.01.15

(511)

30 – Coffee, tea, cocoa and artificial coffee; rice; tapioca and sago; flour and preparations made from cereals; bread, pastries and confectionery; ice cream; sugar, honey, treacle; yeast, baking-powder; salt; mustard; vinegar, sauces [condiments]; spices; flavorings, other than essential oils, for cakes; flavorings, other than essential oils, for beverages; coffee flavorings; food flavorings, other than essential oils; star aniseed; baozi [stuffed buns]; cereal bars; high-protein cereal bars; pancakes; noodle-based prepared meals; freeze-dried dishes with main ingredient being pasta; freeze-dried dishes with main ingredient being rice; buns; bread rolls; edible rice paper; edible paper; burritos; vanillin [vanilla substitute]; vareniki [stuffed dumplings]; waffles; vermicelli [no-

odles]; natural sweeteners; sausage binding materials; binding agents for ice cream; sea water for cooking; seaweed [condiment]; malt biscuits; cloves [spice]; mirror icing [mirror glaze]; cake frosting [icing]; glucose for culinary purposes; gluten additives for culinary purposes; thickening agents for cooking foodstuffs; leaven; rice-based snack food; cereal-based snack food; vegetal preparations for use as coffee substitutes; dressings for salad; fruit jellies [confectionery]; candy decorations for cakes; confectionery for decorating Christmas trees; cakes; pastries; peanut confectionery; almond confectionery; pasta; ginger [spice]; frozen yogurt [confectionery ices]; capers; caramels [candy]; curry [spice]; ketchup [sauce]; gimhap [Korean rice dish]; quiches; gluten prepared as foodstuff; flour-based dumplings; sweetmeats [candy]; liquorice [confectionery]; peppermint sweets; dulce de leche; cinnamon [spice]; unroasted coffee; starch for food; crackers; custard; hominy grits; semolina; oatmeal; crushed barley; groats for human food; ice cubes; corn, milled; corn, roasted; meat pies; turmeric; couscous [semolina]; noodles; ice for refreshment; ice, natural or artificial; edible ices; candy; rice cakes; mayonnaise; macarons [pastry]; macaroni; maltose; hominy; piccaililli; marinades; marzipan; royal jelly; bean meal; tapioca flour; potato flour; corn flour; nut flours; flour; wheat flour; soya flour; barley meal; dessert mousses [confectionery]; chocolate mousses; muesli; mint for confectionery; cocoa beverages with milk; coffee beverages with milk; coffee-based beverages; cocoa-based beverages; chamomile-based beverages; tea-based beverages; chocolate beverages with milk; chocolate-based beverages; infusions, not medicinal; crushed oats; husked oats; okonomiyaki [Japanese savory pancakes]; onigiri [rice balls]; nutmegs; chocolate-coated nuts; stick liquorice [confectionery]; pastilles [confectionery]; molasses for food; pâtés en croûte; pelmeni [dumplings stuffed with meat]; pepper; allspice; peppers [seasonings]; pesto [sauce]; cookies; petit-beurre biscuits; bibimbap [rice mixed with vegetables and beef]; pies; pizzas; meat gravies; fondants [confectionery]; popcorn; powders for making ice cream; baking powder; mustard meal; pralines; aromatic preparations for food; condiments; meat tenderizers for household purposes; oat-based food; propolis; gingerbread; petits fours [cakes]; rice pudding; puddings; cake powder; fruit coulis [sauces]; ravioli; ramen [Japanese noodle-based dish]; chewing gum; relish [condiment]; instant rice; wheat germ for human consumption; spring rolls; palm sugar; sesame seeds [seasonings]; linseed for culinary purposes [seasoning]; processed seeds for use as a seasoning; aniseed; agave syrup [natural sweetener]; confectionery; batter mixes for okonomiyaki [Japanese savory pancakes]; baking soda [bicarbonate of soda for cooking purposes]; malt for human consumption; salt for preserving foodstuffs; cooking salt; celery salt;

sherbets [ices]; ham glaze; soya sauce; tomato sauce; sauces [condiments]; pasta sauce; spaghetti; seasonings; chocolate-based spreads; chocolate spreads containing nuts; preparations for stiffening whipped cream; rusks; breadcrumbs; sushi; sandwiches; tabbouleh; tacos; tarts; dough; pastry dough; almond paste; rice pulp for culinary purposes; cake dough; garden herbs, preserved [seasonings]; chocolate decorations for cakes; beer vinegar; ferments for pastes; halvah; bread; unleavened bread; chips [cereal products]; corn flakes; oat flakes; hot dog sandwiches; jiaozi [stuffed dumplings]; chicory [coffee substitute]; iced tea; chutneys [condiments]; minced garlic [condiment]; cheeseburgers [sandwiches]; chow-chow [condiment]; saffron [seasoning]; chocolate; malt extract for food; essences for foodstuffs, except etheric essences and essential oils; husked barley; vanilla flavorings for culinary purposes; cream of tartar for culinary purposes; soya bean paste [condiment]; golden syrup; tortillas; flowers or leaves for use as tea substitutes.

35 – Advertising; business management; business administration; office functions; import-export agency services; commercial information agency services; advertising agency services; cost price analysis; rental of advertising space; business auditing; business intermediary services relating to the matching of potential private investors with entrepreneurs needing funding; employment agency services; computerized file management; book-keeping; invoicing; demonstration of goods; transcription of communications [office functions]; opinion polling; market studies; business information; commercial information and advice for consumers [consumer advice shop]; business investigations; business research; marketing research; personnel recruitment; business management and organization consultancy; business organization consultancy; consultancy regarding public relations communications strategy; business management consultancy; personnel management consultancy; professional business consultancy; consultancy regarding advertising communications strategy; layout services for advertising purposes; marketing; business management of performing artists; business management of sports people; writing of résumés for others; scriptwriting for advertising purposes; news clipping services; updating and maintenance of information in registries; updating and maintenance of data in computer databases; updating of advertising material; word processing; organization of exhibitions for commercial or advertising purposes; arranging newspaper subscriptions for others; organization of fashion shows for promotional purposes; organization of trade fairs for commercial or advertising purposes; shop window dressing; design of advertising materials; business appraisals; payroll preparation; data search in computer files for others; sponsorship search; business management assistance; commercial or industrial

management assistance; commercial intermediation services; providing business information via a web site; provision of commercial and business contact information; provision of an on-line marketplace for buyers and sellers of goods and services; web indexing for commercial or advertising purposes; economic forecasting; auctioneering; retail or wholesale services for pharmaceutical, veterinary and sanitary preparations and medical supplies; sales promotion for others; production of teleshopping programmes; production of advertising films; office machines and equipment rental; rental of advertising time on communication media; publicity material rental; rental of billboards [advertising boards]; rental of vending machines; rental of photocopying machines; publication of publicity texts; radio advertising; distribution of samples; dissemination of advertising matter; direct mail advertising; registration of written communications and data; writing of publicity texts; on-line advertising on a computer network; advertising by mail order; television advertising; document reproduction; compilation of statistics; compilation of information into computer databases; business inquiries; systemization of information into computer databases; advisory services for business management; negotiation of business contracts for others; negotiation and conclusion of commercial transactions for third parties; compiling indexes of information for commercial or advertising purposes; tax preparation; drawing up of statements of accounts; telemarketing services; psychological testing for the selection of personnel; business management of hotels; business project management services for construction projects; commercial administration of the licensing of the goods and services of others; business management of reimbursement programs for others; administration of consumer loyalty programs; administration of frequent flyer programs; administrative processing of purchase orders; public relations; modelling for advertising or sales promotion; typing; appointment reminder services [office functions]; relocation services for businesses; tax filing services; search engine optimization for sales promotion; appointment scheduling services [office functions]; price comparison services; secretarial services; procurement services for others [purchasing goods and services for other businesses]; shorthand; outsourcing services [business assistance]; telephone answering for unavailable subscribers; photocopying services; business efficiency expert services; arranging subscriptions to telecommunication services for others; presentation of goods on communication media, for retail purposes; rental of sales stands; bill-posting; outsourced administrative management for companies; business management for freelance service providers; web site traffic optimization; pay per click advertising.

(260) AM 2018 95592 A

(800) 1378280

(151) 2016 02 25

(891) 2016 02 25

(731) CAPITAL PARTNERS S.A.

ul. Królewska 16, PL-00-103 Warszawa,
Poland

(540)

CAPITAL
PARTNERS

(591) Claret and white.

(531) 27.05.11; 29.01.05

(511)

35 – Business management assistance to industrial or commercial companies including marketing, business planning, business administration, administration of foreign business affairs, administration of the business affairs of franchises, administration relating to business appraisals; public relations services; advertising agencies; commercial information agencies; business analysis of markets, analysis of market research data, economic analysis for business purposes, business analysis of company behavior; professional business consulting; business analysis and research; business operation, organization and management consultancy, business efficiency expert services, business information, cost benefit analysis; market research; business and market research; market analysis; public relations studies, advertising research, corporate image studies; business efficiency studies, business consultancy and advisory services, business consulting, business advice relating to financing growth, advisory services relating to the corporate structure of businesses, business organisation advice, advice relating to the sale of businesses, commercial assistance in business management, advisory services relating to business risk management, business acquisition and merger consultation, business efficiency advice, consultancy relating to advertising, consultations relating to business advertising, consultancy relating to marketing management, marketing, promotion and strategic marketing; economic analysis; economic forecasting analysis for financial purposes.

36 – Credit agencies, issuance of tokens of value; financial management of shares, providing information relating to financial affairs, funds management services and management of investment funds, management of savings accounts, management of a capital investment fund; investment analysis, financial analysis and economic analysis, financial investment analysis and stock research, stock exchange information services, investment research; financial analysis and consultancy; financial advisory and management services, capital investment consultation, financial investment advisory services, advisory services relating to unit trusts, consultations relating

to investment, financial consulting, relating to securities, asset management; fund management; brokerage; stockbroking agency services; valuation of portfolios of securities; financial evaluation and analysis; business valuation services; valuation of capital stock and assets [financial]; fixed income investment services, execution of financial transactions (services for the -), securities deposit services; funds management services including private client unit trust; financial management, asset management, financial investment management services, derivatives trading services, bail bonding services, corporate trustee services, investment account services, securities investment services for personal investors, securities investment services, private equity fund investment services, hedge fund investment services, securities exchange services; securities brokerage; stock exchange services; stockbroking; fund investments; brokerage services relating to securities offering, including brokerage services relating to securities subscription, establishment of trusts (services for the-), futures exchange services, investment company services, private placement and venture capital investment services, investment trusteeship services; financial investment advisory services; investment risk assessment services, venture capital and venture capital management services, financial guarantee assessment services, consultations relating to banking; financial analysis and research services, economic financial research services; financing services for companies; banking and financing services; venture capital funding services for commercial entities, emerging and start-up companies.

(260) AM 2018 95593 A
 (800) 1378328
 (151) 2017 09 27
 (891) 2017 09 27
 (731) PHILIP MORRIS PRODUCTS S.A.
 Quai Jeanrenaud 3, CH-2000 Neuchâtel,
 Switzerland
 (540)



(591) Black, white
 (531) 05.03.01; 05.03.16; 10.01.25; 13.01.10;
 24.09.12; 25.01.01

(511)
 34 – Tobacco, raw or manufactured; tobacco products; cigars, cigarettes, cigarillos, tobacco for roll-your-own cigarettes, pipe tobacco, chewing tobacco, snuff tobacco, kretek; snus; tobacco substitutes (not for medical purposes); electronic cigarettes; tobacco products for the purpose of being heated; electronic devices and their parts for the purpose of heating cigarettes or tobacco in order to release nicotine-containing aerosol for inhalation; liquid nicotine solutions for use in electronic cigarettes; smokers' articles, cigarette paper, cigarette tubes, cigarette filters, tobacco tins, cigarette cases, ashtrays, pipes, pocket apparatus for rolling cigarettes, lighters, matches.

(260) AM 2018 95594 A
 (800) 1378329
 (151) 2017 09 28
 (891) 2017 09 28
 (731) PHILIP MORRIS PRODUCTS S.A.
 Quai Jeanrenaud 3, CH-2000 Neuchâtel,
 Switzerland
 (540)



(591) Green
 (531) 05.03.01; 05.03.16; 10.01.25; 13.01.10;
 24.09.12; 25.01.01; 25.07.25; 29.01.13
 (511)

34 – Tobacco, raw or manufactured; tobacco products; cigars, cigarettes, cigarillos, tobacco for roll-your-own cigarettes, pipe tobacco, chewing tobacco, snuff tobacco, kretek; snus; tobacco substitutes (not for medical purposes); electronic cigarettes; tobacco products for the purpose of being heated; electronic devices and their parts for the purpose of heating cigarettes or tobacco in order to release nicotine-containing aerosol for inhalation; liquid nicotine solutions for use in electronic cigarettes; smokers' articles, cigarette paper, cigarette tubes, cigarette filters, tobacco tins, cigarette cases, ashtrays, pipes, pocket apparatus for rolling cigarettes, lighters, matches.

(260) AM 2018 95595 A

(800) 1378330

(151) 2017 09 26

(891) 2017 09 26

(731) PHILIP MORRIS PRODUCTS S.A.

Quai Jeanrenaud 3, CH-2000 Neuchâtel,
Switzerland

(591) Red

(531) 05.03.01; 05.03.16; 10.01.25; 13.01.10;

24.09.12; 25.01.01; 25.07.25; 29.01.12

(511)

34 – Tobacco, raw or manufactured; tobacco products; cigars, cigarettes, cigarillos, tobacco for roll-your-own cigarettes, pipe tobacco, chewing tobacco, snuff tobacco, kretek; snus; tobacco substitutes (not for medical purposes); electronic cigarettes; tobacco products for the purpose of being heated; electronic devices and their parts for the purpose of heating cigarettes or tobacco in order to release nicotine-containing aerosol for inhalation; liquid nicotine solutions for use in electronic cigarettes; smokers' articles, cigarette paper, cigarette tubes, cigarette filters, tobacco tins, cigarette cases, ashtrays, pipes, pocket apparatus for rolling cigarettes, lighters, matches.

(260) AM 2018 95620 A

(800) 1378813

(151) 2017 02 10

(891) 2017 02 10

(731) IVOCCLAR VIVADENT AG

Bendererstrasse 2, FL-9494 Schaan,
Liechtenstein

(540)



(591) Black, white

(531) 24.17.02; 26.01.06; 26.11.14; 27.05.07;

27.05.08; 27.05.17

(511)

3 – Dentifrices; bleaching preparations for dental use; dental materials for the bleaching of teeth.

5 – Materials for use in dentistry; materials and auxiliary materials for the manufacture of dental impressions, models, crowns, bridges, inlays, prostheses, artificial teeth; materials for the characterization of teeth; materials for polishing teeth; dental waxes; dental filling materials; materials for relining teeth; materials for root canal filling; core build-up materials for use in dentistry; luting materials; materials for pulp protection and root treatment; materials for cavity treatment; materials for dentin wound and pulp treatment; materials used for acid etching and for the caries prophylaxis; dental adhesive agents; protective varnishes for teeth; drying and degreasing materials for the use in dentistry; materials for cosmetic restoration of damaged teeth; diagnostic substances for medical use; dental composites; dental cements; saliva diagnostic agents, preparations and substances for medical use; disinfectants; preparations for the hygiene of teeth and oral cavity; medical mouthwash; dental materials for the treatment of caries and periodontitis; color stains for use in dentistry; dental alloys; precious metal alloys and non-precious metal alloys for dental use; precious metals and non-precious metals for dental use; investment materials for dental use; dental adhesives; materials for repairing damaged teeth; metal primers; prefabricated parts for crowns, bridges, and pontics; fiber-reinforced resin for the manufacture of crowns, bridges, and pontics; fissure sealants; mixing capsules for dental materials; materials for the detection of plaque; dental ceramic layering; healthcare preparations; ingots made of resin, metal or ceramic for the manufacture of dental crowns, bridges, inlays, prostheses, artificial teeth, opaquers being dental lacquers.

7 – 3D printers for dental use, and parts thereof; accessories for 3D printers for dental use, included in class 7.

9 – Software for dental use; scanners, apparatus for the processing of images, and devices for CAD-CAM-processing.

10 – Apparatus, devices, tools, and instruments for dental use, in this class; impression devices for dental use; registration devices for dental use; articulators for dental use; mixing devices for dental use; blasting devices for dental use; dosing instruments and apparatus for dental use; milling, grinding, and drilling instruments for dental use; artificial teeth and veneers; dental plates; dental crowns and bridges; syringes; shade guides; dental matrices; dental strips; apparatus and instruments for the caries prophylaxis and for the treatment of periodontitis; polishing instruments (terms considered too vague by the International Bureau – Rule 13 (2) (b)

of the Common Regulations); ceramic mixing plates, for dental use; tooth pins for medical use; dental applicators; milling and grinding machines for dental use, and parts thereof; accessories for 3D printers for dental use, included in class 10; polymerization apparatus; ultrasonic cleaning instruments for dental use; milling machines and grinding machines for dental use for the treatment of ceramics, metal and plastic materials, and parts thereof; milling and grinding tools for dental use as machine tools, and parts thereof; holding devices for machine tools and piece holders for milling and grinding machines for dental use.

11 – Dental furnaces.

38 – Providing access to databases.

41 – Organisation of seminars, educational courses and trainings relating to dentistry.

42 – Cloud computing services.

(260) AM 2018 95621 A

(800) 1378536

(151) 2017 05 16

(891) 2017 05 16

(731) EKOL LOJISTIK ANONIM SIRKETI
Ekol Caddesi No. 2, TR-34935 Sultanbeyli
İstanbul, Turkey

(540)



(591) Black, grey and light blue. "ekol" is in black, "logistics 4.0" are in light blue on a grey background

(531) 27.05.10; 29.01.12

(511)

39 – Land, rail, water, and air transport services for the carriage of freight; courier services (for merchandise); establishment and operation of warehouses, namely warehousing services.

(260) AM 2018 95622 A

(800) 1378567

(151) 2017 10 02

(891) 2017 10 02

(731) ZBOM CABINETS CO., LTD.
No.19, Lian Shui Road, Lu Yang Industrial
Zone, Hefei, Anhui, China

(540)



(591) Black, white

(531) 27.05.15

(511)

20 – Furniture; covers for clothing [wardrobe]; sideboards; cupboards; sofas; beds; writing desks; mattresses; display stands; clothes hangers; desks; dressing tables; mirrors [looking glasses]; furniture fittings, not of metal; cushions; coat stands; chairs; slatted indoor blinds.

(260) AM 2018 95623 A

(800) 1378683

(151) 2017 09 11

(891) 2017 09 11

(731) Charitable endowment "FUTURE
CHAMPIONS LEAGUE"
Pobedy st, 11, Khimki, RU-141401 Moscow
region, Russian Federation

(540)



(591) Black, white

(531) 25.01.10; 27.05.01

(511)

32 – Beer-based cocktails; Beer.

33 – Alcoholic beverages.

(260) AM 2018 95624 A

(800) 1378819

(151) 2017 02 07

(891) 2017 02 07

(731) GIORGIO ARMANI S.P.A.
Via Borgonuovo, 11, I-20121 MILANO, Italy

(540)



(591) Black, white

(531) 24.17.02; 26.11.03; 27.07.17

(511)

18 – Handbags; traveling bags; briefcases; leather briefcases; leather credit card holders; wallets; leather document briefcases; leather key cases; purses; suitcases; cosmetic bags sold empty; sports bags; evening and shoulder bags for ladies; leather shopping bags; school bags; garment bags for travel; suit carriers for travel; shoe bags for travel; beach bags; diaper bags; backpacks; Boston bags; traveling trunks; duffel bags; overnight bags; carry-on bags; satchels; opera bags; vanity cases [not fitted]; hides;

cases and boxes made of leather; bags made of leather for packaging; leather straps; umbrellas; leather leashes; saddlery.

25 – Coats; jackets; trousers; skirts; tops; raincoats; overcoats; belts; braces for clothing; suits; stuff jackets; jumpers; jeans; dresses; cloaks; parkas; shirts; T-shirts; sweaters; underwear; baby doll pyjamas; bathrobes; bathing costumes; negligee; swim suits; dressing gowns; shawls; neckerchiefs; scarves; ties; neckties; sweat shirts; under shirts; polo shirts; body suits; shorts; combinations [clothing]; wedding dresses; stockings; socks; shoes; slippers; overshoes; galoshes; wooden clog; soles for footwear; footwear upper; boots; ski boots; snow boots; half boots; esparto shoes or sandals; sandals; bath sandals; gloves; mittens; hats and caps; visors [headwear].

28 – Appliances, machines and devices for sports games, for sport and for physical exercises; video game machines; bags and knapsacks for sporting articles; ornaments for Christmas trees, except illumination articles and confectionery; toys; gloves for games and gloves for playing sports; plush toys; skis; snowboards; playing cards; balls for games; flippers for swimming; roller skates; ice skates.

(260) AM 2018 95625 A

(800) 1378684

(151) 2017 10 06

(891) 2017 10 06

(731) MELEK TEKSTİL SANAYİ VE TİCARET LİMİTED ŞİRKETİ

Namık Kemal Mahallesi 122. Sokak No:6,
E-5 Yolu Üzeri Haramidere, Büyükçekmece,
İstanbul, Turkey

(540)



(591) Black, white

(531) 26.13.25; 27.05.01

(511)

18 – Leather and imitations of leather; animal skins and hides; luggage and carrying bags; umbrellas and parasols; walking sticks; whips, harness and saddlery; collars, leashes and clothing for animals.

25 – Clothing, footwear, headgear.

35 – Bringing together, for benefit of others, of a variety of leather and imitations of leather, animal skins, hides, trunks and travelling bags, umbrellas and parasols, walking sticks, whips, harness and

saddlery, clothing, footwear, headgear, enabling customers to conveniently view and purchase those goods.

(260) AM 2018 95626 A

(800) 1378836

(151) 2017 05 12

(891) 2017 05 12

(731) KOSAN KOZMETİK SANAYİ VE TİCARET ANONİM ŞİRKETİ

Gebze Organize Sanayi Bölgesi,
İhsan Dede Caddesi No:133 Gebze
TR-41480 Kocaeli, Turkey

(540)



(591) Black, white

(531) 27.05.01; 27.05.10

(511)

3 – Bleaching and cleaning preparations included in this class; detergents, laundry bleach, fabric softeners, stain removers, dishwasher detergents; perfumery; cosmetics; fragrances for personal use (including deodorants for human and animals); soaps; dental care preparations; dentifrices, tooth polishing and tooth whitening preparations, mouthwashes not for medical purposes; abrasive preparations; emery cloth, sandpaper, pumice stone, abrasive pastes; polishing and bleaching preparations for leather, vinyl, metal and wood; polishes, polishing creams, wax for polishing.

(260) AM 2018 95627 A

(800) 1378786

(151) 2017 10 06

(891) 2017 10 06

(731) ALPEN PHARMA AG

Casinoplatz 2, CH-3011 Bern, Switzerland

(540)

APICOLD

(591) Black, white

(511)

5 – Pharmaceutical products, medical and veterinary preparations; sanitary products for medical purposes; dietetic food and substances for medical or veterinary use, food for babies; food supplements for humans and animals; plasters, materials for dressings; material for dental fillings and dental impressions; disinfectants; products for destroying vermin; fungicides, herbicides.

(260) AM 2018 95629 A

(800) 1378866

(151) 2017 06 23

(891) 2017 06 23

(731) JOANNE ROWLING

c/o The Blair Partnership, Middlesex House,
4th Floor, 34-42 Cleveland Street London
W1T 4JE, United Kingdom

(540)



(591) Black, white

(531) 27.05.13

(511)

9 – Motion picture films featuring comedy, drama, action, adventure and/or animation, and motion picture films for broadcast on television featuring comedy, drama, action, adventure and/or animation; audio video discs, and digital versatile discs featuring music, comedy, drama, action, adventure, and/or animation; downloadable audio recordings featuring comedy, drama, action and adventure; downloadable audio-video recordings featuring comedy, drama, action and adventure and/or animation; apparatus for processing, recording, transmission or reproduction of sound, video, data and/or images; mouse pads; eyeglasses, sunglasses and cases therefore; downloadable computer software applications; downloadable software for use in playing online computer games, downloadable computer game software; computer game software for use on mobile and cellular phones; video and computer game programs; video game cartridges; computer and video game discs, cartridges, downloadable programs and software applications which are designed for hardware platforms, namely game consoles and personal computers; computer game software for gaming machines including slot machines; computer software or firmware for games of chance on any computerized platform, including dedicated gaming consoles, video based slot machines, reel based slot machines and video lottery terminals; computer software linking digitized video and audio media to a global computer information network; downloadable audio-visual media content in the field of entertainment featuring animated motion pictures, television series, comedies, and dramas; computer software, namely, computer software for streaming audio-visual media content via the Internet, computer software for streaming and storing audio-visual media content, downloadable audio and video players for media content with multimedia and interactive functions; computer programs for accessing, browsing and searching online databases, software that enables users to play and program entertainment-related audio, video, text and multi-media content; computer application software for streaming and sto-

ring audio-visual media content; computer application software for streaming audio-visual media content via the Internet; downloadable computer software for streaming audio-visual media content via the Internet; downloadable computer software for streaming and storing audio-visual media content; downloadable publications in the nature of books featuring characters from animated, action adventure, comedy and/or drama features, comic books, children's books, strategy guides, magazines featuring characters from animated, action adventure, comedy and/or drama features, colouring books, children's activity books and magazines in the field of entertainment; cellular telephone accessories, namely hands-free accessories, cellular telephone covers and cellular telephone face covers; encoded magnetic cards, namely, phone cards, credit cards, cash cards, debit cards and magnetic key cards; downloadable electronic books, magazines, newspapers; downloadable children's books; downloadable audio books; downloadable interactive electronic publications, interactive electronic books and interactive electronic children's books; decorative magnets.

16 – Printed matter, newspapers, periodical publications; books; colouring books; stationery; comic books, children's books; magazines featuring characters from animated, action adventure, comedy and/or drama features; children's activity books; stationery, writing paper, envelopes, notebooks, diaries, note cards, greeting cards, trading cards; lithographs; pens, pencils, cases therefor, erasers, crayons, markers, coloured pencils, painting sets, chalk and chalkboards; decals, heat transfers; posters; mounted and/or unmounted photographs; book covers, book marks, calendars, gift wrapping paper; paper party decorations, namely, paper napkins, paper place mats, crepe paper, invitations, paper table cloths, paper cake decorations; printed transfers for embroidery or for use with fabric appliqué; printed patterns for costumes, pyjamas, sweatshirts and t-shirts.

25 – Clothing; footwear; headgear; T-shirts, sweatshirts, shirts, trousers, shorts, skirts, blouses, dresses, jackets, coats, sleepwear, underwear, swimwear, jumpers, hats, caps, baseball caps, headbands; scarves, woolly hats and gloves; shoes, training shoes, sandals, boots and slippers; belts for wear.

28 – Games, toys and playthings; video game apparatus; games consoles; controllers for games consoles; gymnastic and sporting articles; playing cards; board games; card games; hand-held electronic games; decorations for Christmas trees; jigsaw puzzles and other manipulative puzzles.

45 – Intellectual property licensing services; management of intellectual property rights; online social networking services; social networking services provided via the internet and other electronic com-

munications networks; social networking provided via a website on the internet; Internet based social networking services allowing users to communicate and share, store, transmit, view, and download text, images, audio and video content, and other multimedia materials.

(260) AM 2018 95701 A
(800) 1187937
(151) 2013 07 06
(891) 2013 07 06
(731) Barij Essence pharmaceutical co
P.O. Box 1178, 44 Km of, Kashan-Delijan
Road, Mashhad Ardehal, Kashan, Iran
(Islamic Republic of)

(260)



(591) Green and black.
(531) 01.15.15; 19.11.05; 28.01
(526) Essence.
(511)
5 – Pharmaceutical preparations.

35 – Wholesale and retail sale services for pharmaceutical preparations; export of pharmaceutical preparations.

39 – Packaging of pharmaceutical preparations; delivery of pharmaceutical preparations.

(260) AM 2018 95703 A
(800) 1282366
(151) 2015 12 01
(891) 2017 11 29
(731) VGM HOLDING
107 Avenue Charles de Gaulle, F-54910
VALLEROY, France

(540)

CHAUSSEA

(591) Black, white
(511)
18 – Leather and imitation leather, animal skins; trunks and suitcases; umbrellas, parasols and walking sticks; whips and saddlery, wallets; purses (coin purses); handbags, backpacks, wheeled bags; bags for climbers, for campers, travel bags, beach bags, school bags; vanity cases (empty); collars or clothing for animals; bags or net bags for shopping; bags

or small bags (envelopes, pouches) of leather for packaging.

25 – Clothing, hosiery, footwear, headgear.

(260) AM 2018 95712 A
(800) 1344049
(151) 2017 02 06
(891) 2017 10 27
(731) CUP & CINO KAFFEESYSTEM VERTRIEB
GMBH & CO. KG
Paderborner Straße 33, 33161 Hövelhof,
Germany

(540)



(591) Black, white and red.
(531) 24.17.09; 26.04.24; 27.05.17; 27.05.24;
29.01.13

(511)
11 – Apparatus for lighting, heating, steam generating, cooking, refrigerating, drying, ventilating, water supply and sanitary purposes, in particular electric coffee machines and coffee systems, included in class 11, electric coffee roasting machines.

30 – Coffee, coffee-based beverages, unroasted coffee, tea, cocoa, sugar, rice, tapioca, sago, artificial coffee; flour and preparations made from cereals, bread, pastry and confectionery, ice-cream, iced tea, ices; honey, treacle; yeast, baking-powder; salt, mustard; vinegar, fruit sauces, sauces (condiments); spices; ice, unprocessed ice, pasta, pizzas.

43 – Providing of food and drink and temporary accommodation.

(260) AM 2018 95720 A
(800) 1379373
(151) 2017 04 28
(891) 2017 04 28
(731) XIAOMI INC.
Floor 13, Rainbow City Shopping Mall II of
China Resources, No.68, Qinghe Middle
Street, Haidian District 100085 Beijing, China

(540)



(591) Black, white
(531) 24.01.01; 24.01.25; 26.13.25; 27.05.01;
27.05.17; 27.05.22; 28.03

(511)

25 – Ready-made clothing, layettes [clothing]; bathing suits/swimsuits; waterproof clothing; masquerade costumes; footwear; headgear for wear; hosiery; gloves [clothing]; scarves/scarfs; belts [clothing]; wimples; chasubles; maniples; albs; religious clothing.

35 – Presentation of goods on communication media, for retail purposes; commercial intermediation services; provision of an on-line marketplace for buyers and sellers of goods and services; personnel recruitment; relocation services for businesses; systemization of information into computer databases; book-keeping/accounting; rental of vending machines; sponsorship search; retail or wholesale services for pharmaceutical, veterinary and sanitary preparations and medical supplies.

(260) AM 2018 95722 A

(800) 1379410

(151) 2017 10 06

(891) 2017 10 06

(731) UNIWAGON NORTH AMERICA CORP.

One Bridge Plaza North, Suite 275, Fort
Lee NJ 07024, USA

(540)



(591) Black, white

(531) 26.05.01; 26.05.04; 26.05.18; 26.05.24;
27.05.09; 27.05.24

(526) NORTH AMERICA

(511)

6 – Metallic materials for railway tracks and metal loading gauge rods and pallets for wagons.

12 – Railway cars and their replacement parts, bogies for railway cars and their replacement parts, railway couplings and their replacement parts.

35 – Outsourcing services; marketing and publicity services; business administration and management services; licensing services, namely, commercial administration of the licensing of the goods and services of others; outsourcing services in the nature of arranging procurement of goods for others in the field of railway parts.

(260) AM 2018 95734 A

(800) 1379529

(151) 2017 07 14

(891) 2017 07 14

(731) ABSTRAGAN HOLDING LIMITED

Astra House, Arklow Road, London SE14
6EB, United Kingdom

(540)

LITESLIM

(591) Black, white

(531) 27.05.17

(511)

5 – Pharmaceutical and veterinary preparations; sanitary preparations for medical purposes; dietetic food and substances adapted for medical or veterinary use, food for babies; dietary supplements for humans and animals; plasters, materials for dressings; material for stopping teeth, dental wax; disinfectants; preparations for destroying vermin; fungicides, herbicides.

(260) AM 2018 95735 A

(800) 1379548

(151) 2017 08 29

(891) 2017 08 29

(731) VEDA CAPITAL LTD.

Okulovoy str., 68 B RU-153020 Ivanovo,
Russian Federation

(540)

ORMATEK/OPMATEK

(591) Black, white

(511)

10 – Orthopedic articles; furniture especially made for medical purposes; cushions for medical purposes; pads [pouches] for preventing pressure sores on patient bodies; soporific pillows for insomnia.

20 – Sideboards; coat hangers; coatstands; display stands; showcases [furniture]; signboards of wood or plastics; covers for clothing [wardrobe]; doors for furniture; pegs [pins], not of metal; divans; flowerstands [furniture]; mirrors [looking glasses]; handheld mirrors [toilet mirrors]; bamboo; rattan; plaited straw, except matting; wickerwork; works of art of wood, wax, plaster or plastic; cabinet work; index cabinets [furniture]; cradles; chests of drawers; lecterns; armchairs; hospital beds; bedsteads of wood; beds; air mattresses, not for medical purposes; spring mattresses; mattresses; furniture of metal; office furniture; school furniture; curtain rails; furniture; furniture partitions of wood; mirror tiles; head-rests [furniture]; trestles [furniture]; book rests [furniture]; pillows; cushions; racks [furniture]; library shelves; shelves for file cabinets; furniture shelves; shelves for storage; wood ribbon; hat stands; inflatable publicity objects; counters [tables]; bedding, except linen; door handles, not of metal; writing desks; seats of metal; benches [furniture]; sofas; silvered glass [mirrors]; gun racks; carts for computers [furniture]; dressing tables; washstands [furniture]; typing desks; drafting tables; massage tables; tables of metal; wall-mounted baby changing platforms;

desks; tea carts; dinner wagons [furniture]; tables; steps [ladders], not of metal; chairs [seats]; high chairs for babies; chests, not of metal; placards of wood or plastics; stools; crates; trolleys [furniture]; straw plait; straw mattresses; door fittings, not of metal; bed fittings, not of metal; furniture fittings, not of metal; window fittings, not of metal; infant walkers; chaise longues; poles, not of metal; screens [furniture]; filing cabinets; medicine cabinets; meat safes, not of metal; plate racks; bamboo curtains; paper blinds; slatted indoor blinds; woven timber blinds [furniture]; indoor window blinds [shades] [furniture]; interior textile window blinds; lockers; cases of wood or plastic; chests for toys; letter boxes, not of metal or masonry; wardrobes; cupboards; kitchen cabinets; bookcases; screens for fireplaces [furniture].

22 – Bags [envelopes, pouches] of textile, for packaging; straw for stuffing upholstery; grasses for upholstering; carded wool; camel hair; flock [stuffing]; upholstery wool [stuffing]; wood wool; combed wool; raw or treated wool; shorn wool; padding, cushioning and stuffing materials, except of paper, cardboard, rubber or plastics; packing [cushioning, stuffing] materials, not of rubber, plastics, paper or cardboard.

24 – Household linen; diapered linen; bath linen, except clothing; bed linen; table linen, not of paper; table runners; drugget; shower curtains of textile or plastic; curtains of textile or plastic; net curtains; furniture coverings of textile; fabrics for textile use; wall hangings of textile; pillowcases; mattress covers; bed blankets; eiderdowns [down coverlets]; handkerchiefs of textile; travelling rugs [lap robes]; cloth coasters; curtain holders of textile material; bed covers of paper; furniture coverings of plastic; towels of textile; glass cloths [towels]; ticks [mattress covers]; gummed cloth, other than for stationery purposes; printers' blankets of textile; door curtains; place mats, not of paper; tablecloths, not of paper; oilcloth for use as tablecloths; lingerie fabric; upholstery fabrics; tulle; fitted toilet lid covers of fabric; covers [loose] for furniture; pillow shams; labels of textile; bed covers.

(260) AM 2018 95736 A

(800) 1379581

(151) 2017 09 01

(891) 2017 09 01

(731) HUAWEI TECHNOLOGIES CO., LTD.

Administration Building Huawei

Technologies Co., Ltd., Bantian, Longgang

District Shenzhen, China

(540)

Smart Selfie Butterfliting

(591) Black, white

(511)

9 – Fluorescent screens; video screens; screens for computers; touch screens; screens for liquid crystal displays (LCD); flash-bulbs (photography); screens (photography); darkroom lamps (photography); diaphragms (photography); shutters (photography); magic lanterns; filters (photography); flashlights (photography); filters for ultraviolet rays, for photography; battery chargers; electric batteries; mobile Power source (rechargeable batteries); galvanic cells; notebook computers; laptop computers; tablet computers; covers for tablet computers; interactive touch screen terminals; electronic interactive whiteboards; humanoid robots with artificial intelligence; covers for personal digital assistants; computer keyboards; recorded computer operating programs; recorded computer software; computer hardware; smartglasses; smartwatches; smart rings; smartphones; wearable activity trackers; headphones; earphones; cameras (photography); virtual reality headsets; covers for smartphones; selfie sticks (hand-held monopods); digital photo frames; microphones; data processing apparatus; computer memories; audio and video receivers; network communication apparatus; modems; loudspeakers; portable media players; sound transmitting apparatus; camcorders.

(260) AM 2018 95737 A

(800) 1379619

(151) 2017 08 18

(891) 2017 08 18

(731) CHANEL SARL

Quai du Général-Guisan 24 CH-1204

Genève, Switzerland

(540)



GABRIELLE

(591) Black, white

(531) 26.01.06; 27.05.17; 27.05.22

(511)

3 – Preparations for cosmetic use for skin, scalp, hair or nail care; preparations for cosmetic use for application on the skin, scalp, hair or nails; soaps; perfumery products; perfumes; make-up products; essential oils; cosmetics; toiletries for non-medical use; talcum powder; deodorants; antiperspirants; artificial nails for cosmetic use; nail art stickers; adhesives for affixing artificial nails; temporary tattoos for cosmetic use; perfumed sprays for indoor use; air fragrances; potpourris [fragrances].

(260) AM 2018 95738 A

(800) 1379715

(151) 2017 06 17

(891) 2017 06 17

(731) Behshahr Industrial Company

8th K.m. of Fath Highway, Tehran,
Iran (Islamic Republic of)

(540)

LADAN GOLD

(591) Black, white

(526) GOLD

(511)

29 – Milk and milk products; jams; jellies for food; preserved, dried and boiled (cooked) fruits and vegetables; edible oils and fats; margarine; compotes; meat; meat extracts; tinned meat; canned meat; fish; poultry and game not live; dried nuts; tuna fish; potato chips; eggs; canned and preserved vegetable; vegetable juices for cooking; poultry extracts.

30 – Pastry and confectionery; confectionery ices; flour for food; sugar; spices; bread; cereals and cereal preparations; cocoa; coffee; artificial coffee; rice; sauces [condiments]; starch for food; tapioca; sago; vinegar; ices; honey; treacle; yeast; baking-powder; salt; tea; corn flour; vermicelli; spaghetti; macaroni; pasta.

32 – Non-alcoholic extracts and distillates; non-alcoholic drinks; aerated mineral water; preparations for making beverages; fruit syrups for beverages; mineral water; non-alcoholic beer; fruit juice concentrate.

35 – Advertisement; export agency services, retail/wholesale services of milk and milk products, jams, jellies for food, preserved, dried and boiled (cooked) fruits and vegetables, edible oils fats, margarine, compotes, meat, meat extracts, tinned meat, canned meat, fish, poultry and game not live, dried nuts, tuna fish, potato chips, eggs, canned and preserved vegetable, vegetable juices for cooking, poultry extracts, pastry and confectionery, confectionery ices, flour for food, sugar, spices, bread, cereals and cereal preparations, cocoa, coffee, artificial coffee, rice, sauces [condiments], starch for food, tapioca, sago, vinegar, ices, honey, treacle, yeast, baking-powder, salt, tea, corn flour, vermicelli, spaghetti, macaroni, pasta, non-alcoholic extracts and distillates, non-alcoholic drinks, aerated mineral water, preparations for making beverages, fruit syrups for beverages, mineral water, non-alcoholic beer, fruit juice concentrate.

39 – Packing; transport and storage services of milk and milk products, jams, jellies for food, preserved, dried and boiled (cooked) fruits and vegetables, edible oils and fats, margarine, compotes, meat, meat extracts, tinned meat, canned meat, fish, poultry and game not live, dried nuts, tuna fish, potato chips, eggs, canned and preserved vegetable, vegetable juices for cooking, poultry extracts, pastry

and confectionery, confectionery ices, flour for food, sugar, spices, bread, cereals and cereal preparations, cocoa, coffee, artificial coffee, rice, sauces [condiments], starch for food, tapioca, sago, vinegar, ices, honey, treacle, yeast, backing-powder, salt, tea, corn-flour, vermicelli, spaghetti, macaroni, pasta, non-alcoholic extracts and distillates, non alcoholic drinks, aerated mineral water, preparation for making beverages, fruit syrups for beverages, mineral water, non-alcoholic beer, fruit juice concentrate.

(260) AM 2018 95739 A

(800) 1379719

(151) 2017 08 03

(891) 2017 08 03

(731) Torgovyj Dom Morskoe Sodruzhestvo

Tallinskaya 7, liter A, office 5-H, Saint-
Petersburg, Russian Federation

(540)



(591) Blue, white and dark-blue.

(531) 18.03.14; 25.01.05; 28.05; 29.01.12

(511)

29 – Meat, fish, poultry and game; caviar; isinglass for food; fish, tinned [canned (Am.)]; fish meal for human consumption; liver pâté; liver; salted meats; tripe; tuna fish; shrimps, not live; spiny lobsters, not live; salmon, not live; shellfish, not live; mussels, not live; lobsters, not live; foods made from fish; crustaceans, not live; fish, not live; sardines, not live; herrings, not live; sea-cucumbers, not live; oysters, not live.

(260) AM 2018 95741 A

(800) 1379751

(151) 2017 07 14

(891) 2017 07 14

(731) Abstragan Holding Limited

Astra House, Arklow Road, London SE14
6EB, United Kingdom

(540)

КЕТАНЕИМ
КЕТАНЕЙМ

(591) Black, white

(531) 27.05.01; 27.05.17; 28.05

(511)
5 – Pharmaceutical and veterinary preparations; sanitary preparations for medical purposes; dietetic food and substances adapted for medical or veterinary use, food for babies; dietary supplements for humans and animals; plasters, materials for dressings; material for stopping teeth, dental wax; disinfectants; preparations for destroying vermin; fungicides, herbicides.

(260) AM 2018 95742 A
(800) 1379768
(151) 2017 09 28
(891) 2017 09 28
(731) TENTE GmbH & Co. KG
Herrlinghausen 75,42929 Wermelskirchen,
Germany
(540)



(591) Black, white
(531) 26.11.02; 26.11.06; 26.11.07; 26.11.08;
27.01.01; 27.05.21

(511)
6 – Rollers and wheels of metal.

7 – Rollers and wheels as parts of transportation devices, machines and apparatus.

10 – Rollers and wheels as parts of medical furniture, chairs for medical purposes, hospital and nursing beds, medical devices.

12 – Rollers and wheels as parts of dollies, shopping trolleys, equipment trolleys, fork-lift trucks, pallet trucks, towing tractors, pallet transfer trucks, vehicles.

18 – Rollers and wheels as parts of suitcases, bags, luggage and other carrying cases.

20 – Rollers and wheels as parts of furniture, chairs.

(260) AM 2018 95744 A
(800) 1379805
(151) 2017 09 27
(891) 2017 09 27
(731) DAIICHI SANKYO COMPANY LIMITED
3-5-1, Nihonbashi Honcho, Chuo-ku Tokyo
103-8426, Japan

(540)
ЛИКСИАНА

(591) Black, white
(531) 28.05
(511)
5 – Pharmaceutical preparations and substances.

(260) AM 2018 95813 A
(800) 1381514
(151) 2017 10 25
(891) 2017 10 25
(731) adp Gauselmann GmbH
Merkur-Allee 1-15, 32339 Espelkamp,
Germany
(540)

Rising Liner

(591) Black, white
(511)
9 – Computer software; computer and video games software; games software in particular for use on any computer platform, including electronic entertainment and games consoles; computer game programs; video games (software); computer games provided through a global computer network or supplied by means of multi-media electronic broadcast or through telecommunications or electronic transmission or via the Internet; computer games (software), leisure and recreational software, video games and computer software, all being provided in the form of storage media; programs for operating electric and electronic apparatus for games, amusement and/or entertainment purposes; lottery ticket dispensing apparatus, namely automatic lottery machines; software for automatic lottery machines; computer software for computer games on the Internet; online games (software), in particular for online betting games, online prize games, online gambling games, online games of skill and online casino games; computer software in the form of an app for mobile devices and computers; operational computer games software; computer software for managing of games (game collection); collection of video games (software).

(260) AM 2018 95822 A
(800) 1237318
(151) 2014 11 14
(891) 2017 10 25
(731) BELLES MARKS LTD
4 Arch. Makariou & Kalograion, Nicolaides
Sea View City, Block A-B, Floor 9 th Flat
903-904, CY-6016 Larnaca, Cyprus

(540)
BRÂNCOVEANU

(591) Black, white
(511)
33 – Arak; bitters; brandy; digesters; distilled beverages; gin; liqueurs; rum; vodka; whisky; wine.

(260) AM 2018 95827 A
(800) 1369694
(151) 2017 08 24
(891) 2017 12 05

(731) AstraZeneca AB
SE-151 85 Södertälje, Sweden

(540)

 **IMFINZI**

(591) Black, white

(531) 24.15.01; 24.15.21; 26.07.09

(511)

5 – Pharmaceutical preparations and substances.

(260) AM 2018 96268 A

(800) 1385845

(151) 2017 07 07

(891) 2017 07 07

(731) VARANA UK LTD

Hillbrow House, Hillbrow Road, Esher,
Surrey KT10 9NW, United Kingdom

(540)

ALMORA BOTANICA

(591) Black, white

(511)

3 – Non-medical herbal body oils; non-medical herbal ointments; non-medical herbal skincare oils; non-medical herbal skin lotions; non-medicated lip balm; non-medical herbal soaps; non-medical soap solutions and soap powder; non-medical herbal fragrances; deodorants, not for medical purposes; non-medical body lotions; non-medicated lotions; emollients; non-medical herbal massage oils and lotions; non-medical aromatic extracts and essential oils; non-medical herbal cosmetics and perfumery articles; non-medical herbal hair sprays and hair lotions; non-medical shampoos and conditioners; non-medical herbal moisturisers; non-medical antiperspirants; non-medicated douches; non-medical toiletry articles, bath beads and bath lotions; non-medical herbal face powders and skin ointments; non-medical bath foam and skin cleaning preparations; non-medical hand creams and body sprays; non-medical herbal skin toners, skin tonics and cream cleansers; non-medical foot balms; non-medical herbal bath concentrates, bathing oils, bath crystals and foot lotions; non-medical, plant-based anti-ageing serum; non-medical intimate washing preparations for women; sunscreen preparations; non-medical herbal peels for face and body.

INTERNATIONAL TRADEMARKS PROTECTED IN GEORGIA

(260) AM 2018 89751 A
(800) 1320428
(151) 2016 02 09
(181) 2026 02 09
(891) 2016 02 09
(511) 07, 08, 11

(260) AM 2018 91121 A
(800) 1333001
(151) 2016 06 09
(181) 2026 06 09
(891) 2016 06 09
(511) 03, 05, 10

(260) AM 2018 91143 A
(800) 570261
(151) 1991 02 02
(181) 2001 02 02
(891) 2016 11 10
(511) 01

(260) AM 2018 91728 A
(800) 1338136
(151) 2016 07 28
(181) 2026 07 28
(891) 2016 07 28
(511) 09, 28

(260) AM 2018 92633 A
(800) 1347611
(151) 2017 02 07
(181) 2027 02 07
(891) 2017 02 07
(511) 06, 07, 08, 09, 11, 21, 35, 37, 40, 41, 42

(260) AM 2018 92649 A
(800) 1347971
(151) 2016 11 19
(181) 2026 11 19
(891) 2016 11 19
(511) 28, 42

(260) AM 2018 92658 A
(800) 1348154
(151) 2016 11 03
(181) 2026 11 03
(891) 2016 11 03
(511) 28

(260) AM 2018 92661 A
(800) 1348252
(151) 2017 02 02
(181) 2027 02 02
(891) 2017 02 02
(511) 16

(260) AM 2018 92667 A
(800) 471964
(151) 1982 09 14
(181) 2022 09 14
(891) 2017 04 18
(511) 01, 03, 04

(260) AM 2018 92693 A
(800) 1337909
(151) 2017 01 17
(181) 2027 01 17
(891) 2017 03 30
(511) 09

(260) AM 2018 92821 A
(800) 1348592
(151) 2017 03 17
(181) 2027 03 17
(891) 2017 03 17
(511) 14

(260) AM 2018 92901 A
(800) 1349059
(151) 2016 11 21
(181) 2026 11 21
(891) 2016 11 21
(511) 01, 03, 04, 05, 06, 07, 08, 09, 10, 11, 12, 14, 15, 16, 18, 20, 21, 24, 25, 26, 27, 28, 29, 30, 31, 32, 33, 34, 35, 36, 37, 38, 39, 40, 41, 42, 43, 45

(260) AM 2018 92906 A
(800) 1350272
(151) 2017 03 09
(181) 2027 03 09
(891) 2017 03 09
(511) 25

(260) AM 2018 92907 A
(800) 1350295
(151) 2016 11 03
(181) 2026 11 03

(891) 2017 06 22
(511) 09, 28, 41

(260) AM 2018 92917 A
(800) 1350202
(151) 2017 02 27
(181) 2027 02 27
(891) 2017 02 27
(511) 14

(260) AM 2018 92920 A
(800) 1349947
(151) 2016 09 09
(181) 2026 09 09
(891) 2016 09 09
(511) 09, 35, 38

(260) AM 2018 92944 A
(800) 1350188
(151) 2016 12 26
(181) 2026 12 26
(891) 2016 12 26
(511) 09, 14

(260) AM 2018 92984 A
(800) 1349925
(151) 2017 04 28
(181) 2027 04 28
(891) 2017 04 28
(511) 05

(260) AM 2018 93010 A
(800) 1350629
(151) 2017 02 17
(181) 2027 02 17
(891) 2017 06 27
(511) 03

(260) AM 2018 93033 A
(800) 1351564
(151) 2016 12 27
(181) 2026 12 27
(891) 2016 12 27
(511) 18, 25, 26, 35

(260) AM 2018 93159 A
(800) 1352217
(151) 2017 04 12
(181) 2027 04 12
(891) 2017 04 12
(511) 05

(260) AM 2018 93164 A
(800) 1352218
(151) 2017 04 12
(181) 2027 04 12
(891) 2017 04 12
(511) 05

(260) AM 2018 93171 A
(800) 1352272
(151) 2017 03 14
(181) 2027 03 14
(891) 2017 03 14
(511) 32

(260) AM 2018 93249 A
(800) 1354437
(151) 2017 05 08
(181) 2027 05 08
(891) 2017 05 08
(511) 09, 38

(260) AM 2018 93250 A
(800) 1354515
(151) 2017 01 18
(181) 2027 01 18
(891) 2017 01 18
(511) 35, 36, 43

(260) AM 2018 93252 A
(800) 1354554
(151) 2016 08 29
(181) 2026 08 29
(891) 2016 08 29
(511) 01, 05

(260) AM 2018 93265 A
(800) 1354572
(151) 2016 11 16
(181) 2026 11 16
(891) 2016 11 16
(511) 19, 20, 35, 40, 42

(260) AM 2018 93269 A
(800) 1354764
(151) 2017 04 26
(181) 2027 04 26
(891) 2017 04 26
(511) 10, 44

(260) AM 2018 93270 A
(800) 1354783
(151) 2017 05 03

(181) 2027 05 03
(891) 2017 05 03
(511) 09

(260) AM 2018 93288 A
(800) 1354240
(151) 2016 11 23
(181) 2026 11 23
(891) 2016 11 23
(511) 09

(260) AM 2018 93289 A
(800) 1004341
(151) 2009 04 21
(181) 2019 04 21
(891) 2017 04 19
(511) 05

(260) AM 2018 93290 A
(800) 1354256
(151) 2017 01 10
(181) 2027 01 10
(891) 2017 01 10
(511) 12

(260) AM 2018 93291 A
(800) 1181927
(151) 2013 10 17
(181) 2023 10 17
(891) 2017 06 15
(511) 31

(260) AM 2018 93292 A
(800) 1270283
(151) 2015 07 02
(181) 2025 07 02
(891) 2017 05 26
(511) 30

(260) AM 2018 93297 A
(800) 1353107
(151) 2017 02 06
(181) 2027 02 06
(891) 2017 02 06
(511) 35, 36, 38

(260) AM 2018 93298 A
(800) 1353113
(151) 2017 03 15
(181) 2027 03 15
(891) 2017 03 15
(511) 05

(260) AM 2018 93299 A
(800) 1353117
(151) 2017 04 05
(181) 2027 04 05
(891) 2017 04 05
(511) 03, 05

(260) AM 2018 93301 A
(800) 1353235
(151) 2017 03 30
(181) 2027 03 30
(891) 2017 03 30
(511) 03

(260) AM 2018 93302 A
(800) 1353331
(151) 2017 04 19
(181) 2027 04 19
(891) 2017 04 19
(511) 25, 28, 32

(260) AM 2018 93303 A
(800) 1353352
(151) 2017 04 28
(181) 2027 04 28
(891) 2017 04 28
(511) 05

(260) AM 2018 93305 A
(800) 1353391
(151) 2017 04 24
(181) 2027 04 24
(891) 2017 04 24
(511) 05

(260) AM 2018 93307 A
(800) 1353395
(151) 2017 04 28
(181) 2027 04 28
(891) 2017 04 28
(511) 05

(260) AM 2018 93308 A
(800) 1353396
(151) 2017 04 28
(181) 2027 04 28
(891) 2017 04 28
(511) 05

(260) AM 2018 93310 A
(800) 1353417
(151) 2016 02 03

(181) 2026 02 03
(891) 2016 02 03
(511) 16, 35, 41

(260) AM 2018 93313 A
(800) 1353438
(151) 2016 11 06
(181) 2026 11 06
(891) 2016 11 06
(511) 03, 08

(260) AM 2018 93314 A
(800) 1353453
(151) 2017 02 20
(181) 2027 02 20
(891) 2017 02 20
(511) 33

(260) AM 2018 93322 A
(800) 1353508
(151) 2016 04 18
(181) 2026 04 18
(891) 2016 04 18
(511) 05

(260) AM 2018 93348 A
(800) 1355392
(151) 2017 03 03
(181) 2027 03 03
(891) 2017 03 03
(511) 33

(260) AM 2018 93356 A
(800) 925419
(151) 2007 01 29
(181) 2017 01 29
(891) 2017 04 30
(511) 16

(260) AM 2018 93360 A
(800) 928864
(151) 2007 03 27
(181) 2027 03 27
(891) 2017 04 30
(511) 16

(260) AM 2018 93361 A
(800) 1355594
(151) 2017 10 31
(181) 2026 10 31
(891) 2016 10 31
(511) 09, 11, 37, 42

(260) AM 2018 93371 A
(800) 1298283
(151) 2015 12 08
(181) 2025 12 08
(891) 2017 04 04
(511) 01, 03, 05, 09, 10, 16, 24, 25, 35, 39, 41, 42,
43, 44

(260) AM 2018 93388 A
(800) 1351619
(151) 2017 04 06
(181) 2027 04 06
(891) 2017 06 28
(511) 30, 43

(260) AM 2018 93401 A
(800) 1355174
(151) 2017 05 29
(181) 2027 05 29
(891) 2017 05 29
(511) 05

(260) AM 2018 93402 A
(800) 1355175
(151) 2017 05 26
(181) 2027 05 26
(891) 2017 05 26
(511) 05

(260) AM 2018 93403 A
(800) 1355176
(151) 2017 05 26
(181) 2027 05 26
(891) 2017 05 26
(511) 05

(260) AM 2018 93404 A
(800) 1355222
(151) 2017 03 23
(181) 2027 03 23
(891) 2017 03 23
(511) 34

(260) AM 2018 93406 A
(800) 1355266
(151) 2017 04 25
(181) 2027 04 25
(891) 2017 04 25
(511) 03, 05, 44

(260) AM 2018 93407 A
(800) 1355285
(151) 2017 04 25
(181) 2027 04 25
(891) 2017 04 25
(511) 05, 35

(260) AM 2018 93452 A
(800) 1356029
(151) 2017 01 23
(181) 2027 01 23
(891) 2017 01 23
(511) 01, 02, 05

(260) AM 2018 93453 A
(800) 1356788
(151) 2017 03 01
(181) 2027 03 01
(891) 2017 03 01
(511) 09, 11

(260) AM 2018 93454 A
(800) 1356033
(151) 2017 05 09
(181) 2027 05 09
(891) 2017 05 09
(511) 03, 05

(260) AM 2018 93455 A
(800) 1356049
(151) 2016 11 19
(181) 2026 11 19
(891) 2016 11 19
(511) 09, 28

(260) AM 2018 93456 A
(800) 1356078
(151) 2017 03 16
(181) 2027 03 16
(891) 2017 03 16
(511) 03, 05

(260) AM 2018 93457 A
(800) 1356810
(151) 2017 03 15
(181) 2027 03 15
(891) 2017 03 15
(511) 16

(260) AM 2018 93458 A
(800) 1356092
(151) 2017 04 27

(181) 2027 04 27
(891) 2017 04 27
(511) 02, 07, 09

(260) AM 2018 93459 A
(800) 1356817
(151) 2015 03 29
(181) 2027 03 29
(891) 2015 03 29
(511) 17

(260) AM 2018 93460 A
(800) 1356135
(151) 2017 04 24
(181) 2027 12 02
(891) 2017 04 24
(511) 05

(260) AM 2018 93462 A
(800) 1356152
(151) 2017 03 10
(181) 2027 03 10
(891) 2017 03 10
(511) 03, 05, 30

(260) AM 2018 93463 A
(800) 1356155
(151) 2017 03 13
(181) 2027 03 13
(891) 2017 03 13
(511) 05

(260) AM 2018 93466 A
(800) 1356193
(151) 2016 10 04
(181) 2026 10 04
(891) 2016 10 04
(511) 21, 35

(260) AM 2018 93467 A
(800) 1356201
(151) 2016 12 20
(181) 2026 12 20
(891) 2016 12 20
(511) 05, 10

(260) AM 2018 93469 A
(800) 1356358
(151) 2017 05 18
(181) 2027 05 18
(891) 2017 05 18
(511) 14

(260) AM 2018 93471 A
(800) 1356383
(151) 2017 03 31
(181) 2027 03 31
(891) 2017 03 31
(511) 33

(260) AM 2018 93472 A
(800) 1356941
(151) 2016 12 06
(181) 2026 12 06
(891) 2016 12 06
(511) 05, 16, 29, 30, 43, 44

(260) AM 2018 93482 A
(800) 1356980
(151) 2016 12 23
(181) 2026 12 23
(891) 2016 12 23
(511) 25, 35

(260) AM 2018 93490 A
(800) 1356987
(151) 2017 01 13
(181) 2027 01 13
(891) 2017 01 13
(511) 05, 10, 35, 42, 44

(260) AM 2018 93494 A
(800) 1356420
(151) 2017 02 24
(181) 2027 02 24
(891) 2017 02 24
(511) 08, 15, 41

(260) AM 2018 93503 A
(800) 1356545
(151) 2017 02 08
(181) 2027 02 08
(891) 2017 02 08
(511) 05, 35

(260) AM 2018 93511 A
(800) 1357197
(151) 2017 02 08
(181) 2027 02 08
(891) 2017 02 08
(511) 05, 35

(260) AM 2018 93546 A
(800) 1357870
(151) 2017 03 31
(181) 2027 03 31

(891) 2017 03 31
(511) 30

(260) AM 2018 93547 A
(800) 1357911
(151) 2017 05 03
(181) 2027 05 03
(891) 2017 05 03
(511) 09, 14

(260) AM 2018 93578 A
(800) 1357280
(151) 2017 05 30
(181) 2027 05 30
(891) 2017 05 30
(511) 30

(260) AM 2018 93580 A
(800) 1357281
(151) 2017 03 29
(181) 2027 03 29
(891) 2017 03 29
(511) 16, 20, 21

(260) AM 2018 93581 A
(800) 1357321
(151) 2017 06 06
(181) 2027 06 06
(891) 2017 06 06
(511) 01, 05

(260) AM 2018 93583 A
(800) 1357352
(151) 2017 03 15
(181) 2027 03 16
(891) 2017 03 15
(511) 16

(260) AM 2018 93586 A
(800) 1357494
(151) 2016 12 16
(181) 2026 12 16
(891) 2016 12 16
(511) 03, 09, 16, 18, 21, 24, 25, 28, 30, 32

(260) AM 2018 93587 A
(800) 1357499
(151) 2017 03 21
(181) 2027 03 21
(891) 2017 03 21
(511) 01, 04, 07, 09, 16, 35, 36, 37, 38, 39

(260) AM 2018 93589 A
(800) 1357522
(151) 2017 01 19
(181) 2027 01 19
(891) 2017 01 19
(511) 29, 30, 32, 35, 43

(260) AM 2018 93981 A
(800) 1361621
(151) 2016 12 28
(181) 2026 12 28
(891) 2016 12 28
(511) 35, 36, 37, 38, 41, 42, 45

(260) AM 2018 93591 A
(800) 1357556
(151) 2016 10 20
(181) 2026 10 20
(891) 2016 10 20
(511) 30

(260) AM 2018 93592 A
(800) 1357573
(151) 2016 10 19
(181) 2026 10 19
(891) 2016 10 19
(511) 09, 28

(260) AM 2018 93593 A
(800) 1357574
(151) 2016 10 19
(181) 2026 10 19
(891) 2016 10 19
(511) 09, 28

(260) AM 2018 93594 A
(800) 1357583
(151) 2016 11 04
(181) 2026 11 04
(891) 2016 11 04
(511) 03, 05, 07, 08, 09, 11, 12, 14, 15, 16, 18, 20,
21, 24, 25, 26, 27, 28, 31, 34, 38, 39, 43

(260) AM 2018 93625 A
(800) 1358743
(151) 2017 02 09
(181) 2027 02 03
(891) 2017 02 09
(511) 09, 11

(260) AM 2018 93830 A
(800) 1360869
(151) 2017 06 28
(181) 2027 06 28
(891) 2017 06 28
(511) 05

APPELLATIONS OF ORIGIN AND GEOGRAPHICAL INDICATION OF GOODS

APPELLATIONS OF ORIGIN OF GOODS FILED IN GEORGIA FOR EXAMINATION UNDER LISBON AGREEMENT, ON THE BASIS OF THE INTERNATIONAL REGISTRATION

The decision can be appealed at the Chamber of Appeal of Sakpatenti within 3 months from the publication or at the Mtskheta District Court Administrative Cases Board (Address: №17, Samkhedro str., Mtskheta), within 1 month after publication.

Number of Identification: 1518
Number of International Registration: 1065
Data of International Registration: 2017 09 04
Application Filing Date: 2018 01 31
Name and Address of Applicant: Cooperatives Union for Beekeepers of Ardabil Province Region
of Ardabil, Iran
Appellation of Origin of Good: Asal e Sabalan e Iran
The Goods for which the Registration of Appellation of Origin is Required: 30 – Honey

Number of Identification: 1519
Number of International Registration: 1066
Data of International Registration: 2017 09 04
Application Filing Date: 2018 01 31
Name and Address of Applicant: Dashti Cooling Company
Region of Dashtestan and Tangestan, Iran;
Dates of south Borazjan Company
Region of Dashtestan and Tangestan, Iran
Appellation of Origin of Good: Khormay e Kabkab e Dashtestan va Tangestan e Iran
The Goods for which the Registration of Appellation of Origin is Required: 31 – Date

Number of Identification: 1520
Number of International Registration: 1067
Data of International Registration: 2017 09 04
Application Filing Date: 2018 01 31
Name and Address of Applicant: Cooperative of Hormozgan golden tangerine production
Region of Siyahoo, Iran
Appellation of Origin of Good: Narengi e Siyahoo e Iran
The Goods for which the Registration of Appellation of Origin is Required: 31 – Tangerine

OFFICIAL NOTIFICATION

TRADEMARKS

RENEWAL OF REGISTRATIONS

(111) M 1998 9957 R2

(156) 1998 07 07

(186) 2028 07 07

(732) THE GOODYEAR TIRE & RUBBER
COMPANY

200 Innovation Way, Akron, Ohio
44316-0001, USA

(111) M 1997 7700 R2

(156) 1997 11 24

(186) 2027 11 24

(732) AIWA CO., LTD

1-6-3, Higashi-gotanda, Shinagawa-ku,
Tokyo, Japan

(111) M 1998 9092 R2

(156) 1998 04 30

(186) 2028 04 30

(732) EXIDE TECHNOLOGIES, S.L. (U)

Carretera A-2, Km. 41,800, 19200 Azuqueca-
de-Henares (Guadalajara), Spain

(111) M 1998 9890 R2

(156) 1998 06 26

(186) 2028 06 26

(732) H.J. HEINZ COMPANY BRANDS LLC

One PPG PPlace, Pittsburgh, PA 15222, USA

(111) M 1998 9891 R2

(156) 1998 06 26

(186) 2028 06 26

(732) H.J. HEINZ COMPANY BRANDS LLC

One PPG PPlace, Pittsburgh, PA 15222, USA

(111) M 1998 9892 R2

(156) 1998 06 26

(186) 2028 06 26

(732) H.J. HEINZ COMPANY BRANDS LLC

One PPG PPlace, Pittsburgh, PA 15222, USA

(111) M 1998 9893 R2

(156) 1998 06 26

(186) 2028 06 26

(732) H.J. HEINZ COMPANY BRANDS LLC

One PPG PPlace, Pittsburgh, PA 15222, USA

(111) M 1998 9894 R2

(156) 1998 06 26

(186) 2028 06 26

(732) H.J. HEINZ COMPANY BRANDS LLC

One PPG PPlace, Pittsburgh, PA 15222, USA

(111) M 1998 10884 R2

(156) 1998 09 23

(186) 2028 09 23

(732) SOCIETE DES PRODUITS NESTLE S.A.

Vevey, Switzerland

(111) M 1998 10452 R2

(156) 1998 08 20

(186) 2028 08 20

(732) DOUBLE EAGLE BRANDS N.V.

Kaya W.F.G. Mensing 32, Willemstad,
Curacao, Netherlands Antilles

(111) M 1998 10466 R2

(156) 1998 08 20

(186) 2028 08 20

(732) SOLVAY FRANCE

25, rue de Clichy, F-75009 Paris, France

(111) M 1998 10208 R2

(156) 1998 08 05

(186) 2028 08 05

(732) VALENTIN YUDASHKIN GROUP
LIMITED

15 Agiou Pavlou Str. Ledra House, Agios
Andreas, 1105, Nicosia, Cyprus

(111) M 1998 10209 R2

(156) 1998 08 05

(186) 2028 08 05

(732) VALENTIN YUDASHKIN GROUP LIMITED

15 Agiou Pavlou Str. Ledra House, Agios
Andreas, 1105, Nicosia, Cyprus

(111) M 1998 10082 R2
(156) 1998 07 30
(186) 2028 07 30
(732) DURACELL BATTERIES BVBA
Nijverheidslaan 7, 3220 Aarschot, Belgium

(111) M 1998 10640 R2
(156) 1998 08 27
(186) 2028 08 27
(732) DURACELL BATTERIES BVBA
Nijverheidslaan 7, 3220 Aarschot, Belgium

(111) M 1998 10738 R2
(156) 1998 09 11
(186) 2028 09 11
(732) THE GOODYEAR TIRE & RUBBER
COMPANY
200 Innovation Way, Akron, Ohio
44316-0001, USA

(111) M 1998 10920 R2
(156) 1998 09 23
(186) 2028 09 23
(732) SOCIETE DES PRODUITS NESTLE S.A.
CH-1800 Vevey, Switzerland

(111) M 199810921 R2
(156) 1998 09 23
(186) 2028 09 23
(732) SOCIETE DES PRODUITS NESTLE S.A.
CH-1800 Vevey, Switzerland

(111) M 1998 10923 R2
(156) 1998 09 23
(186) 2028 09 23
(732) SOCIETE DES PRODUITS NESTLE S.A.
CH-1800 Vevey, Switzerland

(111) M 1998 10924 R2
(156) 1998 09 23
(186) 2028 09 23
(732) SOCIETE DES PRODUITS NESTLE S.A.
CH-1800 Vevey, Switzerland

(111) M 1998 10672 R2
(156) 1998 09 10
(186) 2028 09 10
(732) SOCIETE DES PRODUITS NESTLE S.A.
CH-1800 Vevey, Switzerland

(111) M 1998 10675 R2
(156) 1998 09 10
(186) 2028 09 10
(732) SOCIETE DES PRODUITS NESTLE S.A.
CH-1800 Vevey, Switzerland

(111) M 2008 18695 R1
(156) 2008 09 17
(186) 2028 09 17
(732) JSC "SHATEAU MUKHRANI"
Sop. Mukhrani, 3309, Mtskheta, Georgia

(111) M 2008 18696 R1
(156) 2008 09 17
(186) 2028 09 17
(732) JSC "SHATEAU MUKHRANI"
Sop. Mukhrani, 3309, Mtskheta, Georgia

(111) M 2008 18697 R1
(156) 2008 09 17
(186) 2028 09 17
(732) JSC "SHATEAU MUKHRANI"
Sop. Mukhrani, 3309, Mtskheta, Georgia

(111) M 2008 18698 R1
(156) 2008 09 17
(186) 2028 09 17
(732) JSC "SHATEAU MUKHRANI"
Sop. Mukhrani, 3309, Mtskheta, Georgia

(111) M 2008 18699 R1
(156) 2008 09 17
(186) 2028 09 17
(732) JSC "SHATEAU MUKHRANI"
Sop. Mukhrani, 3309, Mtskheta, Georgia

(111) M 2008 18983 R1
(156) 2008 12 15
(186) 2028 12 15
(732) LTD "BAUVEGI"
Enukidzis q. 7, 0182, Tbilisi, Georgia

(111) M 2008 18758 R1
(156) 2008 09 26
(186) 2028 09 26
(732) ABDI IBRAHIM ILAÇ SANAYI VE
TICARET ANONİM ŞİRKETİ
Reşitpaşa Mahallesi Eski Büyükdere Caddesi
No: 4, 34467 Maslak Sarıyer İstanbul, Turkey

(111) M 2008 19030 R1
(156) 2008 12 29
(186) 2028 12 29
(732) E. REMY MARTIN & CO
20, rue de la Société Vinicole, 16100
COGNAC, France

(732) XEROX CORPORATION
201 Merritt 7, Norwalk, Connecticut
06851-1056, USA

(111) M 1998 8320 R2
(156) 1998 02 11
(186) 2028 02 11
(732) COGNIS IP MANAGEMENT GmbH
Henkelstrasse 67, 40589 Dusseldorf,
Germany

(111) M 1998 8321 R2
(156) 1998 02 11
(186) 2028 02 11
(732) COGNIS IP MANAGEMENT GmbH
Henkelstrasse 67, 40589 Dusseldorf,
Germany

(111) M 1998 9495 R2
(156) 1998 06 01
(186) 2028 06 01
(732) H.J. HEINZ COMPANY BRANDS LLC
One PPG PPlace, Pittsburgh, PA 15222, USA

(111) M 1998 9320 R2
(156) 1998 05 13
(186) 2028 05 13
(732) TIME INC.
225 Liberty St. 5-e F1., Niu-iorki, Niu-iorki
10281, USA

(111) M 1998 10858 R2
(156) 1998 09 23
(186) 2028 09 23
(732) MACDERMID AGRICULTURAL
SOLUTIONS HOLDINGS B.V.
245 Freight Street, Waterbury, Connecticut
06702, USA

(111) M 1998 8519 R2
(156) 1998 03 02
(186) 2028 03 02
(732) TIME INC., a Delaware Corporation
225 Liberty St. 5th F1., New York,
New York 10281, USA

(111) M 1998 9407 R2
(156) 1998 05 25
(186) 2028 05 25

COMPLETE TRANSFER OF RIGHTS

(111) M 2014 25534 R
 (732) LTD "LEDI HELSQEA"
 Akaki Gakhokidzis q. 2-4, Iuri Gagarinis q. 5,
 S/F 6, Saburtalos r-ni, Tbilisi, Georgia
 (770) LTD "UNIMED GRUUP CORP"
 Ad. Mitskevichis q. 29, b. 61, 0177, Tbilisi,
 Georgia
 (580) 2018 07 16

(111) M 1997 7700 R
 (732) AIWA CO., LTD
 1-6-3, Higashi-gotanda, Shinagawa-ku,
 Tokyo, Japan
 (770) SONY KABUSHIKI KAISHA
 (also trading as Sony Corporation)
 1-7-1 Konan, Minato-ku, Tokyo, Japan
 (580) 2018 08 03

(111) M 2000 13355 R
 (732) Berloni Group S.R.L.
 Via Bartolucci 3, Pesaro, Italy
 (770) BERLONI S.R.L IN – LIQUIDAZIONE
 Via Bartolucci 3, Pesaro, Italy

(111) M 1997 6302 R
 (732) POLYAD SERVICES GMBH
 Chemiestrasse, Building L 31, 68623
 Lampertheim, Germany
 (770) BASF SE
 Carl-Bosch-Strasse 38, 67056 Ludwigshafen,
 Germany
 (580) 2018 06 05

(111) M 1997 6061 R
 (732) POLYAD SERVICES GMBH
 Chemiestrasse, Building L 31, 68623
 Lampertheim, Germany
 (770) BASF SE
 Carl-Bosch-Strasse 38, 67056 Ludwigshafen,
 Germany
 (580) 2018 06 05

(111) M 1997 6062 R
 (732) POLYAD SERVICES GMBH
 Chemiestrasse, Building L 31, 68623
 Lampertheim, Germany
 (770) BASF SE
 Carl-Bosch-Strasse 38, 67056 Ludwigshafen,
 Germany

(111) M 2007 17882 R
 (732) IRAKLI GURESHIDZE
 Ul. Planernaia, d. 12, korp. 3, kv. 96,
 Moskva, Russian Federation
 (770) NIKOLOZ MEDULASHVILI
 Kakhetis gzatk. 36-v, b. 34, 0190, Tbilisi,
 Georgia

(111) M 2012 22811 R
 (732) LTD "UNIMED GROUP CORP"
 Ad. Mitskevichis q. 29, b. 61, Vake-
 Saburtalos r-ni, Tbilisi, Georgia
 (770) LTD "PRIMA-VITA"
 Sak. Samkhedro gzisa da Akhmetelis quchis
 gadakveta, 0159, Tbilisi, Georgia
 (580) 2018 08 21

(111) M 2012 23094 R
 (732) LTD "OMEGA-2"
 Sarajishvilis q. 13-15-17, 0159, Tbilisi,
 Georgia
 (770) LTD "SAMOCDATSAMETI"
 Kiachelis q. 28, Tbilisi, Georgia
 (580) 2018 08 06

(111) M 2012 22700 R
 (732) LTD "UNIMED GROUP CORP"
 Ad. Mitskevichis q. 29, b. 61, Vake-
 Saburtalos r-ni, Tbilisi, Georgia
 (770) LTD "PRIMA-VITA"
 Sak. Aamkhedro gzisa da Akhmetelis quchis
 gadakveta, 0159, Tbilisi, Georgia
 (580) 2018 08 06

(111) M 2012 22701 R
 (732) LTD "UNIMED GROUP CORP"
 Ad. Mitskevichis q. 29, b. 61, Vake-
 Saburtalos r-ni, Tbilisi, Georgia
 (770) LTD "PRIMA-VITA"
 Sak. Samkhedro gzisa da Akhmetelis quchis
 gadakveta, 0159, Tbilisi, Georgia
 (580) 2018 08 06

(111) M 2013 24268 R
 (732) LTD "UNIMED GROUP CORP"
 Ad. Mitskevichis q. 29, b. 61, Vake-
 Saburtalos r-ni, Tbilisi, Georgia
 (770) LTD "PRIMA-VITA"
 Sak. Samkhedro gzisa da Akhmetelis quchis
 gadakveta, 0159, Tbilisi, Georgia

(580) 2018 08 06

(111) M 2014 24858 R

(732) LLT "UCOM"

Terianis q. 19, b. 4, 0010, Yerevan, Armenia

(770) LTD "TIMELESS"

Rustavelis gamz. 46, 0108, Tbilisi, Georgia

(580) 20 1807 05

(111) M 2013 24321 R

(732) MACMILLAN PUBLISHERS

INTERNATIONAL LIMITED

Brunel Road, Houndmills, Basingstoke,

Hampshire, RG21 6XS, United Kingdom

(770) HM PUBLISHERS HOLDINGS LIMITED

Brunel Road, Houndmills, Basingstoke,

Hampshire, RG21 6XS, United Kingdom

(580) 2018 08 14

(111) M 2013 24322 R

(732) MACMILLAN PUBLISHERS

INTERNATIONAL LIMITED

Brunel Road, Houndmills, Basingstoke,

Hampshire, RG21 6XS, United Kingdom

(770) HM PUBLISHERS HOLDINGS LIMITED

Brunel Road, Houndmills, Basingstoke,

Hampshire, RG21 6XS, United Kingdom

(580) 2018 08 14

(111) M 2014 25537 R

(732) LTD "LEDI HELSQEA"

Akaki Gakhokidzis q. 2-4, Iuri Gagarinis q. 5,

S/F, Saburtalos Raioni, Tbilisi, Georgia

(770) LTD "UNIMED GROUP CORP"

Ad. Mickevichis q. 29, b. 61, Vake-

Saburtalos r-ni, Tbilisi, Georgia

(580) 2018 07 16

(111) M 2018 29831 R

(732) TEONA CHIKVAIDZE

Didi Dighomi, Demetre Tavadebulis q. 14,

b. 22, Tbilisi, Georgia

(770) MARINE KORDZADZE

Kostavas q. 75, Sad. 3, b. 1, Tbilisi,

Georgia

(580) 2018 08 07

CHANGES IN NAMES AND/OR ADDRESSES OF OWNERS

(111) M 1997 7700 R
 (732) SONY KABUSHIKI KAISHA
 (also trading as Sony Corporation)
 1-7-1 Konan, Minato-ku, Tokyo, Japan
 (770) SONY KABUSHIKI KAISHA
 (also trading as Sony Corporation)
 6-7-35 Kitashinagawa, Shinagawa-Ku,
 Tokyo, Japan
 (580) 2018 08 03

(111) M 1998 9600 R
 (732) LUFTHANSA AIRPLUS
 SERVICEKARTEN GmbH
 Dornhofstraße 10, 63263 Neu-Isenburg,
 Germany
 (770) LUFTHANSA AIRPLUS
 SERVICEKARTEN GmbH
 Hans-Boeckler-Strasse 7, 63263 Neu-
 Isenburg, Germany
 (580) 2018 08 13

(111) M 1998 10457 R
 (732) ALZA CORPORATION
 (a Delaware Corporation)
 700 Eubanks Drive, Vacaville CA 95688,
 USA
 (770) ALZA CORPORATION
 (a Delaware Corporation)
 1010 Joaquin Road, Mountain View, CA,
 USA
 (580) 2018 07 19

(111) M 1998 10457 R
 (732) ALZA CORPORATION
 (a Delaware Corporation)
 1010 Joaquin Road, Mountain View, CA,
 USA
 (770) ALZA CORPORATION
 (a Delaware Corporation)
 1900 Charleston Road, P.O. Box. 7210
 Mountain View, California 94039-7210, USA
 (580) 2018 07 19

(111) M 1997 6302 R
 (732) POLYAD SERVICES GMBH
 Stubenwald-Allee 21, 64625 Bensheim,
 Germany
 (770) POLYAD SERVICES GMBH
 Chemiestrasse, Building L 31, 68623
 Lampertheim, Germany
 (580) 2018 06 05

(111) M 1997 6061 R
 (732) POLYAD SERVICES GMBH
 Stubenwald-Allee 21, 64625 Bensheim,
 Germany
 (770) POLYAD SERVICES GMBH
 Chemiestrasse, Building L 31, 68623
 Lampertheim, Germany
 (580) 2018 06 05

(111) M 1997 6062 R
 (732) POLYAD SERVICES GMBH
 Stubenwald-Allee 21, 64625 Bensheim,
 Germany
 (770) POLYAD SERVICES GMBH
 Chemiestrasse, Building L 31, 68623
 Lampertheim, Germany
 (580) 2018 06 05

(111) M 1998 8273 R
 (732) BRITISH AMERICAN TOBACCO
 (BRANDS) INC.
 251 Little Falls Drive, Suite 100,
 Wilmington, DE 19808-1674, USA
 (770) BRITISH AMERICAN TOBACCO
 (BRANDS) INC.
 2711 Centerville Road, Suite 300,
 Wilmington, Delaware 19808, USA
 (580) 2018 08 13

(111) M 2008 18277 R
 (732) BRITISH AMERICAN TOBACCO
 (BRANDS) INC.
 (a Delaware corporation)
 251 Little Falls Drive, Suite 100,
 Wilmington, DE 19808-1674, USA
 (770) BRITISH AMERICAN TOBACCO
 (BRANDS) INC.
 2711 Centerville Road, Suite 300,
 Wilmington, Delaware 19808, USA
 (580) 2018 08 13

(111) M 2008 18758 R
 (732) ABDI IBRAHIM İLAÇ SANAYİ VE
 TİCARET ANONİM ŞİRKETİ
 Reşitpaşa Mahallesi Eski Büyükdere Caddesi
 No: 4, 34467 Maslak Sarıyer İstanbul, Turkey
 (770) ABDI IBRAHIM İLAÇ SANAYİ VE
 TİCARET ANONİM ŞİRKETİ
 Eski Büyükdere Cad. Ayazağa Yolu 34398
 No:5 Maslak, İstanbul, Turkey
 (580) 2018 08 10

(111) M 2008 18994 R
 (732) BRITISH AMERICAN TOBACCO
 (BRANDS) INC. (a Delaware corporation)
 251 Little Falls Drive, Suite 100,
 Wilmington, DE 19808-1674, USA
 (770) BRITISH AMERICAN TOBACCO
 (BRANDS) INC. (a Delaware corporation)
 2711 Centerville Road, Suite 300,
 Wilmington, Delaware 19808, USA
 (580) 2018 08 13

(111) M 2012 23106 R
 (732) SHANTHA BIOTECHNICS PRIVATE
 LIMITED
 3rd & 4t Florsi, H.No.5-10-173, Fateh
 Meiden Roudi, Beshirbagi, Haidarabadi –
 500004, Telangana, India
 (770) SHANTHA BIOTECHNICS LIMIRED
 3rd & 4th Floor, Vasantha Chambers, Fateh
 Maidan Road, Basheerbagh Hyderabad,
 500 004 ANDHRA PRADESH, India
 (580) 2018 06 06

(111) M 2013 23993 R
 (732) SHANTHA BIOTECHNICS PRIVATE
 LIMITED
 3rd & 4t Florsi, H.No.5-10-173, Fateh
 Meiden Roudi, Beshirbagi, Haidarabadi –
 500004, Telangana, India
 (770) SHANTHA BIOTECHNICS LIMIRED
 3rd & 4th Floor, Vasantha Chambers, Fateh
 Maidan Road, Basheerbagh Hyderabad, 500
 004 ANDHRA PRADESH, India
 (580) 2018 06 06

(111) M 2014 25135 R
 (732) SHANTHA BIOTECHNICS PRIVATE
 LIMITED
 3rd & 4th Floors, H.No.5-10-173, Fateh
 Maidan Road, Basheerbagh, Hyderabad –
 500004, Telangana, India
 (770) SHANTHA BIOTECHNICS LIMITED
 3rd & 4th Floor, Vasantha Chambers, Fateh
 Maidan Road, Basheerbagh Hyderabad, 500
 004 ANDHRA PRADESH, India
 (580) 2018 06 06

(111) M 2014 25136 R
 (732) SHANTHA BIOTECHNICS PRIVATE
 LIMITED
 3rd & 4th Floors, H.No.5-10-173, Fateh
 Maidan Road, Basheerbagh, Hyderabad –
 500004 Telangana, India
 (770) SHANTHA BIOTECHNICS LIMITED
 3rd & 4th Floor, Vasantha Chambers, Fateh

Maidan Road, Basheerbagh Hyderabad, 500
 004 ANDHRA PRADESH, India
 (580) 2018 06 06

(111) M 2015 26260 R
 (732) SHANTHA BIOTECHNICS PRIVATE
 LIMITED
 3rd & 4th Floors, H.No.5-10-173, Fateh
 Maidan Road, Basheerbagh, Hyderabad –
 500004, Telangana, India
 (770) SHANTHA BIOTECHNICS LIMITED
 3rd & 4th Floor, Vasantha Chambers, Fateh
 Maidan Road, Basheerbagh Hyderabad, 500
 004 ANDHRA PRADESH, India
 (580) 2018 06 06

(111) M 1998 9320 R
 (732) TIME INC.
 225 Liberty St. 5th Fl., New York,
 New York 10281, USA
 (770) TIME INC.
 Avenue of the America 1271,
 New York, 10020, USA
 (580) 2018 08 14

(111) M 1998 8519 R
 (732) TIME INC.
 a Delaware Corporation
 225 Liberty St. 5th Fl., New York,
 New York 10281, USA
 (770) TIME INC.
 a Delaware Corporation
 1271 Avenue of the Americas, New York,
 New York 10020, USA
 (580) 2018 08 14

INVALIDATION OF TRADEMARK REGISTRATIONS

(111) M 2011 22006 R

(151) 2011 11 30

(181) 2022 05 30

(732) UNIPHARM, INC.

350 Fifth Avenue, Suite 6701, New York,
N.Y. 10118, USA

(111) M 1997 7655 R

(151) 1997 11 21

(181) 2018 05 21

(732) NOVO NORDISK A/S

NOVO ALLE, DK-2880 BAGSVAERD,
DENMARK

(111) M 1997 7679 R

(151) 1997 11 24

(181) 2018 05 24

(732) F. HOFFMANN-LA ROCHE AG

124 Grenzacherstrasse, CH-4002 Basle,
Switzerland

(111) M 1997 6960 R

(151) 1997 09 25

(181) 2018 03 25

(732) DUNHILL TOBACO OF LONDON

LIMITED
GLOBE HOUSE, 4 TEMPLE PLACE,
LONDON WC2R 2PG, UNITED KINGDOM

(111) M 1997 7681 R

(151) 1997 11 24

(181) 2018 05 24

(732) GLAXO GROUP LIMITED

980 Great West Road, Brentford, Middlesex
TW8 9GS, United Kingdom

(111) M 1997 6962 R

(151) 1997 09 25

(181) 2018 03 25

(732) THE POPULATION COUNCIL, INC.

ONE DAG HAMMARSKJOLD PLAZA,
NEW YORK, NEW YORK 10017, USA

(111) M 1997 7686 R

(151) 1997 11 24

(181) 2018 05 24

(732) GLAXO GROUP LIMITED

980 Great West Road, Brentford, Middlesex
TW8 9GS, United Kingdom

(111) M 1997 7691 R

(151) 1997 11 24

(181) 2018 05 24

(732) FL SELENIA S.P.A.

VIA SANTENA 1, 10029 VILLASTELLO-
NE, TORINO, ITALY

(111) M 1997 7654 R

(151) 1997 11 21

(181) 2018 05 21

(732) GLAXO GROUP LIMITED

Glaxo Wellcome House, Berkeley Avenue,
Brentford, Middlesex UB6 0NN, United
Kingdom

(111) M 1997 6964 R

(151) 1997 09 25

(181) 2018 03 25

(732) ANNE COLE DESIGN STUDIO LTD

522 HORTH CRESCENT DRIVE,
BEVERLY HILLS, CA-90210, USA

(111) M 1997 7668 R

(151) 1997 11 21

(181) 2018 05 21

(732) SMITHKLINE BEECHAM PHARMA

GmbH & Co KG
Prinzregentenplatz 9, 81675 Munich, Germany

(111) M 1997 6966 R

(151) 1997 09 25

(181) 2018 03 25

(732) SAMUEL SMITH OLD BREWERY (TADCASTER)

THE OLD BREWERY TADCASTER,
LS24 9SB, UNITED KINGDOM

(111) M 1997 7669 R

(151) 1997 11 21

(181) 2018 05 21

(732) GLAXO GROUP LIMITED

Glaxo Wellcome House, Berkeley Avenue,
Brentford, Middlesex UB6 0NN, United
Kingdom

(111) M 1997 7740 R

(151) 1997 11 28

(181) 2018 05 28

(732) PALM GREEN CAPITAL LIMITED

NEMOURS CHAMBERS, ROAD TOWN,
TORTOLA, VIRGIN ISLANDS (BRITISH)

(111) M 1997 7743 R
(151) 1997 11 28
(181) 2018 05 28
(732) SUPER MANUFACTURING LTD
26 Senoko Way, Singapore 2775, Singapore

(111) M 1997 7701 R
(151) 1997 11 24
(181) 2018 05 24
(732) AMERICAN-CIGARETTE COMPANY
(OVERSEAS) LIMITED
Zählerweg 4, CH-6300 Zug, Switzerland

(111) M 1997 6974 R
(151) 1997 09 26
(181) 2018 03 26
(732) F.E.L OGISTIC
Rue de l'Europe, 57370 Phalsbourg,
France

(111) M 1997 7745 R
(151) 1997 11 28
(181) 2018 05 28
(732) UGINE & ALZ
1-5 rue Luigi Cherubini, 93200 Saint Denis,
France

(111) M 1997 6882 R
(151) 1997 09 22
(181) 2018 03 22
(732) REVLON CONSUMER PRODUCTS
CORPORATION
237 Park Avenue, New York, New York
10017, USA

(111) M 1997 6883 R
(151) 1997 09 22
(181) 2018 03 22
(732) REVLON CONSUMER PRODUCTS
CORPORATION
237 Park Avenue, New York, New York
10017, USA

(111) M 1997 7983 R
(151) 1997 12 26
(181) 2018 06 26
(732) PAPASTRATOS CIGARETE
MANUFACTURING COMPANY
3 Paparrigopoulou Str., Athenas, Greece

(111) M 1997 6570 R
(151) 1997 09 01
(181) 2018 03 01

(732) INSTITUTO LUSOFARMACO D'ITALIA
S.P.A.
Via Carnia 26, Milano, Italy

(111) M 1997 6571 R
(151) 1997 09 01
(181) 2018 03 01
(732) INSTITUTO LUSOFARMACO D'ITALIA
S.P.A.
Via Carnia 26, Milano, Italy

(111) M 1997 6573 R
(151) 1997 09 01
(181) 2018 03 01
(732) INSTITUTO LUSOFARMACO D'ITALIA
S.P.A.
Via Carnia 26, Milano, Italy

(111) M 1997 6780 R
(151) 1997 09 12
(181) 2018 03 12
(732) BOLSIUS INTERNATIONAL B.V.
Kerkendijk 126, 5482 KK Schijndel,
Netherlands

(111) M 1997 6711 R
(151) 1997 09 09
(181) 2018 03 09
(732) ORANGE
78, rue Oliver de Serres, 75015 Paris, France

(111) M 1998 8087 R
(151) 1998 01 20
(181) 2018 07 20
(732) TETRA LAVAL HOLDINGS & FINANCE
S.A.
Avenue General-Guisan 70, CH-1009 Pully,
Switzerland

(111) M 1998 8088 R
(151) 1998 01 20
(181) 2018 07 20
(732) G.D. Searle LLC
235 East 42 nd Street, New York, New York
10017, USA

(111) M 1998 8089 R
(151) 1998 01 20
(181) 2018 07 20
(732) G.D. Searle LLC
235 East 42 nd Street, New York, New York
10017, USA

(111) M 1997 6783 R
 (151) 1997 09 12
 (181) 2018 03 12
 (732) MERCK SHARP & DOHME CORP.
 One Merck Drive, Whitehouse Station,
 New Jersey 08889, USA

(111) M 1998 8034 R
 (151) 1998 01 08
 (181) 2018 07 08
 (732) FLOWIL INTERNATIONAL LIGHTING
 (HOLDING) B.V
 Prins Bernhardplein 200 1097 JB
 Amsterdam, Netherlands

(111) M 1998 8036 R
 (151) 1998 01 08
 (181) 2018 07 08
 (732) FLOWIL INTERNATIONAL LIGHTING
 (HOLDING) B.V
 Prins Bernhardplein 200 1097 JB
 Amsterdam, Netherlands

(111) M 1997 6983 R
 (151) 1997 09 30
 (181) 2018 03 30
 (732) GLAXO GROUP LIMITED
 980 Great West Road, Brentford, Middlesex
 TW8 9GS, United Kingdom

(111) M 1997 6984 R
 (151) 1997 09 30
 (181) 2018 03 30
 (732) CABLE AND WIRELESS PLC
 124 Theobalds Road, London WC1X 8RX,
 United Kingdom

(111) M 1997 7896 R
 (151) 1997 12 18
 (181) 2018 06 18
 (732) BONTEX INC.
 One Bontex Drive, Buena Vista, Virginia
 24416, USA

(111) M 1997 6577 R
 (151) 1997 09 01
 (181) 2018 03 01
 (732) BENCOM S.r.l.
 Via Villa Minelli 1, 31050 Ponzano Veneto
 (Treviso), Italy

(111) M 1997 6692 R
 (151) 1997 09 08
 (181) 2018 03 08

(732) BENCOM S.r.l.
 Via Villa Minelli 1, 31050 Ponzano Veneto
 (Treviso), Italy

(111) M 1997 6693 R
 (151) 1997 09 08
 (181) 2018 03 08
 (732) BENCOM S.r.l.
 Via Villa Minelli 1, 31050 Ponzano Veneto
 (Treviso), Italy

(111) M 1997 6696 R
 (151) 1997 09 08
 (181) 2018 03 08
 (732) BENCOM S.r.l.
 Via Villa Minelli 1, 31050 Ponzano Veneto
 (Treviso), Italy

(111) M 1997 6988 R
 (151) 1997 09 30
 (181) 2018 03 30
 (732) NIPPON KAYAKU CO., LTD
 11-2, Fujimi 1-chome, Chiyoda-ku, Tokyo,
 Japan

(111) M 1997 6991 R
 (151) 1997 09 30
 (181) 2018 03 30
 (732) PHILIP MORRIS PRODUCTS INC.
 9711 Farrar Court Richmond, VA 23236,
 USA

(111) M 1997 6896 R
 (151) 1997 09 23
 (181) 2018 03 23
 (732) HOLA, S.L
 Miguel Angel 1, 28010 Madrid, Spain

(111) M 1997 6545 R
 (151) 1997 08 27
 (181) 2018 02 27
 (732) AT&T INTELLECTUAL PROPERTY II,
 L.P.
 645 East Plumb Lane, Reno, Nevada
 89502, USA

(111) M 1997 6737 R
 (151) 1997 09 10
 (181) 2018 03 10
 (732) APPLICATION DES GAZ, societe anonyme
 Lieudit le Favier, Route de Brignais, 69230
 SAINT GENIS LAVAL, France

(111) M 1997 6738 R (151) 1997 09 10 (181) 2018 03 10 (732) APPLICATION DES GAZ, societe anonyme Lieudit le Favier, Route de Brignais, 69230 SAINT GENIS LAVAL, France	Oxford OX4 4GA, United Kingdom
(111) M 1997 6635 R (151) 1997 09 04 (181) 2018 03 04 (732) WM.WRIGLEY JR.COMPANY Chicago,Illinois, USA	(111) M 1997 6706 R (151) 1997 09 08 (181) 2018 03 08 (732) BRISTOL-MYERS SQUIBB COMPANY 345 Park Avenue, New York, New York 10154, USA
(111) M 1997 6636 R (151) 1997 09 04 (181) 2018 03 04 (732) WM.WRIGLEY JR.COMPANY Chicago,Illinois, USA	(111) M 1997 6707 R (151) 1997 09 08 (181) 2018 03 08 (732) BRISTOL-MYERS SQUIBB COMPANY 345 Park Avenue, New York, New York 10154, USA
(111) M 1997 6623 R (151) 1997 09 03 (181) 2018 03 03 (732) NAF NAF 6/10 Boulevard Foch, 93800 Epinay-Sur- Seine, France	(111) M 1997 6903 R (151) 1997 09 23 (181) 2018 03 23 (732) MARS, INCORPORATED 6885, Elm Street, McLean, Virginia, USA
(111) M 1997 6637 R (151) 1997 09 04 (181) 2018 03 04 (732) WM.WRIGLEY JR.COMPANY Chicago,Illinois, USA	(111) M 1997 6906 R (151) 1997 09 23 (181) 2018 03 23 (732) DIAGEO BRANDS B.V. Molenwerf 10-12, 1014 BG Amsterdam, Netherlands
(111) M 1997 6626 R (151) 1997 09 03 (181) 2018 03 03 (732) REEMTSMA CIGARETTENFABRIKEN GMBH Max-Born-Strasse 4, 22761 Hamburg, Germany	(111) M 1997 6998 R (151) 1997 09 30 (181) 2018 03 30 (732) METSI BOARD CORPORATION Revontulenpuisto 2, FI-02100 Espoo, Finland
(111) M 1997 6627 R (151) 1997 09 03 (181) 2018 03 03 (732) BRISTOL-MYERS SQUIBB COMPANY 345 Park Avenue, New York, New York 10154, USA	(111) M 1997 6628 R (151) 1997 09 03 (181) 2018 03 03 (732) LUCENT TECHNOLOGIES INC. 600 Mountain Avenue, Murray Hill, New Jersey 07974-0636, USA
(111) M 1997 6705 R (151) 1997 09 08 (181) 2018 03 08 (732) CEPHALON LIMITED The Magdalen Centre, Oxford Science Park,	(111) M 1997 6544 R (151) 1997 08 27 (181) 2018 02 27 (732) PREPARADOS ALIMENTICIOS, S.A. Josep Tarradellas, 38, E-08029 Barcelona, Spain

(111) M 1997 7357 R
 (151) 1997 11 03
 (181) 2018 05 03
 (732) DELL INC. (a Delaware corporation)
 One Dell Way, Round Rock, Texas 78682,
 USA

(111) M 1997 7163 R
 (151) 1997 10 10
 (181) 2018 04 10
 (732) MENELAUS B.V.
 Archimedesbaan 18-D, 3439 ME
 Nieuwegein, Netherlands

(111) M 1997 7474 R
 (151) 1997 11 12
 (181) 2018 05 12
 (732) ALCATEL LUCENT
 54, rue La Boetie, 75008 Paris, France

(111) M 1997 7481 R
 (151) 1997 11 12
 (181) 2018 05 12
 (732) ALCATEL LUCENT
 54, rue La Boetie, 75008 Paris, France

(111) M 1997 6732 R
 (151) 1997 09 10
 (181) 2018 03 10
 (732) JOHNSON & JOHNSON
 One Johnson & Johnson Plaza, New
 Brunswick, New Jersey 08933, USA

(111) M 1997 6733 R
 (151) 1997 09 10
 (181) 2018 03 10
 (732) SYSTAGENIX WOUND MANAGEMENT
 IP CO B.V., a Netherland limited liability
 company
 Keizersgracht 64, 1015CS, Amsterdam,
 Netherlands

(111) M 1997 5949 R
 (151) 1997 07 15
 (181) 2018 01 15
 (732) ZYXEL COMMUNICATIONS
 CORPORATION
 N6, Innovation II Rd., Science Based
 Industrial Park, Hsinchu 30077, Taiwan,
 Province of China

(111) M 1997 7172 R
 (151) 1997 10 13
 (181) 2018 04 13
 (732) BEROL CORPORATION
 29 E. Stephenson Street, Freeport, IL
 61032, USA

(111) M 1997 7192 R
 (151) 1997 10 13
 (181) 2018 04 13
 (732) JOHNSON & JOHNSON
 One Johnson & Johnson Plaza, New
 Brunswick, New Jersey 08933, USA

(111) M 1997 6740 R
 (151) 1997 09 10
 (181) 2018 03 10
 (732) Societe Nationale d'Exploitation Industrielle
 des Tabacs et Allumettes (SEITA)
 143, Boulevard Romain Rolland, 75685
 Paris, Cedex 14, France

(111) M 1997 741 R
 (151) 1997 09 10
 (181) 2018 03 10
 (732) Societe Nationale d'Exploitation Industrielle
 des Tabacs et Allumettes (SEITA)
 143, Boulevard Romain Rolland, 75685
 Paris, Cedex 14, France

(111) M 1997 6742 R
 (151) 1997 09 10
 (181) 2018 03 10
 (732) Societe Nationale d'Exploitation Industrielle
 des Tabacs et Allumettes (SEITA)
 143, Boulevard Romain Rolland, 75685
 Paris, Cedex 14, France

(111) M 1997 6743 R
 (151) 1997 09 10
 (181) 2018 03 10
 (732) Societe Nationale d'Exploitation Industrielle
 des Tabacs et Allumettes (SEITA)
 143, Boulevard Romain Rolland, 75685
 Paris, Cedex 14, France

(111) M 1997 7034 R
 (151) 1997 10 02
 (181) 2018 04 02
 (732) ARMSTRONG DLW AG
 Stuttgarter Strasse 75, 74321 Bietgheim-
 Bissingen, Germany

-
- (111) M 1997 6913 R
(151) 1997 09 24
(181) 2018 03 24
(732) BIC VIOLEX S.A.
145 69 Anixi, Attica, Greece
-
- (111) M 1997 7008 R
(151) 1997 09 30
(181) 2018 03 30
(732) TOROS İÇ VE DIŞ TİCARET LİMİTED
ŞİRKETİ
BAHARIYE CAD. NO:80/5 KADIKOY,
ISTANBUL, Turkey
-
- (111) M 1997 7507 R
(151) 1997 11 14
(181) 2018 05 14
(732) ABBOTT GMBH & CO.KG
Max-Planck-Ring 2, 65205 Wiesbaden,
Germany
-
- (111) M 1998 8040 R
(151) 1998 01 08
(181) 2018 07 08
(732) INTERSUN HOLDING FZCO
P.O. Box: 61051, Jebel Ali Free Zone, Dubai,
United Arab Emirates
-
- (111) M 1997 7098 R
(151) 1997 10 08
(181) 2018 04 08
(732) INTELSAT, LTD
14 Dundonald Street West, Hamilton BM 09,
Bermuda
-
- (111) M 1997 7476 R
(151) 1997 11 12
(181) 2018 05 12
(732) THE COCA-COLA COMPANY
One Coca-Cola Plaza, Atlanta, Georgia
30313, USA
-
- (111) M 1997 7477 R
(151) 1997 11 12
(181) 2018 05 12
(732) THE COCA-COLA COMPANY
One Coca-Cola Plaza, Atlanta, Georgia
30313, USA
-
- (111) M 1997 6640 R
(151) 1997 09 04
(181) 2018 03 04
-
- (732) INTRUM JUSTITIA LICENSING AG
Gotthardstrasse 20, 6304 Zug, Switzerland
-
- (111) M 1997 6641 R
(151) 1997 09 04
(181) 2018 03 04
(732) INTRUM JUSTITIA LICENSING AG
Gotthardstrasse 20, 6304 Zug, Switzerland
-
- (111) M 1998 8206 R
(151) 1998 01 30
(181) 2018 07 30
(732) BIOFARMA
50, rue Carnot, 92284 Suresnes cedex, France
-
- (111) M 1997 7540 R
(151) 1997 11 17
(181) 2018 05 17
(732) HEALTHTEX APPAREL CORP.
100 West 33rd Street, Suire 1012, New
York, New York 10001, USA
-
- (111) M 1997 6912 R
(151) 1997 09 24
(181) 2018 03 24
(732) ORIENT TOKEI KABUSHIKI KAISHA
(also trading as "ORIENT WATCH CO.LTD")
4-4, 2-chome, soto canda, chiioda-ku, Tokio,
Japan
-
- (111) M 1997 7177 R
(151) 1997 10 13
(181) 2018 04 13
(732) GALLAHER LIMITED
Members Hill, Brooklands Road, Weybridge,
Surrey KT13 0QU, United Kingdom
-
- (111) M 1997 6647 R
(151) 1997 09 04
(181) 2018 03 04
(732) SOCIETE ARMAGNACAISE DE
PRODUCTION S.A.P.
Bordeneuve, 32530 Panjas, France
-
- (111) M 1997 7181 R
(151) 1997 10 13
(181) 2018 04 13
(732) BRISTOL-MYERS SQUIBB COMPANY
345, Park Avenue, New York, New York
10154, USA
-

(111) M 1997 4768 R
 (151) 1997 03 24
 (181) 2017 09 24
 (732) IN. PRO. DI. - INGHIRAMI
 PRODUZIONE DISTRIBUZIONE S.p.A.
 Corso di Porta Romana, 3, Milano 20122,
 Italy

(111) M 1997 6917 R
 (151) 1997 09 24
 (181) 2018 03 24
 (732) PHILIP MORRIS BRANDS SARL
 Quai Jeanrenaud 3, 2000 Neuchâtel,
 Switzerland

(111) M 1997 6794 R
 (151) 1997 09 16
 (181) 2018 03 16
 (732) AMPER S.A.
 75, calle Torrelaguna, E-28027 Madrid, Spain

(111) M 1997 6795 R
 (151) 1997 09 16
 (181) 2018 03 16
 (732) AMPER S.A.
 75, calle Torrelaguna, E-28027 Madrid, Spain

(111) M 1997 6796 R
 (151) 1997 09 16
 (181) 2018 03 16
 (732) AMPER S.A.
 75, calle Torrelaguna, E-28027 Madrid, Spain

(111) M 1997 6650 R
 (151) 1997 09 04
 (181) 2018 03 04
 (732) DAVIDE CAMPARI-MILANO S.p.A.
 Via Filippo Turati 27, 20121 Milano, Italy

(111) M 1997 6504 R
 (151) 1997 08 26
 (181) 2018 02 26
 (732) ASICS CORPORATION
 1-1 Minatojima-Nakamachi 7-chome, Chuo-Ku,
 Kobe City, Hyogo Prefecture, Japan

(111) M 1997 7370 R
 (151) 1997 11 04
 (181) 2018 05 04
 (732) COÖPERATIE AVEBE U.A.
 Prins Hendrikplein 20, 9641 GK Veendam,
 Netherlands

(111) M 1997 7196 R
 (151) 1997 10 15
 (181) 2018 04 15
 (732) AXEL JOHNSON AB
 Jakobsbergsgatan 7, S-10372 Stockholm,
 Sweden

(111) M 1997 7195 R
 (151) 1997 10 15
 (181) 2018 04 15
 (732) ASTRAZENECA AB
 Vastra Malarehamnen 9, 15185 Sodertalje,
 Sweden

(111) M 1997 6507 R
 (151) 1997 08 26
 (181) 2018 02 26
 (732) HENKEL AG & Co. KGaA
 Henkelstrasse 67, 40589 Dusseldorf,
 Germany

(111) M 1997 7052 R
 (151) 1997 10 07
 (181) 2018 04 07
 (732) HENKEL AG & Co. KGaA
 Henkelstrasse 67, 40589 Dusseldorf,
 Germany

(111) M 1997 7197 R
 (151) 1997 10 15
 (181) 2018 04 15
 (732) HENKEL AG & Co. KGaA
 Henkelstrasse 67, 40589 Dusseldorf,
 Germany

(111) M 1997 7198 R
 (151) 1997 10 15
 (181) 2018 04 15
 (732) HENKEL AG & Co. KGaA
 Henkelstrasse 67, 40589 Dusseldorf,
 Germany

(111) M 1997 7542 R
 (151) 1997 11 17
 (181) 2018 05 17
 (732) NOVARTIS AG
 4002 Basel, Switzerland

(111) M 1997 7518 R
 (151) 1997 11 14
 (181) 2018 05 14
 (732) NOVARTIS AG

4002 Basel, Switzerland	(111) M 1997 7601 R (151) 1997 11 19 (181) 2018 05 19 (732) NOVARTIS AG 4002 Basel, Switzerland
(111) M 1997 7054 R (151) 1997 10 07 (181) 2018 04 07 (732) DAIICHI SANKYO COMPANY, LIMITED 3-5-1, Nihonbashi Honcho, Chuo-ku, Tokyo 103-8426, Japan	(111) M 1997 7602 R (151) 1997 11 19 (181) 2018 05 19 (732) NOVARTIS AG 4002 Basel, Switzerland
(111) M 1997 7589 R (151) 1997 11 19 (181) 2018 05 19 (732) SYNGENTA PARTICIPATIONS AG Schwarzwaldallee 215, 4058 Basel, Switzerland	(111) M 1997 6587 R (151) 1997 09 02 (181) 2018 03 02 (732) JVC KENWOOD CORPORATION 3-12, Moriyacho, Kanagawa-Ku, Yokohama-Shi, Kanagawa, Japan
(111) M 1997 7523 R (151) 1997 11 14 (181) 2018 05 14 (732) NOVARTIS AG 4002 Basel, Switzerland	(111) M 1997 7059 R (151) 1997 10 07 (181) 2018 04 07 (732) MFG LICENSING GMBH Fabrikweg 16, 5033 BUCHS (AG), Switzerland
(111) M 1997 7524 R (151) 1997 11 14 (181) 2018 05 14 (732) SYNGENTA PARTICIPATIONS AG Schwarzwaldallee 215, 4058 Basel, Switzerland	(111) M 2006 16934 R (151) 2006 10 26 (181) 2017 04 26 (732) Warszawskie Zaklady Zielarskie "HERBAPOL" Ul. Oluvkava 54, PL-05-800 Prushkovi, Poland
(111) M 1997 6512 R (151) 1997 08 26 (181) 2018 02 26 (732) CONOPCO, INC. 390 Park Avenue, New York, New York 10022, USA	(111) M 1997 6520 R (151) 1997 08 26 (181) 2018 02 26 (732) AVENTIS PHARMA S.A. 20, avenue Raymond Aron, 92160 Antony, France
(111) M 1997 7371 R (151) 1997 11 04 (181) 2018 05 04 (732) GLAXOSMITHKLINE PHARMACEUTICALS SA GRUNWALDZKA 189, 60-322 POZNAN, Poland	(111) M 1997 6521 R (151) 1997 08 26 (181) 2018 02 26 (732) AVENTIS PHARMA S.A. 20, avenue Raymond Aron, 92160 Antony, France
(111) M 1997 7597 R (151) 1997 11 19 (181) 2018 05 19 (732) NOVARTIS AG 4002 Basel, Switzerland	(111) M 1997 7372 R (151) 1997 11 04 (181) 2018 05 04 (732) AVENTIS PHARMA S.A.

20, avenue Raymond Aron, 92160 Antony,
France

(111) M 1997 6522 R
(151) 1997 08 26
(181) 2018 02 26

(732) AVENTIS PHARMA S.A.
20, avenue Raymond Aron, 92160 Antony,
France

(111) M 2007 17956 R
(151) 2007 10 29
(181) 2018 04 29

(732) INTERSUN HOLDING FZE corporation
P.O. box: 61051 Jebel Ali Free Zone, Dubai,
United Arab Emirates

(111) M 1997 7062 R
(151) 1997 10 07
(181) 2018 04 07

(732) WARNER-LAMBERT COMPANY
LLC 201 Tabor Road, Morris Plains, New
Jersey 07950, USA

(111) M 2007 17691 R
(151) 2007 07 30
(181) 2018 01 30

(732) NEMIROFF INTELLECTUAL PROPERTY
ESTABLISHMENT
Haus Rechsteiner, P.O. Box 634/Stadtle 31,
LI-9490 Vaduz, Liechtenstein

(111) M 2007 17541 R
(151) 2007 06 11
(181) 2017 12 11

(732) GALLAHER SWEDEN AB
Box 1412, Kungsgatan 8, 111 84
STOCKHOLM, Sweden

(111) M 1997 7273 R
(151) 1997 10 21
(181) 2018 04 21

(732) POLFA SP. Z.O.O.
ul. Prosta 69, 00-838 Warszawa, Poland

(111) M 1997 7274 R
(151) 1997 10 21
(181) 2018 04 21

(732) POLFA SP. Z.O.O.
ul. Prosta 69, 00-838 Warszawa, Poland

(111) M 2007 17734 R
(151) 2007 09 18
(181) 2018 03 18

(732) MIKAYEL VARDANYAN
Bairon q. 3, b. 38, Yerevan, Armenia

(111) M 2007 17735 R
(151) 2007 09 18
(181) 2018 03 18

(732) MIKAYEL VARDANYAN
Bairon q. 3, b. 38, Yerevan, Armenia

(111) M 2007 17613 R
(151) 2007 07 12
(181) 2018 01 12

(732) CATERPILLAR INC.
100 N.E. Adams Street, PEORIA, IL 61629,
USA

(111) M 2007 17616 R
(151) 2007 07 12
(181) 2018 01 12

(732) CATERPILLAR INC.
100 N.E. Adams Street, PEORIA, IL 61629,
USA

(111) M 2007 17617 R
(151) 2007 07 12
(181) 2018 01 12

(732) CATERPILLAR INC.
100 N.E. Adams Street, PEORIA, IL 61629,
USA

(111) M 2007 17619 R
(151) 2007 07 12
(181) 2018 01 12

(732) CATERPILLAR INC.
100 N.E. Adams Street, PEORIA, IL 61629,
USA

(111) M 2007 17736 R
(151) 2007 09 18
(181) 2018 03 18

(732) KRAFT GIDA SANAYI VE TICARET
ANONIM SIRKETI
Cumhuriyet Mahallesi 2253, Sokak No:11,
Gebze/Kocaeli, Turkey

(111) M 2007 17547 R
(151) 2007 06 11
(181) 2017 12 11

(732) Development Center For Teaching Chinese

As A Foreign Language Of The Ministry Of
Education P.R.C.
17 th Floor, Fangyuan Mansion B56
Zhongguancun South St., Beijing 100044,
China

(111) M 2007 17546 R
(151) 2007 06 11
(181) 2017 12 11
(732) Development Center For Teaching Chinese
As A Foreign Language Of The Ministry Of
Education P.R.C.
17 th Floor, Fangyuan Mansion B56
Zhongguancun South St., Beijing 100044,
China

(111) M 2007 17990 R
(151) 2007 11 13
(181) 2018 05 13
(732) S&NF IIMITED
28 St. Andrew Square, Edingburg, EH2 1AF
Scotland, United Kingdom

(111) M 2007 17551 R
(151) 2007 06 11
(181) 2017 12 11
(732) PFIZER PRODUCTS INC.
a Connecticut Corporation
Eastern Point Road, Groton, Connecticut
06340, USA

(111) M 2007 17573 R
(151) 2007 06 15
(181) 2017 12 15
(732) AUK HOLDINGS LIMITED
Arch. Makariou III, 134, Yiota Court, 1st
Floor, Flat/Office 102, P.C. 3021, Limassol,
Cyprus

(111) M 2007 17575 R
(151) 2007 06 15
(181) 2017 12 15
(732) AUK HOLDINGS LIMITED
Arch. Makariou III, 134, Yiota Court, 1st
Floor, Flat/Office 102, P.C. 3021, Limassol,
Cyprus

(111) M 2007 17555 R
(151) 2007 06 11
(181) 2017 12 11
(732) AUK HOLDINGS LIMITED
Arch. Makariou III, 134, Yiota Court, 1st
Floor, Flat/Office 102, P.C. 3021, Limassol,
Cyprus

(111) M 1997 6533 R
(151) 1997 08 26
(181) 2018 02 26
(732) BARRY CALLEBAUT AG
Westpark, Pfingstweidstrasse 60, 8005 Zurich,
Switzerland

(111) M 2007 17596 R
(151) 2007 06 28
(181) 2017 12 28
(732) ABDI IBRAHIM ILAÇ SANAYI VE
TICARET ANONİM ŞİRKETİ
Eski Büyükdere Cad. Ayazağa Yolu 34398
No:5 Maslak, İstanbul, Turkey

(111) M 2007 17597 R
(151) 2007 06 28
(181) 2017 12 28
(732) ABDI IBRAHIM ILAÇ SANAYI VE
TICARET ANONİM ŞİRKETİ
Eski Büyükdere Cad. Ayazağa Yolu 34398
No:5 Maslak, İstanbul, Turkey

(111) M 2007 17564 R
(151) 2007 06 11
(181) 2017 12 11
(732) GENERAL MOTORS LLC
300 Renaissance Center, City of Detroit,
State of Michigan 48265-3000, USA

(111) M 2007 17566 R
(151) 2007 06 11
(181) 2017 12 11
(732) CHRYSALIS HOLDINGS LIMITED
The Chrysalis Building, Bramley Road,
London W10 6SP, United Kingdom

(111) M 2007 17743 R
(151) 2007 09 18
(181) 2018 03 18
(732) REEMTSMA CIGARETTENFABRIKEN
GMBH
Max-Born-Strasse 4, 22761 Hamburg,
Germany

(111) M 2007 17744 R
(151) 2007 09 18
(181) 2018 03 18
(732) REEMTSMA CIGARETTENFABRIKEN
GMBH
Max-Born-Strasse 4, 22761 Hamburg,
Germany

(111) M 2007 17745 R
(151) 2007 09 18
(181) 2018 03 18
(732) WIX FILTRON SP. Z O.O.
ul. Wroclawska 145, 63-800 Gostyn,
Poland

(111) M 2007 17626 R
(151) 2007 07 12
(181) 2018 01 12
(732) Development Center For Teaching Chinese
As A Foreign Language Of The Ministry Of
Education P.R.C.
17 th Floor, Fangyuan Mansion B56
Zhongguancun South St., Beijing 100044,
China

(111) M 2007 17627 R
(151) 2007 07 12
(181) 2018 01 12
(732) Development Center For Teaching Chinese
As A Foreign Language Of The Ministry Of
Education P.R.C.
17 th Floor, Fangyuan Mansion B56
Zhongguancun South St., Beijing 100044,
China

(111) M 2007 17697 R
(151) 2007 07 30
(181) 2018 01 30
(732) ISUZU JIDOSHA KABUSHIKI KAISHA
(also trading as Isuzu Motors Limited)
26-1, Minami-Oi 6-Chome, Shinagawa-Ku,
Tokyo, Japan

(111) M 2007 17698 R
(151) 2007 07 30
(181) 2018 01 30
(732) ISUZU JIDOSHA KABUSHIKI KAISHA
(also trading as Isuzu Motors Limited)
26-1, Minami-Oi 6-Chome, Shinagawa-Ku,
Tokyo, Japan

(111) M 2007 17699 R
(151) 2007 07 30
(181) 2018 01 30
(732) ISUZU JIDOSHA KABUSHIKI KAISHA
(also trading as Isuzu Motors Limited)
26-1, Minami-Oi 6-Chome, Shinagawa-Ku,
Tokyo, Japan

(111) M 2007 17700 R
(151) 2007 07 30
(181) 2018 01 30

(732) ISUZU JIDOSHA KABUSHIKI KAISHA
(also trading as Isuzu Motors Limited)
26-1, Minami-Oi 6-Chome, Shinagawa-Ku,
Tokyo, Japan

(111) M 1997 7072 R
(151) 1997 10 08
(181) 2018 04 08
(732) SOCIETE DES PRODUITS NESTLE S.A.
1800 Vevey, Switzerland

(111) M 2007 17746 R
(151) 2007 09 18
(181) 2018 03 18
(732) LLC "V. Tigranyan Company"
Ul. Satyan, d. 4, kv. 78, Yerevan, Armenia

(111) M 2007 17676 R
(151) 2007 07 25
(181) 2018 01 25
(732) NOVARTIS AG
Basel 4002, Switzerland

(111) M 2007 17634 R
(151) 2007 07 12
(181) 2018 01 12
(732) NOVARTIS AG
Basel 4002, Switzerland

(111) M 2007 17580 R
(151) 2007 06 15
(181) 2017 12 15
(732) OMNICOM INTERNATIONAL
HOLDINGS INC. a Delaware corporation
720 California Street, San Francisco,
California 94108, USA

(111) M 2007 17599 R
(151) 2007 06 28
(181) 2017 12 28
(732) ABDI IBRAHIM ILAÇ SANAYI VE
TICARET ANONİM ŞİRKETİ
Eski Büyükdere Cad. Ayazağa Yolu 34398
No:5 Maslak, İstanbul, Turkey

(111) M 2007 17600 R
(151) 2007 06 28
(181) 2017 12 28
(732) ABDI IBRAHIM ILAÇ SANAYI VE
TICARET ANONİM ŞİRKETİ
Eski Büyükdere Cad. Ayazağa Yolu 34398
No:5 Maslak, İstanbul, Turkey

(111) M 1997 7280 R
(151) 1997 10 22
(181) 2018 04 22
(732) BARRY CALLEBAUT AG
Westpark, Pfingstweidstrasse 60, 8005 Zurich,
Switzerland

(111) M 2007 17748 R
(151) 2007 09 18
(181) 2018 03 18
(732) PFIZER PRODUCTS INC.
a Connecticut corporation
Eastern Point Road, Groton, Connecticut
06340, USA

(111) M 2007 17639 R
(151) 2007 07 12
(181) 2018 01 12
(732) FRAM GROUP IP LLC
39 Old Ridgebury Road, Danbury,
Connecticut 06810-5109, USA

(111) M 2007 17749 R
(151) 2007 09 18
(181) 2018 03 18
(732) CHERNOMORSKO ZLATO "AD"
8500 Pomorie, Bulgaria;
"VINEX PRESILAV" AD
Promishlena zona, 9850 Veliki Preslav,
Bulgaria

(111) M 2007 17702 R
(151) 2007 07 30
(181) 2018 01 30
(732) ABDI IBRAHIM İLAÇ SANAYİ VE
TİCARET ANONİM ŞİRKETİ
Eski Büyükdere Cad. Ayazağa Yolu 34398
No:5 Maslak, İstanbul, Turkey

(111) M 2007 17703 R
(151) 2007 07 30
(181) 2018 01 30
(732) ABDI IBRAHIM İLAÇ SANAYİ VE
TİCARET ANONİM ŞİRKETİ
Eski Büyükdere Cad. Ayazağa Yolu 34398
No:5 Maslak, İstanbul, Turkey

(111) M 2007 17677 R
(151) 2007 07 25
(181) 2018 01 25
(732) EVREN MUTFAK ESYALARI SANAYİ
VE TİCARET LIMITED SİRKETİ
İSMETİYE CAD. GUL HAN KAT:2

No:27/28, SULEYMANIYE-EMINONU,
İSTANBUL, Turkey

(111) M 2007 17568 R
(151) 2007 06 11
(181) 2017 12 11
(732) SHANTOU S.E.Z. YE SHENG GARMENT
CO., LTD
2/F., Block 6, Longhu Industry Area, No.10,
Chang Jiang Road, Shantou, Guangdong
Province, China

(111) M 1997 7073 R
(151) 1997 10 08
(181) 2018 04 08
(732) LICENCIAS Y EXCLUSIVAS TEXTILES, S.A.
Avenida Balmes, 16 08700 IGUALADA
(Barcelona), Spain

(111) M 1997 6473 R
(151) 1997 08 22
(181) 2018 02 22
(732) FINDUS SVERIGE AKTIEBOLAG
267 81 Bjuv, Sweden

(111) M 2007 17753 R
(151) 2007 09 18
(181) 2018 03 18
(732) VLAKTOR TRADING LIMITED
Arch. Makariou III, 134, Yiota Court,
Flat/Office 102, P.C. 3021, Limassol
Cyprus

(111) M 2007 17755 R
(151) 2007 09 18
(181) 2018 03 18
(732) VLAKTOR TRADING LIMITED
Arch. Makariou III, 134, Yiota Court,
Flat/Office 102, P.C. 3021, Limassol
Cyprus

(111) M 2007 17641 R
(151) 2007 07 12
(181) 2018 01 12
(732) NOVARTIS CONSUMER HEALTH S.A.
Route de L'Etlaz, 1197 Prangins, Switzerland

(111) M 2007 17644 R
(151) 2007 07 12
(181) 2018 01 12
(732) NOVARTIS CONSUMER HEALTH S.A.
Route de L'Etlaz, 1197 Prangins, Switzerland

(111) M 2007 17678 R

(151) 2007 07 25

(181) 2018 01 25

(732) VIVARTIA INDUSTRIAL &
COMMERCIAL COMPANY OF FOOD
PRODUCTS & CATERING SERVICES
S.A.
10, Ziridi str. Maroussi, 15123 Athens,
Greece

(111) M 2007 17679 R

(151) 2007 07 25

(181) 2018 01 25

(732) VIVARTIA INDUSTRIAL &
COMMERCIAL COMPANY OF FOOD
PRODUCTS & CATERING SERVICES
S.A.
10, Ziridi str. Maroussi, 15123 Athens,
Greece

(111) M 2007 17650 R

(151) 2007 07 12

(181) 2018 01 12

(732) BIZREH BROTHERS COMPANY
AlRawda Street, Bizreh Bldg. 2nd Floor,
P.O. Box 6230, Damascus, Syrian Arab
Republic

(111) M 2007 17765 R

(151) 2007 09 18

(181) 2018 03 18

(732) BRITISH AMERICAN TOBACCO
(BRANDS) INC.
251 Little Falls Drive, Suite 100, Delaware,
19808-1674, Wilmington, USA

(111) M 2007 17766 R

(151) 2007 09 18

(181) 2018 03 18

(732) LLC "NEW PRODUCTS"
Pl. Sportivnaya 3, 01023, Kiev, Ukraine

(111) M 2007 17651 R

(151) 2007 07 12

(181) 2018 01 12

(732) MALLINCKRODT LLC
675 McDonnel Boulevard, P.O. Box 5840,
st. Louis, Missouri 63134, USA

(111) M 2007 17709 R

(151) 2007 07 30

(181) 2018 01 30

(732) KIA MOTORS CORPORATION

231 Yangjae-dong, Seocho-gu, Seoul
137-938, Republic of Korea

(111) M 2007 17680 R

(151) 2007 07 25

(181) 2018 01 25

(732) BRIDGESTONE CORPORATION
10-1, Kyobashi 1-Chome, Chuo-ku,
Tokyo, Japan

(111) M 2007 17774 R

(151) 2007 09 18

(181) 2018 03 18

(732) WYETH LLC
Five Giralda Farms, Madison, New Jersey,
07940, USA

(111) M 2007 17778 R

(151) 2007 09 18

(181) 2018 03 18

(732) VIVARTIA INDUSTRIAL &
COMMERCIAL COMPANY OF FOOD
PRODUCTS & CATERING SERVICES
S.A.
10, Ziridi str. Maroussi, 15123 Athens,
Greece

(111) M 2007 17655 R

(151) 2007 07 12

(181) 2018 01 12

(732) PFIZER INC., a Delaware corporation
235 East 42 th Street, New York, New
York 10017, USA

(111) M 2007 17716 R

(151) 2007 07 30

(181) 2018 01 30

(732) BAYER CONSUMER CARE AG
Peter Merian-Str. 84, 4052 Basel, Switzerland

(111) M 2007 17788 R

(151) 2007 09 18

(181) 2018 03 18

(732) BREAT CORPORATION LTD
Cophall, P.O. Box 2331, Roseau, St. George
00152, Dominica

(111) M 1997 6829 R

(151) 1997 09 18

(181) 2018 03 18

(732) JOHNSON & JOHNSON

One Johnson & Johnson Plaza, New Brunswick, New Jersey 08933, USA

(111) M 2007 1779 R
 (151) 2007 09 18
 (181) 2018 03 18
 (732) WYETH HOLDINGS LLC
 Five Giralda Farms, Madison, New Jersey 07940-0874, USA

(111) M 2007 17608 R
 (151) 2007 06 28
 (181) 2017 12 28
 (732) Avtandil Dakhundaridze
 Dzmebi Kakabadzebis q. 6, 0108, Tbilisi, Georgia

(111) M 2007 17801 R
 (151) 2007 09 18
 (181) 2018 03 18
 (732) Zakrytoe aktsionernoe obshchestvo "MOBILNYE INNOVATSII"
 pom.1, Mayakovskogo per.2, Moscow, RU-109147, Russian Federation

(111) M 2007 17802 R
 (151) 2007 09 18
 (181) 2018 03 18
 (732) Zakrytoe aktsionernoe obshchestvo "MOBILNYE INNOVATSII"
 pom.1, Mayakovskogo per.2, Moscow, RU-109147, Russian Federation

(111) M 2007 17924 R
 (151) 2007 10 12
 (181) 2018 04 12
 (732) Development Center For Teaching Chinese As A Foreign Language Of The Ministry Of Education P.R.C.
 17 th Floor, Fangyuan Mansion B56 Zhongguancun South St., Beijing 100044, China

(111) M 2007 17925 R
 (151) 2007 10 12
 (181) 2018 04 12
 (732) Development Center For Teaching Chinese As A Foreign Language Of The Ministry Of Education P.R.C.
 17 th Floor, Fangyuan Mansion B56 Zhongguancun South St., Beijing 100044, China

(111) M 2007 17958 R
 (151) 2007 10 29
 (181) 2018 04 29
 (732) HOTIX MANAGEMENT LTD
 Geneva Place, Waterfront Drive, P.O. Box 3469, Road Town, Tortola, Virgin Islands (British)

(111) M 2007 17959 R
 (151) 2007 10 29
 (181) 2018 04 29
 (732) HOTIX MANAGEMENT LTD
 Geneva Place, Waterfront Drive, P.O. Box 3469, Road Town, Tortola, Virgin Islands (British)

(111) M 2007 17960 R
 (151) 2007 10 29
 (181) 2018 04 29
 (732) HOTIX MANAGEMENT LTD
 Geneva Place, Waterfront Drive, P.O. Box 3469, Road Town, Tortola, Virgin Islands (British)

(111) M 2007 17812 R
 (151) 2007 09 18
 (181) 2018 03 18
 (732) MERCK SHARP & DOHME CORP.
 One Merck Drive, Whitehouse Station, New Jersey 08889, USA

(111) M 2007 17813 R
 (151) 2007 09 18
 (181) 2018 03 18
 (732) WYETH LLC
 Five Giralda Farms, Madison, New Jersey, 07940, USA

(111) M 2007 17814 R
 (151) 2007 09 18
 (181) 2018 03 18
 (732) WYETH LLC
 Five Giralda Farms, Madison, New Jersey, 07940, USA

(111) M 2007 17815 R
 (151) 2007 09 18
 (181) 2018 03 18
 (732) WYETH LLC
 Five Giralda Farms, Madison, New Jersey, 07940, USA

(111) M 2007 17816 R
(151) 2007 09 18
(181) 2018 03 18
(732) WYETH LLC
Five Giralda Farms, Madison, New Jersey,
07940, USA

(111) M 2007 17817 R
(151) 2007 09 18
(181) 2018 03 18
(732) WYETH LLC
Five Giralda Farms, Madison, New Jersey,
07940, USA

(111) M 2007 17963 R
(151) 2007 10 29
(181) 2018 04 29
(732) WRANGLER APPAREL CORP
3411 Silverside Road, Wilmington, DE
19810, USA

(111) M 2007 17964 R
(151) 2007 10 29
(181) 2018 04 29
(732) WRANGLER APPAREL CORP
3411 Silverside Road, Wilmington, DE
19810, USA

(111) M 2007 17966 R
(151) 2007 10 29
(181) 2018 04 29
(732) International Business Company
"NUTRITEK INTERNATIONAL. CORP."
Reg.No 585930" P.O. Box 3321, Road Town,
Tortola, Virgin Islands (British)

(111) M 2007 17967 R
(151) 2007 10 29
(181) 2018 04 29
(732) International Business Company
"NUTRITEK INTERNATIONAL. CORP."
Reg.No 585930" P.O. Box 3321, Road Town,
Tortola, Virgin Islands (British)

(111) M 2007 17821 R
(151) 2007 09 18
(181) 2018 03 18
(732) BJÖRN SUNDEBY
Grand Rue 19, CH-1297 Founex-UD,
Switzerland

(111) M 2007 17968 R
(151) 2007 10 29
(181) 2018 04 29
(732) International Business Company
"NUTRITEK INTERNATIONAL. CORP."
Reg.No 585930" P.O. Box 3321, Road Town,
Tortola, Virgin Islands (British)

(111) M 2007 17991 R
(151) 2007 11 13
(181) 2018 05 13
(732) FISHER-ROSEMOUNT SYSTEMS, INC.,
a Delaware corporation
Bldg. III, 12301 Research Boulevard,
Research Park Plaza, Austin, Texas 78759,
USA

(111) M 2007 17969 R (151) 2007 10 29
(181) 2018 04 29
(732) LLC "VEDA FINANCE"
22 line v. o., d. 3, korp. 1, liter M, 199106
St. Petersburg, Russian Federation

(111) M 2007 17970 R
(151) 2007 10 29
(181) 2018 04 29
(732) LLC "VEDA FINANCE"
22 line v. o., d. 3, korp. 1, liter M, 199106
St. Petersburg, Russian Federation

(111) M 2007 17971 R
(151) 2007 10 29
(181) 2018 04 29
(732) LLC "VEDA FINANCE"
22 line v. o., d. 3, korp. 1, liter M, 199106
St. Petersburg, Russian Federation

(111) M 2007 17972 R
(151) 2007 10 29
(181) 2018 04 29
(732) LLC "VEDA FINANCE"
22 line v. o., d. 3, korp. 1, liter M, 199106
St. Petersburg, Russian Federation

(111) M 2007 17829 R
(151) 2007 09 18
(181) 2018 03 18
(732) DUN & BRADSTREET
INTERNATIONAL, LTD,
a Delaware Corporation

103 JFK Parkway, Short Hills, New Jersey 07078, USA	(732) BAYER CONSUMER CARE AG Peter Merian-Str. 84, 4052 Basel, Switzerland
(111) M 2007 17891 R (151) 2007 10 10 (181) 2018 04 10 (732) BRITISH AMERICAN TOBACCO (BRANDS) INC. 2711 Centerville Road, Suite 300, Wilmington, Delaware 19808, USA	(111) M 2007 17838 R (151) 2007 09 18 (181) 2018 03 18 (732) BAYER CONSUMER CARE AG Peter Merian-Str. 84, 4052 Basel, Switzerland
(111) M 2007 17893 R (151) 2007 10 10 (181) 2018 04 10 (732) COSTCO WHOLESALE CORPORATION 999 Lake Drive, Issaquah, Washington 98027, USA	(111) M 2007 17841 R (151) 2007 09 18 (181) 2018 03 18 (732) BOYNER HOLDİNG ANONİM ŞİRKETİ Eski Büyükdere Caddesi No:22, Maslak- Istanbul, Turkey
(111) M 2007 17895 R (151) 2007 10 10 (181) 2018 04 10 (732) Price Costco International, Inc. 999 Lake Drive, Issaquah, Washington 98027, USA	(111) M 2007 17842 R (151) 2007 09 18 (181) 2018 03 18 (732) BOYNER HOLDİNG ANONİM ŞİRKETİ Eski Büyükdere Caddesi No:22, Maslak- Istanbul, Turkey
(111) M 2007 17831 R (151) 2007 09 18 (181) 2018 03 18 (732) RFE/RL, Inc., a Delaware corporation 1201 Connecticut Avenue, N.W., Suite 400, Washington, DC 20036-2605, USA	(111) M 2007 17843 R (151) 2007 09 18 (181) 2018 03 18 (732) BOYNER HOLDİNG ANONİM ŞİRKETİ Eski Büyükdere Caddesi No:22, Maslak- Istanbul, Turkey
(111) M 2007 18065 R (151) 2007 11 14 (181) 2018 05 14 (732) BRITISH AMERICAN TOBACCO (BRANDS) INC. 2711 Centerville Road, Suite 300, Wilmington, Delaware 19808, USA	(111) M 2007 17844 R (151) 2007 09 18 (181) 2018 03 18 (732) BOYNER HOLDİNG ANONİM ŞİRKETİ Eski Büyükdere Caddesi No:22, Maslak- Istanbul, Turkey
(111) M 2007 17836 R (151) 2007 09 18 (181) 2018 03 18 (732) THE COCA-COLA COMPANY a Corporate of the State of Delaware One Coca-Cola Plaza, Atlanta, Georgia 30313, USA	(111) M 2007 17997 R (151) 2007 11 13 (181) 2018 05 13 (732) MASTERCARD INTERNATIONAL INCORPORATED, a Delaware Corporation 2000 Purchase Street, Purchase, New York 10577-2509, USA
(111) M 2007 17837 R (151) 2007 09 18 (181) 2018 03 18	(111) M 2007 17900 R (151) 2007 10 10 (181) 2018 04 10 (732) MASTERCARD INTERNATIONAL INCORPORATED, a Delaware Corporation 2000 Purchase Street, Purchase, New York 10577-2509, USA

(111) M 2007 17901 R
(151) 2007 10 10
(181) 2018 04 10
(732) MASTERCARD INTERNATIONAL
INCORPORATED, a Delaware Corporation
2000 Purchase Street, Purchase, New York
10577-2509, USA

(111) M 2007 17902 R
(151) 2007 10 10
(181) 2018 04 10
(732) CPT HOLDINGS, INC.
(a Delaware corporation)
10202 W. Washington Blvd., Culver City,
California 90232, USA

(111) M 2007 17846 R
(151) 2007 09 18
(181) 2018 03 18
(732) SMITHKLINE BEECHAM P.L.C.
980 Great West Road, Brentford, Middlesex
TW8 9GS, United Kingdom

(111) M 2007 17852 R
(151) 2007 09 18
(181) 2018 03 18
(732) REEMTSMA CIGARETTENFABRIKEN
GMBH
Max-Born-Strasse 4, 22761 Hamburg,
Germany

(111) M 2007 17854 R
(151) 2007 09 18
(181) 2018 03 18
(732) REEMTSMA CIGARETTENFABRIKEN
GMBH
Max-Born-Strasse 4, 22761 Hamburg,
Germany

(111) M 2007 17998 R
(151) 2007 11 13
(181) 2018 05 13
(732) OTIS ELEVATOR COMPANY
10 Farm Springs, Farmington, Connecticut
06032, New Jersey, USA

(111) M 2007 17999 R
(151) 2007 11 13
(181) 2018 05 13
(732) PREMIUM HOLDINGS CAPITAL LTD
P.O. Box 3321, Drake Chambers, Road
Town, Tortola, Virgin Islands (British)

(111) M 2007 17861 R
(151) 2007 09 18
(181) 2018 03 18
(732) BAYER CONSUMER CARE AG
Peter Merian-Str. 84, 4052 Basel,
Switzerland

(111) M 2007 18003 R
(151) 2007 11 13
(181) 2018 05 13
(732) THE PROCTER & GAMBLE COMPANY
One Procter & Gamble Plaza, Cincinnati,
Ohio, USA

(111) M 2007 18004 R
(151) 2007 11 13
(181) 2018 05 13
(732) DELTA COMPRESIÓN S.R.L.
Panamericana Colectora Este Km.47.53 -
Escobar-Provincia de Buenos Aires,
Argentina

(111) M 2007 17863 R
(151) 2007 09 18
(181) 2018 03 18
(732) BAYER CONSUMER CARE AG
Peter Merian-Str. 84, 4052 Basel,
Switzerland

(111) M 2007 18006 R
(151) 2007 11 13
(181) 2018 05 13
(732) MERCK SHARP & DOHME CORP
One Merck Drive, Whitehouse Station,
New Jersey 08889, USA

(111) M 2007 18007 R
(151) 2007 11 13
(181) 2018 05 13
(732) MERCK SHARP & DOHME CORP
One Merck Drive, Whitehouse Station,
New Jersey 08889, USA

(111) M 2007 18008 R
(151) 2007 11 13
(181) 2018 05 13
(732) MERCK SHARP & DOHME CORP
One Merck Drive, Whitehouse Station,
New Jersey 08889, USA

(111) M 2007 18013 R
 (151) 2007 11 13
 (181) 2018 05 13
 (732) MERCK SHARP & DOHME CORP
 One Merck Drive, Whitehouse Station,
 New Jersey 08889, USA

(111) M 2007 18009 R
 (151) 2007 11 13
 (181) 2018 05 13
 (732) NINTENDO CO., LTD
 11-1, Hokotate-cho, Kamitoba, Minami-ku,
 Kyoto-shi, Kyoto, Japan

(111) M 2007 17930 R
 (151) 2007 10 29
 (181) 2018 04 29
 (732) JET2.COM LIMITED
 Building 470, Bournemouth International
 Airport, Christchurch, Dorset, BH23 6SE,
 United Kingdom

(111) M 2007 17917 R
 (151) 2007 10 10
 (181) 2018 04 10
 (732) Societe Nationale d'Exploitation Industrielle
 des Tabacs et Allumettes (SEITA)
 143, Boulevard Romain Rolland, 75685 Paris
 Cedex 14, France

(111) M 2007 18012 R
 (151) 2007 11 13
 (181) 2018 05 13
 (732) BIOGEN IDEC MA INC.
 14 Cambridge Center, Cambridge,
 MA 02142, USA

(111) M 2007 18014 R
 (151) 2007 11 13
 (181) 2018 05 13
 (732) BIOGEN IDEC MA INC.
 14 Cambridge Center, Cambridge,
 Massachusetts 02142, USA

(111) M 2007 17875 R
 (151) 2007 09 18
 (181) 2018 03 18
 (732) LABORATORIOS CASASCO S.A.I.C.
 Lavalle 310, Ciudad Aut. De Buenos Aires,
 Argentina

(111) M 2007 18015 R
 (151) 2007 11 13
 (181) 2018 05 13
 (732) BRITISH AMERICAN TOBACCO
 (BRANDS) INC.
 2711 Centerville Road, Suite 300,
 Wilmington, Delaware 19808, USA

(111) M 2007 18016 R
 (151) 2007 11 13
 (181) 2018 05 13
 (732) NINTENDO CO., LTD
 11-1, Hokotate-cho, Kamitoba, Minami-ku,
 Kyoto-shi, Kyoto, Japan

(111) M 2007 17980 R
 (151) 2007 10 29
 (181) 2018 04 29
 (732) GALLAHER LIMITED
 Members Hill, Brooklands Road, Weybridge,
 Surrey KT13 0QU, United Kingdom

(111) M 2007 17931 R
 (151) 2007 10 29
 (181) 2018 04 29
 (732) JAPAN TOBACCO INC.
 2-2-1, Toranomom, Minato-ku, Tokyo, Japan

(111) M 2007 17932 R
 (151) 2007 10 29
 (181) 2018 04 29
 (732) JET2.COM LIMITED
 Building 470, Bournemouth International
 Airport, Christchurch, Dorset, BH23 6SE,
 United Kingdom

(111) M 2007 17933 R
 (151) 2007 10 29
 (181) 2018 04 29
 (732) JET2.COM LIMITED
 Building 470, Bournemouth International
 Airport, Christchurch, Dorset, BH23 6SE,
 United Kingdom

(111) M 2007 17934 R
 (151) 2007 10 29
 (181) 2018 04 29
 (732) JET2.COM LIMITED
 Building 470, Bournemouth International
 Airport, Christchurch, Dorset, BH23 6SE,
 United Kingdom

(111) M 2007 17935 R (151) 2007 10 29 (181) 2018 04 29 (732) JET2.COM LIMITED Building 470, Bournemouth International Airport, Christchurch, Dorset, BH23 6SE, United Kingdom	Building 470, Bournemouth International Airport, Christchurch, Dorset, BH23 6SE, United Kingdom
<hr/>	
(111) M 2007 17936 R (151) 2007 10 29 (181) 2018 04 29 (732) JET2.COM LIMITED Building 470, Bournemouth International Airport, Christchurch, Dorset, BH23 6SE, United Kingdom	(111) M 2007 17942 R (151) 2007 10 29 (181) 2018 04 29 (732) JET2.COM LIMITED Building 470, Bournemouth International Airport, Christchurch, Dorset, BH23 6SE, United Kingdom
<hr/>	
(111) M 2007 17937 R (151) 2007 10 29 (181) 2018 04 29 (732) JET2.COM LIMITED Building 470, Bournemouth International Airport, Christchurch, Dorset, BH23 6SE, United Kingdom	(111) M 2007 17943 R (151) 2007 10 29 (181) 2018 04 29 (732) JET2.COM LIMITED Building 470, Bournemouth International Airport, Christchurch, Dorset, BH23 6SE, United Kingdom
<hr/>	
(111) M 2007 17938 R (151) 2007 10 29 (181) 2018 04 29 (732) JET2.COM LIMITED Building 470, Bournemouth International Airport, Christchurch, Dorset, BH23 6SE, United Kingdom	(111) M 2007 17944 R (151) 2007 10 29 (181) 2018 04 29 (732) JET2.COM LIMITED Building 470, Bournemouth International Airport, Christchurch, Dorset, BH23 6SE, United Kingdom
<hr/>	
(111) M 2007 17939 R (151) 2007 10 29 (181) 2018 04 29 (732) JET2.COM LIMITED Building 470, Bournemouth International Airport, Christchurch, Dorset, BH23 6SE, United Kingdom	(111) M 2007 17945 R (151) 2007 10 29 (181) 2018 04 29 (732) JET2.COM LIMITED Building 470, Bournemouth International Airport, Christchurch, Dorset, BH23 6SE, United Kingdom
<hr/>	
(111) M 2007 17940 R (151) 2007 10 29 (181) 2018 04 29 (732) JET2.COM LIMITED Building 470, Bournemouth International Airport, Christchurch, Dorset, BH23 6SE, United Kingdom	(111) M 2007 17946 R (151) 2007 10 29 (181) 2018 04 29 (732) JET2.COM LIMITED Building 470, Bournemouth International Airport, Christchurch, Dorset, BH23 6SE, United Kingdom
<hr/>	
(111) M 2007 17941 R (151) 2007 10 29 (181) 2018 04 29 (732) JET2.COM LIMITED	(111) M 2007 17947 R (151) 2007 10 29 (181) 2018 04 29 (732) JET2.COM LIMITED Building 470, Bournemouth International Airport, Christchurch, Dorset, BH23 6SE, United Kingdom

(111) M 2007 17981 R
 (151) 2007 10 29
 (181) 2018 04 29
 (732) JET2.COM LIMITED
 Building 470, Bournemouth International
 Airport, Christchurch, Dorset, BH23 6SE,
 United Kingdom

10th floor Hanseo Bldg., 246-3, Seohyun-
 Dong, Bundang-ku, Seongnam, 463-824,
 Republic of Korea

(111) M 2007 17948 R
 (151) 2007 10 29
 (181) 2018 04 29
 (732) JET2.COM LIMITED
 Building 470, Bournemouth International
 Airport, Christchurch, Dorset, BH23 6SE,
 United Kingdom

(111) M 2007 18022 R
 (151) 2007 11 13
 (181) 2018 05 13
 (732) JET2.COM LIMITED
 Building 470, Bournemouth International
 Airport, Christchurch, Dorset, BH23 6SE,
 United Kingdom

(111) M 2007 17949 R
 (151) 2007 10 29
 (181) 2018 04 29
 (732) JET2.COM LIMITED
 Building 470, Bournemouth International
 Airport, Christchurch, Dorset, BH23 6SE,
 United Kingdom

(111) M 2007 18024 R
 (151) 2007 11 13
 (181) 2018 05 13
 (732) SMITHKLINE BEECHAM (CORK)
 LIMITED
 Currabinny, Carrigaline, County Cork,
 Ireland

(111) M 2007 17950 R
 (151) 2007 10 29
 (181) 2018 04 29
 (732) JET2.COM LIMITED
 Building 470, Bournemouth International
 Airport, Christchurch, Dorset, BH23 6SE,
 United Kingdom

(111) M 2007 18025 R
 (151) 2007 11 13
 (181) 2018 05 13
 (732) SMITHKLINE BEECHAM (CORK)
 LIMITED
 Currabinny, Carrigaline, County Cork,
 Ireland

(111) M 2007 17951 R
 (151) 2007 10 29
 (181) 2018 04 29
 (732) JET2.COM LIMITED
 Building 470, Bournemouth International
 Airport, Christchurch, Dorset, BH23 6SE,
 United Kingdom

(111) M 2007 18026 R
 (151) 2007 11 13
 (181) 2018 05 13
 (732) SMITHKLINE BEECHAM (CORK)
 LIMITED
 Currabinny, Carrigaline, County Cork,
 Ireland

(111) M 2007 18018 R
 (151) 2007 11 13
 (181) 2018 05 13
 (732) JET2.COM LIMITED
 Building 470, Bournemouth International
 Airport, Christchurch, Dorset, BH23 6SE,
 United Kingdom

(111) M 2007 18028 R
 (151) 2007 11 13
 (181) 2018 05 13
 (732) BOSNALIJEK, PHARMACEUTICAL AND
 CHEMICAL INDUSTRY, JSC
 71000 Sarajevo, Jukićeva 53, Bosnia and
 Herzegovina

(111) M 2007 18019 R
 (151) 2007 11 13
 (181) 2018 05 13
 (732) TOPFIELD CO., LTD

(111) M 2007 18029 R
 (151) 2007 11 13
 (181) 2018 05 13
 (732) BOSNALIJEK, PHARMACEUTICAL AND
 CHEMICAL INDUSTRY, JSC
 71000 Sarajevo, Jukićeva 53, Bosnia and
 Herzegovina

(111) M 2007 18030 R
 (151) 2007 11 13
 (181) 2018 05 13
 (732) BOSNALIJEK, PHARMACEUTICAL AND
 CHEMICAL INDUSTRY, JSC
 71000 Sarajevo, Jukićeva 53, Bosnia and
 Herzegovina

CORPORATE COMMUNICATION S.P.A.
 Via Nizza 250, 10126 Torino, Italy

(111) M 2007 18031 R
 (151) 2007 11 13
 (181) 2018 05 13
 (732) BOSNALIJEK, PHARMACEUTICAL AND
 CHEMICAL INDUSTRY, JSC
 71000 Sarajevo, Jukićeva 53, Bosnia and
 Herzegovina

(111) M 1997 7224 R
 (151) 1997 10 16
 (181) 2018 04 16
 (732) FIAT GROUP MARKETING &
 CORPORATE COMMUNICATION
 S.P.A.
 Via Nizza 250, 10126 Torino, Italy

(111) M 2007 18032 R
 (151) 2007 11 13
 (181) 2018 05 13
 (732) BOSNALIJEK, PHARMACEUTICAL AND
 CHEMICAL INDUSTRY, JSC
 71000 Sarajevo, Jukićeva 53, Bosnia and
 Herzegovina

(111) M 2007 18048 R
 (151) 2007 11 13
 (181) 2018 05 13
 (732) NOVARTIS CONSUMER HEALTH S.A.
 Route de L'Etlaz, 1197 Prangins, Switzerland

(111) M 2007 18033 R
 (151) 2007 11 13
 (181) 2018 05 13
 (732) BOSNALIJEK, PHARMACEUTICAL AND
 CHEMICAL INDUSTRY, JSC
 71000 Sarajevo, Jukićeva 53, Bosnia and
 Herzegovina

(111) M 2007 18049 R
 (151) 2007 11 13
 (181) 2018 05 13
 (732) NOVARTIS CONSUMER HEALTH S.A.
 Route de L'Etlaz, 1197 Prangins, Switzerland

(111) M 2007 18034 R
 (151) 2007 11 13
 (181) 2018 05 13
 (732) BOSNALIJEK, PHARMACEUTICAL AND
 CHEMICAL INDUSTRY, JSC
 71000 Sarajevo, Jukićeva 53, Bosnia and
 Herzegovina

(111) M 1997 7075 R
 (151) 1997 10 08
 (181) 2018 04 08
 (732) FIAT GROUP MARKETING &
 CORPORATE COMMUNICATION S.P.A.
 Via Nizza 250, 10126 Torino, Italy

(111) M 1997 7377 R
 (151) 1997 11 05
 (181) 2018 05 05
 (732) FIAT GROUP MARKETING &
 CORPORATE COMMUNICATION
 S.P.A.
 Via Nizza 250, 10126 Torino, Italy

(111) M 1997 6837 R
 (151) 1997 09 19
 (181) 2018 03 19
 (732) JOHNSON & JOHNSON
 One Johnson & Johnson Plaza, New
 Brunswick, New Jersey 08933, USA

(111) M 1997 7222 R
 (151) 1997 10 16
 (181) 2018 04 16
 (732) FIAT GROUP MARKETING &

(111) M 1997 7291 R
 (151) 1997 10 22
 (181) 2018 04 22
 (732) LG CORP.
 20, Yoido-dong, Yongdungpo-gu, Seoul,

(111) M 1997 7082 R
 (151) 1997 10 08
 (181) 2018 04 08
 (732) HERTZ SYSTEM, INC.
 225 Brae Boulevard, Park Ridge, State
 of New Jersey 07656, USA

(111) M 1997 7298 R
(151) 1997 10 22
(181) 2018 04 22
(732) NESTLE SKIN HEALTH S.A.
Avenue Gratta-Paille 2, CH-1018 Lausanne,
Switzerland

(111) M 1997 6842 R
(151) 1997 09 19
(181) 2018 03 19
(732) SABIC Innovative Plastics IP B.V.
Plasticslaan 1, 4612 PX Bergen op Zoom,
Netherlands

(111) M 1997 6848 R
(151) 1997 09 19
(181) 2018 03 19
(732) MERCK SHARP & DOHME CORP.
One Merck Drive, Whitehouse Station,
New Jersey 08889, USA

(111) M 1997 7300 R
(151) 1997 10 22
(181) 2018 04 22
(732) FMC CORPORATION
1735 Market Street, Philadelphia,
Pennsylvania 19103, USA

(111) M 1997 6858 R
(151) 1997 09 19
(181) 2018 03 19
(732) JOHNSON & JOHNSON
One Johnson & Johnson Plaza, New
Brunswick, New Jersey 08933, USA

(111) M 1997 7387 R
(151) 1997 11 05
(181) 2018 05 05
(732) G.H. MUMM & CIE, SOCIETE VINICOLE
DE CHAMPAGNE SUCESSEUR
29, rue du Champ de Mars, F-51100 Reimsi,
France

(111) M 1997 7388 R
(151) 1997 11 05
(181) 2018 05 05
(732) G.H. MUMM & CIE, SOCIETE VINICOLE
DE CHAMPAGNE SUCESSEUR
29, rue du Champ de Mars, F-51100 Reimsi,
France

(111) M 1997 7390 R
(151) 1997 11 05
(181) 2018 05 05
(732) SONY KABUSHIKI KAISHA
7-35, Kitashinagawa 6-chome, Shinagawa-ku,
Tokyo, Japan

(111) M 1997 7310R
(151) 1997 10 28
(181) 2018 04 28
(732) SONY OVERSEAS S.A.
3, Oberneuhofstrasse, CH-6340 Baar,
Switzerland

(111) M 1997 7314 R
(151) 1997 10 28
(181) 2018 04 28
(732) SONY KABUSHIKI KAISHA
7-35, Kitashinagawa 6-chome, Shinagawa-ku,
Tokyo, Japan

(111) M 1997 7096 R
(151) 1997 10 08
(181) 2018 04 08
(732) SALOMON S.A.
Les Croiselets, 74370 METZ TESSY-
France

(111) M 1997 7321 R
(151) 1997 10 28
(181) 2018 04 28
(732) RUSSELL CORPORATION
Alexander City, Alabama 35010, USA

(111) M 1997 6922 R
(151) 1997 09 24
(181) 2018 03 24
(732) EXXON MOBIL CORPORATION
5959 Las Colinas Boulevard, Irving, Texas
75039-2298, USA

(111) M 1997 6925 R
(151) 1997 09 24
(181) 2018 03 24
(732) EXXON MOBIL CORPORATION
5959 Las Colinas Boulevard, Irving, Texas
75039-2298, USA

(111) M 1997 6926 R
(151) 1997 09 24
(181) 2018 03 24

(732) EXXON MOBIL CORPORATION
5959 Las Colinas Boulevard, Irving, Texas
75039-2298, USA

(111) M 1997 7398 R
(151) 1997 11 05
(181) 2018 05 05
(732) NALCO COMPANY
1601 W. Diehl Road, Naperville, Illinois,
USA

(111) M 1997 7401 R
(151) 1997 11 05
(181) 2018 05 05
(732) NALCO COMPANY
1601 W. Diehl Road, Naperville, Illinois,
USA

(111) M 1997 7545 R
(151) 1997 11 17
(181) 2018 05 17
(732) SKYY SPIRITS, LLC
1255 Battery Street, Suite 500, San
Francisco, CA 94111, USA

(111) M 1997 6736 R
(151) 1997 09 10
(181) 2018 03 10
(732) DICTATOR TECHNIK GMBH
9 Gutenbergstrasse, D-86356 NEUSASS,
Germany

(111) M 1997 6719 R
(151) 1997 09 10
(181) 2018 03 10
(732) GENERALE BISCUIT (Société par Actions
Simplifiée)
6 Av Réaumur, 92140 klamart, France

(111) M 1997 6724 R
(151) 1997 09 10
(181) 2018 03 10
(732) SAINT-GOBAIN ISOVER
Les Miroirs 18, avenue d'Alsace, 92400
Courbevoie, France

(111) M 1997 7570 R
(151) 1997 11 18
(181) 2018 05 18
(732) SCHINDLER AUFZUEGE AG
CH-6030 Edikon, Switzerland

(111) M 1997 7014 R
(151) 1997 10 01
(181) 2018 04 01
(732) ALTADIS S.A.
Eloy Gonzalo 10, 28010 Madrid, Spain

(111) M 1997 6422 R
(151) 1997 08 18
(181) 2018 02 18
(732) SCHINDLER AUFZUEGE AG
CH-6030 Edikon, Switzerland

(111) M 1997 6423 R
(151) 1997 08 18
(181) 2018 02 18
(732) PFIZER PRODUCTS INC., a Connecticut
corporation
Eastern Point Road, Groton, Connecticut
06340, USA

(111) M 1997 6430 R
(151) 1997 08 18
(181) 2018 02 18
(732) PFIZER PRODUCTS INC., a Connecticut
corporation
Eastern Point Road, Groton, Connecticut
06340, USA

(111) M 1997 7553 R
(151) 1997 11 18
(181) 2018 05 18
(732) THE PROCTER & GAMBLE COMPANY
One Procter & Gamble Plaza, Cincinnati,
Ohio, USA

(111) M 1997 7554 R
(151) 1997 11 18
(181) 2018 05 18
(732) THE PROCTER & GAMBLE COMPANY
One Procter & Gamble Plaza, Cincinnati,
Ohio, USA

(111) M 1997 7555 R
(151) 1997 11 18
(181) 2018 05 18
(732) THE PROCTER & GAMBLE COMPANY
One Procter & Gamble Plaza, Cincinnati,
Ohio, USA

(111) M 1997 7406 R
(151) 1997 11 07
(181) 2018 05 07

(732) BP P.L.C.
1 St James's Square, London SW1Y 4PD,
United Kingdom

(111) M 1997 7417 R
(151) 1997 11 07
(181) 2018 05 07
(732) COURREGES PARFUMS
40, rue Francois 1er, 75008 Paris, France

(111) M 1997 7418 R
(151) 1997 11 07
(181) 2018 05 07
(732) COURREGES PARFUMS
40, rue Francois 1er, 75008 Paris, France

(111) M 1997 7419 R
(151) 1997 11 07
(181) 2018 05 07
(732) COURREGES PARFUMS
40, rue Francois 1er, 75008 Paris, France

(111) M 1997 7422 R
(151) 1997 11 10
(181) 2018 05 10
(732) ATOMIC AUSTRIA G.m.b.H.
Atomic Straße 1, 5541 Altenmarkt im
Pongau, Austria

(111) M 1997 7237 R
(151) 1997 10 16
(181) 2018 04 16
(732) MARQUES DE MONISTROL, S.A.
Apartado 14, E-08100 Mollet del Valles,
Barcelona, Spain

(111) M 1997 6748 R
(151) 1997 09 11
(181) 2018 03 11
(732) PERNOD RICARD ITALIA S.p.A.
Corso Buenos Aires, 54, 20124 Milan, Italy

(111) M 1997 6749 R
(151) 1997 09 11
(181) 2018 03 11
(732) PERNOD RICARD ITALIA S.p.A.
Corso Buenos Aires, 54, 20124 Milan, Italy

(111) M 1997 6750 R
(151) 1997 09 11
(181) 2018 03 11

(732) CANEI s.r.l.
Via Cornalia n. 7, 20124 Milano, Italy

(111) M 1997 6751 R
(151) 1997 09 11
(181) 2018 03 11
(732) HENKEL IP & HOLDING GmbH
Henkelstrasse 67, 40589 Dusseldorf,
Germany

(111) M 1997 6752 R
(151) 1997 09 11
(181) 2018 03 11
(732) HENKEL IP & HOLDING GmbH
Henkelstrasse 67, 40589 Dusseldorf,
Germany

(111) M 1997 6753 R
(151) 1997 09 11
(181) 2018 03 11
(732) HENKEL IP & HOLDING GmbH
Henkelstrasse 67, 40589 Dusseldorf,
Germany

(111) M 1997 7429 R
(151) 1997 11 10
(181) 2018 05 10
(732) APPLE INC.
1 Infinite loop, Cupertino, California 95014,
USA

(111) M 1997 7437 R
(151) 1997 11 10
(181) 2018 05 10
(732) NEWMAN
51, avenue du Marechal Leclerc, F-49309
Cholet, France

(111) M 1997 7442 R
(151) 1997 11 11
(181) 2018 05 11
(732) NICHOLS PLC
Laurel House, 3 Woodlands Park, Ashton
Road, Newton-Le-Willows WA 12 OHH,
England, United Kingdom

(111) M 1997 7341 R
(151) 1997 10 29
(181) 2018 04 29
(732) REEMTSMA CIGARETTENFABRIKEN
GMBH
Max-Born-Strasse 4, 22761 Hamburg,
Germany

(111) M 1997 7342 R
 (151) 1997 10 29
 (181) 2018 04 29
 (732) FILTRONA INTERNATIONAL LIMITED
 Avebury House, 201-249 Avebury
 Boulevard, Milton Keynes MK9 1UA,
 United Kingdom

(111) M 1997 6434 R
 (151) 1997 08 18
 (181) 2018 02 18
 (732) ASTRAZENECA UK LIMITED
 15 Stanhope Gate, London W1Y 6LN, United
 Kingdom

(111) M 1997 7533 R
 (151) 1997 11 17
 (181) 2018 05 17
 (732) KOMPASS INTERNATIONAL
 NEUENSCHWANDER S.A.
 12 Cours Michelet, La Defence 10, 92800
 Puteaux, France

(111) M 1997 7534 R
 (151) 1997 11 17
 (181) 2018 05 17
 (732) THE PROCTER & GAMBLE COMPANY
 One Procter & Gamble Plaza, Cincinnati,
 Ohio, USA

(111) M 1997 6438 R
 (151) 1997 08 18
 (181) 2018 02 18
 (732) THE PROCTER & GAMBLE COMPANY
 One Procter & Gamble Plaza, Cincinnati,
 Ohio, USA

(111) M 1997 6440 R
 (151) 1997 08 18
 (181) 2018 02 18
 (732) THE PROCTER & GAMBLE COMPANY
 One Procter & Gamble Plaza, Cincinnati,
 Ohio, USA

(111) M 1997 6441 R
 (151) 1997 08 18
 (181) 2018 02 18
 (732) INVENTIO A
 Postfach 6052, Hergiswil, Switzerland

(111) M 1997 6442 R
 (151) 1997 08 18
 (181) 2018 02 18

(732) SCHINDLER AUFZUEGE AG
 CH-6030 Edikon, Switzerland

(111) M 1997 6807 R
 (151) 1997 09 17
 (181) 2018 03 17
 (732) ATLANTIC-WATCH PRODUCTION LTD
 (ATLANTIC-WATCH PRODUCTION AG)
 (ATLANTIC-WATCH PRODUCTION S.A.)
 Bündengasse 18, Grenchen, Switzerland

(111) M 1997 6759 R
 (151) 1997 09 11
 (181) 2018 03 11
 (732) PANDROL LIMITED
 Osprey House, 63 Station Road, Addlestone,
 Weybridge, Surrey, KT15 2AR,
 United Kingdom

(111) M 1997 7571 R
 (151) 1997 11 18
 (181) 2018 05 18
 (732) BRITISH AMERICAN TOBACCO
 (BRANDS) INC.
 2711 Centerville Road, Suite 3000,
 Wilmington, Delaware 19808,
 USA

(111) M 1997 7559 R
 (151) 1997 11 18
 (181) 2018 05 18
 (732) BRITISH AMERICAN TOBACCO
 (BRANDS) INC.
 2711 Centerville Road, Suite 3000,
 Wilmington, Delaware 19808, USA

(111) M 1997 6876 R
 (151) 1997 09 22
 (181) 2018 03 22
 (732) COGNIS IP MANAGEMENT GmbH
 Henkelstrasse 67, 40589 Dusseldorf,
 Germany

(111) M 1997 7572 R
 (151) 1997 11 18
 (181) 2018 05 18
 (732) AMERICAN-CIGARETTE COMPANY
 (OVERSEAS) LIMITED
 Zählerweg 4, CH-6300 Zug,
 Switzerland

(111) M 1997 7575 R
(151) 1997 11 18
(181) 2018 05 18
(732) SMITHKLINE BEECHAM LIMITED
980 Great West Road, Brentford, Middlesex
TW8 9GS, United Kingdom

(111) M 1997 7576 R
(151) 1997 11 18
(181) 2018 05 18
(732) AMERICAN-CIGARETTE COMPANY
(OVERSEAS) LIMITED
Zählerweg 4, CH-6300 Zug, Switzerland

(111) M 1997 7564 R
(151) 1997 11 18
(181) 2018 05 18
(732) TURMAC TOBACCO COMPANY BV
Drentestraat 21, Amsterdam, Netherlands

(111) M 1997 6763 R
(151) 1997 09 11
(181) 2018 03 11
(732) REEMTSMA CIGARETTENFABRIKEN
GMBH
51, Parkstrasse, D-22605 Hamburg, Germany

(111) M 1997 6765 R
(151) 1997 09 11
(181) 2018 03 11
(732) CLUB MEDITERRANEE
25, rue Vivienne, Place de la Bourse,
F-75002 Paris, France

(111) M 1997 7454 R
(151) 1997 11 11
(181) 2018 05 11
(732) MARTELL & Co
Place Edouard Martell, F-16100 Cognac,
France

(111) M 1997 7458 R
(151) 1997 11 11
(181) 2018 05 11
(732) TENNECO AUTOMOTIVE OPERATING
COMPANY INC.
500 North Field Drive, LAKE FOREST, IL
60045, USA

(111) M 1997 6928 R
(151) 1997 09 25
(181) 2018 03 25

(732) PHILIP MORRIS BRANDS SARL
Quai Jeanrenaud 3, 2000 Neuchâtel,
Switzerland

(111) M 1997 7789 R
(151) 1997 12 09
(181) 2018 06 09
(732) TOBACNA LJUBLJANA,
Proizvodno In Trgousko Podjetj Za Tobacne
Izdelke, D.O.O. Ljubljana
Tobacna Ulica 5, 61000 Ljubljana,
Slovenia

(111) M 1997 6685 R
(151) 1997 09 08
(181) 2018 03 08
(732) COFINLUXE
6, rue Anatole de la Forge, 75017 Paris,
France

(111) M 1997 7497 R
(151) 1997 11 13
(181) 2018 05 13
(732) SMITHKLINE BEECHAM LIMITED
980 Great West Road, Brentford, Middlesex
TW8 9GS, United Kingdom

(111) M 1997 6686 R
(151) 1997 09 08
(181) 2018 03 08
(732) GENERALE BISCUIT (Société par Actions
Simplifiée)
6 Av Réaumur, 92140 klamart, France

(111) M 1997 6604 R
(151) 1997 09 03
(181) 2018 03 03
(732) HENKEL AG & Co. KGaA
Henkelstrasse 67, 40589 Dusseldorf,
Germany

(111) M 1997 6933 R
(151) 1997 09 25
(181) 2018 03 25
(732) DBA Lux 1
560A, rue de Neuidorf, L-2220,
Luxembourg

(111) M 1997 6934 R
(151) 1997 09 25
(181) 2018 03 25
(732) DBA Lux 1

560A, rue de Neuidorf, L-2220,
Luxembourg

(111) M 1997 6936 R
(151) 1997 09 25
(181) 2018 03 25
(732) SKS LIMITID

633, chongia-dong, changan-gu, suvon,
kiongi-do, Republic of Korea

(111) M 1997 6769 R
(151) 1997 09 11
(181) 2018 03 11

(732) BUMAR SPÓLKA Z ORGANICZONA
ODPOWIEDZIALNOŚCIA
Al. Jana Pawła II 11, 00828 Warszawa,
Poland

(111) M 1997 7708 R
(151) 1997 11 24
(181) 2018 05 24

(732) OLYMPIA INTERNATIONAL HOLDINGS
LIMITED
Shelton Building, Main Street Road Town,
Virgin Islands (British)

(111) M 1997 7619 R
(151) 1997 11 20
(181) 2018 05 20

(732) ATLANTA HANDELSGESELLSCHAFT
HARDER & Co., GmbH
Breitenweg 29, D-28195 Bremen, Germany

(111) M 1997 7623 R
(151) 1997 11 20
(181) 2018 05 20

(732) BUSH BOAKE ALLEN LIMITED
Blackhorse lane, London, United Kingdom

(111) M 1997 7626 R
(151) 1997 11 20
(181) 2018 05 20

(732) PROCTER & GAMBLE HOLDING GmbH
Sulzbacher Strasse 40, 65824 Schwalbach am
Taunus, Germany

(111) M 1997 7657 R
(151) 1997 11 21
(181) 2018 05 21

(732) EYGN LIMITED (Bahamas company)
One Montague Place, East Bay Street,
Nassau, Bahamas

(111) M 1997 7629 R

(151) 1997 11 20
(181) 2018 05 20

(732) Zoetis WHC 2 LLC
100 Campus Drive, Florham Park, NJ 07932,
USA

(111) M 1997 6939 R

(151) 1997 09 25
(181) 2018 03 25

(732) NISSIM ISRAEL
5, Rue lincoln, UCCLE Belgium

(111) M 1997 6260 R

(151) 1997 08 04
(181) 2018 02 04

(732) GLAXO GROUP LIMITED
980 Great West Road, Brentford, Middlesex
TW8 9GS, United Kingdom

(111) M 1997 6943 R

(151) 1997 09 25
(181) 2018 03 25

(732) HERO
CH-5600, Lenzburg 1, Switzerland

(111) M 1997 7634 R

(151) 1997 11 20
(181) 2018 05 20

(732) IMPERIAL TOBACCO LIMITED
P.O. Box 244, Southville BRISTOL, BS99
7UJ, United Kingdom

(111) M 1997 6613 R

(151) 1997 09 03
(181) 2018 03 03

(732) LINVATEC CORPORATION
11311, Concept Boulevard, Largo, Florida
34643, USA

(111) M 1997 6480 R

(151) 1997 08 22
(181) 2018 02 22

(732) AT&T Intellectual Property II, L.P.
645 East Plumb Lane, Reno, Nevada 89502,
USA

(111) M 1997 6483 R

(151) 1997 08 22
(181) 2018 02 22

(732) LUCENT TECHNOLOGIES INC.
600 Mountain Avenue, Murray Hill,

New Jersey 07974-0636, USA

(111) M 1997 7637 R
(151) 1997 11 20
(181) 2018 05 20
(732) MARS INC.
6885 Elm Street, McLean, Virginia, USA

(111) M 1997 7674 R
(151) 1997 11 21
(181) 2018 05 21
(732) MARS INC.
6885 Elm Street, McLean, Virginia, USA

(111) M 1997 7641 R
(151) 1997 11 20
(181) 2018 05 20
(732) SMITHKLINE BEECHAM LIMITED
980 Great West Road, Brentford, Middlesex
TW8 9GS, United Kingdom

(111) M 1997 7642 R
(151) 1997 11 20
(181) 2018 05 20
(732) THE HOUSE OF EDGEWORTH
INCORPORATED
Zählerweg 4, Zug CH 6300, Switzerland

(111) M 1997 7252 R
(151) 1997 10 20
(181) 2018 04 20
(732) BAYER INTELLECTUAL PROPERTY
GMBH
Alfred-Nobel-Strasse 10, 40789 Monheim am
Rhein, Germany

(111) M 1997 7253 R
(151) 1997 10 20
(181) 2018 04 20
(732) BAYER INTELLECTUAL PROPERTY
GMBH
Alfred-Nobel-Strasse 10, 40789 Monheim am
Rhein, Germany

(111) M 1997 7643 R
(151) 1997 11 20
(181) 2018 05 20
(732) BRITISH AMERICAN TOBACCO
(BRANDS) INC.
2711 Centerville Road, Suite 3000,
Wilmington, Delaware 19808, USA

(111) M 1997 5850 R
(151) 1997 07 08
(181) 2018 01 08
(732) L'OREAL
14, rue Royale, F-75008 Paris, France

(111) M 1997 6948 R
(151) 1997 09 25
(181) 2018 03 25
(732) DORMEUIL FRERES
14, avenue du 1er Mai, 91120 Palaiseau,
France

(111) M 1997 7646 R
(151) 1997 11 20
(181) 2018 05 20
(732) AKTSIONERNOE OBSHCHESTVO
OTKRYTOGO TIPJA JAVA-TABAK"
3-JA ULICA JAMSKOGO POLJA 9, 125040
MOSCOW, Russian Federation

CHANGE OF THE LIST OF GOODS AND/OR SERVICES
OF TRADEMARKS

(111) M 1998 10208 R
(732) VALENTIN YUDASHKIN GROUP
LIMITED
15 Agiou Pavlou Str. Ledra House, Agios
Andreas, 1105, Nicosia, Cyprus
(511) 3, 8, 14, 18, 20, 21, 24, 25, 27, 42

(111) M 1998 10209 R
(732) VALENTIN YUDASHKIN GROUP
LIMITED
15 Agiou Pavlou Str. Ledra House, Agios
Andreas, 1105, Nicosia, Cyprus
(511) 3, 8, 14, 18, 20, 21, 24, 25, 27, 42

(111) M 1998 10231 R
(732) ALTICOR INC.
7575 Fulton Street East, ADA, Michigan
49355, USA
(511) 3

(111) M 2008 18983 R
(732) LTD "BAUVEGI"
Enukidzis q. 7, 0182, Tbilisi, Georgia
(511) 35

CANCELLING OF TRADEMARK REGISTRATION

(111) M 2016 27483 R
(151) 2016 08 18
(181) 2026 08 18
(260) AM 2016 81846 A
(220) 2015 04 27
(732) HARRINGTON DEVELOPMENT INC.
Elvira Mendez street, Vallarino Bldg,
3rd floor, Panama, Republic of Panama
(540)



(141) 2018 09 04

GROUNDS: Order №46 of Sakpatenti Chairman of 2018 15 08 for enforcement of the decision of September 18, 2012, of Tbilisi City Court Civil Cases Board (Case №2/18297-17).

CLASSIFICATION INDEXES

INVENTIONS

CONCORDANCE TABLE OF INTERNATIONAL CLASSIFICATION INDEX AND PUBLICATION NUMBERS

INTERNATIONAL CLASSIFICATION INDEXES (51)	NUMBER OF PUBLISHED APPLICATION (10)
A 01 N 43/40	AP 2018 14459 A
A 61 C 8/00	AP 2018 14140 A
A 61 K 31/706; A 61 P 35/00; A 61 P 35/02	AP 2018 13483 A

CONCORDANCE TABLE OF PUBLICATION NUMBERS AND INTERNATIONAL CLASSIFICATION INDEX

NUMBER OF PUBLISHED APPLICATION (10)	INTERNATIONAL CLASSIFICATION INDEXES (51)
AP 2018 13483 A	A 61 K 31/706; A 61 P 35/00; A 61 P 35/02
AP 2018 14140 A	A 61 C 8/00
AP 2018 14459 A	A 01 N 43/40

CONCORDANCE TABLE OF INTERNATIONAL CLASSIFICATION INDEX, PATENT NUMBERS AND PUBLICATION NUMBERS

INTERNATIONAL CLASSIFICATION INDEX (51)	NUMBER OF PATENT (11)	NUMBER OF PUBLISHED APPLICATION (10)
A 01 N 43/48; A 61 K 31/40	P 2018 6891 B	AP 2018 13833 A
C 01 B 3/24; C 10 J 3/00; C 10 J 3/72	P 2018 6890 B	AP 2018 13524 A
C 07 D 211/72; C 07 D 227/10; C 07 D 401/12; C 07 D 405/12; C 07 D 413/12; C 07 D 413/14; C 07 D 417/12; A 61 K 31/435	P 2018 6892 B	AP 2018 14248 A
C 07 D 401/04; C 07 D 241/26; C 07 D 241/28; A 61 K 31/497; A 61 K 31/5377; A 61 P 25/00	P 2018 6893 B	AP 2018 14266 A
C 22 C 5/04; B 01 J 23/40	P 2018 6894 B	AP 2018 14324 A

**CONCORDANCE TABLE OF PATENT NUMBERS,
PUBLICATION NUMBERS AND INTERNATIONAL CLASSIFICATION INDEX**

NUMBER OF PATENT (11)	NUMBER OF PUBLISHED APPLICATION (10)	INTERNATIONAL CLASSIFICATION INDEX (51)
P 2018 6890 B	AP 2018 13524 A	C 01 B 3/24; C 10 J 3/00; C 10 J 3/72
P 2018 6891 B	AP 2018 13833 A	A 01 N 43/48; A 61 K 31/40
P 2018 6892 B	AP 2018 14248 A	C 07 D 211/72; C 07 D 227/10; C 07 D 401/12; C 07 D 405/12; C 07 D 413/12; C 07 D 413/14; C 07 D 417/12; A 61 K 31/435
P 2018 6893 B	AP 2018 14266 A	C 07 D 401/04; C 07 D 241/26; C 07 D 241/28; A 61 K 31/497; A 61 K 31/5377; A 61 P 25/00
P 2018 6894 B	AP 2018 14324 A	C 22 C 5/04; B 01 J 23/40

CONCORDANCE TABLE OF APPLICATION NUMBERS, PUBLICATION NUMBERS AND PATENTS

NUMBER OF APPLICATION (21)	NUMBER OF PUBLISHED APPLICATION (10)	NUMBER OF PATENT (11)
AP 2012 013524	AP 2018 13524 A	P 2018 6890 B
AP 2013 013833	AP 2018 13833 A	P 2018 6891 B
AP 2015 014248	AP 2018 14248 A	P 2018 6892 B
AP 2015 014266	AP 2018 14266 A	P 2018 6893 B
AP 2015 014324	AP 2018 14324 A	P 2018 6894 B

DESIGNS

CONCORDANCE TABLE OF INTERNATIONAL CLASSIFICATION INDEX AND PUBLICATION NUMBERS

INTERNATIONAL CLASSIFICATION INDEXES (51)	NUMBER OF PUBLISHED APPLICATION (10)
31-00	AD 2018 1020 S

CONCORDANCE TABLE OF PUBLICATION NUMBERS AND INTERNATIONAL CLASSIFICATION INDEX

NUMBER OF PUBLISHED APPLICATION (10)	INTERNATIONAL CLASSIFICATION INDEXES (51)
AD 2018 1020 S	31-00

TRADEMARKS

CONCORDANCE TABLE OF REGISTRATION NUMBERS, APPLICATION NUMBERS,
PUBLICATION NUMBERS AND BULLETIN NUMBERS

NUMBER OF REGISTRATION (111)	NUMBER OF APPLICATIONS (210)	NUMBER OF PUBLISHED APPLICATIONS (260)	NUMBER OF BULLETIN
M 2018 30089 R	AM 98969	-	17(501)2018
M 2018 30090 R	AM 98970	-	17(501)2018
M 2018 30091 R	AM 99055	-	17(501)2018
M 2018 30092 R	AM 98976	-	17(501)2018
M 2018 30093 R	AM 99085	-	17(501)2018
M 2018 30094 R	AM 99052	-	17(501)2018
M 2018 30095 R	AM 88989	AM 2016 88989 A	21(481)2017
M 2018 30096 R	AM 89904	AM 2018 89904 A	9(493)2018
M 2018 30097 R	AM 91092	AM 2018 91092 A	7(491)2018
M 2018 30098 R	AM 91846	AM 2017 91846 A	24(484)2017
M 2018 30099 R	AM 91847	AM 2017 91847 A	24(484)2017
M 2018 30100 R	AM 91848	AM 2017 91848 A	24(484)2017
M 2018 30101 R	AM 91851	AM 2017 91851 A	24(484)2017
M 2018 30102 R	AM 91865	AM 2018 91865 A	5(489)2018
M 2018 30103 R	AM 91957	AM 2017 91957 A	24(484)2017
M 2018 30104 R	AM 92189	AM 2017 92189 A	24(484)2017
M 2018 30105 R	AM 92190	AM 2017 92190 A	24(484)2017
M 2018 30106 R	AM 92213	AM 2017 92213 A	24(484)2017
M 2018 30107 R	AM 92608	AM 2018 92608 A	6(490)2018
M 2018 30108 R	AM 92617	AM 2018 92617 A	8(492)2018
M 2018 30109 R	AM 92752	AM 2018 92752 A	4(488)2018
M 2018 30110 R	AM 92765	AM 2018 92765 A	3(487)2018
M 2018 30111 R	AM 92793	AM 2018 92793 A	4(488)2018
M 2018 30112 R	AM 92848	AM 2018 92848 A	4(488)2018
M 2018 30113 R	AM 92850	AM 2018 92850 A	4(488)2018
M 2018 30114 R	AM 93106	AM 2018 93106 A	6(490)2018
M 2018 30115 R	AM 93294	AM 2018 93294 A	6(490)2018
M 2018 30116 R	AM 93315	AM 2018 93315 A	6(490)2018
M 2018 30117 R	AM 93328	AM 2018 93328 A	6(490)2018
M 2018 30118 R	AM 93499	AM 2018 93499 A	8(492)2018
M 2018 30119 R	AM 93500	AM 2018 93500 A	8(492)2018
M 2018 30120 R	AM 93627	AM 2018 93627 A	8(492)2018
M 2018 30121 R	AM 93629	AM 2018 93629 A	8(492)2018
M 2018 30122 R	AM 93691	AM 2018 93691 A	8(492)2018
M 2018 30123 R	AM 93811	AM 2018 93811 A	8(492)2018
M 2018 30124 R	AM 93846	AM 2018 93846 A	8(492)2018
M 2018 30125 R	AM 93852	AM 2018 93852 A	8(492)2018
M 2018 30126 R	AM 93913	AM 2018 93913 A	9(493)2018
M 2018 30127 R	AM 94053	AM 2018 94053 A	8(492)2018
M 2018 30128 R	AM 94309	AM 2018 94309 A	9(493)2018
M 2018 30129 R	AM 94312	AM 2018 94312 A	8(492)2018
M 2018 30130 R	AM 94348	AM 2018 94348 A	9(493)2018
M 2018 30131 R	AM 94349	AM 2018 94349 A	9(493)2018
M 2018 30132 R	AM 94350	AM 2018 94350 A	9(493)2018
M 2018 30133 R	AM 94356	AM 2018 94356 A	9(493)2018
M 2018 30134 R	AM 94358	AM 2018 94358 A	9(493)2018

**CONCORDANCE TABLE OF PUBLICATION NUMBERS
AND APPLICATION NUMBERS**

NUMBER OF PUBLISHED APPLICATION (260)	NUMBER OF APPLICATION (210)	1	2
1	2		
AM 2018 91291 A	AM 91291	AM 2018 95758 A	AM 95758
AM 2018 91292 A	AM 91292	AM 2018 95801 A	AM 95801
AM 2018 91293 A	AM 91293	AM 2018 95830 A	AM 95830
AM 2018 92105 A	AM 92105	AM 2018 95987 A	AM 95987
AM 2018 93349 A*	AM 93349	AM 2018 96115 A	AM 96115
AM 2018 95689 A	AM 95689	AM 2018 96154 A	AM 96154
AM 2018 95713 A	AM 95713	AM 2018 96155 A	AM 96155
AM 2018 95714 A	AM 95714	AM 2018 96240 A	AM 96240
AM 2018 95715 A	AM 95715	AM 2018 96307 A	AM 96307
		AM 2018 96308 A	AM 96308
		AM 2018 96313 A	AM 96313
		AM 2018 96485 A	AM 96485
		AM 2018 96545 A	AM 96545

**CONCORDANCE TABLE OF INDEX OF GOODS AND/OR SERVICES
AND APPLICATION NUMBERS**

INDEX OF GOODS AND/OR SERVICES (511)	NUMBER OF PUBLISHED APPLICATIONS (26)	1	2
1	2		
5	AM 2018 91291 A	32	AM 2018 96308 A
5	AM 2018 91292 A	33	AM 2018 96115 A
5	AM 2018 91293 A	33	AM 2018 96308 A
9	AM 2018 95689 A	34	AM 2018 95758 A
12	AM 2018 96545 A	34	AM 2018 96240 A
16	AM 2018 92105 A	35	AM 2018 95689 A
21	AM 2018 93349 A*	35	AM 2018 96115 A
30	AM 2018 95713 A	35	AM 2018 96154 A
30	AM 2018 95714 A	35	AM 2018 96155 A
30	AM 2018 95715 A	35	AM 2018 96485 A
30	AM 2018 96115 A	41	AM 2018 96115 A
30	AM 2018 96308 A	43	AM 2018 95801 A
30	AM 2018 96485 A	43	AM 2018 95830 A
32	AM 2018 96115 A	43	AM 2018 95987 A
		43	AM 2018 96115 A
		43	AM 2018 96307 A
		43	AM 2018 96308 A
		43	AM 2018 96313 A

CONCORDANCE TABLE OF INDEX OF GOODS AND/OR SERVICES
AND NUMBERS OF TRADEMARKS REGISTERED ACCORDING
TO THE ACCELERATED PROCEDURE

INDEX OF GOODS AND/OR SERVICES (511)	NUMBERS OF REGISTERED ACCORDING TO THE ACCELERATED PROCEDURE (111)
9	M 2018 30093 R
29	M 2018 30092 R
29	M 2018 30094 R
30	M 2018 30092 R
30	M 2018 30094 R
32	M 2018 30092 R
33	M 2018 30091 R
41	M 2018 30089 R
41	M 2018 30093 R
43	M 2018 30090 R

OFFICIAL BULLETIN OF THE INDUSTRIAL PROPERTY

INVENTIONS

DESIGNS

TRADEMARKS

APPELLATIONS OF ORIGIN AND GEOGRAPHICAL INDICATIONS OF GOODS

17(501)

EDITOR-IN-CHIEF: N. Bebrishvili

EDITOR-TRANSLATOR: E. Gabunia

PROOFREADER: A. Shikhashvili

COMPUTER LAYOUT: M. Ordenidze
K. Svanidze

www.sakpatenti.gov.ge

E-mail: info@sakpatenti.org.ge