



საქართველოს ინტელექტუალური საკუთრების ეროვნული ცენტრი
NATIONAL INTELLECTUAL PROPERTY CENTER OF GEORGIA

საქპატენტი
SAKPATENTI

**OFFICIAL BULLETIN
OF THE INDUSTRIAL PROPERTY**

17(525)

2019
TBILISI

INID CODES FOR IDENTIFICATION OF BIBLIOGRAPHIC DATA

INVENTIONS, UTILITY MODELS

- (10) Number of publication for application, which has been examined
- (11) Number of patent and kind of document
- (21) Serial number of application
- (22) Date of filing of the application
- (23) Date of exhibition or the date of the earlier filing and the number of application, if any
- (24) Date from which patent may have effect
- (31) Number of priority application
- (32) Date of filing of priority application
- (33) Code of the country or regional organization allotting priority application number
- (44) Date of publication of application not granted, but examined and number of bulletin
- (45) Date of publication of registered document
- (51) International Patent Classification Index
- (54) Title of the invention
- (57) Abstract
- (60) Number of examined patent document granted by foreign patent office, date from which patent has effect and country code
- (62) Number of the earlier application and in case of divided application, date of filing an application
- (71) Name, surname and address of applicant (country code)
- (72) Name, surname of inventor (country code)
- (73) Name, surname and address of patent owner (country code)
- (74) Name, surname of representative or patent attorney
- (85) Date of commencement of the national phase of International Application
- (86) Number and date of filing of international application
- (87) Number and date of publication of international application

DESIGNS

- (10) Number of publication for application
- (11) Number of patent and kind of document or number of registration
- (15) Date of registration/Date of patent renewal
- (18) Expected expiration date of patent or registration
- (21) Serial number of application
- (22) Date of filing of the application
- (23) Date of exhibition or the date of the earlier filing and the number of application, if any
- (24) Date from which patent may have effect
- (28) Number of designs included in the application
- (30) Data relating to priority (number of application, date of filing of application, two-letter code identifying the authority with whom the priority application was made)
- (31) Number of priority application
- (32) Date of filing of priority application
- (33) Code of the country or regional organization allotting priority application number
- (34) Two-letter code according to WIPO St.3 identifying the authority with which the priority application was made
- (44) Date of publication of design and number of bulletin (the first publication)
- (45) Date of publication of design registered by WIPO and number of bulletin
- (51) International Classification for designs (class and subclass of the Locarno Classification)
- (54) Title of the invention
- (55) Reproduction of the design
- (57) Description of characteristic features of the design including indication of colors
- (58) Date of recording of any kind of amendment in the Register
- (62) Number of the earlier application, registration and document number and if available the date of filing an application in case of divided application
- (71) Name, surname and address of applicant (country code)
- (72) Name, surname of creator (country code)
- (73) Name, surname and address of patent owner (country code)
- (74) Name, surname of representative or patent attorney
- (81) Contracting states concerned
 - II designated contracting states according to the 1960 Act
 - III designated contracting states according to the 1999 Act
- (85) Owner's permanent address
- (86) Owner's nationality
- (87) Owner's residence
- (88) State in which the owner has a real and effective industrial or commercial establishment

TRADEMARKS

- (111) - Number of registration
- (151) - Date of registration
- (156) - Date of the renewal
- (181) - Expected expiration date of registration
- (186) - Renewal expiration date of registration
- (141) - Date of cancel of duration of the mark
- (210) - Serial number of application
- (220) - Date of filing of the application
- (230) - Date concerning exhibition
- (260) - Number of application, for which favorable decision of examination about registration has been taken (publication number)
- (310) - Number of the first application
- (320) - Date of filing of the first application
- (330) - Code, identifying national or regional Office where the first application was made
- (511) - International Classification of Goods and Services for the purposes of registration of trade marks and/or list of goods and/or services classified according thereto
- (531) - Description of figurative elements of Trade Marks according to the International Classification of the Figurative Elements of Marks
- (540) - Reproduction of Trade Mark
- (550) - Nature and kind of Trade Mark
- (580) - Date of recording of any kind changes in respect of applications or registrations
- (591) - Information concerning colors claimed
- (731) - Name and address of the applicant
- (732) - Name and address of the holder of the registration
- (740) - Name and address of the representative
- (750) - Address for correspondence
- (770) - Name and address of the previous applicant or holder in case of change in ownership
- (771) - Previous name and address of the applicant or holder in case of change in ownership
- (791) - Name and address of the licensee
- (793) - Indication of conditions and/or restrictions under the license (Type of license, number of license agreement, data of license, data of validity of license)
- (800) - Certain data relating to the international registration of Trade Marks under the Protocol Relating to Madrid Agreement (International registration number)

CODES FOR PUBLICATION IN BULLETIN

- (21) AP 0000 000000 - serial number of application for invention
- (10) AP 0000 0000 A - number of published application for invention (first publication)
- (11) P 0000 0000 B - number of patent for invention (second publication)
- (21) API 0000 000000 - number of application for imported patent
- (11) PI 0000 0000 A - number of imported patent (first publication)
- (21) AU 0000 000000 - serial number of application for utility model
- (10) AU 0000 000 U - number of published application for utility model (first publication)
- (11) U 0000 000 Y - number of patent for utility model (second publication)
- (21) AD 0000 000000 - serial number of application for design
- (10) AD 0000 000 S - number of published application for design (first publication)
- (11) D 0000 000 S - number of patent for design (second publication)

INTERNATIONAL PATENT CLASSIFICATION FOR INVENTIONS AND UTILITY MODELS

- SECTION A - HUMAN NECESSITIES
- SECTION B - PERFORMING OPERATIONS; TRANSPORTING
- SECTION C - CHEMISTRY; METALLURGY
- SECTION D - TEXTILES; PAPER
- SECTION E - FIXED CONSTRUCTIONS
- SECTION F - MECHANICAL ENGINEERING; LIGHTING; HEATING; WEAPONS; BLASTING
- SECTION G - PHYSICS
- SECTION H - ELECTRICITY

-
- M - Trade Mark
 - (210) AM 0000 000000 - Serial number of application;
 - (260) AAM 0000 00000 A - Publication number of application;
 - (111) M 0000 00000 R - Number of registration;
 - (111) MMM0000 00000 Rn - Number of renewals, in which n=1,2,3;
 - (111) M 0000 00000 R(P) - Number of registration under partial assignment of rights
-

**OFFICIAL BULLETIN
OF THE INDUSTRIAL PROPERTY**

17(525)

**INVENTIONS
DESIGNS
TRADEMARKS**

DATE OF PUBLICATION: 2019 08 12

CONTENTS

PUBLISHED TITLES OF PROTECTION	3
INVENTIONS	
▪ APPLICATIONS APPROVED FOR GRANTING PATENTS	4
DESIGNS	
▪ APPLICATION APPROVED FOR REGISTRATION	5
▪ DESIGNS, WHICH HAVE BEEN REGISTERED WITH THE INTERNATIONAL BUREAU CLAIMING PRIORITY ON THE TERRITORY OF GEORGIA	11
TRADEMARKS	
▪ APPLICATIONS FILED UNDER THE NATIONAL PROCEDURE APPROVED FOR REGISTRATION	27
▪ REGISTERED TRADEMARKS	37
▪ TRADEMARKS REGISTERED ACCORDING TO THE ACCELERATED PROCEDURE	42
▪ INTERNATIONAL TRADEMARKS FOR WHICH A DECISION ON GRANTING PROTECTION IS TAKEN	45
▪ INTERNATIONAL TRADEMARKS PROTECTED IN GEORGIA	160
OFFICIAL NOTIFICATIONS	
INVENTIONS	
▪ RENEWAL OF PATENTS	167
▪ ABOLITION OF PATENTS WITH THE RIGHT TO RESTORE	167
▪ EXPIRATION OF TERM OF RESTORATION OF PATENTS	170
UTILITY MODELS	
▪ RENEWAL OF PATENT	174
▪ ABOLITION OF PATENT WITH THE RIGHT TO RESTORE	174
▪ EXPIRATION OF TERM OF RESTORATION OF PATENTS	175
DESIGNS	
▪ CHANGES OF NAMES AND/OR ADDRESSES OF OWNERS	175
TRADEMARKS	
▪ RENEWAL OF REGISTRATIONS	176
▪ COMPLETE TRANSFER OF RIGHTS	178
▪ CHANGES OF NAMES AND/OR ADDRESSES OF OWNERS	179
▪ TERMINATION OF TRADEMARKS REGISTRATION	181
▪ CANCELLATION OF LISTED CLASSES OF REGISTERED TRADEMARKS ON THE BASIS OF VERDICT	185
▪ LICENSE AGREEMENTS	187
CLASSIFICATION INDEXES	
INVENTIONS	188
DESIGNS	188
TRADEMARKS	189

PUBLISHED TITLES OF PROTECTION

INVENTIONS

- **APPLICATIONS APPROVED FOR GRANTING PATENT:**
14681; 14808

DESIGNS

- **APPLICATION APPROVED FOR REGISTRATION:**
1086
- **DESIGNS WHICH HAVE BEEN REGISTERED WITH THE INTERNATIONAL BUREAU CLAIMING PRIORITY ON THE TERRITORY OF GEORGIA:**
201765; 200542; 200545; 201652; 103136; 201700

TRADEMARKS

- **APPLICATIONS FILED UNDER THE NATIONAL PROCEDURE APPROVED FOR REGISTRATION:**
94699; 98757; 99773; 100024, 100025; 100918; 101217; 101236; 101295; 101378; 101399, 101400; 101415, 101416; 101496; 101499-101505; 101508; 101514; 101519-101522; 11612; 101614, 101615; 101617; 101619, 101620; 101629, 101630; 101632; 101636-101640; 101643; 101645, 101646; 101657; 101677; 101687, 101688; 101906, 101907; 101916, 101917; 101920; 101929; 102025
- **REGISTERED TRADEMARKS:**
31637; 31648-31693
- **TRADEMARKS REGISTERED ACCORDING TO THE ACCELERATED PROCEDURE:**
31636; 31638-31647
- **INTERNATIONAL TRADEMARKS FOR WHICH A DECISION ON GRANTING PROTECTIONS IS TAKEN:**
96491*; 99733; 100259, 100260; 100262; 100266; 100270; 100282; 100288; 100290; 100295; 100300; 100306; 100308; 100310-100315; 100317-100331; 100334; 100341; 100473; 100476, 100477; 100480, 100481; 100483; 100485; 100487-100493; 100506; 100514-100516; 100519-100523; 100525-100532; 100534; 100537, 100538; 100547, 100548; 100550-100554; 100564; 100569; 100632, 100633; 100636--100643; 100645; 100647, 100648; 100653-100655; 100657; 100659, 100660; 100709; 100713; 100720; 100727, 100728; 100730; 100732, 100733; 100739; 100743-100748; 100750; 100752-100754; 100756; 100758; 100830; 100833-100836; 100838-100840; 100847; 100946, 100947; 100951; 100956; 100967-100971; 100973-100976; 101043; 101060; 101066-101070; 101105; 101114-101120; 101148; 101150-101152, 101153; 101155, 101156; 101268, 101269; 101309; 101311-101318; 101339-101341; 101343-101347; 101473; 101479
- **INTERNATIONAL TRADEMARKS PROTECTED IN GEORGIA:**
75173; 75288; 75326; 76851; 80062; 82961; 85248; 94954; 95102, 95103; 95464; 95511; 97613; 97738, 98039; 98051; 98070; 98091; 98263; 98322; 98326, 98327; 98359; 98364; 98460; 98462; 98474; 98481; 98495; 98497, 98498; 98501; 98505, 98506; 98523; 98539; 98627; 98706; 98733; 98811; 98814; 98816; 98820; 98858-98869; 98871-98875; 98933; 98938; 98954-98956; 98960; 99002-99004; 99008; 99010; 99012; 99016, 99017; 99019; 99045; 99118; 99141-99144; 99146, 99147; 99250-99252; 99257; 99552; 99566; 99567

INVENTIONS

APPLICATIONS APPROVED FOR GRANTING PATENTS

The decision can be appealed at the Chamber of Appeal of Sakpatenti within 3 months from the publication or at the Mtskheta District Court Administrative Cases Board (Address: №17, Samkhedro str., Mtskheta), within 1 month following the publication.

PART A

A 61

- (10) AP 2019 14681 A (51) Int. Cl. (2006)
A 61 K 31/4355
A 61 K 321/381
A 61 K 31/437
A 61 P 35/00
C 07 D 403/12
C 07 D 405/04
C 07 D 209/12
C 07 D 495/04
C 07 D 405/12
C 07 D 409/12
C 07 D 471/04
C 07 D 487/04
C 07 D 491/04
C 07 D 333/56
C 07 D 307/81
C 07 D 307/80

- (21) AP 2016 14681 (22) 2016 06 22
(31) 1555750
(32) 2015 06 23
(33) FR
(71) LES LABORATOIRES SERVIER (FR)
35 rue de Verdun 92284 Suresnes (FR);
VERNALIS (R&D) LIMITED (GB)
100 Berkshire Place Wharfedale Road
Berkshire Winnersh, Berkshire
RG41 5RD (GB)
(72) PROSZENYÁK, Ágnes (HU);
MURRAY, James Brooke (GB);
SIPOS, Szabolcs (HU);
KOTSCHY, András (HU);
ONDI, Levente (HU);
BÁLINT, Balázs (HU);
DAVIDSON, James Edward Paul (GB);
CSÉKEI, Márton (HU);
SZLÁVIK, Zoltán (HU);
CHEN, I-Jen (GB);
SZABÓ, Zoltán (HU);
GENESTE, Olivier (FR);
CHANRION, Maïa (FR)
(74) Tamaz Shilakadze
(85) 2018 01 18
(86) PCT/EP2016/064418, 2016 06 22

(54) NEW BICYCLIC DERIVATIVES, A PROCESS FOR THEIR PREPARATION AND PHARMACEUTICAL COMPOSITIONS CONTAINING THEM

(57) An invention relates to compounds of formula (I),

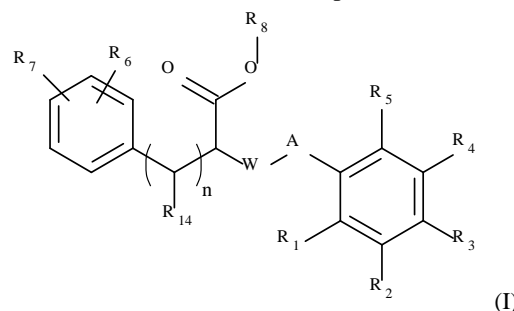

preparation method thereof, and pharmaceutical compositions containing them, and usage therefor cancer and immune system treatment, as well.

Claims: 17 independent
31 dependent

PART C

C 12

- (10) AP 2019 14808 A (51) Int. Cl. (2006)
C 12 G 1/00
C 12 N 1/16
(21) AP 2018 14808 (22) 2018 06 13
(71) Teimuraz Ortoidze (GE)
Tabukashvili St. 47, 0108, Tbilisi (GE);
Elene Salia (GE)
Davit Aghmashebeli Av. 147, 0112,
Tbilisi (GE)
(72) Teimuraz Ortoidze (GE);
Elene Salia (GE)
(54) **GEORGIAN WINE YEAST**
(57) There is represented Georgian wine yeast new strain *Saccharomyces cerevisiae* (vini) GE 02 deposited in Microbial Strain Collection of Latvia, under the No. P-1549, and useable in both: natural and dry forms for European table white wines production.
Claims: 1 independent

DESIGN

APPLICATION APPROVED FOR REGISTRATION

The decision can be appealed at the Chamber of Appeal of Sakpatenti within 3 months from the publication or at the Mtskheta District Court Administrative Cases Board (Address: №17, Samkhedro str., Mtskheta), within 1 month following the publication.

(10) AD 2019 1086 S (51) 11-01
(21) AD 2019 1086 (22) 2019 04 16
(28) 22
(71) LTD "ZARAPKHANA" (GE)
Lublana St. 15, 0159, Tbilisi, Georgia (GE)
(72) Nana Gogichaishvili (GE)
(54) 1.-22. Jewellery
(55)





3.1



3.2

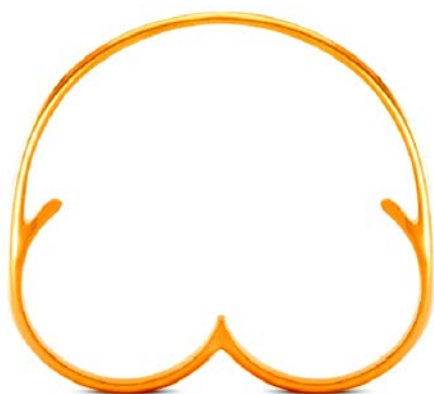

4.1



4.2



5.1



6.1





7.1



7.2



8.1



9.1





10.1



11.1



12.1



13.1



14.1



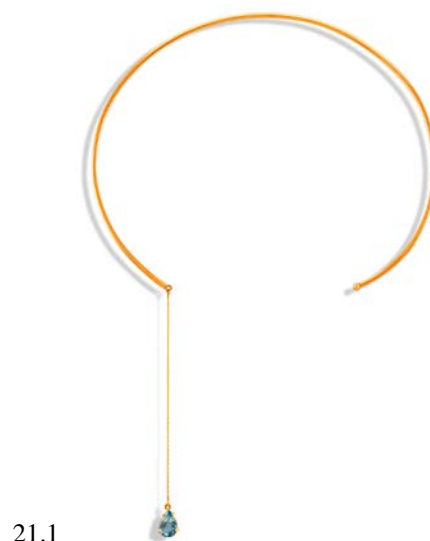

DESIGNS, WHICH HAVE BEEN REGISTERED WITH THE INTERNATIONAL BUREAU CLAIMING PRIORITY ON THE TERRITORY OF GEORGIA

The decision can be appealed at the Chamber of Appeal of Sakpatenti within 3 months from the publication or at the Mtskheta District Court Administrative Cases Board (Address: №17, Samkhedro Str., Mtskheta), within 1 month following the publication.

- (11) DM/201 765 (51) 09-03
 (15) 2018 12 18 (44) 27/2019 (2019 07 05)
 (22) 2018 12 18
 (28) 1
 (73) Economic Society "HASAR"
 11 Altyn suv Str., Shor r/c, 744000 Ashgabat (TM)
 (85) TM
 (86) TM
 (87) TM
 (88) TM
 (89) TM
 (81) III. AM, UA, AZ, TM, TJ, DE, US, GE, TR, OM, PL, GB, SY, CH, RU
 (72) Serdar A. Poladov
 11 Altyn suv Str., Shor r/c, 744000 Ashgabat (TM)
 (74) Gennady G. Galifanov
 Patent attorney Of Turkmenistan, Box 4, Post Office 27, 744027 Ashgabat (TM)
 (54) 1. Box for confectionery
 (55)

1.1



1.2



1.3



1.4



1.5



1.6



1.7



(11) DM/200 542

(15) 2018 12 28

(22) 2018 12 28

(28) 4

(73) The Swatch Group Management Services AG (The Swatch Group Management Services SA)
 (The Swatch Group Management Services Ltd.)
 Seedorstadt 6, 2502 Biel/Bienne (CH)

(85) CH

(86) CH

(87) CH

(88) CH

(89) CH

(81) II. BZ, MA III. UA, AM, AL, AZ, ME, MD, MC, SG, MN, NO, BA, MK, TR, OM, GE, LI, KG, GB,
 TN, EM, CH

(72) 1, 3 Fabrice DUPORT

4, Avenue de la Gare, 2000 Neuchâtel (CH);

2. Maurus MOSER

Rue de l'Evole 27, 2000 Neuchâtel (CH);

4. Michel SAGARDOYBURU

c/o The Swatch Group Recherche et Développement SA (The Swatch Group Forschungs-und
 Entwicklungs AG) (The Swatch Group Research and Development Ltd)

Rue des Sors 3 , 2074 MARIN (CH)

(74) The Swatch Group AG (The Swatch Group SA) (The Swatch Group Ltd)

6, Faubourg du Lac, 2501 Bienne (CH)

(54) 1. Watch case with strap, 2. Watch case with strap, 3. Watch, 4. Watch dial

(55)

1.1**1.2****1.3**

1.4



2.1

2.2

2.3



2.4



3.1



3.2



3.3



3.4



3.5



3.6



3.7



4.1



4.2



(11) DM/200 440

(51) 10-04

(15) 2019 01 04

(44) 27/2019 (2019 07 05)

(22) 2019 01 04

(28) 1

(73) ADVENTIA PHARMA, S.L.

San Bernardo, 22, 1ª Planta, 35002 Las Palmas de Gran Canaria (ES)

(85) ES

(86) ES

(87) ES

(88) ES

(89) EM

(81) III. AM, IS, MD, TJ, BW, ST, MN, GH, TR, KH, TN, KR, JP, KP, CH, BN, UA, AL, AZ, TM, ME, MC, SG, NA, OA, RS, NO, BA, OM, GE, CA, MK, US, LI, KG, EM, SY, RW, RU, EG

(72) Andrés CABELLO REY

Calle Doctor Manuel Lezcano, 8, 35017 Las Palmas de Gran Canaria (ES)

(74) ABG Intellectual Property Law, S.L.

Avenida de Burgos, 16 D., 28036 Madrid (ES)

(54) 1. Measuring instrument

(55)

1.1

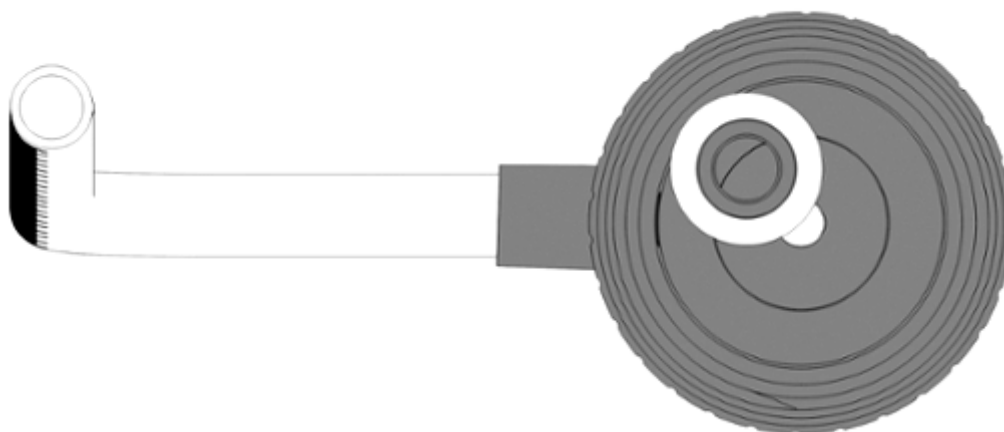

1.2

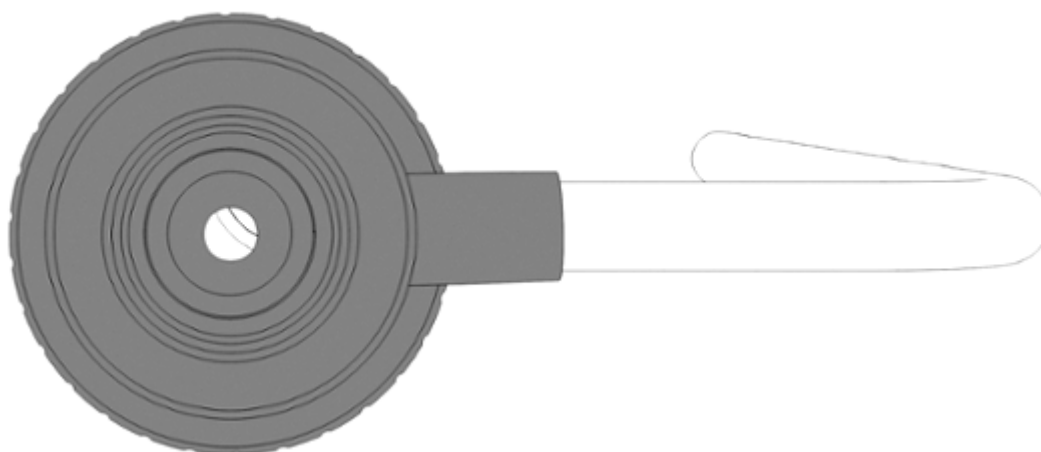

1.3



1.4



1.5



1.6



1.7



1.8

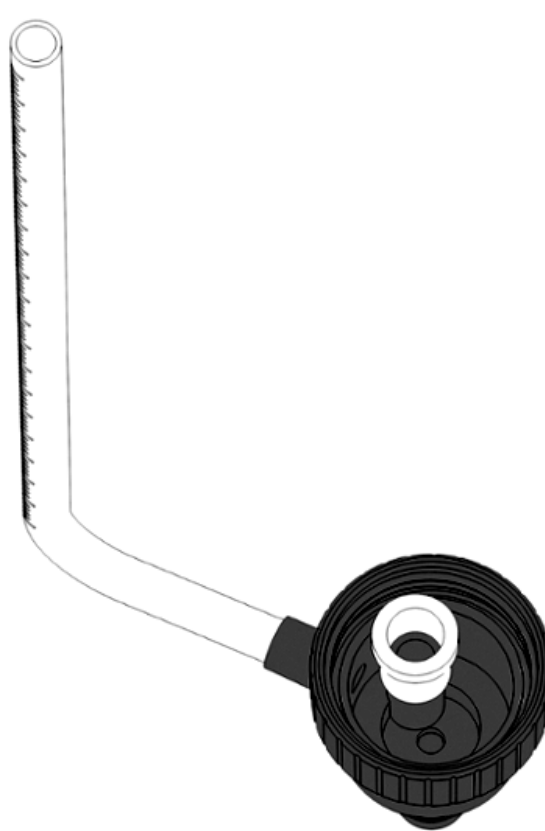

(11) DM/200 545

(51) 10-07

(15) 2018 12 28

(44) 27/2019 (2019 07 05)

(22) 2018 12 28

(28) 3

(73) HARRY WINSTON SA

Chemin du Tourbillon 8, 1228 Plan-Les-Ouates (CH)

(85) CH

(86) CH

(87) CH

(88) CH

(89) CH

(81) II. BZ, MA III. UA, AM, AL, AZ, ME, MD, MC, SG, MN, NO, BA, MK, TR, OM, GE, LI, KG, GB, TN, EM, CH

(72) Christophe LASSERRE

Rue François-Grast 12, 1208 Genève (CH)

(74) The Swatch Group AG (The Swatch Group SA) (The Swatch Group Ltd.)

Faubourg du Lac 6, 2501 BIEL/BIENNE (CH)

(54) 1. Dial,2. Watch case,3. Dial

(55)



1.1

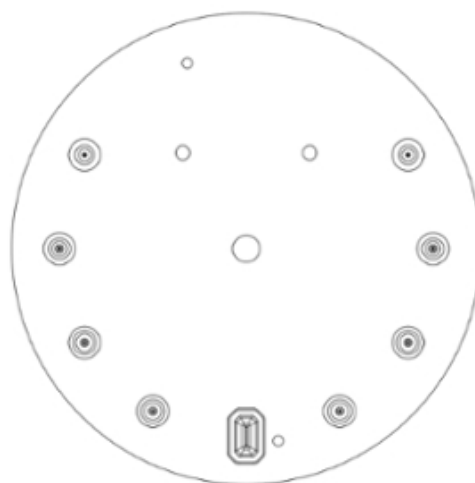

1.2



1.3



1.4

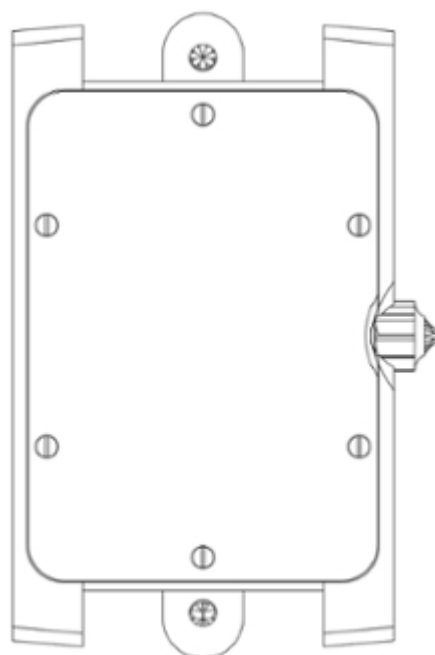
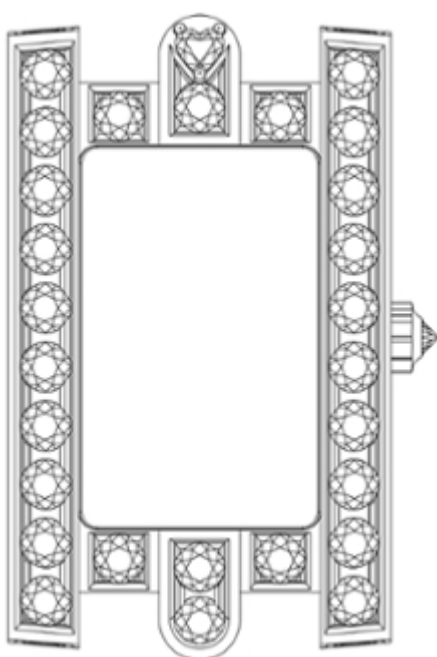
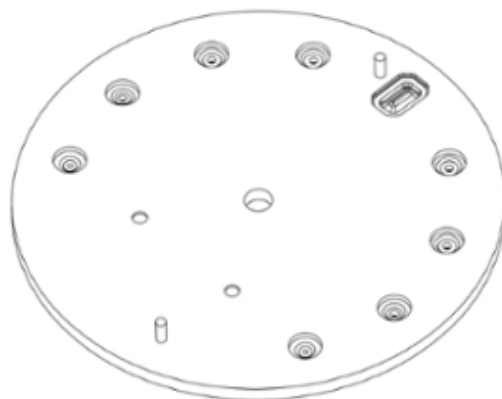

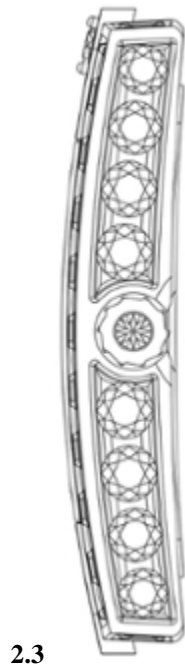

2.3

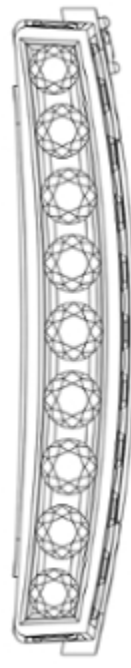

2.4

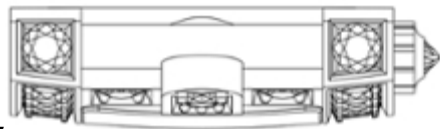

2.5



2.6

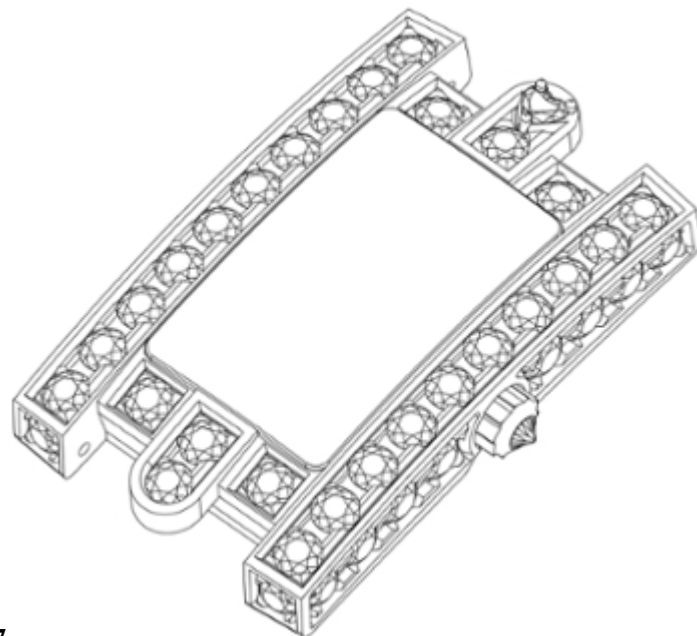

2.7

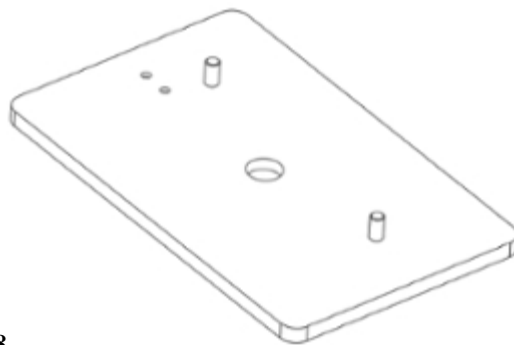
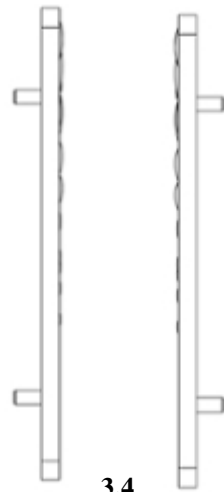
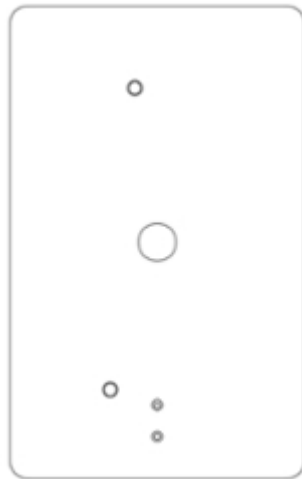
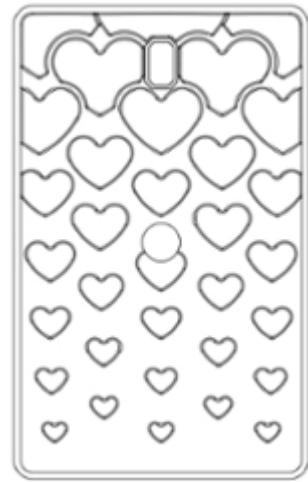
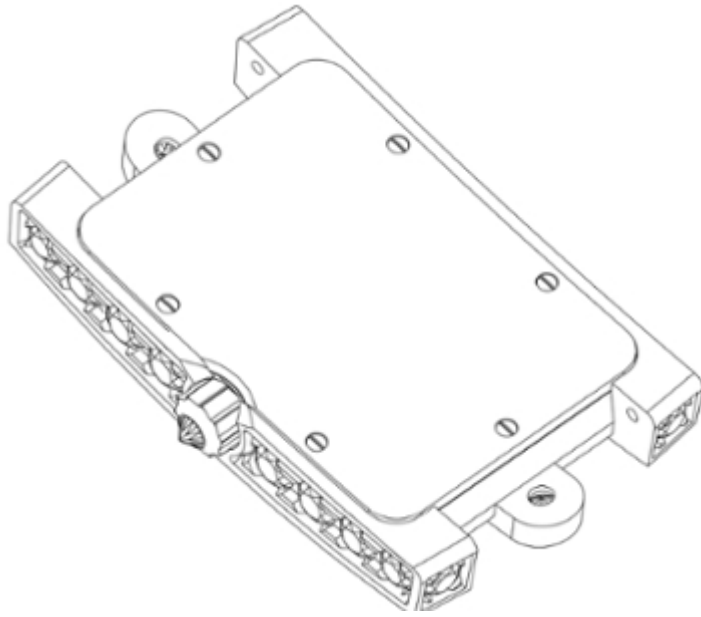

(11) DM/201 652

(51) 14-03

(15) 2018 11 08

(44) 27/2019 (2019 07 05)

(22) 2018 11 08

(28) 1

(73) FUVI COGNITIVE NETWORK CORP.

3 Speen Street, 01701 Framingham (US)

(85) US

(86) US

(87) US

(88) US

(89) US

(81) III. ES, HU, IS, MN, PL, GB, LT, KR, JP, BN, FR, AL, HR, LV, TM, MC, SG, NA, DE, BA, MK, LI, KG, RU, FI, EG, AM, MD, TJ, BW, GH, ST, TR, KH, TN, KP, CH, UA, AZ, ME, SI, OA, NO, RS, EE, OM, GE, CA, RO, EM, DK, SY, BG, RW

(72) Phu-Vinh NGUYEN

4 Green Lane, 01770 Sherborn (US)

(74) Natalya Dvorson

2100 Pennsylvania Avenue Suite 800, 20037-3213 Washington (US)

(54) 1. Smartphone

(55)

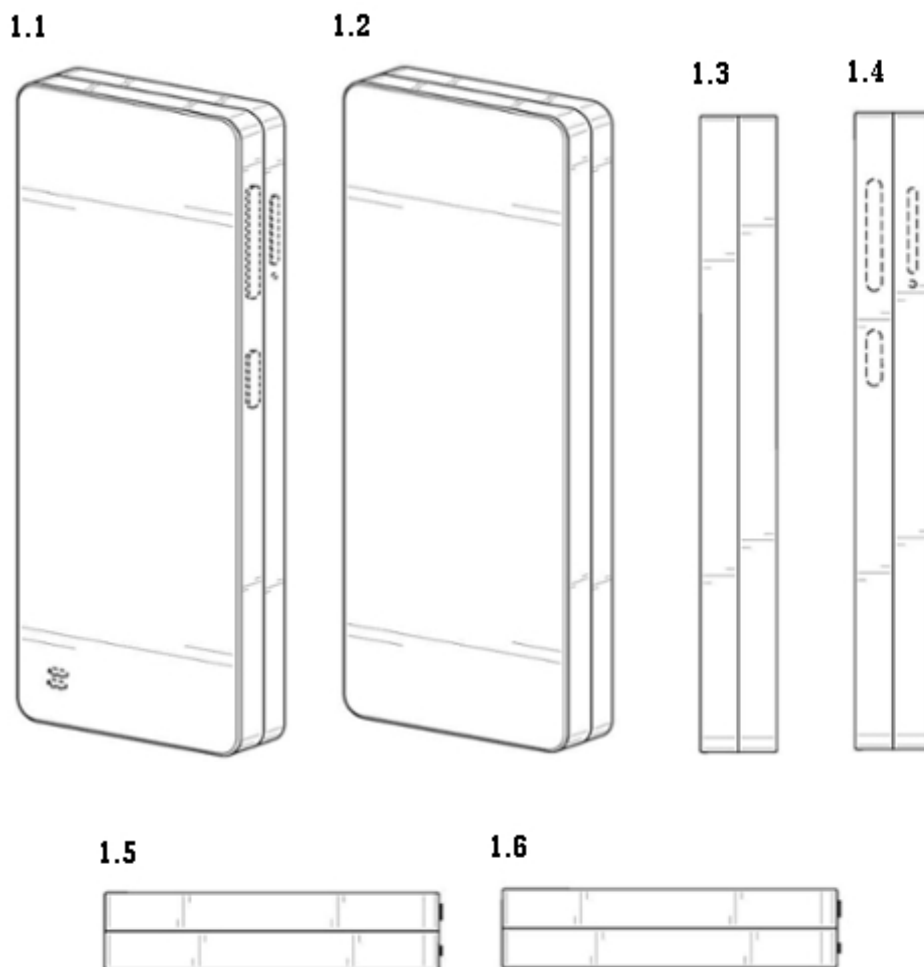

1.7

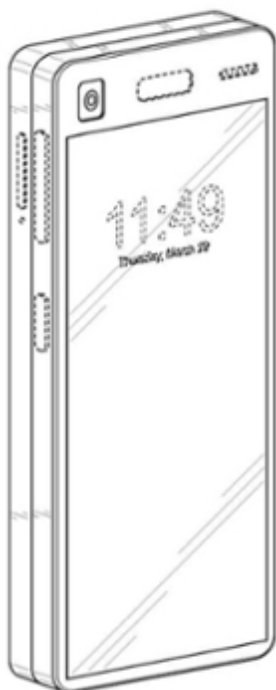

1.8



1.9

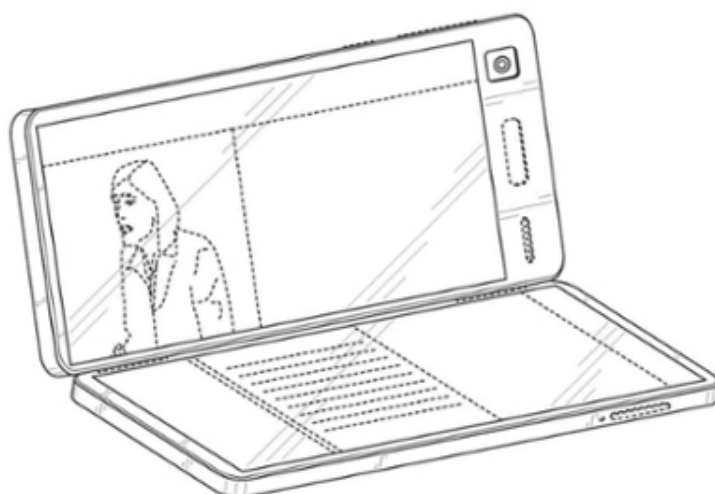

1.10

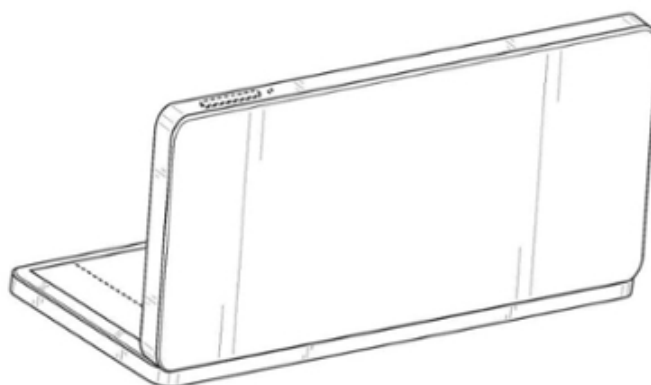

(11) DM/103 136

(15) 2018 07 02

(22) 2018 07 02

(28) 1

(73) BIODOM 27 d.o.o.

Hrplje 4A Kozina, SI-6240 (SI)

(85) SI, EM

(86) SI, EM

(87) SI, EM

(88) SI, EM

(89) SI

(81) III. RS, BA, TR, MK, GE, AM, AL, AZ, ME, EM, MD

(72) Jan Kavcic

Klanec pri Kozini 15, 6240 Kozina (SI)

(74) ZIVKO MIJATOVIC & PARTNERS d.o.o.

Ulica stare pravde, 10 Ljubljana, SI-1000 (SI)

(54) 1. Burner [heating]

(55)

(51) 23-03

(44) 27/2019 (2019 07 05)

1.1

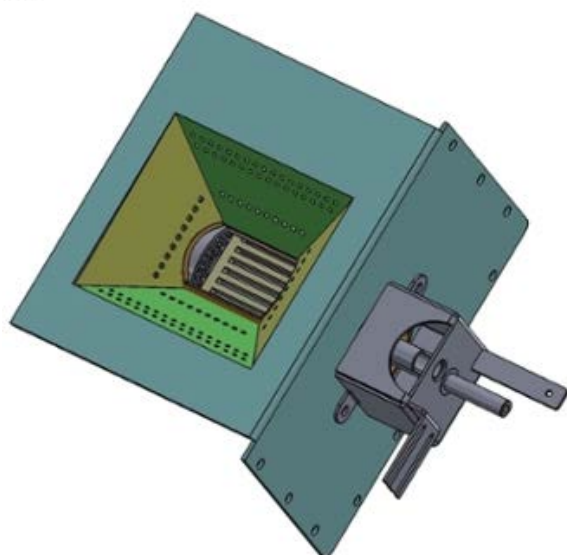

1.2

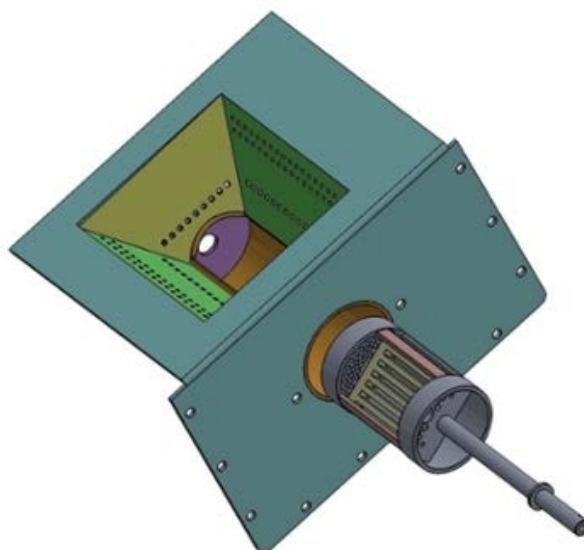

1.3

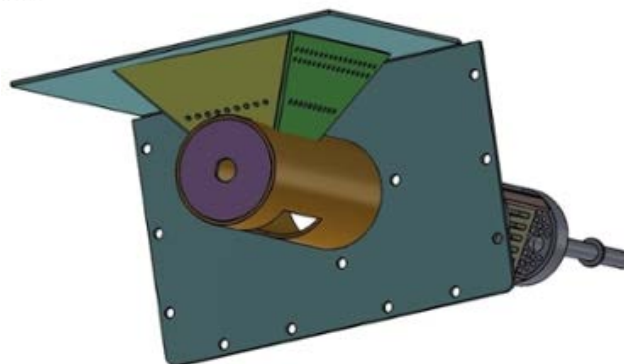

(11) DM/201 700

(15) 2018 05 02

(22) 2018 05 02

(28) 1

(30) No1: 02.11.2017; 29/624,638; US

(73) PREMIUM HOME COMFORT, INC.

2212 Walnut Street, First Floor, 19103 Philadelphia, PA (US)

(85) US

(86) US

(87) US

(88) US

(89) US

(81) III. ES, HU, IS, MN, PL, LT, KR, JP, FR, BN, AL, LV, HR, TM, MC, SG, NA, DE, BA, MK, LI, KG, FI, RU, EG, AM, MD, TJ, BW, GH, ST, TR, KH, TN, KP, CH, UA, AZ, ME, SI, OA, NO, RS, EE, GE, OM, RO, EM, DK, SY, BG, RW

(72) Kurt Michael Swanson

1199 S. 21st Street, 19146 Philadelphia (PA) (US);

Devin Sidell

304 Park Avenue, Apt. 3, 19081 Swarthmore (PA) (US)

(74) Randolph J. Huis

Volpe And Koenig, P.C., 19103 Philadelphia, PA (US)

(54) 1. Dehumidifier

(55)

(51) 23-04

(44) 27/2019 (2019 07 05)

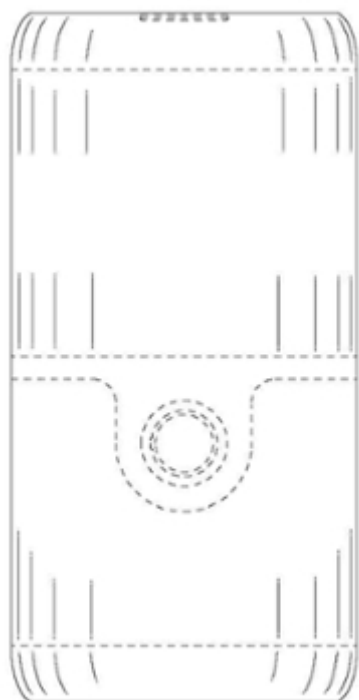
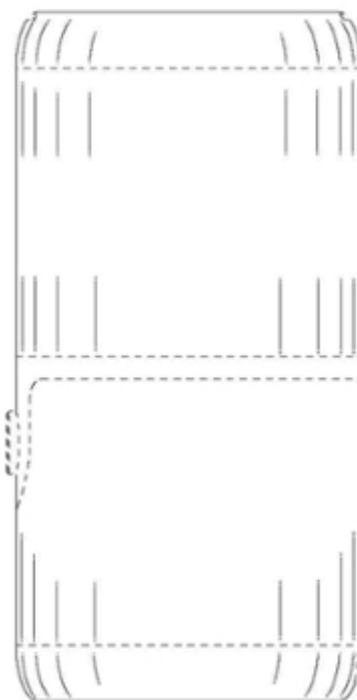
1.1**1.2****1.3**

1.4

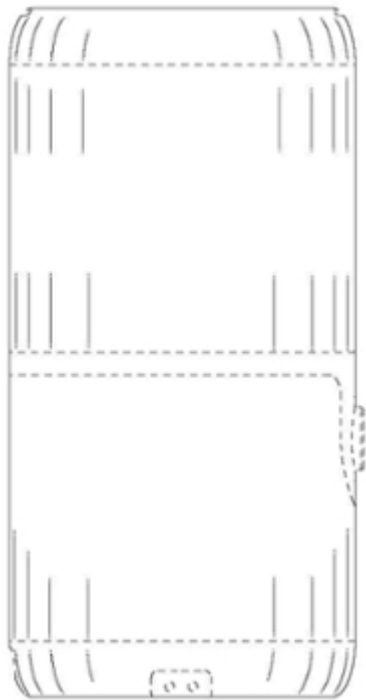

1.5

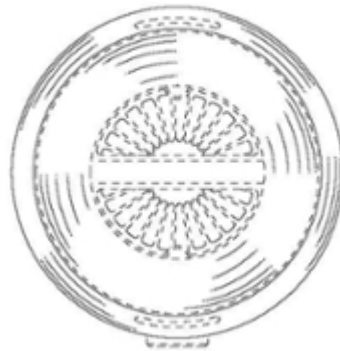

1.6



1.7

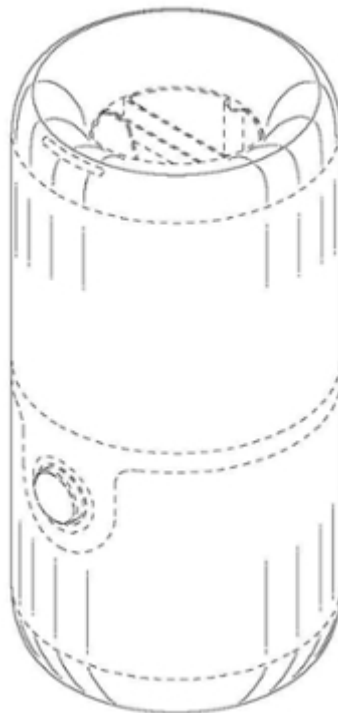

TRADEMARKS

APPLICATIONS FILED UNDER THE NATIONAL PROCEDURE APPROVED FOR REGISTRATION

The decision can be appealed at the Chamber of Appeal of Sakpatenti within 3 months from the publication or at the Mtskheta District Court Administrative Cases Board (Address: №17, Samkhedro St., Mtskheta), within 1 month following the publication.

(260) AM 2019 94699 A

(210) AM 94699

(220) 2017 10 18

(731) LTD "BERIKA"

I. Chavchavadze Av., I Lane 6, ap. 80, 0179,
Tbilisi Georgia

(540)



(591) White, red and black

(531) 26.11.03; 26.11.05; 27.05.01; 28.05; 28.19;
29.01.13

(511) 35

(260) AM 2019 98757 A

(210) AM 98757

(220) 2019 02 18

(731) LTD "INNOVATOR"

Marijan St. 2, 0186, Tbilisi, Georgia

(540)



(591) Black, white

(531) 26.13.25; 27.05.08

(511) 35, 38

(260) AM 2019 99773 A

(210) AM 99773

(220) 2018 10 09

(731) "სას გრუპ (SAS GROUP)"

Mashtots Av. 18, Yerevan, Armenia

(740) Artak Khachatryan

(540)

SAS FOOD COURT

(591) Black, white

(511) 29, 30, 32, 33, 34, 35, 39, 43

(260) AM 2019 100024 A

(210) AM 100024

(220) 2018 10 23

(731) LTD "SAIRME RESORT"

Hotel Sairme, Resort Sairme, Baghdati
Municipality, 1000, Georgia

(740) Giorgi Kartvelishvili

(540)



SAIRME
Hotels & Resorts

(591) Dark red, white

(531) 03.04.07; 03.04.14; 05.01.15; 27.05.01;
27.05.10; 29.01.01

(526) SAIRME

(511) 35, 43

(260) AM 2019 100025 A

(210) AM 100025

(220) 2018 10 23

(731) LTD "SAIRME RESORT"

Hotel Sairme, Resort Sairme, Baghdati
Municipality, 1000, Georgia

(740) Giorgi Kartvelishvili

(540)



სას
კურორტი

(591) Dark red, white
 (531) 03.04.07; 03.04.14; 28.19; 29.01.01; 29.01.12
 (526) საიბრე
 (511) 35, 43

(260) AM 2019 100918 A
 (210) AM 100918
 (220) 2019 01 04
 (731) EXTREME NETWORKS LIMITED
 22 Friars Street, Sudburi, Suffolk, CO10 2AA,
 United Kingdom
 (740) Shalva Gvaramadze
 (540)



(591) Black, white
 (531) 26.01.02; 26.01.18; 26.01.20
 (511) 41, 43

(260) AM 2019 101217 A
 (210) AM 101217
 (220) 2019 01 10
 (731) MUMUSOKR CO., LTD
 601, 47 Sejongdaero 23 Jil Jongro-gu,
 SEOUL, Republic of Korea
 (740) Vakhtang Torotadze
 (540)



(591) Black, white
 (531) 26.01.18; 27.01.06; 27.05.01; 27.05.10
 (511) 8, 14, 20, 24, 26, 29, 30, 32, 33

(260) AM 2019 101236 A
 (210) AM 101236
 (220) 2019 01 16
 (731) PHARMACIA & UPJOHN COMPANY LLC
 7000 Portage Road, Kalamazoo, Michigan
 49001, USA
 (740) Shalva Gvaramadze
 (540)



(591) Dark blue, white, sky-blue
 (531) 26.11.02; 26.11.12; 29.01.12
 (511) 5, 10, 44

(260) AM 2019 101295 A
 (210) AM 101295
 (220) 2019 01 22
 (731) LTD "DND GROUP"
 Kurkhuli St. 11, Tbilisi, Georgia
 (540)



გრაფიკა თბილისი
GRAPHICA TBILISI
 სანტუზერო / HOTEL

(591) Light green, dark green, light blue, dark blue
 (531) 26.03.03; 26.03.04; 26.04.02; 26.04.11;
 27.05.01; 27.05.10; 28.19; 29.01.12
 (526) თბილისი, Tbilisi
 (511) 43

(260) AM 2019 101378 A
 (210) AM 101378
 (220) 2019 01 28
 (731) AGRO LAIF SAIENS KORPOREISHEN
 1115, Me-11 Sartuli, Hemkunt Taueri (modi
 Taueri) 98, Nehru, Niu Deli, 110019, India
 (740) Lia Shalikhshvili
 (540)



(591) Green, yellow, red, white
 (531) 01.13.01; 01.13.15; 05.03.14; 26.01.06;
 26.01.16; 26.01.22; 26.01.24; 27.05.08;
 27.05.24; 29.01.13
 (511) 1, 5

(260) AM 2019 101399 A
 (210) AM 101399
 (220) 2019 01 29

- (731) COLGATE-PALMOLIVE COMPANY
a Delaware corporation
300 Park Avenue, New York, New York
10022, USA
(740) Natela Otariidze
(540)



- (591) Red, white, orange, gold, green, light blue,
sky-blue
(531) 17.01.01; 17.01.02; 26.01.01; 26.01.06;
26.01.17; 26.01.19; 27.05.02; 27.05.03;
27.05.10; 28.05; 29.01.15
(511) 3, 21

- (260) AM 2019 101400 A
(210) AM 101400
(220) 2019 01 29
(731) COLGATE-PALMOLIVE COMPANY
a Delaware corporation
300 Park Avenue, New York, New York
10022, USA
(740) Natela Otariidze
(540)



- (591) Red, white, orange, gold, green, light blue,
sky-blue
(531) 17.01.01; 17.01.02; 26.01.01; 26.01.06;
26.01.17; 26.01.19; 27.05.02; 27.05.03;
27.05.10; 28.05; 29.01.15
(511) 3, 21

- (260) AM 2019 101415 A
(210) AM 101415
(220) 2019 01 31
(731) THE PROCTER & GAMBLE COMPANY
One Procter & Gamble Plaza, Cincinnati,
Ohio 45202, USA
(740) Merab Kvimsadze
(540)

AMBI PUR

- (591) Black, white
(511) 3, 5, 11

- (260) AM 2019 101416 A
(210) AM 101416
(220) 2019 01 31
(731) VIVO MOBILE COMMUNICATION CO.,
LTD.
283, BBK Road, Wusha, Chang'An,
Dongguan, Guangdong, China
(740) Lilianna Darakhvelidze
(540)

iQOO

- (591) Black, white
(511) 9

- (260) AM 2019 101496 A
(210) AM 101496
(220) 2019 02 01
(731) Nino Javriidze
I. Petritsi St. 8, Tbilisi, Georgia
(540)



- (591) Black, silver
(531) 26.04.01; 26.04.02; 26.04.07; 26.04.18;
26.04.24; 27.05.02; 27.05.24
(511) 25, 35, 43

- (260) AM 2019 101499 A
(210) AM 101499
(220) 2019 02 03
(731) "VEYSELOGLU" Limited Liability Company
Baki Town, Nizami district, 2nd Street, cross
2, Baku, Azerbaijan
(740) Giorgi Kartvelishvili
(540)

GOOD LUCK
Гуд Лак

- (591) Black, white
(511) 3

- (260) AM 2019 101500 A
(210) AM 101500
(220) 2019 02 03
(731) "VEYSELOGLU" Limited Liability Company
Baki Town, Nizami district, 2nd Street, cross
2, Baku, Azerbaijan

(740) Giorgi Kartvelishvili
(540)

CAN BALA
Джан Бала

(591) Black, white
(511) 3, 5

(260) AM 2019 101501 A
(210) AM 101501
(220) 2019 02 03

(731) "VEYSELOGLU" Limited Liability Company
Baki Town, Nizami district, 2nd Street, cross
2, Baku, Azerbaijan

(740) Giorgi Kartvelishvili
(540)

SYMPHONY
Симфони

(591) Black, white
(511) 3

(260) AM 2019 101502 A
(210) AM 101502
(220) 2019 02 03

(731) "VEYSELOGLU" Limited Liability Company
Baki Town, Nizami district, 2nd Street, cross
2, Baku, Azerbaijan

(740) Giorgi Kartvelishvili
(540)

LUHANKA
Луганка

(591) Black, white
(511) 29, 35, 39

(260) AM 2019 101503 A
(210) AM 101503
(220) 2019 02 03

(731) "VEYSELOGLU" Limited Liability Company
Baki Town, Nizami district, 2nd Street, cross
2, Baku, Azerbaijan

(740) Giorgi Kartvelishvili
(540)

LYUBIMAYA
Любимая

(591) Black, white
(511) 35, 39

(260) AM 2019 101504 A
(210) AM 101504
(220) 2019 02 04

(731) CARGOTEK PATENTER AB
c/o Cargotec Sweden AB, Box 1133, 16422
KISTA, Sweden

(740) Giorgi Kartvelishvili
(540)



(591) Black, white
(531) 03.02.01; 03.02.15; 26.04.01; 26.04.15;
27.05.17
(511) 7, 12, 37

(260) AM 2019 101505 A
(210) AM 101505
(220) 2019 02 04

(731) LTD "Shuamta-2"
Varketili III Mass., Kvart. VIII, Bl. 6, 0182,
Tbilisi, Georgia

(540)

სასტუმრო პიანო

(591) Black, white
(511) 43

(260) AM 2019 101508 A
(210) AM 101508
(220) 2019 02 04

(731) "VEYSELOGLU" Limited Liability Company
Baki Town, Nizami district, 2nd Street, cross
2, Baku, Azerbaijan

(740) Giorgi Kartvelishvili
(540)

BUTTERGOLD

(591) Black, white
(511) 29, 35, 39

(260) AM 2019 101514 A
(210) AM 101514
(220) 2019 02 05

(731) LTD "Georgian Hydro Power"
Vazha-Pshavela Av. 41, Fl. 3, (Room 4, 5, 6),
0177, Tbilisi, Georgia

(740) Rusudan Gogashvili
(540)



(591) Blue, red
(531) 27.05.01; 27.05.15; 27.05.22; 29.01.12
(511) 42

(260) AM 2019 101519 A
(210) AM 101519
(220) 2019 02 06

(731) LTD "Georgian Alliance"
Giorgi Nadareishvili st. 9, 0120, Tbilisi,
Georgia

(540)



(591) White, pink, black, blue, violet, gray
(531) 04.02.20; 04.05.05; 04.05.15; 27.03.02;
27.03.03; 27.05.02; 29.01.14
(511) 30

(260) AM 2019 101520 A

(210) AM 101520

(220) 2019 02 06

(731) LTD "Georgian Alliance"
Giorgi Nadareishvili St. 9, 0120, Tbilisi,
Georgia

(540)



BIG FRUIT

(554) Three-dimensional
(591) Yellow, green, red, white, black
(531) 04.05.01; 04.05.03; 04.05.05; 08.01.23;
08.01.24; 29.01.15
(511) 30

(260) AM 2019 101521 A

(210) AM 101521

(220) 2019 02 06

(731) Giorgi Bregadze
V. Gorgasali St. 37, ap. 157, Tbilisi,
Georgia

(540)

BIOGRAPHY ®

(591) Black, green
(531) 26.01.18; 27.05.01; 27.05.21; 29.01.12
(511) 33

(260) AM 2019 101522 A

(210) AM 101522

(220) 2019 02 07

(731) BANQUET FOODS INTERNATIONAL FZE
P.O. Box: 327391, Ras Al Khaimah, United
Arab Emirates

(740) Merab Kvimsadze

(540)

Chicking
it's my choice

(591) Black, white
(531) 27.05.01; 27.05.10
(511) 43

(260) AM 2019 101612 A

(210) AM 101612

(220) 2019 02 11

(731) JSC "Georgian Beer Company"
Village Saguramo, 3311, Mtskheta, Georgia

(540)

ბორა-ბორა
Бора-бора
Bora-bora

(591) Black, white
(511) 32, 35

(260) AM 2019 101614 A

(210) AM 101614

(220) 2019 02 11

(731) JSC "DEGUSTO INTERNATIONAL"
Bakhtioni St. 11, ap. 22, Saburtalo district,
0194, Tbilisi, Georgia

(540)



(591) Black, yellow, green
(531) 05.07.11; 05.07.12; 26.04.04; 28.19; 29.01.13
(511) 43

(260) AM 2019 101615 A

(210) AM 101615

(220) 2019 02 11

(731) JSC "DEGUSTO INTERNATIONAL"
Bakhtioni St. 11, ap. 22, Saburtalo district,
0194, Tbilisi, Georgia

(540)



(591) Black, yellow, green
(531) 05.07.11; 05.07.12; 26.04.04; 27.05.01;
27.05.24; 29.01.13
(511) 43

(260) AM 2019 101617 A
 (210) AM 101617
 (220) 2019 02 11
 (731) LTD "GLOBAL TSBS"
 Stanislavskiy St. 5, 0119,
 Tbilisi, Georgia

(540)

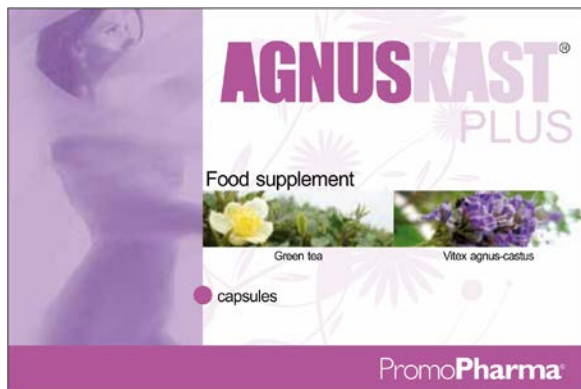

(591) White, purple, pink, yellow, green
 (531) 02.03.15; 05.05.01; 05.05.22; 05.05.23;
 25.01.01; 25.01.18; 27.05.01; 27.05.10;
 29.01.15
 (511) 5

(260) AM 2019 101619 A
 (210) AM 101619
 (220) 2019 02 11
 (731) LTD "GLOBAL TSBS"
 Stanislavskiy St. 5, 0119,
 Tbilisi, Georgia

(540)



(591) Black, white, grey, sky-blue
 (531) 05.11.11; 26.04.12; 26.11.09; 26.11.11;
 27.05.10; 29.01.13
 (511) 5

(260) AM 2019 101620 A
 (210) AM 101620
 (220) 2019 02 11
 (731) LTD "GLOBAL TSBS"
 Stanislavskiy St. 5, 0119, Tbilisi,
 Georgia

(540)



(591) White, red, pink, black
 (531) 25.01.01; 26.01.05; 26.13.25; 27.05.10;
 29.01.13
 (511) 5

(260) AM 2019 101629 A
 (210) AM 101629
 (220) 2019 02 12
 (731) LTD "ORNADO MEDICINE ორნადო
 მედიცინა"
 Village Irganchai, 1707, Dmanisi District,
 Georgia

(740) Natalia Kapanadze

(540)

**ORNAFER
 ОРНАФЕР
 ორნაფერო**

(591) Black, white
 (511) 5

(260) AM 2019 101630 A
 (210) AM 101630
 (220) 2019 02 12
 (731) LTD "NOVATOR PHARMA"
 Village Irganchai, 1707, Dmanisi District,
 Georgia

(740) Natalia Kapanadze

(540)

**KLESTON
 КЛЕСТОН
 კლესტონი**

(591) Black, white
 (511) 5

(260) AM 2019 101632 A
 (210) AM 101632
 (220) 2019 02 12
 (731) LTD "NOVATOR PHARMA"
 Village Irganchai, 1707, Dmanisi District,
 Georgia
 (740) Natalia Kapanadze
 (540)

BROCSEVIN
БРОКСЕВИН
ბროქსეპილი

(591) Black, white
 (511) 5

(260) AM 2019 101636 A
 (210) AM 101636
 (220) 2019 02 12
 (731) LTD "NOVATOR PHARMA"
 Village Irganchai, 1707, Dmanisi District,
 Georgia
 (740) Natalia Kapanadze
 (540)

NOVACHOLIN
НОВАХОЛИН
ნოვაქოლინი

(591) Black, white
 (511) 5

(260) AM 2019 101637 A
 (210) AM 101637
 (220) 2019 02 12
 (731) LTD "NOVATOR PHARMA"
 Village Irganchai, 1707, Dmanisi District,
 Georgia
 (740) Natalia Kapanadze
 (540)

SAKOLIN
САКОЛИН
საკოლინი

(591) Black, white
 (511) 5

(260) AM 2019 101638 A
 (210) AM 101638
 (220) 2019 02 12
 (731) LTD "NOVATOR PHARMA"
 Village Irganchai, 1707, Dmanisi District,
 Georgia
 (740) Natalia Kapanadze

(540)

SAMBOVIN
САМБОВИН
სამბოვილი

(591) Black, white
 (511) 5

(260) AM 2019 101639 A
 (210) AM 101639
 (220) 2019 02 12
 (731) MARSA YAĞ SANAYİ VE TİCARET
 ANONİM ŞİRKETİ
 RAMAZANOĞLU MAH. MAHMUT
 BAYRAM CAD. - NO: 9 ŞEYHLİ 34758
 Pendik İstanbul, Turkey
 (740) Tamaz Shilakadze
 (540)

BUTTER
DREAMS

(591) Purple, sky-blue
 (531) 27.05.10; 29.01.04
 (511) 29, 30, 32

(260) AM 2019 101640 A
 (210) AM 101640
 (220) 2019 02 12
 (731) LTD "GLOBAL TSBS"
 Stanislavskiy St. 5, 0119, Tbilisi, Georgia
 (540)



(591) Blue, yellow, white, black
 (531) 25.05.02; 26.04.02; 26.04.22; 26.04.24;
 27.05.13; 27.07.24; 29.01.14
 (511) 5

(260) AM 2019 101643 A
 (210) AM 101643
 (220) 2019 02 13
 (731) Getz Pharma International FZ LLC
 Office No.1307, 13th Floor, Al-Thuraya
 Tower 1, Dubai Media City, Dubai, United
 Arab Emirates

(740) Merab Kvimsadze
(540)

APIXA

(591) Black, white
(531) 27.05.01
(511) 5

(260) AM 2019 101645 A
(210) AM 101645
(220) 2019 02 13
(731) LTD "GLOBAL TSBS"
Stanislavskiy St. 5, 0119, Tbilisi,
Georgia

(540)



(591) Pink, ivory, white, yellow
(531) 01.15.15; 01.15.25; 25.01.25; 27.05.10;
27.05.24; 29.01.13
(511) 5

(260) AM 2019 101646 A
(210) AM 101646
(220) 2019 02 13
(731) Lado Kiziria
Michurin Av., Olympic Village, Bl. 16,
ap. 131, 119602, Moscow, Russian
Federation

(740) Shalva Gvaramadze
(540)

C.NEK

(591) Black, white
(511) 33

(260) AM 2019 101657 A
(210) AM 101657
(220) 2019 02 15
(731) VORSTAR INVESTMENT LTD
Niqozia, Egkomi 2413, Tiseos 4, 2413,
Cyprus
(740) Khatuna Imnadze

(540)



(591) Red, light purple, grey, blue, beige, white, black
(531) 02.01.23; 09.03.02; 09.03.04; 09.03.13;
09.03.26; 09.07.17; 09.07.25; 17.01.01;
29.01.14
(511) 41, 43

(260) AM 2019 101677 A
(210) AM 101677
(220) 2019 02 19
(731) LTD "MARANI"
Village Napareuli, 2211, Telavi, Georgia
(540)



WINERY

(591) Black, white
(531) 05.01.16; 19.09.02; 24.09.02; 24.09.09;
27.05.01; 27.05.21; 27.05.24
(511) 33

(260) AM 2019 101687 A
(210) AM 101687
(220) 2019 02 20
(731) BRITISH AMERICAN TOBACCO
(BRANDS) INC. (a Delaware corporation)
251 Little Falls Drive, Suite 100, Delaware,
Wilmington, 19808-1674, USA

(740) Tamar Kochlamazashvili
(540)



(591) Blue, dark blue, white
 (531) 26.04.24; 26.11.09; 27.05.24; 27.07.24;
 29.01.13
 (511) 34

(260) AM 2019 101688 A
 (210) AM 101688
 (220) 2019 02 20
 (731) BRITISH AMERICAN TOBACCO
 (BRANDS) INC. (a Delaware corporation)
 251 Little Falls Drive, Suite 100, Delaware,
 Wilmington, 19808-1674, USA
 (740) Tamar Kochlamazashvili
 (540)



(591) Blue, white
 (531) 26.11.09; 27.05.01; 27.05.10; 27.05.17;
 27.07.01; 27.07.17; 29.01.12
 (511) 34

(260) AM 2019 101906 A
 (210) AM 101906
 (220) 2019 02 25
 (731) LTD "ARTPHARMA"
 Gamrekeli str. 19, Office 30, 0160,
 Tbilisi, Georgia
 (740) George Taktakishvili
 (540)

Soliferol D3 Солиферол D3

(591) Black, white
 (511) 5

(260) AM 2019 101907 A
 (210) AM 101907
 (220) 2019 02 25
 (731) LTD "ARTPHARMA"
 Gamrekeli str. 19, Office 30, 0160,
 Tbilisi, Georgia
 (740) George Taktakishvili
 (540)

Bevitum with magnesium

(591) Black, white
 (511) 5

(260) AM 2019 101916 A
 (210) AM 101916
 (220) 2019 02 27
 (731) TENG Ying WANG

Group 13, Hezhai Village, Niansanli Street,
 Yiwu, Zhejiang, China
 (740) Giorgi Kartvelishvili
 (540)



(591) Black, white
 (531) 15.07.01; 15.07.02; 15.07.03; 15.07.19;
 26.11.02; 26.11.06; 26.11.13; 27.05.17
 (511) 25

(260) AM 2019 101917 A
 (210) AM 101917
 (220) 2019 02 27
 (731) FREZYDERM S.A.
 75, Menandrou street, GR 104-37, Athens,
 Greece
 (740) Tamaz Shilakadze
 (540)



(591) Black, white
 (531) 26.01.18; 26.02.07; 26.02.08; 27.05.10;
 27.05.11; 27.05.21
 (511) 3

(260) AM 2019 101920 A
 (210) AM 101920
 (220) 2019 02 27
 (731) GRAND CANDY LLC
 31 May St., 0061, Yerevan, Armenia
 (740) George Taktakishvili
 (540)

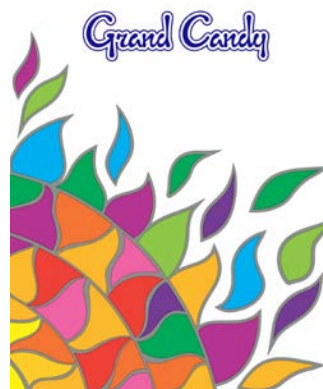

(591) White, yellow, red, blue, green, orange,
crimson, purple, lilac, gold
(531) 01.15.05; 05.03.13; 26.01.05; 26.01.12;
27.05.02; 29.01.15
(511) 16, 20, 30

(260) AM 2019 101929 A
(210) AM 101929
(220) 2019 02 28
(731) LTD "Miss & Mister GOLDEN BRAND"
Dighmis mas., V kvart., Bl. 24, ap. 60,
Tbilisi, Georgia
(540)



(591) Black, yellow
(531) 24.09.01; 27.05.09; 27.05.10; 27.05.24;
29.01.12
(511) 41

(260) AM 2019 102025 A
(210) AM 102025
(220) 2019 03 01
(731) DEEPTI GYANENDRA RAJ MEHTA
Bapna Flats, Hira Bagh Sawai Ram Singh
Road, Jaipur-rajasthan, India
(740) Tamaz Shilakadze
(540)

REWIND

(591) Black, white
(511) 34

REGISTERED TRADEMARKS

<p>(111) M 2019 31637 R (151) 2019 08 21 (181) 2029 08 21 (260) AM 2018 96982 A (220) 2018 03 22 (732) LTD "IPC" K. Kekelidzis q.14, sartulisa da mansardis dasheneba 14b, dzveli Tbilisis raioni, Tbilisi, Georgia</p>	<p>Palm Grove House, P.O. Box 438, Road Town, Tortola, Virgin Islands (British)</p>
<p>(111) M 2019 31648 R (151) 2019 09 03 (181) 2029 09 03 (260) AM 2019 103188 A (220) 2019 05 20 (732) ADP GAUSELMANN GMBH Merkur-Allee 1-15, Espelkamp, 32339, Germany</p>	<p>(111) M 2019 31653 R (151) 2019 09 03 (181) 2029 09 03 (260) AM 2018 98174 A (220) 2018 06 20 (732) MARIELLE GLOBAL LIMITED Palm Grove House, P.O. Box 438, Road Town, Tortola, Virgin Islands (British)</p>
<p>(111) M 2019 31649 R (151) 2019 09 03 (181) 2029 09 03 (260) AM 2018 97805 A (220) 2018 05 23 (732) Pride FC Worldwide Holdings LLC 6650 South Torrey Pines Drive, Las Vegas, Nevada 89118, USA</p>	<p>(111) M 2019 31654 R (151) 2019 09 03 (181) 2029 09 03 (260) AM 2018 98192 A (220) 2018 06 22 (732) MARIELLE GLOBAL LIMITED Palm Grove House, PO Box 438, Road Town, Tortola, Virgin Islands (British)</p>
<p>(111) M 2019 31650 R (151) 2019 09 03 (181) 2029 09 03 (260) AM 2018 98010 A (220) 2018 06 13 (732) LTD "SENSO VITA PHARMACY" Beliashvilis q. 43, 0159, Tbilisi, Georgia</p>	<p>(111) M 2019 31655 R (151) 2019 09 03 (181) 2029 09 03 (260) AM 2018 98194 A (220) 2018 06 22 (732) MARIELLE GLOBAL LIMITED Palm Grove House, PO Box 438, Road Town, Tortola, Virgin Islands (British)</p>
<p>(111) M 2019 31651 R (151) 2019 09 03 (181) 2029 09 03 (260) AM 2018 98011 A (220) 2018 06 13 (732) LTD "SENSO VITA PHARMACY" Beliashvilis q. 43, 0159, Tbilisi, Georgia</p>	<p>(111) M 2019 31656 R (151) 2019 09 03 (181) 2029 09 03 (260) AM 2018 98584 A (220) 2018 07 20 (732) SANTA FARMA İLAÇ SANAYİİ ANONİM ŞİRKETİ Okmeydanı, Boru Çiçeği Sk. No.16 Kat:4, 34382 Şişli İstanbul, Turkey</p>
<p>(111) M 2019 31652 R (151) 2019 09 03 (181) 2029 09 03 (260) AM 2018 98173 A (220) 2018 06 20 (732) MARIELLE GLOBAL LIMITED</p>	<p>(111) M 2019 31657 R (151) 2019 09 03 (181) 2029 09 03 (260) AM 2018 98668 A (220) 2018 07 24 (732) Post ALIONI N. Dumbadze Str. 25, 4900, Chokhatauri, Georgia</p>

(111) M 2019 31658 R
(151) 2019 09 03
(181) 2029 09 03
(260) AM 2018 98756 A
(220) 2018 07 30
(732) Getz Pharma International FZ LLC
Office No.1307, 13th Floor, Al-Thuraya
Tower 1, Dubai Media City, Dubai, United
Arab Emirates

(111) M 2019 31659 R
(151) 2019 09 03
(181) 2029 09 03
(260) AM 2018 98777 A
(220) 2018 08 02
(732) LTD "PALATY"
D. Aghmasheneblis gamz. 22, b. 109, 4600,
Kutaisi, Georgia

(111) M 2019 31660 R
(151) 2019 09 03
(181) 2029 09 03
(260) AM 2018 99066 A
(220) 2018 08 22
(732) BRF S.A.
Rua Jorge Tzachel, 475, Itajai, Santa
Catarina, Brazil

(111) M 2019 31661 R
(151) 2019 09 03
(181) 2029 09 03
(260) AM 2018 99177 A
(220) 2018 08 31
(732) Enriko Beridze
T. Tabidze Str. 10, Deadlock I, Tbilisi, Georgia

(111) M 2019 31662 R
(151) 2019 09 03
(181) 2029 09 03
(260) AM 2018 99179 A
(220) 2018 09 03
(732) Milwaukee Electric Tool Corporation
13135, West Lisbon Road, Brookfield,
Wisconsin 53005, USA

(111) M 2019 31663 R
(151) 2019 09 03
(181) 2029 09 03
(260) AM 2018 99180 A
(220) 2018 09 03
(732) Techtronic Power Tools Technology Limited
Trident Chambers, P.O. Box 146, Road
Town, Tortola, Virgin Islands (British)

(111) M 2019 31664 R
(151) 2019 09 03
(181) 2029 09 03
(260) AM 2018 99181 A
(220) 2018 09 03
(732) Techtronic Power Tools Technology Limited
Trident Chambers, P.O. Box 146, Road
Town, Tortola, Virgin Islands (British)

(111) M 2019 31665 R
(151) 2019 09 03
(181) 2029 09 03
(260) AM 2018 99182 A
(220) 2018 09 03
(732) Techtronic Power Tools Technology Limited
Trident Chambers, P.O. Box 146, Road
Town, Tortola, Virgin Islands (British)

(111) M 2019 31666 R
(151) 2019 09 03
(181) 2029 09 03
(260) AM 2018 99190 A
(220) 2018 09 05
(732) MUSLIM WORLD LEAGUE
Umm Al-Joud, Makkah Al Mukarramah
21955, P.O. Box 537, Saudi Arabia;
MAKKAH AL-MUKARRAMAH HALAL CO.
LIMITED
Office of Walkers Corporate Limited, Cayman
Corporate Center, 27 Hospital Road, George Town,
Grand Cayman KY1-9008, Cayman Islands

(111) M 2019 31667 R
(151) 2019 09 03
(181) 2029 09 03
(260) AM 2018 99198 A
(220) 2018 09 06
(732) MONSTER ENERGY COMPANY
A Delaware corporation
1 Monster Way, Corona, California 92879,
USA

(111) M 2019 31668 R
(151) 2019 09 03
(181) 2029 09 03
(260) AM 2018 99300 A
(220) 2018 09 07
(732) HAIGH INDUSTRIES INC.
N5 - 8118 Nort Freizer Uei, Bernabi,
Britanetis Kolumbia, V5J 0E5, Canada

(111) M 2019 31669 R
(151) 2019 09 03
(181) 2029 09 03

(260) AM 2018 99301 A
 (220) 2018 09 07
 (732) HAIGH INDUSTRIES INC.
 N5 - 8118 Nort Freizer Uei, Bernabi,
 Britanetis Kolumbia, V5J 0E5, Canada

(260) AM 2018 99367 A
 (220) 2018 09 14
 (732) MOBILE OUTFITTERS LLC
 Suite 106, 3901B Main Street, Philadelphia,
 Pennsylvania 19127, USA

(111) M 2019 31670 R
 (151) 2019 09 03
 (181) 2029 09 03
 (260) AM 2018 99306 A
 (220) 2018 09 07
 (732) EXXON MOBIL CORPORATION
 5959 Las Colinas Boulevard, Irving, Texas
 75039-2298, USA

(111) M 2019 31676 R
 (151) 2019 09 03
 (181) 2029 09 03
 (260) AM 2018 99368 A
 (220) 2018 09 14
 (732) Sheraton International Ip LLC
 One StarPoint, Stamford, Connecticut
 06902, USA

(111) M 2019 31671 R
 (151) 2019 09 03
 (181) 2029 09 03
 (260) AM 2018 99310 A
 (220) 2018 09 10
 (732) HP Hewlett Packard Group LLC
 11445 Kompaq Senter Draiv Uesti, Houston,
 Texas, 77070, USA

(111) M 2019 31677 R
 (151) 2019 09 03
 (181) 2029 09 03
 (260) AM 2018 99426 A
 (220) 2018 09 14
 (732) Sheraton International Ip LLC
 One StarPoint, Stamford, Connecticut
 06902, USA

(111) M 2019 31672 R
 (151) 2019 09 03
 (181) 2029 09 03
 (260) AM 2018 99335 A
 (220) 2018 09 12
 (732) LTD "AVERSI-PHARMA"
 D. Aghmashenebeli Ave. 148/2, 0112,
 Tbilisi, Georgia

(111) M 2019 31678 R
 (151) 2019 09 03
 (181) 2029 09 03
 (260) AM 2018 99434 A
 (220) 2018 09 18
 (732) TOYOTA JIDOSHA KABUSHIKI KAISHA
 (also trading as Toyota Motor Corporation)
 1, Toyota-cho, Toyota-shi, Aichi-ken, Japan

(111) M 2019 31673 R
 (151) 2019 09 03
 (181) 2029 09 03
 (260) AM 2018 99349 A
 (220) 2018 09 12
 (732) LTD "AVERSI-PHARMA"
 D. Aghmashenebeli Ave. 148/2, 0112,
 Tbilisi, Georgia

(111) M 2019 31679 R
 (151) 2019 09 03
 (181) 2029 09 03
 (260) AM 2018 99460 A
 (220) 2018 09 20
 (732) Ltd "MATIANE"
 Moscow Ave., Build. 38, Ap. 113, Samgori
 District, 0137, Tbilisi, Georgia

(111) M 2019 31674 R
 (151) 2019 09 03
 (181) 2029 09 03
 (260) AM 2018 99365 A
 (220) 2018 09 14
 (732) Twentieth Century Fox Film Corporation
 10201 West Pico Boulevard, Los Angeles,
 California 90035, USA

(111) M 2019 31680 R
 (151) 2019 09 03
 (181) 2029 09 03
 (260) AM 2018 99645 A
 (220) 2018 09 28
 (732) PEPSICO INTERNATIONAL PTE. LTD.
 99 Bukit-Timah Road, Alfa Centre N05-01,
 2299835, Singapore

(111) M 2019 31675 R
 (151) 2019 09 03
 (181) 2029 09 03

(111) M 2019 31681 R
 (151) 2019 09 03
 (181) 2029 09 03

(260) AM 2018 99658 A
 (220) 2018 10 02
 (732) PHILIP MORRIS PRODUCTS S.A.
 Quai Jeanrenaud 3, 2000 Neuchâtel,
 Switzerland

(111) M 2019 31682 R
 (151) 2019 09 03
 (181) 2029 09 03
 (260) AM 2018 99678 A
 (220) 2018 10 04
 (732)) LTD "HOLOSEUM"
 L. Tabukashvili Str. 7, 0160, Tbilisi, Georgia

(111) M 2019 31683 R
 (151) 2019 09 03
 (181) 2029 09 03
 (260) AM 2018 99888 A
 (220) 2018 10 17
 (732) JSC "LOMISI"
 Vill. Natakhtari, 3308, Mtskheta, Georgia

(111) M 2019 31684 R
 (151) 2019 09 03
 (181) 2029 09 03
 (260) AM 2018 99936 A
 (220) 2018 10 19
 (732) LTD "AVERSI-PHARMA"
 D. Aghmashenebeli Ave. 148/2, 0112,
 Tbilisi, Georgia

(111) M 2019 31685 R
 (151) 2019 09 03
 (181) 2029 09 03
 (260) AM 2018 99937 A
 (220) 2018 10 19
 (732) LTD "AVERSI-PHARMA"
 D. Aghmashenebeli Ave. 148/2, 0112,
 Tbilisi, Georgia

(111) M 2019 31686 R
 (151) 2019 09 03
 (181) 2029 09 03
 (260) AM 2018 99990 A
 (220) 2018 10 23
 (732) LTD "AVERSI-PHARMA"
 D. Aghmashenebeli Ave. 148/2, 0112,
 Tbilisi, Georgia

(111) M 2019 31687 R
 (151) 2019 09 03
 (181) 2029 09 03
 (260) AM 2018 99992 A

(220) 2018 10 23
 (732) LTD "AVERSI-PHARMA"
 D. Aghmashenebeli Ave. 148/2, 0112,
 Tbilisi, Georgia

(111) M 2019 31688 R
 (151) 2019 09 03
 (181) 2029 09 03
 (260) AM 2018 99993 A
 (220) 2018 10 23
 (732) LTD "AVERSI-PHARMA"
 D. Aghmashenebeli Ave. 148/2, 0112,
 Tbilisi, Georgia

(111) M 2019 31689 R
 (151) 2019 09 03
 (181) 2029 09 03
 (260) AM 2018 99995 A
 (220) 2018 10 23
 (732) LTD "AVERSI-PHARMA"
 D. Aghmashenebeli Ave. 148/2, 0112,
 Tbilisi, Georgia

(111) M 2019 31690 R
 (151) 2019 09 03
 (181) 2029 09 03
 (260) AM 2018 99996 A
 (220) 2018 10 23
 (732) LTD "AVERSI-PHARMA"
 D. Aghmashenebeli Ave. 148/2, 0112,
 Tbilisi, Georgia

(111) M 2019 31691 R
 (151) 2019 09 03
 (181) 2029 09 03
 (260) AM 2018 99997 A
 (220) 2018 10 23
 (732) LTD "AVERSI-PHARMA"
 D. Aghmashenebeli Ave. 148/2, 0112,
 Tbilisi, Georgia

(111) M 2019 31692 R
 (151) 2019 09 03
 (181) 2029 09 03
 (260) AM 2018 99998 A
 (220) 2018 10 23
 (732) LTD "AVERSI-PHARMA"
 D. Aghmashenebeli Ave. 148/2, 0112,
 Tbilisi, Georgia

(111) M 2019 31693 R
 (151) 2019 09 03
 (181) 2029 09 03

(260) AM 2018 99999 A

(220) 2018 10 23

(732) LTD "AVERSI-PHARMA"

D. Aghmashenebeli Ave. 148/2, 0112,
Tbilisi, Georgia

TRADEMARKS REGISTERED ACCORDING TO THE ACCELERATED PROCEDURE

The decision can be appealed at the Chamber of Appeal of Sakpatenti within 3 months from the publication.

(111) M 2019 31636 R
(151) 2019 08 19
(181) 2029 08 19
(210) AM 104529
(220) 2019 08 09
(732) JSC TBC BANK
K. Marjanishvili St. 7, 0102, Tbilisi, Georgia
(740) Archil Gabatashvili
(540)

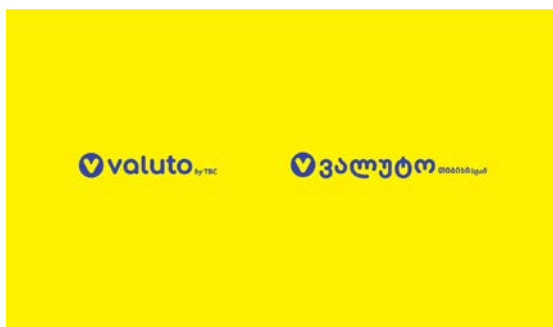

(591) Lilac, yellow
(531) 26.01.01; 26.01.18; 26.01.24; 27.05.01; 28.19;
29.01.12
(511) 36

(111) M 2019 31638 R
(151) 2019 08 22
(181) 2029 08 22
(210) AM 104439
(220) 2019 08 06
(732) Giorgi Dediashvili
Tabukashvili St. 5, Tbilisi, Georgia
(740) Pavle Meipariani;
Giorgi Meipariani
(540)



(591) Dark green, bronze, white
(531) 06.01.01; 06.01.04; 24.09.06; 24.09.09;
25.01.05; 26.02.07; 27.01.12; 28.05; 29.01.13
(511) 32

(111) M 2019 31639 R
(151) 2019 08 23
(181) 2029 08 23
(210) AM 104424
(220) 2019 08 05
(732) Ltd. "N Plus"
Qween Tamara Beach 42, 6200, Kobuleti,
Georgia
(540)



(591) Black, white, gray, blue, brown
(531) 01.15.24; 26.11.03; 26.11.13; 26.15.01; 28.05
(526) Кобулет
(511) 43

(111) M 2019 31640 R
(151) 2019 08 23
(181) 2029 08 23
(210) AM 104317
(220) 2019 07 31
(732) Aleksii Morchiladze
Chkondideli St. 22, 0180, Tbilisi, Georgia
(540)

space

(591) Black, white
(511) 32

(111) M 2019 31641 R
(151) 2019 08 26
(181) 2029 08 26
(210) AM 104459
(220) 2019 08 08
(732) GIORGIO ARMANI S.P.A.
Via Borgonuovo 11, I-20121 Milano, Italy
(740) Giorgi Taktakishvili

(540)



აბრამნი ექსტრინტ

(591) Black, white
 (531) 26.11.01; 26.11.07; 27.05.11; 28.19
 (511) 9, 14, 18, 25, 35

(111) M 2019 31642 R
 (151) 2019 08 26
 (181) 2029 08 26
 (210) AM 104556
 (220) 2019 08 20
 (732) Anzor Tetradze
 I. Petritsi St. 10, ap. 9, Tbilisi, Georgia
 (540)

bicholla

(591) Black, white
 (511) 25

(111) M 2019 31643 R
 (151) 2019 08 27
 (181) 2029 08 27
 (210) AM 104404
 (220) 2019 08 02
 (732) Davit Chkopoia
 D. Aghmashenebeli Alley 12 km. 2, ap. 43,
 0131, Tbilisi, Georgia
 (540)



(591) Silver, golden, black, brown, gray
 (531) 05.07.02; 23.01.01; 25.01.05; 25.01.15;
 25.01.19; 26.04.06; 26.13.25; 27.05.01;
 29.01.15
 (511) 33, 35

(111) M 2019 31644 R
 (151) 2019 08 30
 (181) 2029 08 30
 (210) AM 104311
 (220) 2019 07 29
 (732) ANHUI LIANGLIANG ELECTRONIC
 TECHNOLOGY CO. LTD
 Taiji Road No.631, Economic Development
 Zone Of Guangde Country, Anhui, China
 (740) Bakhadin Ajalov
 (540)

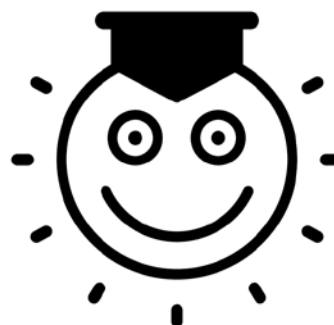

(591) Black, white
 (531) 01.03.20; 02.01.01; 02.01.23; 04.05.02;
 04.05.04; 04.05.05; 04.05.21
 (511) 11

(111) M 2019 31645 R
 (151) 2019 08 30
 (181) 2029 08 30
 (210) AM 104553
 (220) 2019 08 16
 (732) Elene Bochorishvili
 L. Asatiani St. 2, ap. 29, Batumi, Georgia
 (740) Giorgi Kartvelishvili
 (540)



(591) Green, white
 (531) 05.03.08; 05.03.16; 27.05.01; 28.19; 29.01.03
 (511) 10

(111) M 2019 31646 R
(151) 2019 09 02
(181) 2029 09 02
(210) AM 104542
(220) 2019 08 14
(732) LTD "AISI"
I. Evdoshvili St. 37, 1500, Gurjaani,
Georgia
(740) George Taktakishvili
(540)



(591) White, blue, sky-blue
(531) 28.19; 29.01.12
(511) 30

(111) M 2019 31647 R
(151) 2019 09 03
(181) 2029 09 03
(210) AM 104212
(220) 2019 07 24
(732) Gogita Gogilashvili
1049 Fritz Ave, Stroudsburg PA, 18360, USA
(540)



(591) White, black, red, gray
(531) 02.09.01; 24.07.01; 27.01.12; 27.05.02;
27.05.21; 29.01.13
(526) Georgian Flag Fragments
(511) 38

INTERNATIONAL TRADEMARKS FOR WHICH A DECISION ON GRANTING PROTECTIONS IS TAKEN

The decision can be appealed at the Chamber of Appeal of Sakpatenti within 3 months from the publication or at the Mtskheta District Court Administrative Cases Board (Address: №17, Samkhedro str., Mtskheta), within 1 month following the publication.

(260) AM 2019 96491 A*

(800) 1331148

(151) 2016 02 10

(891) 2018 01 23

(731) ARTSANA S.P.A.

Via Saldarini Catelli, 1, I-22070 Grandate (CO), Italy

(540)



(591) Black, white

(531) 26.04.04; 26.04.06; 26.04.24; 27.05.17; 27.05.24

(511)

11 – Apparatus for lighting, heating, steam generating, cooking, refrigerating, drying, ventilating; hot air apparatus; microwave ovens; deodorising apparatus, not for personal use; ionization apparatus for the treatment of air or water; ventilation [air-conditioning] installations and apparatus; air purifying apparatus and machines; lighting apparatus and installations; refrigerating appliances and installations; heating apparatus, electric; kilns; fumigation apparatus, not for medical purposes; disinfectant apparatus; hair driers [dryers]; germicidal burners; pads [cushions] (heating -), electric, not for medical purposes; light diffusers; driers (air -); evaporators; steam generating apparatus; chandeliers; standard lamps; arc lamps; electric lamps; lamps; lights, electric, for Christmas trees; lightbulbs; lamp shades; water heaters [apparatus]; air heating apparatus; heaters, electric, for feeding bottles; baby bottle warmers; toilet seats; sterilisers; sterilisers for babies' feeding bottles; air humidifiers; humidifiers; room humidifiers; air humidifiers, other than for medical purposes; baths.

18 – Umbrellas and parasols; parasols; umbrellas.

35 – Advertising; shop window dressing; dissemination of advertisements; distribution of samples; demonstration of goods; direct mail advertising; marketing services; exhibitions for commercial or advertising purposes; organisation of trade fairs for commercial or advertising purposes; fashion shows for promotional purposes (organization of -); presentati-

on of goods on communication media, for retail purposes; sales promotion for others; procurement services for third parties (acquisition of goods and services for other companies); modelling for advertising or sales promotion; news clipping services; telemarketing services.

(260) AM 2019 99733 A

(800) 1426705

(151) 2018 06 18

(891) 2018 06 18

(731) PAPSTAR GmbH

Daimlerstraße 4-8, 53925 Kall, Germany

(540)



(591) Green, white and black

(531) 01.15.15; 05.11.01; 29.01.12

(511)

8 – Knives, forks and spoons of wood and bioplastic; disposable cutlery of wood and renewable raw materials.

(260) AM 2019 100259 A

(800) 1431531

(151) 2018 09 24

(891) 2018 09 24

(731) Limited Liability Company "ORIMI"

1-st Microrayon Street, 15/4 plot, Sverdlov factory settlement, Vsevolozhsk district, RU-188682 Leningrad oblast, Russian Federation

(540)

**PRINCESS
NOORI**

(591) Black, white

(511)

30 – Tea; iced tea; tea-based beverages.

(260) AM 2019 100260 A
 (800) 1431534
 (151) 2018 09 24
 (891) 2018 09 24
 (731) Limited Liability Company "ORIMI"
 1-st Microrayon Street, 15/4 plot, Vsevolozhsk
 district, Sverdlov factory settlement,
 RU-188682 Leningrad oblast, Russian
 Federation

(540)

GITA

(591) Black, white

(511)

30 – Tea; iced tea; tea-based beverages.

(260) AM 2019 100262 A
 (800) 1431555
 (151) 2018 03 29
 (891) 2018 03 29
 (731) MİRDEM TEKSTİL SANAYİ VE TİCARET
 LİMİTED ŞİRKETİ
 Akincilar Mah. Posta Cad. No:69/5,
 Güngören, İstanbul, Turkey

(540)



(591) Gold and black

(531) 26.04.07; 26.04.18; 26.04.24; 27.05.22;
 27.05.24; 29.01.12

(526) ®

(511)

25 – Clothing, including underwear and outerclot-
 hing, other than special purpose protective clothing,
 footwear, headgear.

35 – Advertising, marketing and public relations, or-
 ganization of exhibitions and trade fairs for commer-
 cial or advertising purposes, office functions, busi-
 ness management, business administration and busi-
 ness consultancy; accounting, commercial consul-
 tancy services, import-export agency services; com-
 mercial or industrial management assistance, auctio-
 neering, the bringing together, for the benefit of oth-
 ers, of clothing, including underwear and outerclo-
 thing, footwear, headgear enabling customers to con-
 veniently view and purchase those goods, such servi-
 ces may be provided by retail stores, wholesale out-
 lets, by means of electronic media or through mail
 order catalogues.

(260) AM 2019 100266 A
 (800) 1431627
 (151) 2018 03 28
 (891) 2018 03 28
 (731) IPCO AB
 2453 Västra Verken, SE-811 81 Sandviken,
 Sweden

(540)

ipco

(591) Black, white

(531) 24.17.08; 27.05.01; 27.05.19

(511)

6 – Steel belts for manufacturing wood based panels,
 chemicals, paper, thin film, bread, biscuits, chocola-
 te, tiles, laminates, composites, paper board; steel
 belts for test equipment and wind tunnels; sintered
 metallic bodies; sheets and plates of metal for use in
 construction and transportation, manufactured in
 scattering and pressing processes with temperature,
 pressure and residence time.

7 – Sulphur (sulfur) forming, wet prilling, granula-
 ting and handling machinery; sulphur (sulfur) reme-
 lting machine and contaminant remover; power
 operated cutting and welding tools for treating of
 metallic sheet material; power operated machines for
 chemical-, food- and agrochemical production of
 granulates or pastilles; machines and machine tools
 for treatment of materials and for manufacturing;
 machines for processing food stuffs and pulp; ma-
 chines and parts thereof for treatment of liquid che-
 micals, petrochemicals, sulphur (sulfur) and food
 stuff, goods sold as a process solution therefor; ma-
 chines and parts thereof for transforming liquid che-
 micals, petrochemicals, sulphur (sulfur) and food
 stuff into solid form, goods sold as a process solu-
 tion therefor; shaping and moulding machines; dry-
 ing machines; mechanical winders; spray moulding
 machines; conveyors and conveyor belts.

11 – Heating apparatus and parts thereof in this
 class; furnaces (not for experimental purposes); ste-
 am generating, boiling, cooling, freezing, drying,
 ventilation and casting apparatus; thick film heating
 elements; drying machines, not laundry tumblers
 [heat dryers] or laundry drier cabinets; electrical fur-
 naces in the form of electrically heated resistance
 elements and apparatus for the destruction of gaseo-
 us impurities; electrical furnaces and refractory sup-
 ports and bricks for insulation of resistance heating
 elements; thick film heating elements, radiation ele-
 ments; parts and fittings included in this class for all
 the aforesaid goods.

37 – Rental, installation, maintenance and repair ser-
 vices relating to steel belts, machines and machine

tools for treatment of materials and for manufacturing, power operated machines, drying machines and dryers.

42 – Engineering design, development and integration in the areas of sulphur (sulfur) forming, granulating and handling machinery, and technical consultancy relating thereto.

(260) AM 2019 100270 A

(800) 1431692

(151) 2018 07 01

(891) 2018 07 01

(731) TETRA PHARM (1997) LTD.

30 Hacharoshet St., Or Yehuda, Israel

(540)

SEBOCALM

(591) Black, white

(511)

3 – Non-medicated cosmetics and toiletry preparations as follows: cosmetic products and cosmetics products for babies, namely, cosmetics; face and body creams; body lotions; beauty lotions; lotions for cosmetic purposes; sun care lotions; skin lotions; age retardant lotions, facial lotions and sun tan lotions; face and body cleaning preparation; soaps; gels for cosmetic purposes; skin moisturizing gels; aftersun gels; age retardant gels; beauty gels; facial beauty masks; skin moisturizer masks; cosmetic masks and skin masks; sunscreen products, namely, sunscreen preparations; all of the foregoing relating to skin care products.

(260) AM 2019 100282 A

(800) 1432014

(151) 2018 06 22

(891) 2018 06 22

(731) HYUNDAI HEAVY INDUSTRIES CO., LTD.

1000, Bangeojinsunhwan-doro, Dong-gu,

Ulsan, Republic of Korea

(540)

HYUNDAI CONSTRUCTION EQUIPMENT

(591) Black, white

(526) CONSTRUCTION EQUIPMENT

(511)

6 – Metallic fuel tanks; bag hangers of metal; screws of metal; nuts of metal; bolts of metal; washers of metal; hooks [metal hardware]; keys of metal; locking mechanisms of metal; foundry molds [moulds] of metal; rings of metal; metal connectors; clamps of metal; machine belt fasteners of metal; clips of metal for cables; bindings of metal.

7 – Electric pumps for swimming pools; electrically operated brushes [parts of machines]; mechanical

stamping machines; vending machines; gas pumps (gas station equipment); dethatchers [machines]; drive devices for opening and closing vehicle doors; skid-steer loaders; stacking machines; cranes; cargo handling machines; backhoe loaders; bucket for backhoe loaders; excavator parts; bulldozers; payloaders; front-end loaders; wheel loader; wheel loader fittings; tools [parts of machines]; rubber tracks being parts of crawlers on construction machines; dust protective units for construction machines; foundation work machines; concrete shredders; civil engineering machinery; agricultural machines; skid steer loaders for agricultural purposes; cylinders for machines; fuel injection devices for internal combustion engines; igniting devices for internal combustion engines; motive power machines (other than for land vehicles); filters for motors and engines; reduction gears being parts of machines; hydraulic controls for machine and prime movers; pneumatic controls for machines, motors and engines; hydraulic controls for machines, motors and engines; power transmissions and gearings (other than for land vehicles); cams being parts of machines; cranks [parts of machines]; shock absorbers for machine (other than for vehicles); braking devices for machine (other than for vehicles); rings other than for land vehicles (parts of machines); filters (parts of machines); drums [parts of machines]; bearings [parts of machines]; rinsing machines; mechanical parking systems; machines for processing plastics; 3D printers; robotic vacuum cleaners; industrial robots; robot loading devices; handling machines, automatic [manipulators]; handling apparatus for loading and unloading; welding electrodes; sericultural machines; motors and engines [except for land vehicles]; rubber tracks for skid-steer loaders.

9 – Electronic keys; sensors for engines; measures; tire pressure sensor; battery starters; electrical controlling devices; battery charge devices; plug connectors; batteries; remote control apparatus for industrial automation instruments; factory automation software; educational software; computer programs [downloadable software]; application software for smart phone; computer software to maintain and operate computer systems; data input/output module for industrial automatic instrument; data collecting apparatus for industrial automatic instrument; computer monitor for industrial automatic instrument; electronic control systems.

12 – Wheelchairs; parachutes; traction vehicles; forklift trucks; air pumps for forklift trucks; radiators for forklift trucks; mud flaps for forklift trucks; exhausts for forklift trucks; mufflers for forklift trucks; tires for vehicle wheels; suspension systems for vehicles; brake systems for vehicles; tractors for agricultural purposes; diesel engines for construction vehicles; motors for land vehicles; military vehicles for transport; doors for vehicles; vehicle bumpers; seat

belts for use in vehicles; fuel tanks for vehicles; hoods for vehicles; bodies for vehicles; seat covers for vehicles; steering wheels for vehicles; vehicle seats; mudguards; apparatus for locomotion by land/air or water; seat belts for use in vehicles.

16 – Stationery; writing instruments; vinyl for wrapping; money clips; boxes of paper; shopping bags of paper; catalogues; manuals [handbooks]; stickers; printed matter.

35 – Advisory and consultancy services relating to import-export agencies; import-export agency services; retail services for backhoe loaders; retail services for wheel loader; retail services for wheel loader fittings; retail services for forklift trucks; retail services for tractors; retail services for skid-steer loaders; retail services for cargo handling machines; retail services for agricultural machines; business intermediary services relating to mail order by telecommunication for construction equipment.

37 – Repair of braking devices; rental of construction and building equipment; providing information about rental of construction and building equipment; construction; construction engineering services; rental of construction vehicle; rental of construction machines and apparatus; providing information relating to construction machines and apparatus; rental of equipment and machine for the civil engineering construction and construction purposes; installation, maintenance and repair of measuring apparatus; repair or maintenance of excavators; maintenance of excavators; repair and maintenance of motor vehicles and parts thereof; installation, maintenance and repair of loading and unloading machines; vehicle battery charging; maintenance, servicing and repair of vehicles; painting of vehicles; installation and maintenance of transport machinery; repair or maintenance of loading-unloading machines and apparatus; repair of fork lift trucks; repair or maintenance of apparatus for loading and unloading; repair or maintenance of construction machines and apparatus; installation of construction machines and apparatus; repair of construction and agricultural machinery; repair or maintenance of construction equipment; repair or maintenance of agricultural machines and implements; installation of air pollution control facilities; installation, maintenance and repair of equipment and apparatus for use in road building; repair of industrial waste treatment machines; repair or maintenance of water purifying apparatus; provision of oil hydraulic equipment repair information; installation, maintenance and repair of hardware for data processing apparatus; maintenance and repair of control systems for radio systems and networks; installation, maintenance and repair of apparatus for distributing electricity; installation, maintenance and repair of batteries and accumulators; cleaning of buildings, industrial sites and building sites; vehicle cleaning; providing information relating to vermin

exterminating, other than for agriculture, forestry or horticulture; shoe cleaning; laundering; tuning of engines for motor vehicles.

39 – Transport/storage and packaging of goods; warehousing; loading and unloading of goods; rental of loading-unloading machines and apparatus; renting of vehicles; vehicle leasing services; rental of vehicle equipment and accessories; portorage; cargo forklift rental; storage of construction machines and apparatus; storage of transport machinery for industrial purposes; storage of agricultural machines and apparatus and parts thereof; depot services for the storage of vehicles.

40 – Treatment of industrial waste.

42 – Design of parts of machines; design of mechanical and micromechanical components; design of machines and apparatus; mechanical drawing; draftsman's services in the nature of technical drawing; corporate logo graphic design services; design of heating and cooling apparatus; design of devices intended for protein analysis; consultancy services relating to design; designing of construction equipment (including backhoe loaders and wheel loader); designing of transport apparatus (including forklift trucks, skid-steer loaders and tractors); design of factory automation equipment; design of vehicles; design of parts for vehicles; design of environmental protection facilities; software design and development; updating and maintenance of computer software; engineering services in the field of environmental technology; research in relation to technology for construction purposes; consultancy in the field of office and workplace automation; inspection of industrial installations; inspection services for new and used vehicles for persons buying or selling their vehicles.

(260) AM 2019 100288 A

(800) 1432225

(151) 2018 04 06

(891) 2018 04 06

(731) Oriflame Cosmetics AG

c/o Oriflame Global Management AG,
Bleicheplatz 3, CH-8200 Schaffhausen,
Switzerland

(540)

ORIFLAME BEAUTY BY SWEDEN

(591) Black, white

(511)

3 – Non-medicated conditioning and care preparations for application to the hair, scalp, skin and nails; shampoos; hair conditioner; soaps; perfumes; perfumery; eau de cologne; toilet waters; essential and herbal oils; cosmetics; make-up; make-up preparati-

ons; lipsticks; nail varnishes; nail varnish removers; eyeliner; mascara; non-medicated toilet preparations; hair lotions; hair sprays and hair gels; preparations for use in the bath or shower; bath and shower oils, gels, creams and foams; face and body masks; face and body scrubs; facial washes; skin cleansers and hydrators; skin toners; skin moisturizers; blemish creams and blemish gels; deodorants; antiperspirants; preparations for use before shaving and after shaving; shaving soaps; shaving creams; shaving gels; after-shave preparations; pre-shave preparations; talcum powders; toiletries; dentifrices; toothpastes; foot care preparations (non-medicated).

35 – Retail services, wholesale services, retail services by direct solicitation by independent sales representatives, retail services by telephone shop at home services, retail services by mail order catalog services, retail services by interactive retail store, wholesale services rendered by means of a global computer information network: all the aforementioned services relating to non-medicated conditioning and care preparations for application to the hair, scalp, skin and nails, shampoos, hair conditioner, soaps, perfumes, perfumery, eau de cologne, toilet waters, essential and herbal oils, cosmetics, make-up, make-up preparations, lipsticks, nail varnishes, nail varnish removers, eyeliner, mascara, non-medicated toilet preparations, hair lotions, hair sprays and hair gels, preparations for use in the bath or shower, non-medicated conditioning and care preparations for application to the hair, scalp, skin and nails, shampoos, hair conditioner, soaps, perfumes, perfumery, eau de cologne, toilet waters, essential and herbal oils, cosmetics, make-up, make-up preparations, lipsticks, nail varnishes, nail varnish removers, eyeliner, mascara, non-medicated toilet preparations, hair lotions, hair sprays and hair gels, preparations for use in the bath or shower, bath and shower oils, gels, creams and foams, face and body masks, face and body scrubs, facial washes, skin cleansers and hydrators, skin toners, skin moisturizers, blemish creams and blemish gels, deodorants, antiperspirants, preparations for use before shaving and after shaving, shaving soaps, shaving creams, shaving gels, after-shave preparations, pre-shave preparations, talcum powders, toiletries, dentifrices, toothpastes, foot care preparations (non-medicated), jewellery, bags, cosmetic bags, dietary supplements, vitamin supplements, soup powders, milk shakes, cereals, bases for making milk shakes [flavourings], cereal bars, high-protein cereal bars, cereal-based snacks, corn-based snacks, rice-based snacks, clothing, footwear and headgear.

(260) AM 2019 100290 A
(800) 1432234
(151) 2018 02 28
(891) 2018 02 28

(731) PAK DAIRY COMPANY

Pak Dairy Company -, Under Pastorizeh
Bridg -, Fath High Way -, Azadi, Tehran,
Islamic Republic of Iran

(540)



(591) Black, white

(531) 27.05.01; 27.05.17; 28.01

(511)

39 – Packaging services of Kephir [milk beverage], Kumys [milk beverage], yoghurt, margarine, butter, chocolate nut butter, coca butter, coconut butter, peanut butter, butter cream, cheese, coconut fat, ryazhenka [fermented baked milk], rennet, whey, whipped cream, yogurt, rennet, flavored milk, milk, predominating, milk products, milk ferments for culinary purposes, soya milk [milk substitute], coffee milk powder, cacao milk powder, tofu, condensed milk, cream [dairy products], kimchi [fermented vegetable dish] (samanoo), curd, milk beverage, vegetable musses, vegetable yogurt, fruit yogurt, fatty substances for the manufacture of edible fats, milk powder, chocolate cream, malt milk, binding agents for ice cream [edible ices], binding agents for ice cream/binding agents for edible ices, ice cream, powders for ice cream/powder for edible ices, edible ices, cream of tartar for culinary purposes, ice cream cakes, cake frosting [icing], ice cream desserts, ice cream bar [confectionery], ice cream mixes, fruit ice creams, coated ice cream (cocoa), coated ice cream (almond), coated ice cream (fruit), coated ice cream (raisins), frozen confectionery, aperitifs (non-alcoholic), preparations for making beverages, milk of almonds [beverage], non-alcoholic beverages, preparations for making mineral water, fruit juices/fruit juice (non-alcoholic), pastilles for effervescing beverages, peanut milk [non-alcoholic beverage], isotonic beverage, fruit beverages/ fruit juices, syrups and other preparations for making beverages, ginger beer/ginger ale (non-alcoholic), unfermented grape juice, powders for the preparation of soft drinks, powders for effervescing beverages, essences for making beverages, sherbets [beverages]/ sorbets [beverages], seltzer water, fruit nectars, non-alcoholic, mineral water [beverages].

(260) AM 2019 100295 A
(800) 1432432
(151) 2018 05 24
(891) 2018 05 24

(731) Bahram GHLIGGHANLO
Ataköy 7-8-9-10 Kısım Mah., Yüzücü Talat
Yüzmen Sokak, No:4J / 86 Bakırköy,
İSTANBUL, Turkey

(540)

MEDELLİN

(591) Black, white

(511)

34 – Tobacco, chewing tobacco, cigarettes, cigars; smokers' articles including those made of precious metals, namely pipes, mouthpieces for cigars and cigarettes, ashtrays, tobacco boxes, pocket apparatus for rolling cigarettes, cigarette paper, tobacco pipes, firestones, lighters for smokers; matches.

(260) AM 2019 100300 A

(800) 1006082

(151) 2009 02 27

(891) 2018 09 13

(731) CATERPILLAR ENERGY SOLUTIONS
GMBH

Carl-Benz-Str. 1, 68167 Mannheim, Germany

(540)



(591) Blue, green

(531) 26.04.09; 27.05.10; 29.01.13

(511)

7 – Combustion engines (except for land vehicles), in particular air and water-cooled diesel engines, gas engines and gas turbines, and parts for the aforesaid combustion engines; combustion engines for water vehicles, for woodworking machines, for grinding mills, for breweries, for hoists and for oil field apparatus; machine assemblies, consisting of stationary and mobile combustion engines and work machines, in particular generators, compressors, pumps, emergency power generating installations and combined heat and power installations, and parts for the aforesaid machine assemblies; fuel conversion apparatus for internal combustion engines; speed governors for machines, engines and motors; compressed air engines; filters (parts of machines or engines); crankcases for machines, motors and engines; hydraulic motors; hydraulic controls for machines and motors; filters for cleaning cooling air [for engines]; regulators (machine parts), in particular electronic regulators for engines; control mechanisms for machines, engines or motors; anti-pollution devices for motors and engines; combustion engines for rollers, excavators, cranes, road building machines, agricultural machines.

11 – Heat pumps; heat regenerators; heat accumulators; heat exchangers; gas generators.

12 – Combustion engines for land vehicles, including rail vehicles and transport machines, in particular air and water-cooled diesel engines and gas engines, and parts for the aforesaid combustion engines.

37 – Overhauling engines that have been worn or partially destroyed, and parts of these engines.

40 – Rental of generators, rental of engines classified in classes 7 and 11.

(260) AM 2019 100306 A

(800) 1432469

(151) 2018 08 10

(891) 2018 08 10

(731) Jiangsu Yellow River Electronic Technology
Co., Ltd

96# Nanjing Road, Suqian Economic and
Technological, Development Area, Jiangsu
Province, China

(540)

黄河赛尔

(591) Black, white

(531) 28.03

(511)

9 – Audiovisual teaching apparatus; television apparatus; video screens; remote control apparatus; theft prevention installations, electric; anti-theft warning apparatus; megaphones; fire alarms; video baby monitors; learning machines.

(260) AM 2019 100308 A

(800) 1432491

(151) 2018 07 26

(891) 2018 07 26

(731) BEIJING JINGDONG 360 DU
E-COMMERCE LTD.

Room 222, Floor 2, Building C, No.18
Kechuang 11 Street, Beijing Economic and
Technological, Development Zone, Beijing,
China

(540)

JD Logistics

(591) Black, white

(531) 27.05.01

(511)

39 – Transport; packaging of goods; piloting; hauling; car transport; air transport; chauffeur services; horse rental; storage of goods; rental of warehouses;

courier services [messages or merchandise]; parcel delivery; delivery of goods by mail order; arranging of travel tours; transport by pipeline.

(260) AM 2019 100310 A

(800) 1432589

(151) 2018 07 30

(891) 2018 07 30

(731) BERLING S.A.

11, Dimitriou Ralli Str, Marousi, GR-151 24
Athens, Greece

(540)



(591) Black, red and white

(531) 03.01.02; 26.04.05; 26.04.22; 26.04.24;
27.05.24; 29.01.13

(511)

2 – Paints, varnishes, lacquers; preservatives against rust and against deterioration of wood; colorants; mordants; raw natural resins; metals in foil and powder form for painters, decorators, printers and artists.

(260) AM 2019 100311 A

(800) 1432624

(151) 2018 06 05

(891) 2018 06 05

(731) Public Joint Stock Company "GAZ"

prospect Lenina, 88, RU-603004 Nizhny
Novgorod, Russian Federation

(540)



(591) Black, white

(531) 03.04.07; 03.04.24; 24.01.09; 24.01.25

(511)

1 – Anti-knock substances for internal combustion engines; antifreeze; lead acetate; foundry binding substances; bismuth; bismuth subnitrate for chemical purposes; aluminium hydrate; power steering fluid;

brake fluid; transmission fluid; glaziers' putty; cement [metallurgy]; catalysts; biochemical catalysts.

2 – Lacquers; anti-corrosive bands; anti-rust oils; mastic [natural resin]; coatings [paints]; undercoating for vehicle chassis; undersealing for vehicle chassis; anti-fouling paints; varnishes; anti-corrosive preparations; protective preparations for metals; mordants; anti-rust greases; natural resins, raw; anti-tarnishing preparations for metals; anti-rust preparations; fixatives [varnishes].

3 – Abrasives; air fragrancing preparations; polishing stones; abrasive paper; emery paper; polishing paper; rust removing preparations.

4 – Benzine; petroleum jelly for industrial purposes; industrial wax; belting wax; fuel gas; fuel; lubricating graphite; cutting fluids; industrial grease; lubricating oil; castor oil for industrial purposes; motor oil; lubricants; lubricating grease; grease for belts; diesel oil; gas oil; carburants; motor fuel.

5 – First-aid boxes, filled.

6 – Vats of metal; casks of metal; screws of metal; sleeves [metal hardware]; ferrules of metal for handles; signboards of metal; nuts of metal; nails; wall plugs of metal; packaging containers of metal; wheel clamps [boots]; locks of metal for vehicles; locks of metal, other than electric; spring locks; closures of metal for containers; latches of metal; tension links; couplings of metal for chains; road signs, non-luminous and non-mechanical, of metal; signs, non-luminous and non-mechanical, of metal; buckles of common metal [hardware]; ropes of metal; rings of metal; stop collars of metal; brackets of metal for building; buildings of metal; buildings, transportable, of metal; containers of metal [storage, transport]; tool boxes of metal, empty; hooks [metal hardware]; clothes hooks of metal; belt stretchers of metal; stretchers for metal bands [tension links]; wire stretchers [tension links]; thread of metal for tying-up purposes; braces of metal for handling loads; harness of metal for handling loads; harness of metal for load handling; laths of metal; latticework of metal; trellis of metal; stops of metal; strap-hinges of metal; door closers, non-electric; door springs, non-electric; door openers, non-electric; springs [metal hardware]; tanks of metal; reservoirs of metal; grilles of metal; gratings of metal; knobs of metal; nozzles of metal; bindings of metal; machine belt fasteners of metal; cables of metal, non-electric; tinsplate packings; window closers, non-electric; window openers, non-electric; clips of metal for cables and pipes; chains of metal; safety chains of metal; cotter pins of metal; cast iron, unwrought or semi-wrought; washers of metal; balls of steel; hinges of metal; pulleys of metal, other than for machines; pins [hardware]; badges of metal for vehicles; lock bolts; tool chests of metal, empty; boxes of common metal.

7 – Expansion tanks [parts of machines]; drums [parts of machines]; concrete mixers [machines]; journal boxes [parts of machines]; bulldozers; crank shafts; valves [parts of machines]; bearings [parts of machines]; water heaters [parts of machines]; bellows [parts of machines]; emergency power generators; alternators; dynamos; current generators; hydraulic controls for machines, motors and engines; mufflers for motors and engines; silencers for motors and engines; cylinder heads for engines; pump diaphragms; jacks [machines]; rack and pinion jacks; injectors for engines; tools [parts of machines]; hand-held tools, other than hand-operated; control cables for machines, engines or motors; carburettors; crankcases for machines, motors and engines; pressure valves [parts of machines]; clack valves [parts of machines]; pressure reducers [parts of machines]; cowlings [parts of machines]; guards [parts of machines]; hoods [parts of machines]; machine wheels; piston segments; piston rings; grease rings [parts of machines]; compressors [machines]; grease boxes [parts of machines]; housings [parts of machines]; taps [parts of machines, engines or motors]; cranks [parts of machines]; lubricators [parts of machines]; igniting magnetos; handling machines, automatic [manipulators]; machine fly-wheels; pumps [parts of machines, engines or motors]; compressed air pumps; lubricating pumps; self-regulating fuel pumps; carburettor feeders; pneumatic controls for machines, motors and engines; anti-friction bearings for machines; anti-friction pads for machines; roller bearings; self-oiling bearings; bearings for transmission shafts; ball-bearings; pistons [parts of machines or engines]; shock absorber plungers [parts of machines]; dashpot plungers [parts of machines]; plunger pistons; pistons for engines; pistons for cylinders; catalytic converters; fuel conversion apparatus for internal combustion engines; springs [parts of machines]; regulators [parts of machines]; pressure regulators [parts of machines]; speed governors for machines, engines and motors; fan belts for motors and engines; dynamo belts; belts for motors and engines; adhesive bands for pulleys; stuffing boxes [parts of machines]; sparking plugs for internal combustion engines; glow plugs for Diesel engines; ball rings for bearings; shaft couplings [machines]; starters for motors and engines; stators [parts of machines]; heat exchangers [parts of machines]; transmissions for machines; turbocompressors; connecting rods for machines, motors and engines; joints [parts of engines]; sealing joints [parts of engines]; igniting devices for internal combustion engines; control mechanisms for machines, engines or motors; filters [parts of machines or engines]; filters for cleaning cooling air, for engines; journals [parts of machines]; cylinders for motors and engines; cylinders for machines; universal joints [Cardan joints]; pulleys [parts of machines]; brushes [parts of machines]; dynamo brushes; brushes, electrically ope-

rated [parts of machines]; ejectors; fuel economisers for motors and engines; excavators.

8 – Lifting jacks, hand-operated; cutting tools [hand tools]; hand tools, hand-operated; earth rammers [hand tools]; centre punches [hand tools]; spanners [hand tools]; wrenches [hand tools]; tap wrenches; hammers [hand tools]; files [tools]; air pumps, hand-operated; hand pumps; screwdrivers, non-electric; cutters; hoop cutters [hand tools].

9 – Fire engines; accumulators, electric; accumulators, electric, for vehicles; batteries, electric, for vehicles; remote control apparatus; solar batteries; solar panels for the production of electricity; batteries, electric; locks, electric; cables, electric; junction sleeves for electric cables; fuses; circuit breakers; navigation apparatus for vehicles [on-board computers]; vehicle radios; voltage regulators for vehicles; speed indicators; kilometer recorders for vehicles; milage recorders for vehicles; revolution counters; thermostats for vehicles; automatic indicators of low pressure in vehicle tires [tyres]; automatic indicators of low pressure in vehicle tyres; automatic indicators of low pressure in vehicle tyres; gasoline gauges; petrol gauges; water level indicators; steering apparatus, automatic, for vehicles.

11 – Defrosters for vehicles; fans [air-conditioning]; fans [parts of air-conditioning installations]; air conditioners for vehicles; lamps for directional signals of automobiles; light bulbs for directional signals for vehicles; heating apparatus for defrosting vehicle windows; lighting apparatus for vehicles; light-emitting diodes [LED] lighting apparatus; anti-dazzle devices for automobiles [lamp fittings]; ventilation [air-conditioning] installations for vehicles; headlights for automobiles; vehicle headlights.

12 – Motor buses; motor coaches; motor homes; camping cars; cars; automobiles; motor cars; sports cars; concrete mixing vehicles; refrigerated vehicles; caravans; shock absorbers for automobiles; suspension shock absorbers for vehicles; ski carriers for cars; luggage carriers for vehicles; bumpers for automobiles; vehicle bumpers; tires for vehicle wheels; tyres for vehicle wheels; brake shoes for vehicles; tailboard lifts [parts of land vehicles]; elevating tailgates (Am.) [parts of land vehicles]; power tailgates (Am.) [parts of land vehicles]; armored vehicles; armoured vehicles; dining cars [carriages]; dinner wagons [carriages]; transmission shafts for land vehicles; bicycles; valves for vehicle tires [tyres]; automobile hoods; hoods for vehicles; trucks; lorries; horns for vehicles; treads for vehicles [tractor type]; treads for vehicles [roller belts]; doors for vehicles; engines for land vehicles; motors for land vehicles; driving motors for land vehicles; screw-propellers; brake discs for vehicles; adhesive rubber patches for repairing inner tubes; rearview mirrors; inner tubes for pneumatic tires [tyres]; hoods for vehicle engines;

crankcases for land vehicle components, other than for engines; bicycle wheels; vehicle wheels; steering wheels for vehicles; casters for trolleys [vehicles] [carts (Am.)]; brake pads for automobiles; hub caps; brake linings for vehicles; gear boxes for land vehicles; bands for wheel hubs; caps for vehicle petrol [gas] tanks; automobile bodies; tipping bodies for lorries [trucks]; bodies for vehicles; treads for retreading tires [tyres]; sprinkling trucks; propulsion mechanisms for land vehicles; freewheels for land vehicles; clutches for land vehicles; repair outfits for inner tubes; air pumps [vehicle accessories]; upholstery for vehicles; rims for bicycle wheels; bicycle wheel rims; rims for vehicle wheels; vehicle wheel rims; windows for vehicles; engine mounts for land vehicles; axles for vehicles; headlight wipers; gearing for land vehicles; head-rests for vehicle seats; vehicle running boards; air bags [safety devices for automobiles]; casings for pneumatic tires [tyres]; sleeping berths for vehicles; torque converters for land vehicles; cigar lighters for automobiles; non-skid devices for vehicle tires [tyres]; non-skid devices for vehicle tires; non-skid devices for vehicle tires; anti-glare devices for vehicles; anti-dazzle devices for vehicles; anti-theft devices for vehicles; sun-blinds adapted for automobiles; balance weights for vehicle wheels; shock absorbing springs for vehicles; reduction gears for land vehicles; safety belts for vehicle seats; security harness for vehicle seats; vehicle suspension springs; rudders; brake segments for vehicles; luggage nets for vehicles; anti-theft alarms for vehicles; reversing alarms for vehicles; safety seats for children, for vehicles; vehicle seats; hydraulic circuits for vehicles; vehicle wheel spokes; spoilers for vehicles; vehicles for locomotion by land, air, water or rail; ambulances; remote control vehicles, other than toys; electric vehicles; windcreens; windshields; windshield wipers; windscreen wipers; hubs for vehicle wheels; vehicle wheel hubs; trailer hitches for vehicles; couplings for land vehicles; brakes for vehicles; torsion bars for vehicles; tractors; transmissions for land vehicles; military vehicles for transport; trailers [vehicles]; direction signals for vehicles; turn signals for vehicles; spoke clips for wheels; vans [vehicles]; automobile chains; driving chains for land vehicles; anti-skid chains; transmission chains for land vehicles; spare wheel covers; spare tire covers; spare tyre covers; covers for vehicle steering wheels; seat covers for vehicles; vehicle covers [shaped]; automobile chassis; vehicle chassis; connecting rods for land vehicles, other than parts of motors and engines; axle journals; automobile tires [tyres]; pneumatic tires; mudguards; motors, electric, for land vehicles.

16 – Fountain pens; albums; scrapbooks; almanacs; posters; tickets; forms, printed; announcement cards [stationery]; loose-leaf binders; pads [stationery]; wristbands for the retention of writing instruments; pamphlets; booklets; wrapping paper; packing paper;

filter paper; newsletters; signboards of paper or cardboard; newspapers; document holders [stationery]; pencil holders; page holders; holders for checkbooks [cheque books]; advertisement boards of paper or cardboard; magazines [periodicals]; money clips; tags for index cards; pen clips; bookmarkers; printed publications; graphic representations; calendars; tracing patterns; pencils; pencil lead holders; pictures; transfers [decalcomanias]; decalcomanias; paintings [pictures], framed or unframed; cards; charts; trading cards, other than for games; catalogues; paintbrushes; printing blocks; books; manifolds [stationery]; comic books; envelopes [stationery]; boxes of paper or cardboard; gummed tape [stationery]; adhesive bands for stationery or household purposes; self-adhesive tapes for stationery or household purposes; flyers; humidity control sheets of paper or plastic for foodstuff packaging; viscose sheets for wrapping; sheets of reclaimed cellulose for wrapping; plastic bubble packs for wrapping or packaging; lithographs; postage stamps; graphic prints; teaching materials [except apparatus]; sealing compounds for stationery purposes; packing [cushioning, stuffing] materials of paper or cardboard; filtering materials [paper]; bags [envelopes, pouches] of paper or plastics, for packaging; stickers [stationery]; bottle envelopes of paper or cardboard; covers [stationery]; wrappers [stationery]; plastic cling film, extensible, for palletization; greeting cards; etchings; conical paper bags; folders for papers; jackets for papers; pen cases; boxes for pens; seals [stamps]; sealing stamps; clipboards; plastic film for wrapping; desk mats; mats for beer glasses; stands for pens and pencils; paperweights; writing cases [sets]; writing materials; printed matter; prospectuses; rubber erasers; graphic reproductions; penholders; marking pens [stationery]; placards of paper or cardboard; writing or drawing books; fabrics for bookbinding; transparencies [stationery]; stencil plates; bottle wrappers of paper or cardboard; manuals [handbooks]; handbooks [manuals]; flags of paper; photo-engravings; photographs [printed]; stencil cases; blueprints; plans; stencils; shields [paper seals].

17 – Shock-absorbing buffers of rubber; fittings, not of metal, for compressed air lines; lute; insulators; valves of india-rubber or vulcanized fiber [fibre]; clack valves of rubber; rings of rubber; water-tight rings; stuffing rings; insulating tapes; insulating bands; adhesive bands, other than stationery and not for medical or household purposes; adhesive tapes, other than stationery and not for medical or household purposes; self-adhesive tapes, other than stationery and not for medical or household purposes; insulating oils; reinforcing materials, not of metal, for pipes; weatherstripping compositions; brake lining materials, partly processed; soundproofing materials; insulating materials; rubber material for recapping tires [tyres]; rubber material for recapping tires; non-conducting materials for retaining heat;

packing [cushioning, stuffing] materials of rubber or plastics; sealant compounds for joints; filtering materials [semi-processed foams or films of plastic]; bags [envelopes, pouches] of rubber, for packaging; pipe muffs, not of metal; pipe jackets, not of metal; sleeves of rubber for protecting parts of machines; rubber sleeves for protecting parts of machines; clutch linings; stops of rubber; insulating plaster; anti-dazzle films for windows [tinted films]; rubber stoppers; expansion joint fillers; fillers for expansion joints; cylinder jointings; washers of rubber or vulcanized fiber [fibre]; pipe gaskets; joint packings for pipes; weatherstripping; draught excluder strips; gaskets; joint packings; seals; junctions, not of metal, for flexible pipes; chemical compositions for repairing leaks; connecting hose for vehicle radiators; waterproof packings.

20 – Bolts, not of metal; screws, not of metal; display stands; signboards of wood or plastics; nuts, not of metal; display boards; plugs [dowels], not of metal; wall plugs, not of metal; containers, not of metal, for liquid fuel; packaging containers of plastic; clips, not of metal, for cables and pipes; rivets, not of metal; locks, not of metal, for vehicles; closures, not of metal, for containers; latches, not of metal; mirrors [looking glasses]; drain traps [valves] of plastic; plastic key cards, not encoded and not magnetic; bottle caps, not of metal; containers, not of metal [storage, transport]; screw tops, not of metal, for bottles; loading pallets, not of metal; handling pallets, not of metal; transport pallets, not of metal; pillows; air pillows, not for medical purposes; corks for bottles; stair rods; door handles, not of metal; knobs, not of metal; placards of wood or plastics; door fittings, not of metal; boxes of wood or plastic; chests for toys.

22 – Packing [cushioning, stuffing] materials, not of rubber, plastics, paper or cardboard; slings, not of metal, for handling loads; awnings of synthetic materials; awnings of textile; car towing ropes; cables, not of metal; vehicle covers, not fitted.

27 – Carpets for automobiles; automobile carpets; non-slip mats; vinyl floor coverings; floor coverings.

28 – Toy vehicles; jigsaw puzzles; toys; stuffed toys; mobiles [toys]; practical jokes [novelties]; parlour games; parlour games; board games; games; building games; kaleidoscopes; playing cards; fairground ride apparatus; swings; toy models; scale model kits [toys]; scale model vehicles; ornaments for Christmas trees, except illumination articles and confectionery; apparatus for games; play balloons.

5 – Arranging subscriptions to telecommunication services for others; rental of advertising space; book-keeping; accounting; demonstration of goods; organization of exhibitions for commercial or advertising purposes; organization of trade fairs for commercial or advertising purposes; shop window dressing; design of advertising materials; presentation of goods

on communication media, for retail purposes; sales promotion for others; production of advertising films; rental of billboards [advertising boards]; billposting; outdoor advertising; distribution of samples; dissemination of advertising matter; direct mail advertising; advertising; publicity; on-line advertising on a computer network; television advertising; commercial administration of the licensing of the goods and services of others; procurement services for others [purchasing goods and services for other businesses].

37 – Rebuilding engines that have been worn or partially destroyed; rebuilding machines that have been worn or partially destroyed; vehicle battery charging; vehicle washing; rustproofing; anti-rust treatment for vehicles; vehicle maintenance; vehicle polishing; vehicle breakdown repair services; rental of bulldozers; motor vehicle maintenance and repair; vehicle lubrication [greasing]; vehicle greasing; vehicle lubrication; installation, maintenance and repair of computer hardware; machinery installation, maintenance and repair.

39 – Motor coach rental; parking place rental; delivery of goods; wrapping of goods; car parking; storage of goods.

41 – Game services provided on-line from a computer network; film production, other than advertising films; on-line publication of electronic books and journals.

42 – Research and development of new products for others; engineering; technical research; calibration [measuring]; technological consultancy; vehicle roadworthiness testing; creating and maintaining web sites for others; outsource service providers in the field of information technology; packaging design; surveying.

(260) AM 2019 100312 A

(800) 1432700

(151) 2018 10 01

(891) 2018 10 01

(731) VALIO LTD

Meijeritie 6, FI-00370 Helsinki, Finland

(540)

Valio CARBO Farm

(591) Black, white

(511)

29 – Meat, fish, poultry and game; meat extracts; preserved, frozen, dried and cooked fruits and vegetables; jellies, jams, compotes; eggs; milk and milk products; yoghurt; cream; sour cream; whipped cream; milk drinks; milk-based beverages containing mainly milk; milkshakes; soured milk; kephir, koumiss; whey; cottage cheese; cheese; cheese products; cheese spreads; milk powder; dried whey products; whey powders; butter; margarine; dairy spreads.

44 – Agriculture services; information services relating to the use of chemicals, fertilizers and manures in agriculture; cultivation advisory services relating to agriculture; agricultural services relating to environmental conservation; farming services; professional consultancy relating to agriculture; advisory and consultancy services relating to weed, pest and vermin control in agriculture; information services relating to the use of fertilizers used in agriculture; advisory and consultancy services relating to the use of non-chemical treatments for sustainable agriculture; information services relating to the use of chemicals used in agriculture; information, advisory and consultancy services relating to all the aforesaid services.

(260) AM 2019 100313 A

(800) 1432704

(151) 2017 08 29

(891) 2017 08 29

(731) VEDA CAPITAL Ltd.

Okulovoy str., 68B, RU-153020 Ivanovo,
Russian Federation

(540)

ORMATEK
VERDA
SINCE



(591) Black, white

(531) 09.01.01; 09.05.01; 09.05.02; 27.05.10

(526) SINCE.

(511)

10 – Orthopedic articles; furniture especially made for medical purposes; cushions for medical purposes; pads [pouches] for preventing pressure sores on patient bodies; soporific pillows for insomnia.

20 – Sideboards; coat hangers; coatstands; display stands; showcases [furniture]; signboards of wood or plastics; covers for clothing [wardrobe]; doors for furniture; pegs [pins], not of metal; divans; flowerstands [furniture]; mirrors [looking glasses]; hand-held mirrors [toilet mirrors]; bamboo; rattan; plaited straw, except matting; wickerwork; works of art of wood, wax, plaster or plastic; cabinet work; index cabinets [furniture]; cradles; chests of drawers; lecterns; armchairs; hospital beds; bedsteads of wood; beds; air mattresses, not for medical purposes; spring mattresses; mattresses; furniture of metal; office furniture; school furniture; curtain rails; furniture; furniture partitions of wood; mirror tiles; head-rests [furniture]; trestles [furniture]; book rests [furniture]; pillows; cushions; racks [furniture]; library shelves; shelves for file cabinets; furniture shelves; shelves for storage; wood ribbon; hat stands; inflatable pub-

licity objects; counters [tables]; bedding, except linen; door handles, not of metal; writing desks; seats of metal; benches [furniture]; sofas; silvered glass [mirrors]; gun racks; carts for computers [furniture]; dressing tables; washstands [furniture]; typing desks; drafting tables; massage tables; tables of metal; wall-mounted baby changing platforms; desks; tea carts; dinner wagons [furniture]; tables; steps [ladders], not of metal; chairs [seats]; high chairs for babies; chests, not of metal; placards of wood or plastics; stools; crates; trolleys [furniture]; straw plaits; straw mattresses; door fittings, not of metal; bed fittings, not of metal; furniture fittings, not of metal; window fittings, not of metal; infant walkers; chaise longues; poles, not of metal; screens [furniture]; filing cabinets; medicine cabinets; meat safes, not of metal; plate racks; bamboo curtains; paper blinds; slatted indoor blinds; woven timber blinds [furniture]; indoor window blinds [shades] [furniture]; interior textile window blinds; lockers; cases of wood or plastic; chests for toys; letter boxes, not of metal or masonry; display cabinets; bookcases; kitchen cabinets; screens for fireplaces [furniture].

22 – Bags [envelopes, pouches] of textile, for packaging; straw for stuffing upholstery; grasses for upholstery; carded wool; camel hair; flock [stuffing]; upholstery wool [stuffing]; wood wool; combed wool; raw or treated wool; shorn wool; padding, cushioning and stuffing materials, except of paper, cardboard, rubber or plastics; packing [cushioning, stuffing] materials, not of rubber, plastics, paper or cardboard.

24 – Household linen; diapered linen; bath linen, except clothing; bed linen; table runners; drugget; curtains of textile or plastic; net curtains; furniture coverings of textile; fabrics for textile use; wall hangings of textile; pillowcases; bed blankets; handkerchiefs of textile; travelling rugs [lap robes]; curtain holders of textile material; bed covers; furniture coverings of plastic; towels of textile; gummed cloth, other than for stationery purposes; printers' blankets of textile; door curtains; place mats, not of paper; oilcloth for use as tablecloths; lingerie fabric; upholstery fabrics; tulle; fitted toilet lid covers of fabric; covers [loose] for furniture; pillow shams; labels of textile; table linen, not of paper; shower curtains of textile or plastic; mattress covers; eiderdowns [down coverlets]; cloth coasters; bed covers of paper; tenugui [Japanese cotton towels]; ticks [mattress covers]; tablecloths, not of paper.

(260) AM 2019 100314 A

(800) 1432709

(151) 2018 10 01

(891) 2018 10 01

(731) VALIO LTD

Meijeritie 6, FI-00370 Helsinki, Finland

(540)

Valio CARBO Farming

(591) Black, white

(511)

29 – Meat, fish, poultry and game; meat extracts; preserved, frozen, dried and cooked fruits and vegetables; jellies, jams, compotes; eggs; milk and milk products; yoghurt; cream; sour cream; whipped cream; milk drinks; milk-based beverages containing mainly milk; milkshakes; soured milk; kephir, koumiss; whey; cottage cheese; cheeses; cheese products; cheese spreads; milk powder; dried whey products; whey powders; butter; margarine; dairy spreads.

44 – Agriculture services; information services relating to the use of chemicals, fertilizers and manures in agriculture; cultivation advisory services relating to agriculture; agricultural services relating to environmental conservation; farming services; professional consultancy relating to agriculture; advisory and consultancy services relating to weed, pest and vermin control in agriculture; information services relating to the use of fertilizers used in agriculture; advisory and consultancy services relating to the use of non-chemical treatments for sustainable agriculture; information services relating to the use of chemicals used in agriculture; information, advisory and consultancy services relating to all the aforesaid services.

(260) AM 2019 100315 A

(800) 1432718

(151) 2018 04 12

(891) 2018 04 12

(731) HEYDAR ALIYEV FOUNDATION

5, Niyazi Street, AZ-1000 Baku, Azerbaijan

(540)

**HEYDAR ALIYEV FOUNDATION**

(591) Golden, blue, white and black

(531) 01.01.25; 27.05.01; 27.05.08; 27.05.22;
29.01.14

(511)

41 – Education, organisation of cultural and sporting events.

(260) AM 2019 100317 A

(800) 1432736

(151) 2018 09 28

(891) 2018 09 28

(731) RDC GROUP LIMITED

Room 1501 A1, Grand Millennium Plaza
(Lower Block), 181 Queen's Road Central,
Hong Kong, China

(540)

MIXTECH

(591) Black, white

(526) MIXTECH

(511)

35 – Business management assistance; business inquiries; outdoor advertising; import-export agency services; commercial information agency services; cost price analysis; dissemination of advertising matter; photocopying services; employment agency services; office machines and equipment rental; accounting; drawing up of statements of accounts; business auditing; business management and organization consultancy; personnel management consultancy; business management consultancy; typing; demonstration of goods; direct mail advertising; commercial or industrial management assistance; document reproduction; updating of advertising material; distribution of samples; business efficiency expert services; auctioneering; market studies; business appraisals; business investigations; publicity material rental; business organization consultancy; publication of publicity texts; advertising; radio advertising; business research; public relations; shorthand; television advertising; transcription of communications [office functions]; shop window dressing; advertising agencies; advisory services for business management; modelling for advertising or sales promotion; marketing research; computerized file management; professional business consultancy; economic forecasting; organization of exhibitions for commercial or advertising purposes; business information; opinion polling; payroll preparation; personnel recruitment; relocation services for businesses; rental of advertising space; sales promotion for others; secretarial services; tax preparation; telephone answering for unavailable subscribers; word processing; arranging newspaper subscriptions for others; advertising by mail order; business management of hotels; business management of performing artists; compilation of information into computer databases; systemization of information into computer databases; organization of trade fairs for commercial or advertising purposes; rental of photocopying machines; on-line advertising on a computer network; procurement services for others [purchasing goods and services for other businesses]; data search in computer files for others; rental of advertising time on communication media; news clipping services; rental of vending machines; psychological testing for the selection of personnel; price comparison services; presentation of goods on communication media, for retail purposes; commercial information and advice for consumers [consumer advice shop]; arranging subscriptions to telecommunication services for others; ad-

ministrative processing of purchase orders; commercial administration of the licensing of the goods and services of others; outsourcing services [business assistance]; invoicing; writing of publicity texts; compilation of statistics; layout services for advertising purposes; sponsorship search; organization of fashion shows for promotional purposes; production of advertising films; business management of sports people; marketing; telemarketing services; retail or wholesale services for pharmaceutical, veterinary and sanitary preparations and medical supplies; rental of sales stands; provision of commercial and business contact information; search engine optimization for sales promotion; web site traffic optimization; pay per click advertising; commercial intermediation services; business management for freelance service providers; negotiation and conclusion of commercial transactions for third parties; updating and maintenance of data in computer databases; business project management services for construction projects; providing business information via a web site; provision of an on-line marketplace for buyers and sellers of goods and services; design of advertising materials; outsourced administrative management for companies; tax filing services; business management of reimbursement programs for others; rental of billboards [advertising boards]; writing of curriculum vitae for others; web indexing for commercial or advertising purposes; administration of frequent flyer programs; appointment scheduling services [office functions]; appointment reminder services [office functions]; administration of consumer loyalty programs; scriptwriting for advertising purposes; retail and wholesale store services; online retail store services.

(260) AM 2019 100318 A
 (800) 1432762
 (151) 2018 06 07
 (891) 2018 06 07
 (731) Aktsionernoye obshchestvo "BAYAN SULU"
 ul. Borodina, 198, 110006 g. Kostanay,
 Kazakhstan
 (540)



(591) Black, white
 (531) 03.07.24; 26.13.25

(511)
 29 – Marmalade.
 30 – Pastry and confectionery.
 35 – Wholesale and retailing services relating to the sale of goods; promoting the goods of others through the intermediaries; import-export agency services; advertising.

(260) AM 2019 100319 A
 (800) 1432785
 (151) 2018 10 11
 (891) 2018 10 11
 (731) BAYER AKTIENGESELLSCHAFT
 Kaiser-Wilhelm-Allee, 51373 Leverkusen,
 Germany
 (540)

RIMVEKTA

(591) Black, white
 (511)
 5 – Pharmaceutical preparations and substances.

(260) AM 2019 100320 A
 (800) 1432790
 (151) 2018 08 02
 (891) 2018 08 02
 (731) QIERTE CORPORATION LIMITED
 Hujing Business Building, South Part,
 Huzhong Village, Chendai Town,
 Jinjiang, Quanzhou, Fujian, China
 (540)

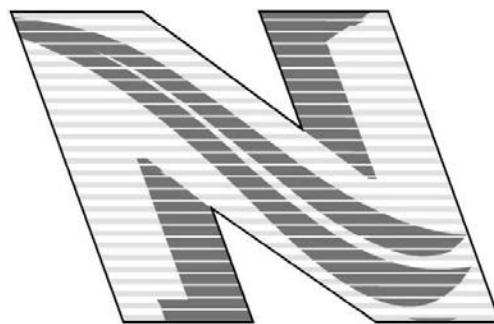

(591) Black, white
 (531) 27.05.11; 27.05.21
 (511)
 25 – Clothing; layettes [clothing]; bathing suits; dance clothing; shoes; hats; hosiery; gloves [clothing]; scarfs; leather belts [clothing].

(260) AM 2019 100321 A
 (800) 1432793
 (151) 2018 08 30
 (891) 2018 08 30
 (731) BAYER AKTIENGESELLSCHAFT
 Kaiser-Wilhelm-Allee, 51373 Leverkusen,
 Germany

(540)



(591) Black, white

(531) 01.13.15; 24.17.02; 26.01.01; 26.01.03;
26.01.12; 26.01.13; 26.13.25

(511)

5 – Pharmaceutical preparations.

(260) AM 2019 100322 A

(800) 1432799

(151) 2018 06 29

(891) 2018 06 29

(731) PUBLIC JOINT STOCK COMPANY
GAZPROM NEFT
Kab. 2401, Ch.Pom. 1N, Liter A, Dom 3-5,
Pochtamskaya Ulitsa RU-190000 ST
PETERSBURG, Russian Federation

(540)



(591) White and blue

(531) 19.01.01; 19.01.06; 29.01.12

(554) Three-dimensional

(511)

4 – Anthracite; benzene; biomass fuel; wood briquettes; combustible briquettes; petroleum jelly for industrial purposes; wax [raw material]; ozokerite; illuminating wax; industrial wax; belting wax; carnauba wax; beeswax; beeswax for use in the manufacture of cosmetics; gas for lighting; oil-gas; fuel gas; gasoline; producer gas; solidified gases [fuel]; fuel; lubricating graphite; additives, non-chemical, to motor fuel; firewood; paper spills for lighting; cu-

ting fluids; fish oil, not edible; greases for the preservation of leather; illuminating grease; grease for leather; grease for footwear; tallow; industrial grease; kerosene; coke; lanolin for use in the manufacture of cosmetics; ligroin; wood spills for lighting; wax for skis; mazut; fuel oil; oils for the preservation of leather; oils for paints; oils for releasing form work [building]; oils for the preservation of masonry; textile oil; lubricating oil; industrial oil; moistening oil; coal tar oil; coal naphtha; castor oil for industrial purposes; bone oil for industrial purposes; motor oil; sunflower oil for industrial purposes; rape oil for industrial purposes; lubricants; naphtha; petroleum, raw or refined; nightlights [candles]; oleine; paraffin; dust removing preparations; soya bean oil preparations for non-stick treatment of cooking utensils; non-slipping preparations for belts; coal dust [fuel]; firelighters; perfumed candles; Christmas tree candles; candles; grease for arms [weapons]; lubricating grease; grease for belts; vaporized fuel mixtures; dust absorbing compositions; dust binding compositions for sweeping; dust laying compositions; alcohol [fuel]; stearine; benzene fuel; diesel oil; lighting fuel; xylene fuel; mineral fuel; carburants; fuel with an alcohol base; petrol; peat [fuel]; peat briquettes [fuel]; tinder; lignite; charcoal [fuel]; coal; coal briquettes; lamp wicks; wicks for candles; ceresine; electrical energy; ethanol [fuel]; petroleum ether.

(260) AM 2019 100323 A

(800) 1432802

(151) 2018 08 10

(891) 2018 08 10

(731) SHENZHEN KENXINDA TECHNOLOGY
CO., LTD
Room 1801, 1802, 1803, 1805, 1806, 1807,
1808, 1809, 18th Floor, Fuchun Orient
Building, Shennan Road, Futian District,
Shenzhen City, Guangdong Province, China

(540)

KXD

(591) Black, white

(531) 27.05.17; 27.05.23

(511)

9 – Cell phones; intercommunication apparatus; radiotelephony sets; video telephones; cell phone straps; mobile phones; smartphones; cordless telephones; telephone apparatus; telephone wires.

(260) AM 2019 100324 A

(800) 1432806

(151) 2018 06 29

(891) 2018 06 29

(731) PUBLIC JOINT STOCK COMPANY
GAZPROM NEFT

Kab. 2401, Ch.Pom. 1N, Liter A, Dom 3-5,
Pochtamskaya Ulitsa RU-190000 ST
PETERSBURG, Russian Federation

(540)



(591) Orange and brown

(531) 19.01.01; 19.01.06; 27.05.21; 29.01.12

(554) Three-dimensional

(511)

4 – Anthracite; benzene; biomass fuel; wood briquettes; combustible briquettes; petroleum jelly for industrial purposes; wax [raw material]; ozokerite; illuminating wax; industrial wax; belting wax; carnauba wax; beeswax; beeswax for use in the manufacture of cosmetics; gas for lighting; oil-gas; fuel gas; gasoline; producer gas; solidified gases [fuel]; fuel; lubricating graphite; additives, non-chemical, to motor fuel; firewood; paper spills for lighting; cutting fluids; fish oil, not edible; greases for the preservation of leather; illuminating grease; grease for leather; grease for footwear; tallow; industrial grease; kerosene; coke; lanolin for use in the manufacture of cosmetics; ligroin; wood spills for lighting; wax for skis; mazut; fuel oil; oils for the preservation of leather; oils for paints; oils for releasing form work [building]; oils for the preservation of masonry; textile oil; lubricating oil; industrial oil; moistening oil; coal tar oil; coal naphtha; castor oil for industrial purposes; bone oil for industrial purposes; motor oil; sunflower oil for industrial purposes; rape oil for industrial purposes; lubricants; naphtha; petroleum, raw or refined; nightlights [candles]; oleine; paraffin; dust removing preparations; soya bean oil preparations for non-stick treatment of cooking utensils; non-slipping preparations for belts; coal dust [fuel]; firelighters; perfumed candles; Christmas tree candles; candles; grease for arms [weapons]; lubricating grease; grease for belts; vaporized fuel mixtures; dust absorbing compositions; dust binding compositions for sweeping; dust laying compositions; alcohol [fuel]; stearine; benzene fuel; diesel oil; lighting fuel; xylene fuel; mineral fuel; carburants; fuel with an alcohol base; petrol; peat [fuel]; peat briquettes [fuel]; tinder; lignite; charcoal [fuel]; coal;

coal briquettes; lamp wicks; wicks for candles; cere-sine; electrical energy; ethanol [fuel]; petroleum ether.

(260) AM 2019 100325 A

(800) 1432810

(151) 2018 08 02

(891) 2018 08 02

(731) QIERTE CORPORATION LIMITED

Hujing Business Building, South Part,
Huzhong Village, Chendai Town, Jinjiang,
Quanzhou, Fujian, China

(540)



(591) Black, white

(531) 27.05.21

(511)

25 – Clothing; layettes [clothing]; bathing suits; dance clothing; shoes; hats; hosiery; gloves [clothing]; scarfs; leather belts [clothing].

(260) AM 2019 100326 A

(800) 1432845

(151) 2018 08 02

(891) 2018 08 02

(731) QIERTE CORPORATION LIMITED

Hujing Business Building, South Part,
Huzhong Village, Chendai Town, Jinjiang,
Quanzhou, Fujian, China

(540)



(591) Black, white

(531) 24.17.05; 26.04.24; 27.05.24

(511)

25 – Clothing; ready-made clothing; layettes [clothing]; bathing suits; shoes; hats; hosiery; gloves [clothing]; neckties; leather belts [clothing].

(260) AM 2019 100327 A

(800) 1432849

(151) 2018 08 02

(891) 2018 08 02

(731) QIERTE CORPORATION LIMITED

Hujing Business Building, South Part,
Huzhong Village, Chendai Town, Jinjiang,
Quanzhou, Fujian, China

(540)



(591) Black, white

(531) 27.05.11; 27.05.21

(511)

25 – Clothing; ready-made clothing; layettes [clothing]; bathing suits; shoes; hats; hosiery; gloves [clothing]; scarfs; leather belts [clothing].

(260) AM 2019 100328 A

(800) 1432852

(151) 2018 10 10

(891) 2018 10 10

(731) MARUSSIA BEVERAGES B.V.

Siriusdreef 41 NL-2132 WT HOOFFDORP,
Netherlands

(540)

MOSSBURN

(591) Black, white

(511)

33 – Alcoholic beverages (except beers); whisky; spirits.

(260) AM 2019 100329 A

(800) 1432867

(151) 2018 08 02

(891) 2018 08 02

(731) XINBAILUN (CHINA) SPORTING GOODS
CO., LTDNo.328 Shanqian, Yuqian Village, Zhangban
Town, Taiwan Merchants Investment Zone,
Quanzhou, Fujian, China

(540)

PRES-JOG

(591) Black, white

(531) 27.05.01

(511)

18 – Animal skins; pocket wallets; travelling sets [leatherware]; school satchels; trimmings of leather for furniture; slings for carrying infants; umbrellas; sling bags for carrying infants; walking sticks; harness fittings.

25 – Clothing; layettes [clothing]; bathing suits; ready-made clothing; shoes; hats; hosiery; gloves [clothing]; leather belts [clothing]; scarfs.

28 – Apparatus for games; toys; Go board games; playing card; playing balls; body-building apparatus; machines for physical exercises; swimming pools [play articles]; protective paddings [parts of sports suits]; in-line roller skates.

(260) AM 2019 100330 A

(800) 1432891

(151) 2018 07 31

(891) 2018 07 31

(731) DR. THEISS NATURWAREN GMBH

Michelinstr. 10, 66406 Homburg, Germany

(540)



(591) Black, white, grey

(531) 01.15.21; 19.03.01; 19.03.25; 26.01.01;
26.01.18; 26.04.05; 26.04.12; 26.04.16;
26.04.18; 26.11.02; 26.11.13; 26.15.01;
27.05.09; 29.01.13

(511)

3 – Bleaching preparations and laundry preparations; Cleaning, polishing, scouring and abrasive preparations; Perfumery, essential oils, non-medicated cosmetics, including non-medicated skin cleaning and skin care preparations, and hair care preparations; Non-medicated dentifrices.

5 – Pharmaceutical and veterinary preparations; Medicines for human purposes; Medicines for veterinary purposes; Sanitary preparations for medical purposes; Dietetic foodstuffs and substances adapted for medical use; Nutritional supplements for humans and animals; Vitamin preparations.

(260) AM 2019 100331 A
 (800) 1432895
 (151) 2018 07 31
 (891) 2018 07 31
 (731) DR. THEISS NATURWAREN GMBH
 Michelinstr. 10, 66406 Homburg, Germany
 (540)



(591) Red, black, white, grey
 (531) 01.15.21; 19.03.01; 19.03.25; 26.01.01;
 26.01.18; 26.04.05; 26.04.10; 26.04.12;
 26.04.16; 26.04.18; 26.11.02; 26.11.13;
 26.15.01; 27.05.09; 29.01.14

(511)
 3 – Bleaching preparations and laundry preparations;
 Cleaning, polishing, scouring and abrasive prepara-
 tions; Perfumery, essential oils, non-medicated cos-
 metics, including non-medicated skin cleaning and
 skin care preparations, and hair care preparations;
 Non-medicated dentifrices.

5 – Pharmaceutical and veterinary preparations; Me-
 dicines for human purposes; Medicines for veterina-
 ry purposes; Sanitary preparations for medical pur-
 poses; Dietetic foodstuffs and substances adapted for
 medical use; Nutritional supplements for humans
 and animals; Vitamin preparations.

(260) AM 2019 100334 A
 (800) 1432932
 (151) 2018 09 29
 (891) 2018 09 29
 (731) BECTON, DICKINSON AND COMPANY
 1 Becton Drive, MC 090, Franklin Lakes NJ
 07417, USA
 (540)

BD VACUTAINER ECLIPSE ULTRAFILL

(591) Black, white
 (511)
 10 – Blood collection needles.

(260) AM 2019 100341 A
 (800) 1433032
 (151) 2018 06 08
 (891) 2018 06 08
 (731) BERGERODE B.V.
 Velperweg 76, NL-6824 BM Arnhem, Netherlands
 (540)

NOURYON

(591) Black, white
 (511)
 5 – Chemicals for pharmaceutical use; salts for me-
 dical purposes; magnesium salts for pharmaceutical
 use; mineral salts for medical purposes; sodium salts
 for medical purposes; combinations of calcium salts
 for pharmaceutical use; disinfectants; preparations
 for destroying vermin; fungicides, herbicides.

30 – Salt; spices; dried herbs; condiments.

(260) AM 2019 100473 A
 (800) 1433835
 (151) 2018 09 03
 (891) 2018 09 03
 (731) SANOFI BIOTECHNOLOGY
 54 rue La Boétie, F-75008 Paris, France
 (540)



(591) Red Pantone 233C, Yellow Pantone 383C,
 Blue Pantone 3025C
 (531) 26.01.01; 26.01.06; 26.11.03; 26.11.12;
 27.05.09; 29.01.13
 (511)
 44 – Provision of information relating to cancer dia-
 gnosis and treatment.

(260) AM 2019 100476 A
 (800) 1433854
 (151) 2018 05 15
 (891) 2018 05 15
 (731) SEL SANAYİ ÜRÜNLERİ TİCARET VE
 PAZARLAMA ANONİM ŞİRKETİ
 Piyalepaşa Bulv. Kastel İş Merkezi No:124, D
 Blok Kat:7, Kasımpaşa Beyoğlu, İstanbul, Turkey
 (540)



(591) Red, white
 (531) 26.04.01; 26.04.18; 27.05.01; 27.05.22;
 27.05.24; 29.01.12
 (511)
 29 – Food gelatine, edible gelatine.

(260) AM 2019 100477 A
 (800) 1433862
 (151) 2018 09 28
 (891) 2018 09 28
 (731) AVON PRODUCTS, INC.
 601 Midland Avenue, Rye New York 10580,
 USA

(540)
AVON LIFE COLOUR

(591) Black, white
 (511)
 3 – Non-medicated toilet preparations; toiletries; skin care preparations; skin moisturizers; body and beauty care preparations; powders, cleansers, creams and lotions, all for the face, hands and body; cosmetic suntan preparations; soaps; shower and bath preparations; beauty masks; talcum powder; nail polish; nail polish remover; false nails; adhesives for cosmetic purposes; cosmetics; eye cream; eye gels; eye lotions; eye make-up remover; eye shadow; eye liner; mascara; lipstick; lip liner; lip-gloss; make-up foundation; blusher; tissues impregnated with cosmetic lotions; cotton sticks for cosmetic purposes; cotton wool for cosmetic purposes; preparations for cleaning, moisturising, colouring and styling the hair; preparations for cleaning the teeth; shaving and aftershave preparations; perfumes; fragrances; toilet waters; cologne; deodorants for human beings; anti-perspirants for personal use (toiletries); essential oils (cosmetic).

(260) AM 2019 100480 A
 (800) 1433937
 (151) 2018 09 13
 (891) 2018 09 13
 (731) EPIC GAMES, INC.
 620 Crossroads Boulevard, Cary NC 27518,
 USA

(540)



(591) Black, white
 (531) 26.04.18; 26.04.24; 27.05.24
 (511)
 9 – Stands for handheld digital electronic devices, namely, cell phones.
 14 – Charms for key rings or key chains; key chains; pins being jewelry.

18 – Backpacks.
 25 – Costumes for use in role-playing games; halloween costumes; socks; sweatshirts.
 26 – Ornamental novelty pins; wigs.
 28 – Bobble head dolls; collectable toy figures; halloween masks; modeled plastic toy figurines; play figures; toy action figures and accessories therefor; toy figures; toy vehicles; toy vehicles and accessories therefor; toys, namely, children's dress-up accessories.

(260) AM 2019 100481 A
 (800) 1433939
 (151) 2018 09 13
 (891) 2018 09 13
 (731) EPIC GAMES, INC.
 620 Crossroads Boulevard, Cary NC 27518,
 USA

(540)

FORTNITE

(591) Black, white
 (511)
 9 – Stands for handheld digital electronic devices, namely, cell phones.
 14 – Charms for key rings or key chains; key chains; pins being jewelry.
 18 – Backpacks.
 25 – Costumes for use in role-playing games; Halloween costumes; socks; sweatshirts.
 26 – Ornamental novelty pins; wigs.
 28 – Bobble head dolls; collectable toy figures; Halloween masks; modeled plastic toy figurines; play figures; toy action figures and accessories therefor; toy figures; toy vehicles; toy vehicles and accessories therefor; toys, namely, children's dress-up accessories.

(260) AM 2019 100483 A
 (800) 1434016
 (151) 2018 09 05
 (891) 2018 09 05
 (731) APPLE INC.
 One Apple Park Way, Cupertino CA 95014, USA
 (540)



(591) Black, white
 (531) 27.05.01
 (511)
 9 – Computers, computer hardware, computer peripherals.

(260) AM 2019 100485 A

(800) 1434172

(151) 2018 08 02

(891) 2018 08 02

(731) GUANGZHOU MINI KING FOOD CO., LTD.

Rm. 807, 808 (position:601, 608), 6&7F,
No.1 Qingyi St., Tianhe Dist., Guangzhou,
Guangdong, China

(540)



(591) Black, white

(531) 02.05.01; 02.05.02; 27.05.02; 28.03

(511)

29 – Meat; fruit-based snack food; vegetables, preserved; eggs; milk products; oils for food; nuts, prepared; albumen for culinary purposes; fruit jellies; fish-based foodstuffs.

35 – Advertising; professional business consultancy; retail or wholesale services for medical supplies; import-export agency services; personnel management consultancy; relocation services for businesses; systemization of information into computer databases; book-keeping; organization of trade fairs for commercial or advertising purposes; commercial administration of the licensing of the goods and services of others.

(260) AM 2019 100487 A

(800) 1434194

(151) 2018 09 25

(891) 2018 09 25

(731) RAHMANI GROUP S.p.A.

Largo Guido Donegani, 2, I-20121 MILANO,
Italy

(540)

ROSTANI

(591) Black, white

(511)

30 – Pasta; deep frozen pasta; alimentary paste [dough]; instant noodles; fresh pasta; puff pastry; pasta sauce; almond paste; pasta salad; pasta containing stuffings; bread doughs; ready-made dishes containing pasta; prepared meals containing [principally] pasta; spaghetti; vinegar; flavoured vinegar; wine vinegar; fruit vinegar; tomato sauce; canned spaghetti in tomato sauce; sauces; sauces [condiments]; food dressings [sauces]; meat pies; meat gravies; canned sauces; canned pasta foods; boxed lunches consisting of rice, with added meat, fish or vegetables; pre-packaged lunches consisting primarily of rice, and also including meat, fish or vegetables; vege-

tal preparations for use as coffee substitutes; vegetable concentrates used for seasoning; vegetable pies; vegetable purees [sauces]; frozen pastry stuffed with vegetables; stir-fried noodles with vegetables (japchae); filled yeast dough with fillings consisting of vegetables; bibimbap [rice mixed with vegetables and beef]; frozen pastry stuffed with meat and vegetables; frozen prepared rice with seasonings and vegetables; pizzas; fresh pizza; pizzas [prepared]; preserved pizzas; frozen pizzas; chilled pizzas; uncooked pizzas; pizza dough; pizza crust; pizza bases; bread; wholemeal bread; cookies; rusks; crackers; brioche; tarts; cakes; salted tarts; fresh pies; candy cake; fruit cakes; cake dough; dumplings; apple tarts; cream pies; pastries; wholemeal pasta; sour dough; ice cream; ice cream confectionery; chilled desserts; ice cream stick bars; ice confectionery; chocolate extracts for the preparation of beverages; coffee essences; essences for foodstuffs, except etheric essences and essential oils; spices; seasoning mixes; fruit jellies [confectionery]; caramels [candy]; yeast powder; baking powder; yeast and leavening agents; yeast; salt; spiced salt; sugar; chili oil for use as a seasoning or condiment; prepared rice dishes; prepared pizza meals; dry and liquid ready-to-serve meals, mainly consisting of pasta; candy; bakery goods; biscotti dough; cereal bars and energy bars; gingerbread nuts; snack bars containing a mixture of grains, nuts and dried fruit [confectionery]; sweet rice with nuts and jujubes (yaksik); food mixtures consisting of cereal flakes and dried fruits; ginger puree; ginger [spice]; preserved ginger; ginger tea; pastries, cakes, tarts and biscuits (cookies); cereals; cereal-based snack food; cereal powders; cereal bars; cereal preparations; processed grains; breakfast cereals, porridge and grits; breakfast cereals; chips [cereal products]; cereal based food bars; cereal based energy bars; preparations made from cereals; muesli; muesli bars; muesli desserts; snacks manufactured from muesli; muesli consisting predominantly of cereals; processed corn; corn, roasted; sugars, natural sweeteners, sweet coatings and fillings, bee products; sweets (candy), candy bars and chewing gum; tea; tea essences; tea mixtures; darjeeling tea; black tea; tea leaves; mate [tea]; oolong tea; black tea [english tea]; white tea; fruit teas; ginseng tea; tea extracts; flavourings of tea; infusions, not medicinal; herbal infusions; tea for infusions; tea-based beverages; earl grey tea; red ginseng tea; packaged tea [other than for medicinal use]; tea bags (non-medicated -); instant tea [other than for medicinal purposes]; coffee, teas and cocoa and substitutes therefor; herb teas, other than for medicinal use; aromatic teas [other than for medicinal use]; coffee; decaffeinated coffee; artificial coffee; mixtures of coffee; coffee flavorings [flavourings]; coffee-based beverages; beverages (coffee-based -); coffee based drinks; ground coffee.

(260) AM 2019 100488 A
 (800) 1434211
 (151) 2018 05 10
 (891) 2018 05 10
 (731) DİORA KİMYA SANAYİ VE TİCARET
 LİMİTED ŞİRKETİ
 2.Organize Sanayi Bölgesi, 83326 No'lu
 cadde No:26, Şehitkamil, Gaziantep, Turkey
 (540)

LOLE'S

(591) Black, white
 (531) 27.05.01
 (511)
 3 – Bleaching and cleaning preparations, detergents other than for use in manufacturing operations and for medical purposes, laundry bleach, fabric softeners for laundry use, stain removers, dishwasher detergents; perfumery, cosmetics, fragrances, deodorants for personal use and animals; soaps; dental care preparations, dentifrices, denture polishes, tooth whitening preparations, mouth washes, not for medical purposes; abrasive preparations, emery cloth, sandpaper, pumice stone, abrasive pastes; polishing preparations for leather, vinyl, metal and wood, polishes and creams for leather, vinyl, metal and wood, wax for polishing.

(260) AM 2019 100489 A
 (800) 1434232
 (151) 2018 08 10
 (891) 2018 08 10
 (731) SHENZHEN ZHIZHI BRAND
 INCUBATION, CO., LTD.
 Rm. 3001, Vanke's Day Central Plaza, Dragon
 Avenue, Longgang, Shenzhen, China

(540)
Jordan & Judy

(591) Black, white
 (531) 24.17.09
 (511)
 35 – Personnel recruitment; advertising; presentation of goods on communication media, for retail purposes; commercial administration of the licensing of the goods and services of others; providing business information via a web site; marketing; import-export agency services; sales promotion for others; provision of an on-line marketplace for buyers and sellers of goods and services; procurement services for others [purchasing goods and services for other businesses].

(260) AM 2019 100490 A
 (800) 1434248
 (151) 2018 07 17

(891) 2018 07 17
 (731) HENKEL AG & CO. KGAA
 Henkelstrasse 67, 40589 Düsseldorf, Germany
 (540)



(591) Black, yellow and red
 (531) 07.01.09; 07.01.24; 14.03.03; 26.04.05;
 26.04.16; 26.04.18; 26.04.24; 27.03.15;
 27.05.10; 29.01.14

(511)
 1 – Adhesives for industrial use; tile adhesives.

16 – Adhesives for stationery and household purposes.

17 – Insulating tapes, adhesive caulking compounds; adhesive tapes, strips, bands and films, other than stationery and not for medical or household purposes; adhesive bands other than stationery and not for household purposes; self-adhesive tapes other than for stationery and not for household purposes; adhesive tapes for industrial purposes; adhesive sealant and caulking compound; insulating materials; sealant compounds for joints; expansion joint fillers; insulating materials for building; insulating materials made of polyurethane foam; insulating plaster; insulating varnish; packing, stopping and insulating materials, sealants; silicone sealants; seals, sealants and fillers.

(260) AM 2019 100491 A
 (800) 1434296
 (151) 2018 09 28
 (891) 2018 09 28
 (731) BIOFARMA
 50 rue Carnot, F-92284 Suresnes Cedex,
 France

(540)

EMOTRALEX

(591) Black, white

(511)

5 – Pharmaceutical products, medical and veterinary preparations; sanitary products for medical purposes; dietetic substances and foodstuffs for medical or veterinary use, food for babies; food supplements for humans and animals; plasters, materials for dressings; material for dental fillings and dental impressions; disinfectants; products for destroying vermin; fungicides, herbicides.

(260) AM 2019 100492 A
 (800) 1434303
 (151) 2018 08 13
 (891) 2018 08 13
 (731) WENZHOU DENGKE ELECTRONICS, CO.,
 LTD.
 No.2 Baocheng Road, Xianyan Industrial
 District, Ouhai, Wenzhou, Zhejiang, China

(540)

D&K

(591) Black, white
 (531) 24.17.09; 27.05.17
 (511)

34 – Tobacco pipes; ashtrays for smokers; pipe racks for tobacco pipes; cigarette filters; pipe cleaners for tobacco pipes; cigarette paper; snuff boxes; snuff; lighters for smokers; cigarette cases; pocket machines for rolling cigarettes.

(260) AM 2019 100493 A
 (800) 1434318
 (151) 2018 09 17
 (891) 2018 09 17
 (731) GANT AB
 P.O. Box 27021, SE-102 51 Stockholm,
 Sweden

(540)



(591) Black, white
 (531) 26.04.03; 26.04.18; 27.05.21
 (511)

14 – Precious metals and their alloys and goods made of these materials or coated therewith not included in other classes; jewelry, precious stones; timepieces and chronometric instruments, cases or presentation cases for timepieces.

(260) AM 2019 100506 A
 (800) 961259
 (151) 2008 01 30
 (891) 2018 09 17
 (731) PROMO-FRUIT AG
 Schluchewäg 1, CH-8197 Rafz, Switzerland

(540)

TulaMagic

(591) Black, white
 (531) 27.05.02
 (511)
 31 – Raspberry bushes, propagation equipment (not included in other classes), plant parts (live), raspberries.

(260) AM 2019 100514 A
 (800) 1422967
 (151) 2018 02 21
 (891) 2018 10 16
 (731) MATICA TECHNOLOGIES AG
 Theresienhöhe 30, 80339 München, Germany

(540)

Matica

(591) Black, white
 (511)
 9 – Printers; laser beam printers; ink jet printers; thermal printers; dye-sub printers; photo printers; copying machines; colour copiers; fax devices; image scanning apparatus; devices for reading and writing data carriers, in particular for magnetic or electronic credit and debit cards and identification and security cards; memory chips; apparatus for the input and output of digital and analog data; recorded content; information technology and audiovisual equipment; safety, security, protection and signalling devices; photographic, holographic, optical, physical, electric, electronic, optical image processing, measuring, signalling, checking (supervision), detecting and monitoring instruments, devices, apparatus and electric regulating apparatus; apparatus, instruments and cables for electricity; apparatus for recording, transmission or reproduction of images; magnetic data carriers; magnetic tape units; data processing apparatus; data storage apparatus; exposure meters; computers; devices for operating, controlling and communicating with communication and telecommunication equipment; safety and control devices for computers, computer networks and telecommunication equipment; software and firmware for operating printer hardware and peripherals; application programs; software drivers; printer drivers; it management software; card reading equipment; encoded cards; read only memory [rom] cards; electronic card readers; usb card readers; printed cards [encoded]; printed cards [magnetic]; encoded cards for use in point of sale transactions; smart cards [integrated circuit cards]; smart cards [integrated circuit cards]; cards bearing electronically recorded data; encoded integrated circuit cards; electronic cards for processing images; card operated electronic locks; encoded cards for use in relation to the electronic transfer of funds; cards encoded with security features for identification purposes; cards encoded to access computer software; encoded cards for use in relation to the electronic transfer of financial transactions; augmented reality software for creating maps; software for

the operational management of portable magnetic and electronic cards; electronic and magnetic id cards for use in connection with payment for services; parts, fittings and replacement parts for all of the aforesaid apparatus, devices, instruments, computer programs and components; printheads; retransfer films; cables; plugs; sorters, being parts of printers; data carriers, passport printers, embossers for plastic cards.

16 – Ink; ink ribbons.

(260) AM 2019 100515 A

(800) 1434664

(151) 2018 05 22

(891) 2018 05 22

(731) CHENGDU KANGHONG

PHARMACEUTICALS GROUP CO., LTD.

No.36, Shuxi Rd., Jinniu District, Chengdu,

Sichuan, China

(540)



(591) Black, white

(531) 26.03.23; 26.04.16; 28.03

(511)

5 – Mothproofing preparations; radioactive drugs for medical purposes; chemico-pharmaceutical preparations; tissues impregnated with pharmaceutical lotions; depuratives; media for bacteriological cultures; medicinal preparations for the mouth in the form of tablets; semen for artificial insemination; medicines for human purposes; vermin destroying preparations; biochemical drug for medical purposes; medicines for veterinary purposes; suppositories; pharmaceutical preparations in the form of liquid; disinfectants for hygiene purposes; mosquito-repellent incense; tissues impregnated with sterilization preparations; chemical conductors for electrocardiograph electrodes; dental lacquer; medicinal drinks in the nature of herb liqueurs; pharmaceutical preparations; infusions for medical purposes; gases for medical purposes; wadding for medical purposes; drugs for medical purposes; bath preparations for medical purposes; diagnostic agents for medical purposes; solutions for contact lenses; crude drugs; pharmaceutical preparations in the form of injection; traditional Chinese medicines; Chinese medicine bag, filled with traditional Chinese medicines.

(260) AM 2019 100516 A

(800) 1434687

(151) 2018 08 10

(891) 2018 08 10

(731) SHENZHEN LONGBO WATCHES
INDUSTRY CO., LTD.

fifth floor, Building B, Chenglong Qiukou
Industrial Park, Xixiang 107 National Road
West, Baoan District, Shenzhen, Guangdong,
China

(540)

LONGBO

(591) Black, white

(531) 27.05.01

(511)

14 – Platinum [metal]; boxes of precious metal; bracelets [jewelry]; clocks; wristwatches; clocks and watches; watch chains; clock cases; watches; watch cases.

(260) AM 2019 100519 A

(800) 1434840

(151) 2018 09 10

(891) 2018 09 10

(731) INDUSTRY LLC

ul. KONSTANTINA SASLONOVA, 187,

Belgorod, RU-308017 Belgorodskaya Oblast,

Russian Federation

(540)



(591) Red, gray and black.

(531) 26.11.01; 26.11.06; 26.11.13; 27.05.01;
27.05.21; 29.01.13

(526) industry

(511)

1 – Adhesives for wallpaper; glue for industrial purposes; gums [adhesives] for industrial purposes.

27 – Wallpaper; textile wallpaper.

(260) AM 2019 100520 A

(800) 1434850

(151) 2018 02 06

(891) 2018 02 06

(731) ADP GAUSELMANN GMBH

Merkur-Allee 1-15, 32339 Espelkamp,

Germany

(540)

7 Temptations

(591) Black, white

(511)

9 – Computer software; coin-operated mechanisms; computer and video games software; games software in particular for use on any computer platform, including electronic entertainment and games consoles; computer game programs; video games (software); computer games provided through a global computer network or supplied by means of multi-media elec-

tronic broadcast or through telecommunications or electronic transmission or via the internet; computer games, leisure and recreational software, video games and computer software, all being provided in the form of storage media; programs for operating electric and electronic apparatus for games, amusement and/or entertainment purposes; computer software for computer games on the internet; online games (software), in particular for online betting games, online prize games, online gambling games, online games of skill and online casino games; computer software in the form of an app for mobile devices and computers; calculating apparatus in coin-operated machines and parts for the aforesaid goods; electric, electronic, optical or automatic apparatus, for identifying data carriers, identity cards and credit cards, bank notes and coins; software in particular for casino and/or amusement arcade games, for gaming machines and/or slot machines each one with or without prize payouts; gaming software that generates or displays wager outcomes of gaming machines; operational computer games software; computer software for managing of games (game collection); computer programs for video games.

28 – Games; toys; gaming apparatus (including coin-operated apparatus); coin-operated arcade games (machines); games for amusement arcades (included in this class); coin-operated video gaming apparatus; video games apparatus adapted for use with external screens or monitors only; casino fittings, namely roulette tables, roulette wheels; coin-operated automatic gaming machines and gaming machines, in particular for gaming arcades, with or without a prize payout; electronic or electrotechnical gaming apparatus, automatic gaming machines, gaming machines, slot machines operated by coins, tokens, banknotes, tickets or by means of electronic, magnetic or biometric storage media, in particular for commercial use in casinos and amusement arcades, with or without a prize payout; automatic gaming machines and gaming machines, in particular for commercial use in casinos and gaming arcades, with or without a prize payout; coin-operated gaming machines and/or electronic money-based gaming apparatus (machines), with or without prizes; housings adapted for gaming machines, gaming apparatus and automatic gaming machines, operated by means of coins, tokens, tickets or by means of electronic, magnetic or biometric storage media, in particular for commercial use in casinos and gaming arcades, with or without a prize payout; electronic games; electronic game entertainment apparatus and parts thereof; video output game machines; drawing apparatus for prize games and lotteries, draws or raffles; housings of metal, plastic and/or wood for coin-operated automatic machines; apparatus for games (including video games), other than adapted for use with external screens or monitors only; electropneumatic and electric slot machines with pulling handles (gaming machines); gaming

tables, in particular for table football, billiards, sliding games; flying discs (toys) and darts; gaming machines, namely, electric, electronic or electromechanical apparatus for bingo games, lotteries or video lottery games and for betting offices, connected or unconnected to a computer network; LCD games consoles; automatic gaming machines; all the aforesaid automatic gaming machines operating in networks; apparatus and devices for accepting and storing money, being fittings for the aforesaid automatic machines, included in this class; automatic lottery machines.

(260) AM 2019 100521 A

(800) 1434884

(151) 2018 07 02

(891) 2018 07 02

(731) CHINA VANKE CO., LTD.

Vanke Center, No.33 Huanmei Road,
Dameisha, Yantian District, Shenzhen,
Guangdong Province, China

(540)



(591) Black, white

(531) 28.03

(511)

36 – Trusteeship; insurance underwriting; financial management; real estate management; real estate services relating to the sale, purchase and leasing of real estate; brokerage; lending against security; art appraisal; surety services; charitable fund raising.

37 – Knife sharpening; installation and repair medical equipment; clock and watch repair; spraying services; elevator installation and repair; rental of drainage pumps; building construction supervision; machinery installation, maintenance and repair; airplane maintenance and repair; shipbuilding; retreading of tires [tyres]; furniture maintenance; disinfecting; pump repair; restoration of works of art; hand tool repair; installation and repair recreational sports facilities; fire alarm installation and repair; telephone installation and repair; shoe repair; commercial housing construction; mining extraction; heating equipment installation and repair; interference suppression in electrical apparatus; photographic apparatus repair; repair of power lines; upholstery repair; motor vehicle maintenance and repair; strong-room maintenance and repair; umbrella repair; swimming-pool maintenance; jewelry repair; restoration of musical instruments; artificial snow-making services.

(260) AM 2019 100522 A

(800) 1434891

(151) 2018 08 02

(891) 2018 08 02
 (731) GP HELLENIC SOIL LIMITED
 6 KOLOKOTRONI STR, CY-1101
 NICOSIA, Cyprus

(540)



(591) Black, white
 (531) 24.01.15; 27.05.10
 (511)
 5 – Dietary supplements for humans.

(260) AM 2019 100523 A
 (800) 1434897
 (151) 2018 07 02
 (891) 2018 07 02
 (731) TCL CORPORATION
 No.19 Zone, Zhongkai High Technology
 Development Zone, Huizhou, Guangdong,
 China

(540)



(591) Black, white
 (531) 27.05.01
 (511)
 9 – Audio-receivers and video-receivers; sound reproduction apparatus; sound recording apparatus; sound transmitting apparatus; cameras; audiovisual teaching apparatus; electric wires and cables; electronic chips for the manufacture of integrated circuits; light emitting diodes (LEDs); theft prevention installations, electric; 3D spectacles; electric batteries; mobile power supply as rechargeable batteries; liquid crystal display; computers; computer programs [downloadable software]; computer peripheral devices; computer monitors; tablet computers; smartwatches; electronic agendas; copy and fax all-in-one machine; electronic notice boards; telephone apparatus; cell phones; navigational instruments; network communication devices; television sets; camcorders; headphones; video disc players; electric switches; video screens; electrical plugs and sockets and other contacts [electric connections]; domestic remote controller.

(260) AM 2019 100525 A
 (800) 1434951
 (151) 2018 09 07
 (891) 2018 09 07
 (731) APPLE INC.
 One Apple Park Way, Cupertino CA 95014,
 USA

(540)



(591) Medium blue and light blue
 (531) 02.01.01; 02.01.23; 02.01.24; 29.01.04
 (511)
 9 – Computer software used in contactless transactions with retailers, merchants, and vendors and to process mobile payments; computer software for storing, transmitting, processing, facilitating, verifying, and authenticating credit and debit card information and transaction and payment information; computer software for ensuring the security of contactless transactions with retailers, merchants and vendors, mobile payments, and of credit and debit card information; data privacy protection computer software.

(260) AM 2019 100526 A
 (800) 1434972
 (151) 2018 04 04
 (891) 2018 04 04
 (731) Limited Liability Company
 "AQUABARRIER"
 Leninskaya Sloboda, at. 1, st. 9, of. 7, k. 28-1,
 RU-115280 Moscow, Russian Federation

(540)



(591) Blue
 (531) 27.05.01; 29.01.04
 (511)
 6 – Metal coatings for deformation joints in floors, walls and ceilings.

17 – Rubber waterproofing dowels for deformation and working joints of construction and hydraulic structures (terms considered too vague by the International Bureau – rule 13 (2) (b) of the Common Regulations).

19 – Plastic waterproofing dowels for deformation and working (terms considered too vague by the International Bureau – rule 13 (2) (b) of the Common Regulations), joints of construction and hydraulic structures (terms considered too vague by the International Bureau – rule 13 (2) (b) of the Common Regulations).

(260) AM 2019 100527 A
 (800) 1435013
 (151) 2018 05 13

(891) 2018 05 13

(731) WORLD MEDICINE İLAÇ SANAYİ VE
TİCARET ANONİM ŞİRKETİ
15 Temmuz Mah. Camiyolu Cad. No.50, K.2
Güneşli Bağcılar, İstanbul, Turkey

(540)

TELMADO
ТЕЛЬМАДО

(591) Black, white

(531) 28.05

(511)

5 – Medicines for human purposes, medicines for veterinary purposes, vitamin preparations, chemical preparations for medical purposes, dietetic substances adapted for medical use, dietetic foods adapted for medical purposes, baby foods, medicinal herbs, herbal beverages adapted for medical purposes, nutritional supplements, pollen dietary supplements, mineral food supplements, protein dietary supplements, dietary supplements for animals, fodder supplements for veterinary purposes, medicines for dental purposes, hygienic products for medical purposes including sanitary pads, breast-nursing pads and bunion pads, waddings for medical purposes, plasters for medical purposes, dressings for medical purposes, babies' napkins, preparations for destroying noxious plants, preparations for destroying noxious animals, fungicides, deodorants other than for human beings or for animals, air deodorising preparations, disinfectants for hygiene purposes, antiseptics, detergents for medical purposes.

(260) AM 2019 100528 A

(800) 1435027

(151) 2018 03 23

(891) 2018 03 23

(731) PUBLIC JOINT STOCK COMPANY
GAZPROM NEFT
Kab. 2401, Ch.Pom. 1N, Liter A, Dom 3-5,
Pochtamtorskaya Ulitsa, RU-190000 ST
PETERSBURG, Russian Federation

(540)



(591) Orange, white

(531) 27.05.21; 29.01.12

(511)

1 – Agar-agar; nitrogen; actinium; alkaloids; alginates for the food industry; alginates for industrial pur-

poses; crotonic aldehyde; ammonium aldehyde; aldehydes; americium; amyl acetate; ammonia [volatile alkali] for industrial purposes; anhydrous ammonia; ammonia; acetic anhydride; anhydrides; anti-knock substances for internal combustion engines; disincrustants; antioxidants for use in the manufacture of cosmetics; antioxidants for use in the manufacture of food supplements; antioxidants for use in the manufacture of pharmaceuticals; antioxidants for use in manufacture; antistatic preparations, other than for household purposes; antifreeze; size for use in the textile industry; argon; lead arsenate; astatine; aluminium acetate; lime acetate; lead acetate; acetate of cellulose, unprocessed; acetates [chemicals]; acetylene; acetone; oenological bactericides [chemical preparations for use in wine making]; balm of gurjun [gurjon, gurjan] for making varnish; barium; barytes; albumin [animal or vegetable, raw material]; animal albumen [raw material]; iodised albumen; malt albumen; benzene; benzol; bentonite; berkelium; bicarbonate of soda for chemical purposes; potassium dioxalate; bichromate of potassium; bichromate of soda; bauxite; bromine for chemical purposes; albumenized paper; baryta paper; diazo paper; blueprint paper; test paper, chemical; self-toning paper [photography]; nitrate paper; sensitized paper; photometric paper; borax; grafting wax for trees; agglutinants for concrete; gas purifying preparations; polish removing substances; preparations for the separation of greases; substances for preventing runs in stockings; water-softening preparations; limestone hardening substances; tanning substances; adhesives for industrial purposes; surface-active chemical agents; foundry binding substances; concrete-aeration chemicals; leather-dressing chemicals; chemicals for the manufacture of paints; chemicals for the manufacture of pigments; starch-liquifying chemicals [ungluing agents]; flower preservatives; seed preserving substances; viscose; bismuth; bismuth subnitrate for chemical purposes; vitamins for the food industry; vitamins for use in the manufacture of cosmetics; vitamins for use in the manufacture of food supplements; vitamins for use in the manufacture of pharmaceuticals; witherite; distilled water; seawater for industrial purposes; acidulated water for recharging accumulators; heavy water; hydrogen; seaweeds [fertilizers]; gadolinium; getters [chemically active substances]; protective gases for welding; solidified gases for industrial purposes; basic gallate of bismuth; gallium; gambier; helium; electrophoresis gels; genes of seeds for agricultural production; hydrazine; aluminium hydrate; hydrates; hyposulfites; ceramic glazings; glycol; expanded clay for hydroponic plant growing [substrate]; kaolin; alumina; glycerides; glycerine for industrial purposes; glucose for the food industry; glucose for industrial purposes; glucosides; gluten for the food industry; gluten for industrial purposes; holmium; hormones for hastening the ripening of fruit; peat pots for horticulture; gra-

phite for industrial purposes; guano; humus; dextrin [size]; detergents for use in manufacturing processes; defoliantes; diastase for industrial purposes; kieselgur; manganese dioxide; titanium dioxide for industrial purposes; zirconia; oil dispersants; petroleum dispersants; dispersions of plastics; dysprosium; bichloride of tin; detergent additives to gasoline [petrol]; ceramic compositions for sintering [granules and powders]; additives, chemical, to drilling muds; additives, chemical, to insecticides; chemical additives for oils; additives, chemical, to motor fuel; additives, chemical, to fungicides; dolomite for industrial purposes; tan-wood; europium; gelatine for photographic purposes; gelatine for industrial purposes; auxiliary fluids for use with abrasives; fluids for hydraulic circuits; liquids for removing sulfates from accumulators; power steering fluid; brake fluid; magnetic fluid for industrial purposes; transmission fluid; tree cavity fillers [forestry]; glaziers' putty; moderating materials for nuclear reactors; diatomaceous earth; fuller's earth for use in the textile industry; lime chloride; isotopes for industrial purposes; iodine for industrial purposes; iodine for chemical purposes; aluminium iodide; alkaline iodides for industrial purposes; ion exchangers [chemicals]; ytterbium; yttrium; casein for the food industry; casein for industrial purposes; kainite; potassium; californium; calomel [mercurous chloride]; gum arabic for industrial purposes; tartar, other than for pharmaceutical purposes; camphor, for industrial purposes; calcium carbide; silicon carbide [raw material]; carbide; lime carbonate; magnesium carbonate; carbonates; cement [metallurgy]; lutetium [cassioptium]; catalysts; biochemical catalysts; catechu; caustics for industrial purposes; alum; ammonia alum; aluminium alum; chrome alum; quebracho for industrial purposes; ketones; cinematographic films, sensitized but not exposed; oxygen; nitric acid; anthranilic acid; benzoic acid; boric acid for industrial purposes; tartaric acid; tungstic acid; gallic acid for the manufacture of ink; gallotannic acid; glutamic acid for industrial purposes; tannic acid; iodic acid; phenol for industrial purposes; citric acid for industrial purposes; lactic acid; formic acid; persulfuric acid; oleic acid; picric acid; pyrogallic acid; salicylic acid; sebacic acid; sulfuric acid; sulfurous acid; spirits of salt; stearic acid; carbonic acid; spirits of vinegar [dilute acetic acid]; phosphoric acid; hydrofluoric acid; cholic acid; chromic acid; oxalic acid; acids; benzene-based acids; fatty acids; mineral acids; arsenious acid; adhesives for billposting; leather glues; adhesives for wall tiles; adhesives for wallpaper; glue for industrial purposes; cement for mending broken articles; gums [adhesives] for industrial purposes; birdlime; isinglass, other than for stationery, household or alimentary purposes; starch paste [adhesive], other than for stationery or household purposes; stem cells, other than for medical or veterinary purposes; collagen for industrial purposes; collo-

dion; compost; plastics, unprocessed; beer preserving agents; preservatives for use in the pharmaceutical industry; mangrove bark for industrial purposes; tan; starch for industrial purposes; silicon; creosote for chemical purposes; krypton; xenon; xylene; xylol; biological tissue cultures, other than for medical or veterinary purposes; curium; lactose [raw material]; lactose for the food industry; lactose for industrial purposes; lanthanum; dry ice [carbon dioxide]; lecithin [raw material]; lecithin for the food industry; lecithin for industrial purposes; lithium; magnesite; manganate; oils for tanning leather; oils for currying leather; oils for preparing leather in the course of manufacture; oils for the preservation of food; transmission oil; carbolineum for the protection of plants; paper pulp; wood pulp; grafting mastic for trees; mastic for leather; cement for pneumatic tires [tyres]; oil cement [putty]; synthetic materials for absorbing oil; brazing preparations; ceramic materials in particulate form, for use as filtering media; filtering materials [unprocessed plastics]; filtering materials [mineral substances]; filtering materials [vegetable substances]; filtering materials [chemical preparations]; blue vitriol; metalloids; alkaline-earth metals; alkaline metals; methane; methyl benzene; methyl benzol; flour for industrial purposes; tapioca flour for industrial purposes; potato flour for industrial purposes; soap [metallic] for industrial purposes; arsenic; emollients for industrial purposes; animal manure; sodium; hypochlorite of soda; naphthalene; sal ammoniac; toxic gas neutralizers; neodymium; neon; neptunium; ammonium nitrate; uranium nitrate; nitrates; combusting preparations [chemical additives to motor fuel]; nitrous oxide; baryta; uranium oxide; oxalates; lithia [lithium oxide]; lead oxide; antimony oxide; chromium oxide; cobalt oxide for industrial purposes; mercuric oxide; olivine [silicate mineral]; gallnuts; purification preparations; wine finings; textile-brightening chemicals; beer-clarifying and preserving agents; must-finings preparations; reducing agents for use in photography; bases [chemical preparations]; wax-bleaching chemicals; fat-bleaching chemicals; organic digestate [fertilizer]; pectin for the food industry; pectin for industrial purposes; pectin [photography]; perborate of soda; humus top dressing; percarbonates; hydrogen peroxide for industrial purposes; persulfates; perchlorates; foundry sand; plastisols; ferrotype plates [photography]; plasticizers; X-ray films, sensitized but not exposed; plutonium; chemical coatings for ophthalmic lenses; polonium; potash; potash water; soil for growing; praseodymium; rubber preservatives; masonry preservatives, except paints and oils; brickwork preservatives, except paints and oils; cement preservatives, except paints and oils; preservatives for tiles, except paints and oils; bacteriological preparations for acetification; vulcanising preparations; renovating preparations for phonograph records; currying preparations for leather;

currying preparations for skins; galvanizing preparations; metal hardening preparations; fixing baths [photography]; opacifiers for glass; opacifiers for enamel; separating and unsticking [ungluing] preparations; metal annealing preparations; metal tempering preparations; preparations for preventing the tarnishing of lenses; preparations for preventing the tarnishing of glass; cement-waterproofing chemicals, except paints; plant growth regulating preparations; wallpaper removing preparations; anti-boil preparations for engine coolants; fulling preparations for use in the textile industry; descaling preparations, other than for household purposes; fertilizing preparations; flashlight preparations; finishing preparations for use in the manufacture of steel; sizing preparations; animal carbon preparations; preparations of microorganisms, other than for medical and veterinary use; corrosive preparations; cryogenic preparations; dehydrating preparations for industrial purposes; degreasing preparations for use in manufacturing processes; degumming preparations; oil-bleaching chemicals; bleaching preparations [decolorants] for industrial purposes; meat tenderizers for industrial purposes; preparations for stimulating cooking for industrial purposes; anti-incrustants; preparations of trace elements for plants; moistening [wetting] preparations for use in the textile industry; moistening [wetting] preparations for use in dyeing; moistening [wetting] preparations for use in bleaching; enzyme preparations for the food industry; enzyme preparations for industrial purposes; filtering preparations for the beverages industry; vine disease preventing chemicals; chemical preparations to prevent mildew; chemical preparations for protection against wheat blight [smut]; chemical condensation preparations; chemical preparations for smoking meat; chemical preparations for facilitating the alloying of metals; engine-decarbonising chemicals; fulling preparations; fuel-saving preparations; coal saving preparations; damp-proofing chemicals, except paints, for masonry; anti-sprouting preparations for vegetables; preparations of the distillation of wood alcohol; chemical substances for preserving foodstuffs; benzene derivatives; cellulose derivatives [chemicals]; promethium; protactinium; protein [raw material]; proteins for the food industry; proteins for use in the manufacture of food supplements; proteins for use in manufacture; mordants for metals; radium for scientific purposes; radon; solvents for varnishes; anti-frothing solutions for accumulators; drilling muds; galvanizing baths; solutions for cyanotyping; silver salt solutions for silvering; toning baths [photography]; rhenium; mercury; rubidium; carbon black for industrial purposes; soot for industrial or agricultural purposes; lamp black for industrial purposes; samarium; saccharin; selenium; saltpeter; sulfur; carbon disulfide; silicates; aluminium silicate; silicones; scandium; topsoil; foundry molding [moulding] preparations; potting soil; acrylic resins, unprocessed;

polymer resins, unprocessed; synthetic resins, unprocessed; epoxy resins, unprocessed; soda ash; calcined soda; caustic soda for industrial purposes; brium compounds; fluorspar compounds; salts [fertilizers]; salts [chemical preparations]; ammoniacal salts; ammonium salts; salts of precious metals for industrial purposes; salts for galvanic cells; salt for preserving, other than for foodstuffs; salts for coloring [colouring] metal; salts for industrial purposes; iron salts; gold salts; iodised salts; calcium salts; sodium salts [chemical compounds]; salt, raw; salts from rare earth metals; mercury salts; toning salts [photography]; chrome salts; chromic salts; salts of alkaline metals; rock salt; mold-release preparations; fire extinguishing compositions; compositions for the manufacture of phonograph records; compositions for the manufacture of technical ceramics; compositions for repairing inner tubes of tires [tyres]; compositions for repairing tires [tyres]; acid proof chemical compositions; glutinous tree-grafting preparations; adhesive preparations for surgical bandages; fireproofing preparations; compositions for threading; sauce for preparing tobacco; amyl alcohol; vinic alcohol; wood alcohol; sal ammoniac spirits; ethyl alcohol; alcohol; adjuvants, other than for medical or veterinary purposes; cement for footwear; concrete preservatives, except paints and oils; water glass [soluble glass]; strontium; substrates for soil-free growing [agriculture]; barium sulfate; sulfates; antimony sulfide; sulfides; benzoic sulfimide; sulfonic acids; sumac for use in tanning; superphosphates [fertilizers]; antimony; thallium; talc [magnesium silicate]; tannin; cream of tartar for the food industry; cream of tartar for industrial purposes; cream of tartar for chemical purposes; tellurium; terbium; tetrachlorides; carbon tetrachloride; acetylene tetrachloride; technetium; thiocarbanilide; titanite; sensitized cloth for photography; blueprint cloth; toluene; fuel for atomic piles; thorium; peat [fertilizer]; gum tragacanth for industrial purposes; thulium; carbonic hydrates; carbon; activated carbon; carbon for filters; animal charcoal; animal carbon; bone charcoal; blood charcoal; fertilizers; nitrogenous fertilizers; fish meal fertilizers; wood vinegar [pyroligneous acid]; uranium; chemical intensifiers for paper; chemical intensifiers for rubber; vulcanisation accelerators; enzymes for the food industry; enzymes for industrial purposes; ferments for chemical purposes; milk ferments for the food industry; milk ferments for industrial purposes; milk ferments for chemical purposes; fermium; ferrocyanides; fixing solutions [photography]; flavonoids for industrial purposes [phenolic compounds]; flocculants; soldering fluxes; brazing fluxes; formic aldehyde for chemical purposes; phosphatides; phosphates [fertilizers]; phosphorus; photographic paper; photosensitive plates; sensitized photographic plates; sensitized films, unexposed; photographic developers; photographic sensitizers; chemical preparations for use in pho-

tography; photographic emulsions; francium; fluorine; chemicals for use in forestry, except fungicides, herbicides, insecticides and parasiticides; glass-frosting chemicals; leather-renovating chemicals; glass-staining chemicals; enamel-staining chemicals; oil-separating chemicals; water-purifying chemicals; oil-purifying chemicals; welding chemicals; condensation-preventing chemicals; stain-preventing chemicals for use on fabrics; anti-tarnishing chemicals for windows; leather-waterproofing chemicals; textile-waterproofing chemicals; chemicals, except pigments, for the manufacture of enamel; radiator flushing chemicals; leather-impregnating chemicals; textile-impregnating chemicals; horticultural chemicals, except fungicides, herbicides, insecticides and parasiticides; agricultural chemicals, except fungicides, herbicides, insecticides and parasiticides; soil conditioning preparations; chimney cleaners, chemical; industrial chemicals; color- [colour-] brightening chemicals for industrial purposes; refrigerants; coolants for vehicle engines; chlorine; chlorates; hydrochlorates; aluminium chloride; magnesium chloride; chlorides; palladium chloride; chromates; flowers of sulfur for chemical purposes; caesium; cellulose; cerium; cyanides [prussiates]; calcium cyanamide [fertilizer]; cymene; loam; slag [fertilizers]; size for finishing and priming; fillers for automobile bodies; spinel [oxide mineral]; alkalis; caustic alkali; tea extracts for the food industry; tea extracts for use in the manufacture of cosmetics; tea extracts for use in the manufacture of pharmaceuticals; radioactive elements for scientific purposes; rare earths; fissionable chemical elements; emulsifiers; erbium; ethane; methyl ether; sulfuric ether; ethyl ether; glycol ether; ethers; esters; cellulose ethers for industrial purposes; cellulose esters for industrial purposes.

4 – Petroleum; motor spirit; industrial gasoline; montan wax; paraffin wax; coal gas; liquefied petroleum gas; liquefied petroleum gases to be used for domestic and industrial purposes and in motor vehicles; liquefied natural gas; alcohol and mixed alcohol fuel; solid fuels; wood pellets for heating [fuel]; pellets of compressed fiber manufactured from a plant crop to be used as fuel; fuel pellets; methylated spirits for fuel [denaturated fuel alcohols]; cutting oil for industrial metal working; lighter fluid; mazut; automotive engine oils; hardened oils [hydrogenated oils for industrial use]; mold releasing oils; leather-preserving oils and greases; mineral oil for use in the manufacture of paint; mineral oil for use in the manufacture of metal cutting fluids; industrial oil for batteries; all-purpose penetrating oil; lubricating oil for motor vehicle engines; lubricating oils and greases; automotive lubricants; lubricants for aircraft engines; motor vehicle lubricants; lubricants for industrial machinery; graphite lubricants; industrial lubricants; all-purpose lubricants; crude oil; heavy oils; petroleum, raw or refined; dust absorbing, wetting and binding compositions; non-chemical addi-

tives for gasoline; non-chemical additives for oils and fuels; non-chemical additives for fuels; non-chemical additives for fuels, lubricants and greases; propane gas; propane gas sold in cylinders for use in torches; flux oil for use as an ingredient in asphalt; firelighters for grills; automotive greases; drilling lubricants; grease for machines; lubricating grease for vehicles; general purpose greases; petroleum-based dust suppressing compositions; granular absorbent oil-based composition for absorbing spills from floors; dust laying and absorbing compositions for use on unpaved roads; dust binding compositions; dust wetting compositions; petroleum-based dust absorbing compositions; wood chips for smoking and flavoring foods; wood chips for use as fuel; fuels, including motor spirit, and illuminants; gaseous fuels; liquid fuels; aviation fuel; biodiesel fuel; fuel for motor vehicles; chafing dish fuel; lamp fuel; fuel for aircraft; fuel for aircraft and ships; fuel for lighters; fuel for ships; heating oil; fuels derived from crude oil; hydrocarbon fuels; mineral spirits for use as accelerants; electrical energy.

37 – Asphalt; drilling of deep oil or gas wells; drilling of wells; drilling for crude oil; rebuilding engines that have been worn or partially destroyed; rebuilding machines that have been worn or partially destroyed; renovation of clothing; retreading of tires [tyres]; vulcanization of tires [tyres] [repair]; building sealing; linen ironing; pressing of clothing; disinfecting; rat exterminating; pumping crude oil; refilling of toner cartridges; vehicle battery charging; knife sharpening; building insulating; repair information; construction information; bricklaying; riveting; construction consultancy; varnishing; re-tinning; scaffolding; road paving; window cleaning; vehicle washing; building construction supervision; tuning of musical instruments; upholstery; rustproofing; anti-rust treatment for vehicles; sanding; pumicing; strong-room maintenance and repair; maintenance of vehicles and machines; vehicle maintenance; maintenance, servicing and repair of vehicles; paper hanging; painting or repair of signs; cleaning of buildings [exterior surface]; recharging of batteries and accumulators; oil pumping and extraction; vehicle polishing; automobile polishing; vehicle breakdown repair services; rental of bulldozers; rental of drainage pumps; rental of dish drying machines; rental of road sweeping machines; rental of cleaning machines; rental of cranes [construction equipment]; rental of dish washing machines; rental of laundry washing machines; rental of construction equipment; rental of excavators; laying of cable; masonry; roofing services; painting, interior and exterior; carpentry services; drilling and pumping of oil; underwater repair; plastering; quarrying services; repair of security locks; umbrella repair; parasol repair; motor vehicle maintenance and repair; burner maintenance and repair; film projector repair and maintenance; repair and maintenance of airplane motors and en-

gines; airplane maintenance and repair; safe maintenance and repair; clock and watch repair; repair of power lines; pump repair; upholstery repair; shoe repair; clothing repair; photographic apparatus repair; furniture restoration; restoration of musical instruments; restoration of works of art; vehicle lubrication [greasing]; demolition of buildings; warehouse construction and repair; vehicle service stations [refuelling and maintenance]; sterilization of medical instruments; washing; washing of linen; pier breakwater building; pipeline construction and maintenance; underwater construction; harbour construction; factory construction; construction of structures for the production of crude oil; construction of structures for the transportation of crude oil; construction of structures for the storage of crude oil; building of fair stalls and shops; construction; shipbuilding; cleaning of automobiles; cleaning of buildings [interior]; street cleaning; vermin exterminating, other than for agriculture, aquaculture, horticulture and forestry; fuel station services; automatic fuel station services; garage services for automobile repair; automobile undercoating services; tire balancing; pest control services, other than for agriculture, aquaculture, horticulture and forestry; hydraulic fracturing services; oil extraction services; computer and telephone battery recharge services; recharging services for electric vehicles; oil pumping services; artificial snow-making services; car cleaning; laundering; installation of doors and windows; irrigation devices installation and repair; elevator installation and repair; heating equipment installation and repair; burglar alarm installation and repair; furnace installation and repair; telephone installation and repair; installation and repair of air-conditioning apparatus; fire alarm installation and repair; freezing equipment installation and repair; electric appliance installation and repair; kitchen equipment installation; installation, construction, maintenance, servicing and repair of energy and power generating apparatus, equipment and installations; installation, maintenance and repair of computer hardware; machinery installation, maintenance and repair; office machines and equipment installation, maintenance and repair; interference suppression in electrical apparatus; swimming-pool maintenance; furniture maintenance; chimney sweeping; automobile cleaning and washing; boiler cleaning and repair; cleaning of clothing; dry cleaning; vehicle cleaning; diaper cleaning; leather care, cleaning and repair; fur care, cleaning and repair.

(260) AM 2019 100529 A

(800) 1435037

(151) 2018 04 11

(891) 2018 04 11

(731) CORNELIANI S.P.A.

Via Panizza, 5, I-46100 MANTOVA,
Italy

(540)

CORNELIANI ID

(591) Black, white

(531) 27.05.01

(511)

3 – Abrasive paper; abrasives; adhesives for affixing false eyelashes; adhesives for affixing false hair; adhesives for cosmetic purposes; after-shave balms; aftershave cologne; after-shave creams; after-shave emulsions; after-shave gel; after-shave lotions; after-sun creams for cosmetic use; after-sun milk; air fragrance reed diffusers; air fragrancing preparations; almond milk for cosmetic purposes; almond oil; almond soap; aloe vera preparations for cosmetic purposes; amber [perfume]; ammonia [volatile alkali] [detergent]; antiperspirants; antiperspirants [toiletries]; antiperspirants for personal use; antistatic preparations for household purposes; anti-wrinkle creams; aromatics [essential oils]; astringents for cosmetic purposes; badian essence; balms, other than for medical purposes; bases for flower perfumes; bath foam; bath preparations, not for medical purposes; bath salts, not for medical purposes; beard dyes; beauty masks; bergamot oil; bleaching preparations [decolorants] for cosmetic purposes; bleaching preparations [decolorants] for household purposes; breath freshening preparations for personal hygiene; breath freshening sprays; cake flavorings [essential oils]; cakes of toilet soap; canned pressurized air for cleaning and dusting purposes; chemical cleaning preparations for household purposes; cleaning preparations; cleansers for intimate personal hygiene purposes, non medicated; cleansing milk for toilet purposes; cloths impregnated with a detergent for cleaning; cloths impregnated with a detergent for cleaning spectacles; collagen preparations for cosmetic purposes; colorants for toilet purposes; color-brightening chemicals for household purposes [laundry]; cosmetic creams; cosmetic dyes; cosmetic kits; cosmetic pencils; cosmetic preparations for baths; cosmetic preparations for eyelashes; cosmetic preparations for shower; cosmetic preparations for skin care; cosmetic preparations for slimming purposes; cosmetics; cosmetics for animals; cotton sticks for cosmetic purposes; cotton wool for cosmetic purposes; decorative transfers for cosmetic purposes; degreasers, other than for use in manufacturing processes; dentifrices; deodorant soap; deodorants for human beings or for animals; deodorants for pets; depilatory creams; depilatory preparations; depilatory wax; detergents, other than for use in manufacturing operations and for medical purposes; disposable wipes impregnated with cleansing chemicals or compounds for personal hygiene; douching preparations for personal sanitary or deodorant purposes [toiletries]; dry-cleaning preparations; eau de Cologne; emery paper; essential oils; essential oils of lemon; ethereal essences; extracts of flowers [perfumes];

eyebrow cosmetics; eyebrow pencils; eye-washes, not for medical purposes; fabric softeners for laundry use; face and body beauty creams; false eyelashes; false nails; floor wax; food flavorings [essential oils]; fragrances for personal use; fumigation preparations [perfumes]; greases for cosmetic purposes; grinding preparations; hair conditioners; hair dyes; hair gel; hair lotions; hair spray; hair straightening preparations; hair waving preparations; henna [cosmetic dye]; herbal extracts for cosmetic purposes; incense; jasmine oil; Javelle water; joss sticks; lacquer-removing preparations; laundry bleach; laundry glaze; laundry soaking preparations; lavender oil; lavender water; lip glosses; lipstick cases; lipsticks; lotions for cosmetic purposes; make-up; make-up powder; make-up preparations; make-up removing gels, lotions and creams; make-up removing preparations; mascara; massage candles for cosmetic purposes; massage gels, other than for medical purposes; mint essence [essential oil]; mint for perfumery; mouthwashes, not for medical purposes; musk [perfumery]; mustache wax; nail art stickers; nail care preparations; nail polish; nail varnish removers; neutralizers for permanent waving; non-medicated balms for use on hair; non-medicated toiletry preparations; non-slipping wax for floors; oils for cleaning purposes; oils for cosmetic purposes; oils for perfumes and scents; oils for toilet purposes; paint stripping preparations; perfumed extracts of flowers for perfumes; perfumery; perfumes; phytocosmetic preparations; polishing creams; polishing paper; polishing preparations; polishing stones; polishing wax; pomades for cosmetic purposes; potpourris [fragrances]; preparations to make the leaves of plants shiny; preservatives for leather [polishes]; rose oil; sachets for perfuming linen; scented linen water; scented water; scented wood; scouring solutions; shampoos; shampoos for animals [non-medicated grooming preparations]; shaving preparations; shaving soap; shaving stones [astringents]; shining preparations [polish]; shoe cream; shoe polish; shoe wax; shoemakers' wax; shower gels, creams and oils; skin bronzer; skin soap; skin whitening creams; soap; stain removers; sunscreen preparations; sun-tanning preparations [cosmetics]; tailors' wax; talcum powder, for toilet use; teeth whitening strips; tissues impregnated with cosmetic lotions; tissues impregnated with essential oils, for cosmetic use; tissues impregnated with make-up removing preparations; toilet water; toiletry preparations; vaginal washes for personal sanitary or deodorant purposes; wallpaper cleaning preparations; bleaching preparations and other substances for laundry use; cleaning, polishing, scouring and abrasive preparations.

9 – 3D spectacles; abacuses; accumulators, electric; acoustic alarms; adding machines; air analysis apparatus; alarm bells, electric; amplifiers; animated cartoons; anodes; antennas; anti-glare glasses; apparatus and instruments for astronomy; apparatus and

instruments for physics; asbestos clothing for protection against fire; baby monitors; bags adapted for laptops; barcode readers; barometers; bathroom scales; batteries, electric; battery chargers; binoculars; biochips; breathing apparatus for underwater swimming; breathing apparatus, except for artificial respiration; bullet-proof clothing; buzzers; cabinets for loudspeakers; calculating machines; camcorders; carpenters' rules; cases especially made for photographic apparatus and instruments; cases for smartphones; cash registers; cassette players; CD cases; CDs; chemistry apparatus and instruments; chronographs [time recording apparatus]; close-up lenses; clothing for protection against fire; coin-operated musical automata [juke boxes]; commutators; compact disc players; compact discs [audio-video]; compasses for measuring; computer game programs; computer hardware; computer programs [downloadable software]; computer programs, recorded; computer software applications, downloadable; computer software, recorded; computers; contact lenses; containers for contact lenses; correcting lenses [optics]; counters; covers for mobile telephones; covers for personal digital assistants [PDAs]; covers for smartphones; covers for tablet computers; data processing apparatus; decorative magnets; digital photo frames; digital weather stations; directional compasses; disk drives for computers; disks, magnetic; distance recording apparatus; distribution boxes [electricity]; distribution consoles [electricity]; divers' masks; DNA chips; downloadable image files; downloadable music files; downloadable ring tones for mobile phones; dressmakers' measures; DVD players; ear plugs for divers; egg timers [sandglasses]; electric and electronic effects units for musical instruments; electric apparatus for commutation; electrical adapters; electronic agendas; electronic book readers; electronic notice boards; electronic publications, downloadable; electronic tags for goods; encoded key cards; encoded magnetic cards; enlarging apparatus [photography]; eyeglass cases; eyeglass chains; eyeglass clips; eyeglass cords; eyeglass frames; eyeglass lenses; eyepieces; eyewear; fire blankets; fire extinguishers; flash-bulbs [photography]; floppy disks; food analysis apparatus; frames for lenses; Global Positioning System [GPS] apparatus; gloves for divers; gloves for protection against accidents; goggles for skiing; goggles for sports; hands-free kits for telephones; head guards for sports; headphones; hemline markers; holograms; humanoid robots with artificial intelligence; identity cards, magnetic; integrated circuit cards [smart cards]; interactive touch screen terminals; intercommunication apparatus; interfaces for computers; joysticks for use with computers, other than for video games; laptop computers; laptops carrying cases; life belts; life buoys; life jackets; life-saving rafts; light-emitting electronic pointers; lorgnettes; loudspeakers; magnetic tapes; magnets; magnifying glasses; mechanisms for

coin-operated apparatus; megaphones; microscopes; mobile phone straps; mobile phones; mobile telephones; monitors [computer hardware]; monocles; mouse [computer peripheral]; mouse pads; nose clips for divers and swimmers; notebook computers; objectives [lenses] [optics]; optical character readers; optical discs; optical lenses; parts, fittings and accessories for all the aforesaid goods (included in this class); pedometers; personal digital assistants [PDAs]; phototelegraphy apparatus; pince-nez; pocket calculators; portable media players; projection apparatus; projection screens; protective films adapted for computer screens; protective films adapted for smartphones; protective goggles; protective helmets; protective helmets for sports; quantity indicators; radio pagers; radios; readers [data processing equipment]; reading spectacles; record players; remote control apparatus; riding helmets; safety restraints, other than for vehicle seats and sports equipment; satellite navigational apparatus; scales; screen savers; security tokens [encryption devices]; selfie lenses; shoes for protection against accidents, irradiation and fire; signalling whistles; signs, luminous; smart rings; smartglasses; smartphones; smartwatches; snorkels; sound recording discs; spectacle cases; spectacle chains; spectacle cords; spectacle frames; spectacle glasses; spectacles; sports whistles; stands for photographic apparatus; stills for laboratory experiments; sunglasses; tablet computers; teaching apparatus; teaching robots; telecommunication apparatus in the form of jewellery; telephone apparatus; television apparatus; temperature indicators; testing apparatus not for medical purposes; theft prevention installations, electric; ticket dispensers; time clocks [time recording devices]; time recording apparatus; transparencies [photography]; USB flash drives; video baby monitors; video cassettes; video screens; video telephones; videotapes; virtual reality headsets; visors for helmets; walkie-talkies; weighing apparatus and instruments; wrist rests for use with computers; scientific, nautical, surveying, photographic, cinematographic, optical, weighing, measuring, signalling, checking (supervision), life-saving and teaching apparatus and instruments; apparatus and instruments for conducting, switching, transforming, accumulating, regulating or controlling electricity; apparatus for recording, transmission or reproduction of sound or images; magnetic data carriers, recording discs; DVDs and other digital recording media; data processing equipment.

14 – Alarm clocks; alloys of precious metal; amulets; atomic clocks; automatic watches; badges of precious metal; boxes of precious metal; bracelets; brooches; buckles for watch straps; cases adapted for holding watches; cases for clock and watchmaking; cases for clocks and watches; chains; charms as personal jewelry; charms for jewellery; chronographs; chronometers; chronometric apparatus and instruments; chronoscopes; clasps for jewelry; clock

and watch hands; clock and watchmaking anchors; clock and watchmaking clock hands; clock and watchmaking pendulums; clock barrels for watchmaking; clock cases; clock dials; clock housings; clocks; clocks electric; clocks incorporating radios; clockworks being clock parts; collectible coins; commemorative coins; control clocks, namely, mechanical and automatic watches featuring built-in remote controls functions, master clocks; costume jewelry; cuff links; dials for clock and watchmaking; diamonds; earrings; electric watches; figurines of precious metal; gold, unwrought or beaten; hat ornaments of precious metal; ingots of precious metals; jewel cases of precious metal; jewellery; jewelry; jewelry brooches; jewelry cases; jewelry ornaments; jewelry rolls; key rings of precious metals; medals; movements for clocks and watches; necklaces; ornamental pins made of precious metal; parts for clocks; paste jewelry; pearls; pins being jewelry; pocket watches; precious metals and their alloys; precious metals, unwrought or semi-wrought; precious stones; rings; rough precious stones; scarf rings being jewelry; shoe ornaments of precious metal; silver, unwrought or beaten; sports watches; statues of precious metal; sundials; threads of precious metal; tie clips; tie pins; watch bands; watch bracelets; watch cases; watch chains; watch clasps; watch crowns; watch glasses; watch movements; watch pouches; watch springs; watch straps; watches; watches containing a game function; watches made of precious metals or coated therewith; works of art of precious metal; wristwatches; semi-precious stones; horological instruments.

18 – Artificial fur; attaché cases; backpacks; bags for sports; beach bags; briefcases; business card cases; calling card cases; canes; canvas shopping bags; credit card cases; dog collars; faux fur; fur pelts; furs sold in bulk; garment bags for travel; handbag frames; handbags; harness fittings; hat boxes of leather; leather and imitation leather; leather cases; leather key cases; leather shopping bags; leather shoulder belts; leather straps; mesh shopping bags; name card cases; pet clothing; pouches made from imitation leather; pouches made out of cloth; pouches of leather; pouches of textile; purses; raw skins; reusable shopping bags; rucksacks; saddlery; school bags; school satchels; suitcases; synthetic fur; textile shopping bags; traveling bags; travelling trunks; umbrellas; unfitted vanity cases; waist pouches; walking sticks; wallets; whips; animal skins; bags; boxes of animal skins; boxes of imitation leather; carry-on-bags; cases of leather for containing shoe polishing apparatus; clothing for pets; collars for animals; document cases; fur; gym bags; harnesses straps; key cases of leather or animal skins or their imitations; leather credit card cases; leather leads; leather, unworked or semi-worked; luggage; overnight cases; parasols; pocket wallets; shopping bags; shoulder bags; sports bags; tie cases; tote bags; trimmings of

leather for furniture; trunks (luggage); wheeled luggage; saddles; harness; moleskin (imitation of leather); boxes of leather; boxes of vulcanized fibre; tool bags of leather, empty; book bags; valises; wheeled shopping bags; travelling garment bags; garment bags; overnight bags; card cases (notecases); belt bags of leather; cases, of leather or leatherboards; music cases; alpenstocks; pouch baby carriers; saddlery; furniture coverings of leather; pouches, of leather, for packaging; harness for animals.

25 – Anoraks (parkas); anti-sweat underwear; aprons (clothing); ascots; babies' pants; ballroom dancing shoes; ballroom dancing uniforms; bandanas; bath sandals; bath slippers; bathing drawers; bathing suits; bathing trunks; bathrobes; beach clothes; beach coverups; beach shoes; beanies; belts; belts (money) (clothing); belts made from imitation leather; berets; bibs not of paper; bikinis; blouses; blousons; boas (necklets); bodices; body linen; bomber jackets; boot uppers; boots; boots (ski); boots for sport; bow ties; boxer shorts; braces for clothing (suspenders); brasseries; breeches for wear; camisoles; cap peaks; caps; caps (headwear); cardigans; chasubles; children's clothing; cloaks; cloth bibs; clothing; clothing for gymnastics; clothing of imitations of leather; clothing of leather; coats; collar protectors for wear; collars (clothing); combinations (clothing); corselets; corsets (underclothing); coveralls; crop tops; cuffs; cyclists' clothing; dance costumes; dance shoes; dance slippers; denims; detachable collars; down clothing; down jackets; down leather clothing; drawers; dress shields; dress shirts; dresses; dressing gowns; dungarees; dust coats; ear muffs (clothing); esparto shoes or sandals; fishing vests; fittings of metal for footwear; fleece bottoms; fleece pullovers; fleece tops; fleece vests; flip flops; football boots; football shoes; footmuffs, not electrically headed; footwear; footwear uppers; foulards; foundation garments; fur stoles; furs (clothing); gabardines (clothing); gaiter straps; gaiters; gaiters of leather; galoshes; garters; girdles; gloves; golf pants, shirts and skirts; gowns; gymnastic shoes; hair shawl; half boots; hat frames (skeletons); hats; head bands (clothing); headgear for wear; headwear; heelpieces for footwear; heelpieces for stockings; heels; hooded sweatshirts; hoods (clothing); hosiery; inner soles; insoles; jackets; Japanese style sandals of leather; jeans; jeans clothing; jerseys; jumper dresses; knitwear (clothing); lace boots; layettes; leather belts; leather boots; leather coats; leather hats; leather headwear; leather jackets; leather shirts; leather shoes; leather skirts; leather slippers; leather spats; leather vests; leg warmers; leggings; leotards; liveries; long underwear; loungewear; maniples; mantillas; masquerade costumes; mitres (hats); mittens; money belts (clothing); motorists' clothing; muffs; neckties; night shirts; non-slipping devices for footwear; outerclothing; overalls; overcoats; padded jackets; pajamas; pants; paper clothing; paper hats; peaks (hat); pelerines; pelisses; pet-

ticoats; pinafore dresses; pocket squares; pockets for clothing; polo shirts; ponchos; pullovers; rain jackets; raincoats; ready-made clothing; ready-made linings (parts of clothing); religion clothing; reversible jackets; rugby shirts; running shoes; sandals; saris; sarongs; sashes for wear; scarfs; shawls; shirt fronts; shirt yokes; shirts; shoes; shorts; short-sleeve shirts; shoulder wraps; shower caps; singlets; ski gloves; skirts; skiwear; skorts; skull caps; sleep masks; sleeping garments; sleeved or sleeveless jackets; slippers; slips (undergarments); smocks; sneakers; sock suspenders; socks; soles for footwear; spats; sport bras; sport pants; sport shoes; sports jackets; sports jerseys; stockings; stocking suspenders; studs for football boots; stuff jackets; stylish shirts; suits; suits of leather; sun visors; suspenders; sweat pants; sweat shirts; sweat shorts; sweat-absorbent stockings; sweat-absorbent underclothing; sweaters; swim suits; tank tops; teddies; thermal underwear; ties; tights; tips for footwear; togas; top hats; topcoats; tops; track suits; trouser straps; trousers; trousers of leather; T-shirts; turbans; underclothing; underpants; undershirts; underwear; uniforms; veils (clothing); vests; visors; waistcoats; waterproof clothing; waterproof footwear; waterproof jackets; waterproof pants; wedding dresses; welts for footwear; wet suits for water-skiing; wimples; wind resistant jackets; windcheaters; wooden shoes; wristbands.

(260) AM 2019 100530 A

(800) 1435054

(151) 2018 07 04

(891) 2018 07 04

(731) BOHNENKAMP AG

Dieselstr. 14, 49076 Osnabrück, Germany

(540)

The logo for TRUCK MOBILITY 4U features the word 'TRUCK' in red, 'MOBILITY' in blue, and '4U' in red. A stylized blue and red graphic element is positioned to the left of the text.

(591) Blue, white and red

(531) 07.11.10; 26.04.05; 26.04.16; 26.04.24;

27.05.10; 27.07.11; 29.01.12

(511)

12 – Pneumatic tires [tyres]; inner tubes for pneumatic tires [tyres]; tyre repair patches; retreaded tyres; tyres for trucks; tires for vehicle wheels; adhesive rubber patches for repairing inner tubes; automobile tires [tyres]; tyres for commercial vehicles; tyres for buses; repair outfits for inner tubes; patching materials for inner tubes for tyres; patches for inner tubes of tyres; tyres for agricultural vehicles; wheels, tyres and continuous tracks; tyres for the wheels of forestry vehicles; treads for retreading tires [tyres]; roadside assistance vehicles.

37 – Retreading of tires [tyres]; tyre rotating and balancing; fitting services for tyres; tire balancing; regrooving of tyres; tyre maintenance and repair; roadside repair of automobiles; vehicle breakdown repair

services; vehicle repair as part of vehicle breakdown services.

39 – Commercial vehicle breakdown recovery; vehicle breakdown assistance [towing]; towing of vehicles in connection with breakdown services; towing and transport of cars as part of vehicle breakdown services.

42 – Tyre analysis services.

(260) AM 2019 100531 A
(800) 1435165
(151) 2018 09 11
(891) 2018 09 11
(731) Nemiroff Intellectual Property Establishment
Städtle 31, FL-9490 Vaduz, Liechtenstein
(540)

THE MAN MAKES THE MAN

(591) Black, white
(511)

33 – Alcoholic beverages, except beer; alcoholic beverages containing fruit; bitters; cocktails; distilled beverages; liqueurs; spirits [beverages]; vodka.

35 – Advertising; rental of billboards [advertising boards]; business management; business administration; organization of exhibitions for commercial or advertising purposes; organization of trade fairs for commercial or advertising purposes; promotion of goods and services through sponsorship of sports events; radio advertising; telemarketing services; television advertising.

(260) AM 2019 100532 A
(800) 1435166
(151) 2018 09 11
(891) 2018 09 11
(731) Nemiroff Intellectual Property Establishment
Städtle 31, FL-9490 Vaduz, Liechtenstein
(540)

ROBUST CHARACTER

(591) Black, white
(511)

33 – Alcoholic beverages, except beer; alcoholic beverages containing fruit; bitters; cocktails; distilled beverages; liqueurs; spirits [beverages]; vodka.

35 – Advertising; rental of billboards [advertising boards]; business management; business administration; organization of exhibitions for commercial or advertising purposes; organization of trade fairs for commercial or advertising purposes; promotion of goods and services through sponsorship of sports events; radio advertising; telemarketing services; television advertising.

(260) AM 2019 100534 A
(800) 1435254
(151) 2018 04 20
(891) 2018 04 20
(731) ZOZO, Inc.
2-6-1, Nakase, Mihama-ku, Chiba-shi, Chiba
261-7116, Japan
(540)

ZOZOSUIT

(591) Black, white
(531) 27.05.01
(511)

9 – Downloadable computer game programs; virtual reality headsets; game programs for arcade video game machines; simulators for the steering and control of vehicles; sports training simulators; photographic machines and apparatus; cinematographic machines and apparatus; optical machines and apparatus; measuring or testing machines and instruments; balances; tape measures; planimeters; measuring rules; length measuring gauges; gauges; body scales; electric measuring devices; dressmakers' measure; power distribution or control machines and apparatus; solar batteries; batteries and cells; electric or magnetic meters and testers; electric wires and cables; cellphone straps; parts and accessories for cell phones; telephone apparatus; broadcasting machines and apparatus; audio frequency devices and apparatus; video frequency devices and apparatus; telecommunication devices and apparatus; personal digital assistants in the shape of a watch; smart phones; application software; computer software for networking application; computer software; electronic machines and apparatus and their parts; computers and their peripherals; integrated circuit cards; IC chips; sunglasses; eyeglasses; computer game software for personal computers and home video game consoles; electronic circuits and CD-ROMs recorded with programs for hand-held games with liquid crystal displays; metronomes; electronic circuits and CD-ROMs recorded with automatic performance programs for electronic musical instruments; electric and electronic effects units for musical instruments; downloadable image, movie and music via communication network; phonograph records; downloadable music; downloadable image; pre-recorded video discs and cassettes; electronic publications; wearable telecommunication machines and apparatus for body measurement; telecommunication machines and apparatus for body measurement; body measuring machines and apparatus; measuring machines and apparatus with telecommunication function; wearable computer; computer software for body measurement.

25 – T-shirts; gloves and mittens (clothing); hoods (clothing); nightcaps; headgear for wear; hats; caps; clothing; non-Japanese style outer clothing; coats; jackets; pants; trousers; vests; sweaters; shirts; night-

wear; underwear (underclothing); layettes; swim wear (bathing suits); swimming caps (bathing caps); camisoles; jerseys; knitwear; skirts; parkas; Japanese traditional clothing, namely kimono; sleep masks; aprons (clothing); socks and stockings; tights; shawls; scarves (scarfs); neckties; bandanas (neckerchiefs); mufflers (clothing); ear muffs (clothing); pajamas; garters; sock suspenders; braces (suspenders); waistbands; belts (clothing); footwear; shoes and boots; slippers; sandals; Japanese style wooden clogs (Geta); Japanese style sandals (Zori); masquerade costumes; clothing for sports; clothes for sports (other than "clothes for water sports"); clothes for water sports; boots for sport; special footwear for sports (other than "horse-riding boots" and "windsurfing shoes"); horse-riding boots; windsurfing shoes; tights with telecommunication function for body measurement; body measuring tights; nightwear with telecommunication function for body measurement; body measuring nightwear; socks with telecommunication function for body measurement; body measuring socks; gloves with telecommunication function for body measurement; body measuring gloves; headwear with telecommunication function for body measurement; body measuring headwear; clothing with telecommunication function for body measurement; body measuring clothing; tights; western style clothing; nightwear; underwear; hosiery; athletic tights.

35 – Marketing; providing information relating to marketing; promoting the goods and services of others over the Internet; fashion shows for promotional purposes (organization of -); Internet advertising; advertising by electronic mail; providing information about advertising inserted in the paper and magazines for commercial purposes; organization and production of promotion video for advertising purposes; providing information relating to organization and production of promotion video for advertising purposes; advertising matter (dissemination of -); advertising and publicity services; organization of exhibitions for commercial or advertising purposes on the Internet; managing and accounting of exchangeable points for sales or marketing of goods or services; promoting the goods and services of others through the administration of sales and promotional incentive schemes involving trading stamps; procurement services for others [purchasing goods and services for other businesses]; consulting services relating to procurement services for others [purchasing goods and services for other businesses]; agency services for providing corporate information; business management of sports facilities; business management of sports clubs; business administration and management of a shopping center or a shopping mall; arranging of buying and selling contracts for third parties on an on-line shopping mall; arranging and providing information of buying and selling contracts in digital commerce; business consultancy

for providers of on-line retail store services on the Internet; agency services relating to contracts for the buying and selling of goods; conducting business and market research surveys; marketing research for consumer reputation; providing information relating to sales ranking or popularity ranking of goods or shops; providing information relating to commercial sales shops via communication networks; providing information concerning commercial sales of fashion goods; business management analysis and business consultancy; marketing research or analysis; providing information concerning commercial sales; business management of hotels; drawing up of statements of accounts; employment agencies for athletes; employment agencies; auctioneering provided on the Internet; providing information relating to goods at auctions; auctioneering; import-export agencies; arranging newspaper subscriptions for others; shorthand; transcription; document reproduction; mediation and conclusion of commercial transactions for others; mediation and conclusion of commercial transactions by telecommunication or the electronic way for others; office functions, namely filing, in particular documents or magnetic tape; data search in computer files for others; compilation of information into computer databases; outsourcing services [business assistance] in the field of the operation of data processing apparatus namely, computers, typewriters, telex machines and other similar office machines; agency services for telephone answering services and providing information relating thereto; reception services for visitors in buildings; rental of advertising space on-line; rental or provision of advertising space; publicity material rental; rental of office equipment; rental of office machinery; rental of electronic desk calculating machines [office equipment]; rental of account machines; rental of typewriters, copying machines and word processing machines; providing employment information; magazines clipping services; books clipping services; news clipping services; rental of vending machines; retail services or wholesale services for a variety of goods in each field of clothing, foods and beverages, and living ware, namely cups, saucers, plates, dishes, mugs, tableware, carrying all goods together; retail services or wholesale services for woven fabrics and beddings; retail services or wholesale services for clothing; retail services or wholesale services for footwear other than special footwear for sports; retail services or wholesale services for bags and pouches; retail services or wholesale services for personal articles, namely personal fans, towels of textile, handkerchiefs, bands for wear, belts for wear, buttons, cuff links, umbrellas; retail services or wholesale services for foods and beverages; retail services or wholesale services for two-wheeled motor vehicles; retail services or wholesale services for bicycles; retail services or wholesale services for furniture; retail services or wholesale

services for joinery fittings; retail services or wholesale services for tatami mats; retail services or wholesale services for electrical machinery and apparatuses; retail services or wholesale services for measuring machines, measuring instruments and measuring apparatus; retail services or wholesale services for bladed or pointed hand tools, hand tools, hardware of metal; retail services or wholesale services for kitchen equipment, cleaning tools and washing utensils; retail or wholesale services for pharmaceutical, veterinary and sanitary preparations and medical supplies; retail services or wholesale services for cosmetics, toiletries, dentifrices, soaps and detergents; retail services or wholesale services for agricultural machines, implements and supplies; retail services or wholesale services for flowers [natural] and trees; retail services or wholesale services for printed matter; retail services or wholesale services for paper and stationery; retail services or wholesale services for sports goods; retail services or wholesale services for toys, dolls, game machines and apparatus; retail services or wholesale services for musical instruments and records; retail services or wholesale services for prerecorded DVDs; retail services or wholesale services for clocks, watches and spectacles [eyeglasses and goggles]; retail services or wholesale services for tobaccos and smokers' articles; retail services or wholesale services for dog chains, clothing for pets, bed for pets, dog kennels, nesting boxes for small birds, feeding vessels for pets, brushes for pets, chewing goods for pet dogs, water tanks for live fish and their parts, bird cages, bird baths and toys for domestic pets; retail services or wholesale services for pet food and food for aquarium fish; retail services or wholesale services for baby oils; retail services or wholesale services for teething rings and feeding bottles; retail services or wholesale services for baby buggies; retail services or wholesale services for diapers of paper for babies; retail services or wholesale services for semi-wrought precious stones and their imitations.

(260) AM 2019 100537 A
 (800) 1435321
 (151) 2018 08 17
 (891) 2018 08 17
 (731) Aktsionernoye obshchestvo "BAYAN SULU"
 ul. Borodina, 198, 110006 g. Kostanay,
 Kazakhstan
 (540)



(591) Brown, black, yellow, vinous, golden, white, light brown, grey, blue, crimson, red and dark brown

(531) 02.03.20; 25.01.19; 28.05; 29.01.15

(511)

29 – Meat, fish, poultry and game; meat extracts; preserved, frozen, dried and cooked fruits and vegetables; jellies, jams, compotes; eggs, milk and milk products; oils and fats for food.

30 – Coffee, tea, cocoa and artificial coffee; sugar, honey, treacle; rice; tapioca and sago; flour and preparations made from cereals; bread, pastries and confectionery; ice cream; yeast, baking-powder; salt; mustard; vinegar; condiments; spices; edible ices.

(260) AM 2019 100538 A

(800) 1435322

(151) 2018 07 31

(891) 2018 07 31

(731) DR. THEISS NATURWAREN GMBH

Michelinstr. 10, 66406 Homburg, Germany

(540)



(591) Green, black, white, grey

(531) 01.15.21; 19.03.01; 19.03.25; 26.01.01;
 26.01.18; 26.04.05; 26.04.10; 26.04.12;
 26.04.16; 26.04.18; 26.11.02; 26.11.13;
 26.15.01; 27.05.09; 29.01.14

(511)

3 – Bleaching preparations and laundry preparations; Cleaning, polishing, scouring and abrasive preparations; Perfumery, essential oils, non-medicated cosmetics, including non-medicated skin cleaning and skin care preparations, and hair care preparations; Non-medicated dentifrices.

5 – Pharmaceutical and veterinary preparations; Medicines for human purposes; Medicines for veterinary purposes; Sanitary preparations for medical purposes; Dietetic foodstuffs and substances adapted for medical use; Nutritional supplements for humans and animals; Vitamin preparations.

(260) AM 2019 100547 A
 (800) 1435511
 (151) 2018 06 20
 (891) 2018 06 20
 (731) HIPPO ANALYTICS
 196 Castro Street, Suite A, Mountain View
 CA 94041, USA
 (540)

Hippo Insurance

(591) Black, white
 (526) INSURANCE
 (511)
 36 – Insurance agencies; insurance agency and brokerage; insurance brokerage; insurance brokerage services; insurance claim processing; insurance information; insurance premium rate computing; insurance services, namely, writing property and casualty insurance.

(260) AM 2019 100548 A
 (800) 1435519
 (151) 2018 08 17
 (891) 2018 08 17
 (731) TALAGAIEVA ELENA VLADIMIROVNA
 Kommunisticheskaya St., d. 3, kv. 145,
 Ramenskoye, RU-140002 Moskovskaya
 oblast, Russian Federation
 (540)

BEAUTY DESSERTS

(591) Black, white
 (531) 27.05.01
 (511)
 3 – Amber [perfume]; aromatics [essential oils]; balms, other than for medical purposes; lip glosses; petroleum jelly for cosmetic purposes; cotton wool for cosmetic purposes; scented water; Javelle water; lavender water; toilet water; depilatory wax; waxes for leather; creams for leather; massage gels, other than for medical purposes; deodorants for human beings or for animals; depilatories; perfumes; greases for cosmetic purposes; perfumery; ionone [perfumery]; eyebrow pencils; cosmetic pencils; hair conditioners; beard dyes; cosmetic dyes; cosmetic creams; hair spray; nail polish; hair lotions; lotions for cosmetic purposes; after-shave lotions; beauty masks; oils for perfumes and scents; oils for cosmetic purposes; oils for toilet purposes; essential oils; essential oils of cedarwood; essential oils of lemon; essential oils of citron; oils for cleaning purposes; bergamot oil; gaultheria oil; jasmine oil; lavender oil; almond oil; rose oil; oil of turpentine for degreasing; almond milk for cosmetic purposes; cleansing milk for toilet purposes; musk [perfumery]; soap; deodorant soap; shaving soap; cakes of soap; almond soap; cosmetic kits; eau de Cologne; bases for flower perfumes; lipsticks; pomades for cosmetic purposes; shaving preparations; cosmetic preparations

for baths; bath preparations, not for medical purposes; hair straightening preparations; waving preparations for the hair; douching preparations for personal sanitary or deodorant purposes [toiletries]; color-removing preparations; make-up removing preparations; nail care preparations; aloe vera preparations for cosmetic purposes; sun screen preparations; make-up powder; potpourris [fragrances]; bath salts, not for medical purposes; fumigation preparations [perfumes]; eyebrow cosmetics; sun-tanning preparations [cosmetics]; hair dyes; neutralizers for permanent waving; cosmetic preparations for eyelashes; cosmetic preparations for skin care; cosmetics; mascara; bleaching preparations [decolorants] for cosmetic purposes; antiperspirants [toiletries]; talcum powder, for toilet use; terpenes [essential oils]; henna [cosmetic dye]; shampoos; dry shampoos; extracts of flowers [perfumes]; ethereal essences; badi-
 an essence; mint essence [essential oil].

(260) AM 2019 100550 A
 (800) 1435581
 (151) 2018 09 27
 (891) 2018 09 27
 (731) APPLE INC.
 One Apple Park Way, Cupertino CA 95014,
 USA
 (540)

IPOD TOUCH

(591) Black, white
 (511)
 28 – Hand-held units for playing electronic games; handheld game consoles.

(260) AM 2019 100551 A
 (800) 1435608
 (151) 2018 08 22
 (891) 2018 08 22
 (731) "SOPHARMA" AD
 Iliensko shose str. 16, BG-1220 Sofia,
 Bulgaria
 (540)

PENTOXIPHARM ПЕНТОКСИФАРМ

(591) Black, white
 (531) 27.05.01; 28.05
 (511)
 5 – Pharmaceuticals, medical and veterinary preparations; sanitary preparations for medical purposes; dietetic food and substances adapted for medical or veterinary use, food for babies; dietary supplements for humans and animals; plasters, materials for dressings; disinfectants.

(260) AM 2019 100552 A
 (800) 1435620
 (151) 2018 04 12
 (891) 2018 04 12
 (731) ORIFLAME COSMETICS AG
 c/o Oriflame Global Management AG,
 Bleicheplatz 3, CH-8200 Schaffhausen,
 Switzerland

(540)

ORIFLAME TREMENDOUS

(591) Black, white

(511)

3 – Non-medicated conditioning and care preparations for application to the hair, scalp, skin and nails; shampoos; hair conditioner; soaps; perfumes; perfumery; eau de cologne; toilet waters; essential and herbal oils; cosmetics; make-up; make-up preparations; lipsticks; nail varnishes; nail varnish removers; eyeliner; mascara; non-medicated toilet preparations; hair lotions; hair sprays and hair gels; preparations for use in the bath or shower; bath and shower oils, gels, creams and foams; face and body masks; face and body scrubs; facial washes; skin cleansers and hydrators; skin toners; skin moisturizers; blemish creams and blemish gels; deodorants; antiperspirants; preparations for use before shaving and after shaving; shaving soaps; shaving creams; shaving gels; after-shave preparations; pre-shave preparations; talcum powders; toiletries; dentifrices; toothpastes; foot care preparations (non-medicated).

(260) AM 2019 100553 A
 (800) 1435633
 (151) 2018 08 20
 (891) 2018 08 20
 (731) JSC Essen Production AG
 proezd Novyy, dom 3, office 95, Avto-
 zavodskiy rayon, RU-445037 gorod Tolyatti,
 Russian Federation

(540)



(591) Black, white

(531) 03.01.06; 03.01.24; 27.05.02

(511)

30 – Zephyr [confectionery]; fruit jellies [confectionery]; cakes; pastries; peanut confectionery; almond confectionery; caramels [candy]; sweetmeats [candy].

(260) AM 2019 100554 A
 (800) 1435636
 (151) 2018 08 17
 (891) 2018 08 17
 (731) TALAGAEVA ELENA VLADIMIROVNA
 Kommunisticheskaya St., d. 3, kv.145,
 Ramenskoye, RU-140002 Moskovskaya
 oblast, Russian Federation

(540)

ДЕСЕРТЫ КРАСОТЫ

(591) Black, white

(531) 28.05

(511)

3 – Amber [perfume]; aromatics [essential oils]; balms, other than for medical purposes; lip glosses; petroleum jelly for cosmetic purposes; cotton wool for cosmetic purposes; scented water; Javelle water; lavender water; toilet water; depilatory wax; waxes for leather; creams for leather; massage gels, other than for medical purposes; deodorants for human beings or for animals; depilatories; perfumes; greases for cosmetic purposes; perfumery; ionone [perfumery]; eyebrow pencils; cosmetic pencils; hair conditioners; beard dyes; cosmetic dyes; cosmetic creams; hair spray; nail polish; hair lotions; lotions for cosmetic purposes; after-shave lotions; beauty masks; oils for perfumes and scents; oils for cosmetic purposes; oils for toilet purposes; essential oils; essential oils of cedarwood; essential oils of lemon; essential oils of citron; oils for cleaning purposes; bergamot oil; gaultheria oil; jasmine oil; lavender oil; almond oil; rose oil; oil of turpentine for degreasing; almond milk for cosmetic purposes; cleansing milk for toilet purposes; musk [perfumery]; soap; deodorant soap; shaving soap; cakes of soap; almond soap; cosmetic kits; eau de Cologne; bases for flower perfumes; lipsticks; pomades for cosmetic purposes; shaving preparations; cosmetic preparations for baths; bath preparations, not for medical purposes; hair straightening preparations; waving preparations for the hair; douching preparations for personal sanitary or deodorant purposes [toiletries]; color-removing preparations; make-up removing preparations; nail care preparations; aloe vera preparations for cosmetic purposes; sun screen preparations; make-up powder; potpourris [fragrances]; bath salts, not for medical purposes; fumigation preparations [perfumes]; eyebrow cosmetics; sun-tanning preparations [cosmetics]; hair dyes; neutralizers for permanent waving; cosmetic preparations for eyelashes; cosmetic preparations for skin care; cosmetics; mascara; bleaching preparations [decolorants] for cosmetic purposes; antiperspirants [toiletries]; talcum powder, for toilet use; terpenes [essential oils]; henna [cosmetic dye]; shampoos; dry shampoos; extracts of flowers [perfumes]; ethereal essences; badian essence; mint essence [essential oil].

(260) AM 2019 100564 A

(800) 1435874

(151) 2018 08 09

(891) 2018 08 09

(731) FORMULA ONE LICENSING B.V.

Beursplein 37, NL-3011 AA Rotterdam,
Netherlands

(540)

FORMULA 1

(591) Black, white

(511)

3 – Soaps; eau-de-cologne; astringents for cosmetic purposes; cleaning chalk; hair conditioners; cosmetic creams; shaving creams, shaving gels; facial cleansing creams; shower gels and creams; skin care creams, beauty creams, moisturising creams; shoe waxes; polishing creams; deodorants and anti-perspirants for personal use; incense; cosmetic pencils; sun care lotions; pre-shave and after-shave lotions; hair lotions, hair gels, hair creams, hair spray; decorative transfers for cosmetic purposes; essential oils; eye shadows; perfumes; face powders; cosmetic preparations for baths; cleaning, polishing, scouring and abrasive preparations for household use, not being preparations for washing automobiles; make-up preparations; washing preparations; cleaning preparations; make-up removing preparations; oral care products, particularly including dentifrices, mouthwashes; cleansing products for the body, particularly including cleansing lotions, beauty masks, cleansing foam, cleansing creams, cleansing gels and cleansing milk; cleaning products; liquid soaps.

6 – Ironmongery; common metals and their alloys; ores; goods of common metal, namely rings of common metal for keys, chains of metal and pins (hardware); small items of metal hardware; towel dispensers, fixed, of metal; metal distributors of hand towels, paper napkins, kitchen paper; badges of metal for vehicles; statuettes of common metal; figurines (statuettes) of common metal; plates, trophies and sheets, all made of common metals.

8 – Hand tools and implements (hand-operated); cutlery, forks and spoons; razor blades; knives; electric or non-electric razors; tweezers; scissors.

11 – Apparatus for lighting, heating, steam generating, cooking, refrigerating, drying, ventilating, water supply and sanitary purposes; lamps; air conditioning apparatus; water filtering apparatus; electric hair dryers; electric laundry dryers; drying apparatus; barbecues; light bulbs; stoves; electric kettles; electric coffee machines; freezers; electric cookers; gas stoves; kitchen ranges (ovens); drinking water fountains; microwave ovens; ovens, other than for experimental purposes; electric deep fryers; grills (cooking appliances); table lamps; incandescent lamps; pocket searchlights; lanterns for lighting; lighting fixtures; decorative lamps; bicycle lights;

lamp shades; solar collectors for heating; refrigerators; toilet seats; electric toasters; flashlights; electric fans for personal use.

20 – Furniture, mirrors, picture frames; containers, not of metal, for storage or transport; unworked or semi-worked bone, horn, whalebone or mother of pearl; shells; meerschaum; yellow amber; air pillows, not for medical purposes; air cushions, not for medical purposes; air mattresses, not for medical purposes; air beds, not for medical purposes; bag hangers, not of metal; bedding, except linen; beds for household pets; beds; benches [furniture]; bins, not of metal; chests, not of metal; bottle racks; bottle closures, not of metal / bottle fasteners, not of metal; bottle casings of wood; boxes of wood or plastic; busts of wood, wax, plaster or plastic; cabinet work; camping mattresses; cask stands, not of metal; casks of wood for decanting wine; casks, not of metal; console tables; containers, not of metal, for liquid fuel containers, not of metal [storage, transport]; counters [tables]; covers for clothing [wardrobe]; crates; cushions; deck chairs; desks; dinner wagons [furniture]; display boards; display stands; fans for personal use, non-electric; filing cabinets; furniture; furniture of metal, furniture shelves; garment covers [storage]; hampers [baskets] for the transport of items; hand-held mirrors [toilet mirrors]; hand-held flagpoles, not of metal; high chairs for babies; identification bracelets, not of metal; index cabinets [furniture]; inflatable publicity objects; inflatable furniture; jewellery organizer displays / jewelry organizer displays; keyboards for hanging keys; labels of plastic; lockers; locks, not of metal, for vehicles locks, other than electric, not of metal; mattresses; mirror tiles; mirrors [looking glasses]; mobile boarding stairs, not of metal, for passengers; mobiles [decoration]; nameplates, not of metal / identity plates, not of metal; newspaper display stands; number plates, not of metal / registration plates, not of metal; office furniture; packaging containers of plastic; picture frames; picture frame brackets / picture rods [frames]; pillows; placards of wood or plastics; plastic key cards, not encoded and not magnetic; plastic keys; plastic ramps for use with vehicles; plugs, not of metal / bungs, not of metal; poles, not of metal; racks [furniture]; seats / chairs [seats]; seats of metal; sleeping pads / sleeping mats; split rings, not of metal, for keys; stools; table tops; tables; tables of metal; tent pegs, not of metal; tool boxes, not of metal, empty; tool chests, not of metal, empty; transport pallets, not of metal; trays, not of metal; vats, not of metal; wind chimes [decoration].

21 – Glassware, porcelain and earthenware for household purposes; articles for cleaning purposes; brush-making materials; combs and sponges; brushes [except paintbrushes]; household or kitchen utensils and containers (not of precious metal or coated therewith); unworked or semi-worked glass, ex-

cept building glass; bottles; insulating bottles; drying racks for washing; mixers, manual (shakers); mixing spoons (kitchen utensils); glass flasks (containers); decorative boxes of non-precious metals; metal boxes for dispensing paper towels; containers for food and beverages; crystal [glassware]; coolers (ice pails); decanters; bottle openers; coasters; statues of porcelain, terra-cotta or glass; clothes racks (for drying); figurines (statuettes) of porcelain, terra-cotta or glass; dental floss; cages for household pets; ice buckets; tankards; beer mugs; glass (receptacles); drinking glasses; gloves for household purposes; fruit presses, non- electric, for household use; feeding troughs for animals; fitted picnic baskets (including dishes); waste paper baskets; combs; cutting boards for the kitchen; toothbrushes; hairbrushes; containers for household or kitchen use; non- electric coolers for food and drinks; coasters, not of paper or textile; trays; decorative glass trays; trays for domestic use; saucers; sugar bowls; cups; tea pots; corkscrews; kitchen utensils; utensils for household purposes; commemorative plates.

29 – Meat; fish; poultry; game; meat extracts; cooked fruits and vegetables; canned fruits and vegetables; frozen fruits and vegetables; frozen meat, fish and poultry; edible oils and fats; potato chips; french fries; processed nuts; jams; jellies; fish and meat preserves; milk, milk drink products; yoghurt drinks; milk shakes; dairy products; cheese; soya milk (milk substitute).

30 – Spices; salt; mustard; vinegar, sauces (condiments); snacks based on corn; rice; cookies; cocoa; coffee; cereals; confectionery; chocolate confectionery; crackers; candies; soya flour; flour; corn flakes; ice cream; yeast; honey; molasses; bread; corn, roasted; pastries; cakes; preparations made from cereals; artificial coffee; sugar; tea; chocolate.

42 – Design and development of computers and software; scientific and technological services and research and design relating thereto; industrial analysis and research services; leasing of computers and computer software; installation, research and update of computer software for the electronic exchange of data and telecommunication networks for third parties; creation and maintenance of database software and applications; creating, maintaining and hosting internet web sites and of wireless electronic communication networks; electronic storage of data; electronic storage; installing and maintenance of computer software; providing temporary use of non- downloadable computer software to enable users to create and share text, documents, images, photos, videos, maps and roadmaps; temporary provision of non-downloadable computer software online; temporary provision of non-downloadable computer software online allowing users to access programs with audio content, video, text and other multimedia content, including music, concerts, videos, radio, television,

news, sports, games, cultural events, and programs in connection with entertainment; recovery of computer data; services of a computer software consultant; computer software design and development services; graphic arts designing; computer services that provide online web pages created according to customer needs and that offer user-specific information, including search engines and online web connections with news, information on sports; computer services that provide online web pages created according to the needs of customers and providing certain information to the user, including search engines and online web links to news, weather information, sports; computer services, namely, creating websites featuring an on- line community for registered users to participate in discussions, get feedback, form virtual communities, and engage in social networking online; services provided by an application service provider (asp) featuring computer software for use in connection with subscription services for online music, software allowing users to play and program music and audio, video, text and multimedia content in connection with entertainment, and computer software featuring recordings of musical sounds, text, audio, video and multimedia content in connection with entertainment.

43 – Services for providing food and drink; providing hotel accommodation; cafés; cafeterias; canteens; tourist homes; information on hotel bookings; temporary accommodation reservation; hotel reservation; food and drink catering; restaurants; self-service restaurants; snack-bars; providing catering services for hospitality suites in relation to the provision of food and drink for sporting or entertainment events, both on- and off -site sports facilities; bar services; fast food restaurant services; services provided by restaurant.

(260) AM 2019 100569 A

(800) 1435983

(151) 2018 05 29

(891) 2018 05 29

(731) NOKIA CORPORATION

Karaportti 3, FI-02610 Espoo, Finland

(540)

NOKIA

(591) Blue Pantone 293

(531) 27.05.01; 27.05.17; 29.01.04

(511)

9 – Smartwatches; head-mounted displays; devices with electric, electronic and digital functions that can connect to computer networks and which have computing, sensory, scanning, communication, data-storage, biofeedback, physiological-tracking, health-monitoring, fitness monitoring, predictive or augmented-reality capabilities, in the form of glasses, gloves, watches, clothing, footwear, headgear, bands

and helmets; batteries; chargers; printers; covers for phones, smartphones, computers, tablets and other wearable and portable handheld computing devices; audio, imaging, video and radio apparatus and instruments; speakers; headsets; microphones; television and multimedia apparatus; displays; hands free kits for phones, smartphones, computers, tablets and other wearable and portable handheld computing devices; electronic publications; Global Positioning System [GPS] apparatus, instruments and devices; navigation apparatus for vehicles [on-board computers]; navigational instruments; satellite navigational apparatus; apparatus and software for GPS navigation and mapping systems; chips; microprocessors; semi-conductors; smart cards [integrated circuit cards]; printed circuits; remote control apparatus; downloadable sound, video and image files; electronic pens; electronic tags for goods; computer software, computer hardware and wearable computing devices allowing the remote monitoring, control and command of vehicles and vehicle parameters, of household appliances and furniture, of energy management systems, of home automation systems, of security systems, of home entertainment and audio/video equipment, of telecommunication devices, social media devices and computing devices, and of fitness and health telecare equipment; machine to machine (M2M) communications equipment and devices; computer game software; software applications; glasses; binoculars; optical lenses; contact lenses; optical goods; goggles for sports; application programming interfaces (APIs); software development tools; computer software and hardware allowing to listen to music and read audio/video files, to send and read out electronic messages, to take, edit, read, display and share digital photographs, sounds and videos, to browse on the Internet, to chat and to connect to social networks; digital maps; software applications for providing location-based and contextually-relevant advertisement; vision recognition software; audio recognition software; computer software and hardware for the provision and rendering of travel and tourism advice and for providing information about location of entertainment venues, local education institutions, hotels, landmarks, museums, public transportation, traffic, parking information, weather, price comparison, shopping, advertisement, health and fitness, employment information, social activities and cultural events, Points of Interest (POIs), sporting events, food and drink; location tracking devices; software applications and hardware enabling the user to obtain location-related and contextually-relevant information; computer software and hardware providing health, fitness and well-being information; equipment and apparatus for measuring and/or recording different physiological or other parameters, including heart rate, blood pressure, weight, sleep quality, ventilation, body temperature, skin conductivity, blood glucose (all being for scien-

tific purposes), lactic acid, time, speed, acceleration, altitude, environmental temperature, humidity and purity; computer software and hardware allowing online payment and payment at distance; algorithms for the compression, decompression, encoding, decoding and processing of audio, video and imaging data; audio, video and images encoder/decoder (codec); computing and communication hardware and software for use by public safety agencies; air analysis apparatus; alarms; animated cartoons; automated teller machines [ATM]; compasses; computer memory devices; data processing apparatus; detectors; diagnostic apparatus, not for medical purposes; distance measuring apparatus; DNA chips; downloadable ring tones for mobile phones; electric installations for the remote control of industrial operations; electro-dynamic apparatus for the remote control of railway points and of signals; encoded magnetic cards and identification bracelets; fiber optic cables; films, exposed; flashlights; food analysis apparatus; wires of metal alloys; galvanic cells; heat regulating apparatus; high-frequency apparatus; holograms; intercommunication apparatus; interfaces for computers; lasers, not for medical purposes; lenses for astrophotography; life-saving equipment; light emitting diodes [LED]; locks, electric; loudspeakers; masts for wireless aerials; material testing instruments and machines; measuring devices, electric; metronomes; microscopes; monitoring apparatus, electric; observation instruments; optical fibers; photocopiers; photovoltaic cells; apparatus and instruments for physics; precision balances; radar apparatus; radiotelephony sets; railway traffic safety appliances; satellites for scientific purposes; scales; scanners; signals, luminous or mechanical; signs, luminous; simulators for the steering and control of vehicles; sound locating instruments; telescopes; temperature indicators; testing apparatus not for medical purposes; theft prevention installations, electric; thermometers, not for medical purposes; thermostats; time recording apparatus; traffic-light apparatus; viewfinders, photographic; walkie-talkies; wavemeters; weighing machines; X-rays producing apparatus and installations, not for medical purposes; humanoid robots with artificial intelligence; wearable activity trackers; wearable computers; wearable video display monitors; scientific, nautical, surveying, photographic, cinematographic, optical, weighing, measuring, signalling, checking (supervision), life-saving and teaching apparatus and instruments; apparatus and instruments for conducting, switching, storing, transforming, accumulating, regulating or controlling electricity; apparatus for recording, capturing, storing, processing, editing, displaying, transmission or reproduction and play back of sound or images; magnetic data carriers, recording discs; compact discs, DVDs and other digital and optical recording media; calculating machines, data processing equipment, computers and computer hardware,

parts and fittings thereof; computer peripheral devices; computer software; telecommunications devices, apparatuses and equipment, parts and fittings thereof; base stations, transmitters, receivers, controllers, switches, antennas, cables; electric wires; amplifiers; commutators; modems; radio and microwave transmission devices and equipment; apparatus and instruments for data communication, satellite communication and telecommunication; apparatus and instruments for monitoring of telecommunication networks and data communication networks; radar equipment; ciphering equipment, phones, smartphones and other wearable and portable electronic devices for capturing, receiving, collecting, recording, reading, displaying, organizing, editing, transmitting, sharing, manipulating and reviewing data, text, maps, images and sounds; portable media players; tablets; electronic agendas; electronic book readers; notebook computers; digital photo frames; cameras; camcorders; sensors; wearable connected devices, namely devices in the form of watches, glasses, contact lenses, headbands, gloves, bracelets, earrings, jewelry and helmets that can be used for computing, sensing, scanning, recording, displaying, monitoring, data-processing, remote-controlling, predicting, programming, connecting to computer networks or for telecommunication purposes; computing devices to be carried by end-users or to be worn on or into the body of end-users or to be incorporated into clothing, footwear, headgear, contact lenses, bags, textiles, fabrics, tissue, furniture and any kinds of materials and portable goods and accessories and that can be used for computing, sensing, scanning, recording, displaying, monitoring, data-processing, remote controlling, predicting, programming, connecting to computer networks or for telecommunication purposes; wearable and portable computing devices; displays for vehicles; sensors for vehicles; parts, fittings and accessories of all the aforementioned goods.

10 – Surgical, medical, dental and veterinary apparatus and instruments; artificial limbs, eyes and teeth; orthopaedic articles; suture materials; therapeutic and assistive devices adapted for the disabled; massage apparatus; apparatus, devices and articles for nursing infants; sexual activity apparatus, devices and articles; air pillows and air mattresses for medical purposes; supportive bandages; electric blankets, for medical purposes; blood testing apparatus; cases fitted for use by surgeons and doctors; containers especially made for medical waste; apparatus for the treatment of deafness; defibrillators; dentures; diagnostic apparatus for medical purposes; teats for babies; ear picks; ear protection devices; elastic stockings for surgical purposes; electrocardiographs; esthetic massage apparatus; feeding bottles; orthopaedic footwear; hair prostheses; hearing aids for the deaf; heart pacemakers; electric heating cushions for medical purposes; ice bags for medical purposes; incontinence sheets; incubators for medical purposes;

invalids' hoists; lamps for medical purposes; lasers for medical purposes; lenses [intraocular prostheses] for surgical implantation; masks for use by medical personnel; operating tables; physiotherapy apparatus; protection devices against X-rays, for medical purposes; pulse meters; soporific pillows for insomnia; blood pressure measuring apparatus; stockings for varices; strait jackets; wheeled stretchers; surgical implants; testing apparatus for medical purposes; apparatus for use in medical analysis; thermometers for medical purposes; thread, surgical; urinals; water bags for medical purposes; X-ray apparatus, photographs and tubes for medical purposes; apparatus and installations for the production of X-rays, for medical purposes; sensors, measuring and monitoring apparatus and instruments for health, wellbeing, medical, surgical and health related self-monitoring purposes; X-ray sensors; probes and cameras for medical and surgical purposes; ear plugs; scales for medical and surgical purposes; clothing, footwear and headgear for medical and surgical purposes; furniture for medical and surgical purposes; lamps for medical and surgical purposes; prostheses for medical and surgical purposes; parts, fittings and accessories for all the aforementioned goods.

11 – Apparatus for lighting, heating, steam generating, cooking, refrigerating, drying, ventilating, water supply and sanitary purposes; air conditioning installations and apparatus; air filtering installations, apparatus and machines; cooling installations, appliances and machines; filters for ventilation apparatus [parts of household or industrial installations]; heating installations; lamps; light bulbs; lighting installations; nuclear reactors; atomic piles; refrigerating appliances and installations; sanitary installations; sauna and spa bath installations; steam generating installations; tanning apparatus [sun beds]; ventilation [air-conditioning] installations; water distribution installations; watering installations, automatic; watering machines for agricultural purposes; parts, fittings and accessories of all the aforementioned goods.

12 – Vehicles; apparatus for locomotion by land, air or water; aeronautical apparatus, machines and appliances; air bags [safety devices for automobiles]; anti-theft devices for vehicles; automobiles; chairlifts; civilian and military drones; driverless vehicles [autonomous vehicles]; engines, electric motors and propulsion mechanisms for land vehicles; parachutes; remote control vehicles, other than toys; safety belts for vehicle seats; side and rear view mirrors; space vehicles; sack-barrows; vehicle joysticks; vehicles for locomotion by rail; wheelchairs; windscreens; parts, fittings and accessories of all the aforementioned goods.

14 – Precious metals and their alloys; jewellery, precious and semi-precious stones; horological and chronometric instruments; boxes of precious metal;

bracelets [jewelry]; coins; cuff links; key rings [trinkets or fobs]; medals; necklaces [jewelry]; ornamental pins; rings [jewelry]; watch bands, straps and chains; watch hands; watches; watch boxes; works of art of precious metal; wristwatches; parts, fittings and accessories of all the aforementioned goods.

35 – Advertising; business management; business administration; office functions; publicity; rental of advertising space; arranging subscriptions to telecommunication services for others; auctioneering; accounting; providing business and commercial information; commercial or industrial management assistance; commercial information and advice for consumers [consumer advice shop]; commercial administration of the licensing of the goods and services of others; collection, compilation, processing, management, updating and maintenance of data in computer databases; compilation of statistics; cost price analysis; data search in computer files for others; demonstration of goods; distribution of samples; document reproduction; economic forecasting; import-export agency services; computerized file management; market studies; marketing; office machines and equipment rental; provision of an on-line marketplace for buyers and sellers of goods and services; arranging and conducting of commercial, trade and business conferences, shows and exhibitions; outsourcing services [business assistance]; personnel management consultancy; presentation of goods on communication media, for retail purposes; procurement services for others; public relations; search engine optimization for sales promotion; sponsorship search; telemarketing services; telephone answering for unavailable subscribers; rental of vending machines; web site traffic optimization; wholesale, retail and online store services in the field of telecommunication devices, equipment, systems, software and solutions comprised of telecommunication devices and software; wholesale, retail and online store services in the field of phones, computers, computer hardware and computer software; wholesale, retail and online store services in the field of handheld mobile digital electronic devices for capturing, receiving, collecting, recording, reading, displaying, organizing, editing, transmitting, sharing, manipulating and reviewing data, text, maps, images and sounds; wholesale, retail and online store services in the field of entertainment apparatus and equipment for recording, capturing, storing, processing, editing, displaying, transmission or reproduction and play back of sound, images or video and for playing video and software games; wholesale, retail and online store services in the field of multimedia apparatus and equipment; wholesale, retail and online store services in the field of telecommunication devices, sensors, printers, energy management systems, home automation systems, security systems, computing devices, fitness and health-monitoring equipment and apparatus; wholesale, retail and online store ser-

vices in the field of horological and chronometric instruments, household and kitchen utensils, clothing, footwear and headgear, games and playthings, machine tools, digital maps, musical instruments, optical goods, location tracking devices, computing devices enabling the user to obtain location-related and contextually-relevant information and carrying cases for such products; wholesale, retail and online store services in the field of medical apparatus and instruments, pharmaceuticals, veterinary and sanitary preparations, physical therapy and sporting equipment; wholesale, retail and online store services in the field of white goods, heating, cooking, cooling and lighting apparatus and equipment, household appliances, sanitary installations, wearable computing devices, navigation devices, Global Positioning System [GPS] apparatus, audio-visual equipment, information technology equipment; retail and wholesale services in the field of machine to machine (M2M) communications equipment and devices; data processing services; collecting and processing of data; administration of consumer loyalty programs; arranging and conducting incentive rewards programs to promote the sale of goods and services; compilation of data regarding the purchase and sale of a wide variety of products and services of others into computer databases; customer experience management (CEM) services; predictive business analytics services; information, advisory and consultancy services relating to all the aforesaid services.

38 – Telecommunications; telephone, sound, images, text and data transmission services; cellular telephone communication; communications by computer terminals; communications by fibre optic and wireless networks; computer aided transmission of messages, sound, data and images; electronic bulletin board services [telecommunications services]; facsimile transmission; rental, hire and leasing of telecommunication devices, equipment and systems; message sending; rental of modems; news agency services; providing online forums; paging services [radio, telephone or other means of electronic communication]; radio broadcasting; radio communications; satellite transmission; streaming of data; providing telecommunications connections to a global computer network; providing user access to global computer networks; providing telecommunication channels for teleshopping services; providing internet chatrooms; providing access to databases; rental of message sending apparatus; rental of access time to global computer networks; telecommunications routing and junction services; teleconferencing services; telegraph services; telephone services; rental of telephones; television broadcasting; telex services; transmission of telegrams; electronic mail; transmission of greeting cards online; transmission of digital files; video-on-demand transmission; videoconferencing services; voice mail services; wireless broadcasting; provision of access to a computerized database that

allow the management and security of connected electronic devices and of software applications; information, advisory and consultancy services relating to all the aforesaid services.

41 – Education; providing of training; entertainment; sporting and cultural activities; rental of audio and video equipment; audio, video and images editing and production services; rental of cinematographic apparatus; coaching [training]; arranging and conducting of colloquiums, concerts, exhibitions, conferences, congresses, in-person educational forums, of symposiums, of seminars, of award ceremonies and of workshops; arranging and conducting of commercial trade and business conferences; film production, other than advertising films; conducting fitness classes; wellbeing coaching services; provision of nutrition, fitness and wellbeing training; fitness co-selling; health club services [health and fitness training]; game services provided on-line from a computer network; games equipment rental; micro-filming; movie studio services; on-line publication of electronic books and journals; providing on-line electronic publications, on-line music and on-line videos, not downloadable; organization of competitions [education or entertainment]; organization of sports competitions; photography; practical training [demonstration]; presentation of live performances; publication of texts, other than publicity texts; publication of books; rental of radio and television sets; recording studio services; rental of sound recordings; rental of sports equipment, except vehicles; videotape editing; videotaping; organizing education, seminars, workshops and training in the field of telecommunications devices, equipment, networks, systems, solutions and software; information, advisory and consultancy services relating to all the aforesaid services.

42 – Scientific and technological services and research and design relating thereto; industrial analysis and research services; design, development, installation, maintenance and upgrading of computer software; design and development of computer hardware; clinical trials; computer programming; computer system analysis and design; computer virus protection services; computer security consultancy; construction drafting; consultancy in the field of energy-saving; conversion of data or documents from physical to electronic media; creating and maintaining web sites for others; data conversion of computer programs and data [not physical conversion]; digitization of documents [scanning]; electronic data storage; energy auditing; hosting computer sites [web sites]; mechanical research; meteorological information; monitoring of computer systems by remote access; outsource service providers in the field of information technology; physics [research]; quality control; recovery of computer data; research and development of new products for others; provision

of scientific information, advice and consultancy in relation to carbon offsetting; scientific laboratory services; providing search engines for the internet; surveying; technical project studies; technical writing; technological consultancy; telecommunications technology consultancy; material and textile testing; urban planning; vehicle roadworthiness testing; water analysis; rental of web servers; web site design consultancy; scientific and technological analysis, research, development, planning, optimization, support, technical troubleshooting and consultancy services in the field of telecommunications devices, equipment, networks, systems, solutions and software; design, engineering and development of telecommunications devices, equipment, networks, systems, solutions and software; scientific and technological analysis, research, development, support, technical troubleshooting and consultancy services in the field of artificial intelligence, nanomaterials, sensors, connectivity, information technology [IT], geolocation and mapping, navigation, computer hardware, computer software, computing technologies, data analytics; scientific and technological analysis, research, development, support, technical troubleshooting and consultancy services in the field of audio technologies, imaging and video technologies, digital media technologies, multimedia technologies, virtual reality technologies, radio technologies; scientific and technological analysis, research, development, support, technical troubleshooting and consultancy services in the field of medical and healthcare technology, public safety technology, energy technologies, transport technologies, wearable computing devices, printing, automation, connected vehicles, connected furniture, connected clothing, connected consumer products, connected home appliances, machine to machines (M2M) systems, presence capture solutions; scientific and technological analysis and research services in the field of vehicles, furniture, clothing, home appliances and consumer products that can communicate via computer or telecommunication network, as well as support, consultancy and development services relating to all the aforementioned services; cloud computing; server hosting; software as a service [SaaS]; infrastructure-as-a-service (IaaS); platform-as-a-service (PaaS); application service provider (ASP) services; providing on-line [non-downloadable] software and mobile applications; providing temporary use of on-line non-downloadable software for use as an application programming interface (API); providing temporary use of on-line non-downloadable software development tools; rental of computer software and hardware; rental of audio, imaging, video, digital media, multimedia, virtual reality and presence capture software and hardware; data encoding and decoding services; leasing of data processing equipment; cartography services; mapping services; map creation services; on demand provision services of online and

digital maps; computer services, namely, creating computer network-based indexes of information, websites and resources; technical digital imaging services; industrial design; off-site data backup; research in the field of environmental protection; collecting, and processing of data; installation, repair and maintenance of computer software; performance monitoring services of electronic devices connected to a network of computers or of telecommunication equipment (Smart Data as a Service); collection, storage and provision of access to information, network data and geolocalisation data (Optimization as a Service); medical and clinical research and trials for improvement of patient/physician interaction; information, advisory and consultancy services relating to all the aforesaid services.

44 – Medical services; veterinary services; hygienic and beauty care for human beings or animals; agriculture, horticulture and forestry services; aquaculture services; chiropractic; convalescent home services; dentistry services; farming equipment rental; health care; health center services; health counseling; provision of nutrition information; provision of wellbeing information (health); hospital services; massage; medical equipment rental; optician services; pharmacy advice; physiotherapy; plastic surgery; services of a psychologist; tattooing; telemedicine services; remote patient monitoring services; medical analysis services relating to the treatment of persons; diagnosis, treatment and rehabilitation of diseases; medical clinic services relating to patient treatment for improvement of patient/physician interaction; therapy services; information, advisory and consultancy services relating to all the aforesaid services.

(260) AM 2019 100632 A

(800) 1437101

(151) 2018 09 11

(891) 2018 09 11

(731) NEW MOBIL TECHNOLOGIES LLC

Chistova street, 4a, bld. 2, RU-109390

Moscow, Russian Federation

(540)

domingo®

(591) Black, gray

(531) 27.05.02; 27.05.03

(526) ®

(511)

3 – Bleaching preparations and other substances for laundry use; cleaning, polishing, scouring and abrasive preparations; soap; perfumery, essential oils, cosmetics, hair lotions; non-medicated dentifrices; abrasives; amber [perfume]; descaling preparations for household purposes; antistatic preparations for

household purposes; aromatics [essential oils]; air fragrancing preparations; cake flavorings [essential oils]; flavorings for beverages [essential oils]; breath freshening sprays; canned pressurized air for cleaning and dusting purposes; balms, other than for medical purposes; lip glosses; polishing stones; abrasive paper; emery paper; polishing paper; petroleum jelly for cosmetic purposes; shoe wax; cobblers' wax; cotton wool for cosmetic purposes; sachets for perfuming linen; drying agents for dishwashing machines; adhesives for cosmetic purposes; scented water; Javelle water; lavender water; toilet water; laundry wax; floor wax; non-slipping wax for floors; depilatory wax; mustache wax; tailors' wax; polish for furniture and flooring; shoemakers' wax; polishing wax; massage gels, other than for medical purposes; heliotropine; dental bleaching gels; geraniol; make-up; deodorants for pets; deodorants for human beings or for animals; scented wood; perfumes; non-slipping liquids for floors; windshield cleaning liquids; greases for cosmetic purposes; volcanic ash for cleaning; decorative transfers for cosmetic purposes; ionone [perfumery]; shaving stones [astringents]; smoothing stones; eyebrow pencils; cosmetic pencils; silicon carbide [abrasive]; carbides of metal [abrasives]; alum stones [astringents]; tripoli stone for polishing; adhesives for affixing false eyelashes; adhesives for affixing false hair; quillaia bark for washing; corundum [abrasive]; laundry blueing; beard dyes; colorants for toilet purposes; cosmetic dyes; laundry starch; laundry glaze; creams for leather; polishing creams; cosmetic creams; skin whitening creams; polishing rouge; incense; hair spray; nail polish; lotions for cosmetic purposes; after-shave lotions; beauty masks; oils for perfumes and scents; oils for cosmetic purposes; oils for toilet purposes; essential oils of cedarwood; essential oils of lemon; oils for cleaning purposes; bergamot oil; gaultheria oil; jasmine oil; lavender oil; almond oil; rose oil; oil of turpentine for degreasing; whitening; cleaning chalk; almond milk for cosmetic purposes; cleansing milk for toilet purposes; musk [perfumery]; deodorant soap; shaving soap; soap for brightening textile; cakes of toilet soap; antiperspirant soap; soap for foot perspiration; almond soap; mint for perfumery; cosmetic kits; emery; nail art stickers; false nails; eau de Cologne; bases for flower perfumes; cotton sticks for cosmetic purposes; joss sticks; pastes for razor strops; pumice stone; hydrogen peroxide for cosmetic purposes; breath freshening strips; abrasive cloth; glass cloth [abrasive cloth]; lipsticks; pomades for cosmetic purposes; shaving preparations; cosmetic preparations for baths; toiletries; hair waving preparations; laundry soaking preparations; grinding preparations; douching preparations for personal sanitary or deodorant purposes [toiletries]; smoothing preparations [starching]; color-removing preparations; leather bleaching preparations; denture polishes; mouthwashes,

not for medical purposes; cosmetic preparations for slimming purposes; starch glaze for laundry purposes; refurbishing preparations; fabric softeners for laundry use; laundry bleach; dry-cleaning preparations; paint stripping preparations; lacquer-removing preparations; make-up removing preparations; floor wax removers [scouring preparations]; varnish-removing preparations; rust removing preparations; nail care preparations; preparations for cleaning dentures; wallpaper cleaning preparations; preparations for unblocking drain pipes; laundry preparations; aloe vera preparations for cosmetic purposes; sunscreen preparations; color-brightening chemicals for household purposes [laundry]; shining preparations [polish]; make-up powder; diamantine [abrasive]; stain removers; scouring solutions; false eyelashes; tissues impregnated with cosmetic lotions; saffrol; turpentine for degreasing; potpourris [fragrances]; bleaching soda; washing soda, for cleaning; bath salts, not for medical purposes; bleaching salts; fumigation preparations [perfumes]; preservatives for leather [polishes]; ammonia [volatile alkali] [detergent]; astringents for cosmetic purposes; eyebrow cosmetics; make-up preparations; sun-tanning preparations [cosmetics]; hair dyes; neutralizers for permanent waving; preparations to make the leaves of plants shiny; cosmetic preparations for eyelashes; depilatories; depilatory preparations; cosmetic preparations for skin care; cosmetics; cosmetics for animals; mascara; detergents, other than for use in manufacturing operations and for medical purposes; degreasers, other than for use in manufacturing processes; bleaching preparations [decolorants] for cosmetic purposes; antiperspirants [toiletries]; talcum powder, for toilet use; terpenes [essential oils]; emery cloth; cloths impregnated with a detergent for cleaning; shampoos; shampoos for pets; dry shampoos; sandpaper; soda lye; extracts of flowers [perfumes]; ethereal essences; badian essence; mint essence [essential oil]; cosmetic cotton pads; pre-moistened cosmetic wipes; hygienic cotton sticks; babies' cotton sticks; hygienic cotton pads; babies' cotton pads; pre-moistened hygienic wipes; pre-moistened babies' wipes; impregnated cloths for household purposes.

5 – Pharmaceutical and veterinary preparations; sanitary preparations for medical purposes; dietetic food and substances adapted for medical or veterinary use, food for babies; dietary supplements for humans and animals; plasters, materials for dressings; material for dental fillings and dental impressions; disinfectants; preparations for destroying noxious animals; fungicides, herbicides; acaricides; aconitine; alkaloids for medical purposes; alginates for pharmaceutical purposes; algicides; aldehydes for pharmaceutical purposes; dental amalgams of gold; dental amalgams; amino acids for veterinary purposes; amino acids for medical purposes; analgesics; anaesthetics; antibiotics; antiseptics; medicine

cases, portable, filled; first-aid boxes, filled; aluminium acetate for pharmaceutical purposes; acetates for pharmaceutical purposes; germicides; balms for medical purposes; hygienic bandages; bandages for dressings; biocides; bromine for pharmaceutical purposes; paper for mustard plasters; fly catching paper; mothproofing paper; petroleum jelly for medical purposes; vaccines; oxygen baths; antiseptic cotton; aseptic cotton; absorbent cotton; wadding for medical purposes; cotton for medical purposes; radiological contrast substances for medical purposes; nutritive substances for microorganisms; radioactive substances for medical purposes; bismuth subnitrate for pharmaceutical purposes; melissa water for pharmaceutical purposes; sea water for medicinal bathing; mineral waters for medical purposes; thermal water; dietary fiber; molding wax for dentists; gases for medical purposes; guaiacol for pharmaceutical purposes; hematogen; hemoglobin; hydrastine; hydrastinine; glycerine for medical purposes; glycerophosphates; glucose for medical purposes; gentian for pharmaceutical purposes; hormones for medical purposes; mustard for pharmaceutical purposes; mustard plasters; mud for baths; medicinal mud; gamboge for medical purposes; gurjun balsam for medical purposes; air deodorising preparations; deodorants, other than for human beings or for animals; deodorants for clothing and textiles; diastase for medical purposes; digitalin; mineral food supplements; nutritional supplements; albumin dietary supplements; dietary supplements for animals; alginate dietary supplements; glucose dietary supplements; casein dietary supplements; lecithin dietary supplements; linseed oil dietary supplements; propolis dietary supplements; protein dietary supplements; protein supplements for animals; royal jelly dietary supplements; pollen dietary supplements; wheat germ dietary supplements; linseed dietary supplements; enzyme dietary supplements; yeast for pharmaceutical purposes; gelatine for medical purposes; cod liver oil; isotopes for medical purposes; insecticides; iodine for pharmaceutical purposes; iodides for pharmaceutical purposes; alkaline iodides for pharmaceutical purposes; iodoform; calomel; cream of tartar for pharmaceutical purposes; tartar for pharmaceutical purposes; camphor for medical purposes; capsules for medicines; cachets for pharmaceutical purposes; hemostatic pencils; wart pencils; caustic pencils; headache pencils; carbolineum [parasiticide]; caustics for pharmaceutical purposes; cachou for pharmaceutical purposes; quassia for medical purposes; quebracho for medical purposes; oxygen for medical purposes; gallic acid for pharmaceutical purposes; acids for pharmaceutical purposes; adhesives for dentures; stem cells for veterinary purposes; stem cells for medical purposes; cocaine; collodion for pharmaceutical purposes; corn rings for the feet; candy, medicated; angostura bark for medical purposes; barks for pharmaceutical purposes; cedar wood

for use as an insect repellent; condurango bark for medical purposes; croton bark; mangrove bark for pharmaceutical purposes; myrobalan bark for pharmaceutical purposes; quinquina for medical purposes; medicinal roots; rhubarb roots for pharmaceutical purposes; lint for medical purposes; starch for dietetic or pharmaceutical purposes; creosote for pharmaceutical purposes; blood for medical purposes; cultures of microorganisms for medical or veterinary use; curare; dental lacquer; liquorice for pharmaceutical purposes; lactose for pharmaceutical purposes; candy for medical purposes; adhesive plasters; medicines for alleviating constipation; adhesive tapes for medical purposes; lecithin for medical purposes; lotions for veterinary purposes; dog lotions; lotions for pharmaceutical purposes; personal sexual lubricants; lupulin for pharmaceutical purposes; magnesia for pharmaceutical purposes; liniments; ointments for pharmaceutical purposes; sunburn ointments; mercurial ointments; frostbite salve for pharmaceutical purposes; gauze for dressings; medicinal oils; mustard oil for medical purposes; camphor oil for medical purposes; castor oil for medical purposes; oil of turpentine for pharmaceutical purposes; dill oil for medical purposes; dental mastics; dental abrasives; dental impression materials; dressings, medical; surgical dressings; drugs for medical purposes; medicines for veterinary purposes; serotherapeutic medicines; medicines for human purposes; medicines for dental purposes; menthol; medicinal drinks; moleskin for medical purposes; almond milk for pharmaceutical purposes; royal jelly for pharmaceutical purposes; milk ferments for pharmaceutical purposes; Irish moss for medical purposes; flour for pharmaceutical purposes; linseed meal for pharmaceutical purposes; fish meal for pharmaceutical purposes; fly glue; mint for pharmaceutical purposes; dietetic beverages adapted for medical purposes; malted milk beverages for medical purposes; narcotics; medicinal infusions; tincture of iodine; eucalyptol for pharmaceutical purposes; tinctures for medical purposes; opium; opodeldoc; decoctions for pharmaceutical purposes; antiparasitic collars for animals; stick liquorice for pharmaceutical purposes; sulfur sticks [disinfectants]; pastilles for pharmaceutical purposes; pectin for pharmaceutical purposes; pepsins for pharmaceutical purposes; peptones for pharmaceutical purposes; hydrogen peroxide for medical purposes; leeches for medical purposes; blood plasma; medical plasters; eyepatches for medical purposes; poultices; compresses; scapulars for surgical purposes; babies' diapers; bunion pads; breast-nursing pads; pomades for medical purposes; powder of cantharides; pyrethrum powder; belts for sanitary napkins [towels]; anti-uric preparations; bacterial preparations for medical and veterinary use; bacteriological preparations for medical and veterinary use; balsamic preparations for medical purposes; albuminous preparations for medical pur-

poses; biological preparations for veterinary purposes; biological preparations for medical purposes; bismuth preparations for pharmaceutical purposes; vitamin preparations; diagnostic preparations for medical purposes; therapeutic preparations for the bath; hemorrhoid preparations; preparations for callouses; preparations to facilitate teething; preparations for the treatment of burns; fumigation preparations for medical purposes; opotherapy preparations; air purifying preparations; eye-washes; bronchodilating preparations; preparations for reducing sexual activity; sterilising preparations; soil-sterilising preparations; corn remedies; pharmaceutical preparations for treating dandruff; herbicides; preparations for destroying dry rot fungus; larvae exterminating preparations; fly destroying preparations; preparations for destroying mice; slug exterminating preparations; vermin destroying preparations; pharmaceutical preparations for skin care; contact lens cleaning preparations; preparations of lime for pharmaceutical purposes; bath preparations, medicated; medicinal hair growth preparations; opiates; anticryptogamic preparations; aloe vera preparations for pharmaceutical purposes; preparations of trace elements for human and animal use; sulfonamides [medicines]; sunburn preparations for pharmaceutical purposes; enzyme preparations for veterinary purposes; enzyme preparations for medical purposes; chemico-pharmaceutical preparations; chemical preparations for veterinary purposes; chemical preparations for the diagnosis of pregnancy; chemical preparations for medical purposes; chemical preparations to treat wheat blight; vine disease treating chemicals; chemical preparations to treat mildew; chemical preparations for treating phylloxera; chemical preparations for pharmaceutical purposes; chilblain preparations; mothproofing preparations; collyrium; lead water; chemical conductors for electrocardiograph electrodes; albuminous foodstuffs for medical purposes; dietetic foods adapted for medical purposes; by-products of the processing of cereals for dietetic or medical purposes; sanitary towels; napkins for incontinents; sanitary pads; panty liners [sanitary]; propolis for pharmaceutical purposes; pearl powder for medical purposes; radium for medical purposes; hydrated chloral for pharmaceutical purposes; solvents for removing adhesive plasters; vaginal washes; solutions for contact lenses; chemical reagents for medical or veterinary purposes; gum for medical purposes; rubber for dental purposes; chewing gum for medical purposes; insect repellents; insect repellent incense; repellents for dogs; tissues impregnated with pharmaceutical lotions; sarsaparilla for medical purposes; sugar for medical purposes; asthmatic tea; fumigating sticks; linseed for pharmaceutical purposes; tobacco-free cigarettes for medical purposes; siccatives [drying agents] for medical purposes; syrups for pharmaceutical purposes; turpentine for pharmaceutical purposes; milking grease; greases for

veterinary purposes; greases for medical purposes; lacteal flour for babies; soporifics; bicarbonate of soda for pharmaceutical purposes; bath salts for medical purposes; salts for mineral water baths; salts for medical purposes; potassium salts for medical purposes; sodium salts for medical purposes; smelling salts; mineral water salts; malt for pharmaceutical purposes; semen for artificial insemination; medicinal alcohol; alloys of precious metals for dental purposes; ergot for pharmaceutical purposes; cooling sprays for medical purposes; adjuvants for medical purposes; styptic preparations; vermifuges; disinfectants for hygiene purposes; disinfectants for chemical toilets; douching preparations for medical purposes; appetite suppressants for medical purposes; medical preparations for slimming purposes; parasitocides; mouthwashes for medical purposes; febrifuges; depuratives; animal washes; detergents for medical purposes; cattle washes; dog washes; vesicants; articles for headache; purgatives; remedies for perspiration; remedies for foot perspiration; chemical contraceptives; antiparasitic preparations; sedatives; laxatives; tonics [medicines]; nervines; digestives for pharmaceutical purposes; media for bacteriological cultures; steroids; strychnine; suppositories; serums; tanning pills; appetite suppressant pills; slimming pills; yeast dietary supplements; antioxidant pills; sanitary tampons; vulnerary sponges; thymol for pharmaceutical purposes; biological tissue cultures for veterinary purposes; biological tissue cultures for medical purposes; surgical tissues; smoking herbs for medical purposes; medicinal herbs; surgical implants [living tissues]; pants, absorbent, for incontinents; sanitary panties; babies' diaper-pants; charcoal for pharmaceutical purposes; fennel for medical purposes; porcelain for dental prostheses; phenol for pharmaceutical purposes; enzymes for veterinary purposes; enzymes for medical purposes; ferments for pharmaceutical purposes; formic aldehyde for pharmaceutical purposes; phosphates for pharmaceutical purposes; quinine for medical purposes; chinoline for medical purposes; diabetic bread adapted for medical use; chloroform; flowers of sulfur for pharmaceutical purposes; cement for animal hooves; bone cement for surgical and orthopaedic purposes; dental cements; medicinal tea; herbal teas for medicinal purposes; eucalyptus for pharmaceutical purposes; tobacco extracts [insecticides]; extracts of hops for pharmaceutical purposes; elixirs [pharmaceutical preparations]; ethers for pharmaceutical purposes; esters for pharmaceutical purposes; cellulose esters for pharmaceutical purposes; cellulose ethers for pharmaceutical purposes; jujube, medicated; rat poison; poisons; bacterial poisons; jalap; disinfectant soap; medicated soap.

6 – Common metals and their alloys; building materials of metal; buildings, transportable, of metal; materials of metal for railway tracks; non-electric cables and wires of common metal; ironmongery,

small items of metal hardware; pipes and tubes of metal; safes [strong boxes]; goods of common metal not included in other classes; ores; aluminium; fittings of metal for compressed air ducts; fittings of metal for building; white metal; beacons of metal, non-luminous; vats of metal; beams of metal; joists of metal; bottles [metal containers] for compressed gas or liquid air; tin cans; reels of metal, non-mechanical, for flexible hoses; swimming pools [metal structures]; beryllium [glucinium]; arbours [structures] of metal; blooms [metallurgy]; ingots of common metal; anchors; bolts of metal; eye bolts; casks of metal; mooring buoys of metal; barrels of metal; identification bracelets of metal, for hospitals; bronze; bells for animals; bells; letters and numerals of common metal, except type; silos of metal; busts of common metal; vanadium; bird baths [structures] of metal; valves of metal, other than parts of machines; screws of metal; aviaries [structures] of metal; tungsten; hoppers of metal, non-mechanical; gates of metal; sleeves [metal hardware]; ferrules of metal for handles; signboards of metal; diving boards of metal; loading gauge rods of metal for railway wagons; nuts of metal; galena [ore]; hafnium [celtium]; nails; tacks [nails]; horseshoe nails; germanium; vice claws of metal; doors of metal; chimney pots of metal; memorial plates of metal; chimney shafts of metal; wall plugs of metal; troughs of metal for mixing mortar; packaging containers of metal; containers of metal for storing acids; jalousies of metal; iron strip; iron, unwrought or semi-wrought; roof gutters of metal; tinplate; door bolts of metal; window fasteners of metal; bolts, flat; binding screws of metal for cables; crampons of metal [cramps]; wheel clamps [boots]; rivets of metal; padlocks; box fasteners of metal; locks of metal for bags; locks of metal for vehicles; locks of metal, other than electric; spring locks; closures of metal for containers; bungs of metal; latches of metal; tension links; couplings of metal for chains; door bells of metal, non-electric; road signs, non-luminous and non-mechanical, of metal; registration plates of metal; signs, non-luminous and non-mechanical, of metal; fences of metal; buckles of common metal [hardware]; bronzes [works of art]; works of art of common metal; hardware of metal, small; indium; cabanas of metal; telephone booths of metal; cadmium; paint spraying booths of metal; telpher cables; ropes of metal; greenhouse frames of metal; framework of metal for building; cornices of metal; skating rinks [structures] of metal; cermets; water-pipe valves of metal; drain traps [valves] of metal; metal cages for wild animals; keys; mooring bollards of metal; cobalt, raw; chill-molds [foundry]; elbows of metal for pipes; bed casters of metal; furniture casters of metal; manifolds of metal for pipelines; pillars of metal for buildings; casings of metal for oilwells; chimney cowls of metal; bottle caps of metal; sealing caps of metal; tent pegs of metal; pegs of

metal; rings of common metal for keys; copper rings; rings of metal; ferrules of metal; door fittings of metal; fittings of metal for windows; buildings of metal; steel buildings; containers of metal [storage, transport]; guard rails of metal for railways; baskets of metal; door frames of metal; tool boxes of metal, empty; stringers [parts of staircases] of metal; faucets of metal for casks; tubing of metal; roofing of metal; brackets of metal for building; turntables [railways]; manhole covers of metal; pitons of metal [mountaineering equipment]; hooks [metal hardware]; pot hooks of metal; hooks for slate [metal hardware]; hooks of metal for clothes rails; clothes hooks of metal; chicken-houses of metal; brass, unwrought or semi-wrought; wrapping or binding bands of metal; scaffolding of metal; staircases of metal; ladders of metal; limonite; steel sheets; cast steel; traps for wild animals; magnesium; manganese; reinforcing materials, of metal, for concrete; reinforcing materials of metal for machine belts; reinforcing materials of metal for pipes; reinforcing materials of metal for building; railway material of metal; materials of metal for funicular railway permanent ways; refractory construction materials of metal; masts of metal; steel masts; copper, unwrought or semi-wrought; german silver; sheets and plates of metal; common metals, unwrought or semi-wrought; pyrophoric metals; metals in powder form; moldings of metal for cornices; molybdenum; door knockers of metal; pipe muffs of metal; porches of metal [building]; monuments of bronze for tombs; tombs of metal; flashing of metal for building; roof flashing of metal; fish plates [rails]; anvils; anvils [portable]; beak-irons; ferrules of metal for walking sticks; rope thimbles of metal; handcuffs; jets of metal; duckboards of metal; belt stretchers of metal; stretchers for metal bands [tension links]; wire stretchers [tension links]; stretchers for iron bands [tension links]; nickel silver; nickel; niobium; grease nipples; binding thread of metal for agricultural purposes; thread of metal for tying-up purposes; house numbers of metal, non-luminous; braces of metal for handling loads; wall claddings of metal [building]; enclosures of metal for tombs; laths of metal; barrel hoops of metal; wall linings of metal [building]; palings of metal; crash barriers of metal for roads; tree protectors of metal; trellis of metal; windows of metal; ironwork for doors; ironwork for windows; tin; shuttering of metal for concrete; filings of metal; poles of metal for power lines; props of metal; branching pipes of metal; monuments of metal; monuments of metal for tombs; wainscotting of metal; signalling panels, non-luminous and non-mechanical, of metal; building panels of metal; partitions of metal; lintels of metal; casement windows of metal; strap-hinges of metal; shims; rocket launching platforms of metal; transport pallets of metal; platforms, prefabricated, of metal; floor tiles of metal; tiles of metal for building; anchor plates; armour plate; gra-

ve slabs of metal; tile floorings of metal; iron slabs; lead seals; loading pallets of metal; handling pallets of metal; firedogs [andirons]; armor-plating; paving blocks of metal; roof coverings of metal; linings of metal for building; steel strip; door panels of metal; floors of metal; sills of metal; ceilings of metal; gold solder; silver solder; door closers, non-electric; door openers, non-electric; collars of metal for fastening pipes; winding spools of metal, non-mechanical, for flexible hoses; floating docks of metal, for mooring boats; aluminium wire; iron wire; wire of common metal; wire of common metal alloys, except fuse wire; barbed wire; copper wire, not insulated; soldering wire of metal; steel wire; springs [metal hardware]; rods of metal for welding; rods of metal for brazing and welding; rods of metal for brazing; window frames of metal; frames of metal for building; containers of metal for liquid fuel; containers of metal for compressed gas or liquid air; tanks of metal; floating containers of metal; rails of metal; straps of metal for handling loads; furnace fireguards of metal; grilles of metal; runners of metal for sliding doors; window pulleys; iron ores; ores of metal; chrome ores; door handles of metal; knobs of metal; sheet piles of metal; lead, unwrought or semi-wrought; insect screens of metal; burial vaults of metal; foot scrapers; cable joints of metal, non-electric; junctions of metal for pipes; nozzles of metal; anti-friction metal; silver-plated tin alloys; alloys of common metal; sheaf binders of metal; bindings of metal; bottle closures of metal; shutters of metal; outdoor blinds of metal; steel alloys; steel, unwrought or semi-wrought; tinfoil; statues of common metal; figurines [statuettes] of common metal; cask stands of metal; tombstone stelae of metal; bars for metal railings; advertisement columns of metal; posts of metal; telegraph posts of metal; railway points; step stools of metal; slings of metal for handling loads; stair treads [steps] of metal; chests of metal; machine belt fasteners of metal; tombstone plaques of metal; identity plates of metal; tantalum [metal]; greenhouses of metal, transportable; titanium; wire cloth; tombac; mobile boarding stairs of metal for passengers; wire rope; pipework of metal; penstock pipes of metal; water-pipes of metal; gutter pipes of metal; ducts of metal for ventilating and air-conditioning installations; drain pipes of metal; chimneys of metal; ducts of metal, for central heating installations; steel pipes; turnstiles of metal; angle irons of metal; tinplate packings; door fasteners of metal; door stops of metal; stops of metal; window stops of metal; sash fasteners of metal for windows; bicycle parking installations of metal; wind-driven bird-repelling devices made of metal; towel dispensers, fixed, of metal; tungsten iron; molybdenum iron; silicon iron; titanium iron; chrome iron; flanges of metal [collars]; weather- or wind-vanes of metal; aluminium foil; foils of metal for wrapping and packaging; ice moulds of metal; foundry molds of

metal; fittings of metal for coffins; fittings of metal for beds; fittings of metal for furniture; building or furniture fittings of nickel-silver; clips of metal for cables and pipes; chromium; cattle chains; chains of metal; safety chains of metal; zinc; zirconium; tiles of metal; cast iron, unwrought or semi-wrought; washers of metal; balls of steel; hinges of metal; poles of metal; crampons [climbing irons]; cashboxes of metal; safety cashboxes; chests of metal for food; pulleys of metal, other than for machines; railroad ties of metal; window casement bolts; cotter pins of metal; spurs; pins [hardware]; roller blinds of steel; latch bars of metal; furnace fire screens; badges of metal for vehicles; lock bolts; tool chests of metal, empty; boxes of common metal; letter boxes of metal.

16 – Paper, cardboard and goods made from these materials, not included in other classes; printed matter; bookbinding material; photographs [printed]; stationery; adhesives [glues] for stationery or household purposes; artists' materials; paintbrushes; typewriters and office requisites [except furniture]; instructional and teaching material [except apparatus]; plastic materials for packaging (not included in other classes); printers' type; printing blocks; fountain pens; aquarelles; albums; almanacs; document laminators for office use; mimeograph apparatus and machines; atlases; posters; paper bows; table linen of paper; tickets; forms, printed; announcement cards [stationery]; note books; pads [stationery]; drawing pads; loose-leaf binders; wristbands for the retention of writing instruments; pamphlets; booklets; paper sheets [stationery]; waxed paper; paper for recording machines; paper for radiograms; electrocardiograph paper; drawer liners of paper, perfumed or not; wood pulp paper; carbon paper; copying paper [stationery]; parchment paper; writing paper; luminous paper; Xuan paper for Chinese painting and calligraphy; toilet paper; wrapping paper; filter paper; blotters; newsletters; rollers for typewriters; house painters' rollers; composing sticks; modelling wax, not for dental purposes; signboards of paper or cardboard; patterns for making clothes; sewing patterns; newspapers; electrotypes; hectographs; modelling clay; terrestrial globes; drawing sets; engravings; slate pencils; pencil leads; document holders [stationery]; pencil holders; chalk holders; holders for cheque books; holders for stamps [seals]; diagrams; engraving plates; writing slates; blackboards; galley racks [printing]; drawing boards; advertisement boards of paper or cardboard; duplicators; punches [office requisites]; cream containers of paper; magazines [periodicals]; money clips; tags for index cards; pen clips; book-markers; etching needles; tracing needles for drawing purposes; periodicals; printed publications; cardboard articles; paper shredders for office use; graphic representations; credit card imprinters, non-electric; graining combs; drawing instruments; ca-

lendars; tracing paper; tracing cloth; tracing patterns; gums [adhesives] for stationery or household purposes; lithographic stones; ink stones [ink reservoirs]; pencils; pencil lead holders; charcoal pencils; pictures; transfers [decalcomanias]; paintings [pictures], framed or unframed; wood pulp board [stationery]; hat boxes of cardboard; files [office requisites]; cards; index cards [stationery]; geographical maps; paper tapes and cards for the recordal of computer programmes; trading cards, other than for games; perforated cards for Jacquard looms; catalogues; spools for inking ribbons; covers of paper for flower pots; paintbrushes; painters' brushes; writing brushes; typewriter keys; glue for stationery or household purposes; isinglass for stationery or household purposes; gluten [glue] for stationery or household purposes; starch paste [adhesive] for stationery or household purposes; books; manifolds [stationery]; comic books; drawing pins; cigar bands; envelopes [stationery]; cases for stamps [seals]; boxes of cardboard or paper; paint boxes [articles for use in school]; correcting fluids [office requisites]; stencils [stationery]; French curves; paper tapes; typewriter ribbons; gummed tape [stationery]; adhesive bands for stationery or household purposes; correcting tapes [office requisites]; inking ribbons; inking ribbons for computer printers; adhesive tapes for stationery or household purposes; self-adhesive tapes for stationery or household purposes; drawing rulers; square rulers; absorbent sheets of paper or plastic for foodstuff packaging; humidity control sheets of paper or plastic for foodstuff packaging; viscose sheets for wrapping; sheets of reclaimed cellulose for wrapping; plastic bubble packs for wrapping or packaging; steel letters; type [numerals and letters]; lithographs; paint trays; architects' models; postage stamps; plastics for modelling; graphic prints; modelling materials; teaching materials [except apparatus]; sealing compounds for stationery purposes; adhesives [glues] for stationery or household purposes; bookbinding material; packaging material made of starches; filtering materials [paper]; addressing machines; pencil sharpening machines, electric or non-electric; bookbinding apparatus and machines [office equipment]; typewriters, electric or non-electric; paper creasers [office requisites]; franking machines for office use; chalk for lithography; writing chalk; tailors' chalk; marking chalk; bags [envelopes, pouches] of paper or plastics, for packaging; garbage bags of paper or of plastics; painters' easels; hand-rests for painters; writing cases [stationery]; printing sets, portable [office requisites]; bibs of paper; stickers [stationery]; finger-stalls [office requisites]; cords for bookbinding; paper knives [cutters] [office requisites]; numbering apparatus; bottle envelopes of cardboard or paper; sealing wafers; covers [stationery]; passport holders; plastic cling film, extensible, for palletization; embroidery designs [patterns]; handwriting specimens for co-

pying; oleographs; musical greeting cards; greeting cards; postcards; etchings; conical paper bags; bags for microwave cooking; palettes for painters; ink sticks; pantographs [drawing instruments]; folders for papers; papier mâché; pastels [crayons]; modelling paste; pen cases; bookbindings; pen wipers; office perforators; pens [office requisites]; nibs of gold; nibs; steel pens; drawing pens; song books; seals [stamps]; sealing stamps; clipboards; address plates for addressing machines; handkerchiefs of paper; plastic film for wrapping; writing pads; letter trays; trays for sorting and counting money; coasters of paper; bookends; stamp stands; mats for beer glasses; stands for pens and pencils; photograph stands; inking pads; stamp pads; binding strips [bookbinding]; towels of paper; inking sheets for document reproducing machines; inking sheets for duplicators; bookbinding cloth; gummed cloth for stationery purposes; printers' blankets, not of textile; portraits; paperweights; writing cases [sets]; inkstands; writing materials; writing instruments; drawing materials; school supplies [stationery]; adhesive tape dispensers [office requisites]; hand labelling appliances; lithographic works of art; prospectuses; printed timetables; ledgers [books]; printers' reglets; indexes; rubber erasers; elastic bands for offices; T-squares for drawing; graphic reproductions; penholders; marking pens [stationery]; tissues of paper for removing make-up; face towels of paper; table napkins of paper; place mats of paper; tablemats of paper; tablecloths of paper; paper clasps; document files [stationery]; scrapers [erasers] for offices; paper-clips; staples for offices; erasing products; biological samples for use in microscopy [teaching materials]; histological sections for teaching purposes; steatite [tailor's chalk]; writing board erasers; composing frames [printing]; sealing wax; arithmetical tables; placards of paper or cardboard; writing or drawing books; fabrics for bookbinding; pencil sharpeners, electric or non-electric; transparencies [stationery]; stencil plates; cardboard tubes; Indian inks; moisteners [office requisites]; moisteners for gummed surfaces [office requisites]; squares for drawing; chart pointers, non-electronic; bottle wrappers of cardboard or paper; envelope sealing machines for offices; sealing machines for offices; vignetting apparatus; apparatus for mounting photographs; stapling presses [office requisites]; manuals [handbooks]; figurines [statuettes] of papier mâché; paper coffee filters; flags of paper; flyers; silver paper; molds for modelling clays [artists' materials]; photo-engravings; photographs [printed]; stencil cases; canvas for painting; chromolithographs [chromos]; compasses for drawing; numbers [type]; watercolor [watercolour] saucers for artists; correcting ink [heliography]; ink; inkwells; blueprints; stencils; erasing shields; balls for ball-point pens; cabinets for stationery [office requisites]; printing type; address stamps; stamps [seals]; shields [paper seals];

prints [engravings]; labels, not of textile; bake foil; cooking bag; food wrapping plastic film for household use; baking paper; food bags for freezing, storage and bake.

21 – Household or kitchen utensils and containers; combs and sponges; brushes, except paintbrushes; material for brush-making; articles for cleaning purposes; steel wool; unworked or semi-worked glass (except glass used in building); glassware, porcelain and earthenware not included in other classes; pressure cookers [autoclaves], non-electric; indoor aquaria; buckets; china ornaments; dishes; paper plates; vegetable dishes; saucers; mugs; candy boxes; bottles; demijohns; busts of china, terra-cotta or glass; vases; epergnes; fruit cups; bird baths; baby baths, portable; plungers for clearing blocked drains; waffle irons, non-electric; coolers [ice pails]; buckets made of woven fabrics; whisks, non-electric, for household purposes; cooking skewers of metal; towel rails and rings; clothing stretchers; hair for brushes; birdcages; funnels; carpet beaters [hand instruments]; signboards of porcelain or glass; candle extinguishers; flower pots; chamber pots; gluepots; cruets; decanters; large-toothed combs for the hair; combs for animals; tea cosies; abrasive sponges for scrubbing the skin; sponges for household purposes; toilet sponges; deodorising apparatus for personal use; sponge holders; toothpick holders; soap holders; napkin holders; holders for flowers and plants [flower arranging]; shaving brush stands; toilet paper holders; soap dispensers; ironing boards; cutting boards for the kitchen; bread boards; washing boards; strainers; smoke absorbers for household purposes; containers for household or kitchen use; kitchen containers; glass jars [carboys]; heat-insulated containers; heat-insulated containers for beverages; thermally insulated containers for food; glass flasks [containers]; frying pans; closures for pot lids; chamois leather for cleaning; toothpicks; ceramics for household purposes; majolica; works of art, of porcelain, terra-cotta or glass; brush goods; domestic grinders, non-electric; cleaning instruments, hand-operated; cabarets [trays]; stew-pans; covers, not of paper, for flower pots; shaving brushes; cages for household pets; polishing leather; hot pots, not electrically heated; glass bulbs [receptacles]; shoe trees [stretchers]; napkin rings; poultry rings; rings for birds; coin banks; bread baskets for household purposes; baskets for household purposes; waste paper baskets; feeding troughs; mangers for animals; lunch boxes; cookie jars; tea caddies; wash-tubs; earthenware saucepans; mess-tins; cauldrons; coffee percolators, non-electric; coffeepots, non-electric; coffee grinders, hand-operated; fused silica [semi-worked product], other than for building; beer mugs; tankards; rat traps; pot lids; aquarium hoods; butter-dish covers; dish covers; cheese-dish covers; buttonhooks; pitchers; perfume burners; non-electric portable coldboxes; watering cans; insect traps; mi-

xing spoons [kitchen utensils]; basting spoons, for kitchen use; scoops [tableware]; pie servers; spatulas [kitchen utensils]; butter dishes; polishing materials for making shiny, except preparations, paper and stone; noodle machines, hand-operated; polishing apparatus and machines, for household purposes, non-electric; pepper mills, hand-operated; mills for household purposes, hand-operated; feather-dusters; brooms; isothermic bags; confectioners' decorating bags [pastry bags]; mixers, manual [cocktail shakers]; bowls [basins]; mosaics of glass, not for building; saucepan scourers of metal; soap boxes; mouse traps; cooking pot sets; nozzles for watering cans; pouring spouts; nozzles for watering hose; fitted picnic baskets, including dishes; toilet cases; floss for dental purposes; fiberglass thread, other than for textile use; cookie [biscuit] cutters; pastry cutters; sprinklers; syringes for watering flowers and plants; cotton waste for cleaning; wool waste for cleaning; cleaning tow; chopsticks; cocktail stirrers; pepper pots; gloves for household purposes; polishing gloves; gardening gloves; plates to prevent milk boiling over; trays for household purposes; trays of paper, for household purposes; lazy susans; heaters for feeding bottles, non-electric; candelabra [candlesticks]; trivets [table utensils]; coasters, not of paper and other than table linen; menu card holders; knife rests for the table; flat-iron stands; egg cups; grill supports; abrasive pads for kitchen purposes; scouring pads; drinking troughs; powdered glass for decoration; pottery; pots; cooking pots; painted glassware; tableware, other than knives, forks and spoons; porcelain ware; earthenware; crystal [glassware]; cosmetic utensils; toilet utensils; trouser presses; cruet sets for oil and vinegar; make-up removing appliances; spice sets; food cooling devices, containing heat exchange fluids, for household purposes; apparatus for wax-polishing, non-electric; bottle openers; glove stretchers; boot jacks; crumb trays; tie presses; clothes-pegs; glass stoppers; powder compacts; perfume vaporizers; powder puffs; dusting apparatus, non-electric; toilet paper dispensers; electric combs; grills [cooking utensils]; sifters [household utensils]; drinking horns; shoe horns; candle rings; salad bowls; sugar bowls; beaters, non-electric; services [dishes]; coffee services [tableware]; liqueur sets; tea services [tableware]; sieves [household utensils]; cinder sifters [household utensils]; tea strainers; pipettes [wine-tasters]; siphon bottles for carbonated water; rolling pins, domestic; steel wool for cleaning; currycombs; blenders, non-electric, for household purposes; fruit presses, non-electric, for household purposes; drinking straws; salt cellars; drinking vessels; vessels of metal for making ices and iced drinks; refrigerating bottles; cups of paper or plastic; glasses [receptacles]; drinking glasses; statues of porcelain, earthenware, ceramic or glass; figurines [statuettes] of porcelain, ceramic, earthenware or glass; glass for vehicle windows [semi-finish-

hed product]; plate glass [raw material]; opal glass; opaline glass; glass incorporating fine electrical conductors; enamelled glass; glass wool, other than for insulation; vitreous silica fibers, other than for textile use; fiberglass, other than for insulation or textile use; clothes racks, for drying; soup bowls; drying racks for laundry; basins [receptacles]; table plates; disposable table plates; graters [household utensils]; insulating flasks; indoor terrariums [plant cultivation]; indoor terrariums [vivariums]; cloth for washing floors; cloths for cleaning; dusting cloths [rags]; furniture dusters; litter boxes [trays] for pets; urns; aerosol dispensers, not for medical purposes; wax-polishing appliances, non-electric, for shoes; water apparatus for cleaning teeth and gums; electric devices for attracting and killing insects; watering devices; utensils for household purposes; cooking utensils, non-electric; strainers for household purposes; coffee filters, non-electric; flasks; drinking flasks; molds [kitchen utensils]; cake moulds; ice cube molds; cookery moulds; deep fryers, non-electric; comb cases; bread bins; fly swatters; teapots; kettles, non-electric; cups; garlic presses [kitchen utensils]; ironing board covers, shaped; tea infusers; glass bowls; mops; mop wringers; corkscrews; animal bristles [brushware]; pig bristles for brush-making; dishwashing brushes; brushes for cleaning tanks and containers; lamp-glass brushes; horse brushes; scrubbing brushes; toothbrushes; toothbrushes, electric; carpet sweepers; brushes for footwear; tar-brushes, long handled; toilet brushes; electric brushes, except parts of machines; brushes; eyebrow brushes; nail brushes; nest eggs, artificial; boxes of metal, for dispensing paper towels; dustbins; window-boxes; boxes of glass; cloths for household purposes, included in 21 class; lint rollers; articles for window cleaning, included in 21 class; disposable tableware; cocktail sticks; serving forks; shower puffs; scourers; broom handles of metal.

24 – Textiles and textile goods, not included in other classes, bed covers and table covers; bed blankets; frieze [cloth]; velvet; household linen; diapered linen; bath linen, except clothing; bed linen; table linen, not of paper; buckram; fustian; felt; gauze [cloth]; damask; jersey [fabric]; table runners; drugget; shower curtains of textile or plastic; curtains of textile or plastic; net curtains; zephyr [cloth]; banners; canvas for tapestry or embroidery; bolting cloth; crepe [fabric]; crepon; marabouts [cloth]; furniture coverings of textile; fabrics for textile use; filtering materials of textile; wall hangings of textile; non-woven textile fabrics; plastic material [substitute for fabrics]; textile material; sleeping bags [sheeting]; moleskin [fabric]; pillowcases; mattress covers; brocades; handkerchiefs of textile; travelling rugs [lap robes]; cloth coasters; linings [textile]; hat linings, of textile, in the piece; curtain holders of textile material; bed covers; bed covers of paper; furniture coverings of plastic; towels of textile;

hemp cloth; gummed cloth, other than for stationery purposes; printers' blankets of textile; cloth; door curtains; bed clothes; sheets [textile]; eiderdowns [down coverlets]; bath mitts; shrouds; glass cloths [towels]; cloths for removing make-up; face towels of textile; tablemats, not of paper; place mats, not of paper; table napkins of textile; mosquito nets; calico; oilcloth for use as tablecloths; tablecloths, not of paper; billiard cloth; taffeta [cloth]; ticks [mattress covers]; tick [linen]; lingerie fabric; fabric, impervious to gases, for aeronautical balloons; jute fabric; fabric for footwear; ramie fabric; esparto fabric; rayon fabric; fiberglass fabrics for textile use; adhesive fabric for application by heat; linen cloth; upholstery fabrics; hemp fabric; lining fabric for footwear; traced cloth for embroidery; chenille fabric; printed calico cloth; bunting; knitted fabric; cotton fabrics; silk fabrics for printing patterns; woollen cloth; elastic woven material; fabric of imitation animal skins; haircloth [sackcloth]; cheese cloth; tulle; flags, not of paper; flannel [fabric]; sanitary flannel; trellis [cloth]; covers for cushions; fitted toilet lid covers of fabric; covers [loose] for furniture; pillow shams; cheviots [cloth]; silk [cloth]; labels of textile.

(260) AM 2019 100633 A

(800) 1437107

(151) 2018 07 24

(891) 2018 07 24

(731) Pashchenko Irina Nikolaevna

ul. Kraynyaya, 80, g. Svetlograd, Stavropol'skiy, RU-356534 kray, Russian Federation

(540)



(591) Blue, yellow, white

(531) 24.09.02; 24.09.05; 28.05; 29.01.12

(511)

30 – Coffee, tea, cocoa and artificial coffee; rice; tapioca and sago; flour and preparations made from cereals; bread, pastries and confectionery; ice cream; sugar, honey, treacle; yeast, baking-powder; salt; mustard; vinegar, sauces [condiments]; spices; ice; aromatic preparations for food; vanilla flavorings for culinary purposes; flavorings, other than essential oils, for cakes; linseed for culinary purposes [seasoning]; flavorings, other than essential oils, for beverages; coffee flavorings; food flavorings, other than essential oils; star aniseed; baozi [stuffed buns]; cereal bars; high-protein cereal bars; pancakes; noodle-based prepared meals; buns; bread rolls; edible rice

paper; edible paper; burritos; vanillin [vanilla substitute]; vareniki [stuffed dumplings]; waffles; vermicelli [noodles]; natural sweeteners; sausage binding materials; binding agents for ice cream [edible ices]; sea water for cooking; seaweed [condiment]; malt biscuits; cloves [spice]; cake frosting [icing]; glucose for culinary purposes; gluten additives for culinary purposes; thickening agents for cooking foodstuffs; leaven; rice-based snack food; cereal-based snack food; vegetal preparations for use as coffee substitutes; dressings for salad; fruit jellies [confectionery]; candy decorations for cakes; confectionery for decorating Christmas trees; cakes; pastries; peanut confectionery; almond confectionery; pasta; ginger [spice]; frozen yogurt [confectionery ices]; cream of tartar for culinary purposes; capers; caramels [candy]; curry [spice]; ketchup [sauce]; gimhap [Korean rice dish]; quiches; gluten prepared as foodstuff; sweetmeats [candy]; liquorice [confectionery]; peppermint sweets; cinnamon [spice]; unroasted coffee; starch for food; crackers; custard; hominy grits; semolina; oatmeal; crushed barley; groats for human food; corn, milled; corn, roasted; meat pies; turmeric; couscous [semolina]; noodles; ice for refreshment; ice, natural or artificial; edible ices; candy; rice cakes; mayonnaise; macarons [pastry]; macaroni; maltose; hominy; marinades; marzipan; soya bean paste [condiment]; royal jelly; bean meal; tapioca flour; potato flour; corn flour; nut flours; flour; wheat flour; soya flour; barley meal; dessert mousses [confectionery]; chocolate mousses; muesli; mint for confectionery; cocoa beverages with milk; coffee beverages with milk; coffee-based beverages; cocoa-based beverages; tea-based beverages; chocolate beverages with milk; chocolate-based beverages; infusions, not medicinal; crushed oats; husked oats; okonomiyaki [Japanese savory pancakes]; nutmegs; chocolate-coated nuts; stick liquorice [confectionery]; pastilles [confectionery]; molasses for food; pâtés en croûte; pelmeni [dumplings stuffed with meat]; pepper; allspice; peppers [seasonings]; pesto [sauce]; cookies; petit-beurre biscuits; pies; pizzas; meat gravies; fondants [confectionery]; popcorn; powders for making ice cream; mustard meal; pralines; meat tenderizers for household purposes; oat-based food; propolis; gingerbread; petits fours [cakes]; rice pudding; puddings; cake powder; fruit coulis [sauces]; ravioli; ramen [Japanese noodle-based dish]; chewing gum; relish [condiment]; wheat germ for human consumption; spring rolls; palm sugar; aniseed; golden syrup; confectionery; batter mixes for okonomiyaki [Japanese savory pancakes]; baking soda [bicarbonate of soda for cooking purposes]; malt for human consumption; salt for preserving foodstuffs; cooking salt; celery salt; sherbets [ices]; ham glaze; soya sauce; tomato sauce; sauces [condiments]; pasta sauce; spaghetti; seasonings; preparations for stiffening whipped cream; rusks; breadcrumbs; sushi; sandwiches; tabbouleh; tacos;

tarts; dough; pastry dough; almond paste; rice pulp for culinary purposes; cake dough; tortillas; garden herbs, preserved [seasonings]; chocolate decorations for cakes; beer vinegar; ferments for pastes; halvah; bread; unleavened bread; chips [cereal products]; corn flakes; oat flakes; flowers or leaves for use as tea substitutes; jiaozi [stuffed dumplings]; chicory [coffee substitute]; iced tea; chutneys [condiments]; minced garlic [condiment]; cheeseburgers [sandwiches]; chow-chow [condiment]; saffron [seasoning]; chocolate; malt extract for food; essences for foodstuffs, except etheric essences and essential oils; husked barley.

(260) AM 2019 100636 A
(800) 1437172
(151) 2018 09 06
(891) 2018 09 06
(731) ARIAD Pharmaceuticals, Inc.
40 Landsdowne Street, CAMBRIDGE MA
02139, USA

(540)

Алунбриг

(591) Black, white
(531) 28.05
(511)
5 – Pharmaceutical preparations for use in oncology.

(260) AM 2019 100637 A
(800) 1437173
(151) 2018 09 27
(891) 2018 09 27
(731) AKTSIONERNOYE OBSHESTVO
"YUZHMOREYBFLOT"
ul. Zavodskaya, 16, p. Yuzhno-Morskoy,
g. Nakhodka, RU-692954 Primorsky kray,
Russian Federation

(540)

**АЗБУКА
МОРЯ**

(591) Navy-blue, red, white
(531) 24.07.01; 24.07.23; 28.05; 29.01.13
(511)
29 – Anchovy, not live; laver, preserved; sea-cucumbers, not live; caviar; fish roe, prepared; isinglass for food; clams, not live; klipfish [salted and dried cod]; fish, tinned; shrimps, not live; prawns, not live; spiny lobsters, not live; mussels, not live; fish meal for human consumption; fish mousses; lobsters, not live; fish liver, preserved; fish-based foodstuffs; crayfish, not live; crustaceans, not live; fish, preserved; fish, not live; salted fish; sardines, not live; herrings, not

live; tuna, not live; oysters, not live; fish fillets; seaweed extracts for food; yakitori.

(260) AM 2019 100638 A
(800) 1437177
(151) 2018 09 24
(891) 2018 09 24
(731) ŠKODA AUTO a.s.
tř. Václava Klementa 869, Mladá Boleslav,
CZ-293 01 Mladá Boleslav II, Czech Republic
(540)

SCALA

(591) Black, white
(511)
12 – Automobiles and their parts and accessories, all included in this class.

(260) AM 2019 100639 A
(800) 1437192
(151) 2018 08 23
(891) 2018 08 23
(731) PEPSICO, INC. (a North Carolina
corporation)
700 Anderson Hill Road, Purchase, New York
10577, USA

(540)

LAY'S STIX

(591) Black, white
(531) 27.05.17
(511)
29 – Fruit-based snack food; potato-based snack foods; nut-based snack foods; vegetable-based snack foods; sunflower seeds, prepared; potato chips; soya chips.

(260) AM 2019 100640 A
(800) 1437289
(151) 2018 09 24
(891) 2018 09 24
(731) Limited Liability Company
"TOSOL-SINTEZ"
Vatutin Street, 31A, Dzerzhinsk, RU-606000
Nizhny Novgorod Region, Russian Federation
(540)



(591) Black, grey and white

(531) 26.04.03; 26.04.12; 26.04.18; 26.04.24;
27.05.24

(511)

1 – Antifreeze; agglutinants for concrete; water-softening preparations; chemicals for the manufacture of paints; chemicals for the manufacture of pigments; distilled water; acidulated water for recharging accumulators; glycol; glycerides; glycerine for industrial purposes; detergents for use in manufacturing processes; oil dispersants; petroleum dispersants; additives, chemical, to motor fuel; fluids for hydraulic circuits; power steering fluid; brake fluid; transmission fluid; caustics for industrial purposes; nitric acid; benzoic acid; boric acid for industrial purposes; tartaric acid; citric acid for industrial purposes; formic acid; sebacic acid; sulfuric acid; sulfurous acid; spirits of salt; phosphoric acid; oxalic acid; fatty acids; mineral acids; glue for industrial purposes; cement for mending broken articles; gums [adhesives] for industrial purposes; transmission oil; hypochlorite of soda; toxic gas neutralizers; nitrates; combusting preparations [chemical additives to motor fuel]; descaling preparations, other than for household purposes; engine-decarbonising chemicals; solvents for varnishes; silicates; wood alcohol; ethyl alcohol; alcohol; radiator flushing chemicals; leather-impregnating chemicals; refrigerants; coolants for vehicle engines; alkalies; caustic alkali; glycol ether; ethers; esters.

2 – Anti-rust oils; oils for the preservation of wood; mastic [natural resin]; wood coatings [paints]; undercoating for vehicle chassis; anti-corrosive preparations; protective preparations for metals; thinners for paints; thinners for lacquers; whitewash; anti-rust greases; anti-tarnishing preparations for metals; anti-rust preparations.

3 – Aromatics [essential oils]; air fragrancing preparations; non-slipping liquids for floors; windshield cleaning liquids; rust removing preparations; ammonia [volatile alkali] [detergent]; shampoos.

4 – Biomass fuel; additives, non-chemical, to motor fuel; cutting fluids; fuel oil; oils for paints; oils for releasing form work [building]; oils for the preservation of masonry; textile oil; lubricating oil; industrial oil; castor oil for industrial purposes; motor oil; lubricants; lubricating grease; grease for belts; dust absorbing compositions; dust laying compositions; alcohol [fuel]; stearine; benzene fuel; diesel oil; lighting fuel; xylene fuel; mineral fuel; carburants; fuel with an alcohol base; ethanol [fuel]; petroleum ether.

7 – Drums [parts of machines]; brake shoes, other than for vehicles; jacks [machines]; rack and pinion jacks; hand-held tools, other than hand-operated; lasts for shoes [parts of machines]; brake pads, other than for vehicles; compressors [machines]; air pumps [garage installations]; brake linings, other

than for vehicles; anti-friction bearings for machines; roller bearings; self-oiling bearings; bearings for transmission shafts; ball-bearings; radiators [cooling] for motors and engines; belts for machines; belts for motors and engines; sparking plugs for internal combustion engines; glow plugs for Diesel engines; brake segments, other than for vehicles; filters [parts of machines or engines]; filters for cleaning cooling air, for engines; brushes [parts of machines].

8 – Lifting jacks, hand-operated; abrading instruments [hand instruments]; blade sharpening instruments; expanders [hand tools]; cutting tools [hand tools]; hand tools, hand-operated; stamping-out tools [hand tools].

9 – Accumulators, electric, for vehicles; anode batteries; galvanic batteries; batteries for lighting; solar batteries; solar panels for the production of electricity; batteries, electric; vehicle breakdown warning triangles; starter cables for motors.

11 – Light bulbs for directional signals for automobiles; light bulbs for directional signals for vehicles; electric lamps; lighting apparatus for vehicles; light-emitting diodes [LED] lighting apparatus.

12 – Brake shoes for vehicles; brake discs for vehicles; brake pads for automobiles; brake linings for vehicles; repair outfits for inner tubes; brake segments for vehicles; hydraulic circuits for vehicles; bicycle brakes; brakes for vehicles.

17 – Insulating oils; insulating oil for transformers; brake lining materials, partly processed; filtering materials [semi-processed foams or films of plastic].

(260) AM 2019 100641 A

(800) 1437301

(151) 2017 05 08

(891) 2017 05 08

(731) A. D. PADMASINGH ISAAC TRADING AS
AACHI SPICES AND FOODS

old no 4, new no 181/1, 6th avenue, thangam,
colony, anna nagar west, 600040 Chennai
600040 Tamilnadu, India

(540)

AACHI

(591) Black, white

(531) 27.05.01

(511)

29 – Meat, fish, poultry and game, meat extracts, preserved, frozen, dried and cooked fruits and vegetables, jellies, jams, compotes, eggs, milk and milk products, edible oils and fats.

30 – Coffee, tea, cocoa and artificial coffee, rice, tapioca and sago, flour and preparations made from cereals, bread, pastry and confectionery, ices, sugar,

honey, treacle, yeast, baking- powder salt, mustard, vinegar, sauces (condiments), spices, ice.

43 – Services for providing food and drink, temporary accomodation.

(260) AM 2019 100642 A
(800) 1437324
(151) 2018 10 23
(891) 2018 10 23
(731) AVON PRODUCTS, INC.
601 Midland Avenue, Rye NY 10580, USA
(540)

AVON MIGS

(591) Black, white
(511)
3 – Hair care products, namely, shampoo, conditioner, combing cream serums, hair masks, hair detangling sprays and hair lotions.

(260) AM 2019 100643 A
(800) 1437332
(151) 2018 10 16
(891) 2018 10 16
(731) CITY STORAGE SYSTEMS LLC
c/o White and Williams LLP, 7 Times
Square, Suite 2900, New York NY 10036,
USA

(540)
CLOUDKITCHENS

(591) Black, white
(511)
36 – Real estate management services; rental of real estate; leasing of real estate.
39 – Delivery of food by restaurants; food delivery.
43 – Providing temporary kitchen facilities; providing temporary kitchen facilities for coworkers in the nature of co-working facilities equipped with kitchen equipment and appliances; providing temporary kitchen facilities, namely, providing facilities for the use of kitchen equipment and appliances; contract food and beverage services; providing specialized facilities for food preparation; providing social function facilities for special occasions.

(260) AM 2019 100645 A
(800) 1437347
(151) 2018 08 17
(891) 2018 08 17
(731) SKYLAB AG
Nüscherstrasse 31, CH-8001 Zürich,
Switzerland
(540)

VITAFRESH

(591) Black, white
(531) 27.05.01
(511)
3 – Breath freshening sprays; dental bleaching gel; toothpaste; breath freshening strips; mouthwashes, not for medical purposes.

(260) AM 2019 100647 A
(800) 1437392
(151) 2018 07 02
(891) 2018 07 02
(731) CHENGDU KANGHONG
PHARMACEUTICALS GROUP CO., LTD.
No.36, Shuxi Rd., Jinniu District, Chengdu,
Sichuan, China

(540)
渴络欣

(591) Black, white
(531) 28.03
(511)
5 – Royal jelly for pharmaceutical purposes; medicinal drinks; tonics [medicines]; radioactive pharmaceuticals; chemico-pharmaceutical preparations; depuratives; medicines for human purposes; pesticides; biomedicine; medicines for veterinary purposes; patches for medical purposes; nutritive substances for microorganisms; disinfectants; tissues impregnated with antibacterial preparations; dental lacquer; medicinal tea; chemical preparations for pharmaceutical purposes; capsules for medicines; pharmaceutical preparations; medicinal alcohol; gases for medical purposes; bath preparations, medicated; diagnostic agents for medical purposes; raw material medicine; pearl powder for medical purposes; prepared Chinese medicine; bag filled with Chinese medicine.

(260) AM 2019 100648 A
(800) 1437397
(151) 2018 08 27
(891) 2018 08 27
(731) Limited Liability Company "Grin-C"
Altufievskoe shosse, 56, prem.VI, room 19,
RU-127549 Moscow, Russian Federation
(540)



(591) Blue, dark blue and white
(531) 01.15.15; 27.05.10; 27.05.17; 29.01.12
(511)
11 – Showers; bath tubs; bath tubs for sitz baths; heaters for baths; hydromassage bath apparatus; spa

baths [vessels]; microbubble generators for baths; bath fittings; bath installations; sinks; sanitary apparatus and installations; pipes [parts of sanitary installations]; wash-hand basins [parts of sanitary installations]; clean chambers [sanitary installations]; urinals [sanitary fixtures]; hand drying apparatus for washrooms; water conduits installations; heating installations; polymerisation installations; drying apparatus and installations; toilet bowls; water flushing installations; toilet seats; toilets [water-closets]; toilets, portable; flushing tanks; disinfectant dispensers for toilets; bidets; shower enclosures; Turkish bath cabinets, portable; hot air bath fittings; taps; faucets for pipes and pipelines; mixer faucets for water pipes; anti-splash tap nozzles; washers for water faucets; boiler pipes [tubes] for heating installations.

20 – Bathtub grab bars, not of metal; removable mats or covers for sinks; mobile boarding stairs, not of metal, for passengers; faucets, not of metal, for casks; collars, not of metal, for fastening pipes; clips, not of metal, for cables and pipes; water-pipe valves of plastic; drain traps [valves] of plastic; indoor window blinds [shades] [furniture]; doors for furniture; woven timber blinds [furniture]; slatted indoor blinds; pulleys of plastics for blinds; interior textile window blinds; paper blinds; bamboo curtains.

35 – Demonstration of goods; presentation of goods on communication media, for retail purposes; retail and wholesale services; retail services provided by on-line shops; sales promotion for others; procurement services for others [purchasing goods and services for other businesses]; layout services for advertising purposes; bill-posting; advertising by mail order; television advertising; rental of advertising space; online advertising on a computer network.

(260) AM 2019 100653 A

(800) 1277485

(151) 2015 09 11

(891) 2018 11 08

(731) THE AMERICAN SOCIETY OF
MECHANICAL ENGINEERS
Two Park Avenue, New York NY
10016-5990, USA

(540)



(591) Black, white

(531) 26.04.06; 26.04.22; 27.05.25

(551) Collective

(511)

6 – Tanks, namely, industrial water storage tanks of metal, industrial water tanks of metal, liquefied gas storage tanks of metal, metal fluid storage tanks, metal storage tanks, water tanks of metal for household purposes; pipes, namely, metal pipes and tubes; valves, namely, metal valves not being parts of machines.

7 – Boilers, namely, steam engine boilers other than for land vehicles; valves and over-pressure protection devices, namely, valves as machine components, valves for pumps, pressure regulators being parts of machines.

9 – Over-pressure protection devices, namely, pressure gauges, pressure indicators, pressure sensors, pressure measuring apparatus, testing equipment for measuring the temperature, pressure, position or form of workpieces in a machine tool, flow switches for monitoring and controlling the flow of gases or liquids, level switches and level indicators for monitoring and controlling liquids in tanks and vessels, pressure regulators for pressure vessels, pressure relief valves for pressure vessels.

11 – Boilers, namely, electric boilers, furnace boilers, heating boilers, industrial boilers, boilers for heating installation, gas boilers, industrial furnace; tanks, namely, hot water tanks for heating, waste water treatment tanks; pipes, namely, heat pipes to cool heat producing components, pipes for heating boilers; nuclear power plant and nuclear facility equipment, components, parts and appurtenances, namely, nuclear generators, nuclear reactors, cooling units for industrial purposes, industrial-water purifying apparatus, heat exchangers not being parts of machines; valves and over-pressure protection devices, namely, pressure regulators for gas installations, pressure regulators for water installations, regulating accessories for water or gas apparatus and pipes, thermostatic valves as parts of heating installations.

19 – Tanks not of metal, namely, liquid storage tanks of masonry for industrial purposes, storage tanks of masonry; pipes not of metal, namely, branching pipes, not of metal, cement mortar pipes, clay pipes and conduits, concrete pipes, drain pipes, not of metal, non-metal water pipes, polyethylene pipes used in geothermal heating and cooling systems, rigid pipes, not of metal; valves not of metal or plastic, namely, water-pipe valves.

20 – Tanks, namely, plastic storage tanks, plastic storage containers for commercial or industrial use; valves, namely, valves of plastic being other than machine parts, non-metal valves for containers.

37 – Services in the assembly and installation of power and pressure equipment such as boilers, pressure

vessels, and related equipment, namely, pipes, valves, tanks, over pressure protection devices and equipment used in nuclear installations for industrial, institutional, and residential use.

(260) AM 2019 100654 A

(800) 1302914

(151) 2016 03 10

(891) 2018 10 12

(731) ALAIN AFFLELOU FRANCHISEUR

11 rue d'Argenson, F-75008 Paris, France

(540)

ALAIN AFFLELOU

(591) Black, white

(511)

9 – Optical apparatus and instruments; contact lenses, optical goods, spectacles (optics), sunglasses, spectacle cases, spectacle lenses, corrective lenses, cases for contact lenses, spectacle frames; acoustic measurement instruments; hearing aids for telephones and televisions; sound recording, transmission or reproduction apparatus; telephones; binoculars; magnifying glasses; telescopes.

10 – Equipment enabling hearing-impaired persons to visualize tone bursts; audiology equipment, hearing aids, prosthetic equipment for hearing corrections; hearing aids.

35 – Advertising; organization of exhibitions for commercial or advertising purposes; organization of promotional and advertising activities for developing customer loyalty; sales promotion for others; commercial information and advisory services in the fields of sale and promotion of optical and acoustic products; retail sale or wholesale services of the following products; cleaning products for hearing aids, cleaning, polishing, scouring and abrasive preparations, cleaning products for spectacles and spectacle lenses, wipes for spectacles and spectacle lenses, cleaning products for contact lenses, optical apparatus and instruments, contact lenses, optical goods, spectacles (optics), sunglasses, spectacle cases, spectacle lenses, corrective lenses, cases for contact lenses, spectacle frames, acoustic measuring instruments, telephone and television hearing aids, apparatus for the recording, transmission, reproduction of sound, telephones, binoculars, magnifying glasses, telescopes, equipment enabling hearing-impaired persons to view noise pulses, audiology equipment, hearing aids, prosthetic hearing correction equipment, prosthetic hearing aids.

44 – Consultancy relating to acoustics and hearing aids for the deaf; optician services; hearing correction office services; health care services relating to acoustics and hearing; consultancy relating to optics.

(260) AM 2019 100655 A

(800) 1312203

(151) 2016 05 18

(891) 2018 07 10

(731) SANTA FARMA İLAÇ SANAYİİ

ANONİM ŞİRKETİ

Okmeydani, BoruÇiçeği Sk., No.16 Kat:4

Şişli, TR-34382 ISTANBUL, Turkey

(540)

ALLERSET

(591) Black, white

(531) 27.05.01

(511)

5 – Pharmaceuticals.

(260) AM 2019 100657 A

(800) 1334291

(151) 2016 08 12

(891) 2018 10 15

(731) AROMATIKA LTD.

7-9 Nyzhniy Val str., Kyiv 04071, Ukraine

(540)



AROMATIKA

(591) Black, white

(531) 01.15.15; 05.03.13; 05.03.14; 24.17.03;

26.01.04; 26.01.21

(511)

5 – Pharmaceuticals, medical and veterinary preparations; sanitary preparations for medical purposes; dietetic food and substances adapted for medical use, food for babies; plasters, materials for dressings; material for stopping teeth, dental wax; disinfectants; preparations for destroying vermin; fungicides, herbicides.

29 – Meat, fish, poultry and game; meat extracts; preserved, frozen, dried and cooked fruits and vegetables; jellies, jams, compotes; eggs; milk and milk products; edible oils and fats.

(260) AM 2019 100659 A

(800) 1363816

(151) 2017 07 10

(891) 2018 10 31

(731) HENKEL AG & CO. KGAA

Henkelstrasse 67, 40589 Düsseldorf, Germany

(540)

GLACIER BREEZE

(591) Black, white

(511)

3 – Soaps for personal use, perfumery, essential oils, cosmetics, hair lotions; dentifrices.

(260) AM 2019 100660 A

(800) 1409443

(151) 2018 02 01

(891) 2018 10 15

(731) AROMATIKA LTD.

7-9 Nyzhnyi Val str., Kyiv 04071, Ukraine

(540)

**AROMATIKA**

(591) Black, white

(531) 01.15.15; 05.03.13; 05.03.14; 24.17.03;
26.01.04; 26.01.21

(511)

11 – Household air cleaners; humidifiers; ionization apparatus; electric and battery operated aromatherapy units; dispensing units and diffusers for room fragrances, air fresheners and room deodorants, all for scenting, purifying or freshening the atmosphere; parts and fittings for all the aforesaid goods sold as a unit therewith.

(260) AM 2019 100709 A

(800) 1437483

(151) 2018 08 10

(891) 2018 08 10

(731) UNI-TREND TECHNOLOGY (CHINA)
LIMITEDNo.6 Gong Ye Bei 1st Road, Songshan Lake
National, High-Tech Industrial Development
Zone, Dongguan City, Guangdong Province,
China

(540)

TOPLIA

(591) Black, white

(531) 27.05.17

(511)

8 – Hand tools, hand-operated; wrenches [hand tools]; garden tools, hand-operated; harpoons; beard clippers; pincers; tweezers; knives; table cutlery [knives, forks and spoons].

9 – Computers; quantity indicators; photocopiers [photographic, electrostatic, thermic]; weighing machines; measures; oscillographs; surveying apparatus and instruments; optical apparatus and instruments; wires, electric.

(260) AM 2019 100713 A

(800) 1437592

(151) 2018 08 08

(891) 2018 08 08

(731) ISAGRO S.p.A

Caldera Park, Orange Building – Via Caldera,
21, I-20153 MILANO, Italy

(540)

BORDEAUX CAFFARO

(591) Black, white

(511)

1 – Chemical used in agriculture, horticulture and forestry; fertilizers, manures.

5 – Preparations for destroying vermin; fungicides, herbicides.

(260) AM 2019 100720 A

(800) 1437822

(151) 2018 08 30

(891) 2018 08 30

(731) SHISEIDO COMPANY, LIMITED

7-5-5, Ginza, Chuo-ku, Tokyo 104-0061,
Japan

(540)

Beauty is ALIVE

(591) Black, white

(511)

3 – Soaps; cosmetics; perfumery, incenses and fragrances; dentifrices; false nails; false eyelashes; cotton for cosmetic purposes.

(260) AM 2019 100727 A

(800) 1437975

(151) 2018 09 20

(891) 2018 09 20

(731) SYLENCO GMBH

Baumwall 7, 20459 Hamburg, Germany

(540)



(591) Black, white

(531) 05.03.11; 05.03.13; 05.03.14; 27.03.11;
27.05.01; 27.05.08; 29.01.12

(511)

1 – Soil additives [fertilizer]; chlorine-free fertilizer; fertilizer; fertilizer for potted plant; fertilizer in solid form; fertilizer in liquid form; fertilizing preparati-

ons; artificial fertilizers; plant nutrition [fertilizer]; synthetic fertilizer.

(260) AM 2019 100728 A

(800) 1437979

(151) 2018 09 07

(891) 2018 09 07

(731) JINAN GOLD PHOENIX BRAKE
SYSTEMS CO., LTD
NO. 6, ANSHUN STREET, JIBEI
ECONOMIC DEVELOPMENT ZONE,
JINAN, 251400 SHANDONG PROVINCE,
China

(540)



(591) Black, white

(531) 27.01.01; 27.05.01

(511)

12 – Automobile chassis; shock absorbers for automobiles; brake pads for automobiles; automobile wheel hubs; clutches for land vehicles; braking device for vehicles; windscreen wipers; brakes for vehicles; brake linings for vehicles; brake shoes for vehicles.

(260) AM 2019 100730 A

(800) 1438119

(151) 2018 07 13

(891) 2018 07 13

(731) UTAIR AVIATION
Aeroport, Khanty-Mansiysk, Tumenskaya
oblast RU-628012 Khanty-Mansiyskiy
avtonomniy okrug., Russian Federation

(540)

(591) Blue

(531) 27.05.01; 27.05.17; 29.01.04

(511)

9 – 3D spectacles; DVD players; ticket dispensers; coin-operated musical automata [juke boxes]; fire engines; answering machines; electrical adapters; batteries for electronic cigarettes; accumulators, electric; accumulators, electric, for vehicles; accelerometers; actinometers; alidades; altimeters; ammeters; anemometers; anodes; antennas; anticathodes; apertometers [optics]; high-frequency apparatus; testing apparatus not for medical purposes; remote control apparatus; electro-dynamic apparatus for the remote control of railway points; electro-dynamic apparatus for the remote control of signals; monitoring appa-

ratus, electric; sound recording apparatus; Global Positioning System [GPS] apparatus; distillation apparatus for scientific purposes; diffraction apparatus [microscopy]; air analysis apparatus; apparatus to check franking; sound transmitting apparatus; apparatus for fermentation [laboratory apparatus]; breathing apparatus for underwater swimming; breathing apparatus, except for artificial respiration; apparatus and installations for the production of X-rays, not for medical purposes; cash registers; electric apparatus for commutation; intercommunication apparatus; stills for laboratory experiments; projection apparatus; fire extinguishing apparatus; radiological apparatus for industrial purposes; X-ray apparatus not for medical purposes; blueprint apparatus; flashing lights [luminous signals]; stereoscopic apparatus; telephone apparatus; facsimile machines; phototelegraphy apparatus; igniting apparatus, electric, for igniting at a distance; acid hydrometers; salinometers; acidimeters for batteries; aerometers; battery jars; barometers; anode batteries; galvanic batteries; batteries for lighting; solar batteries; solar panels for the production of electricity; batteries, electric; balances [steelyards]; betatrons; binoculars; biochips; electronic tags for goods; lens hoods; magnetic tape units for computers; computer memory devices; fire hose nozzles; encoded identification bracelets, magnetic; connected bracelets [measuring instruments]; safety tarpaulins; electronic key fobs being remote control apparatus; bullet-proof clothing; beacons, luminous; signalling buoys; life buoys; marking buoys; vacuum gauges; electrolyzers; variometers; verniers; scales; baby scales; bathroom scales; letter scales; weighbridges; precision balances; scales with body mass analysers; levelling staffs [surveying instruments]; camcorders; video baby monitors; video cassettes; video telephones; video screens; viewfinders, photographic; sockets, plugs and other contacts [electric connections]; micrometer screws for optical instruments; viscosimeters; circuit closers; wavemeters; voltmeters; mechanical signs; signs, luminous; switchboxes [electricity]; current rectifiers; gas testing instruments; gasometers [measuring instruments]; galvanometers; hands-free kits for telephones; heliographic apparatus; hygrometers; hydrometers; weights; peepholes [magnifying lenses] for doors; holograms; plotters; sounding leads; plumb bobs; range finders; densimeters; optical goods; detectors; smoke detectors; infrared detectors; counterfeit [false] coin detectors; joysticks for use with computers, other than for video games; transparencies [photography]; slide projectors; diaphragms [photography]; dictating machines; dynamometers; light-emitting diodes [LED]; floppy disks; sound recording discs; optical discs; circular slide rules; disk drives for computers; juke boxes for computers; DNA chips; electronic interactive whiteboards; electronic notice boards; bullet-proof waistcoats [vests (Am.)]; life jackets; reflective safety

vests; identification threads for electric wires; nose clips for divers and swimmers; locks, electric; bells [warning devices]; alarm bells, electric; electric door bells; signal bells; audio interfaces; acoustic conduits; optical discs; circular slide rules; disk drives for computers; juke boxes for computers; DNA chips; electronic interactive whiteboards; electronic notice boards; bullet-proof waistcoats [vests (Am.)]; life jackets; reflective safety vests; identification threads for electric wires; nose clips for divers and swimmers; locks, electric; bells [warning devices]; alarm bells, electric; electric door bells; signal bells; audio interfaces; acoustic conduits; mirrors for inspecting work; road signs, luminous or mechanical; marine depth finders; probes for scientific purposes; buzzers; needles for surveying compasses; needles for record players; measures; pressure measuring apparatus; simulators for the steering and control of vehicles; inverters [electricity]; pressure indicators; temperature indicators; incubators for bacteria culture; measuring instruments; cosmographic instruments; mathematical instruments; levelling instruments; instruments containing eyepieces; surveying instruments; azimuth instruments; interfaces for computers; ionization apparatus not for the treatment of air or water; spark-guards; coaxial cables; fibre [fiber (Am.)] optic cables; cables, electric; calipers; slide calipers; screw-tapping gauges; calorimeters; calculating machines; pocket calculators; decompression chambers; cinematographic cameras; thermal imaging cameras; mouth guards for sports; life-saving capsules for natural disasters; electronic pens [visual display units]; holders for electric coils; identity cards, magnetic; video game cartridges; toner cartridges, unfilled, for printers and photocopiers; memory cards for video game machines; encoded magnetic cards; riding helmets; protective helmets; carriers for dark plates [photography]; automated teller machines [ATM]; cathodes; spools [photography]; choking coils [impedance]; coils, electric; electromagnetic coils; cinematographic film, exposed; computer keyboards; solenoid valves [electromagnetic switches]; wire connectors [electricity]; encoded key cards; electronic book readers; electronic agendas; push buttons for bells; mouse pads; magnetic encoders; anti-glare visors; collectors, electric; calibrating rings; smart rings; protective suits for aviators; commutators; compact discs [audio-video]; compact discs [read-only memory]; comparators; directional compasses; marine compasses; computers; laptop computers; tablet computers; notebook computers; condensers [capacitors]; contacts, electric; wind socks for indicating wind direction; traffic cones; branch boxes [electricity]; distribution boxes [electricity]; junction boxes [electricity]; battery boxes; cabinets for loudspeakers; diving suits; galena crystals [detectors]; reflecting discs for wear, for the prevention of traffic accidents; covers for electric outlets; logs [measuring instruments]; lasers,

not for medical purposes; lactodensimeters; lactometers; vacuum tubes [radio]; darkroom lamps [photography]; thermionic tubes; amplifying tubes; flashlights [photography]; head cleaning tapes [recording]; magnetic tapes; videotapes; surveying chains; fire escapes; rulers [measuring instruments]; square rulers for measuring; slide-rules; contact lenses; correcting lenses [optics]; close-up lenses; optical lenses; optical condensers; sounding lines; electricity conduits; measuring spoons; magnifying glasses [optics]; thread counters; magnets; decorative magnets; crash test dummies; resuscitation mannequins [teaching apparatus]; mouse [computer peripheral]; pressure gauges; security tokens [encryption devices]; divers' masks; solderers' helmets; protective masks; respiratory masks, other than for artificial respiration; materials for electricity mains [wires, cables]; voting machines; money counting and sorting machines; material testing instruments and machines; furniture especially made for laboratories; megaphones; portable media players; diaphragms [acoustics]; diaphragms for scientific apparatus; metal detectors for industrial or military purposes; digital weather stations; metronomes; rules [measuring instruments]; carpenters' rules; dressmakers' measures; mechanisms for coin-operated apparatus; mechanisms for counter-operated apparatus; coin-operated mechanisms for television sets; shutter releases [photography]; micrometers; microprocessors; microscopes; microtomes; microphones; audio mixers; modems; lightning conductors [rods]; monitors [computer hardware]; monitors [computer programs]; selfie sticks [hand-held monopods]; terminals [electricity]; junction sleeves for electric cables; teeth protectors; temperature indicator labels, not for medical purposes; knee-pads for workers; headphones; surveyors' levels; sound recording carriers; magnetic data media; optical data media; electronic sheet music, downloadable; computer software, recorded; sheaths for electric cables; identification sheaths for electric wires; weighing machines; computer hardware; punched card machines for offices; life saving apparatus and equipment; objectives [lenses] [optics]; lenses for astrophotography; egg-candlers; fire extinguishers; electrified fences; limiters [electricity]; clothing for protection against accidents, irradiation and fire; clothing for protection against fire; asbestos clothing for protection against fire; clothing especially made for laboratories; ozonisers [ozonators]; octants; eyepieces; ohmmeters; wrist rests for use with computers; eyeglass frames; oscillographs; plumb lines; mirrors [optics]; eyeglasses; sunglasses; goggles for sports; electronic collars to train animals; signalling panels, luminous or mechanical; radio pagers; pince-nez; electronic pocket translators; transmitters [telecommunication]; telephone transmitters; transmitters of electronic signals; switches, electric; periscopes; gloves for divers; gloves for protection against accidents; gloves for protection

against X-rays for industrial purposes; asbestos gloves for protection against accidents; furnaces for laboratory use; pipettes; pyrometers; planimeters; plane tables [surveying instruments]; plates for batteries; wafers for integrated circuits; printed circuit boards; compact disc players; cassette players; protective films adapted for computer screens; protective films adapted for smartphones; sound recording strips; X-ray films, exposed; films, exposed; life-saving rafts; laboratory trays; digital signs; semi-conductors; polarimeters; fire pumps; measuring glassware; life belts; fuses; circuit breakers; converters, electric; telerupters; food analysis apparatus; diagnostic apparatus, not for medical purposes; distance recording apparatus; distance measuring apparatus; speed measuring apparatus [photography]; appliances for measuring the thickness of leather; apparatus for measuring the thickness of skins; speed checking apparatus for vehicles; teaching apparatus; time recording apparatus; apparatus and instruments for astronomy; surveying apparatus and instruments; weighing apparatus and instruments; nautical apparatus and instruments; navigational instruments; optical apparatus and instruments; apparatus and instruments for physics; chemistry apparatus and instruments; measuring apparatus; measuring devices, electric; boiler control instruments; meteorological instruments; naval signalling apparatus; observation instruments; navigation apparatus for vehicles [on-board computers]; satellite navigational apparatus; regulating apparatus, electric; precision measuring apparatus; audio- and video-receivers; prisms [optics]; computer software applications, downloadable; printers for use with computers; retorts' stands; apparatus for changing record player needles; drainers for use in photography; cleaning apparatus for sound recording discs; fire beaters; telescopic sights for firearms; telescopic sights for artillery; test tubes; pressure indicator plugs for valves; magnetic wires; telegraph wires; telephone wires; wires, electric; conductors, electric; copper wire, insulated; fuse wire; computer programmes [programs], recorded; computer game software; computer programs [downloadable software]; computer operating programs, recorded; record players; processors [central processing units]; rods for water diviners; electronic publications, downloadable; distribution consoles [electricity]; control panels [electricity]; radar apparatus; baby monitors; masts for wireless aerials; transmitting sets [telecommunication]; radios; vehicle radios; sprinkler systems for fire protection; frames for photographic transparencies; screens for photoengraving; flowmeters; walkie-talkies; voltage surge protectors; voltage regulators for vehicles; stage lighting regulators; light dimmers [regulators], electric; speed regulators for record players; cell switches [electricity]; washing trays [photography]; marking gauges [joinery]; T-squares for measuring; time switches, automatic; relays, electric; safety restraints, other

than for vehicle seats and sports equipment; X-ray photographs, other than for medical purposes; rheostats; respirators for filtering air; retorts; refractometers; refractors; grids for batteries; humanoid robots with artificial intelligence; speaking tubes; horns for loudspeakers; subwoofers; saccharometers; optical fibers [fibres] [light conducting filaments]; traffic-light apparatus [signalling devices]; dog whistles; signalling whistles; sextants; inductors [electricity]; safety nets; nets for protection against accidents; fire alarms; signals, luminous or mechanical; sirens; electronic access control systems for interlocking doors; scanners [data processing equipment]; integrated circuit cards [smart cards]; smartglasses; smartphones; smartwatches; connections for electric lines; couplings, electric; sonars; sound locating instruments; lighting ballasts; resistances, electric; spectrograph apparatus; spectroscopes; speed indicators; alcoholmeters; satellites for scientific purposes; protection devices for personal use against accidents; audiovisual teaching apparatus; charging stations for electric vehicles; radiotelegraphy sets; radiotelephony sets; spectacle lenses; anti-glare glasses; optical glass; personal stereos; stereoscopes; stands for photographic apparatus; stroboscopes; fire boats; sulfimeters; bags adapted for laptops; drying racks [photography]; spherometers; integrated circuits; printed circuits; counters; parking meters; kilometer recorders for vehicles; revolution counters; abacuses; egg timers [sandglasses]; taximeters; ear plugs for divers; tachometers; television apparatus; telegraphs [apparatus]; telescopes; teleprompters; teleprinters; cellular phones; cordless telephones; theodolites; interactive touch screen terminals; thermo-hygrometers; thermometers, not for medical purposes; thermostats; thermostats for vehicles; crucibles [laboratory]; tone arms for record players; totalizers; transistors [electronic]; transponders; protractors [measuring instruments]; transformers [electricity]; step-up transformers; vehicle breakdown warning triangles; triodes; starter cables for motors; discharge tubes, electric, other than for lighting; capillary tubes; neon signs; Pitot tubes; X-ray tubes not for medical purposes; telephone receivers; squares for measuring; gauges; quantity indicators; automatic indicators of low pressure in vehicle tires [tyres]; gasoline gauges; water level indicators; electric loss indicators; light-emitting electronic pointers; slope indicators; levels [instruments for determining the horizontal]; mercury levels; spirit levels; urinometers; amplifiers; particle accelerators; electric installations for the remote control of industrial operations; steering apparatus, automatic, for vehicles; balancing apparatus; video recorders; sound reproduction apparatus; invoicing machines; tape recorders; protection devices against X-rays, not for medical purposes; railway traffic safety appliances; data processing apparatus; oxygen transvasing apparatus; theft prevention installations, electric; film cutting apparatus; drying ap-

paratus for photographic prints; optical character readers; centering apparatus for photographic transparencies; dosage dispensers; battery chargers; chargers for electric batteries; chargers for electronic cigarettes; acoustic alarms; sounding apparatus and machines; editing appliances for cinematographic films; cathodic anti-corrosion apparatus; couplers [data processing equipment]; wearable activity trackers; anti-theft warning apparatus; computer peripheral devices; anti-interference devices [electricity]; demagnetizing apparatus for magnetic tapes; acoustic couplers; alarms; fog signals, non-explosive; whistle alarms; adding machines; readers [data processing equipment]; heat regulating apparatus; photocopiers [photographic, electrostatic, thermic]; electric and electronic effects units for musical instruments; bar code readers; downloadable ring tones for mobile phones; downloadable image files; downloadable music files; animated cartoons; filters [photography]; filters for respiratory masks; filters for ultraviolet rays, for photography; USB flash drives; magic lanterns; optical lamps; signal lanterns; cameras [photography]; glazing apparatus for photographic prints; shutters [photography]; darkrooms [photography]; photometers; flash-bulbs [photography]; digital photo frames; enlarging apparatus [photography]; photovoltaic cells; containers for contact lenses; eyeglass cases; containers for microscope slides; cases for smartphones; cases especially made for photographic apparatus and instruments; chromatography apparatus for laboratory use; chronographs [time recording apparatus]; laboratory centrifuges; eyeglass chains; cyclotrons; compasses for measuring; frequency meters; time clocks [time recording devices]; petri dishes; sleeves for laptops; covers for personal digital assistants [PDAs]; covers for tablet computers; covers for smartphones; fire blankets; chips [integrated circuits]; jigs [measuring instruments]; pedometers; meteorological balloons; electrified rails for mounting spot lights; asbestos screens for firemen; fire hose; virtual reality headsets; protective helmets for sports; head guards for sports; cell phone straps; eyeglass cords; tripods for cameras; switchboards; distribution boards [electricity]; equalizers [audio apparatus]; screens [photography]; workmen's protective face-shields; projection screens; radiology screens for industrial purposes; fluorescent screens; exposure meters [light meters]; ducts [electricity]; galvanic cells; epidiascopes; ergometers; armatures [electricity]; black boxes [data recorders].

12 – Motor buses; motor coaches; motor homes; driverless cars [autonomous cars]; motor racing cars; cars; sports cars; concrete mixing vehicles; refrigerated vehicles; caravans; shock absorbers for automobiles; suspension shock absorbers for vehicles; space vehicles; aircraft; aeronautical apparatus, machines and appliances; air cushion vehicles; hot air balloons; ski carriers for cars; luggage carriers for vehi-

les; bumpers for automobiles; vehicle bumpers; tires for vehicle wheels; barges; brake shoes for vehicles; tailboard lifts [parts of land vehicles]; armored vehicles; buffers for railway rolling stock; waggons; tilt trucks; carriages [railways]; sleeping cars; dining cars; refrigerated wagons [railroad vehicles]; transmission shafts for land vehicles; bicycles; electric bicycles; valves for vehicle tires [tyres]; helicopters [vehicles]; automobile hoods; stroller hoods; hoods for vehicles; oars; paddles for canoes; sculls; screws [propellers] for ships; hydroplanes; seaplanes; flanges for railway wheel tires [tyres]; trucks; horns for vehicles; treads for vehicles [tractor type]; doors for vehicles; bicycle motors; motorcycle engines; engines for land vehicles; jet engines for land vehicles; driving motors for land vehicles; screw-propellers; screw-propellers for boats; dirigible balloons [airships]; brake discs for vehicles; telfer railways [cable cars]; dredgers [boats]; trolleys; military drones; civilian drones; adhesive rubber patches for repairing inner tubes; bicycle bells; rearview mirrors; side view mirrors for vehicles; portholes; cars for cable transport installations; inner tubes for pneumatic tires [tyres]; inner tubes for bicycle tires; canoes; hoods for vehicle engines; crankcases for land vehicle components, other than for engines; boats; caissons [vehicles]; bicycle wheels; vehicle wheels; mine cart wheels; steering wheels for vehicles; casters for trolleys [vehicles] [carts (Am.)]; brake pads for automobiles; hub caps; strollers; side cars; prams; brake linings for vehicles; ships; baskets adapted for bicycles; gear boxes for land vehicles; ship hulls; panniers adapted for bicycles; panniers adapted for motorcycles; fenders for ships; bands for wheel hubs; ejector seats for aircraft; wheelchairs; caps for vehicle petrol [gas] tanks; boat hooks; automobile bodies; tipping bodies for lorries [trucks]; bodies for vehicles; treads for retreading tires [tyres]; locomotives; masts for boats; golf carts [vehicles]; sprinkling trucks; propulsion mechanisms for land vehicles; mopeds; motor scooters; motorcycles; tyre mousse inserts; fitted footmuffs for pushchairs; fitted footmuffs for prams; freewheels for land vehicles; clutches for land vehicles; repair outfits for inner tubes; air pumps [vehicle accessories]; pumps for bicycle tires; upholstery for vehicles; rims for bicycle wheels; rims for vehicle wheels; windows for vehicles; omnibuses; engine mounts for land vehicles; axles for vehicles; headlight wipers; parachutes; ferry boats; bicycle pedals; ashtrays for automobiles; gearing for land vehicles; carts; head-rests for vehicle seats; bicycle kickstands; vehicle running boards; air bags [safety devices for automobiles]; ski lifts; chairlifts; casings for pneumatic tires [tyres]; sleeping berths for vehicles; pontoons; torque converters for land vehicles; cigar lighters for automobiles; non-skid devices for vehicle tires [tyres]; anti-glare devices for vehicles; anti-theft devices for vehicles; sunblinds adapted for automobiles; balance weights for

vehicle wheels; shock absorbing springs for vehicles; bicycle frames; motorcycle frames; spars for ships; reduction gears for land vehicles; safety belts for vehicle seats; security harness for vehicle seats; vehicle suspension springs; rudders; bicycle handlebars; motorcycle handlebars; vehicle joysticks; bicycle cranks; aeroplanes; amphibious airplanes; sleighs [vehicles]; kick sledges; brake segments for vehicles; bicycle saddles; luggage nets for vehicles; dress guards for bicycles; fitted stroller mosquito nets; anti-theft alarms for vehicles; reversing alarms for vehicles; safety seats for children, for vehicles; vehicle seats; bellows for articulated buses; hydraulic circuits for vehicles; push scooters [vehicles]; mobility scooters; snowmobiles; rolling stock for railways; rolling stock for funicular railways; spokes for bicycle wheels; vehicle wheel spokes; spoilers for vehicles; air vehicles; vehicles for locomotion by land, air, water or rail; ambulances; autonomous underwater vehicles for seabed inspections; water vehicles; remotely operated vehicles for underwater inspections; remote control vehicles, other than toys; electric vehicles; tricycles; delivery tricycles; inclined ways for boats; windscreens; windshield wipers; hubs for bicycle wheels; hubs for vehicle wheels; bags adapted for pushchairs; saddlebags adapted for bicycles; railway couplings; trailer hitches for vehicles; couplings for land vehicles; wheelbarrows; handling carts; two-wheeled trolleys; shopping trolleys [carts (Am.)]; hose carts; bogies for railway cars; casting carriages; tilting-carts; forklift trucks; cleaning trolleys; bicycle brakes; brakes for vehicles; torsion bars for vehicles; tractors; tramcars; transmissions for land vehicles; military vehicles for transport; aerial conveyors; trailers [vehicles]; funnels for ships; funnels for locomotives; cleats [nautical]; turbines for land vehicles; direction indicators for bicycles; direction signals for vehicles; rowlocks; disengaging gear for boats; steering gears for ships; cable transport apparatus and installations; spoke clips for wheels; tipping apparatus, parts of trucks and waggons; funiculars; vans [vehicles]; automobile chains; bicycle chains; motorcycle chains; driving chains for land vehicles; anti-skid chains; transmission chains for land vehicles; structural parts for helicopters; structural parts for aircraft; undercarriages for vehicles; stroller covers; spare wheel covers; covers for vehicle steering wheels; saddle covers for bicycles; saddle covers for motorcycles; seat covers for vehicles; vehicle covers [shaped]; automobile chassis; vehicle chassis; connecting rods for land vehicles, other than parts of motors and engines; axle journals; gears for bicycles; tubeless tires for bicycles; bicycle tyres; automobile tires [tyres]; pneumatic tires; solid tires for vehicle wheels; spikes for tires; davits for boats; launches; timbers [frames] for ships; mudguards; bicycle mudguards; motors, electric, for land vehicles; yachts.

16 – Fountain pens; aquarelles; albums; almanacs; document laminators for office use; mimeograph apparatus and machines; atlases; posters; banknotes; banners of paper; paper bows; table linen of paper; tickets; forms, printed; announcement cards [stationery]; note books; pads [stationery]; drawing pads; loose-leaf binders; wristbands for the retention of writing instruments; pamphlets; booklets; paper; paper sheets [stationery]; waxed paper; paper for recording machines; paper for radiograms; electrocardiograph paper; drawer liners of paper, perfumed or not; wood pulp paper; carbon paper; copying paper [stationery]; parchment paper; writing paper; rice paper; luminous paper; Xuan paper for Chinese painting and calligraphy; toilet paper; wrapping paper; filter paper; blotters; newsletters; rollers for typewriters; house painters' rollers; composing sticks; modelling wax, not for dental purposes; signboards of paper or cardboard; sewing patterns; bunting of paper; newspapers; electrotypes; hectographs; modelling clay; polymer modelling clay; terrestrial globes; drawing sets; engravings; slate pencils; pencil leads; document holders [stationery]; pencil holders; chalk holders; holders for checkbooks [cheque books]; holders for stamps [seals]; page holders; diagrams; table runners of paper; engraving plates; writing slates; blackboards; galley racks [printing]; drawing boards; advertisement boards of paper or cardboard; duplicators; punches [office requisites]; cream containers of paper; magazines [periodicals]; money clips; tags for index cards; pen clips; book-markers; etching needles; tracing needles for drawing purposes; periodicals; printed publications; paper shredders for office use; graphic representations; credit card imprinters, non-electric; graining combs; drawing instruments; calendars; tracing paper; tracing cloth; tracing patterns; gums [adhesives] for stationery or household purposes; lithographic stones; ink stones [ink reservoirs]; pencils; pencil lead holders; charcoal pencils; pictures; transfers [decalcomanias]; paintings [pictures], framed or unframed; cardboard; wood pulp board [stationery]; hat boxes of cardboard; files [office requisites]; cards; index cards [stationery]; geographical maps; paper tapes and cards for the recordal of computer programmes; trading cards, other than for games; perforated cards for Jacquard looms; catalogues; spools for inking ribbons; covers of paper for flower pots; paintbrushes; painters' brushes; writing brushes; typewriter keys; glue for stationery or household purposes; isinglass for stationery or household purposes; gluten [glue] for stationery or household purposes; starch paste [adhesive] for stationery or household purposes; printing blocks; books; manifolds [stationery]; comic books; drawing pins; cigar bands; envelopes [stationery]; boxes of paper or cardboard; cases for stamps [seals]; paint boxes [articles for use in school]; correcting fluids [office requisites]; printed coupons; stencils [stationery];

French curves; paper ribbons; typewriter ribbons; gummed tape [stationery]; adhesive bands for stationery or household purposes; correcting tapes [office requisites]; inking ribbons; inking ribbons for computer printers; adhesive tapes for stationery or household purposes; self-adhesive tapes for stationery or household purposes; square rulers for drawing; drawing rulers; flyers; absorbent sheets of paper or plastic for foodstuff packaging; humidity control sheets of paper or plastic for foodstuff packaging; viscose sheets for wrapping; sheets of reclaimed cellulose for wrapping; plastic bubble packs for wrapping or packaging; steel letters; type [numerals and letters]; lithographs; paint trays; architects' models; postage stamps; plastics for modelling; graphic prints; modelling materials; teaching materials [except apparatus]; sealing compounds for stationery purposes; adhesives [glues] for stationery or household purposes; stuffing of paper or cardboard; bookbinding material; packing [cushioning, stuffing] materials of paper or cardboard; packaging material made of starches; filtering materials [paper]; addressing machines; pencil sharpening machines, electric or non-electric; bookbinding apparatus and machines [office equipment]; typewriters, electric or non-electric; covers [stationery]; franking machines for office use; chalk for lithography; writing chalk; tailors' chalk; marking chalk; spray chalk; bags [envelopes, pouches] of paper or plastics, for packaging; garbage bags of paper or of plastics; plastic bags for pet waste disposal; painters' easels; hand-rests for painters; printing sets, portable [office requisites]; bibs of paper; stickers [stationery]; finger-stalls [office requisites]; writing cases [stationery]; cords for bookbinding; paper knives [cutters] [office requisites]; printed sheet music; numbering apparatus; bottle envelopes of paper or cardboard; sealing wafers; passport holders; plastic cling film, extensible, for palletization; embroidery designs [patterns]; handwriting specimens for copying; oleographs; musical greeting cards; greeting cards; postcards; etchings; conical paper bags; bags for microwave cooking; palettes for painters; ink sticks; pantographs [drawing instruments]; folders for papers; papier mâché; pastels [crayons]; modelling paste; pen cases; pen wipers; office perforators; pens [office requisites]; nibs of gold; nibs; steel pens; drawing pens; song books; seals [stamps]; sealing stamps; clipboards; address plates for addressing machines; handkerchiefs of paper; plastic film for wrapping; desk mats; letter trays; trays for sorting and counting money; coasters of paper; bookends; stamp stands; mats for beer glasses; stands for pens and pencils; photograph stands; obliterating stamps; inking pads; stamp pads; binding strips [bookbinding]; towels of paper; inking sheets for document reproducing machines; inking sheets for duplicators; bookbinding cloth; gummed cloth for stationery purposes; printers' blankets, not of textile; portraits; paperweights; writing cases

[sets]; inkstands; office requisites, except furniture; writing materials; writing instruments; drawing materials; school supplies [stationery]; adhesive tape dispensers [office requisites]; hand labelling appliances; printed matter; lithographic works of art; prospectuses; printed timetables; ledgers [books]; printers' reglets; indexes; rubber erasers; elastic bands for offices; T-squares for drawing; graphic reproductions; penholders; marking pens [stationery]; tissues of paper for removing make-up; face towels of paper; place mats of paper; tablemats of paper; tablecloths of paper; paper clasps; document files [stationery]; scrapers [erasers] for offices; paper-clips; staples for offices; erasing products; biological samples for use in microscopy [teaching materials]; histological sections for teaching purposes; steatite [tailor's chalk]; writing board erasers; composing frames [printing]; sealing wax; arithmetical tables; placards of paper or cardboard; writing or drawing books; fabrics for bookbinding; stationery; pencil sharpeners, electric or non-electric; transparencies [stationery]; stencil plates; cardboard tubes; Indian inks; moisteners [office requisites]; moisteners for gummed surfaces [office requisites]; squares for drawing; chart pointers, non-electronic; bottle wrappers of paper or cardboard; envelope sealing machines for offices; sealing machines for offices; vignetting apparatus; apparatus for mounting photographs; stapling presses [office requisites]; manuals [handbooks]; figurines [statuettes] of papier mâché; paper coffee filters; flags of paper; silver paper; molds for modelling clays [artists' materials]; photo-engravings; photographs [printed]; stencil cases; canvas for painting; chromolithographs [chromos]; compasses for drawing; numbers [type]; artists' watercolor saucers; ink; correcting ink [heliography]; inkwells; blueprints; stencils; erasing shields; balls for ballpoint pens; cabinets for stationery [office requisites]; printing type; address stamps; stamps [seals]; shields [paper seals]; prints [engravings]; labels of paper or cardboard.

25 – Wimples; bandanas [neckerchiefs]; underwear; sweat-absorbent underwear; berets; overalls; boas [necklets]; teddies [underclothing]; boxer shorts; ankle boots; ski boots; boots for sports; breeches for wear; trousers; football boots; brassieres; valenki [felted boots]; collars [clothing]; detachable collars; shirt yokes; veils [clothing]; gabardines [clothing]; galoshes; neckties; ascots; leggings [leg warmers]; gaiters; boot uppers; corselets; jerseys [clothing]; vests; sports jerseys; hosiery; heels; hoods [clothing]; hat frames [skeletons]; pockets for clothing; neck scarfs [mufflers]; kimonos; visors [headwear]; cap peaks; tights; slips [underclothing]; combinations [clothing]; wet suits for water-skiing; bodices [lingerie]; corsets [underclothing]; suits; bathing suits; masquerade costumes; beach clothes; leotards; jackets [clothing]; stuff jackets [clothing]; fishing vests; leggings [trousers]; liveries; camisoles; sports

singlets; cuffs; short-sleeve shirts; mantillas; coats; sleep masks; furs [clothing]; mittens; miters [hats]; muffs [clothing]; footmuffs, not electrically heated; heelpieces for footwear; bibs, not of paper; fur stoles; hairdressing capes; ear muffs [clothing]; socks; sweat-absorbent socks; footwear; beach shoes; sports shoes; clothing; paper clothing; outerclothing; ready-made clothing; motorists' clothing; cyclists' clothing; clothing for gymnastics; clothing of imitations of leather; clothing of leather; waterproof clothing; uniforms; fittings of metal for footwear; maniples; overcoats; panties; parkas; pelerines; gloves [clothing]; ski gloves; pajamas; bathing trunks; shirt fronts; scarfs; pocket squares; dresses; headbands [clothing]; garters; sock suspenders; stocking suspenders; ready-made linings [parts of clothing]; dress shields; soles for footwear; braces for clothing [suspenders]; half-boots; lace boots; pullovers; ponchos; girdles; belts [clothing]; money belts [clothing]; layettes [clothing]; non-slipping devices for footwear; heelpieces for stockings; welts for footwear; chasubles; shirts; wooden shoes; sandals; bath sandals; boots; jumper dresses; saris; sarongs; footwear uppers; inner soles; albs; bath slippers; togas; knitwear [clothing]; underpants; shoes; gymnastic shoes; slippers; skull caps; turbans; headgear for wear; aprons [clothing]; judo uniforms; karate uniforms; tee-shirts; dressing gowns; bath robes; top hats; tips for footwear; stockings; sweat-absorbent stockings; shawls; caps [headwear]; paper hats [clothing]; shower caps; bathing caps; sashes for wear; studs for football boots; hats; babies' pants [underwear]; trouser straps; pelisses; esparto shoes or sandals; skirts; petticoats.

35 – Arranging subscriptions to telecommunication services for others; import-export agency services; commercial information agency services; advertising agency services; cost price analysis; rental of advertising space; business auditing; business intermediary services relating to the matching of potential private investors with entrepreneurs needing funding; employment agency services; computerized file management; book-keeping; invoicing; demonstration of goods; transcription of communications [office functions]; opinion polling; market studies; business information; business investigations; business research; marketing research; personnel recruitment; business management and organization consultancy; business organization consultancy; business management consultancy; personnel management consultancy; professional business consultancy; layout services for advertising purposes; marketing; business management of performing artists; business management of sports people; writing of résumés for others; scriptwriting for advertising purposes; news clipping services; updating and maintenance of information in registries; updating and maintenance of data in computer databases; updating of advertising material; word processing; organization of exhibitions for

commercial or advertising purposes; arranging newspaper subscriptions for others; organization of fashion shows for promotional purposes; organization of trade fairs for commercial or advertising purposes; shop window dressing; design of advertising materials; business appraisals; payroll preparation; data search in computer files for others; sponsorship search; business management assistance; commercial or industrial management assistance; commercial intermediation services; providing business information via a web site; provision of commercial and business contact information; provision of an on-line marketplace for buyers and sellers of goods and services; web indexing for commercial or advertising purposes; presentation of goods on communication media, for retail purposes; economic forecasting; auctioneering; retail or wholesale services for pharmaceutical, veterinary and sanitary preparations and medical supplies; sales promotion for others; production of teleshopping programmes; production of advertising films; office machines and equipment rental; rental of advertising time on communication media; publicity material rental; rental of billboards [advertising boards]; rental of vending machines; rental of sales stands; rental of photocopying machines; publication of publicity texts; radio advertising; distribution of samples; dissemination of advertising matter; direct mail advertising; registration of written communications and data; writing of publicity texts; advertising; publicity; on-line advertising on a computer network; bill-posting; advertising by mail order; television advertising; document reproduction; compilation of statistics; compilation of information into computer databases; business inquiries; systemization of information into computer databases; advisory services for business management; negotiation of business contracts for others; negotiation and conclusion of commercial transactions for third parties; compiling indexes of information for commercial or advertising purposes; tax preparation; drawing up of statements of accounts; telemarketing services; psychological testing for the selection of personnel; outsourced administrative management for companies; business management of hotels; business management for freelance service providers; business project management services for construction projects; commercial administration of the licensing of the goods and services of others; business management of reimbursement programs for others; administration of consumer loyalty programs; administration of frequent flyer programs; administrative processing of purchase orders; public relations; services of retail and wholesale outlets; retail and wholesale services via Internet web-sites; appointment reminder services [office functions]; web site traffic optimization; relocation services for businesses; tax filing services; search engine optimization for sales promotion; appointment scheduling services [office functions];

price comparison services; pay per click advertising; secretarial services; procurement services for others [purchasing goods and services for other businesses]; shorthand; outsourcing services [business assistance]; telephone answering for unavailable subscribers; photocopying services; business efficiency expert services.

36 – Credit bureau services; debt collection agency services; real estate agency services; financial analysis; rental of apartments; rental of real estate; rental of offices [real estate]; rental of offices for co-working; rental of farms; lease-purchase financing; savings bank services; accommodation bureau services [apartments]; rent collection; issuance of travelers' checks; issuance of credit cards; issuance of tokens of value; capital investment; insurance information; financial information; clearing, financial; insurance consultancy; financial consultancy; debt advisory services; stock exchange quotations; lending against security; business liquidation services, financial; brokerage; financial management; exchanging money; online banking; processing of debit card payments; processing of credit card payments; factoring; organization of collections; arranging finance for construction projects; antique appraisal; jewelry appraisal; financial evaluation of standing timber; stamp appraisal; real estate appraisal; numismatic appraisal; art appraisal; financial evaluation of wool; financial evaluation [insurance, banking, real estate]; repair costs evaluation [financial appraisal]; electronic funds transfer; surety services; securities brokerage; real estate brokerage; brokerage of carbon credits; insurance brokerage; providing rebates at participating establishments of others through use of a membership card; loans [financing]; pawnbrokerage; providing financial information via a web site; check verification; investment of funds; charitable fund raising; stocks and bonds brokerage; financial sponsorship; mortgage banking; instalment loans; insurance underwriting; life insurance underwriting; health insurance underwriting; accident insurance underwriting; marine insurance underwriting; fire insurance underwriting; apartment house management; real estate management; financial management of reimbursement payments for others; actuarial services; banking; stock brokerage services; retirement payment services; bail-bonding; trusteeship; provident fund services; financial customs brokerage services; mutual funds; financing services; safe deposit services; deposits of valuables; fiscal valuation.

39 – Air transport; motor coach rental; boat rental; garage rental; rental of vehicle roof racks; aircraft rental; parking place rental; rental of warehouses; rental of tractors; booking of seats for travel; transport reservation; towing; vehicle breakdown towing services; bottling services; water distribution; delivery of newspapers; message delivery; parcel delivery; delivery of goods; delivery of goods by mail order;

flower delivery; launching of satellites for others; traffic information; transportation information; storage information; transportation logistics; rescue operations [transport]; arranging of cruises; arranging of travel tours; armored-car transport; hauling; carting; transport and storage of trash; transporting furniture; lighterage services; ferry-boat transport; removal services; transport of travellers; guarded transport of valuables; bus transport; car transport; barge transport; boat transport; railway transport; marine transport; passenger transport; river transport; ambulance transport; streetcar transport; portage; refloating of ships; cash replenishment of automated teller machines; shipbrokerage; transport brokerage; freight brokerage [forwarding (Am.)]; providing driving directions for travel purposes; car rental; railway truck rental; rental of diving bells; rental of diving suits; rental of motor racing cars; rental of aircraft engines; railway coach rental; rental of wheelchairs; rental of storage containers; horse rental; rental of freezers; rental of navigational systems; refrigerator rental; vehicle rental; rental of electric wine cellars; stevedoring; unloading cargo; electricity distribution; distribution of energy; packaging of goods; collection of recyclable goods [transport]; ice-breaking; piloting; water supplying; escorting of travellers; transport by pipeline; wrapping of goods; operating canal locks; car parking; chauffeur services; pleasure boat transport; car sharing services; courier services [messages or merchandise]; salvaging; salvage of ships; gift wrapping; underwater salvage; taxi transport; transport; transport services for sightseeing tours; franking of mail; freight [shipping of goods]; freighting; physical storage of electronically stored data or documents; boat storage; storage of goods; storage; freight forwarding.

(260) AM 2019 100732 A

(800) 1438141

(151) 2018 07 12

(891) 2018 07 12

(731) UTAIR AVIATION

Aeroport, Khanty-Mansiysk, Tumenskaya oblast RU-628012 Khanty-Mansiyskiy avtonomniy okrug., Russian Federation

(540)



(591) White, blue and light blue

(531) 26.04.05; 26.04.18; 26.04.24; 27.05.17; 27.05.21; 27.05.24; 29.01.12

(511)

9 – 3D spectacles; DVD players; ticket dispensers; coin-operated musical automata [juke boxes]; fire engines; answering machines; electrical adapters; batteries for electronic cigarettes; accumulators, electric; accumulators, electric, for vehicles; accelerometers; actinometers; alidades; altimeters; ammeters; anemometers; anodes; antennas; anticathodes; apertometers [optics]; high-frequency apparatus; testing apparatus not for medical purposes; remote control apparatus; electro-dynamic apparatus for the remote control of railway points; electro-dynamic apparatus for the remote control of signals; monitoring apparatus, electric; sound recording apparatus; Global Positioning System [GPS] apparatus; distillation apparatus for scientific purposes; diffraction apparatus [microscopy]; air analysis apparatus; apparatus to check franking; sound transmitting apparatus; apparatus for fermentation [laboratory apparatus]; breathing apparatus for underwater swimming; breathing apparatus, except for artificial respiration; apparatus and installations for the production of X-rays, not for medical purposes; cash registers; electric apparatus for commutation; intercommunication apparatus; stills for laboratory experiments; projection apparatus; fire extinguishing apparatus; radiological apparatus for industrial purposes; X-ray apparatus not for medical purposes; blueprint apparatus; flashing lights [luminous signals]; stereoscopic apparatus; telephone apparatus; facsimile machines; phototelegraphy apparatus; igniting apparatus, electric, for igniting at a distance; acid hydrometers; salinometers; acidimeters for batteries; aerometers; battery jars; barometers; anode batteries; galvanic batteries; batteries for lighting; solar batteries; solar panels for the production of electricity; batteries, electric; balances [steelyards]; betatrons; binoculars; biochips; electronic tags for goods; lens hoods; magnetic tape units for computers; computer memory devices; fire hose nozzles; encoded identification bracelets, magnetic; connected bracelets [measuring instruments]; safety tarpaulins; electronic key fobs being remote control apparatus; bullet-proof clothing; beacons, luminous; signalling buoys; life buoys; marking buoys; vacuum gauges; electrolyzers; variometers; verniers; scales; baby scales; bathroom scales; letter scales; weighbridges; precision balances; scales with body mass analysers; levelling staffs [surveying instruments]; camcorders; video baby monitors; video cassettes; video telephones; video screens; viewfinders, photographic; sockets, plugs and other contacts [electric connections]; micrometer screws for optical instruments; viscosimeters; circuit closers; wavemeters; voltmeters; mechanical signs; signs, luminous; switchboxes [electricity]; current rectifiers; gas testing instruments; gasometers [measuring instruments]; galvanometers; hands-free kits for telephones; heliographic apparatus; hygrometers; hydrometers; weights; peepholes [magnifying lenses] for doors;

holograms; plotters; sounding leads; plumb bobs; range finders; densimeters; optical goods; detectors; smoke detectors; infrared detectors; counterfeit [false] coin detectors; joysticks for use with computers, other than for video games; transparencies [photography]; slide projectors; diaphragms [photography]; dictating machines; dynamometers; light-emitting diodes [LED]; floppy disks; sound recording discs; optical discs; circular slide rules; disk drives for computers; juke boxes for computers; DNA chips; electronic interactive whiteboards; electronic notice boards; bullet-proof waistcoats [vests (Am.)]; life jackets; reflective safety vests; identification threads for electric wires; nose clips for divers and swimmers; locks, electric; bells [warning devices]; alarm bells, electric; electric door bells; signal bells; audio interfaces; acoustic conduits; mirrors for inspecting work; road signs, luminous or mechanical; marine depth finders; probes for scientific purposes; buzzers; needles for surveying compasses; needles for record players; measures; pressure measuring apparatus; simulators for the steering and control of vehicles; inverters [electricity]; pressure indicators; temperature indicators; incubators for bacteria culture; measuring instruments; cosmographic instruments; mathematical instruments; levelling instruments; instruments containing eyepieces; surveying instruments; azimuth instruments; interfaces for computers; ionization apparatus not for the treatment of air or water; spark-guards; coaxial cables; fibre [fiber (Am.)] optic cables; cables, electric; calipers; slide calipers; screw-tapping gauges; calorimeters; calculating machines; pocket calculators; decompression chambers; cinematographic cameras; thermal imaging cameras; mouth guards for sports; life-saving capsules for natural disasters; electronic pens [visual display units]; holders for electric coils; identity cards, magnetic; video game cartridges; toner cartridges, unfilled, for printers and photocopiers; memory cards for video game machines; encoded magnetic cards; riding helmets; protective helmets; carriers for dark plates [photography]; automated teller machines [ATM]; cathodes; spools [photography]; choking coils [impedance]; coils, electric; electromagnetic coils; cinematographic film, exposed; computer keyboards; solenoid valves [electromagnetic switches]; wire connectors [electricity]; encoded key cards; electronic book readers; electronic agendas; push buttons for bells; mouse pads; magnetic encoders; anti-glare visors; collectors, electric; calibrating rings; smart rings; protective suits for aviators; commutators; compact discs [audio-video]; compact discs [read-only memory]; comparators; directional compasses; marine compasses; computers; laptop computers; tablet computers; notebook computers; condensers [capacitors]; contacts, electric; wind socks for indicating wind direction; traffic cones; branch boxes [electricity]; distribution boxes [electricity]; junction boxes [electricity]; battery bo-

xes; cabinets for loudspeakers; diving suits; galena crystals [detectors]; reflecting discs for wear, for the prevention of traffic accidents; covers for electric outlets; logs [measuring instruments]; lasers, not for medical purposes; lactodensimeters; lactometers; vacuum tubes [radio]; darkroom lamps [photography]; thermionic tubes; amplifying tubes; flashlights [photography]; head cleaning tapes [recording]; magnetic tapes; videotapes; surveying chains; fire escapes; rulers [measuring instruments]; square rulers for measuring; slide-rules; contact lenses; correcting lenses [optics]; close-up lenses; optical lenses; optical condensers; sounding lines; electricity conduits; measuring spoons; magnifying glasses [optics]; thread counters; magnets; decorative magnets; crash test dummies; resuscitation mannequins [teaching apparatus]; mouse [computer peripheral]; pressure gauges; security tokens [encryption devices]; divers' masks; solderers' helmets; protective masks; respiratory masks, other than for artificial respiration; materials for electricity mains [wires, cables]; voting machines; money counting and sorting machines; material testing instruments and machines; furniture especially made for laboratories; megaphones; portable media players; diaphragms [acoustics]; diaphragms for scientific apparatus; metal detectors for industrial or military purposes; digital weather stations; metronomes; rules [measuring instruments]; carpenters' rules; dressmakers' measures; mechanisms for coin-operated apparatus; mechanisms for counter-operated apparatus; shutter releases [photography]; micrometers; microprocessors; microscopes; microtomes; microphones; audio mixers; modems; lightning conductors [rods]; monitors [computer hardware]; monitors [computer programs]; selfie sticks [hand-held monopods]; terminals [electricity]; junction sleeves for electric cables; teeth protectors; temperature indicator labels, not for medical purposes; knee-pads for workers; headphones; surveyors' levels; sound recording carriers; magnetic data media; optical data media; electronic sheet music, downloadable; computer software, recorded; sheaths for electric cables; identification sheaths for electric wires; weighing machines; computer hardware; punched card machines for offices; life saving apparatus and equipment; objectives [lenses] [optics]; lenses for astrophotography; egg-candlers; fire extinguishers; electrified fences; limiters [electricity]; clothing for protection against accidents, irradiation and fire; clothing for protection against fire; asbestos clothing for protection against fire; clothing especially made for laboratories; ozonisers [ozonators]; octants; eyepieces; ohmmeters; wrist rests for use with computers; eyeglass frames; oscillographs; plumb lines; mirrors [optics]; eyeglasses; sunglasses; goggles for sports; electronic collars to train animals; signalling panels, luminous or mechanical; radio pagers; pince-nez; electronic pocket translators; transmitters [telecommu-

nication]; telephone transmitters; transmitters of electronic signals; switches, electric; periscopes; gloves for divers; gloves for protection against accidents; gloves for protection against X-rays for industrial purposes; asbestos gloves for protection against accidents; furnaces for laboratory use; pipettes; pyrometers; planimeters; plane tables [surveying instruments]; plates for batteries; wafers for integrated circuits; printed circuit boards; compact disc players; cassette players; protective films adapted for computer screens; protective films adapted for smartphones; sound recording strips; X-ray films, exposed; films, exposed; life-saving rafts; laboratory trays; digital signs; semi-conductors; polarimeters; fire pumps; measuring glassware; life belts; fuses; circuit breakers; converters, electric; telerupters; food analysis apparatus; diagnostic apparatus, not for medical purposes; distance recording apparatus; distance measuring apparatus; speed measuring apparatus [photography]; appliances for measuring the thickness of leather; apparatus for measuring the thickness of skins; speed checking apparatus for vehicles; teaching apparatus; time recording apparatus; apparatus and instruments for astronomy; surveying apparatus and instruments; weighing apparatus and instruments; nautical apparatus and instruments; navigational instruments; optical apparatus and instruments; apparatus and instruments for physics; chemistry apparatus and instruments; measuring apparatus; measuring devices, electric; boiler control instruments; meteorological instruments; naval signalling apparatus; observation instruments; navigation apparatus for vehicles [on-board computers]; satellite navigational apparatus; regulating apparatus, electric; precision measuring apparatus; audio and video-receivers; prisms [optics]; computer software applications, downloadable; printers for use with computers; retorts' stands; apparatus for changing record player needles; drainers for use in photography; cleaning apparatus for sound recording discs; fire beaters; telescopic sights for firearms; telescopic sights for artillery; test tubes; pressure indicator plugs for valves; magnetic wires; telegraph wires; telephone wires; wires, electric; conductors, electric; copper wire, insulated; fuse wire; computer programmes [programs], recorded; computer game software; computer programs [downloadable software]; computer operating programs, recorded; record players; processors [central processing units]; rods for water diviners; electronic publications, downloadable; distribution consoles [electricity]; control panels [electricity]; radar apparatus; baby monitors; masts for wireless aerials; transmitting sets [telecommunication]; radios; vehicle radios; sprinkler systems for fire protection; frames for photographic transparencies; screens for photoengraving; flowmeters; walkie-talkies; voltage surge protectors; voltage regulators for vehicles; stage lighting regulators; light dimmers [regulators], electric; speed regulators

for record players; cell switches [electricity]; washing trays [photography]; marking gauges [joinery]; T-squares for measuring; time switches, automatic; relays, electric; safety restraints, other than for vehicle seats and sports equipment; X-ray photographs, other than for medical purposes; rheostats; respirators for filtering air; retorts; refractometers; refractors; grids for batteries; humanoid robots with artificial intelligence; speaking tubes; horns for loudspeakers; subwoofers; saccharometers; optical fibers [fibres] [light conducting filaments]; traffic-light apparatus [signalling devices]; dog whistles; signalling whistles; sextants; inductors [electricity]; safety nets; nets for protection against accidents; fire alarms; signals, luminous or mechanical; sirens; electronic access control systems for interlocking doors; scanners [data processing equipment]; integrated circuit cards [smart cards]; smartglasses; smartphones; smartwatches; connections for electric lines; couplings, electric; sonars; sound locating instruments; lighting ballasts; resistances, electric; spectrograph apparatus; spectrosopes; speed indicators; alcoholmeters; satellites for scientific purposes; protection devices for personal use against accidents; audiovisual teaching apparatus; charging stations for electric vehicles; radiotelegraphy sets; radiotelephony sets; spectacle lenses; anti-glare glasses; optical glass; personal stereos; stereoscopes; stands for photographic apparatus; stroboscopes; fire boats; sulfitemeters; bags adapted for laptops; drying racks [photography]; spherometers; integrated circuits; printed circuits; counters; parking meters; kilometer recorders for vehicles; revolution counters; abacuses; egg timers [sandglasses]; taximeters; ear plugs for divers; tachometers; television apparatus; telegraphs [apparatus]; telescopes; teleprompters; teleprinters; cellular phones; cordless telephones; theodolites; interactive touch screen terminals; thermo-hygrometers; thermometers, not for medical purposes; thermostats; thermostats for vehicles; crucibles [laboratory]; tone arms for record players; totalizers; transistors [electronic]; transponders; protractors [measuring instruments]; transformers [electricity]; step-up transformers; vehicle breakdown warning triangles; triodes; starter cables for motors; discharge tubes, electric, other than for lighting; capillary tubes; neon signs; Pitot tubes; X-ray tubes not for medical purposes; telephone receivers; squares for measuring; gauges; quantity indicators; automatic indicators of low pressure in vehicle tires [tyres]; gasoline gauges; water level indicators; electric loss indicators; light-emitting electronic pointers; slope indicators; levels [instruments for determining the horizontal]; mercury levels; spirit levels; urinometers; amplifiers; particle accelerators; electric installations for the remote control of industrial operations; steering apparatus, automatic, for vehicles; balancing apparatus; video recorders; sound reproduction apparatus; invoicing machines; tape recorders; protec-

tion devices against X-rays, not for medical purposes; railway traffic safety appliances; data processing apparatus; oxygen transvasing apparatus; theft prevention installations, electric; film cutting apparatus; drying apparatus for photographic prints; optical character readers; centering apparatus for photographic transparencies; dosage dispensers; battery chargers; chargers for electric batteries; chargers for electronic cigarettes; acoustic alarms; sounding apparatus and machines; editing appliances for cinematographic films; cathodic anti-corrosion apparatus; couplers [data processing equipment]; wearable activity trackers; anti-theft warning apparatus; computer peripheral devices; anti-interference devices [electricity]; demagnetizing apparatus for magnetic tapes; acoustic couplers; alarms; fog signals, non-explosive; whistle alarms; adding machines; readers [data processing equipment]; heat regulating apparatus; photocopiers [photographic, electrostatic, thermic]; electric and electronic effects units for musical instruments; bar code readers; downloadable ring tones for mobile phones; downloadable image files; downloadable music files; animated cartoons; filters [photography]; filters for respiratory masks; filters for ultraviolet rays, for photography; USB flash drives; magic lanterns; optical lamps; signal lanterns; cameras [photography]; glazing apparatus for photographic prints; shutters [photography]; darkrooms [photography]; photometers; flash-bulbs [photography]; digital photo frames; enlarging apparatus [photography]; photovoltaic cells; containers for contact lenses; eyeglass cases; containers for microscope slides; cases for smartphones; cases especially made for photographic apparatus and instruments; chromatography apparatus for laboratory use; chronographs [time recording apparatus]; laboratory centrifuges; eyeglass chains; cyclotrons; compasses for measuring; frequency meters; time clocks [time recording devices]; petri dishes; sleeves for laptops; covers for personal digital assistants [PDAs]; covers for tablet computers; covers for smartphones; fire blankets; chips [integrated circuits]; jigs [measuring instruments]; pedometers; meteorological balloons; electrified rails for mounting spot lights; asbestos screens for firemen; fire hose; virtual reality headsets; protective helmets for sports; head guards for sports; cell phone straps; eyeglass cords; tripods for cameras; switchboards; distribution boards [electricity]; equalizers [audio apparatus]; screens [photography]; workmen's protective face-shields; projection screens; radiology screens for industrial purposes; fluorescent screens; exposure meters [light meters]; ducts [electricity]; galvanic cells; epidiascopes; ergometers; armatures [electricity]; black boxes [data recorders].

12 – Motor buses; motor coaches; motor homes; driverless cars [autonomous cars]; motor racing cars; cars; sports cars; concrete mixing vehicles; refrigerated vehicles; caravans; shock absorbers for automo-

biles; suspension shock absorbers for vehicles; space vehicles; aircraft; aeronautical apparatus, machines and appliances; air cushion vehicles; hot air balloons; ski carriers for cars; luggage carriers for vehicles; bumpers for automobiles; vehicle bumpers; tires for vehicle wheels; barges; brake shoes for vehicles; tailboard lifts [parts of land vehicles]; armored vehicles; buffers for railway rolling stock; waggon; tilt trucks; carriages [railways]; sleeping cars; dining cars; refrigerated wagons [railroad vehicles]; transmission shafts for land vehicles; bicycles; electric bicycles; valves for vehicle tires [tyres]; helicopters [vehicles]; automobile hoods; stroller hoods; hoods for vehicles; oars; paddles for canoes; sculls; screws [propellers] for ships; hydroplanes; seaplanes; flanges for railway wheel tires [tyres]; trucks; horns for vehicles; treads for vehicles [tractor type]; doors for vehicles; bicycle motors; motorcycle engines; engines for land vehicles; jet engines for land vehicles; driving motors for land vehicles; screw-propellers; screw-propellers for boats; dirigible balloons [airships]; brake discs for vehicles; trolley railways [cable cars]; dredgers [boats]; trolleys; military drones; civilian drones; adhesive rubber patches for repairing inner tubes; bicycle bells; rearview mirrors; side view mirrors for vehicles; portholes; cars for cable transport installations; inner tubes for pneumatic tires [tyres]; inner tubes for bicycle tires; canoes; hoods for vehicle engines; crankcases for land vehicle components, other than for engines; boats; caissons [vehicles]; bicycle wheels; vehicle wheels; mine cart wheels; steering wheels for vehicles; casters for trolleys [vehicles] [carts (Am.)]; brake pads for automobiles; hub caps; strollers; side cars; prams; brake linings for vehicles; ships; baskets adapted for bicycles; gear boxes for land vehicles; ship hulls; panniers adapted for bicycles; panniers adapted for motorcycles; fenders for ships; bands for wheel hubs; ejector seats for aircraft; wheelchairs; caps for vehicle petrol [gas] tanks; boat hooks; automobile bodies; tipping bodies for lorries [trucks]; bodies for vehicles; treads for retreading tires [tyres]; locomotives; masts for boats; golf carts [vehicles]; sprinkling trucks; propulsion mechanisms for land vehicles; mopeds; motor scooters; motorcycles; tyre mousse inserts; fitted footmuffs for pushchairs; fitted footmuffs for prams; freewheels for land vehicles; clutches for land vehicles; repair outfits for inner tubes; air pumps [vehicle accessories]; pumps for bicycle tires; upholstery for vehicles; rims for bicycle wheels; rims for vehicle wheels; windows for vehicles; omnibuses; engine mounts for land vehicles; axles for vehicles; headlight wipers; parachutes; ferry boats; bicycle pedals; ashtrays for automobiles; gearing for land vehicles; carts; head-rests for vehicle seats; bicycle kickstands; vehicle running boards; air bags [safety devices for automobiles]; ski lifts; chairlifts; casings for pneumatic tires [tyres]; sleeping berths for vehicles; pontoons; torque converters for land

vehicles; cigar lighters for automobiles; non-skid devices for vehicle tires [tyres]; anti-glare devices for vehicles; anti-theft devices for vehicles; sunblinds adapted for automobiles; balance weights for vehicle wheels; shock absorbing springs for vehicles; bicycle frames; motorcycle frames; spars for ships; reduction gears for land vehicles; safety belts for vehicle seats; security harness for vehicle seats; vehicle suspension springs; rudders; bicycle handlebars; motorcycle handlebars; vehicle joysticks; bicycle cranks; aeroplanes; amphibious airplanes; sleighs [vehicles]; kick sledges; brake segments for vehicles; bicycle saddles; luggage nets for vehicles; dress guards for bicycles; fitted stroller mosquito nets; anti-theft alarms for vehicles; reversing alarms for vehicles; safety seats for children, for vehicles; vehicle seats; bellows for articulated buses; hydraulic circuits for vehicles; push scooters [vehicles]; mobility scooters; snowmobiles; rolling stock for railways; rolling stock for funicular railways; spokes for bicycle wheels; vehicle wheel spokes; spoilers for vehicles; air vehicles; vehicles for locomotion by land, air, water or rail; ambulances; autonomous underwater vehicles for seabed inspections; water vehicles; remotely operated vehicles for underwater inspections; remote control vehicles, other than toys; electric vehicles; tricycles; delivery tricycles; inclined ways for boats; windscreens; windshield wipers; hubs for bicycle wheels; hubs for vehicle wheels; bags adapted for pushchairs; saddlebags adapted for bicycles; railway couplings; trailer hitches for vehicles; couplings for land vehicles; wheelbarrows; handling carts; two-wheeled trolleys; shopping trolleys [carts (Am.)]; hose carts; bogies for railway cars; casting carriages; tilting-carts; forklift trucks; cleaning trolleys; bicycle brakes; brakes for vehicles; torsion bars for vehicles; tractors; tramcars; transmissions for land vehicles; military vehicles for transport; aerial conveyors; trailers [vehicles]; funnels for ships; funnels for locomotives; cleats [nautical]; turbines for land vehicles; direction indicators for bicycles; direction signals for vehicles; rowlocks; disengaging gear for boats; steering gears for ships; cable transport apparatus and installations; spoke clips for wheels; tipping apparatus, parts of trucks and waggons; funiculars; vans [vehicles]; automobile chains; bicycle chains; motorcycle chains; driving chains for land vehicles; anti-skid chains; transmission chains for land vehicles; structural parts for helicopters; structural parts for aircraft; undercarriages for vehicles; stroller covers; spare wheel covers; covers for vehicle steering wheels; saddle covers for bicycles; saddle covers for motorcycles; seat covers for vehicles; vehicle covers [shaped]; automobile chassis; vehicle chassis; connecting rods for land vehicles, other than parts of motors and engines; axle journals; gears for bicycles; tubeless tires for bicycles; bicycle tyres; automobile tires [tyres]; pneumatic tires; solid tires for vehicle wheels; spikes

for tires; davits for boats; launches; timbers [frames] for ships; mudguards; bicycle mudguards; motors, electric, for land vehicles; yachts.

16 – Fountain pens; aquarelles; albums; almanacs; document laminators for office use; mimeograph apparatus and machines; atlases; posters; banknotes; banners of paper; paper bows; table linen of paper; tickets; forms, printed; announcement cards [stationery]; note books; pads [stationery]; drawing pads; loose-leaf binders; wristbands for the retention of writing instruments; pamphlets; booklets; paper; paper sheets [stationery]; waxed paper; paper for recording machines; paper for radiograms; electrocardiograph paper; drawer liners of paper, perfumed or not; wood pulp paper; carbon paper; copying paper [stationery]; parchment paper; writing paper; rice paper; luminous paper; Xuan paper for Chinese painting and calligraphy; toilet paper; wrapping paper; filter paper; blotters; newsletters; rollers for typewriters; house painters' rollers; composing sticks; modelling wax, not for dental purposes; signboards of paper or cardboard; sewing patterns; bunting of paper; newspapers; electrotypes; hectographs; modelling clay; polymer modelling clay; terrestrial globes; drawing sets; engravings; slate pencils; pencil leads; document holders [stationery]; pencil holders; chalk holders; holders for check-books [cheque books]; holders for stamps [seals]; page holders; diagrams; table runners of paper; engraving plates; writing slates; blackboards; galley racks [printing]; drawing boards; advertisement boards of paper or cardboard; duplicators; punches [office requisites]; cream containers of paper; magazines [periodicals]; money clips; tags for index cards; pen clips; bookmarkers; etching needles; tracing needles for drawing purposes; periodicals; printed publications; paper shredders for office use; graphic representations; credit card imprinters, non-electric; graining combs; drawing instruments; calendars; tracing paper; tracing cloth; tracing patterns; gums [adhesives] for stationery or household purposes; lithographic stones; ink stones [ink reservoirs]; pencils; pencil lead holders; charcoal pencils; pictures; transfers [decalcomanias]; paintings [pictures], framed or unframed; cardboard; wood pulp board [stationery]; hat boxes of cardboard; files [office requisites]; cards; index cards [stationery]; geographical maps; paper tapes and cards for the recordal of computer programmes; trading cards, other than for games; perforated cards for Jacquard looms; catalogues; spools for inking ribbons; covers of paper for flower pots; paintbrushes; painters' brushes; writing brushes; typewriter keys; glue for stationery or household purposes; isinglass for stationery or household purposes; gluten [glue] for stationery or household purposes; starch paste [adhesive] for stationery or household purposes; printing blocks; books; manifolds [stationery]; comic books; drawing pins; cigar bands; envelopes [stationery]; boxes of paper or

cardboard; cases for stamps [seals]; paint boxes [articles for use in school]; correcting fluids [office requisites]; printed coupons; stencils [stationery]; French curves; paper ribbons; typewriter ribbons; gummed tape [stationery]; adhesive bands for stationery or household purposes; correcting tapes [office requisites]; inking ribbons; inking ribbons for computer printers; adhesive tapes for stationery or household purposes; self-adhesive tapes for stationery or household purposes; square rulers for drawing; drawing rulers; flyers; absorbent sheets of paper or plastic for foodstuff packaging; humidity control sheets of paper or plastic for foodstuff packaging; viscose sheets for wrapping; sheets of reclaimed cellulose for wrapping; plastic bubble packs for wrapping or packaging; steel letters; type [numerals and letters]; lithographs; paint trays; architects' models; postage stamps; plastics for modelling; graphic prints; modelling materials; teaching materials [except apparatus]; sealing compounds for stationery purposes; adhesives [glues] for stationery or household purposes; stuffing of paper or cardboard; bookbinding material; packing [cushioning, stuffing] materials of paper or cardboard; packaging material made of starches; filtering materials [paper]; addressing machines; pencil sharpening machines, electric or non-electric; bookbinding apparatus and machines [office equipment]; typewriters, electric or non-electric; franking machines for office use; chalk for lithography; writing chalk; tailors' chalk; marking chalk; spray chalk; bags [envelopes, pouches] of paper or plastics, for packaging; garbage bags of paper or of plastics; plastic bags for pet waste disposal; painters' easels; hand-rests for painters; printing sets, portable [office requisites]; bibs of paper; stickers [stationery]; finger-stalls [office requisites]; writing cases [stationery]; cords for bookbinding; paper knives [cutters] [office requisites]; printed sheet music; numbering apparatus; bottle envelopes of paper or cardboard; sealing wafers; passport holders; plastic cling film, extensible, for palletization; embroidery designs [patterns]; handwriting specimens for copying; oleographs; musical greeting cards; greeting cards; postcards; etchings; conical paper bags; bags for microwave cooking; palettes for painters; ink sticks; pantographs [drawing instruments]; folders for papers; papier mâché; pastels [crayons]; modelling paste; pen cases; pen wipers; office perforators; pens [office requisites]; nibs of gold; nibs; steel pens; drawing pens; song books; seals [stamps]; sealing stamps; clipboards; address plates for addressing machines; handkerchiefs of paper; plastic film for wrapping; desk mats; letter trays; trays for sorting and counting money; coasters of paper; bookends; stamp stands; mats for beer glasses; stands for pens and pencils; photograph stands; obliterating stamps; inking pads; stamp pads; binding strips [bookbinding]; towels of paper; inking sheets for document reproducing machines; inking sheets for

duplicators; bookbinding cloth; gummed cloth for stationery purposes; printers' blankets, not of textile; portraits; paperweights; writing cases [sets]; inkstands; office requisites, except furniture; writing materials; writing instruments; drawing materials; school supplies [stationery]; adhesive tape dispensers [office requisites]; hand labelling appliances; printed matter; lithographic works of art; prospectuses; printed timetables; ledgers [books]; printers' reglets; indexes; rubber erasers; elastic bands for offices; T-squares for drawing; graphic reproductions; penholders; marking pens [stationery]; tissues of paper for removing make-up; face towels of paper; place mats of paper; tablemats of paper; tablecloths of paper; paper clasps; document files [stationery]; scrapers [erasers] for offices; paper-clips; staples for offices; erasing products; biological samples for use in microscopy [teaching materials]; histological sections for teaching purposes; steatite [tailor's chalk]; writing board erasers; composing frames [printing]; sealing wax; arithmetical tables; placards of paper or cardboard; writing or drawing books; fabrics for bookbinding; stationery; pencil sharpeners, electric or non-electric; transparencies [stationery]; stencil plates; cardboard tubes; Indian inks; moisteners [office requisites]; moisteners for gummed surfaces [office requisites]; squares for drawing; chart pointers, non-electronic; bottle wrappers of paper or cardboard; envelope sealing machines for offices; sealing machines for offices; vignetting apparatus; apparatus for mounting photographs; stapling presses [office requisites]; manuals [handbooks]; figurines [statuettes] of papier mâché; paper coffee filters; flags of paper; silver paper; molds for modelling clays [artists' materials]; photo-engravings; photographs [printed]; stencil cases; canvas for painting; chromolithographs [chromos]; compasses for drawing; numbers [type]; artists' watercolor saucers; ink; correcting ink [heliography]; inkwells; blueprints; stencils; erasing shields; balls for ball-point pens; cabinets for stationery [office requisites]; printing type; address stamps; stamps [seals]; shields [paper seals]; prints [engravings]; labels of paper or cardboard; covers [stationery].

25 – Wimples; bandanas [neckerchiefs]; underwear; sweat-absorbent underwear; berets; overalls; boas [necklets]; teddies [underclothing]; boxer shorts; ankle boots; ski boots; boots for sports; breeches for wear; trousers; football boots; brassieres; valenki [felted boots]; collars [clothing]; detachable collars; shirt yokes; veils [clothing]; gabardines [clothing]; galoshes; neckties; ascots; leggings [leg warmers]; gaiters; boot uppers; corselets; jerseys [clothing]; vests; sports jerseys; hosiery; heels; hoods [clothing]; hat frames [skeletons]; pockets for clothing; neck scarfs [mufflers]; kimonos; visors [headwear]; cap peaks; tights; slips [underclothing]; combinations [clothing]; wet suits for water-skiing; bodices [lingerie]; corsets [underclothing]; suits; bathing

suits; masquerade costumes; beach clothes; leotards; jackets [clothing]; stuff jackets [clothing]; fishing vests; leggings [trousers]; liveries; camisoles; sports singlets; cuffs; short-sleeve shirts; mantillas; coats; sleep masks; furs [clothing]; mittens; miters [hats]; muffs [clothing]; footmuffs, not electrically heated; heelpieces for footwear; bibs, not of paper; fur stoles; hairdressing capes; ear muffs [clothing]; socks; sweat-absorbent socks; footwear; beach shoes; sports shoes; clothing; paper clothing; outerclothing; ready-made clothing; motorists' clothing; cyclists' clothing; clothing for gymnastics; clothing of imitations of leather; clothing of leather; waterproof clothing; uniforms; fittings of metal for footwear; maniples; overcoats; panties; parkas; pelerines; gloves [clothing]; ski gloves; pajamas; bathing trunks; shirt fronts; scarfs; pocket squares; dresses; headbands [clothing]; garters; sock suspenders; stocking suspenders; ready-made linings [parts of clothing]; dress shields; soles for footwear; braces for clothing [suspenders]; half-boots; lace boots; pullovers; ponchos; girdles; belts [clothing]; money belts [clothing]; layettes [clothing]; non-slipping devices for footwear; heelpieces for stockings; welts for footwear; chasubles; shirts; wooden shoes; sandals; bath sandals; boots; jumper dresses; saris; sarongs; footwear uppers; inner soles; albs; bath slippers; togas; knitwear [clothing]; underpants; shoes; gymnastic shoes; slippers; skull caps; turbans; headgear for wear; aprons [clothing]; judo uniforms; karate uniforms; tee-shirts; dressing gowns; bath robes; top hats; tips for footwear; stockings; sweat-absorbent stockings; shawls; caps [headwear]; paper hats [clothing]; shower caps; bathing caps; sashes for wear; studs for football boots; hats; babies' pants [underwear]; trouser straps; pelisses; esparto shoes or sandals; skirts; petticoats.

35 – Arranging subscriptions to telecommunication services for others; import-export agency services; commercial information agency services; advertising agency services; cost price analysis; rental of advertising space; business auditing; business intermediary services relating to the matching of potential private investors with entrepreneurs needing funding; employment agency services; computerized file management; book-keeping; invoicing; demonstration of goods; transcription of communications [office functions]; opinion polling; market studies; business information; business investigations; business research; marketing research; personnel recruitment; business management and organization consultancy; business organization consultancy; business management consultancy; personnel management consultancy; professional business consultancy; layout services for advertising purposes; marketing; business management of performing artists; business management of sports people; writing of résumés for others; scriptwriting for advertising purposes; news clipping services; updating and mainte-

nance of information in registries; updating and maintenance of data in computer databases; updating of advertising material; word processing; organization of exhibitions for commercial or advertising purposes; arranging newspaper subscriptions for others; organization of fashion shows for promotional purposes; organization of trade fairs for commercial or advertising purposes; shop window dressing; design of advertising materials; business appraisals; payroll preparation; data search in computer files for others; sponsorship search; business management assistance; commercial or industrial management assistance; commercial intermediation services; providing business information via a web site; provision of commercial and business contact information; provision of an on-line marketplace for buyers and sellers of goods and services; web indexing for commercial or advertising purposes; presentation of goods on communication media, for retail purposes; economic forecasting; auctioneering; retail or wholesale services for pharmaceutical, veterinary and sanitary preparations and medical supplies; sales promotion for others; production of teleshopping programmes; production of advertising films; office machines and equipment rental; rental of advertising time on communication media; publicity material rental; rental of billboards [advertising boards]; rental of vending machines; rental of sales stands; rental of photocopying machines; publication of publicity texts; radio advertising; distribution of samples; dissemination of advertising matter; direct mail advertising; registration of written communications and data; writing of publicity texts; advertising; publicity; on-line advertising on a computer network; billposting; advertising by mail order; television advertising; document reproduction; compilation of statistics; compilation of information into computer databases; business inquiries; systemization of information into computer databases; advisory services for business management; negotiation of business contracts for others; negotiation and conclusion of commercial transactions for third parties; compiling indexes of information for commercial or advertising purposes; tax preparation; drawing up of statements of accounts; telemarketing services; psychological testing for the selection of personnel; outsourced administrative management for companies; business management of hotels; business management for freelance service providers; business project management services for construction projects; commercial administration of the licensing of the goods and services of others; business management of reimbursement programs for others; administration of consumer loyalty programs; administration of frequent flyer programs; administrative processing of purchase orders; public relations; services of retail and wholesale outlets; retail and wholesale services via Internet web-sites; appointment reminder services [office functions]; web site traffic optimization; reloca-

tion services for businesses; tax filing services; search engine optimization for sales promotion; appointment scheduling services [office functions]; price comparison services; pay per click advertising; secretarial services; procurement services for others [purchasing goods and services for other businesses]; shorthand; outsourcing services [business assistance]; telephone answering for unavailable subscribers; photocopying services; business efficiency expert services.

36 – Credit bureau services; debt collection agency services; real estate agency services; financial analysis; rental of apartments; rental of real estate; rental of offices [real estate]; rental of offices for co-working; rental of farms; lease-purchase financing; savings bank services; accommodation bureau services [apartments]; rent collection; issuance of travelers' checks; issuance of credit cards; issuance of tokens of value; capital investment; insurance information; financial information; clearing, financial; insurance consultancy; financial consultancy; debt advisory services; stock exchange quotations; lending against security; business liquidation services, financial; brokerage; financial management; exchanging money; online banking; processing of debit card payments; processing of credit card payments; factoring; organization of collections; arranging finance for construction projects; antique appraisal; jewelry appraisal; financial evaluation of standing timber; stamp appraisal; real estate appraisal; numismatic appraisal; art appraisal; financial evaluation of wool; financial evaluation [insurance, banking, real estate]; repair costs evaluation [financial appraisal]; electronic funds transfer; surety services; securities brokerage; real estate brokerage; brokerage of carbon credits; insurance brokerage; providing rebates at participating establishments of others through use of a membership card; loans [financing]; pawnbrokerage; providing financial information via a web site; check verification; investment of funds; charitable fund raising; stocks and bonds brokerage; financial sponsorship; mortgage banking; instalment loans; insurance underwriting; life insurance underwriting; health insurance underwriting; accident insurance underwriting; marine insurance underwriting; fire insurance underwriting; apartment house management; real estate management; financial management of reimbursement payments for others; actuarial services; banking; stock brokerage services; retirement payment services; bail-bonding; trusteeship; provident fund services; financial customs brokerage services; mutual funds; financing services; safe deposit services; deposits of valuables; fiscal valuation.

39 – Air transport; motor coach rental; boat rental; garage rental; rental of vehicle roof racks; aircraft rental; parking place rental; rental of warehouses; rental of tractors; booking of seats for travel; trans-

port reservation; towing; vehicle breakdown towing services; bottling services; water distribution; delivery of newspapers; message delivery; parcel delivery; delivery of goods; delivery of goods by mail order; flower delivery; launching of satellites for others; traffic information; transportation information; storage information; transportation logistics; rescue operations [transport]; arranging of cruises; arranging of travel tours; armored-car transport; hauling; carting; transport and storage of trash; transporting furniture; lighterage services; ferry-boat transport; removal services; transport of travellers; guarded transport of valuables; bus transport; car transport; barge transport; boat transport; railway transport; marine transport; passenger transport; river transport; ambulance transport; streetcar transport; portage; refloating of ships; cash replenishment of automated teller machines; shipbrokerage; transport brokerage; freight brokerage [forwarding (Am.)]; providing driving directions for travel purposes; car rental; railway truck rental; rental of diving bells; rental of diving suits; rental of motor racing cars; rental of aircraft engines; railway coach rental; rental of wheelchairs; rental of storage containers; horse rental; rental of freezers; rental of navigational systems; refrigerator rental; vehicle rental; rental of electric wine cellars; stevedoring; unloading cargo; electricity distribution; distribution of energy; packaging of goods; collection of recyclable goods [transport]; ice-breaking; piloting; water supplying; escorting of travellers; transport by pipeline; wrapping of goods; operating canal locks; car parking; chauffeur services; pleasure boat transport; car sharing services; courier services [messages or merchandise]; salvaging; salvage of ships; gift wrapping; underwater salvage; taxi transport; transport; transport services for sightseeing tours; franking of mail; freight [shipping of goods]; freighting; physical storage of electronically stored data or documents; boat storage; storage of goods; storage; freight forwarding.

(260) AM 2019 100733 A

(800) 1438154

(151) 2018 08 20

(891) 2018 08 20

(731) GREENS DESSERTS UK LTD

Thurcroft Industrial Estate, Thurcroft,
Rotherham, United Kingdom, S66 9ER,
United Kingdom

(540)

(591) Red and blue

(531) 27.05.03; 29.01.13

(511)

29 – Albumen for culinary purposes; gelatine; edible fats; peanut butter; butter; cocoa butter for food; coconut butter; buttercream; white of eggs; fruit, preserved; coconut, desiccated; rape oil for food; jams; frozen fruits; raisins; oils for food; cream [dairy products]; crystallized fruits; dates; milk; fruit, stewed; fruit jellies; fruit pulp; jellies for food; ginger jam; corn oil for food; palm kernel oil for food; sesame oil for food; yolk of eggs; yogurt; vegetable juices for cooking; whey; milk products; margarine; marmalade; palm oil for food; nuts, prepared; powdered eggs; olive oil for food; pectin for culinary purposes; fruit salads; sunflower oil for food; fruit peel; alginates for culinary purposes; almonds, ground; peanuts, prepared; coconut fat; coconut oil for food; fruit chips; fruit preserved in alcohol; pollen prepared as foodstuff; whipped cream; fruits, tinned; apple purée; cranberry compote; fruit-based snack food; soya milk; protein milk; linseed oil for food; lecithin for culinary purposes; milk ferments for culinary purposes; compotes; condensed milk; smetana [sour cream]; peanut milk for culinary purposes; almond milk for culinary purposes; rice milk; arrangements of processed fruit; powdered milk; candied nuts; flavored nuts; hazelnuts, prepared; berries, preserved; lemon juice for culinary purposes; oat milk; vegetable-based cream; extra virgin olive oil for food; nut-based spreads; soya bean oil for food; milk substitutes; almond milk; peanut milk; coconut milk; coconut milk for culinary purposes; coconut milk-based beverages; rice milk for culinary purposes; almond milk-based beverages; peanut milk-based beverages; cottage cheese fritters; pressed fruit paste.

30 – Almond paste; confectionery for decorating Christmas trees; coffee flavorings; aromatic preparations for food; cookies; malt biscuits; sweetmeats [candy]; waffles; buns; cocoa; coffee; cakes; caramels [candy]; chocolate; marzipan; sugar confectionery; preparations for stiffening whipped cream; ice cream; pancakes; essences for foodstuffs, except etheric essences and essential oils; thickening agents for cooking foodstuffs; natural sweeteners; gingerbread; flour; bean meal; corn flour; barley meal; soya flour; wheat flour; ferments for pastes; fondants [confectionery]; petits fours [cakes]; sugar; flavorings [flavourings], other than essential oils, for cakes; cake powder; cake dough; ginger [spice]; binding agents for ice cream; glucose for culinary purposes; gluten prepared as foodstuff; leaven; yeast; macaroons [pastry]; maltose; molasses for food; golden syrup; mint for confectionery; honey; nutmegs; pies; pastilles [confectionery]; pastries; petit-beurre biscuits; bread rolls; puddings; pralines; sherbets [ices]; tapioca flour; tarts; vanilla flavourings for culinary purposes; vanillin [vanilla substitute]; powders for making ice cream; almond confectionery; peanut confectionery; food flavorings, other than

essential oils; stick liquorice [confectionery]; cocoa-based beverages; chocolate-based beverages; royal jelly; crackers; custard; fruit jellies [confectionery]; frozen yogurt [confectionery ices]; halvah; quiches; baking powder; baking soda [bicarbonate of soda for cooking purposes]; cake frosting [icing]; chocolate mousses; dessert mousses [confectionery]; fruit coulis [sauces]; high-protein cereal bars; gluten additives for culinary purposes; cereal bars; palm sugar; dough; pastry dough; chocolate decorations for cakes; candy decorations for cakes; chocolate-coated nuts; rice pudding; nut flours; rice pulp for culinary purposes; batter mixes for okonomiyaki [Japanese savoury pancakes]; chocolate-based spreads; chocolate spreads containing nuts; agave syrup [natural sweetener]; mirror icing [mirror glaze]; dulce de leche; sesame seeds [seasonings]; buckwheat flour; cranberry sauce [condiment]; apple sauce [condiment]; zephyr [confectionery]; pastila [confectionery].

(260) AM 2019 100739 A

(800) 1438259

(151) 2018 10 04

(891) 2018 10 04

(731) Joint-Stock Company "ARTISTIC PAINTS PLANT "NEVSKAYA PALITRA"
Serdobolskaya ulitsa, 68, liter F, pomeshenie
17, RU-197342 Saint-Petersburg, Russian
Federation

(540)

МАСТЕР-КЛАСС

(591) Black, white

(531) 28.05

(511)

2 – Binding preparations for paints; coatings [paints]; colorants; dyes; enamels [varnishes]; engraving ink; fixatives [varnishes]; fixatives for watercolors; food dyes; glazes [paints, lacquers]; gum resins; lacquers; mastic [natural resin]; metals in foil and powder form for use in painting, decorating, printing and art; mordants; paints; paper for dyeing Easter eggs; pigments; preservatives against rust and against deterioration of wood; primers; printing ink; thinners for lacquers; titanium white; varnishes; watercolors [paints]; white lead.

4 – Oils for paints.

16 – Artists' and drawing materials; canvas for painting; drawing materials; hand-rests for painters; modelling clay; modelling materials; modelling paste; modelling wax, not for dental purposes; paint boxes [articles for use in school]; paintbrushes; painters' brushes; painters' easels; palettes for painters; pastels [crayons]; pencils; school supplies [stationery].

35 – Demonstration of goods.

(260) AM 2019 100743 A

(800) 1438364

(151) 2018 10 08

(891) 2018 10 08

(731) Limited Liability Company "ORIMI"
1-st Microrayon Street, 15/4 plot, Vsevolozhsk
district, Sverdlov factory settlement,
RU-188682 Leningrad oblast, Russian
Federation

(540)

JOCKEY

(591) Black, white

(531) 27.05.17

(511)

30 – Coffee; unroasted coffee; artificial coffee; coffee-based beverages; coffee beverages with milk.

(260) AM 2019 100744 A

(800) 1438370

(151) 2018 01 23

(891) 2018 01 23

(731) LENZING AKTIENGESSELLSCHAFT
Werkstr. 2, A-4860 Lenzing, Austria

(540)



(591) Green and black

(531) 05.03.13; 05.03.14; 26.13.25; 27.05.01;
29.01.12

(511)

16 – Crepe paper; filtering materials of paper; filter paper; paper filters for coffee makers; printed packaging materials of paper; containers of paper for packaging purposes; bags made of paper for packaging; decorative paper bows for wrapping; decorative wrapping paper; humidity control sheets of paper or plastic for foodstuff packaging; sheets of reclaimed cellulose for wrapping; paper gift tags; gift wrap paper; cardboard packaging; plastic film for packaging; paper impregnated with oil for wrapping purposes; cartons of cardboard for packaging; plastic materials for packaging; paper for wrapping and packaging; paper sacks; bags made of paper for packaging; absorbent sheets of paper or plastic for foodstuff packaging; bows for decorating packaging; bags made of paper for packaging; bags and articles for packaging, wrapping and storage of paper, cardboard or plastics; industrial packaging containers of paper; containers of card for packaging; packaging containers of regenerated cellulose; bags [envelopes, pouches] of paper or plastics, for packaging; films for wrapping foodstuffs; packing cardboard; cartons of cardboard for packaging; fiberboard boxes; plastic materials for packaging (not included)

in other classes); wrapping materials made of paper; packaging materials made of cardboard; packaging materials made of recycled paper; packaging material made of starches; packaging materials; wrapping paper; cartons of cardboard for packaging; cartons of cardboard for packaging; bags made of paper for packaging; viscose sheets for wrapping; paper identification tags; writing tablets; notebooks; labels of paper; pencil boxes; cases for stationery; ball pens; small blackboards; adhesive packaging tapes; printed matter; stickers [stationery]; stickers [decalcomanias]; printed advertising boards of paper; printed advertising boards of cardboard; pamphlets; flags of paper; printed brochures; printed calendars; printed publications; printed promotional material; adhesive wall decorations of paper; annuals [printed publications]; calendars; note-pads; paper banners; posters; postcards; prospectuses; christmas cards; promotional publications; promotional publications; signboards of paper or cardboard; advertisement boards of card; advertisement boards of card; book covers; crepe paper for domestic use; paper for use in the manufacture of wallpaper; tissue paper for use as material of stencil paper (ganpishi); paper for use in the manufacture of tea bags; tissues of paper for removing make-up; coarse tissue [for toiletry use]; filters (paper coffee -); paper wipes; facial tissues of paper; paper tissues; tissue paper; hygienic paper; paper tissues for cosmetic use; cellulose wipes; disposable pads for house-training pets; disposable housebreaking pads for use in training puppies.

20 – Beds, bedding, mattresses, pillows and cushions; replacement seat covers [fitted] for furniture; bedding for cots [other than bed linen]; bedding for cots [other than bed linen]; textile covers [shaped] for furniture; bath pillows; children's beds made of cloth in the form of a bag; mattresses; bedding, except linen; futon mattresses [other than childbirth mattresses]; stuffed pillows; pet cushions; pillows; inflatable pillows; mattresses; mattresses [other than child birth mattresses]; mattress toppers; maternity pillows; neck-supporting pillows; scented pillows; soft furnishings [cushions]; nap mats [cushions or mattresses]; sleeping mats for camping [mattresses]; nursing pillows; support pillows for use in baby car safety seats; support pillows for use in baby seating; head supporting pillows; animal housing and beds; beds for pets; pet houses; advertising display boards; advertisement display boards of plastic [non-luminous].

22 – Raw textile fibers and substitutes; liber; raw cotton; treated wool; chemical fibers for textile use; fibres being partly prepared synthetic materials for textile use; fibres being raw synthetic materials for textile use; silk flock; yarn fibers; twisted cords [sash]; raw fibrous textile; scoured wool; semi-synthetic fibers [for textile use]; true hemp fiber [raw]; rabbit hair; jute; jute fiber [raw]; combed wool; kas-

hmair hair; linters; raw fibrous textile materials treated with flame retardants; mohair; natural fibers; polyester stuffing fibers; polyester filament; polyester plastic netting for packaging goods; vitreous silica fibers for textile use; raffia fibers; ramie fibre; raw textile fibers; raw fibres of carbon for textile use; raw fibres of plastics for textile use; linen (raw -) [flax]; raw silk; raw wool; silk waste; shorn wool; silk fibers; silk polyester monofilaments; carded wool; synthetic fibers for textile use; synthetic fibers for textile use; synthetic textile filaments; textile filaments; textile fibers; non-woven textile fibres; fibres for making up into carpets; fibres for making up into carpet tiles; viscose silica fibres; raw or treated wool; wool flock; bags and sacks for packaging, storage and transport; liners for use in bulk containers; nets; plant hangers of rope; slings and bands, not of metal, for loading, wrapping and binding; strips for tying-up vines; wrapping or binding bands, not of metal; hammocks; storage bags for holding a body prior to cremation; mesh bags for washing lingerie; mesh bags for storage; packaging bags [sacks] of textile for bulk transportation; packaging bags [sacks] of textile for bulk storage; sacks; sacks made of textile materials; sacks for transporting waste; sacks for the transport of materials; sacks for the storage of materials in bulk; sacks and bags of textile for packaging (not included in other classes); sacks for the storage of materials; sacks for the transport and storage of materials in bulk; non-textile bags for the transportation of materials in bulk; non-textile bags for the bulk storage of animal foodstuffs; non-textile bags for the bulk storage of materials; shoe bags for storage; sail bags; textile wine gift bags; protection pouches made of fabric for storing purses when not in use; bags [envelopes, pouches] of textile, for packaging; bags [envelopes, pouches] of textile, for packaging; bags [envelopes, pouches] of textile, for packaging; packaging nets for transporting fruits and vegetables; bags [envelopes, pouches] of textile, for packaging; textile bags for merchandise packaging [envelopes, pouches]; tarpaulins, awnings, tents, and unfitted coverings; tents for use in angling; tents for camping; vehicle covers, not fitted; unfitted covers for boats and marine vehicles; tarpaulins; tents; tents [awnings] for vehicles; tents [awnings] for caravans; tents made of textile materials; tents for mountaineering or camping; sails; material for making sails; ropes and strings; binding thread, not of metal, for agricultural purposes; thread, not of metal, for wrapping or binding; strings; twine made of polypropylene; twine made of sisal; non-metallic twines; strings for tying purposes; packaging string; macrame rope; cordage; ropes and synthetic ropes; rope for use in toys for pets; synthetic ropes; cordage; ropes, not of metal; baling twine; packing rope; elastic netting for meat products; hemp nettings; netting [not of metal or asbestos]; nets for windbreak purposes; chemical fiber nettings;

rockfall prevention nets of textile; commercial fishing nets; commercial nets; nets for use with floating structures; twine for nets; net pens for fish farming; nets for shading; silk netting; fitted nets; padding and stuffing materials; down feathers; feathers for stuffing upholstery; wadding for filtering; fillings of synthetic fibres; fillings for upholstered pillows; materials for padding; fillings of synthetic foam; fillings for duvets; fillings for pillows; fillings for quilts; wood shavings; kapok; loose feathers; padding materials, not of paper, cardboard, rubber or plastics; materials for padding; padding materials, other than of rubber or plastic for pillows; padding materials, other than of rubber or plastic for sleeping bags; padding materials made of fibrous material; padding materials made of fibrous material; padding made of non woven fabrics; padding materials, other than of rubber or plastic for beds; polyester batting; sawdust; sisal; sisal fibers; industrial packaging containers of textile; fleece for the upholstery industry; wadding for padding and stuffing upholstery; wadding fibres; wool (upholstery -) [stuffing]; dust sheets; spun polyester fibre for textile use.

23 – Yarns and threads; angora yarn; spools of thread; spools of yarn; spun cotton; cotton yarn; chenille yarn; chenille yarn; douppioni silk yarn; elastic thread; elastic thread and yarn for textile use; elastic thread and yarn of synthetic fibres for textile use; threads made of spun cotton; thread for textile use; textile filaments [threads]; flocked fibers; yarn; yarns made of angora for textile use; waste cotton yarn; polyester pre-oriented yarns; yarns made of carbon fibres for textile use; yarn of synthetic or mixed fibres for use in textiles; wild silk yarn; knitting yarns; yarns for domestic use; yarns for textile applications; inorganic fiber base mixed thread and yarn; cotton base mixed thread and yarn; chemical fiber base mixed thread and yarn; chemical-fiber threads and yarns for textile use; degreased waste threads and yarns; hemp base mixed thread and yarn; regenerated fiber thread and yarn [for textile use]; silk base mixed thread and yarn; synthetic fiber thread and yarn; wool base mixed thread and yarn; yarns and threads for textile use; yarns for sale in kit form; twisted cotton thread and yarn; twisted threads and yarns; twisted hemp thread and yarn; twisted silk thread and yarn; twisted wool thread and yarn; yarns (combed -) made of natural fibres; twisted mixed thread and yarn; worsted yarn; spun silk yarn; semi-synthetic fiber thread and yarn [chemically treated natural fiber yarn]; hand knitting wools; true hemp thread and yarn; heat-stable yarns and threads; jute thread and yarn; camel hair yarn; combed yarn; carded threads in flax for textile use; carded yarns of hemp for textile use; carded threads in natural fibres for textile use; yarns (carded -) made of wool; carded threads in wool for textile use; cashmere yarns; ceramic fibre yarns for textile use; coir thread and yarn; rayon thread and yarn; linen thread and yarn;

metal fiber thread for textile use; sewing thread for textile use; sewing thread and yarn; natural yarns; non-metallic yarns for textile use; silica threads; ramie thread and yarn; raw silk yarn; spun silk; silk yarn; embroidery thread and yarn; knitting yarns; knitting yarns made of acrylic materials; knitting yarns made of nylon; knitting yarns made of wool; polyester textured yarns; yarns made of synthetic material for textile use; synthetic threads; carpet yarns; textile yarns; textile yarns made of man-made fibres; textile yarns made of natural fibres; covered rubber thread and yarn [for textile use]; mixed spun threads and yarns; waxed thread; waxed yarn; weaving fibres for industrial use; spun thread and yarn; worsted; wool yarn; yarns for use in tyre cord construction.

24 – Flocked fabrics; fabrics being textile piece goods for use in tapestry; tick [linen]; knitted elastic fabrics for ladies underwear; knitted elastic fabrics for bodices; knitted elastic fabrics for sportswear; knitted elastic fabrics for gymnastic dresses; fibre fabrics for use in the manufacture of articles of clothing; fibre fabrics for the manufacture of the exterior coverings of furniture; fibre fabrics for use in the manufacture of linings of shoes; fibre fabrics for use in the manufacture of linings of bags; flame resistant fabrics; felt; felt for use by papermakers; felt cloth; flame retardant fabrics [other than asbestos]; flannel [fabric]; towelling [textile]; linings [textile]; inlay materials of non-woven fabrics; chemical fiber fabrics; fabrics for textile use; knit lace fabrics; knitted fabric; gummed waterproof cloth; towelling [textile]; linens; jersey [fabric]; jersey [fabric]; fabrics of carbon fibre, other than for insulation; fabrics [textile piece goods] made of carbon fibre; fabrics made from artificial fibres [other than for insulation]; upholstery fabrics; furnishing fabrics; upholstery fabrics; furnishing fabrics in the piece; furnishing fabrics in the piece; woven furnishing fabrics; non-woven felts; silk fabrics for furniture; semi-synthetic fiber fabrics; fabrics of chemically produced fibres, other than for insulation; fabrics of organic fibres, other than for insulation; regenerated fiber yarn fabrics; fabrics made from artificial fibres [other than for insulation]; fabrics for use in making jerseys; knitted fabric; knitted fabrics of cotton yarn; knitted fabrics of chemical-fiber yarn; knitted fabrics of wool yarn; fabrics made of mixed synthetic and natural fibres, other than for insulation; textile fabrics for use in the manufacture of beds; textile fabrics for making into linens; textile fabrics for use in the manufacture of bedding; textile fabrics for making into blankets; textile fabrics for use in the manufacture of furniture; textile fabrics for use in the manufacture of sheets; textile fabrics for use in the manufacture of towels; textile fabrics for use in the manufacture of pillowcases; textile piece goods for making bedding covers; textile piece goods for making-up into towels; cloth; tissues being textile piece goods; velo-

urs for furniture; non-woven fabrics; non-woven textile fabrics; non-woven textile fabrics; non-woven textile fabrics for use as interlinings; non-woven fabrics of natural fibres; non-woven fabrics of synthetic fibres; non-woven fabrics in the form of sheeting for use in manufacture; woven fabrics for furniture; textile goods, and substitutes for textile goods; night-dress cases of textile; printers' blankets of textile; disposable cloths; linen lining fabric for shoes; wall fabrics; household textile articles made from non-woven materials; nightdress cases of textile; ticks [mattress covers]; coverings for furniture; mosquito nets; non-woven textile articles; textile tissues; textiles made of flannel; non-woven textile articles; interlinings made of non-woven fabrics; coverings for furniture; furniture coverings (unfitted); loose covers made of textile materials for furniture; furniture coverings of textile; loose covers made of textile materials for furniture; draperies [thick drop curtains]; curtains; markers [labels] of cloth for textile fabrics; wall hangings of textile; bed linen; bed linen; towelling [textile]; towels of textile; kitchen and table linens; towels of textile; hand towels of textile; bed linen and table linen; tea cloths; dish towels for drying; towelling [textile]; hand towels of textile; place mats, not of paper; textile smallwares [table linen]; table covers; tablecloths not made of paper; tablemats of textile; table covers of non-woven textile fabrics; textile napkins; table linen, not of paper; nappery of textile; table linen; washing gloves; receiving blankets; bed pads; duvet covers; comforters; bed blankets made of cotton; bed blankets made of man-made fibres; bed covers of paper; silk bed blankets; woolen blankets; duvet covers; bed sheets; bed skirts; bed throws; fabric bed valances; bed linen made of non-woven textile material; infants' bed linen; covers for eiderdown and duvets; comforters; blankets for household pets; quilts; blankets for outdoor use; disposable bedding of textile; eiderdowns [down coverlets]; terry linen; futon quilts; sleeping bags [sheeting]; impregnated bed linen; cot blankets; cot sheets; children's blankets; shams; lap rugs; contoured mattress covers; pillowcases; ticks (mattress and pillow coverings); mattress covers; mattress covers; quilts filled with down; duvets; travelling rugs [lap robes]; sleeping bag liners; silk blankets; contour sheets; quilt bedding mats; quilts made of terry cloth; quilts of textile; quilts filled with feathers; quilts filled with half down; quilts filled with stuffing materials; quilts filled with synthetic stuffing materials; quilts; quilt covers; textile covers for duvets; textile goods for use as bedding; bed sheets; bed throws; valanced bed sheets; bed skirts; woolen blankets; bath linen; bath sheets; bath towels; bath linen, except clothing; disposable wash cloths; towelling coverlets; face cloths of towelling; turkish towel; turkish towel; bath sheets; bath sheets; towelling [textile] adapted for use in dispensers; hand towels; children's towels; household linen, including

face towels; make-up removal cloths [textile], other than impregnated with cosmetics; make-up removal cloths [textile], other than impregnated with toilet preparations; cloths of woven textile material for washing the body (other than for medical use); cloths of non-woven textile material for washing the body [other than for medical use]; bath mitts; mitts made of non-woven fabric for washing the body; wash cloths; cloths for washing the body [other than for medical use]; filtering materials of textile.

25 – Headgear; swimming caps; bandanas [neckerchiefs]; baseball caps; berets; bobble hats; millinery; shower caps; fascinator hats; fedoras; fezzes; bucket caps; golf caps; hats (headgear); bonnets [headwear]; tams; hats; frames (hat -) [skeletons]; skull caps; waterpolo caps; hoods [clothing]; small hats; knot caps; chefs' hats; sports headgear [other than helmets]; children's headwear; head scarves; head scarves; head scarves; yashmaghs; miters [hats]; fashion hats; caps [headwear]; cap peaks; sun visors [headwear]; nightcaps; hats (paper -) [clothing]; paper hats for wear by chefs; paper hats for wear by nurses; party hats [clothing]; fur muffs; fur hats; head scarves; rain hats; knitted caps; flat caps; garrison caps; sedge hats (suge-gasa); sleep masks; veils [clothing]; wimples; tam o'shanters; tennis sweatbands; ski hats; sun hats; sports caps and hats; sports caps; headbands [clothing]; head sweatbands; beach hats; knitted caps; balaclavas; thermal headgear; toques [hats]; head scarves; woolly hats; top hats; clothing; evening wear; evening coats; detachable neckpieces for kimonos (haneri); detachable collars; underarm gussets [parts of clothing]; aikido suits; albs; american football bibs; parkas; suits; evening suits; women's suits; bowties; dress pants; jumper suits; work shirts; work clothes; coveralls; work aprons; sleeveless jerseys; mantles; arm warmers [clothing]; gowns for doctors; warm-up pants; clothing made of fur; driving gloves; layettes [clothing]; layettes [clothing]; baby bodysuits; baby doll pyjamas; babies' pants [clothing]; plastic baby bibs; baby tops; sleepwear for babies (clothing); babies' pants [clothing]; baby bottoms; layettes [clothing]; pram suits; swimming costumes; bathing costumes for women; bathing suits for men; fitted swimming costumes with bra cups; swim wear for gentlemen and ladies; bathing drawers; swimming costumes; swimming costumes; bathrobes; swim shorts; swimming trunks; bathwraps; robes; ballet suits; ball gowns; bandeaux [clothing]; baseball uniforms; baselayer bottoms; baselayer tops; crop tops; printed t-shirts; leg warmers; cashmere clothing; clothing of imitations of leather; woolen clothing; motorists' clothing; baby clothes; bridesmaids wear; figure skating clothing; christening robes; clothing for wear in judo practices; children's wear; infant wear; girls' clothing; motorcyclists' clothing of leather; leather clothing; linen clothing; paper clothing; plush clothing; silk clothing; clothing for martial arts; clothing for horse-riding

[other than riding hats]; articles of clothing for theatrical use; clothing for fishermen; boys' clothing; clothing for wear in wrestling games; maternity clothing; lounge pants; bermuda shorts; bed jackets; bed socks; maillots; blazers; blousons; boas [necklets]; leotards; body stockings; teddies [underclothing]; boleros; bolo ties; bomber jackets; boxer shorts; wedding dresses; burnouses; brassieres; bustiers; pea coats; capes; pedal pushers; car coats; cargo pants; chaps (clothing); chasubles; chemisettes; cheongsams (chinese gowns); albs; choir robes; evening wear; corduroy trousers; coverups; ladies' clothing; lingerie; gowns; women's outerclothing; knickers; ladies' underwear; ladies' underwear; down jackets; down vests; denim jeans; ladies' underwear; topcoats; donkey jackets; three piece suits [clothing]; duffel coats; pocket squares; one-piece suits; jumper suits; one-piece playsuits; disposable underwear; skating outfits; athletic tights; woollen tights; pleated skirts for formal kimonos (hakama); masquerade costumes; women's ceremonial dresses; moisture-wicking sports bras; moisture-wicking sports shirts; moisture-wicking sports pants; fishing shirts; fishing vests; fleeces; fleece vests; bowties; flying suits; formal evening wear; formalwear; foulards [clothing articles]; morning coats; leisure suits; casual shirts; slacks; casualwear; tap pants; barber smocks; robes; replica football kits; football jerseys; soccer bibs; footmuffs, not electrically heated; gabardines [clothing]; goloshes; gaiters; morning coats; padded pants for athletic use; padded shirts for athletic use; padded shorts for athletic use; knitwear [clothing]; knitted gloves; knit jackets; knitted underwear; guernseys; woven clothing; woven shirts; gilets; polo shirts; golf trousers; golf pants, shirts and skirts; golf skirts; unitards; clothing for gymnastics; ankle socks; halloween costumes; neckbands; neckwear; scarves; neck tubes; wrist warmers; gloves [clothing]; gloves for wetsuits; gloves for cyclists; gloves with conductive fingertips that may be worn while using handheld electronic touch screen devices; gloves including those made of skin, hide or fur; hand-warmers [clothing]; loungewear; aloha shirts; button-front aloha shirts; shirt yokes; shirts; shirts for suits; collared shirts; open-necked shirts; button down shirts; nighties; slippers [underclothing]; shirt-jacks; shirt fronts; men's suits; menswear; outerclothing for men; men's socks; men's underwear; waistcoats; wedding dresses; lumberjackets; hooded pullovers; slippers (undergarments); trousers; trousers of leather; trousers for children; trousers for children; nurse pants; sweatpants; snowboard trousers; pantsuits; culotte skirts; knee-high stockings; suspenders; suspenders (braces); suspender belts for men; girdles; girdles; jackets [clothing]; jackets being sports clothing; polar fleece jackets; fishermen's jackets; sleeved jackets; sleeveless jackets; snowboard jackets; rainproof jackets; men's and women's jackets, coats, trousers, vests; jacket liners; hunting pants;

hunting jackets; hunting vests; hunting shirts; kimonos; denims [clothing]; denim jeans; denim jackets; jumpers; jodhpurs; shell suits; jogging sets [clothing]; sweatpants; jogging tops; sweatpants; heavy jackets; stuff jackets [clothing]; judo uniforms; caftans; bodices [lingerie]; martial arts uniforms; combative sports uniforms; hooded sweaters; karate uniforms; cashmere scarves; kendo outfits; khakis; kilts; kimonos; gowns; pinafores; gowns; nurse dresses; linings (ready-made -) [parts of clothing]; pockets for clothing; leisurewear; bloomers; walking breeches; trouser socks; knee warmers [clothing]; short sets [clothing]; ready-to-wear clothing; basic upper garment of korean traditional clothes [jeogori]; korean traditional women's waistcoats [baeja]; korean topcoats [durumagi]; body warmers; corselets; camisoles; corsets; corsets; corsets; costumes; skirt suits; costumes for use in children's dress up play; costumes for use in role-playing games; shoulder wraps; detachable collars; collars for dresses; neckties; ascots; crinolines; cummerbunds; short-sleeved or long-sleeved t-shirts; short-sleeve shirts; short-sleeve shirts; short trousers; sweatpants; short petticoats; short overcoat for kimono (haori); cowls [clothing]; laboratory coats; long sleeve pullovers; long sleeved vests; long jackets; japanese sleeping robes (nemaki); full-length kimonos (nagagi); long johns; bibs, not of paper; bib overalls for hunting; running suits; running vests; leather suits; leather clothing; leather jackets; leather jackets; casual trousers; leggings [trousers]; underwear; sweat-absorbent underwear; underclothing for women; light-reflecting jackets; lingerie; liveries; bathing suit cover-ups; outerclothing for girls; maniples; athletic uniforms; cuffs; coats; pelisses; cotton coats; coats of denim; coats for women; coats for men; mantillas; sleep masks; eye masks; sailor suits; corselets; foundation garments; miniskirts; monokinis; robes; lounging robes; motorcycle riding suits; motorcycle gloves; motorcycle jackets; muffs [clothing]; muumuus; nighties; nighties; nighties; nightwear; wet suits; negligees; pop socks; women's outerclothing; outerclothing; dress shirts; uppers of woven rattan for japanese style sandals; chemise tops; cycling tops; hooded tops; halter tops; earbands; ear muffs [clothing]; combinations [clothing]; coveralls; coveralls; nurse overalls; overshirts; beach wraps; parkas; pelerines; furs [clothing]; pelisses; fur coats and jackets; fur cloaks; petticoats; petti-pants; polo shirts; pirate pants; plastic aprons; pantaloons; polo shirts; polo knit tops; turtleneck sweaters; polo sweaters; ponchos; sweaters; crew neck sweaters; mock turtleneck sweaters; v-neck sweaters; slipovers [clothing]; bloomers; pyjamas; pajama bottoms; cyclists' clothing; cycling shorts; ramie shirts; rash guards; rainproof clothing; rainwear; waterproof trousers; mackintoshes; rain ponchos; riding gloves; jodhpurs; riding jackets; skirts; turtlenecks; roll necks [clothing]; turtleneck shirts; turtleneck sweaters; rugby

tops; rugby shorts; rugby tops; bushjackets; saris; sarongs; sheepskin jackets; sheepskin coats; neck scarves [mufflers]; mufflers [clothing]; shawls [from tricot only]; shawls and headscarves; shawls and stoles; sashes for wear; sash bands for kimono (obi); referees uniforms; sleepsuits with a tricot appearance; nightwear; nighties; tube tops; cravats; breeches; snow suits; snow suits; snow pants; shoulder scarves; shoulder wraps [clothing]; school uniforms; aprons [clothing]; paper aprons; maternity bands; maternity smocks; sweat-absorbent socks; sweat-absorbent stockings; sweatbands; sweat bands for the wrist; headbands [clothing]; dress shields; anti-perspirant socks; head sweatbands; uniforms for nurses; swimming trunks; silk ties; silk scarves; adhesive bras; shampoo capes; shell jackets; shift dresses; mock turtleneck shirts; shirts and slips; shortalls; shorts; fleece shorts; boy shorts [underwear]; snow suits; ski suits for competition; ski gloves; ski trousers; ski jackets; clothing for skiing; ski balaclavas; sliding shorts; briefs; cummerbunds; dinner jackets; dinner suits; snow boarding suits; snowboard gloves; japanese style socks (tabi); socks and stockings; sock suspenders; bralettes; sundresses; sunsuits; playsuits [clothing]; camiknickers; gym suits; sports clothing [other than golf gloves]; sportswear; sports bras; casual shirts; sports shirts with short sleeves; sports pants; sports jackets; sports socks; singlets; sports jerseys and breeches for sports; gym suits; athletics vests; dust coats; quilted jackets [clothing]; quilted vests; cloth bibs; cloth bibs for adult diners; tightening-up strings for kimonos (datejime); rompers; snap crotch shirts for infants and toddlers; beachwear; beach robes; stretch pants; knitwear [clothing]; knit shirts; cardigans; thongs; garters; stockings; sweat-absorbent stockings; heelpieces for stockings; pantie-girdles; tights; maillots [hosiery]; footless tights; hosiery; footless socks; surfwear; jockstraps [underwear]; sweaters; tracksuit bottoms; sweatjackets; sweat shirts; sweat shorts; taekwondo suits; waist cinchers; tank tops; dance clothing; dance costumes; tabards; camouflage gloves; camouflage shirts; camouflage pants; camouflage jackets; camouflage vests; trews; tennis wear; tennis shirts; tennis dresses; tennis pullovers; tennis skirts; tennis shorts; tennis socks; fabric belts [clothing]; thobes; theatrical costumes; thermal socks; thermal underwear; togas; tops [clothing]; folk costumes; japanese traditional clothing; bra straps; bib tights; pinafore dresses; strapless bras; tank tops; clothing for gymnastics; sweatpants; sweat shorts; tracksuit tops; trench coats; bib shorts; triathlon clothing; knitwear [clothing]; singlets; dry suits; tee-shirts; kerchiefs [clothing]; neckerchiefs; tunics; turbans; clothing for gymnastics; gym shorts; tutus; twin sets; korean outer jackets worn over basic garment [magoja]; nappy pants [clothing]; topcoats; over-trousers; neck scarves; cloaks; shawls; maternity clothing; maternity sleepwear; maternity lingerie; uniforms; uniforms

for commercial use; uniforms for nurses; referees uniforms; union suits; underwear; babies' undergarments; sweat-absorbent underwear; vest tops; undershirts for kimonos (juban); undershirts for kimonos (koshimaki); bottoms [clothing]; pants; chemises; petticoats; bustles for obi-knots (obiage-shin); tracksuit bottoms; underwear; garments for protecting clothing; suit coats; volleyball jerseys; thermally insulated clothing; warm-up jackets; warm-up tops; weatherproof clothing; waterproof suits for motorcyclists; waterproof capes; waterproof outerclothing; water socks; waterproof trousers; rainproof jackets; oilskins [clothing]; wetsuits for water-skiing; chefs' whites; white coats for hospital use; caftans; sweat shirts; reversible jackets; waistcoats; leather waistcoats; cagoules; weatherproof clothing; sailing wet weather clothing; puttees and gaiters; wrap belts for kimonos (datemaki); beach wraps; beach wraps; swaddling clothes; salopettes; windproof clothing; wind suits; wind pants; windshirts; wind vests; winter gloves; winter coats; hosiery; weather resistant outer clothing; woollen socks; yoga pants; yoga shirts; zoot suits; gussets [parts of clothing]; gussets for bathing suits [parts of clothing]; gussets for footlets [parts of clothing]; gussets for leotards [parts of clothing]; gussets for stockings [parts of clothing]; gussets for tights [parts of clothing]; gussets for underwear [parts of clothing]; footwear; heels; heelpieces for footwear; bootees (woollen baby shoes); bath slippers; footwear for women; insoles for footwear; espadrilles; heel inserts; flat shoes; embossed heels of rubber or of plastic materials; embossed soles of rubber or of plastic materials; non-slipping devices for footwear; slippers; slipper socks; stiffeners for shoes; inner socks for footwear; running shoes; infants' footwear; leather slippers; leather shoes; canvas shoes; deck shoes; uppers for japanese style sandals; slippers; pumps [footwear]; welts for footwear; rain boots; riding shoes; riding shoes; shoe straps; rugby boots; mules; slip-on shoes; shoes; athletic shoes; leisure shoes; shoes for foot volleyball; shoes with hook and pile fastening tapes; high-heeled shoes; mountaineering shoes; shoe inserts for non-orthopedic purposes; shoe uppers; footwear soles; shoe covers, other than for medical purposes; footwear uppers; snowboard shoes; shoe soles; slipper soles; soles for japanese style sandals; espadrilles; dance shoes; ballroom dancing shoes; tennis shoes; training shoes; tips for footwear; waterproof boots for fishing; aqua shoes; winter boots; yoga shoes; zori; tongues for shoes and boots; intermediate soles.

27 – Carpets, rugs and mats; bath mats; textile bath mats; bath mats; bath mats; vehicles mats and carpets; rugs (floor -); door mats; runners [mats]; oriental non-woven rugs (mosen); carpet tile backing; carpet backing; carpeting; carpet tiles; primary carpet backing; textile bath mats; carpets [textile]; rugs

(mats); wallpaper; wall paper of vinyl; wall coverings of paper.

35 – Advertising, marketing and promotional services; bill-posting; banner advertising; merchandising; public relations services; online advertising; telemarketing services; sales promotion for others; advertising; display services for merchandise; preparation and presentation of audio visual displays for advertising purposes; arranging of displays for commercial purposes; organisation and conducting of product presentations; arranging of demonstrations for advertising purposes; presentation of goods and services; sales demonstration [for others]; demonstration of goods and services by electronic means, also for the benefit of the so-called teleshopping and homeshopping services; demonstration of goods for promotional purposes; arranging of demonstrations for advertising purposes; demonstration of goods; arranging trade fairs and exhibitions for commercial or advertising purposes; arranging of exhibitions for business purposes; arranging of exhibitions for advertising purposes; exhibitions (conducting -) for business purposes; exhibitions (conducting -) for business purposes; exhibitions (conducting -) for advertising purposes; organisation of exhibitions and trade fairs for business and promotional purposes; shows (conducting business -); fashion show exhibitions for commercial purposes; organisation of events for commercial and advertising purposes; organization of events, exhibitions, fairs and shows for commercial, promotional and advertising purposes; planning and conducting of trade fairs, exhibitions and presentations for economic or advertising purposes; arranging of exhibitions for advertising purposes; rental of advertising space on-line; rental of advertising space; distribution of advertising, marketing and promotional material; distribution of promotional matter; distribution of advertisements and commercial announcements; dissemination of advertising matter; distribution of advertising material; dissemination of advertising and promotional materials; dissemination of advertising, marketing and publicity materials; dissemination of advertisements; dissemination of advertising for others; dissemination of advertising for others via the internet; distribution and dissemination of advertising materials [leaflets, prospectuses, printed material, samples]; handbill distribution; handbill distribution; handbill distribution; distribution of samples for publicity purposes; distribution of prospectuses and samples; handbill distribution; distribution of products for advertising purposes; sample distribution; distribution of advertising announcements; distribution and dissemination of advertising materials [leaflets, prospectuses, printed material, samples]; handbill distribution; handbill distribution; distribution of promotional matter; arranging the distribution of advertising literature in response to telephone enquiries; arranging of presentations for business purposes; office functi-

ons; business management; supply chain management services; business administration.

(260) AM 2019 100745 A
(800) 1438380
(151) 2018 10 18
(891) 2018 10 18
(731) DD IP Holder LLC
P.O. Box 9141, Canton MA 02021, USA
(540)



(591) The color(s) pink and orange is/are claimed as a feature of the mark.

(531) 24.17.01; 27.05.17; 29.01.12

(511)

29 – Cream, non-dairy creamer, fruit-based snack foods, hummus, cream cheese, nut-based snack foods, yogurt, hash brown potatoes.

30 – Doughnuts and bakery products; cookies; cakes; pies; muffins; plain, glazed, coated and filled fried cakes; bagels; sandwiches; pizza; coffee and coffee-based beverages; tea and tea-based beverages; cocoa and cocoa-based beverages; coffee-based iced beverages, namely, coffee-flavored slush-type drinks.

32 – Fruit drinks and fruit juices; fruit-flavored slush-type drinks; smoothies; coffee-flavored soft drinks; syrups and other preparations, concentrates, and powders for making soft drinks and fruit drinks.

43 – Restaurant services; cafe services; snack bar services; fast-food restaurant services.

(260) AM 2019 100746 A
(800) 1438384
(151) 2018 06 21
(891) 2018 06 21
(731) HELIOS Tovarna barv, lakov in umetnih smol
Količevo, d.o.o.
Količevo 65, SI-1230 Domžale, Slovenia
(540)



(591) Red, white, yellow, black and silver

(531) 19.03.01; 27.05.10; 27.05.24; 29.01.15

(554) Three-dimensional

(511)

1 – Chemical products used in industry, especially chemicals used in manufacturing of paints, industrial chemicals, aldehydes, anti-static preparations (except for household purposes), bacteriologic preparations (except for medical and veterinary purposes); chemical reactant (except for medical and veterinary purposes); concrete preservatives, except paints and oils; condensation-preventing chemicals; degreasing preparations for use in manufacturing processes; decolorants for industrial processes; emulsifiers; fireproofing preparations; preservatives used in masonry, except paints and oils; enamel staining chemicals; salts for coloring metal; artificial resins, unprocessed; plastics, unprocessed; tanning substances; adhesives for industrial purposes, solvents for varnishes.

2 – Paints, including wood colorings, bactericidal paints, fireproof paints, paints for ceramics; aluminum paints, printing ink and printing paints; painting coatings, namely, coatings, whitening substances, dyes, and binding substances for paints; varnishes for painting; lacquers, including lacquers on the basis of varnish and painting lacquers; anti-rust preparations, especially preservatives against rust; preservatives for metal, minium, red lead, white lead, undercoatings and coatings for chassis of vehicles; mastic, primers; thinners for paints and lacquers; thickeners for paints and lacquers; agglutinants for paints; mordants; enamels; fixatives for watercolors; mordants for leather; wood preservatives, including wood coatings and wood mordants; metals in foil and powder form for painters, decorators, printers and artists, colorants.

17 – Artificial resins (semi-processed), acrylic resins (semi-processed); rubber (raw other semi-processed); seals and rings of rubber; semi-processed plastics; plastic fibres, not for use in textile; adhesive bands and tapes (other than stationery and not for medical purposes); insulating fabrics, insulating oil, insulating paints, insulating varnish, insulating tape and band, substances for insulating buildings against moisture; filtering materials (semi-processed foams or films of plastics); flexible tubes, not of metal.

(260) AM 2019 100747 A

(800) 1438408

(151) 2018 02 26

(891) 2018 02 26

(731) Société Emerging Market knowledge Holding
Branch Tunisia
Rue du Lac Neuchatel, Les Berges du Lac,
Tunis, Tunisia

(540)

EDUCATION FOR IMPACT

(591) Black, white

(531) 27.05.01

(511)

41 – Education; training; entertainment; sporting and cultural activities; information relating to education, vocational retraining, publication of books; book lending; organization of competitions (education); organization and conducting of colloquiums; organization and conducting of conferences; organization and conducting of congresses; organization of exhibitions for educational purposes; electronic publication of books and journals online.

42 – Scientific research, technical research.

(260) AM 2019 100748 A

(800) 1438440

(151) 2018 10 17

(891) 2018 10 17

(731) APPLE INC.

One Apple Park Way, Cupertino CA 95014,
USA

(540)

LIQUID RETINA

(591) Black, white

(511)

9 – Computers; electronic display screens and electronic display interfaces; handheld mobile digital devices used as a telephone, handheld computer, media player, and personal digital assistant used to access the Internet, electronic mail, digital audio, video, and data; smartphones.

(260) AM 2019 100750 A

(800) 1154434

(151) 2013 03 08

(891) 2018 11 09

(731) UNIFI, INC.

7201 West Friendly Avenue, Greensboro
NC 27410, USA

(540)

REPREVE

(591) Black, white

(511)

23 – Yarn.

(260) AM 2019 100752 A

(800) 1229451

(151) 2014 03 26

(891) 2018 11 05

(731) MALVA KOZMETİK PETR.GIDA TURİZM
İNŞ.İTH.İHR.SAN.VE TİC.LTD ŞTİ
Yenişehir Mh. Ekin Sok. Ayyacı Park, Sitesi B
Blok No:9/28 Kurtköy Pendik, İSTANBUL,
Turkey

(540)



(591) Black, white

(511)

3 – Bleaching and cleaning agents; perfumery, cosmetic products, fragrances, deodorants for personal use and animals; soap; dental care products; abrasive products (emery cloth, emery paper, pumice stones, abrasive pastes included); polishing and shining preparations for leather, vinyl, metal, wood.

(260) AM 2019 100753 A

(800) 1374387

(151) 2017 07 06

(891) 2018 11 22

(731) Euronics G.E.I.E.

Huizermaatweg 480, NL-1276 LM HUIZEN,
Netherlands

(540)



(591) Blue, yellow and white

(531) 01.01.02; 01.01.10; 26.04.02; 26.04.05;

26.04.13; 26.04.22; 26.04.24; 27.05.08;

27.05.24; 29.01.13

(511)

7 – Electric household appliances and machines, namely, washing machines, spin dryers, dishwashers, fully automatic washing machines, including coin or token-operated appliances and machines; mangles, ironing machines; electric, electronic and electromechanical apparatus and appliances for household and kitchen use, in particular food processors, electric beaters, electric mixers, electromechanical grinders and crushers, coffee grinders; electric, electronic and electromechanical apparatus and appliances for household and kitchen use, in particular electric kneading machines, electric juice squeezers and juicers, electric can openers, electromechanical beaters and cutting apparatus for household and kitchen use, electric knives, vacuum cleaners, beaters and floor polishing machines, apparatus for carpet care and parts thereof; vending machines.

9 – Scientific, nautical, surveying and electric apparatus and instruments, photographic, cinematographic, optical, weighing, measuring, signaling, checking (supervision), life-saving and teaching apparatus and instruments; apparatus for recording, trans-

mission or reproduction of sound or images; magnetic data carriers, recording discs; mechanisms for coin-operated apparatus; cash registers; calculating machines; data processing equipment; computers; computer peripheral devices, namely, monitors, printers, keyboards, computer mice, joysticks, plug-in boards, drives, scanners, graphics and network cards, modems, interfaces, recordable discs, hard discs, connector cables, computer programs recorded on data carriers, computer games, software applications; fire extinguishing apparatus; apparatus for recording, transmission or reproduction of sound and/or images and/or electrically processed data, in particular radio and television sets, CD players, video equipment, headphones, microphones, amplifiers, loudspeakers, aerials, telephones including mobile telephones; telephone equipment, answering machines, fax machines, intercoms, satellite receiver installations, including satellite aerials and receivers, recorded and unrecorded sound, image and data carriers, cds, cd-roms, video and audio tapes and cassettes; video players and recorders; camcorders and cameras (photography); equipment for recording or reproduction of sound; photographic, cinematographic and optical apparatus and instruments, in particular cameras for photography, lenses, binoculars, electronic image recording and image reproduction apparatus; video cameras; motion picture cameras; printers; video recorders; camcorders; projectors; electric measuring devices.

11 – Apparatus for lighting, heating, steam generating, cooking, refrigeration, drying, ventilating, water supply and sanitary purposes; air-conditioning apparatus; electric equipment and apparatus for drying hair; electric equipment for household and kitchen use (included in this class), namely heating apparatus, hair dryers, electric radiation apparatus, heat lamps and UV lamps, tanning equipment, air conditioning apparatus, air humidifiers, air purifiers, ventilators, electric laundry dryers, ice makers, gas fires and electric cookers, cooking rings, microwave ovens, refrigerators, freezing apparatus, water heaters, lamps, bulbs.

35 – Business intermediary services in relation to trading in electric, electronic and electromechanical apparatus and instruments; advertising; public relations; business management services; mediation in the field of advertising; job placement; personnel consultancy; business management; business administration; administration services; franchising, namely business management consultancy and assistance, business organization and advertising; drawing up of statistics; bookkeeping; auctioneering services; providing of trade information; market research and analysis; shop-window dressing; conducting opinion polls; marketing; market research; consultancy with regard to business organization and business economics; dissemination of advertising

materials; rental of office machines; outplacement consultancy; retail services with respect to electric household appliances and machines, namely, washing machines, spin dryers, dishwashers, fully automatic washing machines, including coin or token-operated appliances and machines, mangles, ironing machines, electric, electronic and electromechanical apparatus and appliances for household and kitchen use, in particular food processors, electric beaters, electric mixers, electromechanical grinders and crushers, coffee grinders, electric kneading machines, electric juice squeezers and juicers, electric can openers, electromechanical beaters and cutting apparatus for household and kitchen use, electric knives, vacuum cleaners, beaters and floor polishers, carpet care equipment, and components and accessories therefor, scientific, nautical, surveying and electric apparatus and instruments, photographic, cinematographic, optical, weighing, measuring, signaling, checking (supervision), life-saving and teaching apparatus and instruments, apparatus for recording, transmission or reproduction of sound or images, magnetic data carriers, recording discs, vending machines and mechanisms for coin-operated apparatus, cash registers, calculating machines, data processing equipment, computers, computer peripheral devices, namely, monitors, printers, keyboards, computer mice, joysticks, plug-in boards, drives, scanners, graphics and network cards, modems, interfaces, recordable discs, hard discs, connector cables, computer programs recorded on data carriers, computer games, software applications, fire extinguishing apparatus, apparatus for recording, transmission or reproduction of sound and/or images and/or electrically processed data, in particular radio and television sets, cd players, video equipment, headphones, microphones, amplifiers, loudspeakers, aerials, telephones including mobile telephones, telephone equipment, answering machines, fax machines, intercoms, satellite receiver installations, including satellite aerials and receivers, recorded and unrecorded sound, image and data carriers, CDs, CD-ROMs, video and audio tapes and cassettes, electric and electronic entertainment equipment and apparatus, components and accessories therefor (included in class 9), video players and recorders, camcorders and cameras (photography), equipment for recording or reproduction of sound, photographic, cinematographic and optical apparatus and instruments, in particular cameras for photography, lenses, binoculars, electronic image recording and image reproduction apparatus, video cameras, motion picture cameras, printers, video recorders, camcorders, projectors, electric measuring devices, electric irons, steam irons, apparatus for lighting, heating, steam generating, cooking, refrigeration, drying, ventilating, water supply and sanitary purposes, air-conditioning apparatus, electric equipment and apparatus for styling and drying hair, electric equipment for household and kitchen use (in-

cluded in class 11), namely heating apparatus, hair dryers, electric radiation apparatus, heat lamps and UV lamps, tanning equipment, air conditioning apparatus, air humidifiers, air purifiers, ventilators, electric laundry dryers, ice makers, gas fires and electric cookers, cooking rings, microwave ovens, refrigerators, freezing apparatus, water heaters, lamps, bulbs, coffee and tea glasses, dental care preparations, hair care preparations.

36 – Insurance and financial affairs; financing of sales credit, insurance of credit risk (factoring), consultancy regarding granting of credit, intermediary services regarding credits, investigation regarding credit worthiness; credit bureau services.

37 – Building construction; installation services, repair and maintenance of electric, electronic and electromechanical equipment and apparatus.

(260) AM 2019 100754 A

(800) 1374828

(151) 2017 07 06

(891) 2018 11 22

(731) EURONICS G.E.I.E.

Huizermaatweg 480, NL-1276 LM HUIZEN,
Netherlands

(540)



(591) Black, white

(531) 01.01.02; 01.01.10; 27.05.01; 27.05.08

(511)

7 – Electric household appliances and machines, namely, washing machines, spin dryers, dishwashers, fully automatic washing machines, including coin or token-operated appliances and machines; mangles, ironing machines; electric, electronic and electromechanical apparatus and appliances for household and kitchen use, in particular food processors, electric beaters, electric mixers, electromechanical grinders and crushers, coffee grinders; electric, electronic and electromechanical apparatus and appliances for household and kitchen use, in particular electric kneading machines, electric juice squeezers and juicers, electric can openers, electromechanical beaters and cutting apparatus for household and kitchen use, electric knives, vacuum cleaners, beaters and floor polishing machines, apparatus for carpet care and parts thereof; vending machines.

9 – Scientific, nautical, surveying and electric apparatus and instruments, photographic, cinematographic, optical, weighing, measuring, signaling, checking (supervision), life-saving and teaching apparatus and instruments; apparatus for recording, transmission or reproduction of sound or images; magnetic data carriers, recording discs; mechanisms for coin-operated apparatus; cash registers; calculating

machines; data processing equipment; computers; computer peripheral devices, namely, monitors, printers, keyboards, computer mice, joysticks, plug-in boards, drives, scanners, graphics and network cards, modems, interfaces, recordable discs, hard discs, connector cables, computer programs recorded on data carriers, computer games, software applications; fire extinguishing apparatus; apparatus for recording, transmission or reproduction of sound and/or images and/or electrically processed data, in particular radio and television sets, cd players, video equipment, headphones, microphones, amplifiers, loudspeakers, aerials, telephones including mobile telephones; telephone equipment, answering machines, fax machines, intercoms, satellite receiver installations, including satellite aerials and receivers, recorded and unrecorded sound, image and data carriers, cds, cd-roms, video and audio tapes and cassettes; video players and recorders; camcorders and cameras (photography); equipment for recording or reproduction of sound; photographic, cinematographic and optical apparatus and instruments, in particular cameras for photography, lenses, binoculars, electronic image recording and image reproduction apparatus; video cameras; motion picture cameras; printers; video recorders; camcorders; projectors; electric measuring devices.

11 – Apparatus for lighting, heating, steam generating, cooking, refrigeration, drying, ventilating, water supply and sanitary purposes; air-conditioning apparatus; electric equipment and apparatus for drying hair; electric equipment for household and kitchen use (included in this class), namely heating apparatus, hair dryers, electric radiation apparatus, heat lamps and UV lamps, tanning equipment, air conditioning apparatus, air humidifiers, air purifiers, ventilators, electric laundry dryers, ice makers, gas fires and electric cookers, cooking rings, microwave ovens, refrigerators, freezing apparatus, water heaters, lamps, bulbs.

35 – Business intermediary services in relation to trading in electric, electronic and electromechanical apparatus and instruments; advertising; public relations; business management services; mediation in the field of advertising; job placement; personnel consultancy; business management; business administration; administration services; franchising, namely business management consultancy and assistance, business organization and advertising; drawing up of statistics; bookkeeping; auctioneering services; providing of trade information; market research and analysis; shop-window dressing; conducting opinion polls; marketing; market research; consultancy with regard to business organization and business economics; dissemination of advertising materials; rental of office machines; outplacement consultancy; retail services with respect to electric household appliances and machines, namely, was-

hing machines, spin dryers, dishwashers, fully automatic washing machines, including coin or token-operated appliances and machines, mangles, ironing machines, electric, electronic and electromechanical apparatus and appliances for household and kitchen use, in particular food processors, electric beaters, electric mixers, electromechanical grinders and crushers, coffee grinders, electric kneading machines, electric juice squeezers and juicers, electric can openers, electromechanical beaters and cutting apparatus for household and kitchen use, electric knives, vacuum cleaners, beaters and floor polishers, carpet care equipment, and components and accessories therefor, scientific, nautical, surveying and electric apparatus and instruments, photographic, cinematographic, optical, weighing, measuring, signaling, checking (supervision), life-saving and teaching apparatus and instruments, apparatus for recording, transmission or reproduction of sound or images, magnetic data carriers, recording discs, vending machines and mechanisms for coin-operated apparatus, cash registers, calculating machines, data processing equipment, computers, computer peripheral devices, namely, monitors, printers, keyboards, computer mice, joysticks, plug-in boards, drives, scanners, graphics and network cards, modems, interfaces, recordable discs, hard discs, connector cables, computer programs recorded on data carriers, computer games, software applications, fire extinguishing apparatus, apparatus for recording, transmission or reproduction of sound and/or images and/or electrically processed data, in particular radio and television sets, cd players, video equipment, headphones, microphones, amplifiers, loudspeakers, aerials, telephones including mobile telephones, telephone equipment, answering machines, fax machines, intercoms, satellite receiver installations, including satellite aerials and receivers, recorded and unrecorded sound, image and data carriers, cds, cd-roms, video and audio tapes and cassettes, electric and electronic entertainment equipment and apparatus, components and accessories therefor (included in class 9), video players and recorders, camcorders and cameras (photography), equipment for recording or reproduction of sound, photographic, cinematographic and optical apparatus and instruments, in particular cameras for photography, lenses, binoculars, electronic image recording and image reproduction apparatus, video cameras, motion picture cameras, printers, video recorders, camcorders, projectors, electric measuring devices, electric irons, steam irons, apparatus for lighting, heating, steam generating, cooking, refrigeration, drying, ventilating, water supply and sanitary purposes, air-conditioning apparatus, electric equipment and apparatus for styling and drying hair, electric equipment for household and kitchen use (included in class 11), namely heating apparatus, hair dryers, electric radiation apparatus, heat lamps and UV lamps, tanning equipment, air conditioning ap-

paratus, air humidifiers, air purifiers, ventilators, electric laundry dryers, ice makers, gas fires and electric cookers, cooking rings, microwave ovens, refrigerators, freezing apparatus, water heaters, lamps, bulbs, coffee and tea glasses, dental care preparations, hair care preparations.

36 – Insurance and financial affairs; financing of sales credit, insurance of credit risk (factoring), consultancy regarding granting of credit, intermediary services regarding credits, investigation regarding credit worthiness; credit bureau services.

37 – Building construction; installation services, repair and maintenance of electric, electronic and electromechanical equipment and apparatus.

(260) AM 2019 100756 A

(800) 1378424

(151) 2017 07 06

(891) 2018 11 22

(731) Euronics G.E.I.E.

Huizermaatweg 480, NL-1276 LM HUIZEN,
Netherlands

(540)



(591) Blue, yellow and white

(531) 01.01.02; 01.01.10; 26.04.02; 26.04.05;
26.04.13; 26.04.18; 26.04.24; 27.05.08;
27.05.21; 29.01.13

(511)

7 – Electric household appliances and machines, namely, washing machines, spin dryers, dishwashers, fully automatic washing machines, including coin or token-operated appliances and machines; mangles, ironing machines; electric, electronic and electromechanical apparatus and appliances for household and kitchen use, in particular food processors, electric beaters, electric mixers, electromechanical grinders and crushers, coffee grinders; electric, electronic and electromechanical apparatus and appliances for household and kitchen use, in particular electric kneading machines, electric juice squeezers and juicers, electric can openers, electromechanical beaters and cutting apparatus for household and kitchen use, electric knives, vacuum cleaners, beaters and floor polishing machines, apparatus for carpet care and parts thereof; vending machines.

9 – Scientific, nautical, surveying and electric apparatus and instruments, photographic, cinematographic, optical, weighing, measuring, signaling, checking (supervision), life-saving and teaching apparatus

and instruments; apparatus for recording, transmission or reproduction of sound or images; magnetic data carriers, recording discs; mechanisms for coin-operated apparatus; cash registers; calculating machines; data processing equipment; computers; computer peripheral devices, namely, monitors, printers, keyboards, computer mice, joysticks, plug-in boards, drives, scanners, graphics and network cards, modems, interfaces, recordable discs, hard discs, connector cables, computer programs recorded on data carriers, computer games, software applications; fire extinguishing apparatus; apparatus for recording, transmission or reproduction of sound and/or images and/or electrically processed data, in particular radio and television sets, CD players, video equipment, headphones, microphones, amplifiers, loudspeakers, aerials, telephones including mobile telephones; telephone equipment, answering machines, fax machines, intercoms, satellite receiver installations, including satellite aerials and receivers, recorded and unrecorded sound, image and data carriers, CDs, CD-ROMs, video and audio tapes and cassettes; video players and recorders; camcorders and cameras (photography); equipment for recording or reproduction of sound; photographic, cinematographic and optical apparatus and instruments, in particular cameras for photography, lenses, binoculars, electronic image recording and image reproduction apparatus; video cameras; motion picture cameras; printers; video recorders; camcorders; projectors; electric measuring devices.

11 – Apparatus for lighting, heating, steam generating, cooking, refrigeration, drying, ventilating, water supply and sanitary purposes; air-conditioning apparatus; electric equipment and apparatus for drying hair; electric equipment for household and kitchen use (included in this class), namely heating apparatus, hair dryers, electric radiation apparatus, heat lamps and UV lamps, tanning equipment, air conditioning apparatus, air humidifiers, air purifiers, ventilators, electric laundry dryers, ice makers, gas fires and electric cookers, cooking rings, microwave ovens, refrigerators, freezing apparatus, water heaters, lamps, bulbs.

35 – Business intermediary services in relation to trading in electric, electronic and electromechanical apparatus and instruments; advertising; public relations; business management services; mediation in the field of advertising; job placement; personnel consultancy; business management; business administration; administration services; franchising, namely business management consultancy and assistance, business organization and advertising; drawing up of statistics; bookkeeping; auctioneering services; providing of trade information; market research and analysis; shop-window dressing; conducting opinion polls; marketing; market research; consultancy with regard to business organization and business econo-

mics; dissemination of advertising materials; rental of office machines; outplacement consultancy; retail services with respect to electric household appliances and machines, namely, washing machines, spin dryers, dishwashers, fully automatic washing machines, including coin or token-operated appliances and machines, mangles, ironing machines, electric, electronic and electromechanical apparatus and appliances for household and kitchen use, in particular food processors, electric beaters, electric mixers, electromechanical grinders and crushers, coffee grinders, electric kneading machines, electric juice squeezers and juicers, electric can openers, electromechanical beaters and cutting apparatus for household and kitchen use, electric knives, vacuum cleaners, beaters and floor polishers, carpet care equipment, and components and accessories therefor, scientific, nautical, surveying and electric apparatus and instruments, photographic, cinematographic, optical, weighing, measuring, signaling, checking (supervision), life-saving and teaching apparatus and instruments, apparatus for recording, transmission or reproduction of sound or images, magnetic data carriers, recording discs, vending machines and mechanisms for coin-operated apparatus, cash registers, calculating machines, data processing equipment, computers, computer peripheral devices, namely, monitors, printers, keyboards, computer mice, joysticks, plug-in boards, drives, scanners, graphics and network cards, modems, interfaces, recordable discs, hard discs, connector cables, computer programs recorded on data carriers, computer games, software applications, fire extinguishing apparatus, apparatus for recording, transmission or reproduction of sound and/or images and/or electrically processed data, in particular radio and television sets, CD players, video equipment, headphones, microphones, amplifiers, loudspeakers, aerials, telephones including mobile telephones, telephone equipment, answering machines, fax machines, intercoms, satellite receiver installations, including satellite aerials and receivers, recorded and unrecorded sound, image and data carriers, CDs, CD-ROMs, video and audio tapes and cassettes, electric and electronic entertainment equipment and apparatus, components and accessories therefor (included in class 9), video players and recorders, camcorders and cameras (photography), equipment for recording or reproduction of sound, photographic, cinematographic and optical apparatus and instruments, in particular cameras for photography, lenses, binoculars, electronic image recording and image reproduction apparatus, video cameras, motion picture cameras, printers, video recorders, camcorders, projectors, electric measuring devices, electric irons, steam irons, apparatus for lighting, heating, steam generating, cooking, refrigeration, drying, ventilating, water supply and sanitary purposes, air-conditioning apparatus, electric equipment and apparatus for styling and drying hair, electric equipment for house-

hold and kitchen use (included in class 11), namely heating apparatus, hair dryers, electric radiation apparatus, heat lamps and UV lamps, tanning equipment, air conditioning apparatus, air humidifiers, air purifiers, ventilators, electric laundry dryers, ice makers, gas fires and electric cookers, cooking rings, microwave ovens, refrigerators, freezing apparatus, water heaters, lamps, bulbs, coffee and tea glasses, dental care preparations, hair care preparations.

36 – Insurance and financial affairs; financing of sales credit, insurance of credit risk (factoring), consultancy regarding granting of credit, intermediary services regarding credits, investigation regarding credit worthiness; credit bureau services.

37 – Building construction; installation services, repair and maintenance of electric, electronic and electromechanical equipment and apparatus.

(260) AM 2019 100758 A

(800) 1414017

(151) 2018 03 19

(891) 2018 07 13

(731) UiPath SRL

Str. Vasile Alecsandri si Constantin Daniel,
Nr. 4 si 11, Corp A, Et. 5-6, Sector 1,
Bucharest, Romania

(540)

UiPath

(591) Black, white

(511)

9 – Computer programs [downloadable software]; downloadable computer utility programs; computer software applications, downloadable; application software for cloud computing services.

35 – Business management and organization consultancy; business management and enterprise organization consultancy; business organization and management consultancy including personnel management; assistance, advisory services and consultancy with regard to business organization; advisory services for business management; business management consultancy and advisory services; business consulting; professional consultancy relating to business management; business information; collecting information for business; dissemination of business information; computer assisted business information; business advisory and information services; information in business matters; business information for enterprises (provision of -); research of business information; computerised business information services; provision of business information; analysis of business information; computerised business information retrieval; business statistical information services; business advice, inquiries or information; provision of business and commercial information; computerised business information processing servi-

ces; business research and information services; provision of statistical information relating to business; provision of business management information; provision of computerised data relating to business; information services relating to businesses; information services relating to business matters; providing business information via a web site; provision of computerised business management information; drawing up of business statistical information; economic information services for business purposes; business analysis, research and information services; compilation of business statistics and commercial information; advice and information concerning commercial business management; information or enquiries on business and marketing; computerised information services to business opportunities appraisals; provision of commercial and business contact information; provision of business information via global computer networks; provision of computerised information relating to business records; providing business information by way of computer terminals; provision of on-line business and commercial information; providing information about commercial business and commercial information via the global computer network; updating of business information on a computer data base; business consultancy relating to the administration of information technology; providing business information directory services, via a global computer network; information and data compiling and analyzing relating to business management; business management consulting services in the field of information technology; provision of commercial business information by means of a computer database; business information services provided on-line from a computer database or the internet; business information services provided online from a global computer network or the internet; providing business information, also via internet, the cable network or other forms of data transfer; compilation of information into computer databases; compilation and systemization of information into computer databases; compilation of statistics; compilation of business statistics; compilation of statistics [for business or commercial purposes]; computerized file management; data search in computer files for others; document reproduction; outsourcing services [business assistance]; systemization of information into computer databases; updating and maintenance of data in computer databases; assistance in management of business activities; assistance and advice regarding business management; management assistance in business affairs; business assistance, management and administrative services; management and operation assistance to commercial businesses; assistance and advice regarding business organisation and management; advice relating to the organisation and management of business; business management assistance for industrial or commercial companies; assistance, advisory ser-

vices and consultancy with regard to business management; assistance to commercial enterprises in the management of their business; commercial assistance in business management; efficiency experts; business efficiency expert services; business organisation consulting; business organization and operation consultancy; none of the aforementioned services being in relation to alcoholic beverages.

38 – Transmission of information for business purposes; providing access to databases; providing access to online computer databases; providing access to and leasing access time to computer databases; providing access to databases in computer networks; providing access to electronic communications networks and electronic databases; communications by computer terminals; computer-aided transmission of messages and images; computer aided transmission of messages, information and images; streaming of data; transmission of digital files.

41 – Teaching and training in business, industry and information technology; arranging and conducting of conferences; arranging, conducting and organisation of conferences; arranging and conducting of commercial, trade and business conferences; arranging and conducting of seminars; arranging and conducting of seminars and workshops; arranging, conducting and organisation of seminars; programming [scheduling of programs] on a global computer network.

42 – Providing temporary use of non-downloadable computer programs; cloud computing; consulting in the field of cloud computing networks and applications; rental of operating software for accessing and using a cloud computing network; programming of operating software for accessing and using a cloud computing network; design and development of operating software for accessing and using a cloud computing network; providing temporary use of on-line non-downloadable operating software for accessing and using a cloud computing network; computer programming; scientific computer programming services; computer software programming services; computer programming and maintenance of computer programs; computer programming for data processing; computer design and programming services; computer programming and software design; computer programming for the internet; research relating to computer programming; computer programming services for data warehousing; design, development and programming of computer software; technical consultancy services relating to computer programming; computer programming for data processing and communication systems; computer programming services for commercial analysis and reporting; programming of computer software for reading, transmitting and organising data; programming of computer software for evaluation and calculation of data; advisory services relating to computer

programming; computer software design; software design and development; computer software design and updating; design and writing of computer software; design and development of computer software architecture; design, maintenance and updating of computer software; design, drawing and commissioned writing of computer software; research, development, design and upgrading of computer software; design, maintenance, development and updating of computer software; design, maintenance, rental and updating of computer software; design and development of computer software for process control; consultancy relating to the design and development of computer software programs; design and development of computer software for reading, transmitting and organising data; design and development of computer software for evaluation and calculation of data; providing information about the design and development of computer software, systems and networks; rental of software; rental of computer database software; rental of computer software and programs; rental and maintenance of computer software; computer system analysis; advisory services relating to computer systems analysis; computer system design; advisory services relating to computer systems design; design services relating to the development of computerised information processing systems; computer software consultancy; professional advisory services relating to computer software; technical consultancy relating to the installation and maintenance of computer software; technical consultancy relating to the application and use of computer software; providing information, advice and consultancy services in the field of computer software; consultancy and information services relating to the design, programming and maintenance of computer software; research and consultancy services relating to computer software; consultancy services relating to computer networks using mixed software environments; computer technology consultancy; computer and information technology consultancy services; consultancy in the field of computer security; professional consultancy relating to computer security; conversion of computer programs and data, other than physical conversion; electronic data storage; computer services concerning electronic data storage; compression of data for electronic storage; electronic data storage and data back-up services; electronic storage services for archiving databases; electronic storage services for archiving databases, images and other electronic data; temporary electronic storage of information and data; information technology [it] consultancy; providing information on computer technology and programming via a web site; installation of software; installation and maintenance of computer programs; installation and customisation of computer applications software; installation, maintenance and updating of computer software; installation, repair and maintenance of computer

software; installation, maintenance, updating and upgrading of computer software; installation, setting up and maintenance of computer software; installation, maintenance, repair and servicing of computer software; installation, maintenance and repair of software for computer systems; maintenance of computer programs; development and maintenance of computer software; maintenance and updating of computer software; maintenance and upgrading of computer software; development and maintenance of computer database software; maintenance of computer software relating to computer security and prevention of computer risks; updating and maintenance of computer software and programs; monitoring of computer systems by remote access; off-site data backup; outsource service providers in the field of information technology; research and development for others; software as a service [saas]; technological consultation services; updating of computer software; updating and upgrading of computer software; updating of computer software for others; updating of software for databases; updating of computer software relating to computer security and prevention of computer risks; updating of computer programs.

(260) AM 2019 100830 A

(800) 1439754

(151) 2018 07 12

(891) 2018 07 12

(731) EGS GLOBAL CO LIMITED

Aigialousis 74 and Nicou Pattichi 37, 2nd floor, office No. 203, Limassol, CY-3071, Cyprus

(540)



Ekonika

(591) Black, white

(531) 26.01.03; 26.01.12; 26.01.16; 27.05.01

(511)

2 – Dyes for footwear.

3 – Bleaching preparations and other substances for laundry use; cleaning, polishing, scouring and abrasive preparations; soaps; perfumery products; essential oils; cosmetics; hair lotions; dentifrices; perfumes; eaux de toilette; eau de Cologne; deodorants [perfumery]; toilet preparations; pads impregnated with cosmetics; sprays, creams, wax for footwear; cleaning pads, impregnated with wax and creams for footwear; shoe polish.

5 – Deodorizers for footwear.

9 – Magnetic and optical data media including those containing audio and video recordings; sound recording disks; audio disks; videodisks; downloadable

electronic publications; printed matter, periodicals, being digital downloadable from the Internet; spectacles; binoculars; spectacle frames; fine chains for spectacles; spectacle cases; special protective cases and covers for computers; DVD cases; cases for telephones; CD racks; covers for portable telephones; special cases for photographic apparatus and instruments and video equipment; mobile telephones; leather cases for mobile telephones and tablet computers; cases for mobile telephones and tablet computers; mobile telephone accessories, included in this class; decorative magnets.

10 – Orthopedic footwear; orthopedic soles for footwear; foot arch supports for shoes; boots for medical use.

14 – Jewelry, precious stones; timepieces and chronometric instruments; medals; boxes for time-recording apparatus; watch chains; watch bands; watch bands of leather; jewelry charms; amulets [jewelry].

16 – Paper, cardboard and goods made from these materials, not included in other classes; printing products (printed matter); bookbinding material; photographs; stationery; plastic materials for packaging (not included in other classes); printing type; printing blocks; plastic bags for packaging; baggage tags of paper; paper towels, particularly table napkins of paper, face towels of paper; school supplies; pen cases; pencil cases; bags, boxes of cardboard or paper; gift bags, gift boxes of paper; collapsible cardboard boxes; gift bags, gift boxes of cardboard.

18 – Leather and imitation leather, goods made of these materials not included in other classes; animal skins; trunks [luggage]; suitcases; umbrellas; parasols; walking sticks; whips, harness and saddlery; collars for animals; clothing for animals; business card cases; wallets; bags; traveling bags; haversacks; backpacks; purses; vanity cases, not fitted; hat boxes of leather; boxes of leather or leatherboard; cases of leather or leatherboard; travel sets [leatherware]; sling bags for carrying infants; garment bags for travel; beach bags; multi-purpose sports bags; bags for campers; key cases; umbrella covers.

21 – Utensils and containers for household or kitchen use (neither of precious metal nor coated therewith); combs and sponges; brushes (except paintbrushes); shoe horns; shoe stretchers of wood; button hooks; shoe shine gloves; shoe shine cloths; wax-polishing appliances, non-electric, for shoes; brushes for polishing footwear; make-up sponges; scouring sponges; toilet sponges; abrasive sponges for scrubbing the skin; household sponges; spectacle wiping cloths; cloths for polishing.

25 – Clothing, footwear, headgear; underwear; headbands [clothing]; headgear, including hats of fur; belts [clothing]; sashes for wear; money belts [clothing]; shawls; ponchos; heelpieces for footwear;

sports shoes; toe boxes; toe caps [parts of footwear]; rubbers [footwear]; footwear made of wood; stockings; socks; stocking suspenders; tights; gussets for footlets [parts of clothing]; knee-high stockings; gaiters; leggings [leg warmers]; gloves [clothing]; suspenders; shower caps; bathing caps; dressing gowns; ear muffs [clothing]; muffs [clothing]; fittings of metal for footwear; shoe soles for repair; non-slipping devices for footwear; tips for footwear; spikes for sports footwear.

26 – Buttons; snap fasteners; hooks and eyes; artificial flowers; badges (for wear) not of precious metal; competitors' numbers; decorative articles for the hair; hair ornaments; hair grips; hair pins; heat adhesive patches for decoration of textile articles [haberdashery]; trimmings for footwear; trimmings for clothing; trimmings for headgear; shoe fasteners; slide locks for bags; edgings for clothing; sewing boxes; lace and embroidery, ribbons and braid; pins and needles; hair scrunchies; hair bands; bows for the hair; hair barrettes; shoe hooks; shoe laces; ribbons [haberdashery] including those made of textile; numerals or letters for marking linen.

28 – Games, toys; gymnastic and sporting articles, not included in other classes; cricket bags; golf bags, with or without wheels; golf bag carts; bags especially designed for skis and surfboards; bags, cases, boxes, specially adapted for sports equipment, not included in other classes.

35 – Advertising; online advertising on a computer network; radio advertising; television advertising; commercial business management; commercial administration; sales promotion for others; sales promotion services at point of purchase or sale, for others; retail store services; promoting the goods and services of others over the Internet; online retail store services for cosmetic and beauty products; on-line retail store services for clothing, footwear, bags, headgear; online retail store services for jewelry articles; on-line retail store services; organization of exhibitions, trade fairs for commercial or advertising purposes; publication of advertising texts; demonstration of goods; presentation of goods on all communication media, for retail sale; administrative processing of purchase orders; procurement services for others [purchasing goods and services for other businesses]; outsourcing services [business assistance]; compilation and systematization of information into computer databases.

(260) AM 2019 100833 A

(800) 1439860

(151) 2018 11 07

(891) 2018 11 07

(731) MANZI KNITTING CO., LTD.

No.1526, Jiangdong Road, Jiangdong Street,
Yiwu, Zhejiang, 322000, China

(540)



(591) Black, white

(531) 26.03.23; 26.11.02; 27.05.21

(511)

25 – Clothing; underwear; layettes [clothing]; shoes; hats; stockings; hosiery; gloves [clothing]; neckties; leather belts [clothing].

(260) AM 2019 100834 A

(800) 1439976

(151) 2018 09 07

(891) 2018 09 07

(731) SHANDONG SHENGHAI RUBBER CO., LTD.

Zhouzhuang Village, Dawang Town, Guangrao County, Dongying City, 257335 Shandong Province, China

(540)



(591) Black, white

(531) 03.03.15; 26.01.15; 28.03

(511)

12 – Treads for retreading tyres; tyres, solid, for vehicle wheels; adhesive rubber patches for repairing inner tubes; inner tubes for bicycle tyres; tyres for vehicle wheels; bicycle tyres; repair outfits for inner tubes; automobile tyres; inner tubes for pneumatic tyres; pneumatic tyres.

(260) AM 2019 100835 A

(800) 1439988

(151) 2018 11 12

(891) 2018 11 12

(731) L. T. HAMPEL CORP.

W194 N11551 McCormick Drive,
Germantown WI 53022, USA

(540)

CALF-TEL

(591) Black, white

(511)

19 – Transportable, prefabricated houses for calves.

(260) AM 2019 100836 A

(800) 1440027

(151) 2017 12 04

(891) 2017 12 04

(731) Tovarichtchestvo s ogarnitchennoy otvetstvennostyu "Faeton Di Si" "Phaeton DC" mkr. Kolkhozshy, d. 4, Turksibskiy raion, 050019 g. Almaty, Kazakhstan

(540)



WINKOD

(591) Black, white

(531) 26.01.03; 26.01.18; 26.01.24; 27.05.01

(511)

4 – Anthracite; benzine; benzene fuel; wood briquettes; combustible briquettes; petroleum jelly for industrial purposes; wax [raw material]; ozokerite; illuminating wax; industrial wax; belting wax; carnauba wax; beeswax; gas for lighting; oil-gas; fuel gas; gasoline; producer gas; solidified gases [fuel]; fuel; lubricating graphite; additives, non-chemical, to motor fuel; firewood; paper spills for lighting; cutting fluids; fish oil, not edible; lanolin; illuminating grease; grease for leather; grease for footwear; tallow; industrial grease; kerosene; coke; lignoin; wood spills for lighting; mazut; fuel oil; oils for paints; oils for releasing form work [building]; oils for the preservation of masonry; leather-preserving oils and greases; textile oil; lubricating oil; industrial oil; moistening oil; coal tar oil; coal naphtha; castor oil for industrial purposes; bone oil for industrial purposes; motor oil; sunflower oil for industrial purposes; rape oil for industrial purposes; lubricants; naphtha; petroleum, raw or refined; nightlights [candles]; oleine; paraffin; dust removing preparations; soya bean oil preparations for non-stick treatment of cooking utensils; non-slipping preparations for belts; coal dust [fuel]; firelighters; perfumed candles; Christmas tree candles; candles; grease for arms [weapons]; lubricating grease; grease for belts; vaporized fuel mixtures; dust binding compositions for sweeping; dust laying compositions; alcohol [fuel]; methylated spirit; stearine; diesel oil; lighting fuel; mineral fuel; carburants; fuel with an alcohol base; peat [fuel]; peat briquettes [fuel]; tinder; lignite; charcoal [fuel]; coal; coal briquettes; lamp wicks; wicks for candles; ceresine; electrical energy; ethanol [fuel]; petroleum ether; xylene fuel; leather preservatives [fats and oils].

9 – DVD players; 3D spectacles; ticket dispensers; coin-operated musical automata [juke boxes]; fire engines; answering machines; accumulators, electric; accumulators, electric, for vehicles; actinometers; alidades; altimeters; ammeters; anemometers;

anodes; antennas; anticathodes; apertometers [optics]; high-frequency apparatus; testing apparatus not for medical purposes; remote control apparatus; electro-dynamic apparatus for the remote control of railway points; electro-dynamic apparatus for the remote control of signals; monitoring apparatus, other than for medical purposes; sound recording apparatus; Global Positioning System [GPS] apparatus; distillation apparatus for scientific purposes; diffraction apparatus [microscopy]; air analysis apparatus; apparatus to check franking; sound transmitting apparatus; apparatus for fermentation [laboratory apparatus]; breathing apparatus for underwater swimming; breathing apparatus, except for artificial respiration; apparatus and installations for the production of X-rays, not for medical purposes; cash registers; electric apparatus for commutation; intercommunication apparatus; stills for laboratory experiments; projection apparatus; radiological apparatus for industrial purposes; X-ray apparatus not for medical purposes; blueprint apparatus; flashing lights [luminous signals]; stereoscopic apparatus; telephone apparatus; facsimile machines; phototelegraphy apparatus; igniting apparatus, electric, for igniting at a distance; acid hydrometers; acid hydrometers; salinometers; acidimeters for batteries; aerometers; beacons, luminous; beacons, luminous; battery jars; barometers; anode batteries; galvanic batteries; batteries for lighting; solar batteries; solar panels for the production of electricity; batteries, electric; balances [steelyards]; betatrons; binoculars; electronic tags for goods; magnetic tape units for computers; computer memory devices; fire hose nozzles; encoded identification bracelets, magnetic; safety tarpaulins; bullet-proof clothing; signalling buoys; life buoys; marking buoys; directional compasses; directional compasses; vacuum gauges; electrolyzers; variometers; verniers; verniers; scales; letter scales; weighbridges; precision balances; levelling staffs [surveying instruments]; levelling staffs [surveying instruments]; camcorders; video baby monitors; video baby monitors; video cassettes; video telephones; video screens; viewfinders, photographic; plugs, sockets and other contacts [electric connections]; micrometer screws for optical instruments; viscosimeters; circuit closers; wavemeters; voltmeters; mechanical signs; signs, luminous; switchboxes [electricity]; current rectifiers; gas testing instruments; gasometers [measuring instruments]; galvanometers; hands-free kits for telephones; heliographic apparatus; hygrometers; hydrometers; weights; peepholes [magnifying lenses] for doors; holograms; plotters; sounding leads; plumb bobs; range finders; densimeters; densitometers; detectors; smoke detectors; counterfeit coin detectors; transparencies [photography]; slide projectors; diaphragms [photography]; Dictating machines; dynamometers; light-emitting diodes [LED]; floppy disks; sound recording discs; disks, magnetic; optical discs; circular slide rules; disk drives for co-

mputers; juke boxes for computers; DNA chips; electronic notice boards; bullet-proof waistcoats; life jackets; identification threads for electric wires; nose clips for divers and swimmers; locks, electric; bells [warning devices]; alarm bells, electric; electric door bells; signal bells; acoustic conduits; mirrors for inspecting work; road signs, luminous or mechanical; marine depth finders; probes for scientific purposes; buzzers; needles for record players; measures; pressure measuring apparatus; simulators for the steering and control of vehicles; inverters [electricity]; pressure indicators; temperature indicators; incubators for bacteria culture; measuring instruments; cosmographic instruments; mathematical instruments; levelling instruments; instruments containing eyepieces; surveying instruments; azimuth instruments; interfaces for computers; ionization apparatus not for the treatment of air or water; spark-guards; coaxial cables; fiber optic cables; cables, electric; calipers; slide calipers; screw-tapping gauges; calculating machines; pocket calculators; decompression chambers; cinematographic cameras; life-saving capsules for natural disasters; electronic pens [visual display units]; holders for electric coils; identity cards, magnetic; video game cartridges; toner cartridges, unfilled, for printers and photocopiers; memory cards for video game machines; encoded magnetic cards; riding helmets; protective helmets; protective helmets; carriers for dark plates [photography]; automated teller machines [ATM]; cathodes; spools [photography]; choking coils [impedance]; coils, electric; electromagnetic coils; cinematographic film, exposed; computer keyboards; solenoid valves [electromagnetic switches]; wire connectors [electricity]; encoded key cards; electronic book readers; electronic agendas; push buttons for bells; mouse pads; magnetic encoders; collectors, electric; calibrating rings; protective suits for aviators; commutators; compact discs [audio-video]; compact discs [read-only memory]; comparators; marine compasses; computers; laptop computers; tablet computers; notebook computers; condensers [capacitors]; contacts, electric; wind socks for indicating wind direction; traffic cones; branch boxes [electricity]; distribution boxes [electricity]; junction boxes [electricity]; battery boxes; cabinets for loudspeakers; diving suits; galena crystals [detectors]; covers for electric outlets; logs [measuring instruments]; lasers, not for medical purposes; lactodensimeters; lactometers; vacuum tubes [radio]; darkroom lamps [photography]; thermionic tubes; amplifying tubes; flashlights [photography]; head cleaning tapes [recording]; magnetic tapes; videotapes; surveying chains; fire escapes; rulers [measuring instruments]; slide-rules; contact lenses; correcting lenses [optics]; optical lenses; optical condensers; sounding lines; electricity conduits; measuring spoons; magnifying glasses [optics]; thread counters; magnets; decorative magnets; close-up lenses; close-up lenses; crash test dummies; resuscita-

tion mannequins [teaching apparatus]; mouse [computer peripheral]; pressure gauges; divers' masks; solderers' helmets; protective masks; materials for electricity mains [wires, cables]; voting machines; money counting and sorting machines; material testing instruments and machines; furniture especially made for laboratories; megaphones; portable media players; diaphragms [acoustics]; diaphragms for scientific apparatus; metal detectors for industrial or military purposes; metronomes; rules [measuring instruments]; carpenters' rules; dressmakers' measures; mechanisms for coin-operated apparatus; mechanisms for counter-operated apparatus; coin-operated mechanisms for television sets; shutter releases [photography]; micrometers; microprocessors; microscopes; microtomes; microphones; modems; lightning rods; monitors [computer hardware]; monitors [computer programs]; terminals [electricity]; junction sleeves for electric cables; teeth protectors; temperature indicator labels, not for medical purposes; knee-pads for workers; headphones; surveyors' levels; sound recording carriers; magnetic data media; optical data media; computer software, recorded; sheaths for electric cables; identification sheaths for electric wires; weighing machines; computer hardware; punched card machines for offices; life saving apparatus and equipment; shoes for protection against accidents, irradiation and fire; objectives [lenses] [optics]; lenses for astrophotography; egg-candlers; fire extinguishers; electrified fences; limiters [electricity]; clothing for protection against accidents, irradiation and fire; clothing for protection against fire; asbestos clothing for protection against fire; clothing especially made for laboratories; ozonisers [ozonators]; octants; eyepieces; ohmmeters; wrist rests for use with computers; eyeglass frames; oscillographs; plumb lines; mirrors [optics]; eyeglasses; sunglasses; goggles for sports; signalling panels, luminous or mechanical; radio pagers; pince-nez; electronic pocket translators; transmitters [telecommunication]; telephone transmitters; transmitters of electronic signals; switches, electric; periscopes; gloves for divers; gloves for protection against accidents; gloves for protection against X-rays for industrial purposes; asbestos gloves for protection against accidents; furnaces for laboratory use; pipettes; pyrometers; planimeters; plane tables [surveying instruments]; plates for batteries; wafers for integrated circuits; printed circuit boards; compact disc players; cassette players; sound recording strips; X-ray films, exposed; films, exposed; life-saving rafts; laboratory trays; digital signs; semi-conductors; polarimeters; fire pumps; measuring glassware; life belts; fuses; circuit breakers; converters, electric; telerupters; food analysis apparatus; diagnostic apparatus, not for medical purposes; distance recording apparatus; distance measuring apparatus; speed measuring apparatus [photography]; appliances for measuring the thickness of leather; apparatus for

measuring the thickness of skins; speed checking apparatus for vehicles; teaching apparatus; time recording apparatus; apparatus and instruments for astronomy; surveying apparatus and instruments; weighing apparatus and instruments; nautical apparatus and instruments; navigational instruments; optical apparatus and instruments; apparatus and instruments for physics; chemistry apparatus and instruments; measuring apparatus; measuring devices, electric; boiler control instruments; meteorological instruments; naval signalling apparatus; observation instruments; navigation apparatus for vehicles [on-board computers]; satellite navigational apparatus; regulating apparatus, electric; precision measuring apparatus; audio- and video-receivers; prisms [optics]; printers for use with computers; hemline markers; retorts' stands; apparatus for changing record player needles; drainers for use in photography; cleaning apparatus for sound recording discs; fire beaters; telescopic sights for firearms; telescopic sights for artillery; test tubes; pressure indicator plugs for valves; magnetic wires; telegraph wires; telephone wires; wires, electric; conductors, electric; copper wire, insulated; fuse wire; computer programs, recorded; computer game software; computer operating programs, recorded; record players; processors [central processing units]; rods for water diviners; electronic publications, downloadable; distribution consoles [electricity]; control panels [electricity]; radar apparatus; baby monitors; masts for wireless aerials; transmitting sets [telecommunication]; radios; vehicle radios; sprinkler systems for fire protection; frames for photographic transparencies; screens for photoengraving; walkie-talkies; voltage surge protectors; voltage regulators for vehicles; stage lighting regulators; light dimmers [regulators], electric; speed regulators for record players; cell switches [electricity]; washing trays [photography]; marking gauges [joinery]; time switches, automatic; relays, electric; safety restraints, other than for vehicle seats and sports equipment; X-ray photographs, other than for medical purposes; rheostats; respirators for filtering air; retorts; refractometers; refractors; grids for batteries; speaking tubes; horns for loudspeakers; saccharometers; optical fibers [light conducting filaments]; traffic-light apparatus [signalling devices]; dog whistles; signalling whistles; sextants; inductors [electricity]; safety nets; nets for protection against accidents; fire alarms; signals, luminous or mechanical; sirens; scanners [data processing equipment]; smartphones; integrated circuit cards [smart cards]; connections for electric lines; couplings, electric; connectors [electricity]; sonars; sound locating instruments; lighting ballasts; resistances, electric; spectrograph apparatus; spectrosopes; speed indicators; alcoholmeters; satellites for scientific purposes; protection devices for personal use against accidents; audiovisual teaching apparatus; radiotelegraphy sets;

radiotelephony sets; spectacle lenses; anti-glare glasses; optical glass; personal stereos; stereoscopes; stands for photographic apparatus; stroboscopes; fire boats; sulfimeters; bags adapted for laptops; drying racks [photography]; spherometers; integrated circuits; printed circuits; counters; parking meters; kilometer recorders for vehicles; revolution counters; abacuses; egg timers [sandglasses]; taximeters; ear plugs for divers; tachometers; television apparatus; telegraphs [apparatus]; telescopes; teleprompters; teleprinters; cellular phones; cordless telephones; theodolites; thermometers, not for medical purposes; thermostats; thermostats for vehicles; crucibles [laboratory]; tone arms for record players; totalizers; transistors [electronic]; transponders; protractors [measuring instruments]; transformers [electricity]; step-up transformers; vehicle breakdown warning triangles; triodes; starter cables for motors; discharge tubes, electric, other than for lighting; capillary tubes; neon signs; Pitot tubes; X-ray tubes not for medical purposes; telephone receivers; gauges; quantity indicators; automatic indicators of low pressure in vehicle tires; gasoline gauges; water level indicators; electric loss indicators; light-emitting electronic pointers; slope indicators; levels [instruments for determining the horizontal]; mercury levels; spirit levels; urinometers; amplifiers; particle accelerators; electric installations for the remote control of industrial operations; steering apparatus, automatic, for vehicles; balancing apparatus; video recorders; sound reproduction apparatus; invoicing machines; tape recorders; protection devices against X-rays, not for medical purposes; railway traffic safety appliances; data processing apparatus; oxygen transpiring apparatus; theft prevention installations, electric; film cutting apparatus; drying apparatus for photographic prints; optical character readers; centering apparatus for photographic transparencies; dosage dispensers; battery chargers; chargers for electric batteries; acoustic alarms; sounding apparatus and machines; apparatus for editing cinematographic film; cathodic anti-corrosion apparatus; couplers [data processing equipment]; anti-theft warning apparatus; computer peripheral devices; anti-interference devices [electricity]; demagnetizing apparatus for magnetic tapes; acoustic couplers; alarms; fog signals, non-explosive; whistle alarms; adding machines; readers [data processing equipment]; heat regulating apparatus; photocopiers [photographic, electrostatic, thermic]; bar code readers; computer software applications, downloadable; downloadable ring tones for mobile phones; downloadable image files; downloadable music files; animated cartoons; filters [photography]; filters for respiratory masks; filters for ultraviolet rays, for photography; USB flash drives; magic lanterns; optical lamps; signal lanterns; cameras [photography]; glazing apparatus for photographic prints; shutters [photography]; darkrooms [photography]; photometers; flash-bulbs

[photography]; digital photo frames; enlarging apparatus [photography]; photovoltaic cells; containers for contact lenses; eyeglass cases; containers for microscope slides; cases especially made for photographic apparatus and instruments; chromatography apparatus for laboratory use; chronographs [time recording apparatus]; laboratory centrifuges; cyclotrons; compasses for measuring; frequency meters; time clocks [time recording devices]; Petri dishes; sleeves for laptops; fire blankets; chips [integrated circuits]; jigs [measuring instruments]; pedometers; meteorological balloons; electrified rails for mounting spot lights; asbestos screens for firemen; fire hose; protective helmets for sports; cell phone straps; tripods for cameras; switchboards; distribution boards [electricity]; screens [photography]; workmen's protective face-shields; projection screens; radiology screens for industrial purposes; fluorescent screens; exposure meters [light meters]; ducts [electricity]; galvanic cells; epidiascopes; ergometers; armatures [electricity]; pince-nez chains; pince-nez cords; pince-nez cases; pince-nez frames; breathing apparatus, except for artificial respiration; money counting and sorting machines; reflecting discs for wear, for the prevention of traffic accidents; anti-glare visors/anti-dazzle shades; optical goods; loudspeakers; voltmeters; lens hoods; accelerometers; electrical adapters; text processors.

12 – Motor buses; motor coaches; motor homes; cars; sports cars; concrete mixing vehicles; refrigerated vehicles; caravans; shock absorbers for automobiles; suspension shock absorbers for vehicles; space vehicles; aircraft; aeronautical apparatus, machines and appliances; air cushion vehicles; hot air balloons; luggage carriers for vehicles; ski carriers for cars; bumpers for automobiles; vehicle bumpers; tires for vehicle wheels; barges; brake shoes for vehicles; tailboard lifts [parts of land vehicles]; buffers for railway rolling stock; mine cars; tilt trucks; railway carriages; sleeping cars; dining cars; refrigerated railway wagons; transmission shafts for land vehicles; bicycles; valves for vehicle tires; automobile hoods; stroller hoods; hoods for vehicles; oars; sculls; screws [propellers] for ships; hydroplanes; seaplanes; flanges for railway wheel tires; trucks; horns for vehicles; treads for vehicles [tractor type]; doors for vehicles; bicycle motors; engines for land vehicles; jet engines for land vehicles; driving motors for land vehicles; screw-propellers; screw-propellers for boats; airships; telfer railways [cable cars]; dredgers [boats]; trolleys; adhesive rubber patches for repairing inner tubes; bicycle bells; rear-view mirrors; portholes; cars for cable transport installations; inner tubes for bicycle tires; inner tubes for pneumatic tires; hoods for vehicle engines; cranks for land vehicle components, other than for engines; boats; caissons [vehicles]; bicycle wheels; vehicle wheels; mine cart wheels; casters for trolleys [vehicles]; brake pads for automobiles; hub caps;

strollers; side cars; brake linings for vehicles; ships; baskets adapted for bicycles; gear boxes for land vehicles; ship hulls; panniers adapted for bicycles; fenders for ships; bands for wheel hubs; ejector seats for aircraft; wheelchairs; caps for vehicle fuel tanks; boat hooks; automobile bodies; tipping bodies for trucks; bodies for vehicles; treads for retreading tires; locomotives; masts for boats; sprinkling trucks; propulsion mechanisms for land vehicles; mopeds; motorcycles; freewheels for land vehicles; clutches for land vehicles; repair outfits for inner tubes; air pumps [vehicle accessories]; pumps for bicycle tires; upholstery for vehicles; rims for bicycle wheels; rims for vehicle wheels; windows for vehicles; omnibuses; axles for vehicles; headlight wipers; parachutes; ferry boats; bicycle pedals; gearing for land vehicles; carts; head-rests for vehicle seats; bicycle kickstands; vehicle running boards; air bags [safety devices for automobiles]; ski lifts; chairlifts; casings for pneumatic tires [tyres]; sleeping berths for vehicles; pontoons; torque converters for land vehicles; cigar lighters for automobiles; anti-glare devices for vehicles; anti-theft devices for vehicles; sun-blinds adapted for automobiles; non-skid devices for vehicle tires; balance weights for vehicle wheels; shock absorbing springs for vehicles; bicycle frames; spars for ships; reduction gears for land vehicles; safety belts for vehicle seats; security harness for vehicle seats; vehicle suspension springs; steering wheels for vehicles; rudders; bicycle handlebars; bicycle cranks; aeroplanes; amphibious airplanes; sleighs [vehicles]; kick sledges; brake segments for vehicles; bicycle saddles; luggage nets for vehicles; dress guards for bicycles; anti-theft alarms for vehicles; reversing alarms for vehicles; safety seats for children, for vehicles; vehicle seats; hydraulic circuits for vehicles; push scooters [vehicles]; snowmobiles; rolling stock for railways; rolling stock for funicular railways; spokes for bicycle wheels; vehicle wheel spokes; spoilers for vehicles; air vehicles; vehicles for locomotion by land, air, water or rail; ambulances; water vehicles; remote control vehicles, other than toys; electric vehicles; tricycles; delivery tricycles; inclined ways for boats; windscreens; windshield wipers; motorcycle kickstands; hubs for bicycle wheels; hubs for vehicle wheels; railway couplings; trailer hitches for vehicles; couplings for land vehicles; wheelbarrows; handling carts; two-wheeled trolleys; motorized golf carts [vehicles]; shopping trolleys; hose carts; bogies for railway cars; casting carriages; tilting-carts; forklift trucks; cleaning trolleys; bicycle brakes; brakes for vehicles; torsion bars for vehicles; tractors; tramcars; transmissions for land vehicles; military vehicles for transport; aerial conveyors; trailers [vehicles]; funnels for ships; funnels for locomotives; cleats [nautical]; turbines for land vehicles; rowlocks; disengaging gear for boats; steering gears for ships; cable transport apparatus and installations; spoke clips for wheels; tipping

apparatus [parts of railway wagons]; funiculars; vans [vehicles]; undercarriages for vehicles; automobile chains; bicycle chains; driving chains for land vehicles; anti-skid chains; transmission chains for land vehicles; stroller covers; spare wheel covers; covers for vehicle steering wheels; saddle covers for bicycles; saddle covers for motorcycles; seat covers for vehicles; vehicle covers [shaped]; automobile chassis; vehicle chassis; connecting rods for land vehicles, other than parts of motors and engines; axle journals; gears for bicycles; tubeless tires for bicycles; bicycle tyres; automobile tires; tires for land vehicles; pneumatic tires; spikes for tires; davits for boats; launches; timbers [frames] for ships; mudguards; bicycle mudguards; motors, electric, for land vehicles; yachts; direction indicators for bicycles; direction signals for vehicles/turn signals for vehicles; bicycle or motorcycle saddles; oars; dining cars [carriages]/dinner wagons [carriages]; locomobiles; yachts.

(260) AM 2019 100838 A

(800) 1440055

(151) 2018 10 16

(891) 2018 10 16

(731) "IMPALA COSMETICS" EOOD

"17th January" Str. No.53, BG-8800 Sliven,
Bulgaria

(540)

ORYX

(591) Black, white

(511)

3 – Cosmetics; decorative cosmetics; adhesives for cosmetic purposes; cosmetic creams; lotions for cosmetic purposes; greases for cosmetic purposes; beauty masks; make-up; make-up preparations; pomades for cosmetic purposes; make-up powder; cream foundation; creamy rouge; liquid rouge; blush pencils; cotton swabs for cosmetic purposes; make-up removing preparations; tissues impregnated with make-up removing preparations; cosmetic pencils; cosmetic preparations for eyelashes; mascara; eyebrow cosmetics; eyebrow pencils; lipsticks; lip liners; lip glosses; false nails; nail art stickers; nail care preparations; nail varnish; nail conditioners; nail varnish removers; eye shadows; eye pencils.

(260) AM 2019 100839 A

(800) 1440068

(151) 2018 06 21

(891) 2018 06 21

(731) EURO GAMES TECHNOLOGY LTD.

"Maritsa" Str. 4, "Vranya-Lozen-Triugulnika",
BG-1151 Sofia, Bulgaria

(540)

WALL STREET BOY

(591) Light blue, purple and white
 (531) 27.05.02; 27.05.04; 27.05.09; 29.01.12
 (511)
 9 – Apparatus for recording, transmission or reproduction of sound or image; computer software, recorded; monitors [computer hardware].
 28 – Games; coin operated gaming machines; gaming machines adapted for use with an external screen or monitor.

(260) AM 2019 100840 A
 (800) 1440077
 (151) 2018 10 09
 (891) 2018 10 09
 (731) SFERA JOVEN, S.A.
 Hermosilla, 112, E-28009 MADRID, Spain
 (540)



(591) Black, white
 (531) 03.09.14
 (511)
 25 – Clothing, footwear, headgear.

(260) AM 2019 100847 A
 (800) 1440287
 (151) 2018 08 10
 (891) 2018 08 10
 (731) RK GROWERS SRL
 Corso Italia, 56, I-12037 SALUZZO (CN), Italy
 (540)



(591) Light blue, red, green and black
 (531) 05.07.23; 27.01.01; 27.03.11; 29.01.14
 (511)
 31 – Grains and agricultural, horticultural and forestry products not included in other classes; fresh fruits and vegetables; seeds; natural plants and flowers; apples; malt.

(260) AM 2019 100946 A
 (800) 1438588
 (151) 2018 09 04

(891) 2018 09 04
 (731) CHATEAU LION INVESTMENT HOLDING (BEIJING) GROUP CO., LTD
 west of Changzhou Road, No.1 Village, Daotian, Changyang town, Fangshan District, Beijing, China
 (540)



(591) Black, white
 (531) 01.03.16; 04.03.01; 24.01.07; 24.01.17; 24.01.18; 24.01.19; 24.09.01; 24.09.05
 (511)
 33 – Fruit extracts, alcoholic; aperitifs; distilled beverages; cocktails; wine; spirits [beverages]; brandy; alcoholic extracts; alcoholic beverages, except beer; alcoholic beverages containing fruit.

(260) AM 2019 100947 A
 (800) 1438596
 (151) 2018 06 21
 (891) 2018 06 21
 (731) EURO GAMES TECHNOLOGY LTD.
 "Maritsa" Str. 4, "Vranya-Lozen-Triugulnika", BG-1151 Sofia, Bulgaria
 (540)



(591) Black, red, yellow and orange
 (511)
 9 – Apparatus for recording, transmission or reproduction of sound or image; data processing equipment and computers.
 28 – Games and toys, that are not included in other classes.

(260) AM 2019 100951 A
 (800) 1438666
 (151) 2018 09 04
 (891) 2018 09 04
 (731) SHENZHEN ROMOSS TECHNOLOGY CO., LTD.
 4F, South YuYang Building, No.3 Qimin Rd., Songpingshan, Northern Section, Hi-Tech Industrial Park, Nanshan District, Shenzhen, Guangdong Province, China

(540)



(591) Black, white

(531) 26.01.03; 26.01.17; 26.01.22; 27.05.01;
27.07.01

(511)

35 – Advertising; shop window dressing; presentation of goods on communication media, for retail purposes; business management and organization consultancy; import-export agencies; sales promotion for others; personnel management consultancy; search engine optimization for sales promotion; web site traffic optimization; compiling indexes of information for commercial or advertising purposes; market research by means of a computer database.

(260) AM 2019 100956 A

(800) 1438688

(151) 2018 09 13

(891) 2018 09 13

(731) PHILIP MORRIS BRANDS SÀRL

Quai Jeanrenaud 3, CH-2000 Neuchâtel,
Switzerland

(540)



(591) Black, white

(531) 02.01.05; 09.07.25; 10.03.01; 25.07.23;
26.04.02; 26.04.12; 26.04.18; 26.04.24;
26.11.03; 26.11.09; 27.05.24

(511)

34 – Tobacco, raw or manufactured; tobacco products; cigars, cigarettes, cigarillos, tobacco for roll-your-own cigarettes, pipe tobacco, chewing tobacco, snuff tobacco, kretek; snus; tobacco substitutes (not for medical purposes); electronic cigarettes; tobacco products for the purpose of being heated; electronic devices and their parts for the purpose of heating cigarettes or tobacco in order to release nicotine-containing aerosol for inhalation; liquid nicotine solutions for use in electronic cigarettes; smokers' articles, cigarette paper, cigarette tubes, cigarette filters,

tobacco tins, cigarette cases, ashtrays, pipes, pocket apparatus for rolling cigarettes, lighters, matches.

(260) AM 2019 100967 A

(800) 1438922

(151) 2018 11 09

(891) 2018 11 09

(731) Open-Type Joint Stock Company "ROT FRONT"

2-oy Novokuznetskiy pereulok, d. 13/15,
RU-115184 Moscow, Russian Federation

(540)

МЯТЛИК

(591) Black, white

(531) 28.05

(511)

30 – High-protein cereal bars; pancakes; bread rolls; waffles; malt biscuits; fruit jellies [confectionery]; confectionery for decorating Christmas trees; cakes; pastries; peanut confectionery; almond confectionery; cocoa; caramels [candy]; sweetmeats [candy]; liquorice [confectionery]; peppermint sweets; crackers; macarons [pastry]; muesli; pastilles [confectionery]; cookies; petit-beurre biscuits; pies; fondants [confectionery]; pralines; gingerbread; petits fours [cakes]; confectionery; rusks; halvah; chocolate; tea; coffee.

(260) AM 2019 100968 A

(800) 1438932

(151) 2018 10 16

(891) 2018 10 16

(731) SHMULEVYCH VITALII NAUMOVYCH

vul. Levanevskoho, 7, kv. 63, m. Odesa
65062, Ukraine;

MARKUSHEVSKYI IGOR ISAAKOVYCH

vul. Bolharska, 82, kv. 8, m. Odesa 65005,
Ukraine;

MASLENKOV VOLODYMYR

MYKOLAIOVYCH

vul. Marshala Hovorova, 1-2, kv. 101,
m. Odesa 65068, Ukraine

(540)

SVIZHAK

(591) Black, white

(511)

33 – Alcoholic beverages, except beer; alcoholic beverages containing fruit; anisette [liqueur]; anise [liqueur]; aperitifs; arrack [arak]; brandy; wine; whisky; vodka; kirsch; perry; gin; digesters [liqueurs and spirits]; cocktails; liqueurs; hydromel [mead]; peppermint liqueurs; pre-mixed alcoholic beverages, other than beer-based; bitters; distilled beverages; piquette; rice alcohol; rum; cider; spirits [beverages];

alcoholic extracts; alcoholic essences; fruit extracts, alcoholic.

(260) AM 2019 100969 A

(800) 1438977

(151) 2018 11 10

(891) 2018 11 10

(731) APPLE INC.

One Apple Park Way, Cupertino CA 95014, USA

(540)

SWIFTSHOT

(591) Black, white

(511)

9 – Computer game software.

(260) AM 2019 100970 A

(800) 1439019

(151) 2018 08 09

(891) 2018 08 09

(731) EVOLUTION MALTA LIMITED

Level 1, The Centre, Tigne Point, TPO 0001 SLIEMA, Malta

(540)

Evolution gaming

(591) Black, white

(511)

9 – Computer software platforms; databases; computer programs for network management; interactive computer systems.

28 – Gaming machines for gambling; coin-operated games; counters [discs] for games.

35 – Maintenance of data in computer databases.

41 – Casino, gaming and gambling services; gambling services; providing casino facilities [gambling]; leasing of casino games; services for the operation of computerised bingo; game services provided on-line from a computer network; providing of casino and gaming facilities; entertainment provided via the internet; organization of lotteries; production of live television programmes for entertainment; entertainment services; entertainment services provided on-line from a computer database or the internet; education, entertainment and sport services; education, entertainment and sports.

42 – Computer programming; information technology [IT] consultancy services; software development, programming and implementation; IT consultancy, advisory and information services; design, development and programming of computer software; hosting services and software as a service and rental of software; design services; science and technology services.

(260) AM 2019 100971 A

(800) 1439023

(151) 2018 06 06

(891) 2018 06 06

(731) GLOBAL NOTÍCIAS-MEDIA GROUP, S.A.

FILIAL RUA TOMÁS DA FONSECA,

TORRE E, 3º, P-1600-209 LISBOA, Portugal;

GLOBAL NOTÍCIAS-MEDIA GROUP, S.A.

RUA GONÇALO CRISTÓVÃO, 195 A 219,

P-4049-011 PORTO, Portugal

(540)



(591) Black, white

(531) 26.04.19; 27.05.01; 27.05.11

(511)

35 – Merchandising; organisation of events for commercial and advertising purposes.

41 – Football betting services; betting services; conducting of sports events; organisation and conducting of educational events; online gaming and gambling services; organisation of entertainment and cultural events; organisation of sports events.

42 – Design, development and programming of computer software; IT (information technology) services being software design and development; development of new technology for others; IT (information technology) consultancy, advisory and information services; dissemination and provision of information relating to information technology; research in the field of information technology; information technology technical support services; Internet walled garden services, namely hosting closed platforms on the Internet; programming of software for information platforms on the Internet.

(260) AM 2019 100973 A

(800) 1439119

(151) 2018 10 18

(891) 2018 10 18

(731) SHANDONG HUASHENG RUBBER CO., LTD.

Daozhuang Town Government Station,

Guangrao County, DONGYING CITY,

257336, China

(540)

CASTLE

(591) Black, white

(531) 27.05.01

(511)

12 – Repair outfits for inner tubes.

(260) AM 2019 100974 A
 (800) 1439186
 (151) 2018 09 30
 (891) 2018 09 30
 (731) EXLTERRA PRODUCTS SA
 Chemin du Pré-Fleuri 3, CH-1228 Plan-les-
 Ouates, Switzerland

(540)



(591) Black, white
 (531) 01.15.15; 26.05.01; 26.05.13; 27.05.01
 (511)
 7 – Ground drilling machines; drilling machines and
 their parts.

(260) AM 2019 100975 A
 (800) 1439195
 (151) 2018 11 01
 (891) 2018 11 01
 (731) TIMI PERSONAL COMPUTING CO., LTD.
 NO.3, 11TH FLOOR, THE RAINBOW CITY
 OFFICE BUILDING, 68 QINGHE MID
 STREET, HAIDIAN DISTRICT, BEIJING,
 100028, China

(540)



(591) Black, white
 (531) 26.11.01; 26.11.11; 26.15.09; 27.05.21
 (511)
 9 – Mouse [computer peripheral]; computer periph-
 eral devices; computer keyboards; sensors; naviga-
 tion apparatus for vehicles [on-board computers];
 headphones; selfie lenses; face recognition equip-
 ment; induced voltage regulators; inductors [elec-
 tricity]; chips [integrated circuits]; mobile software
 applications, downloadable; batteries, electric.

42 – Computer system design; software as a service
 [SaaS]; computer software design; conversion of da-
 ta or documents from physical to electronic media;
 creating and maintaining web sites for others; con-
 sultancy in the design and development of computer
 hardware; design of interior décor; industrial design;
 technical research; quality control.

(260) AM 2019 100976 A
 (800) 1439337
 (151) 2018 11 07
 (891) 2018 11 07
 (731) LENZING AKTIENGESELLSCHAFT
 Werkstr. 2, A-4860 Lenzing, Austria

(540)

LENZING

(591) Black, white
 (511)
 1 – Wood pulp; pulp (wood -); groundwood pulp;
 paper pulp; pulp (paper -); rag pulp; sulphite pulp;
 cellulose pulp; deinked pulp; thermomechanical
 pulp; straw pulp; esparto pulp; bast pulp; chemi-
 mechanical pulp; paper paste [pulp]; chemiground
 wood pulp; recycled paper pulp; cellulose pulp [raw
 material]; paper pulp for manufacturing purposes;
 pulp for use in papermaking; wood pulp for manu-
 facturing purposes; dissolving wood pulp for manu-
 facturing purposes; dispersants for use in the pulp
 industry; cellulose pulp for the manufacture of pa-
 per; pulp for use in the manufacture of paper; pulp
 for use in the manufacture of board; auxiliary fluids
 for use with additives for wood pulp; bagasse pulp
 for use in the manufacture of paper; additives (che-
 mical -) for use in the treatment of paper pulp; che-
 mical sizing compositions for use in the manufacture
 of pulp; enzymes for removing resins from pulp in
 the paper fabrication industry.

(260) AM 2019 101043 A
 (800) 1441346
 (151) 2018 11 30
 (891) 2018 11 30
 (731) AVON PRODUCTS, INC.
 601 Midland Avenue, Rye New York 10580,
 USA

(540)

AVON SEGNO SUCCESS

(591) Black, white
 (511)
 3 – Non-medicated toilet preparations; toiletries;
 skin care preparations; skin moisturizers; body and
 beauty care preparations; powders, cleansers, creams
 and lotions, all for the face, hands and body; cos-
 metical suntan preparations; soaps; shower and bath
 preparations; beauty masks; talcum powder; nail
 polish; nail polish remover; false nails; adhesives for
 cosmetic purposes; cosmetics; eye cream; eye gels;
 eye lotions; eye make-up remover; eye shadow; eye
 liner; mascara; lipstick; lip liner; lip-gloss; make-up
 foundation; blusher; tissues impregnated with cos-
 metical lotions; cotton sticks for cosmetic purposes;
 cotton wool for cosmetic purposes; preparations for
 cleaning, moisturising, colouring and styling the ha-
 ir; preparations for cleaning the teeth; shaving and
 aftershave preparations; perfumes; fragrances; toilet

waters; cologne; deodorants for human beings; anti-perspirants for personal use (toiletries); essential oils (cosmetic).

(260) AM 2019 101060 A

(800) 1247157

(151) 2015 01 17

(891) 2018 07 12

(731) REGENBOGEN LEUCHTEN GMBH

Bismarckstraße 45, 10627 Berlin, Germany

(540)



(591) Black, red and yellow

(531) 26.11.03; 26.11.06; 26.11.07; 26.11.08;
27.05.17; 29.01.13

(511)

11 – Apparatus for lighting, heating, steam generating, cooking, refrigerating, drying, ventilating, water supply and sanitary purposes.

35 – Retail services, even online, with electrical goods and electronic goods, office supplies, furnishings and decorations, especially decorative lighting elements such as wall, floor, ceiling lights and spotlights.

(260) AM 2019 101066 A

(800) 1441974

(151) 2018 10 19

(891) 2018 10 19

(731) MERCK KGAA

Frankfurter Straße 250, 64293 Darmstadt,
Germany

(540)

Кринон

(591) Black, white

(531) 28.05

(511)

5 – Pharmaceutical preparations for human use.

(260) AM 2019 101067 A

(800) 1441990

(151) 2018 10 22

(891) 2018 10 22

(731) CERRAD Spółka z ograniczoną

Odpowiedzialnością
ul. Radomska 49B, PL-27-200 Starachowice,
Poland

(540)



(591) Black, white

(531) 26.04.01; 26.04.05; 26.04.18; 27.05.10

(511)

19 – Earthenware tiles; glazed ceramic tiles; ceramic tiles for flooring and lining; ceramic wall tiles; ceramic tiles for external floors; ceramic tiles for external walls; clay slabs; terra-cotta floor tiles.

(260) AM 2019 101068 A

(800) 1441992

(151) 2018 09 13

(891) 2018 09 13

(731) EPIC GAMES, INC.

620 Crossroads Boulevard, Cary NC 27518,
USA

(540)

FORTNITE

(591) Black, white

(511)

18 – Carry-all bags; all-purpose carrying bags; sack packs, namely, drawstring bags used as backpacks; ruck sacks; knap sacks; traveling bags; sports bags; school bags; hand bags; gym bags; athletic bags; book bags; messenger bags; tote bags; travelling sacks; bags, duffle bags, waist bags, wallets, card cases, credit card cases and holders, carrying cases, name card cases, business card cases.

21 – Lunch kits comprised of lunch boxes, lunch boxes, lunch pails.

25 – Belts.

(260) AM 2019 101069 A

(800) 1442017

(151) 2018 08 03

(891) 2018 08 03

(731) PRAVANA INTERNATIONAL, LLC

5800 Bristol Parkway, Culver City CA 90230,
USA

(540)

PRAVANA

(591) Black, white

(511)

3 – Hair care preparations; hair coloring preparations; hair styling preparations.

8 – Electric hair tools, namely thermal lightening hair wand.

21 – Hair brushes; hair color application bottles; hair color application brushes; hair combs; hair picks; hair styling implements.

(260) AM 2019 101070 A

(800) 1442057

(151) 2018 06 21

(891) 2018 06 21

(731) EURO GAMES TECHNOLOGY LTD.
"Maritsa" Str. 4, "Vranya-Lozen-Triugulnika",
BG-1151 Sofia, Bulgaria

(540)



(591) Brown, black, green, white and red.

(531) 02.01.20; 09.07.21; 18.02.15; 27.05.01;
27.05.02; 27.07.01; 27.07.02; 29.01.15

(511)

9 – Apparatus for recording, transmission or reproduction of sound or image; computer software, recorded; computer monitors [hardware].

28 – Games; coin and card operated gaming machines; gaming machines for gambling.

(260) AM 2019 101105 A

(800) 1442770

(151) 2018 09 07

(891) 2018 09 07

(731) HENAN CHICHENG ELECTRIC CO.,
LTD.C2D5, NO.11, Chang Chun Road, New
High-Tech District, Zheng Zhou, Henan
Province, China

(540)



(591) Black, white

(531) 26.03.01; 27.01.01; 27.01.05; 27.05.21

(511)

9 – Detectors; air analysis apparatus; gas testing instruments; whole set electric checking apparatus; cables, electric; power station automation equipment; protection devices for personal use against accidents; alcohol content meters; integrated circuit blocks; fire alarms.

(260) AM 2019 101114 A

(800) 1442915

(151) 2018 10 04

(891) 2018 10 04

(731) GRAFF DIAMONDS LIMITED
29 Albemarle Street, W1S 4JA Londres,
United Kingdom

(540)

G R A F F

(591) Black, white

(531) 27.05.01; 27.05.15

(511)

3 – Non-medicated cosmetics and toiletry preparations; non-medicated dentifrices; perfumery, essential oils; perfumes, eau de parfum, toilet water, eau de Cologne, scented water, shampoos, cosmetic preparations for baths, cosmetic preparations for skin care, body deodorants, cleansing milk for toilet purposes, lotions for cosmetic purposes, soap, cakes of toilet soap, air fragrancing preparations, home fragrances.

4 – Candles, perfumed candles.

(260) AM 2019 101115 A

(800) 1442926

(151) 2018 11 09

(891) 2018 11 09

(731) Open-Type Joint Stock Company "ROT
FRONT"2-oy Novokuznetskiy pereulok, d. 13/15,
RU-115184 Moscow, Russian Federation

(540)

ПРОЧай

(591) Black, white

(531) 27.05.09; 27.05.10; 27.05.17; 28.05

(511)

30 – High-protein cereal bars; pancakes; bread rolls; waffles; malt biscuits; fruit jellies [confectionery]; confectionery for decorating Christmas trees; cakes; pastries; peanut confectionery; almond confectionery; cocoa; caramels [candy]; sweetmeats [candy]; liquorice [confectionery]; peppermint sweets; crackers; macaroons [pastry]; muesli; pastilles [confectionery]; cookies; petit-beurre biscuits; pies; fondants [confectionery]; pralines; gingerbread; petits fours [cakes]; confectionery; rusks; halvah; chocolate; tea; coffee.

(260) AM 2019 101116 A

(800) 1442954

(151) 2018 11 06

(891) 2018 11 06

(731) KRKA, tovarna zdravil, d.d., Novo mesto
Šmarješka cesta 6, SI-8000 Novo mesto,
Slovenia

(540)

LAMEGOM

(591) Black, white

(511)

5 – Pharmaceutical preparations.

(260) AM 2019 101117 A
 (800) 1443027
 (151) 2018 09 06
 (891) 2018 09 06
 (731) AVISTA OIL AG
 Bahnhofstraße 82, 31311 UETZE, Germany
 (540)

AVISTA

(591) Black, white
 (511)

1 – Filtering media of chemical and non-chemical substances included in the class; chemical preparations and materials for film, photography and printing; unprocessed plastics; adhesives for industrial purposes; detergents for use in manufacture and industry; chemical substances, chemical materials and chemical preparations; salts for industrial purposes; unprocessed artificial and synthetic resins; starches for use in manufacturing and industry; putties, fillers and pastes for use in industry; chemical and organic compositions for use in the manufacture of food and beverages.

19 – Building and construction materials and elements, not of metal; doors, gates, windows and window coverings, not of metal; structures and transportable buildings, not of metal; unprocessed and semi-processed materials included in the class, not specified for use namely pitch, tar, bitumen and asphalt, stone, rock, clay and minerals, wood and artificial wood; statues and works of art, included in the class; parts and fittings of all the aforesaid goods, included in the class.

40 – Customer-specific fabrication and preparation services, namely 3D printing, acrylic finishing of vehicles, etching, custom manufacture of biopharmaceuticals, metal fabrication and finishing services, oil-spill treatment, lead working, moulding of concrete, boilermaking, custom manufacture of metal hardware, custom manufacture of molds for use in industry, custom construction of machines, custom color compounding of paint, metal stamping, blacksmithing, custom manufacture of molded components, energy production, treatment and transformation of materials, namely textile, leather and fur treatment; recycling and waste treatment; printing, and photographic and cinematographic development; duplication of audio and video recordings; air and water conditioning and purification; slaughtering; hiring, rental and leasing of objects in connection with the provision of the before mentioned services, as far as included in this class; information and consultancy relating to the aforesaid services, as far as included in this class.

(260) AM 2019 101118 A
 (800) 1443029
 (151) 2018 07 17

(891) 2018 07 17
 (731) ORIFLAME COSMETICS AG
 c/o Oriflame Global Management AG,
 Bleicheplatz 3, CH-8200 Schaffhausen,
 Switzerland

(540)

GIORDANI GOLD MASTERCREATION

(591) Black, white
 (511)

3 – Non-medicated conditioning and care preparations for application to the hair, scalp, skin and nails; shampoos; hair conditioner; soaps; perfumes; perfumery; eau de cologne; toilet waters; essential and herbal oils; cosmetics; make-up; make-up preparations; lipsticks; nail varnishes; nail varnish removers; eyeliner; mascara; non-medicated toilet preparations; hair lotions; hair sprays and hair gels; preparations for use in the bath or shower; bath and shower oils, gels, creams and foams; face and body masks; face and body scrubs; facial washes; skin cleansers and hydrators; skin toners; skin moisturizers; blemish creams and blemish gels; deodorants; anti-perspirants; preparations for use before shaving and after shaving; shaving soaps; shaving creams; shaving gels; after-shave preparations; pre-shave preparations; talcum powders; toiletries; dentifrices; toothpastes; foot care preparations (non-medicated -).

(260) AM 2019 101119 A
 (800) 1443066
 (151) 2018 06 28
 (891) 2018 06 28
 (731) LEA BRAND S.r.l.
 Via Duca d'Aosta, 81, I-80045 POMPEI (NA),
 Italy
 (540)

ELPLAYER

(591) Black, white
 (531) 27.05.01; 27.05.17
 (511)

25 – Clothing; sportswear; clothing for gymnastics; suits; bathrobes; berets; underwear; suspenders; leotards; footwear; training shoes; stockings; socks; breeches; swimming trunks; shirts; sports singlets; hats; coats; stuff jackets [clothing]; belts [clothing]; belts (money -) [clothing]; tights; shoulder wraps; swimming costumes; beachwear; neckties; bathing caps; scarves; jackets [clothing]; fishing vests; neck scarves [mufflers]; stuff jackets [clothing]; skirts; aprons [clothing]; gloves [clothing]; ski gloves; leggings [trousers]; maillots; hosiery; sweaters; trousers; mules; parkas; furs [clothing]; pyjamas; sandals; bath sandals; leg warmers; shoes; gymnastic shoes; football boots; training shoes; ski boots; beach shoes; sashes for wear; shawls; topcoats; boots;

football boots; studs for football boots; tee-shirts; footwear soles; combinations [clothing]; visors [headwear]; robes; wooden shoes; menswear; rainproof clothing; children's wear; leisurewear; dance clothing; clothing for skiing; ladies' clothing; men's socks; sports socks; tank tops; clothing for men, women and children; headgear; wrist warmers; sweatbands; headbands, sweatshirts; kerchiefs [clothing]; foulards [clothing articles]; cagoules; track jackets; polar fleece jackets; sports jackets; blousons; gilets; body warmers; gym suits; denim jeans; kimonos; running vests; padded shirts for athletic use; football jerseys; warm-up tops; morning coats; wet suits for surfing; gym shorts; padded shorts for athletic use; sweatpants; ear muffs [clothing]; bowties; bathing suit cover-ups; polo shirts; stiffeners for shoes; jumper suits; goloshes; sport coats; tightening-up strings for kimonos (datejime); running suits; jogging sets [clothing]; snow suits; twin sets.

(260) AM 2019 101120 A

(800) 1443186

(151) 2018 06 13

(891) 2018 06 13

(731) LADUREE INTERNATIONAL SA

Route des Rez 2, CH-1667 Enney, Bas-Intyamon, Switzerland

(540)



(591) Gold

(531) 05.13.04; 05.13.07; 25.01.09; 25.01.10; 29.01.02

(511)

29 – Meat, fish, poultry and game; meat extracts; preserved, frozen, dried and cooked fruits and vegetables; jellies, jams, compotes; eggs; milk and dairy products; edible oils and fats; prepared dishes, based on vegetables, meat, fish, poultry or game, meat, fish, poultry and game, meat extracts, preserved, deep-frozen, dried and cooked fruits and vegetables, potato crisps, preserved garden herbs, Provence herbs, pine nuts, prepared seeds including sesame and poppy, preserved olives, tapenades, prepared walnuts and hazelnuts, prepared almonds, pickles, dried fried onions, jellies, jams, compotes, fruit salads, candied fruits, fruit snacks, vegetable salads, soups, eggs, milk and dairy products, butter, cheeses, yogurt, cream, pastry cream, whipped cream, crème brûlée, edible oils and fats, edible fats, charcuterie, ham, bacon, sausages, salted foods, smoked salmon,

crustaceans (not live), canned meat and fish especially tuna, non-alcoholic milk beverages where milk predominates.

30 – Coffee, tea, cocoa and artificial coffee; rice; tapioca and sago; flour and preparations made from cereals; bread, pastry and confectionery products; edible ices; sugar, honey, golden syrup; yeast, baking powder; salt; mustard; vinegar, sauces (condiments); spices; ice for refreshment; coffee, tea, cocoa, sugar, bread, rusks, pastry, confectionery, Viennese pastries, cakes, pancakes (foodstuffs), edible decorations for cakes, edible ices, custard, honey, golden syrup, ice for refreshment, chocolate; beverages based on coffee, tea, cocoa or chocolate; prepared (or cooked) dishes made with dough, pasta or rice; coffee, tea, cocoa, sugar, rice, tapioca, sago, artificial coffee; flour for food and cereal preparations; bread, rusks, pastry, confectionery, Viennese pastries, cakes, pancakes (foodstuffs), edible decorations for cakes, pizzas, quiches, tacos, tortillas, sandwiches, pasta, meat pies, edible ices, custard, honey, golden syrup, yeast, baking-powder, salt, mustard, vinegar, seasonings, condiments, preserved garden herbs, spices, ice for refreshment, chocolate; beverages based on coffee, tea, cocoa or chocolate; mayonnaise; iced tea, flowers or leaves as tea substitutes.

32 – Beers; mineral and aerated waters and other non-alcoholic beverages; beverages based on fruit and fruit juices; syrups and other preparations for making beverages.

33 – Alcoholic beverages (except beers).

35 – Advertising; commercial business management; commercial administration; office functions; retail sale of foodstuffs including: prepared dishes based on vegetables, meat, fish, poultry or game, meat, fish, poultry and game, meat extracts, preserved, deep-frozen, dried and cooked fruits and vegetables, potato crisps, preserved garden herbs, Provence herbs, pine nuts, prepared seeds especially sesame and poppy, preserved olives, tapenades, prepared nuts and hazelnuts, prepared almonds, pickles, dried fried onions, jellies, jams, compotes, fruit salads, candied fruits, fruit snacks, vegetable salads, soups, eggs, milk and dairy products, butter, cheeses, yogurt, cream, pastry cream, whipped cream, crème brûlée, edible oils and fats, edible fats, charcuterie, ham, bacon, sausages, salted foods, smoked salmon, crustaceans (not live), canned meat and fish especially tuna, non-alcoholic milk beverages where milk predominates; coffee, tea, cocoa, sugar, bread, rusks, pastry, confectionery, Viennese pastries, cakes, pancakes (foodstuffs), edible decorations for cakes, edible ices, custard, honey, golden syrup, ice for refreshment, chocolate, iced tea, flowers or leaves as tea substitutes; retail sale of foodstuffs including beverages based on coffee, tea, cocoa or chocolate, prepared (or cooked) dishes made with dough, pasta or

rice, coffee, tea, cocoa, sugar, rice, tapioca, sago, artificial coffee, flour and preparations made from cereals, bread, rusks, pastry, confectionery, Viennese pastries, cakes, pancakes (foodstuffs); retail sales of foodstuffs including edible decorations for cakes, pizzas, quiches, tacos, tortillas, sandwiches, pasta, meat pies, edible ices, custard, honey, golden syrup, yeast, baking-powder, salt, mustard, vinegar, seasonings, condiments, preserved garden herbs, spices, ice for refreshment, chocolate, beverages based on coffee, tea, cocoa or chocolate, mayonnaise; evaluation of events (opinion polling).

43 – Services for providing food and beverages; temporary accommodation; Services for providing food and drink, catering services, self-service restaurants, fast-food restaurants and snack bars, cafeterias, coffee houses, bar services, tea rooms, preparation of take-away meals and dishes; hotel services; temporary accommodation services; booking services for hotel accommodation and other accommodation; rental and booking of tourist accommodation; travel agencies and tourist offices for booking of accommodation (information services relating to the booking of accommodation); electronic information services relating to hotels; booking services for travelers' accommodation, in particular for travel agencies or brokers; booking services for temporary accommodation; hotel and motel services; booking of hotels and motels for others; online booking services for hotels and motels for others.

(260) AM 2019 101148 A

(800) 1443560

(151) 2018 10 15

(891) 2018 10 15

(731) ROYAL TOBACCO, SİĞARA VE TÛTÛN MAMÛLLERİ, SANAYİ VE TİCARET ANONİM ŞİRKETİ
İbn-İ Melek OSB Mahallesi, TOSBİ Yol 2
Sokak No:14, Tire, İzmir, Turkey

(540)

Marlon

(591) Black, white

(531) 27.05.17

(511)

34 – Tobacco, chewing tobacco, cigarettes, cigars; smokers' articles including those made of precious metals; pipes, mouthpieces for cigars and cigarettes, ashtrays, tobacco boxes, pocket apparatus for rolling cigarettes, cigarette paper, tobacco pipes, firestones, lighters for smokers.

(260) AM 2019 101150 A

(800) 1443617

(151) 2018 08 10

(891) 2018 08 10

(731) TIANJIN LOVOL HEAVY INDUSTRY GROUP CO., LTD.

No.77, Gaoxin Road, Beichen Science and Technology Park, Tanjian, China

(540)

ARBOS

(591) Black, white

(531) 27.05.01

(511)

7 – Carburettor feeders; glow plugs for diesel engines; alternators; dynamo belts; starters for motors and engines; generators of electricity; belts for motors and engines; air filter (engine parts); lubricating pumps; adhesive tape dispensers [machines].

(260) AM 2019 101151 A

(800) 1443618

(151) 2018 10 08

(891) 2018 10 08

(731) GRINDEKS, AS

Krustpils iela 53, LV-1057 Rīga, Latvia

(540)



(591) Light blue, blue, white and black

(531) 01.03.02; 01.15.05; 01.15.15; 02.09.19;
25.01.19; 25.03.01; 25.03.03; 27.05.01;
29.01.13

(511)

3 – Perfumery, body care and beauty care preparations, essential oils, cosmetics and hair care preparations, cosmetic creams, body gels.

5 – Pharmaceutical and veterinary preparations; sanitary preparations for medical purposes; pharmaceutical preparations for skin care; medicated toiletry preparations.

(260) AM 2019 101152 A

(800) 1443622

(151) 2018 10 08

(891) 2018 10 08

(731) GRINDEKS, AS

Krustpils iela 53, LV-1057 Rīga, Latvia

(540)



(591) Light blue, blue, black and white
 (531) 01.03.02; 01.15.05; 01.15.15; 02.09.19;
 25.01.19; 25.03.01; 25.03.03; 27.05.19; 28.05;
 29.01.13

(511)
 3 – Perfumery, body care and beauty care preparations, essential oils, cosmetic creams, body gels, cosmetic preparations for skin care.

5 – Pharmaceutical and veterinary preparations; sanitary preparations for medical purposes; pharmaceutical preparations for skin care; medicated toilet-ry preparations.

(260) AM 2019 101153 A
 (800) 1443629
 (151) 2018 10 08
 (891) 2018 10 08
 (731) GRINDEKS, AS
 Krustpils iela 53, LV-1057 Rīga,
 Latvia

(540)



(591) Light blue, blue, pink, light pink, black and white

(531) 01.15.15; 02.05.06; 02.07.09; 02.09.19;
 25.01.19; 25.03.01; 25.03.03; 27.05.19;
 29.01.14

(511)
 3 – Perfumery, body care and beauty care preparations, essential oils, cosmetic creams, body gels, cosmetic preparations for skin care.

5 – Pharmaceutical and veterinary preparations; sanitary preparations for medical purposes; pharmaceutical preparations for skin care; medicated toilet-ry preparations.

(260) AM 2019 101155 A
 (800) 1443648
 (151) 2018 10 08
 (891) 2018 10 08
 (731) GRINDEKS, AS
 Krustpils iela 53, LV-1057 Rīga, Latvia

(540)



(591) Light blue, blue, pink, light pink, black and white

(531) 01.15.15; 02.05.06; 02.07.09; 02.09.19;
 25.01.19; 25.03.01; 25.03.03; 27.05.19; 28.05;
 29.01.14

(511)
 3 – Perfumery, body care and beauty care preparations, essential oils, cosmetic creams, body gels, cosmetic preparations for skin care.

5 – Pharmaceutical and veterinary preparations; sanitary preparations for medical purposes; pharmaceutical preparations for skin care; medicated toilet-ry preparations.

(260) AM 2019 101156 A
 (800) 1443673
 (151) 2018 07 09
 (891) 2018 07 09
 (731) UIPATH SRL
 Str. Vasile Alecsandri si Constantin Daniel,
 Nr.4 si 11, Corp A, Et. 5-6, Sector 1,
 Bucharest, Romania

(540)

AiPath

(591) Black, white
 (511)

9 – Computer programs [downloadable software]; downloadable computer utility programs; computer software applications, downloadable; application software for cloud computing services.

35 – Assistance in management of business activities; assistance and advice regarding business management; management assistance in business affairs; business assistance, management and administrative services; management and operation assistance to commercial businesses; assistance and advice regarding business organisation and management; advice relating to the organisation and management of business; business management assistance for industrial or commercial companies; assistance, advisory services and consultancy with regard to business management; assistance to commercial enterprises in the management of their business; commercial assistance in business management; efficiency experts; business efficiency expert services; business organisation consulting; business organization and operation consultancy; business management and organization consultancy; business management and enterprise organization consultancy; business organization and management consultancy including personnel management; assistance, advisory services and consultancy with regard to business organization; advisory services for business management; business management consultancy and advisory services; business consulting; professional consultancy relating to business management; business information; collecting information for business; provision of business information; computer assisted business information; business advisory and information services; informa-

tion in business matters; business information for enterprises (provision of -); business information and research services; computerised business information services; provision of business information; analysis of business information; computerised business information retrieval; business statistical information services; business advice, inquiries or information; provision of business and commercial information; computerised business information processing services; business research and information services; provision of statistical information relating to business; provision of business management information; provision of computerised data relating to business; information services relating to businesses; information services relating to business matters; providing business information via a web site; provision of computerised business management information; drawing up of business statistical information; economic information services for business purposes; business analysis, research and information services; compilation of business statistics and commercial information; advice and information concerning commercial business management; information or enquiries on business and marketing; computerised information services to business opportunities appraisals; provision of commercial and business contact information; provision of business information via global computer networks; provision of computerised information relating to business records; providing business information by way of computer terminals; provision of on-line business and commercial information; providing information about commercial business and commercial information via the global computer network; updating of business information on a computer data base; business consultancy relating to the administration of information technology; providing business information directory services, via a global computer network; information and data compiling and analyzing relating to business management; business management consulting services in the field of information technology; provision of commercial business information by means of a computer database; business information services provided on-line from a computer database or the internet; business information services provided online from a global computer network or the internet; providing business information, also via internet, the cable network or other forms of data transfer; compilation of information into computer databases; compilation and systemization of information into computer databases; compilation of statistics; compilation of business statistics; compilation of statistics [for business or commercial purposes]; computerized file management; data search in computer files for others; document reproduction; outsourcing services [business assistance]; systemization of information into computer databases; updating and maintenance of data in computer databases.

38 – Transmission of information for business purposes; providing access to databases; providing access to online computer databases; providing access to and leasing access time to computer databases; providing access to databases in computer networks; providing access to electronic communications networks and electronic databases; communications by computer terminals; computer-aided transmission of messages and images; computer aided transmission of messages, information and images; streaming of data; transmission of digital files.

41 – Teaching and training in business, industry and information technology; arranging and conducting of conferences; arranging, conducting and organisation of conferences; arranging and conducting of commercial, trade and business conferences; arranging and conducting of seminars; arranging and conducting of seminars and workshops; arranging, conducting and organisation of seminars; programming [scheduling of programs] on a global computer network.

42 – Providing temporary use of non-downloadable computer programs; cloud computing; consulting in the field of cloud computing networks and applications; rental of operating software for accessing and using a cloud computing network; programming of operating software for accessing and using a cloud computing network; design and development of operating software for accessing and using a cloud computing network; providing temporary use of on-line non-downloadable operating software for accessing and using a cloud computing network; computer programming; scientific computer programming services; computer software programming services; computer programming and maintenance of computer programs; computer programming for data processing; computer design and programming services; computer programming and software design; computer programming for the internet; research relating to computer programming; computer programming services for data warehousing; design, development and programming of computer software; technical consultancy services relating to computer programming; computer programming for data processing and communication systems; computer programming services for commercial analysis and reporting; programming of computer software for reading, transmitting and organising data; programming of computer software for evaluation and calculation of data; advisory services relating to computer programming; computer software design; software design and development; computer software design and updating; design and writing of computer software; design and development of computer software architecture; design, maintenance and updating of computer software; design, drawing and commissioned writing of computer software; research, development, design and upgrading of computer software;

design, maintenance, development and updating of computer software; design, maintenance, rental and updating of computer software; design and development of computer software for process control; consultancy relating to the design and development of computer software programs; design and development of computer software for reading, transmitting and organising data; design and development of computer software for evaluation and calculation of data; providing information about the design and development of computer software, systems and networks; rental of software; rental of computer database software; rental of computer software and programs; rental and maintenance of computer software; computer system analysis; advisory services relating to computer systems analysis; computer system design; advisory services relating to computer systems design; design services relating to the development of computerised information processing systems; computer software consultancy; professional advisory services relating to computer software; technical consultancy relating to the installation and maintenance of computer software; technical consultancy relating to the application and use of computer software; providing information, advice and consultancy services in the field of computer software; consultancy and information services relating to the design, programming and maintenance of computer software; research and consultancy services relating to computer software; consultancy services relating to computer networks using mixed software environments; computer technology consultancy; computer and information technology consultancy services; consultancy in the field of computer security; professional consultancy relating to computer security; conversion of computer programs and data, other than physical conversion; electronic data storage; computer services concerning electronic data storage; compression of data for electronic storage; electronic data storage and data back-up services; electronic storage services for archiving databases; electronic storage services for archiving databases, images and other electronic data; temporary electronic storage of information and data; information technology [IT] consultancy; providing information on computer technology and programming via a web site; installation of software; installation and maintenance of computer programs; installation and customisation of computer applications software; installation, maintenance and updating of computer software; installation, repair and maintenance of computer software; installation, maintenance, updating and upgrading of computer software; installation, setting up and maintenance of computer software; installation, maintenance, repair and servicing of computer software; installation, maintenance and repair of software for computer systems; maintenance of computer programs; development and maintenance of computer software; maintenance and upda-

ting of computer software; maintenance and upgrading of computer software; development and maintenance of computer database software; maintenance of computer software relating to computer security and prevention of computer risks; updating and maintenance of computer software and programs; monitoring of computer systems by remote access; off-site data backup; outsource service providers in the field of information technology; research and development for others; software as a service [SaaS]; technological consultation services; updating of computer software; updating and upgrading of computer software; updating of computer software for others; updating of software for databases; updating of computer software relating to computer security and prevention of computer risks; updating of computer programs.

(260) AM 2019 101268 A

(800) 1444795

(151) 2018 07 03

(891) 2018 07 03

(731) PHLEXGLOBAL LIMITED

Mandeville House, 62 The Broadway,
Amersham, Buckinghamshire HP7 0HJ,
United Kingdom

(540)

PHLEXGLOBAL

(591) Black, white

(511)

9 – Scientific, nautical, surveying, photographic, cinematographic, optical, weighing, measuring, signalling, checking (supervision), life-saving and teaching apparatus and instruments; apparatus and instruments for conducting, switching, transforming, accumulating, regulating or controlling electricity; apparatus for recording, transmission or reproduction of sound or images; magnetic data carriers, recording discs; compact discs, DVDs and other digital recording media; mechanisms for coin-operated apparatus; cash registers, calculating machines, data processing equipment, computers; computer software; fire-extinguishing apparatus; computer software and telecommunications apparatus to enable connection to databases, local area networks and the Internet; computer software to enable teleconferencing, videoconferencing and videophone services; computer software to enable searching and retrieval of data; computer software for accessing databases, telecommunications services, computer networks and electronic bulletin boards; computer software, hardware and firmware for use in connection with experiments, tests, investigations, trials and projects relating to chemical, cosmetic, clinical, medical, pharmaceutical, naturopathic, veterinary, sanitary, fitness, wellbeing, nutritional, healthcare, beverage and food related products and services; computer software, firmware and hardware for use in connection

with trial master file document creation and management; protective clothing, footwear and headgear; sound, video, television and radio apparatus and instruments; communication, telecommunication, telephone and mobile telephone apparatus and instruments; telephones, mobile telephones, communication devices and cases therefore; ringtones [downloadable]; screen savers and screen wallpaper; communication, wireless communication and mobile communication devices; reading tablets and other devices for reading and viewing text, images and audio-visual content; software applications (apps), including apps for installation on telephones, mobile telephones and communications and wireless communication devices; accessories for telephones, telephone handsets, communication and wireless communication devices; battery chargers and adapters including battery chargers and adapters for use with and telephones, mobile telephones, communication and wireless communication devices; bags and cases adapted for holding or carrying telephones, mobile telephones communications and wireless communications equipment and accessories; electronic and computerised personal organisers; aerials; batteries; micro processors; key boards; modems; calculators; display screens; electronic global positioning systems; electronic navigational, tracking and positioning apparatus and instruments; apparatus and instruments for geolocation; monitoring apparatus and instruments; recordings; digital recordings; films; animations; animated cartoons; sound, audio, visual and audio-visual content and recordings; sound, audio, visual and audio-visual recordings and content provided by downloading and/or streaming from computers and communications networks, including the Internet and the world wide web; apparatus for access to broadcast or transmitted programmes; holograms; satellite broadcast receiving and decoding apparatus and instruments; apparatus, instruments and media for use in recording, storing, generating, carrying, transmitting, manipulating, processing, reproducing and playback of sounds, images, signals, data, software, code, information and audiovisual content; computer hardware and firmware; computer games software and firmware; instructional apparatus and instruments; non-printed, electronic, optical and digital publications; data cards; memory cards; electronic, magnetic, and optical identity cards; encoded pre-paid cards; encoded payment cards; encoded credit cards; encoded charge cards; encoded debit cards; smart cards; cameras; photographic transparencies and films; video films; cinematographic films; pre-recorded video and cinematographic films; spectacles; sunglasses; cases for spectacles and sunglasses; parts, fittings and accessories for all the aforesaid goods.

35 – Advertising; business management; business administration; office functions; marketing; promotion; public relations; endorsement; publicity servi-

ces; business networking and business inquiries; representation and agency services for business purposes; dissemination and display of advertisements and of advertising, marketing, promotion, public relations, endorsement and publicity materials; compilation and transcription of data; compilation of advertisements for use as web pages on the Internet; compilation of directories; compilation of data; rental of advertising time; rental of advertising space; provision of space and space in publications, electronic publications, magazines, websites and other media for advertising goods and services; advertising, marketing and promoting goods and services by distribution and transmission of advertisements including advertisements in the nature of audio, video, text messages and emails via wireless and mobile devices and communications devices; distribution of samples; market research services; organization of fairs and trade shows for business, advertising and promotion purposes; auctioneering services; business information, research, assistance and advice; accountancy services; data-processing services; electronic data and information processing; data processing for the collection of information for business purposes; on-line data processing services; information, advice, assistance and consultancy relating to business document management; business services namely data-processing, documentation creation and management services; data-processing, creation and management of documents for use in connection with experiments, tests, investigations, trials and projects relating to chemical, cosmetic, clinical, medical, pharmaceutical, naturopathic, veterinary, sanitary, fitness, wellbeing, nutritional, healthcare, beverage, and food related products and services; data-processing, creation and management of documents for use in connection with trial master files; personnel and human resource services; recruitment services; purchasing services; retail services, mail order services and wholesaling services in connection with the provision of the following: communications products, computing products, apps, optical, photographic, electronic and electrical products, recordings, films, videos, music, entertainment, educational, audio, visual and audio-visual recordings, medical products, pharmaceutical products, clinical products, documents, publications, printed materials, art works; organisation and management of business incentive and loyalty schemes; administrative processing and organising of mail order services; arranging of business introductions; business research and survey services; business forecasting services; provision of business, clerical and secretarial services; news and current affairs clippings services; provision of information and advice to prospective purchasers of goods and services; telephone answering and message handling services; operation of telephone call centres; business managing of remote monitoring centres; data management and electronic stoc-

ktaking services; providing consulting services relating to any of the aforesaid via web sites and web pages; information, advice and assistance relating to all the aforesaid; including (but not limited to) any of the aforesaid services provided online, and/or provided for use with and/or by way of the Internet, the world wide web and/or via communications, telephone, mobile telephone and/or wireless communication networks.

42 – Scientific and technological services and research and design relating thereto; industrial analysis and research services; hosting of internet sites, web sites, computer sites and microsites; IT advice, assistance, information and consulting; providing search engines and internet search facilities; design services; graphic design; web site design; interior and exterior design; digitisation of documents and content; weather forecasting and providing meteorological information; design and development of computer hardware and software; computer programming; software as a service; application service provider services; updating of computer software; consultancy in the design and development of computer hardware; maintenance of computer software; computer system analysis; industrial design and industrial design services; surveying services; quantity surveying services; construction drafting; engineering; urban planning; technical advisory and assistance services in the field of information technology; technical drawing services; technical testing services; quality testing services; product design; interior design; web site design; quality control services; technological services; materials and construction materials testing and research services; professional services relating to research, design and development; computer software services relating to experiments, tests, investigations, trials and projects relating to chemical, cosmetic, clinical, medical, pharmaceutical, naturopathic, veterinary, sanitary, fitness, well-being, nutritional, healthcare, beverage, and food related products and services and/or relating to data-processing, creation and management of documents for use in connection with trial master files; scientific, research, technological, testing, laboratory and design services including such services relating to chemical, cosmetic, clinical, medical, pharmaceutical, naturopathic, veterinary, sanitary, fitness, well-being, nutritional, healthcare, beverage and food related products and services; providing consulting services relating to any of the aforesaid via websites and webpages; advice, information and assistance relating to all the aforesaid; including (but not limited to) any of the aforesaid services provided online, and/or provided for use with and/or by way of the Internet, the world wide web and/or via communications, telephone, mobile telephone and/or wireless communication networks or devices.

(260) AM 2019 101269 A
 (800) 1444814
 (151) 2018 11 05
 (891) 2018 11 05
 (731) ZIBELE HOLDING AG
 Freiburgstrasse 62, CH-3008 Bern,
 Switzerland
 (540)

GRAVITELLE

(591) Black, white
 (511)
 10 – Surgical, medical, dental and veterinary apparatus and instruments; artificial limbs, eyes and teeth; orthopedic articles; suture material; therapeutic and assistance devices designed for people with disabilities; massage apparatus; apparatus, devices and articles for child care; apparatus, devices and articles for sexual activities.

(260) AM 2019 101309 A
 (800) 1445129
 (151) 2018 12 12
 (891) 2018 12 12
 (731) Victoria's Secret Stores Brand Management,
 Inc.
 4 Limited Parkway, Reynoldsburg OH 43068,
 USA

(540)
**VICTORIA'S SECRET FIRST
 LOVE**

(591) Black, white
 (511)
 25 – Bras; lingerie; panties; pajamas, athletic shorts; athletic tights; jackets; sport shirts; sports bras; sports jerseys; sports pants; sports shirts; swimwear; tank tops.

(260) AM 2019 101311 A
 (800) 1445203
 (151) 2018 11 21
 (891) 2018 11 21
 (731) JAPAN TOBACCO INC.
 2-2-1 Toranomom, Minato-ku, Tokyo, Japan
 (540)

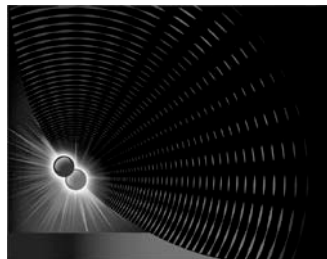

(591) Black, white
 (531) 01.03.02; 01.03.16; 01.15.09; 26.01.06;
 26.04.05; 26.04.12; 26.04.13; 26.04.24;
 26.15.01

(511)

34 – Tobacco, raw or manufactured; smoking tobacco, pipe tobacco, rolling tobacco, chewing tobacco, snus; cigarettes, electronic cigarettes, cigars, cigarettos; snuff; smokers' articles included in class 34; cigarette paper, cigarette tubes and matches.

(260) AM 2019 101312 A

(800) 1445236

(151) 2018 09 11

(891) 2018 09 11

(731) Oriflame Cosmetics AG

c/o Oriflame Global Management AG,
Bleicheplatz 3, CH-8200 Schaffhausen,
Switzerland

(540)

ORIFLAME ONCOLOUR

(591) Black, white

(511)

3 – Non-medicated preparations for the application to, conditioning and care of the hair, scalp, skin and nails; shampoos; hair conditioner; soaps; perfumes; perfumery; eau de cologne; toilet waters, essential and herbal oils; cosmetics; make-up; make-up preparations; lipsticks; nail varnishes; nail varnish removers; eyeliner; mascara; non-medicated toilet preparations; hair lotions; hair sprays and hair gels; preparations for use in the bath or shower; bath and shower oils, gels, creams and foams; face and body masks; face and body scrubs; facial washes; skin cleansers and hydrators; skin toners, skin moisturizers; blemish creams and blemish gels; deodorants; antiperspirants; preparations for use before shaving and after shaving; shaving soaps; shaving creams; shaving gels; after-shave preparations; pre-shave preparations; talcum powders; toiletries; dentifrices; toothpastes; foot care preparations (non-medicated).

(260) AM 2019 101313 A

(800) 1445239

(151) 2018 11 23

(891) 2018 11 23

(731) SHANDONG FENGYUAN TIRE

MANUFACTURING CO., LTD.
YICHENG ECONOMIC DEVELOPMENT,
ZONE OF ZAOZHUANG, 277300 SHAN-
DONG PROVINCE, China

(540)

saferich

(591) Black, white

(531) 27.05.01; 27.05.11

(511)

12 – Remote control vehicles, other than toys; pneumatic tires; tires, solid, for vehicle wheels; automobile tires; adhesive rubber patches for repairing inner

tubes; amphibious airplanes; seaplanes; hydroplanes; yachts; air cushion vehicles.

(260) AM 2019 101314 A

(800) 1445248

(151) 2018 12 04

(891) 2018 12 04

(731) ZINO DAVIDOFF SA

Rue Faucigny 5, CH-1700 Fribourg,
Switzerland

(540)

DAVIDOFF RUN WILD

(591) Black, white

(511)

3 – Perfumery, essential oils, cosmetics; scented waters; scented body sprays; perfumes; liquid perfume, namely eau fraîche; eau de Cologne; toilet water; eau de parfum; toiletries; shower gels; after-shave cologne; deodorant sprays for personal use; deodorant sticks for personal use; antiperspirants.

(260) AM 2019 101315 A

(800) 1445249

(151) 2018 12 05

(891) 2018 12 05

(731) HIGICOL, S.A.

RUA SANTOS DIAS, N.º 1121, P-4465-255
SÃO MAMEDE DE INFESTA, Portugal

(540)

andreaia
professional

(591) Black, white

(531) 27.05.10

(511)

3 – Lipsticks; depilatory wax; cosmetics; cosmetic creams; depilatory creams; non-medicated scalp treatment cream; hair creams; body cream; face creams for cosmetic use; body lotion; cosmetic hair lotions; lotions for face and body care; non-medicated scalp treatment lotions; make-up; oils for cosmetic purposes; cosmetic preparations for the hair and scalp; facial preparations; cosmetic preparations for body care; perfumery; nail varnishes; nail care preparations; nail varnish removers.

(260) AM 2019 101316 A

(800) 1445259

(151) 2018 11 23

(891) 2018 11 23

(731) TRINA SOLAR CO., LTD

NO. 2 TRINA ROAD, TRINA PV PARK,
XINBEI, CHANGZHOU, 213031 JIANGSU,
China

(540)



(591) Black, white

(531) 01.15.09; 01.15.11; 02.07.23; 06.19.01;
06.19.05; 07.01.08; 07.15.26; 18.01.09;
18.05.01; 24.17.08

(511)

9 – Batteries, electric; chargers for electric batteries; accumulator jars; transformers [electricity]; solar panels for the production of electricity; photovoltaic cells; solar batteries; accumulators, electric; accumulator boxes.

(260) AM 2019 101317 A

(800) 1445275

(151) 2018 06 26

(891) 2018 06 26

(731) ZHEJIANG AILIPU TECHNOLOGY CO., LTD

No. 2, Jinyuan Rd., Binhai Xincheng, Haiyou Town, Sanmen County, Taizhou, Zhejiang, China

(540)

爱力浦
AILIPU

(591) Black, white

(531) 28.03

(511)

7 – Water pumps for aquaria; compressors for refrigerators; pumps [machines]; diaphragm type metering pump; gas separating machines; centrifugal pumps; hydraulic pressure pump; soldering apparatus, gas-operated.

(260) AM 2019 101318 A

(800) 1445278

(151) 2018 10 03

(891) 2018 10 03

(731) MITSUBISHI ELECTRIC CORPORATION

7-3 Marunouchi 2-chome, Chiyoda-ku, Tokyo 100-8310, Japan

(540)

Quality
in Motion

(591) Black, green, yellow green and gray

(531) 05.03.15; 27.05.07; 29.01.13

(511)

7 – Elevators; escalators; moving sidewalks.

37 – Maintenance and repair of elevators; maintenance and repair of escalators; maintenance and repair of moving sidewalks.

(260) AM 2019 101339 A

(800) 1445705

(151) 2018 11 08

(891) 2018 11 08

(731) NEWBY TEAS (U.K.) LIMITED

105 St John St., London EC1M 4AS, United Kingdom

(540)



NEWBY

(591) Black, white

(531) 02.01.04; 03.02.01; 03.02.25; 03.02.26;
19.01.01; 27.05.01; 27.05.17

(511)

5 – Herbal teas for medicinal purposes.

30 – Tea, tea-based beverages, iced tea, tea for infusions; coffee, coffee substitutes, coffee beverages, iced coffee, coffee-based beverages.

(260) AM 2019 101340 A

(800) 1445730

(151) 2018 10 08

(891) 2018 10 08

(731) THE NAVIGATOR COMPANY, S.A.

Península da Mitrena – Sado, Sado, P-2910-738 SETÚBAL, Portugal

(540)

PRÉMIO
NAVIGATOR
ARTE EM PAPEL

(591) Black, white

(531) 27.05.09; 27.05.10

(511)

41 – Cultural activities; organizing and conducting competitions and awarding prizes; organization and management of seminars, symposia, meetings, conferences and congresses; organizing and directing social, cultural and artistic events, as well as institutional, scientific, artistic and literary exhibitions for cultural or educational purposes.

(260) AM 2019 101341 A
 (800) 1445733
 (151) 2018 10 12
 (891) 2018 10 12
 (731) LEON CYCLE GMBH
 Eckenerstr. 3, 30179 Hannover, Germany
 (540)



LEON
 C Y C L E

(591) Orange and black
 (531) 03.01.02; 24.01.09; 27.05.10; 29.01.12
 (511)
 12 – Vehicles, namely bicycles, powered or assisted by an energy management system, namely an electric motor, generator, electronic circuitry and control panel, for monitoring and controlling the providing of propulsion energy proportional to user demands, and for charging a battery; recreational vehicles namely snowmobiles, personal watercraft, boats, all-terrain vehicles, light and ultralight aircraft, motorcycles, motor scooters; bicycles, being powered or assisted by electricity; motors and engines for land vehicles, being powered by electricity.

(260) AM 2019 101343 A
 (800) 1445771
 (151) 2018 07 06
 (891) 2018 07 06
 (731) ABAC ARIA COMPRESSA S.P.A.
 Via Colombo, 3, I-10070 ROBASSOMERO
 (TO), Italy
 (540)

AIRTUBE

(591) Black, white
 (511)
 7 – Actuators for valves; electric screwdrivers; reels, mechanical, for flexible hoses; pneumatic valve actuators; compressors; compressors [machines]; compressors as parts of machines, motors and engines; air compressors; air compressors for vehicles; electric compressors; compressors for machines; air condensers [compressors]; compressed air machines; shaft couplings [machines]; compressed air engines; engines for compressors; sprayers [parts of machines], other than for medical use; spray paint machines; grease guns operated by compressed air; painting spray guns; pistons for compressors; compressed air pumps; pumps, compressors and fans; joints

for tubes (metal) [parts of engines]; governors; pressure regulators [parts of machines]; reducers (pressure) [parts of machines]; taps [parts of machines, engines or motors]; steam traps; pneumatic drills; drills [power tools]; air-powered tools; valves; suction valves for air compressors; compressed air switch valves; valves (clack) [parts of machines]; hydraulic valves; fans for the compression.

9 – Electrical remote control apparatus; application software; downloadable application software; downloadable software applications; smartphone software applications, downloadable; application software for smart phones; application software for mobile devices; electronic control systems for machines; application software for cloud computing services; downloadable applications for use with mobile devices; downloadable mobile applications for the management of data; downloadable mobile applications for the transmission of data; computer software for controlling and managing access server applications; computer application software for use in implementing the Internet of Things [IoT]; computer software for mobile applications that enable interaction and interface between vehicles and mobile devices.

(260) AM 2019 101344 A
 (800) 1445844
 (151) 2018 11 29
 (891) 2018 11 29
 (731) APPLE INC.
 One Apple Park Way, Cupertino CA 95014,
 USA
 (540)

SIRI SHORTCUTS

(591) Black, white
 (511)
 9 – Computer software enabling users to create, save, and launch sequences of commands and logic within and between other computer software applications and computer software functionality; computer software for personal information management.

(260) AM 2019 101345 A
 (800) 1445892
 (151) 2018 11 23
 (891) 2018 11 23
 (731) DAW SE
 Roßdörfer Str. 50, 64372 Ober-Ramstadt,
 Germany
 (540)

Capacoustic

(591) Black, white
 (511)
 1 – Industrial chemicals; preservative and damp-proofing preparations for masonry, roofing tiles, cement

and concrete, except paints and oils; artificial resins, synthetic resins and unprocessed plastics; solvents (chemicals); solvents for varnishes and lacquers; adhesives used in industry; adhesives for wallpaper; adhesives used in building; filler for the treatment of subsurfaces for paints (not included in other classes).

2 – Paints; varnishes; lacquers; glazes; coatings; preservatives against rust; primers; colorants, dyestuffs, dye pastes, mordants; paint thickeners; fixatives, siccatives for paints; raw natural resins; thinning and binding preparations for paints and lacquers; solvents for thinning paints; preparations for preserving wood; wood mordants and wood preserving oils; paints, including structuring paints; bactericidal and/or fungicidal paints; anti-corrosion preparations; protective preparations for metals; metals in foil and powder form for painters, decorators, printers and artists.

6 – Building materials of metal or mainly of metal; expanded pierced metal; wire cloths of metal or mainly of metal; adjusting and levelling parts of metal or mainly of metal for building purposes; screws, pins, and bolts (of metal or mainly of metal); spacers of metal or mainly of metal for building purposes; fixing anchors of metal or mainly of metal for building; sills of metal or mainly of metal; window sills of metal or mainly of metal and components of metal or mainly of metal for window sills.

17 – Sealing, thermal protection and insulating materials; insulating paints, insulating varnishes, insulating fabrics, insulating plaster; substances for insulating buildings against moisture; artificial and synthetic resins (semi-finished products); fiberglass fabrics for building insulation; insulating tapes; heat insulators; insulating panels; grid mats of glass fiber fabric and/or plastics, in the form of parts for composite heat insulation systems; plastic films, other than for wrapping purposes; adhesive tapes and strips for building; soundproofing materials.

19 – Building materials, not of metal or mainly not of metal, in particular profile rails and corner irons, finishing profiles; adjusting and levelling parts, spacers for building, sills, all not of metal or mainly not of metal; natural and artificial stone; mortar (building materials); quartz; plaster (building materials); coatings [building materials]; wall and ceiling panels (not of metal or mainly not of metal, for building); fabric embedding compounds for building; fillers (building materials); fabrics for building, not of metal or mainly not of metal, in particular stabilising fabrics.

20 – Fixing materials (not of metal or mainly not of metal), in particular fixing anchors for building; bolts, plugs, pins, screws, nuts, not of metal or mainly not of metal.

(260) AM 2019 101346 A

(800) 1445902

(151) 2018 11 06

(891) 2018 11 06

(731) DAVINES S.p.A.

Via Ravasini, 9/A, I-43100 PARMA (PR), Italy

(540)

ON PROTECTION

with

HAIR PROTECTIVE BOOSTER

(591) Black, white

(531) 26.04.02; 26.04.22; 27.05.10

(511)

3 – Cosmetics; hair care lotions; hair preparations and treatments; hair preparations and treatments; hair protection lotions; hair protection gels; hair protection creams; hair protection mousse; protective concentrates for the hair; preparations for protecting coloured hair; products for protecting coloured hair; hair spray; hair creams; cosmetic preparations for hair care; hair texturizers; conditioning preparations for the hair; shampoo; hair balm; soaps; perfumery; essential oils.

(260) AM 2019 101347 A

(800) 1445905

(151) 2018 07 02

(891) 2018 07 02

(731) JINAN MECH PIPING TECHNOLOGY, CO., LTD.

Meigui Zone of Industrial Park, Pingyin, 250400 Jinan City, China

(540)

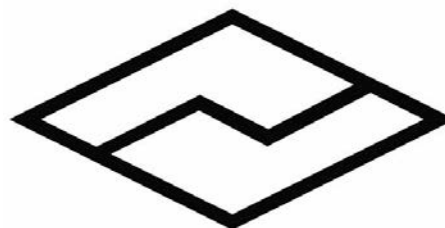

(591) Black, white

(531) 26.03.23; 26.04.03; 26.04.11; 26.04.12; 26.11.13

(511)

6 – Steel pipes; ducts of metal, for central heating installations; water-pipes of metal; sleeves [metal hardware]; elbows of metal for pipes; tubing of metal; drain pipes of metal; pipes of metal; pipe muffs of metal; junctions of metal for pipes; pipework of metal; reinforcing materials of metal for pipes; collars of metal for fastening pipes; clips of metal for cables and pipes; casings of metal for oilwells; gutter pipes of metal; branching pipes of metal; ducts of

metal for ventilating and air-conditioning installations; penstock pipes of metal.

11 – Metal pipe components for water heating equipment, including pipe steam valve, pipe water valve, water nozzle, three direction pipe joint, four direction pipe joint, pipe hoop, pipe fittings for the aforesaid goods.

(260) AM 2019 101473 A

(800) 1447674

(151) 2018 09 25

(891) 2018 09 25

(731) RAHMANI GROUP S.p.A.

Largo Guido Donegani, 2, I-20121 MILANO,
Italy

(540)

KARIZ

(591) Black, white

(511)

29 – Almonds, ground; almonds (prepared -); preserved fruits; cooked fruits; wasabi-coated peanuts; crystallised fruit; crystallized gingers; crystallized ginger; crystallized fruits; crystallized fruit; crystallised ginger; desiccated coconut; dates; cut fruits; cut vegetables; dried beans; dried pawpaws; dried olives; dried nuts; dried mangoes; dried lentils; dried fruits; dried fruit products; dried fruit mixes; dried fruit based snacks; dried fruit; dried flakes of laver for sprinkling on rice in hot water (ochazuke nori); dried figs; dried edible tremella fuciformis; dried edible seaweed (hoshi wakame); dried edible seaweed; dried edible mushrooms; dried edible black fungi; dried edible algae; dried durians; dried dates; dried cranberries; dried coconuts; dried persimmon (got gam); dried pieces of agar jelly (kanten); dried pineapples; dried pulses; dried soya beans; dried strawberries; dried truffles [edible fungi]; dried vegetables; edible nuts; edible seaweed; edible seeds; edible crystallised fruits; edible crystallized fruits; edible dried flowers; potato flakes; flavored nuts; flavoured nuts; frosted fruits; frozen fruits; fruit pulps; fruit purees; fruit conserves; processed fruits in the form of powders; fruit snacks; fruit salads; ground almond; ground almonds; ground nuts; fruit peel; nuts, prepared; nuts being preserved; nuts being dried; nuts being cooked; nut and seed based snack bars; mixtures of fruit and nuts; vegetable mousses; peanut paste; peanuts, prepared; peanuts, processed; peas, preserved; peas, processed; prepared pistachio; prepared nuts; prepared coconut; prepared fruits; prepared pistachios; preserved fruits; preserved nuts; processed fruits; processed nuts; processed walnuts; processed watermelon seeds; processed seeds; roasted nuts; roasted nuts; fruit salads; roasted peanuts; fruit pulp; raisins; prunes; spiced nuts; sliced fruit; seasoned nuts; vegetable juices for cooking; salted nuts; processed fruits, fungi and vegetables (includ-

ing nuts and pulses); snack mixes consisting of dehydrated fruit and processed nuts; snack foods based on nuts; jellies, jams, compotes, fruit and vegetable spreads; fruit jams; ginger jam; milk based beverages containing fruit juice; fruit juices for cooking.

31 – Fresh pistachio nuts; nuts [fruits]; cola nuts; kola nuts; fresh fruits, nuts, vegetables and herbs; unprocessed nuts; fresh pine nuts; fresh cola nuts; raw nuts; raw ginger; fresh ginger; unprocessed grains (cereals); grains [cereals]; malt and unprocessed cereals; unprocessed cereals; unprocessed grains (cereals); unprocessed cereal seeds; raw cereals [unprocessed]; cereal seeds, unprocessed; corn (unprocessed); raw corn; unprocessed tea leaves; fresh fruit; fruit, fresh.

32 – Ginger ale; dry ginger ale; fruit juice; fruit juice; fruit juices; fruit juice beverages; concentrated fruit juice; fruit juice bases; fruit juice concentrates; mixed fruit juice; mixed fruit juices; non alcoholic sparkling fruit juice drinks; beverages consisting principally of fruit juices; non alcoholic beverages containing fruit juices; fruit juice for use as a beverage; beverages consisting of a blend of fruit and vegetable juices; fruit juice beverages (non alcoholic); non alcoholic fruit juice beverages; concentrates for making fruit juices; fruit beverages and fruit juices; aerated fruit juices; concentrated fruit juices.

(260) AM 2019 101479 A

(800) 1447725

(151) 2018 10 12

(891) 2018 10 12

(731) ILIRIJA, d.o.o.

Tržaška cesta 40, SI-1000 Ljubljana, Slovenia

(540)

SUBRINA PROFESSIONAL

(591) Black, white

(511)

3 – Bleaching preparations and other substances for laundry use; cleaning, polishing, scouring and abrasive preparations; soaps; toilet soap; almond soap; deodorant soap; deodorants for personal use; antiperspirants (toiletries); antiperspirant soap; soap for foot perspiration; douching preparations for personal sanitary or deodorant purposes [toiletries]; bath salts, not for medical purposes; cosmetic preparations for baths; toiletries; talcum powder, for toilet use; make-up removing preparations; cleansing milk for toilet purposes; cloths impregnated with a detergent for cleaning; cloths or tissues impregnated with a skin cleanser; tissues impregnated with cosmetic lotions; pre-moistened cosmetic wipes; oils for toilet purposes; colorants for toilet purposes; massage gels other than for medical purposes; perfumery; perfumes; perfumed tissues; scented water; toilet water; eau de cologne; ethereal oils, essential oils; rose oil; cosme-

tics; skincare cosmetics; creams (cosmetic -); cosmetic hand creams; beauty masks; exfoliants; lotions for cosmetic purposes; tonics for cosmetic purposes, almond milk for cosmetic purposes; almond oil; oils for cosmetic purposes; greases for cosmetic purposes; eyebrow cosmetics; cosmetic preparations for eyelashes; make-up preparations; make-up; mascara; cosmetic pencils; eyebrow pencils; lipstick; lip gloss; petroleum jelly for cosmetic purposes; pomades for cosmetic purposes; make-up powder; eyelashes (false -); eyelashes (adhesives for affixing false -); dyes (cosmetic -); bleaching preparations for cosmetic use; skin whitening creams; nail care preparations; nail polish; nail art stickers; false nails; adhesives for cosmetic purposes; sun-tanning preparations (cosmetics); cosmetic preparations for slimming purposes; depilatory preparations; wax (depilatory -); depilatories; shaving preparations; shaving soap; after-shave lotions; hairdressing preparations and products for hair care, styling and setting, included in this class; shampoos for the hair; dry shampoo; hair lotion; hair dyes; hair colorants; colour cream for hair; hair toners; hair balm; conditioning preparations for the hair; oils for hair conditioning; hair creams; hair waxes; hair elixirs; hair tonic; hair spray; hair gels; hair mousses; hair masks; hair serum; hair fixatives; hair spray; hair waving preparations; hair permanent treatments; neutralizers for permanent waving; brightening agents for hair; hair colour removers; hydrogen peroxide for cosmetic purposes; non-medicinal preparations for treating dandruff and hair loss; hair packs; preparations for moisturising and protection of hair, included in this class; mouth washes, not for medical purposes; dentifrices; toothpastes; dental bleaching gels; breath freshening sprays; dentures (preparations for cleaning -); cotton wool for cosmetic purposes; cotton sticks for cosmetic purposes; swabs (toiletries); cosmetic kits.

41 – Education; providing of training; entertainment; sporting and cultural activities; arranging and conducting of seminars; arranging and conducting of conferences, colloquiums, congresses and symposiums; organising of education exhibitions; organisation of fashion shows for entertainment and educational purposes; arranging and conducting of workshops (training); provision of tuition; coaching (training); hairdressing schools and courses; hairdressing demonstrations; organisation of hair-styling-events; hairdressing and beauty teaching; educational seminars relating to hairdressing techniques; organisation of seminars and workshops in the field of fashion and hairdressing; organisation of competitions (education or entertainment); organisation of hairdressing competitions; arranging of beauty contests; photography; prize games.

44 – Human hygiene and beauty care; hairdressing services; hair care services; hairdressing salons; hair-

dressing studios; consultancy and information services relating to hair and hairdressing; beauty salons; barber salons; massage; manicuring; pedicure services; solarium services; visagists' services; therapy services; aromatherapy services; hair implantation.

INTERNATIONAL TRADEMARKS PROTECTED IN GEORGIA

(260) AM 2019 75173 A
(800) 1166351
(151) 2013 05 17
(181) 2023 05 17
(891) 2013 10 01
(511) 29

(260) AM 2019 75288 A
(800) 1185316
(151) 2013 09 13
(181) 2023 09 13
(891) 2013 09 13
(511) 07, 11, 12

(260) AM 2019 75326 A
(800) 1185652
(151) 2013 07 01
(181) 2023 07 01
(891) 2013 07 01
(511) 25, 35

(260) AM 2019 76851 A
(800) 1198324
(151) 2013 10 10
(181) 2023 10 10
(891) 2013 10 10
(511) 30

(260) AM 2019 80062 A
(800) 1089698
(151) 2011 07 22
(181) 2021 07 22
(891) 2014 10 23
(511) 03, 09, 18, 25

(260) AM 2019 82961 A
(800) 1254404
(151) 2014 12 30
(181) 2024 12 30
(891) 2014 12 30
(511) 07, 11

(260) AM 2019 85248 A
(800) 1277904
(151) 2015 09 22
(181) 2025 09 22
(891) 2015 09 22

(260) AM 2019 94954 A
(800) 1372648
(151) 2017 06 29
(181) 2027 06 29
(891) 2017 06 29

(260) AM 2019 95102 A
(800) 1374091
(151) 2017 08 24
(181) 2027 08 24
(891) 2017 08 24
(511) 03, 09, 14, 16, 18, 24, 25

(260) AM 2019 95103 A
(800) 1374092
(151) 2017 08 24
(181) 2027 08 24
(891) 2017 08 24
(511) 03, 09, 14, 16, 18, 24, 25

(260) AM 2019 95464 A
(800) 1378900
(151) 2017 07 18
(181) 2027 07 18
(891) 2017 07 18
(511) 36, 41

(260) AM 2019 95511 A
(800) 1331137
(151) 2016 09 29
(181) 2026 09 29
(891) 2017 10 20
(511) 03

(260) AM 2019 97613 A
(800) 1400265
(151) 2017 06 29
(181) 2027 06 29
(891) 2017 06 29
(511) 41, 43

(260) AM 2019 97738 A
(800) 1402452
(151) 2018 01 15
(181) 2028 01 15
(891) 2018 01 15
(511) 03

(260) AM 2019 98039 A
(800) 1405653
(151) 2017 11 07
(181) 2027 11 07
(891) 2017 11 07
(511) 33, 34, 35

(260) AM 2019 98051 A
(800) 1406011
(151) 2018 01 15
(181) 2028 01 15
(891) 2018 01 15
(511) 29, 30

(260) AM 2019 98070 A
(800) 1183097
(151) 2013 10 30
(181) 2023 10 30
(891) 2018 05 23
(511) 05, 29, 30, 32

(260) AM 2019 98091 A
(800) 1406688
(151) 2018 02 21
(181) 2028 02 21
(891) 2018 02 21
(511) 16, 28, 32

(260) AM 2019 98263 A
(800) 1407984
(151) 2018 01 31
(181) 2028 01 31
(891) 2018 01 31
(511) 03

(260) AM 2019 98322 A
(800) 1409386
(151) 2018 04 03
(181) 2028 04 03
(891) 2018 04 03
(511) 33

(260) AM 2019 98326 A
(800) 1409494
(151) 2018 01 03
(181) 2028 01 03
(891) 2018 01 03
(511) 30

(260) AM 2019 98327 A
(800) 1409514
(151) 2018 01 31
(181) 2028 01 31

(891) 2018 01 31
(511) 30

(260) AM 2019 98359 A
(800) 958386
(151) 2007 12 21
(181) 2027 12 21
(891) 2018 05 20
(511) 07, 11

(260) AM 2019 98364 A
(800) 1204815
(151) 2014 02 19
(181) 2024 02 19
(891) 2018 06 01
(511) 09, 11, 35, 37, 42

(260) AM 2019 98460 A
(800) 1410298
(151) 2018 02 19
(181) 2028 02 19
(891) 2018 02 19
(511) 09, 28

(260) AM 2019 98462 A
(800) 1410320
(151) 2018 02 16
(181) 2028 02 16
(891) 2018 02 16
(511) 11, 21

(260) AM 2019 98474 A
(800) 1410768
(151) 2018 03 14
(181) 2028 03 14
(891) 2018 03 14
(511) 03

(260) AM 2019 98481 A
(800) 1410985
(151) 2017 11 30
(181) 2027 11 30
(891) 2017 11 30
(511) 29, 30, 32

(260) AM 2019 98495 A
(800) 1096649
(151) 2011 07 07
(181) 2021 07 07
(891) 2018 06 14
(511) 06, 20

(260) AM 2019 98497 A
(800) 1240607
(151) 2014 05 13
(181) 2024 05 13
(891) 2018 05 17
(511) 01, 05, 30

(260) AM 2019 98498 A
(800) 1370430
(151) 2017 06 23
(181) 2027 06 23
(891) 2018 06 20
(511) 35, 43

(260) AM 2019 98501 A
(800) 1411460
(151) 2018 02 19
(181) 2028 02 19
(891) 2018 02 19
(511) 09, 28

(260) AM 2019 98505 A
(800) 1411495
(151) 2017 11 27
(181) 2027 11 27
(891) 2017 11 27
(511) 09, 16, 18, 25, 28, 29, 30, 35, 41

(260) AM 2019 98506 A
(800) 1411521
(151) 2017 12 26
(181) 2027 12 26
(891) 2017 12 26
(511) 30

(260) AM 2019 98523 A
(800) 1412353
(151) 2018 04 20
(181) 2028 04 20
(891) 2018 04 20
(511) 32, 33

(260) AM 2019 98539 A
(800) 1363826
(151) 2017 01 24
(181) 2027 01 24
(891) 2018 06 12
(511) 34

(260) AM 2019 98627 A
(800) 1413545
(151) 2018 05 18
(181) 2028 05 18

(891) 2018 05 18
(511) 17

(260) AM 2019 98706 A
(800) 1414400
(151) 2018 04 19
(181) 2028 04 19
(891) 2018 04 19
(511) 30

(260) AM 2019 98733 A
(800) 1414960
(151) 2018 05 17
(181) 2028 05 17
(891) 2018 05 17
(511) 03, 05

(260) AM 2019 98811 A
(800) 1415434
(151) 2018 05 25
(181) 2028 05 25
(891) 2018 05 25
(511) 14

(260) AM 2019 98814 A
(800) 1415444
(151) 2018 05 23
(181) 2028 05 23
(891) 2018 05 23
(511) 25

(260) AM 2019 98816 A
(800) 1415451
(151) 2018 06 01
(181) 2028 06 01
(891) 2018 06 01
(511) 10

(260) AM 2019 98820 A
(800) 1415554
(151) 2018 04 24
(181) 2028 04 24
(891) 2018 04 24
(511) 03, 21

(260) AM 2019 98858 A
(800) 1416172
(151) 2017 12 27
(181) 2027 12 27
(891) 2017 12 27
(511) 09

(260) AM 2019 98859 A
(800) 1416183
(151) 2018 02 16
(181) 2028 02 16
(891) 2018 02 16
(511) 28

(260) AM 2019 98860 A
(800) 1416204
(151) 2018 05 01
(181) 2028 05 01
(891) 2018 05 01
(511) 12

(260) AM 2019 98861 A
(800) 1416209
(151) 2018 04 03
(181) 2028 04 03
(891) 2018 04 03
(511) 33

(260) AM 2019 98862 A
(800) 1416223
(151) 2018 05 18
(181) 2028 05 18
(891) 2018 05 18
(511) 33

(260) AM 2019 98863 A
(800) 1416239
(151) 2018 04 25
(181) 2028 04 25
(891) 2018 04 25
(511) 16

(260) AM 2019 98864 A
(800) 1416247
(151) 2018 05 18
(181) 2028 05 18
(891) 2018 05 18
(511) 25

(260) AM 2019 98865 A
(800) 1416309
(151) 2018 03 20
(181) 2028 03 20
(891) 2018 03 20
(511) 02, 16

(260) AM 2019 98866 A
(800) 1416314
(151) 2018 03 23
(181) 2028 03 23

(891) 2018 03 23
(511) 30

(260) AM 2019 98867 A
(800) 1416329
(151) 2018 04 27
(181) 2028 04 27
(891) 2018 04 27
(511) 35, 38, 39, 42

(260) AM 2019 98868 A
(800) 1416366
(151) 2018 01 22
(181) 2028 01 22
(891) 2018 01 22
(511) 35, 39, 43

(260) AM 2019 98869 A
(800) 1416380
(151) 2017 08 16
(181) 2027 08 16
(891) 2017 08 16
(511) 04

(260) AM 2019 98871 A
(800) 734543
(151) 2000 03 14
(181) 2020 03 14
(891) 2018 06 26
(511) 18

(260) AM 2019 98872 A
(800) 737039
(151) 2000 05 05
(181) 2020 05 05
(891) 2018 06 26
(511) 18

(260) AM 2019 98873 A
(800) 962990
(151) 2008 03 03
(181) 2028 03 03
(891) 2018 07 16
(511) 18, 25

(260) AM 2019 98874 A
(800) 976058
(151) 2008 06 11
(181) 2028 06 11
(891) 2018 07 13
(511) 01, 02, 19

(260) AM 2019 98875 A
(800) 1052978
(151) 2010 09 14
(181) 2020 09 14
(891) 2018 07 16
(511) 05

(260) AM 2019 98933 A
(800) 1416899
(151) 2018 06 05
(181) 2028 06 05
(891) 2018 06 05
(511) 16, 17, 28, 35, 41

(260) AM 2019 98938 A
(800) 1417052
(151) 2018 05 25
(181) 2028 05 25
(891) 2018 05 25
(511) 03, 04, 21

(260) AM 2019 98954 A
(800) 1213747
(151) 2014 05 20
(181) 2024 05 20
(891) 2018 07 23
(511) 35, 36

(260) AM 2019 98955 A
(800) 1213748
(151) 2014 05 20
(181) 2024 05 20
(891) 2018 07 23
(511) 35, 36

(260) AM 2019 98956 A
(800) 1280016
(151) 2015 10 07
(181) 2025 10 07
(891) 2018 06 19
(511) 19

(260) AM 2019 98960 A
(800) 1333441
(151) 2016 06 20
(181) 2026 06 20
(891) 2018 07 03
(511) 25

(260) AM 2019 99002 A
(800) 1417555
(151) 2018 05 10
(181) 2028 05 10

(891) 2018 05 10
(511) 05

(260) AM 2019 99003 A
(800) 1417570
(151) 2018 05 18
(181) 2028 05 18
(891) 2018 05 18
(511) 33

(260) AM 2019 99004 A
(800) 1417584
(151) 2017 10 24
(181) 2027 10 24
(891) 2017 10 24
(511) 35, 36, 37, 42, 43, 45

(260) AM 2019 99008 A
(800) 1417646
(151) 2018 01 29
(181) 2028 01 29
(891) 2018 01 29
(511) 09

(260) AM 2019 99010 A
(800) 1417767
(151) 2017 12 14
(181) 2027 12 14
(891) 2017 12 14
(511) 06, 07

(260) AM 2019 99012 A
(800) 1417831
(151) 2018 06 12
(181) 2028 06 12
(891) 2018 06 12
(511) 30

(260) AM 2019 99016 A
(800) 1417968
(151) 2018 06 28
(181) 2028 06 28
(891) 2018 06 28
(511) 30

(260) AM 2019 99017 A
(800) 1417972
(151) 2018 07 02
(181) 2028 07 02
(891) 2018 07 02
(511) 30

(260) AM 2019 99019 A
(800) 1418008
(151) 2018 06 21
(181) 2028 06 21
(891) 2018 06 21
(511) 30

(260) AM 2019 99045 A
(800) 1348880
(151) 2016 10 27
(181) 2026 10 27
(891) 2018 01 09
(511) 05, 29, 30, 32, 33

(260) AM 2019 99118 A
(800) 1419648
(151) 2018 02 15
(181) 2028 02 15
(891) 2018 02 15
(511) 09, 14, 18, 25

(260) AM 2019 99141 A
(800) 898536
(151) 2006 08 16
(181) 2026 08 16
(891) 2018 08 09
(511) 01, 05, 29

(260) AM 2019 99142 A
(800) 952374
(151) 2007 09 17
(181) 2027 09 17
(891) 2018 08 08
(511) 29, 43

(260) AM 2019 99143 A
(800) 961173
(151) 2008 03 11
(181) 2028 03 11
(891) 2018 08 08
(511) 16, 29, 30, 43

(260) AM 2019 99144 A
(800) 965440
(151) 2008 03 11
(181) 2028 03 11
(891) 2018 08 08
(511) 16, 30

(260) AM 2019 99146 A
(800) 998570
(151) 2009 02 24
(181) 2019 02 24

(891) 2018 07 13
(511) 32

(260) AM 2019 99147 A
(800) 1072626
(151) 2010 10 29
(181) 2020 10 29
(891) 2018 07 11
(511) 10, 25

(260) AM 2019 99250 A
(800) 1421074
(151) 2018 06 18
(181) 2028 06 18
(891) 2018 06 18
(511) 36, 42

(260) AM 2019 99251 A
(800) 1421126
(151) 2018 01 31
(181) 2028 01 31
(891) 2018 01 31
(511) 06, 07, 09, 37

(260) AM 2019 99252 A
(800) 1421131
(151) 2018 06 20
(181) 2028 06 20
(891) 2018 06 20
(511) 02

(260) AM 2019 99257 A
(800) 1421303
(151) 2018 06 18
(181) 2028 06 18
(891) 2018 06 18
(511) 42

(260) AM 2019 99552 A
(800) 1423947
(151) 2018 07 27
(181) 2028 07 27
(891) 2018 07 27
(511) 14, 18, 25

(260) AM 2019 99566 A
(800) 843333
(151) 2004 11 01
(181) 2024 11 01
(891) 2018 08 06
(511) 05

(260) AM 2019 99567 A
(800) 996819
(151) 2009 03 05
(181) 2029 03 05
(891) 2018 07 11
(511) 05

OFFICIAL NOTIFICATION

INVENTIONS

RENEWALL OF PATENTS

(21) AP 2010 11845

(11) P 2013 5743 B

(73) Nora Mamulaishvili

(54) **METHOD OF WATER SURFACE PURIFICATION FROM OIL AND OIL PRODUCTS**

DATE OF CANCELLATION OF PATENT: 2019 06 14

DATE OF RESTORATION OF PATENT: 2019 09 10

(21) AP 2010 12620

(11) P 2014 6057 B

(73) DEUTERIA BEVERAGES LLC

(54) **ALCOHOLIC COMPOSITIONS HAVING LOWERED RISK OF ACETALDEHYDEMIA**

DATE OF CANCELLATION OF PATENT: 2018 08 20

DATE OF RESTORATION OF PATENT: 2019 09 10

ABOLITION OF PATENTS WITH THE RIGHT TO RESTORE

(21) AP 2008 10846

(11) P 2010 4986 B

(73) Elguja Kutelia;

David Gventsadze;

Olga Tsurtsunia;

Revaz Datiashvili;

Lia Gventsadze;

David Dzneladze

(54) **COMPOSITE FOR FRICTIONAL FACING**

DATE OF CANCELLATION OF PATENT: 2019 07 28

PATENT RESTORATION IS AVAILABLE: 2020 07 28

(21) AP 2004 11194

(11) P 2019 6963 B

(73) Amgen inc.

Medarex LLK

(54) **HUMAN ANTI-NGF NEUTRALIZING ANTIBODIES AS SELECTIVE NGF PATHWAY INHIBITORS**

DATE OF CANCELLATION OF PATENT: 2019 07 15

PATENT RESTORATION IS AVAILABLE: 2020 07 15

(21) AP 2009 11351

(11) P 2011 5367 B

(73) NATURIN GMBH & CO.

(54) **STABILIZED LONGLIFE NON-EDIBLE COLLAGEN CASING READY-TO-STUFF**

DATE OF CANCELLATION OF PATENT: 2019 07 06

PATENT RESTORATION IS AVAILABLE: 2020 07 06

(21) AP 2004 11890

(11) P 2014 6050 B

(73) Amgen inc.

E. R. Squibb & Sons LLK

(54) **HUMAN ANTI-NGF NEUTRALIZING ANTIBODIES AS SELECTIVE NGF PATHWAY INHIBITORS**

DATE OF CANCELLATION OF PATENT: 2019 07 15

PATENT RESTORATION IS AVAILABLE: 2020 07 15

(21) AP 2011 12999

(11) P 2015 6376 B

(73) DOW AGROSCIENCES LLC

(54) **SOLID HERBICIDE COMPOSITIONS WITH BUILT-IN ADJUVANT**

DATE OF CANCELLATION OF PATENT: 2019 07 14

PATENT RESTORATION IS AVAILABLE: 2020 07 14

(21) AP 2013 13162

(11) P 2015 6422 B

(73) LES LABORATOIRES SERVIER

(54) **METHOD FOR ENZYMATIC SYNTHESIS OF (7S)-1-(3,4-DIMETHOXYBICYCLO [4.2.0]OCTA-1,3,5-TRIENE-7-YL)N-METHYL METHANAMINE AND APPLICATION THEREIN IVABRADINE SYNTHESIS**

DATE OF CANCELLATION OF PATENT: 2019 07 15

PATENT RESTORATION IS AVAILABLE: 2020 07 15

(21) AP 2014 13545

(11) P 2016 6497 B

(73) Andy Tumanishvili;

Vazha Jamarjashvili

(54) **HYDROPOWER UNIT WITH VARIABLE SCORE**

DATE OF CANCELLATION OF PATENT: 2019 08 06

PATENT RESTORATION IS AVAILABLE: 2020 08 06

(21) AP 2015 13887

(11) P 2016 6537 B

(73) Giorgi Lekvinidze

(54) **CONTROLABLE TROLLEY FOR WHEELCHAIRS AND BABY CARRIAGES MOTION ON ESCALATOR**

DATE OF CANCELLATION OF PATENT: 2019 07 17

PATENT RESTORATION IS AVAILABLE: 2020 07 17

(21) AP 2014 14052

(11) P 2017 6803 B

(73) OTKRYTOYE AKTSIONERNOE OBSHCHESTVO (JSC) "KRASNOYARS- KIY ZAVOD TSVETNYKH METALLOV Im. V.N. GULIDOVA"

(54) **PLATINUM ALLOY FOR CATALYST GAUZES**

DATE OF CANCELLATION OF PATENT: 2019 08 06

PATENT RESTORATION IS AVAILABLE: 2020 08 06

(21) AP 2014 14076

(11) P 2017 6794 B

(73) MACROGENICS INC.

(54) **BI-SPECIFIC MONOVALENT FC DIABODIES THAT ARE CAPABLE OF BINDING CD32B AND CD79B AND USES THEREOF**

DATE OF CANCELLATION OF PATENT: 2019 08 06
PATENT RESTORATION IS AVAILABLE: 2020 08 06

(21) AP 2016 14217

(11) P 2017 6784 B

(73) LEPL Rafiel Dvali Institute of Machine Mechanics

(54) **RESISTANCE COMPOSITION**

DATE OF CANCELLATION OF PATENT: 2019 07 22
PATENT RESTORATION IS AVAILABLE: 2020 07 22

(21) AP 2016 14234

(11) P 2017 6702 B

(73) Jimsher Chkhaidze

(54) **METHOD FOR WHISKY PRODUCTION**

DATE OF CANCELLATION OF PATENT: 2019 08 04
PATENT RESTORATION IS AVAILABLE: 2020 08 04

(21) AP 2000 6316

(11) P 2004 3287 B

(73) Laboratoires des Produits Ethiques Ethypharm

(54) **PHARMACEUTICAL COMPOSITION CONTAINING FENOFIBRATE AND METHOD FOR ITS PRODUCTION**

DATE OF CANCELLATION OF PATENT: 2019 07 07
PATENT RESTORATION IS AVAILABLE: 2020 07 07

(21) AP 2003 8598

(11) P 2007 4047 B

(73) Pharmacia Corporation

(54) **PRAMIPEXOLE ONCE-DAILY DOSAGE FORM**

DATE OF CANCELLATION OF PATENT: 2019 07 25
PATENT RESTORATION IS AVAILABLE: 2020 07 25

(21) AP 2004 9180

(11) P 2009 4675 B

(73) EURO-CELTIQUE S.A.

(54) **HETEROARYL- TETRA-HYDROPIPERIDYL COMPOUNDS USEFUL FOR TREATING OR PREVENTING PAIN**

DATE OF CANCELLATION OF PATENT: 2019 07 23
PATENT RESTORATION IS AVAILABLE: 2020 07 23

(21) AP 2004 9228

(11) P 2010 4887 B

(73) AMGEN INC.

E.R. Squibb & Sons, L.L.K.

(54) **HUMAN ANTI-NGF NEUTRALIZING ANTIBODIES AS SELECTIVE NGF PATHWAY INHIBITORS**

DATE OF CANCELLATION OF PATENT: 2019 07 15
PATENT RESTORATION IS AVAILABLE: 2020 07 15

EXPIRATION OF TERM OF RESTORATION OF PATENTS

(21) AP 2004 10247

(11) P 2010 5122 B

(73) Interdigital Technology Corporation

(54) **METHOD AND SYSTEM FOR TRANSFERRING INFORMATION BETWEEN NETWORK MANAGEMENT ENTITIES OF A WIRELESS COMMUNICATION SYSTEM**

DATE OF CANCELLATION OF PATENT: 2018 07 14

THE TERM OF RESTORATION OF PATENT VALIDITY HAS EXPIRED: 2019 07 14

(21) AP 2006 10480

(11) P 2011 5302 B

(73) NOVARTIS AG

(54) **CRYSTALLINE FORMS OF 4-METHYL-N-[3-(4-METHYL-IMIDAZOL-1-YL)-5-TRIFLUOROMETHYL-PHENYL]-3-(4-PYRIDIN-3-YL-PYRIMIDIN-2-YLAMINO)-BENZAMIDE**

DATE OF CANCELLATION OF PATENT: 2018 07 18

THE TERM OF RESTORATION OF PATENT VALIDITY HAS EXPIRED: 2019 07 18

(21) AP 2006 10547

(11) P 2010 4964 B

(73) Aziende Chimiche Riunite Angelini Francesco A.C.R.A.F. S.p.A.

(54) **3-AMINOCARBAZOLE COMPOUNDS, PHARMACEUTICAL COMPOSITION CONTAINING THE SAME AND METHOD FOR THE PREPARATION THEREOF**

DATE OF CANCELLATION OF PATENT: 2018 07 25

THE TERM OF RESTORATION OF PATENT VALIDITY HAS EXPIRED: 2019 07 25

(21) AP 2010 11905

(11) P 2012 5573 B

(73) Avtandil Balanchivadze

(54) **DRIVE OF FRYING APPARATUS**

DATE OF CANCELLATION OF PATENT: 2018 08 03

THE TERM OF RESTORATION OF PATENT VALIDITY HAS EXPIRED: 2019 08 03

(21) AP 2009 12123

(11) P 2013 5858 B

(73) Aziende Chimiche Riunite Angelini Francesco A.C.R.A.F. S.p.A.

(54) **COMPOUND WITH SEROTONINERGIC ACTIVITY, METHOD OF ITS PREPARATION, AND PHARMACEUTICAL COMPOSITION CONTAINING THEREOF**

DATE OF CANCELLATION OF PATENT: 2018 07 17

THE TERM OF RESTORATION OF PATENT VALIDITY HAS EXPIRED: 2019 07 17

(21) AP 2011 12325

(11) P 2013 5873 B

(73) Manana Shubitidze

(54) **OINTMENT FOR SKIN SUPPURATIVE DISEASES, WOUNDS AND BURN TREATMENT**

DATE OF CANCELLATION OF PATENT: 2018 08 04

THE TERM OF RESTORATION OF PATENT VALIDITY HAS EXPIRED: 2019 08 04

(21) AP 2011 12326

(11) P 2013 5874 B

(73) Manana Shubitidze

(54) DRUG FOR TUBERCULOSIS (T.B.)

DATE OF CANCELLATION OF PATENT: 2018 08 04

THE TERM OF RESTORATION OF PATENT VALIDITY HAS EXPIRED: 2019 08 04

(21) AP 2010 12610

(11) P 2013 5878 B

(73) Aziende Chimiche Riunite Angelini Francesco A.C.R.A.F. S.p.A.

(54) METHOD OF 1-BENZYL-3-HYDROXYMETHYL-1H-INDAZOLE PREPARATION, DERIVATIVES THEREOF, AND REQUIRED MAGNESIUM INTERMEDIATES

DATE OF CANCELLATION OF PATENT: 2018 07 28

THE TERM OF RESTORATION OF PATENT VALIDITY HAS EXPIRED: 2019 07 28

(21) AP 2010 12611

(11) P 2013 5879 B

(73) Aziende Chimiche Riunite Angelini Francesco A.C.R.A.F. S.p.A.

(54) METHOD OF 1-BENZYL-3-HYDROXYMETHYL-1H-INDAZOLE PREPARATION, DERIVATIVES THEREOF, AND REQUIRED MAGNESIUM INTERMEDIATES

DATE OF CANCELLATION OF PATENT: 2018 07 28

THE TERM OF RESTORATION OF PATENT VALIDITY HAS EXPIRED: 2019 07 28

(21) AP 2013 13731

(11) P 2016 6586 B

(73) LABORATORI GUIDOTTI S.P.A.

(54) PEDIATRIC ORAL LIQUID COMPOSITIONS CONTAINING NEPADUTANT

DATE OF CANCELLATION OF PATENT: 2018 07 12

THE TERM OF RESTORATION OF PATENT VALIDITY HAS EXPIRED: 2019 07 12

(21) AP 2013 13734

(11) P 2017 6706 B

(73) OTKRITOE AKTSIONERNOE OBSHESTVO (OJSC) "RESEARCH & DESIGN INSTITUTE OF UREA AND ORGANIC SYNTHESIS PRODUCTS" (OAO NIIK)

(54) UREA PRODUCTION PROCESS AND PLANT AND METHOD FOR MODERNIZATION UREA PRODUCTION PLANT

DATE OF CANCELLATION OF PATENT: 2018 08 05

THE TERM OF RESTORATION OF PATENT VALIDITY HAS EXPIRED: 2019 08 05

(21) AP 2013 13748

(11) P 2017 6707 B

(73) BOEHRINGER INGELHEIM INTERNATIONAL GMBH

(54) 4-METHYL-2,3,5,9B-PENTAZA-CYCLOPENTA[A]NAPHTHALENES

DATE OF CANCELLATION OF PATENT: 2018 07 29

THE TERM OF RESTORATION OF PATENT VALIDITY HAS EXPIRED: 2019 07 29

(21) AP 2014 14005

(11) P 2017 6792 B

(73) CADILA HEALTHCARE LIMITED

(54) SYNERGISTIC COMPOSITIONS

DATE OF CANCELLATION OF PATENT: 2018 07 04

THE TERM OF RESTORATION OF PATENT VALIDITY HAS EXPIRED: 2019 07 04

(21) AP 2014 14025
(11) P 2018 6825 B
(73) CADILA HEALTHCARE LIMITED
(54) **FORMULATION COMPRISING HYPOLIPIDEMIC AGENT**
DATE OF CANCELLATION OF PATENT: 2018 07 24
THE TERM OF RESTORATION OF PATENT VALIDITY HAS EXPIRED: 2019 07 24

(21) AP 2014 14070
(11) P 2018 6812 B
(73) COUNCIL OF SCIENTIFIC & INDUSTRIAL RESEARCH ;
SHANTANI PROTEOME ANALYTICS PVT. LTD
(54) **NOVEL INDAZOLE COMPOUNDS AND A PROCESS FOR THE PREPARATION THEREOF**
DATE OF CANCELLATION OF PATENT: 2018 07 31
THE TERM OF RESTORATION OF PATENT VALIDITY HAS EXPIRED: 2019 07 31

(21) AP 1998 5200
(11) P 2003 3054 B
(73) Janssen Pharmaceutica N.V.
(54) **2,4,4-TRISUBSTITUTED-1,3-DIOXOLANE ANTIFUNGALS**
DATE OF CANCELLATION OF PATENT: 2018 07 07
THE TERM OF RESTORATION OF PATENT VALIDITY HAS EXPIRED: 2019 07 07

(21) AP 2001 6795
(11) P 2004 3362 B
(73) LES LABORATOIRES SERVIER
(54) **NOVEL \$G(Y)\$CRYSTALLINE FORM OF PERINDOPRIL TERT- BUTYLAMINE SALT,
PREPARATION METHOD, AND PHARMACEUTICAL COMPOSITIONS CONTAINING SAME**
DATE OF CANCELLATION OF PATENT: 2018 07 06
THE TERM OF RESTORATION OF PATENT VALIDITY HAS EXPIRED: 2019 07 06

(21) AP 2001 6797
(11) P 2004 3360 B
(73) LES LABORATOIRES SERVIER
(54) **NOVEL \$G(BETA)\$CRYSTALLINE FORM OF PERINDOPRIL TERT-BUTYLAMINE SALT,
PREPARATION METHOD, AND PHARMACEUTICAL COMPOSITIONS CONTAINING SAME**
DATE OF CANCELLATION OF PATENT: 2018 07 06
THE TERM OF RESTORATION OF PATENT VALIDITY HAS EXPIRED: 2019 07 06

(21) AP 2002 8065
(11) P 2005 3650 B
(73) Aziende Chimiche Riunite Angelini Francesco A.C.R.A.F. S.p.A.
(54) **DISINFECTANT SOLUTION BASED ON SODIUM HYPOCHLORITE, AND PROCESS FOR
PREPARING IT**
DATE OF CANCELLATION OF PATENT: 2018 07 23
THE TERM OF RESTORATION OF PATENT VALIDITY HAS EXPIRED: 2019 07 23

(21) AP 2004 9183
(11) P 2016 6538 B
(73) EURO-CELTIQUE S.A.
(54) **PREOPERATIVE TREATMENT OF POST OPERATIVE PAIN**
DATE OF CANCELLATION OF PATENT: 2018 07 26
THE TERM OF RESTORATION OF PATENT VALIDITY HAS EXPIRED: 2019 07 26

(21) AP 2004 9184
(11) P 2012 5454 B
(73) EURO-CELTIQUE S.A.
(54) **TREATMENT OF DRUG DEPENDENCE WITHDRAWAL**
DATE OF CANCELLATION OF PATENT: 2018 07 26
THE TERM OF RESTORATION OF PATENT VALIDITY HAS EXPIRED: 2019 07 26

(21) AP 2004 9234
(11) P 2008 4343 B
(73) Aziende Chimiche Riunite Angelini Francesco A.C.R.A.F. S.p.A.
(54) **USE OF INDOLE DERIVATIVES FOR THE TREATMENT OF NEUROPATHIC PAIN**
THE TERM OF RESTORATION OF PATENT VALIDITY HAS EXPIRED: 2019 07 08

(21) AP 2004 9236
(11) P 2009 4599 B
(73) Interdigital Technology Corporation
(54) **DEVICE FOR TRANSFERRING INFORMATION BETWEEN NETWORK MANAGEMENT ENTITIES OF A WIRELESS COMMUNICATION SYSTEM**
DATE OF CANCELLATION OF PATENT: 2018 07 14
THE TERM OF RESTORATION OF PATENT VALIDITY HAS EXPIRED: 2019 07 14

(21) AP 2004 9238
(11) P 2011 5194 B
(73) Interdigital Technology Corporation
(54) **METHOD AND SYSTEM FOR DELIVERY OF ASSISTANCE DATA**
DATE OF CANCELLATION OF PATENT: 2018 07 16
THE TERM OF RESTORATION OF PATENT VALIDITY HAS EXPIRED: 2019 07 16

(21) AP 2004 9240
(11) P 2010 5135 B
(73) Interdigital Technology Corporation
(54) **METHOD AND DEVICE FOR SIGNALING WLAN NETWORK CONTROL**
DATE OF CANCELLATION OF PATENT: 2018 07 13
THE TERM OF RESTORATION OF PATENT VALIDITY HAS EXPIRED: 2019 07 13

(21) AP 2004 9261
(11) P 2009 4740 B
(73) LES LABORATOIRES SERVIER
(54) **NOVEL METHOD FOR THE SYNTHESIS OF PERINDOPRIL AND THE PHARMACEUTICALLY ACCEPTABLE SALTS THEREOF**
DATE OF CANCELLATION OF PATENT: 2018 07 29
THE TERM OF RESTORATION OF PATENT VALIDITY HAS EXPIRED: 2019 07 29

(21) AP 2005 9836
(11) P 2011 5195 B
(73) RINAT NEUROSCIENCE CORP.
(54) **ANTIBODIES DIRECTED AGAINST AMYLOID-BETA PEPTIDE AND USE THEREOF**
DATE OF CANCELLATION OF PATENT: 2018 08 01
THE TERM OF RESTORATION OF PATENT VALIDITY HAS EXPIRED: 2019 08 01

UTILITY MODELS

RENEWAL OF PATENTS

(21) AU 2011 12112

(11) U 2012 1707 Y

(73) Giorgi Bendelava;
Parmen Margvelashvili;
Vashkhi Zhvania;
David Loladze

(54) **METHOD OF TEA IODINE ENRICHMENT**

DATE OF CANCELLATION OF PATENT: 2019 02 21

DATE OF RESTORATION OF PATENT: 2019 09 10

(21) AU 2013 13112

(11) U 2014 1825 Y

(73) Elguja Shapakidze;
Vladimir Miruashvili

(54) **DEVICE REELING THREAD FROM COCOON**

DATE OF CANCELLATION OF PATENT: 2019 06 06

DATE OF RESTORATION OF PATENT: 2019 09 10

ABOLITION OF PATENTS WITH THE RIGHT TO RESTORE

(21) AU 2013 13164

(11) U 2014 1806 Y

(73) Tengiz Chachanidze

(54) **SMOKING ARTICLE**

DATE OF CANCELLATION OF PATENT: 2019 07 17

MODEL RESTORATION IS AVAILABLE: 2020 07 17

(21) AU 2016 14208

(11) U 2017 1931 Y

(73) Olga Bulatovich

(54) **METHOD AND SYSTEM FOR TRADING WITH INDIVIDUALLY PACKED FOOD PRODUCTS**

DATE OF CANCELLATION OF PATENT: 2019 07 15

MODEL RESTORATION IS AVAILABLE: 2020 07 15

(21) AU 2016 14209

(11) U 2017 1932 Y

(73) Omar Marsagishvili

(54) **EQUIPMENT FOR FORMING "KHINKALI"**

DATE OF CANCELLATION OF PATENT: 2019 07 18

MODEL RESTORATION IS AVAILABLE: 2020 07 18

(21) AU 2017 14550

(11) U 2018 1995 Y

(73) Giorgi Kutelia

(54) **BREAKER HYDROPOWER STATION**

DATE OF CANCELLATION OF PATENT: 2019 07 21

MODEL RESTORATION IS AVAILABLE: 2020 07 21

EXPIRATION OF TERM OF RESTORATION OF PATENTS

(21) AU 2012 12801

(11) U 2015 1847 Y

(73) Vladimir Fadurashvili;

Tea Fadurashvili;

Zaza Fadurashvili;

Nadezhda Eliava

(54) **DISINFECTION-STERILIZATION COMPOSITION "PADIURA-27"**

DATE OF CANCELLATION OF PATENT: 2018 07 19

THE TERM OF RESTORATION OF PATENT VALIDITY HAS EXPIRED: 2019 07 19

(21) AU 2013 13163

(11) U 2014 1810 Y

(73) Gizo Bokeria

(54) **HERBAL INGREDIENTS FOR LIVER DISEASES TREATMENT**

DATE OF CANCELLATION OF PATENT: 2018 07 15

THE TERM OF RESTORATION OF PATENT VALIDITY HAS EXPIRED: 2019 07 15

(21) AU 2016 14200

(11) U 2018 1958 Y

(73) Roland Zhorzholiani

(54) **WALL BLOCK**

DATE OF CANCELLATION OF PATENT: 2018 07 05

THE TERM OF RESTORATION OF PATENT VALIDITY HAS EXPIRED: 2019 07 05

DESIGNS

CHANGES OF NAMES AND/OR ADDRESSES OF PATENTOWNERS

(21) AD 2018 1047

(11) D 2019 804 S

(54) 1.-11. WINDOW PROFILES, 12. WINDOW

NEW NAME AND ADDRESSES: LTD "IRNERO" (GE)
 Sanapiro St. 2a, 0105, Tbilisi Georgia (GE);
 Luka Pachkorია (GE)
 Sanapiro St. 2a, 0105, Tbilisi Georgia (GE)

LAST NAME AND ADDRESSES: LTD "VINTECHPRO" (GE)
 Sanapiro St. 2a, 0105, Tbilisi Georgia (GE);
 Luka Ananidze (GE)
 Sanapiro St. 2a, 0105, Tbilisi Georgia (GE)

DATE OF REGISTRY: 2019 08 21

TRADEMARKS**RENEWAL OF REGISTRATIONS**

(111) M 1999 12697 R2

(156) 1999 08 24

(186) 2029 08 24

(732) STMicroelectronics International N.V.
Schiphol Boulevard 265, 1118 BH Schiphol,
Netherlands

(111) M 1999 12215 R2

(156) 1999 05 14

(186) 2029 05 14

(732) IPSEN PHARMA S.A.S.
65 Quai Georges Gorse, F-92100 Boulogne-
Billancourt, France

(111) M 1999 12421 R2

(156) 1999 07 02

(186) 2029 07 02

(732) HUTHWAITE RESEARCH GROUP
LIMITED
Hooper House, Wentworth, Rotherham,
South Yorkshire S62 7SA, United Kingdom

(111) M 1999 12501 R2

(156) 1999 07 12

(186) 2029 07 12

(732) HARRINGTON DEVELOPMENT INC.
Elivira Mendez Street, Valerino Bldg, 3rd
Floor, Panama, Republic of Panama

(111) M 1999 12502 R2

(156) 1999 07 12

(186) 2029 07 12

(732) HARRINGTON DEVELOPMENT INC.
Elivira Mendez Street, Valerino Bldg, 3rd
Floor, Panama, Republic of Panama

(111) M 1999 12725 R2

(156) 1999 08 31

(186) 2029 08 31

(732) RAYMOND CONSUMER CARE PRIVATE
LIMITED
Plot No G-35 & 36 MIDC Industrial Area,
Waluj, Aurangabad-431136, India

(111) M 1999 12948 R2

(156) 1999 11 04

(186) 2029 11 04

(732) VIACOM INTERNATIONAL INC.

1515 Broadway, New York, NY 10036, USA

(111) M 1999 13039 R2

(156) 1999 12 14

(186) 2029 12 14

(732) VIACOM INTERNATIONAL INC.
1515 Broadway, New York, NY 10036, USA

(111) M 1999 13066 R2

(156) 1999 12 28

(186) 2029 12 28

(732) TOVOTA JIDOSHA KABUSHIKI KAISHA
(also trading as TOVOTA MOTOR
CORPORATION)
1, Toyota-cho, Toyota-shi, Aichi-ken, Japan

(111) M 2009 19911 R1

(156) 2009 11 02

(186) 2029 11 02

(732) NOVARTIS AG
4002 Basel, Switzerland

(111) M 2009 19245 R1

(156) 2009 04 21

(186) 2029 04 21

(732) STANLEY BLACK & DECKER, INC.
1000 Stanley Drive, New Britain, Connecticut
06053, USA

(111) M 2009 19247 R1

(156) 2009 04 21

(186) 2029 04 21

(732) STANLEY BLACK & DECKER, INC.
1000 Stanley Drive, New Britain, Connecticut
06053, USA

(111) M 2009 19881 R1

(156) 2009 10 16

(186) 2029 10 16

(732) VLAKTOR TRADING LIMITED
Zinonos Kitieos, 8, Kato Lakatamia, P.C. 2322
Nicosia, Cyprus

(111) M 2009 19733 R1
(156) 2009 09 08
(186) 2029 09 08
(732) NGK SPARK PLUG CO., LTD
14-18, Takatsuji-cho, Mizuho-ku, Nagoya
City, 467-8525, Japan

a Delaware corporation
4000 Warner Blvd., Burbank, California
91522, USA

(111) M 2009 19735 R1
(156) 2009 09 08
(186) 2029 09 08
(732) NGK SPARK PLUG CO., LTD
14-18, Takatsuji-cho, Mizuho-ku, Nagoya
City, 467-8525, Japan

(111) M 2009 19978 R1
(156) 2009 11 18
(186) 2029 11 18
(732) SOCIETE JAS HENESSY & CO.
rue de la Richonne, 16100 COGNAC, France

(111) M 2009 20022 R1
(156) 2009 11 18
(186) 2029 11 18
(732) NOVARTIS AG
4002 Basel, Switzerland

(111) M 2009 20023 R1
(156) 2009 11 18
(186) 2029 11 18
(732) NOVARTIS AG
4002 Basel, Switzerland

(111) M 2009 20024 R1
(156) 2009 11 18
(186) 2029 11 18
(732) NOVARTIS AG
4002 Basel, Switzerland

(111) M 1999 11776 R2
(156) 1999 03 18
(186) 2029 03 18
(732) WARNER BROS. ENTERTAINMENT INC.
a Delaware corporation
4000 Warner Blvd., Burbank, California
91522, USA

(111) M 1999 11777 R2
(156) 1999 03 18
(186) 2029 03 18
(732) WARNER BROS. ENTERTAINMENT INC.

COMPLETE TRANSFER OF RIGHTS

(111) M 1997 5632 R
(732) FINASSET S.A.
2, Ru Albert I, L-1117 Luxembourg,
Luxembourg
(770) F. HOFFMANN-LA ROCHE AG
124 Grenzacherstrasse, CH-4002 Basle,
Switzerland
(580) 14 08 2019

(111) M 2016 26819 R
(732) VALEANT HOLDINGS AIRLEND
3013 Lake Drive, City West Business
Campus, Dublin 24, Ireland
(770) ASTRAZENECA COLLABORATION
VENTURES, LLC
1800 Concord Pike, Wilmington, Delaware
19850, USA
(580) 14 08 2019

(111) M 2016 26820 R
(732) VALEANT HOLDINGS AIRLEND
3013 Lake Drive, City West Business
Campus, Dublin 24, Ireland
(770) ASTRAZENECA COLLABORATION
VENTURES, LLC
1800 Concord Pike, Wilmington, Delaware
19850, USA
(580) 14 08 2019

(111) M 2016 26821 R
(732) VALEANT HOLDINGS AIRLEND
3013 Lake Drive, City West Business
Campus, Dublin 24, Ireland
(770) ASTRAZENECA COLLABORATION
VENTURES, LLC
1800 Concord Pike, Wilmington, Delaware
19850, USA
(580) 14 08 2019

(111) M 2016 27236 R
(732) VALEANT HOLDINGS AIRLEND
3013 Lake Drive, City West Business
Campus, Dublin 24, Ireland
(770) ASTRAZENECA COLLABORATION
VENTURES, LLC
1800 Concord Pike, Wilmington, Delaware
19850, USA
(580) 14 08 2019

CHANGES OF NAMES AND/OR ADDRESS OF OWNERS

(111) M 1998 9569 R
 (732) KRAFT FOODS DANMARK
 INTELLECTUAL PROPERTY APS
 Ringager 2 A, 2, DK-2605 Brøndby, Denmark
 (770) KRAFT FOODS DANMARK
 INTELLECTUAL PROPERTY APS
 Søndre Ringvej 55, DK-2605 Brøndby,
 Denmark
 (580) 23 08 2019

(111) M 2011 21251 R
 (732) KRAFT FOODS DANMARK
 INTELLECTUAL PROPERTY APS
 Ringager 2 A, 2, DK-2605 Brøndby, Denmark
 (770) KRAFT FOODS DANMARK
 INTELLECTUAL PROPERTY APS
 Søndre Ringvej 55, DK-2605 Brøndby,
 Denmark
 (580) 23 08 2019

(111) M 1997 4984 R
 (732) KRAFT FOODS DANMARK
 INTELLECTUAL PROPERTY APS
 Ringager 2 A, 2, DK-2605 Brøndby, Denmark
 (770) KRAFT FOODS DANMARK
 INTELLECTUAL PROPERTY APS
 Søndre Ringvej 55, DK-2605 Brøndby,
 Denmark
 (580) 23 08 2019

(111) M 2011 21252 R
 (732) KRAFT FOODS DANMARK
 INTELLECTUAL PROPERTY APS
 Ringager 2 A, 2, DK-2605 Brøndby, Denmark
 (770) KRAFT FOODS DANMARK
 INTELLECTUAL PROPERTY APS
 Søndre Ringvej 55, DK-2605 Brøndby,
 Denmark
 (580) 23 08 2019

(111) M 1999 12725 R
 (732) RAYMOND CONSUMER CARE PRIVATE
 LIMITED
 Plot No. G-35 & 36 MIDC Industrial Area,
 Waluj, Aurangabad-431136, India
 (770) J.K. ANSEL PRAIVIT LIMITID
 Plot No. G-35 & 36 MIDC Industrial Area,
 Waluj, Aurangabad-431136, India
 (580) 14 08 2019

(111) M 2013 23977 R
 (732) KRAFT FOODS DANMARK
 INTELLECTUAL PROPERTY APS
 Ringager 2 A, 2, DK-2605 Brøndby, Denmark
 (770) KRAFT FOODS DANMARK
 INTELLECTUAL PROPERTY APS
 Søndre Ringvej 55, DK-2605 Brøndby,
 Denmark
 (580) 23 08 2019

(111) M 2004 15723 R
 (732) KRAFT FOODS DANMARK
 INTELLECTUAL PROPERTY APS
 Ringager 2 A, 2, DK-2605 Brøndby, Denmark
 (770) KRAFT FOODS DANMARK
 INTELLECTUAL PROPERTY APS
 Søndre Ringvej 55, DK-2605 Brøndby,
 Denmark
 (580) 23 08 2019

(111) M 2013 24175 R
 (732) KRAFT FOODS DANMARK
 INTELLECTUAL PROPERTY APS
 Ringager 2 A, 2, DK-2605 Brøndby, Denmark
 (770) KRAFT FOODS DANMARK
 INTELLECTUAL PROPERTY APS
 Søndre Ringvej 55, DK-2605 Brøndby,
 Denmark
 (580) 23 08 2019

(111) M 2009 19692 R
 (732) CHURCH & DWIGHT CO., INC.
 (a Delaware corporation)
 500 Charles Ewing Boulevard, Ewing, New
 Jersey, 08628, USA
 (770) CHURCH & DWIGHT CO., INC.
 (a Delaware corporation)
 469 North Harrison Street, Princeton, New
 Jersey 08543, USA
 (580) 22 08 2019

(111) M 2013 24176 R
 (732) KRAFT FOODS DANMARK
 INTELLECTUAL PROPERTY APS
 Ringager 2 A, 2, DK-2605 Brøndby, Denmark
 (770) KRAFT FOODS DANMARK
 INTELLECTUAL PROPERTY APS
 Søndre Ringvej 55, DK-2605 Brøndby,
 Denmark
 (580) 23 08 2019

(111) M 1997 4825 R
(732) KRAFT FOODS DANMARK
INTELLECTUAL PROPERTY APS
Ringager 2 A, 2, DK-2605 Brøndby, Denmark
(770) KRAFT FOODS DANMARK
INTELLECTUAL PROPERTY APS
Søndre Ringvej 55, DK-2605 Brøndby,
Denmark
(580) 23 08 2019

(770) KRAFT FOODS DANMARK
INTELLECTUAL PROPERTY APS
Søndre Ringvej 55, Brøndby DK-2605,
Denmark
(580) 23 08 2019

(111) M 2017 29030 R
(732) KRAFT FOODS DANMARK
INTELLECTUAL PROPERTY APS
Ringager 2 A, 2, DK-2605 Brøndby, Denmark
(770) KRAFT FOODS DANMARK
INTELLECTUAL PROPERTY APS
Søndre Ringvej 55, Brøndby DK-2605,
Denmark
(580) 23 08 2019

(111) M 1996 4255 R
(732) KRAFT FOODS DANMARK
INTELLECTUAL PROPERTY APS
Ringager 2 A, 2, DK-2605 Brøndby, Denmark
(770) KRAFT FOODS DANMARK
INTELLECTUAL PROPERTY APS
Søndre Ringvej 55, DK-2605 Brøndby,
Denmark
(580) 23 08 2019

(111) M 1997 4962 R
(732) KRAFT FOODS DANMARK
INTELLECTUAL PROPERTY APS
Ringager 2 A, 2, DK-2605 Brøndby, Denmark
(770) KRAFT FOODS DANMARK
INTELLECTUAL PROPERTY APS
Søndre Ringvej 55, DK-2605 Brøndby,
Denmark
(580) 23 08 2019

(111) M 2017 29199 R
(732) KRAFT FOODS DANMARK
INTELLECTUAL PROPERTY APS
Ringager 2 A, 2, DK-2605 Brøndby, Denmark
(770) KRAFT FOODS DANMARK
INTELLECTUAL PROPERTY APS
Søndre Ringvej 55, Brøndby DK-2605,
Denmark
(580) 23 08 2019

(111) M 2017 29200 R
(732) KRAFT FOODS DANMARK
INTELLECTUAL PROPERTY APS
Ringager 2 A, 2, DK-2605 Brøndby, Denmark

TERMINATION OF TRADEMARKS REGISTRATIONS

- (111) M 2018 30624 R
(151) 2018 12 20
(141) 19 08 2019, Decree №270/20 of the
Chairman of the LEPL National
Intellectual Property Center of
Georgia "Sakpatenti" on
August 13, 2019
(732) LTD "HOLIDEI 1993"
Vill. Tkhilvana, Khulo district, Georgia
-
- (111) M 1999 11552 R
(151) 1999 02 16
(141) 2019 09 04, Terminated due to non-payment of
extension
(732) OP HOLDINGS LLC
103 Foulk Road, Suite 200, Wilmington,
Delaware 19803, USA
-
- (111) M 1999 11554 R
(151) 1999 02 17
(141) 2019 09 04, Terminated due to non-payment of
extension
(732) C. JOSEF LAMY GMBH
Grenzhofer Weg 32, 69123 Heidelberg,
Germany
-
- (111) M1999 11565 R
(151) 1999 02 17
(141) 2019 09 04, Terminated due to non-payment of
extension
(732) MSD International Holdings GmbH
Veystrasse 20, CH-6000, Lucerne 6,
Switzerland
-
- (111) M 1999 11454 R
(151) 1999 02 09
(141) 2019 09 04, Terminated due to non-payment of
extension
(732) JTI Sweden AB
Box 24155, 10451 Stockholm, Sweden
-
- (111) M 1999 11560 R
(151) 1999 02 17
(141) 2019 09 04, Terminated due to non-payment of
extension
(732) NOVUS INTERNATIONAL, INC.
530 Maryville Centre Drive, St. Louis, MO
63141, USA
-
- (111) M 1999 11447 R
(151) 1999 02 09
(141) 2019 09 04, Terminated due to non-payment of
extension
(732) H-D U.S.A. LLC
3700 West Juneau Avenue, Milwaukee,
WI 53208, USA
-
- (111) M 1999 11485 R
(151) 1999 02 11
(141) 2019 09 04, Terminated due to non-payment of
extension
(732) HENKEL AG & Co. KgaA
Henkelstrasse 67, 40589 Dusseldorf, Germany
-
- (111) M 1999 11487 R
(151) 1999 02 11
(141) 2019 09 04, Terminated due to non-payment of
extension
(732) HENKEL AG & Co. KgaA
Henkelstrasse 67, 40589 Dusseldorf, Germany
-
- (111) M 1999 11488 R
(151) 1999 02 11
(141) 2019 09 04, Terminated due to non-payment of
extension
(732) HENKEL AG & Co. KgaA
Henkelstrasse 67, 40589 Dusseldorf, Germany
-
- (111) M 1999 11489 R
(151) 1999 02 11
(141) 2019 09 04, Terminated due to non-payment of
extension
(732) HENKEL AG & Co. KgaA
Henkelstrasse 67, 40589 Dusseldorf, Germany
-
- (111) M 1999 11491 R
(151) 1999 02 11
(141) 2019 09 04, Terminated due to non-payment of
extension
(732) HELSINN HEALTHCARE S.A.
Via Pian Scairolo 6912 Pazzallo, Switzerland
-
- (111) M 1999 11582 R
(151) 1999 02 18
(141) 2019 09 04, Terminated due to non-payment of
extension

(732) NOVARTIS CONSUMER HEALTH S.A.
Route de L'Etlaz, 1197 Prangins, Switzerland

(111) M 1999 11662 R
(151) 1999 02 25
(141) 2019 09 04, Terminated due to non-payment of extension

(732) AWD.PHARMA GMBH & CO.KG
Leipziger Strasse 7-13, 01097 Drezden, Germany

(111) M 1999 11663 R
(151) 1999 02 25
(141) 2019 09 04, Terminated due to non-payment of extension

(732) AWD.PHARMA GMBH & CO. KG
Leipziger Strasse 7-13, 01097 Dresden, Germany

(111) M 1999 11664 R
(151) 1999 02 25
(141) 2019 09 04, Terminated due to non-payment of extension

(732) AWD.PHARMA GMBH & CO.KG
Leipziger Strasse 7-13, 01097 Dresden, Germany

(111) M 1999 11585 R
(151) 1999 02 18
(141) 2019 09 04, Terminated due to non-payment of extension

(732) SMITHKLINE BEECHAM LIMITED
980 Great West Road, Brentford, Middlesex TW8 9GS, United Kingdom

(111) M 1999 11587 R
(151) 1999 02 18
(141) 2019 09 04, Terminated due to non-payment of extension

(732) SMITHKLINE BEECHAM (CORK) LIMITED
Currabinny, Carrigaline, County Cork, Ireland

(111) M 1999 11588 R
(151) 1999 02 18
(141) 2019 09 04, Terminated due to non-payment of extension

(732) SMITHKLINE BEECHAM LIMITED
980 Great West Road, Brentford, Middlesex TW8 9GS, United Kingdom

(111) M 1999 11589 R
(151) 1999 02 18
(141) 2019 09 04, Terminated due to non-payment of extension

(732) WARNER CHILCOTT COMPANY, LLC
Union Street KM 1.1, Fajardo, 00738, Puerto Rico, USA

(111) M 1999 11566P R
(151) 1999 02 17
(141) 2019 09 04, Terminated due to non-payment of extension

(732) OLEINA SA
13 Route de Florissant, 1206 GENEVE, Switzerland

(111) M 2009 19075 R
(151) 2009 02 13
(141) 2019 09 04, Terminated due to non-payment of extension

(732) LTD "G-T-C & COMPANY"
Akaki Tseretlis q. 186, 4600, Kutaisi, Georgia

(111) M 2009 19076 R
(151) 2009 02 13
(141) 2019 09 04, Terminated due to non-payment of extension

(732) LTD "GEORGIAN BUSINESS WEEK"
Tkhinvalis q. 9/7, 0108, Tbilisi, Georgia

(111) M 2009 19081 R
(151) 2009 02 13
(141) 2019 09 04, Terminated due to non-payment of extension

(732) LTD " G-T-C & COMPANY"
Akaki Tseretlis q.186, 4600, Qutaisi, Georgia

(111) M 2009 19085 R
(151) 2009 02 13
(141) 2019 09 04, Terminated due to non-payment of extension

(732) GENERAL MOTORS LLC
300 Renaissance Center, City of Detroit, State of Michigan 48265-3000, USA

(111) M 2009 19087 R
(151) 2009 02 13
(141) 2019 09 04, Terminated due to non-payment of extension

(732) LTD "MAGI STILE"
Kindzmaraulis q. 15, 0168, Tbilisi, Georgia

(111) M 2009 19088 R
(151) 2009 02 13
(141) 2019 09 04, Terminated due to non-payment of extension
(732) Aleksandre Bakuridze
Janashias q. 30/35, 0179, Tbilisi, Georgia

(111) M 2009 19089 R
(151) 2009 02 13
(141) 2019 09 04, Terminated due to non-payment of extension
(732) Aleksandre Bakuridze
Janashias q. 30/35, 0179, Tbilisi, Georgia

(111) M 2009 19090 R
(151) 2009 02 13
(141) 2019 09 04, Terminated due to non-payment of extension
(732) Aleksandre Bakuridze
Janashias q. 30/35, 0179, Tbilisi, Georgia

(111) M 2009 19091 R
(151) 2009 02 13
(141) 2019 09 04, Terminated due to non-payment of extension
(732) Aleksandre Bakuridze
Janashias q. 30/35, 0179, Tbilisi, Georgia

(111) M 2009 19092 R
(151) 2009 02 13
(141) 2019 09 04, Terminated due to non-payment of extension
(732) DEUTSCHE TELECOM AG
Friedrich-Ebert-Allee 140, 53113 Bonn,
Germany

(111) M 1999 11564 R
(151) 1999 02 17
(141) 2019 09 04, Terminated due to non-payment of extension
(732) SCHOTT AG
Hattenbergstrasse 10, 55122 Mainz, Germany

(111) M 2009 19093 R
(151) 2009 02 13
(141) 2019 09 04, Terminated due to non-payment of extension
(732) SANOFI PASTEUR
2, avenue Pont Pasteur-69007, Lyons, France

(111) M 1999 11534 R
(151) 1999 02 16
(141) 2019 09 04, Terminated due to non-payment of extension
(732) MARS INC., (corp. State of Delaware)
6885 Elm Street, McLean, Virginia
22101-3883, USA

(111) M 1999 11512 R
(151) 1999 02 16
(141) 2019 09 04, Terminated due to non-payment of extension
(732) Johnson & Johnson
One Johnson & Johnson Plaza, New
Brunswick, New Jersey 08933, USA

(111) M 1999 11515 R
(151) 1999 02 16
(141) 2019 09 04, Terminated due to non-payment of extension
(732) SYSTAGENIX WOUND MANAGEMENT
IP CO B.V.
a Netherland limited liability company
Keizersgracht 64, 1015CS, Amsterdam,
Netherlands

(111) M 1999 11536 R
(151) 1999 02 16
(141) 2019 09 04, Terminated due to non-payment of extension
(732) SYSTAGENIX WOUND MANAGEMENT
IP CO B.V.
a Netherland limited liability company
Keizersgracht 64, 1015CS, Amsterdam,
Netherlands

(111) M 1999 11613 R
(151) 1999 02 18
(141) 2019 09 04, Terminated due to non-payment of extension
(732) BASF Agrochemical 1 Products B.V.
Kadestraat 1, 6811 CA Arnhem, Netherlands

(111) M 1999 11614 R
(151) 1999 02 18
(141) 2019 09 04, Terminated due to non-payment of extension
(732) BASF Agro B.V., Arnhem (NL)
Zweigniederlassung Freienbach
Huobstrasse 3, 8808 Pfeffikon SZ,
Switzerland

(111) M 1999 11618 R
(151) 1999 02 18
(141) 2019 09 04, Terminated due to non-payment of extension
(732) DAME ANNE PALOMA RUIZ-PICASSO,
EPOUSE LOPEZ CAMBIL
14 Avenue Mon Repos, Case Postale 7602,
Lausanne CH 1002, Switzerland

(732) HERMES SUSSTOFF AG
(HERMES EDULCORANTS S. A., HERMES
SWEETENERS LTD.)
Ankerstrasse 53, CH-8026 Zurich,
Switzerland

(111) M 1999 11623 R
(151) 1999 02 18
(141) 2019 09 04, Terminated due to non-payment of extension
(732) NOVO NORDISK A/S
Novo Alle, DK-2880 Bagsvaerd, Denmark

(111) M 1999 11612 R
(151) 1999 02 18
(141) 2019 09 04, Terminated due to non-payment of extension
(732) HENKEL IP & HOLDING GmbH
Henkelstrasse 67, 40589 Dusseldorf,
Germany

(111) M 1999 11648 R
(151) 1999 02 18
(141) 2019 09 04, Terminated due to non-payment of extension
(732) BOSE B.V.
8, Nijverheidstreet, NL-1135 GE EDAM,
Netherlands

(111) M 1999 11654 R
(151) 1999 02 18
(141) 2019 09 04, Terminated due to non-payment of extension
(732) BOSE B.V.
8, Nijverheidstreet, NL-1135 GE EDAM,
Netherlands

(111) M 1999 11546 R
(151) 1999 02 16
(141) 2019 09 04, Terminated due to non-payment of extension
(732) BRITISH AMERICAN TOBACCO
(BRANDS) INC.
2711 Centerville Road, Suite 300,
Wilmington, Delaware 19808, USA

(111) M 1999 11549 R
(151) 1999 02 16
(141) 2019 09 04, Terminated due to non-payment of extension

CANCELLATION OF LISTED CLASSES OF REGISTERED TRADEMARKS ON THE BASIS OF VERDICT

(800) 940802

(210) 45948

(732) RENKSAN PLASTİK SÜNGER SANAYİ
VE TİCARET LİMİTED ŞİRKETİ
Göztepe Mahallesi Saray, Sokak No:14,
Mahmutbey - İstanbul, TR

(540)

ACORD

(141) 27 08 2019, Decision of Tbilisi Civil Court Chamber come in force at 4 June 2018 (Case №2/12989-18).

(852)

5 – Diet foods adapted for medical purposes, diet pills for medical use, powdered milk for babies, infant food, dental materials (except equipments); plasters; bracelets for medical purposes, gases for medical purposes, ear bandages, eye patches, menstruation bandages, menstruation tampons, sanitary napkins, sanitary panties; absorbent cotton, adhesive plaster, bandages for dressings; breast-nursing pads; incontinence diapers; medicinal herbs, herbal tea for medical purposes, ginseng tea; deodorants for rooms, automobiles and other places; disinfectants, germicides, detergents for medical purposes.

(800) 965405

(210) 49355

(732) GOL PAKHSH-E-AVAL
No.9,34 Alley, Vali-e-Asr Avenue Tehran,
Iran

(540)



(141) 21 08 2019, Decision of Tbilisi Civil Court Chamber come in force at 31 January 2019 (Case №2/23477-18).

(852)

29 – Albumen for food, alginates for food; almonds, ground; anchovy, animal marrow for food, apple purée, bacon; beans, preserved; black pudding, blood sausage; bone oil, edible; bouillon, bouillon concentrates, preparations for making bouillon, broth, broth concentrates, butter, chocolate nut butter, cocoa butter, coconut butter, peanut butter, buttercream, casein for food, caviar, charcuterie, cheese, fruit chips, potato chips, clams (not live), coconut, desiccated; coconut fat, coconut oil, colza oil for food, corn oil, cranberry sauce (compote), crayfish (not live), cream (dairy products), whipped cream, potato crisps,

croquettes, crustaceans (not live), crystallized fruits, dates, edible birds' nests, edible fats, edible oils, eggs, powdered eggs, snail eggs (for consumption), fat-containing mixtures for bread slices, fatty substances for the manufacture of edible fats, fish fillets, food products made from fish, fish (not live); fish, preserved; salted fish; fish, tinned; fishmeal for human consumption, potato flakes, foods prepared from fish, frosted fruits, frozen fruits, fruit jellies, fruit peel; fruit, preserved; fruit preserved in alcohol, fruit pulp, fruit salads; fruit, stewed; frosted fruits; fruits, tinned; game (dead); gelatine for food, gherkins, ginger jam, ham, herrings, hummus (chickpea paste), isinglass for food, jams.

30 – Allspice, almond confectionery, almond paste, aniseed, aromatic preparations for food, artificial coffee, crushed barley, husked barley, barley meal, bean meal, bee glue (propolis) for human consumption, beer vinegar, chocolate-based beverages, cocoa-based beverages, coffee-based beverages; flavorings, other than essential oils, for beverages; tea-based beverages, binding agents for ice cream (edible ices), biscuits, bread, ginger bread, bread rolls, breadcrumbs, buns, cake paste, cake powder, cakes, edible decorations for cakes; flavorings, other than essential oils, for cakes; rice cakes, candy for food, capers, caramels (candy), celery salt, cereal preparations; chewing gum, not for medical purposes; chicory (coffee substitute), chips (cereal products), chocolate, chocolate beverages with milk, chow-chow (condiment), confectionery for decorating Christmas trees, chutneys (condiments), cinnamon (spice), cloves (spice), cocoa, cocoa beverages with milk, cocoa products, coffee, coffee beverages with milk, coffee flavorings, vegetal preparations for use as coffee substitutes, unroasted coffee, coffee-based beverages, condiments, confectionery, cookies, cooking salt, corn flakes, corn flour, corn meal, corn (milled), popcorn, corn (roasted), couscous (semolina), crackers, ice cream, curry (spice), custard, edible decorations for cakes, dressings for salad, edible ices, essences for foodstuffs (except etheric essences and essential oils), farinaceous food pastes, farinaceous foods, ferments for pastes, maize flakes, oat flakes; flavorings, other than essential oils; flour for food; garden herbs, preserved.

31 – Additives to fodder, not for medical purposes; algae for human or animal consumption, algarovilla for animal consumption, almonds (fruits), animal fattening preparations, animal foodstuffs, lime for animal forage, products for animal litter, edible chews for animals, live animals, menagerie animals, aromatic sand for pets (litter), bagasses of cane (raw ma-

terial), fishing bait (live), raw barks, barley; beans, fresh; locust beans, beet; berries, fresh fruits; beverages for pets, bird food, dog biscuits, bran, bran mash for animal consumption, bred stock, poultry for breeding, bulbs, bushes; by-products of the processing of cereals, for animal consumption; oil cake, peanut cake for animals, rape cake for cattle, cattle cake, cattle food; cereal seeds, unprocessed; residual products of cereals for animal consumption; chestnuts, fresh; edible chews for animals, chicory roots, chicory (salad), Christmas trees, citrus fruit; cocoa beans, raw; coconut shell, coconuts, cola nuts, hop cones, pine cones, copra, rough cork, crayfish (live), crustaceans (live), cucumbers, cuttle bone for birds, distillery waste for animal consumption, draff, preparations for egg laying poultry, eggs for hatching (fertilised), animal fattening preparations; fish, live; fish spawn, fishmeal for animal consumption, flax meal (fodder), flower bulbs; flowers, dried, for decoration; flowers, natural; wreaths of natural flowers, fodder; pet food, forage; fruit, fresh; fruit residue (marc); garden herbs, fresh; seed germ for botanical purposes, grains (cereals), grains for animal consumption, grains (seeds); grapes, fresh; groats for poultry, hay, hazelnuts; hops, juniper berries.

32 – Aerated water, preparations for making aerated water; aperitifs, non-alcoholic; non-alcoholic beverages, preparations for making beverages, cider (non-alcoholic); cocktails, non-alcoholic; essences for making beverages, non-alcoholic fruit extracts, non-alcoholic fruit juice beverages, fruit juices, fruit nectars (non-alcoholic), lemonades, mineral water (beverages), preparations for making mineral water, sherbets (beverages), soda water, tomato juice (beverage), vegetable juices (beverages), waters (beverages), table waters.

35 – Accounting, drawing up of statements of accounts, advertising, advertising agencies, advertising by mail order, updating of advertising material, dissemination of advertising matter, rental of advertising space, cost price analysis, telephone answering (for unavailable subscribers), business appraisals, arranging newspaper subscriptions (for others), business management of performing artists, business management assistance, auctioneering, auditing, bill-posting, book-keeping, professional business consultancy, business information, business inquiries, business investigations, business management and organization consultancy, business management consultancy, business management of hotels, business organization consultancy, business research, relocation services for businesses, commercial information agencies, commercial or industrial management assistance, compilation of information into computer databases, systemization of information into computer databases, data search in computer files (for others), demonstration of goods, direct mail advertising, distribution of samples, document reproduc-

tion, economic forecasting, efficiency experts, employment agencies, evaluation of standing timber, evaluation of wool, organization of exhibitions for commercial or advertising purposes, computerized file management, grading of wool, import-export agencies, advisory services for business management, personnel management consultancy, marketing research, marketing studies, modelling for advertising or sales promotion, news clipping services, office machines and equipment rental, on-line advertising on a computer network, opinion polling, organization of trade fairs for commercial or advertising purposes, outdoor advertising, payroll preparation, personnel recruitment, photocopying, word processing, procurement services for others (purchasing goods and services for other businesses), psychological testing for the selection of personnel, public relations, publication of publicity texts, publicity, publicity agencies.

(111) M 2011 21498 R

(210) 57015

(732) LTD "ARTFORUM"

Ilia Chavchavadze Av. 74, 0179, Tbilisi,
Georgia

(540)



(141) 16 07 2019, Decision of Tbilisi Civil Court
Chamber come in force at 18
March 2019 (Case № 2/17964-18)

(852) 32, 35

LICENSE AGREEMENT

- (111) M 2017 29127 R
(732) LTD "BLACK SI-FESIFIC INVESTMENT
AND TRADING"
Tskneti highway. 16-18 Houses, 3-3,
Vake-Saburtalo District, 0186, Tbilisi,
Georgia
(791) LTD "AQUA GEO"
Vill. Misaktsieli, 3308, Mtskheta district,
Georgia
(793) 1586
(793) 18 07 2019 – 01 12 2027
(793) Special
(511) 32
-

CLASSIFICATION INDEXES

INVENTIONS

CONCORDANCE TABLE OF INTERNATIONAL CLASSIFICATION INDEX AND PUBLICATION NUMBERS

INTERNATIONAL CLASSIFICATION INDEXES (51)	NUMBER OF PUBLISHED APPLICATION (10)
A 61 K 31/4355; A 61 K 321/381; A 61 K 31/437; A 61 P 35/00; C 07 D 403/12; C 07 D 405/04; C 07 D 209/12; C 07 D 495/04; C 07 D 405/12; C 07 D 409/12; C 07 D 471/04; C 07 D 487/04; C 07 D 491/04; C 07 D 333/56; C 07 D 307/81; C 07 D 307/80	AP 2019 14681 A
C 12 G 1/00; C 12 N 1/16	AP 2019 14808 A

CONCORDANCE TABLE OF PUBLICATION NUMBERS AND INTERNATIONAL CLASSIFICATION INDEX

NUMBER OF PUBLISHED APPLICATION (10)	INTERNATIONAL CLASSIFICATION INDEXES (51)
AP 2019 14681 A	A 61 K 31/4355; A 61 K 321/381; A 61 K 31/437; A 61 P 35/00; C 07 D 403/12; C 07 D 405/04; C 07 D 209/12; C 07 D 495/04; C 07 D 405/12; C 07 D 409/12; C 07 D 471/04; C 07 D 487/04; C 07 D 491/04; C 07 D 333/56; C 07 D 307/81; C 07 D 307/80
AP 2019 14808 A	C 12 G 1/00; C 12 N 1/16

DESIGNS

CONCORDANCE TABLE OF INTERNATIONAL CLASSIFICATION INDEX AND PUBLICATION NUMBERS

INTERNATIONAL CLASSIFICATION INDEXES (51)	NUMBER OF PUBLISHED APPLICATION (10)
11-01	AD 2019 1086 S

CONCORDANCE TABLE OF PUBLICATION NUMBERS AND INTERNATIONAL CLASSIFICATION INDEX

NUMBER OF PUBLISHED APPLICATION (10)	INTERNATIONAL CLASSIFICATION INDEXES (51)
AD 2019 1086 S	11-01

TRADEMARKS

CONCORDANCE TABLE OF REGISTRATION NUMBERS, APPLICATION NUMBERS, PUBLICATION NUMBERS AND BULLETIN NUMBERS

NUMBER OF REGISTRATION (111)	NUMBER OF APPLICATIONS (210)	NUMBER OF PUBLISHED APPLICATIONS (260)	NUMBER OF BULLETIN
M 2019 31636 R	AM 104529	–	17(525)/2019
M 2019 31637 R	AM 96982	AM 2018 96982 A	22(506)/2018
M 2019 31638 R	AM 104439	–	17(525)/2019
M 2019 31639 R	AM 104424	–	17(525)/2019
M 2019 31640 R	AM 104317	–	17(525)/2019
M 2019 31641 R	AM 104459	–	17(525)/2019
M 2019 31642 R	AM 104556	–	17(525)/2019
M 2019 31643 R	AM 104404	–	17(525)/2019
M 2019 31644 R	AM 104311	–	17(525)/2019
M 2019 31645 R	AM 104553	–	17(525)/2019
M 2019 31646 R	AM 104542	–	17(525)/2019
M 2019 31647 R	AM 104212	–	17(525)/2019
M 2019 31648 R	AM 103188	AM 2019 103188 A	–
M 2019 31649 R	AM 97805	AM 2019 97805 A	1(509)/2019
M 2019 31650 R	AM 98010	AM 2019 98010 A	3(511)/2019
M 2019 31651 R	AM 98011	AM 2019 98011 A	3(511)/2019
M 2019 31652 R	AM 98173	AM 2019 98173 A	3(511)/2019
M 2019 31653 R	AM 98174	AM 2019 98174 A	3(511)/2019
M 2019 31654 R	AM 98192	AM 2019 98192 A	3(511)/2019
M 2019 31655 R	AM 98194	AM 2019 98194 A	3(511)/2019
M 2019 31656 R	AM 98584	AM 2019 98584 A	3(511)/2019
M 2019 31657 R	AM 98668	AM 2019 98668 A	5(513)/2019
M 2019 31658 R	AM 98756	AM 2019 98756 A	5(513)/2019
M 2019 31659 R	AM 98777	AM 2019 98777 A	6(514)/2019
M 2019 31660 R	AM 99066	AM 2019 99066 A	6(514)/2019
M 2019 31661 R	AM 99177	AM 2019 99177 A	8(516)/2019
M 2019 31662 R	AM 99179	AM 2019 99179 A	6(514)/2019
M 2019 31663 R	AM 99180	AM 2019 99180 A	6(514)/2019
M 2019 31664 R	AM 99181	AM 2019 99181 A	6(514)/2019
M 2019 31665 R	AM 99182	AM 2019 99182 A	7(515)/2019
M 2019 31666 R	AM 99190	AM 2019 99190 A	6(514)/2019
M 2019 31667 R	AM 99198	AM 2019 99198 A	8(516)/2019
M 2019 31668 R	AM 99300	AM 2019 99300 A	8(516)/2019
M 2019 31669 R	AM 99301	AM 2019 99301 A	8(516)/2019
M 2019 31670 R	AM 99306	AM 2019 99306 A	9(517)/2019
M 2019 31671 R	AM 99310	AM 2019 99310 A	8(516)/2019
M 2019 31672 R	AM 99335	AM 2019 99335 A	9(517)/2019
M 2019 31673 R	AM 99349	AM 2019 99349 A	9(517)/2019
M 2019 31674 R	AM 99365	AM 2019 99365 A	8(516)/2019
M 2019 31675 R	AM 99367	AM 2019 99367 A	9(517)/2019
M 2019 31676 R	AM 99368	AM 2019 99368 A	8(516)/2019
M 2019 31677 R	AM 99426	AM 2019 99426 A	8(516)/2019
M 2019 31678 R	AM 99434	AM 2019 99434 A	9(517)/2019
M 2019 31679 R	AM 99460	AM 2019 99460 A	9(517)/2019
M 2019 31680 R	AM 99645	AM 2019 99645 A	7(515)/2019
M 2019 31681 R	AM 99658	AM 2019 99658 A	8(516)/2019
M 2019 31682 R	AM 99678	AM 2019 99678 A	8(516)/2019

1	2	3	4
M 2019 31683 R	AM 99888	AM 2019 99888 A	8(516)/2019
M 2019 31684 R	AM 99936	AM 2019 99936 A	9(517)/2019
M 2019 31685 R	AM 99937	AM 2019 99937 A	9(517)/2019
M 2019 31686 R	AM 99990	AM 2019 99990 A	9(517)/2019
M 2019 31687 R	AM 99992	AM 2019 99992 A	9(517)/2019
M 2019 31688 R	AM 99993	AM 2019 99993 A	9(517)/2019
M 2019 31689 R	AM 99995	AM 2019 99995 A	9(517)/2019
M 2019 31690 R	AM 99996	AM 2019 99996 A	9(517)/2019
M 2019 31691 R	AM 99997	AM 2019 99997 A	9(517)/2019
M 2019 31692 R	AM 99998	AM 2019 99998 A	9(517)/2019
M 2019 31693 R	AM 99999	AM 2019 99999 A	9(517)/2019

CONCORDANCE TABLE OF PUBLICATION NUMBERS
AND APPLICATION NUMBERS

NUMBER OF PUBLISHED APPLICATION (260)	NUMBER OF APPLICATION (210)	1	2
1	2		
AM 2019 94699 A	AM 94699	AM 2019 101521 A	AM 101521
AM 2019 98757 A	AM 98757	AM 2019 101522 A	AM 101522
AM 2019 99773 A	AM 99773	AM 2019 101612 A	AM 101612
AM 2019 100024 A	AM 100024	AM 2019 101614 A	AM 101614
AM 2019 100025 A	AM 100025	AM 2019 101615 A	AM 101615
AM 2019 100918 A	AM 100918	AM 2019 101617 A	AM 101617
AM 2019 101217 A	AM 101217	AM 2019 101619 A	AM 101619
AM 2019 101236 A	AM 101236	AM 2019 101620 A	AM 101620
AM 2019 101295 A	AM 101295	AM 2019 101629 A	AM 101629
AM 2019 101378 A	AM 101378	AM 2019 101630 A	AM 101630
AM 2019 101399 A	AM 101399	AM 2019 101632 A	AM 101632
AM 2019 101400 A	AM 101400	AM 2019 101636 A	AM 101636
AM 2019 101415 A	AM 101415	AM 2019 101637 A	AM 101637
AM 2019 101416 A	AM 101416	AM 2019 101638 A	AM 101638
AM 2019 101496 A	AM 101496	AM 2019 101639 A	AM 101639
AM 2019 101499 A	AM 101499	AM 2019 101640 A	AM 101640
AM 2019 101500 A	AM 101500	AM 2019 101643 A	AM 101643
AM 2019 101501 A	AM 101501	AM 2019 101645 A	AM 101645
AM 2019 101502 A	AM 101502	AM 2019 101646 A	AM 101646
AM 2019 101503 A	AM 101503	AM 2019 101657 A	AM 101657
AM 2019 101504 A	AM 101504	AM 2019 101677 A	AM 101677
AM 2019 101505 A	AM 101505	AM 2019 101687 A	AM 101687
AM 2019 101508 A	AM 101508	AM 2019 101688 A	AM 101688
AM 2019 101514 A	AM 101514	AM 2019 101906 A	AM 101906
AM 2019 101519 A	AM 101519	AM 2019 101907 A	AM 101907
AM 2019 101520 A	AM 101520	AM 2019 101916 A	AM 101916
		AM 2019 101917 A	AM 101917
		AM 2019 101920 A	AM 101920
		AM 2019 101929 A	AM 101929
		AM 2019 102025 A	AM 102025

CONCORDANCE TABLE OF INDEX OF GOODS AND/OR SERVICES
AND APPLICATION NUMBERS

INDEX OF GOODS AND/OR SERVICES (511)	NUMBER OF PUBLISHED APPLICATIONS (26)	1	2
1	2	29	AM 2019 101639 A
1	AM 2019 101378 A	30	AM 2019 99773 A
3	AM 2019 101399 A	30	AM 2019 101217 A
3	AM 2019 101400 A	30	AM 2019 101519 A
3	AM 2019 101415 A	30	AM 2019 101520 A
3	AM 2019 101499 A	30	AM 2019 101639 A
3	AM 2019 101500 A	30	AM 2019 101920 A
3	AM 2019 101501 A	32	AM 2019 99773 A
3	AM 2019 101917 A	32	AM 2019 101217 A
5	AM 2019 101236 A	32	AM 2019 101612 A
5	AM 2019 101378 A	32	AM 2019 101639 A
5	AM 2019 101415 A	33	AM 2019 99773 A
5	AM 2019 101500 A	33	AM 2019 101217 A
5	AM 2019 101617 A	33	AM 2019 101521 A
5	AM 2019 101619 A	33	AM 2019 101646 A
5	AM 2019 101620 A	33	AM 2019 101677 A
5	AM 2019 101629 A	34	AM 2019 99773 A
5	AM 2019 101630 A	34	AM 2019 101687 A
5	AM 2019 101632 A	34	AM 2019 101688 A
5	AM 2019 101636 A	34	AM 2019 102025 A
5	AM 2019 101637 A	35	AM 2019 94699 A
5	AM 2019 101638 A	35	AM 2019 98757 A
5	AM 2019 101640 A	35	AM 2019 99773 A
5	AM 2019 101643 A	35	AM 2019 100024 A
5	AM 2019 101645 A	35	AM 2019 100025 A
5	AM 2019 101906 A	35	AM 2019 101496 A
5	AM 2019 101907 A	35	AM 2019 101502 A
7	AM 2019 101504 A	35	AM 2019 101503 A
8	AM 2019 101217 A	35	AM 2019 101508 A
9	AM 2019 101416 A	35	AM 2019 101612 A
10	AM 2019 101236 A	37	AM 2019 101504 A
11	AM 2019 101415 A	38	AM 2019 98757 A
12	AM 2019 101504 A	39	AM 2019 99773 A
14	AM 2019 101217 A	39	AM 2019 101502 A
16	AM 2019 101920 A	39	AM 2019 101503 A
20	AM 2019 101217 A	39	AM 2019 101508 A
20	AM 2019 101920 A	41	AM 2019 100918 A
21	AM 2019 101399 A	41	AM 2019 101657 A
21	AM 2019 101400 A	41	AM 2019 101929 A
24	AM 2019 101217 A	42	AM 2019 101514 A
25	AM 2019 101496 A	43	AM 2019 99773 A
25	AM 2019 101916 A	43	AM 2019 100024 A
26	AM 2019 101217 A	43	AM 2019 100025 A
29	AM 2019 99773 A	43	AM 2019 100918 A
29	AM 2019 101217 A	43	AM 2019 101295 A
29	AM 2019 101502 A	43	AM 2019 101496 A
29	AM 2019 101508 A	43	AM 2019 101505 A
		43	AM 2019 101522 A
		43	AM 2019 101614 A
		43	AM 2019 101657 A
		44	AM 2019 101236 A

CONCORDANCE TABLE OF INDEX OF GOODS AND/OR SERVICES
AND NUMBERS OF TRADEMARKS REGISTERED ACCORDING
TO THE ACCELERATED PROCEDURE

INDEX OF GOODS AND/OR SERVICES (511)	NUMBERS OF REGISTERED ACCORDING TO THE ACCELERATED PROCEDURE (111)
9	M 2019 31641 R
10	M 2019 31645 R
11	M 2019 31644 R
14	M 2019 31641 R
18	M 2019 31641 R
25	M 2019 31641 R
25	M 2019 31642 R
30	M 2019 31646 R
32	M 2019 31638 R
32	M 2019 31640 R
33	M 2019 31643 R
35	M 2019 31641 R
35	M 2019 31643 R
36	M 2019 31636 R
38	M 2019 31647 R
43	M 2019 31639 R

OFFICIAL BULLETIN OF THE INDUSTRIAL PROPERTY

INVENTIONS

DESIGNS

TRADEMARKS

17(525)

EDITOR-IN-CHIEF: N. Bebrishvili

EDITOR-TRANSLATOR: E. Gabunia

PROOFREADER: A. Shikhashvili

COMPUTER LAYOUT: M. Ordenidze
K. Svanidze

www.sakpatenti.gov.ge

E-mail: info@sakpatenti.org.ge