

Official Bulletin of the Industrial Property

Inventions

Utility Models

Designs

Trademarks

Appellations of Origin and
Geographical Indications of Goods



საქართველოს ინტელექტუალური
საკუთრების ეროვნული ცენტრი

საქპატენტი

SAKPATENTI

NATIONAL INTELLECTUAL PROPERTY
CENTER OF GEORGIA

www.sakpatenti.gov.ge

Date of Publication – 2022 09 12

17(596)

INID CODES FOR IDENTIFICATION OF BIBLIOGRAPHIC DATA

INVENTIONS, UTILITY MODELS

- (10) Number of publication for application, which has been examined
- (11) Number of patent and kind of document
- (21) Serial number of application
- (22) Date of filing of the application
- (23) Date of exhibition or the date of the earlier filing and the number of application, if any
- (24) Date from which patent may have effect
- (31) Number of priority application
- (32) Date of filing of priority application
- (33) Code of the country or regional organization allotting priority application number
- (44) Date of publication of application not granted, but examined and number of bulletin
- (45) Date of publication of registered document
- (51) International Patent Classification Index

- (54) Title of the invention
- (57) Abstract
- (60) Number of examined patent document granted by foreign patent office, date from which patent has effect and country code
- (62) Number of the earlier application and in case of divided application, date of filing an application
- (71) Name, surname and address of applicant (country code)
- (72) Name, surname of inventor (country code)
- (73) Name, surname and address of patent owner (country code)
- (74) Name, surname of representative or patent attorney
- (85) Date of commencement of the national phase of International Application
- (86) Number and date of filing of international application
- (87) Number and date of publication of international application
- (94) Calculated date of expiry of the SPC or the duration of the SPC

DESIGNS

- (10) Number of publication for application
- (11) Number of patent and kind of document or number of registration
- (15) Date of registration/Date of patent renewal
- (18) Expected expiration date of patent or registration
- (21) Serial number of application
- (22) Date of filing of the application
- (23) Date of exhibition or the date of the earlier filing and the number of application, if any
- (24) Date from which patent may have effect
- (28) Number of designs included in the application
- (30) Data relating to priority (number of application, date of filing of application, two-letter code identifying the authority with whom the priority application was made)
- (31) Number of priority application
- (32) Date of filing of priority application
- (33) Code of the country or regional organization allotting priority application number
- (34) Two-letter code according to WIPO St.3 identifying the authority with which the priority application was made
- (44) Date of publication of design and number of bulletin (the first publication)
- (45) Date of publication of design registered by WIPO and number of bulletin

- (51) International Classification for designs (class and subclass of the Locarno Classification)
- (54) Title of the invention
- (55) Reproduction of the design
- (57) Description of characteristic features of the design including indication of colors
- (58) Date of recording of any kind of amendment in the Register
- (62) Number of the earlier application, registration and document number and if available the date of filing an application in case of divided application
- (71) Name, surname and address of applicant (country code)
- (72) Name, surname of creator (country code)
- (73) Name, surname and address of patent owner (country code)
- (74) Name, surname of representative or patent attorney
- (81) Contracting states concerned
II designated contracting states according to the 1960 Act
III designated contracting states according to the 1999 Act
- (85) Owner's permanent address
- (86) Owner's nationality
- (87) Owner's residence
- (88) State in which the owner has a real and effective industrial or commercial establishment

TRADEMARKS

- (111) - Number of registration
- (151) - Date of registration
- (156) - Date of the renewal
- (181) - Expected expiration date of registration
- (186) - Renewal expiration date of registration
- (141) - Date of cancel of duration of the mark
- (210) - Serial number of application
- (220) - Date of filing of the application
- (230) - Data concerning exhibition
- (260) - Number of application, for which favorable decision of examination about registration has been taken (publication number)
- (310) - Number of the first application
- (320) - Date of filing of the first application
- (330) - Code, identifying national or regional Office where the first application was made
- (511) - International Classification of Goods and Services for the purposes of registration of trade marks and/or list of goods and/or services classified according thereto
- (526) - Disclaimer
- (531) - Description of figurative elements of Trade Marks according to the International Classification of the Figurative Elements of Marks

- (540) - Reproduction of Trade Mark
- (550) - Nature and kind of Trade Mark
- (551) - Indication to the effect that the mark is a collective mark, a certification mark or a guarantee mark
- (554) - Three-dimensional mark
- (580) - Date of recording of any kind changes in respect of applications or registrations
- (591) - Information concerning colors claimed
- (731) - Name and address of the applicant
- (732) - Name and address of the holder of the registration
- (740) - Name and address of the representative
- (750) - Addreses for correspondence
- (770) - Name and address of the previous applicant or holder in case of change in ownership
- (771) - Previous name and address of the applicant or holder in case of change in ownership
- (791) - Name and address of the licensee
- (793) - Indication of conditions and/or restrictions under the license (Type of license, number of license agreement, data of license, data of validity of license)
- (800) - Certain data relating to the international registration of Trade Marks under the Protocol Relating to Madrid Agreement (International registration number)
- (852) - Partial cancellation of the list of goods and services
- (891) - Date of subsequent designation

CODES FOR PUBLICATION IN BULLETIN

- (21) AP 0000 000000 - serial number of application for invention
- (10) AP 0000 0000 A - number of published application for invention (first publication)
- (11) P 0000 0000 B - number of patent for invention (second publication)
- (21) API 0000 000000 - number of application for imported patent
- (11) PI 0000 0000 A - number of imported patent (first publication)
- (21) AU 0000 000000 - serial number of application for utility model
- (10) AU 0000 000 U - number of published application for utility model (first publication)
- (11) U 0000 000 Y - number of patent for utility model (second publication)
- (21) AD 0000 000000 - serial number of application for design
- (10) AD 0000 000 S - number of published application for design (first publication)
- (11) D 0000 000 S - registered design

INTERNATIONAL PATENT CLASSIFICATION FOR INVENTIONS AND UTILITY MODELS

- SECTION A - HUMAN NECESSITIES
- SECTION B - PERFORMING OPERATIONS; TRANSPORTING
- SECTION C - CHEMISTRY; METALLURGY
- SECTION D - TEXTILES; PAPER
- SECTION E - FIXED CONSTRUCTIONS
- SECTION F - MECHANICAL ENGINEERING; LIGHTING; HEATING; WEAPONS; BLASTING
- SECTION G - PHYSICS
- SECTION H - ELECTRICITY

-
- M - Trade Mark
 - (210) AM 0000 000000 - Serial number of application;
 - (260) AAM 0000 00000 A - Publication number of application;
 - (111) M 0000 00000 R - Number of registration;
 - (111) MMM0000 00000 Rn - Number of renewals, in which n=1,2,3;
 - (111) M 0000 00000 R(P) - Number of registration under partial assignment of rights
-

Official Bulletin of the Industrial Property

Inventions

Utility Models

Designs

Trademarks

Appellations of Origin and
Geographical Indications of Goods

CONTENT

PUBLISHED TITLES OF PROTECTION	3
INVENTIONS	
▪ APPLICATIONS APPROVED FOR GRANTING PATENT	4
▪ PATENTED INVENTIONS	6
UTILITY MODELS	
▪ APPLICATION APPROVED FOR GRANTING PATENT.....	8
▪ PATENTED UTILITY MODELS	9
DESIGNS	
▪ APPLICATIONS APPROVED FOR REGISTRATION	10
▪ REGISTERED DESIGNS	12
▪ DESIGNS, WICH HAVE BEEN REGISTERED WITH THE INTERNATIONAL BUREAU CLAIMING PRIORITY ON THE TERRITORY OF GEORGIA	13
TRADEMARKS	
▪ APPLICATIONS FILED UNDER THE NATIONAL PROCEDURE APPROVED FOR REGISTRATION	26
▪ TRADEMARKS REGISTERED ACCORDING TO THE ACCELERATED PROCEDURE	34
▪ INTERNATIONAL TRADEMARKS FOR WHICH A DECISION ON GRANTING PROTECTION IS TAKEN	37
▪ INTERNATIONAL TRADEMARKS PROTECTED IN GEORGIA	70
APPELLATIONS OF ORIGIN AND GEOGRAPHICAL INDICATIONS OF GOODS:	
▪ REGISTERED APPELLATIONS OF ORIGIN OF GOODS	79
▪ REGISTERED GEOGRAPHICAL INDICATION	79
OFFICIAL NOTIFICATIONS	
INVENTIONS	
▪ RESTORATION OF PATENTS	80
▪ ABOLITION OF PATENTS WITH THE RIGHT TO RESTORE	81
▪ EXPIRATION OF DATE OF PATENTS RESTORATION	83
▪ CHANGES OF NAME AND/OR ADDRESS OF PATENT OWNER	85
▪ TRANSFER OF RIGHTS	85
UTILITY MODELS	
▪ RESTORATION OF PATENT	85
▪ ABOLITION OF PATENTS WITH THE RIGHT TO RESTORE	86
▪ EXPIRATION OF DATE OF PATENT RESTORATION	86
▪ TRANSFER OF RIGHT	87
DESIGNS	
▪ EXTENTION OF TERMS OF DESIGN REGISTRATION	87
▪ CANCELLATION OF DESIGNS REGISTRATION	87
▪ EXTENTION OF TERMS OF INTERNATIONAL DESIGNS REGISTRATION	88
▪ CANCELLATION OF INTERNATIONAL DESIGNS REGISTRATION	90
TRADEMARKS	
▪ EXTENSION OF TERMS OF TRADEMARKS REGISTRATION	92
▪ COMPLETE TRANSFER OF RIGHTS	93
▪ CANCELLATION OF TRADEMARKS REGISTRATION	93
▪ REGISTRATION OF LICENSE AGREEMENT	98
CLASSIFICATION INDEXES	
INVENTIONS	99
UTILITY MODELS	100
DESIGNS	102
TRADEMARKS	103

PUBLISHED TITLES OF PROTECTION

INVENTIONS

- **APPLICATIONS APPROVED FOR GRANTING PATENT:**
15517; 13653; 15146, 15147
- **PATENTED INVENTIONS:**
7409-7415

UTILITY MODELS

- **APPLICATION APPROVED FOR GRANTING PATENT:**
15880
- **PATENTED UTILITY MODELS:**
2129-2131

DESIGNS

- **APPLICATIONS APPROVED FOR REGISTRATION:**
1262; 1264
- **REGISTERED DESIGNS:**
942, 943
- **DESIGNS, WHICH HAVE BEEN REGISTERED WITH THE INTERNATIONAL BUREAU CLAIMING PRIORITY ON THE TERRITORY OF GEORGIA:**
221798-221800; 218507; 222075; 218557; 218929

TRADEMARKS

- **APPLICATIONS FILED UNDER THE NATIONAL PROCEDURE APPROVED FOR REGISTRATION:**
116214; 116239; 116246; 116250; 116252; 116314, 116315; 116321-116323; 116332, 116333; 116336; 116394; 116401; 116414, 116415; 116425, 116426; 116431; 116513, 116514; 116517; 116519, 116520; 116526; 116540; 116543-116546; 116622-116626; 116633; 116642; 116657; 116659, 116660; 116669; 116741; 116743-116746; 116754; 116756
- **TRADEMARKS REGISTERED ACCORDING TO THE ACCELERATED PROCEDURE:**
35871-35888
- **INTERNATIONAL TRADEMARKS FOR WHICH A DECISION ON GRANTING PROTECTIONS IS TAKEN:**
104485; 113221; 115443-115446; 115461; 115465-115468; 115484-115492; 115494-115498; 115613-115615; 115617, 115618; 115719-115728; 115811-115819; 116254-116257; 116259-116262; 116663
- **INTERNATIONAL TRADEMARKS PROTECTED IN GEORGIA:**
111254; 111265; 113666; 113844; 114070; 114075-114079; 114083; 114086; 114167-114171; 114176; 114178; 114197, 114198; 114200-114203; 114205-114207; 114214, 114215; 114247-114254; 114260, 114261; 114263- - 114265; 114276-114295; 114351-114355; 114361-114363; 114365; 114371-114373; 114375; 114382-114385; 114427; 114429-114431; 114442-114445; 114478-114482; 114513-114517; 114624-114629; 114631-114634; 114700; 114773-114779; 114882; 114885-114893

APPELLATIONS OF ORIGIN AND GEOGRAPHICAL INDICATIONS OF GOODS:

- **APPELLATIONS OF ORIGIN OF GOODS:**
982, 983
- **GEOGRAPHICAL INDICATION:**
25

INVENTIONS

APPLICATIONS APPROVED FOR GRANTING PATENT

The decision can be appealed at the Chamber of Appeal of Sakpatenti within 3 months from the publication or at the Mtskheta District Court Administrative Cases Board (Address: №17, Samkhedro St., Mtskheta), within 1 month following the publication.

PART A

A 61

- (10) AP 2022 15517 A (51) Int. Cl. (2006)
A 61 K 31/496
A 61 P 3/10
C 07 D 405/14
C 07 D 405/12
C 07 D 413/14
- (21) AP 2019 15517 (22) 2019 06 11
(31) 62/684,696; 62/846,944; 62/851,206
(32) 2018 06 13; 2019 05 13; 2019 05 22
(33) US; US; US
- (71) Pfizer Inc. (US)
235 East 42nd Street, New York, NY 10017,
USA (US)
- (72) ASPNES, Gary Erik (DE);
BAGLEY, Scott W. (US);
CURTO, John M. (US);
EDMONDS, David James (US);
FLANAGAN, Mark E. (US);
FUTATSUGI, Kentaro (US);
GRIFFITH, David A. (US);
HUARD, Kim (US);
LIAN, Yajing (US);
LIMBERAKIS, Chris (US);
LONDREGAN, Allyn T. (US);
MATHIOWETZ, Alan M. (US);
PIOTROWSKI, David W. (US);
RUGGERI, Roger B. (US)
- (74) Shalva Gvaramadze
(85) 2020 12 11
(86) PCT/IB2019/054867, 2019 06 11
(54) GLP-1 RECEPTOR AGONISTS AND
USES THEREOF
- (57) Provided herein are 6-carboxylic acids of
benzimidazoles and 4-aza-5-aza-, and 7-aza-benzi-
midazoles of common formula I

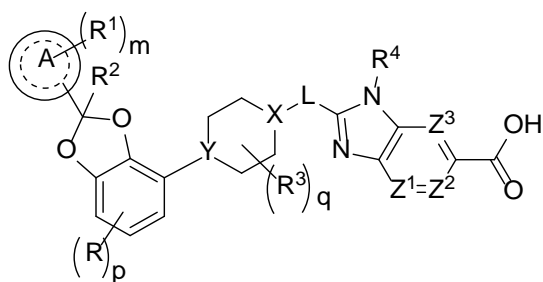

(I)

as GLP-1 R agonists, and methods to make said
compounds, as well.

Claims: 3 independents

19 dependents

Fig.: 2

PART C

C 07

- (10) AP 2022 13653 A (51) Int. Cl. (2006)
C 07 D 403/12
C 07 D 413/12
C 07 D 249/08
- (21) AP 2013 13653 (22) 2013 05 09
(31) 61/798,188; 61/644,802
(32) 2013 03 15; 2012 05 09
(33) US; US
- (71) Biogen Ma Inc. (US)
225 Binney Street, Cambridge, 02142 MA,
USA (US)
- (72) SANDANAYAKA, Vincent, P. (US);
SHECHTER, Sharon (IL);
SHACHAM, Sharon (IL);
MCCAULEY, Dilara (US);
BALOGLU, Erkan (US)
- (74) Tamaz Shilakadze
(85) 2014 12 04
(86) PCT/US2013/040404, 2013 05 09
(54) NUCLEAR TRANSPORT MODULATORS
AND USES THEREOF
- (57) Present invention relates to compounds of
formula I,

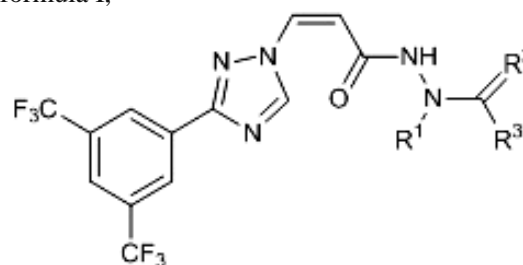

(I)

and pharmaceutically acceptable salts thereof,
pharmaceutical compositions comprising thereof,
and methods of using said compositions in the
treatment of various disorders associated with
CRM1 activity.

Claims: 19 independents
73 dependents
Fig.: 19

C 12

(10) AP 2022 15146 A (51) Int. Cl. (2006)
C 12 N 15/82
(21) AP 2017 15146 (22) 2017 12 22
(31) 62/487,707; 62/437,862; 62/481,284
(32) 2017 04 20; 2016 12 22; 2017 04 04
(33) US; US; US
(71) Basf Agricultural Solutions Seed US LLC (US)
100 Park Avenue, Florham Park, NJ 07932,
USA (US)
(72) MCCARVILLE, Michael (US);
HABEX, Veerle (BE);
AARTSEN, Wendy (BE);
DAUM, Julia (US);
KLEVEN, Tom (US);
BEILINSON, Vadim (US);
SLABBINCK, Filip (BE);
BUYSE, Maxim (BE);
MOSER, Hal (US)
(74) Giorgi Kartvelishvili
(85) 2019 07 20
(86) PCT/US2017/068116, 2017 12 22
(54) ELITE EVENT EE-GM4 AND METHODS
AND KITS FOR IDENTIFYING SUCH
EVENT IN BIOLOGICAL SAMPLES
(57) Present invention provides specific transgenic
soybean plants, plant material and seeds
characterized in that these products harbor specific
nematode resistance and herbicide tolerance
transformation event EE-GM4 at specific location
in soybean genome. The tools are also provided,
which allow rapid and unequivocal identification of
the event in biological samples.
Claims: 13 independents
4 dependents
Fig.: 10

(10) AP 2022 15147 A (51) Int. Cl. (2006)
C 12 N 15/82
(21) AP 2017 15147 (22) 2017 12 22
(31) 62/437,874; 62/481,292
(32) 2016 12 22; 2017 04 04
(33) US; US
(71) Basf Agricultural Solutions Seed US LLC (US)
100 Park Avenue, Florham Park, NJ 07932,
USA (US)
(72) KLEVEN, Tom (US);
BEILINSON, Vadim (US);
MCCARVILLE, Michael (US);
HABEX, Veerle (BE);
AARTSEN, Wendy (BE);

SLABBINCK, Filip (BE);
BUYSE, Maxim (BE);
DAUM, Julia (US);
MOSER, Hal (US)
(74) Giorgi Kartvelishvili
(85) 2019 07 20
(86) PCT/US2017/068121, 2017 12 22
(54) ELITE EVENT EE-GM5 AND METHODS
AND KITS FOR IDENTIFYING SUCH
EVENT IN BIOLOGICAL SAMPLES
(57) Present invention provides specific transgenic
soybean plants, plant material and seeds, charac-
terized in that these products harbor specific nema-
tode resistance and herbicide tolerance transfor-
mation event EE-GM5 at specific location in soy-
bean genome. The tools are also provided which
allow rapid and unequivocal identification of the
event in biological samples.
Claims: 23 independents
11 dependents
Fig.: 11

PATENTED INVENTIONS

PART A

A 01

- (11) P 2022 7413 B (51) Int. Cl. (2006)
A 01 D 46/04
- (10) AP 2022 15842 A (44) 9(588)/2022
- (21) AP 2021 15842
- (22) 2021 12 27
- (24) 2021 12 27
- (73) Temur Revishvili (GE)
Metsniereba St. 10, Ozurgeti, Georgia (GE);
Zurab Andghuladze (GE)
Iliia Chavchavadze St. 10, Ozurgeti, Georgia (GE);
Bakhva Dolidze (GE)
I. Shemokmedeli St. 32, 3500, Ozurgeti,
Georgia (GE);
Dennis Meseroll (FR)
56440, Languedoc, France (FR);
Tamaz Mikadze (GE)
Akaki Tsereteli St. 276s/31, Kutaisi,
Georgia (GE);
Davit Apkhazava (GE)
N. Dumbadze St., I Lane 4, 3500, Ozurgeti,
Georgia (GE);
Revaz Makharadze (GE)
Rustaveli St. 77, Ozurgeti, Georgia (GE)
- (72) Temur Revishvili (GE);
Zurab Andghuladze (GE);
Bakhva Dolidze (GE);
Dennis Meseroll (FR);
Tamaz Mikadze (GE);
Davit Apkhazava (GE);
Revaz Makharadze (GE)
- (54) TEA PICKING MANUAL APPARATUS

A 61

- (11) P 2022 7409 B (51) Int. Cl. (2006)
A 61 K 31/438
A 61 P 25/00
C 07 D 413/14
C 07 D 413/04
C 07 D 417/04
C 07 D 417/14
- (10) AP 2022 15499 A (44) 9(588)/2022
- (21) AP 2019 15499
- (22) 2019 04 29
- (24) 2019 04 29
- (31) 62/665,091
- (32) 2018 05 01
- (33) US
- (86) PCT/US2019/029561, 2019 04 29

- (73) Merck Sharp & Dohme Corp. (US)
126 East Lincoln Ave., Rahway, NJ 07065-
0907, USA (US)
- (72) CROWLEY, Brendan, M. (US);
CAMPBELL, Brian, T. (GE);
CHOBANIAN, Harry, R. (US);
FELLS, James, I. (US);
GUIADEEN, Deodial, G. (US);
GRESHOCK, Thomas, J. (US);
LEAVITT, Kenneth, J. (US);
RADA, Vanessa, L. (US);
BELL, Ian, M. (US)
- (74) Shalva Gvaramadze
- (54) SPIROPIPERIDINE ALLOSTERIC
MODULATORS OF NICOTINIC
ACETYLCHOLINE RECEPTORS

- (11) P 2022 7411 B (51) Int. Cl. (2006)
A 61 M 16/00
- (10) AP 2022 15497 A (44) 6(585)/2022
- (21) AP 2020 15497
- (22) 2020 11 25
- (24) 2020 11 25
- (73) Temur Maisuradze (GE)
Mukhiani I m/r, bld. 10, app. 139, 0172,
Tbilisi, Georgia (GE)
- (72) Temur Maisuradze (GE)
- (54) PORTABLE ARTIFICIAL RESPIRATION
APPARATUS

PART E

E 01

- (11) P 2022 7414 B (51) Int. Cl. (2006)
E 01 F 7/04
E 02 D 17/20
- (10) AP 2022 15051 A (44) 9(588)/2022
- (21) AP 2017 15051
- (22) 2017 10 16
- (24) 2017 10 16
- (31) 2016-213130
- (32) 2016 10 31
- (33) JP
- (86) PCT/JP2017/037333, 2017 10 16
- (73) Tokyo Rope Mfg.Co., LTD. (JP)
6-2, Nihonbashi 3-chome, chuo-ku, Tokyo
1038306, Japan (JP)
- (72) ARITA, Takeshi (JP);
HIRASE, Masashi (JP);
ISHIMOTO, Kazuhiro (JP);

TAKAMORI, Kiyoshi (JP);
OKAYAMA, Takahiro (JP)
(74) Shalva Gvaramadze
(54) HIGH-STRENGTH WIRE MESH AND
ROCK FALL PREVENTION NET

E 03

(11) P 2022 7415 B (51) Int. Cl. (2006)
E 03 B 1/00
(10) AP 2022 15559 A (44) 5(584)/2022
(21) AP 2021 15559
(22) 2021 02 12
(24) 2021 02 12
(73) Savle Chkhitunidze (GE)
K. Timiryazev St. 20, Sokhumi, Georgia (GE)
(72) Savle Chkhitunidze (GE)
(54) WATER SUPPLY SYSTEM WITH
PRINCIPLE OF COMMUNICATING
VESSELS

(73) Guram Dgebuadze (GE)
Tsinamdzghvishvili St. 121, app. 94, 0164,
Tbilisi, Georgia (GE)
(72) Guram Dgebuadze (GE);
Guram Bokuchava (GE);
Bezhan Bendeliani (GE);
Giorgi Giorganashvili (GE);
Ioseb Metskhvarishvili (GE);
Nadezhda Muamladze (GE);
Ekaterine Sanaia (GE);
Kakha Shamatava (GE);
Revaz Giorganashvili (GE);
Vladimer Chanturidze (GE)
(54) HIGH-TEMPERATURE SUPERCON-
DUCTORS (HTS) RESEARCH
CRYOSTAT

E 05

(11) P 2022 7412 B (51) Int. Cl. (2006)
E 05 B 19/00
(10) AP 2022 15413 A (44) 10(589)/2022
(21) AP 2019 15413
(22) 2019 01 18
(24) 2019 01 18
(31) 10 2018 101 438.4; 18197124.3
(32) 2018 01 23; 2018 09 27
(33) DE; EP
(86) PCT/DE2019/100050, 2019 01 18
(73) Assa Abloy Sicherheitstechnik GMBH (DE)
Bildstockstraße 20, Albstadt, 72458,
Germany (DE)
(72) MATSCHKE, Steffen (DE)
(74) Tamar Kochlamazashvili
(54) FLAT KEY PROFILE FOR LOCK-KEY
SYSTEM

PART F

F 17

(11) P 2022 7410 B (51) Int. Cl. (2006)
F 17 C 3/00
F 25 D 3/10
(10) AP 2022 15612 A (44) 9(588)/2022
(21) AP 2021 15612
(22) 2021 04 21
(24) 2021 04 21

UTILITY MODELS

APPLICATION APPROVED FOR GRANTING PATENT

The decision can be appealed at the Chamber of Appeal of Sakpatenti within 3 months from the publication or at the Mtskheta District Court Administrative Cases Board (Address: №17, Samkhedro St., Mtskheta), within 1 month following the publication.

PART F

F 03

(10) AU 2022 15880 U (51) Int. Cl. (2006)
F 03 B 13/00

(21) AU 2022 15880 (22) 2022 02 17

(71) Ana Rokhvadze (GE)
Kazbegi Av. 10a, app. 66, 0177, Tbilisi,
Georgia (GE)

(72) Ana Rokhvadze (GE)

(54) HYDROPOWER PLANT

(57) A plant includes upper and lower reservoirs filled with water, one wherefrom is hermetic. Furthermore, it is equipped with pressure pipeline connecting the reservoirs and return pipeline. A turbine connected to the generator is embedded into pressure pipeline, and submersible pump aggregate is embedded in return pipeline, in its turn, equipped with frequency converter connected to control means.

Claims: 1 independent

Fig.: 2

PATENTED UTILITY MODELS**PART A****A 01**

(11) U 2022 2130 Y (51) Int. Cl. (2006)
A 01 G 25/00
(10) AU 2022 15879 U (44) 10(589)/2022
(21) AU 2022 15879
(22) 2022 02 17
(24) 2022 02 17
(73) Ana Rokhvadze (GE)
Kazbegi Av. 10a, app. 66, 0177, Tbilisi,
Georgia (GE)
(72) Ana Rokhvadze (GE)
(54) NON-PRESSURIZED DRIP IRRIGATION
SYSTEM

(72) Teimuraz Lomsadze (GE)
(74) Shalva Gvaramadze
(54) METHOD FOR MAKING FORTIFIED
WINE

PART B**B 65**

(11) U 2022 2131 Y (51) Int. Cl. (2006)
B 65 D 51/28
(10) AU 2022 15877 U (44) 10(589)/2022
(21) AU 2022 15877
(22) 2022 02 05
(24) 2022 02 05
(73) Luka Sulaberidze (GE)
I. Nikoladze St. 5a, 0179, Tbilisi,
Georgia (GE)
(72) Luka Sulaberidze (GE)
(54) BOTTLE LID

PART C**C 12**

(11) U 2022 2129 Y (51) Int. Cl. (2006)
C 12 G 3/06
(10) AU 2022 15319 U (44) 9(588)/2022
(21) AU 2020 15319
(22) 2020 04 20
(24) 2020 04 20
(73) Teimuraz Lomsadze (GE)
Sairme St. 5, app. 27, 0194, Tbilisi,
Georgia (GE)

DESIGNS

APPLICATIONS APPROVED FOR REGISTRATION

The decision can be appealed at the Chamber of Appeal of Sakpatenti within 3 months from the publication or at the Mtskheta District Court Administrative Cases Board (Address: №17, Samkhedro str., Mtskheta), within 1 month following the publication.

(10) AD 2022 1262 S (51) 09-01

(21) AD 2022 1262 (22) 2022 03 21

(28) 1

(71) LTD "Global Brand" (GE)

Vazha-Pshavela Av. 29 (plot 07/081), 0160, Vake-Saburtalo District, Tbilisi, Georgia (GE)

(72) Kevin Shaw (US)

(54) BOTTLE

(55)



1.1



1.2



1.3



1.4

(10) AD 2022 1264 S (51) 11-01
(21) AD 2022 1264 (22) 2022 04 20
(28) 2
(71) Rionhesi St. 67, 0180, Gldani-Nadzaladevi District, Tbilisi, Georgia (GE)
(72) Gurami Tabatadze (GE)
(54) 1.-2. HANDMADE JEWELRY
(55)



REGISTERED DESIGNS

- (11) D 2022 942 S (51) 11-04
(10) AD 2022 1246 S (44) 2022 05 25 №10
(21) AD 2021 1246
(22) 2021 10 26
(24) 2021 10 26
(28) 1
(18) 2026 10 26
(73) Lia Jighauri (GE)
 Vazha-Pshavela Av., VII qu., bld. 2, app. 57,
 0186, Tbilisi, Georgia (GE);
 Mariam Kldiashvili (GE)
 Ak. Tsereteli Av. 105, 0119, Tbilisi,
 Georgia (GE)
(72) Lia Jighauri (GE);
 Mariam Kldiashvili (GE)
(54) CHRISTMAS TREE
-

- (11) D 2022 943 S (51) 11-05
(10) AD 2022 1242 S (44) 2022 05 25 №10
(21) AD 2021 1242
(22) 2021 10 15
(24) 2021 10 15
(28) 1
(18) 2026 10 15
(73) Gela Tsuladze (GE)
 Kandelaki St. 8, app. 55, 0160, Tbilisi,
 Georgia (GE)
(72) Gela Tsuladze (GE)
(54) FLAG WITH HEARTS
-

DESIGNS, WHICH HAVE BEEN REGISTERED WITH THE INTERNATIONAL BUREAU CLAIMING PRIORITY ON THE TERRITORY OF GEORGIA

The decision can be appealed at the Chamber of Appeal of Sakpatenti within 3 months from the publication or at the Mtskheta District Court Administrative Cases Board (Address: №17, Samkhedro St., Mtskheta), within 1 month following the publication.

- (11) DM/221 798 (51) 10-07
 (15) 2022 06 14 (44) 27/2022 (2022 07 08)
 (22) 2022 06 14
 (28) 2
 (30) No1: 28.02.2022; 146626; CH; No2: 28.02.2022; 146626; CH
 (73) Montres Tudor SA
 3, rue François-Dussaud, 1211 Genève 26 (CH)
 (85) CH
 (86) CH
 (87) CH
 (88) CH
 (89) CH
 (81) II. MA III. AL, AM, AZ, BA, BN, BW, BY, BZ, CA, EG, EM, GB, GE, GH, IL, IS, JM, JP, KG, KH, KP, KR, LI, MC, MD, ME, MK, MN, MX, NA, NO, OA, OM, RS, RU, RW, SG, SM, SR, ST, SY, TJ, TM, TN, TR, UA, VN, WS
 (72) Ander Ugarte
 Rue des Gares 25, 1201, Genève (CH)
 (74) BUGNION S.A.
 10, route de Florissant, 1211 Genève 12 (CH)
 (46) 2022 07 08
 (54) 1.-2. WATCH BRACELET CLASP
 (55)

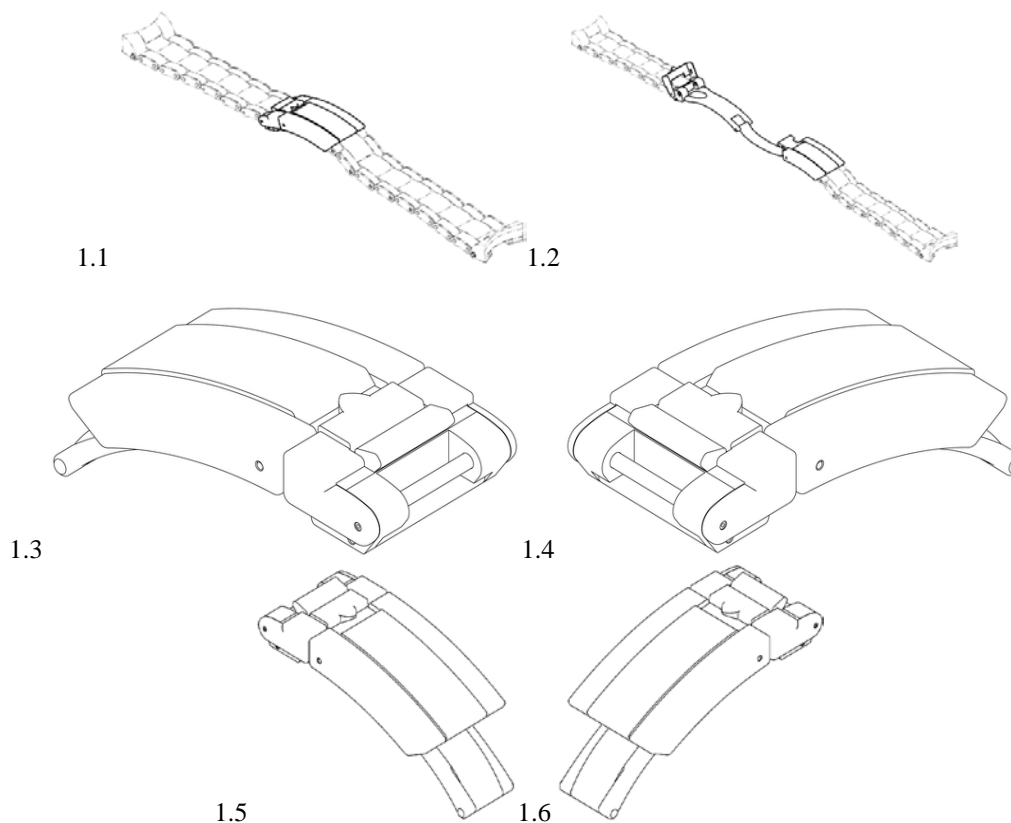

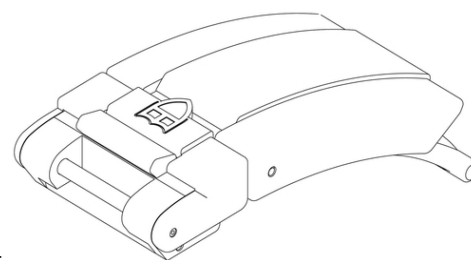
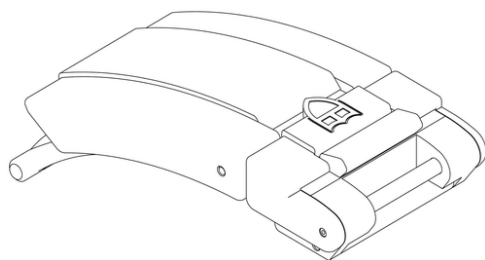
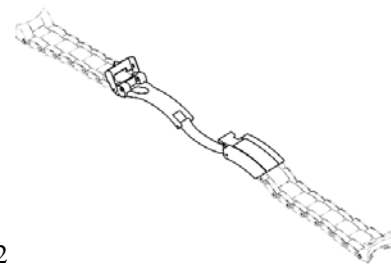
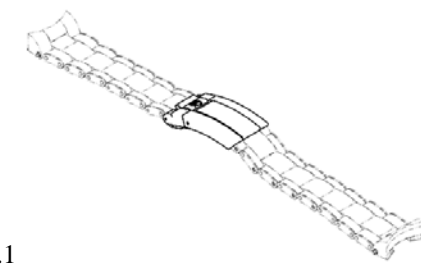
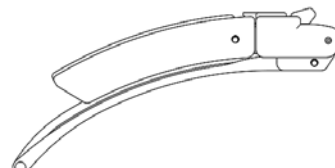
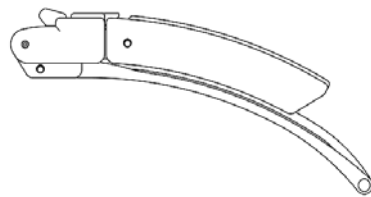
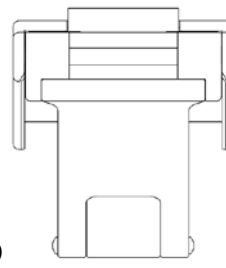
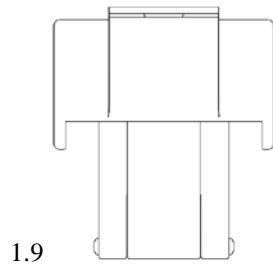
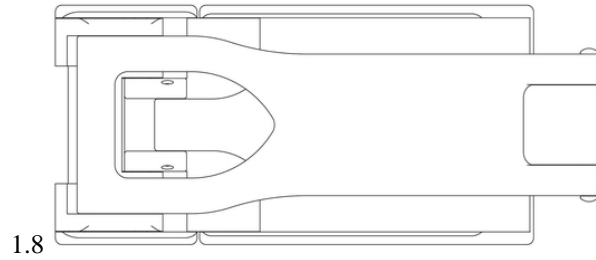
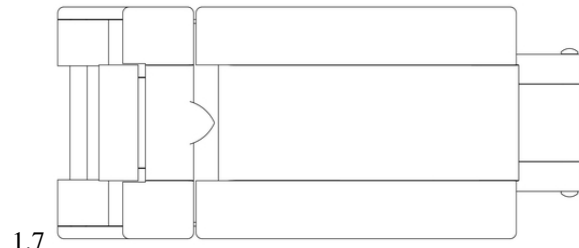

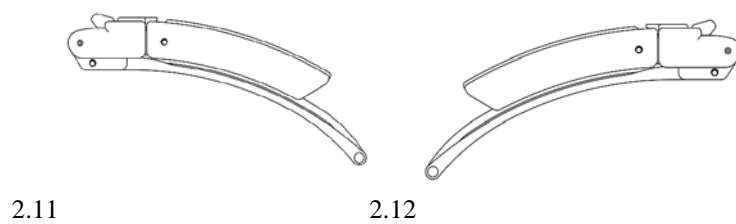
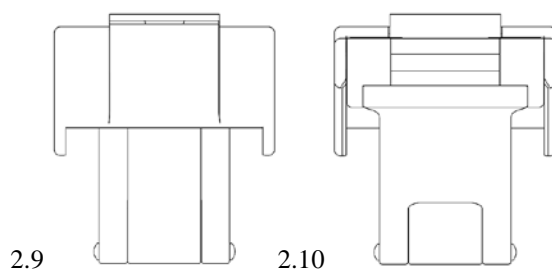
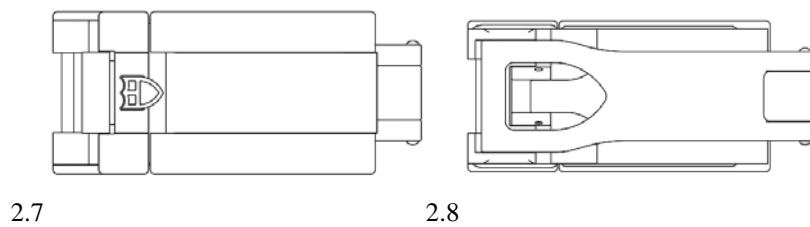
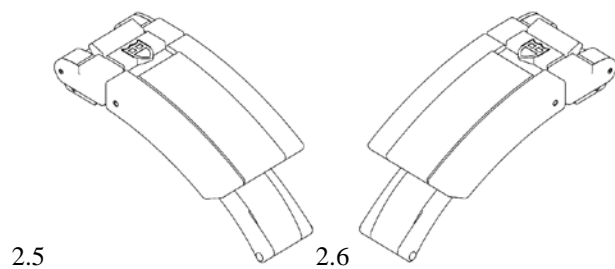

- (11) DM/221 799 (51) 10-07
 (15) 2022 06 14 (44) 27/2022 (2022 07 08)
 (22) 2022 06 14
 (28) 1
 (30) No1: 24.02.2022; 146616; CH
 (73) Montres Tudor SA
 3, rue François-Dussaud, 1211 Genève 26 (CH)
 (85) CH
 (86) CH
 (87) CH
 (88) CH
 (89) CH
 (81) II. MA III. AL, AM, AZ, BA, BN, BW, BY, BZ, CA, EG, EM, GB, GE, GH, IL, IS, JM, JP, KG, KH, KP, KR, LI, MC, MD, ME, MK, MN, MX, NA, NO, OA, OM, RS, RU, RW, SG, SM, SR, ST, SY, TJ, TM, TN, TR, UA, VN, WS
 (72) Ander Ugarte
 Rue des Gares 25, 1201, Genève (CH)
 (74) BUGNION S.A.
 10, route de Florissant, 1211 Genève 12 (CH)
 (46) 2022 07 08
 (54) 1. WATCH BRACELET CLASP
 (55)

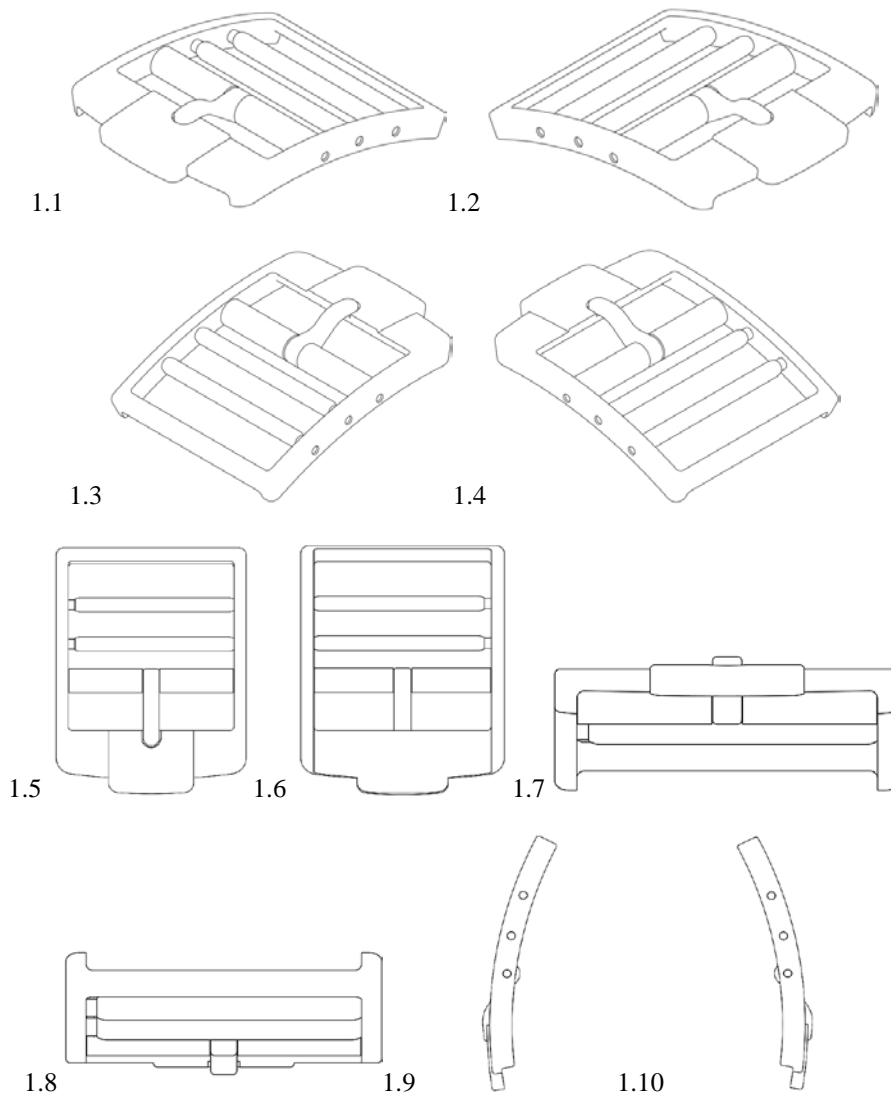

- (11) DM/221 800 (51) 10-07
 (15) 2100 01 01 (44) 27/2022 (2022 07 08)
 (22) 2022 06 14
 (28) 1
 (30) No1: 24.02.2022; 146615; CH
 (73) Montres Tudor SA
 3, rue François-Dussaud, 1211 Genève 26 (CH)
 (85) CH
 (86) CH
 (87) CH
 (88) CH
 (89) CH
 (81) II. MA III. AL, AM, AZ, BA, BN, BW, BY, BZ, CA, EG, EM, GB, GE, GH, IL, IS, JM, JP, KG, KH, KP, KR, LI, MC, MD, ME, MK, MN, MX, NA, NO, OA, OM, RS, RU, RW, SG, SM, SR, ST, SY, TJ, TM, TN, TR, UA, VN, WS
 (72) Ander Ugarte
 Rue des Gares 25, 1201, Genève (CH)
 (74) BUGNION S.A.
 10, route De Florissant, 1211 Genève 12 (CH)
 (46) 2022-07-08
 (54) 1. WATCH HAND
 (55)

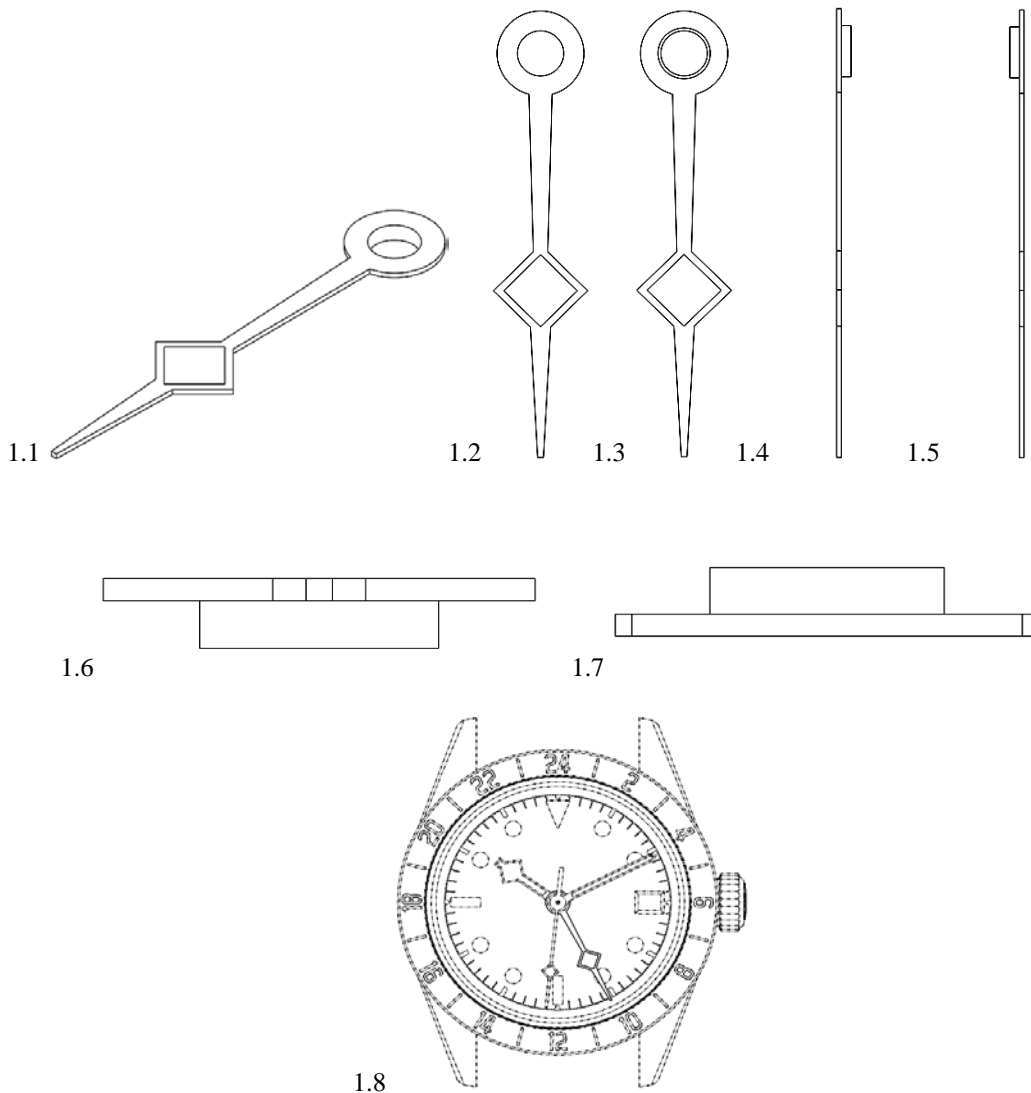

- (11) DM/218 507 (51) 11-01
(15) 2022 01 14 (44) 28/2022 (2022 07 15)
(22) 2022 01 14
(28) 2
(73) HARRY WINSTON SA
Chemin Du Tourbillon 8, 1228 Plan-les-Ouates (CH)
(85) CH
(86) CH
(87) CH
(88) CH
(89) CH
(81) II. MA III. AL, AM, AZ, BA, BZ, CA, CH, EM, GB, GE, KG, LI, MC, MD, ME, MK, MN, NO, OM, SG,
TN, TR, UA
(72) 2 Delphine ABDOURAHIM
C/o Harry Winston Inc. 718 Fifth Avenue, 10019, New York (US)
(74) The Swatch Group AG (The Swatch Group SA) (The Swatch Group Ltd.)
Faubourg Du Lac 6, 2501 Biel/Bienne (CH)
(46) 2022 07 15
(54) 1. NECKLACE, 2. PAIR OF EARRINGS
(55)

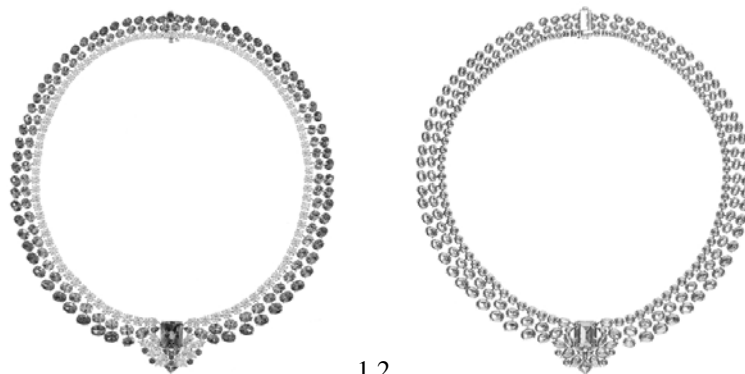

1.1

1.2



1.3



1.4



1.5



1.6



1.7



1.8



2.1



2.2



2.3



2.4



2.5



2.6



2.7



2.8

- (11) DM/222 075 (51) 09-01
(15) 2022 04 18 (44) 29/2022 (2022 07 22)
(22) 2022 04 18
(28) 1
(73) Igor Yuryevich Moskvina
Ul. Kalinina, D. 115, Kv. 136, 636037 Tomskaya Oblast, Seversk (RU)
(85) BY
(86) RU
(87) BY
(88) –
(89) BY
(81) III. AM, AZ, GE, IL, KG, KR, MX, NO, SG, TJ, TR, VN
(72) Igor Yuryevich Moskvina
Ul. Kalinina, D. 115, Kv. 136, 636037 Tomskaya Oblast', Seversk (RU)
(74) Private Service Unitary Enterprise "Lisovskys And Partners"
P. O. Box 49, 220005 Minsk (BY)
(46) 2022 07 22
(54) 1. BOTTLE
(55)

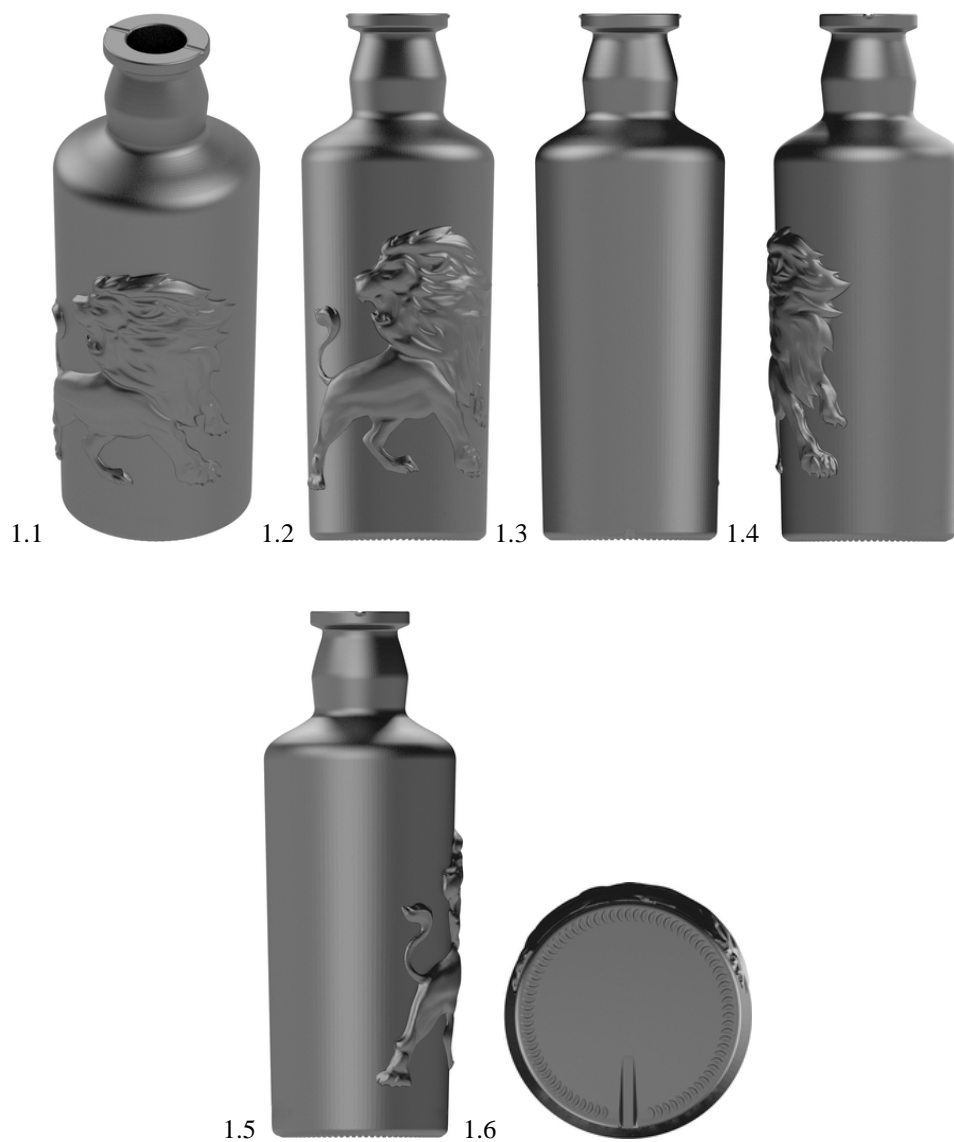

- (11) DM/218 557 (51) 11-01
(15) 2022 01 21 (44) 29/2022 (2022 07 22)
(22) 2022 01 21
(28) 2
(73) HARRY WINSTON SA
Chemin Du Tourbillon 8, 1228 Plan-les-Ouates (CH)
(85) CH
(86) CH
(87) CH
(88) CH
(89) CH
(81) II. MA III. AL, AM, AZ, BA, BZ, CA, CH, EM, GB, GE, KG, LI, MC, MD, ME, MK, MN, NO, OM, SG,
TN, TR, UA
(72) Rie YATSUGI-KANG
C/o Harry Winston Inc., 718 Fifth Avenue, 10019, New York (US)
(74) The Swatch Group AG (The Swatch Group SA) (The Swatch Group Ltd.)
Faubourg Du Lac 6, 2501 Biel/Bienne (CH)
(46) 2022-07-22
(54) 1. NECKLACE, 2. FINGER RING
(55)





1.6



1.7



1.8



2.1



2.2



2.3



2.4



2.5



2.6



2.7



2.8

- (11) DM/218 929 (51) 11-01
- (15) 2022 02 04 (44) 31/2022 (2022 08 05)
- (22) 2022 02 04
- (28) 2
- (73) HARRY WINSTON SA
 Chemin Du Tourbillon 8, 1228 Plan-les-Ouates (CH)
- (85) CH
- (86) CH
- (87) CH
- (88) CH
- (89) CH
- (81) II. MA III. AL, AM, AZ, BA, BZ, CA, CH, EM, GB, GE, KG, LI, MC, MD, ME, MK, MN, NO, OM, SG,
 TN, TR, UA
- (72) 1. Rie YATSUGI-KANG
 C/o Harry Winston Inc. 718 Fifth Avenue, 10019, New York (US);
 2. Dominique RIVIERE
 C/o Harry Winston Inc. 718 Fifth Avenue, 10019, New York (US)
- (74) The Swatch Group AG (The Swatch Group SA) (The Swatch Group Ltd.)
 Faubourg Du Lac 6, 2501 Biel/Bienne (CH)
- (46) 2022 08 05
- (54) 1.-2. PAIR OF EARRINGS
- (55)



1.1



1.2



1.3



1.4



1.5



1.6



1.7



1.8





2.1



2.2



2.3



2.4



2.5



2.6



2.7



2.8



TRADEMARKS

APPLICATIONS FILED UNDER THE NATIONAL PROCEDURE APPROVED FOR REGISTRATION

The decision can be appealed at the Chamber of Appeal of Sakpatenti within 3 months from the publication or at the Mtskheta District Court Administrative Cases Board (Address: №17, Samkhedro St., Mtskheta), within 1 month following the publication.

(260) AM 2022 116214 A
(210) AM 116214
(220) 2022 01 14
(731) JSC "Lomisi"
Vill. Natakhtari, 3308, Mtskheta, Georgia
(540)

სი ლუდი

(591) Black-white
(511) 32

(260) AM 2022 116239 A
(210) AM 116239
(220) 2022 01 18
(731) Rasim Bairamov
Liakhvi St. 47, Tbilisi, Georgia
(740) Shalva Gvaramadze
(540)



(591) Black, light green, white
(531) 18.01.09; 18.01.23; 26.04.16; 26.04.22;
26.04.24; 29.01.13
(511) 35

(260) AM 2022 116246 A
(210) AM 116246
(220) 2022 01 20
(731) LTD "Biopolus"
I. Noneshvili St. 65, 6000, Batumi, Georgia
(740) Monika Kvaratskhelia
(540)

ბიოსპან-ბიო
Biospan-Bio
Биоспан-Био

(591) Black-white
(511) 5

(260) AM 2022 116250 A
(210) AM 116250
(220) 2022 01 20
(731) RK "Winery Bakhtrioni"
Vill. Atskuri, Akhmeta, Georgia
(540)



(591) Green, golden, grey, yellow
(531) 05.01.09; 05.01.11; 05.01.16; 06.07.08;
06.07.25; 06.19.01; 06.19.07; 06.19.13;
06.19.16; 07.01.08; 07.01.09; 07.01.24;
24.03.07; 24.03.14; 26.11.12; 29.01.14
(526) GEORGIA
(511) 33, 43

(260) AM 2022 116252 A
(210) AM 116252
(220) 2022 01 20
(731) Chongqing Qiulong Technology Co., LTD
No.259 Shimiancun, Qiezixi Residential
District, Dadukou District, 400000, Chongqing,
People Republic of China
(740) Giorgi Kartvelishvili
(540)



(591) Black-white
(531) 01.15.03; 26.13.25; 27.05.01; 27.05.04
(511) 12

(260) AM 2022 116314 A
 (210) AM 116314
 (220) 2022 01 24
 (731) Tamaz Tskhakaia
 Zakaria Paliashvili St. 37/2, Arakishvili St. 2,
 Tbilisi, Georgia
 (540)



MONDAY GREENS

WITH CREAMS AND DREAMS

(591) Black-white
 (531) 04.01.02; 27.05.01; 27.05.10
 (511) 29, 30, 32, 35, 43

(260) AM 2022 116315 A
 (210) AM 116315
 (220) 2022 01 24
 (731) Alkaloid AD Skopje
 Blvd. Aleksandar Makedonski 12, 1000 Skopje,
 The Republic of North Macedonia
 (740) Shalva Gvaramadze
 (540)

BOLDENO

(591) Black-white
 (511) 5

(260) AM 2022 116321 A
 (210) AM 116321
 (220) 2022 01 25
 (731) M/S Leaf Fibers Private Limited
 B-2/10a, Model Town Ii Delhi Delhi North
 West DI 110009, India
 (740) Liliana Darakhvelidze
 (540)

MYTH

(591) Black-white
 (511) 5, 30

(260) AM 2022 116322 A
 (210) AM 116322
 (220) 2022 01 25
 (731) Kimberly-Clark Worldwide Inc.
 Neenah, WI 54956, USA
 (740) Shalva Gvaramadze
 (540)

ქვეყნის
natural

(591) Black-white
 (531) 27.05.01; 27.05.09; 27.05.10; 27.05.17
 (511) 3

(260) AM 2022 116323 A
 (210) AM 116323
 (220) 2022 01 25
 (731) M/S Leaf Fibers Private Limited
 B-2/10a, Model Town Ii Delhi Delhi North
 West DI 110009, India
 (740) Liliana Darakhvelidze
 (540)

VASP

(591) Black-white
 (511) 5, 30

(260) AM 2022 116332 A
 (210) AM 116332
 (220) 2022 01 26
 (731) LTD "Barmaglot Tbilisi"
 Giorgi Leonidze St. 2a, space 2, floor 1, 0105,
 Mtatsminda District, Tbilisi, Georgia
 (740) Tamar Donadze
 (540)



BARMAGLOT

ბარმაგლოტი

(591) FFFFFFF white, 020202 black
 (531) 04.03.03; 29.01.12
 (511) 43

(260) AM 2022 116333 A
 (210) AM 116333
 (220) 2022 01 27
 (731) LTD "Medical World"
 Nearby Krtsanisi St. 16, 0114, Tbilisi,
 Georgia
 (540)



(591) FFFFFFF white 2C72D3 blue
 (531) 26.11.07; 26.11.12; 26.11.13; 27.05.01;
 27.05.24; 29.01.12
 (511) 35, 44

(260) AM 2022 116336 A
 (210) AM 116336
 (220) 2022 01 28
 (731) Tamar Keshelava
 Zakaria Paliashvili St. 39a, 0179, Tbilisi,
 Georgia
 (740) Tamar Keshelava

(540)



(591) F4EBEB white, 0A0909 black
 (531) 27.05.04
 (511) 33

(260) AM 2022 116394 A
 (210) AM 116394
 (220) 2022 01 30
 (731) LTD "European Business School and
 Consulting"
 Nodar Tabidze St, I Lane 6, 0114, Tbilisi,
 Georgia
 (740) David Dzamukashvili
 (540)



(591) Blue, white
 (531) 26.04.07; 26.04.22; 26.04.24; 27.05.01;
 27.05.10; 27.05.24; 29.01.12
 (511) 16, 35, 36, 41

(260) AM 2022 116401 A
 (210) AM 116401
 (220) 2022 01 31
 (731) LTD "AquaRoom"
 Bidzina Kvernadze St. 35, app. 82, 0171,
 Saburtalo District, Tbilisi, Georgia

(740) Giorgi Ghvinjilia
 (540)



(591) FFFFFFF white, 71CAF3 turquoise,
 35A2C5 sky-blue, 095D80 blue
 (531) 26.11.12; 27.05.08; 27.05.09; 29.01.04
 (511) 37

(260) AM 2022 116414 A
 (210) AM 116414
 (220) 2022 02 01
 (731) LLC "Ako Bohemia"
 Vill. Tserovani, 3318, Mtskheta, Georgia
 (540)



(591) Black, white, crimson
 (531) 02.03.01; 05.05.20; 29.01.12
 (511) 1, 2, 3, 5, 16, 20, 21, 35, 36, 39, 44

(260) AM 2022 116415 A
 (210) AM 116415
 (220) 2022 02 02
 (731) Melory Tsipouria
 1642 Myra Ct, Chula Vista, CA 91911, USA
 (740) Giorgi Taktakishvili
 (540)

HOTEL GITANO

(591) Black-white
 (511) 43

(260) AM 2022 116425 A
 (210) AM 116425
 (220) 2022 02 02
 (731) LTD "Impexpharm"
 Giorgi Saakadze II exit 17, 0160, Tbilisi,
 Georgia
 (740) Nugzar Ksovreli
 (540)

Bilocard

(591) Black-white
 (511) 5

(260) AM 2022 116426 A
 (210) AM 116426
 (220) 2022 02 02
 (731) Philip Morris Products S.A.
 Quai Jeanrenaud 3, 2000 Neuchâtel,
 Switzerland
 (740) Pavle Meipariani
 (540)

L & M LOFT XL FIRST CUT NIGHT BLUE

(591) Black-white
 (511) 34

(260) AM 2022 116431 A
 (210) AM 116431
 (220) 2022 02 03
 (731) LTD "Eurotrade"
 Cherkezishvili St. 2, Vake-Saburtalo
 District, Tbilisi, Georgia
 (540)



(591) Golden, black, brown, white
 (531) 26.03.23; 27.05.01; 27.05.21; 27.05.24;
 29.01.12
 (511) 3, 5, 16, 30, 35, 39

(260) AM 2022 116513 A
 (210) AM 116513
 (220) 2022 02 04
 (731) Duck Global Licensing AG
 (Duck Global Licensing SA)
 (Duck Global Licensing LTD)
 c/o Fischer & Partner, Sonnenbergstrasse 9,
 6052 Hergiswil, Switzerland
 (740) Giorgi Taktakishvili
 (540)

DUCK

(591) Black-white
 (511) 3, 5, 21

(260) AM 2022 116514 A
 (210) AM 116514
 (220) 2022 02 04
 (731) Duck Global Licensing AG
 (Duck Global Licensing SA)

(Duck Global Licensing LTD)
 c/o Fischer & Partner, Sonnenbergstrasse 9,
 6052 Hergiswil, Switzerland
 (740) Giorgi Taktakishvili
 (540)



(591) White, grey, black
 (531) 03.07.06; 26.01.15; 26.01.19; 27.05.02
 (511) 3, 5, 21

(260) AM 2022 116517 A
 (210) AM 116517
 (220) 2022 02 04
 (731) LTD "Cor"
 Vakhushti Bagrationi St. 3a, app. 26, 0154,
 Tbilisi, Georgia
 (540)

CORE

(591) 64C832 green, 000000 black, FFFFFFF white
 (531) 26.15.01; 27.01.06; 28.11; 29.01.13
 (511) 42

(260) AM 2022 116519 A
 (210) AM 116519
 (220) 2022 02 04
 (731) Apivita S.A.
 Industrial Park of Markopoulo Mesogaïas,
 Markopoulo Mesogaïas, 19003, Athens, Greece
 (740) Tamaz Shilakadze
 (540)

APIVITA



(591) Black-white
 (531) 05.05.20; 25.01.25; 27.05.01
 (511) 3, 35

(260) AM 2022 116520 A
 (210) AM 116520
 (220) 2022 02 04
 (731) Apivita S.A.
 Industrial Park of Markopoulo Mesogaias,
 Markopoulo Mesogaias, 19003, Athens, Greece
 (740) Tamaz Shilakadze
 (540)

APIVITA

(591) Black-white
 (511) 3, 35

(260) AM 2022 116526 A
 (210) AM 116526
 (220) 2022 02 08
 (731) LTD "Nikora"
 A. Mrevlishvili St. 2, 0180, Tbilisi, Georgia
 (740) Melano Gogisvanidze
 (540)

როსტერი
Roster

(591) Black-white
 (511) 29, 43

(260) AM 2022 116540 A
 (210) AM 116540
 (220) 2022 02 09
 (731) LTD "Smart Feed"
 14th St, II Lane 15, 1306, Vill. Gamarjveba,
 Gardabani, Georgia
 (540)

'SMART FEED'

'სმარტ ფიდი'

'СМАРТ ФИД'

(591) Black-white
 (511) 31

(260) AM 2022 116543 A
 (210) AM 116543
 (220) 2022 02 09
 (731) Hyatt International Corporation
 150 North Riverside Plaza, 14th Floor,
 Chicago, IL 60606, USA
 (740) Shalva Gvaramadze
 (540)

JDV BY HYATT

(591) Black-white
 (511) 43

(260) AM 2022 116544 A
 (210) AM 116544
 (220) 2022 02 09
 (731) Hyatt International Corporation
 150 North Riverside Plaza, 14th Floor,
 Chicago, IL 60606, USA
 (740) Shalva Gvaramadze
 (540)



BY HYATT

(591) Black-white
 (531) 02.09.01; 27.05.01; 27.05.07; 27.05.09;
 27.05.10
 (511) 43

(260) AM 2022 116545 A
 (210) AM 116545
 (220) 2022 02 09
 (731) LTD "Biopolus"
 I. Noneshvili St. 65, 6000, Batumi, Georgia
 (740) Monika Kvaratskhelia
 (540)

ESOPRA
ესოპრა
ЭСОПРА

(591) Black-white
 (511) 5

(260) AM 2022 116546 A
 (210) AM 116546
 (220) 2022 02 09
 (731) LTD "Biopolus"
 I. Noneshvili St. 65, 6000, Batumi, Georgia
 (740) Monika Kvaratskhelia
 (540)

Combizol
კომბიზოლი
Комбизол

(591) Black-white
 (511) 5

(260) AM 2022 116622 A
 (210) AM 116622
 (220) 2022 02 13
 (731) LTD "Pharmhub"
 Akaki Tsereteli Av. 116, 0186, Tbilisi, Georgia

(740) Davit Chikhladze
(540)

გამალონი
GAMMALON
ГАММАЛОН

(591) Black-white
(511) 5

(260) AM 2022 116623 A
(210) AM 116623
(220) 2022 02 13
(731) LTD "Pharmhub"

Akaki Tsereteli Av. 116, 0186, Tbilisi, Georgia

(740) Davit Chikhladze
(540)

მექსისოფტი
MEKSISOFT
МЕКСИСОФТ

(591) Black-white
(511) 5

(260) AM 2022 116624 A
(210) AM 116624
(220) 2022 02 13
(731) LTD "Pharmhub"

Akaki Tsereteli Av. 116, 0186, Tbilisi, Georgia

(740) Davit Chikhladze
(540)

როქსაბენი
ROXSABEN
РОКСАБЕН

(591) Black-white
(511) 5

(260) AM 2022 116625 A
(210) AM 116625
(220) 2022 02 13
(731) LTD "Pharmhub"

Akaki Tsereteli Av. 116, 0186, Tbilisi, Georgia

(740) Davit Chikhladze
(540)

პრიმაფაგ პიო
PRIMAFAG PIO
ПРИМАФАГ ПИО

(591) Black-white
(511) 5

(260) AM 2022 116626 A
(210) AM 116626
(220) 2022 02 13
(731) LTD "Pharmhub"

Akaki Tsereteli Av. 116, 0186, Tbilisi, Georgia

(740) Davit Chikhladze
(540)

პრიმაფაგ სტაფი
PRIMAFAG STAF
ПРИМАФАГ СТАФ

(591) Black-white
(511) 5

(260) AM 2022 116633 A
(210) AM 116633
(220) 2022 02 14
(731) LTD "Tao 2052"

Leselidze St. 25, 0105, Old Tbilisi District,
Tbilisi, Georgia

(740) Davit Bibiluri
(540)

კომორები
KOMOREBI

(591) Black-white
(511) 35, 43

(260) AM 2022 116642 A
(210) AM 116642
(220) 2022 02 14
(731) LTD "Pharmhub"

Akaki Tsereteli Av. 116, 0186, Tbilisi, Georgia

(740) Davit Chikhladze
(540)

პრიმაფაგ ულტრა
PRIMAFAG ULTRA
ПРИМАФАГ УЛТРА

(591) Black-white
(511) 5

(260) AM 2022 116657 A
(210) AM 116657
(220) 2022 02 16
(731) Davit Barnabishvili

Varketili 3, IIIa m/r, bld. 337, app. 181,
Tbilisi, Georgia

(740) Levan Gvaramadze;
Ekaterine Nemsadze;
Shalva Gvaramadze

(540)

ბარნა
BARNA
 БАРНА

(591) Black-white
 (511) 33

(260) AM 2022 116659 A

(210) AM 116659

(220) 2022 02 16

(731) LTD "Biopolus"

I. Noneshvili St. 65, 6000, Batumi, Georgia

(740) Monika Kvaratskhelia

(540)

არბიკარდი
ARGICARD
 АРГИКАРД

(591) Black-white
 (511) 5

(260) AM 2022 116660 A

(210) AM 116660

(220) 2022 02 16

(731) LTD "Biopolus"

I. Noneshvili St. 65, 6000, Batumi, Georgia

(740) Monika Kvaratskhelia

(540)

ლ-ელზინატი
L-Elzinat
 Л-ЕЛЗИНАТ

(591) Black-white
 (511) 5

(260) AM 2022 116669 A

(210) AM 116669

(220) 2022 02 17

(731) Foshan Dingzhineng Technology Co., LTD
 No.3,4F, Yitai Industrial Building, Lianfeng
 Industrial Area, Zhoucun, Lishui Town, Nanhai
 District, Foshan City, Guangdong, 528244,
 People Republic of China

(740) Khatuna Imnadze

(540)

BWOO

(591) Black-white
 (531) 27.05.17
 (511) 9

(260) AM 2022 116741 A

(210) AM 116741

(220) 2022 02 21

(731) LTD "Rich Group"

Vill. Mughanlo, Marneuli Region, Georgia

(540)

Myodrops-მიოდროფსი

(591) Black-white
 (511) 5

(260) AM 2022 116743 A

(210) AM 116743

(220) 2022 02 21

(731) LTD "Rich Group"

Vill. Mughanlo, Marneuli Region, Georgia

(540)

Ventajon
 ვენტაჟონი

(591) Black-white
 (511) 5

(260) AM 2022 116744 A

(210) AM 116744

(220) 2022 02 21

(731) LTD "Rich Group"

Vill. Mughanlo, Marneuli Region, Georgia

(540)

Otijon

ოტიჟონი

(591) Black-white
 (511) 5

(260) AM 2022 116745 A

(210) AM 116745

(220) 2022 02 21

(731) LTD "Rich Group"

Vill. Mughanlo, Marneuli Region, Georgia

(540)

Edolbrim

ედოლბრიმი

(591) Black-white
 (511) 5

(260) AM 2022 116746 A

(210) AM 116746

(220) 2022 02 21

(731) LTD "Rich Group"

Vill. Mughanlo, Marneuli Region, Georgia

(540)

Cyclojon
ციკლოჯონი

(591) Black-white
(511) 5

(260) AM 2022 116754 A
(210) AM 116754
(220) 2022 02 22
(310) UK00003754431
(320) 2022 02 14
(330) UK
(731) SC IP Limited
13 Castle Street, St. Helier, JE2 3BT, Jersey
(740) Irakli Gvilia
(540)



(591) White, dark blue, light blue, sky-blue
(531) 26.04.02; 26.04.22; 26.04.24; 27.01.12;
27.05.01; 27.05.24; 29.01.13
(511) 9, 28, 35, 38, 41

(260) AM 2022 116756 A
(210) AM 116756
(220) 2022 02 22
(731) Mariam Lapiashvili
Nino Ramishvili St., II Lane 5, app. 14, 0179,
Tbilisi, Georgia
(540)

ჯოჯანი მორა

(591) FFFFFFF white, 000000 black
(511) 9, 18, 24, 25, 35, 40

TRADEMARKS REGISTERED ACCORDING TO THE ACCELERATED PROCEDURE

The decision can be appealed at the Chamber of Appeal of Sakpatenti within 3 months from the publication.

(111) M 2022 35871 R
(151) 2022 08 19
(181) 2032 08 19
(210) AM 119001
(220) 2022 08 15
(732) LTD "Gastronome Hospitality"
Ana Politkovskaya St. 50, Bld. 1, app. 55, 0186,
Vake District, Tbilisi, Georgia
(540)

ZÉN
DINING BAR

(591) FFFFFFF white, 000000 black
(531) 27.05.01; 27.05.10; 28.19
(511) 43

(111) M 2022 35872 R
(151) 2022 08 19
(181) 2032 08 19
(210) AM 119012
(220) 2022 08 17
(732) LLC "New Digital Technologies"
Iia Chavchavadze Av. 29, 0179, Tbilisi,
Georgia
(540)

 **MyCoins**

(591) Blue, white, morengo
(531) 26.01.01; 26.01.06; 26.01.24; 29.01.12
(511) 36

(111) M 2022 35873 R
(151) 2022 08 23
(181) 2032 08 23
(210) AM 119021
(220) 2022 08 18
(732) LTD "Gastronome Hospitality"
Ana Politkovskaya St. 50, Bld. 1, app. 55, 0186,
Vake District, Tbilisi, Georgia
(540)

გნბ
განბნება ბაზარი

(591) FFFFFFF white, 000000 black

(531) 27.05.10; 28.19
(511) 43

(111) M 2022 35874 R
(151) 2022 08 23
(181) 2032 08 23
(210) AM 119006
(220) 2022 08 16
(732) SIA "Finist Global Trading"
Gertrudes St. 20-5, Riga, LV 1011, Latvia
(740) Davit Dzamukashvili
(540)



(591) Red, brown, white, black, grey, green, yellow
(531) 03.07.12; 03.07.13; 19.07.01; 28.19; 29.01.15
(511) 33

(111) M 2022 35875 R
(151) 2022 08 25
(181) 2032 08 25
(210) AM 118857
(220) 2022 08 04
(732) CJSC "Tabaterra"
Sumgait Chemical Industrial Park,
St. Kimyachilar 1, Sumgait, AZ5002,
Azerbaijan
(740) Tamaz Shilakadze
(540)

Senate

(591) Black-white
(511) 35, 39

(111) M 2022 35876 R
 (151) 2022 08 25
 (181) 2032 08 25
 (210) AM 118858
 (220) 2022 08 04
 (732) CJSC "Tabaterra"
 Sumgait Chemical Industrial Park,
 St. Kimyachilar 1, Sumgait, AZ5002,
 Azerbaijan
 (740) Tamaz Shilakadze
 (540)



(591) Black-white
 (531) 10.01.01; 10.01.10; 10.01.25; 19.03.03;
 19.03.05; 19.03.25; 25.07.20; 25.07.21;
 26.04.22; 26.04.24
 (511) 35, 39

(111) M 2022 35877 R
 (151) 2022 08 25
 (181) 2032 08 25
 (210) AM 118940
 (220) 2022 08 11
 (732) LTD "Blanko"
 Area of Agrarian University, Plot 14/467,
 Tbilisi, Georgia
 (740) Giorgi Kartvelishvili
 (540)

blanco

(591) Black-white
 (511) 16

(111) M 2022 35878 R
 (151) 2022 08 25
 (181) 2032 08 25
 (210) AM 118922
 (220) 2022 08 08
 (732) LTD "Bolero & Company"
 Kuchishvili St. 12-14-16, 0179, Tbilisi,
 Georgia
 (540)

თავლა
Tavla
Тавла

(591) Black-white
 (511) 33

(111) M 2022 35879 R
 (151) 2022 08 25
 (181) 2032 08 25
 (210) AM 119089
 (220) 2022 08 23
 (732) LLC "Trezori"
 Ortachala St. 82, 0114, Tbilisi, Georgia
 (540)

ტრეზორი

(591) 000000 black, FFFFFFFF white
 (511) 35

(111) M 2022 35880 R
 (151) 2022 08 25
 (181) 2032 08 25
 (210) AM 118724
 (220) 2022 07 22
 (732) LTD "Kaklebi"
 Bagebi Forestry District 3/24, Tbilisi, Georgia
 (540)

კაკლები

KARLEBI

(591) Black-white
 (531) 27.05.01; 28.19
 (511) 43

(111) M 2022 35881 R
 (151) 2022 08 25
 (181) 2032 08 25
 (210) AM 118942
 (220) 2022 08 11
 (732) LTD "Alfa"
 Tevdore Mghvdeli St. 53, Tbilisi, Georgia
 (740) Giorgi Taktakishvili
 (540)



(591) Red, yellow, blue, sky-blue, brown, beige,
 golden, green, black
 (531) 05.05.04; 26.11.05; 26.11.09; 26.11.12;
 27.05.01; 27.05.21; 29.01.15
 (511) 29

(111) M 2022 35882 R
 (151) 2022 08 29
 (181) 2032 08 29
 (210) AM 119115
 (220) 2022 08 25
 (732) LTD "Europe Plus"
 Besiki St. 1, app. 9, 5400, Tskaltubo, Georgia
 (740) Davit Dzamukashvili
 (540)



(591) Red, white
 (531) 26.04.02; 26.04.18; 26.04.24; 27.05.21;
 29.01.12
 (511) 13

(111) M 2022 35883 R
 (151) 2022 08 31
 (181) 2032 08 31
 (210) AM 119083
 (220) 2022 08 22
 (732) LTD "Ori Nabiji"
 Navtlughi St. 39-41, 0113, Isani District,
 Tbilisi, Georgia
 (540)

(591) white, green
 (531) 27.05.01; 27.05.02; 27.05.19; 29.01.12
 (511) 32

(111) M 2022 35884 R
 (151) 2022 08 31
 (181) 2032 08 31
 (210) AM 119097
 (220) 2022 08 24
 (732) LTD "Europe Plus"
 Besiki St. 1, app. 9, 5400, Tskaltubo, Georgia
 (740) Davit Dzamukashvili
 (540)

Riopril

(591) Black-white
 (511) 13

(111) M 2022 35885 R
 (151) 2022 08 31
 (181) 2032 08 31
 (210) AM 119088
 (220) 2022 08 23
 (732) LTD "Road Production"
 A. Aladashvili St. 6, Tbilisi, Georgia
 (540)

DAVID'S ROAD

(591) Black-white
 (531) 26.11.08; 27.05.01; 27.05.11; 27.05.17
 (511) 25

(111) M 2022 35886 R
 (151) 2022 08 31
 (181) 2032 08 31
 (210) AM 119102
 (220) 2022 08 25
 (732) LLC "True Hospitality"
 Kote Abkhazi St., I Lane 5, Mtatsminda
 District, Tbilisi, Georgia
 (540)

ეპიზოდი episode

(591) Black-white
 (511) 35

(111) M 2022 35887 R
 (151) 2022 09 01
 (181) 2032 09 01
 (210) AM 119002
 (220) 2022 08 16
 (732) IERmitage Holding Inc.
 52 Chartwell Road, Oakville, Ontario
 L6J3Z5, Canada
 (740) Giorgi Taktakishvili
 (540)

(591) Red, white
 (531) 26.04.02; 26.04.09; 26.04.18; 26.04.24;
 29.01.12
 (511) 37, 42, 44

(111) M 2022 35888 R
 (151) 2022 09 01
 (181) 2032 09 01
 (210) AM 119101
 (220) 2022 08 25
 (732) LTD "Drops"
 Iakob Nikoladze St. 3, app. 40, 0108, Tbilisi,
 Georgia
 (540)

(591) Golden, blue
 (531) 01.15.15; 27.03.12; 27.05.01; 27.05.09;
 27.05.10; 29.01.12
 (511) 44

INTERNATIONAL TRADEMARKS FOR WHICH A DECISION ON GRANTING PROTECTIONS IS TAKEN

The decision can be appealed at the Chamber of Appeal of Sakpatenti within 3 months from the publication or at the Mtskheta District Court Administrative Cases Board (Address: №17, Samkhedro St., Mtskheta), within 1 month following the publication.

(260) AM 2022 104485 A
 (800) 1481159
 (151) 2019 07 09
 (891) 2019 07 09
 (731) ZHEJIANG KEMA ENGINE & MACHINERY CO., LTD.
 TANGSHANG VILLAGE, JINQING TOWN,
 LUQIAO DISTRICT, TAIZHOU, ZHEJIANG,
 China

(540)



The logo for KEMAGE features the word "KEMAGE" in a bold, black, sans-serif font. A stylized, curved line element is positioned to the left of the letters, resembling a wing or a swoosh.

(591) Black, white
 (531) 27.05.01
 (511)

7 – Wrapping machines; diesel engines, not for land vehicles; gasoline engines, not for land vehicles; wind-powered electricity generators; hand-held tools, other than hand-operated; dynamos; driving motors, other than for land vehicles; pumps [machines]; compressed air machines; washing apparatus.

(260) AM 2022 113221 A
 (800) 1362756
 (151) 2017 03 27
 (891) 2021 03 18
 (731) "GRAND TOBACCO" LLC
 22, Shahamiryanneri street, 0061 Yerevan,
 Armenia

(540)



(591) Blue, white, red

(531) 10.01.10; 10.01.25; 19.03.03; 19.03.24;
 24.01.15; 25.01.01; 26.11.01; 26.11.08;
 26.11.11; 29.01.14

(511)

34 – Tobacco, smokers' articles, matches; gas containers for lighters; absorbent paper for tobacco pipes, cigarette papers, lighters; tobacco pouches (bags); books of cigarette papers; humidors; match boxes, firestones; cigar cutters; tobacco pipes, pipe racks for tobacco pipes, tips of yellow amber for cigar and cigarette holders; ashtrays; spittoons for tobacco; tobacco holders; pipe cleaners for tobacco pipes, cigarettes; cigarillos; cigars; tobacco jars, match boxes, not from precious metals; chewing tobacco; snuff; tobacco cases; pipes, pocket machines for rolling cigarettes, cigarette filters; cigar cases, cigarette cases for tobacco.

(260) AM 2022 115443 A
 (800) 1625993
 (151) 2021 10 20
 (891) 2021 10 20
 (731) Kalle GmbH
 Rheingastr. 190-196, 65203 Wiesbaden,
 Germany

(540)

NaloRoyal

(591) Black, white
 (511)
 29 – Sausage casings.

(260) AM 2022 115444 A
 (800) 1626001
 (151) 2021 10 13
 (891) 2021 10 13
 (731) BRANDLINE GROUP SPÓŁKA Z
 OGRANICZONĄ ODPOWIEDZIALNOŚCIĄ
 ul. Adama Kręglewskiego 1, PL-61-248
 Poznań, Poland

(540)



The logo for lionelo features a stylized black circle with a white dot inside, resembling an eye or a lion's head. Below this symbol, the word "lionelo" is written in a bold, lowercase, sans-serif font. Underneath "lionelo", the phrase "made by parents" is written in a smaller, lowercase, sans-serif font.

(591) Black, white
 (531) 26.01.01; 26.01.03; 26.01.16; 26.01.24;
 26.13.25; 27.05.08; 27.05.10

(511)
 12 – Balance bicycles [vehicles]; children's bicycles; children's car seats; car safety seats for children; pushchairs; fold-up pushchairs; pushchair covers; baskets for perambulators; pushchair hoods; children's safety belts for use in vehicles; portable babies' seats for vehicles; safety seats for children, for vehicles; vehicle booster seats for children; children's seats for use in vehicles; perambulators incorporating carry cots.

20 – Travel cots; adjustable seat carriers; cots for babies; bassinets; fitted crib rail covers; playpens for babies; babies' chairs; bath seats for babies; babies' bouncing chairs; bed rails.

(260) AM 2022 115445 A

(800) 1626008

(151) 2021 06 08

(891) 2021 06 08

(731) Euro Games Technology Ltd.

4, "Maritsa" Str., "Vranya-Lozen-Triugulnika",
 BG-1151 Sofia, Bulgaria

(540)



(591) Yellow, gold, red, purple and black

(531) 27.05.03; 27.05.09; 27.05.17; 27.07.03;
 29.01.15

(511)

9 – Software; computer gaming software; computer software packages; computer operating system software; computer software, recorded; software drivers; virtual reality software; games software; entertainment software for computer games; computer programs for network management; operating computer software for main frame computers; monitors (computer hardware); computer hardware; apparatus for recording images; monitors (computer programs); computer game programs; computer programs for recorded games; apparatus for recording, transmission or reproduction of sound or images; communications servers [computer hardware]; electronic components for gambling machines; computer application software featuring games and gaming; computer software for the administration of on-line games and gaming; computer hardware for games and gaming; electronic components and software for gambling, gambling machines, gambling games on the Internet and via telecommunication network.

28 – Gaming machines for gambling; chips for gambling; mah-jong; arcade games; gambling machines operating with coins, notes and cards; games; electro-

nic games; parlor games; gaming chips; gaming tables; slot machines [gaming machines]; LCD game machines; slot machines and gaming devices; coin-operated amusement machines; roulette chips; poker chips; chips and dice [gaming equipment]; gaming equipment for casinos; roulette tables; gaming roulette wheels; casino games; gambling machines and amusement machines, automatic and coin-operated; coin-operated amusement machines and/or electronic coin-operated amusement machines with or without the possibility of gain; boxes for coin-operated machines, slot machines and gaming machines; electronic or electrotechnical amusement machines and apparatus, gaming machines, coin-operated entertainment machines; housings for coin-operated machines, gaming equipment, gaming machines, machines for gambling; electropneumatic and electrical gambling machines (slot machines).

41 – Gambling; entertainment services related to gambling; gaming services for entertainment purposes; casino, gaming and gambling services; training in the development of software systems; provision of equipment for gambling halls; providing casino equipment [gambling]; gaming machine entertainment services; providing casino facilities [gambling]; gaming hall services; amusement arcade services; games equipment rental; rental of gaming machines; providing amusement arcade services; rental of gaming machines with images of fruits; editing or recording of sounds and images; sound recording and video entertainment services; hire of sound reproducing apparatus; provision of gaming equipment for casinos; providing of casino facilities; online gambling services; casino, gaming and gambling services; provision of gaming facilities, gaming hall facilities, Internet casinos and online gambling services.

(260) AM 2022 115446 A

(800) 1626009

(151) 2021 06 08

(891) 2021 06 08

(731) Euro Games Technology Ltd.

4, "Maritsa" Str., "Vranya-Lozen-Triugulnika",
 BG-1151 Sofia, Bulgaria

(540)



(591) Yellow, gold, red, brown and black

(531) 27.01.16; 27.05.03; 27.05.10; 27.05.17;
 29.01.15

(511)

9 – Software; computer gaming software; computer software packages; computer operating system soft-

ware; computer software, recorded; software drivers; virtual reality software; games software; entertainment software for computer games; computer programs for network management; operating computer software for main frame computers; monitors (computer hardware); computer hardware; apparatus for recording images; monitors (computer programs); computer game programs; computer programs for recorded games; apparatus for recording, transmission or reproduction of sound or images; communications servers [computer hardware]; electronic components for gambling machines; computer application software featuring games and gaming; computer software for the administration of on-line games and gaming; computer hardware for games and gaming; electronic components and software for gambling, gambling machines, gambling games on the Internet and via telecommunication network.

28 – Gaming machines for gambling; chips for gambling; mah-jong; arcade games; gambling machines operating with coins, notes and cards; games; electronic games; parlor games; gaming chips; gaming tables; slot machines [gaming machines]; LCD game machines; slot machines and gaming devices; coin-operated amusement machines; roulette chips; poker chips; chips and dice [gaming equipment]; gaming equipment for casinos; roulette tables; gaming roulette wheels; casino games; gambling machines and amusement machines, automatic and coin-operated; coin-operated amusement machines and/or electronic coin-operated amusement machines with or without the possibility of gain; boxes for coin-operated machines, slot machines and gaming machines; electronic or electrotechnical amusement machines and apparatus, gaming machines, coin-operated entertainment machines; housings for coin-operated machines, gaming equipment, gaming machines, machines for gambling; electropneumatic and electrical gambling machines (slot machines).

41 – Gambling; entertainment services related to gambling; gaming services for entertainment purposes; casino, gaming and gambling services; training in the development of software systems; provision of equipment for gambling halls; providing casino equipment [gambling]; gaming machine entertainment services; providing casino facilities [gambling]; gaming hall services; amusement arcade services; games equipment rental; rental of gaming machines; providing amusement arcade services; rental of gaming machines with images of fruits; editing or recording of sounds and images; sound recording and video entertainment services; hire of sound reproducing apparatus; provision of gaming equipment for casinos; providing of casino facilities; online gambling services; casino, gaming and gambling services; provision of gaming facilities, gaming hall facilities, Internet casinos and online gambling services.

(260) AM 2022 115461 A
(800) 1626451
(151) 2021 05 12
(891) 2021 05 12
(731) MATRIZE Handels-GmbH
Alter Fischmarkt 11, 20457 Hamburg, Germany
(540)



(591) Black and blue
(531) 27.05.01; 27.05.05; 29.01.12
(511)
8 – Tool belts [holders]; waistcoats for holding hand tools and instruments; cases for hand tools and instruments; belts for hand instruments bags; belts for hand instrument cases; wall mounted holders for hand tools and instruments; covers for hand tools and instruments.

18 – Tool bags, empty; shopping bags; wheeled shopping bags.

(260) AM 2022 115465 A
(800) 1626643
(151) 2021 10 15
(891) 2021 10 15
(731) HI Limited Partnership
1815 The Exchange, Atlanta GA 30339, USA
(540)

HOOTIE'S CHICKEN TENDERS

(591) Black, white
(511)
43 – Restaurant services, namely, the provision of food and drink via online ordering for delivery or pick up.

(260) AM 2022 115466 A
(800) 1626660
(151) 2021 06 14
(891) 2021 06 14
(731) UPGAMING AG
Steinhauserstrasse 74, CH-6300 Zug,
Switzerland
(540)

upgaming

(591) Black, white
(511)
9 – Software; game software; audiovisual and information technology equipment; computers and computer hardware; peripherals adapted for computers; electronically recorded data.

25 – Clothing; footwear; headwear.

28 – Sporting equipment and articles; toys; games.

35 – Advertising, marketing and promotional services; company management assistance; assistance services regarding company administration and management.

38 – Telecommunication services; program dissemination on the Internet; Internet communication services.

41 – Provision of electronic games on the Internet; rental of game machines and equipment; provision of cinema facilities; education, training, entertainment and sporting activities.

42 – Design services; information technology engineering; scientific and technological services; quality control and authentication services.

(260) AM 2022 115467 A

(800) 1626667

(151) 2021 06 01

(891) 2021 06 01

(731) UPGAMING AG

Steinhauserstrasse 74, CH-6300 Zug,
Switzerland

(540)



(591) Blue, green, black and white

(531) 27.01.01; 27.05.22; 29.01.14

(511)

9 – Software; game software; audiovisual and information technology equipment; computers and computer hardware; peripherals adapted for computers; electronically recorded data.

25 – Clothing; footwear; headwear.

28 – Sporting equipment and articles; toys; games.

35 – Advertising, marketing and promotional services; company management assistance; assistance services regarding company administration and management.

38 – Telecommunication services; program dissemination on the Internet; Internet communication services.

41 – Provision of electronic games on the Internet; rental of game machines and equipment; provision of cinema facilities; education, training, entertainment and sporting activities.

42 – Design services; information technology engineering; scientific and technological services; quality control and authentication services.

(260) AM 2022 115468 A

(800) 1626685

(151) 2021 10 22

(891) 2021 10 22

(731) Bora Creations S.L.

11, Calle Velázquez (Pto. de Andratx),
E-07157 Andratx, Balearn, Spain

(540)

HEART CORE

(591) Black, white

(511)

3 – Cosmetics; decorative cosmetics; lipsticks; lip balms [non-medicated]; lip glosses; lip liners; non-medicated lip care preparations; exfoliating scrubs for the face; exfoliating scrubs for cosmetic purposes; exfoliant creams.

(260) AM 2022 115484 A

(800) 1627396

(151) 2021 06 16

(891) 2021 06 16

(731) LALETA LTD

14 Griva, Office 103, Agios Antonios,
CY-1055 Nicosia, Cyprus

(540)



LIGA PRO

(591) Ivory, black

(531) 26.15.25; 27.05.01; 27.05.09; 27.05.10;
29.01.12

(511)

35 – Administration of competitions for advertising purposes; advertisement for others on the internet; advertising and marketing services provided by means of social media; provision of advertising space, time and media; affiliate marketing; advertising services relating to esports events; brand creation services (advertising and promotion); brand strategy services; arranging and conducting of promotional events; compilation of statistics relating to advertising; business marketing services; graphic advertising services; information services relating to advertising; digital advertising services; digital marketing; development of promotional campaigns; development of advertising concepts; development and implementation of marke-

ting strategies for others; marketing services relating to esports events; marketing the goods and services of others; internet marketing; on-line advertising and marketing services; production of advertising material; promoting the sale of goods and services of others through promotional events; promoting the goods and services of others over the internet; promotion of sports competitions and events; promotion of goods and services through sponsorship of international sports events; web site traffic optimization; trade promotional services; search engine optimisation; search engine marketing services; intermediary services relating to the rental of advertising time and space; providing and rental of advertising space on the internet; provision and rental of advertising space, time and media; rental of advertisement space and advertising material; providing advertising space in periodicals, newspapers and magazines; demonstration of goods for promotional purposes; organisation and conducting of product presentations; advertising and marketing consultancy; business advice relating to marketing; consultancy relating to advertising and promotion services; consultancy services relating to advertising, publicity and marketing; providing advice relating to the analysis of consumer buying habits; organisation of promotions using audiovisual media; marketing assistance; administration of loyalty rewards programs; marketing the goods and services of others by distributing coupons; dissemination of advertisements via the internet; provision of space on web-sites for advertising goods and services; provision of computerised advertising services; provision of advertising space on electronic media.

41 – Amusement center services; arranging of entertainment events; organisation of games; advisory services relating to entertainment; arranging of presentations for entertainment purposes; arranging of festivals for entertainment purposes; arranging of entertainment shows; arranging of contests; audio-visual display presentation services for educational purposes; audio-visual display presentation services for entertainment purposes; conducting of cultural events; conducting of entertainment activities; entertainment, education and instruction services; entertainment provided via the internet; entertainment, sporting and cultural activities; entertainment services relating to competitions; interactive entertainment services; information about entertainment and entertainment events provided via online networks and the internet; organizing community sporting and cultural events; organising of shows for entertainment purposes; organising events for entertainment purposes; organising events for cultural purposes; organizing and arranging exhibitions for entertainment purposes; providing information to game players about the ranking of their scores of games through the web sites; providing information in the field of entertainment by means of a global computer network; providing facilities for playing paintball games; providing facilities for enter-

tainment; provision of amusement facilities; providing online entertainment in the nature of game tournaments; providing online entertainment in the nature of fantasy sports leagues; provision of rooms for entertainment; video entertainment services; war game services; computer and video game amusement services; conducting of live esports events; arcade game services; entertainment services relating to esports; on-line gaming services; video game services; arranging and conducting of esports events; organising of esports activities; arranging and conducting athletic competitions; arranging and conducting of sports events; educational services relating to sports; conducting marathons; entertainment services relating to sport; organisation of football competitions; operation of sports facilities; organisation of sporting events; sports club services; organization, arranging and conducting of sports competitions; organising of sporting events, competitions and sporting tournaments; organisation of tournaments; organising gymnastics events; organization of sports competitions; organizing and conducting college athletic events; providing facilities for sports tournaments; providing facilities for sports events; arranging and conducting of sporting events; physical education; provision of information relating to sporting events; provision of information relating to sports persons; sporting education services; recreation and training services; arranging and conducting of games; arranging of competitions for education or entertainment; arranging of seminars relating to entertainment; conducting of competitions on the internet; organisation of competitions and awards for cultural, entertainment and sporting purposes; organisation of e-sports competitions; organisation of quizzes, games and competitions; organisation of sports tournaments; organising of exhibitions for entertainment purposes; providing of casino and gaming facilities; card room services.

(260) AM 2022 115485 A
 (800) 1627444
 (151) 2021 06 18
 (891) 2021 06 18
 (731) Quanzhi (Tianjin) Technology Co., Ltd.
 No.16 Tianzhong Road, Economic
 Development Area, Baodi, 301800
 Tianjin City, China
 (540)

FOHERB

(591) Black, white
 (531) 27.05.01
 (511)
 10 – Massage apparatus; medical apparatus and instruments; dental apparatus and instruments; physiotherapy apparatus; cushions for medical purposes; sanitary masks for medical purposes; face masks being

sanitary masks for protection against viral infection; feeding bottles; contraceptives, non-chemical; surgical implants comprised of artificial materials; orthopedic articles; suture materials.

24 – Household linen; bed covers; quilts; sheets [textile]; pillowcases; pillow towels; bed quilt; mattress covers; quilt covers; hada [traditional ceremonial or offering fabric made of silk]; silk fabrics for printing patterns; loose covers for furniture; curtains of textile or plastic; fitted toilet lid covers of fabric; marabouts [cloth]; flags of textile or plastic; shrouds; textile material; lingerie fabric; non-woven textile fabrics; felt.

30 – Coffee-based beverages; cocoa-based beverages; tea; flowers or leaves for use as tea substitutes; tea-based beverages; natural sweeteners; sweets; honey; propolis; royal jelly; biscuits; pastries; cereal preparations; noodles; cereal-based snack food; starch for food; ice cream; cooking salt; vinegar; condiments; yeast; food flavourings, other than essential oils; preparations for stiffening whipped cream; meat tenderizers for household purposes; gluten prepared as food-stuff.

35 – Advertising; commercial administration of the licensing of the goods and services of others; marketing; personnel management consultancy; administrative services for the relocation of businesses; systemization of information into computer databases; accounting; rental of vending machines; sponsorship search; rental of sales stands; retail or wholesale services for pharmaceutical, veterinary and sanitary preparations and medical supplies.

(260) AM 2022 115486 A
(800) 1627480
(151) 2021 07 13
(891) 2021 07 13
(731) GUANGDONG OPPO MOBILE
TELECOMMUNICATIONS CORP., LTD.
No. 18 Haibin Road, Wusha, Chang'an,
Dongguan, Guangdong, China
(540)

Find N

(591) Black, white
(511)
9 – Materials for electricity mains [wires, cables]; selfie sticks for use with smartphones; cell phones; USB cables; converters for electric plugs; batteries, electric; facial recognition apparatus; chronographs [time recording apparatus]; facsimile machines; body fat scales for household use; smartphones; protective films adapted for smartphones; cameras [photography]; neon signs; measures; selfie sticks [hand-held monopods]; intercommunication apparatus; touch screens; portable power supplies (rechargeable batteries); biometric scanners; electronic chips; eyeglasses; covers for smartphones; smartphone software applica-

tions, downloadable; smartwatches; computer programs, recorded; computer programs, downloadable; tablet computers.

(260) AM 2022 115487 A
(800) 1627489
(151) 2021 09 03
(891) 2021 09 03
(731) AdVita Lifescience GmbH
Alte Bundesstraße 20, 79194 Gundelfingen,
Germany
(540)

Advirin

(591) Black, white
(511)
42 – Research and development of new products for others in the field of respiratory diseases; research and development services in the field of respiratory diseases.
44 – Medical services, namely, conducting medical tests for diagnosis and treatment in the field of respiratory diseases.

(260) AM 2022 115488 A
(800) 1627522
(151) 2021 07 27
(891) 2021 07 27
(731) Henkel AG & Co. KgaA
Henkelstrasse 67, 40589 Düsseldorf, Germany
(540)



(591) Blue, black, grey and white
(531) 14.05.02; 14.05.15; 24.13.01; 27.05.01;
27.05.08; 27.05.09; 27.05.10; 27.05.24;
29.01.14

(511)
1 – Chemicals used in industry, and construction industry; unprocessed artificial resins, unprocessed plastics; adhesives used in industry.

2 – Paints, varnishes, lacquers; preservatives against rust and against deterioration of wood; colorants; mordants; raw natural resins; metals in foil and powder form for painters, decorators, printers and artists.

17 – Rubber, gutta-percha, gum, asbestos, mica and goods made from these materials and included in this class; plastics in extruded form for use in manufacture; packing, stopping and insulating materials; flexible pipes, not of metal; isolating plaster.

19 – Non-metallic building material; asphalt, pitch and bitumen; non-metallic transportable buildings, plaster, cement plaster (fire proof).

(260) AM 2022 115489 A
(800) 1627527
(151) 2021 10 01
(891) 2021 10 01
(731) National Pork Board
1776 N.W. 114th Street, Clive IA 50325, USA
(540)



(591) The color(s) red, white and blue is/are claimed as a feature of the mark.
(531) 03.04.18; 03.04.24; 24.07.01; 29.01.13
(526) U.S. PORK".
(511)
35 – Promoting public interest and awareness of pork products and the pork industry.

(260) AM 2022 115490 A
(800) 1627529
(151) 2021 09 24
(891) 2021 09 24
(731) RESPECTA Maschinenbau GmbH
Tönisheiderstr. 12-16, 42489 Wülfrath,
Germany
(540)

RESPECTA

(591) Black, white
(511)
7 – Machines, mechanical equipment and tools for processing, metering and mixing plastics, liquid and solid mixtures of mortar, concrete, polymer concrete and other reactive compounds; all aforesaid goods, included in this class.
37 – Repair, maintenance and servicing of machines, mechanical equipment and tools for processing, metering and mixing plastics, liquid and solid mixtures of mortar, concrete, polymer concrete and other reactive compounds.
42 – Technical consultancy in the field of machines, mechanical equipment and tools for processing, metering and mixing plastics, liquid and solid mixtures of mortar, concrete, polymer concrete and other reactive compounds, and relating to the repair, maintenance and servicing thereof; planning and construction of machines, mechanical equipment and tools for proces-

sing, metering and mixing plastics, liquid and solid mixtures of mortar, concrete, polymer concrete and other reactive compounds.

(260) AM 2022 115491 A
(800) 1627537
(151) 2021 10 07
(891) 2021 10 07
(731) ELDAN COSMETICS ITALIA S.R.L. S.U.S.
Via Strada Sora 47, I-27100 PAVIA, Italy
(540)



(591) Blue and grey
(531) 26.11.03; 26.11.05; 26.11.06; 26.11.13;
27.05.01; 27.05.09; 27.05.10; 29.01.12
(511)
3 – Cosmetics; cosmetics and cosmetic preparations; moisturising preparations; tonics [cosmetic]; moisturising concentrates [cosmetic]; skin cleansers [cosmetic]; make-up foundations; lip protectors [cosmetic]; powder compacts [cosmetics]; fluid creams [cosmetics]; tanning milks [cosmetics]; cosmetic facial lotions; toning creams [cosmetic]; cosmetics in the form of powders; facial toners [cosmetic]; skin masks [cosmetics]; moisturising gels [cosmetic]; face packs; concealers; exfoliating scrubs for cosmetic purposes; facial moisturisers [cosmetic]; cosmetics in the form of gels; cosmetics in the form of lotions; beauty care cosmetics; facial masks; facial peel preparations for cosmetic use; cosmetics in the form of creams; moisturising skin lotions [cosmetic]; cosmetics for use in the treatment of wrinkled skin; cosmetics for use on the skin; skincare cosmetics.

(260) AM 2022 115492 A
(800) 1627555
(151) 2021 08 31
(891) 2021 08 31
(731) ZHUHAI LTWOO CONTROLLER
TECHNOLOGY CO., LTD.
Building B-2, No. 8, Honghui Road 5,
Shuanglin Area, Liangang Industrial Zone,
Jinwan District, Zhuhai City, Guangdong
Province, China
(540)



(591) Black, white
(531) 27.05.17
(511)
12 – Bicycle derailleur; bicycle transmission; bicycle brakes; bicycle shift control device; bicycle chains; gears for cycles; bicycle gear transmission device; bi-

cycle internal transmission; brake levers for bicycles; bicycle transmission device.

(260) AM 2022 115494 A

(800) 1098654

(151) 2011 09 23

(891) 2021 10 01

(731) LABORATORIOS BABE, S.L.

Conde Alessandro Volta, 7, Parque Tecnológico, E-46980 Paterna (Valencia), Spain

(540)

BABE

(591) Black, white

(531) 27.05.01

(511)

3 – Perfumery, toilet water, shaving preparations, lotions for before and after shaving, colognes; essential oils, cosmetics, make-up, dentifrices; products for sun-block and sun-tanning preparations, deodorants for personal use (perfumery); tissues impregnated with cosmetic lotions; masks; preparations for the care of the scalp and hair; hair shampoos and conditioners; hair dyes; hair lotions; hairstyling products; creams and lotions for the skin; non-medicated toiletries; cosmetic preparations for bath and shower, cosmetic preparations for skin care; lip care preparations.

(260) AM 2022 115495 A

(800) 1191078

(151) 2013 12 06

(891) 2021 10 20

(731) "Selectel", Co. Ltd.

Tsvetochnaya ul. 21, liter A, RU-196084 Saint-Petersburg, Russian Federation

(540)

Selectel

(591) White, red and black

(531) 27.05.01; 29.01.12

(511)

35 – Arranging subscriptions to telecommunication services for others; commercial information agencies; advertising agencies; cost price analysis; rental of advertising space; business auditing; computerized file management; invoicing; demonstration of goods; transcription; opinion polling; marketing studies; business information; commercial information and advice for consumers [consumer advice shop]; business investigations; marketing research; business management and organization consultancy; business organization consultancy; business management consultancy; layout services for advertising purposes; news

clipping services; updating of advertising material; word processing; secretarial services; organization of exhibitions for commercial or advertising purposes; organization of trade fairs for commercial or advertising purposes; shop window dressing; business appraisals; payroll preparation; business management assistance; commercial or industrial management assistance; presentation of goods on communication media, for retail purposes; economic forecasting; sales promotion for others; office machines and equipment rental; rental of advertising time on communication media; publicity material rental; publication of publicity texts; radio advertising; bill-posting; distribution of samples; dissemination of advertising matter; writing of publicity texts; advertising; on-line advertising on a computer network; advertising by mail order; television advertising; document reproduction; compilation of statistics; compilation of information into computer databases; business inquiries; systemization of information into computer databases; drawing up of statements of accounts; publicity columns preparation; commercial administration of the licensing of the goods and services of others; administrative processing of purchase orders; public relations; price comparison services; procurement services for others [purchasing goods and services for other businesses]; outsourcing services [business assistance]; telephone answering for unavailable subscribers; business efficiency expert services.

38 – News agencies; television broadcasting; cable television broadcasting; electronic bulletin board services [telecommunications services]; information about telecommunication; telecommunications routing and junction services; providing internet chatrooms; providing user access to global computer networks; providing access to databases; providing telecommunications connections to a global computer network; providing telecommunication channels for teleshopping services; message sending; computer aided transmission of messages and images; sending of telegrams; transmission of telegrams; electronic mail; rental of message sending apparatus; rental of access time to global computer networks; rental of telecommunication equipment; radio broadcasting; communications by fiber [fibre] optic networks; cellular telephone communication; communications by computer terminals; satellite transmission; communications by telephone; facsimile transmission; paging services [radio, telephone or other means of electronic communication]; teleconferencing services; telex services; voice mail services; telegraph services; telephone services.

42 – Computer system analysis; recovery of computer data; computer virus protection services; technical project studies; engineering; installation of computer software; research in the field of environmental protection; technical research; calibration [measuring]; consultancy in the design and development of com-

puter hardware; computer software consultancy; architectural consultation; quality control; vehicle roadworthiness testing; updating of computer software; maintenance of computer software; conversion of data or documents from physical to electronic media; providing search engines for the internet; data conversion of computer programs and data [not physical conversion]; computer system design; rental of web servers; computer rental; rental of computer software; hosting computer sites [web sites]; duplication of computer programs; construction drafting; computer software design; creating and maintaining web sites for others; computer programming; surveying; consultancy in the field of computer system integration.

(260) AM 2022 115496 A

(800) 1403682

(151) 2018 03 21

(891) 2021 11 03

(731) BERKO İLAÇ VE KİMYA SANAYİ A.Ş.

Yenisehir Mah. Ozgur, Sok. No:16-18,
Atasehir, Istanbul, Turkey

(540)

Berko Dermiton

(591) Black, white

(511)

5 – Dietary supplements for pharmaceutical and veterinary purposes; cosmetics containing medicine; dietary supplements; nutritional supplements; medical preparations for slimming purposes; food for babies; herbs and herbal beverages adapted for medicinal purposes; dental preparations and articles; teeth filling material, dental impression material, dental adhesives and material for repairing teeth; sanitary preparations for medical use; hygienic pads; hygienic tampons; plasters; materials for dressings; diapers, including those made of paper and textiles; disinfectants; antiseptics; detergents for medical purposes; disinfectant soap; medicated soap; antibacterial soap; pharmaceutical and veterinary preparations for medical purposes; chemical preparations for medical and veterinary purposes, chemical reagents for pharmaceutical and veterinary purposes; deodorants, other than for human beings or for animals; air deodorizing preparations and preparations for remedy of bad smells; preparations for destroying vermin; fungicides, herbicides; preparations for destroying rodents; lotions for pharmaceutical purposes; lotions for veterinary purposes.

(260) AM 2022 115497 A

(800) 1449482

(151) 2018 10 12

(891) 2021 10 20

(731) "Selectel", Co. Ltd.

Tsvetochnaya ul. 21, liter A, RU-196084
Saint-Petersburg, Russian Federation

(540)

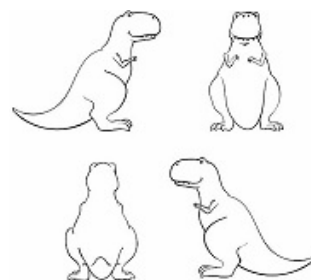

(591) Black, white

(531) 03.15

(511)

9 – 3D spectacles; antennas; aerials; holograms; floppy disks; sound recording discs; phonograph records; disks, magnetic; optical discs; electronic notice boards; interfaces for computers; coaxial cables; fiber optic cables; cables, electric; calculating machines; pocket calculators; identity cards, magnetic; video game cartridges; memory cards for video game machines; encoded magnetic cards; electronic book readers; electronic agendas; mouse pads; compact discs [audio-video]; compact discs [read-only memory]; computers; laptop computers; tablet computers; notebook computers; decorative magnets; monitors [computer hardware]; monitors [computer programs]; headphones; magnetic data media; optical data media; electronic sheet music, downloadable; computer software, recorded; computer hardware; sunglasses; goggles for sports; radio pagers; computer software applications, downloadable; computer programs, recorded; computer game software; computer programs [downloadable software]; computer operating programs, recorded; electronic publications, downloadable; smart cards [integrated circuit cards]; smartglasses; smartphones; smartwatches; bags adapted for laptops; downloadable ring tones for mobile phones; downloadable image files; downloadable music files; animated cartoons; USB flash drives; covers for tablet computers; covers for smartphones; cell phone straps.

16 – Fountain pens; albums; scrapbooks; almanacs; posters; banners of paper; tickets; forms, printed; announcement cards [stationery]; note books; pads [stationery]; drawing pads; loose-leaf binders; pamphlets; booklets; wrapping paper; packing paper; paper; newsletters; signboards of paper or cardboard; bunting of paper; newspapers; magazines [periodicals]; book-markers; periodicals; printed publications; graphic representations; calendars; pencils; pencil lead holders; pictures; transfers [decalcomanias]; catalogues; books; comic books; envelopes [stationery]; boxes of paper or cardboard; printed coupons; flyers; bags [envelopes, pouches] of paper or plastics, for packaging; stickers [stationery]; passport holders; musical greeting cards; greeting cards; postcards; conical paper bags; folders for papers; jackets for papers; desk mats; writing cases [sets]; office requisites, except furniture; writing materials; writing instruments; printed matter; prospectuses; writing or drawing books; bottle wrap-

pers of paper or cardboard; manuals [handbooks]; figurines [statuettes] of papier mâché; flags of paper; stencils; stamps [seals]; shields [paper seals]; labels of paper or cardboard.

28 – Board games; building games; playing cards; dolls, including life-size; play balloons.

38 – Wireless broadcasting; electronic bulletin board services [telecommunications services]; information about telecommunication; providing user access to global computer networks; providing access to databases; providing internet chatrooms; providing telecommunications connections to a global computer network; message sending; computer aided transmission of messages and images; transmission of digital files; providing online forums; rental of access time to global computer networks; rental of telecommunication equipment; communications by fiber optic networks; communications by computer terminals; telecommunications routing and junction services; streaming of data.

41 – Academies [education]; publication of books; layout services, other than for advertising purposes; game services provided on-line from a computer network; providing on-line electronic publications, not downloadable; practical training [demonstration]; providing recreation facilities; arranging and conducting of internships; arranging and conducting of conferences; arranging and conducting of workshops [training]; arranging and conducting of seminars; organization of competitions [education or entertainment]; organization of lotteries; vocational guidance [education or training advice]; providing on-line videos, not downloadable; providing on-line music, not downloadable; educational examination; electronic desktop publishing; on-line publication of electronic books and journals; publication of texts, other than publicity texts; entertainment services; tutoring.

42 – Computer system analysis; recovery of computer data; computer virus protection services; installation of computer software; computer security consultancy; information technology [IT] consultancy; consultancy in the design and development of computer hardware; internet security consultancy; computer software consultancy; data security consultancy; technological consultancy; updating of computer software; monitoring of computer systems to detect breakdowns; monitoring of computer systems for detecting unauthorized access or data breach; monitoring of computer systems by remote access; software as a service [SaaS]; maintenance of computer software; providing information on computer technology and programming via a website; providing search engines for the internet; conversion of computer programs and data, other than physical conversion; computer system design; rental of web servers; computer rental; rental of computer software; hosting computer sites [web sites]; server hosting; computer software design; creating and main-

taining web sites for others; computer programming; technical writing; duplication of computer programs; cloud computing; outsource service providers in the field of information technology; off-site data backup; computer technology consultancy; telecommunications technology consultancy; data encryption services; electronic data storage.

(260) AM 2022 115498 A

(800) 1449517

(151) 2018 10 12

(891) 2021 10 20

(731) "Selectel", Co. Ltd.

Tsvetochnaya ul. 21, liter A, RU-196084

Saint-Petersburg, Russian Federation

(540)

T-Rex

(591) Black, white

(511)

16 – Fountain pens; albums; scrapbooks; almanacs; posters; banners of paper; tickets; forms, printed; announcement cards [stationery]; note books; pads [stationery]; drawing pads; loose-leaf binders; pamphlets; booklets; wrapping paper; packing paper; paper; newsletters; signboards of paper or cardboard; bunting of paper; newspapers; magazines [periodicals]; book-markers; periodicals; printed publications; graphic representations; calendars; pencils; pencil lead holders; pictures; transfers [decalcomanias]; catalogues; books; comic books; envelopes [stationery]; boxes of paper or cardboard; printed coupons; flyers; bags [envelopes, pouches] of paper or plastics, for packaging; stickers [stationery]; passport holders; musical greeting cards; greeting cards; postcards; conical paper bags; folders for papers; jackets for papers; desk mats; writing cases [sets]; office requisites, except furniture; writing materials; writing instruments; printed matter; prospectuses; writing or drawing books; bottle wrappers of paper or cardboard; manuals [handbooks]; figurines [statuettes] of papier mâché; flags of paper; stencils; stamps [seals]; shields [paper seals]; labels of paper or cardboard.

38 – Wireless broadcasting; electronic bulletin board services [telecommunications services]; information about telecommunication; providing user access to global computer networks; providing access to databases; providing internet chatrooms; providing telecommunications connections to a global computer network; message sending; computer aided transmission of messages and images; transmission of digital files; providing online forums; rental of access time to global computer networks; rental of telecommunication equipment; communications by fiber optic networks; communications by computer terminals; telecommunications routing and junction services; streaming of data.

42 – Computer system analysis; recovery of computer data; computer virus protection services; installation of computer software; computer security consultancy; information technology [IT] consultancy; consultancy in the design and development of computer hardware; internet security consultancy; computer software consultancy; data security consultancy; technological consultancy; updating of computer software; monitoring of computer systems to detect breakdowns; monitoring of computer systems for detecting unauthorized access or data breach; monitoring of computer systems by remote access; software as a service [Saas]; maintenance of computer software; providing information on computer technology and programming via a website; providing search engines for the internet; conversion of computer programs and data, other than physical conversion; computer system design; rental of web servers; computer rental; rental of computer software; hosting computer sites [web sites]; server hosting; computer software design; creating and maintaining web sites for others; computer programming; technical writing; duplication of computer programs; cloud computing; outsource service providers in the field of information technology; off-site data backup; computer technology consultancy; telecommunications technology consultancy; data encryption services; electronic data storage.

(260) AM 2022 115613 A

(800) 1628997

(151) 2021 07 26

(891) 2021 07 26

(731) WORLD MEDICINE İLAÇ, SAN. VE TİC.

A.Ş.

15 Temmuz Mah. Cami Yolu Cad.; No:50

Bağcılar; İstanbul, Turkey

(540)

FILBET-ФИЛБЕТ

(591) Black, white

(531) 28.05

(511)

5 – Pharmaceutical and veterinary preparations for medical purposes, chemical preparations for medical purposes, dietary supplements, including those adapted for medical purposes, dietary supplements for slimming purposes, food for babies, herbs and herbal beverages adapted for medicinal purposes, dental preparations and articles, sanitary preparations for medical use, hygienic pads, hygienic tampons, plasters, materials for dressings, diapers, including those made of paper and textiles, preparations for destroying vermin, fungicides, herbicides, deodorants, other than for human beings or for animals, air deodorising preparations, disinfectants, antiseptics, detergents for medical purposes.

(260) AM 2022 115614 A

(800) 1629108

(151) 2021 09 08

(891) 2021 09 08

(731) Gaz & Jo Intellectual Property Holdings

Limited

Suite 4, Queripel House, 1 Duke of York

Square, London SW3 4LY, United Kingdom

(540)

JO'S LAUNDRY

(591) Black, white

(511)

3 – Soaps; perfumery, essential oils, cosmetics, hair lotions; dentifrices, cleaning, polishing, scouring and abrasive preparations; aftershave; after shave balms, lotions and gels; air fragrancing preparations; anti-perspirants; antistatic preparations for household purposes; antistatic dryer sheets; aromatherapy oils, lotions, creams and gels; bath and shower preparations, oils, lotions, creams, foams and gels; beauty creams, gels, lotions, serums, masks and foams; bleaching preparations for household use; bleaching preparations for laundry; face and body creams, lotions, gels, serums, masks and foams; body scrubs; fragrancing preparations; shampoos and conditioners for the hair; degreasing preparations for household purposes; detergents; dishwashing preparations; fabric softeners and conditioners; floor cleaning preparations; hair care preparations; fragrances for the hair; hair care creams, lotions, gels, liquids; hair pomades; household fragrances; impregnated cloths and wipes; laundry preparations; polishes; pot pourri; reed diffusers and refills for reed diffusers; scented fabric refresher sprays; sachets for perfuming linen; scented room sprays; skin care preparations.

(260) AM 2022 115615 A

(800) 1629118

(151) 2021 09 27

(891) 2021 09 27

(731) REHAU Industries SE & Co. KG

Rheniumhaus, Otto-Hahn-Str. 2, 95111

Rehau, Germany

(540)

OLIVIA-Design

(591) Black, white

(511)

6 – Lock bolts; latches (metal-) being fittings for doors; latches (metal-) being fittings for windows; handles of metal for windows; grab rails of metal; metal sash lifts; metal handles; window furniture of metal; catches (window-) of metal; metal window jambs; window rails of metal; window surrounds of metal; fittings of metal for windows; windows of metal.

20 – Door, gate and window fittings, non-metallic; latches, not of metal; mechanisms (non-metallic, non-

electric-) for locking windows; non-metallic grab rails; window fasteners (non-metallic-); plastic window handles; porcelain window handles; window stops of plastic; window handles (non-metallic-); window fittings, not of metal.

(260) AM 2022 115617 A
 (800) 1629165
 (151) 2021 06 15
 (891) 2021 06 15
 (731) Faber-Castell Aktiengesellschaft
 Nürnberger Str. 2, 90546 Stein, Germany
 (540)

Faber-Castell

(591) Black, white
 (511)

3 – Non-medical cosmetics and preparations for body and beauty care; non-medical cosmetic preparations and substances for the care of and for use on the skin, body, face, eyes, hair, teeth and nails; decorative cosmetics; conditioning cosmetics; make-up; eyelash cosmetics; eyebrow cosmetics; eyeliners; cosmetic pencils; lipsticks; lip balms; lip liners; eye contour pencils; eye shadows; eyebrow pencils; make-up pencils; body paints for cosmetic purposes; cosmetic powders; make-up foundations; face powders; make-up powders; liquid make-up foundations; color cosmetics; cosmetic pencils, especially sharpened products of wood and plastic, mechanical cosmetic pencils, capillary systems; eyeliner pencils; liquid eyeliners; eye pencils; retractable pencils for eyes; pencils for liquid eyeliners; liquid concealer; eye make-up; liquid eye shadow; nail care preparations; nail polishing pens; mascara; eyelash care preparations; nourishing creams, not for medical purposes; perfumes; perfumery; fragrance preparations; fragrances.

21 – Applicators and applicators with capillary systems for cosmetics; adjusted cosmetic containers for non-medical cosmetics and preparations for body and beauty care and non-medical cosmetic preparations and substances for the care of and for use on the skin, body, face, eyes, hair, teeth and nails and decorative cosmetics and conditioning cosmetics and make-up and eyelash cosmetics and eyebrow cosmetics and eyeliners and cosmetic pencils and lipsticks and lip balms and lip liners and eye contour pencils and eye shadows and eyebrow pencils and make-up pencils and body paints for cosmetic purposes and cosmetic powders; and make-up foundations and face powders and make-up powders and liquid make-up foundations and color cosmetics and cosmetic pencils, especially sharpened products of wood and plastic, mechanical cosmetic pencils, capillary systems and eyeliner pencils and liquid eyeliners and eye pencils and retractable pencils for eyes and pencils for liquid eyeliners and liquid concealer and eye make-up and liquid eye shadow and nail care preparations and nail polishing

pens and mascara and eyelash care preparations and nourishing creams, not for medical purposes and perfumes and perfumery and fragrance preparations and fragrances.

(260) AM 2022 115618 A
 (800) 1629239
 (151) 2021 09 28
 (891) 2021 09 28
 (731) Siemens Healthcare GmbH
 Henkestraße 127, 91052 Erlangen, Germany
 (540)

myExam Autopilot

(591) Black, white
 (511)

9 – Computer software for medical imaging apparatus; software being a component of medical imaging apparatus; computer software integrated with medical imaging apparatus.

10 – Medical imaging apparatus and parts thereof, medical imaging apparatus and parts thereof, in particular medical X-ray apparatus, computed tomography scanner, magnetic resonance scanners, medical ultrasound apparatus, medical apparatus for proton imaging, nuclear medicine diagnostic apparatus, apparatus for use in angiography, 3D cameras and patient tables for use with apparatus and medical imaging apparatus.

42 – Software as a service (SaaS) for use in connection with apparatus for medical imaging.

(260) AM 2022 115719 A
 (800) 1631569
 (151) 2021 09 16
 (891) 2021 09 16
 (731) Limited Liability Company
 "PRODKONTRAKTINVEST"
 Sovkhoznaya st., vld. 52a, Belaya Kalitva,
 RU-347041 Rostov region, Russian Federation
 (540)

**ВЕРНЫЕ
ДРУЗЬЯ**

(591) Black, white
 (531) 28.05
 (511)
 31 – Animal foodstuffs.

35 – Advertising; business management services.

(260) AM 2022 115720 A

(800) 1631690

(151) 2021 08 12

(891) 2021 08 12

(731) ECZACIBAŞI TÜKETİM ÜRÜNLERİ
SANAYİ VE TİCARET ANONİM ŞİRKETİ
Kavacık Ofis Rüzgarlı Bahçe Mah., Kavak Sk.
No. 20 Beykoz, İstanbul, Turkey

(540)



(591) Blue, yellow, pink and green

(531) 05.03.13; 05.03.14; 27.05.01; 27.05.07;
27.05.10; 27.05.17; 27.05.19; 29.01.14

(511)

3 – Bleaching and cleaning preparations, detergents other than for use in manufacturing operations and for medical purposes, laundry bleach, fabric softeners for laundry use, stain removers, dishwasher detergents; cleaning, polishing, scouring and abrasive preparations; perfumery; non-medicated cosmetics; fragrances; deodorants for personal use and animals; essential oils, cosmetics, hair lotions; soaps; dental care preparations; dentifrices, denture polishes, tooth whitening preparations, mouth washes, not for medical purposes; abrasive preparations; emery cloth; sandpaper; pumice stone; abrasive pastes; polishing preparations for leather, vinyl, metal and wood, polishes and creams for leather, vinyl, metal and wood, wax for polishing; wet wipes, tissue papers moisturized with cosmetics; cotton buds; tissues impregnated with cosmetic lotions; pre-moistened and impregnated cleansing pads, tissues and wipes, namely, impregnated cleaning pads impregnated with cosmetics, pre-moistened cosmetic tissues impregnated with make-up removing preparations, and pre-moistened cosmetic wipes; cosmetic pads impregnated with make-up removing preparations; cloths impregnated with cleaning preparations; baby wipes; face wipes; baby wipes for cosmetic purposes; baby wipes for cosmetic use; face cleaning wipes; pre-impregnated cleansing wipes; pre-moistened cleansing wipes; pre-moistened cosmetic wipes; wipes impregnated with a skin cleanser; wipes impregnated with cleaning preparations; wipes impregnated with cosmetic preparations; wipes impregnated with skincare preparations; baby wipes impregnated with cleaning preparations; disposable baby wipes impregnated with cosmetic preparations; wipes impregnated with personal cleansing preparations; disposable wipes impregnated with eau de Cologne; disposable baby wipes impregnated with personal cleansing preparations; pre-moistened or impregnated cleaning pads, tissues or wipes; pre-moistened wipes with clea-

ning preparations for household purposes; wipes impregnated with anti-perspirant preparations for personal use; wipes impregnated with make-up removing preparations; wipes impregnated with deodorant preparations for personal use; disposable wipes impregnated with cleansing chemicals or compounds for personal hygiene; disposable wipes impregnated with cleansing compounds for use on the face.

(260) AM 2022 115721 A

(800) 1631700

(151) 2021 10 28

(891) 2021 10 28

(731) Apple Inc.

One Apple Park Way, Cupertino CA 95014,
USA

(540)

APPLE AIRTAG

(591) Black, white

(511)

9 – Radio transmitters and receivers; wireless communication devices for the transmission of data and audio; downloadable computer software for locating, monitoring, and tracking the position of objects and other electronic devices; peripheral devices for computers, mobile telephones, and mobile electronic devices, namely, electronic tags used for locating, monitoring, and tracking the position of objects and other electronic devices; wearable computer peripherals used for locating, monitoring, and tracking the position of objects and other electronic devices; electronic tags for goods; lanyards for mobile digital electronic devices and wearable electronic devices; carrying cases for wearable computer peripherals used for locating, monitoring, and tracking the position of objects and other electronic devices; carrying cases for electronic tags for goods.

(260) AM 2022 115722 A

(800) 1631743

(151) 2021 09 30

(891) 2021 09 30

(731) REAL MADRID CLUB DE FUTBOL

Avenida de las Fuerzas Armadas n° 402,
E-28055 Madrid, Spain

(540)



Realmadrid

(591) Black, white

(531) 24.01.03; 24.01.15; 24.01.18; 24.01.25;
24.09.01; 24.09.13

(511)

28 – Games, toys; playing cards; gymnastic and sporting articles not included in other classes; decorations for Christmas trees.

(260) AM 2022 115723 A

(800) 1631802

(151) 2021 08 17

(891) 2021 08 17

(731) Rillius Holding Limited

28 Oktovriou, 365 Vashiotis Seafont Building,
6th floor, Flat/Office 602 Neapoli CY-3107

Limassol, Cyprus

(540)



(591) Black, white

(531) 26.04.09; 26.04.24

(511)

35 – Web indexing for commercial or advertising purposes; business management of performing artists; business management of sports people; organization of exhibitions for commercial or advertising purposes; business intermediary services relating to the matching of potential private investors with entrepreneurs needing funding; business efficiency expert services; outsourcing services [business assistance]; sponsorship search; advertising / publicity; pay per click advertising; online advertising on a computer network; dissemination of advertising matter; systemization of information into computer databases; sales promotion for others; promotion of goods and services through sponsorship of sports events; negotiation and conclusion of commercial transactions for third parties; professional business consultancy.

41 – Academies [education]; arranging and conducting of conferences; arranging and conducting of in-person educational forums; arranging and conducting of seminars; electronic desktop publishing; providing user reviews for entertainment or cultural purposes; providing information in the field of education; providing information in the field of entertainment; providing information relating to recreational activities; providing online videos, not downloadable; providing online electronic publications, not downloadable; providing television programmes, not downloadable, via video-on-demand services / providing television

programs, not downloadable, via video-on-demand services; providing films, not downloadable, via video-on-demand services; providing user rankings for entertainment or cultural purposes / providing user ratings for entertainment or cultural purposes; providing sports facilities; providing casino facilities [gambling]; booking of seats for shows; game services provided online from a computer network; organization of shows [impresario services]; organization of exhibitions for cultural or educational purposes; organization of lotteries; organization of sports competitions; providing amusement arcade services; club services [entertainment or education]; health club services [health and fitness training]; nightclub services [entertainment]; amusement park services; sport camp services; gambling services; conducting fitness classes; online publication of electronic books and journals; publication of books; publication of texts, other than publicity texts; entertainment services; production of shows; physical education.

(260) AM 2022 115724 A

(800) 1631803

(151) 2021 08 17

(891) 2021 08 17

(731) Rillius Holding Limited

28 Oktovriou, 365 Vashiotis Seafont Building,
6th floor, Flat/Office 602 Neapoli CY-3107

Limassol, Cyprus

(540)



(591) Black, white

(531) 26.04.09; 26.04.24; 27.05.01; 27.05.17

(511)

35 – Web indexing for commercial or advertising purposes; business management of performing artists; business management of sports people; organization of exhibitions for commercial or advertising purposes; business intermediary services relating to the matching of potential private investors with entrepreneurs needing funding; business efficiency expert services; outsourcing services [business assistance]; sponsorship search; advertising / publicity; pay per click advertising; online advertising on a computer network; dissemination of advertising matter; systemization of information into computer databases; sales promotion for others; promotion of goods and services through sponsorship of sports events; negotiation and conclusion of commercial transactions for third parties; professional business consultancy.

41 – Academies [education]; arranging and conducting of conferences; arranging and conducting of in-person educational forums; arranging and conducting of seminars; electronic desktop publishing; providing user reviews for entertainment or cultural purposes; providing information in the field of education; providing information in the field of entertainment; providing information relating to recreational activities; providing online videos, not downloadable; providing online electronic publications, not downloadable; providing television programmes, not downloadable, via video-on-demand services / providing television programs, not downloadable, via video-on-demand services; providing films, not downloadable, via video-on-demand services; providing user rankings for entertainment or cultural purposes / providing user ratings for entertainment or cultural purposes; providing sports facilities; providing casino facilities [gambling]; booking of seats for shows; game services provided online from a computer network; organization of shows [impresario services]; organization of exhibitions for cultural or educational purposes; organization of lotteries; organization of sports competitions; providing amusement arcade services; club services [entertainment or education]; health club services [health and fitness training]; nightclub services [entertainment]; amusement park services; sport camp services; gambling services; conducting fitness classes; online publication of electronic books and journals; publication of books; publication of texts, other than publicity texts; entertainment services; production of shows; physical education.

(260) AM 2022 115725 A

(800) 1631804

(151) 2021 08 17

(891) 2021 08 17

(731) Rillius Holding Limited

28 Oktovriou, 365 Vashiotis Seafront Building,
6th floor, Flat/Office 602 Neapoli CY-3107
Limassol, Cyprus

(540)



(591) Yellow and black

(531) 25.05.03; 26.04.05; 26.04.24; 29.01.12

(511)

35 – Web indexing for commercial or advertising purposes; business management of performing artists; business management of sports people; organization of exhibitions for commercial or advertising purposes;

business intermediary services relating to the matching of potential private investors with entrepreneurs needing funding; business efficiency expert services; outsourcing services [business assistance]; sponsorship search; advertising / publicity; pay per click advertising; online advertising on a computer network; dissemination of advertising matter; systemization of information into computer databases; sales promotion for others; promotion of goods and services through sponsorship of sports events; negotiation and conclusion of commercial transactions for third parties; professional business consultancy.

41 – Academies [education]; arranging and conducting of conferences; arranging and conducting of in-person educational forums; arranging and conducting of seminars; electronic desktop publishing; providing user reviews for entertainment or cultural purposes; providing information in the field of education; providing information in the field of entertainment; providing information relating to recreational activities; providing online videos, not downloadable; providing online electronic publications, not downloadable; providing television programmes, not downloadable, via video-on-demand services / providing television programs, not downloadable, via video-on-demand services; providing films, not downloadable, via video-on-demand services; providing user rankings for entertainment or cultural purposes / providing user ratings for entertainment or cultural purposes; providing sports facilities; providing casino facilities [gambling]; booking of seats for shows; game services provided online from a computer network; organization of shows [impresario services]; organization of exhibitions for cultural or educational purposes; organization of lotteries; organization of sports competitions; providing amusement arcade services; club services [entertainment or education]; health club services [health and fitness training]; nightclub services [entertainment]; amusement park services; sport camp services; gambling services; conducting fitness classes; online publication of electronic books and journals; publication of books; publication of texts, other than publicity texts; entertainment services; production of shows; physical education.

(260) AM 2022 115726 A

(800) 1631819

(151) 2021 10 30

(891) 2021 10 30

(731) De Vlaamse Waterweg NV

Havenstraat 44, B-3500 Hasselt, Belgium

(540)

eRIBa

(591) Black, white

(511)

9 – Computer software; software suites; computer software platforms; application software; interactive

computer software; data communications software; computer software, recorded; data management software; interactive software; logistics software; computer software; computer programmes for data processing; computer software; traffic management software; unified communications software; computer software for communicating purposes between micro-computers; data storage automation software; computer software for the collection of positioning data; positioning data processing software; computer software for the transmission of positioning data; computer software for the dissemination of positioning data; interactive computer software that provides navigational and travel information.

35 – Compilation of information into computer databases; compilation of statistics; invoicing.

39 – Barge transport; boat transport; marine transport; pleasure boat transport; river transport; traffic information; transport; transportation information.

42 – Computer systems integration services; computer software design; software development; rental of computer software; maintenance of computer software; testing of computer software; maintenance and updating of software for communication systems; design and development of route planning software; design and development of computer software for logistics; rental of software for importing and managing data; programming of computer software for reading, transmitting and organising data.

(260) AM 2022 115727 A

(800) 1631914

(151) 2020 11 20

(891) 2020 11 20

(731) Zakrytoe aktsionerное obshchestvo "Myasnaya galereya"
ul. Poliny Osipenko, 65, of. 10, RU-600009
g. Vladimir, Russian Federation

(540)



(591) Yellow, orange, red, black and white

(531) 03.07.17; 11.03.05; 11.03.18; 28.05; 29.01.15

(526) Symbol ®

(511)

29 – Ajvar [preserved peppers]; aloe vera prepared for human consumption; alginates for culinary purposes; anchovy, not live; peanuts, prepared; artichokes, preserved; albumen for culinary purposes; white of eggs;

beans, preserved; soya beans, preserved, for food; broth; ginger jam; ham; fatty substances for the manufacture of edible fats; laver, preserved; edible birds' nests; sea-cucumbers, not live; peas, preserved; mushrooms, preserved; guacamole [mashed avocado]; game, not live; gelatine; meat jellies; jellies for food; fruit jellies; yolk of eggs; coconut fat; bone oil for food; lard; suet for food; edible fats; curd; fruit-based snack food; milk substitutes; soya patties; tofu patties; charcuterie; raisins; caviar; eggplant paste; vegetable marrow paste; fish roe, prepared; yogurt; galbi [grilled meat dish]; sauerkraut; kefir [milk beverage]; kimchi [fermented vegetable dish]; isinglass for food; clams, not live; potato-based dumplings; klipfish [salted and dried cod]; milk shakes; black pudding; onion rings; arrangements of processed fruit; compotes; meat, canned; vegetables, canned; fish, canned; fruits, canned; broth concentrates; corn dogs; gherkins; shrimps, not live; prawns, not live; buttercream; croquettes; silkworm chrysalis for human consumption; sweet corn, processed; kumys [milk beverage]; spiny lobsters, not live; lecithin for culinary purposes; salmon, not live; onions, preserved; margarine; marmalade; oils for food; peanut butter; cocoa butter for food; coconut oil for food; coconut butter; corn oil for food; sesame oil for food; linseed oil for food; extra virgin olive oil for food; olive oil for food; palm oil for food; palm kernel oil for food; sunflower oil for food; rape oil for food; butter; soya bean oil for food; mussels, not live; almonds, ground; animal marrow for food; mollusks, not live; milk; peanut milk; peanut milk for culinary purposes; coconut milk; coconut milk for culinary purposes; almond milk; almond milk for culinary purposes; oat milk; rice milk; rice milk for culinary purposes; protein milk; condensed milk; soya milk; powdered milk; fish meal for human consumption; vegetable mousses; fish mousses; fruit pulp; meat; meat, preserved; freeze-dried meat; milk beverages, milk predominating; peanut milk-based beverages; coconut milk-based beverages; almond milk-based beverages; edible insects, not live; pieces of chicken fried in batter; chicken wings fried in batter; sausage casings, natural or artificial; vegetables, preserved; freeze-dried vegetables; vegetables, dried; vegetables, cooked; potato fritters; olives, preserved; lobsters, not live; flavored nuts; candied nuts; coconut, desiccated; nuts, prepared; tomato paste; pressed fruit paste; liver pâté; pectin for culinary purposes; liver; pickles; jams; powdered eggs; milk products; fish-based foodstuffs; prostokvasha [soured milk]; poultry, not live; bulgogi; pollen prepared as foodstuff; cranberry compote; tomato purée; apple purée; crayfish, not live; crustaceans, not live; fish, preserved; fish, not live; salted fish; ryazhenka [fermented baked milk]; vegetable salads; fruit salads; bacon; sardelki [sausages]; sardines, not live; pork; herrings, not live; seeds, prepared; sunflower seeds, prepared; cream [dairy products]; whipped cream; vegetable-based cream; fat-containing mixtures for bread slices; smetana [sour cream]; lemon jui-

ce for culinary purposes; tomato juice for cooking; vegetable juices for cooking; salted meats; sausages; sausages in batter; hot dog sausages; preparations for making bouillon; preparations for making soup; nut-based spreads; tripe; soups; vegetable soup preparations; whey; cottage cheese fritters; cheese; tajine [prepared meat, fish or vegetable dish]; tahini [sesame seed paste]; tofu; truffles, preserved; tuna, not live; oysters, not live; falafel; milk ferments for culinary purposes; rennet; fish fillets; dates; frosted fruits; frozen fruits; fruit, preserved; fruit preserved in alcohol; fruit, stewed; hazelnuts, prepared; potato flakes; hummus [chickpea paste]; fruit peel; preserved garlic; lentils, preserved; potato chips; low-fat potato chips; fruit chips; non-alcoholic eggnog; seaweed extracts for food; meat extracts; escamoles [edible ant larvae, prepared]; yuba [tofu skin]; berries, preserved; eggs; snail eggs for consumption; yakitori.

30 – Seaweed [condiment]; vanilla flavorings for culinary purposes; flavorings, other than essential oils, for cakes; flavorings, other than essential oils, for beverages; coffee flavorings; food flavorings, other than essential oils; star aniseed; baozi; cereal bars; high-protein cereal bars; pancakes; noodle-based prepared meals; freeze-dried dishes with the main ingredient being pasta; freeze-dried dishes with the main ingredient being rice; buns; bulgur; bread rolls; edible rice paper; edible paper; burritos; vanillin [vanilla substitute]; vareniki [stuffed dumplings]; waffles; vermicelli; natural sweeteners; sausage binding materials; binding agents for ice cream; sea water for cooking; malt biscuits; cloves [spice]; mirror icing [mirror glaze]; cake frosting [icing]; glucose for culinary purposes; mustard; croutons; buckwheat, processed; gluten additives for culinary purposes; yeast; pelmeni [dumplings stuffed with meat], fried; thickening agents for cooking foodstuffs; leaven; rice-based snack food; cereal-based snack food; artificial coffee; vegetal preparations for use as coffee substitutes; dressings for salad; zefir [confectionery]; fruit jellies [confectionery]; candy decorations for cakes; confectionery for decorating Christmas trees; cakes; pastries; peanut confectionery; almond confectionery; pasta; ginger [spice]; frozen yogurt [confectionery ices]; cocoa; cream of tartar for culinary purposes; capers; caramels [sweets]; curry [spice]; ketchup [sauce]; prepared rice rolled in seaweed; kimchijeon [fermented vegetable pancakes]; quinoa, processed; quiches; gluten prepared as foodstuff; flour-based dumplings; sweets; liquorice [confectionery]; peppermint sweets; mints for breath freshening; dulce de leche; cinnamon [spice]; coffee; unroasted coffee; starch for food; crackers; custard; hominy grits; semolina; oatmeal; crushed barley; groats for human food; ice cubes; corn, milled; corn, roasted; meat pies; turmeric; couscous; noodles; soba noodles; udon noodles; ice for refreshment; ice, natural or artificial; edible ices; rice cakes; potato-based flatbreads; mayonnaise; macarons; macaroni; maltose; hominy; manti [stuffed dumplings]; piccali-

lli; marinades; marzipan; honey; miso [seasoning]; royal jelly; ice cream; bean meal; buckwheat flour; tapioca flour; potato flour; corn flour; nut flours; flour; wheat flour; soya flour; barley meal; dessert mousses [confectionery]; chocolate mousses; muesli; mint for confectionery; cocoa beverages with milk; coffee beverages with milk; coffee-based beverages; cocoa-based beverages; chamomile-based beverages; tea-based beverages; chocolate beverages with milk; chocolate-based beverages; infusions, not medicinal; crushed oats; husked oats; okonomiyaki [Japanese savory pancakes]; onigiri [rice balls]; nutmegs; chocolate-coated nuts; stick liquorice [confectionery]; soya bean paste [seasoning]; pastila [confectionery]; pastilles [confectionery]; molasses for food; pâtés en croûte; pelmeni [dumplings stuffed with meat]; pepper; allspice; peppers [seasonings]; pesto [sauce]; cookies; petit-beurre biscuits; bibimbap [rice mixed with vegetables and beef]; pies; pizzas; meat gravies; fondants [confectionery]; popcorn; powders for making ice cream; baking powder; mustard meal; pralines; aromatic preparations for food; condiments; meat tenderizers for household purposes; cereal preparations; ravioli; ramen [Japanese noodle-based dish]; chewing gum; chewing gum for breath freshening; relish [condiment]; rice; instant rice; wheat germ for human consumption; spring rolls; sago; sugar; palm sugar; sesame seeds [seasonings]; linseed for culinary purposes [seasoning]; processed seeds for use as a seasoning; aniseed; agave syrup [natural sweetener]; golden syrup; confectionery; batter mixes for okonomiyaki [Japanese savory pancakes]; baking soda [bicarbonate of soda for cooking purposes]; malt for human consumption; salt for preserving foodstuffs; cooking salt; celery salt; sherbets [ices]; ham glaze; cranberry sauce [condiment]; soya sauce; tomato sauce; apple sauce [condiment]; sauces [condiments]; pasta sauce; spaghetti; spices; chocolate-based spreads; chocolate spreads containing nuts; preparations for stiffening whipped cream; shaved ice with sweetened red beans; rusks; breadcrumbs; sushi; senbei [rice crackers]; sandwiches; tabbouleh; tacos; tapioca; tarts; dough; pastry dough; almond paste; rice pulp for culinary purposes; cake dough; tortillas; garden herbs, preserved [seasonings]; chocolate decorations for cakes; vinegar; beer vinegar; ferments for pastes; halvah; khinkali [stuffed dumplings]; bread; unleavened bread; chips [cereal products]; corn flakes; oat flakes; hot dog sandwiches; flowers or leaves for use as tea substitutes; jiaozi; chicory [coffee substitute]; tea; iced tea; chutneys [condiments]; chebureki [deep-fried pies]; minced garlic [condiment]; cheeseburgers [sandwiches]; chow-chow [condiment]; saffron [seasoning]; chocolate; malt extract for food; essences for foodstuffs, except etheric essences and essential oils; husked barley.

35 – Arranging subscriptions to telecommunication services for others; import-export agency services; commercial information agency services; publicity

agency services; cost price analysis; rental of office equipment in co-working facilities; rental of advertising space; business auditing; financial auditing; business intermediary services relating to the matching of potential private investors with entrepreneurs needing funding; employment agency services; computerized file management; accounting; invoicing; demonstration of goods; transcription of communications [office functions]; opinion polling; market studies; business information; commercial information and advice for consumers in the choice of products and services; business investigations; business research; marketing research; personnel recruitment; business management and organization consultancy; business organization consultancy; business management consultancy; personnel management consultancy; professional business consultancy; consultancy regarding advertising communication strategies; consultancy regarding public relations communication strategies; layout services for advertising purposes; marketing; marketing in the framework of software publishing; targeted marketing; business management of performing artists; business management of sports people; writing of résumés for others; scriptwriting for advertising purposes; news clipping services; updating and maintenance of information in registries; updating and maintenance of data in computer databases; updating of advertising material; word processing; online retail services for downloadable and pre-recorded music and movies; online retail services for downloadable ring tones; online retail services for downloadable digital music; organization of exhibitions for commercial or advertising purposes; arranging newspaper subscriptions for others; organization of fashion shows for promotional purposes; organization of trade fairs for commercial or advertising purposes; shop window dressing; development of advertising concepts; business appraisals; payroll preparation; data search in computer files for others; sponsorship search; administrative assistance in responding to calls for tenders; business management assistance; commercial or industrial management assistance; commercial intermediation services; providing business information via a web site; providing commercial and business contact information; provision of an online marketplace for buyers and sellers of goods and services; web indexing for commercial or advertising purposes; presentation of goods on communication media, for retail purposes; media relations services; economic forecasting; auctioneering; wholesale services for pharmaceutical, veterinary and sanitary preparations and medical supplies; retail services for works of art provided by art galleries; retail services for pharmaceutical, veterinary and sanitary preparations and medical supplies; sales promotion for others; promotion of goods and services through sponsorship of sports events; production of teleshopping programs; production of advertising films; office machines and equipment rental; rental of advertising

time on communication media; publicity material rental; rental of billboards [advertising boards]; rental of vending machines; rental of sales stands; rental of photocopying machines; publication of publicity texts; radio advertising; bill-posting; distribution of samples; dissemination of advertising matter; direct mail advertising; registration of written communications and data; writing of publicity texts; advertising; online advertising on a computer network; outdoor advertising; advertising by mail order; television advertising; document reproduction; compilation of statistics; compilation of information into computer databases; business inquiries; systemization of information into computer databases; advisory services for business management; corporate communications services; negotiation of business contracts for others; negotiation and conclusion of commercial transactions for third parties; compiling indexes of information for commercial or advertising purposes; tax preparation; drawing up of statements of accounts; telemarketing services; psychological testing for the selection of personnel; interim business management; outsourced administrative management for companies; business management of hotels; business management for freelance service providers; business project management services for construction projects; commercial administration of the licensing of the goods and services of others; business management of reimbursement programs for others; administration of consumer loyalty programs; administration of frequent flyer programs; administrative processing of purchase orders; public relations; commercial lobbying services; competitive intelligence services; modelling for advertising or sales promotion; typing; market intelligence services; appointment reminder services [office functions]; web site traffic optimization; administrative services for the relocation of businesses; tax filing services; search engine optimization for sales promotion; appointment scheduling services [office functions]; gift registry services; price comparison services; pay per click advertising; secretarial services; procurement services for others [purchasing goods and services for other businesses]; shorthand; outsourcing services [business assistance]; telephone answering for unavailable subscribers; photocopying services; business efficiency expert services.

43 – Accommodation bureau services [hotels, boarding houses]; rental of temporary accommodation; rental of meeting rooms; tourist home services; hotel reservations; boarding house bookings; temporary accommodation reservations; hotel services; retirement home services; snack-bar services; information and advice in relation to the preparation of meals; café services; cafeteria services; motel services; boarding house services; boarding for animals; rental of cooking apparatus; rental of chairs, tables, table linen, glassware; rental of lighting apparatus; rental of tents; rental of transportable buildings; rental of drinking water dispensers; restaurant services; self-service res-

restaurant services; reception services for temporary accommodation [management of arrivals and departures]; food sculpting; canteen services; decorating of food; cake decorating; holiday camp services [lodging]; bar services; providing campground facilities; personal chef services; food and drink catering; washoku restaurant services; udon and soba restaurant services; day-nursery [crèche] services.

(260) AM 2022 115728 A

(800) 1631920

(151) 2021 06 03

(891) 2021 06 03

(731) UAB "VIČIŪNŲ GRUPĖ"

Karaliaus Mindaugo pr. 38 LT-44307 Kaunas,
Lithuania

(540)



(591) Grey, white, red and blue

(531) 03.07.16; 03.07.24; 25.03.01; 27.05.01;
27.05.09; 28.05; 29.01.14

(511)

29 – Vegetable marrow paste; ajvar (preserved peppers); aloe vera prepared for human consumption; albumen for culinary purposes; albumin milk; alginates for culinary purposes; oils for food; olive oil for food; anchovy, not live; yakitori; arrangements of processed fruit; flavoured nuts; extra virgin olive oil for food; oysters, not live; oat milk; guacamole; eggplant paste; protein milk; bacon; broth; potato-based dumplings; potato flakes; potato fritters; potato chips; lemon juice for culinary purposes; candied nuts; frosted fruits; vegetable mousses; vegetable salads; vegetable soup preparations; vegetable juices for cooking; vegetable-based cream; dates; hot dog sausages; sausages; sausages in batter; spiny lobsters, not live; jellies for food; coconut, desiccated; vegetables, dried; falafel; non-alcoholic eggnog; suet for food; animal marrow for food; smetana; cream (dairy products); buttercream; sea-cucumbers, not live; hummus; caviar; ginger jam; edible birds' nests; yogurt; seaweed extracts for food; clams, not live; cocoa butter for food; bone oil for food; kefir; liver; liver pate; liver pastes; galbi; pork; eggs; white of eggs; powdered eggs; yolk of eggs; kimchi; coconut oil for food; coconut milk; coconut milk for culinary purposes; coconut milk-based beverages; coconut fat; coconut butter; compotes; meat, preserved; meat, tinned; fish, preserved; fish, tinned; artichokes, preserved; preserved garlic; mushrooms, preserved; laver, preserved; onions, preserved; truffles, preserved; fruit, preserved; fruits, canned; pe-

as, preserved; olives, preserved; vegetables, preserved; vegetables, canned; beans, preserved; soya beans, preserved, for food; berries, preserved; bulgogi; gherkins; blood sausage; shrimps, not live; prawns, not live; croquettes; maize oil for food; corn dogs; koumiss; ham; salmon, not live; game, not live; lecithin for culinary purposes; lyophilized meat; lyophilized vegetables; lard; edible fats; isinglass for food; margarine; marmalade; klipfish (salted and dried cod); meat; meat jellies; meat extracts; charcuterie; mussels, not live; almond milk; almond milk for culinary purposes; almond milk-based beverages; molluscs, not live; poultry, not live; sausage casings, natural or artificial; low-fat potato chips; apple puree; lobsters, not live; palm oil for food; palm kernel oil for food; hazelnuts, prepared; nuts, prepared; sweet corn, processed; peanuts, prepared; fish roe, prepared; sunflower seeds, prepared; seeds, prepared; edible ant larvae, prepared; pectin for culinary purposes; milk; milk ferments for culinary purposes; milk beverages, milk predominating; whey; milk shakes; powdered milk; milk substitutes; milk products; rennet; pickles; whipped cream; tomato paste; tomato puree; tomato juice for cooking; rape oil for food; sauerkraut; raisins; fermented baked milk; fatty substances for the manufacture of edible fats; fat-containing mixtures for bread slices; nut-based spreads; rice milk; rice milk for culinary purposes; soured milk; sardines, not live; sunflower oil for food; linseed oil for food; sesame oil for food; tahini; herrings, not live; almonds, ground; soya patties; soya milk; soya bean oil for food; tofu; tofu patties; cranberry compote; fruit preserved in alcohol; snail eggs for consumption; soups; broth concentrates; preparations for making soup; salted fish; salted meats; bouillon; bouillon concentrates; preparations for making bouillon; cheese; condensed milk; butter; onion rings; freeze-dried meat; freeze-dried vegetables; frozen fruits; silkworm chrysalis for human consumption; tofu skin; tuna, not live; jams; fruit-based snack food; fruit, stewed; pressed fruit paste; fruit pulp; fruit salads; fruit chips; fruit jellies; fruit peel; edible insects, not live; curd; cottage cheese fritters; crustaceans, not live; crayfish, not live; vegetables, cooked; tripe; gelatine; peanut milk; peanut milk for culinary purposes; peanut milk-based beverages; peanut butter; pollen prepared as foodstuff; fish-based foodstuffs; fish, not live; fish fillets; fish meal for human consumption; fish mousses.

(260) AM 2022 115811 A

(800) 1633794

(151) 2021 10 15

(891) 2021 10 15

(731) Tovarishchestvo s ogranichennoy

otvetstvennostyu "Asia Su Kompaniyasy"

Promyshlennaya zona Severnaya, proezd 11,

zdanie 54/1, Kokshetau, 020006 Akmolinskaya
oblast', Kazakhstan

(540)



(591) Black, white

(531) 17.01.02; 24.15.01; 24.15.05; 24.15.11;
25.01.25; 27.05.01

(511)

32 – Aperitifs, non-alcoholic; barley wine [beer]; lithia water; seltzer water; soda water; waters [beverages]; carbonated water; mineral water [beverages]; table waters; kvass; cocktails, non-alcoholic; beer-based cocktails; lemonades; non-alcoholic beverages; isotonic beverages; non-alcoholic honey-based beverages; rice-based beverages, other than milk substitutes; soya-based beverages, other than milk substitutes; aloe vera drinks, non-alcoholic; whey beverages; protein-enriched sports beverages; soft drinks; non-alcoholic beverages flavoured with coffee; non-alcoholic beverages flavoured with tea; non-alcoholic fruit juice beverages; energy drinks; fruit nectars, non-alcoholic; orgeat; beer; ginger beer; malt beer; powders for effervescing beverages; sarsaparilla [non-alcoholic beverage]; syrups for lemonade; syrups for beverages; smoothies; tomato juice [beverage]; cider, non-alcoholic; vegetable juices [beverages]; fruit juices; preparations for making carbonated water; non-alcoholic essences for making beverages; non-alcoholic preparations for making beverages; must; grape must, unfermented; beer wort; malt wort; pastilles for effervescing beverages; sherbet [beverages]; non-alcoholic fruit extracts; extracts of hops for making beer; essences for making beverages.

33 – Aperitifs; arrack [arak]; baijiu [Chinese alcoholic beverage], brandy; wine; piquette; whisky; vodka; anisette [liqueur]; kirsch; gin; digestifs [liqueurs and spirits]; cocktails; curacao; anise [liqueur]; liqueurs; pre-mixed alcoholic beverages, other than beer-based; alcoholic beverages, except beer, alcoholic beverages containing fruit; spirits [beverages]; distilled beverages; hydromel [mead]; peppermint liqueurs; bitters; nira [sugarcane-based alcoholic beverage]; rum; sake; perry; cider; rice alcohol; alcoholic extracts; fruit extracts, alcoholic; alcoholic essences.

(260) AM 2022 115812 A

(800) 1633802

(151) 2021 10 14

(891) 2021 10 14

(731) Apple Inc.

One Apple Park Way, Cupertino CA 95014,
USA

(540)



(591) Black, white

(531) 04.05.03; 26.01.03; 26.11.12

(511)

9 – Computer software; downloadable computer software for use in transmitting, receiving, browsing, searching, selecting, playing, streaming, and viewing television, movies, music, electronic publications, software applications, and other audio, video, and multimedia content; downloadable computer software allowing multiple users to simultaneously view, interact with, and comment on television, movies, music, electronic publications, software applications, and other audio, video, and multimedia content; downloadable computer software for controlling the operation of media players, digital audio and video players, streaming devices, set top boxes, and computers; downloadable computer software for electronic data transmission, video conferencing, real-time video and audio communication, and sending and receiving electronic messages, images, audio, video, and multimedia content; downloadable pre-recorded audio, video, and multimedia files featuring television, movies, music, electronic publications and other audio, video, and multimedia content; downloadable computer software for use in developing other software applications; application development software; downloadable pre-recorded audio, video and multimedia content; media players, digital audio and video players, and set top boxes.

(260) AM 2022 115813 A

(800) 1633865

(151) 2021 11 08

(891) 2021 11 08

(731) Janssen Pharmaceutica NV

Turnhoutseweg 30, B-2340 Beerse, Belgium

(540)

ADPARPGA

(591) Black, white

(511)

5 – Human pharmaceutical preparations for the prevention and treatment of viral diseases, auto-immune and inflammatory diseases, cardiovascular and pulmonary diseases, central nervous system diseases, peripheral neurological system diseases, pain, dermatologic diseases, gastro-intestinal diseases, infectious-related diseases, metabolic diseases, oncologic diseases, respiratory diseases, digital ulcers, and cerebrovascular diseases; vaccines; anxiolytics; anti-allergics; anti-

infectives; none being ophthalmic pharmaceutical preparations.

(260) AM 2022 115814 A

(800) 1633879

(151) 2021 11 07

(891) 2021 11 07

(731) TOZO INC

1546 NW 56TH ST# 743, SEATTLE WA

98101, USA

(540)

TOZO

(591) Black, white

(511)

9 – Adapter cables for headphones; batteries; battery cases; battery chargers; cases adapted for cameras; cases adapted for computers; cases adapted for mobile phones; cases for mobile phones; cases for contact lenses; cases for eyeglasses and sunglasses; cell phone straps; chargers for electric batteries; chargers for smartphones; computer keyboards; computer mice; covers for tablet computers; data cables; earphone accessories, namely, earphone cases; earphone accessories, namely, earphone cushions, earphone pads, earphone cases, and earphone extension cords; earphones and headphones; electric cables; electric wires; electrical storage batteries; headphones; mouse pads; protective films adapted for smartphones; rechargeable batteries; remote controls for radios, televisions, stereos; selfie sticks; wires, electric; carrying cases specially adapted for electronic equipment, namely, document printers, computers, cell phones; head-clip cell phone holders; plastic cases specially adapted holding compact discs, dvds and other electronic media; tape measures; none of these goods having audio (except for headphones), video, imaging, virtual reality and/or augmented reality capabilities.

(260) AM 2022 115815 A

(800) 1633916

(151) 2021 07 28

(891) 2021 07 28

(731) YVES SAINT LAURENT

37-39 rue de Bellechasse, F-75007 Paris, France

(540)



(591) Black, white

(531) 27.05.22

(511)

35 – Retailing and online retailing of glasses, accessories for telephones and tablets, jewelry, time instruments, bags and small leather goods, namely, wallets, coin purses, card cases (leatherware), banknote holders, document cases, briefcases (leather goods), clutch bags (leather goods), key cases (leather goods), luggage label holders, clothing, footwear, headwear, hosiery, connected clothing, smart clothing, connected footwear, smart footwear; advertising; marketing; organizing, conducting and promoting social events for commercial and advertising purposes; organizing fashion shows for promotional and advertising purposes; shop window dressing; public relations; dissemination (distribution) of samples; sales promotion; dissemination of advertisements (leaflets, prospectuses, printed matter, samples).

(260) AM 2022 115816 A

(800) 1633970

(151) 2021 10 11

(891) 2021 10 11

(731) SAVENCIA SA

42 rue Rieussec, F-78220 VIROFLAY

FRANCE, France

(540)



(591) Black, white

(531) 08.03.08; 18.03.21; 18.03.23; 19.03.05;
26.04.05; 26.04.06; 26.04.18; 26.04.24;
26.05.01; 27.05.01; 27.05.08; 27.05.09;
27.05.10; 27.05.11; 27.05.24

(511)

29 – Cheese.

(260) AM 2022 115817 A
 (800) 949642
 (151) 2007 09 17
 (891) 2021 12 01
 (731) GALLETAS GULLON, S.A.
 Avda. Burgos, 2, E-34800 AGUILAR DE
 CAMPOO (PALENCIA), Spain
 (540)



(591) Yellow, green and white
 (531) 01.15.09; 29.01.13
 (511)
 30 – Cookies and biscuits.

(260) AM 2022 115818 A
 (800) 999870
 (151) 2009 02 23
 (891) 2021 10 12
 (731) Skorpion Limited
 Via Serafino Balestra 12, CH-6900 Lugano,
 Switzerland
 (540)

DRKSHDW

(591) Black, white
 (511)
 18 – Leather and imitations of leather, and goods made of these materials and not included in other classes; animal skins, hides; trunks and travelling bags; umbrellas, parasols and walking sticks; whips, harness and saddlery.
 25 – Clothing, footwear, headgear.

(260) AM 2022 115819 A
 (800) 1026597
 (151) 2009 12 30
 (891) 2021 10 12
 (731) Skorpion Limited
 Via Serafino Balestra 12, CH-6900 Lugano,
 Switzerland
 (540)

(591) Black, white
 (531) 27.05.13

(511)
 18 – Leather and imitations of leather, and goods made of these materials and not included in other classes; animal skins, hides; trunks and travelling bags; umbrellas, parasols and walking sticks; whips, harness and saddlery.
 25 – Clothing, footwear, headgear.

(260) AM 2022 116254 A
 (800) 1639271
 (151) 2021 10 04
 (891) 2021 10 04
 (731) Premier Beverages P.B. Limited
 Amathountos, 50E, PEARL BUILDING,
 3rd floor, Flat/Office 1, CY-4532 Agios
 Tychonas Limassol, Cyprus
 (540)



(591) Black, white
 (531) 26.04.05; 26.04.18; 26.04.24; 27.05.01;
 27.05.17; 27.05.24
 (526) TM
 (511)
 30 – Tea; tea substitutes; fruit teas; theine-free tea; green tea; lime tea; instant tea; iced tea; chai tea; black tea; mugi-cha [roasted barley tea]; herbal teas, other than for medicinal use.

32 – Beer; beer-based beverages; non-alcoholic beverages; mineral and aerated waters; vitamin enriched water [beverages]; fruit beverages and fruit juices; syrups and other non-alcoholic preparations for making beverages; aperitifs, non-alcoholic; barley wine [beer]; carbonated water; lithia water; seltzer water; soda water; waters [beverages]; mineral water [beverages]; table waters; kvass; cocktails, non-alcoholic; beer-based cocktails; lemonades; isotonic beverages; non-alcoholic honey-based beverages; rice-based beverages, other than milk substitutes; soya-based beverages, other than milk substitutes; aloe vera drinks, non-alcoholic; whey beverages; protein-enriched sports beverages; soft drinks; non-alcoholic beverages flavoured with coffee; non-alcoholic beverages flavoured with tea; soft drinks flavored with tea; fruit-based soft drinks flavored with tea; non-alcoholic fruit juice beverages; energy drinks; fruit nectars, non-alcoholic; orgeat; pale ale; dark beer; de-alcoholized beer; low-alcohol beer; flavored beers; wheat beer; ginger beer; malt beer; powders for effervescing beverages; sarsaparilla [non-alcoholic beverage]; syrups for lemonade; syrups for beverages; smoothies; tomato juice [beverage]; cider, non-alcoholic; vegetable juices [beverage];

ges]; fruit juices; preparations for making non-alcoholic beverages; preparations for making carbonated water; must; grape must, unfermented; beer wort; malt wort; pastilles for effervescing beverages; sherbets [beverages]; non-alcoholic fruit extracts; extracts of hops for making beer; non-alcoholic essences for making beverages.

33 – Alcoholic beverages; alcoholic preparations for making beverages; alcoholic tea-based beverages; aperitifs; arrack [arak]; baijiu [Chinese distilled alcoholic beverage]; brandy; wine; piquette; whisky; vodka; anisette [liqueur]; kirsch; gin; digestifs [liqueurs and spirits]; cocktails; curacao; anise [liqueur]; liqueurs; pre-mixed alcoholic beverages, other than beer-based; alcoholic beverages, except beer; alcoholic beverages containing fruit; spirits [beverages]; distilled beverages; hydromel [mead]; peppermint liqueurs; bitters; nira [sugarcane-based alcoholic beverage]; rum; sake; perry; cider; rice alcohol; alcoholic extracts; fruit extracts, alcoholic; alcoholic essences.

(260) AM 2022 116255 A

(800) 1639398

(151) 2021 04 28

(891) 2021 04 28

(731) Publichne aktsionerne tovarystvo «Zakrytyi nedyversyfikovanyi venchurnyi korporatyvnyi investutsiynyi fond «HOLDYNH INVEST Office V704, building 1V, Pavla Tychyny Avenue, Kyiv City 02152, Ukraine

(540)



(591) Black, white

(531) 18.07.09; 25.01.10; 25.03.07; 26.04.06; 27.01.01; 28.05

(511)

29 – Meat, fish, poultry and game; meat extracts; charcuterie; canned fruits and vegetables; nuts, prepared; jellies for food; marmalade; compotes; milk and milk products; edible oils and fats.

(260) AM 2022 116256 A

(800) 1639399

(151) 2021 12 17

(891) 2021 12 17

(731) Obshchestvo s ogranichennoi otvetstvennost'yu "Laboratoriya sovremennogo zdorovya" ul. Khimzavodskaya, 11/20, Berdsk, RU-633004 Novosibirskaya oblast', Russian Federation

(540)

BEAUTY BOX

(591) Black, white

(511)

5 – Acai powder dietary supplements; adhesive plasters; adhesive tapes for medical purposes; air deodorising preparations; air purifying preparations; albumin dietary supplements; albuminous foodstuffs for medical purposes; albuminous preparations for medical purposes; alginate dietary supplements; almond milk for pharmaceutical purposes; aloe vera preparations for pharmaceutical purposes; amino acids for medical purposes; anaesthetics; analgesics; antibacterial hand-washes; antibacterial soap; antioxidant pills; antiseptic cotton; antiseptics; anti-uric preparations; appetite suppressant pills; appetite suppressants for medical purposes; asthmatic tea; babies' diapers; balms for medical purposes; barks for pharmaceutical purposes; biological preparations for medical purposes; cachets for pharmaceutical purposes; capsules for medicines; casein dietary supplements; chemico-pharmaceutical preparations; chewing gum for medical purposes; chilblain preparations; cod liver oil; contact lens cleaning preparations; decoctions for pharmaceutical purposes; deodorants for clothing and textiles; deodorants, other than for human beings or for animals; depuratives; dietary fiber; dietary supplements for animals; dietary supplements with a cosmetic effect; dietetic beverages adapted for medical purposes; dietetic foods adapted for medical purposes; dietetic substances adapted for medical use; digestives for pharmaceutical purposes; disinfectant soap; disinfectants for hygiene purposes; dressings, medical; drugs for medical purposes; elixirs [pharmaceutical preparations]; enzyme dietary supplements; enzyme preparations for medical purposes; eucalyptus for pharmaceutical purposes; febrifuges; ferments for pharmaceutical purposes; first-aid boxes, filled; flaxseed dietary supplements; flour for pharmaceutical purposes; food for babies; freeze-dried food adapted for medical purposes; frostbite salve for pharmaceutical purposes; gauze for dressings; gelatine for medical purposes; glucose dietary supplements; glucose for medical purposes; hematogen; hemostatic pencils; herbal extracts for medical purposes; herbal teas for medicinal purposes; homogenised food adapted for medical purposes; immunostimulants; infant formula; lacteal flour for babies; lactose for pharmaceutical purposes; laxatives; lecithin dietary supplements; liniments; linseed for pharmaceutical purposes; linseed oil dietary supplements; lotions for pharmaceutical purposes; magnesia for pharmaceutical purposes; medical preparations for slimming purposes; medicated candies; medicated eye-washes; medicated soap; medicated toiletry preparations; medicated toothpaste; medicinal drinks; medicinal herbs; medicinal infusions; medicinal roots; medicinal tea; medicine cases, portable, filled; medicines for alleviating constipation; medicines for human pur-

poses; milk ferments for pharmaceutical purposes; mineral food supplements; mouthwashes for medical purposes; mustard plasters; nervines; nutraceutical preparations for therapeutic or medical purposes; nutritional supplements; ointments for pharmaceutical purposes; organotherapy preparations; panty liners [sanitary]; pastilles for pharmaceutical purposes; pearl powder for medical purposes; personal sexual lubricants; petroleum jelly for medical purposes; pharmaceutical preparations for treating dandruff; pharmaceutical preparations; pharmaceuticals; phytotherapy preparations for medical purposes; pollen dietary supplements; pomades for medical purposes; poultices; powdered milk for babies; preparations of trace elements for human and animal use; propolis dietary supplements; propolis for pharmaceutical purposes; protein dietary supplements; protein supplements for animals; purgatives; remedies for perspiration; royal jelly dietary supplements; royal jelly for pharmaceutical purposes; salts for medical purposes; sanitary napkins; sedatives; tranquilizers; serums; sexual stimulant gels; slimming pills; solutions for contact lenses; styptic preparations; sugar for medical purposes; suppositories; syrups for pharmaceutical purposes; tanning pills; tissues impregnated with pharmaceutical lotions; tonics [medicines]; vitamin preparations; vitamin supplement patches; wadding for medical purposes; wheat germ dietary supplements; yeast dietary supplements; yeast for pharmaceutical purposes.

(260) AM 2022 116257 A

(800) 1639431

(151) 2021 10 21

(891) 2021 10 21

(731) Hunan Newman Digital Technology Co., Ltd.
No. 2 Lixiang East Road, Economic and
Technology Development Zone, Changsha,
Hunan Province, China

(540)

Geeneu

(591) Black, white

(531) 27.05.17

(511)

9 – Computers; computer keyboards; USB flash drives; electronic interactive whiteboards; smartglasses of data processing apparatus; smartwatches of data processing apparatus; sound cards; desktop printers; computer display monitors; solid state drives; electronic pocket translators; optical discs; pocket calculators; tablet computers; scanners of data processing equipment; mouse of computer peripheral; external computer hard drives; pedometers; counterfeit coin detectors; ticket dispensers; dictating machines; facial recognition apparatus; photocopiers for photographic, electrostatic, thermic; time clocks for time recording devices; scales; rulers of measuring instruments; vehicle breakdown warning triangles; navigational ins-

truments; telephone apparatus; mobile telephones; selfie sticks for mobile phones; cases for smartphones; protective films adapted for smartphones; computer network hubs, switches and routers; wireless routers; Global Positioning System [GPS] apparatus; sound recording apparatus; portable media players; audiobooks; digital book readers; electronic book readers; virtual reality headsets; megaphones; dashboard cameras; microphones; camcorders; DVD players; digital photo frames; headsets; graphics tablets; cabinets for loudspeakers; cameras for photography; air analysis apparatus; food analysis apparatus; telescopes; cables, electric; integrated circuits; light-emitting diodes [LED]; inverters for electricity; electric sockets; electrical adapters; electronic key fobs being remote control apparatus; lightning conductors; electrolyzers; fire extinguishing apparatus; radiological apparatus for industrial purposes; protective helmets; life-saving apparatus and equipment; electric door bells; locks, electric; spectacles; batteries, electric; power banks; battery chargers; battery jump starters; photovoltaic apparatus for converting solar radiation to electrical energy; films, exposed; refrigerator magnets.

(260) AM 2022 116259 A

(800) 1639455

(151) 2021 06 10

(891) 2021 06 10

(731) Egis Gyógyszergyár Zrt.

Keresztúri út 30-38., H-1106 Budapest,
Hungary

(540)

SKINSOLUTE

(591) Black, white

(511)

9 – Wearable activity trackers; connected bracelets [measuring instruments]; smartwatches; artificial intelligence software; personal digital assistants; apparatus and instruments for reproducing of data; data processing systems; downloadable applications for use with mobile devices; educational mobile applications; software; computer software for use in medical decision support systems; mobile application software; downloadable mobile applications; software for remote diagnostics; data processing equipment and accessories (electrical and mechanical).

10 – Medical apparatus and devices; surgical apparatus and instruments for medical use; medical devices; medical diagnostic apparatus for medical purposes; measuring devices for medical use; tools for medical diagnostics; diagnostic apparatus for medical purposes; diagnostic, examination, and monitoring equipment (term considered too vague by the International Bureau – rule 13 (2) (b) of the Regulations); electronic analyzers for medical purposes; sensor apparatus for medical use in monitoring the vital signs of patients.

41 – Educational services in the healthcare sector; conducting educational support programmes for healthcare professionals; health education.

44 – Medical services; medical diagnostic services; hygienic and beauty care; advisory services relating to health; pharmacy advice; therapy services; respite care services in the nature of home nursing aid; pharmaceutical services; providing medical support in the monitoring of patients receiving medical treatments; medical consultancy services; consultancy and information services relating to medical products; providing information to patients in the field of administering medications; medical counselling; health counselling; monitoring of patients.

(260) AM 2022 116260 A

(800) 1639457

(151) 2020 12 21

(891) 2020 12 21

(731) "MY REPUBLIC" Ltd.

Pohodniy proezd, building 14, lev/place/room
5/II/№5, RU-125373 Moscow, Russian
Federation

(540)

People&Home

(591) Purple

(531) 24.17.25; 27.05.01; 29.01.05

(511)

1 – Nitrogen; actinium; alkaloids; alginates for industrial purposes; crotonic aldehyde; ammonium aldehyde; aldehydes; americium; amyl acetate; ammonia; ammonia [volatile alkali] for industrial purposes; anhydrous ammonia; acetic anhydride; anhydrides; anti-knock substances for internal combustion engines; disincrustants; antioxidants for use in manufacture; antistatic preparations, other than for household purposes; antifreeze; size for use in the textile industry; argon; lead arsenate; astatine; aluminium acetate; lime acetate; lead acetate; acetate of cellulose, unprocessed; acetates [chemicals]; acetylene; acetone; benzene; benzol; bentonite; bicarbonate of soda for chemical purposes; potassium dioxalate; bichromate of potassium; bichromate of soda; bauxite; bromine for chemical purposes; albumenized paper; baryta paper; diazo paper; blueprint paper; test paper, chemical; self-toning paper [photography]; sensitized paper; photometric paper; borax; agglutinants for concrete; polish removing substances; preparations for the separation of greases; limestone hardening substances; tanning substances; adhesives for industrial purposes; surface-active chemical agents; foundry binding substances; concrete-aeration chemicals; leather-dressing chemicals; chemicals for the manufacture of paints; chemicals for the manufacture of pigments; viscose; bismuth; distilled water; seawater for industrial purposes; gallium; gambier; helium; electropho-

resis gels; aluminium hydrate; hydrates; hyposulfites; ceramic glazings; glycol; expanded clay for hydropo-
nic plant growing [substrate]; kaolin; glycerides; glycerine for industrial purposes; glucose for industrial purposes; glucosides; gluten for industrial purposes; holmium; peat pots for horticulture; graphene; graphite for industrial purposes; gurjun balsam for use in the manufacture of varnish; dendrimer-based polymers for use in the manufacture of capsules for pharmaceuticals; detergents for use in manufacturing processes; defoliants; dispersions of plastics; ceramic compositions for sintering [granules and powders]; gelatine for photographic purposes; gelatine for industrial purposes; auxiliary fluids for use with abrasives; magnetic fluid for industrial purposes; glaziers' putty; diatomaceous earth; fuller's earth for use in the textile industry; lime chloride; californium; silicon carbide [raw material]; carbide; lime carbonate; magnesium carbonate; carbonates; lutetium [cassioptium]; catalysts; biochemical catalysts; catechu; caustics for industrial purposes; adhesives for billposting; leather glues; adhesives for wall tiles; adhesives for wallpaper; glue for industrial purposes; cement for mending broken articles; gums [adhesives] for industrial purposes; birdlime; isinglass, other than for stationery, household or alimentary purposes; starch paste [adhesive], other than for stationery or household purposes; collagen for industrial purposes; collodion; compost; mangrove bark for industrial purposes; tan; starch for industrial purposes; silicon; creosote for chemical purposes; manganate; paper pulp; wood pulp; mastic for leather; oil cement [putty]; synthetic materials for absorbing oil; brazing preparations; ceramic materials in particulate form, for use as filtering media; filtering materials of unprocessed plastics; filtering materials of mineral substances; filtering materials of vegetable substances; filtering materials of chemical substances; metalloids; alkaline-earth metals; alkaline metals; methane; methyl benzene; methyl benzol; flour for industrial purposes; emollients for industrial purposes; nanopowders for industrial purposes; sodium; hypochlorite of soda; naphthalene; sal ammoniac; toxic gas neutralizers; neodymium; neptunium; nitrates; lithia [lithium oxide]; purification preparations; textile-brightening chemicals; reducing agents for use in photography; bases [chemical preparations]; wax-bleaching chemicals; fat-bleaching chemicals; pectin for industrial purposes; pectin [photography]; percarbonates; hydrogen peroxide for industrial purposes; persulfates; perchlorates; foundry sand; plastisols; ferrotype plates [photography]; plasticizers; plastics, unprocessed; X-ray films, sensitized but not exposed; plutonium; chemical coatings for ophthalmic lenses; rubber preservatives; currying preparations for leather; currying preparations for skins; galvanizing preparations; metal hardening preparations; fixing baths [photography]; opacifiers for glass; opacifiers for enamel; separating and unsticking [ungluing] preparations; preparations for preventing the tarnishing of lenses;

preparations for preventing the tarnishing of glass; cement-waterproofing chemicals, except paints; wall-paper removing preparations; fulling preparations for use in the textile industry; descaling preparations, other than for household purposes; flashlight preparations; sizing preparations; animal carbon preparations; corrosive preparations; cryogenic preparations; dehydrating preparations for industrial purposes; degreasing preparations for use in manufacturing processes; degumming preparations; anti-incrustants; moistening [wetting] preparations for use in the textile industry; moistening [wetting] preparations for use in dyeing; moistening [wetting] preparations for use in bleaching; enzyme preparations for industrial purposes; chemical condensation preparations; fulling preparations; damp-proofing chemicals, except paints, for masonry; cellulose derivatives [chemicals]; protein [raw material]; proteins for use in manufacture; mordants for metals; solvents for varnishes; drilling muds; solutions for cyanotyping; silver salt solutions for silvering; toning baths [photography]; saltpeter; silicates; aluminium silicate; silicones; foundry molding preparations; acrylic resins, unprocessed; polymer resins, unprocessed; synthetic resins, unprocessed; epoxy resins, unprocessed; compositions for the manufacture of technical ceramics; fireproofing preparations; ethyl alcohol; alcohol; concrete preservatives, except paints and oils; water glass [soluble glass]; tannin; sensitized cloth for photography; chemical intensifiers for paper; chemical intensifiers for rubber; enzymes for industrial purposes; ferments for chemical purposes; fixing solutions [photography]; soldering fluxes; brazing fluxes; photographic paper; photosensitive plates; sensitized photographic plates; sensitized films, unexposed; photographic developers; photographic sensitizers; chemical preparations for use in photography; photographic emulsions; glass-frosting chemicals; leather-renovating chemicals; glass-staining chemicals; enamel-staining chemicals; welding chemicals; condensation-preventing chemicals; stain-preventing chemicals for use on fabrics; anti-tarnishing chemicals for windows; leather-waterproofing chemicals; textile-waterproofing chemicals; chemicals, except pigments, for the manufacture of enamel; leather-impregnating chemicals; textile-impregnating chemicals; industrial chemicals; color-brightening chemicals for industrial purposes; fissionable chemical elements; emulsifiers; ethane; methyl ether; ethyl ether; ethers; esters; cellulose ethers for industrial purposes; cellulose esters for industrial purposes; litmus paper; reagent paper, other than for medical or veterinary purposes; bismuth subnitrate for chemical purposes; propellant gases for aerosols; gluten [glue], other than for stationery or household purposes; blue vitriol; bate for dressing skins; sensitized plates for offset printing; bacterial preparations, other than for medical and veterinary use; chemical reagents, other than for medical or veterinary purposes; silver nitrate.

8 – Razors, electric or non-electric; carving forks; table forks; weeding forks [hand tools]; agricultural forks [hand tools]; lawn clippers [hand instruments]; harpoons; harpoons for fishing; nail pullers, hand-operated; rakes [hand tools]; sand trap rakes; cutter bars [hand tools]; whetstone holders; priming irons [hand tools]; sculptors' chisels; pickhammers; spades [hand tools]; cutlery; edge tools [hand tools]; garden tools, hand-operated; abrading instruments [hand tools]; implements for decanting liquids [hand tools]; depilation appliances, electric and non-electric; sharpening instruments; blade sharpening instruments; livestock marking tools; oyster openers; polishing irons [glazing tools]; ear-piercing apparatus; tube cutting instruments; wire strippers [hand tools]; riveters [hand tools]; cutting tools [hand tools]; hand tools, hand-operated; picks [hand tools]; sharpening stones; centre punches [hand tools]; daggers; pickaxes; mallets [hand instruments]; pliers; punch pliers [hand tools]; blades [weapons]; wrenches [hand tools]; ladles [hand tools]; foundry ladles [hand tools]; meat claws; diggers [hand tools]; scythes; hainault scythes; fire irons; emery grinding wheels; grindstones [hand tools]; sledgehammers; thistle extractors [hand tools]; nail nippers; nail drawers [hand tools]; blades [hand tools]; razor blades; blades for planes; plane irons; jig-saws; spoons; table knives, forks and spoons for babies; table knives, forks and spoons of plastic; crow bars; trowels [gardening]; shovels [hand tools]; machetes; beard clippers; hair clippers for personal use, electric and non-electric; hair clippers for animals [hand instruments]; taps [hand tools]; fireplace bellows [hand tools]; swords; hammers [hand tools]; emergency hammers; stone hammers; masons' hammers; riveting hammers [hand tools]; mattocks; ditchers [hand tools]; mincing knives [hand tools]; manicure sets; manicure sets, electric; pedicure sets; bits [hand tools]; files [tools]; emery files; air pumps, hand-operated; hand pumps; shaving cases; knives; fruit segmenters; vegetable knives; scaling knives; hobby knives [scalpels]; fruit corers; molding irons; ceramic knives; farriers' knives; budding knives; hunting knives; penknives; grafting tools [hand tools]; carving knives; braiders [hand tools]; box cutters; billhooks; paring knives; cleavers; scissors; wick trimmers [scissors]; shears; cattle shearers; border shears; pruning shears; shearers [hand instruments]; sword scabbards; vegetable slicers; kitchen mandolines; vegetable peelers [hand tools]; agricultural implements, hand-operated; side arms, other than firearms; stroping instruments; screwdrivers, non-electric; sabres; stirring sticks for mixing paint; reamer sockets; drill holders [hand tools]; perforating tools [hand tools]; pestles for pounding [hand tools]; emery boards; nail files; nail files, electric; saws [hand tools]; bow saws; tweezers; hair-removing tweezers; guns [hand tools]; guns, hand-operated, for the extrusion of mastics; dies [hand tools]; fruit pickers [hand tools]; saw blades [parts of hand tools]; shear blades; tool belts [hol-

ders]; hair braiders, electric; table cutlery [knives, forks and spoons]; crimping irons; hand implements for hair curling; vegetable choppers; money scoops; instruments and tools for skinning animals; hackles [hand tools]; punches [hand tools]; insecticide sprayers [hand tools]; rasps [hand tools]; paring irons [hand tools]; graving tools [hand tools]; milling cutters [hand tools]; razor strops; leather strops; scythe handles; knife handles; handles for hand-operated hand tools; marline spikes; secateurs; silver plate [knives, forks and spoons]; sickles; drawing knives; scrapers [hand tools]; mortise chisels; caulking irons; gouges [hand tools]; mortars for pounding [hand tools]; mitre boxes [hand tools]; branding irons; hatchets; adzes [tools]; vices; hoop cutters [hand tools]; axes; squares [hand tools]; extension pieces for braces for screw taps; embossers [hand tools]; flat irons; irons [non-electric hand tools]; razor cases; ratchets [hand tools]; scraping tools [hand tools]; awls; choppers [knives]; palette knives; spatulas [hand tools]; spatulas for use by artists; wine bottle foil cutters, hand-operated; bayonets; curling tongs; cuticle tweezers; eyelash curlers; nail clippers, electric or non-electric; cutters; fullers [hand tools]; cheese slicers, non-electric; egg slicers, non-electric; pizza cutters, non-electric; can openers, non-electric; vegetable spiralizers, hand-operated; non-electric caulking guns; fingernail polishers, electric or non-electric.

10 – Cupping glasses; bracelets for medical purposes; anti-nausea wristbands; anti-rheumatism bracelets; feeding bottles; air cushions for medical purposes; surgical sponges; pill cutters; containers especially made for medical waste; clips, surgical; probes for medical purposes; surgical implants comprised of artificial materials; incubators for medical purposes; incubators for babies; chambers for inhalers; endoscopy cameras for medical purposes; droppers for medical purposes; dropper bottles for medical purposes; catheters; clips for dummies; beds specially made for medical purposes; feeding bottle valves; love dolls [sex dolls]; spoons for administering medicine; child-birth mattresses; air mattresses for medical purposes; furniture especially made for medical purposes; water bags for medical purposes; cooling pads for first aid purposes; ear picks; spittoons for medical purposes; pads for preventing pressure sores on patient bodies; air pillows for medical purposes; soporific pillows for insomnia; heating cushions, electric, for medical purposes; veterinary apparatus and instruments; medical apparatus and instruments; ear trumpets; sex toys; dummies for babies; feeding bottle teats; baby feeding dummies; receptacles for applying medicines; vaginal syringes; commode chairs; basins for medical purposes; bed pans; instrument cases for use by doctors; ear plugs [ear protection devices]; drainage tubes for medical purposes; X-ray tubes for medical purposes; cases fitted for medical instruments; tongue depressors for medical purposes; biodegradable bone fixation implants.

11 – Lamp shades; steam accumulators; heat accumulators; defrosters for vehicles; disinfectant apparatus for medical purposes; distillation apparatus; desiccating apparatus; hydromassage bath apparatus; disinfectant apparatus; air deodorizing apparatus; tanning apparatus [sun beds]; ionization apparatus for the treatment of air or water; coffee roasters; beverage cooling apparatus; hand drying apparatus for wash-rooms; fruit roasters; water purifying apparatus and machines; refrigerating apparatus and machines; underfloor heating apparatus and installations; drying apparatus and installations; freezers; heating and cooling apparatus for dispensing hot and cold beverages; drying apparatus; coolers for furnaces; expansion tanks for central heating installations; flushing tanks; refining towers for distillation; bidets; boilers, other than parts of machines; bath tubs; spa baths [vessels]; bath tubs for sitz baths; waffle irons, electric; fans [air-conditioning]; fans [parts of air-conditioning installations]; electric fans for personal use; roasting spits; refrigerating display cabinets; heated display cabinets; water heaters; water flushing installations; air reheaters; extractor hoods for kitchens; gas condensers, other than parts of machines; acetylene generators; fog machines; microbubble generators for baths; hydrants; burners; acetylene burners; gas burners; burners for lamps; germicidal burners; incandescent burners; oxyhydrogen burners; laboratory burners; oil burners; alcohol burners; hot water bottles; footwarmers, electric or non-electric; bed warmers; USB-powered hand warmers; pocket warmers; warming pans; grills [cooking appliances]; food dehydrators, electric; lampshade holders; stills; showers; refrigerating containers; lighters; gas lighters; friction lighters for igniting gas; chimney blowers; coils [parts of distilling, heating or cooling installations]; furnace ash boxes; evaporators; shower enclosures; Turkish bath cabinets, portable; heating apparatus; cool boxes, electric; refrigerating chambers; fireplaces, domestic; chimney flues; coffee capsules, empty, for electric coffee machines; structural framework for ovens; air valves for steam heating installations; level controlling valves in tanks; thermostatic valves [parts of heating installations]; electrically heated carpets; light bulbs; light bulbs, electric; solar thermal collectors [heating]; distillation columns; furnace grates; ventilation hoods; ventilation hoods for laboratories; lamp globes; air-conditioning apparatus; air conditioners for vehicles; gas boilers; laundry room boilers; heating boilers; coffee machines, electric; taps; faucets for pipes and pipelines; mixer faucets for water pipes; forges, portable; lava rocks for use in barbecue grills; couscous cookers, electric; electric lights for Christmas trees; acetylene flares; safety lamps; gas lamps; curling lamps; nail lamps; curing lamps, not for medical purposes; germicidal lamps for purifying air; light bulbs for directional signals for vehicles; arc lamps; laboratory lamps; oil lamps; ultraviolet ray lamps, not for medical purposes; miners' lamps; elec-

tric lamps; chandeliers; barbecues; watering machines for agricultural purposes; ice-cream making machines; soya milk making machines, electric; pounded rice cake making machines, electric, for household purposes; multicookers; footmuffs, electrically heated; heaters for baths; heaters for heating irons; immersion heaters; brackets for gas burners; anti-splash tap nozzles; heat pumps; filaments for electric lamps; magnesium filaments for lighting; heating filaments, electric; luminous house numbers; socks, electrically heated; heating apparatus for defrosting vehicle windows; hot air bath fittings; bath fittings; loading apparatus for furnaces; kiln furniture [supports]; sauna bath installations; refrigerating appliances and installations; directional lights for bicycles; electrically heated clothing; blankets, electric, not for medical purposes; fabric steamers; lamp reflectors; vehicle reflectors; hearths; electric cooktops; food steamers, electric; steam boilers, other than parts of machines; pasteurisers; lamp mantles; sockets for electric lights; coffee percolators, electric; stoves [heating apparatus]; bakers' ovens; hot air ovens; kitchen ranges [ovens]; microwave ovens [cooking apparatus]; microwave ovens for industrial purposes; incinerators; kilns; solar furnaces; dental ovens; furnaces, other than for laboratory use; urinals being sanitary fixtures; feeding apparatus for heating boilers; heating plates; cookers; hot plates; wine cellars, electric; heaters, electric, for feeding bottles; aquarium heaters; USB-powered cup heaters; aquarium lights; heating cushions, electric, not for medical purposes; clean chambers [sanitary installations]; tortilla presses, electric; water intake apparatus; deodorizing apparatus, not for personal use; apparatus for dehydrating food waste; fumigation apparatus, not for medical purposes; gas scrubbing apparatus; oil-scrubbing apparatus; glue-heating appliances; forage drying apparatus; water filtering apparatus; air purifying apparatus and machines; ice machines and apparatus; cooling appliances and installations; cooking apparatus and installations; lighting apparatus and installations; sanitary apparatus and installations; cooking rings; lighting apparatus for vehicles; light-emitting diodes [LED] lighting apparatus; heating apparatus for solid, liquid or gaseous fuels; heating apparatus, electric; hot air apparatus; steam facial apparatus [saunas]; safety accessories for water or gas apparatus and pipes; regulating and safety accessories for gas apparatus; regulating accessories for water or gas apparatus and pipes; regulating and safety accessories for water apparatus; regulating and safety accessories for gas pipes; roasting jacks; plate warmers; anti-glare devices for vehicles [lamp fittings]; rotisseries; radiator caps; searchlights; diving lights; light projectors; washers for water faucets; heat guns; radiators [heating]; central heating radiators; radiators, electric; sinks; disinfectant dispensers for toilets; drip irrigation emitters [irrigation fittings]; light diffusers; nuclear reactors; heat regenerators; pressure water tanks; roasters; beverage

urns, electric; lamps; ceiling lights; toilet seats; hydroponic growing systems; lighting installations for air vehicles; pressure cookers, electric; gas scrubbers [parts of gas installations]; lamp glasses; sterilizers; water sterilizers; air sterilizers; air dryers; laundry dryers, electric; hair dryers; malt roasters; tobacco roasters; tajines, electric; heat exchangers, other than parts of machines; bread toasters; discharge tubes, electric, for lighting; lamp chimneys; luminous tubes for lighting; pipes [parts of sanitary installations]; flues for heating boilers; boiler pipes [tubes] for heating installations; toilets [water-closets]; toilets, portable; humidifiers; humidifiers for central heating radiators; wash-hand basins [parts of sanitary installations]; toilet bowls; water conduits installations; air-conditioning installations; desalination plants; installations for processing nuclear fuel and nuclear moderating material; watering installations, automatic; cooling installations for water; cooling installations for liquids; milk cooling installations; cooling installations for tobacco; water purification installations; purification installations for sewage; steam generating installations; water distribution installations; air filtering installations; swimming pool chlorinating apparatus; ventilation [air-conditioning] installations and apparatus; ventilation [air-conditioning] installations for vehicles; water softening apparatus and installations; cooling installations and machines; heating installations; heaters for vehicles; hot water heating installations; polymerisation installations; water supply installations; flare stacks for use in the oil industry; ash conveyor installations, automatic; whirlpool-jet apparatus; air cooling apparatus; aquarium filtration apparatus; cooking utensils, electric; flaming torches; headlights for automobiles; vehicle headlights; filters for air conditioning; filters for drinking water; wicks adapted for oil stoves; lights for automobiles; bicycle lights; motorcycle lights; lights for vehicles; electric torches; head torches; lanterns for lighting; candle lanterns; street lamps; Chinese lanterns; fountains; ornamental fountains; chocolate fountains, electric; air fryers; deep fryers, electric; fittings, shaped, for ovens; oven fittings made of fireclay; bread-making machines; refrigerators; refrigerators, cooling apparatus and freezers for medical storage purposes; chromatography apparatus for industrial purposes; kettles, electric; dampers [heating]; book sterilization apparatus; refrigerating cabinets; carbon for arc lamps; heating elements; fairy lights for festive decoration; electric appliances for making yogurt; bread baking machines; standard lamps; thermo-pots, electric; bath installations.

17 – Shock-absorbing buffers of rubber; asbestos; asbestos felt; insulating felt; asbestos fibers; plastic fibers, other than for textile use; foam supports for flower arrangements [semi-finished products]; liquid rubber; synthetic rubber; rubber, raw or semi-worked; valves of india-rubber or vulcanized fiber; clack valves of rubber; rings of rubber; water-tight rings; insu-

lating paints; insulating varnish; latex [rubber]; duct tapes; insulating tapes; adhesive bands, other than stationery and not for medical or household purposes; self-adhesive tapes, other than stationery and not for medical or household purposes; asbestos sheets; weatherstripping compositions; caulking materials; sound-proofing materials; insulating materials; insulating refractory materials; padding materials of rubber or plastics; packing [cushioning, stuffing] materials of rubber or plastics; sealant compounds for joints; filtering materials of semi-processed foams of plastic; filtering materials of semi-processed films of plastic; compositions to prevent the radiation of heat; bags [envelopes, pouches] of rubber, for packaging; pipe muffs, not of metal; threads of plastic for soldering; plastic filaments for 3D printing; threads of rubber, other than for textile use; elastic threads, other than for textile use; door stops of rubber; window stops of rubber; plastic sheeting for agricultural purposes; plastic film, other than for wrapping; anti-dazzle films for windows [tinted films]; gaskets; rubber solutions; acrylic resins, semi-processed; synthetic resins, semi-processed; pipe couplings, not of metal; flexible hoses, not of metal; ebonite molds; watering hose; ebonite; threads of plastic materials, other than for textile use; plastic substances, semi-processed.

20 – Picture frame brackets; reels, not of metal, non-mechanical, for flexible hoses; pulleys of plastics for blinds; bolts, not of metal; casks of wood for decanting wine; mooring buoys, not of metal; casks, not of metal; barrels, not of metal; sideboards; busts of wood, wax, plaster or plastic; costume stands; bolsters; fans for personal use, non-electric; work benches; coatstands; shoulder poles [yokes]; screws, not of metal; display stands; showcases [furniture]; newspaper display stands; jewelry organizer displays; comb foundations for beehives; signboards of wood or plastics; loading gauge rods, not of metal, for railway wagons; nuts, not of metal; covers for clothing [wardrobe]; nesting boxes; coffins; doors for furniture; curtain holders, not of textile material; pegs [pins], not of metal; divans; kennels for household pets; keyboards for hanging keys; display boards; plugs [dowels], not of metal; containers, not of metal, for liquid fuel; troughs, not of metal, for mixing mortar; oil drainage containers, not of metal; packaging containers of plastic; indoor window blinds [furniture]; flower-stands [furniture]; curtain tie-backs; binding screws, not of metal, for cables; clips of plastic for sealing bags; rivets, not of metal; imitation tortoiseshell; locks, not of metal, for vehicles; locks, other than electric, not of metal; bead curtains for decoration; door bolts, not of metal; bottle closures, not of metal; closures, not of metal, for containers; latches, not of metal; mirrors [looking glasses]; hand-held mirrors [toilet mirrors]; registration plates, not of metal; bamboo; scratching posts for cats; animal claws; animal hooves; coral; meerscham; whalebone, unworked or semi-worked; stag antlers; tortoiseshell; shells; horn, unworked or

semi-worked; animal horns; rattan; corozo; plaited straw, except matting; wickerwork; works of art of wood, wax, plaster or plastic; cabinet work; reeds [plaiting materials]; settees; jerrycans, not of metal; curtain rods; index cabinets [furniture]; drain traps [valves] of plastic; water-pipe valves of plastic; valves, not of metal, other than parts of machines; staves of wood; plastic keys; plastic key cards, not encoded and not magnetic; mats for infant playpens; sleeping mats; saw horses; bed casters, not of metal; furniture casters, not of metal; brush mountings; chopping blocks [tables]; wind chimes [decoration]; door bells, not of metal, non-electric; bottle caps, not of metal; cradles; tent pegs, not of metal; curtain rings; split rings, not of metal, for keys; chests of drawers; console tables; containers, not of metal [storage, transport]; floating containers, not of metal; lecterns; dog kennels; bakers' bread baskets; baskets, not of metal; moses baskets; bottle casings of wood; tool boxes, not of metal, empty; faucets, not of metal, for casks; armchairs; hairdressers' chairs; deck chairs; beds; hospital beds; bedsteads of wood; cots for babies; edgings of plastic for furniture; brackets, not of metal, for furniture; screw tops, not of metal, for bottles; table tops; sash fasteners, not of metal, for windows; hooks, not of metal, for clothes rails; curtain hooks; clothes hooks, not of metal; bag hangers, not of metal; beds for household pets; nesting boxes for household pets; ladders of wood or plastics; playpens for babies; mannequins; mattresses; air mattresses, not for medical purposes; furniture of metal; office furniture; school furniture; mobiles [decoration]; door knockers, not of metal; curtain rails; runners, not of metal, for sliding doors; barrel hoops, not of metal; window stops, not of metal or rubber; moldings for picture frames; furniture partitions of wood; freestanding partitions [furniture]; mother-of-pearl, unworked or semi-worked; ambroid plates; identity plates, not of metal; loading pallets, not of metal; handling pallets, not of metal; transport pallets, not of metal; head-rests [furniture]; stakes, not of metal, for plants or trees; trestles [furniture]; magazine racks; book rests [furniture]; stands for calculating machines; flower-pot pedestals; baby changing mats; pet cushions; pillows; cushions; head support cushions for babies; anti-roll cushions for babies; air cushions, not for medical purposes; air pillows, not for medical purposes; head positioning pillows for babies; removable mats or covers for sinks; racks [furniture]; library shelves; shelves for file cabinets; furniture shelves; shelves for storage; wood ribbon; straw edgings; towel stands [furniture]; hat stands; cask stands, not of metal; inflatable publicity objects; counters [tables]; bedding, except linen; corks for bottles; corks; stoppers, not of glass, metal or rubber; sealing caps, not of metal; stair rods; standing desks; embroidery frames; dispensers for dog waste bags, fixed, not of metal; towel dispensers, fixed, not of metal; sections of wood for beehives; crucifixes of wood, wax, plaster or plastic, other than jewelry;

tanks, not of metal nor of masonry; fodder racks; curtain rollers; door handles, not of metal; knobs, not of metal; fishing baskets; writing desks; bath seats for babies; seats of metal; benches [furniture]; vats, not of metal; honeycombs; sofas; bungs, not of metal; statues of wood, wax, plaster or plastic; oyster shells; silvered glass [mirrors]; shelving units; ambroid bars; umbrella stands; gun racks; carts for computers [furniture]; lap desks; dressing tables; washstands [furniture]; tables; typing desks; drafting tables; massage tables; tables of metal; wall-mounted baby changing platforms; desks; portable desks; tea carts; dinner wagons [furniture]; steps [ladders], not of metal; chairs [seats]; high chairs for babies; shower chairs; chests, not of metal; placards of wood or plastics; stools; footstools; crates; trolleys [furniture]; straw plaits; mobile boarding stairs, not of metal, for passengers; straw mattresses; decorations of plastic for foodstuffs; beehives; bathroom vanities [furniture]; door fittings, not of metal; coffin fittings, not of metal; bed fittings, not of metal; furniture fittings, not of metal; window fittings, not of metal; infant walkers; garment covers [storage]; stuffed animals; stuffed birds; hinges, not of metal; chaise longues; poles, not of metal; screens [furniture]; filing cabinets; medicine cabinets; plate racks; meat safes; bamboo curtains; slatted indoor blinds; labels of plastic; lockers; chests for toys; tool chests, not of metal, empty; bottle racks; coat hangers; reels of wood for yarn, silk, cord; trays, not of metal; figurines of wood, wax, plaster or plastic; step stools, not of metal; winding spools, not of metal, non-mechanical, for flexible hoses; letter boxes, not of metal or masonry.

21 – Indoor aquaria; buckets; cookie jars; candle jars [holders]; dishes; paper plates; vegetable dishes; saucers; mugs; boxes for sweets; bottles; demijohns; vases; epergnes; fruit cups; inflatable bath tubs for babies; bird baths; baby baths, portable; plungers for clearing blocked drains; waffle irons, non-electric; diaper disposal pails; coolers [ice pails]; mop wringer buckets; buckets made of woven fabrics; whisks, non-electric, for household purposes; cooking skewers of metal; towel rails and rings; hair for brushes; funnels; carpet beaters [hand instruments]; signboards of porcelain or glass; candle extinguishers; flower pots; chamber pots; glue-pots; cruets; decanters; large-toothed combs for the hair; combs for animals; tea cossies; abrasive sponges for scrubbing the skin; make-up sponges; sponges for household purposes; toilet sponges; sponge holders; stands for portable baby baths; toothpick holders; soap holders; table napkin holders; holders for flowers and plants [flower arranging]; tea bag rests; shaving brush stands; toilet paper holders; soap dispensers; toilet paper dispensers; ironing boards; cutting boards for the kitchen; bread boards; washing boards; strainers for household purposes; smoke absorbers for household purposes; containers for household or kitchen use; kitchen containers; glass jars [carboys]; heat-insulated containers;

heat-insulated containers for beverages; thermally insulated containers for food; glass flasks [containers]; closures for pot lids; chamois leather for cleaning; toothpicks; ceramics for household purposes; majolica; works of art of porcelain, ceramic, earthenware, terra-cotta or glass; kitchen grinders, non-electric; cleaning instruments, hand-operated; cabarets [trays]; stew-pans; covers, not of paper, for flower pots; shaving brushes; birdcages; baking mats; ladles for serving wine; polishing leather; hot pots, not electrically heated; glass bulbs [receptacles]; shoe trees; napkin rings; poultry rings; rings for birds; disposable aluminium foil containers for household purposes; coin banks; piggy banks; bread baskets for household purposes; baskets for household purposes; waste paper baskets; feeding troughs; mangers for animals; lunch boxes; tea caddies; washtubs; earthenware saucepans; mess-tins; cauldrons; coffee percolators, non-electric; coffeepots, non-electric; coffee grinders, hand-operated; fused silica [semi-worked product], other than for building; beer mugs; tankards; rat traps; pot lids; aquarium hoods; butter-dish covers; dish covers; cheese-dish covers; reusable silicone food covers; button-hooks; pitchers; perfume burners; watering cans; insect traps; ice cream scoops; mixing spoons [kitchen utensils]; basting spoons [cooking utensils]; pie servers; spatulas for kitchen use; litter boxes for pets; butter dishes; material for brush-making; polishing materials for making shiny, except preparations, paper and stone; noodle machines, hand-operated; polishing apparatus and machines, for household purposes, non-electric; pepper mills, hand-operated; mills for household purposes, hand-operated; feather-dusters; brooms; isothermic bags; confectioners' decorating bags [pastry bags]; bowls [basins]; pet feeding bowls; mosaics of glass, not for building; saucepan scourers of metal; soap boxes; mouse traps; cooking pot sets; nozzles for watering cans; pouring spouts; wine pourers; cake decorating tips and tubes; nozzles for watering hose; fitted picnic baskets, including dishes; toilet cases; floss for dental purposes; fiberglass thread, other than for textile use; cookie [biscuit] cutters; pastry cutters; sprinklers; syringes for watering flowers and plants; egg yolk separators; cotton waste for cleaning; wool waste for cleaning; cleaning tow; cold packs for chilling food and beverages; chopsticks; cocktail stirrers; pepper pots; gloves for household purposes; polishing gloves; gardening gloves; pestles for kitchen use; droppers for household purposes; droppers for cosmetic purposes; plates to prevent milk boiling over; dripping pans; trays for household purposes; trays of paper, for household purposes; lazy susans; heaters for feeding bottles, non-electric; candelabra [candlesticks]; trivets [table utensils]; coasters, not of paper or textile; grill supports; menu card holders; knife rests for the table; flat-iron stands; egg cups; abrasive pads for kitchen purposes; scouring pads; drinking troughs; serving ladles; pottery; pots; cooking pots; painted glassware; tableware, other than knives,

forks and spoons; porcelain ware; earthenware; crystal [glassware]; cosmetic utensils; toilet utensils; trouser presses; cruet sets for oil and vinegar; make-up removing appliances; spice sets; apparatus for wax-polishing, non-electric; glove stretchers; bootjacks; crumb trays; tie presses; clothes-pegs; glass stoppers; powder compacts, empty; perfume vaporizers; powder puffs; dusting apparatus, non-electric; foam toe separators for use in pedicures; combs; electric combs; grills [cooking utensils]; sifters [household utensils]; drinking horns; shoe horns; candle drip rings; broom handles; salad bowls; sugar bowls; beaters, non-electric; services [dishes]; coffee services [tableware]; liqueur sets; tea services [tableware]; sieves [household utensils]; cinder sifters [household utensils]; tea strainers; siphon bottles for carbonated water; rolling pins, domestic; squeegees [cleaning instruments]; steel wool for cleaning; currycombs; blenders, non-electric, for household purposes; scoops for household purposes; fruit presses, non-electric, for household purposes; drinking straws; salt cellars; drinking vessels; vessels of metal for making ices and iced drinks; refrigerating bottles; cups of paper or plastic; glasses [receptacles]; drinking glasses; statues of porcelain, ceramic, earthenware, terra-cotta or glass; figurines of porcelain, ceramic, earthenware, terra-cotta or glass; glass for vehicle windows [semi-finished product]; plate glass [raw material]; opal glass; glass, unworked or semi-worked, except building glass; opaline glass; glass incorporating fine electrical conductors; glass wool, other than for insulation; vitreous silica fibers, other than for textile use; fiberglass, other than for insulation or textile use; portable cool boxes, non-electric; soup bowls; drying racks for laundry; basins [receptacles]; table plates; disposable table plates; insulating flasks; indoor terrariums [plant cultivation]; indoor terrariums [vivariums]; cloth for washing floors; cloths for cleaning; dusting cloths [rags]; furniture dusters; aerosol dispensers, not for medical purposes; wax-polishing appliances, non-electric, for shoes; water apparatus for cleaning teeth and gums; electric devices for attracting and killing insects; watering devices; utensils for household purposes; kitchen utensils; cooking utensils, non-electric; coffee filters, non-electric; flasks; hip flasks; drinking bottles for sports; boot trees; molds [kitchen utensils]; egg poachers; cake moulds; ice cube molds; cookery moulds; deep fryers, non-electric; comb cases; bread bins; fly swatters; teapots; kettles, non-electric; cups; ironing board covers, shaped; tea infusers; decorative glass spheres; mops; mop wringers; cocktail shakers; cosmetic spatulas; animal bristles [brushware]; brushes; dishwashing brushes; brushes for cleaning tanks and containers; lamp-glass brushes; horse brushes; scrubbing brushes; toothbrushes; toothbrushes, electric; carpet sweepers; brushes for footwear; tar-brushes, long handled; toilet brushes; electric brushes, except parts of machines; eyebrow brushes; nail brushes; nest eggs, artificial; boxes for dispensing paper towels;

dustbins; window-boxes; boxes of glass; busts of porcelain, ceramic, earthenware, terra-cotta or glass; clothing stretchers; cages for household pets; animal grooming gloves; bulb basters.

28 – Toy vehicles; swimming pools [play articles]; trampolines; novelty toys for parties; bodyboards; boomerangs; dolls' feeding bottles; stationary exercise bicycles; creels [fishing traps]; shuttlecocks; spinning tops [toys]; jigsaw puzzles; bite sensors [fishing tackle]; hang gliders; flying discs [toys]; discuses for sports; dolls' houses; playhouses for children; dominoes; swimming kickboards; paddleboards; surfboards; spring boards [sports articles]; skateboards; sailboards; drones [toys]; darts; Christmas trees of synthetic material; cups for dice; swimming jackets; needles for pumps for inflating balls for games; toys; toys for pets; stuffed toys; inflatable games for swimming pools; plush toys; novelty toys for playing jokes; games; parlor games; board games; ring games; building games; toy imitation cosmetics; swimming pool air floats; kaleidoscopes; bladders of balls for games; trading cards for games; fairground ride apparatus; reels for fishing; rocking horses; swings; yoga swings; skittles; skittles [games]; baby gyms; bells for Christmas trees; dolls' rooms; dice; ski bindings; dolls' beds; roulette wheels; fish hooks; building blocks [toys]; dolls; flippers for swimming; fishing lines; gut for fishing; bows for archery; masts for sailboards; targets; toy models; scale model kits [toys]; scale model vehicles; kite reels; balls for games; artificial fishing bait; billiard table cushions; knee guards [sports articles]; elbow guards [sports articles]; pumps specially adapted for use with balls for games; dolls' clothes; play tents; ski sticks for roller skis; ski sticks; paragliders; baseball gloves; boxing gloves; golf gloves; gloves for games; batting gloves [accessories for games]; pinatas; toy pistols; toy air pistols; percussion caps [toys]; caps for pistols [toys]; toy dough; rattles [playthings]; horseshoe games; candle holders for Christmas trees; Christmas tree stands; sole coverings for skis; water wings; floats for fishing; portable games with liquid crystal displays; swimming belts; waist trimmer exercise belts; decoys for hunting or fishing; scent lures for hunting or fishing; archery implements; soap bubbles [toys]; divot repair tools [golf accessories]; billiard markers; protective paddings [parts of sports suits]; rackets; protective cups for sports; surfboard leashes; harness for sailboards; tennis nets; bite indicators [fishing tackle]; fishing tackle; remote-controlled toy vehicles; clay pigeon traps; strings for rackets; golf bags, with or without wheels; cricket bags; golf bag carts; slides [playthings]; rods for fishing; ornaments for Christmas trees, except lights, candles and confectionery; apparatus for games; bowling apparatus and machinery; toy figures; counters [discs] for games; chips for gambling; foosball tables; party poppers [party novelties]; Christmas crackers [party novelties]; bags especially designed for skis and surfboards; marbles for games; bi-

liard balls; playing balls; play balloons; paintballs [ammunition for paintball guns] [sports apparatus]; chess games; checkers [games]; poles for pole vaulting; paper party hats; shin guards [sports articles]; camouflage screens [sports articles]; chest expanders [exercisers]; toy mobiles; flippers for diving; swimming webs; paintball guns [sports apparatus].

35 – Arranging subscriptions to telecommunication services for others; import-export agency services; commercial information agency services; advertising agency services; cost price analysis; rental of advertising space; business auditing; employment agency services; computerized file management; book-keeping; invoicing; demonstration of goods; transcription of communications [office functions]; opinion polling; market studies; business investigations; business research; marketing research; personnel recruitment; business management and organization consultancy; business organization consultancy; business management consultancy; personnel management consultancy; professional business consultancy; consultancy regarding advertising communication strategies; layout services for advertising purposes; marketing services; targeted marketing; business management of performing artists; business management of sports people; updating and maintenance of information in registries; updating and maintenance of data in computer databases; updating of advertising material; word processing; organization of exhibitions for commercial or advertising purposes; arranging newspaper subscriptions for others; organization of fashion shows for promotional purposes; organization of trade fairs; shop window dressing; business appraisals; payroll preparation; data search in computer files for others; sponsorship search; administrative assistance in responding to calls for tenders; business management assistance; commercial or industrial management assistance; commercial intermediation services; providing business information; providing business information via a web site; providing commercial information and advice for consumers in the choice of products and services; providing user reviews for commercial or advertising purposes; web indexing for commercial or advertising purposes; providing user rankings for commercial or advertising purposes; economic forecasting; auctioneering; sales promotion for others; promotion of goods and services through sponsorship of sports events; production of advertising films; office machines and equipment rental; rental of advertising time on communication media; publicity material rental; rental of vending machines; rental of sales stands; publication of publicity texts; radio advertising; development of advertising concepts; distribution of samples; dissemination of advertising matter; direct mail advertising; writing of publicity texts; advertising; online advertising on a computer network; bill-posting; advertising by mail order; television advertising; compilation of statistics; compilation of information into computer databases; bu-

siness inquiries; systemization of information into computer databases; interim business management; administration of consumer loyalty programs; administrative processing of purchase orders; public relations; modelling for advertising or sales promotion; typing; market intelligence services; search engine optimization for sales promotion; gift registry services; price comparison services; procurement services for others [purchasing goods and services for other businesses]; outsourcing services [business assistance]; photocopying services; business efficiency expert services; provision of an online marketplace for buyers and sellers of goods and services; presentation of goods on communication media, for retail purposes; outsourced administrative management for companies.

(260) AM 2022 116261 A

(800) 1639461

(151) 2021 05 26

(891) 2021 05 26

(731) DELLA 1 KİMYA VE KOZMETİK SANAYİ
DİŞ TİCARET LTD. ŞTİ.

Adnan Kahveci Mah., Yavuz Sultan Selim
Bulvarı Çalışlar Cad., Midpoint Residence
D:52, Beylikdüzü İstanbul, Turkey

(540)



(591) Brown, white

(531) 27.05.24; 29.01.12

(511)

31 – Unprocessed agricultural and horticultural products, seeds; forestry products; live animals (including hatching eggs, fertilized eggs); live and dried plants and herbs; animal foods, pet foods; malt (not for human consumption); bedding for domestic animals; cat litter.

(260) AM 2022 116262 A

(800) 1639466

(151) 2021 08 13

(891) 2021 08 13

(731) LED INTELLECTUAL PROPERTIES, LLC

16552 VON KARMAN AVENUE,
IRVINE CA 92606, USA

(540)

LIGHTSTIM

(591) Black, white

(511)

10 – An LED light device used to improve conditions in the body.

(260) AM 2022 116663 A

(800) 1637893

(151) 2021 11 21

(891) 2021 11 21

(731) Raafat MHD Sayah Tarabishi

Akar 21/2013, Main Street, Al-Ahdath,

Kudsaia, Damascus Country side, Syrian

Arab Republic

(540)



(591) Black and yellow

(531) 03.07.03; 28.01; 29.01.12

(511)

43 – Restaurant, cafeterias, self-service restaurants,
food and beverage provision services, temporary ac-
commodation services, hotels, motels.

INTERNATIONAL TRADEMARKS PROTECTED IN GEORGIA

(260) AM 2022 111254 A
(800) 1570189
(151) 2020 07 30
(181) 2030 07 30
(891) 2020 07 30
(511) 18, 20, 35

(260) AM 2022 114077 A
(800) 1603950
(151) 2021 06 28
(181) 2031 06 28
(891) 2021 06 28
(511) 34

(260) AM 2022 111265 A
(800) 1478790
(151) 2019 05 23
(181) 2029 05 23
(891) 2020 10 28
(511) 05, 05

(260) AM 2022 114078 A
(800) 1604013
(151) 2021 06 04
(181) 2031 06 04
(891) 2021 06 04
(511) 33

(260) AM 2022 113666 A
(800) 1598906
(151) 2020 11 26
(181) 2030 11 26
(891) 2020 11 26
(511) 35

(260) AM 2022 114079 A
(800) 1604081
(151) 2021 05 13
(181) 2031 05 13
(891) 2021 05 13
(511) 09

(260) AM 2022 113844 A
(800) 1592029
(151) 2021 03 05
(181) 2031 03 05
(891) 2021 04 13
(511) 36, 42

(260) AM 2022 114083 A
(800) 1604316
(151) 2021 02 03
(181) 2031 02 03
(891) 2021 02 03
(511) 01, 03, 05, 10

(260) AM 2022 114070 A
(800) 1603911
(151) 2021 06 28
(181) 2031 06 28
(891) 2021 06 28
(511) 33

(260) AM 2022 114086 A
(800) 1604391
(151) 2021 01 07
(181) 2031 01 07
(891) 2021 01 07
(511) 05, 10, 41, 42, 44

(260) AM 2022 114075 A
(800) 1603938
(151) 2021 04 30
(181) 2031 04 30
(891) 2021 04 30
(511) 07, 11

(260) AM 2022 114167 A
(800) 1605357
(151) 2021 05 26
(181) 2031 05 26
(891) 2021 05 26
(511) 12

(260) AM 2022 114076 A
(800) 1603940
(151) 2020 12 30
(181) 2030 12 30
(891) 2020 12 30
(511) 03, 05, 10, 44

(260) AM 2022 114168 A
(800) 1605370
(151) 2021 04 23
(181) 2031 04 23
(891) 2021 04 23
(511) 07

(260) AM 2022 114169 A
(800) 1605374
(151) 2021 06 03
(181) 2031 06 03
(891) 2021 06 03
(511) 09

(260) AM 2022 114200 A
(800) 1606252
(151) 2021 04 06
(181) 2031 04 06
(891) 2021 04 06
(511) 29

(260) AM 2022 114170 A
(800) 1605385
(151) 2021 06 01
(181) 2031 06 01
(891) 2021 06 01
(511) 12

(260) AM 2022 114201 A
(800) 1606253
(151) 2021 03 09
(181) 2031 03 09
(891) 2021 03 09
(511) 36

(260) AM 2022 114171 A
(800) 1605490
(151) 2021 04 14
(181) 2031 04 14
(891) 2021 04 14
(511) 29

(260) AM 2022 114202 A
(800) 1606257
(151) 2021 05 20
(181) 2031 05 20
(891) 2021 05 20
(511) 30

(260) AM 2022 114176 A
(800) 1605672
(151) 2021 05 01
(181) 2031 05 01
(891) 2021 05 01
(511) 05

(260) AM 2022 114203 A
(800) 1606259
(151) 2021 01 08
(181) 2031 01 08
(891) 2021 01 08
(511) 01, 04, 09

(260) AM 2022 114178 A
(800) 1605693
(151) 2021 05 01
(181) 2031 05 01
(891) 2021 05 01
(511) 05

(260) AM 2022 114205 A
(800) 1606314
(151) 2021 02 01
(181) 2031 02 01
(891) 2021 02 01
(511) 04

(260) AM 2022 114197 A
(800) 1606172
(151) 2021 03 16
(181) 2031 03 16
(891) 2021 03 16
(511) 19, 20, 35

(260) AM 2022 114206 A
(800) 1606325
(151) 2021 04 19
(181) 2031 04 19
(891) 2021 04 19
(511) 09, 35, 36, 38, 41, 42

(260) AM 2022 114198 A
(800) 1606193
(151) 2021 04 26
(181) 2031 04 26
(891) 2021 04 26
(511) 03

(260) AM 2022 114207 A
(800) 1606391
(151) 2021 04 15
(181) 2031 04 15
(891) 2021 04 15
(511) 01, 04, 31

(260) AM 2022 114214 A
(800) 1473041
(151) 2019 04 26
(181) 2029 04 26
(891) 2021 04 05
(511) 03, 14, 18, 28, 44

(260) AM 2022 114252 A
(800) 1606460
(151) 2021 06 18
(181) 2031 06 18
(891) 2021 06 18
(511) 33

(260) AM 2022 114215 A
(800) 1591519
(151) 2021 02 01
(181) 2031 02 01
(891) 2021 07 19
(511) 03, 05

(260) AM 2022 114253 A
(800) 1606472
(151) 2021 06 18
(181) 2031 06 18
(891) 2021 06 18
(511) 33

(260) AM 2022 114247 A
(800) 1606408
(151) 2021 06 04
(181) 2031 06 04
(891) 2021 06 04
(511) 03, 05, 21

(260) AM 2022 114254 A
(800) 1606483
(151) 2021 06 09
(181) 2031 06 09
(891) 2021 06 09
(511) 03

(260) AM 2022 114248 A
(800) 1606428
(151) 2021 04 08
(181) 2031 04 08
(891) 2021 04 08
(511) 03, 05

(260) AM 2022 114260 A
(800) 1606712
(151) 2021 05 11
(181) 2031 05 11
(891) 2021 05 11
(511) 29, 30

(260) AM 2022 114249 A
(800) 1606429
(151) 2021 04 08
(181) 2031 04 08
(891) 2021 04 08
(511) 03, 05

(260) AM 2022 114261 A
(800) 1606713
(151) 2021 05 11
(181) 2031 05 11
(891) 2021 05 11
(511) 29, 30

(260) AM 2022 114250 A
(800) 1606445
(151) 2021 05 16
(181) 2031 05 16
(891) 2021 05 16
(511) 30

(260) AM 2022 114263 A
(800) 1606776
(151) 2021 05 17
(181) 2031 05 17
(891) 2021 05 17
(511) 32, 33

(260) AM 2022 114251 A
(800) 1606452
(151) 2021 06 09
(181) 2031 06 09
(891) 2021 06 09
(511) 03

(260) AM 2022 114264 A
(800) 1606787
(151) 2021 06 03
(181) 2031 06 03
(891) 2021 06 03
(511) 30

(260) AM 2022 114265 A
(800) 1606801
(151) 2021 02 08
(181) 2031 02 08
(891) 2021 02 08
(511) 03, 04

(260) AM 2022 114282 A
(800) 1607316
(151) 2021 01 08
(181) 2031 01 08
(891) 2021 01 08
(511) 05

(260) AM 2022 114276 A
(800) 1607138
(151) 2021 05 04
(181) 2031 05 04
(891) 2021 05 04
(511) 05

(260) AM 2022 114283 A
(800) 1607331
(151) 2021 07 05
(181) 2031 07 05
(891) 2021 07 05
(511) 03

(260) AM 2022 114277 A
(800) 1607150
(151) 2021 03 17
(181) 2031 03 17
(891) 2021 03 17
(511) 01, 03, 05, 10

(260) AM 2022 114284 A
(800) 1607332
(151) 2021 05 17
(181) 2031 05 17
(891) 2021 05 17
(511) 25

(260) AM 2022 114278 A
(800) 1607153
(151) 2021 04 19
(181) 2031 04 19
(891) 2021 04 19
(511) 09

(260) AM 2022 114285 A
(800) 1607350
(151) 2021 05 17
(181) 2031 05 17
(891) 2021 05 17
(511) 29, 30, 31

(260) AM 2022 114279 A
(800) 1607223
(151) 2021 06 24
(181) 2031 06 24
(891) 2021 06 24
(511) 05, 10

(260) AM 2022 114286 A
(800) 1607411
(151) 2021 05 07
(181) 2031 05 07
(891) 2021 05 07
(511) 05

(260) AM 2022 114280 A
(800) 1607234
(151) 2021 07 01
(181) 2031 07 01
(891) 2021 07 01
(511) 09, 12, 37

(260) AM 2022 114287 A
(800) 1607420
(151) 2021 05 11
(181) 2031 05 11
(891) 2021 05 11
(511) 34

(260) AM 2022 114281 A
(800) 1607252
(151) 2021 07 12
(181) 2031 07 12
(891) 2021 07 12
(511) 28

(260) AM 2022 114288 A
(800) 1607423
(151) 2021 01 22
(181) 2031 01 22
(891) 2021 01 22
(511) 09, 16, 28, 35, 38, 41, 42

(260) AM 2022 114289 A
(800) 1607482
(151) 2021 03 15
(181) 2031 03 15
(891) 2021 03 15
(511) 01, 04, 37

(260) AM 2022 114290 A
(800) 1607525
(151) 2021 04 14
(181) 2031 04 14
(891) 2021 04 14
(511) 09, 35, 36, 42

(260) AM 2022 114291 A
(800) 1607591
(151) 2021 07 12
(181) 2031 07 12
(891) 2021 07 12
(511) 06, 11, 21

(260) AM 2022 114292 A
(800) 1607594
(151) 2021 06 02
(181) 2031 06 02
(891) 2021 06 02
(511) 12

(260) AM 2022 114293 A
(800) 1607668
(151) 2021 03 30
(181) 2031 03 30
(891) 2021 03 30
(511) 30, 31, 32

(260) AM 2022 114294 A
(800) 1607699
(151) 2021 04 15
(181) 2031 04 15
(891) 2021 04 15
(511) 06, 19

(260) AM 2022 114295 A
(800) 1607700
(151) 2020 12 16
(181) 2030 12 16
(891) 2020 12 16
(511) 03, 05, 06, 16, 21, 35

(260) AM 2022 114351 A
(800) 1607959
(151) 2021 04 14
(181) 2031 04 14
(891) 2021 04 14
(511) 09, 35, 36, 42

(260) AM 2022 114352 A
(800) 1607965
(151) 2021 03 26
(181) 2031 03 26
(891) 2021 03 26
(511) 05, 35

(260) AM 2022 114353 A
(800) 1607978
(151) 2021 07 19
(181) 2031 07 19
(891) 2021 07 19
(511) 32, 34

(260) AM 2022 114354 A
(800) 1608003
(151) 2021 04 14
(181) 2031 04 14
(891) 2021 04 14
(511) 09, 35, 36, 42

(260) AM 2022 114355 A
(800) 1608027
(151) 2021 03 26
(181) 2031 03 26
(891) 2021 03 26
(511) 06, 19, 37

(260) AM 2022 114361 A
(800) 1608163
(151) 2021 05 25
(181) 2031 05 25
(891) 2021 05 25
(511) 33

(260) AM 2022 114362 A
(800) 1608194
(151) 2021 05 26
(181) 2031 05 26
(891) 2021 05 26
(511) 11, 40, 42

(260) AM 2022 114363 A
(800) 1608210
(151) 2021 05 16
(181) 2031 05 16
(891) 2021 05 16
(511) 36

(260) AM 2022 114383 A
(800) 1608920
(151) 2021 05 11
(181) 2031 05 11
(891) 2021 05 11
(511) 12

(260) AM 2022 114365 A
(800) 1608334
(151) 2021 07 14
(181) 2031 07 14
(891) 2021 07 14
(511) 05

(260) AM 2022 114384 A
(800) 1608922
(151) 2021 05 11
(181) 2031 05 11
(891) 2021 05 11
(511) 12

(260) AM 2022 114371 A
(800) 1608552
(151) 2021 05 25
(181) 2031 05 25
(891) 2021 05 25
(511) 08, 21

(260) AM 2022 114385 A
(800) 653290
(151) 1996 03 27
(181) 2026 03 27
(891) 2021 07 28
(511) 05

(260) AM 2022 114372 A
(800) 1608554
(151) 2021 05 27
(181) 2031 05 27
(891) 2021 05 27
(511) 03

(260) AM 2022 114427 A
(800) 1609000
(151) 2021 06 08
(181) 2031 06 08
(891) 2021 06 08
(511) 05

(260) AM 2022 114373 A
(800) 1608587
(151) 2021 05 18
(181) 2031 05 18
(891) 2021 05 18
(511) 03, 05

(260) AM 2022 114429 A
(800) 1609075
(151) 2020 12 30
(181) 2030 12 30
(891) 2020 12 30
(511) 30

(260) AM 2022 114375 A
(800) 1608638
(151) 2021 06 02
(181) 2031 06 02
(891) 2021 06 02
(511) 29

(260) AM 2022 114430 A
(800) 1609078
(151) 2021 06 24
(181) 2031 06 24
(891) 2021 06 24
(511) 11

(260) AM 2022 114382 A
(800) 1608906
(151) 2021 06 18
(181) 2031 06 18
(891) 2021 06 18
(511) 33

(260) AM 2022 114431 A
(800) 1609261
(151) 2021 06 17
(181) 2031 06 17
(891) 2021 06 17
(511) 03, 05, 35

(260) AM 2022 114442 A
(800) 1609710
(151) 2021 06 08
(181) 2031 06 08
(891) 2021 06 08
(511) 36

(260) AM 2022 114481 A
(800) 1610275
(151) 2021 02 17
(181) 2031 02 17
(891) 2021 02 17
(511) 09, 14, 18

(260) AM 2022 114443 A
(800) 1609725
(151) 2021 02 01
(181) 2031 02 01
(891) 2021 02 01
(511) 03

(260) AM 2022 114482 A
(800) 1610290
(151) 2021 05 21
(181) 2031 05 21
(891) 2021 05 21
(511) 29, 30

(260) AM 2022 114444 A
(800) 1609726
(151) 2021 05 14
(181) 2031 05 14
(891) 2021 05 14
(511) 19

(260) AM 2022 114513 A
(800) 1611400
(151) 2021 05 28
(181) 2031 05 28
(891) 2021 05 28
(511) 35

(260) AM 2022 114445 A
(800) 1609730
(151) 2021 07 21
(181) 2031 07 21
(891) 2021 07 21
(511) 41, 42

(260) AM 2022 114514 A
(800) 1611402
(151) 2021 07 01
(181) 2031 07 01
(891) 2021 07 01
(511) 19

(260) AM 2022 114478 A
(800) 1610108
(151) 2021 04 23
(181) 2031 04 23
(891) 2021 04 23
(511) 06, 09, 19, 37, 42

(260) AM 2022 114515 A
(800) 1611441
(151) 2021 06 28
(181) 2031 06 28
(891) 2021 06 28
(511) 05, 10, 44

(260) AM 2022 114479 A
(800) 1610244
(151) 2021 03 31
(181) 2031 03 31
(891) 2021 03 31
(511) 35, 36, 42

(260) AM 2022 114516 A
(800) 1611488
(151) 2021 07 09
(181) 2031 07 09
(891) 2021 07 09
(511) 30

(260) AM 2022 114480 A
(800) 1610253
(151) 2021 05 19
(181) 2031 05 19
(891) 2021 05 19
(511) 36, 39

(260) AM 2022 114517 A
(800) 587530
(151) 1992 05 27
(181) 2022 05 27
(891) 2021 08 18
(511) 05

(260) AM 2022 114624 A
(800) 1612651
(151) 2021 06 03
(181) 2031 06 03
(891) 2021 06 03
(511) 30

(260) AM 2022 114632 A
(800) 1613118
(151) 2021 07 22
(181) 2031 07 22
(891) 2021 07 22
(511) 16, 44

(260) AM 2022 114625 A
(800) 1612678
(151) 2021 06 16
(181) 2031 06 16
(891) 2021 06 16
(511) 33

(260) AM 2022 114633 A
(800) 1613136
(151) 2021 07 26
(181) 2031 07 26
(891) 2021 07 26
(511) 09

(260) AM 2022 114626 A
(800) 1612781
(151) 2021 03 26
(181) 2031 03 26
(891) 2021 03 26
(511) 32

(260) AM 2022 114634 A
(800) 1613220
(151) 2021 08 03
(181) 2031 08 03
(891) 2021 08 03
(511) 05, 31

(260) AM 2022 114627 A
(800) 1612798
(151) 2021 06 04
(181) 2031 06 04
(891) 2021 06 04
(511) 06, 21, 42

(260) AM 2022 114700 A
(800) 1614222
(151) 2021 04 07
(181) 2031 04 07
(891) 2021 04 07
(511) 03, 05, 16

(260) AM 2022 114628 A
(800) 1613025
(151) 2021 04 21
(181) 2031 04 21
(891) 2021 04 21
(511) 35

(260) AM 2022 114773 A
(800) 1615570
(151) 2021 04 22
(181) 2031 04 22
(891) 2021 04 22
(511) 09, 25

(260) AM 2022 114629 A
(800) 1613029
(151) 2021 06 12
(181) 2031 06 12
(891) 2021 06 12
(511) 34

(260) AM 2022 114774 A
(800) 1615647
(151) 2021 06 08
(181) 2031 06 08
(891) 2021 06 08
(511) 39

(260) AM 2022 114631 A
(800) 1613069
(151) 2021 06 07
(181) 2031 06 07
(891) 2021 06 07
(511) 35, 36, 42

(260) AM 2022 114775 A
(800) 1615652
(151) 2021 05 05
(181) 2031 05 05
(891) 2021 05 05
(511) 05

(260) AM 2022 114776 A
(800) 1615661
(151) 2021 05 19
(181) 2031 05 19
(891) 2021 05 19
(511) 30

(260) AM 2022 114887 A
(800) 1281464
(151) 2015 07 16
(181) 2025 07 16
(891) 2021 09 14
(511) 06, 07, 09, 11

(260) AM 2022 114777 A
(800) 1615711
(151) 2021 06 18
(181) 2031 06 18
(891) 2021 06 18
(511) 02

(260) AM 2022 114888 A
(800) 1325445
(151) 2016 10 28
(181) 2026 10 28
(891) 2021 09 13
(511) 05

(260) AM 2022 114778 A
(800) 1615712
(151) 2021 08 13
(181) 2031 08 13
(891) 2021 08 13
(511) 09

(260) AM 2022 114889 A
(800) 1375737
(151) 2017 09 01
(181) 2027 09 01
(891) 2021 09 21
(511) 21

(260) AM 2022 114779 A
(800) 1615835
(151) 2021 05 17
(181) 2031 05 17
(891) 2021 05 17
(511) 03, 05

(260) AM 2022 114890 A
(800) 1482529
(151) 2018 10 24
(181) 2028 10 24
(891) 2021 09 01
(511) 09, 35, 36, 38, 42, 45

(260) AM 2022 114882 A
(800) 1225924
(151) 2014 06 18
(181) 2024 06 18
(891) 2021 09 17
(511) 01, 17

(260) AM 2022 114891 A
(800) 1491039
(151) 2019 06 24
(181) 2029 06 24
(891) 2021 09 16
(511) 35, 36

(260) AM 2022 114885 A
(800) 1275008
(151) 2015 07 20
(181) 2025 07 20
(891) 2021 09 05
(511) 33

(260) AM 2022 114892 A
(800) 1491341
(151) 2018 10 16
(181) 2028 10 16
(891) 2021 09 01
(511) 09, 35, 36, 38, 42, 45

(260) AM 2022 114886 A
(800) 1280409
(151) 2015 06 26
(181) 2025 06 26
(891) 2021 09 14
(511) 06, 07, 09, 11

(260) AM 2022 114893 A
(800) 1522863
(151) 2020 02 05
(181) 2030 02 05
(891) 2021 08 13
(511) 05

APPELLATIONS OF ORIGIN AND GEOGRAPHICAL INDICATIONS OF GOODS

REGISTERED APPELLATIONS OF ORIGIN OF GOODS

(111) 982
(151) 2022 08 30
(540)

ზეგაანი

(732) N(N)LE "Zegaani"
Village Zegaani, Gurjaani Region, Georgia
(511) 33

(111) 983
(151) 2022 08 30
(540)

ოყურეშის უსახელოური

(732) Usakhelouri Vine & Wine Protection Association, Tsageri Municipality, Village Okureshi, Georgia
(511) 33

REGISTERED GEOGRAPHICAL INDICATION

(111) 25
(151) 2022 08 30
(540)

ქართული დაფნა

(732) The Ministry of Environmental Protection and Agriculture of Georgia; Marshal Gelovani Ave. №6, 0159, Tbilisi, Georgia
(511) 30

**OFFICIAL NOTIFICATIONS
INVENTIONS
RESTORATION OF PATENTS**

(21) AP 2010 11695
(11) P 2011 5360 B
(73) Vazha Khositashvili
(54) VEGETATIVE GATHERING – ANTIOXIDANT, ANTIRADIATION AND FOR TREATMENT OF
CARDIOVASCULAR DISEASES AND MEDICAL MEANS ON ITS BASIS
DATE OF PATENT CANCELLATION: 2022 02 23
DATE OF PATENT RESTORATION: 2022 09 12

(21) AP 2010 11696
(11) P 2011 5361 B
(73) Vazha Khositashvili
Levanᄁ Khositashvili
Babri Oreni
(54) PREPARATION - ANTIOXIDANT, ANTIRADIATION, REGULATING LIPIDIC EXCHANGE AND
PREPARATION FOR TREATMENT OF CARDIOVASCULAR DISEASES
DATE OF PATENT CANCELLATION: 2022 02 23
DATE OF PATENT RESTORATION: 2022 09 12

(21) AP 2018 14846
(11) P 2020 7135 B
(73) LEPL "Shota Rustaveli National Science Foundation of Georgia";
Teona Ghvinianidze;
Papuna Chikovani;
Temur Ghvinianidze;
Akaki Tsereteli State University
(54) ANTIOXIDANT FOOD CONCENTRATE
DATE OF PATENT CANCELLATION: 2022 08 01
DATE OF PATENT RESTORATION: 2022 09 12

(21) AP 2020 15403
(11) P 2021 7322 B
(73) LTD "National Center for High Technology of Georgia"
(54) METHOD FOR DETERMINATION OF OXYGEN-17 ISOTOPE ATOMIC FRACTION IN MOLECULAR
OXYGEN
DATE OF PATENT CANCELLATION: 2022 08 04
DATE OF PATENT RESTORATION: 2022 09 12

(21) AP 2020 15404
(11) P 2021 7321 B
(73) LTD "National Center for High Technology of Georgia"
(54) MASS-SPECTROMETRIC METHOD FOR DETERMINATION OF CARBON-13 ISOTOPE ATOMIC
FRACTION DIRECTLY IN SALICYLIC ACID
DATE OF PATENT CANCELLATION: 2022 08 04
DATE OF PATENT RESTORATION: 2022 09 12

ABOLITION OF PATENTS WITH THE RIGHT TO RESTORE

(21) AP 2010 12614
(11) P 2016 6419 B
(73) Geox S.P.A.
(54) VAPOR-PERMEABLE SHOE
DATE OF PATENT CANCELLATION: 2022 08 04
LIMITED DATE OF PATENT RESTORATION: 2023 08 04

(21) AP 2010 12630
(11) P 2016 6420 B
(73) Geox S.P.A.
(54) INSERT FOR VAPOR-PERMEABLE AND WATERPROOF SOLES
DATE OF PATENT CANCELLATION: 2022 08 04
LIMITED DATE OF PATENT RESTORATION: 2023 08 04

(21) AP 2014 13542
(11) P 2017 6658 B
(73) Eter Kemertelidze;
 Mariam Benidze;
 Alexander Skhirtladze
(54) METHOD FOR RECEIVING PLANT GROWTH-PROMOTING FACTOR "ALEXIN"
DATE OF PATENT CANCELLATION: 2022 08 05
LIMITED DATE OF PATENT RESTORATION: 2023 08 05

(21) AP 2014 13545
(11) P 2016 6497 B
(73) Endi Tumanishvili;
 Vazha Jamarjashvili
(54) HYDROPOWER UNIT WITH VARIABLE SCORE
DATE OF PATENT CANCELLATION: 2022 08 06
LIMITED DATE OF PATENT RESTORATION: 2023 08 06

(21) AP 2014 14100
(11) P 2019 7053 B
(73) Macrogenics Inc.
(54) BI-SPECIFIC MONOVALENT DIABODIES THAT ARE CAPABLE OF BINDING CD123 AND CD3,
 AND USES THEROF
DATE OF PATENT CANCELLATION: 2022 08 20
LIMITED DATE OF PATENT RESTORATION: 2023 08 20

(21) AP 2014 14103
(11) P 2018 6905 B
(73) Merck Sharp & Dohme Corp.
(54) MODULATION OF TUMOR IMMUNITY
DATE OF PATENT CANCELLATION: 2022 08 18
LIMITED DATE OF PATENT RESTORATION: 2023 08 18

(21) AP 2015 14450
(11) P 2021 7331 B
(73) Merck Sharp & Dohme Corp.
(54) ANTI-TIGIT ANTIBODIES

DATE OF PATENT CANCELLATION: 2022 08 17
LIMITED DATE OF PATENT RESTORATION: 2023 08 17

(21) AP 2016 14726
(11) P 2020 7182 B
(73) Merck Sharp & Dohme Corp.
(54) CYCLIC DI-NUCLEOTIDE COMPOUNDS AS STING AGONISTS
DATE OF PATENT CANCELLATION: 2022 08 11
LIMITED DATE OF PATENT RESTORATION: 2023 08 11

(21) AP 2016 14730
(11) P 2020 7071 B
(73) Sergey Dmitrievich Filipov
(54) HYDROGEN-ENRICHED WATER WITH INCREASED ANTIOXIDANT ACTIVITY AND PREPARATION METHODS THEREOF
DATE OF PATENT CANCELLATION: 2022 08 08
LIMITED DATE OF PATENT RESTORATION: 2023 08 08

(21) AP 2018 14846
(11) P 2020 7135 B
(73) LEPL "Shota Rustaveli National Science Foundation of Georgia";
Teona Ghvinianidze;
Papuna Chikovani;
Temur Ghvinianidze;
Akaki Tsereteli State University
(54) ANTIOXIDANT FOOD CONCENTRATE
DATE OF PATENT CANCELLATION: 2022 08 01
LIMITED DATE OF PATENT RESTORATION: 2024 08 01

(21) AP 2018 14849
(11) P 2020 7123 B
(73) LTD "Scientific-Industrial Union Composite Materials"
(54) METHOD FOR CLADDING OF NANOSTRUCTURAL POWDER MATERIALS AND THEIR MIXTURE
DATE OF PATENT CANCELLATION: 2022 08 03
LIMITED DATE OF PATENT RESTORATION: 2023 08 03

(21) AP 2018 14850
(11) P 2020 7115 B
(73) LTD "Scientific-Industrial Union Composite Materials"
(54) METHOD FOR OBTAINING METALLIC COPPER FROM INDUSTRIAL WASTEWATER
DATE OF PATENT CANCELLATION: 2022 08 03
LIMITED DATE OF PATENT RESTORATION: 2023 08 03

(21) AP 2020 15403
(11) P 2021 7322 B
(73) LTD "National Center for High Technology of Georgia"
(54) METHOD FOR DETERMINATION OF OXYGEN-17 ISOTOPE ATOMIC FRACTION IN MOLECULAR OXYGEN
DATE OF PATENT CANCELLATION: 2022 08 04
LIMITED DATE OF PATENT RESTORATION: 2024 08 04

(21) AP 2020 15404
(11) P 2021 7321 B
(73) LTD "National Center for High Technology of Georgia"
(54) MASS-SPECTROMETRIC METHOD FOR DETERMINATION OF CARBON-13 ISOTOPE ATOMIC FRACTION DIRECTLY IN SALICYLIC ACID
DATE OF PATENT CANCELLATION: 2022 08 04
LIMITED DATE OF PATENT RESTORATION: 2024 08 04

EXPIRATION OF DATE OF PATENTS RESTORATION

(21) AP 2007 10228
(11) P 2009 4695 B
(73) NanaTsiklauri
(54) ALCOHOLIC BEVERAGE
DATE OF PATENT CANCELLATION: 2021 08 14
DATE OF PATENT RESTORATION EXPIRATION: 2022 08 14

(21) AP 2009 11400
(11) P 2011 5344 B
(73) Les Laboratoires Servier
(54) NEW PROCESS FOR SYNTHESIS OF AGOMELATINE
DATE OF PATENT CANCELLATION: 2021 08 03
DATE OF PATENT RESTORATION EXPIRATION: 2022 08 03

(21) AP 2009 11401
(11) P 2011 5345 B
(73) Les Laboratoires Servier
(54) NEW PROCESS FOR SYNTHESIS OF AGOMELATINE
DATE OF PATENT CANCELLATION: 2021 08 03
DATE OF PATENT RESTORATION EXPIRATION: 2022 08 03

(21) AP 2009 11402
(11) P 2012 5408 B
(73) Les Laboratoires Servier
(54) NEW METHOD FOR OBTAINING CRYSTAL FORM V OF AGOMELATINE
DATE OF PATENT CANCELLATION: 2021 08 03
DATE OF PATENT RESTORATION EXPIRATION: 2022 08 03

(21) AP 2009 11403
(11) P 2012 5512 B
(73) Les Laboratoires Servier
(54) NEW PROCESS FOR SYNTHESIS OF AGOMELATINE
DATE OF PATENT CANCELLATION: 2021 08 03
DATE OF PATENT RESTORATION EXPIRATION: 2022 08 03

(21) AP 2008 11699
(11) P 2012 5586 B
(73) Les Laboratoires Servier
(54) NOVEL METHOD FOR SYNTHESIS OF (7-METHOXY-L-NAPHTHYL)-ACETONITRILE AND APPLICATION THEREOF IN SYNTHESIS OF AGOMELATINE

DATE OF PATENT CANCELLATION: 2021 08 01
DATE OF PATENT RESTORATION EXPIRATION: 2022 08 01

(21) AP 2014 13553
(11) P 2016 6584 B
(73) Zurab Dzneladze
(54) METHOD FOR IODIZED CONCENTRATE PRODUCTION
DATE OF PATENT CANCELLATION: 2021 08 18
DATE OF PATENT RESTORATION EXPIRATION: 2022 08 18

(21) AP 2016 14233
(11) P 2017 6750 B
(73) LEPL "Rapiel Dvali Institute of Mechanics of Mechanics"
(54) METHOD AND DEVICE FOR EXTRACTION BIOLOGICALLY ACTIVE SUBSTANCES FROM PLANT
RAW MATERIAL WITH USAGE OF NON TRADITIONAL TECHNOLOGIES
DATE OF PATENT CANCELLATION: 2021 08 02
DATE OF PATENT RESTORATION EXPIRATION: 2022 08 02

(21) AP 2004 9292
(11) P 2008 4469 B
(73) Perma-Fix Environmental Services Inc.;
Sbr Technologies Inc.
(54) METHOD FOR TREATMENT OF CHEMICAL AGENT HYDROLYSATES
DATE OF PATENT CANCELLATION: 2021 08 16
DATE OF PATENT RESTORATION EXPIRATION: 2022 08 16

(21) AP 2006 9558
(11) P 2009 4576 B
(73) Les Laboratoires Servier
(54) NEW CYRSTALLINE FORM III OF AGOMELATINE, A PROCESS FOR ITS PREPARATION AND
PHARMACEUTICAL COMPOSITIONS CONTAINING IT
DATE OF PATENT CANCELLATION: 2021 08 02
DATE OF PATENT RESTORATION EXPIRATION: 2022 08 02

(21) AP 2006 9559
(11) P 2009 4577 B
(73) Les Laboratoires Servier
(54) NEW CRYSTALLINE FORM IV OF AGOMELATINE, A PROCESS FOR ITS PREPARATION AND
PHARMACEUTICAL COMPOSITIONS CONTAINING IT
DATE OF PATENT CANCELLATION: 2021 08 02
DATE OF PATENT RESTORATION EXPIRATION: 2022 08 02

(21) AP 2006 9560
(11) P 2009 4652 B
(73) Les Laboratoires Servier
(54) NEW CYRSTALLINE FORM V OF AGOMELATINE, A PROCESS FOR ITS PREPARATION AND
PHARMACEUTICAL COMPOSITIONS CONTAINING IT
DATE OF PATENT CANCELLATION: 2021 08 02
DATE OF PATENT RESTORATION EXPIRATION: 2022 08 02

CHANGES OF NAME AND/OR ADDRESS OF PATENT OWNER

(21) AP 2014 13592
(11) P 2016 6516 B
(54) COMPOSITION OF INGREDIENTS FOR BIOACTIVE SUPPLEMENT "GRAIL"
NEW NAME AND ADDRESS OF PATENT OWNER: LTD "Botanisti" (GE)
R. Tabukashvili St. 47, 0108, Tbilisi, Georgia (GE)
FORMER NAME AND ADDRESSES OF PATENT OWNER: LTD "Georgian Natural Product"
R. Tabukashvili St. 47, 0108, Tbilisi, Georgia (GE)
DATE OF REGISTRATION: 2022 09 01

TRANSFER OF RIGHTS

(21) AP 2011 13043
(11) P 2017 6728 B
(54) NOXIOUS ORGANISM CONTROL AGENT
NEW NAME AND ADDRESS OF PATENT OWNER: MMAG Co., LTD. (JP)
1-19-1, Nihonbashi, Chuo-ku, Tokyo, 1030027, Japan (JP)
FORMER NAME AND ADDRESSES OF PATENT OWNER: Meiji Seika Pharma Co., LTD.
4-16, Kyobashi 2-chome, Chuo-ku, Tokyo
1030027, Japan (JP)
DATE OF REGISTRATION: 2022 08 31

(21) AP 2013 13585
(11) P 2019 6964 B
(54) PEST CONTROL COMPOSITION INCLUDING NOVEL IMINOPYRIDINE DERIVATIVE
NEW NAME AND ADDRESS OF PATENT OWNER: MMAG Co., LTD. (JP)
1-19-1, Nihonbashi, Chuo-ku, Tokyo, 1030027, Japan (JP)
FORMER NAME AND ADDRESSES OF PATENT OWNER: Meiji Seika Pharma Co., LTD.
4-16, Kyobashi 2-chome, Chuo-ku, Tokyo
1030027, Japan (JP)
DATE OF REGISTRATION: 2022 08 31

UTILITY MODELS RESTORATION OF PATENT

(21) AU 2015 13872
(11) U 2016 1898 Y
(73) Giorgi Jighauri
(54) METHOD FOR KAKHETIAN TATARA PREPARATION
DATE OF PATENT CANCELLATION: 2021 06 30
DATE OF PATENT RESTORATION: 2022 09 12

ABOLITION OF PATENTS WITH THE RIGHT TO RESTORE

(21) AU 2016 14246

(11) U 2017 1944 Y

(73) Zurab Dzneladze;

Berdia Elgujauri;

Guram Iobishvili;

Nani Dzneladze

(54) METHOD FOR IODIZED ENRICH PEKOE (BLACK, GREEN, RED, YELLOW) TEA PRODUCTION

DATE OF PATENT CANCELLATION: 2022 08 18

LIMITED DATE OF PATENT RESTORATION: 2023 08 18

(21) AU 2017 14570

(11) U 2018 1990 Y

(73) G. Eliava Institute of Bacteriophagy, Microbiology and Virusology;

Tara Gabisonia

(54) METHOD FOR BACTERIOPHAGE DRUGS PREPARATION TO USE THEREIN VETERINARY
MEDICINE

DATE OF PATENT CANCELLATION: 2022 08 16

LIMITED DATE OF PATENT RESTORATION: 2023 08 16

(21) AU 2020 15406

(11) U 2021 2084 Y

(73) Nona Dadvani

(54) VINEYARD POLE

DATE OF PATENT CANCELLATION: 2022 08 09

LIMITED DATE OF PATENT RESTORATION: 2023 08 09

EXPIRATION OF DATE OF PATENT RESTORATION

(21) AU 2013 13201

(11) U 2014 1815 Y

(73) Archil Ghaghanidze;

Shalva Kandelaki;

Dimitri Lominadze

(54) METHOD OF QUICKLY IGNITING AND SMOOTHLY BURNING COAL BRIQUETTE PRODUCTION

DATE OF PATENT CANCELLATION: 2021 08 21

DATE OF PATENT RESTORATION EXPIRATION: 2022 08 21

TRANSFER OF RIGHT

(21) AU 2021 15548

(11) U 2022 2104 Y

(54) ADVERTISING EQUIPMENT

NEW NAME AND ADDRESS OF PATENT OWNER: LTD "Novation" (GE)

Gigo Zaziashvili St. 47, 0102, Tbilisi, Georgia (GE)

FORMER NAME AND ADDRESS OF PATENT OWNER: Mukheil Siradze (GE)

Gigo Zaziashvili St. 47, 0102, Tbilisi, Georgia (GE);

Kakha Simonidze (GE)

Dgebuaдзе St. 8, 0102, Tbilisi, Georgia (GE)

DATE OF REGISTRATION: 2022 08 31

DESIGNS

EXTENSION OF TERMS OF DESIGN REGISTRATION

(11) D 2013 537 S

(73) Gia Gamtkitsulashvili (GE)

Vazha-Pshavela Av. 71, app. 7, 0186, Tbilisi, Georgia (GE);

Gela Gamtkitsulashvili (GE)

Tbilisi Av. 3, app. 8, 2200, Telavi, Georgia (GE)

(54) QVEVRI

(28) 1

(24) 2012 08 17

(18) 2027 08 17

(58) 2022 09 01

CANCELLATION OF DESIGNS REGISTRATION

(11) D 2012 521 S

(73) LTD "Agro Invest" (GE)

Davit Aghmashenebeli Av. 20, 0102, Tbilisi, Georgia (GE) (GE)

(54) INSECT-TRAP

(18) 2022 02 16

(58) 2022 09 01

(11) D 2017 728 S

(73) Nino Dumbadze (GE)

Z. Paliashvili St. 66, app. 3, 0179, Tbilisi, Georgia (GE)

(54) JIGULINE

(18) 2022 02 06

(58) 2022 08 23

(11) D 2017 729 S
(73) Nino Dumbadze (GE)
Z. Paliashvili St. 66, app. 3, 0179, Tbilisi, Georgia (GE)
(54) JIGULINE
(18) 2022 02 06
(58) 2022 08 23

(11) D 2017 726 S
(73) Mikheil Panjikidze (GE)
M. Tamarashvili St. 10, 0162, Tbilisi, Georgia (GE)
(54) CASING FOR BUSINESS CARDS, FLYERS OR MOBILE PHONES
(18) 2022 02 08
(58) 2022 09 01

(11) D 2017 725 S
(73) Giorgi Osipovi (GE)
Gali St. 10, 0179, Tbilisi, Georgia (GE)
(54) TILE
(18) 2022 02 13
(58) 2022 08 23

(11) D 2017 700 S
(73) Rudolf Asaturovi (GE)
Tskneti St., bld. 14, app. 38, 0162, Tbilisi, Georgia (GE)
(54) ORNAMENTAL ARTICLE
(18) 2022 02 14
(58) 2022 08 22

EXTENSION OF TERMS OF INTERNATIONAL DESIGN REGISTRATION

(11) DM/69447
(73) SWISS KUBIK SA
Grand-Rue 13, CH-1204 Genève (CH)
(15) 2007 10 22
(24) 2007 10 22
(18) 2027 10 22
(28) 2
(28') 2
(54) WATCH WINDING MECHANISMS

(11) DM/78834
(73) SOREMARTEC S.A.
Rue Joseph Netzer 5, B-6700 ARLON (BX)
(15) 2012 07 06
(24) 2012 07 06
(18) 2027 07 06
(28) 2
(28') 2
(54) BOXES

(11) DM/78886
(73) SOREMARTEC S.A.
Rue Joseph Netzer 5, B-6700 ARLON (BX)
(15) 2012 07 27
(24) 2012 07 27
(18) 2027 07 27
(28) 15

(28') 7
(54) BOTTLE, BOXES, CONTAINER [PACKAGING], CONTAINERS [PACKAGING], PACKAGINGS

(11) DM/79124
(73) HANS GEORG HAGLEITNER
Lindenallee 11, A-5700 Zell am See (EM)
(15) 2012 07 31
(24) 2012 07 31
(18) 2027 07 31
(28) 8
(28') 8
(54) 1.-2. SOAP DISPENSERS, 3.-4. TOWEL DISPENSERS; 5.-6. TOILET PAPER DISPENSERS;
7.- 8. TOWEL DISPENSERS WITH BIN

(11) DM/79151
(73) SWISS KUBIK SA
Grand-Rue 13, CH-1204 Genève (CH)
(15) 2012 08 29
(24) 2012 08 29
(18) 2027 08 29
(28) 1

(28') 1
(54) WATCH WINDING BOX WITH ROTOR

(11) DM/97355
(73) TISSOT SA (TISSOT AG) (TISSOT LTD)
Chemin des Tourelles 17, CH-2400 Le Locle (CH)
(15) 2017 08 09
(24) 2017 08 09
(18) 2027 08 09
(28) 4
(28') 4
(54) 1.-4. LOGOS TO BE AFFIXED TO ALL MEDIA

(11) DM/97537
(73) TISSOT SA (TISSOT AG) (TISSOT LTD)
Chemin des Tourelles 17, CH-2400 Le Locle (CH)
(15) 2017 08 29
(24) 2017 08 29
(18) 2027 08 29
(28) 9
(28') 9
(54) 1. WATCH CASE WITH STRAP, 2. WATCH CASE, 3.-6. WATCH DIALS, 7. WATCH FLANGE,
8. WATCH CASE, 9. WATCH CASE WITH STRAP

(11) DM/98229
(73) MAGNISENSE SE
16 avenue Hoche, F-75008 PARIS (FR)
(15) 2017 07 19
(24) 2017 07 19
(18) 2027 07 19
(28) 2

(28) 1
(54) HOUSING WITH AN INTEGRATED TEST STRIP FOR DIAGNOSIS FOR MEDICAL, ETERINARY
OR NON-MEDICAL USE, READER FOR MEDICAL OR NON-MEDICAL DIAGNOSTIC USE

CANCELLATION OF INTERNATIONAL DESIGNS REGISTRATION

(11) DM/88575
(73) IPEK KAGIT SANAYI VE TICARET ANONIM SIRKETI
Kanyon Ofis Buyukdere Caddesi No: 185, TR-34394 Istanbul (TR)
DATE OF REGISTRATION CANCELLATION: 2020 12 01
(58) 2022 08 18

(11) DM/88701
(73) GUCCIO GUCCI S.P.A.
Via Tornabuoni, 73/R, I-50123 FIRENZE (IT)
DATE OF REGISTRATION CANCELLATION: 2020 12 14
(58) 2022 08 18

(11) DM/88744
(73) SCHREDER, SOCIÉTÉ ANONYME
Rue de Lusambo 67, B-1190 Brussels (EM)
DATE OF REGISTRATION CANCELLATION: 2020 12 17
(58) 2022 08 18

(11) DM/88754
(73) PATROIS GUILLAUME
55 avenue Marceau, F-75016 Paris (FR)
DATE OF REGISTRATION CANCELLATION: 2020 08 14
(58) 2022 08 18

(11) DM/88755
(73) PATROIS GUILLAUME
55 avenue Marceau, F-75016 Paris (FR)
DATE OF REGISTRATION CANCELLATION: 2020 09 09
(58) 2022 08 18

(11) DM/88767
(73) VALENTINO S.P.A.
Via Turati, 16/18, I-20121 MILANO (EM)
DATE OF REGISTRATION CANCELLATION: 2020 12 21
(58) 2022 08 18

(11) DM/88768
(73) VALENTINO S.P.A.
Via Turati, 16/18, I-20121 MILANO (EM)
DATE OF REGISTRATION CANCELLATION: 2020 12 21
(58) 2022 08 18

(11) DM/88769
(73) VALENTINO S.P.A.
Via Turati, 16/18, I-20121 MILANO (EM)
DATE OF REGISTRATION CANCELLATION: 2020 12 21
(58) 2022 08 18

(11) DM/88792
(73) BAYADERA MANAGEMENT LIMITED
Karpenisiou, 30, P.C., CY-1660 Nicosia (CY)
DATE OF REGISTRATION CANCELLATION: 2020 10 09
(58) 2022 08 18

(11) DM/88864
(73) PATROIS GUILLAUME
55 avenue Marceau, F-75016 Paris (FR)
DATE OF REGISTRATION CANCELLATION: 2020 04 10
(58) 2022 08 18

TRADEMARKS

EXTENSION OF TERMS OF REGISTRATION

(111) M 2002 14605 R2
(156) 2002 09 13
(186) 2032 09 13
(732) JSC "Nobel Ilac Sanayii Ve Ticaret Anonim
Sirketi" Representative in Georgia
Freedom Square 4, 0105, Tbilisi, Georgia

(111) M 2002 14607 R2
(156) 2002 09 13
(186) 2032 09 13
(732) JSC "Nobel Ilac Sanayii Ve Ticaret Anonim
Sirketi" Representative in Georgia
Freedom Square 4, 0105, Tbilisi, Georgia

(111) M 2002 14596 R2
(156) 2002 08 15
(186) 2032 08 15
(732) Bushnell Inc.
9200 Cody, Overland Park, Kansas 66214,
USA

(111) M 2011 22146 R1
(156) 2011 12 29
(186) 2031 12 29
(732) Harrington Business Inc.
4th Floor, RJT Edifice, Waterfront Drive,
P.O. Box 260, Road Town, Tortola, Virgin
Islands (British)

(111) M 2012 22917 R1
(156) 2012 08 30
(186) 2032 08 30
(732) Popeyes Louisiana Kitchen Inc.
A Minnesota Corporation
5707 Blue Lagoon Drive, Miami, Florida
33126, USA

(111) M 2012 22918 R1
(156) 2012 08 30
(186) 2032 08 30
(732) Popeyes Louisiana Kitchen Inc.
A Minnesota Corporation
5707 Blue Lagoon Drive, Miami, Florida
33126, USA

COMPLETE TRANSFER OF RIGHTS

(111) M 2022 35199 R
(732) Fang Bo
Pridon Khalvashi St. 18, 6000, Batumi,
Georgia
(770) LTD "Fanshin Trade Limited Company"
Pridon Khalvashi St. 18, 6000, Batumi,
Georgia
(580) 2022 08 04

(111) M 2015 26218 R
(732) EL Corte Inglés S.A.
Hermosilla, 112, 28009, Madrid, Spain
(770) Sfera Joven, S.A.
Hermosilla, 112. 28009 Madrid, Spain
(580) 2022 08 25

CANCELLATION OF TRADEMARKS REGISTRATION

(111) M 2002 14287 R
(151) 2002 02 18
(732) Harrington Development Inc.
Elvira Mendez Street, Vallarino bldg.,
3rd Floor, Panama, Republic of Panama
(141) 2022 08 29

(111) M 2002 14310 R
(151) 2002 02 18
(732) Mars Incorporated (a Delaware corporation)
6885 Elm Street, McLean, Virginia
22101-3883, USA
(141) 2022 08 29

(111) M 2002 14294 R
(151) 2002 02 18
(732) Bayer Consumer Care AG
Peter Merian-Strasse 84, 4002 Basel,
Switzerland
(141) 2022 08 29

(111) M 2002 14295 R
(151) 2002 02 18
(732) N.V. Organon
Kloosterstraat 6, 5349 AB Oss, Netherlands
(141) 2022 08 29

(111) M 2002 14296 R
(151) 2002 02 18
(732) MSD International Holdings GmbH
Veystrasse 20, CH-6000, Lucerne 6,
Switzerland
(141) 2022 08 29

(111) M 2002 14299 R
(151) 2002 02 18
(732) Bayer Consumer Care AG
Peter Merian-Strasse 84, 4002 Basel,
Switzerland
(141) 2022 08 29

(111) M 2002 14300 R
(151) 2002 02 18
(732) N.V. Organon
Kloosterstraat 6, 5349 AB Oss, Netherlands
(141) 2022 08 29

(111) M 2002 14301 R
(151) 2002 02 18
(732) MSD International Holdings GmbH
Veystrasse 20, CH-6000, Lucerne 6,
Switzerland
(141) 2022 08 29

(111) M 2002 14311 R
 (151) 2002 02 18
 (732) Pioneer Investment Management USA Inc.
 60 State Street, Boston, Massachusetts
 02109, USA
 (141) 2022 08 29

(111) M 2002 14312 R
 (151) 2002 02 18
 (732) Pioneer Investment Management USA Inc.
 60 State Street, Boston, Massachusetts
 02109, USA
 (141) 2022 08 29

(111) M 2002 14327 R
 (151) 2002 02 18
 (732) Ursa Sas
 3, rue Joseph Monier, 92500 Rueil Melmaison,
 France
 (141) 2022 08 29

(111) M 2012 22309 R
 (151) 2012 02 23
 (732) Valerian Tabaghua
 Ul. Zemlyanoy Val. 46, B. 25, Moskow,
 Russian Federation
 (141) 2022 09 01

(111) M 2012 22312 R
 (151) 2012 02 23
 (732) Aleksandre Kavtaradze
 Varketili 3, II m/r., bld. 14, app. 96, 0163,
 Tbilisi, Georgia
 (141) 2022 08 31

(111) M 2012 22314 R
 (151) 2012 02 24
 (732) Unilever IP Holdings B.V.
 Weena 455, 3013 AL Rotterdam, Netherlands
 (141) 2022 09 01

(111) M 2012 22317 R
 (151) 2012 02 24
 (732) LTD "Adjarian Tobacco"
 E. Ninoshvili St. 25, 6010, Batumi,
 Georgia,
 (141) 2022 09 01

(111) M 2012 22318 R
 (151) 2012 02 24
 (732) Darejan Nizharadze
 Avchala St. 1, 7, 0125, Tbilisi, Georgia
 (141) 2022 09 01

(111) M 2012 22313 R
 (151) 2012 02 23
 (732) A Non-Commercial Legal Entity "Value
 Research"
 Freedom Square 4, 0105, Tbilisi, Georgia
 (141) 2022 08 31

(111) M 2012 22321 R
 (151) 2012 02 24
 (732) PolimerPharm
 Davit Aghmashenebeli Alley, 12th km., 0131,
 Tbilisi, Georgia
 (141) 2022 09 01

(111) M 2012 22322 R
 (151) 2012 02 24
 (732) LTD "Neopharm"
 Davit Aghmashenebeli Alley, 12th km., 0131,
 Tbilisi, Georgia;
 Iuri Kikabidze
 Varketili, II m/r., bld. 28, app. 39, 0163,
 Tbilisi, Georgia
 (141) 2022 09 01

(111) M 2012 22325 R
 (151) 2012 02 24
 (732) LTD "Georgian Distribution-Marketing
 Company"
 Moscow Av. 31a, 0120, Tbilisi, Georgia
 (141) 2022 09 01

(111) M 2012 22327 R
 (151) 2012 02 24
 (732) JSC "Georgian Bank"
 Gagarin St. 29s, 0160, Tbilisi, Georgia
 (141) 2022 09 01

(111) M 2012 22328 R
 (151) 2012 02 24
 (732) JSC "Georgian Bank"
 Gagarin St. 29s, 0160, Tbilisi, Georgia
 (141) 2022 09 01

(111) M 2012 22329 R
(151) 2012 02 24
(732) JSC "Georgian Bank"
Gagarin St. 29s, 0160, Tbilisi, Georgia
(141) 2022 09 01

(111) M 2012 22330 R
(151) 2012 02 24
(732) JSC "Georgian Bank"
Gagarin St. 29s, 0160, Tbilisi, Georgia
(141) 2022 09 01

(111) M 2012 22331 R
(151) 2012 02 24
(732) JSC "Georgian Bank"
Gagarin St. 29s, 0160, Tbilisi, Georgia
(141) 2022 09 01

(111) M 2012 22333 R
(151) 2012 02 24
(732) LTD "Sofhia +"
Vazha-Pshavela Av., VII qu., corp. 6, app. 20,
0186, Tbilisi, Georgia
(141) 2022 09 01

(111) M 2012 22334 R
(151) 2012 02 24
(732) LTD Insurance "Company IC Group"
Arakishvili St. 2, 0179, Tbilisi, Georgia
(141) 2022 09 01

(111) M 2012 22335 R
(151) 2012 02 24
(732) Public JSC Commercial Bank "Privatbank"
Ul. Nabehezhnaya Pobedi 50, Dnepropetrovsk, 49094, Ukraine
(141) 2022 09 01

(111) M 2012 22338 R
(151) 2012 02 24
(732) JSC "Lomisi"
Village Natakhtari, 3308, Mtskheta Region,
Georgia
(141) 2022 09 01

(111) M 2012 22339 R
(151) 2012 02 24
(732) JSC "Lomisi"
Village Natakhtari, 3308, Mtskheta Region,
Georgia
(141) 2022 09 01

(111) M 2012 22340 R
(151) 2012 02 24
(732) Turkmall Real Estate Yatirim İnşaat ve Ticaret
Anonim Şirketi
Ebulula Mardin Caddesi Maya Meridyen İş
Merkezi kat: 13 akatlar-Beşiktaş-İstanbul,
Türkiye
(141) 2022 09 01

(111) M 2012 22341 R
(151) 2012 02 24
(732) LTD "Wissol Auto Express"
Ilia Chavchavadze Av. 74b, 0160, Tbilisi,
Georgia
(141) 2022 09 01

(111) M 2012 22344 R
(151) 2012 02 24
(732) Republican Board of Adjara of the Georgian
Music Society of the Creative Union
Memed Abashidze Str. 49, 6010, Batumi,
Georgia
(141) 2022 09 01

(111) M 2012 22347 R
(151) 2012 02 24
(732) LTD "Via Travel"
I. AbaShidze St. 24, 0179, Tbilisi, Georgia
(141) 2022 09 01

(111) M 2012 22350 R
(151) 2012 02 24
(732) Merab Peradze
Village Apeni, 2701, Lagodekhi, Georgia
(141) 2022 09 01

(111) M 2012 22351 R
(151) 2012 02 24
(732) LTD "Roberto"
Shota Rustaveli Av. 32, 0108, Tbilisi, Georgia
(141) 2022 09 01

(111) M 2012 22352 R
(151) 2012 02 24
(732) Cobb-Vantress Inc.
P.O. Box 1030, Siloam Springs, Arkansas
72761, USA
(141) 2022 09 01

(111) M 2012 22353 R
(151) 2012 02 24
(732) Zezva Gagnidze
Cholokashvili St. 41, 2200, Telavi, Georgia;
Domenti Gagnidze
Village Shalauri, 2216, Telavi, Georgia
(141) 2022 09 01

(111) M 2012 22354 R
(151) 2012 02 24
(732) Zezva Gagnidze
Cholokashvili St. 41, 2200, Telavi, Georgia;
Domenti Gagnidze
Village Shalauri, 2216, Telavi, Georgia
(141) 2022 09 01

(111) M 2012 22356 R
(151) 2012 02 24
(732) AO "Danon Russian"
Ul. Vyatskaya, dom 27, stroenie 13-14,
127015, Moskow, Russian Federation
(141) 2022 09 01

(111) M 2012 22357 R
(151) 2012 02 24
(732) AO "Danon Russian"
Ul. Vyatskaya, dom 27, stroenie 13-14,
127015, Moskow, Russian Federation
(141) 2022 09 01

(111) M 2012 22359 R
(151) 2012 02 24
(732) AO "Danon Russian"
Ul. Vyatskaya, dom 27, stroenie 13-14,
127015, Moskow, Russian Federation
(141) 2022 09 01

(111) M 2012 22360 R
(151) 2012 02 24
(732) AO "Danon Russian"
Ul. Vyatskaya, dom 27, stroenie 13-14,
127015, Moskow, Russian Federation
(141) 2022 09 01

(111) M 2012 22361 R
(151) 2012 02 24
(732) Sanofi
54, rue La Boétie, 75008 Paris, France
(141) 2022 09 01

(111) M 2012 22362 R
(151) 2012 02 24
(732) Nissan Jidosha Kabushiki Kaisha
(also trading as Nissan Motor Co., Ltd.)
No.2 Takaracho, Kanagawa-ku, Yokohama-
shi, Kanagawa-ken, Japan
(141) 2022 09 01

(111) M 2012 22363 R
(151) 2012 02 24
(732) Nissan Jidosha Kabushiki Kaisha
(also trading as Nissan Motor Co., Ltd.)
No.2 Takaracho, Kanagawa-ku, Yokohama-
shi, Kanagawa-ken, Japan
(141) 2022 09 01

(111) M 2012 22367 R
(151) 2012 02 24
(732) Nine West Development LLC
1411 Broadway, New York, NY 10018, USA
(141) 2022 09 01

(111) M 2012 22371 R
(151) 2012 02 24
(732) OAO "Company Unimilk"
Ul. Vyatskaya, dom 27, stroenie 13-14,
127015, Moskow, Russian Federation
(141) 2022 09 01

(111) M 2012 22372 R
(151) 2012 02 24
(732) OAO "Company Unimilk"
Ul. Vyatskaya, dom 27, stroenie 13-14,
127015, Moskow, Russian Federation
(141) 2022 09 01

(111) M 2012 22374 R
(151) 2012 02 24
(732) OAO "Company Unimilk"
Ul. Vyatskaya, dom 27, stroenie 13-14,
127015, Moskow, Russian Federation
(141) 2022 09 01

(111) M 2012 22375 R
(151) 2012 02 24
(732) OAO "Company Unimilk"
Ul. Vyatskaya, dom 27, stroenie 13-14,
127015, Moskow, Russian Federation n
(141) 2022 09 01

(111) M 2012 22376 R
(151) 2012 02 24
(732) OAO "Company Unimilk"
Ul. Vyatskaya, dom 27, stroenie 13-14,
127015, Moskow, Russian Federation
(141) 2022 09 01

(111) M 2012 22377 R
(151) 2012 02 24
(732) OAO "Company Unimilk"
Ul. Vyatskaya, dom 27, stroenie 13-14,
127015, Moskow, Russian Federation
(141) 2022 09 01

(111) M 2012 22304 R
(151) 2012 02 21
(732) Gallaher Limited
Members Hill, Brooklands Road, Weybridge,
Surrey, KT13 0QU, United Kingdom
(141) 2022 08 29

(111) M 2012 22305 R
(151) 2012 02 21
(732) Gallaher Limited
Members Hill, Brooklands Road, Weybridge,
Surrey, KT13 0QU, United Kingdom
(141) 2022 08 29

(111) M 2012 22306 R
(151) 2012 02 21
(732) Gallaher Limited
Members Hill, Brooklands Road, Weybridge,
Surrey, KT13 0QU, United Kingdom
(141) 2022 08 29

(111) M 2012 22307 R
(151) 2012 02 21
(732) Gallaher Limited
Members Hill, Brooklands Road, Weybridge,
Surrey, KT13 0QU, United Kingdom
(141) 2022 08 29

(111) M 2012 22299 R
(151) 2012 02 14
(732) Gallaher Limited
Members Hill, Brooklands Road, Weybridge,
Surrey, KT13 0QU, United Kingdom
(141) 2022 08 29

(111) M 2012 22301 R
(151) 2012 02 14
(732) Gallaher Limited
Members Hill, Brooklands Road, Weybridge,
Surrey, KT13 0QU, United Kingdom
(141) 2022 08 29

(111) M 2012 22302 R
(151) 2012 02 14
(732) Gallaher Limited
Members Hill, Brooklands Road, Weybridge,
Surrey, KT13 0QU, United Kingdom
(141) 2022 08 29

(111) M 2012 22298 R
(151) 2012 02 14
(732) LTD "Suntrade"
Varketili3, IIIA m/r., bld. 340, app. 8, 0163,
Tbilisi, Georgia
(141) 2022 08 29

(111) M 2012 22378 R
(151) 2012 02 24
(732) Moka & Co Sarl
Fakhoury Center, Kaslik Street-2nd
Floor, Sarba, Lebanon
(141) 2022 09 01

REGISTRATION OF LICENSE AGREEMENT

(111) M 2015 26106 R

(732) LTD "Kapiloni" (436032339)

Village Misaktsieli, Mtskheta Region,

Georgia

(791) LTD "Kapiloni" (431433601)

Barnov St. 10, Telavi, Georgia

(793) №1709

01 08 2022 to 01 08 2052

Simple

Class: 43

CLASSIFICATION INDEXES

INVENTIONS

CONCORDANCE TABLE OF INTERNATIONAL CLASSIFICATION INDEX AND PUBLICATION NUMBERS

INTERNATIONAL CLASSIFICATION INDEXES (51)	NUMBER OF PUBLISHED APPLICATION (10)
A 61 K 31/496; A 61 P 3/10; C 07 D 405/14; C 07 D 405/12; C 07 D 413/14	AP 2022 15517 A
C 07 D 403/12; C 07 D 413/12; C 07 D 249/08	AP 2022 13653 A
C 12 N 15/82	AP 2022 15146 A
C 12 N 15/82	AP 2022 15147 A

CONCORDANCE TABLE OF PUBLICATION NUMBERS AND INTERNATIONAL CLASSIFICATION INDEX

NUMBER OF PUBLISHED APPLICATION (10)	INTERNATIONAL CLASSIFICATION INDEXES (51)
AP 2022 13653 A	C 07 D 403/12; C 07 D 413/12; C 07 D 249/08
AP 2022 15146 A	C 12 N 15/82
AP 2022 15147 A	C 12 N 15/82
AP 2022 15517 A	A 61 K 31/496; A 61 P 3/10; C 07 D 405/14; C 07 D 405/12; C 07 D 413/14

CONCORDANCE TABLE OF INTERNATIONAL CLASSIFICATION INDEX, PATENT NUMBERS AND PUBLICATION NUMBERS

INTERNATIONAL CLASSIFICATION INDEX (51)	NUMBER OF PATENT (11)	NUMBER OF PUBLISHED APPLICATION (10)
A 01 D 46/04	P 2022 7413 B	AP 2022 15842 A
A 61 K 31/438; A 61 P 25/00; C 07 D 413/14; C 07 D 413/04; C 07 D 417/04; C 07 D 417/14	P 2022 7409 B	AP 2022 15499 A
A 61 M 16/00	P 2022 7411 B	AP 2022 15497 A
E 01 F 7/04; E 02 D 17/20	P 2022 7414 B	AP 2022 15051 A
E 03 B 1/00	P 2022 7415 B	AP 2022 15559 A
E 05 B 19/00	P 2022 7412 B	AP 2022 15413 A
F 17 C 3/00; F 25 D 3/10	P 2022 7410 B	AP 2022 15612 A

**CONCORDANCE TABLE OF PATENT NUMBERS,
PUBLICATION NUMBERS AND INTERNATIONAL CLASSIFICATION INDEX**

NUMBER OF PATENT (11)	NUMBER OF PUBLISHED APPLICATION (10)	INTERNATIONAL CLASSIFICATION INDEX (51)
P 2022 7409 B	AP 2022 15499 A	A 61 K 31/438; A 61 P 25/00; C 07 D 413/14; C 07 D 413/04; C 07 D 417/04; C 07 D 417/14
P 2022 7410 B	AP 2022 15612 A	F 17 C 3/00; F 25 D 3/10
P 2022 7411 B	AP 2022 15497 A	A 61 M 16/00
P 2022 7412 B	AP 2022 15413 A	E 05 B 19/00
P 2022 7413 B	AP 2022 15842 A	A 01 D 46/04
P 2022 7414 B	AP 2022 15051 A	E 01 F 7/04; E 02 D 17/20
P 2022 7415 B	AP 2022 15559 A	E 03 B 1/00

**CONCORDANCE TABLE OF APPLICATION NUMBERS,
PUBLICATION NUMBERS AND PATENTS**

NUMBER OF APPLICATION (21)	NUMBER OF PUBLISHED APPLICATION (10)	NUMBER OF PATENT (11)
AP 2017 15051	AP 2022 15051 A	P 2022 7414 B
AP 2019 15413	AP 2022 15413 A	P 2022 7412 B
AP 2020 15497	AP 2022 15497 A	P 2022 7411 B
AP 2019 15499	AP 2022 15499 A	P 2022 7409 B
AP 2021 15559	AP 2022 15559 A	P 2022 7415 B
AP 2021 15612	AP 2022 15612 A	P 2022 7410 B
AP 2021 15842	AP 2022 15842 A	P 2022 7413 B

UTILITY MODELS

**CONCORDANCE TABLE OF INTERNATIONAL CLASSIFICATION INDEX
AND PUBLICATION NUMBERS**

INTERNATIONAL CLASSIFICATION INDEXES (51)	NUMBER OF PUBLISHED APPLICATION (10)
F 03 B 13/00	AU 2022 15880 U

**CONCORDANCE TABLE OF PUBLICATION NUMBERS
AND INTERNATIONAL CLASSIFICATION INDEX**

NUMBER OF PUBLISHED APPLICATION (10)	INTERNATIONAL CLASSIFICATION INDEXES (51)
AU 2022 15880 U	F 03 B 13/00

**CONCORDANCE TABLE OF INTERNATIONAL CLASSIFICATION INDEX,
PATENT NUMBERS AND PUBLICATION NUMBERS**

INTERNATIONAL CLASSIFICATION INDEX (51)	NUMBER OF PATENT (11)	NUMBER OF PUBLISHED APPLICATION (10)
A 01 G 25/00	U 2022 2130 Y	AU 2022 15879 U
B 65 D 51/28	U 2022 2131 Y	AU 2022 15877 U
C 12 G 3/06	U 2022 2129 Y	AU 2022 15319 U

**CONCORDANCE TABLE OF PATENT NUMBERS,
PUBLICATION NUMBERS AND INTERNATIONAL CLASSIFICATION INDEX**

NUMBER OF PATENT (11)	NUMBER OF PUBLISHED APPLICATION (10)	INTERNATIONAL CLASSIFICATION INDEX (51)
U 2022 2129 Y	AU 2022 15319 U	C 12 G 3/06
U 2022 2130 Y	AU 2022 15879 U	A 01 G 25/00
U 2022 2131 Y	AU 2022 15877 U	B 65 D 51/28

**CONCORDANCE TABLE OF APPLICATION NUMBERS,
PUBLICATION NUMBERS AND PATENTS**

NUMBER OF APPLICATION (21)	NUMBER OF PUBLISHED APPLICATION (10)	NUMBER OF PATENT (11)
AU 2020 15319	AU 2022 15319 U	U 2022 2129 Y
AU 2022 15877	AU 2022 15877 U	U 2022 2131 Y
AU 2022 15879	AU 2022 15879 U	U 2022 2130 Y

DESIGNS**CONCORDANCE TABLE OF INTERNATIONAL CLASSIFICATION INDEX
AND PUBLICATION NUMBERS**

INTERNATIONAL CLASSIFICATION INDEXES (51)	NUMBER OF PUBLISHED APPLICATION (10)
09-01	AD 2022 1262 S
11-01	AD 2022 1264 S

**CONCORDANCE TABLE OF PUBLICATION NUMBERS
AND INTERNATIONAL CLASSIFICATION INDEX**

NUMBER OF PUBLISHED APPLICATION (10)	INTERNATIONAL CLASSIFICATION INDEXES (51)
AD 2022 1262 S	09-01
AD 2022 1264 S	11-01

**CONCORDANCE TABLE OF INTERNATIONAL CLASSIFICATION INDEX,
NUMBERS OF REGISTRATION AND PUBLICATION NUMBERS**

INTERNATIONAL CLASSIFICATION INDEX (51)	NUMBER OF REGISTRATION (11)	NUMBER OF PUBLISHED APPLICATION (10)
11-04	D 2022 942 S	AD 2022 1246 S
11-05	D 2022 943 S	AD 2022 1242 S

**CONCORDANCE TABLE OF NUMBERS OF REGISTRATION,
PUBLICATION NUMBERS AND INTERNATIONAL CLASSIFICATION INDEX**

NUMBER OF REGISTRATION (11)	NUMBER OF PUBLISHED APPLICATION (10)	INTERNATIONAL CLASSIFICATION INDEX (51)
D 2022 942 S	AD 2022 1246 S	11-04
D 2022 943 S	AD 2022 1242 S	11-05

**CONCORDANCE TABLE OF APPLICATION NUMBERS,
PUBLICATION NUMBERS AND NUMBERS OF REGISTRATION**

NUMBER OF APPLICATION (21)	NUMBER OF PUBLISHED APPLICATION (10)	NUMBER OF REGISTRATION (11)
AD 2021 1242	AD 2022 1242 S	D 2022 943 S
AD 2021 1246	AD 2022 1246 S	D 2022 942 S

TRADEMARKS

CONCORDANCE TABLE OF REGISTRATION NUMBERS, APPLICATION NUMBERS, PUBLICATION NUMBERS AND BULLETIN NUMBERS

NUMBER OF REGISTRATION (111)	NUMBER OF APPLICATIONS (210)	NUMBER OF PUBLISHED APPLICATIONS (260)	NUMBER OF BULLETIN
M 2022 35871 R	AM 119001	–	17(596)2022
M 2022 35872 R	AM 119012	–	17(596)2022
M 2022 35873 R	AM 119021	–	17(596)2022
M 2022 35874 R	AM 119006	–	17(596)2022
M 2022 35875 R	AM 118857	–	17(596)2022
M 2022 35876 R	AM 118858	–	17(596)2022
M 2022 35877 R	AM 118940	–	17(596)2022
M 2022 35878 R	AM 118922	–	17(596)2022
M 2022 35879 R	AM 119089	–	17(596)2022
M 2022 35880 R	AM 118724	–	17(596)2022
M 2022 35881 R	AM 118942	–	17(596)2022
M 2022 35882 R	AM 119115	–	17(596)2022
M 2022 35883 R	AM 119083	–	17(596)2022
M 2022 35884 R	AM 119097	–	17(596)2022
M 2022 35885 R	AM 119088	–	17(596)2022
M 2022 35886 R	AM 119102	–	17(596)2022
M 2022 35887 R	AM 119002	–	17(596)2022
M 2022 35888 R	AM 119101	–	17(596)2022

CONCORDANCE TABLE OF PUBLICATION NUMBERS
AND APPLICATION NUMBERS

NUMBER OF PUBLISHED APPLICATION (260)	NUMBER OF APPLICATION (210)	1	2
1	2		
AM 2022 116214 A	AM 116214	AM 2022 116517 A	AM 116517
AM 2022 116239 A	AM 116239	AM 2022 116519 A	AM 116519
AM 2022 116246 A	AM 116246	AM 2022 116520 A	AM 116520
AM 2022 116250 A	AM 116250	AM 2022 116526 A	AM 116526
AM 2022 116252 A	AM 116252	AM 2022 116540 A	AM 116540
AM 2022 116314 A	AM 116314	AM 2022 116543 A	AM 116543
AM 2022 116315 A	AM 116315	AM 2022 116544 A	AM 116544
AM 2022 116321 A	AM 116321	AM 2022 116545 A	AM 116545
AM 2022 116322 A	AM 116322	AM 2022 116546 A	AM 116546
AM 2022 116323 A	AM 116323	AM 2022 116622 A	AM 116622
AM 2022 116332 A	AM 116332	AM 2022 116623 A	AM 116623
AM 2022 116333 A	AM 116333	AM 2022 116624 A	AM 116624
AM 2022 116336 A	AM 116336	AM 2022 116625 A	AM 116625
AM 2022 116394 A	AM 116394	AM 2022 116626 A	AM 116626
AM 2022 116401 A	AM 116401	AM 2022 116633 A	AM 116633
AM 2022 116414 A	AM 116414	AM 2022 116642 A	AM 116642
AM 2022 116415 A	AM 116415	AM 2022 116657 A	AM 116657
AM 2022 116425 A	AM 116425	AM 2022 116659 A	AM 116659
AM 2022 116426 A	AM 116426	AM 2022 116660 A	AM 116660
AM 2022 116431 A	AM 116431	AM 2022 116669 A	AM 116669
AM 2022 116513 A	AM 116513	AM 2022 116741 A	AM 116741
AM 2022 116514 A	AM 116514	AM 2022 116743 A	AM 116743
		AM 2022 116744 A	AM 116744
		AM 2022 116745 A	AM 116745
		AM 2022 116746 A	AM 116746
		AM 2022 116754 A	AM 116754
		AM 2022 116756 A	AM 116756

CONCORDANCE TABLE OF INDEX OF GOODS AND/OR SERVICES
AND APPLICATION NUMBERS

INDEX OF GOODS AND/OR SERVICES (511)	NUMBER OF PUBLISHED APPLICATIONS (260)	1	2
1	2		
1	AM 2022 116414 A	21	AM 2022 116514 A
2	AM 2022 116414 A	24	AM 2022 116756 A
3	AM 2022 116322 A	25	AM 2022 116756 A
3	AM 2022 116414 A	28	AM 2022 116754 A
3	AM 2022 116431 A	29	AM 2022 116314 A
3	AM 2022 116513 A	29	AM 2022 116526 A
3	AM 2022 116514 A	30	AM 2022 116314 A
3	AM 2022 116519 A	30	AM 2022 116321 A
3	AM 2022 116520 A	30	AM 2022 116323 A
5	AM 2022 116246 A	30	AM 2022 116431 A
5	AM 2022 116315 A	31	AM 2022 116540 A
5	AM 2022 116321 A	32	AM 2022 116214 A
5	AM 2022 116323 A	32	AM 2022 116314 A
5	AM 2022 116414 A	33	AM 2022 116250 A
5	AM 2022 116425 A	33	AM 2022 116336 A
5	AM 2022 116431 A	33	AM 2022 116657 A
5	AM 2022 116513 A	34	AM 2022 116426 A
5	AM 2022 116514 A	35	AM 2022 116239 A
5	AM 2022 116545 A	35	AM 2022 116314 A
5	AM 2022 116546 A	35	AM 2022 116333 A
5	AM 2022 116622 A	35	AM 2022 116394 A
5	AM 2022 116623 A	35	AM 2022 116414 A
5	AM 2022 116624 A	35	AM 2022 116431 A
5	AM 2022 116625 A	35	AM 2022 116519 A
5	AM 2022 116626 A	35	AM 2022 116520 A
5	AM 2022 116642 A	35	AM 2022 116633 A
5	AM 2022 116659 A	35	AM 2022 116754 A
5	AM 2022 116660 A	35	AM 2022 116756 A
5	AM 2022 116741 A	36	AM 2022 116394 A
5	AM 2022 116743 A	36	AM 2022 116414 A
5	AM 2022 116744 A	37	AM 2022 116401 A
5	AM 2022 116745 A	38	AM 2022 116754 A
5	AM 2022 116746 A	39	AM 2022 116414 A
9	AM 2022 116669 A	39	AM 2022 116431 A
9	AM 2022 116754 A	40	AM 2022 116756 A
9	AM 2022 116756 A	41	AM 2022 116394 A
12	AM 2022 116252 A	41	AM 2022 116754 A
16	AM 2022 116394 A	42	AM 2022 116517 A
16	AM 2022 116414 A	43	AM 2022 116250 A
16	AM 2022 116431 A	43	AM 2022 116314 A
18	AM 2022 116756 A	43	AM 2022 116332 A
20	AM 2022 116414 A	43	AM 2022 116415 A
21	AM 2022 116414 A	43	AM 2022 116526 A
21	AM 2022 116513 A	43	AM 2022 116543 A
		43	AM 2022 116544 A
		43	AM 2022 116633 A
		44	AM 2022 116333 A
		44	AM 2022 116414 A

CONCORDANCE TABLE OF INDEX OF GOODS AND/OR SERVICES
AND NUMBERS OF TRADEMARKS REGISTERED ACCORDING
TO THE ACCELERATED PROCEDURE

INDEX OF GOODS AND/OR SERVICES (511)	NUMBERS OF REGISTERED ACCORDING TO THE ACCELERATED PROCEDURE (111)
13	M 2022 35882 R
13	M 2022 35884 R
16	M 2022 35877 R
25	M 2022 35885 R
29	M 2022 35881 R
32	M 2022 35883 R
33	M 2022 35874 R
33	M 2022 35878 R
35	M 2022 35875 R
35	M 2022 35876 R
35	M 2022 35879 R
35	M 2022 35886 R
36	M 2022 35872 R
37	M 2022 35887 R
39	M 2022 35875 R
39	M 2022 35876 R
42	M 2022 35887 R
43	M 2022 35871 R
43	M 2022 35873 R
43	M 2022 35880 R
44	M 2022 35887 R
44	M 2022 35888 R

OFFICIAL BULLETIN OF THE INDUSTRIAL PROPERTY

**INVENTIONS
UTILITY MODELS
DESIGNS
TRADEMARKS
APPELLATIONS OF ORIGIN AND GEOGRAPHICAL
INDICATIONS OF GOODS**

17(596)

EDITOR-IN-CHIEF: N. Bebrishvili

EDITOR-TRANSLATOR: E. Gabunia

PROOFREADER: A. Shixashvili

COMPUTER LAYOUT: M. Ordenidze

ISSN 2720-8486

info@sakpatenti.gov.ge
www.sakpatenti.gov.ge