



Official Bulletin of the Industrial Property

Inventions

Designs

Trademarks

Appellations of Origin of Goods



საქართველოს ინტელექტუალური
საკუთრების ეროვნული ცენტრი

საკპატი

SAKPATENTI

NATIONAL INTELLECTUAL PROPERTY
CENTER OF GEORGIA

www.sakpatenti.gov.ge

17(620)

INID CODES FOR IDENTIFICATION OF BIBLIOGRAPHIC DATA

INVENTIONS, UTILITY MODELS

- (10) Number of publication of examined application/
Application publication number***
- (11) Patent number/ Patent number***
Registered utility model number***
- (21) Application number
- (22) Date of filing of the application
- (23) Date of exhibition priority
- (24) Date from which patent may have effect
- (31) Number of priority application
- (32) Date of filing of priority application
- (33) Code of the country or regional organization allotting application number
- (43) Date of publication of application, number of bulletin***
- (44) Date of publication of examined application, on which no grant has taken place and number of bulletin
- (45) Date of publication of patent/ Date of publication of patent***
Date of publication of registered utility model***
- (51) International Patent Classification Index
- (54) Title of the invention/title of the utility model
- (57) Abstract
- (60) Number of examined patent document granted by foreign patent office, date from which patent has effect and country code
- (62) Number and filing date of the earlier application in case of a divisional application
- (71) Name and address of applicant (country code)
- (72) Name of inventor (country code)
- (73) Name and address of patent owner/patent owner***/ registered utility model owner*** (country code)
- (74) Name of representative or patent attorney
- (85) Date of commencement of the national phase of international application (PCT)
- (86) Number and date of filing of international application (PCT)
- (87) Number and date of publication of international application (PCT)
- (94) Calculated date of expiry of the SPC or the duration of the SPC

DESIGNS

- (10) Number of publication for application
- (11) Number of patent and kind of document or number of registration
- (15) Date of registration/Date of patent renewal
- (18) Expected expiration date of patent or registration
- (21) Serial number of application
- (22) Date of filing of the application
- (23) Date of exhibition or the date of the earlier filing and the number of application, if any
- (24) Date from which patent may have effect
- (28) Number of designs included in the application
- (30) Data relating to priority (number of application, date of filing of application, two-letter code identifying the authority with whom the priority application was made)
- (31) Number of priority application
- (32) Date of filing of priority application
- (33) Code of the country or regional organization allotting priority application number
- (34) Two-letter code according to WIPO St.3 identifying the authority with which the priority application was made
- (44) Date of publication of design and number of bulletin (the first publication)
- (45) Date of publication of design registered by WIPO and number of bulletin
- (51) International Classification for designs (class and subclass of the Locarno Classification)
- (54) Title of the invention
- (55) Reproduction of the design
- (57) Description of characteristic features of the design including indication of colors
- (58) Date of recording of any kind of amendment in the Register
- (62) Number of the earlier application, registration and document number and if available the date of filing an application in case of divided application
- (71) Name, surname and address of applicant (country code)
- (72) Name, surname of creator (country code)
- (73) Name, surname and address of patent owner (country code)
- (74) Name, surname of representative or patent attorney
- (81) Contracting states concerned
II designated contracting states according to the 1960 Act
III designated contracting states according to the 1999 Act
- (85) Owner's permanent address
- (86) Owner's nationality
- (87) Owner's residence
- (88) State in which the owner has a real and effective industrial or commercial establishment

TRADEMARKS

- (111) – Number of registration
- (151) – Date of registration
- (156) – Date of the renewal
- (181) – Expected expiration date of registration
- (186) – Renewal expiration date of registration
- (141) – Date of cancel of duration of the mark
- (210) – Serial number of application
- (220) – Date of filing of the application
- (230) – Data concerning exhibition
- (260) – Number of application, for which favorable decision of examination about registration has been taken (publication number)
- (310) – Number of the first application
- (320) – Date of filing of the first application
- (330) – Code, identifying national or regional Office where the first application was made
- (511) – International Classification of Goods and Services for the purposes of registration of trade marks and/or list of goods and/or services classified according thereto
- (526) – Disclaimer
- (531) – Description of figurative elements of Trade Marks according to the International Classification of the Figurative Elements of Marks
- (540) – Reproduction of Trade Mark
- (550) – Nature and kind of Trade Mark
- (551) – Indication to the effect that the mark is a collective mark, a certification mark or a guarantee mark
- (554) – Three-dimensional mark
- (580) – Date of recording of any kind changes in respect of applications or registrations
- (591) – Information concerning colors claimed
- (731) – Name and address of the applicant
- (732) – Name and address of the holder of the registration
- (740) – Name and address of the representative
- (750) – Addreses for correspondence
- (770) – Name and address of the previous applicant or holder in case of change in ownership
- (771) – Previous name and address of the applicant or holder in case of change in ownership
- (791) – Name and address of the licensee
- (793) – Indication of conditions and/or restrictions under the license (Type of license, number of license agreement, data of license, data of validity of license)
- (800) – Certain data relating to the international registration of Trade Marks under the Protocol Relating to Madrid Agreement (International registration number
- (852) – Partial cancellation of the list of goods and services
- (891) – Date of subsequent designation

CODES FOR PUBLICATION IN BULLETIN

- (21) AP 0000 000000 – number of application for invention
- (10) AP 0000 0000 A – number of publication of application for invention
- (11) P 0000 0000 B – number of patent for invention/ patent number***
- (21) API 0000 000000 – number of application for imported patent
- (11) PI 0000 0000 A – number of imported patent
- (21) AU 0000 000000 – number of application for utility model
- (10) AU 0000 000 U – number of publication of application for utility model
- (11) U 0000 000 Y – number of patent for utility model/ registered utility model number***
- (21) AD 0000 000000 – serial number of application for design
- (10) AD 0000 000 S – number of published application for design (first publication)
- (11) D 0000 000 S – registered design

INTERNATIONAL PATENT CLASSIFICATION FOR INVENTIONS AND UTILITY MODELS

- SECTION A – HUMAN NECESSITIES
- SECTION B – PERFORMING OPERATIONS; TRANSPORTING
- SECTION C – CHEMISTRY; METALLURGY
- SECTION D – TEXTILES; PAPER
- SECTION E – FIXED CONSTRUCTIONS
- SECTION F – MECHANICAL ENGINEERING; LIGHTING; HEATING; WEAPONS; BLASTING
- SECTION G – PHYSICS
- SECTION H – ELECTRICITY

* Number of application published after the decision of Appellation Chamber of SAKPATENTI

** Number of application published after Court decision

*** Materials published according to the amendments of May 16, 2023 (No. 2883-XI0b-X03) to the Patent Law of Georgia

- M – Trade Mark
- (210) AM 0000 000000 – Serial number of application;
- (260) AAM 0000 00000 A – Publication number of application;
- (111) M 0000 00000 R – Number of registration;
- (111) MMM0000 00000 Rn – Number of renewals, in which n=1,2,3;
- (111) M 0000 00000 R(P) – Number of registration under partial assignment of rights

Official Bulletin of the Industrial Property

Inventions

Designs

Trademarks

Appellations of Origin of Goods

CONTENT

PUBLISHED TITLES OF PROTECTION	3
INVENTIONS	
▪ APPLICATIONS APPROVED FOR GRANTING PATENT	4
▪ PATENTED INVENTIONS	6
▪ APPLICATIONS***	8
DESIGNS	
▪ APPLICATIONS APPROVED FOR REGISTRATION	10
▪ DESIGN REGISTERED ACCORDING TO THE ACCELERATED PROCEDURE	19
▪ DESIGNS, WICH HAVE BEEN REGISTERED WITH THE INTERNATIONAL BUREAU CLAIMING PRIORITY ON THE TERRITORY OF GEORGIA	20
TRADEMARKS	
▪ APPLICATIONS FILED UNDER THE NATIONAL PROCEDURE APPROVED FOR REGISTRATION	37
▪ REGISTERED TRADEMARKS	48
▪ TRADEMARKS REGISTERED ACCORDING TO THE ACCELERATED PROCEDURE	49
▪ INTERNATIONAL TRADEMARKS FOR WHICH A DECISION ON GRANTING PROTECTION IS TAKEN	54
▪ INTERNATIONAL TRADEMARKS PROTECTED IN GEORGIA	115
APPELLATION OF ORIGIN OF GOODS	
APPELLATION OF ORIGIN OF GOODS FILED IN GEORGIA FOR EXAMINATION UNDER LISBON AGREEMENT, ON THE BASIS OF THE INTERNATIONAL REGISTRATION	125
OFFICIAL NOTIFICATION	
INVENTIONS	
▪ RESTORATION OF PATENTS	126
▪ LAPSE OF PATENTS WITH THE RIGHT TO RESTORE	127
▪ EXPIRATION OF PATENTS RESTORATION TERM	128
▪ CHANGES OF NAME AND/OR ADDRESS OF PATENT OWNERS	129
UTILITY MODELS	
▪ RESTORATION OF PATENT	129
▪ LAPSE OF PATENT WITH THE RIGHT TO RESTORE	129
▪ EXPIRATION OF PATENT RESTORATION TERM	130
DESIGNS	
▪ EXTENSION OF TERM OF DESIGNS REGISTRATION	130
▪ CANCELLATION OF DESIGN REGISTRATION	130
▪ REGISTRATION OF LICENSE AGREEMENT	131
▪ EXTENSION OF TERM OF INTERNATIONAL DESIGNS REGISTRATION	131
TRADEMARKS	
▪ EXTENSION OF TERM OF TRADEMARKS REGISTRATION	134
▪ COMPLETE TRANSFER OF RIGHTS	135
▪ CHANGES OF NAME AND/OR ADDRESS OF TRADEMARKS OWNERS	136
▪ CANCELLATION OF TRADEMARKS REGISTRATION	137
▪ INTERNATIONAL LICENSE AGREEMENTS	139
CLASSIFICATION INDEXES	
INVENTIONS	140
DESIGNS	142
TRADEMARKS	144

PUBLISHED TITLES OF PROTECTION

INVENTIONS

- **APPLICATIONS APPROVED FOR GRANTING PATENT:**
15695; 15999; 15070; 15019; 15747
- **PATENTED INVENTIONS:**
7534-7540
- **APPLICATIONS:** ***
16320; 16286, 16287; 16298

DESIGNS

- **APPLICATIONS APPROVED FOR REGISTRATION:**
1305; 1303
- **DESIGN REGISTERED ACCORDING TO THE ACCELERATED PROCEDURE:**
978
- **DESIGNS, WHICH HAVE BEEN REGISTERED WITH THE INTERNATIONAL BUREAU CLAIMING PRIORITY ON THE TERRITORY OF GEORGIA:**
226164; 229601; 229924-229929; 229932, 229933; 226257

TRADEMARKS

- **APPLICATIONS FILED UNDER THE NATIONAL PROCEDURE APPROVED FOR REGISTRATION:**
119366; 120605; 120704; 120830, 120831; 121120, 121121; 121143; 121153; 121156; 121217, 121218; 121221-121223; 121232; 121239; 121241; 121244; 121298; 121300; 121308-121311; 121317; 121321, 121322; 121336-121338; 121340, 121341; 121343; 121345; 121347; 121351; 121414-121416; 121418, 121419; 121423, 121424; 121430; 121435, 121436; 121502; 121507; 121516, 121517; 121521; 121527, 121528; 121532; 121632; 121636; 121640; 121650; 121666; 121668; 121670; 121721, 121722; 121725; 121730; 121732; 121735, 121736; 121741; 121760; 121772
- **REGISTERED TRADEMARKS:**
37207; 37209-37218
- **TRADEMARKS REGISTERED ACCORDING TO THE ACCELERATED PROCEDURE:**
37208; 37219-37244
- **INTERNATIONAL TRADEMARKS FOR WHICH A DECISION ON GRANTING PROTECTIONS IS TAKEN:**
116721*; 119304; 120070; 120465-120469; 120486; 120492; 120559; 120561-120564; 120568; 120571-120573; 120647-120650; 120652; 120679; 120681; 120689; 120756-120760; 120767-120778; 120867, 120868; 120870, 120871; 120873, 120874; 120876-120878; 120881-120884; 120917, 120918; 120920-120928; 121025; 121036; 121062; 121071; 121073; 121084; 121100; 121103; 121111; 121115; 121157, 121158; 121160-121166; 121203, 121204; 121209, 121210; 121248; 121250, 121251; 121361, 121362; 121364-121366; 121451; 121554; 121556; 121607-121609
- **INTERNATIONAL TRADEMARKS PROTECTED IN GEORGIA:**
115046; 116054; 116277; 117936; 118967; 118971; 118978; 118982; 118984; 119036; 119043, 119044; 119046-119052; 119054-119058; 119143-119146; 119148; 119150-119163; 119165, 119166; 119168-119174; 119213-119215; 119220-119222; 119226-119231; 119236-119242; 119244-119248; 119250-119253; 119255, 119256; 119306-119309; 119312, 119313; 119315; 119317, 119318; 119326-119330; 119332-119338; 119340; 119414, 119415; 119441, 119442; 119444, 119445; 119447, 119448; 119462-119465; 119514-119518; 119521; 119523, 119524; 119543-119552

APPELLATION OF ORIGIN OF GOODS

3536

INVENTIONS

APPLICATIONS APPROVED FOR GRANTING PATENT

The decision can be appealed at the Chamber of Appeal of Sakpatenti within 3 months from the publication or at the Mtskheta District Court Administrative Cases Board (Address: №17, Samkhedro St., Mtskheta), within 1 month following the publication.

PART A

A 61

- (10) AP 2023 15695 A (51) Int. Cl. (2006)
A 61 K 31/47
A 61 P 35/00
C 07 D 215/48
- (21) AP 2019 15695 (22) 2019 12 12
(31) 62/779,430; 62/856,469
(32) 2018 12 13; 2019 06 03
(33) US; US
(71) Exelixis Inc. (US)
Delaware Corporation (US)
1851 Harbor Bay Parkway, Alameda
CA, 94502, USA (US)
- (72) DEMORIN, Frenel (US);
SHAH, Khalid (US);
SHAKYA, Sagar (US);
WONG, Peter (US);
JOHNSON, Courtney, S. (US);
BEVILL, Melanie, Janelle (US);
PARENT, Stephan, D. (US)
- (74) Tamaz Shilakadze
(85) 2021 07 12
(86) PCT/US2019/065972, 2019 12 12
(54) CRYSTALLINE FORMS AND SALT
FORMS OF A KINASE INHIBITOR
(57) Compound 1 or salts thereof

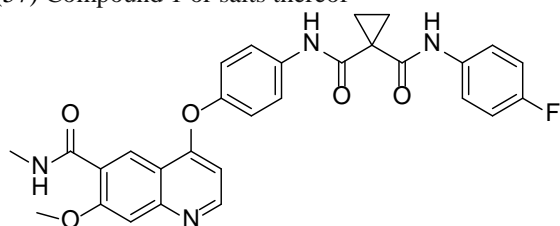

Compound 1

solid crystalline forms of pharmaceutical composition on a basis thereof, and their usage for cancer treatment, at least, partially due to in vivo modulation of protein kinase activity.

Claims: 22 independents
85 dependents

Table: 30
Fig.: 56

- (10) AP 2023 15999 A (51) Int. Cl. (2006)
A 61 K 31/7076
C 07 H 19/16
- (21) AP 2016 15999 (22) 2016 03 07
(62) AP 2016 15528 2016 03 07
(31) 62/129,319; 62/253,958; 62/276,597
(32) 2015 03 06; 2015 11 11; 2016 01 08
(33) US; US; US
(71) Atea Pharmaceuticals Inc. (US)
125 Summer Street Boston, MA 02110,
USA (US)
- (72) SOMMADOSSI, Jean-Pierre (US);
MOUSSA, Adel (US)
- (74) Tamaz Shilakadze
(85) 2022 07 05
(86) PCT/US2016/021276, 2016 03 07
(54) β -D-2'-DEOXY-2' α -FLUORO-2'- β -C-SUBSTITUTED-2-MODIFIED-N⁶-SUBSTITUTED PURINE NUCLEOTIDES FOR HCV TREATMENT
(57) Pharmaceutical composition comprising effective amount of compound of formula:

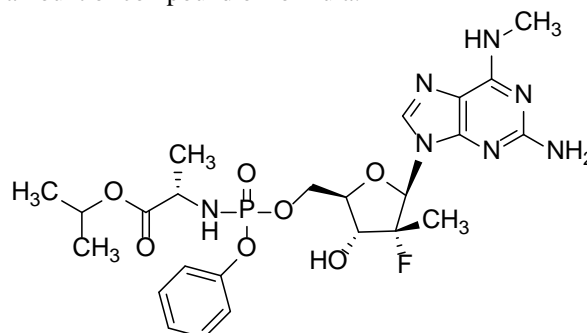

or pharmaceutically acceptable salt in combination with additional effective amount of antiviral compound selected from the group consisting of: protease inhibitor, NS5B polymerase inhibitor, and NS5A inhibitor or pharmaceutically acceptable salt thereof, and pharmaceutically acceptable carrier thereof.

Claims: 1 independent
35 dependents

Table: 9
Fig.: 11

- (10) AP 2023 15070 A (51) Int. Cl. (2006)
A 61 K 45/00
A 61 K 48/00
A 61 K 31/7105
A 61 K 39/00
A 61 K 39/395
A 61 P 7/00
- (21) AP 2017 15070 (22) 2017 10 12
(31) 62/407,979; 15/399,524; 15/470,647; 62/527,926
(32) 2016 10 13; 2017 01 05; 2017 03 27; 2017 06 30
(33) US; US; US; US
- (71) University of Leicester (GB)
University Road of Leicester, Leicestershire,
LE1 7RH, UK (GB);
Omeros Corporation (US)
201 Elliott Avenue, West Seattle, WA 98119,
USA (US)
- (72) DEMOPULOS, Gregory, A. (US);
SCHWAEBLE, Hans-Wilhelm (GB);
DUDLER, Tom (US);
BRUNSKILL, Nigel, John (GB)

- (74) Tamar Kochlamazashvili
(85) 2019 05 07
(86) PCT/US2017/056386, 2017 10 12
- (54) METHODS FOR REDUCING PROTEINURIA
IN A HUMAN SUBJECT SUFFERING FROM
IMMUNOGLOBULIN A NEPHROPATHY
- (57) Present invention relates to usage of MASP-2
inhibitory antibody or antigen-binding fragment
thereto reduce proteinuria in a subject with steroid-
dependent lupus nephritis (MN).
Claims: 1 independent
7 dependents
Fig.: 51

- (10) AP 2023 15019 A (51) Int. Cl. (2006)
A 61 K 45/06
A 61 K 39/395
C 07 K 16/40
- (21) AP 2017 15019 (22) 2017 07 31
(31) 62/369,674; 62/419,420; 62/478,336
(32) 2016 08 01; 2016 11 08; 2017 03 29
(33) US; US; US
- (71) University of Leicester (GB)
University Road of Leicester, Leicestershire,
LE1 7RH, UK (GB);
Omeros Corporation (US)
201 Elliott Avenue, West Seattle, WA 98119,
USA (US)
- (72) WOOD, Christi, L. (US);
DEMOPULOS, Gregory, A. (US);
SCHWAEBLE, Hans-Wilhelm (GB);
CUMMINGS, W., Jason (US);
YABUKI, Munehisa (US);
DUDLER, Thomas (US);
TJOELKER, Larry, W. (US)
- (74) Tamar Kotchlamazashvili

- (85) 2019 03 01
(86) PCT/US2017/044714, 2017 07 31
- (54) COMPOSITIONS AND METHODS OF
INHIBITING MASP-3 FOR THE TREA-
TMENT OF VARIOUS DISEASES AND
DISORDERS
- (57) Present invention relates to MASP-3 inhibitory
antibodies and compositions comprising such
antibodies for use in inhibiting the adverse effects of
MASP-3 dependent complement activation.
Claims: 8 independents
6 dependents
Fig.: 93

PART C

C 08

- (10) AP 2023 15747 A (51) Int. Cl. (2006)
C 08 B 37/10
- (21) AP 2020 15747 (22) 2020 04 24
(31) 202010078241.3; P201930373
(32) 2020 01 23; 2019 04 26
(33) CN; ES
- (71) Laboratorios Farmacéuticos Rovi, S.A. (ES)
Julián Camarillo, 35, Madrid, E-28037,
Spain (ES)
- (72) GUTIERRO ADURIZ, Ibon (ES);
FRANCO RODRÍGUEZ, Guillermo (ES)
- (74) Giorgi Kartvelishvili
(85) 2021 10 04
(86) PCT/ES2020/070263, 2020 04 24
- (54) METHOD FOR OBTAINING LOW-MOLE-
CULAR-WEIGHT HEPARINS BY MEANS
OF TANGENTIAL FLOW FILTRATION
- (57) A method for obtaining low-molecular-weight
heparins (LMWH) with a molecular weight distri-
bution of 3.0-5.0 kDa, which comprises the following
steps: a) preparation of impure depolymerized heparin
solution, wherein the resulting impure depolymerized
heparin solution has oligosaccharide chain length
ranging within 0.6-10 kDa and heparin concentration
between 3% w/v and 4% w/v, and b) providing of at
least one concentration stage of aqueous phase
tangential flow filtration (TFF) using a membrane
with nominal cutoff of 1 kDa to achieve heparin
concentration ranging within 5%-25% w/v to obtai-
ning said molecular heparin (LMWH).
Claims: 1 independent
21 dependents
Table: 10
Fig.: 10

PATENTED INVENTIONS

PART A

A 01

- (11) P 2023 7540 B (51) Int. Cl. (2006)
A 01 G 7/00
(10) AP 2023 15983 A (44) 9(612)/2023
(21) AP 2022 15983
(22) 2022 06 21
(24) 2022 06 21
(73) Tamaz Bichiashvili (GE)
Demetre Tavdadebuli St. 2, Tbilisi,
Georgia (GE)
(72) Tamaz Bichiashvili (GE)
(54) PHYTOTESTER

- (32) 2017 12 07
(33) US
(86) PCT/US2018/063541, 2018 12 03
(73) Merck Sharp & Dohme LLC (US)
126 East Lincoln Ave. P.O. Box 2000, Rahway,
NJ 07065, USA (US)
(72) RYAN, Michael, S. (US);
MARTIN, Sherrie-Ann, P. (US);
JONES, Morrisa (US);
STANBRO, Justin (US);
BHAMBHANI, Akhilesh (US);
BLUE, Jeffrey Thomas (US);
PIXLEY, Heidi Joanne (US);
GREEN-TREXLER, Erin, J. (US);
ISOPI, Lynne Ann (US)
(74) Shalva Gvaramadze
(54) FORMULATIONS OF DENGUE VIRUS
VACCINE COMPOSITIONS

A 24

- (11) P 2023 7535 B (51) Int. Cl. (2006)
A 24 F 1/30
(10) AP 2023 15741 A (44) 9(612)/2023
(21) AP 2020 15741
(22) 2020 03 06
(24) 2020 03 06
(31) 62/929,273; 62/815,167
(32) 2019 11 01; 2019 03 07
(33) US; US
(86) PCT/IB2020/000117, 2020 03 06
(73) Adalsia Limited (CY)
Arch. Makariou III, 195 Neocleous House, 3030
Limassol, Cyprus (CY)
(72) TYNESKI, Frank (US);
KHACHATRYAN, Artyom (AM);
BROYAN, Mikhail (AM);
ELAM, John, Michael (US);
GILBERT, Alexander (US);
HEDDEN, Jackson (US)
(74) Larisa Amirkhanyan
(54) HOOKAH DEVICE

- (11) P 2023 7534 B (51) Int. Cl. (2006)
A 61 K 31/397
A 61 P 25/18
C 07 D 471/04
C 07 D 491/107
(10) AP 2023 15557 A (44) 9(612)/2023
(21) AP 2019 15557
(22) 2019 07 12
(24) 2019 07 12
(31) P1800248
(32) 2018 07 13
(33) HU
(86) PCT/IB2019/055948, 2019 07 12
(73) Richter Gedeon Nyrt. (HU)
Gyömrői út 19-21, H-1103 Budapest,
Hungary (HU)
(72) ÉLES, János (HU);
DUDÁSNÉ MOLNÁR, Katalin (HU);
LEDNECZKI, István (HU);
TAPOLCSÁNYI, Pál (HU);
HORVÁTH, Anita (HU);
NÉMETHY, Zsolt (HU);
LÉVAY, György István (HU)
(74) Liliana Darakhvelidze
(54) SPIROCHROMANE DERIVATIVES

A 61

- (11) P 2023 7539 B (51) Int. Cl. (2006)
A 61 K 47/26
A 61 K 39/12
A 61 K 9/14
A 61 K 9/00
(10) AP 2023 15384 A (44) 10(613)/2023
(21) AP 2018 15384
(22) 2018 12 03
(24) 2018 12 03
(31) 62/595,842

- (11) P 2023 7538 B (51) Int. Cl. (2006)
A 61 K 39/395
A 61 K 39/00
C 07 K 16/00
(10) AP 2023 15864 A (44) 10(613)/2023
(21) AP 2016 15864
(22) 2016 07 28
(24) 2016 07 28

(62) AP 2016 14712 2016 07 28
 (31) 62/198,867; 62/239,559; 62/255,140; 62/322,974
 (32) 2015 07 30; 2015 10 09; 2015 11 13; 2016 04 15
 (33) US; US; US; US
 (86) PCT/US2016/044430, 2016 07 28
 (73) Macrogenics Inc. (US)
 9704 Medical Center Drive, Rockville,
 MD 20850, USA (US)
 (72) SHAH, Kalpana (US);
 SMITH, Douglas, H. (US);
 LA MOTTE-MOHS, Ross (US);
 JOHNSON, Leslie, S. (US);
 MOORE, Paul, A. (US);
 BONVINI, Ezio (US);
 KOENIG, Scott (US)
 (74) Shalva Gvaramadze
 (54) PD-1-BINDING MOLECULES AND
 METHODS OF USE THEREOF

(72) Kamo Kuregyan (RU)
 (74) Vakhtang Torotadze
 (54) METHOD AND DEVICE FOR INTERNAL
 COMBUSTION ENGINES EXHAUST
 GASES DECONTAMINATION

PART B

B 66

(11) P 2023 7536 B (51) Int. Cl. (2006)
 B 66 C 1/10
 (10) AP 2023 15737 A (44) 6(609)/2023
 (21) AP 2019 15737
 (22) 2019 04 10
 (24) 2019 04 10
 (86) PCT/RU2019/000234, 2019 04 10
 (73) NOSIREV, Sergey Vasilievich (RU)
 Chudnovsky Str. 8, bld. 1, ap. 523, 193312, Saint
 Petersburg, Russian Federation (RU)
 (72) NOSIREV, Sergey Vasilievich (RU)
 (74) Nikoloz Gogilidze
 (54) DEVICE FOR CONTROLLING CONTAINER,
 PARTICULARLY BOTTOM-DUMP CONTAI-
 NER

PART F

F 01

(11) P 2023 7537 B (51) Int. Cl. (2006)
 F 01 N 3/00
 (10) AP 2023 15686 A (44) 9(612)/2023
 (21) AP 2021 15686
 (22) 2021 07 06
 (24) 2021 07 06
 (73) Kamo Kuregyan (RU)
 Krasnoslobodskaya Ul. 42A, Piatigorsk,
 Stavropol Region, 357538, Russian
 Federation (RU)

APPLICATIONS***

PART A

A 61

- (10) AP 2023 16320 A (51) A 61 K 31/137
A 61 K 31/42
A 61 K 31/506
A 61 K 31/551
A 61 K 31/7008
A 61 K 45/06
- (43) 2023 09 11 №17
(21) AP 2018 16320
(22) 2018 04 26
(62) AP 2018 15757 2018 04 26
(31) 62/491,504; 62/558,814
(32) 2017 04 28; 2017 09 14
(33) US; US
(71) The Brigham and Women's Hospital, INC. (US)
75 Francis Street, Boston, MA 02115, USA (US)
(72) WELLMAN, D. Andrew (US);
TARANTO-MONTEMURRO, Luigi (US)
(74) Giorgi Kartvelishvili
(85) 2023 08 05
(86) PCT/US2018/029518, 2018 04 26
(54) METHODS AND COMPOSITIONS
FOR TREATING SLEEP APNEA
(57) Methods and compositions for the treatment of
conditions associated with pharyngeal airway muscle
collapse while the subject is in a non-fully conscious
state, e.g., sleep apnea and snoring, comprising admi-
nistration of a norepinephrine reuptake inhibitor (NRI)
and a muscarinic receptor antagonist.

- (10) AP 2023 16286 A (51) A 61 K 31/496
A 61 P 9/10
C 07 D 401/04
- (43) 2023 09 11 №17
(21) AP 2021 16286
(22) 2021 12 09
(31) 20213016.7
(32) 2020 12 10
(33) EP
(71) Bayer Aktiengesellschaft (DE)
Kaiser-Wilhelm-Allee 1, 51373 Leverkusen,
Germany (DE)
(72) BOULTADAKIS-ARAPINIS, Melissa (DE);
DIETZ, Lisa (DE);
VAKALOPOULOS, Alexandros (DE);
DIESKAU, Andre (DE);
CANDISH, Lisa (DE);
STELLFELD, Timo (DE);
WEBSTER, Robert, Alan (DE);
SCHMECK, Carsten (DE);
MONDRITZKI, Thomas (DE);

- COLLIN-KRÖPELIN, Marie-Pierre (DE);
ORTEGA HERNANDEZ, Nuria (DE);
HOFMEISTER, Lucas, Hudson (DE);
SANDNER, Peter (DE);
WUNDER, Frank (DE);
MATHAR, Ilka (DE)
- (74) Giorgi Kartvelishvili
(85) 2023 07 10
(86) PCT/EP2021/084980, 2021 12 09
(54) SUBSTITUTED PYRAZOLO PIPERIDINE
CARBOXYLIC ACIDS
(57) The invention relates to substituted pyrazolo
piperidine carboxylic acids, their salts and to processes
for their preparation, and also to their use for preparing
medicaments for the treatment and/or prophylaxis of
diseases, in particular cardiovascular and cardiac
diseases, preferably heart failure with reduced and
preserved ejection fraction (HFrEF, HFmrEF and
HFpEF), hypertension (HTN), peripheral arterial
diseases (PAD, PAOD), cardio-renal and kidney
diseases, preferably chronic and diabetic kidney
disease (CKD and DKD), cardiopulmonary and lung
diseases, preferable pulmonary hypertension (PH), and
other diseases, preferably neurodegenerative diseases
and different forms of dementias, fibrotic diseases,
systemic sclerosis (SSc), sickle cell disease (SCD),
wound healing disorders such as diabetic foot ulcer
(DFU).

- (10) AP 2023 16287 A (51) A 61 K 31/496
A 61 P 11/00
A 61 P 13/12
A 61 P 7/00
A 61 P 9/00
C 07 D 401/04
- (43) 2023 09 11 №17
(21) AP 2021 16287
(22) 2021 12 09
(31) 20213020.9
(32) 2020 12 10
(33) EP
(71) Bayer Aktiengesellschaft (DE)
Kaiser-Wilhelm-Allee 1, 51373 Leverkusen,
Germany (DE)
(72) VAKALOPOULOS, Alexandros (DE);
COLLIN-KRÖPELIN, Marie-Pierre (DE);
ORTEGA HERNANDEZ, Nuria (DE);
DIESKAU, Andre (DE);
BOULTADAKIS-ARAPINIS, Melissa (DE);
CANDISH, Lisa (DE);
SCHMECK, Carsten (DE);
STELLFELD, Timo (DE);
MATHAR, Ilka (DE);
HOFMEISTER, Lucas, Hudson (DE);

SANDNER, Peter (DE);
WUNDER, Frank (DE);
DIETZ, Lisa (DE);
WEBSTER, Robert, Alan (DE);
MONDRITZKI, Thomas (DE)

(74) Giorgi Kartvelishvili

(85) 2023 07 10

(86) PCT/EP2021/084987, 2021 12 09

(54) SUBSTITUTED PYRAZOLO PIPERIDINE
CARBOXYLIC ACIDS

(57) The invention relates to substituted pyrazolo piperidine carboxylic acids, their salts and to processes for their preparation, and also to their use for preparing medicaments for the treatment and/or prophylaxis of diseases, in particular cardiovascular and cardiac diseases, preferably heart failure with reduced and preserved ejection fraction (HFrEF, HFmrEF and HFpEF), hypertension (HTN), peripheral arterial diseases (PAD, PAOD), cardio-renal and kidney diseases, preferably chronic and diabetic kidney disease (CKD and DKD), cardiopulmonary and lung diseases, preferable pulmonary hypertension (PH), and other diseases, preferably neurodegenerative diseases and different forms of dementias, fibrotic diseases, systemic sclerosis (SSc), sickle cell disease (SCD), wound healing disorders such as diabetic foot ulcer (DFU).

(10) AP 2023 16298 A (51) A 61 K 31/7076
A 61 P 31/14
C 07 H 19/207

(43) 2023 09 11 №17

(21) AP 2021 16298

(22) 2021 02 24

(62) AP 2021 16047 2021 02 24

(31) 62/982,670; 63/032,247; 62/994,206; 63/039,352;
63/040,985; 63/054,680; 63/073,328; 63/146,456

(32) 2020 02 27; 2020 05 29; 2020 03 24; 2020 06 15;
2020 06 18; 2020 07 21; 2020 09 01; 2021 02 05

(33) US; US; US; US; US; US; US; US; US

(71) Atea Pharmaceuticals, INC. (US)

225 Franklin Street, Suite 2100, Boston,
MA 02110, USA (US)

(72) SOMMADOSSI, Jean-pierre (US);

MOUSSA, Adel (US)

(74) Giorgi Kartvelishvili

(85) 2023 07 16

(86) PCT/US2021/019468, 2021 02 24

(54) HIGHLY ACTIVE COMPOUNDS AGAINST
COVID-19

(57) Present invention is the use of purine nucleotide phosphoramidates or pharmaceutically acceptable salts thereof administered in an effective amount for the treatment or prevention of COVID-19, an infection caused by the SARS CoV-2 virus in a host, for example a human, in need thereof.

DESIGNS

APPLICATIONS APPROVED FOR REGISTRATION

The decision can be appealed at the Chamber of Appeal of Sakpatenti within 3 months from the publication or at the Mtskheta District Court Administrative Cases Board (Address: №17, Samkhedro str., Mtskheta), within 1 month following the publication.

- (10) AD 2023 1305 S (51) 07-02
- (21) AD 2023 1305 (22) 2023 04 19
- (28) 7
- (71) LTD "Meama" (GE)
Givi Amilakhvari St. 2, 0109, Samgori District, Georgia(GE)
- (72) Luka Janjghava (GE)
- (74) Nikoloz Gogilidze (GE)
- (54) COFFEE MACHINE
- (55)



1.1



1.2



1.3



1.4



1.5



2.1



2.2



2.3

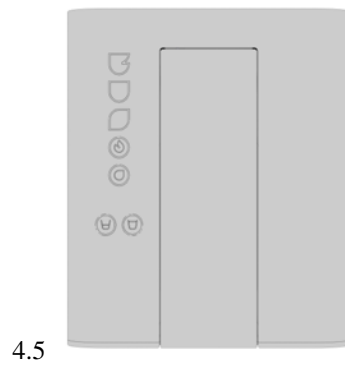
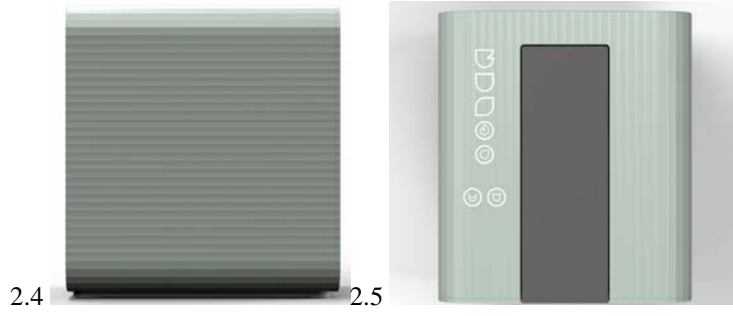

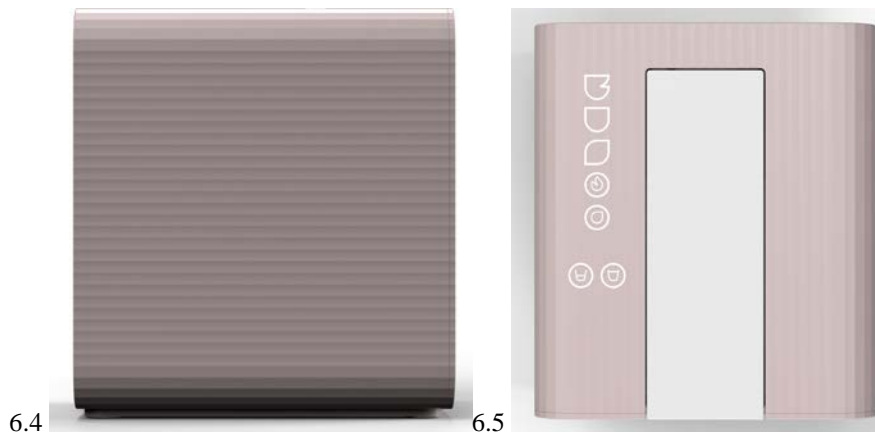
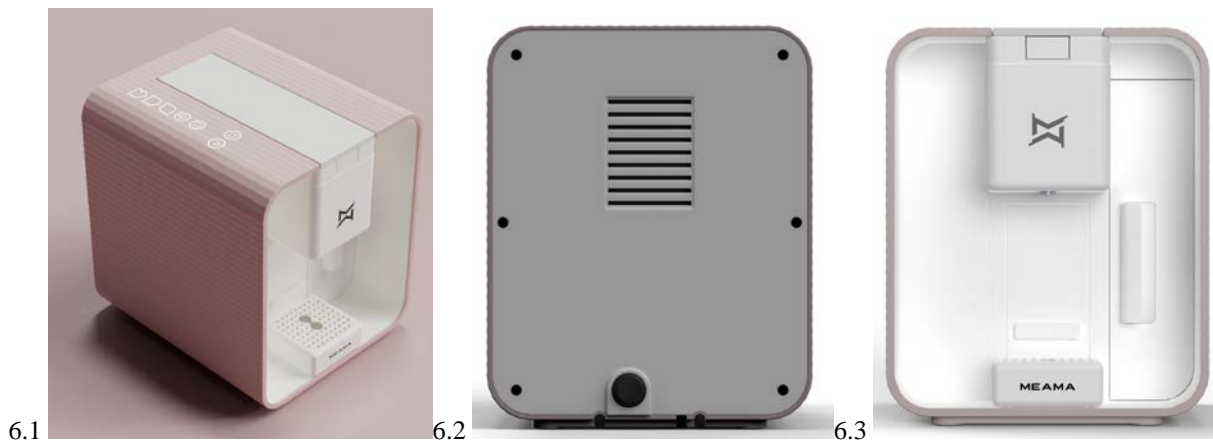
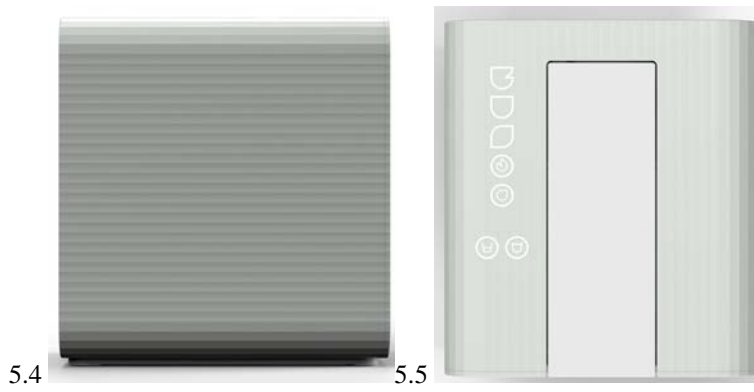
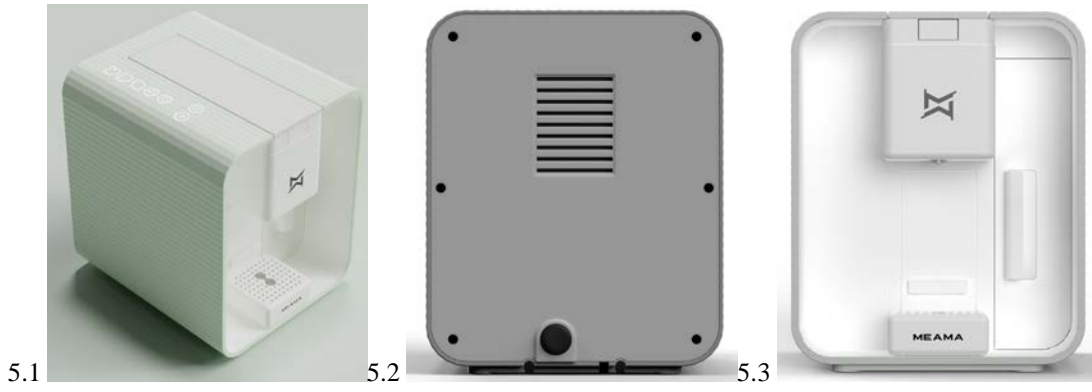



7.1



7.2



7.3

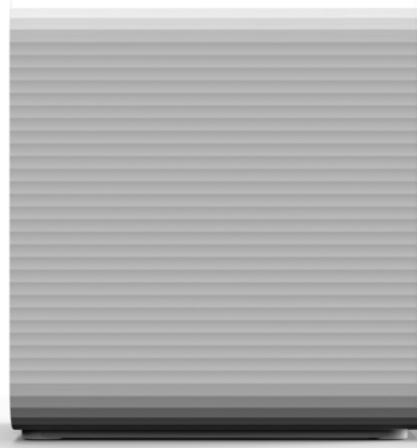

7.4

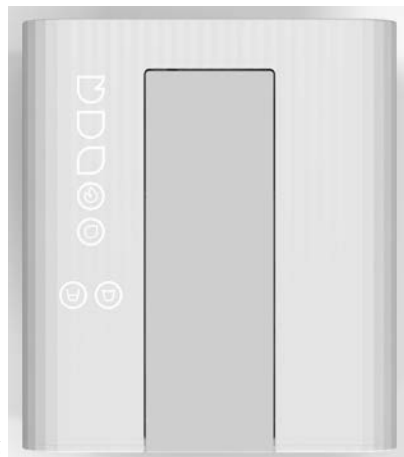

7.5

(10) AD 2023 1303 S

(51) 11-01

(21) AD 2023 1303

(22) 2023 04 07

(28) 17

(71) LTD "Zarapkhan" (GE)

Ljubljana St. 15, 0159, Tbilisi, Georgia (GE)

(72) Tea Tetradze (GE)

(54) 10. BRACELET; 11.-12. EARRING; 13. NECKLACE; 14.-16. EARRING; 17. RING; 1. NECKLACE;

2. RING; 3. EARRING; 4.-6. BRACELET 7. NECKLACE; 8.-9. EARRING

(55)





4.2



5.1



5.2



5.3



6.1



6.2



7.1



8.1



9.1



10.1



10.2



11.1



12.1





13.1



14.1



15.1



16.1



17.1



17.2

DESIGN REGISTERED ACCORDING TO THE ACCELERATED PROCEDURE

The decision can be appealed at the Chamber of Appeal of Sakpatenti within 3 months from the publication.

(11) D 2023 978 S (51) 02-04
(21) AD 2023 1322 (22) 2023 07 05
(24) 2023 07 05
(28) 1
(18) 2028 07 05
(73) Anna Biani (GE)
Solomon Kurdiani St. 23, 0101, Tbilisi, Georgia (GE)
(72) Anna Biani (GE)
(54) SHOES
(55)



1.1

**DESIGNS, WHICH HAVE BEEN REGISTERED WITH THE INTERNATIONAL
BUREAU CLAIMING PRIORITY ON THE TERRITORY OF GEORGIA**

The decision can be appealed at the Chamber of Appeal of Sakpatenti within 3 months from the publication or at the Mtskheta District Court Administrative Cases Board (Address: №17, Samkhedro St., Mtskheta), within 1 month following the publication.

- (11) DM/226 164
- (15) 2022 12 23
- (22) 2022 12 23
- (28) 3
- (73) Harry Winston SA
Chemin Du Tourbillon 8, 1228 Plan-les-Ouates (CH)
- (85) CH
- (86) CH
- (87) CH
- (88) CH
- (89) CH
- (81) III. KG, LI, MK, OM, GE, TR, CA, BA, MN, NO, CH, EM, AL, UA, AM, MA, SG, MC, MD, ME, BZ,
AZ, TN, GB
- (72) Tobias WUEST
C/o Harry Winston Inc. 718 Fifth Avenue, 10019, New York (US)
- (74) The Swatch Group AG (The Swatch Group SA) (The Swatch Group Ltd.)
Faubourg Du Lac 6, 2501 Biel/Bienne (CH)
- (46) 2023 06 23
- (54) 1.-2. BRACELET, 3. BROOCH
- (55)





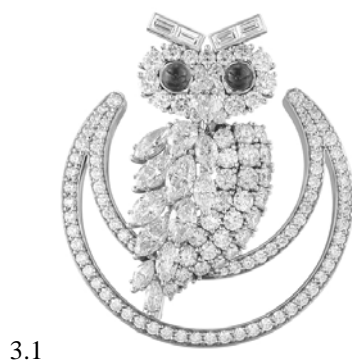



3.3



3.4



3.5



3.6



3.7



3.8

- (11) DM/229 601 (51) 09-05
- (15) 2023 05 25 (44) 27/2023 (2023 07 07)
- (22) 2023 05 25
- (28) 8
- (30) №1: 12.01.2023; 015008469-0002; EM; №2: 12.01.2023; 015008469-0002; EM;
 №3: 12.01.2023; 015008469-0002; EM; №4: 12.01.2023; 015008469-0002; EM;
 №5: 12.01.2023; 015008469-0002; EM; №6: 12.01.2023; 015008469-0002; EM;
 №7: 12.01.2023; 015008469-0002; EM; №8: 12.01.2023; 015008469-0002; EM
- (73) Qrean Limited
 Fifth Floor Watson House, 54-60 Baker Street, W1U 7BU London (GB);
 London Pharma Capital Ltd
 Fifth Floor Watson House, 54-60 Baker Street, W1U 7BU London (GB)
- (85) -; -
- (86) -; -
- (87) GB; GB
- (88) GB; GB
- (89) GB; GB
- (81) III. GE, OM, CA, NO, RS, RW, SY, MU, AM, BW, TJ, MD, VN, TN, SR, MN, JP, KR, CN, UA, OA, MA,
 ME, AZ, SM, KG, WS, LI, US, MK, BA, EG, RU, JM, IS, BY, GB, KH, TR, ST, GH, IL, KP, CH, AL, MX,
 BN, NA, SG, MC, BZ, TM
- (72) Ivan Berkes
 20E Queens Gate Place, SW7 5NY, London (GB)
- (74) Rott, Ruzicka & Guttman A Spol
 Vyskocilova 1566, 140 00 Praha 4 (CZ)
- (46) 2023 06 23
- (54) 1.-8. PART OF BLISTER PACKAGE
- (55)

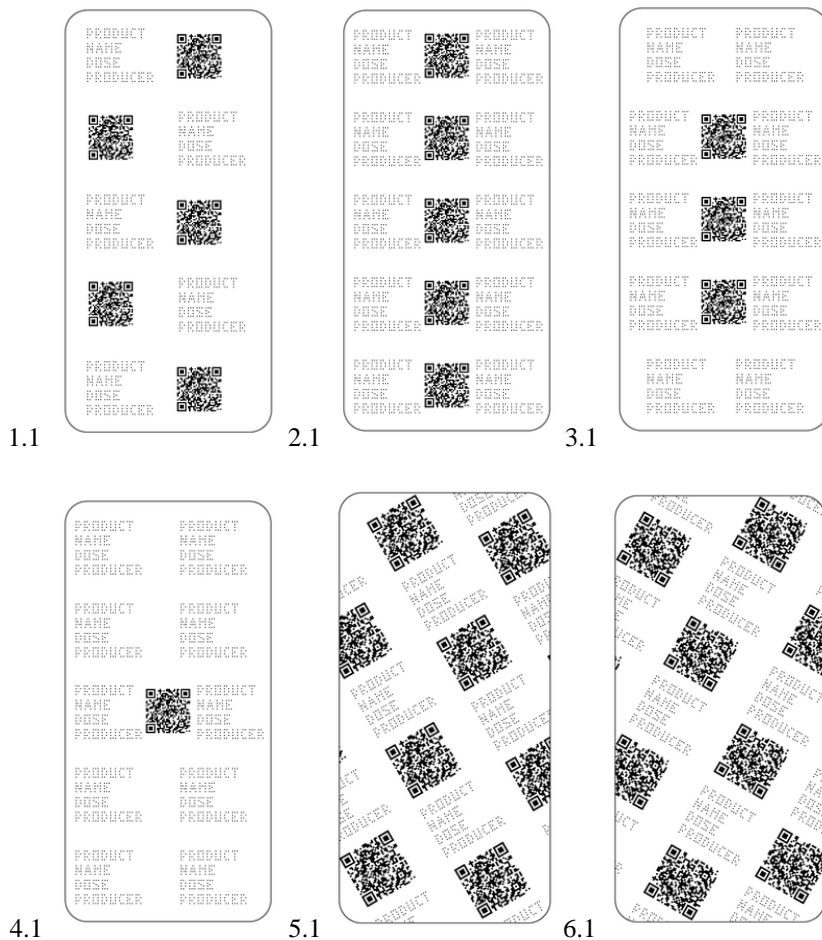

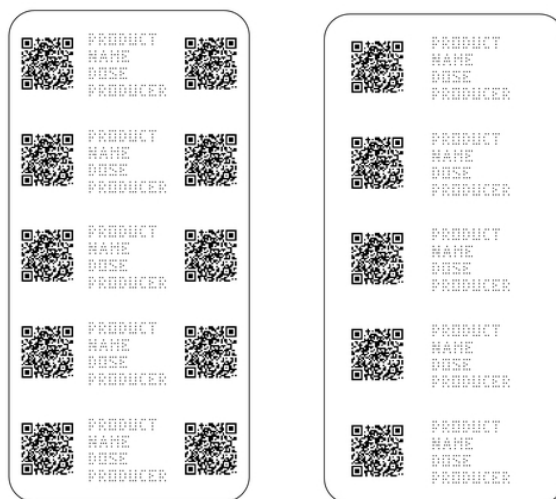

7.1

8.1

- (11) DM/229 924 (51) 10-07
 (15) 2023 06 21 (44) 27/2023 (2023 07 07)
 (22) 2023 06 21
 (28) 1
 (30) No1: 10.03.2023; 2023-00131; CH
 (73) Rolex SA
 Rue François-Dussaud 3-5-7, 1211 Genève 26 (CH)
 (85) CH
 (86) CH
 (87) CH
 (88) CH
 (89) CH
 (81) III. OM, GE, CA, NO, RS, RW, EM, MU, AM, BW, TJ, MD, VN, TN, SR, MN, JP, KR, UA, OA, MA, ME, AZ, SM, WS, KG, LI, MK, BA, EG, RU, JM, IS, BY, GB, KH, TR, ST, GH, IL, KP, AL, MX, BN, NA, SG, MC, BZ, TM
 (72) Davide AIROLDI
 16 Rue Du Grand-Bureau, 1227, Genève (CH)
 (74) Bugnion S.A.
 10, Route De Florissant, Case Postale 375, 1211 Genève 12 (CH)
 (46) 2023 07 07
 (54) 1. WATCH CASE
 (55)



1.1



1.2

1.3

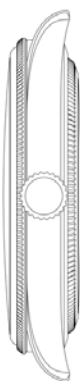

1.4

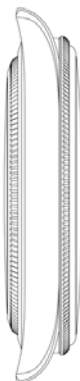

1.5

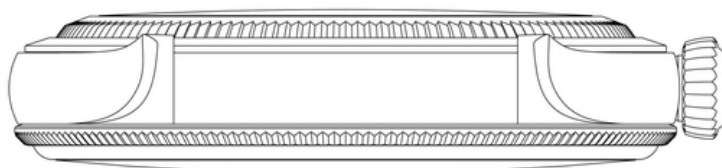

1.6



1.7



1.8

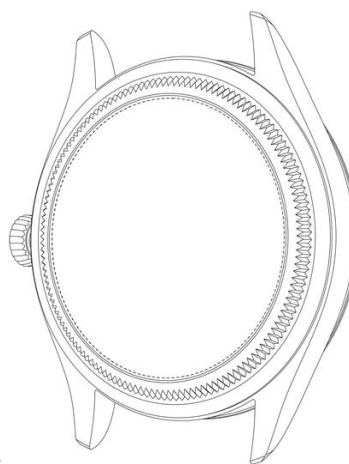

- (11) DM/229 925 (51) 10-07
 (15) 2023 06 22 (44) 27/2023 (2023 07 07)
 (22) 2023 06 22
 (28) 1
 (30) No1: 14.03.2023; 2023-00141; CH
 (73) Rolex SA
 rue François-Dussaud 3-5-7, 1211 Genève 26 (CH)
 (85) CH
 (86) CH
 (87) CH
 (88) CH
 (89) CH
 (81) III. CA, GE, OM, NO, RS, RW, EM, MU, AM, BW, TJ, MD, VN, TN, SR, MN, JP, KR, UA, OA, MA, ME, AZ, SM, KG, WS, LI, MK, BA, EG, JM, RU, IS, BY, GB, KH, TR, ST, GH, IL, KP, AL, MX, BN, NA, SG, MC, BZ, TM
 (72) Giovanni Siciliano
 9, Chemin Docteur-Adolphe Pasteur, 1209, Genève (CH)
 (74) Bugnion S.A.
 10, route de Florissant, Case postale 375, 1211 Genève 12 (CH)
 (46) 2023 07 07
 (54) 1. WATCH WINDING CROWN
 (55)



1.1

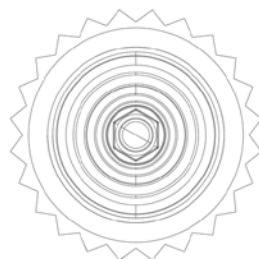

1.2

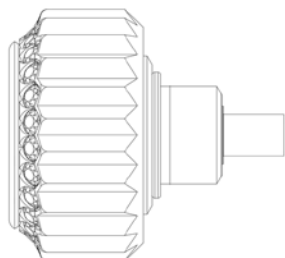

1.3

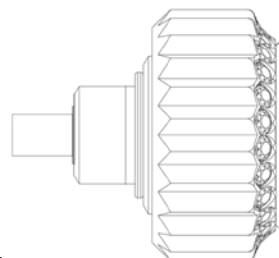

1.4

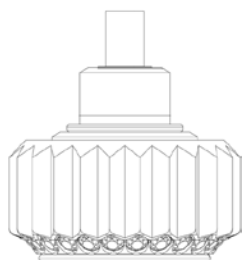

1.5

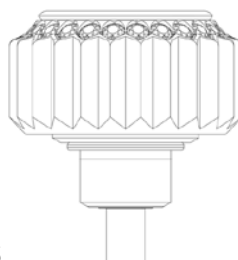

1.6

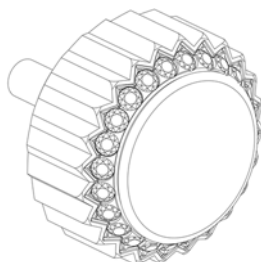

1.7

- (11) DM/229 926
- (15) 2023 06 22
- (22) 2023 06 22
- (28) 1
- (30) No1: 23.03.2023; 2023-00184; CH
- (73) Rolex SA
rue François-Dussaud 3-5-7, 1211 Genève 26 (CH)
- (85) CH
- (86) CH
- (87) CH
- (88) CH
- (89) CH
- (81) III. CA, GE, OM, NO, RS, RW, EM, MU, AM, BW, TJ, MD, VN, TN, SR, MN, JP, KR, UA, OA, MA, ME, AZ, SM, KG, WS, LI, MK, BA, EG, JM, RU, IS, BY, GB, KH, TR, ST, GH, IL, KP, AL, MX, BN, NA, SG, MC, BZ, TM
- (72) Giovanni Siciliano
9, Chemin Docteur-Adolphe Pasteur, 1209, Genève (CH)
- (74) Bugnion S.A.
10, route de Florissant, Case postale 375, 1211 Genève 12 (CH)
- (46) 2023 07 07
- (54) 1. WATCH CASE
- (55)



- (11) DM/229 927 (51) 10-07
 (15) 2023 06 22 (44) 27/2023 (2023 07 07)
 (22) 2023 06 22
 (28) 1
 (30) No1: 17.03.2023; 2023-00162; CH
 (73) Rolex SA
 rue François-Dussaud 3-5-7, 1211 Genève 26 (CH)
 (85) CH
 (86) CH
 (87) CH
 (88) CH
 (89) CH
 (81) III. CA, OM, GE, NO, RS, RW, MU, EM, AM, BW, TJ, MD, VN, TN, SR, MN, JP, KR, UA, OA, MA, ME, AZ, SM, KG, WS, LI, MK, BA, EG, RU, JM, IS, BY, GB, KH, TR, GH, ST, IL, KP, MX, AL, BN, NA, SG, MC, BZ, TM
 (72) Davide AIROLDI
 16 rue du Grand-Bureau, 1227, Genève (CH)
 (74) Bugnion S.A.
 10, route de Florissant, Case postale 375, 1211 Genève 12 (CH)
 (46) 2023 07 07
 (54) 1. TIMEPIECE MOVEMENT
 (55)

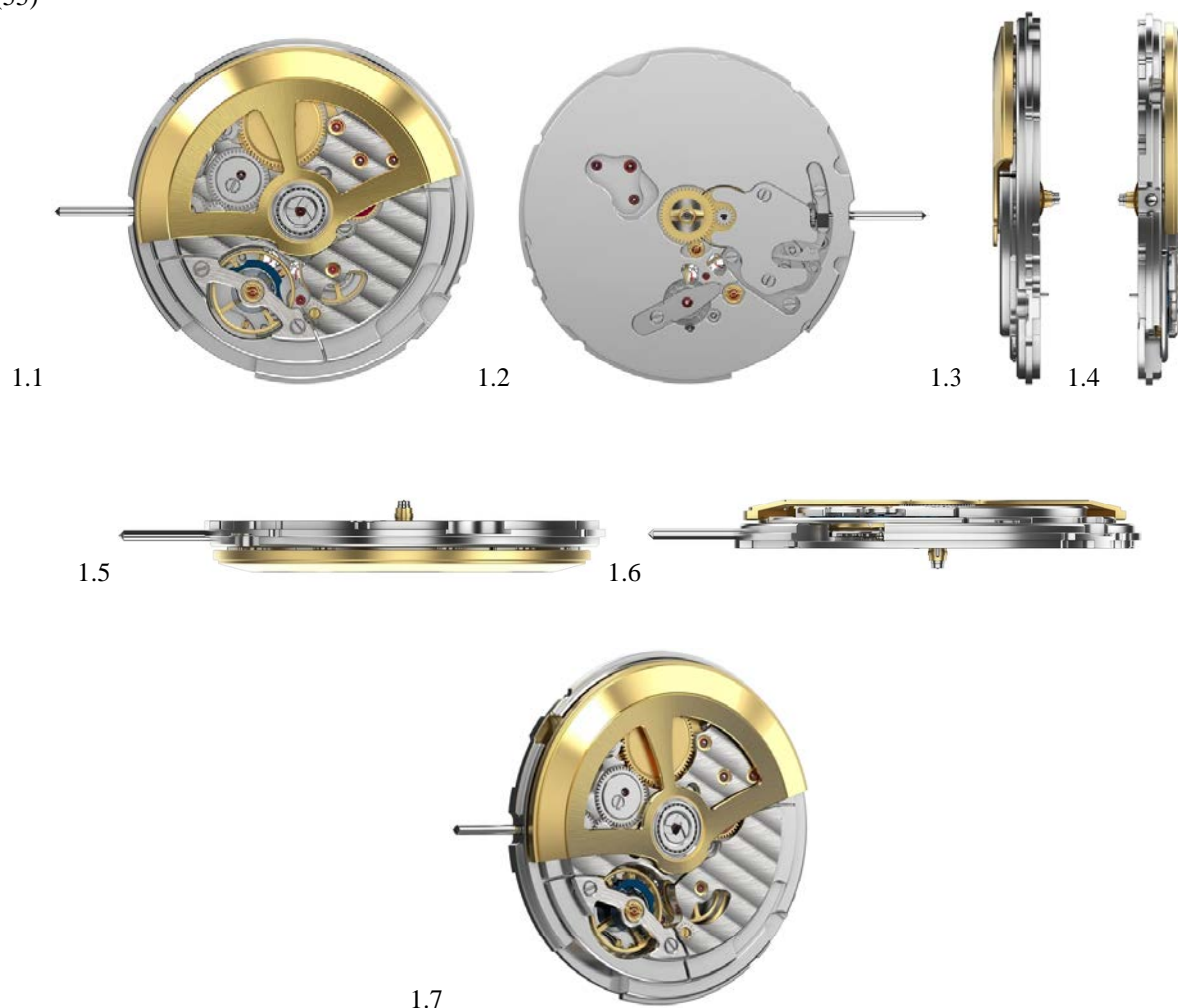

- (11) DM/229 928
- (15) 2023 06 22
- (22) 2023 06 22
- (28) 1
- (30) No1: 16.03.2023; 2023-00157; CH
- (73) Rolex SA
rue François-Dussaud 3-5-7, 1211 Genève 26 (CH)
- (85) CH
- (86) CH
- (87) CH
- (88) CH
- (89) CH
- (81) III. CA, GE, OM, NO, RS, RW, EM, MU, AM, BW, TJ, MD, VN, TN, SR, MN, JP, KR, UA, OA, MA, ME, AZ, SM, KG, WS, LI, MK, BA, EG, JM, RU, IS, BY, GB, KH, TR, ST, GH, IL, KP, AL, MX, BN, NA, SG, MC, BZ, TM
- (72) Giovanni Siciliano
9, Chemin Docteur-Adolphe Pasteur, 1209, Genève (CH)
- (74) Bugnion S.A.
10, route de Florissant, Case postale 375, 1211 Genève 12 (CH)
- (46) 2023 07 07
- (54) 1. WATCH DIAL
- (55)

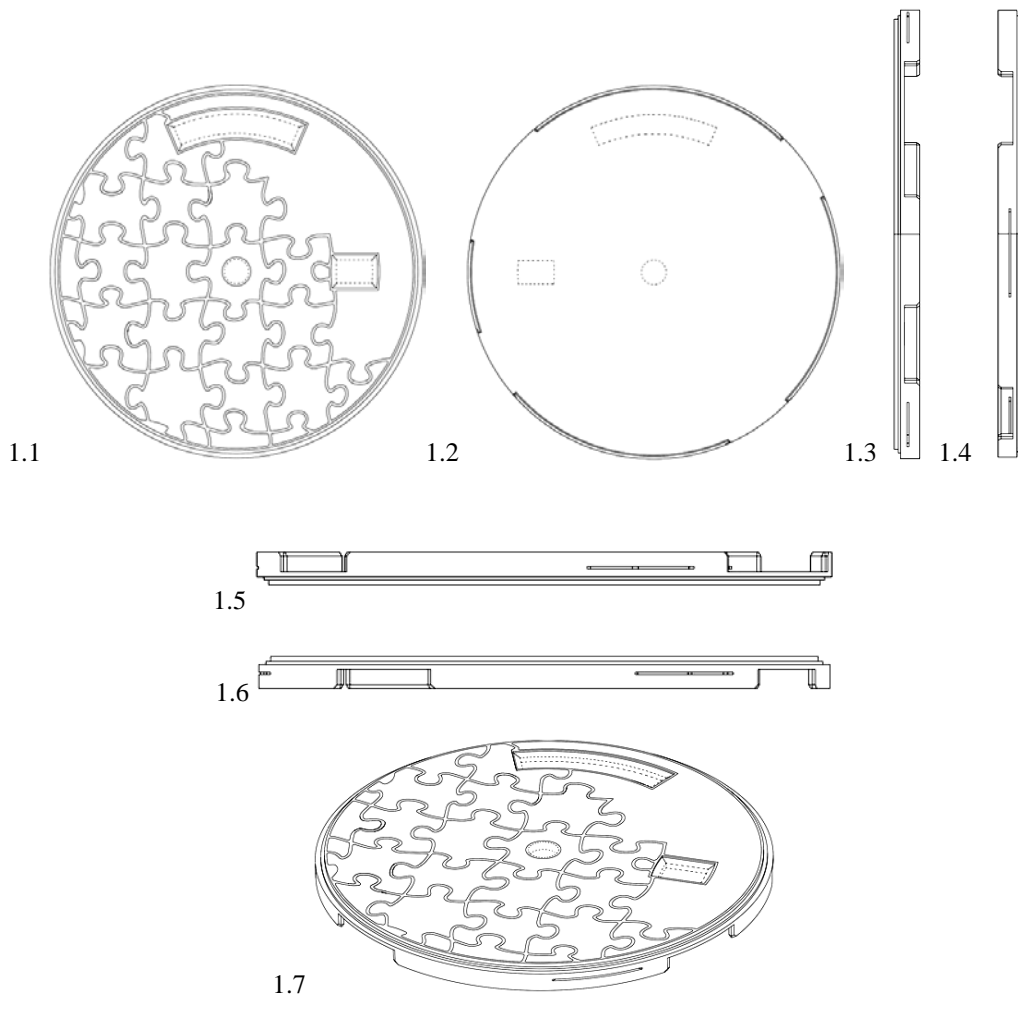

- (11) DM/229 929 (51) 10-07
 (15) 2023 06 22 (44) 27/2023 (2023 07 07)
 (22) 2023 06 22
 (28) 1
 (30) No1: 20.03.2023; 2023-00171; CH
 (73) Rolex SA
 rue François-Dussaud 3-5-7, 1211 Genève 26 (CH)
 (85) CH
 (86) CH
 (87) CH
 (88) CH
 (89) CH
 (81) III. CA, OM, GE, NO, RS, RW, MU, EM, AM, BW, TJ, MD, VN, TN, SR, MN, JP, KR, UA, OA, MA, ME,
 AZ, SM, KG, WS, LI, MK, BA, EG, RU, JM, IS, BY, GB, KH, TR, GH, ST, IL, KP, MX, AL, BN, NA, SG,
 MC, BZ, TM
 (72) Davide AIROLDI
 16 rue du Grand-Bureau, 1227, Genève (CH)
 (74) Bugnion S.A.
 10, route de Florissant, Case postale 375, 1211 Genève 12 (CH)
 (46) 2023 07 07
 (54) 1. TIMEPIECE MOVEMENT
 (55)

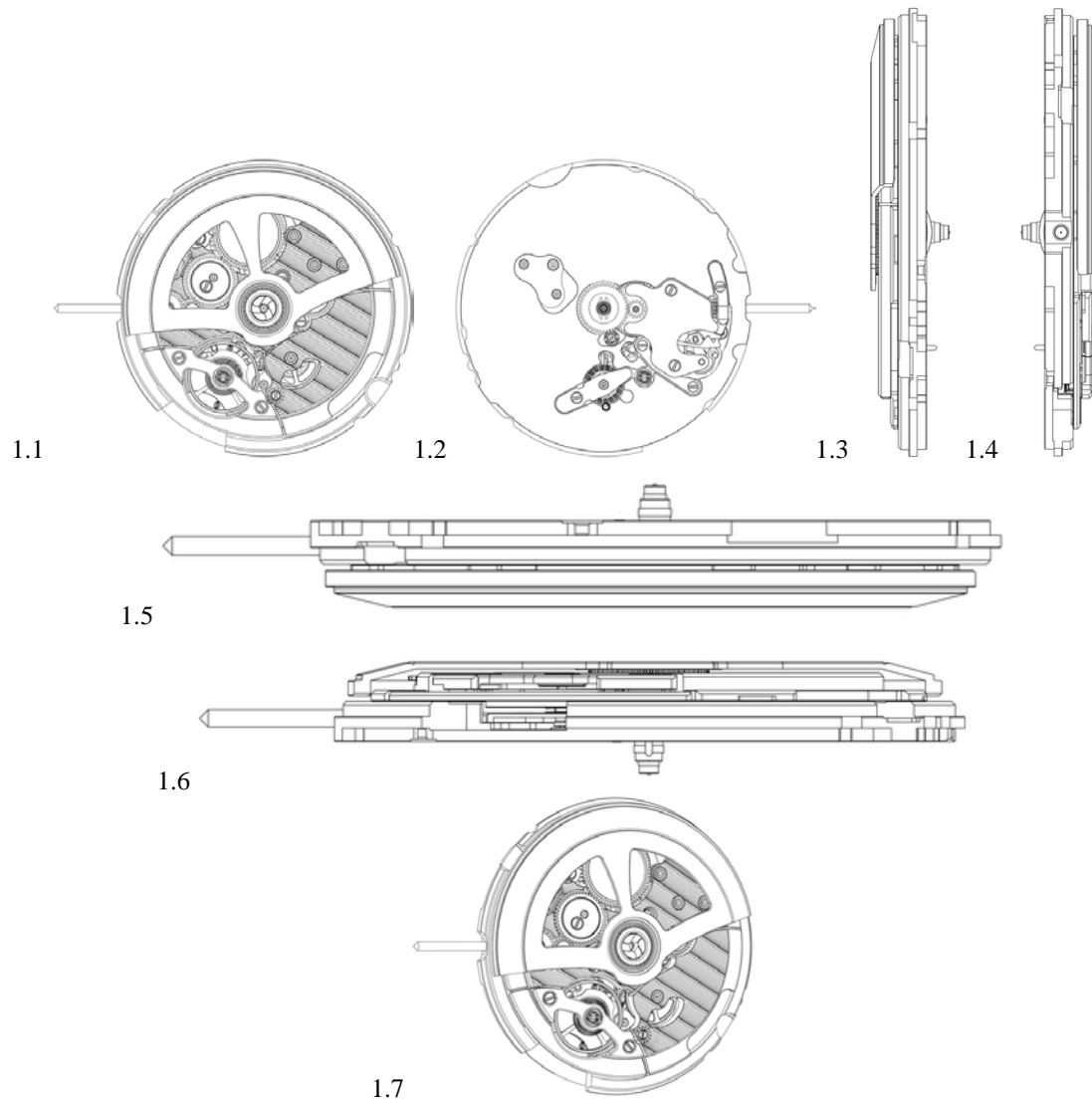

- (11) DM/229 932 (51) 10-07
- (15) 2023 06 22 (44) 27/2023 (2023 07 07)
- (22) 2023 06 22
- (28) 2
- (30) No1: 20.03.2023; 2023-00169; CH; No2: 20.03.2023; 2023-00169; CH
- (73) Rolex SA
rue François-Dussaud 3-5-7, 1211 Genève 26 (CH)
- (85) CH
- (86) CH
- (87) CH
- (88) CH
- (89) CH
- (81) III. CA, GE, OM, NO, RS, RW, EM, MU, AM, BW, TJ, MD, VN, TN, SR, MN, JP, KR, UA, OA, MA, ME, AZ, SM, KG, WS, LI, MK, BA, EG, JM, RU, IS, BY, GB, KH, TR, ST, GH, IL, KP, AL, MX, BN, NA, SG, MC, BZ, TM
- (72) Giovanni Siciliano
9, Chemin Docteur-Adolphe Pasteur, 1209, Genève (CH)
- (74) Bugnion S.A.
10, route de Florissant, Case postale 375, 1211 Genève 12 (CH)
- (46) 2023 07 07
- (54) 1.-2. WATCH DIAL
- (55)

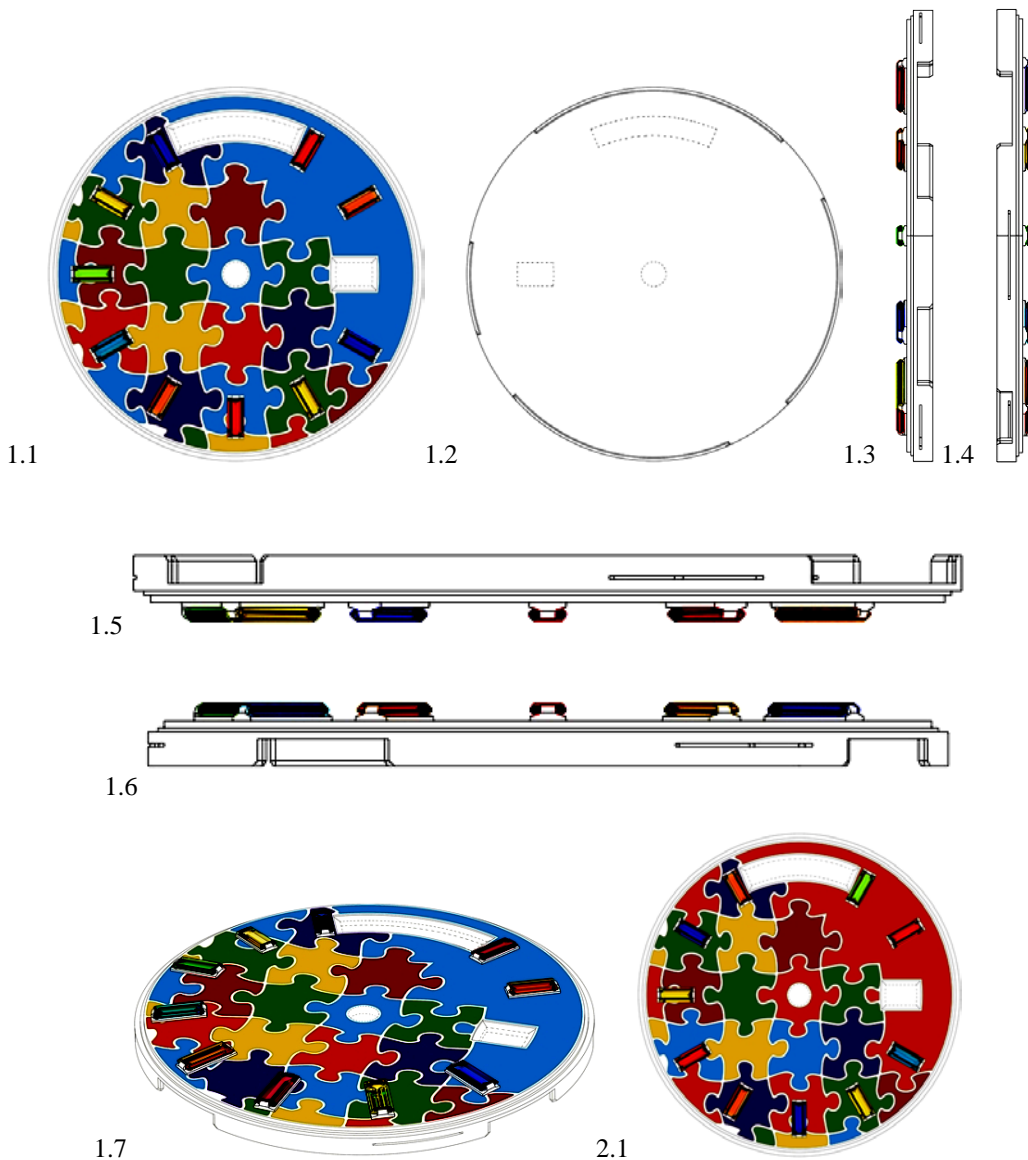

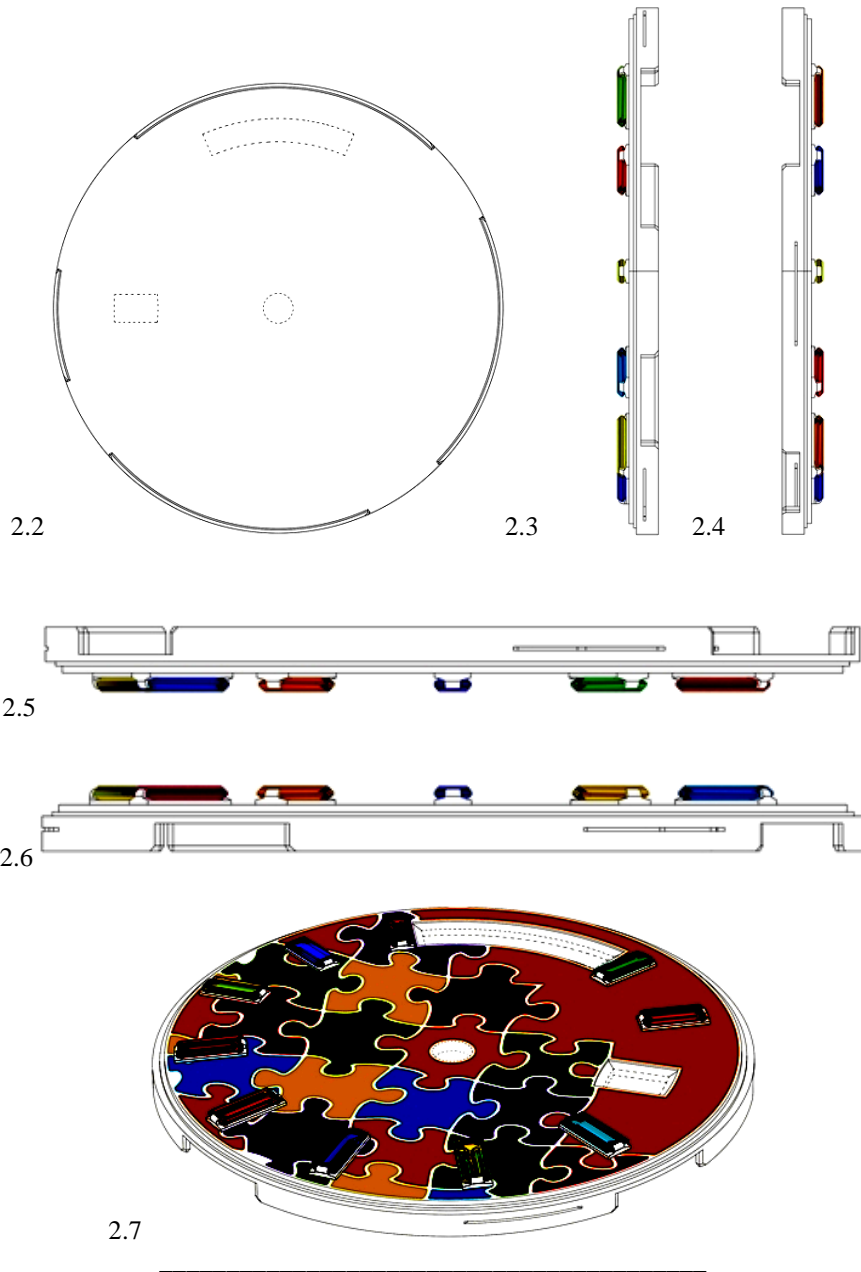

- (11) DM/229 933 (51) 10-07
 (15) 2023 06 22 (44) 27/2023 (2023 07 07)
 (22) 2023 06 22
 (28) 1
 (30) No1: 20.03.2023; 2023-00167; CH
 (73) Rolex SA
 rue François-Dussaud 3-5-7, 1211 Genève 26 (CH)
 (85) CH
 (86) CH
 (87) CH
 (88) CH
 (89) CH
 (81) III. CA, OM, GE, NO, RS, RW, MU, EM, AM, BW, TJ, MD, VN, TN, SR, MN, JP, KR, UA, OA, MA, ME, AZ, SM, KG, WS, LI, MK, BA, EG, RU, JM, IS, BY, GB, KH, TR, GH, ST, IL, KP, MX, AL, BN, NA, SG, MC, BZ, TM
 (72) Davide AIROLDI
 16 rue du Grand-Bureau, 1227, Genève (CH)
 (74) Bugnion S.A.
 10, route de Florissant, Case postale 375, 1211 Genève 12 (CH)
 (46) 2023 07 07
 (54) 1. WATCH BRACELET
 (55)

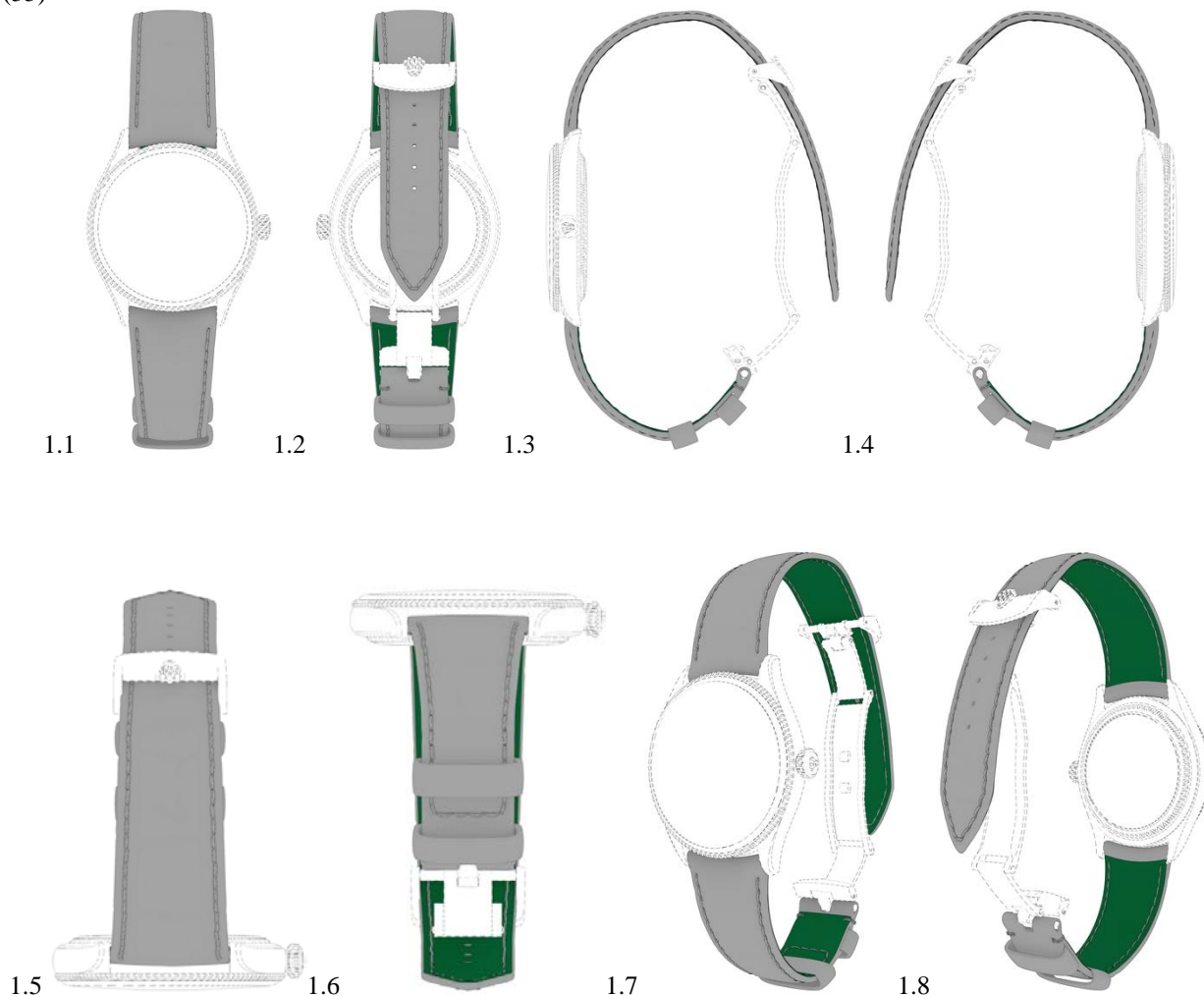

- (11) DM/226 257 (51) 10-07
 (15) 2023 01 12 (44) 28/2023 (2023 07 14)
 (22) 2023 01 12
 (28) 2
 (73) Omega SA (Omega AG) (Omega LTD.)
 Jakob-Stämpfli-Strasse 96, 2502 Biel/Bienne (CH)
 (85) CH
 (86) CH
 (87) CH
 (88) CH
 (89) CH
 (81) III. KG, LI, MK, GE, OM, TR, BA, MN, NO, CH, EM, AL, UA, AM, SG, MA, MC, MD, ME, BZ, AZ,
 TN, GB
 (72) Gregory Kissling
 C/o Omega SA (Omega AG) (Omega LTD.), Jakob-Stämpfli-Strasse 96, 2502, Biel/Bienne (CH)
 (74) The Swatch Group AG (The Swatch Group SA) (The Swatch Group Ltd.)
 6, Faubourg Du Lac, 2501 Biel/Bienne (CH)
 (46) 2023 07 14
 (54) 1. WATCH DIAL, 2. PART OF THE WATCH MOVEMENT
 (55)

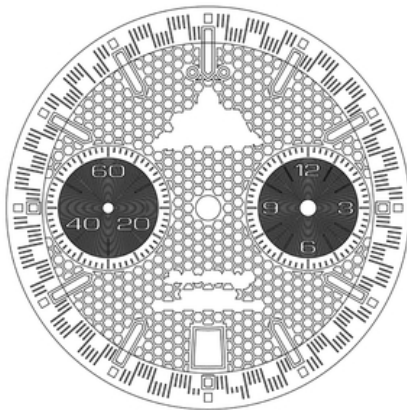

1.1

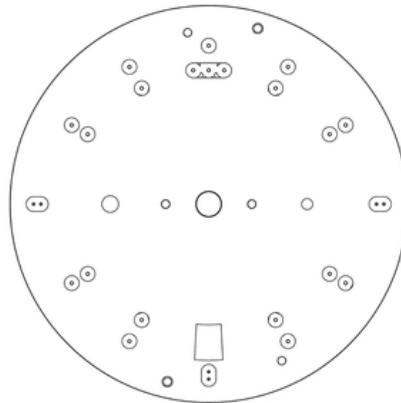

1.2



1.3



1.4

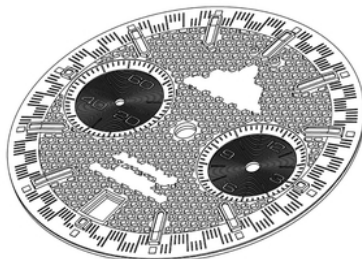

1.5

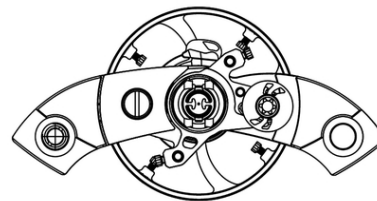

2.1



2.2

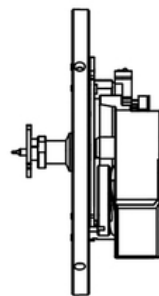

2.3

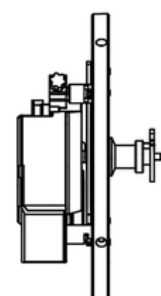

2.4

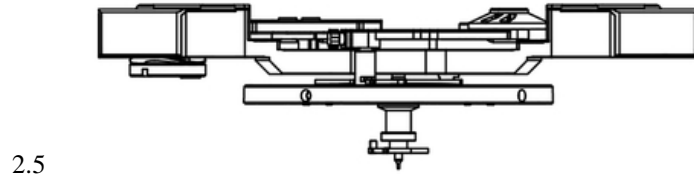

2.5

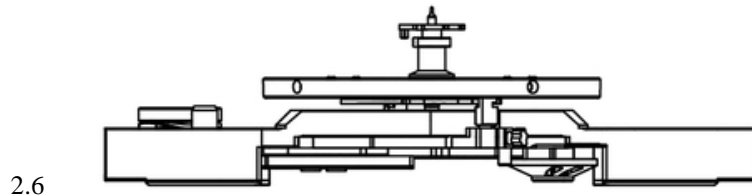

2.6

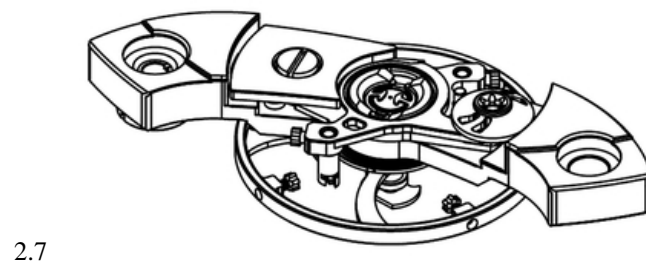

2.7

TRADEMARKS

APPLICATIONS FILED UNDER THE NATIONAL PROCEDURE APPROVED FOR REGISTRATION

The decision can be appealed at the Chamber of Appeal of Sakpatenti within 3 months from the publication or at the Mtskheta District Court Administrative Cases Board (Address: №17, Samkhedro St., Mtskheta), within 1 month following the publication.

(260) AM 2023 119366 A
(210) AM 119366
(220) 2022 09 14
(731) The News Hub Limited
Office at 10th Floor, Building 7 Chiswick Park,
566 Chiswick High Road, London, W4 5YG,
United Kingdom
(540)

وكالة أنباء العالم العربي

(591) Black-white
(531) 28.01
(511) 38, 41

(260) AM 2023 120605 A
(210) AM 120605
(220) 2022 12 02
(310) 4177688(7)
(320) 2022 07 12
(330) ES
(731) Antonio Banderas Limited
114, The Strand, Gzira GZR 1027, Malta
(740) Shalva Gvaramadze
(540)

THE ICON BANDERAS

(591) Black-white
(511) 3

(260) AM 2023 120704 A
(210) AM 120704
(220) 2022 12 12
(731) LTD "Tfilisis Marani"
Zakaria Paliashvili St. 33, ap. 6, 0179, Tbilisi,
Georgia
(540)

კახეთის ვარსკვლავები
Звёзды Кახетии
Stars of Kakheti

(591) Black-white
(531) 28.19
(526) კახეთი, Кახети, Kakheti
(511) 32, 33

(260) AM 2023 120830 A
(210) AM 120830
(220) 2022 12 20
(731) LTD "T-I-D Foods"
Gldani, Patara Vake, Tbilisi, Georgia
(540)



(591) Red, white, golden
(531) 04.01.02; 26.04.06; 26.04.22; 26.04.24;
27.05.01; 27.05.24; 29.01.13
(511) 32

(260) AM 2023 120831 A
(210) AM 120831
(220) 2022 12 20
(731) LTD "T-I-D Foods"
Gldani, Patara Vake, Tbilisi, Georgia
(540)



(591) Red, white, golden
(531) 04.01.02; 26.04.06; 26.04.22; 26.04.24;
27.05.01; 27.05.24; 29.01.13
(511) 32

(260) AM 2023 121120 A
(210) AM 121120
(220) 2023 01 09
(731) Retaj Hotels End Hospiteliti
Dafna, Diplomatic District, P.O. Box: 25556,
Doha, Qatar
(540)

كافيه زون
CAFÉZONE

(591) Black-white
(531) 26.11.08; 27.05.01; 28.01
(511) 43

(260) AM 2023 121121 A
(210) AM 121121
(220) 2023 01 09
(731) Retaj Hotels End Hospiteliti
Dafna, Diplomatic District, P.O. Box: 25556,
Doha, Qatar

(540)

RETAJ رتاج

(591) Black-white
(531) 27.05.01; 28.01
(511) 43

(260) AM 2023 121143 A
(210) AM 121143
(220) 2023 01 11
(731) LTD "Provence Tbilisi"
Ketevan Tsamebuli St. 63, ap. 84, Batumi,
Georgia

(540)

Provence

(591) Black-white
(531) 27.05.01
(511) 3, 29, 33, 43

(260) AM 2023 121153 A
(210) AM 121153
(220) 2023 01 12
(731) Galaktion Gagnidze
Sanzona, Choporti St. 8, 0192, Tbilisi, Georgia

(540)

VA
INNOVATIS

(591) White, golden
(531) 26.03.23; 27.01.01; 27.05.01; 29.01.02
(511) 3, 35

(260) AM 2023 121156 A
(210) AM 121156
(220) 2023 01 12
(731) alkaloid AD Skopje
Blvd. Aleksandar Makedonski 12, 1000 Skopje,
The Republic of North Macedonia

(740) Shalva Gvaramadze

(540)

Alkaloid Nutraceuticals

(591) Black-white
(511) 5, 30, 35

(260) AM 2023 121217 A
(210) AM 121217
(220) 2023 01 16
(731) Wenling Awt Machinery Co., Ltd.
East Xincheng Avenue, Qiaowu Village, Zeguo
Town, Wenling, Taizhou, Zhejiang Province,
People's Republic of China

(540)

AWT

(591) Black-white
(531) 27.05.01; 27.05.17; 27.05.23
(511) 7

(260) AM 2023 121218 A
(210) AM 121218
(220) 2023 01 16
(731) Nikoloz Grdzeldidze
March 8 St. 18, 0108, (Mtatsminda-Krtsanisi
District), Tbilisi, Georgia

(540)

RENT
SCOOTER

(591) 42515F blue, E54846 red
(531) 18.01.05; 27.05.01; 29.01.12
(511) 39

(260) AM 2023 121221 A
(210) AM 121221
(220) 2023 01 17
(731) LTD "Stepads"
Davit Gamrekeli St. 3, Saburtalo District,
Tbilisi, Georgia

(540)

STEP

(591) Wgite, dark blue
(531) 27.05.01; 27.05.21; 29.01.04; 29.01.12
(511) 35

(260) AM 2023 121222 A
 (210) AM 121222
 (220) 2023 01 17
 (731) LTD "GM Pharmaceuticals"
 Rustavi Highway 52, 0114, Tbilisi, Georgia
 (740) Nugzar Ksovrel
 (540)

რანოლაზი
PAHOJAZ
RANOLAZ

(591) Black-white
 (511) 5

(260) AM 2023 121223 A
 (210) AM 121223
 (220) 2023 01 17
 (731) LTD "GM Pharmaceuticals"
 Rustavi Highway 52, 0114, Tbilisi, Georgia
 (740) Nugzar Ksovrel
 (540)

რანოკორი
PAHOKOP
RANOCOR

(591) Black-white
 (511) 5

(260) AM 2023 121232 A
 (210) AM 121232
 (220) 2023 01 17
 (731) LLC "Maranik"
 Avan, Avan street 4, building 19, 0060,
 Yerevan, Armenia
 (740) Nana Kvinikadze
 (540)



(591) 00A650 green, 000000 black, A8A9AD
 grey, ED1B24 red, FFFFFFF white
 (531) 25.03.01; 25.03.03; 26.01.02; 26.01.22;
 26.01.24; 28.19; 29.01.14
 (511) 29, 30, 31, 39

(260) AM 2023 121239 A
 (210) AM 121239
 (220) 2023 01 18
 (731) JSC "Telavi Wine Cellar"
 Village Kurdghelauri, 2200, Telavi, Georgia
 (740) Giorgi Taktakishvili
 (540)

ველური
VELURI

(591) Black-white
 (511) 33

(260) AM 2023 121241 A
 (210) AM 121241
 (220) 2023 01 18
 (731) LTD "Kakhetian Traditional Winemaking"
 Sulkhan Tsintsadze St. 12, 0160, Tbilisi,
 Georgia
 (540)



CHATEAU
ASKANA

(591) Black-white
 (531) 24.01.16; 24.01.25; 26.13.25; 27.05.01
 (526) Askana
 (511) 33

(260) AM 2023 121244 A
 (210) AM 121244
 (220) 2023 01 19
 (731) JSC "Friends Cellar"
 Village Shilda, 4816, Kvareli, Georgia
 (540)



(591) 000000 black
 (531) 19.09.02; 27.05.01; 27.05.10
 (511) 33, 43

(260) AM 2023 121298 A
 (210) AM 121298
 (220) 2023 01 20
 (731) Darine Dumbadze
 Tevdore Mghvedeli St. 29, b. 18, Batumi,
 Georgia
 (540)



(591) Brown, white
 (531) 01.15.11; 11.03.04; 26.04.02; 26.04.16;
 26.04.22; 26.04.24; 26.11.12; 27.05.01;
 27.05.10; 27.05.24; 29.01.12
 (511) 30

(260) AM 2023 121300 A
 (210) AM 121300
 (220) 2023 01 20
 (731) Valerian Datukishvili
 Village Zemo Khodasheni, Akhmeta, Georgia
 (540)



(591) Black-white
 (531) 26.13.25
 (511) 18, 25, 32, 35

(260) AM 2023 121308 A
 (210) AM 121308
 (220) 2023 01 20
 (731) LTD "KTW Development"
 Sulkhan Tsintsadze St. 12, Space 3-6, 0160,
 Tbilisi, Georgia
 (540)



(591) Golen
 (531) 05.07.10; 27.05.01; 27.05.04; 27.05.19;
 27.05.23; 29.01.02
 (511) 36

(260) AM 2023 121309 A
 (210) AM 121309
 (220) 2023 01 20
 (731) LTD "KTW Development"
 Sulkhan Tsintsadze St. 12, Space 3-6, 0160,
 Tbilisi, Georgia
 (540)



ORBELIANI
 RESIDENCE

(591) Black-white

(531) 03.01.22; 03.03.17; 07.01.01; 23.01.01;
 23.01.05; 24.07.01; 24.07.13; 24.15.02;
 26.01.16; 27.05.01
 (511) 43

(260) AM 2023 121310 A
 (210) AM 121310
 (220) 2023 01 20
 (731) LTD "KTW Development"
 Sulkhan Tsintsadze St. 12, Space 3-6, 0160,
 Tbilisi, Georgia
 (540)



ORBELIANI
 GARDEN

(591) Black-white
 (531) 03.01.02; 03.01.22; 03.03.17; 07.01.01;
 23.01.01; 23.01.05; 24.07.01; 24.07.13;
 24.15.02; 26.01.01; 26.01.16; 27.05.01
 (511) 43

(260) AM 2023 121311 A
 (210) AM 121311
 (220) 2023 01 20
 (731) Ievgen Pantus
 Khortytske highway 44a, 186, Zaporizhzhya,
 Ukraine
 (740) Khatuna Imnadze
 (540)

COSMOPOLIS
 კოსმოპოლისი

(591) Black-white
 (511) 33

(260) AM 2023 121317 A
 (210) AM 121317
 (220) 2023 01 23
 (731) LTD "Wet Dog"
 Abashidze St. 68, ap. 36a, 0162, Tbilisi,
 Georgia
 (540)



(591) Red, pink, light red, black

(531) 03.01.08; 27.05.01; 28.19; 29.01.12
(511) 32, 33

(260) AM 2023 121321 A
(210) AM 121321
(220) 2023 01 24
(731) Soci t  des Produits Nestl  S.A.
1800 Vevey, Switzerland
(740) Tamaz Shilakadze
(540)

LILY'S KITCHEN

(591) Black-white
(511) 5, 31

(260) AM 2023 121322 A
(210) AM 121322
(220) 2023 01 24
(731) LTD "Wine Company Shumi"
Lionidze St. 33, Telavi, Georgia
(740) Shalva Gvaramadze
(540)

ნუნუა
Nunua
Нунуа

(591) Black-white
(511) 32

(260) AM 2023 121336 A
(210) AM 121336
(220) 2023 01 25
(731) Limited Liability Company Tami I Co.
(LLC Tami I Co)
Repin St. 34, Khimki, Moscow Region,
RU-141402, Russian Federation
Limited Liability Company Tami I Co.
(LLC Tami I Co)
Repin St. 34, Khimki, Moscow Region,
RU-141402, Russian Federation
(740) Tamar Kotchlamazashvili
(540)



(591) Blue, white
(531) 25.01.10; 26.13.25; 27.05.21; 29.01.12
(511) 3, 14, 18, 25, 35

(260) AM 2023 121337 A
(210) AM 121337
(220) 2023 01 25
(731) Limited Liability Company Tami I Co.

(LLC Tami I Co)
Repin St. 34, Khimki, Moscow Region,
RU-141402, Russian Federation

(740) Tamar Kotchlamazashvili
(540)



HENDERSON

(591) Blue, white
(531) 25.01.10; 26.13.25; 27.05.21; 29.01.12
(511) 3, 14, 18, 35

(260) AM 2023 121338 A
(210) AM 121338
(220) 2023 01 25
(731) Limited Liability Company Tami I Co.
(LLC Tami I Co)
Repin St. 34, Khimki, Moscow Region,
RU-141402, Russian Federation
(740) Tamar Kotchlamazashvili
(540)

HENDERSON

(591) Blue, white
(531) 27.05.01; 27.05.17; 29.01.04
(511) 3, 14, 18, 35

(260) AM 2023 121340 A
(210) AM 121340
(220) 2023 01 25
(731) LTD "Spraibi"
Keskline District, Tartu Road 83-701, Tallinn,
10115, Estonia
(740) Nikoloz Chomakhidze;
Mariam Ghubianuri
(540)

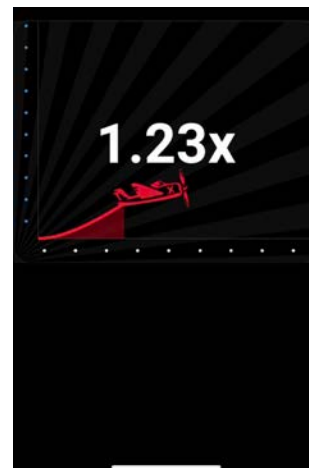

(591) White, black, red
(531) 18.05.01; 18.05.03; 26.04.02; 26.04.05;
26.04.16; 26.04.22; 26.04.24; 27.07.11;
27.07.13; 27.07.24; 29.01.13
(511) 9, 41, 42

(260) AM 2023 121341 A
 (210) AM 121341
 (220) 2023 01 25
 (731) I/E Lasha Akhvlediani
 Nikoloz Baratashvili St. 28, Vani Region,
 Georgia
 (540)



(591) 701E51 Transitioning from blue to red,
 the intermediate color is dark lilac, B41418
 dark red, 182680 dark blue
 (531) 03.07.11; 03.07.16; 27.05.10; 27.05.17;
 29.01.12
 (511) 41

(260) AM 2023 121343 A
 (210) AM 121343
 (220) 2023 01 25
 (731) Mitsubishi Jidosha Kogyo Kabushiki Kaisha
 1-21, Shibaura 3-chome, Minato-ku, Tokyo
 108-8410, Japan
 (740) Pavle Meipariani
 (540)

XPANDER CROSS

(591) Black-white
 (511) 12

(260) AM 2023 121345 A
 (210) AM 121345
 (220) 2023 01 26
 (731) LTD "Impexpharm"
 Giorgi Saakadze II exit 17, 0160, Tbilisi,
 Georgia
 (740) Nugzar Ksovreli
 (540)

Levoreng

(591) Black-white
 (511) 5

(260) AM 2023 121347 A
 (210) AM 121347
 (220) 2023 01 26
 (731) LTD "Winpak Professional"
 University St. 24, Entranse 4, Fl. 7, 0186,
 Tbilisi, Georgia
 (540)



(591) DBD0D0 beige, 5E2929 brown

(531) 05.01.04; 05.01.16; 05.01.21; 25.03.03;
 27.05.08; 27.05.17; 29.01.12
 (511) 20

(260) AM 2023 121351 A
 (210) AM 121351
 (220) 2023 01 26
 (731) LTD "KTW Development"
 Sulokhan Tsintsadze St. 12, Space 3-6, 0160,
 Tbilisi, Georgia
 (540)

კატევი თაუერ
KTW Tower
KTB Tayəp

(591) Black-white
 (511) 36, 37

(260) AM 2023 121414 A
 (210) AM 121414
 (220) 2023 01 30
 (310) 97/641176
 (320) 2022 10 20
 (330) US
 (731) Western Union Holdings Inc.
 7001 East Belleview Avenue, Denver,
 Colorado 80237, USA
 (740) Pavle Meipariani
 (540)



(591) Black-white
 (531) 27.05.01; 27.05.15; 27.05.17; 27.05.21
 (511) 9, 36, 42

(260) AM 2023 121415 A
 (210) AM 121415
 (220) 2023 01 30
 (731) LTD "West Invest"
 Grigol Lortkipanidze St. 13a, 0137, Tbilisi,
 Georgia
 (540)



(591) Green, blue, white
 (531) 03.09.01; 26.04.02; 26.04.04; 26.04.15;
 26.04.22; 26.11.12; 27.05.01; 27.05.24;
 29.01.13
 (511) 29

(260) AM 2023 121416 A
 (210) AM 121416
 (220) 2023 01 30
 (731) LTD "West Invest"
 Grigol Lortkipanidze St. 13a, 0137, Tbilisi,
 Georgia
 (540)

PREMFISH

(591) Blue, gree, white
 (531) 03.09.01; 27.05.01; 27.05.17; 29.01.12
 (511) 29

(260) AM 2023 121418 A
 (210) AM 121418
 (220) 2023 01 30
 (310) VA 2022 01756
 (320) 2022 10 20
 (330) DK
 (731) Lego Juris A/S
 7190 Billund, Denmark
 (740) Tamaz Shilakadze
 (540)

Friends

(554) Three Dimentional
 (591) Black, white, red, green, royal blue, sky-blue,
 pink, orange, sea green
 (531) 01.01.02; 01.01.10; 27.05.02; 27.05.03;
 29.01.15
 (511) 9, 16, 28, 41

(260) AM 2023 121419 A
 (210) AM 121419
 (220) 2023 01 30
 (731) Revaz Sakhvadze
 Kakheti Highway, bld. 7, ap. 5, 0190, Tbilisi,
 Georgia
 (740) Revaz Sakhvadze
 (540)

HC

(591) FFFFFFF white, 000000 black
 (531) 26.04.02; 26.04.18; 26.04.24; 27.05.22;
 27.05.24
 (511) 12

(260) AM 2023 121423 A
 (210) AM 121423
 (220) 2023 02 01
 (731) LLC "Vaporium"
 Vazisubani St. 14, Loft 19, Isani-Samgori
 District, Tbilisi, Georgia

(540)

UWELL

(591) Black, yellow
 (531) 26.04.02; 26.04.22; 26.04.24; 27.05.17;
 27.05.24; 29.01.12
 (511) 34, 35

(260) AM 2023 121424 A
 (210) AM 121424
 (220) 2023 02 01
 (731) LLC "Vaporium"
 Vazisubani St. 14, Loft 19, Isani-Samgori
 District, Tbilisi, Georgia
 (540)

IVG®
 PREMIUM E-LIQUIDS

(591) White, black, red
 (531) 27.05.01; 27.05.02; 27.05.19; 27.05.23;
 29.01.13
 (511) 34, 35

(260) AM 2023 121430 A
 (210) AM 121430
 (220) 2023 02 01
 (731) Levan Gvaramadze
 Aleksandre Kazbegi St. 2, b. 12, 0160, Tbilisi,
 Georgia
 (540)

მიდამო
Midamo
Мидамо

(591) Black-white
 (511) 33

(260) AM 2023 121435 A
 (210) AM 121435
 (220) 2023 02 02
 (731) Cooperative RK New Product
 Lekhaindrao, Martvili, Georgia
 (540)

 საქონლის
 პროდუქტი

(591) Green, blue, brown, white
 (531) 03.04.01; 03.04.02; 03.04.04; 03.04.05;
 03.04.11; 26.01.15; 28.19; 29.01.14
 (511) 29

(260) AM 2023 121436 A
 (210) AM 121436
 (220) 2023 02 02
 (731) Manana Meskhishvili
 Vill. Poka, Ninotsminda, Georgia
 (540)



(591) FFFFFFF Green, golden
 (531) 24.13.01; 24.13.09; 24.13.13; 24.13.14;
 24.13.17; 24.13.24; 27.05.01; 29.01.12
 (511) 14, 21, 35

(260) AM 2023 121502 A
 (210) AM 121502
 (220) 2023 02 03
 (731) Davit Shvelidze
 Nutsubidze Slope, II m/r. V qu., bld. 5, ap. 22,
 Tbilisi, Georgia
 (540)

ზეკონდიტერი

(591) Black-white
 (511) 43

(260) AM 2023 121507 A
 (210) AM 121507
 (220) 2023 02 05
 (731) Shalva Chocheli
 Tashkent St. 23/1, b. 4, Tbilisi, Georgia
 (540)

მოსართი

(591) Black-white
 (511) 25, 35

(260) AM 2023 121516 A
 (210) AM 121516
 (220) 2023 02 06
 (731) LLC "Online Clinic"
 Tskaltubo St. Corp. 3, ap. 58, 0119, Tbilisi,
 Georgia

(540)



(591) 2BA8E2 sky-blue, 88F404 green,
 light green, white
 (531) 26.03.23; 27.05.01; 27.05.22; 29.01.13
 (511) 44

(260) AM 2023 121517 A
 (210) AM 121517
 (220) 2023 02 06
 (731) LLC "Artonomia"
 Giorgi Mirotadze St. 10a, ap. 1, 0171, Tbilisi,
 Georgia
 (540)



(591) 050404 Black-white
 (531) 27.05.01; 27.05.21; 28.19
 (511) 41, 44

(260) AM 2023 121521 A
 (210) AM 121521
 (220) 2023 02 07
 (731) LTD "Green Country"
 Kviratskhoveli St. 83, Tbilisi, Georgia
 (540)

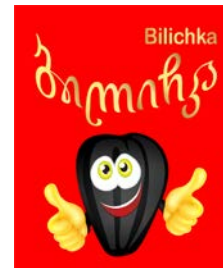

(591) 0C0B0B black, E8E829 golden, EFE3E3
 white, EF1010 red
 (531) 04.05.11; 05.07.01; 05.07.06; 27.05.01; 28.19;
 29.01.14
 (511) 30

(260) AM 2023 121527 A
 (210) AM 121527
 (220) 2023 02 08
 (731) LTD "Macro Tourism"
 Vakhtang Gorgasali St. 9, 0105, Tbilisi,
 Georgia

(540)



(591) FFFAEB white, 141414 black, B9AF3C light green, 6E7832 light swampy
 (531) 05.03.17; 05.07.19; 27.05.01; 27.05.08; 27.05.09; 27.05.10; 29.01.13
 (511) 43

(260) AM 2023 121528 A
 (210) AM 121528
 (220) 2023 02 08
 (731) LTD "Macro Tourism"
 Vakhtang Gorgasali St. 9, 0105, Tbilisi, Georgia
 (540)



(591) 8C4123 dark copper, FA9B64 light copper, 000000 black
 (531) 26.04.02; 26.04.22; 26.04.24; 27.01.06; 27.05.01; 27.05.24; 29.01.13
 (511) 43

(260) AM 2023 121532 A
 (210) AM 121532
 (220) 2023 02 08
 (731) Must Energy (Guangdong) Technology Co., LTD
 1-5,7,9,10 floor of No.8 building, №115 Zhangcha Road 1, Chancheng District, Foshan City, Guangdong, People's Republic of China
 (740) Giorgi Kartvelishvili
 (540)



(591) Black-white
 (531) 26.11.03; 26.11.12; 27.05.17
 (511) 9

(260) AM 2023 121632 A
 (210) AM 121632
 (220) 2023 02 13
 (731) JSC "Telavi Wine Cellar"
 Vill. Kurdghelauri, 2200, Telavi Region, Georgia
 (740) Giorgi Taktakishvili
 (540)

EQUATOR

(591) Black-white
 (511) 33

(260) AM 2023 121636 A
 (210) AM 121636
 (220) 2023 02 13
 (731) Ucha Lursmanashvili
 Shio Aragvispireli St. 3, Khashuri, Georgia
 (540)



(591) FFFFFF white, FCE80A yellow, 020000 black
 (531) 26.03.01; 26.03.23; 27.05.01; 28.19; 29.01.13
 (511) 37

(260) AM 2023 121640 A
 (210) AM 121640
 (220) 2023 02 13
 (731) Kuber Products Private Limited
 1/8 West Patel Nagar, New Delhi-110008, India
 (740) Giorgi Taktakishvili
 (540)

LONDON CLUB

(591) Black-white
 (511) 34

(260) AM 2023 121650 A
 (210) AM 121650
 (220) 2023 02 14
 (731) Enrico Beridze
 G. Tsitsishvili St. 18, Tbilisi, Georgia
 (740) Salome Jeladze
 (540)



(591) Black-white
(531) 27.05.04; 27.05.22
(511) 33, 35

(260) AM 2023 121666 A
(210) AM 121666
(220) 2023 02 16
(731) JSC "TBS Insurance"
Al. Kazbegi Av. 24b, fl. 3, 0177, Tbilisi,
Georgia

(540)



(591) White, purple
(531) 26.04.02; 26.04.22; 26.04.24; 28.19; 29.01.12
(511) 16, 25, 28, 35, 36, 38, 39, 41, 44

(260) AM 2023 121668 A
(210) AM 121668
(220) 2023 02 16
(731) JSC "TBS Insurance"
Al. Kazbegi Av. 24b, fl. 3, 0177, Tbilisi,
Georgia

(540)



(591) Lilac, white
(531) 26.04.02; 26.04.22; 26.04.24; 28.19; 29.01.12
(511) 16, 35, 36

(260) AM 2023 121670 A
(210) AM 121670
(220) 2023 02 16
(731) JSC "TBS Insurance"
Al. Kazbegi Av. 24b, fl. 3, 0177, Tbilisi,
Georgia

(540)

უპირობო სიყვარული

(591) Black-white
(511) 36

(260) AM 2023 121721 A
(210) AM 121721
(220) 2023 02 17
(731) Obshchestvo s Ogranichenoy Otvetstvenosti
"Saizon"
Ul. Trubnaya, dom 14, Pomeschenie I, Etaj 1,
komnata 11, Vn.ter.g. Municipalni Okrug
Meshchanskiy, 107045, Moscow, Russian
Federation

(740) Shalva Gvaramadze
(540)

DRAGONCELLO

(591) Black-white
(511) 32, 33

(260) AM 2023 121722 A
(210) AM 121722
(220) 2023 02 17
(731) Giorgi Baghashvili
Irakli Abashidze St. 34/36, ap. 19, 0179,
Tbilisi, Georgia

(540)

იუმორინა

IUMORINA

ЮМОРИНА

(591) Black-white
(511) 9, 16, 35, 38

(260) AM 2023 121725 A
(210) AM 121725
(220) 2023 02 18
(731) LLC "Renover Georgia"
3rd turn of Petre Kavtaradze St. 5, 0186,
Tbilisi, Georgia

(540)

VOLTER

(591) 0F0E0E black, white
(531) 01.15.03; 27.01.06
(511) 7, 8, 11

(260) AM 2023 121730 A
(210) AM 121730
(220) 2023 02 20
(731) Enrico Beridze
G. Tsitsishvili St. 18, Tbilisi, Georgia

(740) Salome Jeladze
(540)



ALCORIUS

(591) Blue, white
 (531) 02.01.15; 02.01.16; 02.01.23; 19.09.02;
 27.05.01; 29.01.04
 (511) 33, 35

(260) AM 2023 121732 A
 (210) AM 121732
 (220) 2023 02 20
 (731) Enrico Beridze
 G. Tsitsishvili St. 18, Tbilisi, Georgia
 (740) Salome Jeladze
 (540)

კავავინ Cavavin

(591) Black-white
 (511) 35

(260) AM 2023 121735 A
 (210) AM 121735
 (220) 2023 02 20
 (731) Enrico Beridze
 G. Tsitsishvili St. 18, Tbilisi, Georgia
 (740) Salome Jeladze
 (540)

იბერულა Iberula

(591) Black-white
 (511) 33

(260) AM 2023 121736 A
 (210) AM 121736
 (220) 2023 02 20
 (731) Enrico Beridze
 G. Tsitsishvili St. 18, Tbilisi, Georgia
 (740) Salome Jeladze
 (540)

მარკეა Markea

(591) Black-white
 (511) 35

(260) AM 2023 121741 A
 (210) AM 121741
 (220) 2023 02 21
 (731) LLC "Gezi Travel"
 Vill. Lesitchine, 55th St. 6, 5006, Chkhorotsku
 Region, Georgia
 (740) Nino Gazdeliani

(540)



(591) Black, grey, color of bluestone, orange,
 yellowish orange
 (531) 26.03.23; 26.04.01; 26.04.02; 26.04.11;
 26.04.22; 26.04.24; 27.05.01; 27.05.10;
 27.05.24; 28.19; 29.01.15
 (511) 39

(260) AM 2023 121760 A
 (210) AM 121760
 (220) 2023 02 22
 (731) LLC "Lavprod"
 Vn.Ter.G. Municipal District Altufevsky,
 Altufevskoe Shosse 48, Room 1, Floor/Room
 3/1, Com./Office 2/307V, 127566, Moscow,
 Russian Federation
 (740) Tamaz Shilakadze
 (540)

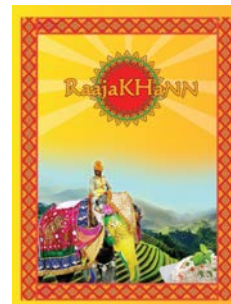

(591) Grey, dark green, light green, green, orange,
 brown, blue, sky-blue, pink, dark red, red, light
 yellow, dark yellow, yellow, white, black
 (531) 01.03.01; 01.03.17; 02.01.21; 03.02.01;
 03.02.03; 06.06.25; 25.01.09; 25.01.10;
 25.01.13; 26.01.19; 27.05.01; 27.05.02;
 29.01.15
 (511) 30, 35

(260) AM 2023 121772 A
 (210) AM 121772
 (220) 2023 02 23
 (731) Reckitt & Colman (Overseas) Health Limited
 103-105 Bath Road, Slough, Berkshire,
 SL1 3UH, United Kingdom
 (740) Shalva Gvaramadze
 (540)

SWEETEX

(591) Black-white
 (511) 1

REGISTERED TRADEMARKS

(111) M 2023 37207 R
(151) 2023 08 21
(181) 2033 08 21
(260) AM 2022 119786 A
(220) 2022 10 11

(732) LTD "Impexpharm"
Giorgi Saakadze II Exit 17, 0160, Tbilisi,
Georgia

(111) M 2023 37209 R
(151) 2023 08 21
(181) 2033 08 21
(260) AM 2022 119706 A
(220) 2022 10 05

(732) LTD "Impexpharm"
Giorgi Saakadze II Exit 17, 0160, Tbilisi,
Georgia

(111) M 2023 37210 R
(151) 2023 08 21
(181) 2033 08 21
(260) AM 2022 117545 A
(220) 2022 04 20

(732) Meta Platforms Inc.
1601 Willow Road, Menlo Park, California
94025, USA

(111) M 2023 37211 R
(151) 2023 08 21
(181) 2033 08 21
(260) AM 2022 119704 A
(220) 2022 10 05

(732) LTD "Impexpharm"
Giorgi Saakadze II Exit 17, 0160, Tbilisi,
Georgia

(111) M 2023 37212 R
(151) 2023 08 21
(181) 2033 08 21
(260) AM 2022 119703 A
(220) 2022 10 05

(732) (732) LTD "Impexpharm"
Giorgi Saakadze II Exit 17, 0160, Tbilisi,
Georgia

(111) M 2023 37213 R
(151) 2023 08 21
(181) 2033 08 21
(260) AM 2022 119206 A
(220) 2022 09 01

(732) Kolmar Korea Holdings Co., LTD.
12-11, Deokgogae-gil, Jeonui-myeon,
Sejong-si, Republic of Korea

(111) M 2023 37214 R
(151) 2023 08 21
(181) 2033 08 21
(260) AM 2022 117806 A
(220) 2022 05 13

(732) LLC "Geb Group"
Simon Chikovani St. 24a, ap. 24, 0108, Vake
District, Tbilisi, Georgia

(111) M 2023 37215 R
(151) 2023 08 21
(181) 2033 08 21
(260) AM 2022 118737 A
(220) 2022 07 26

(732) LTD "Andronikashvili's Gamma"
Udabnos Monasteri St. 28, Tbilisi, Georgia

(111) M 2023 37216 R
(151) 2023 08 21
(181) 2033 08 21
(260) AM 2022 118850 A
(220) 2022 08 03

(732) Antonio Tarazona, S.L.U.
Avenida Espioca 50-52, 46460 Silla (Valencia),
Spain

(111) M 2023 37217 R
(151) 2023 08 21
(181) 2033 08 21
(260) AM 2022 118469 A
(220) 2022 07 08

(732) Ekaterina Nikitenko
Mukhran Matchavariani Str., II Dead End 6,
Sachkhere, Georgia

(111) M 2023 37218 R
(151) 2023 08 21
(181) 2033 08 21
(260) AM 2022 119271 A
(220) 2022 09 02

(732) Token Ödeme Hizmetleri ve Elektronik Para
Anonim Şirketi
Ayazağa Mahallesi, Mimar Sinan Sokak,
A Blok, No:21/A - 44 Sarıyer İstanbul, Türkiye

TRADEMARKS REGISTERED ACCORDING TO THE ACCELERATED PROCEDURE

The decision can be appealed at the Chamber of Appeal of Sakpatenti within 3 months from the publication.

(111) M 2023 37208 R
(151) 2023 08 21
(181) 2033 08 21
(210) AM 122200
(220) 2023 03 24
(732) Irakli Baramidze
Mikheil Asatiani St. 14, 0177, Tbilisi,
Georgia
(740) Khatuna Imnadze
(540)

აგრო სახლი
AGRO HOUSE

(591) Black-white
(511) 35

(732) RK "Imedi"
Vill. Mokhe, Adigeni, Samtskhe-Javakheti,
Georgia
(540)



(591) FFFFFFF Black, white, blue, green, yellow
(531) 03.04.01; 03.04.02; 05.13.08; 06.03.14;
06.19.11; 06.19.13; 26.01.02; 26.01.15;
26.01.19; 29.01.15
(511) 29

(111) M 2023 37219 R
(151) 2023 08 23
(181) 2033 08 23
(210) AM 124055
(220) 2023 07 27
(732) LEPL "Unified National Accreditation Body –
Accreditation Center"
Akaki Tsereteli Ave. 67a, 0154,
Tbilisi Georgia
(540)



(591) 1C468C blue, EA1F27 red, FFFFFFF white
(531) 24.07.01; 24.09.01; 24.09.13; 24.13.01;
24.13.22; 26.01.01; 26.01.16; 26.01.21;
27.01.06; 28.19; 29.01.13
(526) Georgia; Image of the Flag of Georgia
(511) 42

(111) M 2023 37221 R
(151) 2023 08 23
(181) 2033 08 23
(210) AM 124311
(220) 2023 08 14
(732) RK "Khvamli"
Vill. Tsageri, 5100, Larchvali, Georgia
(540)



(591) Yellow, brown
(531) 25.01.25; 26.05.01; 26.05.02; 26.05.16;
26.05.22; 29.01.12
(511) 30

(111) M 2023 37220 R
(151) 2023 08 23
(181) 2033 08 23
(210) AM 123502
(220) 2023 06 27

(111) M 2023 37222 R
(151) 2023 08 23
(181) 2033 08 23
(210) AM 124301
(220) 2023 08 11
(732) Gadir Hasanov
Hurriyet Mah. 301 Sok. No: 2-4, ap. 5,
Gaziosmanpasa, Istanbul, Türkiye
(740) Einar Iliazovi

(540)



(591) White, black, green

(531) 26.01.01; 26.01.06; 26.04.02; 26.04.04;
26.04.22; 27.01.06; 29.01.13

(511) 25

(111) M 2023 37223 R

(151) 2023 08 23

(181) 2033 08 23

(210) AM 124300

(220) 2023 08 11

(732) Gadir Hasanov

Hurriyet Mah. 301 Sok. No: 2-4, ap. 5,
Gaziosmanpasa, Istanbul, Türkiye

(740) Einar Iliazovi

(540)



(591) White, black, blue

(531) 26.01.01; 26.01.24; 27.01.06; 29.01.13

(511) 25

(111) M 2023 37224 R

(151) 2023 08 23

(181) 2033 08 23

(210) AM 124148

(220) 2023 08 01

(732) Magomed Malsagov

Kartmazovo, Moskow St., Moskow, Russian
Federation

(740) Irina Jangirashvili

(540)



(591) Green, white, brown, blue, lilac, yellow

(531) 06.01.02; 07.01.06; 26.01.04; 26.01.22;
26.01.24; 27.05.01; 27.05.24

(526) Tsavkisi

(511) 36

(111) M 2023 37225 R

(151) 2023 08 23

(181) 2033 08 23

(210) AM 124120

(220) 2023 07 31

(732) Varvara Avdushko

None, Cyprus

(740) Tamar Malishava

(540)

•CULT OF INNOCENCE•

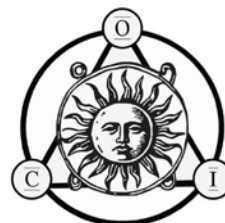

(591) Black-white

(531) 01.03.07; 01.03.20; 26.01.01; 26.01.10;
26.01.13; 26.03.10; 26.03.13; 27.05.11

(511) 14, 25

(111) M 2023 37226 R

(151) 2023 08 23

(181) 2033 08 23

(210) AM 124244

(220) 2023 08 09

(732) LTD "Geo express"

Davit Aghmashenebeli Av. 153, Tbilisi,
Georgia

(540)



(591) Black, white, yellow

(531) 03.07.07; 19.03.04; 27.05.01; 27.05.10;
27.05.14; 29.01.13

(511) 39

(111) M 2023 37227 R

(151) 2023 08 23

(181) 2033 08 23

(210) AM 124169

(220) 2023 08 03

(732) LTD "L.N.D. Group"

Aleksandre Kazbegi Av. 34a, ap. 128, 0186,
Vake-Saburtalo District, Tbilisi, Georgia

(540)



m a r r o n

(591) 383435 black, white

(531) 27.05.01; 27.05.22
(511) 29, 30, 39, 42, 43

(111) M 2023 37228 R
(151) 2023 08 23
(181) 2033 08 23
(210) AM 124170
(220) 2023 08 03
(732) LTD "L.N.D. Group"
Aleksandre Kazbegi Av. 34a, ap. 128, 0186,
Vake-Saburtalo District, Tbilisi, Georgia
(540)



(591) AB8D45 golden, 694C39 brown, E2D9C3 grey,
F29444 orange, E2D16A yellow, FCDE2A
dark yellow
(531) 26.01.01; 26.01.12; 26.01.22; 28.19; 29.01.15
(511) 29, 30, 39, 42, 43

(111) M 2023 37229 R
(151) 2023 08 23
(181) 2033 08 23
(210) AM 124032
(220) 2023 07 26
(732) LTD "Winery Khareba"
Davit Agmashenebeli Alley 170a, 0131,
Tbilisi, Georgia
(540)



საქართველოს მარანი
MARANI OF GEORGIA

(591) Black-white
(531) 05.07.10; 27.05.01; 28.19
(526) საქართველო, GEORGIA
(511) 33

(111) M 2023 37230 R
(151) 2023 08 23
(181) 2033 08 23
(210) AM 124231
(220) 2023 08 07
(732) LTD "Bolero & Company"
Kuchishvili St. 12-14-16, 0179, Tbilisi, Georgia
(540)

La Tour d'amour

(591) Black-white
(511) 33

(111) M 2023 37231 R
(151) 2023 08 23
(181) 2033 08 23
(210) AM 124230
(220) 2023 08 07
(732) LTD "Bolero & Company"
Kuchishvili St. 12-14-16, 0179, Tbilisi, Georgia
(540)

Montevino

(591) Black-white
(511) 33

(111) M 2023 37232 R
(151) 2023 08 23
(181) 2033 08 23
(210) AM 124229
(220) 2023 08 07
(732) LTD "Bolero & Company"
Kuchishvili St. 12-14-16, 0179, Tbilisi, Georgia
(540)

Le phare d'amour

(591) 872020 Black-white
(511) 33

(111) M 2023 37233 R
(151) 2023 08 24
(181) 2033 08 24
(210) AM 124114
(220) 2023 07 28
(732) TiM S.A.
ul. T. Regera 111, 43-382 Bielsko-Biala, Poland
(740) Shalva Gvaramadze
(540)



GAMZIRI

(591) Black-white
(531) 05.07.10; 05.13.06; 05.13.10; 05.13.11;
27.05.01
(511) 33

(111) M 2023 37234 R
(151) 2023 08 24
(181) 2033 08 24
(210) AM 124316

(220) 2023 08 14
 (732) LTD "Daily"
 Varketili farm Settlement, Akhmet Melashvili
 St. 2, Samgori District, Tbilisi, Georgia
 (540)



(591) Green, light green, white
 (531) 02.09.01; 24.17.20; 26.03.23; 27.05.21;
 28.19; 29.01.12
 (511) 35

(111) M 2023 37235 R
 (151) 2023 08 24
 (181) 2033 08 24
 (210) AM 124302
 (220) 2023 08 11
 (732) LTD "Skillwill"
 Akhmet St. 1, 0177, Isni district, Tbilisi,
 Georgia
 (540)



(591) 161515 Black-white
 (531) 27.05.01
 (511) 41

(111) M 2023 37236 R
 (151) 2023 08 24
 (181) 2033 08 24
 (210) AM 124129
 (220) 2023 07 31
 (732) LTD "Keeps.Me"
 Mikheil Tamarashvili Av. 13t, 0177, Saburtalo
 District, Tbilisi, Georgia
 (540)



(591) Green, sky-blue, dark blue
 (531) 24.17.03; 27.05.01; 29.01.13
 (511) 36

(111) M 2023 37237 R
 (151) 2023 08 25
 (181) 2033 08 25
 (210) AM 124416
 (220) 2023 08 21
 (732) Maya Tavadze
 Amagheba St. 9, floor 2, ap. 6, 0105,
 Tbilisi Georgia
 (740) Giorgi Taktakishvili
 (540)



(591) Black sky-blue, golden, pink
 (531) 03.13.01; 03.13.24; 03.13.25
 (511) 41

(111) M 2023 37238 R
 (151) 2023 08 25
 (181) 2033 08 25
 (210) AM 124046
 (220) 2023 07 26
 (732) LTD "D&A Partners"
 Davit Aghmashenebeli Av. 104, Loft 17b,
 Tbilisi, Georgia
 (740) Giorgi Taktakishvili
 (540)



(591) Black-white
 (531) 24.17.09; 26.04.02; 26.04.04; 26.04.18;
 27.05.01
 (511) 36, 41, 45

(111) M 2023 37239 R
 (151) 2023 08 25
 (181) 2033 08 25
 (210) AM 124343
 (220) 2023 08 16
 (732) LTD "Fonex Group"
 Baku St. 3, Tbilisi, Georgia
 (540)



(591) Blue, white, yellow
 (531) 25.05.02; 26.04.05; 26.04.22; 26.04.24;
 27.05.10; 27.05.22; 27.05.24; 29.01.13
 (511) 36

(111) M 2023 37240 R
 (151) 2023 08 25
 (181) 2033 08 25
 (210) AM 124307
 (220) 2023 08 14
 (732) Ramaz Kharebava
 Vill. Jebota, Tianeti, Georgia
 (740) Lia Shikhiashvili;
 Ioane Iarajuli
 (540)

რამოს RAMO'S

(591) Yellow, black, white
 (531) 01.01.02; 01.01.10; 27.05.01; 28.19; 29.01.13
 (511) 43

(111) M 2023 37241 R
 (151) 2023 08 29
 (181) 2033 08 29
 (210) AM 124041
 (220) 2023 07 26
 (732) JSC "Teliani Valley"
 Telavi, Tbilisi Highway 3, 2201, Kakheti,
 Georgia
 (540)



(591) White, black, green
 (531) 19.07.01; 27.05.01; 29.01.12
 (526) Teliani
 (511) 33

(111) M 2023 37242 R
 (151) 2023 08 29
 (181) 2033 08 29
 (210) AM 124354
 (220) 2023 08 17
 (732) JSC "Bank of Georgia"
 Gagarin St. 29a, 0160, Tbilisi, Georgia

(740) Giorgi Taktakishvili
 (540)



(591) Turquoise, yellow, grey, white
 (531) 26.04.02; 26.04.05; 26.04.16; 26.04.22;
 26.04.24; 26.11.12; 28.19; 29.01.14
 (511) 36

(111) M 2023 37243 R
 (151) 2023 08 30
 (181) 2033 08 30
 (210) AM 124502
 (220) 2023 08 25
 (732) Nino Amonashvili
 Heroes of Marukhi St. 15, Tbilisi, Georgia
 (540)

Amonashvili
ამონაშვილი

(591) Black-white
 (511) 41

(111) M 2023 37244 R
 (151) 2023 08 30
 (181) 2033 08 30
 (210) AM 124422
 (220) 2023 08 22
 (732) PepsiCo Inc.,
 a North Carolina Corporation
 700 Anderson Hill Road, Purchase, New York,
 10577, USA
 (740) Tamar Kotchlamazashvili
 (540)

PEPSI ZERO SUGAR

(591) Black-white
 (511) 32

INTERNATIONAL TRADEMARKS FOR WHICH A DECISION ON GRANTING PROTECTIONS IS TAKEN

The decision can be appealed at the Chamber of Appeal of Sakpatenti within 3 months from the publication or at the Mtskheta District Court Administrative Cases Board (Address: №17, Samkhedro St., Mtskheta), within 1 month following the publication.

(260) AM 2023 116721 A*

(800) 706282

(151) 1999 01 05

(891) 2022 01 24

(731) Neway Valve (Suzhou) Co., Ltd
No. 666 Taishan Road, New & Hi-tech
Industrial Development Zone, Suzhou, 215000
Jiangsu Province, China

(540)



(591) Black, white

(531) 27.05.01

(511)

6 – Valves of metal (other than parts of machine); pipes of metal; ducts of metal; junctions of metal.

(260) AM 2023 119304 A

(800) 1681320

(151) 2022 05 01

(891) 2022 05 01

(731) Obshchestvo s ogranichennoy otvetstvennostyu
"ODIN DOM"
shosse Kamyshovoe, dom 40, pomeshhenie
III-34, 35, RU-299014 Sevastopol, Russian
Federation

(540)



(591) Black, white

(531) 28.05

(511)

32 – carbonated water; lithia water; seltzer water; soda water; waters [beverages]; mineral water [beverages]; table waters; lemonades; non-alcoholic dried fruit beverages; isotonic beverages; non-alcoholic honey-based beverages; rice-based beverages, other than milk substitutes; soya-based beverages, other than milk substitutes; aloe vera drinks, non-alcoholic; whey beverages; protein-enriched sports beverages; soft drinks; non-alcoholic beverages flavoured with coffee; non-alcoholic beverages flavoured with tea; non-alcoholic fruit juice beverages; energy drinks; fruit nectars, non-alcoholic; orgeat; powders for effervescent beverages; sarsaparilla [non-alcoholic beverage]; syrups for lemonade; syrups for beverages;

starch-based dry mixes for beverage preparation; smoothies; tomato juice [beverage]; vegetable juices [beverages]; fruit juices; preparations for making non-alcoholic beverages; preparations for making carbonated water; pastilles for effervescent beverages; non-alcoholic fruit extracts; non-alcoholic essences for making beverages.

(260) AM 2023 120070 A

(800) 1691876

(151) 2021 12 28

(891) 2021 12 28

(731) BioNTech SE

An der Goldgrube 12, 55131 Mainz, Germany

(540)



(591) Dark green and light green

(531) 27.05.01; 29.01.12

(511)

1 – Chemicals for use in pharmaceutical industry; active chemical ingredients for use in manufacture of anti-cancer drugs and vaccines; adjuvants for use in manufacture of vaccines; nucleic acids, proteins and peptides for laboratory use; diagnostic preparations for scientific or research use.

9 – Mobile apps and computer software to enable healthcare professionals and patients to access information on pharmaceutical, medical and vaccine products and services; e-commerce software to enable users to perform electronic business transactions via a global computer network.

10 – Surgical and medical apparatus and instruments; medical diagnostic devices; medical diagnostic devices for analysis of body fluids and biopsies for diagnosis and monitoring of cancer, infectious diseases, and immunological diseases; medical diagnostic devices for analysis of body fluids and biopsies for patient stratification.

42 – Scientific research for medical purposes; medical and scientific research in the field of treatment of immunological diseases, cancer treatment, and treatment of infectious diseases; providing medical and scientific research information, consultancy, and advisory services, all in the fields of treatment of immunological diseases, cancer treatment, and treatment of infectious diseases; medical and scientific research ser-

vices by compiling data for clinical trials and drug admission.

44 – Medical, hygienic and beauty care; healthcare services; provision of medical information and services; provision of information to patients and healthcare professionals concerning pharmaceutical products, vaccines, medical products, medical diseases and disorders and related treatments via the Internet; medical services in the field of gene therapy; medical services in the field of cell therapy; medical and psychological counseling services; medical and health care services, health counseling and medical services; medical services, namely, providing therapies for treating cancer, infectious diseases and immunological diseases; veterinary services, namely, providing therapies for treating cancer, infectious diseases, and immunological diseases; medical and pharmaceutical consultation; medical diagnostic testing, monitoring and reporting services; genetic testing for medical purposes; provision of customer information on pharmaceutical and medical products through an on-line computer network.

(260) AM 2023 120465 A
(800) 1697470
(151) 2022 10 19
(891) 2022 10 19
(731) KRKA, tovarna zdravil, d.d., Novo mesto
Šmarješka cesta 6, SI-8000 Novo mesto,
Slovenia
(540)

TOLMIPINO

(591) Black, white
(511)
5 – Pharmaceutical preparations.

(260) AM 2023 120466 A
(800) 1697471
(151) 2022 10 19
(891) 2022 10 19
(731) KRKA, tovarna zdravil, d.d., Novo mesto
Šmarješka cesta 6, SI-8000 Novo mesto,
Slovenia
(540)

TOLMIDUO

(591) Black, white
(511)
5 – Pharmaceutical preparations.

(260) AM 2023 120467 A
(800) 1697472
(151) 2022 10 19
(891) 2022 10 19
(731) KRKA, tovarna zdravil, d.d., Novo mesto

Šmarješka cesta 6, SI-8000 Novo mesto,
Slovenia

(540)

TOLUPIND

(591) Black, white
(511)
5 – Pharmaceutical preparations.

(260) AM 2023 120468 A
(800) 1697473
(151) 2022 10 19
(891) 2022 10 19
(731) KRKA, tovarna zdravil, d.d., Novo mesto
Šmarješka cesta 6, SI-8000 Novo mesto,
Slovenia
(540)

TOLURINDO

(591) Black, white
(511)
5 – Pharmaceutical preparations.

(260) AM 2023 120469 A
(800) 1697496
(151) 2022 09 09
(891) 2022 09 09
(731) Philip Morris Products S.A.
Quai Jeanrenaud 3, CH-2000 Neuchâtel,
Switzerland
(540)

VEEV ONE

(591) Black, white
(511)
34 – Wired vaporizers for electronic cigarettes and electronic smoking devices; tobacco, raw or manufactured; tobacco products, including cigars, cigarettes, cigarillos, tobacco for roll-your-own cigarettes, pipe tobacco, chewing tobacco, snuff tobacco, kretek; snus; tobacco substitutes (not for medical purposes); smokers' articles, namely cigarette paper and tubes, cigarette filters, tobacco tins, cigarette cases and ashtrays, pipes, pocket apparatus for rolling cigarettes, lighters; matches; tobacco sticks, tobacco products for the purpose of being heated, electronic devices and their parts for the purpose of heating cigarettes or tobacco in order to release nicotine-containing aerosols for inhalation; liquid nicotine solutions for use in electronic cigarettes; electronic smoking devices; electronic cigarettes; electronic cigarettes as substitutes for traditional cigarettes; electronic devices for the inhalation of nicotine-containing aerosols; oral vaporizing devices for smokers, tobacco products and tobacco substitutes; smokers' articles for electronic cigarettes; parts and fittings for the aforesaid products included in this class; devices for extinguishing heated

cigarettes and cigars as well as heated tobacco sticks; electronic rechargeable cigarette cases.

(260) AM 2023 120486 A

(800) 1557013

(151) 2020 03 18

(891) 2022 07 22

(731) LOEWE IP HOLDING LIMITED

Arch. Makariou & Kalogration, 4, Nicolaides
Sea View City, Flat/Office 903-904, Block
A-B, CY-6016 Larnaca, Cyprus

(540)

WE by LOEWE

(591) Black, white

(511)

9 – Imaging devices for scientific purposes; biochips; microscopes; apparatus and instruments for microscopy; science sets for children being instructional apparatus; science sets for children being teaching apparatus; optical frequency metrology devices; instrumentation simulators; teaching apparatus; audiovisual teaching apparatus; teaching apparatus and instruments; scientific apparatus and instruments; apparatus and instruments for accumulating and storing electricity; apparatus and instruments for controlling electricity; electric and electronic components; photovoltaic devices; uninterruptible power supply apparatus; electricity mains apparatus; regulated power supply apparatus; dc/ac converters; mains power units (electric -); power-line transmission apparatus; uninterruptible power supply apparatus [battery]; ac/dc converters; electronic text and/or image publications recorded on media; software; recorded data files; pre-recorded compact discs; pre-recorded cassettes; data carriers containing stored typographic typefaces; computer digital maps; directories [electric or electronic]; data recorded electronically; telephone ring tones [downloadable]; holograms; downloadable ring tones for mobile phones; magnetic recordings; recorded data [magnetic]; pre-recorded compact discs featuring games; recording substrates [optical]; optical disc recordings; recorded tapes; pre-recorded magnetic data carriers; pre-programmed discs; sensors and detectors; controllers (regulators); monitoring instruments; electricity indicators; switchboard indicating lamps; traffic sign recognition apparatus and instruments; load indicators; image analyzers; diagnostic apparatus, not for medical purposes; digital indicators; torque transducers; electric power analyzers; electronic colour analyzers; electronic control instruments; electro-optic transducers; high frequency transducers; wireless controllers to remotely monitor and control the function and status of other electrical, electronic, and mechanical devices or systems; wireless controllers to remotely monitor and control the function and status of security systems; checking (supervision) apparatus and instruments; luminous indicators; linear transducers; logic probes; piezoelectrical transducers; autonomous

driving control systems for vehicles; spectrum analyzers, other than for medical use; ultrasonic transducers; universal disturbance analyzers; load cells; heat sensing identification indicators; GPS receivers; cases for satellite navigation devices; vehicle tracking systems; vehicle tracking apparatus; global positioning system [GPS] apparatus; global positioning systems for use with bicycles; global positioning instruments; interactive computer software that provides navigational and travel information; directional compasses; personnel tracking devices; satellite navigational system for bicycles; sensors for determining position; GPS transmitters; display devices, television receivers and film and video devices; audio devices and radio receivers; image capturing and developing devices; 3D spectacles; 3D spectacles for television receivers; covers for digital media players; cases for portable media players; playing devices for sound and image carriers; cases adapted for DVD players; containers for films; bags for cameras and photographic equipment; audiovisual apparatus; recording devices for sound and image carriers; tape players; tape drives; sound filters made of cloth, for radio apparatus; compact disc players; CD-ROM drives; digital audio servers; digital video players; digital video servers; docking stations for MP3 players; docking stations for smart phones; docking stations for digital music players; DVD recorders; DVD burners; DVD players; wireless audio and video receivers; motion-activated cameras; electric cables for the transmission of sounds and images; audio- and video-receivers; endoscopic equipment for industrial purposes; cases for digital media players; lens cases; fm transmitters; remote controls for televisions; remote controls for radios; remote controls for stereos; motion-picture cameras for self-developing film; cables for transmitting and receiving cable television signals; receivers for receiving cable television; multiframe view cameras; karaoke equipment; pairable wireless speakers; laser pointers; luminous pointers; mp4 players; magnetic tape drives; multi-camera systems for vehicles; multifunctional remote controls; optical finders; head cleaning tapes [recording]; magnetic tape cleaners; vibration dampeners for electronic audio equipment; sync generators; tablet monitors; portable DVD players; video imaging systems; head cleaning tapes for video recorder; video servers; signal cables for IT, AV and telecommunication; data processing equipment and accessories (electrical and mechanical); calculators; covers for personal digital assistants [PDAs]; humanoid robots with artificial intelligence; audio digitisers; image setting apparatus; image stabilisers; image synthesizers; compact disc recorders; CD burners; CD-ROM writers; chromatogram analyzers for scientific or laboratory use; computerized vehicle engine analyzers; computerised personal organisers; computer interface apparatus; data exit terminals; data exchange units; data entry terminals; data terminals; data gloves; data processors; data conversion apparatus; storage apparatus for

computer data; data processing equipment; data processing terminals; data processing apparatus; real-time data processing apparatus; programming units (electric -); electronic data processing equipment; programming units (electronic -); electronic calculators; electronic spell-checkers; electronic control systems; electronic currency converters; hand-held electronic dictionaries; electronic word processors; electronic desk calculators; cases for PDAs; cases for pocket calculators; invoicing machines; hand scanner; fluorescence analyzers; peripheral devices for data reproduction; instruments for analysing photographs; cards containing microprocessors; couplers [data processing equipment]; optical character readers; readers [data processing equipment]; magnetic coded card readers; optical disc players; magnetic strip readers; storage apparatus for computer programs; memory card readers; programmable logic controllers; vocoders; voice recognisers; voice processing systems; speech processing equipment; bar code terminals; bar code readers; electronic pocket translators; word processing apparatus; tape recorders; tape recorders; audio processing apparatus; USB port cards; USB card readers; multi-channel analyzers; virtual reality headsets; computer central processing units; translation apparatus; point-to-point communications equipment; broadcasting equipment; acoustic couplers; alarm signalling transmitters; amplitude modulation tuners; mounting fittings for radios; connectors for telecommunication apparatus; indicator lights for telecommunication apparatus; audio transmitter units; automatic switching apparatus [for telecommunication]; automatic telephone dialers; automatic telegraph apparatus; automatic dialling apparatus; apparatus for the transmission of images; satellite earth stations; broadband installations; DAB radios; demodulators; digital transmitters; digital telecommunications apparatus; wire communication apparatus; wireless high frequency transmission instruments; fibre optic telecommunications apparatus; telegraphic transmitting apparatus; open-wire transmission apparatus; frequency modulation apparatus; frequency scanners; frequency modulators; radio-frequency receivers; high-frequency apparatus; radio-frequency transmitter; interactive computer software enabling exchange of information; wireless communication devices for voice, data, or image transmission; tone pads; coding modulators; microwave communications apparatus; microwave filters; solar powered radios; listening devices for monitoring babies; mobile radio receiving apparatus; mobile data receivers; mobile radio transmitting apparatus; radio frequency amplifiers; low noise converters; noise filters; noise suppression apparatus; transmitter receivers; transmitters; transmitters [telecommunication]; transmitters for the transmission of electric signals; transmitters for the transmission of electronic signals; SIM cards; transmitters for use in emergency communications; fuses for telecommunication apparatus; signal attenuation apparatus; signal tuners; signal convertors; signal transmitters;

signal couplers; signal splitters; signal processing apparatus; signal delay apparatus; signal transmission apparatus; speed repeaters; speech synthesizers; voice operated coders; voice response equipment; stereo receivers; synchronous data units; parts and fittings for communications apparatus; telecommunication apparatus; video transmitters; guided wave intercoms; duplexers; two-way radios; digitiser pads; electronic coding apparatus; electronic control systems for machines; software developing apparatus [electronic]; air analysis apparatus; mathematical instruments; measuring transducers; metric converters; optical disk drives; personal digital assistants; photometric analyzers [other than for medical use]; physical analysing apparatus [other than for medical use]; scanners [data processing equipment]; character recognition apparatus; adapters for connecting telephones to hearing aids; stands adapted for mobile phones; carriers adapted for mobile phones; phone covers [specifically adapted]; answering machines; facsimile transmission machines; dashboard mounts for mobile phones; audio conference apparatus; telephone recorders; car telephone installations; car telephones; in-car telephone handset cradles; phototelegraphy apparatus; video telephones; smart bracelets; digital telephone switching apparatus; digital cellular phones; digital phones; display modules for mobile phones; displays for mobile phones; displays for smartphones; display screen protectors in the nature of films for mobile phones; mobile phone docking stations; hands free kits for phones; hands-free holders for cell phones; hands-free microphones for cell phones; speakerphones; radiotelegraphy sets; mobile telephone batteries; cell phones; mobile telephones for use in vehicles; mobile telephone cases made of leather or imitations of leather; cell phones having large keys and numbers that assist users having impaired vision or dexterity; mobile telephone covers made of cloth or textile materials; network junction points for telephone exchange networks; devices for hands-free use of mobile phones; holders adapted for mobile phones; headsets for mobile telephones; cell phone covers; covers for smart phones; covers for telephone receivers; Internet phones; flip covers for mobile phones; encoded telephone cards; telephone headsets; leather cases for mobile phones; leather cases for smart phones; local mobile telephone systems; manual telegraph apparatus; microphones [for telecommunication apparatus]; solar powered telephones; mobile telephone apparatus with built-in facsimile systems; mobile or portable fax machines; paging equipment; pagers; radio pagers; private branch exchanges; point-to-point receivers; point-to-point transmitters; radiotelephones; auxiliary batteries for mobile phones; auxiliary speakers for mobile phones; cell phone straps; satellite telephones; cases for smart phones; wireless headsets for smart phones; cordless telephones; liquid crystal protective films for smart phones; selfie sticks used as smart phone accessories; selfie sticks [hand-held mono-

Pods]; smartbands; flip covers for smart phones; smart phones; smart phones in the shape of a watch; smartwatches; keyboards for mobile phones; telephone adapters; telephone connecting cords; telephone connectors; telephone sets with screen and keyboard; telephones incorporating intercommunication systems; telephone terminals; telephone intercom apparatus; telephone receivers; telephone earpieces; telephone transmitters; telephone concentrators; telephone switchboards; phone plugs; phone extension jacks; phone extension leads; telegraphs [apparatus]; portable fax machines; wearable smart phones; walkie-talkies; beeper carrying cases; smartwatches that communicate data to smart phones; video communications apparatus; video conferencing apparatus; video door telephone apparatus; video intercom apparatus; VoIP phones; intercommunication apparatus; intercoms; audio books; electronic databases recorded on computer media; electronic publications recorded on computer media; books recorded on tape; series of musical sound recordings; books recorded on disc; typeface fonts recorded on magnetic media; digital books downloadable from the Internet; discstorage containers; instruction manuals in electronic format; downloadable digital music provided from the Internet; pre-recorded CD-ROMs; pre-recorded CD-Is; pre-recorded music videos; recorded discs bearing images; recorded tape cassettes; pre-recorded video compact discs; pre-recorded videodiscs; e-books; electronic publications, downloadable; downloadable printable planners and organizers; downloadable video recordings; downloadable video recordings featuring music; downloadable digital music provided from MP3 Internet web sites; downloadable electronic books; downloadable templates for designing audiovisual presentations; holographic images; talking books; interactive DVDs; compact discs featuring music; pre-recorded DVDs featuring music; pre-recorded video tapes featuring music; optical discs featuring music; pre-recorded DVDs featuring games; multimedia software recorded on CD-ROM; multi-media recordings; musical sound recordings; musical recordings in the form of discs; downloadable music files; musical video recordings; training manuals in the form of a computer program; audio visual recordings; audio recordings; USB web keys; USB web keys for automatically launching pre-programmed website URLs; video recordings; downloadable digital music provided from a computer database or the Internet; audio/visual and photographic devices; head-mounted video display apparatus; display screen filters adapted for use with televisions; racks adapted to house video apparatus; bags adapted to carry video apparatus; wall mountings adapted for television monitors; vehicle autonomous driving systems featuring interactive displays; anti-glare filters for televisions; apparatus for the processing of images; car televisions; monitors; video mixers; apparatus for the reproduction of images; visual monitoring apparatus; screen filters for computers and televisions;

anti-glare filters for televisions and computer monitors; wide-aspect ratio monitors; electronic book readers; electronic paper (display devices); camera monopods; luminous electric signs; television recorders; television decoders; television receiving dishes; television receivers; DMB (digital multimedia broadcasting) televisions; television standards converters; electric and electronic video surveillance installations; electroluminescent display panels; electric luminescent display panels; electronic displays; electronic notice boards; electronic advertising displays; electronic visual display units; memo boards [electronic]; electronic panels for displaying messages; electronic digital sign boards; electronic numeric displays; electrophoretic displays; colour monitors; colour video processors; television apparatus; recorded content; scientific and laboratory devices for treatment using electricity; information technology and audiovisual equipment; magnets, magnetizers and demagnetizers; measuring, detecting and monitoring instruments, indicators and controllers; navigation, guidance, tracking, targeting and map making devices; optical devices, enhancers and correctors; safety, security, protection and signalling devices; computer components and parts; wristband computer devices; cases adapted for notebook computers; cloud servers; computers; work stations [computer apparatus]; computers for use in data management; computers for use with bicycles; computer docking station; computer touch screens; work stations [computers]; programming units (computer -); computer hardware for use in computer-assisted software engineering; computer hardware for the dissemination of positioning data; computer hardware for the transmission of positioning data; communications computers; communications servers [computer hardware]; sleeves for laptops; notebook computers; bags adapted for laptops; microchips [computer hardware]; leather cases for tablet computers; computer servers; covers for tablet computers; file servers; computer database servers; smart glasses; digital tablets; laptop docking stations; tablet docking stations; electronic mail servers; electronic notebooks; cases for tablet computers; stands for computer equipment; graphics tablets; personal digital assistants; interactive computer systems; Internet servers; intranet servers; flip covers for tablet computers; tablet computers; pocket computers for note-taking; thin client computers; wearable computers; handheld personal computers; transmitting and receiving apparatus for radio broadcasting; transmitting and receiving apparatus for television broadcasting; transmitting apparatus for television broadcasting; video streaming devices; firmware for computer peripherals; oscilloscopes; testing apparatus for electronic equipment; generators (signal -); computer component testing and calibrating equipment; semiconductor testing apparatus; smoke alarm testers; resistance testing apparatus.

(260) AM 2023 120492 A

(800) 1664553

(151) 2021 12 27

(891) 2022 10 28

(731) PACO RABANNE

17 rue François 1er, F-75008 Paris, France

(540)

RABANNE

(591) Black, white

(511)

9 – Optical apparatus, enhancers and correctors; vision improvement products; optical products; products for vision; corrective lenses; spectacles; sunglasses; clip-on sunglasses; contact lenses; lenses, glasses lenses, frames, ear stems, chains and cords for glasses and sunglasses; covers and cases adapted for optical apparatus and goods; covers and cases for glasses, sunglasses, contact lenses and correcting lenses; holders for glasses and sunglasses; covers, satchels and bags adapted for computers, telephones, electronic agendas, radios and portable multimedia players.

14 – Precious metals and their alloys; jewelry, precious stones; timepieces and chronometric instruments; imitations of precious stones and precious metals; pearls and imitations thereof; jewelry boxes and cases; jewelry organizer rolls for travel; watches, wall clocks, clocks, and parts thereof; watch bands; watch chains; cases, boxes and presentation cases for timepieces and watches; cuff links and tie clips; key rings and key chains and their charms; medals; coins; boxes of precious metals, their alloys, and imitations thereof; statues, figures and ornaments, made of or coated with precious, semi-precious metals, their alloys and imitations thereof; statues, figures and ornaments, made of or coated with pearls, precious, semi-precious stones or imitations thereof; works of art of precious stones and precious metals; trophies of precious metal.

18 – Leather and imitations of leather; animal skins; luggage and transport bags; umbrellas and parasols; walking sticks; whips, harness and saddlery; collars, leashes and clothing for animals; Bags, wallets; frames, handles and straps for luggage, carrying bags, bags, briefcases; handbags; evening purses [handbags]; shopping bags; net bags for shopping; small bags; tote bags; backpacks; satchels; fanny packs; carry-all bags; shoulder straps; baby carriers worn on the body and reins for guiding children; empty cases and boxes for holding cosmetics and toiletries; travel sets; cases of leather or of leather board; garment bags for suits, shirts and dresses; tie cases; document cases; document cases; purses; chain mesh purses; banknote holders; key cases; wallets with card compartments; credit card cases (wallets); boxes of leather or leatherboard; cords and straps made of leather; covers for umbrellas and parasols; rings, handles, walking sticks, frames and umbrella and parasol ribs; walking-stick handles; body warmers and blankets for animals; leat-

herboard; skins and hides and imitations thereof, unworked, worked or semi-worked.

25 – Clothing, footwear, headwear; dress shoes; shoes for casual wear; sports footwear; beach shoes; work shoes; rain footwear; bath shoes; indoor footwear; dancing shoes; footwear for babies; footwear uppers, fittings, heel pieces, straps, anti-slip soles, inner soles, tongues, soles for footwear, tips, welts and heels for footwear; boot uppers; studs for football boots; hats; caps and peaked caps; berets; hoods (clothing); visors; cap peaks; turbans; headdresses; mantillas; wimples (clothing); caps (headgear); hat veils; headbands (clothing); hat frames [skeletons]; cuffs (clothing); ankle socks; heel pieces for stockings; ready-made linings (parts of clothing); shirt yokes; coats; layettes [clothing]; bathrobes; anoraks; masks for sleeping; neck wear; bibs not made of paper; headbands; headbands against sweating and sweatbands for the head; dressing gowns (robes); overalls; dressing gowns; bathing suits; bikinis; Bermuda shorts; blazers; blouses; boas; pockets for clothing; long scarves; kaftans; socks and stockings; warm-up suits; shirts; tee-shirts; nightgowns; hooded pullovers; capes and cloaks; blouses; vests; shawls and stoles; jackets; tail coats; tracksuits; stuff jackets; belts (clothing); petticoats; twin sets; combinations (clothing); neckties; bustiers; corsets; aprons (clothing); masquerade costumes; tuxedos; skirts; scarves; gabardines; gloves (clothing); jerseys (clothing); lingerie articles; tights; garters; muffs (clothing); pelerines; shawls made of silk; fingerless gloves; work overalls; combination trousers; money belts (clothing); ear muffs (clothing); bow ties; trousers; pareus; parkas; balaclavas; scarves (clothing); pocket squares; shoulder scarves; headscarves; bandanas [neckerchiefs]; shirt fronts; pelisses; dungarees; jumper dresses; furs (clothing); pajamas; polo shirts; ponchos; dress suits; sports clothing; protective clothing; knitwear (clothing); denim clothing; underwear for babies; raincoats; pullovers; kimonos; cardigans; ready-made clothing; leather clothing; clothing of imitations of leather; maternity clothing; clothing for children; clothing for babies; paper clothing; beach clothes; outdoor clothing; fur clothing; casual wear; underwear; clothing for motorists and motorcyclists; negligees; saris; sarongs; dress shields; overtrousers; overcoats; sweatshirts; G-strings; togas; tops (clothing); suits; duffel coats; tunics; uniforms; dresses; evening dress; wedding dresses; men's suits; dress suits; women's suits; ballet wear; christening robes; loungewear; clothing for protection against bad weather.

35 – Retail or wholesale services, including those provided in stores, via global computer networks, by mail order and catalogs, for the following goods: non-medicated cosmetics and toiletry preparations, non-medicated dentifrices, perfumery products, essential oils, bleaching preparations and other substances for laundry use, cleaning, polishing, scouring and abrading

preparations, fragrances for personal use, eau de Cologne, eau de parfum, eau de toilette, scented water, perfumes, extracts of perfumes, non-medicinal products for oral hygiene, body cleansing and care products not for medical use, lotions, body milks and creams not for medical use, deodorants for personal use, antiperspirants for personal use, non-medicinal soaps, non-medicinal soaps for personal use, non-medicinal liquid, solid or gel soaps for personal use, bath gels not for medical use, shower gels not for medical use, bath preparations not for medical use, bath salts not for medical use, skin care preparations other than for medical use, exfoliants, talcum powder for toilet use, perfumed powders, wipes, cottons and pads impregnated with non-medicinal cosmetic lotions and for scenting, cosmetics not for medical use, non-medicinal toiletries and perfumery products for the care and beauty of eyelashes, eyebrows, eyes, lips and nails, non-medicated lip balms, nail polishes, nail polish removers, adhesives for cosmetic use, cosmetic slimming preparations other than for medical use, hair preparations and treatments other than for medical use, shampoos other than for medical use, make-up, make-up removing products, depilatories, non-medicinal shaving products, non-medicinal pre-shave products, non-medicinal after-shave products, beauty products other than for medical use, cosmetic preparations for tanning and self-tanning, other than for medical use, cosmetic kits, household perfumes, incense, potpourris [fragrances], scented wood, products for perfuming linen, aromatic extracts, non-medicinal preparations for the care and cleaning of animals, tailors' and shoemakers' wax, cleaning and polishing preparations for leather and footwear, optical apparatus, enhancers and correctors, vision improvement products, optical products, products for vision, correcting lenses, glasses, sunglasses, clip-on sunglasses, contact lenses, lenses, glasses lenses, frames, branches, chains and cords for glasses and sunglasses, covers and cases adapted for optical apparatus and goods, covers and cases for spectacles, sunglasses, contact lenses and corrective lenses, holders for glasses and sunglasses, covers, satchel bags and bags adapted for computers, telephones, electronic agendas, portable radios and media players, precious metals and alloys thereof, fine jewelry, jewelry, precious stones, horological and chronometric instruments, imitations of precious stones and precious metals, pearls and imitations thereof, jewelry boxes and cases, jewelry organizer rolls for travel, watches, pendulum clocks, clocks, and parts thereof, watch bands, watch chains, cases, boxes and presentation cases for timepieces and watches, cuff links and tie clips, key rings and key chains and charms thereof, medals, coins, boxes of precious metals, their alloys, and imitations thereof, statues, figures and ornaments, made of or coated with precious, semi-precious metals, their alloys and imitations thereof, Statues, figures and ornaments, made of or coated with pearls, precious, semi-precious stones

or imitations thereof, works of art of precious stones and precious metals, trophies of precious metals, leather and imitations of leather, animal skins, luggage and carrying bags, umbrellas and parasols, walking sticks, whips and saddlery, collars, leashes and clothing for animals, bags, wallets and other carriers, reinforcing materials, handles and straps for luggage, carrier bags, bags, document cases and other carriers, handbags, evening handbags, shopping bags, net bags for shopping, small bags, carry-all bags, rucksacks, school satchels, waist packs, duffle bags, shoulder straps, baby carriers worn on the body and reins for guiding children, unfitted vanity cases and sets, travelling sets, cases of leather or leatherboard, covers for suits, shirts and dresses, tie cases, document cases, document covers, coin purses, chain mesh purses, billfolds, key cases, card wallets, credit card cases [wallets], boxes of leather or leather board, cords and straps of leather, covers for umbrellas and parasols, rings, handles, walking sticks, frames and umbrella and parasol ribs, walking stick handles, blankets and hot clothing for animals, leather board, hides and leather and imitations thereof, unworked, worked or semi-worked, clothing, footwear, headgear, dress footwear, casual footwear, sports footwear, beach footwear, work footwear, rain footwear, bath footwear, indoor footwear, dance footwear, baby footwear, footwear uppers, iron fittings, heel pieces, straps, anti-slip soles, inner soles, tongues, soles for footwear, tips, welts and heels for footwear, boot uppers, studs for football boots, hats, caps and peaked caps, berets, hoods [clothing], visors, cap peaks, turbans, headdresses, mantillas wimples [clothing], toques [headwear], half veils, headbands [clothing], hat frames, cuffs [clothing], low socks, heel pieces for stockings, ready-made linings [parts of clothing], clothing inserts, shirt yokes, coats, layettes, bath robes, anoraks, eye masks, neckwear, bibs not of paper, headbands, sweatbands and wristbands, dressing gowns, overalls, dressing gowns, bathing suits, bikinis, Bermuda shorts, blazers, shirt blouses, boas, pockets for clothing, sashes for wear, caftans, socks and stockings, warm-up suits, shirts, t-shirts, nightgowns, hooded pullovers, capes and cloaks, blousons, vests, shawls and stoles, jackets, suit coats, tracksuits, stuff jackets, belts [clothing], petticoats, twin sets, slips [clothing], neckties, bustiers, corsets, aprons [clothing], masquerade costumes, tuxedos, skirts, scarves, gabardines, gloves [clothing], jerseys [clothing], lingerie, tights, garters, muffs [clothing], mantles, shawls of silk, mittens, working overalls, jumpsuits, money belts [clothing], ear muffs [clothing], bow ties, trousers, pareos, parkas, balaclavas, scarves [clothing] pocket squares, pocket squares [clothing], shoulder scarves, head scarves, bandanas [neckerchiefs], shirt fronts, pelisses, coveralls, jumper dresses, furs [clothing], pajamas, polo shirts, ponchos, evening wear, sportswear, protective clothing for wear, knitwear [clothing], clothing of denim, underwear for babies, raincoats, pullovers, kimonos, cardigans,

ready-made clothing, clothing of leather, clothing of imitations of leather, maternity clothing, children's clothing, clothing for babies, clothing of paper, beach clothes, outdoor clothing, fur clothing, casual wear, underwear, motorists' and motorcyclists' clothing, negligees, saris, sarongs, dress shields, over-trousers, overcoats, sweatshirts, thongs, togas, tops [clothing], suits, duffle coats, tunics, uniforms, dresses, evening wear, wedding dresses, men's suits, evening suits, women's suits, ballet suits, christening robes, loungewear, weather protection clothing.

(260) AM 2023 120559 A

(800) 1698764

(151) 2022 10 28

(891) 2022 10 28

(731) Closed Joint Stock Company "Sotex,

"PharmFirm"

selskoe poselenie Bereznyakovskoe, pos.

Belikovo, d. 11, Sergievo-Posadsky municipal district, RU-141345 Moscow Region, Russian Federation

(540)

ТАФАЛГИН

(591) Black, white

(531) 28.05

(511)

5 – Anaesthetics; nutritional supplements; cachets for pharmaceutical purposes; chemico-pharmaceutical preparations; drugs for medical purposes; pastilles for pharmaceutical purposes; pomades for medical purposes; vitamin preparations; pharmaceutical preparations; suppositories.

(260) AM 2023 120561 A

(800) 1698842

(151) 2022 10 10

(891) 2022 10 10

(731) Zakrytoe aktsionernoe obshchestvo Bulochno-konditersky kombinat "Kolomenskiy"

Khlebozavodsky pr-d, d. 7, RU-115230 Moskva, Russian Federation

(540)



(591) White, blue and brown

(531) 26.01.02; 26.01.04; 26.01.16; 26.01.24; 28.05; 29.01.13

(511)

30 – Bagels; cereal bars; high-protein cereal bars; sponge cakes; buns; bread rolls; chokolatines; edible paper wafers; waffles; croutons; cereal-based snack food; zephyr being confectionery; confectionery; frozen confectionery; cakes; puff pastry; cake butter pas-

tries; pastries; frozen Danish pastries; frozen cake butter pastries; baked goods; frozen baked goods; candy decorations for cakes; crackers; croissants; breadsticks; pastila [confectionery]; biscuits; coconut macarons; petit-beurre biscuits; pies; gingerbread; rusks; pastry dough; almond paste; rice pulp for culinary purposes; cake batter; dough; yeast dough; frozen pastry; shortcrust pastry dough; puff pastry dough; challah bread; tortillas; iced cakes; waffle cakes; chocolate decorations for cakes; bread; gluten-free bread; unleavened bread; yeast-free bread; wheat-rye bread; wheat bread; rye bread; wholemeal bread; bread containing vegetables; bread flavored with spices; crispbread; waffle crispbread; whole grain crispbread; crispbread with vitamin and mineral preparations, not for medical purposes; ciabatta.

(260) AM 2023 120562 A

(800) 1698901

(151) 2022 10 18

(891) 2022 10 18

(731) Qingzhou Tanboer Garment Co., Ltd.

No. 3588 Zhaode South Road, Qingzhou City, Weifang City, Shandong Province, China

(540)

TANBOER

(591) Black, white

(531) 27.05.01

(511)

25 – Waterproof clothing; footwear; scarves; down garments; hats; hosiery; gloves [clothing]; clothing; girdles; wedding dresses.

(260) AM 2023 120563 A

(800) 1698928

(151) 2022 07 20

(891) 2022 07 20

(731) Obshchestvo s ogranichennoy otvetstvenosti yu "SINDIKAOIL"

ul. Dovatorcev, dom 47 korpus B, pomeshchenie 57, Stavropol, RU-355042 Stavropolskiy kray, Russian Federation

(540)



(591) Black, white and turquoise.

(531) 15.01.25; 19.03.03; 29.01; 29.01.13

(511)

7 – 3d bioprinters; 3d printers; vending machines; welding machines, electric; welding apparatus, gas-

operated; vulcanisation apparatus; acetylene cleaning apparatus; high pressure washers; apparatus for drawing up beer under pressure; apparatus for aerating water; apparatus for aerating beverages; electrical apparatus for sealing plastics [packaging]; electric arc cutting apparatus; electric arc welding apparatus; electric welding apparatus; inking apparatus for printing machines; soldering apparatus, electric; fittings for engine boilers; expansion tanks [parts of machines]; drums [parts of machines]; reels, mechanical, for flexible hoses; brake shoes other than for vehicles; concrete mixers [machines]; bioreactors for use in manufacturing biopharmaceuticals; reels for weaving looms; harrows; journal boxes [parts of machines]; bulldozers; hoppers [mechanical discharging]; mine borers; truck lifts; rolling mill cylinders; crank shafts; printing rollers for machines; camshafts for vehicle engines; transmission shafts, other than for land vehicles; valves [parts of machines]; fans for motors and engines; saw benches [parts of machines]; winnowers; vibrators [machines] for industrial use; bearings [parts of machines]; water heaters being parts of machines; bellows [parts of machines]; agitators; drilling rigs, floating or non-floating; lawnmowers [machines]; card clothing [parts of carding machines]; nail extractors, electric; emergency power generators; alternators; dynamos; bicycle dynamos; current generators; generators of electricity; hydraulic controls for machines, motors and engines; mufflers for motors and engines; drilling heads [parts of machines]; drilling bits [parts of machines]; cylinder heads for engines; soldering blow pipes, gas-operated; gas-operated blow torches; raking machines; stalk separators [machines]; sieves [machines or parts of machines]; mud catchers and collectors [machines]; tarring machines; rubber tracks being parts of crawlers on mining machines; rubber tracks being parts of crawlers on snow ploughs; rubber tracks being parts of crawlers on loading-unloading machines and apparatus; rubber tracks being parts of crawlers on agricultural machines; rubber tracks being parts of crawlers on construction machines; hydraulic engines and motors; aeronautical engines; aeroplane engines; engines for air cushion vehicles; compressed air engines; engines for boats; motors, other than for land vehicles; disintegrators; tympan [parts of printing presses]; holding devices for machine tools; turf removing ploughs; pump diaphragms; door closers, hydraulic; door closers, pneumatic; chisels for machines; jacks [machines]; rack and pinion jacks; moving pavements [sidewalks]; electric hand drills; crushers for kitchen use, electric; flues for engine boilers; reapers; reapers and binders; millstones; rakes for raking machines; shredders [machines] for industrial use; kitchen grinders, electric; vegetable shredders, electric; injectors for engines; incubators for eggs; tools [parts of machines]; ski edge sharpening tools, electric; hand-held tools, other than hand-operated; agricultural implements, other than hand-operated; air condensers; control cables for machines,

engines or motors; capstans; mangles; rotary steam presses, portable, for fabrics; ditchers [ploughs]; carburettors; slides for knitting machines; crankcases for machines, motors and engines; road rollers; pressure valves [parts of machines]; clack valves [parts of machines]; pressure reducers [parts of machines]; hoods [parts of machines]; machine wheels; machine boiler scale collectors; shoe lasts [parts of machines]; piston rings; grease rings [parts of machines]; reapers and threshers; coalcutting machines; compressors [machines]; air pumps [garage installations]; compressors for refrigerators; conveyors [machines]; belt conveyors; converters for steelworks; condensers [steam] [parts of machines]; aerocondensers; diggers [machines]; rams [machines]; thermic lances [machines]; mechanized livestock feeders; boxes for matrices [printing]; grease boxes [parts of machines]; housings [parts of machines]; harvesting machines; steam engine boilers; coffee grinders, other than hand-operated; taps [parts of machines, engines or motors]; cranes [lifting and hoisting apparatus]; roller bridges; mobile cranes; drain cocks; spray guns for paint; cranks [parts of machines]; potters' wheels; grindstones [parts of machines]; cultivators [machines]; soldering lamps; winches; blades [parts of machines]; ploughshares; belts for conveyors; lubricators [parts of machines]; igniting magnetos; handling machines, automatic [manipulators]; churns; matrices for use in printing; machine fly-wheels; shearing machines for animals; blowing machines; knitting machines; galvanizing machines; bending machines; ironing machines; mine-working machines; blowing machines for the compression, exhaustion and transport of gases; blowing machines for the compression, sucking and carrying of grain; net hauling machines [fishing]; electroplating machines; bottle sealing machines; sealing machines for industrial purposes; embossing machines; engraving machines; finishing machines; crushing machines; waste disposals; stropping machines; earth moving machines; cord making machines; lace making machines; butter machines; cigarette machines for industrial purposes; sausage making machines; stereotype machines; hosiery looms; dyeing machines; bottle washing machines; dishwashers; machines for the application of sizing; bottle filling machines; cheese slicers, electric; racket stringing machines; leather-working machines; dairy machines; glass working machines; tobacco processing machines; corn husking machines; painting machines; oil refining machines; peeling machines; machines for processing plastics; ore treating machines; printing machines for use on sheet metal; brewing machines; whitewashing machines; road sweeping machines [self-propelled]; leather paring machines; machines for generating gas by electrolysis; bitumen making machines; papermaking machines; pasta making machines, electric; sugar making machines; weeding machines; sifting machines; cinder sifters [machines]; puddling machines; notchers [machine tools]; bread cutting machines;

road making machines; railroad constructing machines; machines for the textile industry; rammers [machines]; rail-laying machines; bottle capping machines; bottle stoppering machines; trash compacting machines; vegetable peelers, electric; die-stamping machines; stamping machines; darning machines; milking machines; drainage machines; wrapping machines; grain separators; bookbinding apparatus and machines for industrial purposes; machines and apparatus for cleaning, electric; machines and apparatus for carpet shampooing, electric; machines and apparatus for polishing [electric]; punching machines; riveting machines; kitchen machines, electric; foundry machines; smoothing presses; fleshing machines; flour mill machines; type-setting machines [printing]; hemming machines; grating machines for vegetables; braiding machines; rinsing machines; wringing machines for laundry; cutting machines; steam engines; printing machines; rotary printing presses; industrial inkjet printing machines; compressed air machines; tilling machines for agricultural purposes; trimming machines; spinning machines; filling machines; friezing machines; cutters [machines]; satinizing machines; agricultural machines; mixing machines; sorting machines for industry; stitching machines; washing machines [laundry]; coin-operated washing machines; laundry washing machines incorporating a drying tumbler; clippers [machines]; spinning frames; looms; kneading machines; typographic machines; type-setting machines [photocomposition]; beating machines; beaters, electric; packing machines; packaging machines; filtering machines; molding machines; carding machines; sewing machines; typecasting machines; electromechanical machines for chemical industry; labellers [machines]; mills [machines]; mills for household purposes, other than hand-operated; centrifugal mills; machine wheelwork; feeders [parts of machines]; transmission mechanisms, other than for land vehicles; forge bellows; mixers [machines]; blenders, electric, for household purposes; vacuum cleaner bags; threshing machines; pneumatic hammers; hammers [parts of machines]; tilt hammers; power hammers; reeling apparatus, mechanical; motorized cultivators; motors for boats; meat choppers, electric; superchargers; guides for machines; suction nozzles for vacuum cleaners; vacuum cleaner attachments for disseminating perfumes and disinfectants; pumps [machines]; pumps [parts of machines, engines or motors]; aerating pumps for aquaria; vacuum pumps [machines]; compressed air pumps; pumps for heating installations; beer pumps; pumps for counter-current swimming; lubricating pumps; self-regulating fuel pumps; fuel dispensing pumps for service stations; centrifugal pumps; hydrogen dispensing pumps for service stations; tin openers, electric; knives for mowing machines; chaff cutter blades; knives, electric; knives being parts of machines; shears, electric; scissors, electric; vegetable spiralizers, electric; engine mounts, other than for land vehicles; bearing brackets

for machines; spraying machines; axles for machines; steam traps; chucks [parts of machines]; drill chucks [parts of machines]; exhaust manifold for engines; soldering irons, gas-operated; soldering irons, electric; superheaters; gears, other than for land vehicles; reduction gears other than for land vehicles; drilling machines; saws [machines]; chain saws; guns [tools using explosive cartridges]; glue guns, electric; compressed air guns for the extrusion of mastics; carburetter feeders; feeding apparatus for engine boilers; loading ramps; ploughs; pneumatic transporters; pneumatic controls for machines, motors and engines; hangers [parts of machines]; anti-friction pads for machines; roller bearings; self-oiling bearings; bearings for transmission shafts; ball-bearings; elevators [lifts]; hoists; lifts, other than ski-lifts; pulleys; saw blades [parts of machines]; pistons [parts of machines or engines]; plunger pistons; pistons for engines; pistons for cylinders; catalytic converters; torque converters other than for land vehicles; fuel conversion apparatus for internal combustion engines; presses [machines for industrial purposes]; wine presses; fodder presses; basket presses; printing presses; typographic presses; swaging machines; pneumatic or hydraulic linear actuators, other than for land vehicles; pedal drives for sewing machines; portable laser imprinters; cleaning appliances utilizing steam; food processors, electric; springs [parts of machines]; spinning wheels; punches for punching machines; vacuum cleaners; touchless stationary vacuums; radiators [cooling] for motors and engines; sewage pulverisers; air brushes for applying colour; regulators [parts of machines]; pressure regulators [parts of machines]; speed governors for machines, engines and motors; cutting blow pipes, gas-operated; blade holders [parts of machines]; loom shafts; gears for weaving looms; belts for machines; lift belts; fan belts for motors and engines; dynamo belts; belts for motors and engines; adhesive bands for pulleys; industrial robots; household cleaning and laundry robots with artificial intelligence; 3d printing pens; kick starters for motorcycles; joysticks being parts of machines, other than for game machines; stuffing boxes [parts of machines]; paper feeders [printing]; whisks, electric, for household purposes; sparking plugs for internal combustion engines; glow plugs for diesel engines; bedding machines; steam/oil separators; cream/milk separators; ball rings for bearings; sowers [machines]; pigs for cleaning pipes; snow ploughs; sheaf-binding machines; shaft couplings [machines]; juice extractors, electric; chaff cutters; teat cups for milking machines; stands for machines; machine tools; nut-tapping machines; woodworking machines; sharpening machines; bicycle assembling machines; paring machines; stone working machines; metalworking machines; size adjustment cutting machines for industrial purposes; threading machines; trueing machines; planing machines; lathes [machine tools]; milling machines; metal drawing machines; rolling mills; starters for motors and engines; stators

[parts of machines]; glaziers' diamonds [parts of machines]; tables for machines; derricks; slide rests [parts of machines]; spin dryers [not heated]; heat exchangers [parts of machines]; transmissions for machines; boiler tubes [parts of machines]; wind turbines; hydraulic turbines; turbocompressors; central vacuum cleaning installations; suction machines for industrial purposes; machines for the mineralization of drinking water; vehicle washing installations; degreasers [machines]; dust exhausting installations for cleaning purposes; sifting installations; pneumatic tube conveyors; dust removing installations for cleaning purposes; condensing installations; floating production, storage and offloading [fpso] units; pneumatic waste oil drainers; lifting apparatus; air suction machines; dividing machines; igniting devices for internal combustion engines; washing apparatus; binding apparatus for hay; extractors for mines; hydraulic door openers and closers [parts of machines]; pneumatic door openers and closers [parts of machines]; door openers, electric; curtain drawing devices, electrically operated; adhesive tape dispensers [machines]; anti-pollution devices for motors and engines; beverage preparation machines, electromechanical; food preparation machines, electromechanical; portable ultrasonic washing devices for laundry; lift operating apparatus; control mechanisms for machines, engines or motors; shoe polishers, electric; machines and apparatus for wax-polishing, electric; air cushion devices for moving loads; handling apparatus for loading and unloading; elevating apparatus; carriage aprons; filter presses; filters for cleaning cooling air, for engines; filters being parts of machines or engines; molds [parts of machines]; printing plates; journals [parts of machines]; centrifugal machines; elevator chains [parts of machines]; driving chains other than for land vehicles; cylinders for motors and engines; cylinders for machines; printing cylinders; pneumatic jacks; shuttles [parts of machines]; universal joints [cardan joints]; connecting rods for machines, motors and engines; steam mops; pulleys [parts of machines]; vacuum cleaner hoses; screwdrivers, electric; brushes [parts of machines]; dynamo brushes; brushes for vacuum cleaners; brushes, electrically operated; carbon brushes [electricity]; ejectors; robotic exoskeleton suits, other than for medical purposes.

12 – Motor buses; motor coaches; motor homes; driverless cars [autonomous cars]; motor racing cars; lorries; cars; hydrogen-fueled cars; robotic cars; sports cars; concrete mixing vehicles; refrigerated vehicles; caravans; shock absorbers for automobiles; suspension shock absorbers for vehicles; space vehicles; aircraft; aeronautical apparatus, machines and appliances; hot air balloons; ski carriers for cars; luggage carriers for vehicles; bumpers for automobiles; vehicle bumpers; tires for vehicle wheels; barges; brake shoes for vehicles; tailboard lifts [parts of land vehicles]; buffers for railway rolling stock; waggons; tilt trucks; railway carriages; sleeping cars; dining cars; refrige-

rated wagons [railroad vehicles]; transmission shafts for land vehicles; cycles; electric bicycles; valves for vehicle tires [tyres]; helicopters; helicams; automobile hoods; pushchair hoods; hoods for vehicles; oars; paddles for canoes; sculls; screws [propellers] for ships; surveillance towers specially adapted for vehicles; lug nuts for vehicle wheels; seaplanes; hydroplanes; flanges of railway wheel tires; trucks with a crane feature incorporated; horns for vehicles; treads for vehicles [roller belts]; doors for vehicles; motors for cycles; motorcycle engines; motors for land vehicles; jet engines for land vehicles; driving motors for land vehicles; screw-propellers; screw-propellers for boats; airships; rims for vehicle wheels; brake discs for vehicles; telfer railways [cable cars]; self-balancing boards; dredgers [boats]; hand cars; military drones; civilian drones; delivery drones; camera drones; vehicle bonnet pins; adhesive rubber patches for repairing inner tubes; bicycle bells; rearview mirrors; portholes; cars for cable transport installations; inner tubes for pneumatic tires [tyres]; inner tubes for bicycle tires; canoes; hoods for vehicle engines; crankcases for land vehicle components, other than for engines; boats; caissons [vehicles]; wheels for bicycles, cycles; vehicle wheels; mine cart wheels; casters for trolleys [vehicles] [carts (am.)]; brake pads for automobiles; diving bells; hub caps; pushchairs; pet strollers; side cars; prams; brake linings for vehicles; ships; baskets adapted for cycles; gear boxes for land vehicles; ships' hulls; fenders for ships; bands for wheel hubs; ejector seats for aircraft; wheelchairs; caps for vehicle fuel tanks; boat hooks; automobile bodies; tipping bodies for lorries [trucks]; bodies for vehicles; treads for retreading tires [tyres]; locomotives; masts for boats; golf carts [vehicles]; sprinkling trucks; propulsion mechanisms for land vehicles; transmission mechanisms for land vehicles; self-balancing electric unicycles; mopeds; motor scooters; motorcycles; rubbish trucks; tyre mousse inserts; fitted footmuffs for prams; fitted footmuffs for pushchairs; freewheels for land vehicles; clutches for land vehicles; repair outfits for inner tubes; fitted dashboard covers for vehicles; bicycle pumps; upholstery for vehicles; rims for bicycle wheels; windows for vehicles; engine mounts for land vehicles; axles for vehicles; headlight wipers; parachutes; ferry boats; pedals for cycles; ashtrays for automobiles; gearing for land vehicles; carts; horse-drawn carriages; forklift trucks; straddle carriers; head-rests for vehicle seats; bicycle kickstands; motorcycle kickstands; vehicle running boards; cup holders for vehicles; air bags [safety devices for automobiles]; ski lifts; chairlifts; casings for pneumatic tyres; sleeping berths for vehicles; pontoons; torque converters for land vehicles; pneumatic or hydraulic linear actuators for land vehicles; cigar lighters for automobiles; non-skid devices for vehicle tires; anti-glare devices for vehicles; anti-theft devices for vehicles; sun-blinds adapted for automobiles; trailers for transporting bicycles; bicycle trailers; balance weights for vehicle

wheels; shock absorbing springs for vehicles; pulks for transportation; cycle frames; motorcycle frames; spars for ships; reduction gears for land vehicles; safety belts for vehicle seats; security harness for vehicle seats; vehicle suspension springs; self-driving robots for delivery; rudders; cycle handle bars; motor-cycle handlebars; vehicle joysticks; cranks for cycles; signal arms for vehicles; push scooters [vehicles]; aeroplanes; amphibious airplanes; sleighs [vehicles]; kick sledges; brake segments for vehicles; cycle saddles; luggage nets for vehicles; dress guards for bicycles; fitted pushchair mosquito nets; anti-theft alarms for vehicles; reversing alarms for vehicles; safety seats for children, for vehicles; vehicle seats; bellows for articulated buses; hydraulic circuits for vehicles; water scooters [personal watercraft]; mobility scooters; self-balancing scooters; snowmobiles; rolling stock for railways; rolling stock for funicular railways; spokes for bicycle wheels; vehicle wheel spokes; spoilers for vehicles; ambulances; autonomous underwater vehicles for seabed inspections; amphibious vehicles; armoured vehicles; all-terrain vehicles; water vehicles; air vehicles; swamp-going vehicles; vehicles for locomotion by land, air, water or rail; snow-going vehicles; air cushion vehicles; remotely operated vehicles for underwater inspections; remote control vehicles, other than toys; electric vehicles; tricycles; carrier tricycles; inclined ways for boats; windscreens; windscreen wipers; hubs for bicycle wheels; vehicle wheel hubs; rescue boats; saddlebags adapted for bicycles; railway couplings; trailer hitches for vehicles; couplings for land vehicles; wheelbarrows; trolleys; handling carts; sack-barrows; shopping trolleys [carts (am.)]; fishing trolleys; hose carts; bogies for railway cars; ladle cars; tilting-carts; roll cage trolleys; cleaning trolleys; cycle brakes; brakes for vehicles; torsion bars for vehicles; tractors; tramcars; military vehicles for transport; aerial conveyors; trailers [vehicles]; funnels for ships; funnels for locomotives; turbines for land vehicles; oarlocks; disengaging gear for boats; cable transport apparatus and installations; spoke clips for wheels; tipping apparatus [parts of railway wagons]; steering gears for ships; cleats [nautical]; funiculars; vans [vehicles]; cycle chains; motorcycle chains; driving chains for land vehicles; anti-skid chains; transmission chains for land vehicles; undercarriages for vehicles; pushchair covers; spare tire covers; covers for vehicle steering wheels; saddle covers for bicycles; saddle covers for motorcycles; seat covers for vehicles; vehicle covers [shaped]; automobile chassis; vehicle chassis; connecting rods for land vehicles, other than parts of motors and engines; axle journals; gears for cycles; tubeless tires [tyres] for bicycles, cycles; tires for bicycles, cycles; automobile tires [tyres]; tyres for snow ploughs; tires, solid, for vehicle wheels; solid tyres for vehicle wheels.

(260) AM 2023 120564 A

(800) 1698948

(151) 2022 10 04

(891) 2022 10 04

(731) Premier Beverages P.B. Limited

Amathountos, 50E, PEARL BUILDING, 3rd floor, Flat/Office 1, CY-4532 Agios Tychonas Limassol, Cyprus

(540)

ΦΑΡΕΝΓΕΪΤ
FAHRENHEIT

(591) Black, white

(531) 28.05

(511)

32 – Non-alcoholic beverages; fruit beverages and fruit juices; syrups and other non-alcoholic preparations for making beverages; kvass [non-alcoholic beverage]; whey beverages; non-alcoholic fruit juice beverages; fruit nectars with pulp, non-alcoholic; orgeat.

(260) AM 2023 120568 A

(800) 1699394

(151) 2022 09 14

(891) 2022 09 14

(731) NDI SOPOT SPÓŁKA AKCYJNA

ul. Powstańców Warszawy 19, PL-81-718 Sopot, Poland

(540)

NDI

(591) Black, white

(511)

36 – Financial analysis; real estate management; rental of real estate; financial advice; real estate appraisal; real estate agency services; rental of offices [real estate]; rental of apartments; trusteeship; real estate services related to management of property investments; real estate investment; providing investors with financial information; real estate brokerage; mortgage banking; mortgage brokerage; real estate financing; advisory services relating to investments and finance; consultancy services relating to corporate finance; real estate investment management; financial planning; real estate trustee services; financial consultancy relating to real estate investment; financial management of building projects; financial management of building renovation projects; real estate acquisition services; real estate investment; real estate consultancy; rental of real estate and property; real estate agency services for the rental of buildings; real estate agency services relating to the purchase and sale of buildings; real estate agency services relating to the purchase and sale of land.

37 – Construction; construction of industrial buildings; residential and commercial building construction; onshore construction; shipbuilding; underwater construction; harbour construction; underground construction; irrigation devices installation and repair; pipeline construction and maintenance; oil pipeline construction; laying and construction of pipelines; construction consultancy; consultation in building construction supervision; offshore construction; building construction advisory services; building construction supervision; building construction supervision services for building projects; pier construction; construction of bridges; construction of railways; construction of tunnels; maintenance and repair of office buildings; construction of airports; road construction; custom construction of motorways; construction of carriageways; factory construction; underwater repair; building maintenance and repair; building of offices; construction of ceilings; building of canal locks; pier breakwater building; infrastructure construction; construction of property; house building; construction of sports arenas; building of apartments buildings; rail infrastructure construction; construction of railways; construction of structures for the transportation of crude oil; construction of structures for the transportation of natural gas; construction of structures for the production of natural gas; building of commercial properties.

42 – Architectural services; consultancy in the field of architectural design; architectural services for the design of buildings; interior design; architectural and engineering services; land surveying; engineering surveying; conducting technical project studies; technical research; urban planning; engineering feasibility studies; design feasibility studies; conducting of technical feasibility studies; research in the field of building construction; preparation of architectural plans; architectural services for the design of industrial buildings; design of building exteriors; building design services.

(260) AM 2023 120571 A
 (800) 1699452
 (151) 2022 10 24
 (891) 2022 10 24
 (731) Lashify, Inc.
 11437 Chandler Blvd, North Hollywood
 CA 91601, USA
 (540)

LASHIFY

(591) Black, white
 (511)
 35 – Retail store services and online retail store services featuring consumer packaged goods and cosmetic products; retail store services and online retail store services featuring cosmetic products for use with eyelashes, false eyelashes and eyelash extensions, adhesives and sealers for affixing false eyelashes and eye-

lash extensions, artificial eyelash kits, make-up and false eyelash and eyelash extension removing preparations, skincare preparations, cosmetic tools for use with eyelashes, eyelash applicators, eyelash tweezers, eyelash curlers, eyelash separators and eyelash combs; retail store services and online retail store services featuring apparel, bags, dog toys, hair wraps and hair bands; consumer membership program services; membership club services in the nature of providing discounts to members in the field of beauty products; administration of a customer loyalty program; providing information in the cosmetic business field; retail store services and online retail store services featuring cosmetic products for use with eyelashes, namely, false eyelashes and eyelash extensions, adhesives for affixing false eyelashes and eyelash extensions, preparations for removing eyelash adhesives, utensils for use with eyelashes, namely, eyelash applicators, eyelash curlers, eyelash separators, eyelash formers, and eyelash combs, false eyelash application and eyelash extension services.

(260) AM 2023 120572 A
 (800) 1699461
 (151) 2022 11 01
 (891) 2022 11 01
 (731) ACADIA Pharmaceuticals, Inc.
 12830 El Camino Real, Suite 400, San Diego
 CA 92130, USA

(540)



(591) Black, white
 (531) 26.01.03; 26.01.24; 26.03.04; 26.03.06;
 26.03.24

(511)
 5 – Pharmaceuticals for use in the prevention and treatment of neurologic, genetic, psychologic, and psychiatric diseases and disorders.

35 – Promoting awareness of patient support offerings for neurologic, genetic, psychologic, and psychiatric diseases and disorders; medical referrals.

42 – Scientific and industrial biotechnological and biomedical research; chemical, biochemical and molecular biological analyses; medical testing, namely, in vitro and in vivo preclinical testing of potential drugs; consultation related thereto; providing medical and scientific research information in the field of pharmaceuticals and clinical trials.

44 – Medical consulting with respect to neurologic, genetic, psychologic, and psychiatric diseases and disorders, including Rett syndrome and its identification and treatment; providing online information for health care providers, caregivers, and patients in the field of neurologic, genetic, psychologic, and psychiatric diseases and disorders; medical informational support services, namely, providing information about the benefits of diagnostic tools, medical information regarding disease diagnosis, identification, treatment, and management, and healthcare-related information to patients, caregivers, and healthcare professionals all related to neurologic, genetic, psychologic, and psychiatric diseases and disorders.

(260) AM 2023 120573 A
 (800) 1699532
 (151) 2022 11 03
 (891) 2022 11 03
 (731) Incyte Holdings Corporation
 1801 Augustine Cut-Off, Wilmington
 DE 19803, USA
 (540)

QPARIK

(591) Black, white
 (511)
 5 – Pharmaceutical preparations for the treatment of oncological disorders; pharmaceutical preparations for the treatment of auto-immune disorders; pharmaceutical preparations for the treatment of hematological disorders; pharmaceutical preparations for the treatment graft versus host disorders.

16 – Printed publications, namely, brochures, newsletters, and pamphlets relating to medical healthcare issues, procedures, disease symptoms and treatments, patient support and community building.

44 – Providing healthcare information to physicians, patients and caregivers relating to diagnosis and treatment of medical diseases and disorders.

(260) AM 2023 120647 A
 (800) 1699887
 (151) 2022 07 07
 (891) 2022 07 07
 (731) ANDREA BIZZOTTO SPA
 VIA MOTTON, 9, I-36061 BASSANO DEL
 GRAPPA (VI), Italy
 (540)

bizzotto

(591) Black, white
 (531) 27.05.01
 (511)
 20 – Furniture; mirrors [furniture]; tables; console tables; coffee tables; desks; bookcases, seats, armchairs;

sofas, chaise longues; stools; sideboards, showcases; beds, mattresses; pillows, cushions, wardrobes; statues and figurines of plastic; statues and figurines of wax; wooden statues and figurines; rocking chairs; screens [furniture]; bottle racks; baskets, not of metal; wicker baskets; non-metallic containers; umbrella stand; magazine racks; wall decorations of wood; clothes hangers; coat hangers [furniture]; houses and kennels for animals; furniture chests; closures for containers, not of metal; picture frames; displays not of metal; signs of wood or plastic; locks and keys, not of metal; venetian blinds; packaging containers of plastic; plastic trays for packaging of foodstuffs; waste dumpsters, not of metal, other than for medical use.

(260) AM 2023 120648 A
 (800) 1699894
 (151) 2022 05 13
 (891) 2022 05 13
 (731) Fédération Internationale de Football
 Association (FIFA)
 FIFA-Strasse 20, CH-8044 Zürich, Switzerland
 (540)



La'eeb

(591) Black, white
 (531) 04.05.21; 09.01.07; 09.03.13; 09.07.25;
 25.01.25; 27.05.01; 28.01
 (511)
 9 – Eyeglasses, sunglasses, diving and swimming goggles, cases, cords and chains for sunglasses and eyeglasses; Binoculars; magnets and decorative magnets; directional compasses; electronic monitoring instrument clusters; electronic control mechanisms for automobile propellants; electronic control mechanisms for automobile bodies and chassis; remote door locking systems; Hi-Fi audio systems and components; apparatus for recording, transmitting, editing, mixing and reproducing of sound and images; radios; television apparatus; flat screens; liquid crystal display screens; high-definition and plasma screens; home-cinema system apparatus; video recorders; compact disk players; portable CD players; DVD players; MP3 players; players containing music in digital format; cassette players; mini-disk players; loudspeakers; headphones; earphones; microphones; remote controls, voice-activated remote controls; navigation apparatus; PDAs (personal digital assistants); computers; data processing apparatus; computer keyboards; computer screens;

modems; computer carrying cases; computer mice; mouse pads; electronic pocket translators; dictating apparatus; electronic notebooks and agendas; scanners; printers; photocopiers; facsimile machines; telephone apparatus; telephone answering machines; video telephones; cellular telephones; cases for cellular telephones; devices for handsfree use of mobile phones; earphones and headsets for cellular telephones; keyboards for cellular telephones; cellular telephone straps; special bags for carrying cellular telephones; mobile telephone handsets which include a camera feature; photographic cameras and video cameras integrated into cellular telephones; smart watches; calculating machines; credit card readers; cash exchanging machines; automated teller machines; automated teller machine (ATM); video cameras, portable video cameras with built-in videocassette recorders (camcorders); photographic equipment, photographic apparatus, cameras (cinematographic apparatus), projectors, exposed films, photographic slides, flash-bulbs (photography); special cases and cords for photographic apparatus and instruments; electric batteries and cells; karaoke apparatus and programs for karaoke; video game disks; voice-activated or manually-activated remote controls; software (recorded computer programs), including software for games; computer programs; data bank management software; screensaver software; magnetic, digital or analog recording media, recorded or not, for sounds or images; video disks, video tapes, magnetic tapes, magnetic disks, DVDs, floppy disks, optical disks, compact disks, mini-disks, CD-ROMs, all the aforesaid goods being blank or prerecorded with music, sound or images (which may be animated); holograms; magnetic cards (encoded), including gift vouchers; memory adapters (computer equipment); smart cards [integrated circuit cards]; memory sticks (blank or prerecorded); integrated circuit cards (smart cards); microchip or magnetic credit cards, microchip or magnetic phone cards, microchip or magnetic cards for cash dispensers, microchip or magnetic cards for automated teller and money exchange machines, microchip or magnetic prepaid cards for mobile phones, microchip or magnetic travel and entertainment cards, microchip or magnetic check guarantee and debit cards; coded credit cards; digital dashboards; alarms; remote control apparatus for opening and closing vehicle doors; windsocks (for indicating wind direction); photovoltaic cells and solar electric panels; gauges; distance-measuring apparatus; apparatus for measuring and displaying speed; downloadable electronic publications; downloadable electronic road maps; audio receivers, sound amplifiers; computer software and hardware, including set-top boxes, which can convert, supply, receive and transmit audio and video data; disk drives for computers; rechargeable batteries; protective helmets for sports; magnetic identification bracelets; electronic tickets; tickets in the form of magnetic cards; virtual reality headsets for game consoles; downloadable computer

software to enable consumers and businesses to manage digital collectibles using blockchain-based software technology and smart contracts featuring players, games, recordings, statistics, information, photos, images, game footage, highlights and experiences in the field of football.

14 – Jewelry ("joaillerie"); Necklaces; jewelry; precious stones; jewelry articles made of crystal; gemstones; watches; wristwatches; clocks; wall clocks; chronographs; chronometers, cases for watches, pendulums; medallions, pendants, brooches; bracelets, bracelets of leather; silicone bracelets (jewelry); pins (jewelry); team and player pins (jewelry); tie clips and tie pins; cuff links; medals; commemorative medals of precious metal; medallions, trophies, statues and sculptures of precious metal; decorative pins (jewelry) for hats, all of precious metal; decorative key rings; coins; medals and badges for clothing of precious metal; decorative key holders; lanyards [key cords]; medallions, not of precious metal; collectors' printed caps (pogs) made of precious metal.

16 – Money clips for holding bank notes; Tablecloths of paper; towels of paper; bags of paper; invitation cards; greeting cards; cardboard packaging boxes in collapsible form; gift-wrapping paper; coasters of paper, doilies and place mats of paper; garbage bags of paper or of plastics; plastic shopping bags; food wrappers; labels of paper or cardboard, hand towels of paper; tissues of paper for removing make-up; boxed tissues; handkerchiefs of paper; writing materials and school supplies (except apparatus); magnetic boards; typewriters; paper for typewriters, paper for copiers and letter paper (stationery); envelopes, themed pads of paper; notepads; writing books; scribble pads; binders, archiving boxes; document sleeves, book covers; bookmarks; lithographs; framed or unframed paintings (pictures); painting pads, drawing pads, books of games, crosswords and puzzles; luminous paper; self-adhesive labels, not of textile; crêpe paper; tissue paper, staples; staplers; flags of paper; pennants (flags) of paper; writing instruments; nibs; pencils; pens; pen sets; pencil sets; felt pens, felt-tip pens; ballpoint pens; felt-tip markers; ink; inking pads; rubber stamps; paint boxes; coloring and drawing pencils; chalks; decorations for pencils (stationery articles); printing blocks; magazines; newspapers; books and journals, particularly concerning athletes and sports events; printed teaching material; schedules (for recording results); event programs; event albums; photograph albums; autograph books; address books; diaries (planners); diaries (personal journals), road maps; entry tickets; airplane tickets and boarding passes; bank checks; printed timetables; circulars and pamphlets; comic strips; collectable trading cards; collectable trading cards in the field of sports; stickers for cars; stickers; sticker albums; calendars; posters; photographs; postcards; stamps; commemorative stamp sheets; advertising signs and banners of paper or card-

board; transfers (decalcomanias); office requisites (except furniture); correcting fluids; rubber erasers; pencil sharpeners; stands for pens and pencils; paper clips; thumbtacks; drawing rulers, adhesive tapes for stationery; adhesive tape dispensers; stencils; stencil plates; clipboards; notepad holders; bookends; stamps (seals); credit cards without magnetic coding; suitcase labels; passport holders; cords for identity cards of paper.

18 – Leather and imitations of leather; Leather straps; umbrellas, parasols; sports bags (other than those adapted for products they are designed to contain); sports bags with wheels; duffel bags; leisure bags; traveling bags; backpacks; carrier bags; school bags; bags for hanging on belts; handbags; leather bags; ball-shaped leather bags; beach bags; garment bags for travel; suitcases; belts for suitcases; tote bags; briefcases of leather; toiletry cases (vanity cases) (empty); toiletry bags; key cases of leather; business card cases; identity card holders; luggage tags of leather; document cases; wallets; purses (coin purses); check holders; clothing for pets; collars for pets; leashes for animals.

21 – Household or kitchen utensils and containers (non-electric); Portable cooking kits for outdoor use; glass bottles (containers); spoons for mixing (kitchen utensils); fruit presses (non-electric) for household needs; cutting boards for the kitchen; trays for household needs; ice buckets; manual mixers (shakers); shakers; sugar bowls; beer mugs, beer jugs, mugs, cups and drinking glasses; decanters; plates and dishes, coasters for glasses or bottles, saucers, glasses; teapots; household gloves; corkscrews; bottle openers; bottle cap removers; bottles; insulating flasks; non-electric containers for food and beverages; combs and hair brushes; toothbrushes; dental floss; flossing devices; interdental stimulators; statues, sculptures, figurines, ornaments and trophies of terracotta or glass; decorative bottles for cosmetic use; clothes racks for drying; waste paper baskets; piggy banks (not of metal); souvenir table plates; feeding bowls and cages for pets; commemorative plates.

24 – Bed linen; Sheets; eiderdowns [quilts]; bed covers; pillowcases; curtains; shower curtains; linen; dish towels for drying; blankets; handkerchiefs of textile; wall hangings of textile materials; flags; flags for cars (not of paper); banners of textile materials; pennants; table linen of textile; labels of cloth; hand towels of textile; sleeping bags; sleeping bags for babies.

25 – Clothing; Shoes; headwear; shirts; knitwear (clothing); pullovers, sweatshirts; slipovers; tee-shirts; vests; jerseys; dresses; sports dresses; skirts; sports skirts; underwear; swimsuits, two-piece swimsuits (bikinis); tankinis; dressing gowns (robes); shorts; trousers; sweaters; stocking caps; caps; hats; scarves; headscarves; long scarves; shawls; visors; peaked caps;

tracksuits; sweatshirts; jackets; sports jackets; stadium jackets; blazers; waterproof clothing; coats; uniforms; neckties; wristbands (clothing); wristbands against perspiration; bandeaux (clothing); gloves; aprons; bibs (not of paper); pajamas; play suits for infants and children; clothing for babies; socks and stockings; garters; belts; suspenders; sandals, flip-flops; sports shoes, namely, outdoor shoes, hiking shoes, basketball shoes, cross-training shoes, cycling shoes, indoor sports shoes, footwear for track and field athletics, tap shoes, football shoes (indoor and outdoor), football boots, canvas shoes, tennis shoes, street sports shoes, sailing shoes, aerobic shoes; clothing for athletic use, namely, fleece sweaters, jogging suits, sports knitwear, sports pants, polo shirts, sweatshirts, running pants, football style jerseys, rugby style jerseys, socks, bathing suits, warming tights and stockings, tracksuits, functional underwear, jerseys, tops with integrated bra, leotards, snow suits, snow jackets, snow pants.

28 – Games and toys; Finger resistance band (hand grip strengthener); play balloons; table-top games; tables for indoor football; dolls and plush toys; miniature football kit replicas as toys; vehicles (toys); jigsaw puzzles; balloons; inflatable toys; playing cards; confetti; gymnastic and sporting articles; appliances for gymnastics; football equipment, namely footballs, gloves, knee, elbow and shoulder pads, shin guards and football goals; kick-at-goal walls; bags and covers specially adapted for transporting sporting articles; party hats (toys); hand-held electronic games adapted for use with television receivers only; joysticks for video games; video game consoles; apparatus for video games; game consoles; electronic game machines with liquid crystal displays; hand-held electronic games other than those adapted for use with television receivers only; game pads; steering wheels and dancing mats for video games; foam hands (toys); robots (toys) for entertainment, arcade games; scale model airplanes; toys for household pets; scratch cards for playing lottery games; kites; roller skates; scooters (toys); skateboards.

38 – Telecommunication services; Communications by telephones and mobile telephones; electronic communication services by telephone; radio communications; paging services; teleconferencing services; television program broadcasting; radio program broadcasting; press and news agency services; rental of telephone apparatus, facsimile and other telecommunication apparatus; transmission of commercial Internet pages online or via wireless electronic communication devices; radio and television programming and broadcasting services provided via satellite, cable or wireless networks; electronic transmission of messages; provision of access time to a blog, chat room, bulletin board or discussion service; provision of access to live chat rooms online and electronic bulletin boards enabling transmission of messages, comments and multi-

media content among users, for creating a network of contacts; provision of access time to Internet sites containing road maps, information about driving directions and the location of businesses; computer-aided transmission of messages and images; rental of access time to private and commercial purchasing and ordering services via computer, a global computer network and/or interactive communication technologies; electronic mail services; provision of connections for telecommunications via data banks or the Internet; provision of access time to websites for listening to digital music on the Internet via wireless electronic communication devices; transmission (or broadcasting) of radio and television programs relating to sports and sports events; broadcasting of radio or television programs related to sports and sports events; providing connections to computer installations (telecommunications services); rental of access time to a centralized computer and to data banks; rental of access time on the Internet via a global computer network or via wireless electronic communication devices; real-time transmission (streaming) of video and audio material from the Internet; real-time transmission (streaming) of audio, video and television material; provision of access time to search engines; telecommunications services, namely, electronic transmission of virtual reality data and content.

39 – Travel agency services, namely, travel arrangement and reservation; Reservation of travel tickets, information relating to travel and sale of travel tickets; airplane, train, boat, bus and truck transportation services; logistics services with respect to transport; air transportation services featuring a frequent flyer bonus program; boat excursion services; tour operation services; vehicle rental services; rental of parking spaces; taxi services; merchandise delivery services; transport of goods by motor vehicles, trucks, trains, boats and airplanes; packaging of goods; transport and delivery of goods; postal services, messenger and courier services; warehousing; replenishing vending machines with food and beverages; distribution of water, heating, gas or electricity; distribution (delivery) of films and sound and image recordings; distribution of tickets; satellite-assisted navigation services; distribution (transport), delivery and storage of gasoline, petroleum, hydrocarbons, gas, lubricants, solvents, paraffin, wax and bitumen; transmission and distribution of electricity; transport of oil or gas through pipelines; transport and disposal of waste; consultancy relating to the delivery of energy and electricity.

41 – Education; Training; provision of training courses; entertainment; entertainment services in the nature of public projections of sports events; organization of sporting and cultural events and activities; organization of lotteries and competitions; organization of sporting competitions and events in the field of football; providing sports facilities; fun park services; health and fitness club services; rental of audio and vi-

deo equipment; production, presentation, publication and/or rental of films, sound and video recordings; publication and/or rental of interactive educational and entertainment products, namely films, books, compact discs, DVDs, mini-discs, CD-ROMs; publication of statistics and other information on sports performances; publication of radio and television reports of sports events; production and editing services for radio and television programs; photography services; photographic, audio and video recording services; production of cartoons; production of animated television programs; seat booking services for entertainment and sporting events; ticket reservation services for entertainment and sporting events; ticket sales agency services for sports events; timing of sports events; recording of sports events; organization of beauty contests; interactive entertainment; gambling services; provision of raffle services; online game services; providing online entertainment in the nature of tournaments; organization of computer game competitions including online game competitions; information relating to entertainment or education, provided online from a computer database or the Internet or on wireless electronic communication devices; electronic game services provided via a global computer network (the Internet) or via wireless electronic communication devices (entertainment); editing of books; electronic publication of books and journals online; entertainment services provided via chat rooms on a global computer network (the Internet) or through wireless electronic communication devices; entertainment services in the form of cinema performances; translation services; interpreter services; corporate hospitality services in the form of entertainment services; ticket agency services in connection with sports or entertainment events; providing entertainment services in VIP lounges and sky boxes both within and outside stadiums; provision of online information concerning sport and sports events from a computer databank or the Internet; entertainment services, namely, online providing of footwear, headwear, eyewear, clothing, bags, sports bags, backpacks, sports equipment, balls for football games, works of art, trophies, non-downloadable virtual games and toys for use in virtual environments, virtual reality games, interactive video games; coordinating and conducting competitions for promoting the use and development of entertainment in the nature of electronic games, virtual reality games, augmented reality games, electronic game pieces, and entertainment-related computer hardware and software with respect to entertainment in the nature of video games; entertainment services in the form of public gatherings during the retransmission of sports events; providing entertainment content for the purpose of forming virtual communities and engaging in social networking activities; entertainment services (content and virtual reality experiences) provided via the Internet and other communication networks; organizing and conducting of con-

ferences in the field of interactive entertainment, virtual reality, consumer electronics and video games.

(260) AM 2023 120649 A
 (800) 1699934
 (151) 2022 09 19
 (891) 2022 09 19
 (731) ROYAL-VOSTOK INVESTMENTS LIMITED
 Arch. Makariou III, 206 Chrysalia Court,
 5th floor, CY-3030 Limassol, Cyprus
 (540)



(591) Black, white
 (531) 03.09.01; 03.09.10; 25.01.15; 26.01.03;
 26.01.12; 26.01.15; 26.01.20; 26.04.05;
 26.04.06; 26.04.18; 27.01.12; 27.05.01;
 27.05.10
 (511)
 33 – Aperitifs; arrack; brandy; wine; piquette; whiskey; vodka; anisette [liqueur]; kirsch; gin; digesters [liqueurs and spirits]; cocktails; anise [liqueur]; liqueurs; pre-mixed alcoholic beverages, other than beer-based; alcoholic beverages, except beer; alcoholic beverages containing fruit; spirits [beverages]; distilled beverages; mead (hydromel); peppermint liqueurs; bitters; nira (sugarcane-based alcoholic beverage); rum; sake; perry; cider; rice alcohol; alcoholic extracts; alcoholic fruit extracts; alcoholic essences.

(260) AM 2023 120650 A
 (800) 1699935
 (151) 2022 10 20
 (891) 2022 10 20
 (731) Reuzel, Inc.
 Suite 125, 1120 Lincoln Street, Denver
 CO 80203, USA
 (540)

TAT

(591) Black, white
 (531) 27.05.01; 27.05.23
 (511)
 3 – Exfoliating cleanser for the skin; skin hydrating gels; skin hydrating preparations for use on tattooed surfaces; non-medicated skin sprays for tattoo maintenance; hydrating balms for enhancing appearance of existing tattoos; sunscreen creams and lotions; hydra-

ting body lotions; non-medicated skincare preparations, namely, creams and ointments for tattoo after-care.

(260) AM 2023 120652 A
 (800) 1699967
 (151) 2022 07 04
 (891) 2022 07 04
 (731) Egis Gyógyszergyár Zrt.
 Keresztúri út 30-38., H-1106 Budapest,
 Hungary
 (540)

PRESKEDON

(591) Black, white
 (511)
 5 – Pharmaceutical preparations for human use; dietic substances adapted for medical use; vitamin compositions; mineral food supplements; dietary supplements.

(260) AM 2023 120679 A
 (800) 1700623
 (151) 2022 09 12
 (891) 2022 09 12
 (731) Oy Karl Fazer Ab
 Fazerintie 6, FI-01230 Vantaa, Finland
 (540)



(591) Black, blue, yellow, white
 (531) 26.01.05; 26.01.24; 27.05.24; 29.01.13
 (511)
 30 – Coffee, tea, cocoa and substitutes therefor; rice; tapioca and sago; flour and preparations made from cereals; bread, pastry and confectionery; edible ices; sugar, honey, treacle; yeast, baking-powder; salt; mustard; vinegar, sauces (condiments); spices; ice; chocolate; caramels; cookies; biscuits; buns; pastilles; chewing gum; sal ammoniac liquorice sweets (non-medicated); pies; lollipops; cakes; candy; liquorice [confectionery].

(260) AM 2023 120681 A
 (800) 1700648
 (151) 2022 10 08
 (891) 2022 10 08
 (731) SAIC-GM-WULING AUTOMOBILE CO.,
 LTD.

No. 18, Hexi Road, Liunan District, Liuzhou,
545007 Guangxi, China

(540)

BAOJUN

(591) Black, white

(531) 27.05.01

(511)

35 – Advertising; television advertising; presentation of goods on communication media, for retail purposes; outdoor advertising; advertising planning services; business inquiries; market studies; organization of trade fairs for commercial or advertising purposes; providing business information via a website; administrative assistance in responding to calls for tenders; import-export agency services; marketing; telemarketing services; provision of an online marketplace for buyers and sellers of goods and services; personnel management consultancy; photocopying services; accounting; business auditing.

(260) AM 2023 120689 A

(800) 1700928

(151) 2022 09 21

(891) 2022 09 21

(731) BECOR S.R.L., întreprindere mixtă
Str. Calea Orheiului nr. 111/5, MD-2020
Chişinău, Republic of Moldova

(540)

Clinic⁺S
CLINIC SOLUTIONS

(591) Black, white

(531) 24.17.07; 27.05.01; 27.05.10; 27.05.17

(526) „Clinic“, „S“, „CLINIC SOLUTIONS“, „+“

(511)

10 – Surgical, medical, dental and veterinary apparatus and instruments; artificial limbs, eyes and teeth; orthopaedic articles; suture materials; therapeutic and assistive devices adapted for persons with disabilities; massage apparatus; apparatus, devices and articles for nursing infants; sexual activity apparatus, devices and articles.

(260) AM 2023 120756 A

(800) 1701315

(151) 2022 06 13

(891) 2022 06 13

(731) ESPN, Inc.

ESPN Plaza, Bristol CT 06010, USA

(540)

ANDSCAPE

(591) Black, white

(511)

9 – Downloadable software; musical sound recordings; digital media; downloadable non-fiction e-books on a variety of topics; downloadable fiction e-books on a variety of topics; downloadable podcasts.

16 – Printed non-fiction books on a variety of topics; printed fiction books on a variety of topics.

25 – Clothing; headwear; footwear.

41 – Entertainment services; educational services; providing information, news and commentary; providing non-downloadable prerecorded music; providing non-downloadable videos; providing news, sports, politics, lifestyle, culture, pop culture, and social issue blogs and non-downloadable publications via a website; record label services; movie studio services; recording, production and distribution of music.

(260) AM 2023 120757 A

(800) 1701326

(151) 2022 11 15

(891) 2022 11 15

(731) Jitusmi Imports Inc.

214 E. Lynn Street, Seattle WA 98102, USA

(540)

elftank

(591) Black, white

(511)

34 – Cigarettes; matchboxes; snuff; ashtrays for smokers; cigarette cases; cigarette filters; cigarette holders; cigarette paper; electronic cigarettes; filter tips for cigarettes; flavourings, other than essential oils, for tobacco; flavourings, other than essential oils, for use in electronic cigarettes; lighters for smokers; liquid nicotine solutions for use in electronic cigarettes; smokers' mouthpieces for electronic cigarettes.

(260) AM 2023 120758 A

(800) 1701338

(151) 2022 10 21

(891) 2022 10 21

(731) "TELS POLSKA" SPÓŁKA Z
OGRANICZONĄ ODPOWIEDZIALNOŚCIĄ
ul. ks. Ignacego Kłopotowskiego 22,
PL-03-717 Warszawa, Poland

(540)

TELS GLOBAL

(591) Blue, orange

(531) 24.15.01; 24.15.07; 26.03.23; 27.05.01;

27.05.19; 29.01.12

(511)

35 – Business management; commercial management; advertising; administrative support and data processing services; secretarial and clerical services; computerized file management; market research for adver-

tising; market research and business analyses; business investigations; marketing research; market research and marketing studies; data search in computer files for others; economic forecasting and analysis; information and data compiling and analyzing relating to business management; data processing, systematization and management; compilation of computer databases; systemization of information into computer databases; collating of data in computer databases; updating and maintenance of data in computer databases; price comparison services; management administration of commercial undertakings; advice relating to the organisation and management of business; business consultancy and advisory services.

36 – Insurance underwriting; finance services; financial transfers and transactions, and payment services; real estate services; financial analysis and consultancy.

39 – Transport; packaging services; transporting furniture; ferry-boat transport; freighting; transport by road; railway transport; marine transport; leasing of warehouse units; wrapping of goods; transport services; freight forwarding; air transport; car transport; barge transport; transport of goods; river transport; transport by water; ship transport; boat transport; transport by land; transportation and delivery of goods; warehouse storage; goods warehousing; removal services; freight and cargo transportation and removal services; freight and transport brokerage; aircraft charter brokerage; freight brokerage [forwarding (am.)]; chartering of vehicles for transportation; rental of means of transportation; rental services related to vehicles, transportation, and storage; travel arrangement.

(260) AM 2023 120759 A

(800) 1701362

(151) 2022 09 06

(891) 2022 09 06

(731) VEFA İLAÇ SANAYİ VE TİCARET

ANONİM ŞİRKETİ

BEYLİKDÜZÜ OSB MAH. 2 CAD. 3 2,

Beylikdüzü, İstanbul, Türkiye

(540)

Metforix

(591) Blue

(531) 27.05.17; 29.01.04

(511)

5 – Pharmaceuticals, medical preparations.

(260) AM 2023 120760 A

(800) 1701388

(151) 2022 11 10

(891) 2022 11 10

(731) Apple Inc.

One Apple Park Way, Cupertino CA 95014,
USA

(540)

LIVE ACTIVITIES

(591) Black, white

(511)

42 – Design and development of computer software for others; computer programming; computer software design; computer programming services for data processing; writing of computer code; computer software consultancy; providing non-downloadable software; providing non-downloadable application development software; providing non-downloadable software used in developing other software applications; providing non-downloadable software for processing, transmitting and displaying text, data, images, audio, audio visual content, and other multimedia content; providing non-downloadable software for sending and receiving electronic messages, alerts, notifications and reminders; providing non-downloadable computer software for providing geographic information, interactive maps and satellite and aerial images; providing information relating to computer programs.

(260) AM 2023 120767 A

(800) 1701503

(151) 2022 11 16

(891) 2022 11 16

(731) ASCEM B.V. 1

Schaarweg 4, NL-6991 GV Rheden 4,

Netherlands

(540)

INVIE

(591) Black, white

(511)

19 – Cement; mortar; concrete; non-chemical binder components not included in other classes.

(260) AM 2023 120768 A

(800) 1701520

(151) 2022 11 15

(891) 2022 11 15

(731) FLO MAĞAZACILIK VE PAZARLAMA

ANONİM ŞİRKETİ

MAHMUTBEY MAH., TAŞOCAĞI YOLU

CAD. 24 31 Bağcılar, İstanbul, Türkiye

(540)

PROSHOT

(591) Black, white

(531) 27.05.01

(511)

25 – Clothing, including underwear and outer clothing, other than special purpose protective clothing, socks, mufflers [clothing], shawls, bandanas, scarves, belts [clothing], footwear, shoes, slippers, sandals, headge-

ar, hats, caps with visors, berets, caps [headwear], skull caps.

(260) AM 2023 120769 A

(800) 1701600

(151) 2022 09 09

(891) 2022 09 09

(731) Tovarichtchestvo s ogranichennoy otvetstvennostyu "Asia Su Kompaniyasy" zdanie 54/1, proezd 11, Promyshlennaya zona Severnaya, Kokshetau, 020006 Akmolinskaya oblast', Kazakhstan

(540)



(591) Blue and blue and shades

(531) 03.13.01; 27.05.09; 27.05.10; 29.01.04

(526) KOKSHETAU, KAZAKHSTAN, ICE TEA

(511)

32 – Aperitifs, non-alcoholic; lithia water; seltzer water; soda water; waters [beverages]; carbonated water; mineral water [beverages]; table waters; kvass; cocktails, non-alcoholic; lemonades; non-alcoholic beverages; isotonic beverages; non-alcoholic honey-based beverages; rice-based beverages, other than milk substitutes; soya-based beverages, other than milk substitutes; aloe vera drinks, non-alcoholic; whey beverages; soft drinks; non-alcoholic beverages flavoured with coffee; non-alcoholic beverages flavoured with tea; non-alcoholic fruit juice beverages; energy drinks; fruit nectars, non-alcoholic; powders for effervescing beverages; syrups for lemonade; syrups for beverages; smoothies; tomato juice [beverage]; cider, non-alcoholic; vegetable juices [beverages]; fruit juices; preparations for making carbonated water; preparations for making non-alcoholic beverages; pastilles for effervescing beverages; sherbets [beverages]; non-alcoholic fruit extracts; non-alcoholic essences for making beverages.

(260) AM 2023 120770 A

(800) 1701601

(151) 2022 09 09

(891) 2022 09 09

(731) Tovarichtchestvo s ogranichennoy otvetstvennostyu "Asia Su Kompaniyasy" zdanie 54/1, proezd 11, Promyshlennaya zona Severnaya, Kokshetau, 020006 Akmolinskaya oblast', Kazakhstan

(540)



(591) Blue, gray, blue and shades and black-blue

(531) 03.13.01; 27.05.09; 27.05.10; 29.01.04

(526) KOKSHETAU, KAZAKHSTAN, WATER

(511)

32 – Aperitifs, non-alcoholic; lithia water; seltzer water; soda water; waters [beverages]; carbonated water; mineral water [beverages]; table waters; kvass; cocktails, non-alcoholic; lemonades; non-alcoholic beverages; isotonic beverages; non-alcoholic honey-based beverages; rice-based beverages, other than milk substitutes; soya-based beverages, other than milk substitutes; aloe vera drinks, non-alcoholic; whey beverages; soft drinks; non-alcoholic beverages flavoured with coffee; non-alcoholic beverages flavoured with tea; non-alcoholic fruit juice beverages; energy drinks; fruit nectars, non-alcoholic; powders for effervescing beverages; syrups for lemonade; syrups for beverages; smoothies; tomato juice [beverage]; cider, non-alcoholic; vegetable juices [beverages]; fruit juices; preparations for making carbonated water; preparations for making non-alcoholic beverages; pastilles for effervescing beverages; sherbets [beverages]; non-alcoholic fruit extracts; non-alcoholic essences for making beverages.

(260) AM 2023 120771 A

(800) 1701630

(151) 2022 11 10

(891) 2022 11 10

(731) Apple Inc.

One Apple Park Way, Cupertino CA 95014, USA

(540)

LIVE ACTIVITIES

(591) Black, white

(511)

9 – Computer software; application development software; computer software for use as an application programming interface (API) for building software applications; software for processing, transmitting and displaying text, data, images, audio, audio visual content, and other multimedia content; software for sending and receiving electronic messages, alerts, notifications and reminders; computer software for providing geographic information, interactive maps and satellite and aerial images; computer software for facilitating com-

mercial transactions through mobile telecommunication devices.

(260) AM 2023 120772 A

(800) 1701662

(151) 2022 11 11

(891) 2022 11 11

(731) Limited Liability Company "Consortium-PIQ"

Oruzheyniy pereulok, d. 25, str. 1, pomesch.

I/etazh1/komnata21, RU-125047 Moscow,

Russian Federation

(540)

ВИСМОСЕПТ

(591) Black, white

(531) 28.05

(511)

5 – Pharmaceutical and veterinary preparations; sanitary preparations for medical purposes; dietetic food and substances adapted for medical or veterinary use; food for babies; dietary supplements for human beings and animals; plasters; material for dental fillings and dental impressions; disinfectants; preparations for destroying vermin; fungicides, herbicides.

(260) AM 2023 120773 A

(800) 1701674

(151) 2022 11 15

(891) 2022 11 15

(731) Guangdong Baolun Electronics Co.

No. 56 Nanli East Road Shiqi Town, Panyu

District, Guangzhou, Guangdong, China

(540)

itCAML

(591) Black, white

(531) 26.11.01; 26.11.12; 27.05.01; 27.05.09;
27.05.11; 27.05.17

(511)

9 – Data processing apparatus; face recognition equipment; radios; audio- and video-receivers; camcorders; digital signs; chips for the manufacture of integrated circuits; computer programs for downloadable software; public address systems; cabinets for loudspeakers; microphones; remote control apparatus; electric batteries; electronic numeric displays.

11 – Lighting installations; lighting apparatus for vehicles; heating apparatus; air-conditioning installations; cooking apparatus and installations; stage lighting apparatus; lamps; pipes being parts of sanitary installations; refrigerating apparatus and machines; water purification installations.

35 – Presentation of goods on communication media, for retail purposes; provision of an online marketplace

for buyers and sellers of goods and services; systemization of information into computer databases; retail services for pharmaceutical, veterinary and sanitary preparations and medical supplies; import-export agency services; public relations; personnel management consultancy; book-keeping; advertising; rental of sales stands.

(260) AM 2023 120774 A

(800) 1701700

(151) 2022 11 21

(891) 2022 11 21

(731) MAX INTERNATIONAL

10, rue Michel Rodange, L-2430 Luxembourg,

Luxembourg

(540)

FAYMONVILLE

(591) Black, white

(511)

12 – Trailers; trailer hitches for vehicles; coupling and transmission components for land vehicles.

(260) AM 2023 120775 A

(800) 1701748

(151) 2022 11 07

(891) 2022 11 07

(731) Obshchestvo s ogranichennoy otvetstvennostyu

"Lazernyi Tsentr"

Piskarevsky pr-kt, 25, pom. 132, RU-195176

St. Petersburg, Russian Federation

(540)

SuperBarking

(591) Black, white

(511)

7 – Engraving machines; leather-working machines; glass-working machines; printing machines for use on sheet metal; cutting machines; cutters [machines]; industrial robots.

10 – Dental apparatus and instruments; microdermabrasion apparatus; artificial teeth; surgical implants comprised of artificial materials; lasers for medical purposes.

14 – Agates; diamonds; jewellery charms; brooches [jewellery]; pins [jewellery]; pearls [jewellery]; clasps for jewellery; badges of precious metal; gold, unwrought or beaten; works of art of precious metal; jewellery; ivory jewellery; jewellery of yellow amber; iridium; cabochons; precious stones; semi-precious stones; necklaces [jewellery]; rings [jewellery]; boxes of precious metal; precious metals, unwrought or semi-wrought; gold thread [jewellery]; threads of precious metal [jewellery]; silver thread [jewellery]; osmium; palladium; platinum [metal]; crucifixes as jewellery; rhodium; ruthenium; silver, unwrought or beaten; earrings; ingots of precious metals; alloys of precious

metal; statues of precious metal; figurines of precious metal; paste jewellery; chains [jewellery]; spinel [precious stones].

40 – Engraving; metal tempering; providing information relating to material treatment; soldering; pattern printing; laser scribing.

42 – Engineering; installation of computer software; research and development of new products for others; scientific research; technological consultancy; quality control; updating of computer software; conducting technical project studies; computer software design; computer programming; technical writing; scientific laboratory services; surveying.

(260) AM 2023 120776 A

(800) 1701757

(151) 2022 06 02

(891) 2022 06 02

(731) UAB "VIČIŪNŲ GRUPĖ"

Karaliaus Mindaugo pr. 38, LT-44307 Kaunas,
Lithuania

(540)

ANYTHING
by VIČI

(591) Black, white

(531) 27.05.01

(511)

29 – Surimi-based foodstuffs; fish-based foodstuffs.

(260) AM 2023 120777 A

(800) 1701761

(151) 2022 07 26

(891) 2022 07 26

(731) WORLD MEDICINE İLAÇ SAN.VE TİC.A.Ş.

15 TEMMUZ MAH. CAMİ YOLU CAD. 50,
Bağcılar, İstanbul, Türkiye

(540)

METIGAST

(591) Black, white

(511)

5 – Pharmaceutical and veterinary preparations for medical purposes, chemical preparations for medical purposes, dietary supplements, including those adapted for medical purposes, dietary supplements for slimming purposes, food for babies, herbs and herbal beverages adapted for medicinal purposes, dental preparations and articles, sanitary preparations for medical use, hygienic pads, hygienic tampons, plasters, materials for dressings, diapers, including those made of paper and textiles, preparations for destroying vermin, fungicides, herbicides, deodorants, other than for human beings or for animals, air deodorising preparations, disinfectants, antiseptics, detergents for medical purposes.

(260) AM 2023 120778 A

(800) 1701763

(151) 2022 10 05

(891) 2022 10 05

(731) Honi Poke Group Ltd

1 Kings Avenue, LONDON N21 3NA,
United Kingdom

(540)

Honi Poke

(591) Black, white

(511)

43 – Restaurants.

(260) AM 2023 120867 A

(800) 1702442

(151) 2022 10 05

(891) 2022 10 05

(731) COMPAGNIE LAITIÈRE EUROPÉENNE

F-50890 CONDE-SUR-VIRE, France

(540)



(591) Black, white

(531) 03.04.01; 03.04.02; 06.19.11; 07.05.02;
24.17.25; 25.03.01; 25.03.03; 25.05.25;
27.05.01

(511)

29 – Edible oils and fats; dairy products and substitutes; cheeses; butter; flavored beverages with milk; milk-based beverages; yogurt-based beverages; milk; processed fruits, mushrooms, vegetables, nuts and legumes; jellies, jams, compotes, fruit and vegetable spreads; prepared nuts; dried nuts; fruit-based fillings for cakes and pies; fruit-based fillings for fruit pies; fruit jellies; legume-based spreads; hazelnut-based spreads; fruit pulps; edible fats; vegetable fats for food; vegetable fats for cooking; oils for food; cream [dairy product]; milk desserts; dairy-based desserts; yogurt-based desserts; canned vegetables; canned cut fruits; vegetable mixture; dried fruit mixes; snack mixes consisting of prepared fruits and prepared nuts; yogurt; vegetable spreads; vegetable yogurt; alternative cheese based on vegetable fat (cheese substitutes); milk beverages containing fruit; dairy products and substitutes made with rice, soya, almond, oat, coconuts and nuts; rice milk (milk substitute); soy milk (milk substitute); almond milk; coconut milk; dairy beverages containing rice, soy, almond, oat, coconut and nuts; yogurt based on rice, soy, almond, oat, coconut and nuts (dairy product substitutes); cream (dairy product) containing rice, soy, almond, oat, coconut and nuts; pudding-type yogurts based on rice, soy, al-

mond, oat, coconut and nuts (dairy product substitutes); desserts based on milk substitutes; vegetable cream (dairy product substitutes); vegetable butter; ultra-fresh margarine; alternative yogurt based on vegetable fat (dairy product substitutes); alternative cream based on vegetable fat (dairy product substitutes); alternative butter based on vegetable fat; preserved soybeans for food; prepared sunflower seeds; prepared seeds; linseed oil for food.

30 – Coffee, teas, cocoa and their substitutes; milk-based chocolate beverages; chocolate-based beverages; chocolate; chocolate beverage with milk; ice, ice creams, frozen yogurts and sherbets; ice cream based on dairy products; ice cream; ice cream [desserts]; fruit ice creams; frozen desserts made with milk products; vegan edible ice; ice for refreshment; edible ices; pastries, cakes, tarts, cookies and biscuits; foodstuffs containing cocoa [as the main component]; cocoa-based foods; dairy-based confectionery; chocolate-based confectionery for non-medical use; chocolate decorations for confectionery articles; chocolate-based spreads; chocolate spreads containing nuts; prepared foodstuffs in the form of sauces; pizza crusts; savory pastries; sweet or savory pies; sugar, natural sweeteners, sweet fillings and coatings, apicultural products; sweet fillings and toppings; syrups and molasses; sugar-based foods for dessert preparation; food products based on sugar for sweetening desserts; natural sweeteners; pastries; fresh pastries; dough [pastry]; prepared desserts [pastries]; cakes; edible ices made with rice, soya, almond, oat, coconuts and nuts; ice cream substitutes based on rice, soy, almond, oat, coconut and nuts; frozen yogurt substitutes based on rice, soy, almond, oat, coconut and nuts (edible ices); pastries based on rice, soy, almonds, oats, coconut and hazelnuts; confectionery based on rice, soy, almonds, oats, coconut and hazelnuts; oat-based food; dessert in the nature of mousses based on rice, soy, almonds, oats, coconut and hazelnuts.

(260) AM 2023 120868 A
(800) 1702452
(151) 2022 11 21
(891) 2022 11 21
(731) H & M Hennes & Mauritz AB
SE-106 38 Stockholm, Sweden
(540)

ThermoMove

(591) Black, white
(511)
24 – Textiles and substitutes for textiles; coated textiles; textiles for making up into articles of clothing; waterproof fabric for use in the manufacture of clothing; textile fabrics for use in the manufacture of sportswear; waterproofed textile piece goods.

25 – Clothing; headgear; athletic clothing; bathing trunks; bathing suits; bath robes; bikinis; pantsuits; athletic pants; neckerchiefs; gloves [clothing]; sports jackets; shell jackets; soft shell jackets; quilted jackets [clothing]; training shorts; skirts; underwear for sports; short-sleeve shirts; athletic jumpers; coveralls; pocket squares; turtleneck shirts; rainwear; neck scarves; sports jerseys; beach clothes; sports singlets; sports bras; athletic tights; sports socks; sweaters (pull-overs); sports T-shirts; waistcoats; underwear; mittens; outer clothing; coats; jackets [clothing]; children's wear; tee-shirts; shorts; footless tights; tank tops; pants; jerseys [clothing]; stockings.

(260) AM 2023 120870 A
(800) 1702552
(151) 2022 07 05
(891) 2022 07 05
(731) AKDEMİR GLOBAL DIŞ TİCARET
ANONİM ŞİRKETİ
YEŞİLBAYIR MAH. ŞİMŞİR SOK. NO:20,
HADIMKÖY ARNAVUTKÖY, İSTANBUL,
Türkiye
(540)



(591) Blue, white and golden
(531) 25.03.01; 25.03.13; 26.04.05; 26.04.22;
26.04.24; 27.05.24; 29.01.13

(511)
29 – Meat, fish, poultry and game; processed meat products; dried pulses; soups, bouillon; processed olives, olive paste; milk and milk products, butter; edible oils; dried, preserved, frozen, cooked, smoked or salted fruits and vegetables; tomato paste; prepared nuts and dried fruits as snacks; hazelnut spreads and peanut butter; tahini (sesame seed paste); eggs and powdered eggs; potato chips.

30 – Coffee, cocoa; coffee or cocoa based beverages, chocolate based beverages; pasta, stuffed dumplings, noodles; pastries and bakery products based on flour; desserts based on flour and chocolate; bread, simit [Turkish ring-shaped bagel covered with sesame seeds], pasties, pita, sandwiches, pies, cakes, baklava [Turkish dessert based on dough coated with syrup]; desserts based on dough coated with syrup; puddings, custard, rice pudding; honey, bee glue for human consumption, propolis for food purposes; condiments for foodstuff, vanilla (flavoring), spices, sauces (condiments), tomato sauce; yeast, baking powder; flour, semolina, starch for food; sugar, cube sugar, powdered sugar; tea, iced tea; confectionery, chocolate, biscuits, crackers, wafers; chewing gums; ice-cream, edible

ices; salt; cereal-based snack food, popcorn, crushed oats, corn chips, breakfast cereals, processed wheat for human consumption, crushed barley for human consumption, processed oats for human consumption, processed rye for human consumption, rice; molasses for food.

32 – Beers; extracts of hops for making beer; mineral water, spring water, table water, soda water; fruit and vegetable juices, fruit and vegetable concentrates and extracts for making beverages, non-alcoholic soft drinks; energy drinks, protein-enriched sports beverages.

(260) AM 2023 120871 A
(800) 1702558
(151) 2022 10 27
(891) 2022 10 27
(731) SUSHI JIRO IP PTY LTD
Level 7, SE 1 520 Collins St, Melbourne
VIC 3000, Australia

(540)

Sushi Jiro

(591) Black, white

(511)

42 – Quality control relating to the hygiene of food.

43 – Cafe services; cafes; cafeteria services; cafeterias; internet cafe services (provision of food and drink prepared for consumption); self-service cafeteria services; booking of restaurant places; booking of restaurant seats; inn keeping (bar, restaurant and accommodation); provision of information relating to restaurants; provision of restaurant booking or reservations from customer loyalty and frequent buyer schemes; restaurant booking or reservation services provided in relation to a customer loyalty or frequent buyer scheme; restaurant booking or reservation services provided in relation to a frequent flyer scheme; restaurant booking or reservation services provided in relation to frequent flyer schemes; restaurant reservation services; restaurant services; restaurant services for the provision of fast food; restaurants; salad bar restaurant services; self-service restaurants; theatre restaurants (provision of food and drink); preparation of takeaway and fast food; take away food services; arranging for the provision of food; arranging of wedding receptions (food and drink); club services for the provision of food and drink; coffee bar and coffee house services (provision of food and drink); consultancy services relating to food; consultancy services relating to food preparation; consultancy, advisory and information services in relation to the provision of food and drink; consultation services relating to food; country club services (provision of food, drink and temporary accommodation); food and drink catering; food cooking services; food preparation; food sculpting; hospitality services (food and drink); preparation of food and drink; providing food and drink; providing

information, including online, about services for providing food and drink, and temporary accommodation; provision of carry out foods and beverages; provision of information relating to the preparation of food and drink; rental of food service apparatus; snack bars (provision of food and drink); social clubs (provision of food); take out food and beverage services; takeaway food and drink services.

(260) AM 2023 120873 A
(800) 1702588
(151) 2022 06 21
(891) 2022 06 21
(731) Otkrytoe aktsionernoe obshchestvo "Brestsky myasokombinat"
ul. Pisatelya Smirnova, 4, 224034 Brest,
Belarus

(540)

МЯСНЫЕ ПОДУШЕЧКИ ДОМАШНИЕ

(591) Black, white

(531) 28.05

(526) Word elements with transliteration
"MYASNYE", "DOMASHNIE".

(511)

29 – Meat, poultry, game and foods made therefrom; meat, preserved, dried, smoked; cooked meat; meat, tinned [canned (am.)]; meat products; charcuterie; sausages; small sausages; smoked foods [meat, poultry, game]; ham; bacon; tripe and foods made therefrom; liver; pork, lard, speck (bacon), ribs and foods made therefrom; meat extracts; meat pastes; liver pastes; pastes made from tripe products; semi-prepared foods made from meat, poultry, game, tripe.

30 – Precooked foods made from dough with filling; precooked foods made from mainly dough with meat; pelmeni; vareniki [stuffed dumplings]; pies; pasties; meat pies; pancakes; pizzas.

(260) AM 2023 120874 A
(800) 1702605
(151) 2022 06 02
(891) 2022 06 02
(731) Gyrfalcon Electronics (Shenzhen) Co., Ltd
2101E1, Qiancheng Commercial Center,
No.5 Haicheng Road, Mabu Community,
Xixiang Street, Bao'an District, Shenzhen,
Guangdong, China

(540)



The logo consists of the word "Didu" in a large, bold, black sans-serif font. Below it, the word "MIA" is written in a similar bold, black sans-serif font. To the right of "MIA", the word ".COM" is written in a smaller, black sans-serif font, with the "C" and "O" stacked vertically.

(591) Black, white
 (531) 24.17.02; 27.05.09; 27.05.15; 27.05.17
 (511)

34 – Cigarette; cigarette mouthpiece; match; cigarette lighter for smoking; cigarette filter; condiments for electronic cigarettes other than essential oil (terms considered too vague by the International Bureau – Rule 13 (2) (b) of the Common Regulations); electronic cigarette; electronic cigarette liquid; electronic cigarette box; nicotine equivalent liquid for e-cigarette.

(260) AM 2023 120876 A
 (800) 1702694
 (151) 2022 08 09
 (891) 2022 08 09
 (731) FINANCIERA MADERERA, S.A.
 Formaris, s/n, Santiago de Compostela,
 E-15707 A Coruña, Spain
 (540)



(591) Black, white
 (531) 24.13.05; 26.01.05; 26.01.21
 (511)

19 – Building materials not of metal; floor materials of wood and products derived from wood, vinyl or PVC; wood materials and processed wood for construction; non-metallic laminated boards for walls, non-metallic wall claddings for building; interior linings of wood and products derived from wood, vinyl or PVC for construction; parquet floor; floor coverings made of wood as well as products derived from wood; floors made of sheets; non-metallic rigid pipes for building, asphalt, pitch and bitumen; transportable buildings, not of metal; monuments, not of metal, building panels, not of metal; non-metallic boards for floor coverings; boards, not of metal, for building; boards, not of metal, for walls and partitions; boards not of metal for doors; covering for boards (not of metal); laminated particleboards; laminated boards (not of metal) for building; plywood boards; veneered boards; boards of wood fiber bound with resin and particleboards, laminated fiber boards; boards of wood, particleboards of wood; boards for floors (not of metal); laminated floors of wood and products derived from wood; ground cover layer made of wood, vinyl, vinyl or PVC sheets; skirtings of the following materials wood, building timber, vinyl or PVC and materials derived from wood, building timber, vinyl or PVC; floors, not of metal; wall claddings, not of metal, for building; floor boards of wood; boards of

wood for floors; elements of wood for building; planks of wood for building; components of wood for building; vinyl floor coverings for forming a floor; vinyl siding; bamboo flooring; other flooring made made of wood fiber or chips; PVC flooring; flooring made of wood and plastic; non-metallic floors comprised primarily of linoleum, ceramic tiles for flooring and lining; moldings, not of metal, for building; finishing of wood, moldable wood, moldable wood, sawn timber; wood for hobby use; building panels of wood; tiles of wood; wood fiber board; wood fiber and particle boards; structural reinforcement (non-metallic) for construction purposes; prefabricated components for constructions (not of metal); interior partition walls made of non-metallic materials; bridge bearings based on wood, products derived from wood, vinyl or PVC [building materials], wood cladding, roof coverings and roofing based on wood, products derived from wood, vinyl or PVC; coverings of wood, products derived from wood, vinyl or PVC for building; vinyl or PVC columns for building; columns of wood for building; beams of wood, products derived from wood, vinyl or PVC; beams of wood; trellis of wood, products derived from wood, vinyl or PVC for building; parts and accessories for all the aforesaid goods.

20 – Furniture, mirrors, picture frames; containers not of metal for storage or transport; bone, horn, whale-bone or mother-of-pearl, unwrought or semi-wrought; shells; meerschaum; yellow amber; furniture of wood; door fittings of wood; storage chests of wood; coffins of wood; barrels of wood; wooden boxes; drawers of wood; wooden beds; kennels for animals; wall decorations of wood; furniture partitions of wood; shelves of wood [furniture]; garden furniture made of wood; picture and photo moldings of wood; works of art made of wood; decorative wooden panels [furniture]; panels of wood for furniture; doors for furniture; products of wood and plastic materials, not included in other classes; louver screens of wood; blinds of wood; plaques of wood; door knobs of wood; prefabricated doors of wood for furniture; containers of wood (other than for household or kitchen use); bed bases made of flexible wood; window fasteners of wood; drawer pulls of wood; door stops of wood; wood screws (non-metallic); outdoor furniture; files for storing magazines [furniture]; pedestals for planters and flowerpots; parasol supports; seat cushions.

(260) AM 2023 120877 A
 (800) 1702708
 (151) 2022 08 16
 (891) 2022 08 16
 (731) PAMES AYAKKABICILIK İTHALAT
 İHRACAT SANAYİ VE TİCARET ANONİM
 ŞİRKETİ
 Selahaddin Eyyubi Mahallesi, Uğur Mumcu
 Caddesi, Pames Ayakkabıcılık, No:31,
 Esenyurt – İstanbul, Türkiye

(540)



(591) Black, white

(531) 26.01.02; 26.01.03; 26.01.18; 26.01.24;
27.05.01; 27.05.03; 27.05.24

(511)

25 – Clothing, including underwear and outer clothing, other than special purpose protective clothing; knitwear [clothing]; denim clothing; leather clothing; clothes for sport; bathing suits; beach clothes; lingerie; singlets; drawers [clothing]; bras; petticoats; camisole; undershirts; bodysuits; bustiers; corsets [underclothing]; dressing gowns; nightgowns; coats; overcoats; reefer jackets; topcoats; raincoats; trench coats; winter coats; jackets [clothing]; trousers; skirts; dresses; vests; shirts; tee-shirts; sweatshirts; jumpers [pull-overs]; cardigans; sweaters; blouses [clothing]; shorts; bermuda shorts; overalls; work clothes; aprons [clothing]; footwear, except orthopaedic footwear; half-boots; boots; slippers; booties; sports shoes; studs for sports shoes; heels for shoes; boot uppers; knee-high stockings; soles for shoes; babies' clothing; babies' pants [underwear].

(260) AM 2023 120878 A

(800) 1702754

(151) 2022 02 06

(891) 2022 02 06

(731) DSM GRUP DANIŞMANLIK İLETİŞİM VE
SATIŞ TİCARET A.Ş.

Maslak Mahallesi Büyükdere Caddesi, (Spine
Plaza) No:243, İç Kapı No:19 Sarıyer, İstanbul,
Türkiye

(540)

Trendyol Limited

(591) Black, white

(531) 27.05.01

(511)

25 – Clothing, footwear and headwear for human beings namely clothing; outer clothing; waterproof clothing; overalls; overcoats; paper clothing; parkas; pel-erines; pelisses; petticoats; pockets for clothing; ponchos; rash guards; ready-made clothing; shirt fronts; shirts; shirt yokes; short-sleeve shirts; coats; collars [clothing]; combinations [clothing]; suits; dresses; dressing gowns; dress shields; sweaters; aprons [clothing]; jackets [clothing]; clothing of imitations of leather; clothing of leather; liveries; maniples; mantillas; masquerade costumes; leggings [leg warmers];

leggings [trousers]; leotards; tee-shirts; tights; trousers; trouser straps; uniforms; vests, babies' pants [underwear]; bibs, not of paper; layettes [clothing]; bathing caps; bathing suits; bathing trunks; bath robes; bath sandals; bath slippers; beach clothes; beach shoes; wet suits for water-skiing; cyclists' clothing jackets [clothing]; jerseys [clothing]; judo uniforms; jumper dresses; karate uniforms; kimonos; knitwear [clothing]; fishing vests; furs [clothing]; fur stoles; clothing containing slimming substances; clothing for gymnastics; clothing incorporating LEDs; motorists' clothing; belts [clothing]; money belts [clothing]; headwear; berets; caps being headwear; hats; headbands [clothing]; headscarves; hoods [clothing]; visors being headwear; ear muffs [clothing]; cuffs; detachable collars; gloves [clothing]; mittens; muffs [clothing]; neck gaiters; neckties; paper hats [clothing]; shower caps; ready-made linings [parts of clothing]; saris; sarongs; sashes for wear; scarfs; shawls; veils [clothing]; togas; turbans; bandanas [neckerchiefs]; ascots; bodices [lingerie]; camisoles; corselets; corsets [underclothing]; garters; girdles; boxer shorts; braces for clothing [suspenders]; gaiters; pyjamas; panties; brasieres; underpants; underwear; sweat-absorbent underwear; hosiery; stockings; stocking suspenders; footwear; shoes; footwear uppers; boots; boots for sports; boot uppers; sandals; football boots; foot muffs, not electrically heated; gymnastic shoes; half-boots; heel-pieces for footwear; heelpieces for stockings; heel protectors for shoes; heels; inner soles; galoshes; breches for wear; non-slipping devices for footwear; ski boots; ski gloves; skirts; shorts; skull caps; sleep masks; slippers; slips [underclothing]; socks; sock suspenders; soles for footwear; sports jerseys; sports shoes; sports singlets.

35 – Advertising; business management; business administration; office functions; organization, operation and supervision of loyalty and incentive schemes; advertising services provided via the Internet; production of television and radio advertisements; accountancy; auctioneering; trade fairs; opinion polling; data processing; provision of business information; advertising agency services; advertising services provided for others; database management; compilation of information into computer databases; business consulting services; business consulting services in the field of web based events, conferences, training programs, learning programs, and seminars; business consulting services in the field of delivering web-based knowledge; business consulting services in the field of online collaboration and collaboration technologies; business consulting services in the fields of sales and marketing; business project management services; business project management services relating to development, set up; staging, production, recording, monitoring and follow-up for web based events, conferences, training programs, learning programs, and seminars; market research and business consulting services; business consultancy services relating to facilitating the tran-

saction of business via local and global computer networks by locating and providing referrals for the delivery of a wide variety of business and consumer products and services; dissemination of business information of goods and services of others via local and global computer networks; business consultancy services relating to providing a web site on a global computer network by which third parties can offer and source goods and services, place, determine the status of and fulfil trade leads and orders, enter into contracts and transact business; providing computerized online ordering services; advertising of goods and services of others via local and global computer networks; international import and export agency services; rental of advertising space on communication media; online trading services relating to electronic auctioneering and providing online business evaluation relating thereto; providing a directory of third party web sites to facilitate business transactions; business consultancy services relating to operating an electronic marketplace for the buyers and sellers of goods and/or services on a global computer network; business assistance relating to facilitating business transaction via local and global computer networks; corporate management consultancy services; marketing and promotion services; publication of publicity materials; marketing of vacant premises; dissemination of advertising materials, updating of advertising materials, compilation of advertisements for use as web pages on the Internet; rental of advertising space; computer data processing; sales, business and promotional information services; telephone answering (for unavailable subscribers); telephone answering (for others); auctioneering provided on the Internet; personnel management; provision of sales, business, advertising and promotional information through a global computer network and via the Internet; presentation of goods on communication media for retail purposes; retail and wholesale of cosmetics, perfumery, toiletries, dentifrices, soaps, detergents, deodorants for personal use and household use, bleaching and cleaning preparations, dental care preparations, dentifrices, mouth washes, polishing preparations, candles, wax, pharmaceuticals, veterinary and medical preparations, disinfectants, dietary supplements, baby food, herbs and herbal beverages, sanitary preparations, sanitary diapers, sanitary pads, goods and materials of common metal used for storage, wrapping, packaging and sheltering purposes, containers of metal (storage, transport), metal boxes, packaging containers of metal, aluminium foil, storage containers of metal, metal containers for the transportation of goods, ladders of metal, ironmongery, small hardware of metal, safes of metal, machines, machine tools and industrial robots for processing and shaping wood, metals, glass, plastics and minerals, 3D printers, electric kitchen machines for chopping, grinding, crushing, mixing and mincing foodstuff, washing machines, laundry washing machines, dishwashers, spin driers (not heated), electric cleaning machines for

cleaning floors, carpets or floorings, vacuum cleaners and parts thereof, forks, spoons, knives and non-electric cutters, slicers, peelers for kitchen use, including those made of precious metals, tools and apparatus for personal beauty care use, tools and apparatus for shaving, epilation, manicure and pedicure, electric hand implements for straightening and curling hair, scissors, hand-operated hand tools for the repair of machines, apparatus and vehicles and for use in construction, agriculture, horticulture and forestry, electric or non-electric irons, steam irons, thermometers, microscopes, magnifying glasses, apparatus for recording, transmission or reproduction of sound or images, cameras, photographic cameras, television apparatus, video recorders, CD and DVD players and recorders, MP3 players, computers, desktop computers, tablet computers, microphones, loudspeakers, earphones, telecommunications apparatus, apparatus for the reproduction of sound or images, computer peripheral devices, cell phones, covers for cell phones, telephone apparatus, computer printers, scanners as data processing equipment, photocopiers, magnetic and optic data carriers and computer software and programmes recorded thereto, downloadable and recordable electronic publications, encoded magnetic and optic cards, photocells, optical sensors, counters, clothing for protection against accidents, irradiation and fire, safety vests and life-saving apparatus and equipment, eyeglasses, sunglasses, optical lenses and cases, containers, parts and components thereof, decorative magnets, metronomes, medical orthopaedic articles, corsets for medical purposes, orthopaedic shoes, elastic bandages and supportive bandages, condoms, babies' bottles, babies' pacifiers, teats, teeters for babies, lighting installations, hair driers, hand drying apparatus, water softening apparatus, electric bed warmers and electric blankets, not for medical use, electric pillow warmers, electric or non-electric foot warmers, hot water bottles, pasteurizers and sterilizers, motorcycles, mopeds, vehicle seats, head-rests for vehicle seats, safety seats for children, for vehicles, seat covers for vehicles, vehicle covers, sun-blinds adapted for vehicles, wipers for vehicles, baby carriages, wheelchairs, pushchairs, shopping carts, shopping trolleys, fireworks, sprays for personal defence, jewellery, watches, statuettes and figurines of precious metal, clocks, watches, parts thereof, chronometers, music instruments, their cases, paper and cardboard, paper and cardboard for packaging and wrapping purposes, cardboard boxes, paper towels, toilet paper, paper napkins, plastic materials for packaging and wrapping purposes, printed publications, printed matter, books, magazines, newspapers, bill books, printed dispatch notes, printed vouchers, calendars, posters, photographs [printed], paintings, stickers [stationery], postage stamps, stationery, office stationery, instructional and teaching material [except furniture and apparatus], writing and drawing implements, artists' materials, paper products for stationery purposes, adhesives

for stationery purposes, pens, pencils, erasers, adhesive tapes for stationery purposes, cardboard cartons [artists' materials], writing paper, copying paper, paper rolls for cash registers, drawing materials, chalkboards, painting pencils, watercolours [paintings], stationery, instructional and teaching material, writing and drawing implements, artists' materials, paper products for stationery purposes, adhesives for stationery purposes, pens, pencils, erasers, adhesive tapes for stationery purposes, cardboard cartons [artists' materials], writing paper, copying paper, paper rolls for cash registers, drawing materials, chalkboards, painting pencils, watercolours [paintings], paint roller, paint brushes, rosaries, goods made of leather, imitations of leather or other materials designed for carrying items, bags, wallets, straps, boxes and trunks made of leather or stout leather, key cases, trunks [luggage], suitcases, umbrellas, parasols, walking sticks, monuments and statuettes of stone, concrete and marble, furniture, mattresses, pillows, air mattresses and cushions, sleeping bags for camping, water beds, mirrors, bouncing chairs for babies, playpens for babies, cradles, infant walkers, display boards, frames for pictures and paintings, identification plates, identification tags, nameplates, identification labels made of wood or synthetic materials, packaging containers of wood or plastics, storage containers, chests, ornaments and decorative goods of wood, cork, reed, cane, wicker, horn, bone, ivory, whalebone, shell, amber, mother-of-pearl, meerschaum, beeswax, plastic or plaster, figurines, holiday ornaments for walls and sculptures, baskets, kennels, nesting boxes and beds for household pets, cages for household pets, indoor aquariums, vivarium and indoor terrariums for animals and plant cultivation, bamboo curtains, roller indoor blinds [for interiors], slatted indoor blinds, strip curtains, bead curtains for decoration, curtain hooks, curtain rings, curtain tie-backs, curtain rods, hand-operated non-electric cleaning instruments and appliances, brushes, other than paintbrushes, sponges for cleaning, steel wool for cleaning, cloths of textile for cleaning, gloves for dishwashing, non-electric polishing machines for household purposes, brooms for carpets, mops, tooth brushes, shaving brushes, hair brushes, non-electric household or kitchen utensils, service dishes, pots and pans, bottle openers, flower pots, drinking straws, non-electric cooking utensils, ironing boards and shaped covers therefor, drying racks for washing, clothes drying hangers, ornaments and decorative goods of glass, porcelain, earthenware or clay, statues, figurines and vases, perfume burners, perfume sprayers, perfume vaporizers, electric or non-electric make-up removing appliances, powder puffs, toilet cases, plant watering devices and containers, ropes, strings, hammocks, tents, bags of textile, yarns, threads, textile goods for household use, curtains, bed covers, sheets (textile), pillowcases, blankets, quilts, towels, flags, labels, blankets, clothing, headgear, footwear, swimwear, scarves, hats, caps, laces and embroidery,

guipures, festoons, ribbons (haberdashery), ribbons and braid, fastening tapes for clothing, cords for clothing, letters and numerals for marking linen, embroidered emblems, badges for wear, not of precious metal, shoulder pads for clothing, buttons for clothing, fasteners for clothing, eyelets for clothing, zippers, buckles for shoes and belts, fasteners, shoe and belt buckles, pins, other than jewellery, adhesive patches for decoration of textile articles, laces, needles, sewing needles, needles for sewing machines, needles for knitting and embroidery, boxes for needles, needle cushions, artificial flowers, artificial fruits, hair pins, hair buckles, hair bands, decorative articles for the hair, wigs, hair extensions, electric or non-electric hair curlers, carpets, rugs, mats, wallpaper, wall hangings, games, toys, gymnastic and sporting articles, fishing tackle, artificial fishing bait, decoys for hunting and fishing, Christmas trees of artificial material, ornaments for Christmas trees, artificial snow, rattles (playthings), novelties for parties, paper party hats, foodstuff, beverages, matches, tobacco and tobacco products enabling customers to conveniently view and purchase those goods, such services may be provided by retail stores, wholesale outlets, through vending machines, mail order catalogues or by means of electronic media, for example, through web sites or television shopping programmes.

(260) AM 2023 120881 A

(800) 1702822

(151) 2022 08 09

(891) 2022 08 09

(731) FERRERO S.P.A.

PIAZZALE PIETRO FERRERO 1, I-12051
ALBA, CUNEO, Italy

(540)



(591) Black and red

(531) 19.07.01; 26.11.03; 26.11.22; 27.05.10;
29.01.12

(511)

30 – Pastries; confectionery; ice cream; honey; chocolate; chocolate products; chocolate-based spread cream; chocolate spreads containing nuts; cocoa-based beverages.

(260) AM 2023 120882 A

(800) 1702824

(151) 2022 10 18

(891) 2022 10 18

(731) ODEON TURİZM İŞLETMECİLİĞİ
ANONİM ŞİRKETİ

ERGENEKON MAH. CUMHURİYET CAD.,
EFSER HAN 181 4 Şişli, İstanbul, Türkiye

(540)

CORAL WORLD

(591) Black, white

(511)

39 – Land, water and air transport services; rental of land, water or air vehicles; arranging of tours; travel reservation; issuing of tickets for travel; courier services (messages or merchandise); car parking; garage rental; boat storage; transport by pipeline; electricity distribution; water supplying; rescue operations for vehicles and goods; storage, wrapping and packaging of goods; transport and storage of trash; transport and storage of waste.

43 – Services for providing food and drink; temporary accommodation; reservation of temporary accommodation; rental of rooms for wedding ceremonies; providing rooms for conferences and various meetings; day-nurseries (crèches); boarding for animals.

(260) AM 2023 120883 A

(800) 1702827

(151) 2022 11 01

(891) 2022 11 01

(731) Jack Daniel's Properties, Inc.

4040 Civic Center Drive, Suite 528, San Rafael
CA 94903, USA

(540)

JD

(591) Black, white

(511)

33 – Alcoholic beverages, namely, distilled spirits.

(260) AM 2023 120884 A

(800) 1702829

(151) 2022 11 03

(891) 2022 11 03

(731) NEXTERS GLOBAL LTD

Faneromenis 107, CY-6031 Larnaca, Cyprus

(540)

PawBall

(591) Black, white

(511)

9 – Computer programmes [programs], recorded; computer software, recorded; computer programs [downloadable software]; games software; downloadable music files; downloadable image files; computer software applications, downloadable.

41 – Entertainment services; game services provided on-line from a computer network; providing on-line electronic publications, not downloadable.

(260) AM 2023 120917 A

(800) 1703645

(151) 2022 06 03

(891) 2022 06 03

(731) Limited Liability Company "SLADKIJ
ORESHEK"

d. Melechkino, stroenie 123, g. Solnechnogorsk,
RU-141554 Moskovskaya oblast, Russian
Federation

(540)

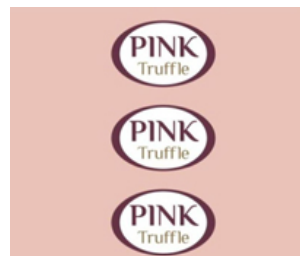

(591) Pink, brown, white and yellow-gray

(531) 19.03.24; 26.01.06; 26.01.18; 26.04.05;
26.04.10; 27.05.01; 27.05.09; 27.05.10;
29.01.14

(526) Truffle

(511)

30 – Sweets; chocolate.

(260) AM 2023 120918 A

(800) 1703660

(151) 2022 07 14

(891) 2022 07 14

(731) Euro Games Technology Ltd.

4, "Maritsa" Str., "Vranya-Lozen-Triugulnika",
BG-1151 Sofia, Bulgaria

(540)



(591) Red and black

(531) 27.05.01; 27.05.10; 29.01.12

(511)

9 – Operating computer software for main frame computers; monitors [computer hardware]; computer hardware; apparatus for recording images; monitors [computer programs]; games software; computer programs for recorded games; apparatus for recording, transmission or reproduction of sound or images; communications servers [computer hardware]; electronic components for gambling machines; computer application software featuring games and gaming; computer software for the administration of on-line games and gaming; computer hardware for games and gaming; hardware and software for gambling, gambling machines, gambling games on the Internet and via telecommunication network; computer operating system software; computer terminals; interactive ter-

minals; multimedia terminals; electronic terminals for generating lottery tickets; interactive touch screen terminals; computer touchscreens; electronic display panels; liquid crystal display screens; digital signage display panels; multimedia software; multimedia apparatus and instruments; interactive multimedia software for playing games; computer screens; LCD large-screen displays; liquid crystal displays [LCDs] for home theatres; media streaming software; computer application software for streaming audio-visual media content via the internet; software; computer gaming software; computer software packages; computer operating system software; computer software, recorded; software drivers; virtual reality software; games software; entertainment software for computer games; computer programs for network management; electronic lottery tickets; computer software platforms; operating systems; interactive computer systems; operating system programs; computer game software for use with on-line interactive games.

28 – Gaming machines for gambling; chips for gambling; mah-jong; arcade games; gambling machines operating with coins, notes and cards; games; electronic games; parlor games; gaming chips; gaming tables; slot machines [gaming machines]; LCD game machines; slot machines and gaming devices; coin-operated amusement machines; roulette chips; poker chips; chips and dice [gaming equipment]; gaming equipment for casinos; roulette tables; gaming roulette wheels; casino games; automats and gambling machines; coin-operated amusement machines and/or electronic coin-operated amusement machines with or without the possibility of gain; boxes for coin-operated amusement machines, slot machines and gaming machines; electronic or electrotechnical amusement machines and apparatus, gaming machines, coin-operated entertainment machines; housings for coin-operated amusement machines, gaming equipment, gaming machines, machines for gambling; electropneumatic and electrical gambling machines (slot machines); lottery games; electronic targets for games and sports.

37 – Installation of plant; machinery installation, maintenance and repair; providing information relating to the installation of machinery; installation of computers; installation of audiovisual equipment; installation of hardware for computer systems; installation of computer hardware; computer hardware (Installation, maintenance and repair of -); consultancy relating to the installation, maintenance and repair of computer hardware; upgrading of computer hardware; repair of game machines and apparatus; installation, maintenance and repair of computer network and information technology equipment.

38 – Telecommunication services; computer communication and Internet access; broadcasting services; automatic transfer of digital data using telecommunications channels; audiovisual communication servi-

ces; video communication services; video transmission via digital networks; remote transmission of audio signals by means of telecommunications; remote transmission of data by means of telecommunications; delivery of messages by electronic media; electronic communications services; communication services for the electronic transmission of data; electronic transmission and retransmission of sounds, images, documents, messages and data; message sending, receiving and forwarding; interactive communication services; interactive telecommunications services; interactive transmission of video over digital networks; cable transmission of sounds, images, signals and data; communication by electronic means; communications via multinational telecommunication networks; communications services; communications services for the exchange of data in electronic form; communication services provided electronically; advisory services relating to communications equipment; mobile media services in the nature of electronic transmission of entertainment media content; network transmission of sounds, images, signals and data; virtual chatrooms established via text messaging; providing electronic telecommunication connections; transmission of data, messages and information; transmission of sound and vision via satellite or interactive multimedia networks; computer-aided transmission of sound; transmission of sound via interactive multimedia networks; transmission of sound or visual recordings over networks; transmission of vision via interactive multimedia networks; transmission of information through video communication systems; transmission of information in the audiovisual field; provision of communications facilities for the interchange of digital data; telecommunications services between computer networks; telecommunications services relating to electronic commerce; telecommunication of information (including web pages); electronic transmission of information (Services for the -); secured data, sound and image transmission services; inter-active video text services; video uploading services; photo uploading services; delivery of messages by audiovisual media; telematic data transmission and file transfer; digital transmission services for audio and video data; rental of telecommunication devices and equipment enabling connection to networks; rental of telecommunication equipment; provision of access to content, websites and portals; provision of access to data or documents stored electronically in central files for remote consultation; provision of access to electronic sites; providing access to multimedia content online; providing access to platforms on the Internet; providing access to gambling and gaming websites on the Internet; providing access to websites on the Internet or any other communications network; providing user access to portals on the Internet; providing user access to platforms on the Internet; provision of telecommunication access to video and audio content provided via an online video-on-demand service; provision of telecommunication

access to video content provided via the Internet; electrical data transmission over a global remote data processing network, including the Internet; video-on-demand transmission services; sending and receiving of electronic messages; message sending via a website; computerised communication services; communications by computer terminals; computer intercommunication; communication by computer; on-line communication services; on-line transmission of electronic publications; transmission and distribution of data or audiovisual images via a global computer network or the Internet; transmission of data, audio, video and multimedia files; transmission of data, audio, video and multimedia files, including downloadable files and files streamed over a global computer network; data transmission and data broadcasting; transmission of data or audio visual images via a global computer network or the Internet; transmission of data and information by computer and electronic communication means; transmission of information on-line; transmission of multimedia content via the Internet; transmission of sound, picture and data signals; computer-aided transmission of messages and images; exchange of messages via computer transmission; distribution of data or audio visual images via a global computer network or the Internet; streaming audio and video material on the Internet; streaming of audio, visual and audiovisual material via a global computer network; streaming of data; Internet based telecommunication services; web conferencing services; video, audio and television streaming services; access to content, websites and portals; online messaging services; broadcasting of audiovisual and multimedia content via the Internet.

41 – Gambling; services related to gambling; gaming services for entertainment purposes; casino, gaming and gambling services; training in the development of software systems; provision of gaming equipment for gambling halls; providing casino equipment [gambling]; gaming machine entertainment services; providing casino facilities [gambling]; providing halls with gaming machines; amusement arcade services; games equipment rental; rental of gaming machines; providing amusement arcade services; rental of gaming machines with images of fruits; editing or recording of sounds and images; sound recording and video entertainment services; hire of sound reproducing apparatus; provision of gaming equipment for casinos; providing of casino facilities; online gambling services; casino, gaming and gambling services; providing amusement arcade services, online casino and betting services provided via websites; lottery services; organization of lotteries; provision of games by means of a computer based system; online interactive entertainment; on-line casino services; online game services through mobile devices; providing online entertainment in the nature of game tournaments; providing on-line information in the field of computer gaming

entertainment; sports betting services; online sports betting services.

42 – Computer software technical support services; troubleshooting of computer software problems; provision of technical support in the supervision of computing networks; provision of technical support in the operation of computing networks; technical support services relating to computer software and applications; technical supervision and inspection; monitoring of computer systems by remote access; machine condition monitoring; installation, repair and maintenance of computer software; design, maintenance and updating of computer software; installation, setting up and maintenance of computer software; design, maintenance, development and updating of computer software; installation and customisation of computer applications software; technical consultancy relating to the installation and maintenance of computer software; computer system monitoring services; design of graphic software systems; development of interactive multimedia software; design and development of computer hardware; advice relating to the design of computer hardware; advisory and information services relating to the design and development of computer hardware; design, development and testing of computer software and hardware, and in particular for gambling, casino games and betting; platform as a service [PaaS]; development of computer platforms; platforms for gaming as software as a service [SaaS]; development of computer systems; computer system design and development.

(260) AM 2023 120920 A

(800) 1703743

(151) 2022 10 07

(891) 2022 10 07

(731) WELCOME TRAVEL GROUP S.P.A.

VIA LUGARO 15, I-10126 TORINO, Italy

(540)



(591) White, blue, grey, red and green

(531) 26.01.03; 26.01.18; 26.01.24; 27.05.01;
27.05.07; 27.05.08; 27.05.09; 27.05.10;
27.05.24; 29.01.15

(511)

16 – Printed matter, in particular stickers, brochures, labels (non-textile), admission tickets, posters, postcards, advertising leaflets.

35 – Advertising; business management; business administration; office functions; promotion of assets, goods and services for others, namely temporary vacation rental accommodation, via advertising and advertisements via computer networks and global computer networks.

38 – Providing on-line electronic bulletin boards for transmission of messages among computer users in the field of travel.

39 – Arranging of transportation for travel tours; travel information services; providing travel information via an online computer database; providing online travel information in the form of reviews about travel service providers, travel destinations, and local sightseeing tours; travel tour reservation services; providing travel information via an online database; boat rental; car rental; motor coach rental; rental of diving suits; transportation information; sightseeing [tourism].

41 – Entertainment services; cultural activities; organisation and conducting of sporting and cultural events; providing on-line electronic publications, not downloadable.

42 – Scientific and technological services and research and design relating thereto; industrial analysis and research services; design and development of computer hardware and software; computer services, namely, providing search engines for obtaining travel data on a global computer network; hosting websites containing reviews of hotel accommodation and travel service providers, travel destinations and local attractions, hosting a website that allows users to make reservations and bookings relating to rental of temporary vacation lodgings; computer services, namely, providing search engines for obtaining temporary vacation rental lodgings information via computer and global information networks; hosting interactive websites and computer databases containing reviews of accommodation, namely reviews about rental of temporary vacation accommodation where users can post and view ratings about rental of temporary vacation accommodation.

43 – Services for providing food and drink; providing temporary accommodation; resort reservation services; temporary accommodation reservations; room booking; restaurant reservation services; hotel reservations; boarding house bookings; temporary accommodation reservations; temporary accommodation reservations; clubs providing food and drink, campground accommodation; booking of hotel accommodation; travel agency services for booking accommodation; hospitality services being temporary accommodation; providing of food and drink and temporary accommodation; hotel restaurant services; providing information relating to rental of accommodation for short-term holidays, namely information containing descriptions and images of properties, places and comforts, availability, provided via websites and online databases, in which users can post and receive booking requests for rental accommodation for short-term holidays; providing of information relating to rental accommodation for short-term holidays; making reservations for travel, namely, bookings for rental accommodation for short-term holidays and rental

of property by means of a global computer network; providing reviews relating to rental of temporary vacation lodgings via computer networks and global information networks; providing information about temporary accommodation containing reviews about accommodation, namely reviews about rental of temporary vacation accommodation via interactive websites and databases.

(260) AM 2023 120921 A

(800) 1703755

(151) 2022 09 20

(891) 2022 09 20

(731) Shevchenko Denis Sergeevich

st. Dikuna, 33, DNT Verkhny Kazachiy hutor,
Krasnodar, RU-350910 Krasnodar region,
Russian Federation

(540)

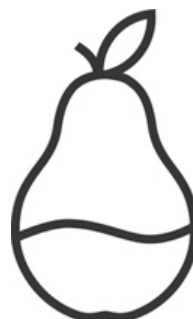

(591) Black, white

(531) 05.07.15; 05.07.23

(511)

34 – Gas containers for cigar lighters; hookah bowls; absorbent paper for tobacco pipes; cigarette paper; lighters for smokers; hookahs; tobacco pouches; books of cigarette papers; hookah flasks; humidors; matchboxes; firestones; cigar cutters; hookah mouthpieces; cigar holders; cigarette holders; mouthpieces for cigarette holders; tips of yellow amber for cigar and cigarette holders; ashtrays for smokers; spittoons for tobacco users; hookah stands; pipe racks for tobacco pipes; hookah cleaners; pipe cleaners for tobacco pipes; cigarettes; cigarettes containing tobacco substitutes, not for medical purposes; electronic cigarettes; cigarillos; cigars; tobacco jars; match holders; matches; chewing tobacco; tobacco and tobacco blends for hookahs; snuff; tobacco; snuff boxes; herbs for smoking; hookah pipes; tobacco pipes; pocket machines for rolling cigarettes; cigarette filters; cigarette tips; hookah shafts; hookah hoses; cigar cases; cigarette cases.

(260) AM 2023 120922 A

(800) 1703756

(151) 2022 10 18

(891) 2022 10 18

(731) ODEON TURİZM İŞLETMECİLİĞİ A.Ş

ERGENEKON MAH. CUMHURİYET CAD.,
EFSER HAN 181 4 Şişli, İstanbul, Türkiye

(540)



(591) The colors of the lines in the circle: Coral Coral, Tint of Coral Amber, Coral Amber, Coral Orange,

Tint of Coral Blue, Coral Cobalt; the color of the letters of "coraltravel" is Coral Blue

(531) 01.03.02; 26.01.01; 26.01.03; 26.01.12; 27.05.01; 27.05.09; 29.01.15

(511)

39 – Land, water and air transport services; rental of land, water or air vehicles; arranging of tours; travel reservation; issuing of tickets for travel; courier services (messages or merchandise); car parking; garage rental; boat storage; transport by pipeline; electricity distribution; water supplying; rescue services for vehicles and goods; storage, wrapping and packaging of goods; transport and storage of trash; transport and storage of waste.

43 – Services for providing food and drink; temporary accommodation; reservation of temporary accommodation; rental of rooms for wedding ceremonies; providing rooms for conferences and various meetings; day-nurseries (crèches); boarding for animals.

(260) AM 2023 120923 A

(800) 1703768

(151) 2022 10 28

(891) 2022 10 28

(731) Guess?, Inc.

1444 South Alameda Street, Los Angeles
CA 90021, USA

(540)

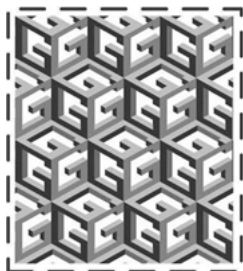

(591) Black, white

(531) 25.07.01; 26.15.09; 27.01.01

(511)

9 – Eyewear, sunglasses, eyeglass frames and cases for eyewear; covers and cases for portable electronic devices, personal electronic devices, cell phones, mobile phones, telephones, computers, laptop computers, tablet computers, notebook computers, mp3 players, portable music players, personal digital assistants, electronic reading devices, digital cameras and cameras.

14 – Watches, chronometric instruments; watch bands, pocket watches, wrist watches, key chains.

18 – Purses, wallets, handbags, luggage, key cases, business card cases, change purses, grooming organizers for travel, backpacks, attaché cases and briefcases; leather and imitation leather goods, namely, athletic bags, attaché cases, backpacks, beach bags, bill-folds, book bags, briefcases, all-purpose carrying bags, coin purses, cosmetic cases sold empty, credit card cases, duffel bags, kit bags, messenger bags, satchels, shopping bags, shoulder bags, small bags for men, sport bags, tie cases, traveling bags, travel kit bags sold empty, toiletry bags sold empty, tote bags, and waist packs.

25 – Men's, women's, boys', girls', children's and infant's apparel, namely, underwear, footwear, swimwear, caps, headwear, robes, pajamas, hosiery, gloves, suspenders, belts, neckties, undershirts, socks, shirts, t-shirts, sweatpants, sweatshirts, knit tops, skirts, pants, trousers, shorts, sweaters, jeans, vests, coats, jackets, overalls, blazers, dresses, scarves, blouses, cardigans, gowns, golf shirts, jogging suits, turtle-necks, suits and polo shirts; women's panties, bras, tank tops, crop tops, bustiers, camisoles, tap pants and teddies; men's briefs and boxer shorts.

(260) AM 2023 120924 A

(800) 1703812

(151) 2022 11 07

(891) 2022 11 07

(731) Obshchestvo s ogranichennoy otvetstvennostyu "Lazernyi Tsentr"

Piskarevsky pr-kt, 25, pom. 132, RU-195176
St. Petersburg, Russian Federation

(540)



(591) Black, white

(531) 26.01.03; 26.01.12; 26.01.24; 27.05.01

(511)

7 – Engraving machines; leather-working machines; glass-working machines; printing machines for use on sheet metal; cutting machines; cutters [machines]; industrial robots.

10 – Dental apparatus and instruments; microdermabrasion apparatus; artificial teeth; surgical implants comprised of artificial materials; lasers for medical purposes.

14 – Agates; diamonds; jewellery charms; brooches [jewellery]; pins [jewellery]; pearls [jewellery]; clasps for jewellery; badges of precious metal; gold, unwrought or beaten; works of art of precious metal; jewellery; ivory jewellery; jewellery of yellow amber; iridium; cabochons; precious stones; semi-precious stones; necklaces [jewellery]; rings [jewellery]; boxes of precious metal; precious metals, unwrought or se-

mi-wrought; gold thread [jewellery]; threads of precious metal [jewellery]; silver thread [jewellery]; osmium; palladium; platinum [metal]; crucifixes as jewellery; rhodium; ruthenium; silver, unwrought or beaten; earrings; ingots of precious metals; alloys of precious metal; statues of precious metal; figurines of precious metal; paste jewellery; chains [jewellery]; spinel [precious stones].

40 – Engraving; metal tempering; providing information relating to material treatment; pattern printing; laser scribing.

42 – Engineering; installation of computer software; research and development of new products for others; scientific research; technological consultancy; quality control; updating of computer software; conducting technical project studies; computer software design; computer programming; technical writing; scientific laboratory services; surveying.

(260) AM 2023 120925 A

(800) 1703854

(151) 2022 11 18

(891) 2022 11 18

(731) Reconomy (UK) Limited

Kelsall House, Stafford Court, Stafford Park 1,
Telford, Shropshire TF3 3BD, United Kingdom

(540)

ECOVEND

(591) Black, white

(511)

7 – Recycling machines; reverse vending machines.

37 – Installation, repair and maintenance of reverse vending machines; installation, repair and maintenance of recycling machines; providing information relating to the installation, repair or maintenance of reverse vending machines; providing information relating to the installation, repair or maintenance of recycling machines.

(260) AM 2023 120926 A

(800) 921912

(151) 2007 03 19

(891) 2022 11 17

(731) "FICOSOTA" OOD

Madara Blvd. 48, BG-9700 Shumen, Bulgaria

(540)

EMEKA

(591) Black, white

(511)

16 – Paper, cardboard and goods made from these materials, which are not included in other classes; printed matter; stationery; babies' napkin-pants (diaper-pants) and babies' napkins of paper and cellulose (disposable); napkins of paper, face towels of paper, bibs of pa-

per, handkerchiefs of paper, napkins of paper for removing make-up, toilet paper, hygienic paper, paper for household purposes.

(260) AM 2023 120927 A

(800) 1357160

(151) 2017 02 06

(891) 2022 03 10

(731) Jaguar Land Rover Limited

Abbey Road, Whitley, Coventry CV3 4LF,
United Kingdom

(540)

DEFENDER

(591) Black, white

(511)

37 – Maintenance, servicing, repair, stripping, restoration, cleaning, washing, valeting, painting, respraying and polishing of motor vehicles, bicycles, scooters, prams or strollers or of parts and accessories therefor; finishing and tuning of motor vehicles; wheel balancing, alignment and repair; vehicle breakdown repair services; garage services for vehicle repair and maintenance; information, advice and consultancy relating to any of the aforesaid services.

(260) AM 2023 120928 A

(800) 1469820

(151) 2019 03 05

(891) 2022 11 30

(731) Nintendo Co., Ltd.

11-1, Hokotate-cho, Kamitoba, Minami-ku,
Kyoto-shi, Kyoto 601-8501, Japan

(540)

SUPER MARIO

(591) Black, white

(511)

9 – Electronic game programs; downloadable electronic game programs; video game programs; downloadable video game programs; video game cartridges; cases for smartphones; covers for smartphones; covers for tablet computers; protective films adapted for smartphones; sleeves for laptops; integrated circuit cards [smart cards]; mouse pads; computer game software, recorded; computer game software, downloadable; computer programs, recorded; compact discs [audio-video]; downloadable image files; downloadable music files; electronic publications, downloadable; batteries, electric; headphones; eyeglasses; sunglasses.

16 – Stencils; bags [envelopes, pouches] of paper or plastics, for packaging; boxes of paper or cardboard; plastic film for wrapping; wrapping paper; coasters of paper; place mats of paper; table napkins of paper; towels of paper; tablecloths of paper; stationery; greeting cards; note books; pencils; stickers [stationery]; pen cases; rubber erasers; writing materials; post-

cards; printed matter; posters; calendars; books; manuals [handbooks]; graphic reproductions; photograph stands; office requisites, except furniture; pencil sharpeners, electric or non-electric.

28 – Games; toys; stuffed toys; dolls; portable games with liquid crystal displays; protective films adapted for screens for portable games; video game machines; controllers for game consoles; apparatus for games; arcade video game machines; board games; playing cards; protective carrying cases specially adapted for handheld video games; joysticks for video games; trading cards for games; puzzles; fairground ride apparatus; play balloons; ornaments for Christmas trees, except illumination articles and confectionery; paper party hats.

41 – Entertainment services; entertainment information; providing online electronic publications, not downloadable; providing online videos, not downloadable; providing online music, not downloadable; game services provided online from a computer network; organization of competitions [education or entertainment]; providing amusement arcade services; amusement park services; organization of electronic game competitions; providing sports facilities.

(260) AM 2023 121025 A

(800) 717450

(151) 1999 07 13

(891) 2022 12 07

(731) Max Mara International S.A.

17, Boulevard Royal, L-2449 R.C.S.

Luxembourg B. 41.757, Luxembourg

(540)

MaxMara

(591) Black, white

(531) 27.05.01

(511)

3 – Perfumery, essential oils, cosmetics, soaps, shampoos, hair lotions; dentifrices; cosmetic preparations for the bath or shower; cosmetic sunscreen products.

9 – Spectacles, spectacle lenses, sunglasses; optical lenses, spectacle cases, spectacle frames, chains and cords for spectacles, lenses for spectacles and sunglasses; parts and accessories for all the aforesaid articles.

14 – Jewelry, real and fake jewelry, precious stones; timepieces and chronometric instruments, clocks in frames.

(260) AM 2023 121036 A

(800) 1609199

(151) 2021 05 31

(891) 2022 12 13

(731) Limited Liability Company "HIMBALT"

Kv. 217, d. 9-2, ul. Antonova-Ovseenko,

RU-190000 Saint Petersburg, Russian

Federation

(540)

ASPRO

(591) Orange

(531) 27.05.01; 29.01.01

(511)

6 – Scaffolding of metal.

7 – Welding machines, electric; electric arc cutting apparatus; soldering apparatus, electric; concrete mixers [machines]; mine borers; vibrators [machines] for industrial use; emergency power generators; alternators; dynamos; current generators; generators of electricity; soldering blow pipes, gas-operated; steamrollers; spray guns for paint; grindstones [parts of machines]; winches; bending machines; dyeing machines; painting machines; whitewashing machines; notchers [machine tools]; rammers [machines]; machines and apparatus for polishing [electric]; mixing machines; mixers [machines]; pneumatic hammers; glue guns, electric; compressed air guns for the extrusion of mastics; air brushes for applying colour; trueing machines; washing apparatus; electrodes for welding machines.

8 – Augers [hand tools]; carpenters' augers; dibbers, hand-operated; tube cutting instruments; hammers [hand tools]; fullers [hand tools]; stone hammers; masons' hammers; riveting hammers [hand tools]; shears; earth rammers [hand tools].

11 – Heat guns.

19 – Building timber.

(260) AM 2023 121062 A

(800) 1705496

(151) 2022 11 04

(891) 2022 11 04

(731) Richter Gedeon Nyrt.

Gyömrői út 19-21, H-1103 Budapest,

Hungary

(540)

UROBEDIN

(591) Black, white

(511)

5 – Pharmaceutical preparations.

(260) AM 2023 121071 A

(800) 1705746

(151) 2022 12 02

(891) 2022 12 02

(731) Becton, Dickinson and Company

1 Becton Drive, Franklin Lakes NJ 07417,

USA

(540)

MINIDRAW

(591) Black, white

(511)

10 – Medical devices and apparatus, namely, specimen collection tubes and parts and fittings therefor.

(260) AM 2023 121073 A

(800) 1705890

(151) 2022 12 09

(891) 2022 12 09

(731) UAB "Narbutas International"

Odminių g. 3-23, LT-01122 Vilnius, Lithuania

(540)

COMBUS

(591) Black, white

(511)

20 – Furniture; furniture fittings, not of metal.

(260) AM 2023 121084 A

(800) 1706148

(151) 2022 09 30

(891) 2022 09 30

(731) Cuchen Co., Ltd

530, Samseong-ro, Gangnam-gu, Seoul,
Republic of Korea

(540)

CUCHEN 

(591) Black, brown

(531) 01.01.02; 01.01.10; 24.17.03; 27.05.01;
29.01.12

(511)

7 – 3D printers; sewing machines for household purposes; electric juicers for household purposes; electric ice crushers for household purposes; electric milk frothers for household purposes; electric food waste compressing apparatus for domestic purposes; high pressure washers; gumball machines; robotic vacuum cleaners; powdered milk making machines; washing apparatus; wet-dry vacuum cleaners; dishwashers; garbage disposal machines; clothes washing machines; electric washing machines; electric kitchen machines; electric vacuum cleaners; electric kitchen mixers; robots for cleaning.

9 – Computer application software for use in implementing the internet of things (IoT); electronic control systems for home automation; server for home automation; virtual reality software; computer software for use in providing multiple user access to a global computer information network; computer software for application and database integration; computer application software for mobile phones; computer e-commerce software; downloadable coupon; downloadable

electronic gift certificates; computer software for data and document capture, transmission, storage and indexing; augmented reality software; network operating system programs; computer software for use in remote meter monitoring; computer application software for electric rice cookers; computer application software for electric ovens; computer application software for electric cookers; computer application software for microwave ovens; display keypads; electronic message displays.

11 – Air purifiers [for household purposes]; electric steamers for household purposes; electric coffee machines for household purposes; electric ovens for household purposes; industrial rice cookers; refrigerators; pressure multicookers; multicookers; air fryers; cooking apparatus and installations; cookers; electric rice cookers; autoclaves, electric, for cooking; electric pressure cookers; electric cookers; electric induction ranges; electric rice steamer; electric toasters; bakers' ovens; non-electric sterilizers for baby bottles (other than for medical use); air sterilizing and disinfecting device; disinfectant apparatus; electric ranges; microwave ovens; electric fans; induction grills; electric grills; grill ovens; microwave ovens for cooking.

17 – Rings of rubber; rubber packings; water-tight rings; waterproof packings; sealant compounds for joints; joint packings; plastics materials for packing; synthetic rubber.

21 – Rice cooking pots for use with gas stoves; containers for household or kitchen use; heatproof earthenware pans; non-electric pans; non-electric rice cooking pots; non-electric pots; non-electric egg poachers; non-electric stew-pans; non-electric cooking utensils; non-electric kettles; non-electric frying pan; thermally insulated containers for food; non-electric pans for cooking; non-electric kettles for cooking; kitchen containers; kitchen utensils; jugs; tea infusers; non-electric deep fryers; mess-tins.

35 – Retail services for containers for household or kitchen use; retail services for electric milk frothers for household purposes; retail services for electric steamers for household purposes; retail services for rubber packings; retail services for industrial rice cookers; retail services for multicookers; retail services for non-electric pans; retail services for non-electric pots; retail services for non-electric cooking utensils; retail services for dishwashers; retail services for cooking apparatus and installations; retail services for non-electric kettles for cooking; retail services for cookers; promoting the goods and services of others by means of operating an on-line comprehensive shopping mall; retail services for electric pressure cookers; retail services for electric cookers; business intermediary services relating to mail order by telecommunications; retail services for feeding bottle washers; retail services for kitchen containers; retail services for milking machines; business management;

retail services for microwave ovens; retail services for dried beans; retail services for polished cereals; retail services for disinfectant apparatus; retail services for electric ranges; sales promotion through the provision of coupons; organisation of events for commercial/promotional and publicity purposes; marketing services; administration of incentive award programs to promote the sale of the goods and services of others; advertising, promotional and public relations services; import-export agency services; administrative processing of purchase orders; business administration services for the processing of goods delivery; sales promotion through the administration of customer loyalty coupons; marketing the goods and services of others by distributing coupons.

37 – Repair of containers for household or kitchen use; repair of electric ovens for household purposes; repair of high pressure washers; repair of industrial rice cookers; repair of refrigerators; repair of multi-cookers; repair of non-electric rice cookers; repair of non-electric stew-pans; repair of non-electric cooking utensils; repair of air fryers; repair of non-electric pans for cooking; repair of milk frothers; repair of electric pressure rice cookers; repair of electric pressure cookers; repair of electric kitchen machines; repair of feeding bottle washers; repair of tea infusers.

(260) AM 2023 121100 A

(800) 1706617

(151) 2022 09 26

(891) 2022 09 26

(731) SUOL INNOVATIONS LTD

41 Themistokli Dervi, Hawaii Tower, 1st floor,
Office 106, CY-1066 Nicosia, Cyprus

(540)

*people
driven*

(591) Black, white

(531) 27.05.01; 29.01.03

(511)

9 – Computer software applications for computers and mobile phones for coordinating transportation services, namely, computer software applications for automated scheduling and dispatch of motorized vehicles; software programs for automated scheduling and dispatch of motorized vehicles; downloadable computer software programs for passengers to negotiate prices and rides with vehicle drivers.

38 – Electronic bulletin board services [telecommunications services]; providing access to databases; providing internet chatrooms; computer aided transmission of messages and images; providing online forums; videoconferencing services; teleconferencing services.

39 – Traffic information; transportation information; transportation logistics, namely arranging the transportation of passengers; passenger transport; providing driving directions for travel purposes; taxi and ride-for-hire services.

42 – Computer system analysis; recovery of computer data; computer virus protection services; industrial design; graphic arts design; technical project studies; engineering; installation of computer software; information technology [IT] consultancy; computer software consultancy; updating of computer software; monitoring of computer systems by remote access; software as a service [SaaS]; maintenance of computer software; data conversion of computer programs and data [not physical conversion]; computer system design; rental of web servers; duplication of computer programs; computer software design; computer programming; surveying.

(260) AM 2023 121103 A

(800) 1706726

(151) 2022 05 31

(891) 2022 05 31

(731) CHAMBRE DE COMMERCE

INTERNATIONALE

33-43 avenue du Président Wilson, F-75116

Paris, France

(540)



(591) Blue and black

(531) 26.11.03; 26.11.07; 26.11.12; 27.05.01;
27.05.17; 29.01.12

(511)

16 – Instructional and teaching material (except apparatus); notebooks; stationery; photographs, instructional and teaching material; printed publications; wall hangings; cards; magazines, newsletters, bulletins, circulars, reports, guides, drawing rulers, printed publications; books; posters; printed matter; photographs.

35 – Corporate audits (commercial analyses); opinion polling; business advice in government management, in particular, providing information in the field of government affairs; advice regarding communication (advertising); systematization of information and data in computer databases; corporate consultation with respect to commercial and business matters; dissemination of advertising material (leaflets, prospectuses, printed matter, samples); market studies; business management for freelance service providers; office functions; commercial administration; services for providing commercial information using corporate databases and corporate services; advice to businesses with

respect to security; advice regarding communication (public relations); accounting; dissemination of advertisements; conducting, organizing and arranging fairs and trade shows for commercial and advertising purposes; corporate management connected with charity services; commercial information and assistance in the fields of sustainability, conservation, recycling, renewable energy, carbon footprint reduction, climate change and the environment; market research; rental of advertising space; rental of advertising time on all communication media; employment agency services; traffic optimization for websites; organization of exhibitions for commercial or advertising purposes; organizing exhibitions for professional or commercial purposes; commercial business management; organizing and conducting incentive reward programs; commercial intermediation services; commercial information services rendered via databases to facilitate the creation of commercial relations online or via the Internet; commercial information services; business management and organization consultancy; commercial advisory services and providing corporate advice; commercial data analysis services; arranging subscriptions to telecommunication services for others; newspaper subscription services (for third parties); administrative services; advertising services to promote public awareness in the field of sustainability, conservation, recycling, renewable energy, carbon footprint reduction, climate change and the environment; photocopying services; public relations; compiling information in computer databases; online advertising on a computer network; retail store services, available via catalogs and global computer networks; publication of advertising texts; economic forecasting; advertising services; computerized file management service; providing advertising documentation; collection of information; collecting information with respect to legal matters in the fields of international business and trade, policy development, codes, guidelines and self-regulatory rules for international business and trade, as well as alternative dispute resolution.

41 – Book lending; production of sports events; producing audiovisual content for television channels broadcast over the Internet; providing online training and examination services; producing cinematographic films, producing audiovisual programs; electronic publication of books and journals online; producing, editing and publishing books, guidebooks and texts on any medium, including in electronic form; training services; booking of seats for shows; education services; photography services; game services provided online from a computer network; publishing and providing news in the nature of current event reporting; translation services; publication of books; providing non-downloadable films via video-on-demand services; organization of exhibitions for cultural or educational purposes; organizing and conducting seminars, exhibitions, conferences, competitions and congresses; providing recreational facilities; sporting and cul-

tural activities; entertainment; professional training; information with respect to entertainment; information relating to training; educational instruction; information with respect to education; rental of show scenery; rental of books; organization of competitions relating to education or entertainment; arranging and conducting of colloquiums; arranging and conducting of conferences; arranging and conducting of congresses; rental of television sets.

45 – Legal and private investigation services with respect to commercial crime (including fraud, piracy, counterfeiting, cybercrime); providing information, advice and assistance connected with all the aforementioned services; legal services in relation to contract negotiation for third parties; online social networking services; extrajudicial dispute resolution services; alternative dispute resolution services, consultancy in legal matters in the field of developing codes, guidelines and self-regulatory rules for international business and trade; litigation services; preparation of legal documents; legal services; arbitration services; accreditation services, namely, establishing and providing standards for businesses, professional associations and chambers of commerce for the purpose of accreditation; providing information with respect to arbitration and mediation; mediation; intellectual property licensing; advice regarding intellectual property; legal administration of licenses; audit services for legal compliance purposes; online fraud prevention.

(260) AM 2023 121111 A

(800) 1482674

(151) 2019 03 07

(891) 2022 12 06

(731) Naturland-Verband für ökologischen Landbau e.V.

Kleinhaderner Weg 1, 82166 Gräfelfing,
Germany

(540)



(591) Green and white

(531) 05.03.11; 05.03.15; 26.04.05; 26.04.15;
27.05.01; 29.01.12

(551) Collective

(511)

29 – Meats; charcuterie; meat substitutes; meatballs; steaks of meat; meat, tinned; meat jellies; prepared meat dishes; fresh meat; smoked meats; corned beef; dried meat; meat, preserved; packaged meats; prepa-

red meat; frozen meat; cooked meats; meat preserves; lamb products; processed lamb; beef; beef steaks; beef stew; beef jerky; prepared beef; beef burgers; beef slices; pulled beef; pork loin; pork steaks; roast pork; pork; pork cutlets; canned pork; pickled pigs' feet; knuckle of ham; pork preserves; pulled pork; minced meat; meats; sausage meat; preserved sausages; smoked sausages; air-dried sausages; uncooked sausages; meat spreads; meat-based mousses; fish, seafood and molluscs; fish fillets; fish paste; fish jellies; fish sticks; fish-based foodstuffs; fish, tinned; fish extracts; frozen fish; pickled fish; processed fish; fish spread; fish meal for human consumption; shrimp paste; shelled prawns; prawns, not live; smoked salmon; salmon, not live; frozen clams; processed clams; poultry, not live; poultry salads; game, not live; preserves of game; dairy products and dairy substitutes; butter; buttermilk; buttercream; butter substitutes; peanut milk; peanut milk-based beverages; prostokvasha [soured milk]; sheep cheese; sheep milk; goat milk; goat cheese; goat milk powder; yoghurt made from goats milk; yoghurt; yogurt drinks; preparations for making yoghurt; milk drinks containing fruits; fruit flavoured yoghurts; butter with herbs; cheese containing herbs; milk beverages with cocoa; cocoa flavored milk beverages; cheese; cheese dips; cheese powder; blended cheese; processed cheese; smoked cheese; coconut milk; coconut milk powder; rice milk; soya milk; soya yoghurt; powdered soya milk; soya-based beverages used as milk substitutes; birds eggs and egg products; eggs; egg substitutes; processed eggs; frozen eggs; powdered eggs; yolk of eggs; egg white; liquid eggs; processed fruits, fungi and vegetables (including nuts and pulses); refried beans; tofu; beans; baked beans; dried beans; cooked beans; processed bean sprouts; beans, preserved; canned beans; bean dip; beans cooked in soy sauce (kongjaban); dried pineapples; apple chips; apple flakes; stewed apples; processed apricots; walnut kernels; processed nuts; processed eggplant; banana chips; dried bananas; processed bananas; dried pears; edible dried flowers; processed edible flowers; vegetable salads; vegetable puree; vegetable soup preparations; frozen vegetables; frozen vegetables; pickled vegetables; vegetables, dried; vegetables, cooked; peeled vegetables; vegetable chips; cut vegetables; grilled vegetables; pickled vegetables; fruit salads; fruits, tinned; prepared fruits; pickled fruits; frozen fruits; dried fruit; glazed fruits; cooked fruits; tinned fruits; mixtures of fruit and nuts; fruit preserves; bottled fruits; broccoli, processed; berries, preserved; mushrooms, preserved; mushrooms, prepared; dried edible mushrooms; processed chia seed for food; chilli beans; preserved chilli peppers; chile rellenos; dried edible algae; seaweed extracts for food; algae prepared for human foods; dates; dried dates; processed dates; peas, preserved; peas, processed; strawberries being preserved; dried strawberries; peanut paste; canned peanuts; coated peanuts; peanuts, prepared; roasted peanuts; gherkins; dried figs; vegetable-based

meat substitutes; prepared meals consisting primarily of meat substitutes; canned pork and beans; tzatziki; fruit pulp; fruit chips; fruit salads; fruit-based snack food; fruit pectin; fruit jellies; fruits in preserved form; fruit purees; fruit desserts; fruit, preserved; pickled fruits; crystallized fruits; dried fruit products; cut fruits; fermented fruits; canned sliced fruits; fruit preserved in alcohol; fruit-based meal replacement bars; dried turnip; processed beets; flavoured nuts; pickled peppers; potato-based dumplings; potato crisps; potato fritters; potato salad; mashed potato; potato snacks; filled potato skins; peeled potatoes; processed potatoes; boiled potatoes; hash brown potatoes; coconut chips; coconut flakes; coconut, desiccated; prepared coconut; coconut-based snacks; mushrooms, preserved; prepared salads; soy chips; soya patties; soya [prepared]; soya beans, preserved, for food; sunflower seeds, prepared; processed asparagus; processed spirulina; french fries; frozen french fries; vegetarian charcuterie; onion rings; pickled onions; processed onions; preserved onions; processed apples; jellies; jellies for food; jams; compotes; fruit and vegetable spreads; apple puree; aubergine paste; vegetable pastes; vegetable jellies; vegetable spreads; vegetable-based spreads; pressed fruit paste; nut-based spreads; butter made of nuts; spreads consisting mainly of eggs; peanut butter; fruit paste; fruit spread; fruit marmalade; soups and broths; meat extracts; vegetable stock; seafood stocks; broth; broth concentrates; roast beef; vegetable extracts for culinary purposes; yoghurt desserts; oils and fats; fat-containing mixtures for bread slices; butter oil; clarified butter; butter preparations; concentrated butter; butter for use in cooking; chia seed oil for food; groundnut oil; edible oils derived from fish [other than cod liver oil]; beef tallow [for food]; lard; spiced oils; honey butter; cocoa butter for food; coconut oil for food; coconut fat; coconut butter; palm oil for food; linseed oil for food; maize oil for food; corn fats; olive oil; rape oil for food; rice bran oil for food; soya bean oil for food; sunflower oil for food; sausage skins and imitations thereof; vegetable pastes; flax seeds for human consumption.

30 – Rice-based prepared meals; prepared meals in the form of pizzas; prepared meals consisting primarily of pasta; cereal-based snack food; snack foods consisting principally of extruded cereals; prepared foodstuffs in the form of sauces; egg pies; meat pies; poultry and game meat pies; sandwiches containing minced beef; pork pies; prawn crackers; cereal-based snack food; chips [cereal products]; crisps made of cereals; cereal-based meal replacement bars; snack food products made from potato flour; cheese curls [snacks]; pesto [sauce]; snack food products made from maize flour; pasta containing stuffings; canned pasta foods; rice-based snack food; rice based dishes; chocolate-based ready-to-eat food bars; snack food products made from soya flour; mincemeat pies; onion biscuits; edible salt; seasonings; spices; flavourings for beverages, other than essential oils; basil,

dried; vegetable thickeners; vegetable concentrates used for seasoning; flavourings made from vegetables [other than essential oils]; fruit vinegar; flavourings for butter; chili powders; chili oil for use as a seasoning or condiment; dried chili peppers seasoning; seaweed [condiment]; sauces; flavourings in the form of concentrated sauces; curry [spice]; curry powder [spice]; curry mixes; helichrysum [spices]; sauces for ice cream; vinegar; flavoured vinegar; flavourings made from pickles; dried fig-based condiment; fish sauce; flavourings made from fish; seasoned coating for meat, fish, poultry; flavourings made from poultry; fruit coulis [sauces]; fruit flavourings, except essences; flavourings made from fruits; sweeteners consisting of fruit concentrates; condiments; spice extracts; spice preparations; dry seasonings; spice rubs; garden herbs (preserved); cinnamon [spice]; peppers [seasonings]; saffron [seasoning]; ginger [spice]; vanilla flavourings for culinary purposes; clove powder [spice]; curry [spice]; sage [seasoning]; marinades containing herbs; processed herbs; dried herbs; pepper; coffee oils; coffee flavourings; extracts of cocoa for use as flavours in foodstuffs; flavourings for cheeses; salad dressings containing cream; chocolate syrup; chocolate flavourings; chocolate based products; chocolate spreads for use on bread; mustard preparations for food; tea essences; flavourings of tea; sausage binding materials; savory sauces, chutneys and pastes; bean paste; miso bean paste; apple sauce [condiment]; vegetable pastes [sauces]; vegetable concentrates [seasonings]; chili sauce; chili seasoning; chili pepper paste being condiment; mixes for preparing sauces; pesto; tomato ketchup; food dressings; concentrated sauce; pasta sauce; cooking sauces; sauces for rice; mixes for preparing sauces; curry sauces; curry pastes; sauces for frozen fish; shrimp sauce; spicy sauces; herb sauces; pepper sauces; cheese sauce; mushroom sauces; dressings for salad; mustard; soya sauce; pastry and confectionery; chocolate; puddings; prepared desserts [confectionery]; prepared desserts [chocolate based]; rice-based pudding dessert; frozen confectionery containing ice cream; viennoiserie; chocolate coated fruits; fruited scones; fruit jellies [confectionery]; confectionery having liquid fruit fillings; foods with a cocoa base; cocoa-based ingredients for confectionery products; cocoa based creams in the form of spreads; potato flour confectionery; bread; thin breadsticks; bread and buns; pre-baked bread; unfermented bread; fresh bread; toasted bread; low-salt bread; gluten-free bread; toasts [biscuits]; fruit breads; bread casings filled with fruit; tea cakes; onion or cheese biscuits; pastries, cakes, tarts and biscuits (cookies); apple tarts; vegetable pies; frozen pastry stuffed with vegetables; pastries containing fruit; tarts; fruit cakes; pastries containing fruit; fruit filled pastry products; pastries containing creams and fruit; petit-beurre biscuits; shortbread with chocolate coating; cones for ice cream; pie shells; cake bars; frozen cakes; chocolate cakes; fruit cakes; fruit cake snacks; biscuits contain-

ing fruit; biscuits flavoured with fruit; biscuits for human consumption made from cereals; sweets (candy), candy bars and chewing gum; sugared beans (ama-natto); candy decorations for cakes; fruit drops [confectionery]; fruit gums [other than for medical use]; cereal bars and energy bars; snack bars containing a mixture of grains, nuts and dried fruit [confectionery]; cereal bars; sugars, natural sweeteners, sweet coatings and fillings, bee products; sugar for making conserves of fruit; sweet spreads [honey]; cake frosting [icing]; fruit sugar; natural sweeteners in the form of fruit concentrates; herbal honey; honey; honey substitutes; biological honey for human consumption; invert sugar; palm sugar; ice, ice creams, frozen yogurts and sorbets; ice confectionery; ice cream stick bars; ice cream mixes; ice cubes; frozen yoghurt [confectionery ices]; fruit ices; edible fruit ices; ice beverages with a coffee base; ice beverages with a cocoa base; ice beverages with a chocolate base; coffee, teas and cocoa and substitutes therefor; coffee in whole-bean form; apple flavoured tea [other than for medicinal use]; asian apricot tea (maesilcha); iced tea; iced coffee; coffee-based beverages containing ice cream (afogato); fruit teas; fruit flavoured tea [other than medicinal]; infusions, not medicinal; peppermint tea; coffee in whole-bean form; coffee-based beverages; cocoa-based beverages; cocoa powder; cocoa-based drinks; chocolate powder; chocolate-based beverages; tea pods; tea bags; tea leaves; tea extracts; tea-based beverages; tea mixtures; tea substitutes; black tea; green tea; ginger tea; tapioca; sago; processed grains, starches, and goods made thereof, baking preparations and yeasts; buckwheat, processed; preparations made from cereals; processed cereals for food for human consumption; linseed for culinary purposes [seasoning]; potato flour; potato flour [for food]; coconut meal for human consumption; dried and fresh pastas, noodles and dumplings; bean-starch noodles (harusame, uncooked); buckwheat noodles; egg noodles; pasta containing eggs; shrimp noodles; rice vermicelli; cereals; rice; flour; bean meal; vegetable flour; buckwheat flour; breakfast cereals containing fruit; processed cereals; foodstuffs made from cereals; cereal flour; cereal powders; toasted grain flour; processed corn; modified corn starch; foodstuffs made from maize; foodstuffs made of rice; mustard meal; soya flour; breakfast cereals, porridge and grits; red bean porridge (patjuk); breakfast cereals containing fruit and fibre; ready-to-eat cereals; food mixtures consisting of cereal flakes and dried fruits; doughs, batters, and mixes therefor; bread doughs; mixes for the preparation of bread; bun mix; cake batter; cake mixes; filled yeast dough with fillings consisting of fruits; yeast and leavening agents; cereal preparations; syrups and treacles; agave syrup [natural sweetener]; corn syrup; chocolate topping; maple syrup; fruit syrup; berry treacle; peppermint treacle; caramel treacle; cinnamon treacle; almond treacle; lime treacle; unprocessed coffee in whole-bean form; chili oil for

use as a seasoning; snack foods prepared from maize; dessert soufflés.

31 – Agricultural and aquacultural crops, horticulture and forestry products; raw and unprocessed agricultural and aquacultural crops, horticulture and forestry products; raw and unprocessed grains and seeds; algae for human or animal consumption; fresh seaweed; unprocessed spirulina; fungi; mushrooms, fresh; unprocessed mushrooms; fresh champignons; plants; pineapples [fresh]; fresh pineapple guavas (feijoa); living fruit plants; hops; flax [linseed] plants; sugarcane; fresh fruits, nuts, vegetables and herbs; unprocessed beans; fresh bean sprouts; beans, fresh; raw red beans; fresh apples; unprocessed apples; fresh apple mangos; fresh apricots; unprocessed apricots; fresh walnuts; fresh aronia; eggplants; fresh bananas; fresh basil; pears, fresh; fresh edible flowers; vegetables, fresh; unprocessed vegetables; fruit, fresh; fresh broccoli; berries, fresh; berries, unprocessed; fresh chilies; chillies, unprocessed; fresh dates; unprocessed dates; peas, fresh; strawberries [fresh]; peanuts, unprocessed; fresh figs; garden herbs, fresh; almonds [fruits]; unprocessed fruits; unprocessed beets; beet, fresh; unprocessed herbs; garden herbs, fresh; cocoa beans, raw; unprocessed potatoes; potatoes, fresh; unprocessed coconuts; fresh coconuts; salad crops; fresh soya beans; fresh asparagus; unprocessed asparagus; unprocessed tea leaves; unprocessed onions; onions, fresh; flowers; preserved flowers; floral decorations [fresh]; seeds, bulbs and plant seedlings; crop seeds; seeds for planting; apple tree seeds; seeds for flowers; flower corms; flower bulbs; vegetable seeds; seeds for fruit; chia seeds; seeds for fruit; crop seeds; seeds for growing herbs; sunflower seeds; agricultural seeds; bulbs (plant) for agricultural use; unprocessed seeds for agricultural use; seeds for horticultural purposes; bulbs for horticultural purposes; trees and forestry products; apple trees; fruit trees; fruit shrubs; fruit shrubs; undressed timber; palm trees; plant residues (raw materials); bark-based products for use in mulching; fruit residue [marc]; coconut shell; coconut fibre mulches; pressed sugar beet pulp; mulches of natural materials for use in suppressing weeds in horticultural environments; malts and unprocessed cereals; buckwheat, unprocessed; grains [cereals]; unprocessed cereals; hop pellets; flax [linseed] plant seeds; unprocessed corn; fresh corn; rice, unprocessed; paddy; foodstuffs and fodder for animals; animal foodstuffs derived from vegetable matter; peanut meal for animals; foodstuffs for fish; fish meal for animal consumption; mash for fattening livestock; foodstuffs for poultry; preparations for egg laying poultry; food for wild birds; wildlife seed mixtures; mineral salts for cattle; foods containing beef for feeding cats; foods containing beef for feeding dogs; foodstuffs for sheep; foodstuffs for pigs; cereal based foodstuffs for animals; by-products of the processing of cereals, for animal consumption; hay; animal foodstuffs derived from hay; foodstuffs for chickens; foodstuffs for dairy

animals; maize for consumption by animals; foodstuffs for horses; rice meal for forage; animal foodstuffs consisting of soya bean products; bedding and litter for animals; bedding material for fowl; bark for use as animal litter; straw litter; live animals, organisms for breeding; eggs for hatching, fertilized; fish spawn; fish, live; poultry, live; live game; live cattle; sheep; pigs; live goats; crayfish, live; salmon, live; live clams; live lamas; live horses; poultry for breeding; boars for breeding purposes.

33 – Preparations for making alcoholic beverages; fruit extracts, alcoholic; alcoholic beverages (except beer); cider; dry cider; perry; sparkling fruit wine; hydromel [mead]; rice alcohol; alcoholic tea-based beverage; wine; fruit wine; sparkling wines; pre-mixed alcoholic beverages; alcoholic beverages containing fruit; spirits and liquors; brandy; digesters [liqueurs and spirits]; fermented spirit; spirits [beverages]; advocaat; herb liqueurs; peppermint liqueurs; fruit liqueurs; sake.

(260) AM 2023 121115 A

(800) 1686040

(151) 2022 08 02

(891) 2022 12 17

(731) GIUSEPPE EROS LANA

Via Corridoni Filippo n. 28, I-20091 Bresso,
Italy

(540)



(591) Blue, white

(531) 16.01.25; 26.11.02; 26.11.12; 29.01.04

(511)

9 – Software; downloadable software applications; downloadable computer software; mobile apps; financial management software; software for financial information and analysis; software allowing one user to interact with other users regarding investments; software allowing users to manage investments via the internet; day trading software; computer games programmes for simulating financial securities trading [software]; computer programs for use in trading stocks and bonds; downloadable software.

36 – Financial consultation services; financial consulting services; financial consultancy services; fund investment services; financial analysis; financial management; financial information; financial information management and analysis services; providing information and analysis via the internet in the field of financial investments; providing financial information

via a website; brokerage services for capital investments; financial consultancy; financial research; financial transactions; financial advice; financial analysis and research services; financial investment analysis and stock research; derivatives trading services; trading in stocks; trading in futures; on-line real-time currency trading; providing information on trading in securities; trading of securities options for others; providing information relating to the trading of commodity futures; providing information relating to the trading of securities index futures; providing information relating to the trading of overseas market securities futures.

42 – Software as a service; Software as a service [SaaS]; consulting services in the field of software as a service [SaaS]; SaaS for financial management; SaaS for financial consultancy; SaaS for financial research and analysis; SaaS for brokerage services; Application service provider (ASP).

(260) AM 2023 121157 A

(800) 1706828

(151) 2022 08 19

(891) 2022 08 19

(731) KĘSTUTIS RAMANAUSKAS

Pamėnkalnio g. 18-17, LT-01114 Vilnius,
Lithuania;

VYTAUTAS KANAPECKAS

Širvintų g. 37-1, LT-08215 Vilnius, Lithuania

(540)

LUCKY GEPARDO

(591) Black, white

(511)

32 – Aerated water; shandy; beer-based cocktails; beer wort; beer; extracts of hops for making beer; vegetable juices (beverages); energy drinks; aloe vera drinks, non-alcoholic; aperitifs, non-alcoholic; non-alcoholic beverages flavoured with tea; non-alcoholic dried fruit beverages; non-alcoholic beverages; non-alcoholic beverages flavoured with coffee; cocktails, non-alcoholic; non-alcoholic honey-based beverages; non-alcoholic fruit extracts; fruit nectars, non-alcoholic; non-alcoholic fruit juice beverages; carbonated water; table waters; kvass; ginger beer; isotonic beverages; whey beverages; lemonades; lithia water; barley wine (beer); must; soft drinks; tomato juice (beverage); rice-based beverages, other than milk substitutes; malt beer; malt wort; sarsaparilla (non-alcoholic beverage); seltzer water; cider, non-alcoholic; syrups for beverages; syrups for lemonade; soda water; soyabased beverages, other than milk substitutes; protein-enriched sports beverages; smoothies; fruit juices; waters (beverages); grape must, unfermented; sherbets (beverages).

(260) AM 2023 121158 A

(800) 1706831

(151) 2022 09 16

(891) 2022 09 16

(731) Limited Liability Company "Gexa – nonwoven materials"

Tsentralnaya street, dom 3, litera A, A1, A2, a,
pomeshchenie 304, d. Golievo, g. Krasnogorsk,
RU-143405 Moskovskaya oblast, Russian
Federation

(540)



(591) Blue

(531) 26.05.01; 27.05.21; 28.05; 29.01.04

(511)

5 – Bandages for dressings; bracelets impregnated with insect repellent; paper for mustard plasters; fly catching paper; reagent paper for veterinary purposes; reagent paper for medical purposes; mothproofing paper; antiseptic cotton; aseptic cotton; absorbent cotton; wadding for medical purposes; cotton for medical purposes; contraceptive sponges; corn rings for the feet; adhesive plasters; gauze for dressings; dressings, medical; surgical dressings; moleskin for medical purposes; fly glue; antiparasitic collars for animals; cotton sticks for medical purposes; nicotine patches for use as aids to stop smoking; eyepatches for medical purposes; poultices; compresses; scapulars for surgical purposes; babies' diapers; diapers for pets; swim diapers, reusable, for babies; swim diapers, disposable, for babies; diapers for incontinence; disposable absorbent mats for lining pet crates; diaper changing mats, disposable, for babies; disposable housebreaking pads for pets; bunion pads; breast-nursing pads; diagnostic strips for testing breast milk for medical purposes; collyrium; lead water; sanitary towels; panty liners [sanitary]; tissues impregnated with pharmaceutical lotions; cotton swabs for medical purposes; sanitary tampons; vulnery sponges; pants, absorbent, for incontinence; sanitary panties; babies' diaper-pants.

10 – Physical exercise apparatus for medical purposes; body rehabilitation apparatus for medical purposes; dental apparatus and instruments; surgical apparatus and instruments; physiotherapy apparatus; nasal aspirators; trusses; maternity belts; support bandages; bandages, elastic; cupping glasses; ear plugs [hearing protection devices]; acupressure bands; bracelets for medical purposes; anti-nausea wristbands; anti-rheumatism bracelets; air cushions for medical purposes; vibromassage apparatus; surgical sponges; pill cutters; containers especially made for medical waste; clips,

surgical; mirrors for dentists; mirrors for surgeons; probes for medical purposes; urethral probes; orthopedic articles; pill crushers; biodegradable bone fixation implants; contraceptive implants; surgical implants comprised of artificial materials; inhalers; hydrogen inhalers; injectors for medical purposes; incubators for medical purposes; incubators for babies; obstetric apparatus; surgical cutlery; chambers for inhalers; cannulae; droppers for medical purposes; dropper bottles for medical purposes; catheters; draw-sheets for sick beds; enema apparatus for medical purposes; clips for dummies; menstrual cups; biomagnetic rings for therapeutic or medical purposes; teething rings; anti-rheumatism rings; abdominal corsets; corsets for medical purposes; crutches; haptic suits for medical purposes; waterbeds for medical purposes; air beds for medical purposes; beds specially made for medical purposes; lancets; kinesiology tapes; spoons for administering medicine; spoons for patients with tremor; sanitary masks; reusable sanitary masks made of gauze; masks for use by medical personnel; respiratory masks for artificial respiration; protective masks for medical purposes; anaesthetic masks; disposable steam-heated masks for therapeutic purposes; LED masks for therapeutic purposes; therapeutic facial masks; gum massagers for babies; suture materials; childbirth mattresses; air mattresses for medical purposes; furniture especially made for medical purposes; water bags for medical purposes; douche bags; breast pumps; urinals being vessels; portable hand-held urinals; teeth protectors for dental purposes; temperature indicator labels for medical purposes; knee bandages, orthopaedic; tips for crutches; fingerstalls for medical purposes; medical guidewires; thread, surgical; knives for surgical purposes; scissors for surgery; ambulance stretchers; stretchers, wheeled; boots for medical purposes; orthopaedic footwear; clothing especially for operating rooms; compression garments; blankets, electric, for medical purposes; supports for flat feet; cooling pads for first aid purposes; portable earpicks with endoscopy function; disposable steam-heated patches for therapeutic purposes; slings [support bandages]; gloves for massage; gloves for medical purposes; pessaries; ear picks; electric massage guns; cooling patches for medical purposes; spittoons for medical purposes; plaster bandages for orthopaedic purposes; orthopaedic bandages for joints; abdominal pads; cushions for medical purposes; pads for preventing pressure sores on patient bodies; air pillows for medical purposes; soporific pillows for insomnia; heating cushions, electric, for medical purposes; abdominal belts; galvanic belts for medical purposes; hypogastric belts; belts for medical purposes; orthopaedic belts; umbilical belts; belts, electric, for medical purposes; condoms; aerosol dispensers for medical purposes; esthetic massage apparatus; massage apparatus; veterinary apparatus and instruments; medical apparatus and instruments; urological apparatus and instruments; incontinence sheets; sterile sheets, surgical;

surgical drapes; ice bags for medical purposes; toe separators for orthopaedic purposes; surgical bougies; orthodontic rubber bands; ear trumpets; strait jackets; scalpels; tongue scrapers; dummies for babies; vaginal syringes; hearing protectors; contraceptives, non-chemical; orthopaedic soles; medical examination tables; commode chairs; basins for medical purposes; bed pans; instrument cases for use by doctors; arch supports for footwear; suspensory bandages; thermal packs for first aid purposes; walking sticks for medical purposes; quad canes for medical purposes; drainage tubes for medical purposes; capillary tubes for medical use; X-ray tubes for medical purposes; radium tubes for medical purposes; intrauterine devices; balling guns; patient examination gowns; wheeled walkers to aid mobility; walking frames for disabled persons; cases fitted for medical instruments; elastic stockings for surgical purposes; stockings for varices; splints, surgical; tongue depressors for medical purposes; syringes for injections; syringes for medical purposes; hypodermic syringes; uterine syringes; urethral syringes; forceps.

17 – Shock-absorbing buffers of rubber; fittings, not of metal, for compressed air lines; asbestos; cellulose acetate, semi-processed; balata; floating anti-pollution barriers; asbestos paper; paper for electrical capacitors; insulating paper; cotton wool for packing [caulking]; mineral wool [insulator]; asbestos felt; insulating felt; asbestos fibres; plastic fibres, other than for textile use; carbon fibres, other than for textile use; vulcanized fibre; gutta-percha; foam supports for flower arrangements [semi-finished products]; dielectrics [insulators]; lute; insulators; insulators for railway tracks; insulators for electric mains; insulators for cables; asbestos millboards; liquid rubber; synthetic rubber; rubber, raw or semi-worked; valves of india-rubber or vulcanized fibre; clack valves of rubber; rings of rubber; water-tight rings; insulating paints; insulating varnish; latex [rubber]; duct tapes; insulating bands; adhesive tapes, other than stationery and not for medical or household purposes; self-adhesive tapes, other than stationery and not for medical or household purposes; asbestos sheets; viscose sheets, other than for wrapping; foil of regenerated cellulose, other than for wrapping; insulating oils; insulating oil for transformers; reinforcing materials, not of metal, for pipes; weatherstripping compositions; caulking materials; brake lining materials, partly processed; soundproofing materials; insulating materials; insulating refractory materials; padding materials of rubber or plastics; rubber material for recapping tyres; non-conducting materials for retaining heat; boiler composition to prevent the radiation of heat; packing [cushioning, stuffing] materials of rubber or plastics; sealant compounds for joints; filtering materials of semi-processed foams of plastic; filtering materials of semi-processed films of plastic; compositions to prevent the radiation of heat; bags [envelopes, pouches] of rubber, for packaging; pipe muffs, not of metal; rubber slee-

ves for protecting parts of machines; asbestos packing; clutch linings; threads of plastic for soldering; plastic filaments for 3D printing; threads of plastic materials, other than for textile use; threads of rubber, other than for textile use; elastic yarns, other than for textile use; door stops of rubber; window stops of rubber; stops of rubber; dock bumpers of rubber; insulating gloves; plastic substances, semi-processed; plastic sheeting for agricultural purposes; plastic film, other than for wrapping; anti-glare films for windows [tinted films]; asbestos coverings; bark coverings for sound insulation; asbestos cloth; rubber stoppers; expansion joint fillers; cylinder jointings; washers of rubber or vulcanized fibre; pipe gaskets; draught excluder strips; gaskets; rubber solutions; gum, raw or semi-worked; mica, raw or partly processed; acrylic resins, semi-processed; synthetic resins, semi-processed; junctions, not of metal, for pipes; substances for insulating buildings against moisture; chemical compositions for repairing leaks; acrylic glass, semi-processed; organic glass, semi-processed; glass wool for insulation; fibreglass for insulation; asbestos fabrics; fibreglass fabrics for insulation; insulating fabrics; flexible hoses, not of metal; hoses of textile material; connecting hose for vehicle radiators; waterproof packings; rubber seals for jars; fittings, not of metal, for flexible pipes; fittings, not of metal, for rigid pipes; foils of metal for insulating; ebonite moulds; insulating inks; asbestos slate; slag wool [insulator]; watering hose; canvas hose pipes; cords of rubber; asbestos safety curtains; insulating plaster; ebonite.

19 – Aquaria [structures]; alabaster; door frames, not of metal; asbestos cement; asphalt; beams, not of metal; balustrades, not of metal; huts; swimming pools [structures], not of metal; silos, not of metal; harbours [structures], not of metal; concrete; bitumen; plastic landscape edgings; joists, not of metal; telephone booths, not of metal; beacons, not of metal, non-luminous; building paper; busts of stone, concrete or marble; bird baths [structures], not of metal; binding agents for making briquettes; binding material for road repair; stained-glass windows; felt for building; aviaries [structures], not of metal; gates, not of metal; diving boards, not of metal; geotextiles; gypsum [building material]; plaster; potters' clay; earth for bricks; clay; roofing shingles; gravel; aquarium gravel; granite; tar; armoured doors, not of metal; doors, not of metal; swing doors, not of metal; accordion doors, not of metal; folding doors, not of metal; coal tar; chimney pots, not of metal; prefabricated houses [kits], not of metal; parquet floor boards; floating floor boards, not of metal; memorial plaques, not of metal; wood for making household utensils; veneer wood; mouldable wood; chimney shafts, not of metal; jalousies, not of metal; roof gutters, not of metal; street gutters, not of metal; agglomerated bagasses of cane [building material]; road signs, non-luminous and non-mechanical, not of metal; non-luminous and non-mechanical signs, not of metal; limestone; lime; fen-

ces, not of metal; works of stonemasonry; works of art of stone, concrete or marble; cabanas, not of metal; soundproof booths, transportable, not of metal; stone; rubble; artificial stone; building stone; paint spraying booths, not of metal; gravestones; reeds for building; horticultural frames, not of metal; framework, not of metal, for building; greenhouse frames, not of metal; cornices, not of metal; bitumen paper for building; wood pulp board for building; paperboard for building; skating rinks [structures], not of metal; quartz; caissons for construction work under water; bricks; firebricks; water-pipe valves, not of metal or plastic; drain traps [valves], not of metal or plastic; cask wood; mooring bollards, not of metal; cement posts; pillars, not of metal, for building; chimney cowls, not of metal; brackets, not of metal, for building; buildings, not of metal; buildings, transportable, not of metal; stringers [parts of staircases], not of metal; silica [quartz]; roofing, not of metal; roofing, not of metal, incorporating photovoltaic cells; manhole covers, not of metal; xylolith; chicken-houses, not of metal; manufactured timber; sawn timber; building timber; wood, semi-worked; staircases, not of metal; road marking sheets and strips of synthetic material; reinforcing materials, not of metal, for building; bituminous products for building; road coating materials; materials for making and coating roads; fireclay; pitch; building materials, not of metal; refractory construction materials, not of metal; masts [poles], not of metal; raw chalk; calcareous marl; mosaics for building; mouldings, not of metal, for building; marble; slate powder; porches [structures], not of metal; tombs, not of metal; flashing, not of metal, for building; roof flashing, not of metal; perches; duckboards, not of metal; wall claddings, not of metal, for building; mouldings, not of metal, for cornices; coatings [building materials]; tomb or grave enclosures, not of metal; grave or tomb enclosures, not of metal; laths, not of metal; wood panelling; wall linings, not of metal, for building; palings, not of metal; crash barriers, not of metal, for roads; latticework, not of metal; windows, not of metal; olivine for building; shuttering, not of metal, for concrete; posts, not of metal, for power lines; props, not of metal; rubber bearings for seismic isolation of buildings; branching pipes, not of metal; fair huts; tombs [monuments], not of metal; monuments, not of metal; acoustic panels, not of metal; wainscoting, not of metal; signalling panels, non-luminous and non-mechanical, not of metal; building panels, not of metal; parquet flooring; partitions, not of metal; lintels, not of metal; casement windows, not of metal; aquarium sand; play sand; silver sand; sand, except foundry sand; sandstone for building; tarred strips for building; planks of wood for building; rocket launching platforms, not of metal; platforms, prefabricated, not of metal; wall tiles, not of metal; floor tiles, not of metal; tiles, not of metal, for building; paving slabs, not of metal; cement slabs; grave slabs, not of metal; tile floorings, not of metal; slabs, not of metal, for

building; scaffolding, not of metal; armour-plating, not of metal; asphalt paving; wood paving; paving blocks, not of metal; luminous paving blocks; macadam; fireproof cement coatings; bituminous coatings for roofing; roof coverings, not of metal; wooden floor boards; cladding, not of metal, for building; linings, not of metal, for building; fireplace mantles, not of metal; door panels, not of metal; floors, not of metal; sills, not of metal; porphyry [stone]; ceilings, not of metal; floating docks, not of metal, for mooring boats; agglomerated cork for building; window frames, not of metal; mortar for building; asbestos mortar; tanks of masonry; scantlings [carpentry]; furrings of wood; vinyl siding; pilings, not of metal; pigsties, not of metal; insect screens, not of metal; burial vaults, not of metal; schists; outdoor blinds, not of metal and not of textile; shutters, not of metal; statues of stone, concrete or marble; statuettes of stone, concrete or marble; alabaster glass; safety glass; glass granules for road marking; window glass for building; window glass, other than vehicle window glass; building glass; plate glass [windows] for building; insulating glass for building; enamelled glass, for building; tombstone stelae, not of metal; stables, not of metal; advertisement columns, not of metal; posts, not of metal; telegraph posts, not of metal; hips for roofing; stair-treads [steps], not of metal; tombstone plaques, not of metal; greenhouses, transportable, not of metal; terra-cotta [building material]; penstock pipes, not of metal; water-pipes, not of metal; gutter pipes, not of metal; ducts, not of metal, for ventilating and air-conditioning installations; drain pipes, not of metal; chimneys, not of metal; rigid pipes, not of metal, for building; sandstone pipes; turnstiles, not of metal; tufa; angle irons, not of metal; lengthening pieces, not of metal, for chimneys; bicycle parking installations, not of metal; plywood; figurines of stone, concrete or marble; flagpoles [structures], not of metal; foundry moulds, not of metal; rock crystal; cement for blast furnaces; cement for furnaces; magnesia cement; cement; pantiles, not of metal; roofing tiles, not of metal; slate; roofing slates; slag [building material]; slag stone; railway sleepers, not of metal; wood veneers; clinker ballast; concrete building elements; letter boxes of masonry.

20 – Picture frame brackets; recycling bins, not of metal; reels, not of metal, non-mechanical, for flexible hoses; sew-on tags of plastic or rubber for clothing; identification bracelets, not of metal; bolsters; screws, not of metal; removable covers for sinks; collars, not of metal, for fastening pipes; signboards of wood or plastics; nuts, not of metal; curtain holders, not of textile material; dowels, not of metal; kennels for household pets; birdhouses; keyboards for hanging keys; plugs [dowels], not of metal; display boards; packaging containers of plastic; clips, not of metal, for cables and pipes; binding screws, not of metal, for cables; clips of plastic for sealing bags; rivets, not of metal; locks, not of metal, for vehicles; padlocks, other than

electronic, not of metal; locks, other than electric, not of metal; door bolts, not of metal; closures, not of metal, for containers; latches, not of metal; number-plates, not of metal; wickerwork; hampers [baskets] for the transport of items; works of art of wood, wax, plaster or plastic; cabinet work; drain traps [valves] of plastic; water-pipe valves of plastic; valves, not of metal, other than parts of machines; plastic keys; mats for infant playpens; reusable baby changing mats; sleeping pads; mats, removable, for sinks; tent pegs, not of metal; waste dumpsters, not of metal, other than for medical use; containers, not of metal [storage, transport]; floating containers, not of metal; tool boxes, not of metal, empty; taps, not of metal, for casks; brackets, not of metal, for furniture; sash fasteners, not of metal, for windows; beds for household pets; nesting boxes for household pets; ladders of wood or plastics; furniture; runners, not of metal, for sliding doors; house numbers, not of metal, non-luminous; door stops, not of metal or rubber; window stops, not of metal or rubber; stakes, not of metal, for plants or trees; pet cushions; cushions for lining pet crates; bedding, except linen; sealing caps, not of metal; drawer organizers; reservoirs, not of metal nor of masonry; fodder racks; curtain rollers; door handles, not of metal; knobs, not of metal; vats, not of metal; honeycombs; plugs, not of metal; steps [ladders], not of metal; step stools, not of metal; placards of wood or plastics; nameplates, not of metal; door fasteners, not of metal; window fasteners, not of metal; window closers, not of metal, non-electric; door openers, not of metal, non-electric; window openers, not of metal, non-electric; winding spools, not of metal, non-mechanical, for flexible hoses; furniture fittings, not of metal; window fittings, not of metal; garment covers [storage]; hinges, not of metal; poles, not of metal; sneeze guards; labels of plastic; boxes of wood or plastic.

21 – Bird baths; pails; flower pots; sponges for household purposes; holders for flowers and plants [flower arranging]; containers for household or kitchen use; heat-insulated containers; ceramics for household purposes; cleaning instruments, hand-operated; flower-pot covers, not of paper; cages for household pets; birdcages; cages for collecting insects; disposable aluminium foil containers for household purposes; feeding troughs; watering cans; insect traps; material for brush-making; tablemats, not of paper or textile; brooms; isothermic bags; nozzles for watering cans; pouring spouts; nozzles for watering hose; fibreglass thread, other than for textile use; sprinklers; syringes for watering flowers and plants; oven mitts; animal grooming gloves; gloves for household purposes; polishing gloves; gardening gloves; barbecue mitts; dripping pans; drinking troughs; potholders; clothes-pegs; combs; sifters [household utensils]; broom handles; blenders, non-electric, for household purposes; scoops for household purposes; fused silica [semi-worked product], other than for building; plate glass [raw ma-

terial]; glass, unworked or semi-worked, except building glass; glass wool, other than for insulation; vitreous silica fibres, other than for textile use; fibreglass, other than for insulation or textile use; indoor terrariums [plant cultivation]; indoor terrariums [vivariums]; electric devices for attracting and killing insects; watering devices; ultrasonic pest repellers; utensils for household purposes; kitchen utensils; mops; animal bristles [brushware]; brushes; barbecue tongs; decanter tags; nest eggs, artificial; window-boxes.

22 – String; tarpaulins; wadding for padding and stuffing upholstery; wadding for filtering; ropes; hemp fibres; carbon fibres for textile use; coconut fibre; plastic fibres for textile use; jute; ropes, not of metal; strips for tying-up vines; ladder tapes for Venetian blinds; wrapping or binding bands, not of metal; padding materials, not of rubber, plastics, paper or cardboard; packing [cushioning, stuffing] materials, not of rubber, plastics, paper or cardboard; bags [envelopes, pouches] of textile, for packaging; binding thread, not of metal, for agricultural purposes; thread, not of metal, for wrapping or binding; braces, not of metal, for handling loads; bindings, not of metal; tents; purse seines; straps, not of metal, for handling loads; hemp bands; nets; sisal; sheaf-binding yarns; outdoor blinds of textile; vitreous silica fibres for textile use; glass fibres for textile use; slings, not of metal, for handling loads; cables ties, not of metal; raw fibrous textile; awnings of synthetic materials; awnings of textile; network; cables, not of metal; dust sheets; cords for hanging pictures; sash cords; pig bristles.

24 – Frieze [cloth]; banners of textile or plastic; velvet; household linen; diapered linen; bath linen, except clothing; bed linen; table linen, not of paper; sew-on tags of textile for clothing; adhesive tags of textile for bags; cot bumpers [bed linen]; buckram; fustian; sleeping bag liners; felt; bunting of textile or plastic; gauze [cloth]; damask; jersey [fabric]; table runners, not of paper; drugget; shower curtains of textile or plastic; curtains of textile or plastic; net curtains; zephyr [cloth]; canvas for tapestry or embroidery; dimity; bolting cloth; mats of textile for beer glasses; baby buntings; crepe [fabric]; crepon; marabouts [cloth]; furniture coverings of textile; fabrics for textile use; filtering materials of textile; wall hangings of textile; non-woven textile fabrics; plastic material [substitute for fabrics]; textile material; tablemats of textile; bivouac sacks being covers for sleeping bags; sleeping bags; sleeping bags for babies; moleskin [fabric]; muslin fabric; pillowcases; mattress covers; bed blankets; blankets for household pets; brocades; diaper changing cloths for babies; handkerchiefs of textile; picnic blankets; travelling rugs [lap robes]; coasters of textile; bed valances; linings [textile]; hat linings, of textile, in the piece; curtain holders of textile material; bed covers; bed covers of paper; furniture coverings of plastic; face towels of textile; dish towels; towels of textile; tea towels; hemp cloth; gum-

med cloth, other than for stationery purposes; printers' blankets of textile; cloth; door curtains; bedsheets; eiderdowns [down coverlets]; bath mitts; shrouds; glass cloths [towels]; cloths for removing make-up; place mats of textile; table napkins of textile; mosquito nets; calico; oilcloth for use as tablecloths; tablecloths, not of paper; billiard cloth; taffeta [cloth]; ticks [mattress covers]; tick [linen]; lingerie fabric; fabric, impervious to gases, for aeronautical balloons; jute fabric; fabric for footwear; ramie fabric; esparto fabric; rayon fabric; fibreglass fabrics for textile use; adhesive fabric for application by heat; linen cloth; upholstery fabrics; hemp fabric; lining fabric for footwear; reusable wax coated fabrics for wrapping food; traced cloths for embroidery; chenille fabric; printed calico cloth; knitted fabric; cotton fabrics; silk fabrics for printing patterns; woollen cloth; elastic woven fabrics; fabric; fabric imitating animal skins; haircloth [sackcloth]; cheese cloth; tulle; flags of textile or plastic; flannel [fabric]; trellis [cloth]; covers for cushions; fitted toilet lid covers of fabric; covers [loose] for furniture; pillow shams; cheviots [cloth]; silk [cloth]; labels of textile.

25 – Underwear; sweat-absorbent underwear; trousers; brassieres; adhesive bras; collars [clothing]; detachable collars; shirt yokes; waistcoats; sports jerseys; hosiery; pockets for clothing; scarves; cap peaks; visors being headwear; tights; combinations [clothing]; suits; headscarves; jackets [clothing]; leggings [trousers]; camisoles; sports singlets; cuffs; face coverings [clothing], not for medical or sanitary purposes; sleep masks; bibs, not of paper; bibs, sleeved, not of paper; hairdressing capes; heel protectors for shoes; ear muffs [clothing]; sweat-absorbent socks; footwear; paper clothing; outerclothing; ready-made clothing; latex clothing; waterproof clothing; clothing incorporating LEDs; sportswear incorporating digital sensors; uniforms; clothing; clothing containing slimming substances; overcoats; knickers; parkas; pelerines; gloves [clothing]; warm gloves for touchscreen devices; pyjamas; headscarfs; scarfs; dresses; headbands [clothing]; garters; ready-made linings [parts of clothing]; dress shields; soles for footwear; girdles; belts [clothing]; sashes for wear; money belts [clothing]; layettes [clothing]; non-slipping devices for footwear; shirts; wooden shoes; sandals; bath sandals; boots; inner soles; bath slippers; knitwear [clothing]; underpants; slippers; shoes; headwear; aprons [clothing]; tee-shirts; rash guards; dressing gowns; tips for footwear; stockings; sweat-absorbent stockings; paper hats [clothing]; shower caps; bathing caps.

(260) AM 2023 121160 A
 (800) 1706863
 (151) 2022 11 28
 (891) 2022 11 28
 (731) Joint Stock Company "Cherkizovsky meat processing plant"

ul. Permskaya, d. 5, RU-107143 Moscow,
Russian Federation

(540)

ПРЕОБРАЖЕНСКАЯ

(591) Black, white

(531) 28.05

(511)

29 – Ham; game, not live; smoked-boiled beef products; smoked-boiled pork products; charcuterie; smoked meat products; meat products, including bacon, buzhenina being baked meat product, roll, loin, ham, brisket, neck; carbonade being pork meat product; black pudding; meat, tinned; meat; meat, preserved; sausage casings, natural or artificial; liver pâté; liver; semi-finished poultry products; chilled semi-finished meat products; chilled prepared poultry products; chilled prepared meat products; poultry, not live; bacon; pork; salted meats; sausages; sausages in batter; hot dog sausages; tripe; minced meat; meat fillet; meat extracts.

(260) AM 2023 121161 A

(800) 1706872

(151) 2022 11 11

(891) 2022 11 11

(731) JOINT STOCK COMPANY "FATS AND OIL
INTEGRATED WORKS"

UL. TITOVA 27, EKATERINBURG,
RU-620085SVERDLOVSKAYA OBLAST,
Russian Federation

(540)

НОВЫЙ ПУТЬ

(591) Black, white

(531) 28.05

(511)

1 – Antioxidants for use in the manufacture of food supplements; antioxidants for use in the manufacture of food products; fatty acids; vitamins for the food industry; vitamins for use in the manufacture of food supplements; proteins for use in the manufacture of food supplements.

5 – Mineral dietary supplements; nutritional supplements, including dietary supplements, dietary supplements containing omega-3 fatty acids; antioxidants for use as food supplements; albumin dietary supplements; yeast dietary supplements; alginate dietary supplements; glucose dietary supplements; casein dietary supplements; lecithin dietary supplements; linseed oil dietary supplements; brewer's yeast dietary supplements; propolis dietary supplements; protein dietary supplements; royal jelly dietary supplements; pollen dietary supplements; wheat germ dietary supplements; linseed dietary supplements; whey protein dietary supplements; acai powder dietetic supplements; dietary supplements with a cosmetic effect; enzyme dietary supplements; antioxidant pills; amino acids for medi-

cal purposes; acids for pharmaceutical purposes; vitamin preparations.

29 – Oils and fats for food; peanut butter; cocoa butter for food; coconut oil for food; coconut butter; maize oil for food; sesame oil for food; linseed oil for food; extra virgin olive oil for food; olive oil for food; palm oil for food; palm kernel oil for food; sunflower oil for food; rape oil for food; butter; soya bean oil for food; vegetable oils, vegetable oil substitutes.

(260) AM 2023 121162 A

(800) 1706925

(151) 2022 07 25

(891) 2022 07 25

(731) BALENCIAGA

40 rue de Sèvres, F-75007 Paris, France

(540)

BALENCIAGA

(591) Black, white

(511)

9 – Downloadable virtual goods, namely, computer programs featuring clothing, shoes, belts (clothing), headwear items, bags, bags for sports, backpacks, cases for computers and telephones, wallets, hand bags, clutch bags, purses, suitcases, document cases, hair accessories, spectacles, jewelry, watches, chronometric instruments, household linen, art objects, crockery, mats, furniture, perfumes, room fragrances, cosmetics, make-up products, games and toys, for use in online virtual environments; downloadable multimedia file containing works of art, text, audio, and video connected with fashion authenticated by non-fungible tokens (NFTs); downloadable image files and video recordings featuring clothing, shoes, belts (clothing), headwear items, bags, bags for sports, backpacks, cases for computers and telephones, wallets, hand bags, clutch bags, purses, suitcases, document cases, hair accessories, spectacles, jewelry, watches, chronometric instruments, household linen, art objects, crockery, mats, furniture, perfumes, room fragrances, cosmetics, make-up products, games and toys, authenticated by non-fungible tokens (NFTs); downloadable augmented reality software for mobile apparatus for integrating electronic data with real world environments for the purposes of creating works of art, design elements in the field of fashion and art facilities; downloadable software for generating cryptographic keys for receiving and spending cryptocurrencies; downloadable computer software for managing and verifying cryptocurrency transactions over a blockchain; downloadable and recorded computer game software; downloadable wallpapers for computers and telephones; software; spectacle frames, spectacles, sunglasses, tinted or anti-glare spectacles, spectacle cases and cases for contact lenses, for wear in virtual worlds and/or virtual environments.

(260) AM 2023 121163 A
 (800) 1706976
 (151) 2022 08 24
 (891) 2022 08 24
 (731) Bayerische Motoren Werke Aktiengesellschaft
 Petuelring 130, 80809 München, Germany
 (540)

BMW ALPINA

(591) Black, white
 (511)
 12 – Automobiles; apparatus for locomotion by land;
 engines for land vehicles; motors for land vehicles;
 parts and fittings for vehicles except wheels for mo-
 torcycles and bicycles.

(260) AM 2023 121164 A
 (800) 1706988
 (151) 2022 09 27
 (891) 2022 09 27
 (731) UNIGRA' S.p.A.
 Via Gardizza 9/b, I-48017 Conselice (RA), Italy
 (540)



(591) Blue, brown, green, white
 (531) 05.03.14; 27.05.17; 29.01.13
 (511)
 29 – Milk-based beverages containing coffee; milk-
 based beverages, in which milk predominates; bevera-
 ges based on or containing milk; dairy products based
 beverages; yoghurt-based beverages; flavored milk
 drinks; milk drinks with a high milk content; milk
 drinks containing fruit; milk drinks in which milk pre-
 dominates; dairy-based puddings; butter, honey bu-
 tter; milk; sour milk; egg white milk; flavored milk;
 beaten milk; organic milk; curdled milk; coagulated
 milk; condensed milk; peanut milk for food; hemp
 milk for use as a milk substitute; goat milk; powdered
 coconut milk; coconut milk for culinary purposes;
 almond milk for food; sheep's milk; rice milk (milk
 substitutes); soya milk; soya milk (milk substitutes);
 dehydrated milk; evaporated milk; fermented milk;
 milk powder, flavored powdered milk for making be-
 verages; powdered milk for food; protein milk; skim-
 med milk; cow milk; dairy products; sour cream; whip-
 ping cream; powdered cream (dairy product); whip-
 ped cream, powdered coffee cream; cream (dairy pro-
 duct); butter-based preparations; dairy products and
 their substitutes; products which replace butter; dairy
 products; coffee staining preparations mainly based
 on dairy products; margarine substitutes; cream subs-
 titutes (substitutes for dairy products); sour cream su-
 bstitutes; buttermilk-based beverages; peanut milk

(non-alcoholic drinks); coconut milk used as a drink;
 almond milk (drinks).

32 – Frozen fruit drinks; smoked plum-based bevera-
 ges; rice-based beverages other than milk substitutes;
 brown rice based beverages other than milk substitu-
 tes; rice-based beverages, other than milk substitutes;
 soya based beverages, not milk substitutes; fruit juice
 drinks; pineapple juice drinks; grape juice beverages;
 vegetable based beverages; alcohol-free drinks; non-
 alcoholic honey-based beverages; non-alcoholic fruit-
 based tea flavored drinks; non-alcoholic grape juice
 drinks; non-alcoholic vegetable juice drinks; non-
 alcoholic tea flavored beverages; non-alcoholic fruit
 flavored drinks; nonalcoholic coffee flavored drinks;
 non-alcoholic beer flavored drinks; nonalcoholic tea
 flavored drinks; non-alcoholic drinks containing fruit
 juices; nonalcoholic beverages containing vegetable
 juices; carbonated non-alcoholic drinks; tea flavored
 carbonated non-alcoholic drinks; low calorie non-al-
 coholic drinks; non-alcoholic malt-free beverages
 (other than for medical purposes); fruit flavored
 drinks; nutritionally enriched beverages; beverages
 consisting of a mixture of fruit and vegetable juices;
 beverages consisting mainly of fruit juices; de-alcohol-
 ic beverages; non-alcoholic aloe vera beverages; fruit
 drinks; nonalcoholic fruit drinks; non-alcoholic fruit
 drinks; non-alcoholic malt drinks; orange juice drinks;
 energy drinks; energy drinks containing caffeine;
 energy drinks not for medical use; functional water-
 based beverages; isotonic drinks; isotonic drinks (not
 for medical use); non-alcoholic beverages; non-alco-
 holic fruit drinks; non-alcoholic beverages; drinks;
 non-alcoholic honey-based beverages; sports drinks;
 protein-enriched sports drinks; protein drinks for
 sportsmen; alcohol-free beverages; sports drinks con-
 taining electrolytes; non-alcoholic fruit (beverages).

35 – Advertising; business administration of the licen-
 sing of the goods and services of others; business ma-
 nagement assistance, business management consultan-
 cy; professional business consultation; dissemination
 of advertising material, flyers, prospectuses, printed
 matter, samples, practical demonstration of goods for
 advertising purposes; distribution of samples for ad-
 vertising purposes; organization of trade fairs for co-
 mmercial or advertising purposes; commercial infor-
 mation disseminated via websites, business informati-
 on; commercial information and advice to consumers;
 marketing; organization of exhibitions for commercial
 or advertising purposes; presentation of goods via
 communication media for retail purposes; sales pro-
 motion for others; advertising; online advertising on a
 computer network; market research; business rese-
 arch; business consultancy relating to the creation and
 operation of franchises; business management consul-
 tancy relating to franchising at wholesale warehouses,
 through mail order catalogs, by electronic means,
 through websites, teleshopping programs; services in-
 volving the grouping, on behalf of others, of a variety

of products, in particular of food products, such as to enable them to be easily viewed for the purpose of their purchase; display of products for advertising purposes, advertising communications by e-mail; marketing services; presentation of goods in retail media; advertising services; publication of publicity texts; on-line advertising via the Internet; television advertisements.

(260) AM 2023 121165 A

(800) 1706994

(151) 2022 11 02

(891) 2022 11 02

(731) HeidelbergCement AG

Berliner Str. 6, 69120 Heidelberg, Germany

(540)



(591) Green and white

(531) 05.03.14; 26.04.04; 26.04.08; 27.05.01; 29.01.13

(511)

1 – Chemicals and chemical preparations for use in construction; chemical additives; chemicals being additives for cement, concrete and other cementitious construction materials.

9 – Computer software (application software, artificial intelligence and machine learning software, software for monitoring, analysing, controlling and running physical world operations, system and system support software, and firmware, virtual and augmented reality software, web applications and server software).

19 – Building and construction materials and elements, not of metal; concrete; cement; aggregate materials for use in concrete; aggregates; asphalt.

42 – Chemical laboratories; technological consultation services relating to construction materials, building materials and construction services; chemistry services; engineering services; IT services (software development, programming and implementation, hosting services and software as a service [SaaS] and rental of software, data duplication and data conversion services, data coding services).

(260) AM 2023 121166 A

(800) 1707008

(151) 2022 11 15

(891) 2022 11 15

(731) KMG International N.V.

Strawinskylaan 807, Tower A-8, NL-1077 XX Amsterdam, Netherlands

(540)



Impreuna Crestem Oameni

Together We Grow People

(591) Red, black, orange, white and yellow

(531) 01.03.01; 01.03.02; 01.03.09; 01.03.16; 05.05.04; 05.05.19; 05.05.20; 26.01.06; 27.05.10; 29.01.13

(511)

35 – Advertising; business management; business administration; office functions; retail services in relation to fuels; office function; rental of advertising space; commercial information and advice for consumers [consumer advice shop]; commercial information and commercial advice for consumers [consumer advice shop]; presentation of goods on communication media, for retail purposes; price comparison services; exhibitions (organization of-) for commercial or advertising purposes; public relations; administrative loyalty card services; administration of consumer loyalty programs; administration of loyalty rewards programs; loyalty, incentive and bonus program services; organisation, operation and supervision of loyalty schemes; customer loyalty services for commercial, promotional and /or advertising purposes; sales promotion; commercial business promotion services; drafting business administrative guidelines and administrative management of (savings and discount) schemes aimed at promoting customer loyalty; sales promotion using or based on price and reward schemes; business administration of savings and other funds; accounting services being administrative services consisting of converting (converting) valuations of points into monetary quantities or purchase, exchange and discount rights.

(260) AM 2023 121203 A

(800) 1707801

(151) 2022 11 04

(891) 2022 11 04

(731) SHENZHEN IVPS TECHNOLOGY CO. LTD.

101, Building B8, No. 2, Cengyao Industrial Area, Yulv Community, Yutang Subdistrict, Guangming District, Shenzhen, 518000 Guangdong, China

(540)

(591) Black, white

(531) 27.05.01

(511)

34 – Cigarettes containing tobacco substitutes, not for medical purposes; cigarillos; electronic cigarettes; tips of yellow amber for cigar and cigarette holders; liquid solutions for use in electronic cigarettes; cigarette

tips; flavorings, other than essential oils, for use in electronic cigarettes; cigarette cases; oral vaporizers for smokers; pipe racks for tobacco pipes.

(260) AM 2023 121204 A

(800) 1707829

(151) 2022 04 15

(891) 2022 04 15

(731) TECHIIA HOLDING LIMITED

Vasili Michailidi, 9, CY-3026 Limassol, Cyprus

(540)

aestech

(591) Black, white

(531) 27.05.01

(511)

19 – Building and construction materials, not of metal; rigid pipes, not of metal, for building; asphalt, pitch, tar and bitumen; buildings, transportable, not of metal; monuments, not of metal; asbestos mortar; asbestos cement; aquaria [structures]; alabaster; arbours [structures], not of metal; reinforcing materials, not of metal, for building; asphalt; beacons, not of metal, non-luminous; balustrades, not of metal; huts; crash barriers, not of metal, for roads; swimming pools [structures], not of metal; concrete; concrete building elements; bitumen; bituminous products for building; bituminous coatings for roofing; bitumen paper for building; plastic landscape edgings; armoured doors, not of metal; armour-plating, not of metal; beams, not of metal; girders, not of metal; building stone; building paper; buildings, not of metal; buildings, transportable, not of metal; building materials, not of metal; construction materials, not of metal; rubble; bird baths [structures], not of metal; lime; limestone; calcareous stone; calcareous marl; works of stonemasonry; agglomerated bagasses of cane [building material]; windows, not of metal; shutters, not of metal; vinyl siding; stained-glass windows; tanks of masonry; refractory construction materials, not of metal; fireproof cement coatings; water-pipes, not of metal; roof gutters, not of metal; gutter pipes, not of metal; aviaries [structures], not of metal; gates, not of metal; street gutters, not of metal; binding material for road repair; binding agents for making briquettes; geotextiles; gypsum [building material]; fireclay; grog [fired refractory material]; potters' clay; earth for bricks; clay; gravel; aquarium gravel; granite; latticework, not of metal; trellises, not of metal; hips for roofing; roof coverings, not of metal; accordion doors, not of metal; doors, not of metal; swing doors, not of metal; cask wood; wood for making household utensils; wood, semi-worked; wood veneers; wooden floor boards; wood panelling; chimney cowls, not of metal; chimneys, not of metal; chimney shafts, not of metal; lengthening pieces, not of metal, for chimneys; floating floor boards, not of metal; furrings of wood; drain pipes,

not of metal; jalousies, not of metal; pantiles, not of metal; railway sleepers, not of metal; outdoor blinds, not of metal and not of textile; prefabricated houses [kits], not of metal; road signs, non-luminous and non-mechanical, not of metal; non-luminous and non-mechanical signs, not of metal; cabanas, not of metal; paint spraying booths, not of metal; soundproof booths, transportable, not of metal; telephone booths, not of metal; stone; coal tar; framework, not of metal, for building; horticultural frames, not of metal; cold frames, not of metal; greenhouse frames, not of metal; cornices, not of metal; building cardboard; wood pulp board for building; quartz; sandstone pipes; caissons for construction work under water; fair huts; water-pipe valves, not of metal or plastic; drain traps [valves], not of metal or plastic; clinker ballast; mooring bollards, not of metal; skating rinks [structures], not of metal; chimney pots, not of metal; pillars, not of metal, for building; bicycle parking installations, not of metal; agglomerated cork for building; raw chalk; silica [quartz]; manhole covers, not of metal; rock crystal; brackets, not of metal, for building; xylolith; chicken-houses, not of metal; angle irons, not of metal; foundry moulds, not of metal; building timber; manufactured timber; sawn timber; magnesia cement; macadam; marble; materials for making and coating roads; linings, not of metal, for building; wall linings, not of metal, for building; cladding, not of metal, for building; wall claddings, not of metal, for building; road coating materials; memorial plaques, not of metal; mosaics for building; tombs, not of metal; gravestones; tombs [monuments], not of metal; grave slabs, not of metal; tombstone stelae, not of metal; flashing, not of metal, for building; roof flashing, not of metal; penstock pipes, not of metal; duckboards, not of metal; wainscotting, not of metal; tomb or grave enclosures, not of metal; fences, not of metal; olivine for building; shuttering, not of metal, for concrete; rubber bearings for seismic isolation of buildings; reeds for building; monuments, not of metal; acoustic panels, not of metal; building panels, not of metal; door panels, not of metal; signalling panels, non-luminous and non-mechanical, not of metal; parquet flooring; parquet floor boards; branching pipes, not of metal; partitions, not of metal; lintels, not of metal; scantlings [carpentry]; porches [structures], not of metal; floors, not of metal; props, not of metal; aquarium sand; play sand; silver sand; sand, except foundry sand; sandstone for building; floating docks, not of metal, for mooring boats; mouldings, not of metal, for building; planks of wood for building; mouldings, not of metal, for cornices; rocket launching platforms, not of metal; platforms, prefabricated, not of metal; slabs, not of metal, for building; paving slabs, not of metal; luminous paving blocks; road marking sheets and strips of synthetic material; tiles, not of metal, for building; floor tiles, not of metal; tile floorings, not of metal; felt for building; busts of stone, concrete or marble; stringers [parts of staircases], not of metal;

coatings [building materials]; asphalt paving; wood paving; paving blocks, not of metal; roofing tiles, not of metal; roofing shingles; roofing slates; roofing, not of metal; roofing, not of metal, incorporating photovoltaic cells; fireplace mantles, not of metal; joists, not of metal; sills, not of metal; porphyry [stone]; letter boxes of masonry; tarred strips for building; tar; window frames, not of metal; door frames, not of metal; door casings, not of metal; scaffolding, not of metal; mortar for building; pigsties, not of metal; silos, not of metal; perches; laths, not of metal; insect screens, not of metal; burial vaults, not of metal; alabaster glass; safety glass; building glass; window glass for building; window glass, other than vehicle window glass; glass granules for road marking; enamelled glass, for building; insulating glass for building; plate glass [windows] for building; slate; slate powder; pitch; statues of stone, concrete or marble; ceilings, not of metal; stables, not of metal; wall tiles, not of metal; posts, not of metal, for power lines; poles, not of metal, for power lines; posts, not of metal; casement windows, not of metal; folding doors, not of metal; staircases, not of metal; stair-treads [steps], not of metal; tombstone plaques, not of metal; works of art of stone, concrete or marble; telegraph posts, not of metal; greenhouses, transportable, not of metal; terra-cotta [building material]; diving boards, not of metal; ducts, not of metal, for ventilating and air-conditioning installations; rigid pipes, not of metal, for building; advertisement columns, not of metal; turnstiles, not of metal; tufa; plywood; veneer wood; figurines of stone, concrete or marble; flagpoles [structures], not of metal; mouldable wood; bricks; firebricks; refractory bricks; cement for blast furnaces; cement for furnaces; cement; cement slabs; cement posts; palings, not of metal; schists; slag [building material]; slag stone; clinker stone; pilings, not of metal; plaster; artificial stone; masts [poles], not of metal.

37 – Construction services; installation and repair services; mining extraction, drilling of wells for mining petroleum and gas; asphaltting; tire balancing; road paving; shipbuilding; pier breakwater building; building of fair stalls and shops; drilling of deep oil or gas wells; drilling of wells; rebuilding engines that have been worn or partially destroyed; rebuilding machines that have been worn or partially destroyed; retreading of tires; installation of doors and windows; custom installation of exterior, interior and mechanical parts of vehicles [tuning]; elevator installation and repair; lift installation and repair; electric appliance installation and repair; irrigation devices installation and repair; heating equipment installation and repair; burglar alarm installation and repair; furnace installation and repair; fire alarm installation and repair; installation and repair of air-conditioning apparatus; telephone installation and repair; freezing equipment installation and repair; kitchen equipment installation; scaffolding; installation and repair of flood protection equipment; installation, maintenance and repair of compu-

ter hardware; machinery installation, maintenance and repair; office machines and equipment installation, maintenance and repair; vulcanization of tires [repair]; building sealing; damp-proofing [building]; knife sharpening; disinfecting; sanitizing of upholstery; disinfecting of surgical instruments; deodorizing of upholstery; mining extraction; leather care, cleaning and repair; fur care, cleaning and repair; providing information relating to repairs; providing construction information; vehicle battery charging; charging of electric vehicles; vehicle greasing; demolition of buildings; vermin exterminating, other than for agriculture, aquaculture, horticulture and forestry; building insulating; riveting; construction consultancy; varnishing; vehicle washing; masonry; bricklaying; building construction supervision; tuning of musical instruments; upholstering; vehicle service stations [refuelling and maintenance]; irradiation of medical instruments; chimney sweeping; refilling of toner cartridges; refilling of ink cartridges; underwater repair; underwater construction; re-tinning; roofing services; vehicle polishing; renovation of clothing; services of electricians; pest control services, other than for agriculture, aquaculture, horticulture and forestry; hydraulic fracturing services; assembly services relating to the installation of furniture; vehicle breakdown repair services; quarrying services; housekeeping services [cleaning services]; hardscaping services; artificial snow-making services; cell phone battery charging services; joinery services [repair of woodwork]; washing; washing of linen; laundering; linen ironing; pressing of clothing; street cleaning; snow removal; installation of utilities in construction sites; rental of construction equipment; rental of bulldozers; rental of road sweeping machines; rental of drainage pumps; rental of excavators; rental of portable power chargers; rental of battery chargers; rental of cranes [construction equipment]; rental of dishwashing machines; rental of laundry washing machines; rental of dish drying machines; rental of cleaning machines; laying of cable; rustproofing; anti-rust treatment for vehicles; shoe repair; clock and watch repair; repair of power lines; film projector repair and maintenance; pump repair; upholstery repair; clothing repair; umbrella repair; parasol repair; repair of security locks; photographic apparatus repair; furniture restoration; restoration of musical instruments; restoration of works of art; painting, interior and exterior; excavation of ruins, not for research; factory construction; warehouse construction and repair; pipeline construction and maintenance; harbour construction; construction; sterilization of medical instruments; dry cleaning; carpentry services; swimming-pool maintenance; strong-room maintenance and repair; airplane maintenance and repair; motor vehicle maintenance and repair; burner maintenance and repair; safe maintenance and repair; furniture maintenance; maintenance of elevators [lifts] via remote; vehicle maintenance; plumbing; tuning of bodies for automobiles; laying of artificial turf; interfe-

rence suppression in electrical apparatus; painting or repair of signs; cleaning of buildings [interior]; cleaning of buildings [exterior surface]; window cleaning; boiler cleaning and repair; cleaning of clothing; diaper cleaning; pumicing; sanding; vehicle cleaning; paper hanging; plastering.

40 – Material treatment; recycling of waste and trash; air purification and water treating; printing services; food and drink preservation; custom 3D printing for others; abrasion; applying finishes to textiles; fulling of cloth; fabric bleaching; wine making for others; key cutting; custom fashioning of fur; custom manufacture of boats; custom manufacture of yachts; pottery firing; custom manufacturing of bread; production of energy; skin dressing; vulcanization [material treatment]; galvanization; electroplating; engraving; decontamination of hazardous materials; air deodorizing; crushing of concrete; printing; pattern printing; photographic printing; tanning; textile dyeing; cloth dyeing; fur dyeing; providing information relating to material treatment; slaughtering of animals; freezing of foods; custom assembly of aircraft; custom manufacturing of aircraft; boilermaking; destruction of waste and trash; gilding; gold plating; timber felling and processing; cadmium plating; permanent-press treatment of fabrics; blacksmithing; food and drink preservation; consultancy in the field of wine making; food smoking; custom tailoring; laser scribing; laminating; saddlery working; metal casting; lithographic printing; fur glossing; tin plating; flour milling; textile fireproofing; fabric waterproofing; magnetization; nickel plating; framing of works of art; leather working; waste treatment [transformation]; wool treating; water treating; woodworking; processing of cinematographic films; metal treating; processing of oil; crease-resistant treatment for clothing; stripping finishes; paper treating; textile treating; cloth treating; fur conditioning; cloth edging; irradiation of food; air freshening; paper finishing; offset printing; air purification; bookbinding; pasteurizing of food and beverages; soldering; recycling of waste and trash; upcycling [waste recycling]; clothing alteration; beer brewing for others; sawing of materials; fruit crushing; metal plating; burnishing by abrasion; cloth pre-shrinking; distillation services; colour separation services; cryopreservation services; sandblasting services; refining services; cheese processing services in the nature of ripening, maturing and aging of cheese; taxidermy; photocomposing services; welding services; services of a dental technician; dyeing services; joinery services [custom manufacturing of woodwork]; rental of batteries; rental of boilers; knitting machine rental; rental of electricity generators; rental of air-conditioning apparatus; rental of space heating apparatus; rental of industrial robots for use in manufacturing; textile mothproofing; fur mothproofing; photographic film development; cloth cutting; fur satining; custom assembling of materials for others; glass-blowing; warping [looms]; sorting of waste and recyclable ma-

terial [transformation]; incineration of waste and trash; silver plating; planing of materials; quilting; metal tempering; window tinting treatment being surface coating; tinting of car windows; shoe staining; leather staining; photogravure; millworking; chromium plating; dressmaking; grinding; optical glass grinding; silkscreen printing.

42 – Scientific and technological services research and development relating thereto (term considered too vague by the International Bureau – rule 13 (2) (b) of the Regulations); industrial analysis, industrial research and design services; quality control and authentication services; design and development of computer hardware and software; water analysis; analysis for oil-field exploitation; computer system analysis; handwriting analysis [graphology]; architectural consultancy; architectural services; construction drafting; geological test drilling; material testing; oil-well testing; recovery of computer data; authenticating works of art; geological surveys; geological prospecting; graphic arts design; graphic design of promotional materials; business card design; interior design; computer graphic design for video projection mapping; design of costumes; packaging design; off-site data backup; research in the field of excavation; bacteriological research; biological research; geological research; cosmetic research; medical research; technological research; chemical research; geotechnical investigations; research and development of new products for others; mechanical research; research in the field of building construction; research in the field of environmental protection; research in the field of welding; research in the field of telecommunications technology; research in the field of artificial intelligence technology; research in the field of physics; duplication of computer programs; oil-field surveys; electronic data storage; electronic monitoring of personally identifying information to detect identity theft via the internet; electronic monitoring of credit card activity to detect fraud via the internet; energy auditing; providing virtual computer systems through cloud computing; providing geographic information; providing information relating to computer technology and programming via a website; providing scientific information, advice and consultancy relating to carbon offsetting; providing online geographic maps, not downloadable; providing search engines for the internet; cloud seeding; engineering; installation of computer software; information technology services provided on an outsourcing basis; calibration [measuring]; cartography services; quantum computing; clinical trials; computer programming; conversion of data or documents from physical to electronic media; conversion of computer programs and data, other than physical conversion; computer technology consultancy; telecommunication network security consultancy; telecommunications technology consultancy; consultancy in the field of energy-saving; internet security consultancy; data security consultancy; information technology

[IT] consultancy; computer software consultancy; computer security consultancy; consultancy in the design and development of computer hardware; website design consultancy; artificial intelligence consultancy; quality control; culturing of cells for scientific research purposes; cryptocurrency mining; cryptomining; meteorological information; dress designing; monitoring of computer systems for detecting unauthorized access or data breach; monitoring of computer systems to detect breakdowns; monitoring of computer systems by remote access; writing of computer code; scientific research; surveying; scientific and technological research in the field of natural disasters; scientific and technological research relating to patent mapping; maintenance of computer software; updating of computer software; digitization of documents [scanning]; quality evaluation of wool; vehicle roadworthiness testing; underwater exploration; urban planning; platform as a service [PaaS]; user authentication services using blockchain technology; user authentication services using technology for e-commerce transactions; user authentication services using single sign-on technology for online software applications; logo design services; exploration services in the field of the oil, gas and mining industries; computer programming services for data processing; software engineering services for data processing; hosting computer websites; data encryption services; cartographic or thermographic measurement services by drone; scientific laboratory services; technological consulting services for digital transformation; chemistry services; computer virus protection services; conducting technical project studies; weather forecasting; software as a service [SaaS]; design of interior decor; design of computer-simulated models; computer system design; computer software design; golf course design; design of prototypes; rental of web servers; computer rental; rental of computer software; rental of meters for the recording of energy consumption; rental of data centre facilities; industrial design; unlocking of mobile phones; oil prospecting; development of video and computer games; development of computer platforms; software development in the framework of software publishing; technical writing; digital forensic investigations in the field of computer crimes; creating and maintaining websites for others; creating and designing website-based indexes of information for others [information technology services]; technological consultancy; land surveying; chemical analysis; server hosting; styling [industrial design].

(260) AM 2023 121209 A

(800) 1693630

(151) 2022 10 03

(891) 2022 12 22

(731) Steven Madden, Ltd.

52-16 Barnett Avenue, Long Island City
NY 11104, USA

(540)

STEVE MADDEN

(591) Black, white

(511)

25 – Bandanas; bodysuits; dresses; footies; footwear; hosiery; jumpsuits; leggings; rompers; socks; sunsuits; belts for clothing; bottoms as clothing; tops as clothing; clothing belts; shoes, sandals and boots.

(260) AM 2023 121210 A

(800) 1696052

(151) 2022 10 03

(891) 2022 12 22

(731) Steven Madden, Ltd.

52-16 Barnett Avenue, Long Island City
NY 11104, USA

(540)

STEVE MADDEN

(591) Black, white

(511)

18 – Backpacks; handbags; luggage; purses; wallets; bags for sports; clutch bags; umbrellas; all purpose sports bags; all-purpose athletic bags; all-purpose carrying bags; athletic bags; book bags; bum bags; carry-on bags; duffle bags; duffle bags for travel; gym bags; leather bags and wallets; leather bags for merchandise packaging; leather bags, suitcases and wallets; leather and imitation leather bags; messenger bags; shoulder bags; sport bags; tote bags.

(260) AM 2023 121248 A

(800) 1707834

(151) 2022 06 27

(891) 2022 06 27

(731) ATMACA ELEKTRONİK SANAYİ VE
TİCARET ANONİM ŞİRKETİ

Zafer Mahallesi, 177. Sokak, No: 2 Esenyurt,
İstanbul, Türkiye

(540)

atmaca

(591) Black, white

(531) 27.05.01

(511)

7 – Machines, machine tools and industrial robots for processing and shaping wood, metals, glass, plastics and minerals, 3D printers; construction machines and robotic mechanisms (machines) for use in construction, bulldozers, diggers (machines), excavators, road construction and road paving machines, drilling machines, rock drilling machines, road sweeping machines; lifting, loading and transmission machines and robotic mechanisms (machines) for lifting, loading and transmission purposes: elevators, escalators and cranes; machines and robotic mechanisms (machines)

for use in agriculture and animal breeding, machines and robotic mechanisms (machines) for processing cereals, fruits, vegetables and food; beverage preparation machines, electromechanical; beverage processing machines; engines and motors, other than for land vehicles, parts and fittings therefor, hydraulic and pneumatic controls for engines and motors, brakes other than for vehicles, brake linings for engines, cranks-hafts, transmission gears for machines, cylinders for engines, pistons for engines, turbines, not for land vehicles, filters for engines and motors, oil, air and fuel filters for land vehicle engines, exhausts for land vehicle engines, exhaust manifolds for land vehicle engines, engine cylinders for land vehicles, engine cylinder heads for land vehicles, pistons for land vehicle engines, carburetors for land vehicles, fuel conversion apparatus for land vehicle engines, injectors for land vehicle engines, fuel economisers for land vehicle engines, pumps for land vehicle engines, valves for land vehicle engines, starters for motors and engines, dynamos for land vehicle engines, sparking plugs for land vehicle engines; bearings (parts of machines), roller or ball bearings; machines for mounting and detaching tires; alternators, current generators, electric generators, current generators operated with solar energy; painting machines, automatic spray guns for paint, electric, hydraulic and pneumatic punching machines and guns, electric adhesive tape dispensers (machines), electric guns for compressed gas or liquid spraying machines, electric hand drills, electric hand saws, electric jigsaw machines, spiral machines, compressed air machines, compressors (machines), vehicle washing installations, robotic mechanisms (machines) with the abovementioned functions; electric and gas-operated welding apparatus, electric arc welding apparatus, electric soldering apparatus, electric arc cutting apparatus, electrodes for welding machines, industrial robots (machines) with the abovementioned functions; printing machines; packaging machines, filling, plugging and sealing machines, labellers (machines), sorting machines, industrial robots (machines) with the abovementioned functions, electric packing machines for plugging and sealing of plastics; machines for textile processing, sewing machines, industrial robots (machines) with the abovementioned functions; pumps [machines], self-regulating fuel pumps; electric kitchen machines for chopping, grinding, crushing, mixing and mincing foodstuff, washing machines, laundry washing machines, dishwashers, spin driers (not heated), electric cleaning machines for cleaning floors, carpets or floorings, vacuum cleaners and parts thereof; automatic vending machines; galvanizing and electroplating machines; electric door openers and closers; joints (parts of engines).

9 – Measurement apparatus and equipment including those for scientific, nautical, topographic, meteorologic, industrial and laboratory purposes, thermometers, not for medical purposes, barometers, ammeters, voltmeters, hygrometers, testing apparatus not for medical

purposes, telescopes, periscopes, directional compasses, speed indicators, laboratory apparatus, microscopes, magnifying glasses, binoculars, stills, ovens and furnaces for laboratory experiments; apparatus for recording, transmission or reproduction of sound or images, cameras, photographic cameras, television apparatus, video recorders, CD and DVD players and recorders, MP3 players, computers, desktop computers, tablet computers, wearable activity trackers, microphones, loudspeakers, earphones, telecommunications apparatus, apparatus for the reproduction of sound or images, computer peripheral devices, cell phones, covers for cell phones, telephone apparatus, computer printers, scanners [data processing equipment], photocopiers; magnetic and optical data carriers and computer software and programmes recorded thereto, downloadable and recordable electronic publications, encoded magnetic and optic cards; prerecorded motion picture films; prerecorded music videos; antennas, satellite antennas, amplifiers for antennas, parts of the aforementioned goods; ticket dispensers, automatic teller machines (ATM); electronic components used in the electronic parts of machines and apparatus, semi-conductors, electronic circuits, integrated circuits, chips [integrated circuits], diodes, transistors [electronic], magnetic heads for electronic apparatus, electronic locks, photocells, remote control apparatus for opening and closing doors, optical sensors; counters and quantity indicators for measuring the quantity of consumption, automatic time switches; clothing for protection against accidents, irradiation and fire, safety vests and life-saving apparatus and equipment; eyeglasses, sunglasses, optical lenses and cases, containers, parts and components thereof; apparatus and instruments for conducting, transforming, accumulating or controlling electricity, electric plugs, junction boxes [electricity], electric switches, circuit breakers, fuses, lighting ballasts, battery starter cables, electrical circuit boards, electric resistances, electric sockets, transformers [electricity], electrical adapters, battery chargers, electric doorbells, electric and electronic cables, batteries, electric accumulators; solar panels for production of electricity; alarms and anti-theft alarms, other than for vehicles, electric bells; signalling apparatus and instruments, luminous or mechanical signs for traffic use; fire extinguishing apparatus, fire engines, fire hose and fire hose nozzles; radar apparatus, sonars, night vision apparatus and instruments; decorative magnets; metronomes.

11 – Lighting installations; lights for vehicles and interior-exterior spaces; steam, gas and fog generators, steam boilers, other than parts of machines, acetylene generators, oxygen generators, nitrogen generators; installations for air-conditioning and ventilating; cooling installations and freezers; sanitary installations, taps [faucets], shower installations, toilets [water-closets], shower and bathing cubicles, bath tubs, toilet seats, sinks, wash-hand basins [parts of sanitary installations]; washers for water taps; water softening

apparatus; water purification apparatus; water purification installations; waste water purification installations; electric bed warmers and electric blankets, not for medical use; electric pillow warmers; electric or non-electric footwarmers; hot water bottles; socks, electrically heated; filters for aquariums and aquarium filtration apparatus; industrial type installations for cooking, drying and cooling purposes; pasteurizers and sterilizers.

(260) AM 2023 121250 A

(800) 1707844

(151) 2022 11 15

(891) 2022 11 15

(731) Richter Gedeon Nyrt.

Gyömrői út 19-21., H-1103 Budapest, Hungary

(540)

УРОБЕДИН

(591) Black, white

(531) 28.05

(511)

5 – Pharmaceutical preparations.

(260) AM 2023 121251 A

(800) 1707851

(151) 2022 11 30

(891) 2022 11 30

(731) JOINT STOCK COMPANY "FATS AND OIL INTEGRATED WORKS"

UL. TITOVA 27, EKATERINBURG,
RU-620085 SVERDLOVSKAYA OBLAST,
Russian Federation

(540)

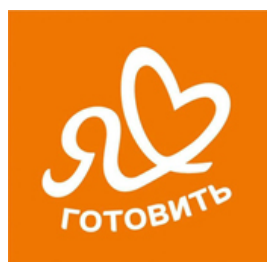

(591) White and orange

(531) 02.09.01; 26.04.05; 26.04.16; 28.05; 29.01.12

(511)

30 – Mustard; dressings for salad; mayonnaise; ketchup [sauce]; cranberry sauce [condiment]; soya sauce; tomato sauce; apple sauce [condiment]; sauces [condiments]; pasta sauce.

(260) AM 2023 121361 A

(800) 1708659

(151) 2022 10 04

(891) 2022 10 04

(731) ALTONA COSMETICS TECHNOLOGY
SANAYİ VE TİCARET ANONİM ŞİRKETİ

KARAMEHMET MAH/SEMT AVRUPA,
SERBEST BÖLGESİ 13. SK. 8 1 Ergene,
ekirdağ, Türkiye

(540)

Rosa De Rosa

(591) Black, white

(531) 27.05.01

(511)

3 – Non-medicated cosmetics and toiletry preparations; non-medicated dentifrices; perfumery, essential oils; soaps; hair lotions; bleaching preparations and other substances for laundry use; cleaning, polishing, scouring and abrasive preparations.

(260) AM 2023 121362 A

(800) 1708660

(151) 2022 11 17

(891) 2022 11 17

(731) TÜRKİYE TURİZM TANITIM VE
GELİŞTİRME AJANSI

Esentepe Mahallesi, Büyükdere Caddesi,
Astoria 127 B/71, Şişli – İstanbul, Türkiye

(540)



(591) Green, blue and white

(531) 05.03.15; 26.01.15; 26.01.18; 27.05.10;
29.01.13

(511)

35 – Advertising, marketing and public relations; organization of exhibitions and trade fairs for commercial or advertising purposes; development of advertising concepts; provision of an online marketplace for buyers and sellers of goods and services.

39 – Land, water and air transport services; rental of land, water or air vehicles; arranging of tours; travel reservation; issuing of tickets for travel; courier services (messages or merchandise).

41 – Arranging and conducting of conferences, congresses and seminars; sporting and cultural activities; entertainment; ticket reservation and booking services for entertainment, sporting and cultural events, including ticket reservation and booking services for theatres, cinemas, museums and concerts; publication and editing of printed matter, including magazines, books, newspapers, other than publicity texts; electronic publication services.

(260) AM 2023 121364 A

(800) 1708805

(151) 2022 12 13

(891) 2022 12 13

(731) Nelson Alfonso Egüed

Avenida Hermanos Granda, 5, E-28022 Madrid,
Spain

(540)

NELSON

(591) Black, white

(511)

34 – Tobacco and tobacco substitutes; cigarettes and cigars; electronic cigarettes and oral vaporizers for smokers; articles for use in conjunction with tobacco; humidors for tobacco and humidors for cigars; ashtrays; lighters for smokers; matches.

(260) AM 2023 121365 A

(800) 1708873

(151) 2022 07 05

(891) 2022 07 05

(731) IŞIK ELEKTRONİK SANAYİ VE TİCARET

ANONİM ŞİRKETİ

OSMANGAZİ MAH, SEMT AHMET YESEVİ

CAD. 12 Esenyurt, TR-34538 İstanbul, Türkiye

(540)

Fobem

(591) Blue and white

(531) 27.05.01; 29.01.04

(511)

7 – Machines, machine tools and industrial robots for processing and shaping wood, metals, glass, plastics and minerals, 3D printers; construction machines and robotic mechanisms for use in construction, bulldozers, diggers, machines, excavators, road construction and road paving machines, drilling machines, rock drilling machines, road sweeping machines; lifting, loading and transmission machines and robotic mechanisms for lifting, loading and transmission purposes: elevators, escalators and cranes; machines and robotic mechanisms for use in agriculture and animal breeding, machines and robotic mechanisms for processing cereals, fruits, vegetables and food; machines for preparing and processing beverages; engines and motors, other than for land vehicles, parts and fittings therefor, hydraulic and pneumatic controls for engines and motors, brakes other than for vehicles, brake linings for engines, crankshafts, gearboxes, other than for land vehicles, gearboxes, cylinders for engines, pistons for engines, turbines, not for land vehicles, filters for engines and motors, oil, air and fuel filters for land vehicle engines, exhausts for land vehicle engines, exhaust manifolds for land vehicle engines, engine cylinders for land vehicles, engine cylinder heads for land vehicles, pistons for land vehicle engines,

carburetors for land vehicles, fuel conversion apparatus for land vehicle engines, injectors for land vehicle engines, fuel economisers for land vehicle engines, valves for land vehicle engines, starter motors for land vehicles, dynamos for land vehicle engines, sparking plugs for land vehicle engines; bearings as parts of machines, roller or ball bearings; machines for mounting and detaching tires; alternators, current generators, electric generators, current generators operated with solar energy; painting machines, automatic spray guns for paint, electric, hydraulic and pneumatic punching machines and guns, electric adhesive tape dispensers machines, electric guns for compressed gas or liquid spraying machines, electric hand drills, electric hand saws, electric jigsaw machines, spiral binding machines for industrial purposes, compressed air machines, compressors, vehicle washing installations, robotic mechanisms machines with the abovementioned functions; electric and gas-operated welding apparatus, electric arc welding apparatus, electric soldering apparatus, electric arc cutting apparatus, electrodes for welding machines, industrial robots machines with the abovementioned functions; printing machines; packaging machines, filling, plugging and sealing machines for industrial purposes, labellers [machines], sorting machines, industrial robots machines with the abovementioned functions, electric packing machines for plugging and sealing of plastics; machines for textile processing, sewing machines, industrial robots machines with the abovementioned functions; electric kitchen machines for chopping, grinding, crushing, mixing and mincing foodstuff, washing machines, laundry washing machines, dishwashers, spin driers not heated, electric cleaning machines for cleaning floors, carpets or floorings, vacuum cleaners and parts thereof; automatic vending machines; galvanizing and electroplating machines; electric door openers and closers; gaskets for engines and motors.

8 – Forks, spoons, knives and non-electric cutters, slicers, peelers for kitchen use, including those made of precious metals; side arms and blades weapons; tools and apparatus included in this class for personal beauty care use, tools and apparatus included in this class for shaving, epilation, manicure and pedicure, electric hand implements for straightening and curling hair, scissors; hand-operated non-electric hand tools included in this class for the repair of machines, apparatus and vehicles and for use in construction, agriculture, horticulture and forestry, none of them being power tools; electric or non-electric irons, steam irons; handles for hand-operated hand tools.

9 – Measurement apparatus and equipment including those for scientific, nautical, topographic, meteorologic, industrial and laboratory purposes, thermometers, not for medical purposes, barometers, ammeters, voltmeters, hygrometers, testing apparatus not for medical purposes, telescopes, periscopes, directional compasses, speed indicators, laboratory apparatus, micro-

scopes, magnifying glasses, stills, binoculars, ovens and furnaces for laboratory experiments; apparatus for recording, transmission or reproduction of sound or images, cameras, photographic cameras, television apparatus, video recorders, CD and DVD players and recorders, MP3 players, computers, desktop computers, tablet computers, clothing that protects against serious or life-threatening injuries, for example, clothing for protection against accidents, irradiation and fire, bullet-proof clothing, protective helmets, head guards for sports, mouth guards for sports, protective suits for aviators, knee-pads for workers; smartwatches, wearable activity trackers, head-mounted cameras; microphones, loudspeakers, earphones, telecommunications apparatus, apparatus for the reproduction of sound or images, computer peripheral devices, cell phones, covers for cell phones, telephone apparatus, computer printers, scanners [data processing equipment], photocopiers; magnetic and optic data carriers and computer software and programmes recorded thereto, downloadable and recordable electronic publications, encoded magnetic and optic cards, movies, tv series and video music clips recorded on magnetic, optical and electronic media; antennas, satellite antennas, amplifiers for antennas, parts of the aforementioned goods; ticket dispensers, automatic teller machines ATM; electronic components used in the electronic parts of machines and apparatus, semi-conductors, electronic circuits, integrated circuits, chips [integrated circuits], diodes, transistors [electronic], magnetic heads for electronic apparatus, electronic locks, photocells, remote control apparatus for opening and closing doors, optical sensors; counters and quantity indicators for measuring the quantity of consumption, automatic time switches; clothing for protection against accidents, irradiation and fire, safety vests and life-saving apparatus and equipment; eyeglasses, sunglasses, optical lenses and cases, containers, parts and components thereof; apparatus and instruments for conducting, transforming, accumulating or controlling electricity, electric plugs, junction boxes [electricity], electric switches, circuit breakers, fuses, lighting ballasts, battery starter cables, electrical circuit boards, electric resistances, electric sockets, transformers [electricity], electrical adapters, battery chargers, electric door bells, electric and electronic cables, batteries, electric accumulators, solar panels for production of electricity; alarms and anti-theft alarms, other than for vehicles, electric bells; signalling apparatus and instruments, luminous or mechanical signs for traffic use; fire extinguishing apparatus, fire engines, fire hose and fire hose nozzles; radar apparatus, sonars, night vision apparatus and instruments; decorative magnets; metronomes.

11 – Lighting installations, lights for vehicles and interior-exterior spaces; heating installations using solid, liquid or gas fuels or electricity, central heating boilers, boilers for heating installations, radiators [heating], heat exchangers, not parts of machines, stoves,

kitchen stoves, solar thermal collectors heating; steam, gas and fog generators, steam boilers, other than parts of machines, acetylene generators, oxygen generators, nitrogen generators; installations for air-conditioning and ventilating; cooling installations and freezers; electric and gas-powered devices, installations and apparatus for cooking, drying and boiling: cookers, electric cooking pots, electric water heaters, barbecues, electric laundry driers; hair driers; hand drying apparatus, bath installations, bath fittings, bath plumbing fixtures, toilets, urinals; water softening apparatus; water purification apparatus, water purification installations; waste water purification installations; electric bed warmers and electric blankets, not for medical use, electric pillow warmers, electric or non-electric footwarmers; hot water bottles, electrically heated socks; filters for aquariums and aquarium filtration apparatus; industrial type installations for cooking, drying and cooling purposes; pasteurizers and sterilizers.

21 – Hand-operated non-electric cleaning instruments and appliances: brushes, other than paintbrushes, steel chips for cleaning, sponges for cleaning, steel wool for cleaning, cloths of textile for cleaning, gloves for dishwashing, non-electric polishing machines for household purposes, brooms for carpets, mops; toothbrushes, electric toothbrushes, dental floss, shaving brushes, hair brushes, combs; non-electric household or kitchen utensils, included in this class, other than forks, knives, spoons, services [dishes], pots and pans, bottle openers, flower pots, drinking straws, non-electric cooking utensils; ironing boards and shaped covers therefor, drying racks for washing, clothes drying hangers; cages for household pets, indoor aquariums, vivariums and indoor terrariums for animals and plant cultivation; ornaments and decorative goods of glass, porcelain, earthenware or clay namely statues, figurines, vases and trophies; mouse traps, insect traps, electric devices for attracting and killing flies and insects, fly catchers, fly swatters; perfume burners, perfume sprayers, perfume vaporizers, electric or non-electric make-up removing appliances, powder puffs, toilet cases; nozzles for sprinkler hose, nozzles for watering cans, watering devices, garden watering cans; unworked or semi-worked glass, except building glass, mosaics of glass and powdered glass for decoration, except for building, glass wool other than for insulation or textile use.

(260) AM 2023 121366 A

(800) 1708910

(151) 2022 12 12

(891) 2022 12 12

(731) URSA Salgótarján Glass Wool Close Co., Ltd.
Szépvölgyi út 41, 2/2, H-1037 Budapest,
Hungary

(540)

URSA MINERALWOOL

(591) Black, white

(511)

17 – Insulating, soundproofing and stopping materials; fabrics, felts, webs, plates, panels and sheets for use as insulation material; rubber or plastics for padding and stuffing; mineral wool, glass wool, stone wool, rock wool, slag wool and fiber glass for thermal or acoustic insulation; glass fibers for insulation; slag wool, glass wool blankets and panels for building insulation; wood fiber, plastic insulation materials, especially foamed plastic materials; insulation boards, made from polystyrene, especially made from extruded polystyrene; XPS (extruded polystyrene) material for packing and stuffing; XPS (extruded polystyrene) panels for insulation; plastic film, other than for packaging purposes; substances for insulating buildings against moisture; sealant compounds for joints; insulating paper, insulating tape and band, rubber, gutta-percha, gum, asbestos, mica; plastics in extruded form for use in manufacture; packing materials, joint packaging for flexible pipes, not of metal; membranes and insulating materials for air tightness and vapor barriers (membrane for moisture protection); vapor barriers; insulating adhesives for sealing and/or attaching or linking membranes of air tightness and/or vapor barriers (for moisture protection) to anything that has to pass through like carpentry, timber studs, tubes, chimney, parts used for ventilation, ducts; insulating adhesives, especially in the form of tapes to be used in combination with insulating material, like mineral wool and XPS (extruded polystyrene); adhesive tapes for industrial purposes; insulating material for buildings and glass mineral wool for insulation purposes together with the respective fixing material for fastening the insulation material and mineral wool for the building, namely warm frame construction, cold frame construction, wall/floor junction timber floor, cavity batts made of mineral fibers, pitched roof insulation, roof junctions for separating wall / attic space, roof junctions for separating wall / room in the roof.

19 – Building materials (non-metallic), including panels and sheets of mineral fibers (especially fiber glass) for buildings; ducts for air conditioning, not of metal; self-bearing duct designs made from mineral wool especially glass fiber panels used for HVAC (heating, ventilation and air conditioning); mineral wool panels with woven or non-woven facings or coverings; non-metallic rigid pipes for building; asphalt, pitch and bitumen; non-metallic transportable buildings; monuments, not of metal, waterproofing claddings.

(260) AM 2023 121451 A

(800) 1710115

(151) 2022 10 17

(891) 2022 10 17

(731) BTL Industries

Tzar Kaloyan str 8, BG-1000 Sofia, Bulgaria

(540)

EMFRACTIONAL

(591) Black, white

(511)

10 – Medical apparatus and instruments; aesthetic apparatus and instruments for aesthetic therapy, namely apparatus and instruments generating electrical, magnetic, electromagnetic, mechanical or thermal therapeutic energy; aesthetic apparatus and instruments for aesthetic therapy, namely apparatus and instruments for body shaping, fat removal, girth reduction, skin tightening, cellulite reduction, skin rejuvenation, wrinkle reduction, scar reduction, stretch mark reduction, increasing muscle mass, increasing amount of muscle fibres, increasing muscle tone; aesthetic massage apparatus, in particular apparatus for lymphatic drainage and increasing the circulation of bodily fluids; physical therapy apparatus, in particular apparatus for treating pain and preventing muscle cramps; gynaecological and urological apparatus and instruments; dental equipment; body rehabilitation apparatus for medical purposes; physical therapy equipment; physiotherapy and rehabilitation equipment; beds specially made for medical purposes; contraceptives, non-chemical; artificial limbs; orthopedic articles; suture materials.

(260) AM 2023 121554 A

(800) 1711707

(151) 2022 11 04

(891) 2022 11 04

(731) KAYHAN AV TUFEKLERI SANAYI VE DIS TICARET LIMITED SIRKETI
BARBAROS MAH. MİLLET CAD., ISIS
PLAZA 77 2 Ataşehir, İstanbul, Türkiye

(540)

KHAN ARMS

(591) Black, white

(531) 27.05.01

(511)

13 – Firearms, air pistols (weapons), spring-loaded firearms, adapted cases and shoulder straps therefor.

(260) AM 2023 121556 A

(800) 1711766

(151) 2023 01 09

(891) 2023 01 09

(731) International Fruit Genetics, LLC

8224 Espresso Drive, Suite 200, Bakersfield
CA 93312, USA

(540)

CHEERY CHAP

(591) Black, white

(511)

31 – Fresh fruits and fresh vegetables; live plants, namely, live cherry trees; live plants and live propagating material, namely, live cuttings, live plant tissue, and live plant clones, all for growing live plants.

(260) AM 2023 121607 A

(800) 1712882

(151) 2022 11 16

(891) 2022 11 16

(731) GROUPAUTO INTERNATIONAL

147 avenue Charles de Gaulle, F-92200

NEUILLY-SUR-SEINE, France

(540)



(591) Blue, yellow, white

(531) 01.01.05; 24.15.07; 24.15.13; 27.05.01; 29.01.13

(511)

35 – Advertising, commercial business management, consulting, information or inquiries, and particularly business organization and management consulting, business management consultancy, cost price analysis, business management consulting services, market study, business investigations, market research, economic forecasts, public relations, research for business purposes, marketing studies, business consulting and studies for the creation, development, and management of commercial networks and signs, commercial advice on defining the commercial network policy relating to the selection of suppliers, supply, logistics, and distribution, studies for commercial partnerships with third parties, recruitment; Services for the sale, retail sale, wholesale, Internet sale and mail-order sale of spare parts for cars and heavy goods vehicles, industrial oils and greases, lubricants, products for absorbing oil, fuels (including gasolines for motors and engines) and illuminants, candles, wicks and particularly non-chemical additives for fuels, fuels based on alcohol, benzene, benzine, benzol, dust-removing preparations, turbo injection systems, starters, diesel engine and gasoline engine injection systems, radiators, ball bearings, valves, winches, hydraulic presses, accumulators (batteries), warning devices, alarms, alcoholmeters, batteries, suppressors, electric welding apparatus, luminous beacons, electrical coils, junction boxes, cabinets for loudspeakers, pressure indicator plugs for valves, fog signals, electric cables, circuit breaker, indicator lights, switches, meters, electrical conductors, connectors, electrical control apparatus, speed controllers for vehicles, diagnostic ap-

paratus, dynamometers, kilometer recorders for vehicles, luminous signs, balancing devices, fire extinguishers, fuses, sheaths for electric cables, gasometers, loudspeakers, electrical indicators, gauges, electric cells (batteries), revolution counters, warning triangles, radars, radios, apparatus for charging electrical apparatus, controllers, electric locks, signage products, warning devices against theft, testers, scales for paint, stationary or mobile grease distribution apparatus, stationary or mobile oil distribution apparatus, oil recovery apparatus, accumulators (batteries), gas analyzers, programmable logic controllers for testing and maintaining the functions of a vehicle, test benches, batteries and battery chargers, heat accumulators, acetylene apparatus, devices for cooling and conditioning air in vehicles, air filters, light bulbs, demisters, anti-glare devices, antifreeze, automotive lights, headlights, radiator caps, heating installations for vehicles, vehicle air conditioning, defrosters, lighting equipment for vehicles, electric radiators, reflector lamps, heaters, air conditioning installations, vehicles, apparatus for locomotion by land, accessories and all spare parts for vehicles, namely, spring dampers, shock absorbers, anti-skid devices, anti-glare devices, anti-theft devices, head rests, transmission shafts, trailer hitches, hoods, bodies for vehicles, chains, chassis, bumpers, blinds, alarms, valves for wheel tires, treads for retreading tires, torsion bars, mine cart wheels, truck bodies, gear boxes, plugs for fuel tanks, windshield, hoods for vehicles, crankcases, safety belts, inner tubes, tracks, hydraulic circuits, torque converters, direction indicators, electric motors and engines, clutches, gears, hub caps, pneumatic tires, wheel balancing apparatus, axles, axle journals, windshield wiper, brake linings, brake shoes, brake segments, brakes, bands for wheel hubs, covers, wheel rims, running boards, sun visors, propulsion mechanisms, trailers, fuel tanks, rear-view mirrors, wheels, car gear trains, transmission mechanisms, turbines, balance weights for wheels, doors, seats, steering wheels, windows, alarms, alternators, carburetors, air compressors, capacitors, plain shaft bearings, cylinder heads, cycles, spoilers, engine equipment, air pumps for vehicles, heavy goods vehicle, vehicle hoists, sunroofs, turbo injection systems, starters, fuel injection systems for diesel engines and gasoline engines, radiators, ball bearings, valves, winches, hydraulic presses, accumulators (batteries), warning devices, alarms, alcoholmeters, batteries, suppressors, electric welding devices, luminous beacons, electric coils, connection boxes, cabinets for loudspeakers, pressure indicator plugs for valves, fog signals, electric cables, circuit breaker, indicator lights, switches, meters, electrical conductors, connectors, electrical control apparatus, speed controllers for vehicles, diagnostic apparatus, dynamometers, kilometer recorders for vehicles, luminous signs, balancing devices, fire extinguishers, fuses, sheaths for electric cables, gasometers, speakers, electrical indicators, gauges, cells (batteri-

es), revolution counters, warning triangles, radars, radios, chargers for electrical devices, controllers, electric locks, signage products, warning devices against theft, testers, scales for paint, stationary of mobile grease distribution devices, stationary of mobile oil distribution devices, oil recovery devices, accumulators, gas analyzers, programmable logic controllers for testing and maintaining the functions of a vehicle, test benches, batteries and battery chargers, joints.

37 – Construction; repair of motor vehicles and of spare parts and accessories for motor vehicles; installation services of spare parts and accessories for motor vehicles; retreading or vulcanization of tires; maintenance, cleaning, washing, and repair of motor vehicles, tool rentals.

39 – Vehicle breakdown assistance, warehousing, rental of vehicle roof racks, vehicle rental, towing; vehicle rental.

(260) AM 2023 121608 A

(800) 1712897

(151) 2022 11 16

(891) 2022 11 16

(731) Montres Breguet SA (Montres Breguet AG)

(Montres Breguet Ltd)

Place de la Tour 23, CH-1344 L'Abbaye,

Switzerland

(540)

T Y P E 20

(591) Black, white

(531) 15.01.13; 27.03.01; 27.03.15

(511)

14 – Precious metals and their alloys; figurines and trophies in precious metals or plated precious metals; jewelry, namely rings, earrings, cuff links, bracelets, charms, brooches, chains, necklaces, tie pins, tie clips, jewelry caskets, jewelry cases; precious stones, semi-precious stones (gemstones); timepieces and chronometric instruments, namely chronometers, chronographs, clocks, watches, pendulum clocks, alarm clocks as well as parts and accessories for the afore-said goods, namely hands, anchors, pendulums, barrels, watch cases, watch bands, watch dials, clock-works, watch chains, movements for timepieces, watch springs, watch glasses, presentation cases for timepieces, cases for timepieces.

(260) AM 2023 121609 A

(800) 836565

(151) 2004 09 27

(891) 2023 01 25

(731) BARON PHILIPPE DE ROTHSCHILD, S.A.

Rue de Grassi, F-33250 Pauillac, France

(540)



(591) Black, white

(531) 03.04.11; 05.07.10

(511)

33 – Alcoholic beverages (except beers).

INTERNATIONAL TRADEMARKS PROTECTED IN GEORGIA

(260) AM 2023 115046 A
(800) 1620199
(151) 2021 07 15
(181) 2031 07 15
(891) 2021 07 15
(511) 05, 42, 42

(260) AM 2023 118982 A
(800) 1677746
(151) 2022 04 27
(181) 2032 04 27
(891) 2022 04 27
(511) 03, 05, 10

(260) AM 2023 116054 A
(800) 1636769
(151) 2021 08 23
(181) 2031 08 23
(891) 2021 08 23
(511) 09, 35

(260) AM 2023 118984 A
(800) 1677757
(151) 2022 05 26
(181) 2032 05 26
(891) 2022 05 26
(511) 43

(260) AM 2023 116277 A
(800) 1639620
(151) 2021 12 01
(181) 2031 12 01
(891) 2021 12 01
(511) 12

(260) AM 2023 119036 A
(800) 1678138
(151) 2022 02 18
(181) 2032 02 18
(891) 2022 02 18
(511) 09, 11, 12, 25, 35, 38, 41, 42

(260) AM 2023 117936 A
(800) 1662707
(151) 2022 03 14
(181) 2032 03 14
(891) 2022 03 14
(511) 28, 37

(260) AM 2023 119043 A
(800) 1678363
(151) 2021 11 15
(181) 2031 11 15
(891) 2021 11 15
(511) 34

(260) AM 2023 118967 A
(800) 1677182
(151) 2022 01 21
(181) 2032 01 21
(891) 2022 01 21
(511) 09, 37, 38, 42

(260) AM 2023 119044 A
(800) 1678416
(151) 2022 06 10
(181) 2032 06 10
(891) 2022 06 10
(511) 41
(511) Collective

(260) AM 2023 118971 A
(800) 1677459
(151) 2022 04 26
(181) 2032 04 26
(891) 2022 04 26
(511) 09

(260) AM 2023 119046 A
(800) 1678498
(151) 2022 05 31
(181) 2032 05 31
(891) 2022 05 31
(511) 36

(260) AM 2023 118978 A
(800) 1677676
(151) 2021 11 15
(181) 2031 11 15
(891) 2021 11 15
(511) 07, 11

(260) AM 2023 119047 A
(800) 1678500
(151) 2022 06 21
(181) 2032 06 21
(891) 2022 06 21

(511) 39

(260) AM 2023 119048 A
(800) 1678501
(151) 2022 07 08
(181) 2032 07 08
(891) 2022 07 08
(511) 36

(260) AM 2023 119049 A
(800) 1678569
(151) 2021 12 10
(181) 2031 12 10
(891) 2021 12 10
(511) 03, 04, 05, 08, 09, 10, 11, 12, 14, 16, 18, 20, 21,
24, 25, 26, 27, 28, 29, 30, 31, 32, 33, 35, 36, 38,
39, 41, 42, 43, 44, 45

(260) AM 2023 119050 A
(800) 1678628
(151) 2022 01 11
(181) 2032 01 11
(891) 2022 01 11
(511) 06, 20, 21

(260) AM 2023 119051 A
(800) 1678639
(151) 2022 04 20
(181) 2032 04 20
(891) 2022 04 20
(511) 09

(260) AM 2023 119052 A
(800) 1678647
(151) 2022 04 20
(181) 2032 04 20
(891) 2022 04 20
(511) 06, 37

(260) AM 2023 119054 A
(800) 1678774
(151) 2022 04 28
(181) 2032 04 28
(891) 2022 04 28
(511) 09, 28, 41

(260) AM 2023 119055 A
(800) 1678817
(151) 2022 06 23
(181) 2032 06 23
(891) 2022 06 23

(511) 07, 09, 11, 35

(260) AM 2023 119056 A
(800) 1678824
(151) 2022 06 22
(181) 2032 06 22
(891) 2022 06 22
(511) 32, 33

(260) AM 2023 119057 A
(800) 1678856
(151) 2022 06 27
(181) 2032 06 27
(891) 2022 06 27
(511) 12

(260) AM 2023 119058 A
(800) 1678861
(151) 2022 07 08
(181) 2032 07 08
(891) 2022 07 08
(511) 05

(260) AM 2023 119143 A
(800) 1679203
(151) 2022 06 14
(181) 2032 06 14
(891) 2022 06 14
(511) 29

(260) AM 2023 119144 A
(800) 1679260
(151) 2022 02 07
(181) 2032 02 07
(891) 2022 02 07
(511) 29, 30, 31, 32

(260) AM 2023 119145 A
(800) 1679265
(151) 2022 06 08
(181) 2032 06 08
(891) 2022 06 08
(511) 34

(260) AM 2023 119146 A
(800) 1679274
(151) 2022 07 21
(181) 2032 07 21
(891) 2022 07 21
(511) 25, 35

(260) AM 2023 119148 A
(800) 1679463
(151) 2022 05 13
(181) 2032 05 13
(891) 2022 05 13
(511) 01, 02, 03, 04, 17

(260) AM 2023 119156 A
(800) 1679696
(151) 2022 01 20
(181) 2032 01 20
(891) 2022 01 20
(511) 06, 07, 08, 09, 11, 35

(260) AM 2023 119150 A
(800) 1679537
(151) 2022 06 14
(181) 2032 06 14
(891) 2022 06 14
(511) 09, 11, 37, 42

(260) AM 2023 119157 A
(800) 1679707
(151) 2022 03 17
(181) 2032 03 17
(891) 2022 03 17
(511) 09

(260) AM 2023 119151 A
(800) 1679565
(151) 2022 03 16
(181) 2032 03 16
(891) 2022 03 16
(511) 01, 05, 35, 44

(260) AM 2023 119158 A
(800) 1679761
(151) 2022 02 11
(181) 2032 02 11
(891) 2022 02 11
(511) 03, 05

(260) AM 2023 119152 A
(800) 1679614
(151) 2022 07 12
(181) 2032 07 12
(891) 2022 07 12
(511) 03

(260) AM 2023 119159 A
(800) 1679824
(151) 2022 07 12
(181) 2032 07 12
(891) 2022 07 12
(511) 03, 05

(260) AM 2023 119153 A
(800) 1679638
(151) 2022 05 27
(181) 2032 05 27
(891) 2022 05 27
(511) 03, 06, 09, 14, 16, 18, 24, 25, 35

(260) AM 2023 119160 A
(800) 1679849
(151) 2022 05 31
(181) 2032 05 31
(891) 2022 05 31
(511) 09, 35, 38, 42

(260) AM 2023 119154 A
(800) 1679657
(151) 2022 04 28
(181) 2032 04 28
(891) 2022 04 28
(511) 09, 28, 41

(260) AM 2023 119161 A
(800) 479675A
(151) 1983 09 15
(181) 2023 09 15
(891) 2022 07 29
(511) 03

(260) AM 2023 119155 A
(800) 1679690
(151) 2021 11 01
(181) 2031 11 01
(891) 2021 11 01
(511) 06, 19, 20, 35

(260) AM 2023 119162 A
(800) 549848
(151) 1990 03 26
(181) 2030 03 26
(891) 2022 04 15
(511) 05

(260) AM 2023 119163 A
 (800) 912896
 (151) 2006 11 28
 (181) 2026 11 28
 (891) 2022 08 04
 (511) 03

(260) AM 2023 119172 A
 (800) 1653554
 (151) 2022 01 27
 (181) 2032 01 27
 (891) 2022 06 23
 (511) 33

(260) AM 2023 119165 A
 (800) 1121260
 (151) 2012 04 27
 (181) 2032 04 27
 (891) 2022 08 04
 (511) 10

(260) AM 2023 119173 A
 (800) 1667536
 (151) 2022 03 11
 (181) 2032 03 11
 (891) 2022 08 08
 (511) 01, 17

(260) AM 2023 119166 A
 (800) 1172562
 (151) 2013 05 14
 (181) 2023 05 14
 (891) 2022 07 18
 (511) 07, 09

(260) AM 2023 119174 A
 (800) 1667609
 (151) 2022 03 11
 (181) 2032 03 11
 (891) 2022 08 08
 (511) 01, 17

(260) AM 2023 119168 A
 (800) 1346151
 (151) 2017 03 03
 (181) 2027 03 03
 (891) 2022 08 10
 (511) 33

(260) AM 2023 119213 A
 (800) 1679953
 (151) 2022 04 28
 (181) 2032 04 28
 (891) 2022 04 28
 (511) 09, 28, 41

(260) AM 2023 119169 A
 (800) 1494784
 (151) 2019 09 12
 (181) 2029 09 12
 (891) 2022 08 10
 (511) 33

(260) AM 2023 119214 A
 (800) 1679954
 (151) 2022 04 28
 (181) 2032 04 28
 (891) 2022 04 28
 (511) 09, 28, 41

(260) AM 2023 119170 A
 (800) 1598401
 (151) 2021 02 19
 (181) 2031 02 19
 (891) 2022 08 05
 (511) 05

(260) AM 2023 119215 A
 (800) 1679957
 (151) 2022 04 28
 (181) 2032 04 28
 (891) 2022 04 28
 (511) 09, 28, 41

(260) AM 2023 119171 A
 (800) 1647347
 (151) 2021 11 30
 (181) 2031 11 30
 (891) 2022 07 11
 (511) 05

(260) AM 2023 119220 A
 (800) 1680211
 (151) 2022 05 30
 (181) 2032 05 30
 (891) 2022 05 30
 (511) 09, 10, 42

(260) AM 2023 119221 A
(800) 1680238
(151) 2022 06 07
(181) 2032 06 07
(891) 2022 06 07
(511) 09

(260) AM 2023 119231 A
(800) 1680397
(151) 2022 07 27
(181) 2032 07 27
(891) 2022 07 27
(511) 05

(260) AM 2023 119222 A
(800) 1680246
(151) 2022 06 20
(181) 2032 06 20
(891) 2022 06 20
(511) 09

(260) AM 2023 119236 A
(800) 1680607
(151) 2022 07 08
(181) 2032 07 08
(891) 2022 07 08
(511) 03

(260) AM 2023 119226 A
(800) 1680271
(151) 2022 07 13
(181) 2032 07 13
(891) 2022 07 13
(511) 20

(260) AM 2023 119237 A
(800) 1680615
(151) 2022 06 27
(181) 2032 06 27
(891) 2022 06 27
(511) 09

(260) AM 2023 119227 A
(800) 1680281
(151) 2022 04 06
(181) 2032 04 06
(891) 2022 04 06
(511) 07, 11

(260) AM 2023 119238 A
(800) 1680641
(151) 2022 04 14
(181) 2032 04 14
(891) 2022 04 14
(511) 09, 28, 41

(260) AM 2023 119228 A
(800) 1680300
(151) 2022 01 27
(181) 2032 01 27
(891) 2022 01 27
(511) 06, 17, 20, 35

(260) AM 2023 119239 A
(800) 1680664
(151) 2022 07 27
(181) 2032 07 27
(891) 2022 07 27
(511) 05

(260) AM 2023 119229 A
(800) 1680305
(151) 2022 02 08
(181) 2032 02 08
(891) 2022 02 08
(511) 09, 14, 18, 25

(260) AM 2023 119240 A
(800) 1680724
(151) 2022 04 11
(181) 2032 04 11
(891) 2022 04 11
(511) 09, 35, 38

(260) AM 2023 119230 A
(800) 1680317
(151) 2022 04 04
(181) 2032 04 04
(891) 2022 04 04
(511) 07, 11

(260) AM 2023 119241 A
(800) 1680734
(151) 2022 05 05
(181) 2032 05 05
(891) 2022 05 05
(511) 30

(260) AM 2023 119242 A
(800) 1680741
(151) 2022 06 17
(181) 2032 06 17
(891) 2022 06 17
(511) 12, 25, 36, 37

(260) AM 2023 119251 A
(800) 1680989
(151) 2022 06 20
(181) 2032 06 20
(891) 2022 06 20
(511) 34

(260) AM 2023 119244 A
(800) 1680789
(151) 2022 08 04
(181) 2032 08 04
(891) 2022 08 04
(511) 03, 35

(260) AM 2023 119252 A
(800) 1680999
(151) 2022 07 20
(181) 2032 07 20
(891) 2022 07 20
(511) 34

(260) AM 2023 119245 A
(800) 1680829
(151) 2022 07 22
(181) 2032 07 22
(891) 2022 07 22
(511) 30

(260) AM 2023 119253 A
(800) 1681041
(151) 2022 02 01
(181) 2032 02 01
(891) 2022 02 01
(511) 07, 09, 11, 12

(260) AM 2023 119246 A
(800) 1680856
(151) 2022 07 22
(181) 2032 07 22
(891) 2022 07 22
(511) 30

(260) AM 2023 119255 A
(800) 954515
(151) 2007 08 28
(181) 2027 08 28
(891) 2022 07 08
(511) 09, 18, 25, 28

(260) AM 2023 119247 A
(800) 1680865
(151) 2022 06 21
(181) 2032 06 21
(891) 2022 06 21
(511) 39

(260) AM 2023 119256 A
(800) 1281853
(151) 2015 10 22
(181) 2025 10 22
(891) 2022 08 15
(511) 25

(260) AM 2023 119248 A
(800) 1680900
(151) 2022 06 07
(181) 2032 06 07
(891) 2022 06 07
(511) 05, 10, 35, 42, 44

(260) AM 2023 119306 A
(800) 1681374
(151) 2022 07 13
(181) 2032 07 13
(891) 2022 07 13
(511) 29, 30, 31, 32, 35, 39, 43

(260) AM 2023 119250 A
(800) 1680957
(151) 2022 06 06
(181) 2032 06 06
(891) 2022 06 06
(511) 34

(260) AM 2023 119307 A
(800) 1681394
(151) 2022 03 25
(181) 2032 03 25
(891) 2022 03 25
(511) 29, 31, 40

(260) AM 2023 119308 A
(800) 1681465
(151) 2022 06 01
(181) 2032 06 01
(891) 2022 06 01
(511) 29, 30, 31, 39, 40

(260) AM 2023 119326 A
(800) 1681853
(151) 2022 03 29
(181) 2032 03 29
(891) 2022 03 29
(511) 14

(260) AM 2023 119309 A
(800) 1681471
(151) 2022 04 07
(181) 2032 04 07
(891) 2022 04 07
(511) 09, 28, 41

(260) AM 2023 119327 A
(800) 1681862
(151) 2022 04 27
(181) 2032 04 27
(891) 2022 04 27
(511) 43

(260) AM 2023 119312 A
(800) 1681494
(151) 2022 06 06
(181) 2032 06 06
(891) 2022 06 06
(511) 35, 39, 43

(260) AM 2023 119328 A
(800) 1681867
(151) 2022 07 29
(181) 2032 07 29
(891) 2022 07 29
(511) 25

(260) AM 2023 119313 A
(800) 1681595
(151) 2022 03 18
(181) 2032 03 18
(891) 2022 03 18
(511) 03, 07, 09, 11, 21, 30, 35, 37, 39, 41, 42, 43

(260) AM 2023 119329 A
(800) 1681927
(151) 2022 04 15
(181) 2032 04 15
(891) 2022 04 15
(511) 30

(260) AM 2023 119315 A
(800) 1681629
(151) 2022 05 18
(181) 2032 05 18
(891) 2022 05 18
(511) 09, 41

(260) AM 2023 119330 A
(800) 1681943
(151) 2022 04 14
(181) 2032 04 14
(891) 2022 04 14
(511) 09, 28, 41

(260) AM 2023 119317 A
(800) 1681736
(151) 2022 08 03
(181) 2032 08 03
(891) 2022 08 03
(511) 09, 10

(260) AM 2023 119332 A
(800) 1682037
(151) 2021 12 22
(181) 2031 12 22
(891) 2021 12 22
(511) 03, 08, 10, 35

(260) AM 2023 119318 A
(800) 1681750
(151) 2021 12 03
(181) 2031 12 03
(891) 2021 12 03
(511) 31

(260) AM 2023 119333 A
(800) 1682049
(151) 2022 04 07
(181) 2032 04 07
(891) 2022 04 07
(511) 09, 28, 41

(260) AM 2023 119334 A
 (800) 1682057
 (151) 2022 05 31
 (181) 2032 05 31
 (891) 2022 05 31
 (511) 24

(260) AM 2023 119415 A
 (800) 1683264
 (151) 2022 06 17
 (181) 2032 06 17
 (891) 2022 06 17
 (511) 35, 39

(260) AM 2023 119335 A
 (800) 1682109
 (151) 2022 05 30
 (181) 2032 05 30
 (891) 2022 05 30
 (511) 34

(260) AM 2023 119441 A
 (800) 1683978
 (151) 2022 07 18
 (181) 2032 07 18
 (891) 2022 07 18
 (511) 42

(260) AM 2023 119336 A
 (800) 883951
 (151) 2006 02 13
 (181) 2026 02 13
 (891) 2022 07 27
 (511) 20

(260) AM 2023 119442 A
 (800) 1683994
 (151) 2022 08 02
 (181) 2032 08 02
 (891) 2022 08 02
 (511) 09

(260) AM 2023 119337 A
 (800) 1318840
 (151) 2016 07 07
 (181) 2026 07 07
 (891) 2022 08 10
 (511) 35, 37

(260) AM 2023 119444 A
 (800) 1684017
 (151) 2022 07 25
 (181) 2032 07 25
 (891) 2022 07 25
 (511) 10

(260) AM 2023 119338 A
 (800) 1328606
 (151) 2016 10 10
 (181) 2026 10 10
 (891) 2022 08 18
 (511) 35, 43

(260) AM 2023 119445 A
 (800) 1684018
 (151) 2022 07 25
 (181) 2032 07 25
 (891) 2022 07 25
 (511) 10

(260) AM 2023 119340 A
 (800) 1437252
 (151) 2018 09 28
 (181) 2028 09 28
 (891) 2022 07 24
 (511) 14

(260) AM 2023 119447 A
 (800) 1684033
 (151) 2022 08 12
 (181) 2032 08 12
 (891) 2022 08 12
 (511) 05

(260) AM 2023 119414 A
 (800) 1683183
 (151) 2021 11 17
 (181) 2031 11 17
 (891) 2021 11 17
 (511) 09, 17

(260) AM 2023 119448 A
 (800) 1684046
 (151) 2022 02 02
 (181) 2032 02 02
 (891) 2022 02 02
 (511) 09, 11, 38, 42, 45

(260) AM 2023 119462 A
(800) 1684120
(151) 2022 08 12
(181) 2032 08 12
(891) 2022 08 12
(511) 03

(260) AM 2023 119517 A
(800) 1684364
(151) 2022 08 04
(181) 2032 08 04
(891) 2022 08 04
(511) 05

(260) AM 2023 119463 A
(800) 1684133
(151) 2022 06 29
(181) 2032 06 29
(891) 2022 06 29
(511) 07, 11, 20

(260) AM 2023 119518 A
(800) 1684369
(151) 2022 06 01
(181) 2032 06 01
(891) 2022 06 01
(511) 24

(260) AM 2023 119464 A
(800) 485009
(151) 1984 04 11
(181) 2024 04 11
(891) 2022 08 30
(511) 03

(260) AM 2023 119521 A
(800) 1684417
(151) 2022 04 07
(181) 2032 04 07
(891) 2022 04 07
(511) 09, 28, 41

(260) AM 2023 119465 A
(800) 511597
(151) 1986 12 18
(181) 2026 12 18
(891) 2022 09 01
(511) 03

(260) AM 2023 119523 A
(800) 1684477
(151) 2022 03 14
(181) 2032 03 14
(891) 2022 03 14
(511) 09, 37, 38, 42

(260) AM 2023 119514 A
(800) 1684257
(151) 2022 08 04
(181) 2032 08 04
(891) 2022 08 04
(511) 10

(260) AM 2023 119524 A
(800) 1684485
(151) 2022 06 10
(181) 2032 06 10
(891) 2022 06 10
(511) 10

(260) AM 2023 119515 A
(800) 1684298
(151) 2022 07 07
(181) 2032 07 07
(891) 2022 07 07
(511) 35, 39

(260) AM 2023 119543 A
(800) 1685193
(151) 2022 08 10
(181) 2032 08 10
(891) 2022 08 10
(511) 05

(260) AM 2023 119516 A
(800) 1684299
(151) 2022 06 29
(181) 2032 06 29
(891) 2022 06 29
(511) 01

(260) AM 2023 119544 A
(800) 1685194
(151) 2022 08 10
(181) 2032 08 10
(891) 2022 08 10
(511) 05

(260) AM 2023 119545 A
(800) 1685195
(151) 2022 08 10
(181) 2032 08 10
(891) 2022 08 10
(511) 05

(260) AM 2023 119552 A
(800) 1685390
(151) 2022 07 13
(181) 2032 07 13
(891) 2022 07 13
(511) 36, 41, 45

(260) AM 2023 119546 A
(800) 1685196
(151) 2022 08 10
(181) 2032 08 10
(891) 2022 08 10
(511) 05

(260) AM 2023 119547 A
(800) 1685201
(151) 2022 08 30
(181) 2032 08 30
(891) 2022 08 30
(511) 01

(260) AM 2023 119548 A
(800) 1685215
(151) 2022 05 31
(181) 2032 05 31
(891) 2022 05 31
(511) 12, 37

(260) AM 2023 119549 A
(800) 1685258
(151) 2022 08 24
(181) 2032 08 24
(891) 2022 08 24
(511) 32

(260) AM 2023 119550 A
(800) 1685344
(151) 2022 07 21
(181) 2032 07 21
(891) 2022 07 21
(511) 25, 35

(260) AM 2023 119551 A
(800) 1685387
(151) 2022 05 05
(181) 2032 05 05
(891) 2022 05 05
(511) 01

APPELLATION OF ORIGIN OF GOODS

APPELLATION OF ORIGIN OF GOODS FILED IN GEORGIA FOR EXAMINATION UNDER LISBON AGREEMENT, ON THE BASIS OF THE INTERNATIONAL REGISTRATION

The decision can be appealed at the Chamber of Appeal of Sakpatenti within 3 months from the publication or at the Mtskheta District Court Administrative Cases Board (Address: №17, Samkhedro St., Mtskheta), within 1 month following the publication.

(210) 3536

(800) 1282

(151) 2022 07 20

(731) Cooperative Company 3580 supplying the needs of Bijar Slim Carpets

The cities of Sanandaj, Bijar, Qorveh, Saqez, Kamyaran, Dehgolan, Marivan, Divandareh,
located in Kurdistan Province, Iran;

Iran Carpet Company, Bijar Branch

The cities of Sanandaj, Bijar, Qorveh, Saqez, Kamyaran, Dehgolan, Marivan, Divandareh,
located in Kurdistan Province, Iran;

Iran Carpet Company, Sanandaj Branch

The cities of Sanandaj, Bijar, Qorveh, Saqez, Kamyaran, Dehgolan, Marivan, Divandareh,
located in Kurdistan Province, Iran;

Union of Carpet Sellers and Carpet Weavers of Bijar City

The cities of Sanandaj, Bijar, Qorveh, Saqez, Kamyaran, Dehgolan, Marivan, Divandareh,
located in Kurdistan Province, Iran;

Union of Kurdistan Handwoven Carpet Cooperatives

The cities of Sanandaj, Bijar, Qorveh, Saqez, Kamyaran, Dehgolan, Marivan, Divandareh,
located in Kurdistan Province, Iran;

Union of Rural Handwoven Carpet Cooperatives of Kurdistan Province

The cities of Sanandaj, Bijar, Qorveh, Saqez, Kamyaran, Dehgolan, Marivan, Divandareh,
located in Kurdistan Province, Iran;

Union of Sanandaj Handwoven Carpet Weavers

The cities of Sanandaj, Bijar, Qorveh, Saqez, Kamyaran, Dehgolan, Marivan, Divandareh,
located in Kurdistan Province, Iran

(540) Senneh Handmade Carpet

فرش دستبافت سنه

(511)

27 – Handmade Carpet.

OFFICIAL NOTIFICATIONS

INVENTIONS

RESTORATION OF PATENTS

(21) AP 2009 11397
(11) P 2011 5308 B
(73) LLC "Pharma Start"
(54) MEDICINAL MEANS TRIMETAZIDINE DIHYDROCHLORIDE IN THE FORM OF MATRIX TABLETS
WITH THE PROLONGED ACTION (VARIANTS) AND METHODS FOR ITS RECEPTION (VARIANTS)
DATE OF PATENT LAPSE: 2023 07 31
DATE OF PATENT RESTORATION: 2023 09 11

(21) AP 2008 11722
(11) P 2012 5539 B
(73) Ipsen Consumer Healthcare
(54) FLAVOURED CLAY-BASED THERAPEUTIC COMPOSITION
DATE OF PATENT LAPSE: 2023 08 12
DATE OF PATENT RESTORATION: 2023 09 11

(21) AP 2013 13205
(11) P 2015 6402 B
(73) LLC "Pharma Start"
(54) SOLID DRUG OF SEDATIVE, SPASMOLYTIC AND HYPNOTIC ACTION
DATE OF PATENT LAPSE: 2023 08 23
DATE OF PATENT RESTORATION: 2023 09 11

(21) AP 2013 13661
(11) P 2017 6697 B
(73) Eco D'Gas AS
(54) REFRIGERANT GAS COMPOSITION
DATE OF PATENT LAPSE: 2023 05 08
DATE OF PATENT RESTORATION: 2023 09 11

(21) AP 2021 15794
(11) P 2023 7515 B
(73) Pfizer Inc.
(54) NITRILE-CONTAINING ANTIVIRAL COMPOUNDS
DATE OF PATENT LAPSE: 2023 08 06
DATE OF PATENT RESTORATION: 2023 09 11

LAPSE OF PATENTS WITH THE RIGHT TO RESTORE

(21) AP 2010 11918
(11) P 2011 5341 B
(73) Allied Global Tobacco Limited
(54) CIGARETTES WITHOUT THE FILTER
DATE OF PATENT LAPSE: 2023 08 16
PATENT RESTORATION TERM: 2024 08 16

(21) AP 2010 12620
(11) P 2014 6057 B
(73) Deuteria Beverages LLC
(54) ALCOHOLIC COMPOSITIONS HAVING LOWERED RISK OF ACETALDEHYDEmia
DATE OF PATENT LAPSE: 2023 08 20
PATENT RESTORATION TERM: 2024 08 20

(21) AP 2012 12846
(11) P 2013 5995 B
(73) General Electric Company
(54) METHOD OF CONTAMINATED ADMIXTURE REMOVAL FROM BORON POWDER
DATE OF PATENT LAPSE: 2023 08 24
PATENT RESTORATION TERM: 2024 08 24

(21) AP 2013 13205
(11) P 2015 6402 B
(73) LLC "Pharma Start"
(54) SOLID DRUG OF SEDATIVE, SPASMOLYTIC AND HYPNOTIC ACTION
DATE OF PATENT LAPSE: 2023 08 23
PATENT RESTORATION TERM: 2025 08 23

(21) AP 2013 13761
(11) P 2017 6708 B
(73) Chiesi Farmaceutici S.P.A.
(54) ISOXAZOLIDINE DERIVATIVES
DATE OF PATENT LAPSE: 2023 08 23
PATENT RESTORATION TERM: 2024 08 23

(21) AP 2013 13771
(11) P 2017 6755 B
(73) Paion UK Limited
(54) METHOD FOR ADMINISTERING HYPNOTIC/SEDATIVE AGENT
DATE OF PATENT LAPSE: 2023 08 30
PATENT RESTORATION TERM: 2024 08 30

(21) AP 2018 15281
(11) P 2021 7327 B
(73) H. Lundbeck A/S
(54) SPIROCYCLE COMPOUNDS AND METHODS OF MAKING AND USING SAME
DATE OF PATENT LAPSE: 2023 08 28
PATENT RESTORATION TERM: 2024 08 28

(21) AP 2020 15408
(11) P 2022 7430 B
(73) Jemal Shengelia;
Guram Galogre
(54) METHOD OF MAKING ZEOLITE MODIFIED WITH MANGANESE DIOXIDE CONTAINING
FE₃₊ IONS
DATE OF PATENT LAPSE: 2023 08 14
PATENT RESTORATION TERM: 2024 08 14

(21) AP 2020 15415
(11) P 2021 7297 B
(73) Zaali Patckoria
(54) DESINFACTION ROBOT
DATE OF PATENT LAPSE: 2023 08 21
PATENT RESTORATION TERM: 2024 08 21

(21) AP 2021 15722
(11) P 2022 7450 B
(73) JSC "Zago Techology"
(54) MULTI-DISC INDUCTION GENERATOR WITH POWER REGULATION IN EXCITATION WINDING
DATE OF PATENT LAPSE: 2023 08 23
PATENT RESTORATION TERM: 2024 08 23

(21) AP 2020 15886
(11) P 2023 7512 B
(73) Denis Valentinovich Tyaglin
(54) ENERGY GENERATOR
DATE OF PATENT LAPSE: 2023 08 13
PATENT RESTORATION TERM: 2024 08 13

EXPIRATION OF PATENTS RESTORATION TERM

(21) AP 2014 14100
(11) P 2019 7053 B
(73) Macrogenix Inc.
(54) BI-SPECIFIC MONOVALENT DIABODIES THAT ARE CAPABLE OF BINDING CD123 AND CD3,
AND USES THEROF
DATE OF PATENT LAPSE: 2022 08 20
DATE OF EXPIRATION OF PATENT RESTORATION TERM: 2023 08 20

(21) AP 2014 14103
(11) P 2018 6905 B
(73) Merck Sharp & Dohme Corp.
(54) MODULATION OF TUMOR IMMUNITY
DATE OF PATENT LAPSE: 2022 08 18
DATE OF EXPIRATION OF PATENT RESTORATION TERM: 2023 08 18

(21) AP 2016 14726
(11) P 2020 7182 B
(73) Merck Sharp & Dohme Corp.

(54) CYCLIC DI-NUCLEOTIDE COMPOUNDS AS STING AGONISTS
DATE OF PATENT LAPSE: 2022 08 11
DATE OF EXPIRATION OF PATENT RESTORATION TERM: 2023 08 11

(21) AP 2016 14734
(11) P 2020 7170 B
(73) Les Laboratoires Servier
(54) PHARMACEUTICAL COMPOSITION COMPRISING AN HMG- CoA REDUCTASE INHIBITOR AND
AN ECA INHIBITOR
DATE OF PATENT LAPSE: 2022 08 26
DATE OF EXPIRATION OF PATENT RESTORATION TERM: 2023 08 26

EXPIRATION OF PATENT TERM

(21) AP 2003 8495
(11) P 2010 4914 B
(73) Teimuraz Tchkadua
(54) METHOD AND DEVICE FOR TRANSFER OF MONEY VIA TELECOMMUNICATION NETWORK
DATE OF EXPIRATION OF PATENT: 2023 08 20

UTILITY MODELS RESTORATION OF PATENT

(21) AU 2019 15177
(11) U 2021 2064 Y
(73) LTD "Geo Mulch"
(54) EXCLUSIVE TECHNOLOGY FOR ECOLOGICALLY PURE "BIOORGANIC MULCH" PRODUCTION
DATE OF PATENT LAPSE: 2022 08 26
DATE OF PATENT RESTORATION: 2023 09 11

LAPSE OF PATENT WITH THE RIGHT TO RESTORE

(21) AU 2020 15425
(11) U 2022 2109 Y
(73) Giorgi Zhorzholiani
(54) COASTLINE ANTI-LANDSLIDE FAST CONSTRUCTING WALL
DATE OF PATENT LAPSE: 2023 08 26
PATENT RESTORATION TERM: 2024 08 26

EXPIRATION OF PATENT RESTORATION TERM

(21) AU 2016 14246

(11) U 2017 1944 Y

(73) Zurab Dzneladze;

Berdia Elgujauri;

Guram Iobishvili;

Nani Dzneladze

(54) METHOD FOR IODIZED ENRICH PEKOE (BLACK, GREEN, RED, YELLOW) TEA PRODUCTION

DATE OF PATENT LAPSE: 2022 08 18

DATE OF EXPIRATION OF PATENT RESTORATION TERM: 2023 08 18

DESIGNS

EXTENSION OF TERM OF DESIGNS REGISTRATION

(11) D 2019 802 S

(73) Tamaz Kakhidze (GE)

Didachari St. 17, 6000, Khelvachauri, Batumi, Georgia (GE);

Mirian Kakhidze (GE)

Didachari St. 17, 6000, Khelvachauri, Batumi, Georgia (GE)

(54) GLASS CAN

(28) 1

(24) 2018 08 16

(18) 2028 08 16

(58) 2023 08 24

(11) D 2019 813 S

(73) Zviad Tsikolia (GE)

Ar. Kurdiani St. 6, ap. 73, 0112, Tbilisi, Georgia (GE)

(54) 1.-4. ORNAMENTAL METAL FABRICATIONS

(28) 4

(24) 2018 11 22

(18) 2028 11 22

(58) 2023 08 24

CANCELLATION OF DESIGN REGISTRATION

(11) D 2013 552 S

(73) Nugzar Gogua (GE)

Tsutskiridze Lane 4, 0103, Tbilisi, Georgia (GE)

(54) FLAG POST

(18) 2023 02 13

(58) 2023 08 24

REGISTRATION OF LICENSE AGREEMENT

(11) D 2017 697 S
LICENSEE: LTD "Suntrade"
Varketili-3, 3a m/r., bld. 340, ap. 8, 0141, Tbilisi, Georgia
LICENSE AGREEMENT REGISTRATION NUMBER: 0007
DATE OF REGISTRATION OF THE LICENSE AGREEMENT: 2023 08 29
EFFECTIVE DATE OF THE LICENSE AGREEMENT: 2023 02 01
LICENSE AGREEMENT EXPIRATION DATE: 2028 12 31
LICENSE FORM: Non-Exclusive
TERRITORY OF VALIDITY OF THE LICENSE: Georgia

EXTENSION OF TERM OF INTERNATIONAL DESIGNS REGISTRATION

(11) DM/102055
(73) Balev Eood
blvd. Vladislav Varnenchik No.256 BG-9009 Varna (BG);
BALEV Corporation EOOD
blvd. Vladislav Varnenchik No.260 BG-9009 Varna (BG)
Dimitar Hristov BALEV
Blvd. Vitosha No.137, apt. 17 BG-1408 Sofia (BG)
(15) 2018 07 21
(24) 2018 07 21
(18) 2028 07 21
(28) 7
(28') 7
(54) 1.-2. AIR FRESHENERS [OTHER THAN APPARATUS], 3.-7. PARTS FOR AIR FRESHENERS
[OTHER THAN APPARATUS]

(11) DM/102492
(73) Tolkar Makina Sanayi Ve Ticaret Anonim Şirketi
10036 Sokak No: 6 Aosb Çigli, İzmir (TR)
(15) 2018 08 16
(24) 2018 08 16
(18) 2028 08 16
(28) 2
(28') 2
(54) WASHING MACHINE DRUMS

(11) DM/103 369
(73) Swatch AG (Swatch SA) (Swatch LTD.)
94, Rue Jakob Stämpfli, CH-2502 Biel/Bienne (CH)
(15) 2018 08 28
(24) 2018 08 28
(18) 2028 08 28
(28) 2
(28') 2
(54) 1. DISPLAY SCREEN WITH GRAPHICAL USER INTERFACE, 2. GRAPHICAL USER INTERFACE
FOR DISPLAY PANEL

(11) DM/103 724
(73) Volka Entertainment Limited
3, Kleopatras Street 3042 Limassol (CY)
(15) 2018 10 12
(24) 2018 10 12
(18) 2028 10 12
(28) 1
(28') 1
(54) 1. CUDDLY TOY

(11) DM/70616
(73) Dimitar Hristov Balev
Blvd. Vitosha No. 137, Apt.17, BG-1408 Sofia (BG)
(15) 2008 08 17
(24) 2008 08 17
(18) 2028 08 17
(28) 1
(28') 1
(54) AIR FRESHENER

(11) DM/70624
(73) Swatch AG (Swatch SA) (Swatch LTD.)
Jakob-Stämpfli-Strasse 94, CH-2502 Biel/Bienne (CH)
(15) 2008 08 26
(24) 2008 08 26
(18) 2028 08 26
(28) 7
(28') 7
(54) MONTRES-BRACELETS

(11) DM/81719
(73) Public Joint Stock Company Gazprom Neft
Kab. 2401, Ch.Pom. 1N, Liter A, Dom 3-5, Pochtamtskaya Ulitsa 190000 St Petersburg (RU)
(15) 2013 07 25
(24) 2013 07 25
(18) 2028 07 25
(28) 1
(28') 1
(54) CANISTER

(11) DM/81957
(73) Aebi & Vincent Partner AG
Monbijoustrasse 61, CH-3007 Berne (CH)
(15) 2013 09 19
(24) 2013 09 19
(18) 2028 09 19
(28) 1
(28') 1
(54) DOOR HANDLE

(11) DM/82620
(73) Valentino S.P.A.
Via Turati, 16/18, I-20121 MILANO (IT)
(15) 2013 12 11
(24) 2013 12 11
(18) 2028 12 11
(28) 2
(28') 2
(54) 1.-2. SHOES

(11) DM/82634
(73) Valentino S.P.A.
Via Turati, 16/18, I-20121 Milano (IT)
(15) 2013 12 11
(24) 2013 12 11
(18) 2028 12 11
(28) 1
(28') 1
(54) BAG

(11) DM/83437
(73) Public Joint Stock Company Gazprom Neft
Kab. 2401, Ch.Pom. 1N, Liter A, Dom 3-5, Pochtamskaya Ulitsa 190000 ST PETERSBURG (RU)
(15) 2013 07 25
(24) 2013 07 25
(18) 2028 07 25
(28) 1
(28') 1
(54) CANISTER

TRADEMARKS

EXTENSION OF TERM OF TRADEMARKS REGISTRATION

(111) M 2003 15278 R2

(151) 2003 10 15

(186) 2033 10 15

(732) Nintendo Co. LTD

11-1, Hokotate-cho, Kamitoba, Minami-ku,
Kyoto-shi, Kyoto, Japan

(151) 2014 01 21

(186) 2034 01 21

(732) Marriott Worldwide Corporation

10400 Fernwood Road, Bethesda,
Maryland 20817, USA

(111) M 2003 15293 R2

(151) 2003 10 15

(186) 2033 10 15

(732) Mitsubishi Jidosha Kogyo Kabushiki Kaisha

1-21, Shibaura 3-chome, Minato-ku,
Tokyo 108-8410, Japan

(111) M 2013 24133 R1

(151) 2013 10 17

(186) 2033 10 17

(732) Syngenta Limited

Jealott's Hill International Research Centre,
Bracknell, Berkshire, RG42 6EY, United
Kingdom

(111) M 2013 23970 R1

(151) 2013 09 02

(186) 2033 09 02

(732) LTD "Newspaper Sarbieli"

Al. Kazbegi Av. 42, 0177, Tbilisi, Georgia

(111) M 2013 24111 R1

(151) 2013 09 30

(186) 2033 09 30

(732) The Children's Place Inc.

500 Plaza Drive, Secaucus, New Jersey , USA

(111) M 2013 24184 R1

(151) 2013 10 17

(186) 2033 10 17

(732) Champion Glory Limited

38/f., OnE Kowloon, 1 Wang Yuen Street,
Kowloon Bay, Hong Kong

COMPLETE TRANSFER OF RIGHTS

-
- | | |
|--|---|
| <p>(111) M 2020 32953 R
 (732) Light & Wonder Inc.
 6601 Bermuda Road, Las Vegas,
 Nevada 89119, USA
 (770) SG Gaming Inc.
 6601 Bermuda Road, Las Vegas,
 Nevada 89119, USA
 (580) 2023 08 15</p> | <p>12th km National Road Athens-Lamia, 14452,
 Metamorfofosis, Attica, Greece
 (580) 2023 07 26</p> |
|--|---|
-
- | | |
|--|--|
| <p>(111) M 2020 32954 R
 (732) Light & Wonder Inc.
 6601 Bermuda Road, Las Vegas,
 Nevada 89119, USA
 (770) SG Gaming Inc.
 6601 Bermuda Road, Las Vegas,
 Nevada 89119, USA
 (580) 2023 08 15</p> | <p>(111) M 1996 3508 R
 (732) GSK PSC Poland Sp. z o.o.
 Grunwaldzka 189, 60-322 Poznan, Poland
 (770) Glaxosmithkline Pharmaceuticals Spolka
 Akcyjna Grunwaldzka 189, 60-322 Poznan,
 Poland
 (580) 2023 07 04</p> |
|--|--|
-
- | | |
|--|--|
| <p>(111) M 2020 32955 R
 (732) Light & Wonder Inc.
 6601 Bermuda Road, Las Vegas,
 Nevada 89119, USA
 (770) SG Gaming Inc.
 6601 Bermuda Road, Las Vegas,
 Nevada 89119, USA
 (580) 2023 08 15</p> | <p>(111) M 1996 3509 R
 (732) GSK PSC Poland Sp. z o.o.
 Grunwaldzka 189, 60-322 Poznan, Poland
 (770) Glaxosmithkline Pharmaceuticals Spolka
 Akcyjna Grunwaldzka 189, 60-322 Poznan,
 Poland
 (580) 2023 07 04</p> |
|--|--|
-
- | | |
|--|--|
| <p>(111) M 2014 25497 R
 (732) LTD "ILLI Georgia"
 Beri Gabriel Salosi Av. 139, ap. 10,
 Isani District, Tbilisi, Georgia;
 LTD "იდეგო გრუპი Idego Group"
 Bogdan Khmelitskiy St. 44a, bld. 4, ap. 8,
 Isani-Samgori District, Tbilisi, Georgia
 (770) LTD "იდეგო გრუპი Idego Group"
 Bogdan Khmelitskiy St. 44a, bld. 4, ap. 8,
 Isani-Samgori District, Tbilisi, Georgia
 (580) 2023 07 04</p> | <p>(111) M 2019 31917 R
 (732) LTD "Retail Group"
 Vill. Tserovani, Mtskheta Region,
 Georgia
 (770) Nikoloz Paiashvili
 Zahesi, Andronikashvili St. 143,
 Tbilisi Georgia
 (580) 2023 07 26</p> |
|--|--|
-
- | | |
|---|---|
| <p>(111) M 2016 27852 R
 (732) LTD "Retail Group"
 Vill. Tserovani, Mtskheta Region, Georgia
 (770) Nikoloz Paiashvili
 Varketili 3, IIIa m/r, bld. 338, ap. 173, 0163,
 Tbilisi, Georgia
 (580) 2023 07 26</p> | <p>(111) M 2004 15774 R
 (732) Mondelez Hellas S.A.
 19-21 Aristotelous Street, Metamorfofosi
 Attikis 144 51, Greece
 (770) Mondelez Hellas Snacks Production S.M.S.A.
 12th km National Road Athens-Lamia, 14452,
 Metamorfofosis, Attica, Greece
 (580) 2023 07 26</p> |
|---|---|
-
- | | |
|---|---|
| <p>(111) M 2018 30219 R
 (732) LLC "Folklore Laboratory"
 Village Mtispiri, Ozurgeti Region, Georgia
 (770) LLC "Gemovani"
 Saakadze Descent 6, 8th floor, Tbilisi, Georgia
 (580) 2023 08 04</p> | <p>(111) M 2004 15775 R
 (732) Mondelez Hellas S.A.
 19-21 Aristotelous Street, Metamorfofosi
 Attikis 144 51, Greece
 (770) Mondelez Hellas Snacks Production S.M.S.A.</p> |
|---|---|
-

(111) M 2019 31508 R

(732) Mylan Inc.

1000 Mylan Blvd Canonsburg,
PA 15317, USA

(770) Mylan Pharmaceuticals Private Limited

Plot No. 1-A/2, MIDC Industrial Estate,
Taloja, Panvel, District Raigad, Maharashtra –
410 208, India

(580) 2023 07 26

CHANGES OF NAME AND/OR ADDRESS OF TRADEMARKS OWNERS

(111) M 1998 11305 R

(732) Invista Technologies S.A.R.L.

19 rue du Puits Romain, L-8070 Bertrange, Luxembourg

(770) Invista Technologies S.A.R.L.

2-4, Riu Iujin Ruperti, L-2453 Luqsemburgi, Luxembourg

(580) 2023 07 14

(111) M 2002 14704 R

(732) LTD "Wine Company Shumi"

Leonidze St. 33, Telavi, Georgia

(770) LTD "Wine Company Shumi"

Sulkhan Tsintsadze St. 18, 0160, Tbilisi, Georgia

(580) 2023 08 07

CANCELLATION OF TRADEMARKS REGISTRATION

(111) M 2003 14990 R

(151) 2003 02 12

(732) Unilever N.V.

Weena 455, NL-3013 AL Rotterdam,
Netherlands

(141) 2023 08 24

(111) M 2003 14975 R

(151) 2003 02 12

(732) Balkanfarma Trojan ad

"Krajrechna" 1, Trojan 5600, Bulgaria

(141) 2023 08 24

(111) M 2013 23309 R

(151) 2013 02 12

(732) Harrington Development Inc.

Arango-Orillac Bldg., East 54th street,
Republic of Panama

(141) 2023 08 24

(111) M 2013 23312 R

(151) 2013 02 12

(732) Capricorn Life Sciences B.V.

Traviatastraat 110, 2555 VH Hague,
Netherlands

(141) 2023 08 24

(111) M 2013 23313 R

(151) 2013 02 12

(732) Capricorn Life Sciences B.V.

Traviatastraat 110, 2555 VH Hague,
Netherlands

(141) 2023 08 24

(111) M 2013 23314 R

(151) 2013 02 12

(732) Capricorn Life Sciences B.V.

Traviatastraat 110, 2555 VH Hague,
Netherlands

(141) 2023 08 24

(111) M 2013 23317 R

(151) 2013 02 12

(732) Biogen MA Inc., a Massachusetts Corporation
a Massachusetts Corporation

250 Binney Street, Cambridge, Massachusetts
02142, USA

(141) 2023 08 24

(111) M 2013 23318 R

(151) 2013 02 12

(732) Biogen MA Inc., a Massachusetts Corporation
a Massachusetts Corporation

250 Binney Street, Cambridge, Massachusetts
02142, USA

(141) 2023 08 24

(111) M 2013 23319 R

(151) 2013 02 12

(732) Biogen MA Inc., a Massachusetts Corporation
a Massachusetts Corporation

250 Binney Street, Cambridge, Massachusetts
02142, USA

(141) 2023 08 24

(111) M 2013 23320 R

(151) 2013 02 12

(732) Biogen MA Inc., a Massachusetts Corporation
a Massachusetts Corporation

250 Binney Street, Cambridge, Massachusetts
02142, USA

(141) 2023 08 24

(111) M 2013 23322 R

(151) 2013 02 12

(732) Biogen MA Inc., a Massachusetts Corporation
a Massachusetts Corporation

250 Binney Street, Cambridge, Massachusetts
02142, USA

(141) 2023 08 24

(111) M 2013 23325 R

(151) 2013 02 12

(732) S.A. Infinity LTD Co.

Unit 1111, 11/f Chuangs's Hung Hom Plaza,
83 Wuhu Street Hung Hom, Know loon,
Hong Kong

(141) 2023 08 24

(111) M 2013 23326 R

(151) 2013 02 12

(732) S.A. Infinity LTD Co.

Unit 1111, 11/f Chuangs's Hung Hom Plaza,
83 Wuhu Street Hung Hom, Know loon,
Hong Kong

(141) 2023 08 24

(111) M 2013 23327 R
(151) 2013 02 12
(732) S.A. Infinity LTD Co.
Unit 1111, 11/f Chuangs's Hung Hom Plaza,
83 Wuhu Street Hung Hom, Know loon, China
(141) 2023 08 24

(111) M 2013 23328 R
(151) 2013 02 12
(732) S.A. Infinity LTD Co.
Unit 1111, 11/f Chuangs's Hung Hom Plaza,
83 Wuhu Street Hung Hom, Know loon, China
(141) 2023 08 24

(111) M 2013 23329 R
(151) 2013 02 12
(732) S.A. Infinity LTD Co.
Unit 1111, 11/f Chuangs's Hung Hom Plaza,
83 Wuhu Street Hung Hom, Know loon, China
(141) 2023 08 24

(111) M 2013 23333 R
(151) 2013 02 12
(732) JSC "RMG Cooper"
Vill. Kazreti, 1100, Bolnisi, Georgia
(141) 2023 08 25

(111) M 2013 23336 R
(151) 2013 02 12
(732) Research Investment & Development
S.A.L. (Holdings)
Najjar Building, facing Mar Youssef hospital,
Sad Al bawchrieh, Beirut, Lebanon
(141) 2023 08 24

(111) M 2013 23337 R
(151) 2013 02 12
(732) Harrington Development Inc.
Elivira Mendez Street, Valerino Bldg,
3rd Floor, Panama, Republic of Panama
(141) 2023 08 24

(111) M 2013 23338 R
(151) 2013 02 12
(732) Harrington Development Inc.
Elivira Mendez Street, Valerino Bldg,
3rd Floor, Panama, Republic of Panama
(141) 2023 08 24

(111) M 2013 23342 R
(151) 2013 02 12
(732) British American Tobacco (Brands) Inc.
(a Delaware corporation)
251 Little Falls Drive, Suite 100, Wilmington,
DE 19808-1674, USA
(141) 2023 08 24

(111) M 2013 23343 R
(151) 2013 02 12
(732) British American Tobacco (Brands) Inc.
(a Delaware corporation)
251 Little Falls Drive, Suite 100, Wilmington,
DE 19808-1674, USA
(141) 2023 08 24

(111) M 2013 23344 R
(151) 2013 02 12
(732) British American Tobacco (Brands) Inc.
(a Delaware corporation)
251 Little Falls Drive, Suite 100, Wilmington,
DE 19808-1674, USA
(141) 2023 08 24

(111) M 2013 23351 R
(151) 2013 02 12
(732) LTD "Routeh"
Vazha-Pshavela Av., VI qu., bld. 25/Kavta-
radze St. 17, ap. 17, 0186, Tbilisi, Georgia
(141) 2023 08 24

(111) M 2013 23353 R
(151) 2013 02 12
(732) LTD "Mil-Ari Heorgia"
Sulkhan Tsintsadze St. 3-7, Saburtalo District,
Tbilisi, Georgia
(141) 2023 08 30

INTERNATIONAL LICENSE AGREEMENTS

(800) 1536201

(732) DP Global Group Limited

Vistra Corporate Services Centre, Wickhams

Cay II, Road Town, Tortola, Virgin Islands

(British)

(791) Dodo Brands International DMCC

Number of Blok: 3602-19, Easy Business

Avenue AA1 Plot No: JLTE-PH2-AA1

Jimmera Lakes Towers, Dubai, United

Arab Emirates

(793) №1816

Special

From 05 07 2023 to 02 03 2030

Class: 25, 29, 30, 35, 39,43

(800) 1537267

(732) DP Global Group Limited

Vistra Corporate Services Centre, Wickhams

Cay II, Road Town, Tortola, Virgin Islands

(British)

(791) Dodo Brands International DMCC

Number of Blok: 3602-19, Easy Business

Avenue AA1 Plot No: JLTE-PH2-AA1

Jimmera Lakes Towers, Dubai, United

Arab Emirates

(793) №1817

Special

From 05 07 2023 to 02 03 2030

Class: 9, 29, 30, 35, 39, 43

CLASSIFICATION INDEXES

INVENTIONS

CONCORDANCE TABLE OF INTERNATIONAL CLASSIFICATION INDEX AND PUBLICATION NUMBERS

INTERNATIONAL CLASSIFICATION INDEXES (51)	NUMBER OF PUBLISHED APPLICATION (10)
A 61 K 31/47; A 61 P 35/00; C 07 D 215/48	AP 2023 15695 A
A 61 K 31/7076; C 07 H 19/16	AP 2023 15999 A
A 61 K 45/00; A 61 K 48/00; A 61 K 31/7105; A 61 K 39/00; A 61 K 39/395; A 61 P 7/00	AP 2023 15070 A
A 61 K 45/06; A 61 K 39/395; C 07 K 16/40	AP 2023 15019 A
C 08 B 37/10	AP 2023 15747 A

CONCORDANCE TABLE OF PUBLICATION NUMBERS AND INTERNATIONAL CLASSIFICATION INDEX

NUMBER OF PUBLISHED APPLICATION (10)	INTERNATIONAL CLASSIFICATION INDEXES (51)
AP 2023 15019 A	A 61 K 45/06; A 61 K 39/395; C 07 K 16/40
AP 2023 15070 A	A 61 K 45/00; A 61 K 48/00; A 61 K 31/7105; A 61 K 39/00; A 61 K 39/395; A 61 P 7/00
AP 2023 15695 A	A 61 K 31/47; A 61 P 35/00; C 07 D 215/48
AP 2023 15747 A	C 08 B 37/10
AP 2023 15999 A	A 61 K 31/7076; C 07 H 19/16

CONCORDANCE TABLE OF INTERNATIONAL CLASSIFICATION INDEX, PATENT NUMBERS AND PUBLICATION NUMBERS

INTERNATIONAL CLASSIFICATION INDEX (51)	NUMBER OF PATENT (11)	NUMBER OF PUBLISHED APPLICATION (10)
A 01 G 7/00	P 2023 7540 B	AP 2023 15983 A
A 24 F 1/30	P 2023 7535 B	AP 2023 15741 A
A 61 K 47/26; A 61 K 39/12; A 61 K 9/14; A 61 K 9/00	P 2023 7539 B	AP 2023 15384 A
A 61 K 31/397; A 61 P 25/18; C 07 D 471/04; C 07 D 491/107	P 2023 7534 B	AP 2023 15557 A
A 61 K 39/395; A 61 K 39/00; C 07 K 16/00	P 2023 7538 B	AP 2023 15864 A
B 66 C 1/10	P 2023 7536 B	AP 2023 15737 A
F 01 N 3/00	P 2023 7537 B	AP 2023 15686 A

**CONCORDANCE TABLE OF PATENT NUMBERS,
PUBLICATION NUMBERS AND INTERNATIONAL CLASSIFICATION INDEX**

NUMBER OF PATENT (11)	NUMBER OF PUBLISHED APPLICATION (10)	INTERNATIONAL CLASSIFICATION INDEX (51)
P 2023 7534 B	AP 2023 15557 A	A 61 K 31/397; A 61 P 25/18; C 07 D 471/04; C 07 D 491/107
P 2023 7535 B	AP 2023 15741 A	A 24 F 1/30
P 2023 7536 B	AP 2023 15737 A	B 66 C 1/10
P 2023 7537 B	AP 2023 15686 A	F 01 N 3/00
P 2023 7538 B	AP 2023 15864 A	A 61 K 39/395; A 61 K 39/00; C 07 K 16/00
P 2023 7539 B	AP 2023 15384 A	A 61 K 47/26; A 61 K 39/12; A 61 K 9/14; A 61 K 9/00
P 2023 7540 B	AP 2023 15983 A	A 01 G 7/00

**CONCORDANCE TABLE OF APPLICATION NUMBERS,
PUBLICATION NUMBERS AND PATENTS**

NUMBER OF APPLICATION (21)	NUMBER OF PUBLISHED APPLICATION (10)	NUMBER OF PATENT (11)
AP 2018 15384	AP 2023 15384 A	P 2023 7539 B
AP 2019 15557	AP 2023 15557 A	P 2023 7534 B
AP 2021 15686	AP 2023 15686 A	P 2023 7537 B
AP 2019 15737	AP 2023 15737 A	P 2023 7536 B
AP 2020 15741	AP 2023 15741 A	P 2023 7535 B
AP 2016 15864	AP 2023 15864 A	P 2023 7538 B
AP 2022 15983	AP 2023 15983 A	P 2023 7540 B

APPLICATION***

**CONCORDANCE TABLE OF INTERNATIONAL CLASSIFICATION INDEX
AND PUBLICATION NUMBERS**

INTERNATIONAL CLASSIFICATION INDEXES (51)	NUMBER OF PUBLISHED APPLICATION (10)
A 61 K 31/137; A 61 K 31/42; A 61 K 31/506; A 61 K 31/551; A 61 K 31/7008; A 61 K 45/06	AP 2023 16320 A
A 61 K 31/496; A 61 P 9/10; C 07 D 401/04	AP 2023 16286 A
A 61 K 31/496; A 61 P 11/00; A 61 P 13/12; A 61 P 7/00; A 61 P 9/00; C 07 D 401/04	AP 2023 16287 A
A 61 K 31/7076; A 61 P 31/14; C 07 H 19/207	AP 2023 16298 A

**CONCORDANCE TABLE OF PUBLICATION NUMBERS
AND INTERNATIONAL CLASSIFICATION INDEX**

NUMBER OF PUBLISHED APPLICATION (10)	INTERNATIONAL CLASSIFICATION INDEXES (51)
AP 2023 16286 A	A 61 K 31/496; A 61 P 9/10; C 07 D 401/04
AP 2023 16287 A	A 61 K 31/496; A 61 P 11/00; A 61 P 13/12; A 61 P 7/00; A 61 P 9/00; C 07 D 401/04
AP 2023 16298 A	A 61 K 31/7076; A 61 P 31/14; C 07 H 19/207
AP 2023 16320 A	A 61 K 31/137; A 61 K 31/42; A 61 K 31/506; A 61 K 31/551; A 61 K 31/7008; A 61 K 45/06

DESIGNS

**CONCORDANCE TABLE OF INTERNATIONAL CLASSIFICATION INDEX
AND PUBLICATION NUMBERS**

INTERNATIONAL CLASSIFICATION INDEXES (51)	NUMBER OF PUBLISHED APPLICATION (10)
07-02	AD 2023 1305 S
11-01	AD 2023 1303 S

**CONCORDANCE TABLE OF PUBLICATION NUMBERS
AND INTERNATIONAL CLASSIFICATION INDEX**

NUMBER OF PUBLISHED APPLICATION (10)	INTERNATIONAL CLASSIFICATION INDEXES (51)
AD 2023 1303 S	11-01
AD 2023 1305 S	07-02

DESIGN REGISTERED ACCORDING TO THE ACCELERATED
PROCEDURE

CONCORDANCE TABLE OF INTERNATIONAL CLASSIFICATION INDEX
AND PUBLICATION NUMBERS

INTERNATIONAL CLASSIFICATION INDEXES (51)	NUMBER OF REGISTRATION (11)
02-04	D 2023 978 S

CONCORDANCE TABLE OF PUBLICATION NUMBERS
AND INTERNATIONAL CLASSIFICATION INDEX

NUMBER OF REGISTRATION (11)	INTERNATIONAL CLASSIFICATION INDEXES (51)
D 2023 978 S	02-04

CONCORDANCE TABLE OF APPLICATION NUMBERS,
PUBLICATION NUMBERS AND PATENTS

NUMBER OF APPLICATION (21)	NUMBER OF REGISTRATION (11)
AD 2023 1322	D 2023 978 S

TRADEMARKS

CONCORDANCE TABLE OF REGISTRATION NUMBERS, APPLICATION NUMBERS, PUBLICATION NUMBERS AND BULLETIN NUMBERS

NUMBER OF REGISTRATION (111)	NUMBER OF APPLICATIONS (210)	NUMBER OF PUBLISHED APPLICATIONS (260)	NUMBER OF BULLETIN
M 2023 37207 R	AM 119786	AM 2023 119786 A	9(612)2023
M 2023 37208 R	AM 122200	–	17(620)2023
M 2023 37209 R	AM 119706	AM 2023 119706 A	9(612)2023
M 2023 37210 R	AM 117545	AM 2023 117545 A	8(611)2023
M 2023 37211 R	AM 119704	AM 2023 119704 A	9(612)2023
M 2023 37212 R	AM 119703	AM 2023 119703 A	9(612)2023
M 2023 37213 R	AM 119206	AM 2023 119206 A	8(611)2023
M 2023 37214 R	AM 117806	AM 2023 117806 A	3(606)2023
M 2023 37215 R	AM 118737	AM 2023 118737 A	3(606)2023
M 2023 37216 R	AM 118850	AM 2023 118850 A	5(608)2023
M 2023 37217 R	AM 118469	AM 2023 118469 A	5(608)2023
M 2023 37218 R	AM 119271	AM 2023 119271 A	7(610)2023
M 2023 37219 R	AM 124055	–	17(620)2023
M 2023 37220 R	AM 123502	–	17(620)2023
M 2023 37221 R	AM 124311	–	17(620)2023
M 2023 37222 R	AM 124301	–	17(620)2023
M 2023 37223 R	AM 124300	–	17(620)2023
M 2023 37224 R	AM 124148	–	17(620)2023
M 2023 37225 R	AM 124120	–	17(620)2023
M 2023 37226 R	AM 124244	–	17(620)2023
M 2023 37227R	AM 124169	–	17(620)2023
M 2023 37228 R	AM 124170	–	17(620)2023
M 2023 37229 R	AM 124032	–	17(620)2023
M 2023 37230 R	AM 124231	–	17(620)2023
M 2023 37231 R	AM 124230	–	17(620)2023
M 2023 37232 R	AM 124229	–	17(620)2023
M 2023 37233 R	AM 124114	–	17(620)2023
M 2023 37234 R	AM 124316	–	17(620)2023
M 2023 37235 R	AM 124302	–	17(620)2023
M 2023 37236 R	AM 124129	–	17(620)2023
M 2023 37237 R	AM 124416	–	17(620)2023
M 2023 37238 R	AM 124046	–	17(620)2023
M 2023 37239 R	AM 124343	–	17(620)2023
M 2023 37240 R	AM 124307	–	17(620)2023
M 2023 37241 R	AM 124041	–	17(620)2023
M 2023 37242 R	AM 124354	–	17(620)2023
M 2023 37243 R	AM 124502	–	17(620)2023
M 2023 37244 R	AM 124422	–	17(620)2023

CONCORDANCE TABLE OF PUBLICATION NUMBERS
AND APPLICATION NUMBERS

NUMBER OF PUBLISHED APPLICATION (260)	NUMBER OF APPLICATION (210)	1	2
1	2	AM 2023 121345 A	AM 121345
AM 2023 119366 A	AM 119366	AM 2023 121347 A	AM 121347
AM 2023 120605 A	AM 120605	AM 2023 121351 A	AM 121351
AM 2023 120704 A	AM 120704	AM 2023 121414 A	AM 121414
AM 2023 120830 A	AM 120830	AM 2023 121415 A	AM 121415
AM 2023 120831 A	AM 120831	AM 2023 121416 A	AM 121416
AM 2023 121120 A	AM 121120	AM 2023 121418 A	AM 121418
AM 2023 121121 A	AM 121121	AM 2023 121419 A	AM 121419
AM 2023 121143 A	AM 121143	AM 2023 121423 A	AM 121423
AM 2023 121153 A	AM 121153	AM 2023 121424 A	AM 121424
AM 2023 121156 A	AM 121156	AM 2023 121430 A	AM 121430
AM 2023 121217 A	AM 121217	AM 2023 121435 A	AM 121435
AM 2023 121218 A	AM 121218	AM 2023 121436 A	AM 121436
AM 2023 121221 A	AM 121221	AM 2023 121502 A	AM 121502
AM 2023 121222 A	AM 121222	AM 2023 121507 A	AM 121507
AM 2023 121223 A	AM 121223	AM 2023 121516 A	AM 121516
AM 2023 121232 A	AM 121232	AM 2023 121517 A	AM 121517
AM 2023 121239 A	AM 121239	AM 2023 121521 A	AM 121521
AM 2023 121241 A	AM 121241	AM 2023 121527 A	AM 121527
AM 2023 121244 A	AM 121244	AM 2023 121528 A	AM 121528
AM 2023 121298 A	AM 121298	AM 2023 121532 A	AM 121532
AM 2023 121300 A	AM 121300	AM 2023 121632 A	AM 121632
AM 2023 121308 A	AM 121308	AM 2023 121636 A	AM 121636
AM 2023 121309 A	AM 121309	AM 2023 121640 A	AM 121640
AM 2023 121310 A	AM 121310	AM 2023 121650 A	AM 121650
AM 2023 121311 A	AM 121311	AM 2023 121666 A	AM 121666
AM 2023 121317 A	AM 121317	AM 2023 121668 A	AM 121668
AM 2023 121321 A	AM 121321	AM 2023 121670 A	AM 121670
AM 2023 121322 A	AM 121322	AM 2023 121721 A	AM 121721
AM 2023 121336 A	AM 121336	AM 2023 121722 A	AM 121722
AM 2023 121337 A	AM 121337	AM 2023 121725 A	AM 121725
AM 2023 121338 A	AM 121338	AM 2023 121730 A	AM 121730
AM 2023 121340 A	AM 121340	AM 2023 121732 A	AM 121732
AM 2023 121341 A	AM 121341	AM 2023 121735 A	AM 121735
AM 2023 121343 A	AM 121343	AM 2023 121736 A	AM 121736
		AM 2023 121741 A	AM 121741
		AM 2023 121760 A	AM 121760
		AM 2023 121772 A	AM 121772

CONCORDANCE TABLE OF INDEX OF GOODS AND/OR SERVICES
AND APPLICATION NUMBERS

INDEX OF GOODS AND/OR SERVICES (511)	NUMBER OF PUBLISHED APPLICATIONS (260)	1	2
1	2	30	AM 2023 121156 A
1	AM 2023 121772 A	30	AM 2023 121232 A
3	AM 2023 120605 A	30	AM 2023 121298 A
3	AM 2023 121143 A	30	AM 2023 121521 A
3	AM 2023 121153 A	30	AM 2023 121760 A
3	AM 2023 121336 A	31	AM 2023 121232 A
3	AM 2023 121337 A	31	AM 2023 121321 A
3	AM 2023 121338 A	32	AM 2023 120704 A
5	AM 2023 121156 A	32	AM 2023 120830 A
5	AM 2023 121222 A	32	AM 2023 120831 A
5	AM 2023 121223 A	32	AM 2023 121300 A
5	AM 2023 121321 A	32	AM 2023 121317 A
5	AM 2023 121345 A	32	AM 2023 121322 A
7	AM 2023 121217 A	32	AM 2023 121721 A
7	AM 2023 121725 A	33	AM 2023 120704 A
8	AM 2023 121725 A	33	AM 2023 121143 A
9	AM 2023 121340 A	33	AM 2023 121239 A
9	AM 2023 121414 A	33	AM 2023 121241 A
9	AM 2023 121418 A	33	AM 2023 121244 A
9	AM 2023 121532 A	33	AM 2023 121311 A
9	AM 2023 121722 A	33	AM 2023 121317 A
11	AM 2023 121725 A	33	AM 2023 121430 A
12	AM 2023 121343 A	33	AM 2023 121632 A
12	AM 2023 121419 A	33	AM 2023 121650 A
14	AM 2023 121336 A	33	AM 2023 121721 A
14	AM 2023 121337 A	33	AM 2023 121730 A
14	AM 2023 121338 A	33	AM 2023 121735 A
14	AM 2023 121436 A	34	AM 2023 121423 A
16	AM 2023 121418 A	34	AM 2023 121424 A
16	AM 2023 121666 A	34	AM 2023 121640 A
16	AM 2023 121668 A	35	AM 2023 121153 A
16	AM 2023 121722 A	35	AM 2023 121156 A
18	AM 2023 121300 A	35	AM 2023 121221 A
18	AM 2023 121336 A	35	AM 2023 121300 A
18	AM 2023 121337 A	35	AM 2023 121336 A
18	AM 2023 121338 A	35	AM 2023 121337 A
20	AM 2023 121347 A	35	AM 2023 121338 A
21	AM 2023 121436 A	35	AM 2023 121423 A
25	AM 2023 121300 A	35	AM 2023 121424 A
25	AM 2023 121336 A	35	AM 2023 121436 A
25	AM 2023 121507 A	35	AM 2023 121507 A
25	AM 2023 121666 A	35	AM 2023 121650 A
25	AM 2023 121666 A	35	AM 2023 121666 A
25	AM 2023 121666 A	35	AM 2023 121668 A
25	AM 2023 121666 A	35	AM 2023 121722 A
28	AM 2023 121418 A	35	AM 2023 121730 A
28	AM 2023 121666 A	35	AM 2023 121732 A
29	AM 2023 121143 A	35	AM 2023 121736 A
29	AM 2023 121232 A	35	AM 2023 121736 A
29	AM 2023 121415 A	35	AM 2023 121760 A
29	AM 2023 121416 A	36	AM 2023 121308 A
29	AM 2023 121435 A	36	AM 2023 121351 A
		36	AM 2023 121414 A

1	2	1	2
36	AM 2023 121666 A	41	AM 2023 121517 A
36	AM 2023 121668 A	41	AM 2023 121666 A
36	AM 2023 121670 A	42	AM 2023 121340 A
37	AM 2023 121351 A	42	AM 2023 121414 A
37	AM 2023 121636 A	43	AM 2023 121120 A
38	AM 2023 119366 A	43	AM 2023 121121 A
38	AM 2023 121666 A	43	AM 2023 121143 A
38	AM 2023 121722 A	43	AM 2023 121244 A
39	AM 2023 121218 A	43	AM 2023 121309 A
39	AM 2023 121232 A	43	AM 2023 121310 A
39	AM 2023 121666 A	43	AM 2023 121502 A
39	AM 2023 121741 A	43	AM 2023 121527 A
41	AM 2023 119366 A	43	AM 2023 121528 A
41	AM 2023 121340 A	44	AM 2023 121516 A
41	AM 2023 121341 A	44	AM 2023 121517 A
41	AM 2023 121418 A	44	AM 2023 121666 A

**CONCORDANCE TABLE OF INDEX OF GOODS AND/OR SERVICES
AND NUMBERS OF TRADEMARKS REGISTERED ACCORDING
TO THE ACCELERATED PROCEDURE**

INDEX OF GOODS AND/OR SERVICES (511)	NUMBERS OF REGISTERED ACCORDING TO THE ACCELERATED PROCEDURE (111)
1	2
14	M 2023 37225 R
25	M 2023 37222 R
25	M 2023 37223 R
25	M 2023 37225 R
29	M 2023 37220 R
29	M 2023 37227 R
29	M 2023 37228 R
30	M 2023 37221 R
30	M 2023 37227 R
30	M 2023 37228 R
32	M 2023 37244 R
33	M 2023 37229 R
33	M 2023 37230 R
33	M 2023 37231 R
33	M 2023 37232 R
33	M 2023 37233 R
33	M 2023 37241 R
35	M 2023 37208 R
35	M 2023 37234 R
36	M 2023 37224 R
36	M 2023 37236 R
36	M 2023 37238 R
36	M 2023 37239 R
36	M 2023 37242 R
39	M 2023 37226 R
39	M 2023 37227 R
39	M 2023 37228 R

1	2
41	M 2023 37235 R
41	M 2023 37237 R
41	M 2023 37238 R
41	M 2023 37243 R
42	M 2023 37219 R
42	M 2023 37227 R
42	M 2023 37228 R
43	M 2023 37227 R
43	M 2023 37228 R
43	M 2023 37240 R
45	M 2023 37238 R

OFFICIAL BULLETIN OF THE INDUSTRIAL PROPERTY

INVENTIONS

DESIGNS

TRADEMARKS

APPELLATION OF ORIGIN OF GOODS

17(620)

EDITOR-IN-CHIEF: N. Bebrishvili

EDITOR-TRANSLATOR: E. Gabunia

PROOFREADER: A. Shikhashvili

COMPUTER LAYOUT: M. Ordenidze
K. Svanidze

ISSN 2720-8486

info@sakpatenti.gov.ge
www.sakpatenti.gov.ge