



**NATIONAL INTELLECTUAL PROPERTY CENTER OF GEORGIA  
SAKPATENTI**

**OFFICIAL BULLETIN  
OF THE INDUSTRIAL PROPERTY**

**19(479)**

**2017  
TBILISI**

# INID CODES FOR IDENTIFICATION OF BIBLIOGRAPHIC DATA

## INVENTIONS, UTILITY MODELS

- (10) Number of publication for application, which has been examined
- (11) Number of patent and kind of document
- (21) Serial number of application
- (22) Date of filing of the application
- (23) Date of exhibition or the date of the earlier filing and the number of application, if any
- (24) Date from which patent may have effect
- (31) Number of priority application
- (32) Date of filing of priority application
- (33) Code of the country or regional organization allotting priority application number
- (44) Date of publication of application not granted, but examined and number of bulletin
- (45) Date of publication of registered document
- (51) International Patent Classification Index
- (54) Title of the invention
- (57) Abstract
- (60) Number of examined patent document granted by foreign patent office, date from which patent has effect and country code
- (62) Number of the earlier application and in case of divided application, date of filing an application
- (71) Name, surname and address of applicant (country code)
- (72) Name, surname of inventor (country code)
- (73) Name, surname and address of patent owner (country code)
- (74) Name, surname of representative or patent attorney
- (85) Date of commencement of the national phase of International Application
- (86) Number and date of filing of international application
- (87) Number and date of publication of international application

## DESIGNS

- (10) Number of publication for application
- (11) Number of patent and kind of document or number of registration
- (15) Date of registration/Date of patent renewal
- (18) Expected expiration date of patent or registration
- (21) Serial number of application
- (22) Date of filing of the application
- (23) Date of exhibition or the date of the earlier filing and the number of application, if any
- (24) Date from which patent may have effect
- (28) Number of designs included in the application
- (30) Data relating to priority (number of application, date of filing of application, two-letter code identifying the authority with whom the priority application was made)
- (31) Number of priority application
- (32) Date of filing of priority application
- (33) Code of the country or regional organization allotting priority application number
- (34) Two-letter code according to WIPO St.3 identifying the authority with which the priority application was made
- (44) Date of publication of design and number of bulletin (the first publication)
- (45) Date of publication of design registered by WIPO and number of bulletin
- (51) International Classification for designs (class and subclass of the Locarno Classification)
- (54) Title of the invention
- (55) Reproduction of the design
- (57) Description of characteristic features of the design including indication of colors
- (58) Date of recording of any kind of amendment in the Register
- (62) Number of the earlier application, registration and document number and if available the date of filing an application in case of divided application
- (71) Name, surname and address of applicant (country code)
- (72) Name, surname of creator (country code)
- (73) Name, surname and address of patent owner (country code)
- (74) Name, surname of representative or patent attorney
- (81) Contracting states concerned
  - II designated contracting states according to the 1960 Act
  - III designated contracting states according to the 1999 Act
- (85) Owner's permanent address
- (86) Owner's nationality
- (87) Owner's residence
- (88) State in which the owner has a real and effective industrial or commercial establishment

## TRADEMARKS

- (111) - Number of registration
- (151) - Date of registration
- (156) - Date of the renewal
- (181) - Expected expiration date of registration
- (186) - Renewal expiration date of registration
- (141) - Date of cancel of duration of the mark
- (210) - Serial number of application
- (220) - Date of filing of the application
- (230) - Date concerning exhibition
- (260) - Number of application, for which favorable decision of examination about registration has been taken (publication number)
- (310) - Number of the first application
- (320) - Date of filing of the first application
- (330) - Code, identifying national or regional Office where the first application was made
- (511) - International Classification of Goods and Services for the purposes of registration of trade marks and/or list of goods and/or services classified according thereto
- (531) - Description of figurative elements of Trade Marks according to the International Classification of the Figurative Elements of Marks
- (540) - Reproduction of Trade Mark
- (550) - Nature and kind of Trade Mark
- (580) - Date of recording of any kind changes in respect of applications or registrations
- (591) - Information concerning colors claimed
- (731) - Name and address of the applicant
- (732) - Name and address of the holder of the registration
- (740) - Name and address of the representative
- (750) - Address for correspondence
- (770) - Name and address of the previous applicant or holder in case of change in ownership
- (771) - Previous name and address of the applicant or holder in case of change in ownership
- (791) - Name and address of the licensee
- (793) - Indication of conditions and/or restrictions under the license (Type of license, number of license agreement, data of license, data of validity of license)
- (800) - Certain data relating to the international registration of Trade Marks under the Protocol Relating to Madrid Agreement (International registration number)

## CODES FOR PUBLICATION IN BULLETIN

- (21) AP 0000 000000 - serial number of application for invention
- (10) AP 0000 0000 A - number of published application for invention (first publication)
- (11) P 0000 0000 B - number of patent for invention (second publication)
- (21) API 0000 000000 - number of application for imported patent
- (11) PI 0000 0000 A - number of imported patent (first publication)
- (21) AU 0000 000000 - serial number of application for utility model
- (10) AU 0000 000 U - number of published application for utility model (first publication)
- (11) U 0000 000 Y - number of patent for utility model (second publication)
- (21) AD 0000 000000 - serial number of application for design
- (10) AD 0000 000 S - number of published application for design (first publication)
- (11) D 0000 000 S - number of patent for design (second publication)

## INTERNATIONAL PATENT CLASSIFICATION FOR INVENTIONS AND UTILITY MODELS

- SECTION A - HUMAN NECESSITIES
- SECTION B - PERFORMING OPERATIONS; TRANSPORTING
- SECTION C - CHEMISTRY; METALLURGY
- SECTION D - TEXTILES; PAPER
- SECTION E - FIXED CONSTRUCTIONS
- SECTION F - MECHANICAL ENGINEERING; LIGHTING; HEATING; WEAPONS; BLASTING
- SECTION G - PHYSICS
- SECTION H - ELECTRICITY

- 
- M - Trade Mark
  - (210) AM 0000 000000 - Serial number of application;
  - (260) AAM 0000 00000 A - Publication number of application;
  - (111) M 0000 00000 R - Number of registration;
  - (111) MMM0000 00000 Rn - Number of renewals, in which n=1,2,3;
  - (111) M 0000 00000 R(P) - Number of registration under partial assignment of rights
-



**NATIONAL INTELLECTUAL PROPERTY CENTER OF GEORGIA  
SAKPATENTI**

**OFFICIAL BULLETIN  
OF THE INDUSTRIAL PROPERTY**

**19(479)**

**INVENTIONS  
UTILITY MODELS  
DESIGNS  
TRADEMARKS**

DATE OF PUBLICATION  
2017 10 10

# CONTENTS

<b>PUBLISHED TITLES OF PROTECTION .....</b>	<b>2</b>
<b>INVENTIONS</b>	
▪ APPLICATIONS APPROVED FOR GRANTING PATENT .....	4
▪ PATENTED INVENTIONS .....	7
<b>UTILITY MODELS</b>	
▪ APPLICATIONS APPROVED FOR GRANTING PATENT .....	9
<b>DESIGNS</b>	
▪ APPLICATION APPROVED FOR REGISTRATION .....	10
▪ REGISTERED DESIGN .....	11
▪ DESIGNS REGISTERED ACCORDING TO THE ACCELERATED PROCEDURE .....	12
▪ DESIGNS, WICH HAVE BEEN REGISTERED WITH THE INTERNATIONAL BUREAU CLAIMING PRIORITY ON THE TERRITORY OF GEORGIA .....	18
<b>TRADEMARKS</b>	
▪ APPLICATIONS FILED UNDER THE NATIONAL PROCEDURE APPROVED FOR REGISTRATION .....	41
▪ REGISTERED TRADEMARKS .....	53
▪ TRADEMARKS REGISTERED ACCORDING TO THE ACCELERATED PROCEDURE .....	57
▪ INTERNATIONAL TRADEMARKS FOR WHICH A DECISION ON GANTING PROTECTION IS TAKEN .....	58
▪ INTERNATIONAL TRADEMARKS PROTECTED IN GEORGIA .....	141
<b>OFFICIAL NOTIFICATIONS</b>	
<b>INVENTIONS</b>	
▪ RENEWAL OF PATENTS .....	148
<b>UTILITY MODELS</b>	
▪ RENEWAL OF PATENT .....	148
▪ CORRECTION OF PUBLISH INFORMATIONS .....	148
<b>TRADEMARKS</b>	
▪ RENEWAL OF REGISTRATIONS .....	149
▪ COMPLETE TRANSFER OF RIGHTS .....	151
▪ CHANGES IN NAMES AND/OR ADDRESSES OF OWNERS .....	157
<b>CLASSIFICATION INDEXES</b>	
INVENTIONS .....	159
UTILITY MODELS .....	160
DESIGNS .....	161
TRADEMARKS .....	163

# PUBLISHED TITLES OF PROTECTION

## INVENTIONS

- **APPLICATIONS APPROVED FOR GRANTING PATENT:**  
13662; 13929; 14022; 14070; 14336; 14155
- **PATENTED INVENTIONS:**  
6745-6751

## UTILITY MODELS

- **APPLICATIONS APPROVED FOR GRANTING PATENT:**  
14354; 13995; 14200

## DESIGNS

- **APPLICATION APPROVED FOR REGISTRATION:**  
958
- **REGISTERED DESIGN:**  
725
- **DESIGNS REGISTERED ACCORDING TO THE ACCELERATED PROCEDURE:**  
724; 723
- **DESIGNS, WHICH HAVE BEEN REGISTERED WITH THE INTERNATIONAL BUREAU CLAIMING PRIORITY ON THE TERRITORY OF GEORGIA:**  
96565; 96607; 94208; 94224; 94226; 94462; 96672; 94257; 94349; 96766

## TRADEMARKS

- **APPLICATIONS FILED UNDER THE NATIONAL PROCEDURE APPROVED FOR REGISTRATION:**  
87568; 88286; 88319; 88676; 89523; 89781; 89879; 90091; 90094; 90138; 90141; 90302; 90418; 90428, 90429; 90451; 90569; 90649; 90687; 90689-90692; 90694; 90696; 90728; 90748; 90762; 90766; 90768, 90769; 90771; 90774; 90778, 90779; 90863; 90929, 90930; 90962; 90964; 90977; 91002, 91003; 91006; 91025; 91052, 91053; 91062; 91065; 91068; 91070-91072; 91075, 91076; 91078; 91089; 91129; 91136; 91152, 91153; 91155; 91178; 91180; 91183; 91188-91191; 91194, 91195; 91198
- **REGISTERED TRADEMARKS:**  
28913-28958
- **TRADEMARKS REGISTERED ACCORDING TO THE ACCELERATED PROCEDURE:**  
28908-28912
- **INTERNATIONAL TRADEMARKS FOR WHICH A DECISION ON GRANTING PROTECTIONS IS TAKEN:**  
84832\*; 87044; 88313; 88851; 88936; 89005; 89029; 89407; 89414; 89422, 89423; 89510; 89554; 89559-89561; 89563, 89564; 89728; 89794; 89807-89810; 89815; 89821-89823; 89840; 89842, 89843; 89845-89851; 89854-89857; 89914; 89917; 89920; 89927; 89930; 89936; 89939-89941; 89944, 89945; 89947; 89950, 89951; 89953, 89954; 89956-89961; 89970-89973; 90019; 90023-90028; 90030; 90040; 90042; 90055, 90056; 90058; 90063, 90064; 90080; 90086; 90109, 90110; 90112, 90113; 90115; 90117-90119; 90166; 90169; 90171-90177; 90180-90183; 90185-90188; 90190-90194; 90202-90205; 90207, 90208; 90210, 90211; 90213-90218; 90220; 90223-90242; 90244-90246; 90276; 90296; 90307, 90308; 90310; 90312-90322; 90324-90326; 90337; 90390; 90392-90396; 90398, 90399; 90401, 90402; 90404-90408; 90661, 90662; 90668-90671; 90676; 90682, 90683; 90721, 90722; 90897-90900; 90902
- **INTERNATIONAL TRADEMARKS PROTECTED IN GEORGIA:**  
85361; 85403; ; 85867; 87540; 87603; 87725; 87734, 87735; 87738, 87739; 87750; 87771, 87772; 87824; 87924; 87931-87933; 87935; 87944; 87951-87956; 87958-87960; 88039; 88048; 88053; 88135-88137; 88143; 88146; 88192; 88196, 88197; 88235; 88238, 88239; 88266, 88267; 88294-88298; 88302, 88303; 88365; 88378; 88384; 88393; 88399; 88418, 88419; 88422; 88425; 88428; 88437, 88438; 88440, 88441; 88445, 88446; 88451; 88492; 88599, 88600; 88630-88632; 88635, 88636; 88639-88641; 88657; 88683; 88696; 88728; 88731; 88734; 88762, 88763; 88776; 88800; 88803; 88891

---

# INVENTIONS

## APPLICATIONS APPROVED FOR GRANTING PATENTS

The decision can be appealed at the Chamber of Appeal of Sakpatenti within 3 months from the publication or at the Mtskheta District Court Administrative Cases Board (Address: №17, Samkhedro str., Mtskheta), within 1 month following the publication.

### PART A

#### A 61

(10) AP 2017 13662 A (51) Int. Cl. (2006)  
A 61 K 9/00  
A 61 K 31/00  
A 61 K 31/164  
A 61 K 31/4174  
A 61 K 31/505  
A 61 K 31/728  
A 61 P 11/02

(21) AP 2013 013662 (22) 2013 04 16  
(31) 10 2012 009 495.7; 10 2012 011 447.8  
(32) 2012 05 14; 2012 05 15  
(33) DE; DE

(71) MARIA CLEMENTINE MARTIN  
KLOSTERFRAU  
VERTRIEBSGESELLSCHAFT MBH (DE)  
Gereonsmühlengasse 1-11 50670 Köln (DE)

(72) GREVE, Harald (DE)

(74) Tamar Kochlamazashvili

(85) 2014 12 12

(86) PCT/EP2013/001117, 2013 04 16

(54) **COMBINATION THERAPY AGENT  
FOR TREATING RHINITIS**

(57) An abstract relates to the usage of pantothenol (dexpantenol) or physiologically acceptable esters thereof and pantothenic acid or physiologically acceptable salts therein combination with imidazoline-based  $\alpha$ -sympathomimetics for reducing undesired systemic resorption of said imidazoline-based  $\alpha$ -sympathomimetics, at topical, in particular, nasal treatment of rhinitis.

Claims: 2 independent  
8 dependent

---

(10) AP 2017 13929 A (51) Int. Cl. (2006)  
A 61 K 9/20  
A 61 K 9/28  
A 61 K 9/50  
A 61 K 31/4196  
A 61 P 39/04

(21) AP 2014 013929 (22) 2014 03 06  
(31) 61/824,435; 61/774,893  
(32) 2013 05 17; 2013 03 08

(33) US; US

(71) NOVARTIS AG (CH)

Lichtstrasse 35 CH-4056 Basel (CH)

(72) GHOSH, Indrajit (IN);

ZHANG, Jia-Ai (UA)

(74) Aleksandre Kartvelishvili

(85) 2015 09 08

(86) PCT/IB 2014/059494, 2014 03 06

(54) **ORAL FORMULATIONS OF  
DEFERASIROX**

(57) A tablet contains deferasirox, microcrystalline cellulose, polyvinyl pyrrolidone, crospovidone, poloxamer, silicon dioxide, magnesium stearate and protective coating.

Claims: 3 independent

Fig.: 11

---

### PART C

#### C 07

(10) AP 2017 14022 A (51) Int. Cl. (2006)  
C 07 D 401/14  
C 07 D 405/14  
C 07 D 401/12  
A 61 K 31/513  
A 61 K 31/501  
A 61 K 31/497  
A 61 P 25/00

(21) AP 2014 014022 (22) 2014 06 13

(31) 61/840,144

(32) 2013 06 27

(33) US

(71) PFIZER INC. (US)

235 East 42<sup>nd</sup> St., New-York, NY 10017 (US)

(72) BRODNEY, Michael, Aaron (US);

DAVOREN, Jennifer, Elizabeth (US);

DOUNAY, Amy Beth (US);

EFREMOV, Ivan Viktorovich (US);

GRAY, David Lawrence Firman (US);

GREEN, Michael Eric (US);

HENDERSON, Jaclyn Louise (GB);

LEE, Chewah (US);

MENTE, Scot Richard (US);

O'NEIL, Steven Victor (US);  
 ROGERS, Bruce Nelsen (US);  
 ZHANG, Lei (US)

(74) Shalva Gvaramadze

(85) 2015 12 21

(86) PCT/IB2014/062217, 2014 06 13

(54) **HETEROAROMATIC COMPOUNDS  
 AND THEIR USE AS DOPAMINE  
 D1 LIGANDS**

(57) Compound of formula (I)

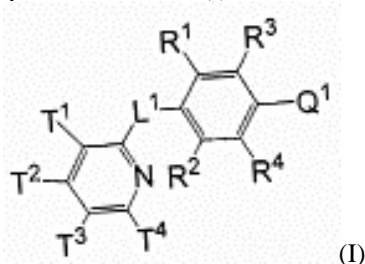

or (IA-1),

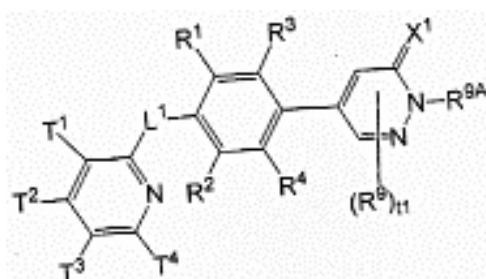

wherein values of substituents  $R^1$ ,  $R^2$ ,  $R^3$ ,  $R^4$ ,  $R^{9A}$ ,  $R^9$ ,  $X^1$ ,  $Q^1$ ,  $T^1$ ,  $T^2$ ,  $T^3$ ,  $T^4$ ,  $L^1$  and variable  $t_1$  are provided in the claims or pharmaceutically acceptable salt and pharmaceutical composition on the basis thereof, usage of said compound and salt at the treatment of such diseases as schizophrenia, dementia, cognitive and autistic spectrum disorders, etc.

Claims: 3 independent

25 dependent

Table: 4

(10) AP 2017 14070 A (51) Int. Cl. (2006)  
 C 07 D 403/04  
 A 61 K 31/4178  
 A 61 K 31/4184  
 A 61 P 3/10

(21) AP 2014 014070

(22) 2014 07 31

(31) 2296/DEL/2013

(32) 2013 07 31

(33) IN

(71) COUNCIL OF SCIENTIFIC &  
 INDUSTRIAL RESEARCH (IN)  
 Anusandhan Bhawan Rafi Marg New Delhi  
 110 001 (IN);  
 SHANTANI PROTEOME ANALYTICS  
 PVT. LTD (IN)

100 Ncl Innovation Park Dr. Homi Bhabha  
 Road Pune, Maharashtra 411008 (IN)

(72) REDDY, Dumbala, Srinivasa (IN);

SAXENA, Chaitanya (IN);

KOMIRISHETTY, Kashinath (IN)

(74) Shalva Gvaramadze

(85) 2016 02 25

(86) PCT/IN2014/000507, 2014 07 31

(54) **NOVEL INDAZOLE COMPOUNDS  
 AND A PROCESS FOR THE  
 PREPARATION THEREOF**

(57) Indazole compounds of formula (I),

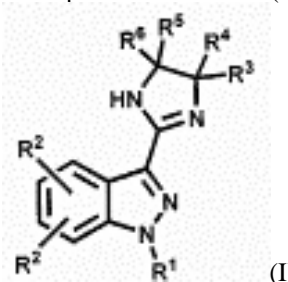

wherein values of substituents  $R^1$ ,  $R^2$ ,  $R^3$ ,  $R^4$ ,  $R^5$ ,  $R^6$  are provided in the claims, their stereoisomers, pharmaceutically acceptable salts and pharmaceutical compositions on the basis thereof. Usage of said compound at diabetes, metabolic disorders, cardiovascular dysfunction, etc. treatment.

Claims: 5 independent

3 dependent

Fig.: 10

Table: 4

## C 12

(10) AP 2017 14336 A (51) Int. Cl. (2006)

C 12 G 3/00

C 12 H 1/22

(21) AP 2016 014336 (22) 2016 12 02

(71) Jimsher Chkhaidze (GE)

Paliashvilis q. 92/10, 0162, Tbilisi (GE)

(72) Jimsher Chkhaidze (GE)

(54) **METHOD FOR WHISKY**

**PREPARATION**

(57) A method provides smoking malt, whisky alcohol distillation therefrom and ripening; at that smoking is executed with burning pruning vine smoke in open capacity having perforated bottom, and locking thereof after scorching coals and continuing the process; at that, scorching coals are sparged from time to time.

Claims: 1 independent

2 dependent



**PART G****G 01**

(10) AP 2017 14155 A (51) Int. Cl. (2006)

G 01 W 1/02

G 01 W 1/06

G 01 W 1/10

(21) AP 2016 014155 (22) 2016 05 24

(71) TECHNICAL UNIVERSITY OF  
GEORGIA (GE)

M. Kostavas q. 77, 0175, Tbilisi (GE)

(72) Giorgi Adamov (GE);

Uri Baghaturia (GE);

Levan Imnaishvili (GE);

Dato Lomidze (GE);

Irakli Lomidze (GE);

Archil Prangishvili (GE);

Iver Prangishvili (GE);

Zviad Tsamalaide (GE);

Arsen Khvedelidze (GE)

(54) **CRITICAL METEOROLOGICAL  
SITUATION MONITORING,  
DETECTION AND NOTIFICATION  
SYSTEM**

(57) Critical meteorological situation monitoring, detection and notification system includes switched to the GSM communication net, at least one multifunctional meteorological station and one central data treating station. Multifunctional meteorological station includes meteorological, geological, geophysical, hydrological, ecological parameters measuring means. At that, measuring means are executed as separate digital modules having parallel ports. Meteorological station includes the GSM communication first module and central processor module having central microprocessor and operative memory block, as well. Central microprocessor has the GPIO ports wherewith is switched to measuring and the GSM modules. On the bases of information received from measuring means the central processor module detects critical meteorological, geological, geophysical, hydrological, ecological situations and transmits data into central station by means of GSM communication net.

Claims: 1 independent

7 dependent

Fig.: 7

# PATENTED INVENTIONS

## PART A

### A 61

- (11) **P 2017 6747 B** (51) **Int. Cl. (2006)**  
**A 61 K 31/205**  
**A 61 P 9/10**  
**A 61 P 13/12**
- (10) AP 2017 13706 A (44) 12(472)/2017  
 (21) AP 2013 013706  
 (22) 2013 10 24  
 (24) 2013 10 24  
 (31) P-12-163  
 (32) 2012 10 25  
 (33) LV  
 (86) PCT/IB2013/059604, 2013 10 24  
 (73) LATVIAN INSTITUTE OF ORGANIC SYNTHESIS (LV)  
 Aizkraukles Str. 21, LV-1006 Riga (LV)  
 (72) KALVINS, Ivars (LV);  
 DAMBROVA, Maija (LV);  
 LIEPINS, Edgars (LV);  
 MAKAROVA, Elina (LV);  
 PUGOVICS, Osvalds (LV);  
 GRINBERGA, Solveiga (LV);  
 SEVOSTJANOVŠ, Eduards (LV)  
 (74) Aleksandre Gegechkori  
 (54) **PHARMACEUTICAL COMPOSITION FOR REDUCING THE TRIMETHYLAMINE N-OXIDE LEVEL**
- 
- (11) **P 2017 6746 B** (51) **Int. Cl. (2006)**  
**A 61 M 15/00**
- (10) AP 2017 13678 A (44) 12(472)/2017  
 (21) AP 2013 013678  
 (22) 2013 05 16  
 (24) 2013 05 16  
 (31) 2013/01847; 2013/01562; 2012/06167  
 (32) 2013 02 15; 2013 02 08; 2012 05 25  
 (33) TR; TR; TR  
 (86) PCT/TR2013/000140, 2013 05 16  
 (73) ARVEN İLAÇ SAN. VE TIC. A.Ş. (TR)  
 Balabandere Cd. İlaç Sanayi Sk. No:14 İstinye  
 İstanbul 34460 (TR)  
 (72) TOKSOZ, Zafer (TR);  
 CIFTER, Umit (TR);  
 TURKYILMAZ, Ali (TR);  
 MUTLU, Onur (TR)  
 (74) Shalva Gvaramadze  
 (54) **A TRIGGER MECHANISM FOR INHALER DEVICE**

## PART B

### B 01

- (11) **P 2017 6750 B** (51) **Int. Cl. (2006)**  
**B 01 D 11/02**
- (10) AP 2017 14233 A (44) 12(472)/2017  
 (21) AP 2016 014233  
 (22) 2016 08 02  
 (24) 2016 08 02  
 (73) LEPL RAPHAEL DVALI INSTITUTE OF MASHINE MECHANICS (GE)  
 Mindelis q. 10, 0186, Tbilisi (GE)  
 (72) Roman Kenkishvili (GE);  
 Guram Dgebuadze (GE);  
 Tamaz Natriashvili (GE);  
 Zurab Maisuradze (GE);  
 Jumber Meskhi (GE);  
 Paata Dolidze (GE);  
 Soso Sabashvili (GE)  
 (54) **METHOD AND DEVICE FOR EXTRACTION BIOLOGICALLY ACTIVE SUBSTANCES FROM PLANT RAW MATERIAL WITH USAGE OF NON TRADITIONAL TECHNOLOGIES**

## PART C

### C 07

- (11) **P 2017 6749 B** (51) **Int. Cl. (2006)**  
**C 07 D 295/096**
- (10) AP 2017 13919 A (44) 12(472)/2017  
 (21) AP 2014 013919  
 (22) 2014 02 20  
 (24) 2014 02 20  
 (31) PA201300104  
 (32) 2013 02 22  
 (33) DK  
 (86) PCT/EP2014/053313, 2014 02 20  
 (73) H. LUNDBECK A/S (DK)  
 Otiliavej 9, DK-2500, Valby (DK)  
 (72) Thomas Ruhland (DK);  
 Kim Lasse Christensen (DK)  
 (74) Tamaz Shilakadze  
 (54) **VORTIOXETINE MANUFACTURING PROCESS**

**(11) P 2017 6748 B**      **(51) Int. Cl. (2006)**  
**C 07 D 401/14**  
**C 07 D 405/14**  
**C 07 D 413/14**  
**C 07 D 231/38**  
**C 07 D 401/04**  
**C 07 D 401/06**  
**C 07 D 403/02**  
**C 07 D 403/06**  
**C 07 D 417/02**  
**C 07 D 417/04**  
**C 07 D 417/06**  
**C 07 D 277/56**  
**C 07 D 403/04**  
**A 61 P 19/00**  
**A 61 P 11/00**

(10) AP 2017 13757 A      (44) 12(472)/2017

(21) AP 2013 013757

(22) 2013 08 08

(24) 2013 08 08

(31) 61/681,684

(32) 2012 08 10

(33) US

(86) PCT/US2013/054096, 2013 08 08

(73) BOEHRINGER INGELHEIM  
INTERNATIONAL GMBH (DE)  
Binger straÙe 173, 55216 Ingelheim  
am Rhein (DE)

(72) BENTZIEN, Joerg Martin (DE);

BERRY, Angela Kay (US);

BOSANAC, Todd (US);

BURKE, Michael Jason (US);

DISALVO, Darren Todd (US);

HORAN, Joshua Courtney (US);

LIANG, Shuang (CN);

MAO, Can (CN);

MAO, Wang (CN);

SHEN, Yue (CN);

SOLEYMANZADEH, Fariba (CA);

ZINDELL, Renee M. (US)

(74) Tamar Kochlamazashvili

**(54) HETEROAROMATIC COMPOUNDS  
AS BRUTON'S TYROSINE KINASE  
(BTK) INHIBITORS**

**(11) P 2017 6745 B**      **(51) Int. Cl. (2006)**  
**C 07 D 498/00**

(10) AP 2017 13141 A      (44) 12(472)/2017

(21) AP 2011 013141

(22) 2011 02 16

(24) 2011 02 16

(62) 12/708,836 2010 02 19 (US)

(31) 12/708,836

(32) 2010 02 19

(33) US

(86) PCT/US2011/024981, 2011 02 16

(73) SALIX PHARMACEUTICALS, LTD. (US)  
8510 Colonnade Center Dr. Raleigh,  
NC 27615 (US)

(72) Karen S. Gushurst (US);

Donglai Yang (US);

Petinka Vlahova (US);

Jeffrey S. Stults (US)

(74) Tamaz Shilakadze

**(54) FORMS OF RIFAXIMIN AND  
USAGE THEREOF**

## PART E

### E 04

**(11) P 2017 6751 B**      **(51) Int. Cl. (2006)**  
**E 04 G 3/30**

(10) AP 2017 13150 A      (44) 12(472)/2017

(21) AP 2013 013150

(22) 2013 07 03

(24) 2013 07 03

(73) Avtandil Metreveli (RU)

Privolis q., sakhli 39, korp. 1, b. 17, 109156,

Moscow (RU)

(72) Avtandil Metreveli (RU)

**(54) SUSPENDEE FALSEWORK WITH  
LIFTERS**

# UTILITY MODELS

## APPLICATION APPROVED FOR GRANTING PATENT

The decision can be appealed at the Chamber of Appeal of Sakpatenti within 3 months from the publication or at the Mtskheta District Court Administrative Cases Board (Address: №17, Samkhedro str., Mtskheta), within 1 month following the publication.

### PART A

#### A 23

(10) AU 2017 14354 U (51) Int. Cl. (2006)

A 23 L 2/00

(21) AU 2016 014354 (22) 2016 12 20

(71) Revaz Melkadze (GE)

A. Tseretlis gamz. 101, b. 14, 0119,  
Tbilisi (GE);

Davit Kiladze (GE)

Sanapiros q. 6, 0108, Tbilisi (GE);

Aleksandre Kiladze (GE)

Chonkadzis q. 12, 0105, Tbilisi (GE)

(72) Revaz Melkadze (GE);

Davit Kiladze (GE);

Aleksandre Kiladze (GE)

(54) NON-ALCOHOLIC NON

CARBONATED BEVERAGE GEO  
VITAMIN

(57) A beverage contains feijoa or aloe and grape or raspberry aromatizer, sugar and stevia mixture or multisweet, blackberry foliage, hips, chlorophyll extract, magnesium dicitrate, color, multifruit, citric acid, plant pectin, propylene glycol, ascorbic acid, potassium sorbate, sodium benzoate and water.

Claims: 1 independent

#### A 61

(10) AU 2017 13995 U (51) Int. Cl. (2006)

A 61 K 9/08

A 61 K 31/475

(21) AU 2015 013995 (22) 2015 11 18

(71) ECOPHARM PATENT

MANAGEMENT AG (CH)

Haldenstrasse 5, Baar, CH-6342 (CH)

(74) Khatuna Imnadze

(54) DRUG FOR PARENTERAL USAGE

(57) A drug contains 1-desoxy-1N-[methyl-(2-acridon-9-on-10-yl-acetate)]-ammonium-D-glucitol and water for injection; at that drug pH is equal to 6-8.

Claims: 1 independent

### PART E

#### E 04

(10) AU 2017 14200 U (51) Int. Cl. (2006)

E 04 B 1/00

(21) AU 2016 014200 (22) 2016 07 05

(71) Roland Zhorzholiani (GE)

Bogdan Khmel'nitskis q. 17v, b. 40, 0121,  
Tbilisi (GE)

(72) Roland Zhorzholiani (GE)

(54) WALL BLOCK

(57) A block has rectangular parallelepiped-shaped case 1 and round or tetragonal through interstice 2. Trapezium-shaped projection 5 and seizure 6, having lengths less than the block, are executed on block side walls 3 and 4 on opposite sides. Such seizures 7 are executed on front 8 and or back 9 walls, as well.

Claims: 1 independent

Fig.: 3

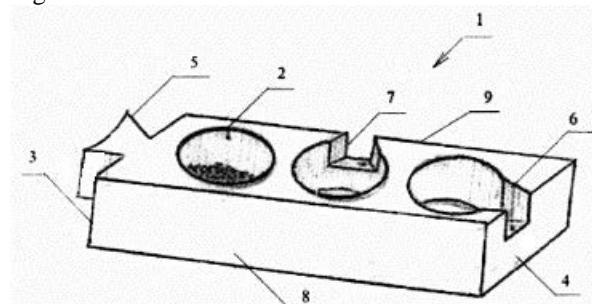

Fig. 2

---

# DESIGNS

## APPLICATION APPROVED FOR REGISTRATION

The decision can be appealed at the Chamber of Appeal of Sakpatenti within 3 months from the publication or at the Mtskheta District Court Administrative Cases Board (Address: №17, Samkhedro str., Mtskheta), within 1 month following the publication.

- (10) AD 2017 958 S      (51) 09-03  
(21) AD 2017 958      (22) 2017 05 15  
(28) 1  
(71) Giorgi Gordeziani (GE)  
Kavsadzis q. 4, 0179, Tbilisi (GE)  
(72) Giorgi Gordeziani (GE)  
(54) **PACKAGING BOX**  
(55)

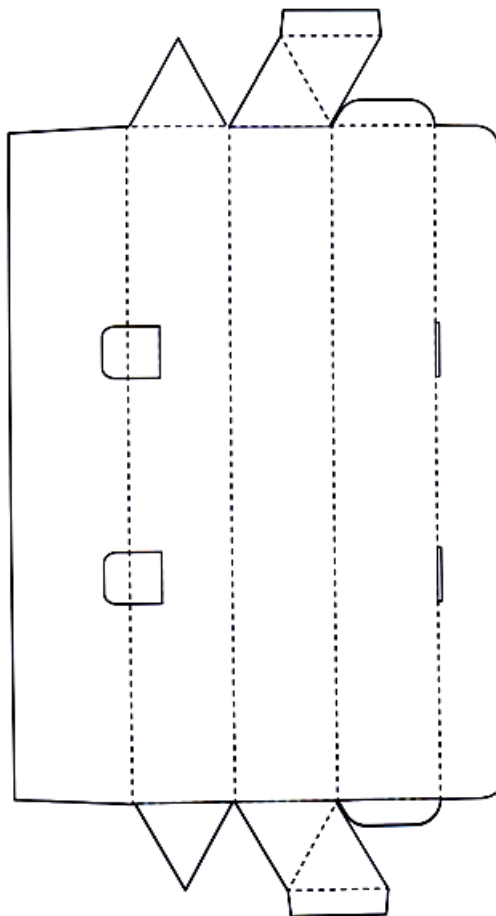

## REGISTERED DESIGN

**(11) D 2017 725 S**      **(51) 25-01**  
(10) AD 2017 942 S      (44) 12(472)/2017  
(21) AD 2017 000942  
(22) 2017 02 13  
(24) 2017 02 13  
(28) 1  
(18) 2022 02 13  
(71) Giorgi Osipov (GE)  
    Galis q. 10, 0179, Tbilisi (GE)  
(72) Giorgi Osipov (GE)  
(54) **WALL FACING TILE**

---

## DESIGNS REGISTERED ACCORDING TO THE ACCELERATED PROCEDURE

The decision can be appealed at the Chamber of Appeal of Sakpatenti within 3 months from the publication.

- (11) **GE D 2017 724 S** (51) **19-08**  
(21) AD 2017 984 (22) 2017 08 25  
(24) 2017 08 25  
(28) 5  
(18) 2022 08 25  
(73) JSC "ARGO" (GE)  
Lilo, Lotchinis khevi (nakv. 05/001), 0151, Tbilisi (GE)  
(72) Vladimir Vardidze (GE)  
(74) Roland Gabadze (GE)  
(54) **1.-5. LABEL**  
(55)



1.1



2.1



3.1





- (11) GE D 2017 723 S (51) 32-00  
(21) AD 2017 983 (22) 2017 08 25  
(24) 2017 08 25  
(28) 6  
(18) 2022 08 25  
(73) JSC "ARGO" (GE)  
Lilo, Lotchinis khevi (nakv. 05/001), 0151, Tbilisi (GE)  
(72) Vladimer Vardidze (GE)  
(74) Roland Gabadze (GE)  
(54) 1.-6. GRAPHIC IMAGE  
(55)



1.1



2.1



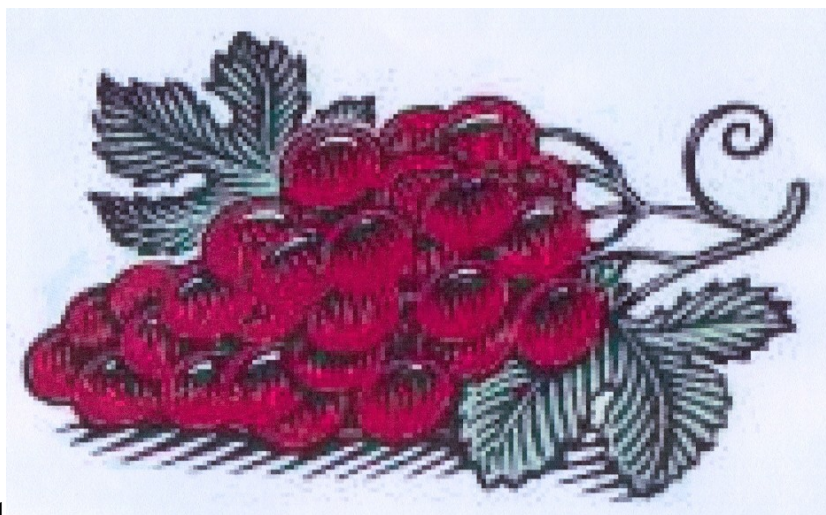

3.1

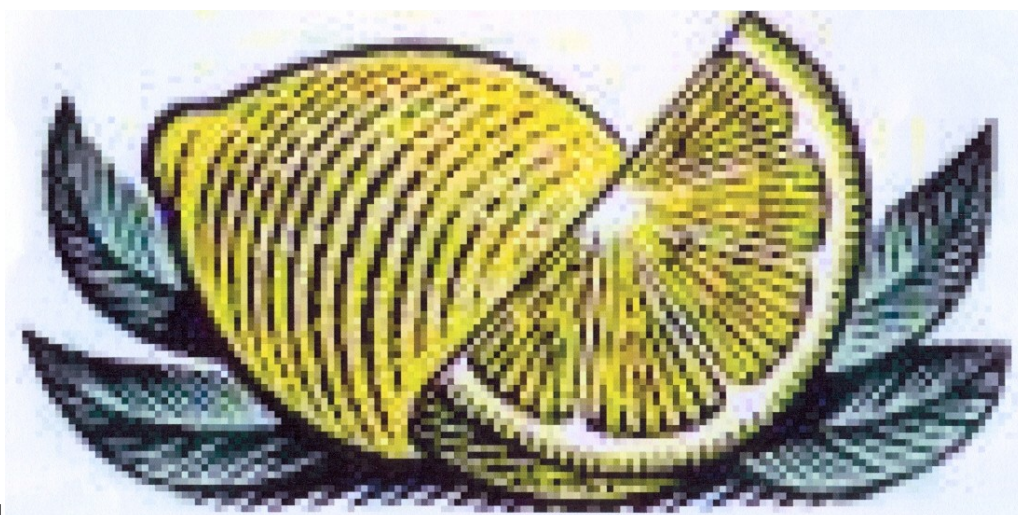

4.1

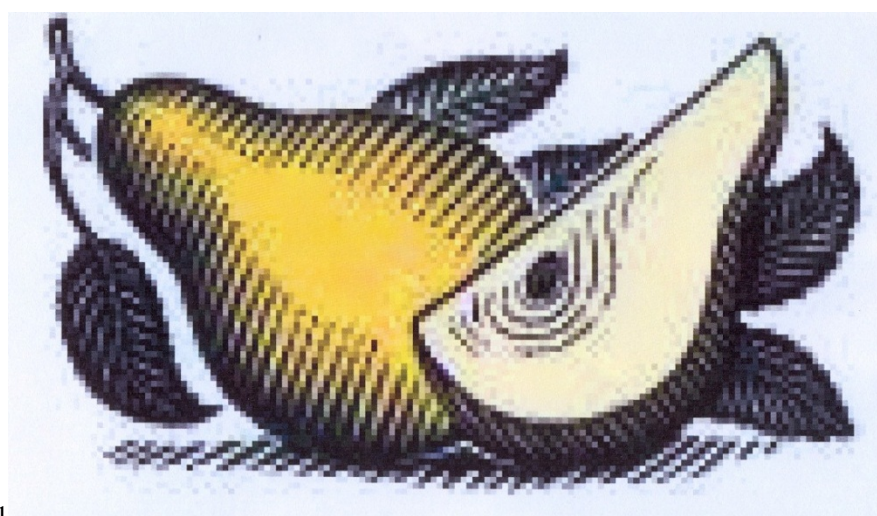

5.1



6.1

---

**DESIGNS, WHICH HAVE BEEN REGISTERED WITH THE INTERNATIONAL BUREAU CLAIMING PRIORITY ON THE TERRITORY OF GEORGIA**

The decision can be appealed at the Chamber of Appeal of Sakpatenti within 3 months from the publication or at the Mtskheta District Court Administrative Cases Board (Address: №17, Samkhedro Str., Mtskheta), within 1 month following the publication.

**(11) DM/096565**

(15) 2016 12 29

(22) 2016 12 29

(28) 2

(73) THEODORA TRAPALI

51 Kallipoleos, GR-162 32 ATHENS (GR)

(85) EM

(86) GR, EM

(87) GR, EM

(88) GR, EM

(89) EM

(81) II. BX III. AL, AM, BA, CH, EM, GE, IS, LI, MC, MD, ME, MK, NO, RS, TR, UA, US

(72) THEODORA TRAPALI

51 Kallipoleos, ATHENS, GR-162 32, GREECE

(54) 1.-2. Decorative magnetic strips for footwear and clothing

(55)

**(51) 02-07**

(45) 2017/26 (2017 07 07)

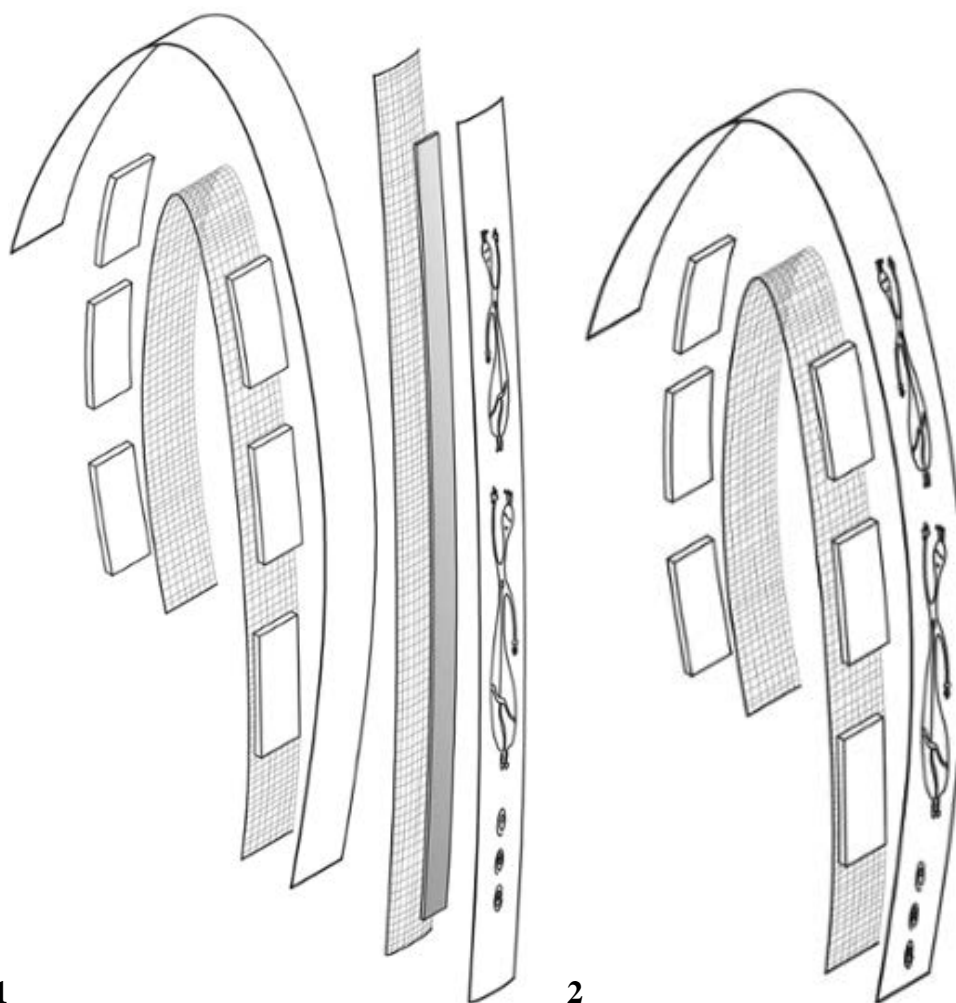

**(11) DM/096607****(51) 13-03**

(15) 2017 06 08

(45) 2017/26 (2017 07 07)

(22) 2017 06 08

(28) 2

(73) DERNEK GRUP ELEKTRİK ELEKTRONİK DİŞ TİCARET VE SANAYİ LİMİTED SİRKETİ İstanbul  
Trakya Serbest Bölgesi Ferhatpaşa Sb Mahallesi, Sumbul Sokak No:5/41, Catalca, İstanbul (TR)

(85) TR

(86) TR

(87) TR

(88) TR

(89) TR

(81) III. AL, AM, AZ, BA, BG, EG, EM, ES, FR, GE, GH, HU, KG, LT, LV, ME, MK, MN, NA, OA, OM, PL,  
RO, RS, SI, SY, TJ, UA

(72) TUNCAY CEYRAN

İSTANBUL TRAKYA SERBEST BÖLGESİ FERHATPAŞA SB MAHALLESİ, SUMBUL SOKAK  
NO:5/41, İSTANBUL, Turkey

(54) 1. Electrical switch; 2. Electrical socket

(55)

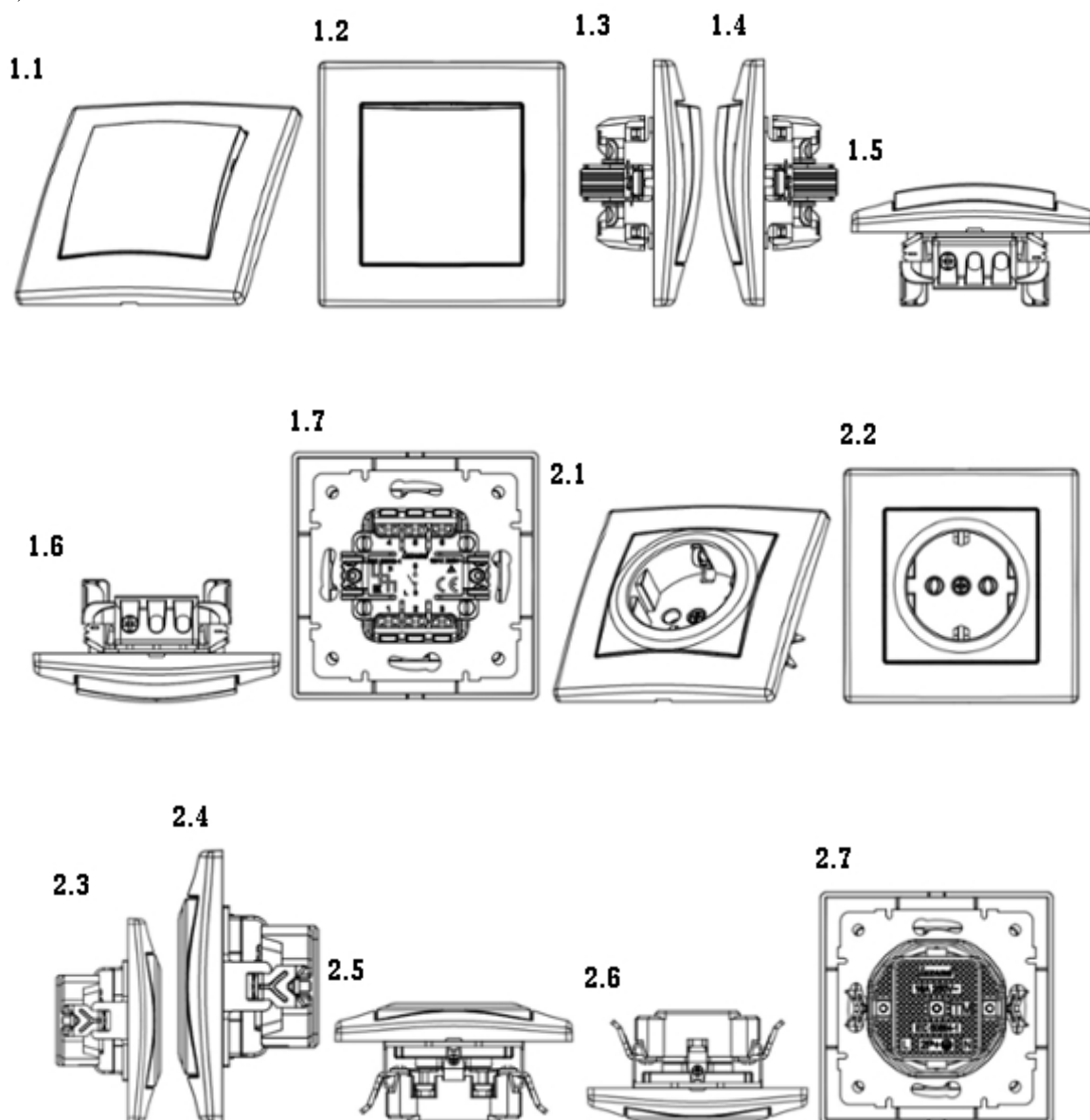

(11) DM/094208

(51) 10-07

(15) 2017 01 09

(45) 2017/27 (2017 07 14)

(22) 2017 01 09

(28) 15

(73) HAMILTON INTERNATIONAL AG

(HAMILTON INTERNATIONAL SA) (HAMILTON INTERNATIONAL LTD)

Mattenstrasse 149, CH-2503 Biel/Bienne (CH)

(85) CH

(86) CH

(87) CH

(88) CH

(89) CH

(81) II. BZ, MA III. AL, AM, AZ, BA, CH, EM, GE, KG, LI, MC, MD, ME, MK, MN, NO, OM, SG, TN, TR, UA

(72) 1,4-5, 8-9, 13-14: Fernando SOARES

5, rue Fleury, 2000 Neuchâtel, Suisse;

2-3, 6-7: Fabrice DUPORT

4, avenue de la Gare, 2000 Neuchâtel, Suisse;

10-12,15: Sébastien PERRET

Route de Serroue 3, 2037 Montmollin, Suisse;

10-12: Julien DELCAMBRE

Route de Portalban 33, 1567 Dellex, Suisse;

15: Nicolas BERTHOUD

Chemin de la Marnière 2, 2054 Chézard-Saint-Martin, Suisse

(54) 1.-5. Dials; 6. Watch case; 7.-15. Dials

(55)

1.1



1.2



2.1



3.1

2.2



3.2





4.1



4.2



5.1



5.2



6.1



6.2



6.3



6.4



6.5



6.6



7.1



7.2





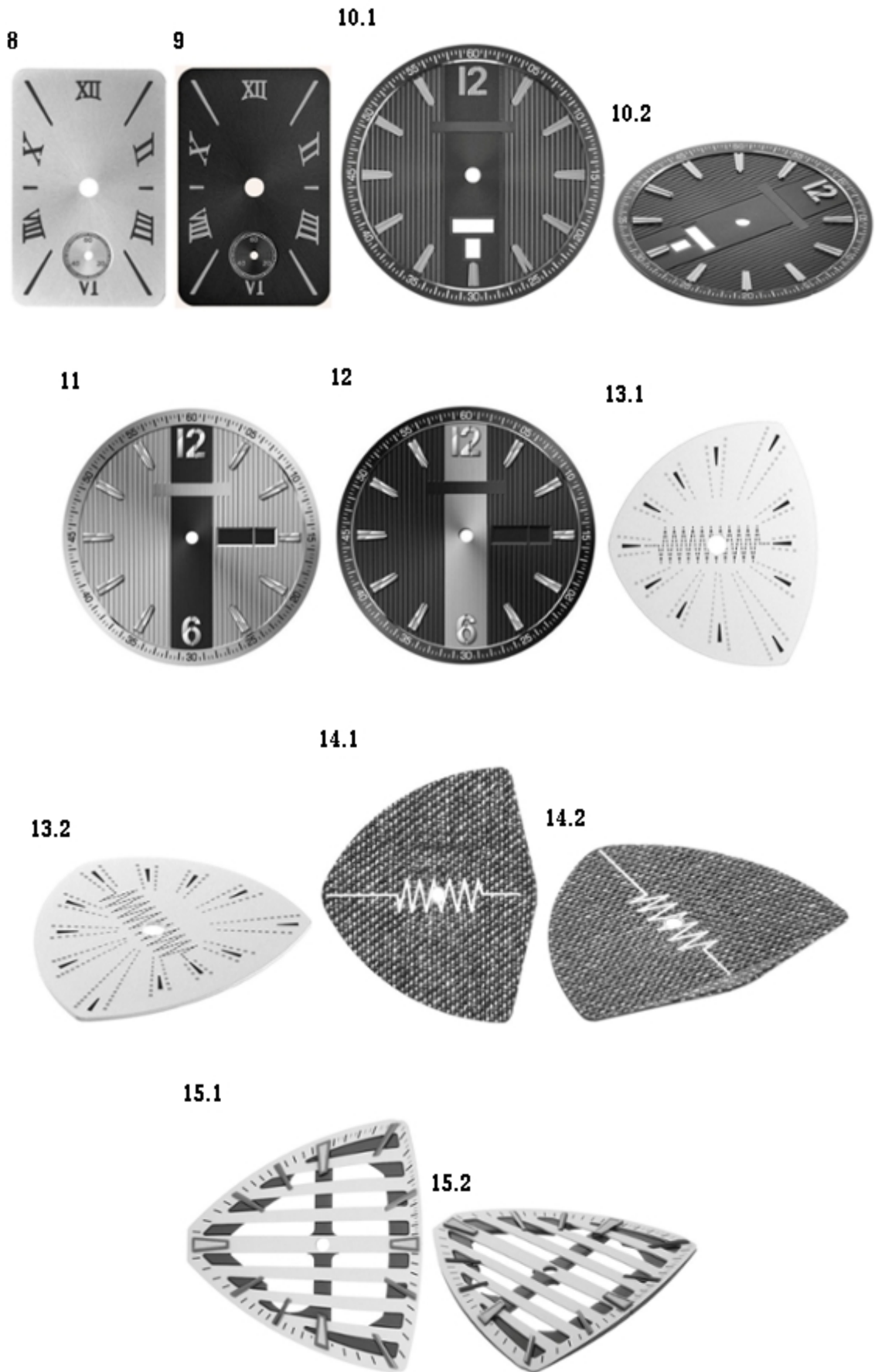

**(11) DM/094224****(51) 10-02**

(15) 2017 01 11

(45) 2017/27 (2017 07 14)

(22) 2017 01 11

(28) 1

(73) RADO UHREN AG (RADO WATCH CO. LTD.)

(MONTRES RADO SA)

RADO UHREN AG (RADO WATCH CO. LTD.)

(MONTRES RADO SA) (CH)

(85) CH

(86) CH

(87) CH

(88) CH

(89) CH

(81) II. BZ, MA III. AL, AM, AZ, BA, CH, EM, GE, KG, LI, MC, MD, ME, MK, MN, NO, OM, SG, TN, TR, UA

(72) Fernando SOARES

Rue Fleury 5, 2000 Neuchâtel, Suisse

(54) 1. Wristwatch

(55)

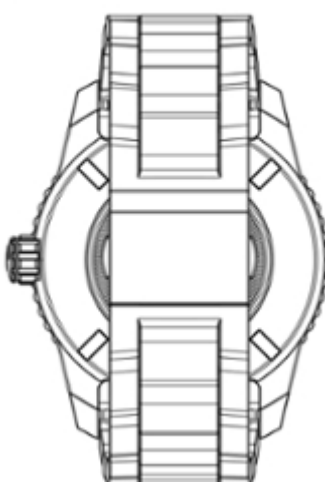
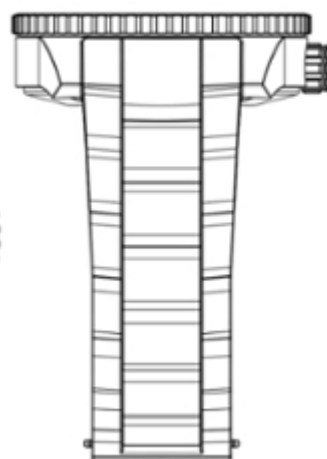
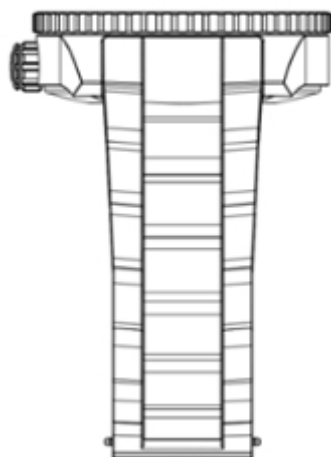
**1.1****1.2****1.3****1.4****1.5**

1.6

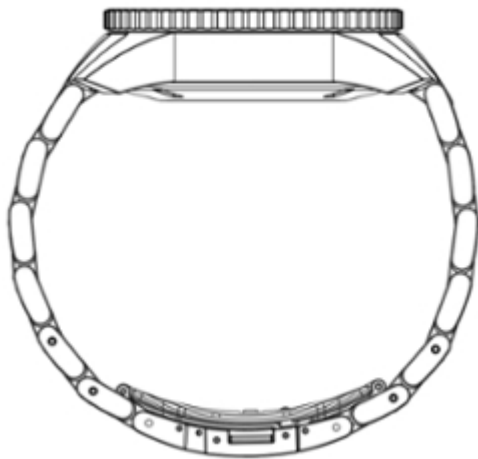

1.7

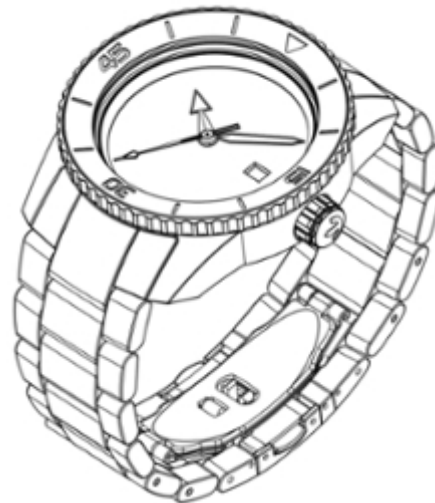

1.8



(11) DM/094226

(51) 10-07

(15) 2017 01 13

(45) 2017/27 (2017 07 14)

(22) 2017 01 13

(28) 2

(73) HARRY WINSTON SA

Chemin du Tourbillon 8, CH-1228 Plan-les-Ouates (CH)

(85) CH

(86) CH

(87) CH

(88) CH

(89) CH

(81) II. BZ, MA III. AL, AM, AZ, BA, CH, EM, GE, KG, LI, MC, MD, ME, MK, MN, NO, OM, SG, TN, TR, UA

(72) 1: Coralie BLOOTACKER

45, route du Battoir, Le hameau des Templiers, 74520 VULBENS, France;

2: Steve KAMILINDI

Avenue Théodore-Weber 9, 1208 Genève, Suisse

(54) 1.-2. Dials

(55)

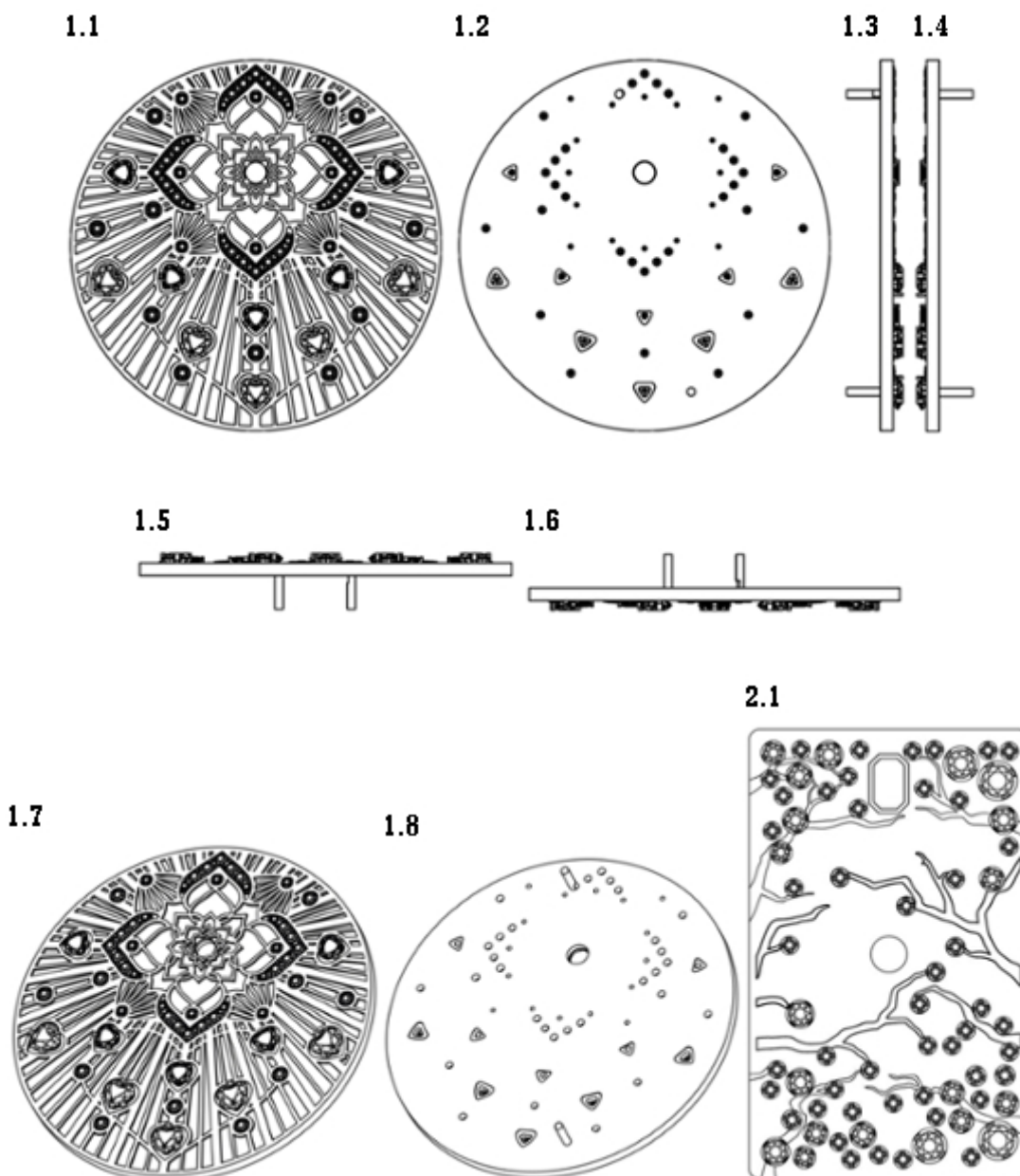

2.2

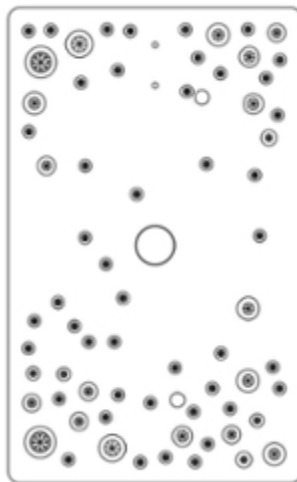

2.3



2.4



2.5



2.6



2.7

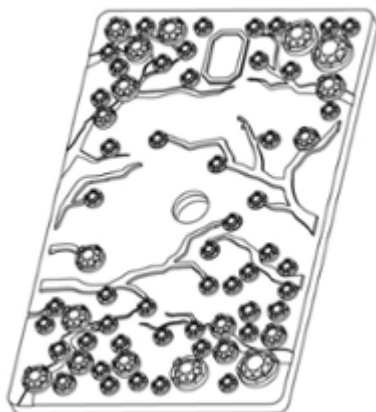

2.8

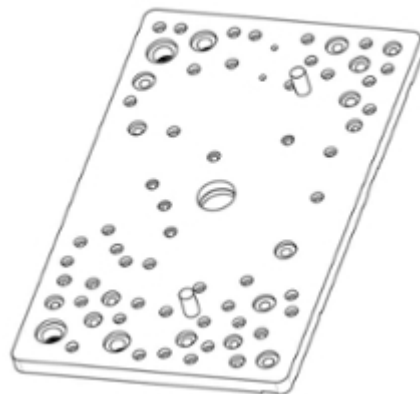

(11) DM/094462

(51) 10-07

(15) 2017 01 11

(45) 2017/27 (2017 07 14)

(22) 2017 01 11

(28) 2

(73) RADO UHREN AG (RADO WATCH CO. LTD.)

(MONTRES RADO SA)

Bielstrasse 45, CH-2543 Lengnau (CH)

(85) CH

(86) CH

(87) CH

(88) CH

(89) CH

(81) IL, BZ, MA III, AL, AM, AZ, BA, CH, EM, GE, KG, LI, MC, MD, ME, MK, MN, NO, OM, SG, TN, TR, UA

(72) Fabrice DUPORT

Avenue de la Gare 4, 2000 Neuchâtel, Suisse

(54) 1. Watch case with bracelet; 2. Dial

(55)

1.1

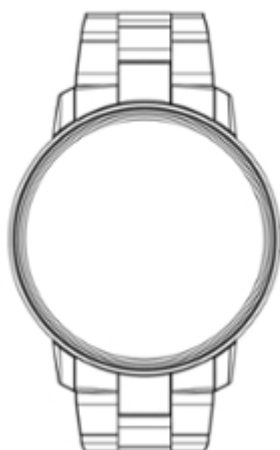

1.2

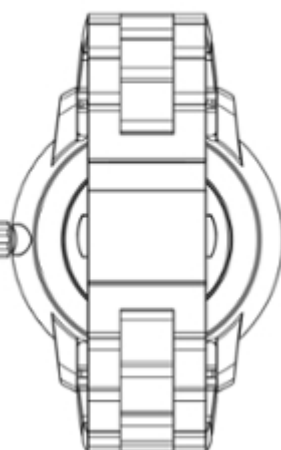

1.3

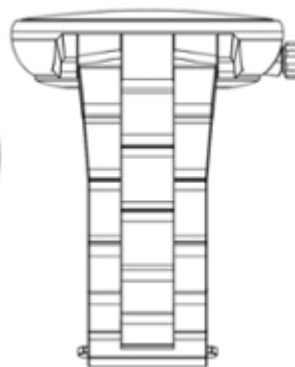

1.4

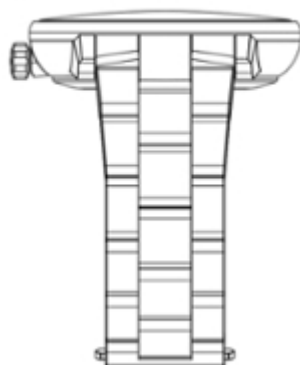

1.5

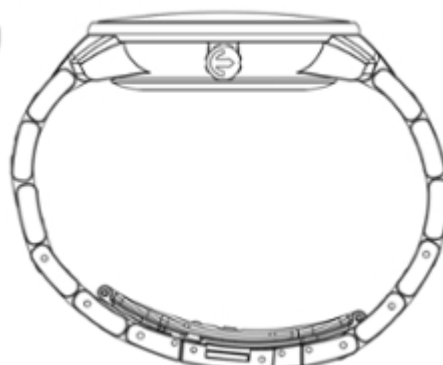

1.6

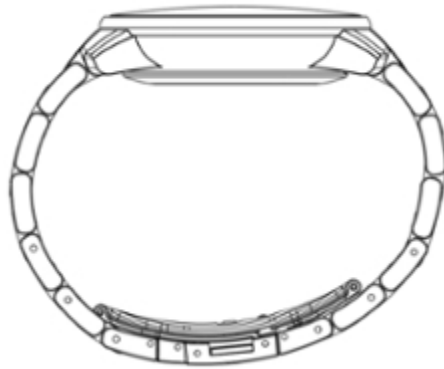

1.7



1.8

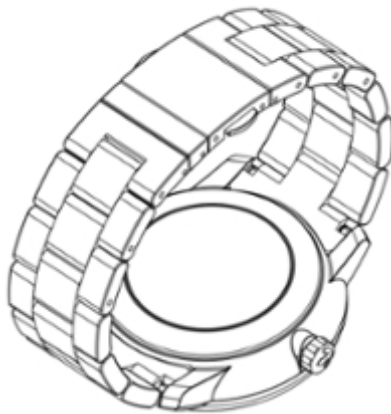

2.1



2.2

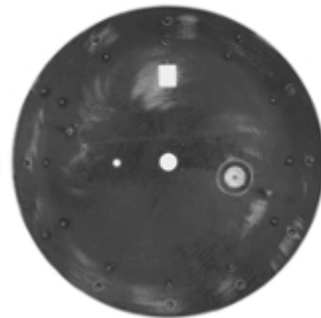

2.3 2.4 2.5 2.6



2.7



2.8



**(11) DM/096672**

(15) 2017 05 04

(22) 2017 05 04

(28) 12

(73) TRI STAR LTD

Polevaya str., 5, Cherniakhovka village, Kirovograd region 27641 (UA)

(88) UA

(89) UA

(81) II. MA III. AM, AZ, EG, EM, GE, KG, KR, MD, OM, TJ, TM, TN, TR, US

(72) Sukhoi Sergei Aleksandrovich

Podlesnyi Passage 10 A, 25018 Kropivnitskiy, Ukraine

(54) 1.-12. Labels for packaging

(55)

**(51) 19-08**

(45) 2017/27 (2017 07 14)

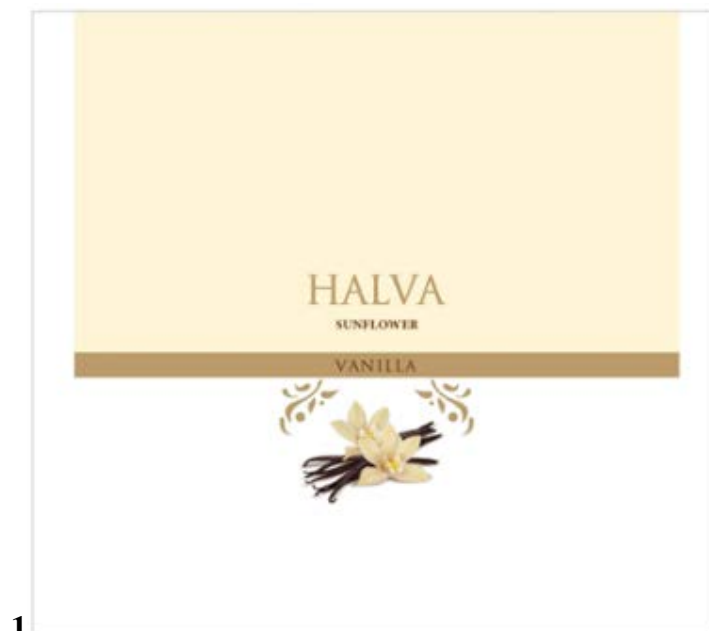



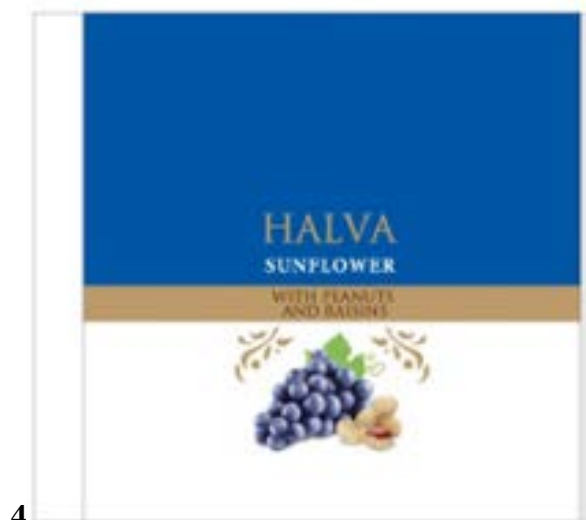

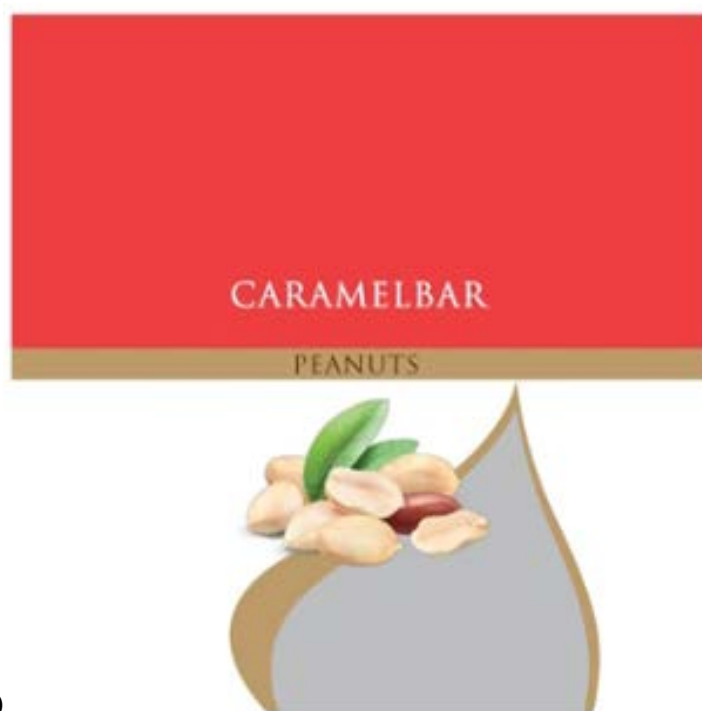

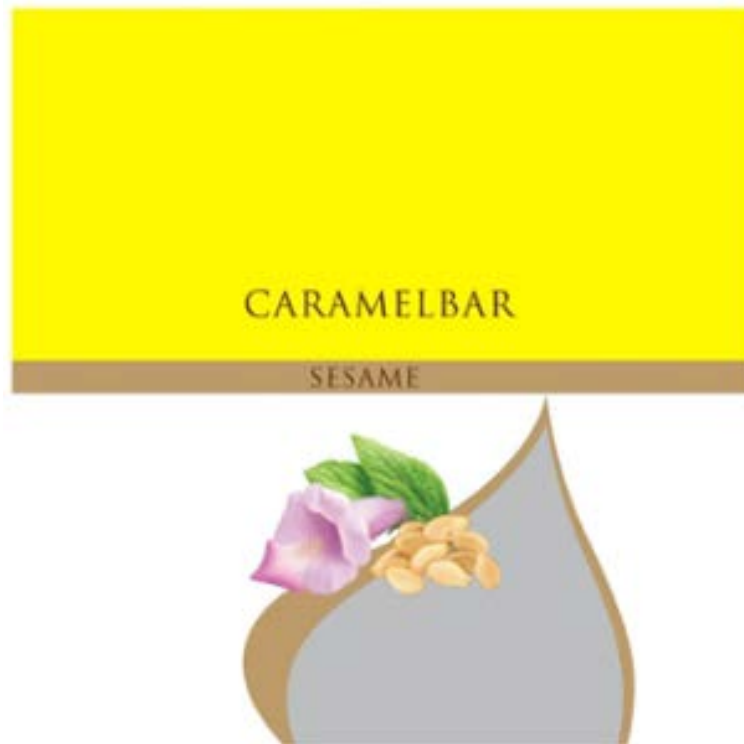

(11) DM/094257

(15) 2017 01 16

(22) 2017 01 16

(28) 1

(73) HAMILTON INTERNATIONAL AG  
(HAMILTON INTERNATIONAL SA)  
(HAMILTON INTERNATIONAL LTD)  
Mattenstrasse 149, CH-2503 Biel/Bienne (CH)

(85) CH

(86) CH

(87) CH

(88) CH

(89) CH

(81) II. BZ, MA III. AL, AM, AZ, BA, CH, EM, GE, KG, LI, MC, MD, ME, MK, MN, NO, OM, SG, TN,  
TR, UA

(72) Fabrice DUPORT

4, avenue de la Gare, 2000 Neuchâtel, Suisse

(54) 1. Watch case

(55)

(51) 10-07

(45) 2017/28 (2017 07 21)

1.1



1.2



1.3



1.4



1.5



1.6



(11) DM/094349

(51) 10-07

(15) 2017 01 19

(45) 2017/28 (2017 07 21)

(22) 2017 01 19

(28) 2

(73) HARRY WINSTON SA

Chemin du Tourbillon 8, CH-1228 Plan-les-Ouates (CH)

(85) CH

(86) CH

(87) CH

(88) CH

(89) CH

(81) II. BZ, MA III. AL, AM, AZ, BA, CH, EM, GE, KG, LI, MC, MD, ME, MK, MN, NO, OM, SG, TN, TR, UA

(72) Coralie BLOOTACKER

Route du Battoir 45 Le Hameau des Templiers, 74520 VULBENS, France

(54) 1. Dial; 2. Oscillating weight

(55)

1.1

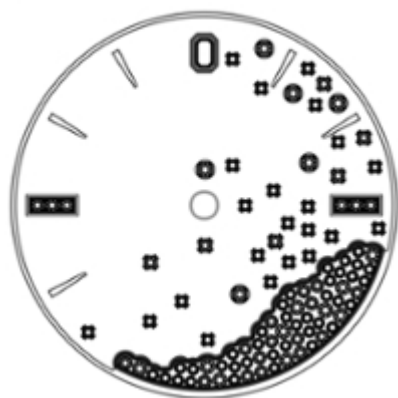

1.2

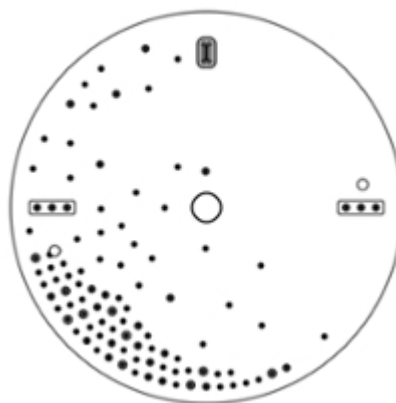

1.3



1.4



1.5



1.6



1.7

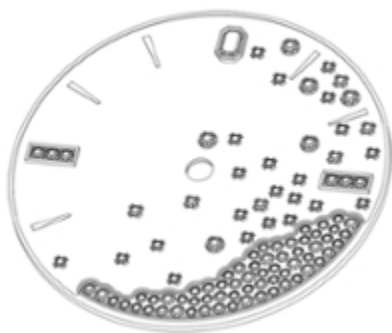

1.8



2.1



2.2



2.3



2.4



2.5



2.6



2.7



2.8



**(11) DM/096766**

(15) 2017 02 01

(22) 2017 02 01

(28) 14

(73) PEUGEOT CITROËN AUTOMOBILES SA

Route de Gisy, F-78140 VELIZY-VILLACOUBLAY (FR)

(85) FR, EM

(86) FR, EM

(87) FR, EM

(88) FR, EM

(89) FR

(81) II. BJ, BX, BZ, CI, GA, GR, IT, MA, ML, NE, SN, SR III. AL, AM, AZ, BA, BG, BN, BW, CH, DE, DK, EE, EG, ES, FI, FR, GE, GH, HR, HU, IS, JP, KG, KP, KR, LI, LT, LV, MC, MD, ME, MK, MN, NA, NO, OA, OM, PL, RO, RS, RW, SG, SI, ST, SY, TJ, TM, TN, TR, UA

(72) Jean-Pierre Ploué

Route de Gisy, 78140 Velizy-Villacoublay, France

(54) 1. Front wing for motor vehicles; 2. Spoiler for vehicles; 3. Protection device for vehicle door; 4. Radiator grille for motor vehicles; 5. Hood for motor vehicles; 6. Front bumper for motor vehicles; 7. Rear bumper for motor vehicles; 8. Front bumper for motor vehicles; 9. Front door for motor vehicles; 10. Rear door for motor vehicles; 11. Front door for motor vehicles; 12. Rear door for motor vehicles; 13. Rear trunk door for a motor vehicle; 14. Exterior rearview mirror for motor vehicles

(55)

**1.1****1.2****2.1****2.2**

3.1



3.2



4.1



4.2



5.1



5.2



6.1





6.2



7.1



7.2

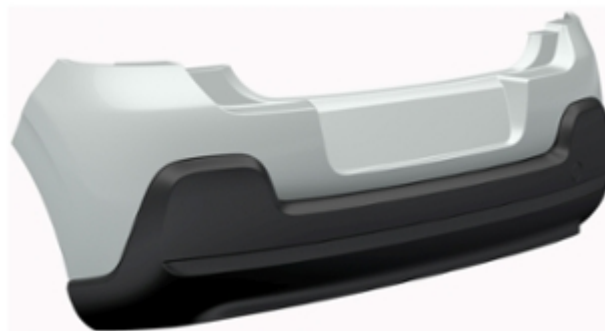

8.1



8.2



9.1



9.2



10.1



10.2



11.1



11.2



12.1



12.2



13.1



13.2



14.1



14.2



---

# TRADEMARKS

## APPLICATIONS FILED UNDER THE NATIONAL PROCEDURE APPROVED FOR REGISTRATION

The decision can be appealed at the Chamber of Appeal of Sakpatenti within 3 months from the publication or at the Mtskheta District Court Administrative Cases Board (Address: №17, Samkhedro St., Mtskheta), within 1 month following the publication.

(260) AM 2017 87568 A  
(210) AM 87568  
(220) 2016 06 10  
(731) LTD "ANASEULIS KOMBINATI"  
Anaseuli, 3500, Ozurgeti, Georgia  
(740) Giorgi Taktakishvili  
(540)

otka  
ოტკა

(511) 33

---

(260) AM 2017 88286 A  
(210) AM 88286  
(220) 2016 08 15  
(731) LTD "ZHORZHOLIANI TRADING"  
Nutsubidzis IV m/r, me-17 korp, Saburtalos  
raioni, Tbilisi, Georgia  
(540)

მ ა დ ა  
მადის აღმშენებელი პროდუქტები

(591) Blue, brown  
(531) 28.19, 29.01.12  
(511) 35, 43

---

(260) AM 2017 88319 A  
(210) AM 88319  
(220) 2016 08 16  
(731) HAMIDI SHARIATI  
Kipshidzis q. 3b, I sad., b.19, 0162, Tbilisi,  
Georgia  
(740) HAMIDI SHARIATI

(540)



(591) Black and golden  
(531) 25.01.01, 25.01.25, 27.05.10, 29.01.12  
(511) 43

---

(260) AM 2017 88676 A  
(210) AM 88676  
(220) 2016 09 26  
(731) LTD "NATURAL+"  
Marneulis q. 43, 0165, Tbilisi, Georgia  
(740) Teona Korshia  
(540)

ნატურალ+

(511) 29

---

(260) AM 2017 89523 A  
(210) AM 89523  
(220) 2016 11 18  
(731) LTD "SAPH PHARMA"  
G. Kartoziას q. 8, korp. 6, b. 10, 0177, Tbilisi,  
Georgia

(740) Tsira Kvaraia  
(540)

**MILSIM**  
**МИЛСИМ**  
**მილსიმი**

(511) 5

(260) AM 2017 89781 A  
(210) AM 89781  
(220) 2016 12 02  
(731) LTD "MARNISKARI"  
Sh. Askuravas q. 17, Tbilisi, Georgia  
(740) Davit Gogidze  
(540)

**შატო ნეკრესი**  
**Chateau Nekresi**  
**Шато Некреси**

(526) The trademark is protected as a whole. "ნეკრესი", "Nekresi", "Некреси" shall not be subject to independent legal protection.  
(511) 33, 35

(260) AM 2017 89879 A  
(210) AM 89879  
(220) 2016 12 08  
(731) EUOPHARMA GEORGIA  
Machabelis q. 5, 0114, Tbilisi, Georgia  
(740) Nia Masijkovich  
(540)

**კოლინორმი**  
**Колинорм**  
**Colinorm**

(511) 5, 35

(260) AM 2017 90091 A  
(210) AM 90091  
(220) 2016 12 23  
(731) LTD "Georgian Wine and Spirits Company"  
Sop. Achinebuli, 2200, Telavi, Georgia  
(740) Elene Totibadze  
(540)

**Новый Тбилиси**

(526) The trademark is protected as a whole. "Тбилиси" shall not be subject to independent legal protection.  
(511) 33

(260) AM 2017 90094 A  
(210) AM 90094  
(220) 2016 12 23  
(731) LTD "Georgian Wine and Spirits Company"  
Sop. Achinebuli, 2200, Telavi, Georgia  
(740) Elene Totibadze  
(540)

**New Tbilisi**

(526) The trademark is protected as a whole. "Tbilisi" shall not be subject to independent legal protection.  
(511) 33

(260) AM 2017 90138 A  
(210) AM 90138  
(220) 2016 12 26  
(731) ASTRAZENECA UK LIMITED  
Cambridge Biomedical Campus, 1 Francis  
Crick Avenue, Cambridge, CB2 0AA, United  
Kingdom  
(740) Tamaz Shilakadze  
(540)

**ზოლადექსი**

(511) 5

(260) AM 2017 90141 A (210) AM 90141  
(220) 2016 12 26  
(731) SANCTUARY HEALTH SDN. BHD  
16 PERSIARAN PERINDUSTRIAN  
KANTHAN  
1 KAWASAN PERINDUSTRIAN  
KANTHAN, Peraki Chemori, 31200,  
Malaysia  
(740) Nugzar Ksovreli  
(540)

**Sanctuary**

(511) 10

(260) AM 2017 90302 A  
(210) AM 90302  
(220) 2017 01 06  
(731) JSC "GEORGIAN BEER COMPANY"  
Sop. Saguramo, 3311, Mtskheta,  
Georgia  
(740) Aleksandre Mekhrishvili  
(540)

**ჩერო**

**CHERO**

(511) 32

(260) AM 2017 90418 A  
 (210) AM 90418  
 (220) 2017 01 13  
 (731) LTD "ALTA"  
 Chachavas q. 2-4-6-8-10-12, Tbilisi,  
 Georgia  
 (740) Kakha Chovelidze

(540)



(591) Black-white  
 (531) 05.03.14, 24.13.01, 27.05.08  
 (511) 9, 11

(260) AM 2017 90428 A  
 (210) AM 90428  
 (220) 2017 01 16  
 (731) JSC "INSURANCE COMPANY UNISON"  
 Gamrekelis q. 19, I sar., Tbilisi, Georgia  
 (740) Tamta Kanteladze  
 (540)

**უნიონი**  
**UNISON**

(511) 16

(260) AM 2017 90429 A  
 (210) AM 90429  
 (220) 2017 01 16  
 (731) JSC "PRIVATE"  
 Gamrekelis q. 19, I sar., Tbilisi, Georgia  
 (740) Tamta Kanteladze  
 (540)

**პრივატი**  
**Private**

(511) 16

(260) AM 2017 90451 A  
 (210) AM 90451  
 (220) 2017 01 17  
 (731) Levan Kalmakhelidze  
 Nutsubidzis me-3 mkr., I kv., korp. 8 , b. 24,  
 0183, Tbilisi, Georgia  
 (740) Levan Kalmakhelidze

(540)



(591) Black and brown  
 (531) 05.07.10, 19.09.02, 27.05.05, 28.19  
 (511) 33, 35

(260) AM 2017 90569 A  
 (210) AM 90569  
 (220) 2017 01 23  
 (731) LTD "G-M-P"  
 Sop. Ponitchala 65, 0165, Tbilisi, Georgia  
 (740) Nugzar Ksovreli  
 (540)

**მონტელანო**  
**MOHTEJAH**  
**MONTELAN**

(511) 5

(260) AM 2017 90649 A  
 (210) AM 90649  
 (220) 2017 01 31  
 (731) LTD "GHRUBELI"  
 Dighmis mas. me-6 kv., korp. 20, b.38, 0159,  
 Tbilisi, Georgia  
 (740) Giorgi Imedashvili  
 (540)



(591) White and blue  
 (531) 01.15.11, 07.01.18, 10.01.25, 28.19, 29.01.12  
 (511) 34, 35, 43

(260) AM 2017 90687 A  
 (210) AM 90687  
 (220) 2017 02 03  
 (731) LTD "ASPHARMA GEORGIA  
 PHARMACEUTICAL COMPANY"  
 Mtskhethis q. 8, 0179, Tbilisi, Georgia  
 (740) Maia Samadashvili  
 (540)

**Alfolin**  
**Алфалин**  
**ალფოლინი**

(511) 5

(260) AM 2017 90689 A  
 (210) AM 90689  
 (220) 2017 02 03  
 (731) LTD "ASPHARMA GEORGIA  
 PHARMACEUTICAL COMPANY"  
 Mtskhethis q. 8, 0179, Tbilisi, Georgia  
 (740) Maia Samadashvili

(540)

**Trimeza**  
**Тримеза**  
**ტრიმეზა**

(511) 5

(260) AM 2017 90690 A  
 (210) AM 90690  
 (220) 2017 02 03  
 (731) LTD "KANTI"  
 Samgoris chikhi 4 (nakv. 8/89), 0120, Tbilisi,  
 Georgia  
 (740) Nodar Melashvili  
 (540)

**Kirke**  
**კირკე**

(511) 32

(260) AM 2017 90691 A  
 (210) AM 90691  
 (220) 2017 02 03  
 (731) PEPSICO, INC.  
 700 Anderson Hill Road, Purchase,  
 New York, 10577, USA  
 (740) Tamar Kochlamazashvili

(540)

**ყოველი დღე ლეისტან**  
**ერთად უფრო გემრიელია**  
 (511) 29, 30

(260) AM 2017 90692 A  
 (210) AM 90692  
 (220) 2017 02 06  
 (731) NISSAN JIDOSHA KABUSHIKI KAISHA  
 (also trading as Nissan Motor Co., Ltd.)  
 No.2, Takara-cho, Kanagawa-ku, Yokohama-shi,  
 Kanagawa-ken, Japan  
 (740) Shalva Gvaramadze  
 (540)



(591) Black, white  
 (531) 26.01.05, 26.01.11, 26.01.19, 26.07.05,  
 27.05.17  
 (511) 4, 7, 25, 28, 35

(260) AM 2017 90694 A  
 (210) AM 90694  
 (220) 2017 02 06  
 (731) LTD "GASTRONAUT"  
 I. Chavchavadzis q. 6, b.13, 6000, Batumi,  
 Georgia  
 (740) Levan Kokiashvili  
 (540)

**Gastronaut**  
 art to gastro

(591) Cornelian-red  
 (531) 27.05.01, 29.01.01  
 (511) 35

(260) AM 2017 90696 A  
 (210) AM 90696  
 (220) 2017 02 06  
 (731) CELLTRION, INC.  
 23, Academy-ro, Yeonsu-gu, Incheon,  
 Republic of Korea

(740) Shalva Gvaramadze

(540)

# Герзума

(591) Black, white

(531) 28.05

(511) 5

(260) AM 2017 90728 A

(210) AM 90728

(220) 2017 02 08

(731) NANYANG BROTHERS TOBACCO  
COMPANY LIMITED9 Tsing Yeung Circuit, Tuen Mun, New  
Territories, Hong Kong, China

(740) Pavle Meipariani

(540)

## Peony Deluxe

(591) Black, white

(531) 27.05.05

(511) 34

(260) AM 2017 90748 A

(210) AM 90748

(220) 2017 02 08

(731) PHILIP MORRIS BRANDS SÀRL  
Quai Jeanrenaud 3, 2000 Neuchâtel,  
Switzerland

(740) Shalva Gvaramadze

(540)



**PLEASANT  
AROMA**

(591) Black, white

(531) 26.01.12, 26.11.13, 27.05.15

(511) 34

(260) AM 2017 90762 A

(210) AM 90762

(220) 2017 02 08

(731) LTD "NIKALA"

I Kheivanis q. 12, 0114, Tbilisi, Georgia

(740) Irine Namgalauri

(540)

ბალავარი  
**Balavari**

(511) 33

(260) AM 2017 90766 A

(210) AM 90766

(220) 2017 02 09

(731) PREMIUM TOBACCO FZ LTD

P.O. Box: 31291, Al-Jazeera Al-Hamra,  
Ras Al Khaimah, United Arab Emirates

(740) Liliana Darakhvelidze

(540)



(591) Black, white

(531) 24.01.15, 25.01.01, 26.04.18, 26.11.13,  
27.05.10

(511) 34

(260) AM 2017 90768 A

(210) AM 90768

(220) 2017 02 09

(731) LTD "BEAUTY LIFE"

Gagarinis shesak. 2/5-4, sart. 3, s.f.4, 0160,  
Tbilisi, Georgia

(540)

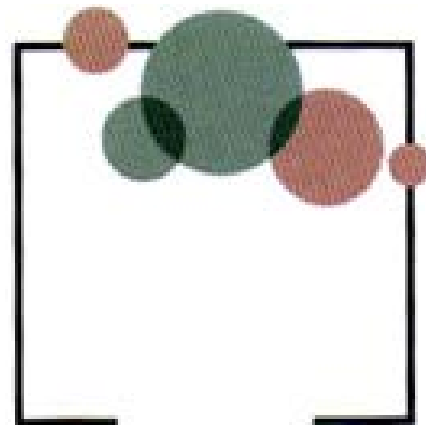



(591) Black, green, intensive pink  
 (531) 26.01.06, 26.04.10, 29.01.14  
 (511) 5, 35, 44

(260) AM 2017 90769 A  
 (210) AM 90769  
 (220) 2017 02 09

(731) LTD "BEAUTY LIFE"  
 Gagarinis shesak. 2/5-4, sart. 3, s.f.4, 0160,  
 Tbilisi, Georgia

(540)

**The science of beauty**

(511) 5, 35, 44

(260) AM 2017 90771 A  
 (210) AM 90771  
 (220) 2017 02 09

(731) LTD "BEAUTY LIFE"  
 Gagarinis shesak. 2/5-4, sart. 3, s/p 4, 0160,  
 Tbilisi, Georgia

(540)

**სილამაზის მეცნიერება**

(511) 5, 35, 44

(260) AM 2017 90774 A  
 (210) AM 90774  
 (220) 2017 02 09

(731) LTD "BINADARI"  
 Nutsubidzis q. 60, b.13, 0186, Tbilisi, Georgia

(540)



(591) Dark brown, black and white  
 (531) 07.01.08, 25.01.01, 27.05.11, 28.19, 29.01.13  
 (511) 35, 36, 37

(260) AM 2017 90778 A  
 (210) AM 90778  
 (220) 2017 02 10

(731) LTD "BEAUTY LIFE"  
 Gagarinis shesak. 2/5-4, sart. 3, s/p 4, 0160,  
 Tbilisi, Georgia

(540)

**nuage.com.ge**

(511) 5, 35, 44

(260) AM 2017 90779 A  
 (210) AM 90779  
 (220) 2017 02 10

(731) LTD "BEAUTY LIFE"  
 Gagarinis shesak. 2/5-4, sart. 3, s/p 4, 0160,  
 Tbilisi, Georgia

(540)

**nuage.ge**

(511) 5, 35, 44

(260) AM 2017 90863 A  
 (210) AM 90863  
 (220) 2017 02 15

(731) Levan Lashkarashvili  
 Gudamakris q. 10, sanzona, 0141, Tbilisi,  
 Georgia

(740) Levan Lashkarashvili

(540)



(591) Black, white  
 (531) 26.01.04, 26.01.10, 27.05.02  
 (511) 9, 35

(260) AM 2017 90929 A  
 (210) AM 90929  
 (220) 2017 02 20

(731) LTD "TPILISI"  
 Vazha-Pshavelas gamz., VII kv., kor. 23,  
 b. 31a, Tbilisi, Georgia

(740) Nino Bakhtadze

(540)



(591) Black, white, golden, light brown, dark brown  
 (531) 02.01.15, 25.01.15, 25.01.19, 27.05.01,  
 27.07.01, 28.19, 29.01.14  
 (511) 33

(260) AM 2017 90930 A  
 (210) AM 90930  
 (220) 2017 02 20  
 (731) Gela Sulaberidze  
 Vazha-Pshavelas gamz., me-6 kvart., korp. 34,  
 b. 24, 0186, Tbilisi, Georgia  
 (740) Nugzar Ksovreli  
 (540)

**მარგო**  
**MARGI**

(511) 5, 29, 30

(260) AM 2017 90962 A  
 (210) AM 90962  
 (220) 2017 02 22  
 (731) LTD "KVARELI WINE COMPANY"  
 Lermontovis q. 3, 4800, Kvareli, Georgia  
 (540)

**Satevari**  
**Сатевари**  
**სატევარი**

(511) 32, 33, 35

(260) AM 2017 90964 A  
 (210) AM 90964  
 (220) 2017 02 22  
 (731) LTD "KVARELI WINE COMPANY"  
 Lermontovis q. 3, 4800, Kvareli, Georgia  
 (540)

**Salkhino**  
**Салхино**  
**სალხინო**

(511) 32, 33, 35

(260) AM 2017 90977 A  
 (210) AM 90977  
 (220) 2017 02 23  
 (310) 015782998  
 (320) 2016 08 26  
 (330) EUIPO  
 (731) BRITISH AMERICAN TOBACCO  
 (BRANDS) INC (a Delaware corporation)  
 2711 Centerville Road, Suite 300,

Wilmington, Delaware 19808, USA  
 (740) Tamar Kochlamazashvili  
 (540)



(591) Black, white  
 (531) 26.11.05, 26.11.07, 26.11.08, 27.05.11  
 (511) 34

(260) AM 2017 91002 A  
 (210) AM 91002  
 (220) 2017 02 24  
 (731) LTD "J.S.V."  
 I. Chavchavadzis gamz. 56, b. 24,  
 Vake-Saburtalos r-ni, 0162, Tbilisi, Georgia  
 (740) Shota Piliani  
 (540)

**SADA**  
**სადა**

(511) 33

(260) AM 2017 91003 A  
 (210) AM 91003  
 (220) 2017 02 25  
 (731) GAP (ITM) INC.  
 2 Folsom Street., San Francisco,  
 CA 94105, USA  
 (740) Tamar Kochlamazashvili  
 (540)

**GAPFIT**

(511) 25, 35

(260) AM 2017 91006 A  
 (210) AM 91006  
 (220) 2017 02 27  
 (731) Vache Chinchaladze  
 A. Apakidzis q. 7, b.27, Tbilisi, Georgia  
 (740) Vakhtang Torotadze  
 (540)



(591) Black, white

(531) 24.09.07, 24.09.12, 25.01.25, 28.05  
(511) 29

(260) AM 2017 91025 A  
(210) AM 91025  
(220) 2017 02 27  
(731) INTERSUN HOLDING FZCO.  
P.O. Box 61051 Jebel Ali Free Zone, Dubai,  
United Arab Emirates  
(740) Tamar Kochlamazashvili  
(540)



(591) Yellow, green, brown, black  
(531) 05.03.15, 25.01.17, 25.03.07, 29.01.14  
(511) 29, 32

(260) AM 2017 91052 A  
(210) AM 91052  
(220) 2017 02 27  
(731) LTD "K. BERIOSI"  
Tsagarelis q. 43, 0194, Tbilisi, Georgia  
(540)

**კ. ბერიოსი**  
**K. BERIOSI**

(511) 1, 2, 6, 7, 8, 10, 11, 12, 14, 15, 16, 18, 19, 20,  
21, 22, 24, 25, 27, 28, 29, 30, 31, 32, 33, 35,  
36, 37, 38, 39, 41, 43, 45

(260) AM 2017 91053 A  
(210) AM 91053  
(220) 2017 02 28  
(731) Sopiko Lobzhanidze  
Mtskhetis q.6, me-3 sart. B.3, 0179, Tbilisi,  
Georgia  
(740) Sopiko Lobzhanidze  
(540)



(591) White, pink  
(531) 05.05.01, 27.05.08, 29.01.07  
(511) 43

(260) AM 2017 91062 A  
(210) AM 91062  
(220) 2017 02 28  
(731) CHOICE HOTELS INTERNATIONAL INC.  
1 Choice Hotels Circle, Rockville, Maryland  
20850, USA  
(740) Tamaz Shilakadze  
(540)



(591) Black, white  
(531) 26.02.05, 26.02.09  
(511) 43

(260) AM 2017 91065 A  
(210) AM 91065  
(220) 2017 02 28  
(731) CHOICE HOTELS INTERNATIONAL INC.  
1 Choice Hotels Circle, Rockville, Maryland  
20850, USA  
(740) Tamaz Shilakadze  
(540)



(591) Black, white  
(531) 26.01.12, 26.04.10, 26.04.24, 26.11.13,  
27.05.24  
(511) 43

(260) AM 2017 91068 A  
(210) AM 91068  
(220) 2017 02 28  
(731) CHOICE HOTELS INTERNATIONAL INC.  
1 Choice Hotels Circle, Rockville, Maryland  
20850, USA  
(740) Tamaz Shilakadze

(540)



(591) Black, white  
 (531) 26.01.12, 26.04.04, 26.04.07, 26.04.24,  
 27.05.24  
 (511) 43

(260) AM 2017 91070 A  
 (210) AM 91070  
 (220) 2017 02 28  
 (731) CHOICE HOTELS INTERNATIONAL INC.  
 1 Choice Hotels Circle, Rockville, Maryland  
 20850, USA  
 (740) Tamaz Shilakadze  
 (540)

**CLARION**

(511) 43

(260) AM 2017 91071 A  
 (210) AM 91071  
 (220) 2017 02 28  
 (731) CHOICE HOTELS INTERNATIONAL INC.  
 1 Choice Hotels Circle, Rockville, Maryland  
 20850, USA  
 (740) Tamaz Shilakadze  
 (540)

**ASCEND HOTEL  
COLLECTION**

(511) 43

(260) AM 2017 91072 A  
 (210) AM 91072  
 (220) 2017 02 28  
 (731) CHOICE HOTELS INTERNATIONAL INC.  
 1 Choice Hotels Circle, Rockville, Maryland  
 20850, USA  
 (740) Tamaz Shilakadze  
 (540)



(591) Black, white  
 (531) 26.11.13, 27.05.10  
 (511) 43

(260) AM 2017 91075 A  
 (210) AM 91075  
 (220) 2017 02 28  
 (731) CHOICE HOTELS INTERNATIONAL INC.  
 1 Choice Hotels Circle, Rockville, Maryland  
 20850, USA  
 (740) Tamaz Shilakadze  
 (540)



(591) Black, white  
 (531) 26.01.18, 26.04.10, 26.04.24, 27.05.22,  
 27.05.24  
 (511) 43

(260) AM 2017 91076 A  
 (210) AM 91076  
 (220) 2017 02 28  
 (731) CHOICE HOTELS INTERNATIONAL INC.  
 1 Choice Hotels Circle, Rockville, Maryland  
 20850, USA  
 (740) Tamaz Shilakadze  
 (540)



(591) Black, white  
 (531) 26.01.12, 26.04.10, 26.04.24, 27.05.24  
 (511) 43

(260) AM 2017 91078 A  
 (210) AM 91078  
 (220) 2017 02 28  
 (731) CHOICE HOTELS INTERNATIONAL INC.  
 1 Choice Hotels Circle, Rockville, Maryland  
 20850, USA

(740) Tamaz Shilakadze  
(540)

**ASCEND**

(511) 43

(260) AM 2017 91089 A  
(210) AM 91089  
(220) 2017 03 01  
(731) LTD "ASPHARMA GEORGIA  
PHARMACEUTICAL COMPANY"  
Mtskhethis q.8, 0179, Tbilisi, Georgia  
(740) Maia Samadashvili  
(540)

**UDEX**  
**უდჰქს**  
**უდჰქსი**

(511) 5

(260) AM 2017 91129 A  
(210) AM 91129  
(220) 2017 03 06  
(731) LTD "J.S.V"  
I. Chavchavadzis gamz. 56, b. 24, Tbilisi,  
Georgia  
(740) Shota Paliani  
(540)

**PALIANI**

(511) 33

(260) AM 2017 91136 A  
(210) AM 91136  
(220) 2017 03 06  
(731) HASBRO, INC.  
1027 Newport Avenue, 02862 Pawtucket,  
Rhode Island, USA  
(740) Tamaz Shilakadze  
(540)



(591) Black, white  
(531) 25.01.09, 27.05.24  
(511) 28

(260) AM 2017 91152 A  
(210) AM 91152  
(220) 2017 03 06  
(731) JSC "CHATEAU MUKHRANI"  
Sop. Mukhrani, 3309, Mtskheta, Georgia  
(740) Irine Pilauri  
(540)

**საიდუმლო კოლექცია**

(511) 33

(260) AM 2017 91153 A  
(210) AM 91153  
(220) 2017 03 06  
(731) JSC "CHATEAU MUKHRANI"  
Sop. Mukhrani, 3309, Mtskheta, Georgia  
(740) Irine Pilauri  
(540)

**Collection Secrète**

(511) 33

(260) AM 2017 91155 A  
(210) AM 91155  
(220) 2017 03 07  
(731) IE "ALINA KAZANDZHIYAN-ONEGIN  
ROOMS"  
Al. Kazbegis gamz. 33, b.1, 0177, Tbilisi,  
Georgia  
(740) Alina Kazandzhiyan  
(540)

**ONEGIN**

(511) 39, 43

(260) AM 2017 91178 A  
(210) AM 91178  
(220) 2017 03 07  
(731) HYUNDAI OILBANK CO., LTD.  
182, Pyeongsin 2-ro, Daesan-eup, Seosan-si,  
Chungcheongnam-do, Republic of Korea  
(740) Shalva Gvaramadze  
(540)

**XTeer**

(511) 1, 2, 4, 35

(260) AM 2017 91180 A  
(210) AM 91180  
(220) 2017 03 07  
(731) MONSTER ENERGY COMPANY  
a Delaware corporation  
1 Monster Way, Corona, California 92879,  
USA

(740) Shalva Gvaramadze  
(540)

**MONSTER REHAB**

(511) 30, 32

(260) AM 2017 91183 A  
(210) AM 91183  
(220) 2017 03 07  
(731) ALLERGAN HOLDINGS France SAS  
12 Place de la Defense, 4eme etage, 92400,  
Courbevoie, France  
(740) Shalva Gvaramadze  
(540)

**JUVEDERM**

(511) 5

(260) AM 2017 91188 A  
(210) AM 91188  
(220) 2017 03 09  
(731) LTD "PALITRA TV"  
Iosebldzls q. 49, 0160, Tbilisi, Georgia  
(740) Giorgi Revishvili  
(540)



(591) Red, white, black  
(531) 25.05.02, 27.05.01, 27.05.24, 29.01.13  
(511) 16, 35, 38, 41, 45

(260) AM 2017 91189 A  
(210) AM 91189  
(220) 2017 03 10  
(731) ALTECO CHEMICAL PTE LTD  
19, Tuas Avenue 11, Singapore 639084,  
Singapore  
(740) Giorgi Taktakishvili  
(540)

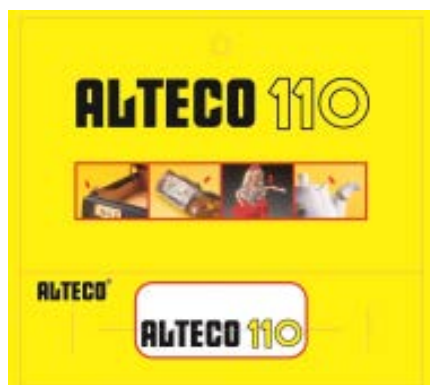

(591) White, yellow, red, brown, beige,  
khaki, black  
(531) 02.05.03, 11.03.14, 17.02.13, 19.03.03,  
27.05.01, 27.05.17, 27.07.02, 29.01.15  
(511) 1, 16

(260) AM 2017 91190 A  
(210) AM 91190  
(220) 2017 03 10  
(731) ALTECO CHEMICAL PTE LTD  
19, Tuas Avenue 11, Singapore 639084,  
Singapore  
(740) Giorgi Taktakishvili  
(540)

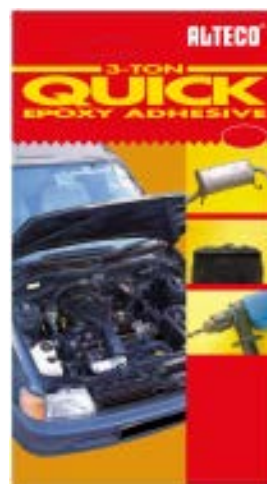

(591) White, yellow, red, sky-blue, grey, beige,  
black  
(531) 14.07.11, 14.07.13, 15.01.25, 18.01.09,  
19.03.24, 29.01.15  
(511) 1, 16

(260) AM 2017 91191 A  
(210) AM 91191  
(220) 2017 03 10  
(731) LTD "S-G-S GRUUP"  
Pushkinis q. 19, dzveli Tbilisis r-i, 0105,  
Tbilisi, Georgia  
(740) Sopio Kordzakhia  
(540)

**ბონ-პეჩო**  
**Bon-Pecho**

(511) 30

(260) AM 2017 91194 A  
(210) AM 91194  
(220) 2017 03 10  
(731) LTD "GEORGIAN WINE HOUSE"  
Sops. Zegaani, Gurjaani, Georgia  
(740) Amza Kakauridze

(540)

**ნეტარება**  
**Нетареба**  
**Netareba**

(511) 33

---

(260) AM 2017 91195 A

(210) AM 91195

(220) 2017 03 10

(731) CJSC "KANONPHARMA PRODUCTION"

Ul. Zarechnaya 105, Moskovis olki,  
Shcholkovos r-ni, Shcholkovo, 141100,  
Russian Federation

(740) Davit Chkopoia

(540)

**ჰისტერო**  
**HISTER**  
**ГИСТЕР**

(511) 5

---

(260) AM 2017 91198 A

(210) AM 91198

(220) 2017 03 10

(731) TAKEDA PHARMA A/S

Dybendal Alle 10, 2630 TAASTRUP,  
Denmark

(740) Khatuna Imnadze

(540)



(591) Blue, white, red, pink

(531) 02.09.01, 28.05, 29.01.13

(511) 5

---

---

**REGISTERED TRADEMARK**

(111) M 2017 28913 R  
 (151) 2017 10 03  
 (181) 2027 10 03  
 (260) AM 2017 86757 A  
 (220) 2016 03 25

(732) JVC KENWOOD Corporation  
 3-12, Moriyacho, Kanagawa-Ku, Yokohama-  
 Shi, Kanagawa, Japan

---

(111) M 2017 28914 R  
 (151) 2017 10 03  
 (181) 2027 10 03  
 (260) AM 2017 87015 A  
 (220) 2016 04 15

(732) BAYADERA MANAGEMENT LIMITED  
 Karpenisiou, 30, P.C., CY-1660 Nicosia,  
 Cyprus

---

(111) M 2017 28915 R  
 (151) 2017 10 03  
 (181) 2027 10 03  
 (260) AM 2017 87509 A  
 (220) 2016 06 06

(732) LTD "MADLOBA"  
 Ak. Beliashvilis q. 55, 0159, Tbilisi, Georgia

---

(111) M 2017 28916 R  
 (151) 2017 10 03  
 (181) 2027 10 03  
 (260) AM 2017 87539 A  
 (220) 2016 06 08

(732) FIL LIMITED  
 Pembroke Hall, 42 Crow Lane, Pembroke  
 HM 19, P.O. Box HM 670, Hamilton HMCX,  
 Bermuda

---

(111) M 2017 28917 R  
 (151) 2017 10 03  
 (181) 2027 10 03  
 (260) AM 2017 87886 A  
 (220) 2016 07 08

(732) LTD "3G - Georgian Global Group"  
 Mukhiani I m/r, korp. 13, b.25, Tbilisi, Georgia

---

(111) M 2017 28918 R  
 (151) 2017 10 03  
 (181) 2027 10 03  
 (260) AM 2017 87890 A  
 (220) 2016 07 08

(732) MAIA LEKISHVILI  
 K. Kekelidzis q.16, b.6, Tbilisi, Georgia

---

(111) M 2017 28919 R  
 (151) 2017 10 03  
 (181) 2027 10 03  
 (260) AM 2017 87906 A  
 (220) 2016 07 11

(732) UBER TECHNOLOGIES, INC.  
 a Delaware corporation  
 1455 Market Street, 4 floor, San Francisco,  
 California, 94103, USA

---

(111) M 2017 28920 R  
 (151) 2017 10 03  
 (181) 2027 10 03  
 (260) AM 2017 87908 A  
 (220) 2016 07 11

(732) UBER TECHNOLOGIES, INC.  
 a Delaware corporation  
 1455 Market Street, 4 floor, San Francisco,  
 California, 94103, USA

---

(111) M 2017 28921 R  
 (151) 2017 10 03  
 (181) 2027 10 03  
 (260) AM 2017 88000 A  
 (220) 2016 07 22

(732) ALLIED GLOBAL TOBACCO LIMITED  
 Wey Court West, Union Road, Farnham,  
 GU9 7PT, Surrey, United Kingdom

---

(111) M 2017 28922 R  
 (151) 2017 10 03  
 (181) 2027 10 03  
 (260) AM 2017 88227 A  
 (220) 2016 08 11

(732) COTT BEVERAGES INC.  
 5519 West Idlewild Avenue, Tampa, Florida  
 33634-8016, USA

---

(111) M 2017 28923 R  
 (151) 2017 10 03  
 (181) 2027 10 03  
 (260) AM 2017 88320 A  
 (220) 2016 08 16

(732) IBRAHIM ÖNDER  
 Merkez Mah. Muhammet Kabaoğlu Cad.  
 No:16 / 7 Ardeşen / Rize Turkey

---

(111) M 2017 28924 R  
 (151) 2017 10 03  
 (181) 2027 10 03  
 (260) AM 2017 88321 A  
 (220) 2016 08 16



(732) Pharmaceutical Chemical Cosmetic industry  
ALKALOID AD - Skopje  
Bul. Aleksandar Makedonski, 12, 1000  
Skopje, Republic of Macedonia, The Former  
Yugoslav

---

(111) M 2017 28925 R  
(151) 2017 10 03  
(181) 2027 10 03  
(260) AM 2017 88407 A  
(220) 2016 08 25  
(732) AZTEC SHOPS, LTD.

San Diego State University, San Diego,  
California, 92182-1701, USA

---

(111) M 2017 28926 R  
(151) 2017 10 03  
(181) 2027 10 03  
(260) AM 2017 88487 A  
(220) 2016 09 05  
(732) PHILIP MORRIS BRANDS SÀRL  
Quai Jeanrenaud 3, 2000 Neuchâtel, Switzerland

---

(111) M 2017 28927 R  
(151) 2017 10 03  
(181) 2027 10 03  
(260) AM 2017 88488 A  
(220) 2016 09 05  
(732) PHILIP MORRIS BRANDS SÀRL  
Quai Jeanrenaud 3, 2000 Neuchâtel, Switzerland

---

(111) M 2017 28928 R  
(151) 2017 10 03  
(181) 2027 10 03  
(260) AM 2017 88584 A  
(220) 2016 09 14  
(732) BAYER CONSUMER CARE AG  
Peter Merian-Str. 84, 4052 Basel, Switzerland

---

(111) M 2017 28929 R  
(151) 2017 10 03  
(181) 2027 10 03  
(260) AM 2017 88586 A  
(220) 2016 09 15  
(732) HERBALIFE INTERNATIONAL, INC  
800 W. Olympic Boulevard, Suite 406,  
Los Angeles, California 90015, USA

---

(111) M 2017 28930 R  
(151) 2017 10 03  
(181) 2027 10 03  
(260) AM 2017 88587 A  
(220) 2016 09 15

(732) HERBALIFE INTERNATIONAL, INC  
800 W. Olympic Boulevard, Suite 406,  
Los Angeles, California 90015, USA

---

(111) M 2017 28931 R  
(151) 2017 10 03  
(181) 2027 10 03  
(260) AM 2017 88602 A  
(220) 2016 09 15  
(732) PHILIP MORRIS PRODUCTS S.A.  
Quai Jeanrenaud 3, 2000 Neuchâtel,  
Switzerland

---

(111) M 2017 28932 R  
(151) 2017 10 03  
(181) 2027 10 03  
(260) AM 2017 88653 A  
(220) 2016 09 21  
(732) BAYER INTELLECTUAL PROPERTY  
GMBH  
Alfred-Nobel-Str. 10, 40789 Monheim am  
Rhein, Germany

---

(111) M 2017 28933 R  
(151) 2017 10 03  
(181) 2027 10 03  
(260) AM 2017 88691 A  
(220) 2016 09 27  
(732) HYATT INTERNATIONAL CORPORATION  
71 S. Wacker Drive, 14th Floor, Chicago,  
IL 60606, USA

---

(111) M 2017 28934 R  
(151) 2017 10 03  
(181) 2027 10 03  
(260) AM 2017 88693 A  
(220) 2016 09 27  
(732) LTD "GLAVSPIRTPROMI"  
Lilos 51, 0198, Tbilisi, Georgia

---

(111) M 2017 28935 R  
(151) 2017 10 03  
(181) 2027 10 03  
(260) AM 2017 88709 A  
(220) 2016 09 28  
(732) LTD "AVERSI-PHARMA"  
D. Aghmasheneblis gamz. 148/2, 0112, Tbilisi,  
Georgia

---

(111) M 2017 28936 R  
(151) 2017 10 03  
(181) 2027 10 03  
(260) AM 2017 88713 A

(220) 2016 09 28  
 (732) LTD "AVERSI-PHARMA"  
 D. Aghmasheneblis gamz. 148/2, 0112, Tbilisi,  
 Georgia

(260) AM 2017 88729 A  
 (220) 2016 09 28  
 (732) LTD "AVERSI-PHARMA"  
 D. Aghmasheneblis gamz. 148/2, 0112, Tbilisi,  
 Georgia

(111) M 2017 28937 R  
 (151) 2017 10 03  
 (181) 2027 10 03  
 (260) AM 2017 88718 A  
 (220) 2016 09 28  
 (732) LTD "AVERSI-PHARMA"  
 D. Aghmasheneblis gamz. 148/2, 0112, Tbilisi,  
 Georgia

(111) M 2017 28943 R  
 (151) 2017 10 03  
 (181) 2027 10 03  
 (260) AM 2017 88732 A  
 (220) 2016 09 28  
 (732) LTD "AVERSI-PHARMA"  
 D. Aghmasheneblis gamz. 148/2, 0112, Tbilisi,  
 Georgia

(111) M 2017 28938 R  
 (151) 2017 10 03  
 (181) 2027 10 03  
 (260) AM 2017 88721 A  
 (220) 2016 09 28  
 (732) LTD "AVERSI-PHARMA"  
 D. Aghmasheneblis gamz. 148/2, 0112, Tbilisi,  
 Georgia

(111) M 2017 28944 R  
 (151) 2017 10 03  
 (181) 2027 10 03  
 (260) AM 2017 88735 A  
 (220) 2016 09 28  
 (732) LTD "AVERSI-PHARMA"  
 D. Aghmasheneblis gamz. 148/2, 0112, Tbilisi,  
 Georgia

(111) M 2017 28939 R  
 (151) 2017 10 03  
 (181) 2027 10 03  
 (260) AM 2017 88723 A  
 (220) 2016 09 28  
 (732) LTD "AVERSI-PHARMA"  
 D. Aghmasheneblis gamz. 148/2, 0112, Tbilisi,  
 Georgia

(111) M 2017 28945 R  
 (151) 2017 10 03  
 (181) 2027 10 03  
 (260) AM 2017 88737 A  
 (220) 2016 09 28  
 (732) LTD "AVERSI-PHARMA"  
 D. Aghmasheneblis gamz. 148/2, 0112, Tbilisi,  
 Georgia

(111) M 2017 28940 R  
 (151) 2017 10 03  
 (181) 2027 10 03  
 (260) AM 2017 88725 A  
 (220) 2016 09 28  
 (732) LTD "AVERSI-PHARMA"  
 D. Aghmasheneblis gamz. 148/2, 0112, Tbilisi,  
 Georgia

(111) M 2017 28946 R  
 (151) 2017 10 03  
 (181) 2027 10 03  
 (260) AM 2017 88738 A  
 (220) 2016 09 28  
 (732) LTD "AVERSI-PHARMA"  
 D. Aghmasheneblis gamz. 148/2, 0112, Tbilisi,  
 Georgia

(111) M 2017 28941 R  
 (151) 2017 10 03  
 (181) 2027 10 03  
 (260) AM 2017 88727 A  
 (220) 2016 09 28  
 (732) LTD "AVERSI-PHARMA"  
 D. Aghmasheneblis gamz. 148/2, 0112, Tbilisi,  
 Georgia

(111) M 2017 28947 R  
 (151) 2017 10 03  
 (181) 2027 10 03  
 (260) AM 2017 88835 A  
 (220) 2016 10 05  
 (732) ALEKSANDRE BABAYAN  
 Tsitsishvili-Panaskertelis g. korp. 14, b.39,  
 0194, Tbilisi, Georgia

(111) M 2017 28942 R  
 (151) 2017 10 03  
 (181) 2027 10 03

(111) M 2017 28948 R  
 (151) 2017 10 03  
 (181) 2027 10 03

(260) AM 2017 89050 A  
(220) 2016 10 17  
(732) JSC "GEORGIAN BEER COMPANY"  
Sop. Saguramo, 3311, Mtskheta, Georgia

---

(220) 2016 10 27  
(732) TURNER BROADCASTING SYSTEM, INC.  
a Georgia corporation  
One CNN Center, Atlanta GA 30303, USA

---

(111) M 2017 28949 R  
(151) 2017 10 03  
(181) 2027 10 03  
(260) AM 2017 89095 A  
(220) 2016 10 21  
(732) MONSTER ENERGY COMPANY  
a Delaware corporation  
1 Monster Way, Corona, California 92879, USA

---

(111) M 2017 28955 R  
(151) 2017 10 04  
(181) 2027 10 04  
(260) AM 2017 89179 A  
(220) 2016 10 27  
(732) TURNER BROADCASTING SYSTEM, INC.  
a Georgia corporation  
One CNN Center, Atlanta GA 30303, USA

---

(111) M 2017 28950 R  
(151) 2017 10 03  
(181) 2027 10 03  
(260) AM 2017 89096 A  
(220) 2016 10 21  
(732) MONSTER ENERGY COMPANY  
a Delaware corporation  
1 Monster Way, Corona, California 92879, USA

---

(111) M 2017 28956 R  
(151) 2017 10 04  
(181) 2027 10 04  
(260) AM 2017 89429 A  
(220) 2016 11 11  
(732) LTD "AGROHABI"  
Krtsanisis q. 8, korp. 2, b. 23, 0114, Tbilisi,  
Georgia

---

(111) M 2017 28951 R  
(151) 2017 10 04  
(181) 2027 10 04  
(260) AM 2017 89099 A  
(220) 2016 10 21  
(732) JSC "NOVA TECHNOLOGY"  
Uznadzis q. 37, 0102, Tbilisi, Georgia

---

(111) M 2017 28957 R  
(151) 2017 10 04  
(181) 2027 10 04  
(260) AM 2017 89430 A  
(220) 2016 11 11  
(732) LTD "AGROHABI"  
Krtsanisis q. 8, korp. 2, b. 23, 0114, Tbilisi,  
Georgia

---

(111) M 2017 28952 R  
(151) 2017 10 04  
(181) 2027 10 04  
(260) AM 2017 89102 A  
(220) 2016 10 24  
(732) LTD "PIKOLO"  
S. Chikovani-Balanchivadzis q. 22, sart. 8,  
b. 64, Tbilisi, Georgia

---

(111) M 2017 28958 R  
(151) 2017 10 04  
(181) 2027 10 04  
(260) AM 2017 89538 A  
(220) 2016 11 18  
(732) LTD "GEMOVANI"  
Krtsanisis q. 22-24, b. 44, Tbilisi, Georgia

---

(111) M 2017 28953 R  
(151) 2017 10 04  
(181) 2027 10 04  
(260) AM 2017 89103 A  
(220) 2016 10 24  
(732) LTD "PIKOLO"  
S. Chikovani-Balanchivadzis q. 22, sart. 8,  
b. 64, Tbilisi, Georgia

---

(111) M 2017 28954 R  
(151) 2017 10 04  
(181) 2027 10 04  
(260) AM 2017 89178 A

---

## TRADEMARKS REGISTERED ACCORDING TO THE ACCELERATED PROCEDURE

The decision can be appealed at the Chamber of Appeal of Sakpatenti within 3 months from the publication.

(111) M 2017 28908 R  
(151) 2017 09 26  
(181) 2027 09 26  
(210) AM 94164  
(220) 2017 09 12  
(732) JAPAN TOBACCO INC.  
2-2-1 Toranomom, Minato-Ku, Tokyo, Japan  
(740) Shalva Gvaramadze  
(540)

**WINSTON**  
— EST. 1954 —  
PREMIUM BLEND

(591) Black, white  
(531) 26.11.08, 27.05.08  
(511) 34

(111) M 2017 28909 R  
(151) 2017 09 29  
(181) 2027 09 29  
(210) AM 94179  
(220) 2017 09 13  
(732) JSC "CHATEAU MUKHRANI"  
Sop. Mukhrani, 3309, Mtskhethis raioni,  
Georgia  
(740) Irine Pilauri  
(540)

**Parfum d'été**

(591) Black, white  
(511) 33

(111) M 2017 28910 R  
(151) 2017 10 02  
(181) 2027 10 02  
(210) AM 94004  
(220) 2017 09 01  
(732) LTD "VEGAPHARM-GEORGIA"  
Akaki Gakhokidzis q. 2-4, Iuri Gagarinis  
q. 5, s/p 6, Tbilisi, Georgia  
(540)

**Revianox**  
რევიანოქსი  
**Ревьянокс**

(511) 5

(111) M 2017 28911 R  
(151) 2017 10 02  
(181) 2027 10 02  
(210) AM 94217  
(220) 2017 09 19  
(732) LTD "GEO FITNESS"  
I. Chavchavadzis gamz. 49b, 0162, Tbilisi,  
Georgia  
(540)



**ვაკის პუზი**  
VAKE SWIMMING  
POOL

(591) Black, white, sky-blue, blue  
(531) 01.15.24, 26.11.13, 26.15.01, 29.01.13  
(511) 41

(111) M 2017 28912 R  
(151) 2017 10 02  
(181) 2027 10 02  
(210) AM 94339  
(220) 2017 09 28  
(732) LTD "NEXTRA GROUP"  
Irodion Evdoshvilis q.18, Sart. 2, s/p 3,  
Didube-Chuguretis r-ni, 0154, Tbilisi, Georgia  
(540)

**კალციდვიტი**  
**CALCIDVIT**  
**КАЛЦИДВИТ**

(511) 5

## INTERNATIONAL TRADEMARKS FOR WHICH A DECISION ON GRANTING PROTECTIONS IS TAKEN

The decision can be appealed at the Chamber of Appeal of Sakpatenti within 3 months from the publication or at the Mtskheta District Court Administrative Cases Board (Address: №17, Samkhedro str., Mtskheta), within 1 month following the publication.

(260) AM 2017 84832 A\*  
 (800) 1274456  
 (891) 2015 04 02  
 (731) Dochirnie pidpriemstvo "KONDYTERSKA KORPORATSIIA "ROSHEN"  
 Elektrykiv vul., 26/9, Kyiv 04176, Ukraine  
 (540)



(591) Grey, white, red, green, blue, azure, crimson, yellow, bluebottle and peachy  
 (511)  
 30 – Confectionery; caramels [candy]; sweetmeats [candy].

(260) AM 2017 87044 A  
 (800) 1190838  
 (891) 2013 10 22  
 (731) M.P.I. PHARMACEUTICA GMBH  
 Ballindamm 8 20095 Hamburg, Germany  
 (540)

### Masculan

(511)  
 5 – Pharmaceutical products as well as preparations and chemical products for health care, in particular aphrodisiacs, lubricants (oil and cream), contraceptive creams and suppositories, massage oils, orgasm creams, medicated preparations for physical strengthening and increasing the potency.

28 – Accessories for erotic games, namely, dice, dice cups, masks, eye masks, electronic erotic games, in particular video games; joke articles, playing cards with erotic pictures.

(260) AM 2017 88313 A  
 (800) 1277927  
 (891) 2016 04 22

(731) OSHEE POLSKA SP. Z O.O.  
 Aleja Modrzewiowa 13, PL-30-224 Kraków,  
 Poland  
 (540)

### Oshee

(511)  
 5 – Dietetic substances adapted for medical use; mineral food supplements; nutritional supplements; preparations of microelements for medical and veterinary use; dietetic foods adapted for medical purposes.

30 – Bars (terms too vague in the opinion of the International Bureau – Rule 13(2)(b) of the Common Regulation); chocolate; fruit jellies; chewing gum; crackers; popcorn; ice cream; vinegar; candy; lozenges; sweetmeats; chips; tea-based beverages; iced tea; cocoa-based beverages; coffee-based beverages; chocolate-based beverages; honey; sandwiches.

32 – Mineral water; aerated water; table waters; non-alcoholic beverages; non-alcoholic fruit juice beverages; fruit juices; isotonic beverages; energy drinks; syrups for beverages; preparations for making beverages; vegetable juices; beer.

(260) AM 2017 88851 A  
 (800) 1311038  
 (891) 2016 06 10  
 (731) OBSHCHESTVO S OGRANICHENNOY OTVETSTVENNOSTYU "NPO Petrovaks Farm"  
 yl. Sosnovaya, d. 1, s, Pokrov, Podolskiy district, RU-142143 Moscow region, Russian Federation

(540)  
**ЛОНГИДАЗА**

(591) Black and white  
 (511)  
 3 – Cosmetics; creams for cosmetic purposes; beauty masks; preparations for cosmetic purposes; powders for cosmetic purposes; paste for cosmetic purposes; lotions for cosmetic purposes; soap; pomades for cosmetic purposes.

5 – Pharmaceutical, veterinary and sanitary preparations; dietetic substances adapted for medical use; biological preparations for medical and veterinary purposes; medicines for medical purposes; vaccines;

capsules for medicines; liniments; pills for medical purposes; suppositories; enzyme preparations for medical purposes; chemico-pharmaceutical preparations.

(260) AM 2017 88936 A

(800) 1149796

(891) 2016 09 06

(731) ENTERPRISE HOLDINGS, INC.

600 Corporate Park Drive, St. Louis MO  
63105, USA

(540)



(591) black-white

(511)

12 – Vehicles, namely, automobiles, trucks, cars, land vehicles.

35 – Vehicle dealership services, namely, dealerships in the field of automobiles, trucks, cars, land vehicles; vehicle fleet business management services related to tracking and monitoring vehicles for commercial purposes, and business consultation services relating to the management of a fleet of vehicles for commercial purposes.

36 – Vehicle fleet management services, namely, facilitating and arranging for financing, and insurance agency services in the fields of liability, collision, and comprehensive insurance, of vehicles for others.

37 – Vehicle repair services; vehicle fleet management services, namely, vehicle repair and maintenance.

39 – Vehicle rental and leasing services; and reservation services for the rental and leasing of vehicles, namely, rental reservations for automobiles, trucks, cars, land vehicles.

(260) AM 2017 89005 A

(800) 1312562

(891) 2016 08 04

(731) APPLE INC.

1 Infinite Loop, Cupertino CA 95014, USA

(540)

**MAGIC TOOLBAR**

(511)

9 – Computers; computer hardware; computer software; computer peripheral devices; computer display screens and keyboards; electronic interfaces for use with computers.

(260) AM 2017 89029 A

(800) 1314113

(891) 2016 03 02

(731) Obshchestvo s ogranichennoy

otvetstvennostyu "KAPUS KOSMETIKS"  
komn. 18, str. 1-1, Volokolamskoe chosse,  
RU-125080 Moskva, Russian Federation

(540)



(591) black and white

(511)

8 – Beard clippers; razors, electric or non-electric; razor blades; depilation appliances, electric and nonelectric; hand implements for hair curling; curling tongs; manicure sets; manicure sets, electric; pedicure sets; nail files; nail files, electric; nail nippers; scissors; tweezers; hair-removing tweezers; hair clippers for personal use, electric and non-electric; tongs; cuticle tweezers; shearers [hand instruments].

11 – Sauna bath installations; hair dryers.

20 – Mirrors [looking glasses]; hairdressers' chairs.

21 – Eyebrow brushes; large-toothed combs for the hair; shaving brushes; combs; comb cases; electric combs; nail brushes.

35 – Sales promotion for others.

44 – Hair implantation; hairdressing salons; beauty salons; sanatoriums; manicuring; massage.

(260) AM 2017 89407 A

(800) 1316959

(891) 2016 06 15

(731) Limited Liability Company "DSSL"

Nizhnaya Krasnoselskaya street, 40/12,  
building 7, RU-105066 Moscow, Russian  
Federation

(540)

**ACTIVECAM**

(591) Black, white

(511)

9 – DVD players; ticket dispensers; coin-operated musical automata; fire engines; answering machines; accumulators, electric; accumulators, electric, for ve-

hicles; actinometers; alidades; altimeters; ammeters; anemometers; anodes; antennas; anticathodes; apertometers (optics); high-frequency apparatus; testing apparatus not for medical purposes; remote control apparatus; electro-dynamic apparatus for the remote control of railway points; electro-dynamic apparatus for the remote control of signals; monitoring apparatus, electric; sound recording apparatus; distillation apparatus for scientific purposes; diffraction apparatus (microscopy); air analysis apparatus; apparatus to check stamping mail; sound transmitting apparatus; apparatus for fermentation (laboratory apparatus); breathing apparatus, except for artificial respiration; breathing apparatus for underwater swimming; apparatus and installations for the production of X-rays, not for medical purposes; cash registers; electric apparatus for commutation; intercommunication apparatus; stills for laboratory experiments; projection apparatus; radiological apparatus for industrial purposes; blueprint apparatus; flashing lights (luminous signals); stereoscopic apparatus; telegraphs [apparatus]; telephone apparatus; facsimile machines; phototelegraphy apparatus; igniting apparatus, electric, for igniting at a distance; acid hydrometers; salinometers; acidimeters for batteries; aerometers; beacons, luminous; barometers; anode batteries; galvanic batteries; batteries for lighting; solar batteries; batteries, electric; balances; betatrons; binoculars; electronic tags for goods; magnetic tape units for computers; computer memory devices; fire hose nozzles; encoded identification bracelets, magnetic; safety tarpaulins; signalling buoys; life buoys; marking buoys; directional compasses; vacuum gauges; electrolyzers; variometers; mechanical signs; scales; letter scales; weighbridges; precision balances; levelling staffs (surveying instruments); camcorders; video cassettes; video telephones; video screens; viewfinders, photographic; sockets, plugs and other contacts (electric connections); micrometer screws for optical instruments; viscosimeters; circuit closers; wavemeters; voltmeters; switchboxes (electricity); current rectifiers; gas testing instruments; gasometers (measuring instruments); galvanometers; heliographic apparatus; hygrometers; hydrometers; weights; peepholes [magnifying lenses] for doors; holograms; plotters; loudspeakers; sounding leads; plumb bobs; range finders; densimeters; densitometers; optical goods; detectors; galena crystals (detectors); smoke detectors; false coin detectors; transparencies (photography); slide projectors; diaphragms (photography); dictating machines; dynamometers; floppy disks; sound recording discs; disks, magnetic; optical discs; circular slide rules; disk drives for computers; juke boxes for computers; DNA chips; electronic notice boards; bullet-proof waistcoats (vests (Am.)); life jackets; identification threads for electric wires; nose clips for divers and swimmers; locks, electric; bells (warning devices); alarm bells, electric; electric door bells; signal bells;

acoustic conduits; mirrors for inspecting work; road signs, luminous or mechanical; signs, luminous; marine depth finders; probes for scientific purposes; buzzers; needles for record players; measures; pressure measuring apparatus; simulators for the steering and control of vehicles; inverters (electricity); pressure indicators; temperature indicators; incubators for bacteria culture; measuring instruments; mathematical instruments; levelling instruments; surveying instruments; azimuth instruments; interfaces for computers; ionization apparatus not for the treatment of air or water; spark-guards; coaxial cables; fibre (fiber (Am.)) optic cables; cables, electric; calipers; slide calipers; screw-tapping gauges; calculating machines; pocket calculators; decompression chambers; cinematographic cameras; electronic pens (visual display units); holders for electric coils; identity cards, magnetic; video game cartridges; encoded magnetic cards; riding helmets; protective helmets; carriers for dark plates (photography); automated teller machines (ATM); cathodes; choking coils (impedance); coils, electric; electromagnetic coils; spools (photography); cinematographic film, exposed; computer keyboards; solenoid valves [electromagnetic switches]; wire connectors (electricity); electronic agendas; push buttons for bells; mouse pads; magnetic encoders; anti-glare visors; collectors, electric; calibrating rings; protective suits for aviators; commutators; compact discs (audio-video); compact discs (read-only memory); comparators; marine compasses; computers; notebook computers; condensers; contacts, electric; wind socks for indicating wind direction; branch boxes (electricity); distribution boxes (electricity); connectors (electricity); junction boxes (electricity); battery boxes; cabinets for loudspeakers; diving suits; reflecting discs for wear, for the prevention of traffic accidents; covers for electric outlets; logs (measuring instruments); lasers, not for medical purposes; lactodensimeters; lactometers; darkroom lamps (photography); neon signs; thermionic tubes; amplifying tubes; flashlights (photography); head cleaning tapes (recording); magnetic tapes; videotapes; surveying chains; fire escapes; rulers (measuring instruments); slide-rules; contact lenses; correcting lenses (optics); optical lenses; close-up lenses; optical condensers; sounding lines; electricity conduits; measuring spoons; magnifying glasses (optics); thread counters; waling glasses; magnets; decorative magnets; resuscitation mannequins (teaching apparatus); mouse (computer peripheral); manometers; divers' masks; solderers' helmets; protective masks; materials for electricity mains (wires, cables); voting machines; money counting and sorting machines; material testing instruments and machines; megaphones; diaphragms (acoustics); diaphragms for scientific apparatus; metal detectors for industrial or military purposes; metronomes; rules (measuring instruments); carpenters' rules; dressmakers' measures; mechanisms for coin-operated appa-

ratus; coin-operated mechanisms for television sets; shutter releases (photography); micrometers; microprocessors; microscopes; microtomes; microphones; modems; lightning conductors; monitors (computer hardware); terminals (electricity); junction sleeves for electric cables; teeth protectors; knee-pads for workers; headphones; surveyors' levels; verniers; sound recording carriers; magnetic data media; optical data media; socks, electrically heated; sheaths for electric cables; identification sheaths for electric wires; weighing machines; punched card machines for offices; shoes for protection against accidents, irradiation and fire; objectives [lenses] [optics]; lenses for astrophotography; egg-candlers; fire extinguishers; electrified fences; limiters (electricity); clothing for protection against accidents, irradiation and fire; clothing for protection against fire; asbestos clothing for protection against fire; clothing especially made for laboratories; ozonisers [ozonators]; octants; eyepieces; ohmmeters; wrist rests for use with computers; eyeglass frames; oscillographs; plumb lines; mirrors (optics); eyeglasses (optics); sunglasses; goggles for sports; signalling panels, luminous or mechanical; radio pagers; pince-nez; electronic pocket translators; transmitters (telecommunication); transmitters of electronic signals; switches, electric; periscopes; gloves for divers; asbestos gloves for protection against accidents; gloves for protection against X-rays for industrial purposes; furnaces for laboratory use; pipettes; pyrometers; planimeters; plane tables (surveying instruments); plates for batteries; wafers for integrated circuits; compact disc players; sound recording strips; X-ray films, exposed; films, exposed; life-saving rafts; laboratory trays; semi-conductors; polarimeters; fire pumps; measuring glassware; life belts; circuit breakers; fuses; converters, electric; telerupters; food analysis apparatus; diagnostic apparatus, not for medical purposes; distance measuring apparatus; speed measuring apparatus (photography); apparatus for measuring the thickness of skins; appliances for measuring the thickness of leather; speed checking apparatus for vehicles; teaching apparatus; time recording apparatus; apparatus and instruments for astronomy; surveying apparatus and instruments; weighing apparatus and instruments; navigational instruments; optical apparatus and instruments; apparatus and instruments for physics; chemistry apparatus and instruments; measuring apparatus; measuring devices, electric; boiler control instruments; meteorological instruments; naval signalling apparatus; observation instruments; navigation apparatus for vehicles (on-board computers); satellite navigational apparatus; regulating apparatus, electric; precision measuring apparatus; instruments containing eyepieces; audio- and video-receivers; prisms (optics); printers for use with computers; apparatus for changing record player needles; retorts' stands; drainers for use in photography; cleaning ap-

paratus for sound recording discs; fire beaters; telescopic sights for firearms; test tubes; pressure indicator plugs for valves; magnetic wires; telegraph wires; telephone wires; wires, electric; conductors, electric; copper wire, insulated; wires of metal alloys [fuse wire]; computer programmes (programs), recorded; computer game software; computer programmes (downloadable software); record players; central processing units; rods for water diviners; electronic publications, downloadable; distribution consoles (electricity); control panels (electricity); radar apparatus; vacuum tubes (radio); masts for wireless aerials; transmitting sets (telecommunication); radios; vehicle radios; frames for photographic transparencies; screens for photoengraving; walkie-talkies; voltage surge protectors; voltage regulators for vehicles; light dimmers (regulators), electric; stage lighting regulators; speed regulators for record players; cell switches (electricity); washing trays (photography); marking gauges (joinery); time switches, automatic; relays, electric; safety restraints, other than for vehicle seats and sports equipment; X-ray photographs, other than for medical purposes; rheostats; respiratory masks, other than for artificial respiration; respirators for filtering air; retorts; refractometers; refractors; grids for batteries; horns for loudspeakers; saccharometers; optical fibers; traffic-light apparatus (signalling devices); dog whistles; signalling whistles; sextants; inductors (electricity); safety nets; nets for protection against accidents; fire alarms; signals, luminous or mechanical; sirens; scanners (data processing equipment); integrated circuit cards (smart cards); connections for electric lines; couplings, electric; sonars; sound locating instruments; lighting ballasts; resistances, electric; spectrograph apparatus; spectroscopes; speed indicators; alcoholmeters; satellites for scientific purposes; protection devices for personal use against accidents; audiovisual teaching apparatus; radiotelegraphy sets; radiotelephony sets; spectacle lenses; optical glass; anti-glare glasses; personal stereos; stereoscopes; fire boats; sulfimeters; drying racks (photography); spherometers; integrated circuits; printed circuits; meters; parking meters; kilometer recorders for vehicles; milage recorders for vehicles; revolution counters; abacuses; taximeters; ear plugs for divers; tachometers; television apparatus; telescopes; teleprompters; teletypewriters; cordless telephones; theodolites; thermometers, not for medical purposes; thermostats; thermostats for vehicles; crucibles (laboratory); tone arms for record players; totalizers; transistors (electronic); protractors (measuring instruments); step-up transformers; transformers (electricity); vehicle breakdown warning triangles; starter cables for motors; discharge tubes, electric, other than for lighting; capillary tubes; X-ray tubes not for medical purposes; telephone receivers; quantity indicators; automatic indicators of low pressure in vehicle tires; gasoline gauges; water level indicators; electric loss



indicators; light-emitting electronic pointers; inclinometers; levels [instruments for determining the horizontal]; mercury levels; spirit levels; urinometers; amplifiers; particle accelerators; electric installations for the remote control of industrial operations; steering apparatus, automatic, for vehicles; balancing apparatus; video recorders; sound reproduction apparatus; invoicing machines; tape recorders; protection devices against X-rays, not for medical purposes; railway traffic safety appliances; data processing apparatus; oxygen transvasing apparatus; theft prevention installations, electric; time clocks [time recording devices]; film cutting apparatus; drying apparatus for photographic prints; optical character readers; centering apparatus for photographic transparencies; dosimeters; chargers for electric batteries; sound alarms; sounding apparatus and machines; life saving apparatus and equipment; editing appliances for cinematographic films; cathodic anti-corrosion apparatus; couplers (data processing equipment); computer peripheral devices; anti-interference devices (electricity); demagnetizing apparatus for magnetic tapes; acoustic couplers; alarms; whistle alarms; fog signals, non-explosive; adding machines; readers (data processing equipment); heat regulating apparatus; photocopiers (photographic, electrostatic, thermic); bar code readers; filters for respiratory masks; filters for ultraviolet rays, for photography; filters (photography); magic lanterns; optical lamps; signal lanterns; cameras (photography); glazing apparatus for photographic prints; shutters (photography); darkrooms (photography); photometers; flash-bulbs (photography); enlarging apparatus (photography); photovoltaic cells; containers for contact lenses; eyeglass cases; containers for microscope slides; cases especially made for photographic apparatus and instruments; chromatography apparatus for laboratory use; chronographs (time recording apparatus); cyclotrons; compasses (measuring instruments); frequency meters; sandglasses; fire blankets; chips (integrated circuits); pedometers; meteorological balloons; electrified rails for mounting spot lights; asbestos screens for firemen; protective helmets for sports; tripods for cameras; switchboards; distribution boards (electricity); workmen's protective face-shields; projection screens; radiology screens for industrial purposes; fluorescent screens; screens (photography); exposure meters; ducts (electricity); galvanic cells; epidiascopes; ergometers; armatures (electricity).

42 – Computer system analysis; chemical analysis; architectural services; authenticating works of art; recovery of computer data; graphic arts design; computer virus protection services; technical project studies; engineering; installation of computer software; meteorological information; material testing; textile testing; bacteriological research; biological research; geological research; research in the field of environmental protection; cosmetic research; mechanical re-

search; physics (research); chemical research; research and development of new products for others; analysis for oil-field exploitation; underwater exploration; technical research; calibration (measuring); consultancy in the design and development of computer hardware; computer software consultancy; oil-well testing; quality control; vehicle roadworthiness testing; land surveying; dress designing; updating of computer software; maintenance of computer software; design of interior decor; conversion of data or documents from physical to electronic media; urban planning; providing search engines for the internet; data conversion of computer programs and data (not physical conversion); computer system design; rental of web servers; computer rental; rental of computer software; geological prospecting; oil prospecting; hosting computer sites (web sites); duplication of computer programs; construction drafting; computer software design; cloud seeding; consultancy in the field of energy-saving; creating and maintaining web sites for others; computer programming; styling (industrial design); chemistry services; packaging design; surveying.

(260) AM 2017 89414 A

(800) 1317044

(891) 2016 04 04

(731) Obshchestvo s ogranichennoy  
otvetstvennostyu "MULTIKUBIK"  
ul. Nobelya, d. 7, korp. 1Territoria  
SKOLKOVO Innovatsionnogo centra,  
Moscow, RU-143026, Russian Federation

(540)

# CINEMOOD

(591) Black, white

(511)

9 – DVD players; sound recording apparatus; intercommunication apparatus; projection apparatus; sound transmitting apparatus; blueprint apparatus; flashing lights [luminous signals]; stereoscopic apparatus; telephone apparatus; computer memory devices; camcorders; video baby monitors; video telephones; video screens; holograms; loudspeakers; optical goods; slide projectors; transparency projection apparatus; dictating machines; sound recording discs; disks, magnetic; optical discs; disk drives for computers; buzzers; temperature indicators; interfaces for computers; fibre [fiber (Am.)] optic cables; cinematographic cameras; video game cartridges; memory cards for video game machines; electronic book readers; electronic agendas; compact discs [audio-video]; computers; laptop computers; tablet computers; notebook computers; lasers, not for medical purposes; optical lenses; portable media players; microphones; modems; monitors [computer hardware]; monitors [computer programs]; headphones; optical data media; computer software, recorded; ob-

jectives [lenses] [optics]; electronic pocket translators; transmitters of electronic signals; wafers for integrated circuits; compact disc players; teaching apparatus; audio- and video-receivers; prisms [optics]; wires, electric; computer programmes [programs], recorded; computer game software; computer programs [downloadable software]; computer operating programs, recorded; record players; processors [central processing units]; electronic publications, downloadable; radios; audiovisual teaching apparatus; personal stereos; stereoscopes; television apparatus; video recorders; sound reproduction apparatus; centering apparatus for photographic transparencies; battery chargers; computer peripheral devices; readers [data processing equipment]; bar code readers; computer software applications, downloadable; downloadable image files; downloadable music files; animated cartoons; USB flash drives; cameras [photography]; sleeves for laptops; projection screens.

35 – Arranging subscriptions to telecommunication services for others; demonstration of goods; marketing; organization of exhibitions for commercial or advertising purposes; presentation of goods on communication media, for retail purposes; sales promotion for others; advertising.

39 – Delivery of goods; wrapping of goods; storage of goods.

(260) AM 2017 89422 A

(800) 1317180

(891) 2016 07 05

(731) SWISS COFFEE INNOVATION AG

Leberngasse 21, CH-4600 Olten

(Switzerland), Switzerland

(540)

**CoffeeBall**

(591) Black, white

(511)

11 – Electric machines for making coffee, tea and cocoa-based beverages for the home, canteens and restaurants; electric apparatus for making coffee, tea and cocoa-based beverages for the home, canteens and restaurants.

21 – Household utensils and containers.

30 – Coffee, tea, cocoa.

35 – Advertising; retail sale, wholesale.

(260) AM 2017 89423 A

(800) 1317226

(891) 2016 06 23

(731) LABORATOIRES DE BIOLOGIE

VEGETALE YVES ROCHER

La Croix des Archers, F-56200 LA

GACILLY, France

(540)

**ACT BEAUTIFUL**

(591) Black, white

(511)

16 – Paper, cardboard and goods made thereof or of plastic (not included in other classes), namely books, booklets, magazines, journals, newspapers, periodicals, pamphlets, posters, almanacs, tear-off calendars, calendars, note books, catalogs, prospectuses; bottle packaging of cardboard or paper; packaging for bottles of cardboard or paper; packaging of cardboard or paper for cosmetic product containers; goods of paper, cardboard or plastic (not included in other classes), namely leaflets, printed matter, direct mail advertising, bags and pouches of paper, cardboard or plastic for packaging, loyalty cards, envelopes, greeting cards, gift cards, discount cards, point cards, cards (other than playing cards), pictures, photographs, photo-engravings, printing blocks, graphic prints, writing paper, small bags of paper, wrapping paper, scented paper; boxes of cardboard or paper; cardboard articles; cardboard packages; transfers for cosmetic use; tissues of paper for removing make-up; pencil sharpeners; printed publications, namely educational brochures, technical and sales guides, textbooks and workbooks in the fields of skincare and beauty.

(260) AM 2017 89510 A

(800) 1318125

(891) 2016 08 10

(731) Blahodiinyi fond "SID FORUM UKRAINA"

vul. Khreshchatyk, 10, m. Kyiv 01001,

Ukraine

(540)



(591) black and white

(511)

35 – Advertising; business management; business administration; office functions; outdoor advertising; dissemination of advertising matter; accounting; drawing up of statements of accounts; business management and organization consultancy; business management consultancy; direct mail advertising; business efficiency expert services; market studies; business appraisals; publication of publicity texts; transcription of communications [office functions]; marketing research; computerized file management; professional business consultancy; business information; opinion polling; payroll preparation; personnel

recruitment; word processing; compilation of information into computer databases; systemization of information into computer databases; on-line advertising on a computer network; news clipping services; rental of vending machines; invoicing; writing of publicity texts; compilation of statistics; layout services for advertising purposes; sponsorship search; production of advertising films; marketing; provision of commercial and business contact information; search engine optimization; web site traffic optimization; updating and maintenance of data in computer databases; business project management services for construction projects; providing business information via a web site.

36 – Financial affairs; monetary affairs; real estate affairs; financial analysis; banking; repair costs evaluation [financial appraisal]; arranging finance for construction projects; electronic funds transfer; safe deposit services; deposits of valuables; organization of collections; charitable fund raising; real estate management; financial information; financial management; financial consultancy.

41 – Providing of training; organization of competitions [education or entertainment]; publication of texts, other than publicity texts; teaching; educational services; arranging and conducting of colloquiums; arranging and conducting of conferences; practical training [demonstration]; arranging and conducting of workshops [training]; publication of electronic books and journals on-line; electronic desktop publishing; providing on-line electronic publications, not downloadable; photographic reporting; photography; translation; writing of texts, other than publicity texts; layout services, other than for advertising purposes; coaching [training]; language interpreter services; vocational retraining; services of schools [education].

(260) AM 2017 89554 A  
(800) 1319305  
(891) 2016 03 24  
(731) SHENZHEN CITY ENKOR ELECTRONICS LTD.  
2/F, 3/F, 5/F, Building G, Kaiyuan Area,  
Fenghuang No.4 Industrial Zone, FuYong  
street, Bao'an District 6 Shenzhen, China  
(540)



(591) Black, white  
(511)  
9 – Telephone transmitters; cabinets for loudspeakers; loudspeakers; horns for loudspeakers; micro-

phones; diaphragms [acoustics]; headphones; vehicle radios; players (DVD -); personal stereos.

(260) AM 2017 89559 A  
(800) 1319315  
(891) 2016 09 14  
(731) VP BRANDS INTERNATIONAL S.A  
Dunav bul. 5, BG-4000 Plovdiv, Bulgaria  
(540)

## BRAVE HEART

(591) Black, white  
(511)  
33 – Alcoholic extracts, alcoholic essences, alcoholic beverages [except beer], alcoholic beverages containing fruit, anisette [liqueur], anise [liqueur], aperitifs; arrack [arak], baijiu [Chinese distilled alcoholic beverage], brandy, wine, kirsch, vodka, bitters, distilled beverages, gin, digesters [liqueurs and spirits], cocktails, perry, curacao, liqueurs, hydromel [mead]; peppermint liqueurs, nira [sugarcane-based alcoholic beverage], rice alcohol, piquette, fruit extracts [alcoholic]; pre-mixed alcoholic beverages, other than beer based; rum, cider, -sake, spirits [beverages], whiskey.

(260) AM 2017 89560 A  
(800) 1319340  
(891) 2016 08 10  
(731) W. L. GORE & ASSOCIATES, INC.  
555 Paper Mill Road, Newark DE 19711,  
USA  
(540)

## SHAKEDRY

(591) Black, white  
(511)  
9 – Protective clothing for protection against water pressure, chemicals and fire.  
24 – Fabric for the manufacture of outerwear; fabric for the manufacture of protective clothing for safety purposes.  
25 – Clothing, namely, glove liners, pants, coats, footwear, coveralls, jackets, gloves, mitten, pants, parkas, vests, jumpsuits, rainsuits, headwear, tights, shorts, arm warmers, leg warmers, singlets, crop tops, knee warmers, neck gaiters, jerseys and fishing waders.

(260) AM 2017 89561 A  
(800) 1319344  
(891) 2016 03 14  
(731) NEMIROFF INTELLECTUAL PROPERTY  
ESTABLISHMENT  
Städtle 31, FL-9490 Vaduz, Liechtenstein

(540)



(591) Black, white

(554) Three-dimensional

(511)

33 – Alcoholic beverages (except beers).

35 – Advertising; business management; business administration; office functions.

(260) AM 2017 89563 A

(800) 1319370

(891) 2016 01 19

(731) SAPPORO HOLDINGS LIMITED

20-1, Ebisu 4 chome, Shibuya-ku, Tokyo  
150-8522, Japan

(540)



(591) Yellow, light yellow and black

(511)

32 – Beer; low malt beer; carbonated drinks (refreshing beverages); non-alcoholic fruit juice beverages; extracts of hops for making beer; whey beverages.

(260) AM 2017 89564 A

(800) 1319371

(891) 2016 02 10

(731) EASYPUFF HOLDINGS LIMITED

C/- BDO TAURANGA LTD, Level 1,  
The Hub, 525 Cameron Road, Tauranga  
3110, New Zealand

(540)



(591) Black, white

(511)

34 – Electronic cigarettes; liquid nicotine solutions for use in electronic cigarettes; flavourings, other than essential oils, for use in electronic cigarettes; electronic cigarette liquid (e-liquid) comprised of flavorings in liquid form used to refill; electronic cigarette refill cartridges sold empty; electronic cigarette lighters; electronic cigarette boxes; electronic cigarette cases; oral vaporizers for smokers; smokeless cigarette vaporizer pipe; electronic cigarette starter kits comprising electronic cigarettes and cartridges sold filled with chemical flavourings in liquid form for electronic cigarettes; components and accessories for electronic cigarettes, namely, atomizers, cartomizers, cartridges and refill cartridges for electronic cigarettes; liquid solutions for use in electronic cigarettes.

(260) AM 2017 89728 A

(800) 1320647

(891) 2016 07 12

(731) Limited Liability Company "ASSOCIATION  
"SOYUZPICHSHEPROM"pos. Melkombinat-2, uchastok 1, d. 37,  
RU-454080 Chelyabinsk, Russian Federation

(540)



(591) Green, light green, white

(511)

29 – Albumin milk; bouillon concentrates; colza oil for food; corn oil; edible oils; fruit chips; fruit-based snack food; lecithin for culinary purposes; linseed oil for culinary purposes; low-fat potato chips; milk shakes; potato chips; potato flakes; powdered milk; rice milk [milk substitute]; soups; soya beans, preserved, for food; soya milk [milk substitute]; sunf-

lower oil for food; sunflower seeds, prepared; tofu; vegetable soup preparations.

30 – Baking powder; baozi [stuffed buns]; barley meal; batter mixes for okonomiyaki [Japanese savory pancakes]; bread; bread rolls; breadcrumbs; buns; burritos; cake dough; cakes; cereal bars; cereal-based snack food; cereal preparations; cheeseburgers [sandwiches]; chips [cereal products]; chocolate beverages with milk; cocoa beverages with milk; coffee beverages with milk; cookies; corn flakes; corn flour; corn, milled; corn, roasted; couscous [semolina]; crackers; crushed barley; crushed oats; dough; edible paper; edible rice paper; ferments for pastes; flour; gimbap [korean rice dish]; gingerbread; gluten additives for culinary purposes; gluten prepared as foodstuff; groats for human food; halvah; high-protein cereal bars; hominy; hominy grits; husked barley; husked oats; jiaozi [stuffed dumplings]; linseed for human consumption; macaroni; macaroons [pastry]; malt biscuits; malt extract for food; malt for human consumption; maltose; meat pies; meat tenderizers, for household purposes; molasses for food; muesli; natural sweeteners; noodle-based prepared meals; noodles; oat flakes; oat-based food; oatmeal; okonomiyaki [Japanese savory pancakes]; pancakes; pasta; pasta sauce; pastries; pastry dough; pelmeni [dumplings stuffed with meat]; petit-beurre biscuits; petits fours [cakes]; pies; pizzas; popcorn; potato flour; preparations for stiffening whipped cream; quiches; ramen [Japanese noodle-based dish]; ravioli; rice; rice cakes; rice pudding; rice pulp for culinary purposes; rice-based snack food; rusks; sago; sandwiches; sausage binding materials; semolina; soya flour; spaghetti; spring rolls; starch for food; tacos; tarts; thickening agents for cooking foodstuffs; tortillas; unleavened bread; vareniki [stuffed dumplings]; vermicelli [noodles]; waffles; wheat flour; wheat germ for human consumption.

(260) AM 2017 89794 A  
(800) 1321625  
(891) 2016 09 22  
(731) NOVARTIS AG  
CH-4002 Basel, Switzerland  
(540)

## HYPERVIT

(511)  
10 – Surgical apparatus and instruments for use in ophthalmic surgery.

(260) AM 2017 89807 A  
(800) 1321127  
(891) 2016 09 20  
(731) W. L. GORE & ASSOCIATES, INC.  
555 Paper Mill Rd., P.O. Box 9329,  
Newark DE 19714, USA

(540)

## OPTIWEB

(591) Black, white  
(511)  
15 – Protective plastic coating sold as a component of musical instrument strings.

(260) AM 2017 89808 A  
(800) 1321202  
(891) 2016 05 09  
(731) FOSHAN HAI TIAN FLAVORING & FOOD COMPANY LIMITED  
No.16, Wen Sha Road, Foshan City,  
Guangdong Province, China

(540)



(591) Black, white  
(511)  
30 – Condiments; fermented soybean paste [condiment]; monosodium glutamate [seasonings]; oyster sauce; seasonings; soya sauce; chicken essence (condiment); vinegar; flavoring sauce; meat tenderizers for household purposes; ketchup (sauce); seafood powder [seasonings]; flavorings for beverages, other than essential oils; fish sauce; essences for foodstuffs, except etheric essences and essential oils; cereal preparations; sample of aspergillus for soya sauce.  
33 – Rice alcohol; saki; yellow rice or millet wine; alcoholic fruit extracts; arrack; alcoholic extracts; alcoholic beverages, except beer; alcoholic beverages containing fruit; digesters [liqueurs and spirits]; cooking wine.

(260) AM 2017 89809 A  
(800) 1321208  
(891) 2016 03 09  
(731) APPLE INC.  
1 Infinite Loop, Cupertino CA 95014, USA  
(540)



(591) Black, purple and blue

(511)

9 – Computers; computer peripheral devices; computer hardware; handheld digital electronic devices; digital format audio and video players; radios, radio transmitters, and receivers; car audio apparatus; audio components and accessories; network communication apparatus; electronic communication equipment and instruments; optical apparatus and instruments; telecommunications apparatus and instruments; global positioning system (GPS) devices; telephones; wireless communication devices for voice, data or image transmission; apparatus for data storage; computer software; couplers, cables, chargers, dock connectors, docking stations, interfaces, and adapters for use with all of the aforesaid goods; computer equipment for use with all of the aforesaid goods.

(260) AM 2017 89810 A

(800) 1321238

(891) 2016 03 31

(731) KONINKLIJKE PHILIPS N.V.

High Tech Campus 5, 5656 AE Eindhoven,  
Netherlands

(540)

# UGROW

(591) Black, white

(511)

3 – Bleaching preparations and other substances for laundry use; cleaning, polishing, scouring and abrasive preparations; soaps; perfumery, essential oils, cosmetics, hair lotions; dentifrices; toothpaste; non-medicated toilet preparations; cosmetics; soaps; shampoos, non-medicated talcum powder; baby wipes, cologne impregnated disposable wipes, facial wipes impregnated with cosmetics, moist wipes for sanitary and cosmetic purposes, moist wipes impregnated with a cosmetic lotion, pre-moistened cosmetic wipes, wipes impregnated with a skin cleanser, wipes incorporating cleaning preparations; non-medicated preparations, creams and lotions for the body, skin and hair; massage creams, oils and gels, not medicated; liquid talc for babies; nipple cream; descaling preparations for household use; tissues impregnated with lotions; pre-moistened or impregnated cleansing pads, tissues or wipes; disposable wipes impregnated with cleansing chemicals or compounds for personal hygiene; baby bottom balm, baby crème; body cream for mothers, bath and shower, moisturizing and cleansing foam for mothers, moisturizing oil for mothers, body wash for babies, hair wash for babies.

5 – Pharmaceutical and veterinary preparations; sanitary preparations for medical purposes; dietetic food and substances adapted for medical or veterinary use, food for babies; dietary supplements for

humans and animals; plasters, materials for dressings; material for stopping teeth, dental wax; disinfectants; preparations for destroying vermin; fungicides, herbicides; baby foods; vitamin and mineral preparations; plasters; impregnated antiseptic or medicated wipes, moist wipes impregnated with a pharmaceutical lotion, sanitizing wipes, wipes for medical use; breast-nursing pads; infants and babies' disposable napkins made of paper or cellulose; sterilized wet wipes; baby diapers; tissues and wipes impregnated with pharmaceutical lotions and creams; milkpowder for babies.

7 – Appliances for household purposes not included in other classes, electric blenders, can openers, food processors, fruit presses, mills and mixers, electric knives; kitchen appliances for food; parts and fittings of the aforesaid goods.

8 – Hand tools and implements (hand-operated); razors; table cutlery of plastic, for babies and children; punches for making holes in teats included in this class; cutlery and cutlery for babies, infants and children, spoons, forks and knives; electric hair clippers, hair trimmers, scissors to trim hair, baby nail clipper, nose cleaner, namely, nose hair trimmers; depilation appliances, electric and non-electric, hair clippers for personal use, electric and non-electric, hair-removing tweezers; nail clippers, electric or non-electric; nail files, electric or non-electric; manicure and pedicure sets; nail files and emery boards, electric or non-electric; tongs for picking up teats and other objects from a sterilizer; tongs for picking up hot objects; parts and fittings of the aforesaid goods.

9 – Scientific, nautical, surveying, photographic, cinematographic, optical, weighing, measuring, signalling, checking (supervision), life-saving and teaching apparatus and instruments; apparatus and instruments for conducting, switching, transforming, accumulating, regulating or controlling electricity; apparatus for recording, transmission or reproduction of sound or images; magnetic data carriers, recording discs; compact discs, DVDs and other digital recording media; data processing equipment, computers; computer software; alarms; scales for babies; digital photograph frames, electronic baby monitoring devices, namely, digital enhanced cordless telecommunication (DECT) baby monitors, thermometers and electronic thermometers, other than for medical purposes; anti-radiation garment; downloadable electronic publications, in the nature of magazines, manuals and newsletters in the field of child development, storage media, interactive compact discs and CD-ROMs; records, tapes, discs, cassettes, cartridges, cards and other carriers, all containing or for recording sound, video, data, images, games, text, programs or information; all the aforesaid goods for or relating to babies, young children, pregnant women, breast-feeding mothers and

young mothers; computer software programs and software applications for mobile phones and other handheld mobile digital electronic devices, mobile apps; computer programs for accessing, browsing and searching online databases, computer software and firmware, namely, operating system programs, data synchronization programs, and application development computer software programs for personal and handheld computers; spectacle frames, eyeglasses, sunglasses; fridge magnets; parts and fittings for all the aforesaid goods, except hearing aids and related goods; monitoring apparatus, electric; baby monitors; audio monitors; digital video monitors; monitors (hardware); charger for electric batteries; battery charger; batteries and rechargeable batteries; rechargeable battery pack; central processing unit for baby monitor; electric connections for baby monitor; power cord; charger stand for parent unit; parts and fittings for baby monitors; soother thermometer; bath and room thermometers; digital photograph frames; stress meter; parts and fittings for all the aforesaid goods, except hearing aids and related goods.

10 – Surgical, medical, dental and veterinary apparatus and instruments, artificial limbs, eyes and teeth; orthopedic articles; suture materials; surgical, medical, dental and veterinary apparatus; instruments, clothes, lights and lamps for medical, curative, surgical, dental and veterinary use; feeding bottles, feeding bottles handles; teats; soothers, pacifiers and teething rings; spoons and medical feeder for administering medicines; cups and vessels adapted for feeding babies and children; incubators; toilet chair; toilet chair for babies and children; breast pumps; nursing appliances for use in breast feeding, including appliances for the treatment and correction of inverted nipples; breast shields, nipple protectors, breasts cooling pads, breasts heating pads; thermometers; condoms; parts and fittings for all the aforesaid goods; massage apparatus, electric or non-electric, body and breast massagers; gloves for massage, thermal massage pads; vibration generating apparatus for massage; pregnancy support belt; babies bottles; disposable feeding bottles; disposable babies bottles; parts and fittings for feeding bottles and babies bottles; breast pumps, including manual breast pump, electric breast pump, battery operated breast pump; parts and fittings for breast pumps; nipple shields; icepack for medical purposes; medical coolers for breast milk; parts and fittings for feeding bottles and babies bottles, namely, teats and valves; medical pouches and containers for collection, deep-freezing, storing, transport and reheating breast milk for medical purposes; teats; pacifiers and teats for baby bottles; dummies and teats for babies; dummy chains, namely, pacifier clips and holders; ear and forehead thermometers; apparatus for removing nasal mucous, namely, external nasal dilators, nasal aspirators, nasal irrigation vessel, nasal lavage ves-

sel; inserts for breast shells; breast shells; parts and fittings for all the aforesaid goods.

11 – Apparatus for lighting, heating, steam generating, cooking, refrigerating, drying, ventilating, water supply and sanitary purposes; apparatus and instruments for sterilizing, heating, lighting, cooking, refrigerating, drying or for sanitary purposes; multi-function sterilizer (sterilizer + milk and food warmer + dryer) fans, heaters and warmers for feeding bottles, foodstuffs, liquids and solids; congee maker; boiler kettle (to boil water made of both glass / stainless steel); air purifiers; humidifiers; wake up lights, namely electric lamps; guide lights and soothing lights, namely, electric lamps and lighting fixtures; parts and fittings for all the aforesaid goods; hot water bottles; sterilizers; steam sterilizers; sterilizers for feeding bottles and babies bottles, including microwave steam sterilizers and electric steam sterilizers; disposable sterilization pouches; microwave sterilizing bag; parts and fittings for sterilizers; air purifiers; humidifiers; wake up lights; steamers for food and meal preparation; parts and fittings for all the aforesaid goods.

16 – Paper, cardboard and goods made from these materials, not included in other classes; printed matter; bookbinding material; photographs; stationery; adhesives for stationery or household purposes; artists' materials; instructional and teaching material (except apparatus); plastic materials for packaging (not included in other classes); printing blocks; printed matter, newspapers, newsletters, printed publications and magazines; wipes for cleaning babies and infants; disposable bibs made of plastic and paper; table napkins of paper; ice bags; bags for microwave cooking; plastic oven cooking bags; bibs of paper; handkerchiefs of paper; cellulose wipes.

21 – Household or kitchen utensils and containers; combs and sponges; brushes (except paint brushes); toothbrushes, finger toothbrush; brush-making materials; articles for cleaning purposes; glassware, porcelain and earthenware not included in other classes; small domestic utensils and containers (none of precious metals or coated therewith); containers for use in the sterilization of babies' feeding bottles and closures for such containers; combs, sponges (not for surgical purposes), heat insulated containers; milk powder dispensers; heat insulated containers and carriers for baby feeding bottles; brushes and tableware; household, kitchen, domestic, cosmetic and toilet utensils and containers; baby food containers sold empty, cups, non-spill valves for use with cups, spouts for cups; baths and potties for babies; glass, porcelain and earthenware; bowls and buckets; small ornaments; drinking vessels; figurines, statuettes, and work of art made of china, crystal, ceramic, earthenware, glass, porcelain and terra cotta; cleaning articles and materials, namely, cleaning cloths, mops, brooms, buckets; money boxes; closures for

aforesaid domestic utensils and containers; bags and containers for household use, namely, containers for storing, freezing, preserving, transporting and heating of breast milk; heat insulated containers and carriers for baby feeding bottles; bottles of glass; cups; closures for cups; brushes for cleaning (parts of) bottles, teats, containers; thermal and isothermic bags to keep bottles and cups warm or cool, including insulated pockets; portable baths for babies; plates and divider plates; travel feeding set with suction mat to prevent spills; bowls and buckets; drinking straws for drinking; blenders, non-electric, for household purposes; insulated and vacuum flasks, and vacuum bottles; bottle drying rack; brushes for cleaning (parts of) bottles, teats, containers; bottle, bottle openers and bottle brushes; sleeves for protecting cups, bottles and containers; parts and fittings for all the aforesaid goods.

28 – Games and playthings; gymnastic and sporting articles not included in other classes; decorations for christmas trees; toys, games, playthings and rattles; dolls.

35 – Business management; business administration; office functions; compilation and management of computerized databases, namely, setting up and managing data files stored in databases; information, advisory and consultancy services regarding the aforesaid services whether or not via the Internet.

38 – Telecommunication services; electronic communications; wireless communications; digital communications services; electronic communication services; online communication services; mobile communication services; communication via telematics; advising on communications; rentals of communications equipment; rental of communication apparatus; data transmission via communication satellites; advice regarding electronic communications; communication by electronic means; communication via optic fiber networks; communication via electronic networks; communication via lighting and lighting apparatus; providing online communication services.

42 – Scientific and technological services and research and design relating thereto; industrial analysis and research services; design and development of computer hardware and software; computer and mobile services, namely, providing technology featuring online non-downloadable software that enables users of computers and mobile devices to share information and images, to form virtual communities, to engage in social networking, to monitor babies and infants; electronic data storage, including data of babies and children.

(260) AM 2017 89815 A  
(800) 1321300  
(891) 2016 06 02

(731) Publichne aktsionerne tovarystvo  
"MONPHARM"  
vul. Zavodska, 8, m. Monastyryshche,  
Cherkaska oblast 19100, Ukraine

(540)

**АНДИПАЛ**

(591) Black, white

(511)

5 – Pharmaceutical and veterinary preparations; sanitary preparations for medical purposes; dietetic substances adapted for medical use; food for babies; plasters, materials for dressings; material for stopping teeth, dental wax; disinfectants; preparations for destroying vermin; fungicides, herbicides; dental abrasives; acaricides; aconitine; alkaloids for medical purposes; algicides; aldehydes for pharmaceutical purposes; dental amalgams; amino acids for veterinary purposes; amino acids for medical purposes; analgesics; anaesthetics; antibiotics; appetite suppressants for medical purposes; first-aid boxes, filled; aluminium acetate for pharmaceutical purposes; acetates for pharmaceutical purposes; cotton for medical purposes; tonics (medicines); germicides; bacterial poisons; bacterial preparations for medical and veterinary use; bacteriological preparations for medical and veterinary use; balms for medical purposes; balsamic preparations for medical purposes; menstruation bandages; aseptic cotton; tobacco-free cigarettes for medical purposes; bandages for dressings; bicarbonate of soda for pharmaceutical purposes; albuminous preparations for medical purposes; albuminous foodstuffs for medical purposes; biological preparations for veterinary purposes; biological preparations for medical purposes; biocides; bismuth subnitrate for pharmaceutical purposes; flaxseed meal for pharmaceutical purposes; flour for pharmaceutical purposes; bracelets for medical purposes; bromine for pharmaceutical purposes; bronchodilating preparations; vaginal washes; vaccines; oxygen baths; bath preparations, medicated; wadding for medical purposes; absorbent cotton; decoctions for pharmaceutical purposes; tartar for pharmaceutical purposes; insect repellents; vitamin preparations; panty liners; sea water for medicinal bathing; mineral waters for medical purposes; hydrated chloral for pharmaceutical purposes; dietary fiber; charcoal for pharmaceutical purposes; gases for medical purposes; gallic acid for pharmaceutical purposes; guaiacol for pharmaceutical purposes; haematogen; haemoglobin; sanitary knickers; sanitary pads; sanitary towels; sanitary napkins; sanitary panties; hydrastine; hydrastinine; stick liquorice for pharmaceutical purposes; mustard for pharmaceutical purposes; mustard oil for medical purposes; mustard plasters; anthelmintics; glycerine for medical purposes; glycerophosphates; glucose for medical purposes; hormones for medical purposes; mud for baths; medicinal mud; vulnerary sponges; rubber



for dental purposes; gamboge for medical purposes; gurjun balsam for medical purposes; disinfectants for chemical toilets; deodorants for clothing and textiles; deodorants, other than for human beings or for animals; detergents for medical purposes; digitalin; diagnostic preparations for medical purposes; diastase for medical purposes; dietetic beverages adapted for medical purposes; dietetic foods adapted for medical purposes; yeast for pharmaceutical purposes; eucalyptus for pharmaceutical purposes; eucalyptol for pharmaceutical purposes; extracts of hops for pharmaceutical purposes; elixirs (pharmaceutical preparations); esters for pharmaceutical purposes; cellulose esters for pharmaceutical purposes; ethers for pharmaceutical purposes; cellulose ethers for pharmaceutical purposes; gelatine for medical purposes; milking grease; cod liver oil; greases for veterinary purposes; greases for medical purposes; jujube, medicated; chewing gum for medical purposes; articles for headache; sedatives; nervines; dental amalgams of gold; dental lacquer; dental mastics; dental cements; isotopes for medical purposes; adjuvants for medical purposes; insecticides; irish moss for medical purposes; caustic pencils; caustics for pharmaceutical purposes; iodine for pharmaceutical purposes; alkaline iodides for pharmaceutical purposes; iodides for pharmaceutical purposes; iodoform; calomel; camphor for medical purposes; camphor oil for medical purposes; capsules for medicines; cachets for pharmaceutical purposes; carbolineum (parasiticide); castor oil for medical purposes; cachou for pharmaceutical purposes; quassia for medical purposes; quebracho for medical purposes; cedar wood for use as an insect repellent; oxygen for medical purposes; acids for pharmaceutical purposes; anti-rheumatism rings; bone cement for surgical and orthopaedic purposes; adhesives for dentures; fly catching adhesives; cocaine; collodion for pharmaceutical purposes; insect repellent incense; compresses; condurango bark for medical purposes; angostura bark for medical purposes; mangrove bark for pharmaceutical purposes; barks for pharmaceutical purposes; cinchona for medical purposes; medicinal roots; rhubarb roots for pharmaceutical purposes; lint for medical purposes; cream of tartar for pharmaceutical purposes; creosote for pharmaceutical purposes; blood for medical purposes; depuratives; haemostatic pencils; styptic preparations; dill oil for medical purposes; croton bark; starch for dietetic or pharmaceutical purposes; cultures of microorganisms for medical or veterinary use; curare; lactose for pharmaceutical purposes; adhesive plasters; lecithin for medical purposes; fly catching paper; adhesive bands for medical purposes; medicinal alcohol; medicine cases, portable, filled; medicines for alleviating constipation; medical preparations for slimming purposes; medicines for veterinary purposes; medicines for human purposes; remedies for perspiration; air purifying preparations; medicines

for dental purposes; medicinal tea; medicinal herbs; remedies for foot perspiration; medicinal drinks; medicinal infusions; medicinal oils; medicinal hair growth preparations; liniments; liquorice for pharmaceutical purposes; dog lotions; lotions for veterinary purposes; lotions for pharmaceutical purposes; lupulin for pharmaceutical purposes; candy for medical purposes; linseed for pharmaceutical purposes; magnesia for pharmaceutical purposes; sunburn ointments; ointments for pharmaceutical purposes; frostbite salve for pharmaceutical purposes; gauze for dressings; royal jelly for pharmaceutical purposes; melissa water for pharmaceutical purposes; menstruation tampons; menthol; milk of almonds for pharmaceutical purposes; dog washes; animal washes; cattle washes; myrobalan bark for pharmaceutical purposes; mineral food supplements; bunion pads; moleskin for medical purposes; lacteal flour for babies; milk ferments for pharmaceutical purposes; mint for pharmaceutical purposes; scapulars for surgical purposes; vesicants; narcotics; tincture of iodine; tinctures for medical purposes; antiparasitic collars for animals; fumigation preparations for medical purposes; fumigating pastilles; fumigating sticks; wart pencils; headache pencils; oil of turpentine for pharmaceutical purposes; opium; opiates; opodeldoc; rat poison; poisons; sulfur sticks (disinfectants); pants, absorbent, for incontinents; paper for mustard plasters; mothproof paper; parasiticides; pectin for pharmaceutical purposes; diapers for incontinents; pepsins for pharmaceutical purposes; peptones for pharmaceutical purposes; surgical dressings; hydrogen peroxide for medical purposes; pesticides; pills for pharmaceutical purposes; pyrethrum powder; blood plasma; eyepatches for medical purposes; breast-nursing pads; nutritional supplements; nutritive substances for microorganisms; bacteriological culture mediums; pomades for medical purposes; powder of cantharides; porcelain for dental prostheses; laxatives; belts for sanitary napkins; haemorrhoid preparations; preparations for callouses; chilblain preparations; pharmaceutical preparations for treating sunburn; corn remedies; chemical preparations for the diagnosis of pregnancy; mothproofing preparations; preparations for destroying dry rot fungus; larvae exterminating preparations; preparations for destroying mice; fly destroying preparations; slug exterminating preparations; preparations for destroying noxious plants; preparations for the treatment of burns; mouthwashes for medical purposes; soil-sterilising preparations; lime-based pharmaceutical preparations; preparations of trace elements for human and animal use; preparations of microorganisms for medical or veterinary use; bismuth preparations for pharmaceutical purposes; opotherapy preparations; preparations to facilitate teething; eye-washes; poultices; food for babies; by-products of the processing of cereals for dietetic or medical purposes; evacuants; asthmatic tea; febrif-

fuges; chemical contraceptives; antiseptic cotton; antiseptics; corn rings for the feet; antiparasitic preparations; anti-rheumatism bracelets; anti-uric preparations; anticryptogamic preparations; leeches for medical purposes; radium for medical purposes; radioactive substances for medical purposes; chemical reagents for medical or veterinary purposes; radiological contrast substances for medical purposes; repellents for dogs; digestives for pharmaceutical purposes; fish meal for pharmaceutical purposes; ergot for pharmaceutical purposes; solutions for contact lenses; solvents for removing adhesive plasters; mercurial ointments; sarsaparilla for medical purposes; goulard water; suppositories; tissues impregnated with pharmaceutical lotions; serotherapeutic medicines; siccatives (drying agents) for medical purposes; serums; syrups for pharmaceutical purposes; turpentine for pharmaceutical purposes; soporifics; bath salts for medical purposes; smelling salts; salts for mineral water baths; potassium salts for medical purposes; mineral water salts; salts for medical purposes; sodium salts for medical purposes; malt for pharmaceutical purposes; malted milk beverages for medical purposes; semen for artificial insemination; alcohol for pharmaceutical purposes; alloys of precious metals for dental purposes; sterilising preparations; steroids; strychnine; sulphoamides (medicines); sticking plasters; therapeutic preparations for the bath; thermal water; thymol for pharmaceutical purposes; gentian for pharmaceutical purposes; tissues impregnated with pharmaceutical lotions; smoking herbs for medical purposes; herbal teas for medicinal purposes; tranquilizers; tobacco extracts (insecticides); pharmaceutical preparations for treating dandruff; pharmaceutical preparations for skin care; phenol for pharmaceutical purposes; fennel for medical purposes; enzymes for veterinary purposes; enzymes for medical purposes; ferments for pharmaceutical purposes; enzyme preparations for veterinary purposes; enzyme preparations for medical purposes; formic aldehyde for pharmaceutical purposes; molding wax for dentists; phosphates for pharmaceutical purposes; chemical preparations to treat wheat blight (smut); chemical preparations for treating phylloxera; chemico-pharmaceutical preparations; petroleum jelly for medical purposes; vine disease treating chemicals; chemical preparations for veterinary purposes; chemical preparations for medical purposes; chemical preparations for pharmaceutical purposes; chemical preparations to treat mildew; chemical conductors for electrocardiograph electrodes; quinine for medical purposes; chinoline for medical purposes; surgical implants comprised of living tissues; diabetic bread adapted for medical use; chloroform; flowers of sulfur for pharmaceutical purposes; cement for animal hooves; candy, medicated; sugar for medical purposes; contact lens cleaning preparations; jalap.

(260) AM 2017 89821 A

(800) 1321347

(891) 2016 08 03

(731) TAYYAR INVESTMENT FİNANSAL  
YÖNETİM ANONİM ŞİRKETİ  
Organize Sanayi Bölgesi 5. Cadde No:18,  
Merkez, Karaman, Turkey

(540)

# Rotto

(591) Black, white

(511)

30 – Coffee; cocoa; artificial coffee; vegetal preparations for use as coffee substitutes; cocoa-based beverages; coffee-based beverages; chocolate based beverages; pasta; stuffed dumplings; noodles; macaroni; ravioli; bread; pastry and bakery products, namely, pies, cakes, donuts, muffins, cookies, pastries, tarts, pizzas, sandwiches, puddings, ready-made cake mixes, biscuits, petit-beurre biscuits; desserts, namely, bakery desserts, chocolate desserts, desserts [confectionery] and desserts made of flour; honey; royal jelly for human consumption; propolis for human consumption; flavorings, other than essential oils; vanilla flavorings; sauces; tomato sauce; spices; yeast; baking powder; flour for food; semolina; starch for food; granulated sugar; cube sugar; powdered sugar; teas; ice teas; confectionery; chocolates; chocolate bars; candies; biscuits; wafers; chocolate wafers; crackers; chocolate coated crackers; chewing gums not for medical purposes; ice; ice creams; edible fruit ices; salt; processed cereals and cereal products; snacks made of cereals, namely, corn flakes, popcorn, crushed oats, corn chips, breakfast cereals, processed wheat for human consumption, crushed barley for human consumption, processed oats for human consumption, processed rye for human consumption; rice; molasses syrup for food.

(260) AM 2017 89822 A

(800) 1321356

(891) 2016 08 03

(731) Open joint stock company

"TATSPIRTPROM"

ul. Bauman, d. 44/8 RU-420111 Kazan,  
Russian Federation

(540)

# ТУНДРА

(591) Black, white

(511)

33 – Alcoholic beverages (except beers).

(260) AM 2017 89823 A  
(800) 1321374  
(891) 2016 09 16  
(731) APPLE INC.

1 Infinite Loop, Cupertino CA 95014, USA

(540)  
**MACOS**

(591) Black, white

(511)

42 – Design and development of computer software; computer software consulting services; support and consultation services for developing computer systems, databases and applications, namely, providing information on computer technology and programming via a web site; providing information in the fields of technology and software development via an on-line website; maintenance and updating of computer software.

(260) AM 2017 89840 A  
(800) 1321388  
(891) 2016 09 23  
(731) HYFLUX LTD

80 Bendemeer Road, Hyflux Innovation Centre Singapore 339949, Singapore

(540)  
**ELO GREEN**

(591) Black, white

(511)

5 – Meal for pharmaceutical purposes; medicinal herbs; herbal teas for medicinal purposes; medicinal roots; dietetic foods adapted for medical purposes; dietetic beverages adapted for medicinal purposes; medical preparations for slimming purposes; mineral food supplements; nutritional supplements; plant extracts for pharmaceutical purposes; pharmaceuticals.

31 – Citrus fruit, fresh; animal foodstuffs; oats; berries, fresh; mushrooms, fresh; vegetables, fresh; beans, fresh; flowers, natural; fruit, fresh; seeds for planting; plant seeds; garden herbs, fresh; plants; pet food.

32 – Non-alcoholic fruit extracts; non-alcoholic fruit juice beverages; preparations for making beverages; fruit juices; waters [beverages]; vegetable juices [beverages]; non-alcoholic beverages.

35 – Import-export agency services; advertising; publicity; marketing research; on-line advertising on a computer network; procurement services for others [purchasing goods and services for other businesses]; administrative processing of purchase orders; invoicing; retail or wholesale services for pharmaceutical, veterinary and sanitary preparations and

medical supplies; providing business information via a web site.

(260) AM 2017 89842 A

(800) 1321419

(891) 2016 05 20

(731) GEELY HOLDING GROUP CO., LTD.

1760 Jiangling Road, Binjiang District Hangzhou, Zhejiang, China

(540)



(591) Blue, gray and black.

(511)

12 – Electric vehicles; vehicles for locomotion by land, air, water or rail; mopeds; automobile chassis; motorcycles; propulsion mechanisms for land vehicles; automobiles; gear boxes for land vehicles; tires for vehicle wheels; brakes for vehicles.

37 – Construction consultancy; construction; upholstering; air conditioning apparatus installation and repair; motor vehicle maintenance and repair; vehicle breakdown repair services; vehicle washing; vehicle battery charging; vehicle service stations [refuelling and maintenance].

(260) AM 2017 89843 A

(800) 1321465

(891) 2016 05 18

(731) SANTA FARMA İLAÇ SANAYİİ ANONİM ŞİRKETİ

Okmeydanı, BoruÇiçeği Sk. No.16 Kat:4, Şişli TR-34382 İstanbul, Turkey

(540)

**THERMOFLEX**



(591) Black, white

(511)

5 – Pharmaceuticals.

(260) AM 2017 89845 A  
 (800) 1321541  
 (891) 2016 08 05  
 (731) SOREMARTEC SA  
 Findel Business Center, Complexe B,  
 Rue de Trèves L-2632 Findel, Luxembourg

(540)



(591) Brown, prune

(511)

29 – Preserved, frozen, dried and cooked fruit and vegetables; jellies, jams, compotes; milk and dairy products; fruit snacks, candied fruit, milk beverages [milk predominating], milk shakes.

30 – Coffee, tea, cocoa and artificial coffee; rice; tapioca and sago; flour and preparations made from cereals; bread, pastry and confectionery; edible ices; sugar, honey, treacle; yeast, baking powder; salt; mustard; vinegar, sauces (condiments); spices; ice for refreshment; chocolate and chocolate goods, pralines, sweets, marzipan, biscuits, cereal-based snack food, chocolate mousses, mousse desserts, custard, beverages made with chocolate, beverages made with cocoa, beverages made with tea, beverages made with coffee.

(260) AM 2017 89846 A  
 (800) 1321793  
 (891) 2016 05 30  
 (731) LOUIS DREYFUS TRADEMARKS B.V.  
 World Trade Center, Amsterdam Tower H -,  
 Level 25 – Zuidplein 208, NL-1077 XV  
 Amsterdam, Netherlands

(540)

## LOUIS DREYFUS

(511)

35 – Advertising; business management; business administration; office functions; market studies; import-export agency services; wholesale services; import and export agency services for products in the energy, chemical, metal, food, beverage and agricultural industries; layout services for advertising purposes in the energy, chemical, food, metal, beverage and agricultural industries; retail or wholesale of energy, chemical, food, beverage, metal and agricultural products; distribution of sample for energy, chemical, metal, food, beverage and agricultural products; public relations.

(260) AM 2017 89847 A  
 (800) 1321806  
 (891) 2016 06 22

(731) AMADEUS IT GROUP, S.A.  
 Calle Salvadorde Madariaga, 1, E-28027  
 Madrid, Spain;  
 AMADEUS IT GROUP, S.A.  
 Calle Salvadorde Madariaga, 1, E-28027  
 Madrid Spain

(540)

## AMADEUS

(511)

9 – Apparatus and instruments for recording, processing, transmission or reproduction of sound or images; magnetic recording media, sound recording disks; compact disks, DVDs and other digital recording media; calculating machines; data processing equipment; modems; microprocessors; computers; firmware and hardware; computer interface boards; computer interface cards; interactive computers for use in the certification of airport security personnel; encoding and decoding apparatus and instruments; electronic self check-in counters; operating hardware and software for VPN (virtual private network); operating hardware and software for WAN (wide area network); operating hardware and software for LAN (local area network); computer software; data processing programs and software; application software; insurance software; compiler software; scanning software; printing software; website development software; software and applications for mobile devices; downloadable cloud computing software; communications software, including communications software for connecting computer network users, for enabling the transmission of communications from mobile devices, enabling data exchange between airlines, airports and ground crews including via a shared platform, and to allow customers to access bank account information and perform banking transactions; search engine software; computer software for businesses; utility programs for managing computer files; computer software for controlling self-service terminals and self check-in counters; interface software; face, voice and eye recognition software; computer software for data processing, including searching, capturing, analyzing, storing, sharing, transferring and displaying data or complex data sets for optimizing business efficiency; computer software for importing, collecting, managing and centralizing data and data sets for calculating and distributing information concerning the availability, prices and tariffs in the transport, travel, hotels, restaurants, sports, cultural and entertainment sectors; computer software for booking and sale of tickets and seats in the transport, travel, hotels, restaurants, sports, cultural and entertainment sectors; computer software for managing all means of passenger transportation by air, land, water or rail, including multimodal and shared means, tour packages, travel arrangements, travel itineraries; computer software for managing cruises; computer software for providing geographical maps, information and

recommendations on travel routes, travel and driving guidance, travel news, city directories and listings, travel guidebooks, shared and multimodal transport; computer software for managing travel agencies; computer software for travel expenses; computer software for hotel management and property management for use in the hotel industry, including computer software for scheduling and managing hotel rooms and functional spaces, for inventory and stock management, for coordinating reception functions, for automating employees' tasks, for managing maintenance, for managing catering services, for housekeeping in rooms and for energy management; computer software for managing meetings and events in the hotel industry, including identifying suitable venues for meetings and events, establishing and controlling logistics for meetings and events, resource requirements, use of installations, availability, preparation of accounts and reports on events and cost tracking; computer software for use in the hotel industry to display the general design of hotels, temporary accommodation and meeting rooms and facilities; computer software for restaurant management, including computer software for inventory and stock management, for automating employees' tasks, for managing maintenance, for managing catering, and for managing parking facilities; computer software for use in automating and managing business processes; computer software for the management of airports, airlines and crews, airport and airline operations, aircraft maintenance planning and fuel management, for flight planning, programming, preparation, navigation, monitoring and analysis; computer software for flight management, for passenger, cargo and luggage tracking, for cargo and luggage handling; computer software for controlling check-in counters and for enabling passenger boarding, registration and check-in, including validation of passengers' check-in status and travel documents; computer software for issuing, redeeming and exchanging vouchers for providing targeted offers, vouchers, discounts, special promotions and promotional information and for customer relations management; computer software for advertising, marketing and content management, namely, for collecting, managing and publishing information in all forms or means; computer software for the management of human resources and personnel management, including placement planning, human resources allocation and use of personnel; computer software for payment services, including electronic payment processing and credit card services, for the safeguarding of financial transactions and the detection and management of fraud; computer software for accounting, financial management and invoice management; computer software for acquisitions management and analysis; computer software for managing security risks; computer software for revenue management, including for calculating, com-

parison, cost analysis and optimization, pricing, price comparison and sales tracking; downloadable electronic publications, including publications in the field of computing, repair of computer systems, computer programming, in the transport, travel, hotels, restaurants, sports, cultural and entertainment sectors; downloadable electronic operation and user manuals; downloadable electronic instructional materials; downloadable electronic instructional and teaching materials; downloadable electronic periodical publications, including newsletters and journals.

35 – Business management; computerized business file management; commercial administration; office functions; compilation and systemization of data on computer databases; compilation of statistical information; updating and maintenance of data on an on-line computer database in the field of airline and travel booking, departure control services, passenger check-in, ticket sales, pricing and invoicing; preparation of business statistics; analyses and drafting of statistical reports; compilation of business statistics and commercial information; compilation and analysis of data and information relating to business management; market research by means of a computer database; business assistance; business information; business consultancy; business data analysis; advice on business efficiency; conducting business feasibility studies; assistance in establishing a network of business contacts; business project management; business process management and consultancy; provision of business information via global computer networks; cost price analysis; billing services; accounting services; computerized and on-line accounting services; revenue accounting management services; business management consultancy in the fields of revenue management, price and profit optimization, performance management, inventory management, sales effectiveness, refund management, budgeting and forecasting; travel expenses administration; stock management (computerized); inventory management services (computerized); search engine optimization services; direct marketing services; on-line marketing services, namely, providing links to third-party websites featuring goods and services relating to travel, transportation and tourism; provision and rental of advertising space; rental of advertising space on the Internet; consultancy on marketing and strategy in the field of social media; marketing of brands via customer-based on-line social media; direct electronic on-line marketing services, advertising and promotional services for hotels, airlines, cruise lines, car rental companies, train operators and service providers in the travel, transportation and hotel industries, for third parties; organization and conducting of marketing and promotional events; planning of business meetings; business management and administration, namely, providing on-line services for buyers and

suppliers in the conference, events and hotel industries for the interactive planning of meetings and to book facilities via local, national and global computer networks; retail sale of computer software; business mediation in purchasing and sales, import and export, and wholesale and retail sale of software, software packages and Web applications; business services provided to travel agencies, namely, negotiating special discounts and commissions; placement of temporary personnel, including specialists in information technology and information and communications technology, for third parties; provision of information and advisory services relating to e-commerce; consultancy and provision of information relating to the foregoing services.

36 – Services relating to electronic financial payment and transactions; payment processing services; credit and debit card payment processing services; electronic payment services; processing of payment transactions; insurance services, in particular in the field of travel; insurance mediation, including insurance mediation for motor vehicles, transport and travel; insurance underwriting, including in the field of travel; accident, car, life, motor vehicle, transport and travel insurance services; property management services; issuing, exchanging and redeeming travel vouchers, in particular of vouchers for transport, accommodation vouchers, meal vouchers, event vouchers and vouchers for activities; fundraising for others via a global computer network; collection of charitable donations and charitable fund raising for individuals and organizations for the purposes of humanitarian, scientific, environmental, educational and cultural activities; consultancy and provision of information relating to the foregoing services.

38 – Telecommunications services, including the transmission of voice, data, graphics, images, audio and video via telecommunications networks, wireless communications networks, the Internet and wireless telephony; telecommunications services for data exchange between airlines, airports and ground crews among others via a connectivity or shared platform; providing access to telecommunication networks and telecommunications infrastructures; providing access to a cloud computing network; providing access to computer networks and to computer databases, electronic and online; providing access to data, information and computer software on computer networks; rental of access time to a computer database in the field of travel information and reservations, namely for flights, trains, boats, cruises, hotels, restaurants, car rental and for cultural, entertainment, leisure and sports events; transmission of data, information and computer software via global computer networks; providing access to platforms on the Internet; providing access to e-commerce platforms on the Internet; electronic messaging services; providing electronic message alerts to

travelers and others relating to routes, flights, climate conditions, accommodation, destinations and events via mobile digital electronic devices and global computer communications networks; providing discussion forums (chat rooms); providing bulletin boards and on-line forums for the transmission of messages in the field of travel, transportation and temporary accommodation; VPN (virtual private network) service provider; telecommunications services relating to operations and processes for the airline, airports, tourism and travel industries; information and advice relating to the foregoing services.

39 – Services provided by travel agencies or intermediaries; tourist travel information, timetables, times of arrival and departure of all means of transport by air, land, water or rail, routes and fares; providing information to tourists relating to excursions and tours at their travel destination; providing travel information including electronic documents, graphics and audiovisual information via a global computer network; providing travel information, including information on cruises, geographical maps, routes and travel recommendations, travel and driving tips, travel news, city directories and listings, and travel guidebooks; information on parking and checking-in at airports; providing information relating to the amount of carbon dioxide emissions produced by means of transport; travel booking services, including reservation services for airlines, cruises, car rental and tourist excursions; travel ticket reservation services; travel arrangement services; transport reservation services for sporting, scientific, political and cultural events; car rental intermediary services; boarding, check-in, seats and booking with frequent-flyer priority; automated check-in services for travelers; transport invoicing; luggage check-in; providing information relating to seat availability for a specific means of transport by air, land, water or rail, and the available class or rate; providing transport information recorded on a database, in particular transport information in the field of transportation by air, land, water or rail, for others; generating routes from confirmed reservations; management services for transport routes; booking and organization of cruises, excursions, expeditions and sightseeing tours; organization of transport by air, land, water and rail; services for the planning, programming, development, operation, navigation, control, analysis and management of flights, trains, cruises and boats; tracking of passengers, cargo, luggage or vehicles by computer or via GPS; consultancy and provision of information relating to the foregoing services.

41 – Education; organization of events, seminars, workshops and education conventions in the fields of information and communications technology, transport, travel, hotels, restaurants, sports, cultural activities and entertainment; provision of training

and courses, including training and courses in the fields of information and communications technology, transportation, travel, hotels, restaurants, sports, cultural activities and entertainment; providing classes and training seminars in the field of installation, operation, analysis, implementation, management, integration and deployment of computer software; providing training and courses in the field of business process enhancement, such as expenses management, management of meetings and payment processing; providing classroom training and courses in the field of corporate and personal travel and bookings, bookings and sales of tickets and seats in the transportation, travel, hotels, restaurants, sports, cultural and entertainment sectors; providing a training program for travel agents in the fields of travel agency management and administration and travel information resources; publication of texts, other than publicity texts; publication of educational material, information sheets and scientific articles; reservation of tickets for cultural events, entertainment, leisure and sports, including music concerts and theater events; consultancy and information relating to the foregoing services.

42 – Engineering services for third parties, including software engineering; scientific and technological services, as well as research and design related thereto; design and development of computer hardware and software; consultancy services in computer software; computer engineering; programming, configuration, testing, repair, maintenance, customization, duplication, rental, research and computer software support; installation, testing, updating and duplication of computer software; technical consultancy and advisory services relating to computer hardware, software and peripherals; cloud computing network hosting; rental of operating software for accessing and using a cloud computing network; provision of information relating to the design and development of computer software, systems and networks; programming of operating software for accessing and using a cloud computing network; development and testing of computing methods, algorithms and software for processing telecommunication and navigation signals; providing temporary use of non-downloadable operating software for accessing, and using, a cloud computing network; providing temporary use of non-downloadable software for analyzing financial data and generating reports; hosting computer application software in the field of knowledge management for creating searchable databases of information and data; computerized data storage services; hosting of servers; hosting of computer database; hosting of e-commerce platforms on the Internet; provision of search engines for the Internet; design, development, programming, rental and providing temporary use of on-line non-downloadable software for inventory management; design, development, programming, rental and providing tempo-

rary use of on-line non-downloadable communication software, computer search engine software and computer interface software; design, development, programming, rental and providing temporary use of on-line non-downloadable computer software for business purposes, for file management, for face, voice and eye recognition, for processing, import, collection, management and consolidation of data and data sets, for bookings and sales of tickets and seats in the transportation, travel, hotels, restaurants, sports, cultural and entertainment sectors, for handling passenger transportation by all means of transport by air, land, water or rail, for making travel arrangements, for travel itineraries, for providing travel information for cruises, for managing travel agencies, travel expenses, for managing hotels and property in the hotel industry, for managing meetings and events in the hotel industry, for managing restaurants, for parking facility management, for managing airports, airlines and crews, for flight management, for passenger tracking, for monitoring and management of cargo and luggage, for advertising, marketing and content management, for issuing, redemption and exchange of vouchers, for providing targeted offers, vouchers, discounts, special offers and promotional information, for managing customer relations, for managing human resources and personnel, for payment services, for safeguarding financial transactions, for managing fraud and for use in automating and managing business processes; hosting and maintenance of software online communicated by interface with a variety of distribution systems, travel organizers and property management systems enabling reservation and booking to be conducted in real time, room inventory management and collection and processing guest information, all in relation to the hotel industry; technical support services for computer software, including on-line support for troubleshooting computer software problems; design and development of electronic data security systems; consultancy and provision of information relating to the foregoing services.

43 – Provision of rooms, hotels, temporary accommodation and restaurant reservation services; providing accommodation information, namely prices, reviews and recommendations of hotels and temporary accommodation via global computer communication networks; consultancy and provision of information relating to the foregoing services.

45 – Licensing of industrial property rights (legal services); licensing of computer programs and software; fraud detection services in the use of credit cards for purchases online; online social networking services; registration of domain names; consultancy and provision of information relating to the foregoing services; safety information in airports.

---



(260) AM 2017 89848 A  
 (800) 1321808  
 (891) 2016 07 14  
 (731) DR. THEISS NATURWAREN GMBH  
 Michelinstr. 10, 66424 Homburg, Germany  
 (540)



The logo for 'pedibell' features the word in a lowercase, rounded, green sans-serif font. The letters 'p' and 'b' are underlined with thick red horizontal bars.

(591) Red and green

(511)

3 – Soaps; essential oils; cosmetics, including foam and cream preparations for baths; massage oils, non-medicated foot lotions, foot creams and foot ointment, including in stick form.

5 – Pharmaceutical preparations, including pharmaceutical preparations for skin care; foot lotions for athletes, embrocations, including rubbing alcohol; medicated cough sweets; sanitary preparations for medical purposes; medical preparations for sanitary purposes; medicated plasters.

10 – Orthopaedic articles; foot massagers.

(260) AM 2017 89849 A  
 (800) 1321814  
 (891) 2016 06 17  
 (731) ZHEJIANG RAYTTLE NEW ENERGY  
 MOTORS CO., LTD  
 No.189, Binhai 3rd Road, Hangzhou Bay  
 New Zone, Ningbo, 315336 Zhejiang, China  
 (540)



The logo for 'RAYTTLE' consists of a stylized black 'C' shape with a white arrow-like cutout pointing to the right. Below the symbol, the word 'RAYTTLE' is written in a bold, black, sans-serif font, followed by the Chinese characters '微米电动' (Weimi Electric) in a smaller font.

(591) Black, white

(511)

12 – Vehicles for locomotion by land, air, water or rail; electric vehicles; motorcycles; accumulator vehicle; golf carts; motor coaches; wagons; trucks; motor cars; cars.

(260) AM 2017 89850 A  
 (800) 761260  
 (891) 2016 11 16  
 (731) N.V. NUTRICIA  
 Eerste Stationsstraat 186 NL-2712 HM  
 ZOETERMEER, Netherlands  
 (540)

**FORTINI**

(511)  
 5 – Pharmaceutical products; dietetic and strengthening substances adapted for medical use; food for babies; food supplements for medical use, such as vitamin preparations.

29 – Meat, fish, poultry and game; meat extracts; preserved, dried and cooked fruit and vegetables; marmalades, jams, compotes; eggs, milk and dairy products; edible oils and fats; food supplements for non-medical purposes, included in this class.

(260) AM 2017 89851 A  
 (800) 831862  
 (891) 2016 07 01  
 (731) GUANG DONG KIN LONG HARDWARE  
 PRODUCTS CO., LIMITED  
 No.1 Xizibian Road, Daping Village, Tangxia  
 Town, Dongguan City, Guangdong Province,  
 China  
 (540)



The logo for 'KIN LONG' features the words in a large, bold, black, sans-serif font. The letters are filled with a dense, textured pattern of small black and white squares, giving it a mosaic-like appearance.

(591) Black, white

(511)

6 – Cast steel; aluminium; props of metal; fittings of metal for buildings; porches of metal (building); roofing of metal; framework of metal for building; poles of metal; reinforcing materials of metal for building; chains of metal; fittings of metal for windows; door openers, non-electric; door closers, non-electric; door springs (non-electric); hinges of metal; locks (other than electric) of metal; fittings of metal for windows; doors of metal; windows of metal; buildings of metal; building materials of metal.

(260) AM 2017 89854 A  
 (800) 1026024  
 (891) 2016 11 14  
 (731) SWAROVSKI AKTIENGESELLSCHAFT  
 Dröschstrasse 15, FL-9495 Triesen,  
 Liechtenstein  
 (540)

**SWAROVSKI**

(511)

16 – Paper, cardboard and goods made of these materials, not included in other classes; packing paper; bags, envelopes and pouches of paper for packaging; boxes of cardboard or paper; bottle wrappers of cardboard or paper; printed matter; pamphlets, catalogues, handbooks (manuals), books and prospec-



tuses; plastic materials for packaging (not included in other classes); bags, envelopes and pouches of plastics for packaging; labels not of textile.

(260) AM 2017 89855 A

(800) 1320789

(891) 2016 06 10

(731) TROMMSDORFF GMBH & CO. KG  
Arzneimittel Trommsdorffstrasse 2-6, 52477  
Alsdorf, Germany

(540)



(591) black and white

(511)

3 – Soaps; perfumeries; essential oils; preparations for body and beauty care; tooth care preparations; medical soaps.

5 – Medicine; pharmaceutical and veterinary preparations, as well as medicine, health care preparations; chemical-medicinal preparations for medical-therapeutic purposes; hygiene preparations for medical purposes; plasters; dressings; teeth filling material and dental impression material; disinfectants; preparations for destroying vermin; fungicides; herbicides; dietetic foods for medical purposes; dietetic preparations for medical purposes, dietetic substances for medical purposes, food supplements; food supplements for dietetic purposes, mineral food supplements; vitamin preparations; baby food; chemical and pharmaceutical preparations for supplemental balanced diet, dietetic foods adapted for medical purposes; dietetic beverages adapted for medical purposes.

29 – Dietetic foods for non-medical purposes based on proteins, fats with added fatty acids, vitamins, mineral substances, trace elements, either singly or in combination, as far as included in class 29.

30 – Dietetic foods for non-medical purposes based on carbohydrates, fibers, with added vitamins, mineral substances, trace elements, either singly or in combination, as far as included in class 30.

35 – Business administration and management; business administration; office functions; marketing; market research and market analysis; advertising and distribution of goods for advertising purposes; planning and conducting of advertising campaigns and

events; retail and wholesale services in respect of the aforementioned goods of classes 03, 05, 29, and 30; retail and wholesale services via the Internet, also via online shops as well as via teleshopping programs in respect of all aforementioned goods of classes 03, 05, 29, and 30.

(260) AM 2017 89856 A

(800) 1320791

(891) 2016 08 10

(731) Tovarystvo z obmezheniou  
vidpovidalnistiu "UDC-INVEST"  
vul. Viacheslava Chornovola, bud. 12, Kyiv  
01135, Ukraine

(540)



(591) black and white

(511)

33 – Alcoholic beverages, except beer; alcoholic beverages containing fruit; aperitifs; arrack [arak]; brandy; wine; whisky; anisette [liqueur]; anise [liqueur]; vodka; kirsch; perry; gin; cocktails; curacao; liqueurs; mead [hydromel]; peppermint liqueurs; pre-mixed alcoholic beverages, other than beer-based; bitters; distilled beverages; piquette; rum; sake; cider; spirits [beverages]; alcoholic extracts; alcoholic essences; fruit extracts, alcoholic.

35 – Advertising; import-export agency services; commercial information agency services; computerized file management; demonstration of goods; opinion polling; market studies; business information; commercial information and advice for consumers [consumer advice shop]; business investigations; marketing research; business management consultancy; layout services for advertising purposes; marketing; scriptwriting for advertising purposes; organization of exhibitions for commercial or advertising purposes; organization of trade fairs for commercial or advertising purposes; shop window dressing; design of advertising materials; business appraisals; business management assistance; commercial or industrial management assistance; commercial intermediation services; web indexing for commercial or advertising purposes; provision of an on-line marketplace for buyers and sellers of goods and services; presentation of goods on communication media, for retail purposes; sales promotion for others; rental of advertising time on communication media; publicity material rental; radio advertising; dissemination of

advertising matter; direct mail advertising; writing of publicity texts; on-line advertising on a computer network; advertising by mail order; television advertising; compilation of information into computer databases; telemarketing services; price comparison services; business efficiency expert services.

(260) AM 2017 89857 A

(800) 1294696

(891) 2016 10 03

(731) ACINO PHARMA AG

Birsweg 2, CH-4253 Liesberg, Switzerland

(540)

**Zuporys**

(511)

5 – Pharmaceutical and veterinary products.

(260) AM 2017 89914 A

(800) 1322097

(891) 2016 05 07

(731) LILANG (SHANGHAI) CO., LTD.

6/F, Building B, No.633, Jinzhong Road,  
Changning District, Shanghai, China

(540)



(591) black and white

(511)

25 – Clothing; layettes (clothing); bathing suits; running shoes with metal nails; shoes; hats; hosiery; gloves [clothing]; neckties; leather belts for clothing.

(260) AM 2017 89917 A

(800) 1322315

(891) 2016 04 21

(731) RIVACOLD S.R.L.

Via Sicilia, 7, Frazione Montecchio,  
VALLEFOGLIA (PS) I-61022, Italy

(540)



(591) Green

(511)

7 – Refrigeration condensers; compressors; compressors for refrigerators; heat exchangers [parts of

machines]; aerocondensers; steam condensers [parts of machines].

11 – Refrigerant condensers; water coolers; refrigerating appliances and installations; heat exchangers, not parts of machines; fans [air-conditioning]; air conditioning apparatus; air conditioning installations; evaporators; cooling evaporators; refrigerating cabinets; refrigerating chambers; freezers.

35 – Business management; the bringing together, for the benefit of others, of a variety of goods, excluding the transport thereof, namely refrigeration condensers, compressors, compressors for refrigerators, heat exchangers in the nature of parts of machines, aerocondensers, steam condensers in the nature of parts of machines, refrigerant condensers, water coolers, refrigerating appliances and installations, heat exchangers not parts of machines, fans for air-conditioning, air conditioning apparatus, air conditioning installations, evaporators, cooling evaporators, refrigerating cabinets, refrigerating chambers, freezers, enabling customers to conveniently view and purchase those goods; on-line retail and wholesale store services featuring refrigeration condensers, compressors, compressors for refrigerators, heat exchangers in the nature of parts of machines, aerocondensers, steam condensers in the nature of parts of machines, refrigerant condensers, water coolers, refrigerating appliances and installations, heat exchangers not parts of machines, fans for air-conditioning, air conditioning apparatus, air conditioning installations, evaporators, cooling evaporators, refrigerating cabinets, refrigerating chambers, freezers; presentation of goods on communication media, for retail purposes; business merchandising display services; sales promotion for others; organization of events, exhibitions, fairs and shows for commercial, promotional and advertising purposes; advertising, including on-line advertising on a computer network; business administration; office functions.

(260) AM 2017 89920 A

(800) 1322331

(891) 2016 07 22

(731) SHENZHEN SEAORY TECHNOLOGY  
CO., LTD

Room No.601, Deguanting Business Center,  
Xinan 3rd Road No.88, 28th Area of Baoan  
District, (Formerly Known as Dormitory  
No.8 and 9 of 28th Area), Shenzhen, China

(540)



(591) Black, white

(511)

9 – Printers for use with computers; data processing apparatus; computer peripheral devices; computer software, recorded; couplers [data processing equipment]; interfaces for computers; magnetic data media; magnetic encoders; readers [data processing equipment]; computer programs [downloadable software].

(260) AM 2017 89927 A

(800) 1322566

(891) 2016 07 15

(731) "PREDO" Limited Liability Company  
ul. Pobedy 9, pom. 5, Reutov, RU-143966  
Moskovskaya Oblast, Russian Federation

(540)



(591) Black, white

(511)

29 – Albumen for culinary purposes; seaweed extracts for food; gelatine; edible fats; anchovy; peanut butter; butter; cocoa butter for food; coconut butter; buttercream; white of eggs; blood sausage; bouillon; preparations for making bouillon; caviar; fruit, preserved; charcuterie; potato chips; sauerkraut; coconut, desiccated; colza oil for food; bouillon concentrates; jams; frozen fruits; soups; raisins; gherkins; vegetables, preserved; vegetables, cooked; vegetables, dried; edible oils; cream [dairy products]; cheese; crystallized fruits; croquettes; crustaceans, not live; dates; milk; crayfish, not live; fish fillets; rennet; fruit, stewed; fruit jellies; fruit pulp; meat; fish, not live; jellies for food; meat jellies; game, not live; ginger jam; soya beans, preserved, for food; fatty substances for the manufacture of edible fats; fat-containing mixtures for bread slices; herrings, not live; lobsters, not live; corn oil; palm kernel oil for food; sesame oil; oysters, not live; isinglass for food; ham; yolk of eggs; yoghurt; vegetable soup preparations; vegetable juices for cooking; meat extracts; kephir [milk beverage]; kumys [milk beverage]; milk beverages, milk predominating; whey; milk products; spiny lobsters, not live; bacon; lentils, preserved; margarine; marmalade; animal marrow for food; shellfish, not live; mussels, not live; palm oil for food; nuts, prepared; eggs; powdered eggs; liver pâté; onions, preserved; olives, preserved; olive oil

for food; bone oil, edible; pectin for culinary purposes; piccalilli; pickles; peas, preserved; sausages; salted meats; preparations for making soup; tomato purée; vegetable salads; lard; fruit salads; sardines, not live; salmon, not live; suet for food; tuna, not live; tomato juice for cooking; sunflower oil for food; tripe; truffles, preserved; poultry, not live; fruit peel; alginates for culinary purposes; almonds, ground; peanuts, prepared; mushrooms, preserved; coconut fat; coconut oil; beans, preserved; liver; fish-based foodstuffs; fruit chips; clams, not live; fruit preserved in alcohol; pollen prepared as foodstuff; prawns, not live; fish, preserved; meat, preserved; shrimps, not live; snail eggs for consumption; tofu; whipped cream; pork; edible birds' nests; fish, tinned; fish meal for human consumption; fruits, tinned; meat, tinned; potato fritters; salted fish; sea-cucumbers, not live; silkworm chrysalis, for human consumption; vegetables, tinned; sausages in batter; potato flakes; apple purée; cranberry sauce [compote]; tahini [sesame seed paste]; hummus [chickpea paste]; toasted laver; fruit-based snack food; curd; kimchi [fermented vegetable dish]; soya milk [milk substitute]; milk shakes; ajvar [preserved peppers]; sunflower seeds, prepared; fish mousses; non-alcoholic eggnog; vegetable mousses; fish roe, prepared; seeds, prepared; aloe vera prepared for human consumption; preserved garlic; albumin milk; linseed oil for culinary purposes; low-fat potato chips; lecithin for culinary purposes; milk ferments for culinary purposes; compotes; condensed milk; smetana [sour cream]; ryazhenka [fermented baked milk]; prostokvasha [soured milk]; tomato paste; vegetable marrow paste; eggplant paste; peanut milk for culinary purposes; milk of almonds for culinary purposes; rice milk [milk substitute]; artichokes, preserved; arrangements of processed fruit; powdered milk; yakitori; bulgogi [Korean beef dish]; candied nuts; flavoured nuts; hazelnuts, prepared; berries, preserved.

30 – Seaweed [condiment]; pasta; almond paste; aniseed; star aniseed; confectionery for decorating Christmas trees; infusions, not medicinal; coffee flavoured; aromatic preparations for food; seasonings; unleavened bread; salt for preserving foodstuffs; rusks; cookies; malt biscuits; peppermint sweets; sweetmeats [candy]; waffles; buns; cocoa; coffee; unroasted coffee; vegetal preparations for use as coffee substitutes; cakes; cinnamon [spice]; capers; caramels [candy]; curry [spice]; cereal preparations; chewing gum; chicory [coffee substitute]; tea; chocolate; marzipan; cloves [spice]; condiments; confectionery; corn flakes; popcorn; preparations for stiffening whipped cream; ice cream; pancakes; essences for foodstuffs, except etheric essences and essential oils; cooking salt; thickening agents for cooking foodstuffs; turmeric; natural sweeteners; spices; gingerbread; allspice; meal; bean meal; corn flour; mustard meal; barley meal; soya flour; wheat flour; starch for food; ferments for pastes; fondants [con-

fectionery]; petits fours [cakes]; sugar; flavorings, other than essential oils, for cakes; cake powder; cake dough; ginger [spice]; binding agents for ice cream [edible ices]; ice, natural or artificial; ice for refreshment; glucose for culinary purposes; gluten prepared as foodstuff; groats for human food; vinegar; ketchup [sauce]; cocoa beverages with milk; coffee beverages with milk; chocolate beverages with milk; leaven; yeast; sausage binding materials; macarons [pastry]; macaroni; corn, milled; corn, roasted; bread; maltose; molasses for food; golden syrup; mint for confectionery; honey; husked barley; mustard; nutmegs; noodles; pies; crushed barley; sandwiches; pastilles [confectionery]; pastries; petit-beurre biscuits; bread rolls; peppers [seasonings]; pizzas; pepper; potato flour; puddings; pralines; ravioli; liquorice [confectionery]; rice; saffron [seasoning]; sago; sauces [condiments]; celery salt; semolina; sherbets [ices]; spaghetti; tapioca; tapioca flour; tarts; vanilla flavorings for culinary purposes; vanillin [vanilla substitute]; vermicelli [noodles]; meat pies; pâtés en croûte; meat tenderizers, for household purposes; edible ices; powders for making ice cream; almond confectionery; peanut confectionery; food flavorings, other than essential oils; flavorings, other than essential oils, for beverages; crushed oats; husked oats; oat-based food; oat flakes; oatmeal; stick liquorice [confectionery]; beer vinegar; coffee-based beverages; cocoa-based beverages; chocolate-based beverages; artificial coffee; candy; chips [cereal products]; chow-chow [condiment]; couscous [semolina]; malt extract for food; malt for human consumption; propolis; relish [condiment]; royal jelly; sea water for cooking; sushi; tomato sauce; mayonnaise; crackers; custard; fruit jellies [confectionery]; muesli; rice cakes; soya sauce; frozen yogurt [confectionery ices]; chutneys [condiments]; spring rolls; tacos; tortillas; iced tea; tea-based beverages; dressings for salad; breadcrumbs; tabbouleh; halvah; quiches; meat gravies; miso [condiment]; soya bean paste [condiment]; cereal-based snack food; rice-based snack food; hominy; hominy grits; baking powder; baking soda [bicarbonate of soda for cooking purposes]; garden herbs, preserved [seasonings]; noodle-based prepared meals; cake frosting [icing]; chocolate mousses; dessert mousses [confectionery]; fruit coulis [sauces]; marinades; cheeseburgers [sandwiches]; pesto [sauce]; ham glaze; linseed for human consumption; wheat germ for human consumption; high-protein cereal bars; cream of tartar for culinary purposes; gluten additives for culinary purposes; pasta sauce; cereal bars; palm sugar; dough; flowers or leaves for use as tea substitutes; pastry dough; vareniki [stuffed dumplings]; pelmeni [dumplings stuffed with meat]; chocolate decorations for cakes; candy decorations for cakes; chocolate-coated nuts; rice pudding; nut flours; minced garlic [condiment]; baozi [stuffed buns]; rice pulp for culinary purposes; jiaozi [stuffed dumplings];

ramen [Japanese noodle-based dish]; okonomiyaki [Japanese savoury pancakes]; batter mixes for okonomiyaki [Japanese savory pancakes]; burritos; gim-bap [Korean rice dish]; edible paper; edible rice paper.

31 – Citrus fruit, fresh; algae for human or animal consumption; seaweed for human or animal consumption; nuts [fruits]; menagerie animals; live animals; animal foodstuffs; trees; Christmas trees, included in this class; trunks of trees; bushes; oats; berries, fresh; salt for cattle; beet, fresh; bran; unsawn timber; wood chips for the manufacture of wood pulp; undressed timber; cocoa beans, raw; sugarcane; locust beans, raw; cereal seeds, unprocessed; mushrooms, fresh; mushroom spawn for propagation; oil cake; cattle cake; chestnuts, fresh; lime for animal forage; chicory roots; chicory, fresh; dog biscuits; lemons, fresh; coconut shell; coconuts; bird food; rape cake for cattle; cucumbers, fresh; hop cones; bran mash for animal consumption; copra; shellfish, live; vegetables, fresh; squashes, fresh; wreaths of natural flowers; eggs for hatching, fertilized; straw mulch; distillery waste for animal consumption; draff; bred stock; animal fattening preparations; rice meal for forage; beans, fresh; flowers, natural; flowers, dried, for decoration; pollen [raw material]; hay; strengthening animal forage; fodder; wheat; fruit, fresh; turf, natural; juniper berries; seed germ for botanical purposes; grains [cereals]; grains for animal consumption; seeds for planting; groats for poultry; garden herbs, fresh; plants; seedlings; hops; kola nuts; lettuce, fresh; lentils, fresh; yeast for animal consumption; rough cork; flax meal [fodder]; litter for animals; litter peat; maize; maize cake for cattle; malt for brewing and distilling; fruit residue [marc]; hazelnuts, fresh; meal for animals; fish spawn; silkworm eggs; flower bulbs; onions, fresh; olives, fresh; oranges, fresh; barley, included in this class; nettles; cuttle bone for birds; straw litter; straw [forage]; palms [leaves of the palm tree]; palm trees; mash for fattening livestock; fish, live; vine plants; pine cones; peppers [plants]; plants, dried, for decoration; leeks, fresh; peas, fresh; potatoes, fresh; preparations for egg laying poultry; stall food for animals; roots for food; grapes, fresh; rhubarb, fresh; rose bushes; rye; silkworms; edible sesame, unprocessed; truffles, fresh; residue in a still after distillation; poultry, live; algarovilla for animal consumption; almonds [fruits]; peanuts, fresh; peanut meal for animals; peanut cake for animals; by-products of the processing of cereals, for animal consumption; bagasses of cane [raw material]; fishing bait, live; crayfish, live; crustaceans, live; lobsters, live; mussels, live; oysters, live; pet food; raw barks; spiny lobsters, live; edible chews for animals; beverages for pets; fish meal for animal consumption; rice, unprocessed; sea-cucumbers, live; sanded paper for pets [litter]; aromatic sand for pets [litter]; aloe vera plants; spinach, fresh; linseed for animal consump-

tion; linseed meal for animal consumption; wheat germ for animal consumption; artichokes, fresh; herrings, live; salmon, live; sardines, live; tuna, live; garlic, fresh; vegetable marrows, fresh; edible linseed, unprocessed; arrangements of fresh fruit.

32 – Non-alcoholic fruit extracts; beer; ginger beer; malt beer; beer wort; non-alcoholic fruit juice beverages; whey beverages; preparations for making beverages; essences for making beverages; fruit juices; syrups for beverages; waters [beverages]; preparations for making aerated water; lithia water; mineral water [beverages]; preparations for making mineral water; seltzer water; table waters; must; lemonades; extracts of hops for making beer; vegetable juices [beverages]; syrups for lemonade; preparations for making liqueurs; malt wort; grape must, unfermented; orgeat; soda water; sherbets [beverages]; tomato juice [beverage]; non-alcoholic beverages; milk of almonds [beverage]; pastilles for effervescing beverages; powders for effervescing beverages; aerated water; sarsaparilla [non-alcoholic beverage]; aperitifs, non-alcoholic; cocktails, non-alcoholic; fruit nectars, non-alcoholic; isotonic beverages; peanut milk [non-alcoholic beverage]; cider, non-alcoholic; kvass [non-alcoholic beverage]; non-alcoholic honey-based beverages; smoothies; aloe vera drinks, non-alcoholic; beer-based cocktails; soya-based beverages, other than milk substitutes; protein-enriched sports beverages; rice-based beverages, other than milk substitutes; non-alcoholic beverages flavoured with coffee; non-alcoholic beverages flavoured with tea.

(260) AM 2017 89930 A

(800) 1322106

(891) 2016 06 20

(731) Mejeriforeningen Danish Dairy Board  
Agro Food Park 13, DK-8200 Aarhus N,  
Denmark

(540)



(591) Dark grey, light grey, red, blue and silver

(511)

29 – Meat, fish, poultry and game; meat extracts; preserved, frozen, dried and cooked fruits and vegetables; jellies, jams, compotes; eggs, milk and milk products; butter; concentrated butter; spreadables mainly consisting of a mixture of butter and vegetable oil; flavoured butter; ghee; cheese; crème

fraiche; edible oils and fats; butter oil; rennet; cheese powder, substitutes for milk and cream; milk and cream in powder form.

(260) AM 2017 89936 A

(800) 1322851

(891) 2016 01 15

(731) JYSK A/S

Sødalsparken 18, DK-8220 Brabrand,  
Denmark

(540)



(591) Yellow and black

(511)

20 – Furniture, mirrors, picture frames; bamboo curtains; bead curtains for decoration; bed bases; beds for household pets; bedsteads of wood; wine shelves; boxes of wood or plastic; chests for toys; coat stands; curtain rails; curtain rods; edgings of plastic for furniture; hand-held mirrors [toilet mirrors]; hat stands; water beds, not for medical purposes; keyboards for hanging keys; ladders of wood or plastics; magazine racks; magazine display stands; mattresses; mattress pads; pillows; mattress toppers; sleeping bags for camping; packaging containers of plastic; paper blinds; placards of wood or plastics; plate racks; playpens for babies; pulleys of plastics for blinds; shelves for storage; slatted indoor blinds; vertical blinds [indoor]; indoor window blinds [shades] [furniture]; step stools, not of metal; straw mattresses; straw edgings; towel dispensers, fixed, not of metal; umbrella stands; baby changing platforms; wickerwork; air cushions, not for medical purposes; air mattresses, not for medical purposes; bedding, except linen (furniture); pet cushions; goods (not included in other classes) of wood, cork, reed, cane, wicker, horn, bone, ivory, whalebone, shell, amber, mother-of-pearl, meerschaum and substitutes for all these materials, or of plastics, namely bread baskets, baskets, hooks for clothing, clothes hangers and clothes hooks, hooks for clothes rails, containers, covers for clothing [wardrobe], crates, curtain rings, curtain holders, curtain rollers, curtain tie-backs, fans for personal use, non-electric, hampers, letter boxes, mobiles, nameplates, nesting boxes, fittings for curtains and blinds of wood or plastic and trays.

21 – Household utensils or containers; combs and sponges; brushes; brush-making materials; articles for cleaning purposes; metal scouring pads; unworked or semi-worked glass (except glass used in buildings); glassware, porcelain and ceramics (not included in other classes), baby baths, ceramic goods, toilet utensils, toilet brushes, bathroom waste

bins; cooking pots; flower pots; laundry drying racks; empty spray bottles; brooms and dust pans.

24 – Textiles and textile goods, not included in other classes; bed and table covers; curtains; towels; bedding; sheets; bed linen; covers for cushions; quilt bedding mats; duvets; eiderdowns; shower curtains of textile or plastic; travelling rugs; bedspreads; cushions covers; dish towels; individual place mats made of textile or plastics.

(260) AM 2017 89939 A  
(800) 1322107  
(891) 2016 06 20  
(731) Mejeriforeningen Danish Dairy Board  
Agro Food Park 13, DK-8200 Aarhus N,  
Denmark

(540)



(591) Red and silver

(511)

29 – Butter; dairy and vegetable spreads mainly consisting of a mixture of butter and vegetable oil; crème fraiche; edible oils and fats.

(260) AM 2017 89940 A  
(800) 1322156  
(891) 2016 07 29  
(731) BAYERISCHE MOTOREN WERKE  
AKTIENGESELLSCHAFT  
Petuelring 130, 80809 Munich, Germany

(540)

### Original BMW Engine Oil

(511)

4 – Industrial oils; industrial greases; lubricants; engine oils; gear oils; non-chemical petrol additives; non-chemical additives for fuels for vehicles; fuel for vehicles.

(260) AM 2017 89941 A  
(800) 1322157  
(891) 2016 07 29  
(731) BAYERISCHE MOTOREN WERKE  
AKTIENGESELLSCHAFT  
Petuelring 130, 80809 Munich, Germany

(540)

### BMW TwinPower Turbo

(511)

4 – Industrial oils; industrial greases; lubricants; engine oils; gear oils; non-chemical petrol additives; non-chemical additives for fuels for vehicles; fuel for vehicles.

(260) AM 2017 89944 A  
(800) 1322158  
(891) 2016 07 29  
(731) BAYERISCHE MOTOREN WERKE  
AKTIENGESELLSCHAFT  
Petuelring 130, 80809 Munich, Germany

(540)

### BMW

(511)

4 – Industrial oils; industrial greases; lubricants; engine oils; gear oils; non-chemical petrol additives; non-chemical additives for fuels for vehicles; fuel for vehicles.

(260) AM 2017 89945 A  
(800) 1322727  
(891) 2016 08 17  
(731) Obshchestvo s ogranichennoy  
otvetstvennostyu "KOMPANIYA ANTA"  
Kompaniya Anta» D. 71, korp. 4G-D, str. 5,  
Izmajlovskoe sh. RU-105613 g. Moskva,  
Russian Federation

(540)



(591) Black, white

(511)

25 – Headgear for wear, including head sweatbands [clothing], ear muffs [clothing], headbands [clothing]; sporting caps, bathing caps; visors [headwear]; sports jerseys; footwear, including sneakers, shoes, football boots; beach shoes; sports shoes; bathing shoes, koma-geta [low wooden clogs], sandals, boots, gymnastic shoes, slippers; outerclothing, including gaiters, breeches for wear, trousers, vests, jumpsuits [clothing], tracksuits, bathing suits, beach clothes, jackets [clothing]; motorists' clothing; cyclists' clothing; clothing for gymnastics; gloves [clothing]; dresses; raincoats; belts [clothing]; shirts; sweaters; muscle shirts; tee-shirts; dressing gowns; underwear, including brassieres, tights; socks; bathing trunks; underpants; thermal underwear; braces for clothing [suspenders]; inner soles; sashes for wear; studs for football boots.

(260) AM 2017 89947 A  
(800) 1322162  
(891) 2016 08 04  
(731) APPLE INC.  
1 Infinite Loop, Cupertino CA 95014, USA

(540)





(591) black and white  
 (526) "Made for"  
 (511)  
 28 – Toys; games and playthings; electronic hand-held game units; musical toys, games and playthings; toy audio apparatus; toy musical instruments; musical games; battery operated toys; electronic toys; electric computer games, other than those adapted for use with television receivers; electrical and electronic amusement apparatus (automatic, coin/counter freed); toy handheld electronic devices; gymnastic and sporting articles; body-building apparatus; body rehabilitation apparatus; body-training apparatus; stationary exercise bicycles; parts and fittings for all the aforesaid goods.

(260) AM 2017 89950 A  
 (800) 1322899  
 (891) 2016 03 27  
 (731) HUANG YUN FENG  
 Group 9, Niansanli Village, Niansanli Town,  
 Yiwu City Jinhua City, Zhejiang Province,  
 China

(540)

**Анфуса**

(591) Black, white  
 (511)  
 25 – Clothing; dust coats; shoes; hats; hosiery; gloves [clothing]; neckties; scarfs; girdles; belts [clothing].

(260) AM 2017 89951 A  
 (800) 1322900  
 (891) 2016 06 02  
 (731) SGB-SMIT Management GmbH  
 Ohmstraße 10, 93055 Regensburg, Germany

(540)

**SGB-SMIT**

(511)  
 9 – Transformers; housings for transformers.

(260) AM 2017 89953 A  
 (800) 1322932  
 (891) 2016 10 28  
 (731) ALIGN TECHNOLOGY, INC.  
 2560 Orchard Parkway, San Jose CA 95131, USA

(540)



(591) Black, white  
 (511)  
 10 – Dental apparatus, namely, orthodontic appliances.

(260) AM 2017 89954 A  
 (800) 1323004  
 (891) 2016 09 30  
 (731) NEMIROFF INTELLECTUAL PROPERTY  
 ESTABLISHMENT  
 Städtle 31, FL-9490 Vaduz, Liechtenstein

(540)



(591) Black, white  
 (554) Three-dimensional  
 (511)  
 33 – Alcoholic beverages (except beers).

(260) AM 2017 89956 A  
 (800) 1323037  
 (891) 2016 02 10  
 (731) BIOMIN HOLDING GMBH  
 Erber Campus 1, A-3131 Getzersdorf bei  
 Traismauer, Austria

(540)

**Дигестаром**

(591) Black, white  
 (511)  
 5 – Fodder supplements for veterinary purposes; nutritional supplements for animal foodstuffs not for veterinary purposes, containing natural herbs and agents for enhancing the flavour, for stabilising the gastrointestinal tract, for stimulating the appetite and/or for favouring secretions.

31 – Animal foodstuffs.

(260) AM 2017 89957 A  
 (800) 1322169  
 (891) 2016 06 23  
 (731) CADA ITALIA S.R.L.  
 Corso Plebisciti, 9, I-20129 MILANO, Italy

(540)

**SEMIRAMIDE**

(511)

18 – Trunks and travelling bags; bags; duffel bags; clutches [purses]; shoulder bags; backpacks; sport backpacks; daypacks; attaché cases; business cases; purses; wallets; key-cases of leather; boxes of leather or leatherboard; beauty cases (empty); umbrellas and parasols.

25 – Clothing; trousers; jeans; shorts; jackets; ponchos; coats; gilets; overcoats; rainproof jackets; hosiery; knitwear (clothing); sweaters; cardigans; pullovers; twin sets; vests; shirts; sweat shirts; t-shirts; ladies' dresses; skirts; dresses; sportswear; tracksuits; leather clothing; clothing of imitation of leather; bathrobes; bathing suits; beach wraps; underwear; nighties; pajamas; robes; stockings; headbands; neck scarfs; headscarfs; gloves; ties; belts; headgear; hats; berets; visors (headwear); bandanas [neckerchiefs]; footwear; shoes; dress shoes; gymnastic shoes; boots; sandals; slippers.

(260) AM 2017 89958 A

(800) 1322766

(891) 2016 03 22

(731) UNILEVER N.V.

455, Weena, NL-3013 AL ROTTERDAM,  
Netherlands

(540)

**LUX SOFT BLOOM**

(511)

3 – Soaps; bath and shower gels.

(260) AM 2017 89959 A

(800) 1322175

(891) 2016 07 29

(731) BIOFARMA

50 rue Carnot, F-92284 Suresnes cedex, France

(540)

**OBEONE**

(591) black and white

(511)

5 – Pharmaceutical preparations; sanitary products for medical purposes; implants for pharmaceutical use; implantable medicines; dietetic substances for medical use; food for babies; dietetic preparations and food supplements; plasters, materials for dressings; compresses; teeth filling material; dental impression materials; disinfectants; products for destroying vermin; fungicides; herbicides, all the aforesaid goods intended for the diabetic, oncological and osteoporosis fields, excluding veterinary products.

10 – Medical apparatus and instruments; applicators for medicines; medical implants; applicators for

pharmaceutical preparations; pumps for medical use for administering pharmaceutical products contained in receptacles; infusion pumps for administering medicines; injection devices for pharmaceutical products; implants for pharmaceutical use; holders for medical use; surgical apparatus and instruments; cases fitted for medical instruments; suture materials; scalpels; knives for surgical purposes; surgical knives; scissors for surgery; knives for surgical use; cases fitted for use by doctors; containers especially made for medical waste; containers for applying medicines, all the aforesaid goods intended for the diabetic, oncological and osteoporosis fields, excluding apparatus and instruments for the veterinary field.

(260) AM 2017 89960 A

(800) 1323041

(891) 2016 05 02

(731) WILHELMSEN SHIPS SERVICE AS

Strandveien 20, N-1366 Lysaker, Norway

(540)



(591) Black, white

(511)

6 – Ropes of metal or predominantly made of metal; wire rope; wire rope slings; straps of metal for load handling; rope thimbles of metal.

22 – Ropes, rope slings, rope ladders, cables, cords, cordage, string, twine, anchoring ropes, mooring ropes, towing ropes; sheets and halyards for sailboats, ropes for hunting, fishing and fish farming; arborist's ropes and slings; fishing nets, net pens for fish farming; nets and slings for load handling; all the aforesaid goods not being made of metal or predominantly being made of other materials than metal; sails for yachts; textile fibres; textile fibres for repairing and reinforcement of surfboards, skateboards, helmets and skis; plastic fibers for textile use.

(260) AM 2017 89961 A

(800) 1322193

(891) 2016 08 31

(731) EXELIXIS, INC.

210 East Grand Avenue, South San Francisco  
CA 94080, USA

(540)





(591) gray, black and white  
(511)  
5 – Pharmaceutical preparations for the treatment of cancer, pain, infection, inflammation, hormone disorders, bone disorders, and mental disorders; analgesics; hormones; psychotropics; anti-infectives; anti-inflammatories; anti-cancer preparations.

(260) AM 2017 89970 A  
(800) 1323043  
(891) 2016 05 30  
(731) LE HOLDINGS (BEIJING) CO., LTD.  
1102, 10F, Building No. 3, 105 Yaojiayuan Road, Chaoyang District, Beijing, China

(540)



(591) Black, white  
(511)  
12 – Cycle cars; electric vehicles; direction indicators for bicycles; upholstery for vehicles; motorcycles; bicycles; audible warning systems for cycles; vehicle wheel tires [tyres]; steering wheels for vehicles; automobiles.

28 – Apparatus for games; controllers for game consoles; toys; playing balls; playing cards; skis; body-building apparatus; gloves for games; games; bite indicators [fishing tackle]; bite sensors [fishing tackle]; snowshoes; scratch cards for playing lottery; video game machines; in-line roller skates; stationary exercise bicycles.

35 – Rental of advertising space; on-line advertising on a computer network; rental of advertising time on communication media; production of advertising films; sales promotion for others; import-export agencies; advertising; procurement services for others [purchasing goods and services for other businesses]; systemization of information into computer databases; presentation of goods on communication media, for retail purposes.

38 – Television broadcasting; wireless broadcasting; message sending; computer aided transmission of messages and images; communications by fiber optic networks; electronic bulletin board services [telecommunications services]; providing telecommunications connections to a global computer network; providing internet chatrooms; providing access to databases; providing online forums.

41 – Educational services; organization of competitions [education or entertainment]; modelling for artists; publication of electronic books and journals on-line; film production, other than advertising films; amusements; game services provided on-line from a computer network; health club services [health and fitness training]; production of shows; operating lotteries.

42 – Technical research; cloud computing; industrial design; design of interior decor; dress designing; computer software design; rental of computer software; conversion of data or documents from physical to electronic media; hosting computer sites [web sites]; providing search engines for the internet.

45 – Security consultancy; chaperoning; clothing rental; funerary undertaking; dating services; on-line social networking services; marriage agencies; nanny services; licensing of intellectual property; copyright management.

(260) AM 2017 89971 A  
(800) 1323068  
(891) 2016 04 21  
(731) ELFOS CERÁMICA  
2009, S.L. Carretera Ribesalbes, S/N E-12110 ALCORA (CASTELLÓN), Spain

(540)



(591) Black, white  
(511)  
19 – Non-metallic building materials, in particular: ceramic wall and floor tiles.

(260) AM 2017 89972 A  
(800) 1323142  
(891) 2016 09 02  
(731) VP BRANDS INTERNATIONAL SA  
Dunav blvd. 5 BG-4000 Plovdiv, Bulgaria

(540)

**BLUE WARRIOR**

(591) Black, white  
(511)  
33 – Alcoholic extracts, alcoholic essences, alcoholic beverages [except beer], alcoholic beverages containing fruit, anisette [liqueur], anise [liqueur], aperi-

tifs, arak [arrack], arrack [arak], baijiu [chinese distilled alcoholic beverage], brandy, wine, kirsch, vodka, bitters, distilled beverages, gin, digesters [liqueurs and spirits], cocktails, perry, curacao, liqueurs, hydromel [mead], mead [hydromel], peppermint liqueurs, nira [sugarcane-based alcoholic beverage], rice alcohol, piquette, fruit extracts [alcoholic], pre-mixed alcoholic beverages, other than beer based, rum, cider, sake, spirits [beverages], whisky.

(260) AM 2017 89973 A  
(800) 849537  
(891) 2016 11 24  
(731) HEINZE GRUPPE VERWALTUNGS GMBH  
Eupener Str. 35, 32051 Herford, Germany  
(540)

## COBIAX

(511)  
6 – Building materials of metal; reinforcing materials of metal for building, strips and binding strips, binding wires, nets, formwork for concrete; all the aforesaid goods made of metal.

19 – Non-metallic building materials, reinforcing materials for building, concrete building elements, formwork for concrete, plastic moving elements for casting concrete; all the aforesaid goods not of metal.

42 – Architectural consultation; expert technical surveys; engineering work; engineering project studies; patent exploitation.

(260) AM 2017 90019 A  
(800) 1324016  
(891) 2016 08 12  
(731) RANCILIO GROUP S.P.A.  
Viale della Repubblica, 40, Frazione Villastanza, I-20010 PARABIAGO (Milano), Italy  
(540)



(591) Black, white  
(511)  
7 – Electric coffee grinders; dishwashers; cup washing machines; apparatus for mincing edible ice.

11 – Espresso coffee machines; ice makers; refrigerators; water softening units; steam wands.

30 – Coffee, cocoa, chocolate and tea beverages; tea, chocolate, cocoa and coffee substitutes and blends; coffee (roasted, powdered, granulated, or in drinks).

(260) AM 2017 90023 A  
(800) 1324161  
(891) 2016 08 31  
(731) Sovmestnoe obschestvo s ogranichennoy otvetsvennostyu "LEKPHARM"  
Komn. 301, d. 2A, ul. Minskaya, g. Logoysk, 223141 Minskaya obl., Belarus  
(540)

## ХОИДРОМЕД

(511)  
5 – Pharmaceutical and veterinary preparations; sanitary preparations for medical purposes; dietetic substances adapted for medical use, food for babies; plasters, materials for dressings; material for stopping teeth, dental wax; disinfectants; preparations for destroying vermin; fungicides, herbicides; dietary supplements.

(260) AM 2017 90024 A  
(800) 1324238  
(891) 2016 07 18  
(731) SOCIÉTÉ DES PRODUITS NESTLÉ S.A.  
CH-1800 Vevey, Switzerland  
(540)



(591) Black, white  
(511)  
11 – Apparatus for heating and cooking; apparatus for heating and foaming milk; apparatus and machines for making beverages including coffee, tea, chocolate, cappuccino and/or cocoa-based beverages; coffee makers and electrical percolators; electric coffee filters; parts and component parts for all the aforesaid goods.

30 – Coffee, coffee extracts, coffee-based beverages and preparations; iced coffee; artificial coffee, artificial coffee extracts, artificial coffee-based beverages and preparations; chicory (coffee substitute); tea, tea extracts, tea-based beverages and preparations; iced

tea; malt-based preparations for human consumption; cocoa and cocoa-based beverages and preparations; chocolate, chocolate products, chocolate-based beverages and preparations; confectionery, sugar confectionery, candy; sugar; chewing gum not for medical use; natural sweeteners; bakery products, bread, yeast, pastries; biscuits, cakes, cookies, wafers, caramels, puddings; edible ices, water ices, sherbets, frozen confectionery, frozen cakes, ice creams, frozen yogurts, powders and binding agents (included in this class) for making edible ices and/or water ices and/or sherbets and/or frozen confectionery and/or frozen cakes and/or ice creams and/or frozen yogurts; breakfast cereals, muesli, corn flakes, cereal bars, ready-to-eat cereals; cereal preparations.

32 – Still waters, aerated or carbonated waters, treated waters, spring waters, mineral waters, flavored waters; fruit-flavored beverages and fruit-based beverages, fruit juices and vegetable juices, nectars, lemonades, soda water and other non-alcoholic beverages; syrups, extracts and essences and other preparations for making non-alcoholic beverages (excluding essential oils); soy-based beverages; malt-based beverages; isotonic beverages.

(260) AM 2017 90025 A  
 (800) 1009268  
 (891) 2016 12 01  
 (731) AUGUST STORCK KG  
 Waldstrasse 27, 13403 Berlin, Germany  
 (540)



(591) Green, orange and red  
 (511)  
 30 – Confectionery, chocolate and chocolate products, pastries, ice-cream, preparations for making the aforementioned products, included in this class.

(260) AM 2017 90026 A  
 (800) 1010199  
 (891) 2016 12 01  
 (731) AUGUST STORCK KG  
 Waldstrasse 27, 13403 Berlin, Germany

(540)



(591) Yellow, green, orange and red  
 (511)  
 30 – Confectionery, chocolate and chocolate products, pastries, ice-cream, preparations for making the aforementioned products, included in this class.

(260) AM 2017 90027 A  
 (800) 1010200  
 (891) 2016 12 01  
 (731) AUGUST STORCK KG  
 Waldstrasse 27, 13403 Berlin, Germany  
 (540)



(591) Green, orange and red  
 (511)  
 30 – Confectionery, chocolate and chocolate products, pastries, ice-cream, preparations for making the aforementioned products, included in this class.

(260) AM 2017 90028 A  
 (800) 1076198  
 (891) 2016 10 26  
 (731) LABORATOIRE FRANÇAIS DU FRACTI-  
 ONNEMENT ET DES BIOTECHNOLOGIES  
 3, avenue des Tropiques, F-91940 Les Ulis,  
 France  
 (540)

**WILFACTIN**

(511)

5 – Pharmaceutical products, pharmaceutical products for the treatment and normalization of disorders of the body's circulatory system, pharmaceutical products for the treatment of diseases of the blood or of the lymphatic circulatory system.

42 – Medical, sanitary and beauty care; veterinary and agricultural services; scientific and industrial research; computer programming; laboratories.

(260) AM 2017 90030 A

(800) 1205718

(891) 2016 10 19

(731) DELIA COSMETICS Sp. z o.o.

ul. Lesna 5, PL-95-030 Rzgów, Poland

(540)

**Delia**  
COSMETICS

(591) Black, white

(511)

3 – Toilet soaps and cleaning preparations, including bath and shower preparations, perfumery, deodorants for personal use, antiperspirants, colorants for toilet purposes, cosmetics, cosmetics for cleaning, protection, care, nutrition, beautification and correction of imperfections in face and body skin, and cosmetics for care and beautification of the eyes, nails and hair, serum, creams, gels, lotions, milks, masks, lotions, ointments, pomades, sticks, cosmetics for colouring (colorants), cosmetic glitter, glosses, make-up preparations, concealers, make-up powders and fluids, make-up removing preparations, eyebrow pencils, eyeliner and lipliner, eyeshadow, mascaras, lipsticks, coloured cosmetics for face and neck skin, nail varnish, nail varnish remover and nail care preparations, shaving foams and shaving gels, shaving liquids and shaving balms, sun-tanning preparations (cosmetics), sun-tanning and self-tanning preparations (cosmetics), perfume and/or cosmetic sets, preparations for washing, styling, care and nutrition of the hair, shampoos and hair-colouring preparations and hair dyes, highlight dyes, hair-bleaching and colour-removing preparations, preparations for colouring eyebrows and eyelashes, straightening, curling and waving preparations, hair lotions and conditioners, hair spray and hair fixing products, including colorants, depilatory preparations.

(260) AM 2017 90040 A

(800) 1283115

(891) 2016 10 17

(731) L. ROBINSON &amp; CO. (GILLINGHAM) LIMITED

Owens Way, Gads Hill, Gillingham, Kent  
ME7 2RS, United Kingdom

(540)

**JUBILEE**

(511)

6 – Clips, clamps, couplings and connectors, all for hoses; parts and fittings for all the aforesaid goods.

(260) AM 2017 90042 A

(800) 1316713

(891) 2016 11 28

(731) MERCK KGAA

Frankfurter Str. 250, 64293 Darmstadt,  
Germany

(540)



(591) Black, white

(511)

5 – Pharmaceutical preparations for use in the field of oncology.

(260) AM 2017 90055 A

(800) 1323254

(891) 2016 07 14

(731) PHILIP MORRIS BRANDS SÀRL

Quai Jeanrenaud 3, CH-2000 Neuchâtel,  
Switzerland

(540)



(591) Black, white

(511)

34 – Tobacco, raw or manufactured; tobacco products; cigars, cigarettes, cigarillos, tobacco for roll-your-own cigarettes, pipe tobacco, chewing tobacco, snuff tobacco, kretek; snus; tobacco substitutes (not for medical purposes); electronic cigarettes; tobacco products for the purpose of being heated; electronic

devices and their parts for the purpose of heating cigarettes or tobacco in order to release nicotine-containing aerosol for inhalation; liquid nicotine solutions for use in electronic cigarettes; smokers' articles, cigarette paper, cigarette tubes, cigarette filters, tobacco tins, cigarette cases, ashtrays, pipes, pocket apparatus for rolling cigarettes, lighters, matches.

(260) AM 2017 90056 A

(800) 1323269

(891) 2016 08 12

(731) HUAWEI TECHNOLOGIES CO., LTD.

Administration Building Huawei Technologies Co., Ltd., Bantian, Longgang Dist. Shenzhen, China

(540)

**HUAWEI Y6**

(591) Black, white

(511)

9 – Tablet computers; mobile phones; covers for smartphones; protective covers adapted for tablet computers; set-top boxes; modems; loudspeakers; earphone; mobile power source (rechargeable batteries); network communication equipment; smartwatches; wearable activity trackers; smartglasses; selfie sticks (hand-held monopods); covers for smartphones; cases for smartphones; protective films adapted for screens for mobile phones; protective films adapted for computer screens; joysticks for use with computers, other than for video games.

(260) AM 2017 90058 A

(800) 1323312

(891) 2016 04 30

(731) SHANDONG DESHI PETROLEUM ENGINEERING GROUP CO., LTD.

Petroleum Business Park, Dongying, Shandong Province, China

(540)



**德仕集团**  
**DESHI GROUP**

(591) Black, white

(511)

7 – Mine borers; mine working machines; geo exploration machines; drilling rigs, floating or non-floating; oil refining machines; petroleum exploitation machines; slurry pump for petroleum; taking out

petroleum pump; steam condensers [parts of machines] boiler tubes [parts of machines].

(260) AM 2017 90063 A

(800) 1323317

(891) 2016 06 20

(731) MEJERIFORENINGEN DANISH DAIRY BOARD

Agro Food Park 13, DK-8200 Aarhus N, Denmark

(540)



(591) Dark grey, light grey, red and white

(511)

29 – Meat, fish, poultry and game; meat extracts; preserved, frozen, dried and cooked fruits and vegetables; jellies, jams, compotes; eggs, milk and milk products; butter; concentrated butter; dairy and vegetable spreads mainly consisting of a mixture of butter and vegetable oil; flavoured butter; ghee; cheese; crème fraiche; edible oils and fats; butter oil; rennet; cheese powder, substitutes for milk and cream; milk and cream in powder form; meat pâtés.

(260) AM 2017 90064 A

(800) 1323378

(891) 2016 07 22

(731) SHENGLI XINDA INDUSTRIAL GROUP CO., LTD.

No.59 Beiyi Road, Dongying District, Dongying City, 257000 Shandong Province, China

(540)



(591) Black, white

(511)

19 – Concrete building elements; fireproof cement coatings; water-pipes, not of metal; drain pipes, not of metal; plastic tube used in building; aluminum-plastic composite pipe; glass material, excluding sanitary installation; fiberglass building components; building glass.

(260) AM 2017 90080 A  
 (800) 1323568  
 (891) 2016 07 29  
 (731) ROTKÄPPCHEN-MUMM  
 SEKTKELLEREIEN GMBH  
 Sektkellereistraße 5, 06632 Freyburg,  
 Germany

(540)



(591) Black, white

(511)

32 – Beers; mineral waters; aerated waters; non-alcoholic beverages; de-alcoholised beverages; fruit beverages; fruit juices; syrups for making beverages; preparations for making beverages.

33 – Alcoholic beverages (except beers).

41 – Education; providing of training; entertainment; sporting activities; cultural activities.

43 – Services for providing food and drink; temporary accommodation.

(260) AM 2017 90086 A  
 (800) 1323600  
 (891) 2016 08 08  
 (731) NEMIROFF INTELLECTUAL PROPERTY  
 Establishment Staedtle 31, FL-9490 Vaduz,  
 Liechtenstein

(540)



(591) Blue, grey and red

(511)

33 – Alcoholic beverages, except beer; alcoholic beverages containing fruit; bitters; brandy; cocktails;

distilled beverages; alcoholic essences; liqueurs; fruit extracts, alcoholic; spirits (beverages); vodka.

35 – Advertising; business management; business administration; office functions.

(260) AM 2017 90109 A  
 (800) 1323651  
 (891) 2016 08 18  
 (731) HOCHLAND SE  
 Kemptener Straße 17, 88178 Heimenkirch,  
 Germany

(540)



(591) Blue, red, green, yellow, white

(511)

29 – Dairy products, especially cheese and cheese preparations; spreads made using cheese and/or cheese preparations with non-milk ingredients; butter; edible fats and edible oils; substitute products on the basis of vegetable fats for dairy products; prepared meals made using cheese, prepared salads.

35 – Retail and wholesale services relating to the following goods: dairy products, especially cheese and cheese preparations, spreads made using cheese and/or cheese preparations with non-milk ingredients, butter, edible fats and edible oils, substitute products on the basis of vegetable fats for dairy products, prepared meals made using cheese, prepared salads; distribution of products for advertising purposes; demonstration of goods; provision of information and advice to consumers relating to cheese and cheese products; presentation of goods for retail.

(260) AM 2017 90110 A  
 (800) 1323670  
 (891) 2016 11 11  
 (731) LOWTECH STUDIOS LLC  
 4303 Choctaw Drive S.W., Grandville MI  
 49418, USA

(540)

slither.io

(591) Black, white

(511)

9 – Computer game software and cases for mobile phones.

(260) AM 2017 90112 A

(800) 1323736

(891) 2016 06 28

(731) RED MOON Srl

Via della Mendola, 21, I-39100 BOLZANO,  
Italy

(540)



(591) Black, white

(511)

31 – Fresh fruit; fresh apples; fruit plants; fruit trees;  
rootstocks for fruit tree grafting; scions for fruit tree  
grafting.

33 – Distilled spirits; liquors (distilled).

(260) AM 2017 90113 A

(800) 1323737

(891) 2015 11 13

(731) CONG TY TRACH NHIEM HUU HAN

HOANG PHUC QUOC TE (Also known as  
HOANG PHUC INTERNATIONAL  
COMPANY LIMTIED)137 Nguyen Trai, Phuong Ben Thanh, quan 1,  
Thanh pho Ho Chi Minh, Viet Nam

(540)



(591) Black, white

(511)

25 – Ready-made clothing, namely, T-shirts, shirts,  
jackets (clothing), suits, pants, trousers, breeches for  
wear, shorts, skirts and dresses; footwear; headgear  
for wear, namely, caps and hats; ties [clothing]; nec-  
kties; belts (clothing); underwear; socks; stockings.

(260) AM 2017 90115 A

(800) 1323765

(891) 2016 07 29

(731) BIOFARMA

50 rue Carnot, F-92284 SURESNES Cedex,  
France

(540)

**PRESTAMSA**

(511)

5 – Pharmaceutical preparations; veterinary prepara-  
tions; sanitary products for medical purposes; die-  
tetic substances for medical use; dietetic substancesfor veterinary use; food for babies; dietetic prepara-  
tions and food supplements; food supplements for  
animals; plasters, materials for dressings; teeth  
filling material; dental impression materials; disin-  
fectants; products for destroying vermin; fungicides;  
herbicides.

(260) AM 2017 90117 A

(800) 1323783

(891) 2016 02 15

(731) DMYTRO KORCHEVSKYI

44 Rupniecibas St., apt. 17, Riga, Latvia

(540)



(591) Black, white

(511)

35 – Arranging subscriptions to telecommunication  
services for others; advertising agencies services; ad-  
vertising by mail order; business management for  
freelance service providers; commercial information  
agency services; commercial information and advice  
for consumers (consumer advice shop); compilation  
of information into computer databases; compilation  
of statistics; computerized file management; data  
search in computer files for others; design of ad-  
vertising materials; dissemination of advertising mat-  
ter; document reproduction; employment agencies;  
layout services for advertising purposes; marketing;  
marketing research; marketing studies; office machi-  
nes and equipment rental; on-line advertising on a  
computer network; organization of exhibitions for  
commercial or advertising purposes; organization of  
trade fairs for commercial or advertising purposes;  
outdoor advertising; outsourced administrative ma-  
nagement for companies; pay per click advertising;  
personnel recruitment; photocopying services; pre-  
sentation of goods on communication media, for re-  
tail purposes; production of advertising films; provi-  
ding business information via a web site; providing  
information about variety of goods and about range  
of services via a websites, enabling customers to  
conveniently view and purchase the aforesaid goods  
and services on-line; provision of commercial and  
business contact information; provision of an on-line  
marketplace for buyers and sellers of goods and ser-  
vices; public relations; publication of publicity texts;  
publicity; publicity material rental; radio advertising;  
rental of billboards (advertising boards); rental of  
vending machines; rental of photocopying machines;



rental of advertising time on communication media; rental of advertising space; relocation services for businesses; secretarial services; sponsorship search; search engine optimization; systemization of information into computer databases; typing; updating of advertising material; updating and maintenance of data in computer databases; web site traffic optimization.

41 – Academies (education); arranging and conducting of colloquiums; arranging and conducting of competitions and contests in the sphere of innovations and information technologies; arranging and conducting of conferences; arranging and conducting of congresses; arranging and conducting of seminars; arranging and conducting of symposiums; arranging and conducting of workshops (training); boarding school education; bookmobile services; club services (entertainment or education); coaching (training); corporate training; correspondence courses; education information; educational examination; educational services, instruction services, teaching; electronic desktop publishing; layout services, other than for advertising purposes; lending libraries; organization of competitions (education or entertainment); organization of exhibitions for cultural or educational purposes; practical training (demonstration); practical IT-training; professional training in the field of computer technologies; providing on-line electronic publications, not downloadable; providing on-line videos, not downloadable; publication of books; publication of electronic books and journals on-line; publication of texts, other than publicity texts; services of schools (education); services of summer children's camps (entertainment or education); services of summer computer camps (entertainment or education); teaching of Internet marketing; teaching computer design; teaching of computer maintaining; teaching of computer network technologies and system administration; teaching of development a software for mobile phones and other portable devices; teaching of development and promotion of websites and other web projects; teaching of system administration; training in computer graphics and design; training in computer programming; training in the academies; training of testing of computer programs; training on courses; training to use the computer programs; training to use the computers; tutoring; vocational guidance (education or training advice); vocational retraining.

42 – Advice and consultancy in relation to computer technologies; cloud computing, computer programming; computer rental; computer software development; computer software consultancy; computer software design; computer system analysis; computer system design; computer technology consultancy; computer virus protection services; consultancy in the design and development of computer hardware; conversion of data or documents from

physical to electronic media; creating and maintaining web sites for others; data conversion of computer programs and data (not physical conversion); development and improvement of the computer equipment consultancy; digitization of documents (scanning); dress designing using the computer programs; duplication of computer programs; electronic data storage; engineering; graphic arts design; hosting computer sites (web sites); industrial design; information technology (IT) consultancy; installation of computer software; interior designing using the computer programs; maintenance of computer software; monitoring of computer systems by remote access; off-site data backup; outsource service providers in the field of information technology; packaging designing using the computer programs; providing information on computer technology and programming via a web site; providing search engines for the internet; provision of scientific information, advice and consultancy in relation to computer technologies; recovery of computer data; rental of computer software; rental of web servers; scientific research; server hosting; services of experts in computer technologies; software as a service (SaaS); software development for mobile phones and other portable devices; structural designing using the computer programs; styling (industrial design); surveying; technical project studies; technical research; technological consultancy; telecommunications technology consultancy; updating of computer software; web site design consultancy; web site development consultancy

(260) AM 2017 90118 A

(800) 1323797

(891) 2016 06 14

(731) CONDEVO S.p.A.

Via Giacomo Leopardi, 20, I-20123

MILANO, Italy

(540)



(591) Black, white

(511)

11 – Heating installations, namely heating boilers, heating elements and their parts, namely, gas-water heat exchangers, stainless steel plate heat exchangers and three-way valves for heating installations.

(260) AM 2017 90119 A

(800) 1323811

(891) 2016 08 08



(731) NEMIROFF INTELLECTUAL PROPERTY ESTABLISHMENT

Städtle 31, FL-9490 Vaduz, Liechtenstein

(540)



(591) Blue, grey, red and white

(511)

33 – Alcoholic beverages (except beers); distilled beverages; alcoholic essences; spirits (beverages); vodka.s.

35 – Advertising; business management; business administration; office function.

(260) AM 2017 90166 A

(800) 1002927

(891) 2016 10 17

(731) NV SPANOLUX DIV. BALTERIO

Wakkensteenweg 37 B, B-8710 SINT-BAAFS-VIJVE, Belgium

(540)

## BALTERIO

(511)

19 – Wooden floors; parquet flooring and parquet flooring boards, including laminate parquet flooring and parquet flooring boards; parquet flooring veneered with wood; sheet material comprising layers of wood veneer pressed and glued together.

(260) AM 2017 90169 A

(800) 1083287

(891) 2016 10 19

(731) ATLANTICA AGRICOLA, S.A.

c/ Corredera, 33, E-03400 VILLENA (Alicante), Spain

(540)

## MICROCAT

(511)

1 – Chemical products for use in industry, science, photography as well as in agriculture, horticulture,

and forestry; unprocessed artificial resins; unprocessed plastics; fertilizers, fire-extinguishing compositions, tempering and soldering preparations; chemical substances for preserving foodstuffs; tanning substances; adhesives used in industry.

(260) AM 2017 90171 A

(800) 1144506

(891) 2016 10 25

(731) Obshchestvo s ogranichennoy

otvetstvennostyu "KONSORTSIUM-PIK" building 1. 25, Oruzheinyi side street, RU-125047 Moscow, Russian Federation

(540)

## ПАНТОГАМ

(511)

5 – veterinary preparations; pharmaceutical preparations.

(260) AM 2017 90172 A

(800) 1324295

(891) 2016 07 12

(731) KERR CORPORATION

1717 West Collins Avenue, Orange CA 92867, USA

(540)

## KERR

(591) black and white

(511)

5 – Dental materials, namely, impression compounds, dental waxes, investment compounds for use in the investment casting of dental articles, plaster of Paris for use in the creation of dental articles, sealing agents for dental purposes.

10 – Dental instruments, namely, pulp-canal instruments, broach holders, mouth-mirrors, handles for dental instruments, articulators, dental spatulas, engine-drills; dental impression trays.

(260) AM 2017 90173 A

(800) 1223491

(891) 2016 08 31

(731) VIPORI LIMITED

33 Lordou Vyrona Laiki Megaro, 5th Floor, Flat/Office 54, CY-6023 LARNACA, Cyprus

(540)



(591) Black and white

(511)

9 – Accumulators, electric, for vehicles; antennas; remote control apparatus; sound recording apparatus; sound transmitting apparatus; loudspeakers; coaxial cables; fibre [fiber (Am.)] optic cables; cables, electric; contacts, electric; cabinets for loudspeakers; megaphones; diaphragms [acoustics]; microphones; headphones; sheaths for electric cables; transmitters [telecommunication]; transmitters of electronic signals; switches, electric; converters, electric; satellite navigational apparatus; telegraph wires; telephone wires; wires, electric; conductors, electric; copper wire, insulated; record players; control panels [electricity]; voltage surge protectors; horns for loudspeakers; couplings, electric; amplifiers; sound reproduction apparatus; ducts [electricity].

(260) AM 2017 90174 A

(800) 1324314

(891) 2016 08 15

(731) SHANDONG YINBAO TYRE GROUP CO., LTD.

Taitou Town, Shouguang City, 262735

Shandong Province, China;

SHANDONG YINBAO TYRE GROUP CO., LTD.

Taitou Town, Shouguang City, 262735

Shandong Province, China

(540)

# MILEMORE

(591) black and white

(511)

12 – Inner tubes for pneumatic tyres; tyres for vehicle wheels; bicycle tyres; automobile tyres; airplane tyre; repair outfits for inner tubes; vehicles for locomotion by land, air, water or rail; motor cars; vehicle wheels; hubs for vehicle wheels.

(260) AM 2017 90175 A

(800) 1226294

(891) 2016 10 18

(731) NOVARTIS AG

CH-4002 Basel, Switzerland

(540)

# KISQALI

(511)

5 – Pharmaceutical preparations.

(260) AM 2017 90176 A

(800) 1324352

(891) 2016 07 12

(731) Obshchestvo s ogranichennoy

otvetstvennostyu "ALUKO-SERVICE"

ul. Partizanskaya, 6 korp. A, g,

RU-658087 Novoaltaysk, Altai territory,

Russian Federation

(540)

# ZIAS

(591) red

(511)

6 – Common metals and their alloys; metal building materials; transportable buildings of metal; materials of metal for railway tracks; non-electric cables and wires of common metal; ironmongery, small items of metal hardware; pipes and tubes of metal; safes; goods of common metal not included in other classes; framework of metal for ventilated facades.

(260) AM 2017 90177 A

(800) 1226662

(891) 2016 09 23

(731) "COMPANY "SHOKOOOOOOOLAD"

Poshtova 16A, Lviv 79020, Ukraine

(540)



LVIV LEGENDARY PRODUCT

(591) White and chocolate

(511)

21 – Souvenir products from glass, porcelain, including: souvenir cups, souvenir products from ceramic, souvenir vases, souvenir mugs for beer; coffee pots, non-electric; coffee grinders, hand-operated; coffee services [tableware]; rolling pins, domestic; ceramics for household purposes; boxes of glass; baskets for domestic use; pie servers; tart scoops; trivets [table utensils]; drinking vessels.

30 – Coffee, tea, cocoa and artificial coffee; rice; tapioca and sago; flour and preparations made from cereals; bread, pastry and confectionery; edible ices; sugar, honey, treacle; yeast, baking-powder; salt; mustard; vinegar, sauces (condiments); spices; ice; peanut confectionery; buns; waffles; pastries; fruit jellies (confectionery); frozen yoghurt [confectionery ices]; coffee-based beverages; coffee beverages with milk; cocoa beverages with milk; cocoa-based beverages; caramels [candy]; pastilles [con-

fectionery]; confectionery for decorating Christmas trees; marzipan; almond confectionery; chocolate mousse; pralines; tarts; sweetmeats [candy]; chocolate; chocolate-based beverages; chocolate beverages with milk.

35 – Administrative processing of purchase orders; cost price analysis; marketing studies; opinion polling; organization of exhibitions for commercial or advertising purposes; demonstration of goods; business management assistance; marketing research; presentation of goods on communication media, for wholesale and retail purposes; professional business consultancy; payroll preparation; price comparison services; arrangement of advertising material services; procurement services for others [purchasing goods and services for other businesses]; presentation of goods on communication media, for retail purposes; advertising; organization of trade fairs for commercial or advertising purposes.

43 – Services of restaurants, bars, tasting rooms, coffee shops, cafes, snack bars, canteens; fast-food restaurants services; services for providing food and drink; temporary accommodation reservations; tourist homes; hotels; accommodation bureaux [hotels, boarding houses]; motels; rental of transportable buildings; rental of tents; holiday camp services [lodging]; rental of chairs, tables, table linen, glassware; boarding houses; reservations of hotels, motels, campgrounds; services of hotels, motels, campgrounds; food and drink catering; pubs or snack bars.

---

(260) AM 2017 90180 A

(800) 1324435

(891) 2016 08 30

(731) Товариство з обмеженою  
відповідальністю "PATENT-KYIV"  
вул. Vyshhorodska, 50B, м. Kyiv 04114,  
Ukraine;  
Товариство з обмеженою відповідальністю  
"PATENT-KYIV"  
вул. Vyshhorodska, 50B, м. Kyiv 04114,  
Ukraine

(540)

## NEFRATEST

(591) black and white

(511)

10 – Surgical, medical, dental and veterinary apparatus and instruments; medical apparatus and instrument; diagnostic apparatus for medical purposes; diagnostic devices for medical purposes; instrument cases for use by doctors; surgical apparatus and instruments; blood testing apparatus; medical testing apparatus.

(260) AM 2017 90181 A

(800) 1255809

(891) 2016 09 06

(731) Товариство з обмеженою відповідальністю  
"LUN UA"

вул. Radianska, 2, с. Pliakhova, Koziatynskyi  
r-n, Vinnytska obl. 22132, Ukraine

(540)

## FLATFY

(511)

35 – Import-export agencies; commercial information agencies; cost price analysis; dissemination of advertising matter; demonstration of goods; marketing studies; advertising; public relations; shop window dressing; modelling for advertising or sales promotion; computerized file management; organization of exhibitions for commercial or advertising purposes; sales promotion for others; compilation of information into computer databases; systemization of information into computer databases; on-line advertising on a computer network; procurement services for others (purchasing goods and services for other businesses); data search in computer files for others; rental of vending machines; presentation of goods on communication media, for retail purposes; administrative processing of purchase orders; marketing; commercial intermediation services; business management for freelance service providers; updating and maintenance of data in computer databases; providing business information via a web site.

36 – Insurance; financial affairs; monetary affairs; real estate affairs, including debt collection agencies; accommodation bureaux (apartments); real estate agencies; financial analysis; banking; stock brokerage services; repair costs evaluation (financial appraisal); issuing of, travellers' checks (cheques); issuance of credit cards; issue of tokens of value; capital investment; arranging finance for construction projects; online banking; leasing of farms; electronic funds transfer; apartment house management; safe deposit services; deposits of valuables; organization of collections; charitable fund raising; rent collection; stock exchange quotations; real estate management; clearing, financial; insurance consultancy; debt advisory services; pawnbrokerage; leasing of real estate; customs brokerage; marine insurance underwriting; instalment loans; loans (financing); providing financial information via a web site; renting of apartments; hire-purchase financing; rental of offices (real estate); exchanging money; credit card services; antique appraisal; jewellery appraisal; stamp appraisal; art appraisal; real estate appraisal; numismatic appraisal; check (cheque) verification; mortgage banking; fiscal assessments; credit bureau; lending against security; brokerage; brokerage of carbon credits; real estate brokers; stocks and bonds brokerage; debit card services; savings bank servi-

ces; provident fund services; surety services; actuarial services; trusteeship; retirement payment services; insurance information; insurance brokerage; insurance underwriting; accident insurance underwriting; fire insurance underwriting; life insurance underwriting; health insurance underwriting; factoring, financial information; financial management; financial consultancy; financial evaluation (insurance, banking, real estate); financial evaluation of wood; financial evaluation of standing timber; financial sponsorship; business liquidation services financial; financing services; mutual funds.

---

(260) AM 2017 90182 A

(800) 1324437

(891) 2016 09 19

(731) TURNER BROADCASTING SYSTEM, INC.

One CNN Center, Atlanta GA 30303, USA

(540)

## FULL FRONTAL WITH SAMANTHA BEE

(511)

9 – Audio visual recordings in all media, featuring entertainment in the nature of an on-going television series in the field of comedy, action, drama, reality and adventure; downloadable television programming featuring comedy, action, drama reality and adventure distributed via the Internet and wireless communications.

41 – Entertainment services, namely, a multimedia program series featuring comedy, action, drama, reality and adventure distributed via various platforms across multiple forms of transmission media; providing online computer games.

---

(260) AM 2017 90183 A

(800) 1265473

(891) 2016 09 14

(731) FIFTH GENERATION INC.

12101 Moore Road, Austin TX 78719, USA

(540)

## TITO'S

(511)

33 – Distilled spirits.

---

(260) AM 2017 90185 A

(800) 1324438

(891) 2016 09 19

(731) TURNER BROADCASTING SYSTEM, INC.

One CNN Center, Atlanta GA 30303, USA

(540)

## TARANTULA

(511)

9 – Audio visual recordings in all media, featuring entertainment in the nature of an on-going television series in the field of comedy, action, drama and adventure; downloadable television programming featuring comedy, action, drama and adventure distributed via the Internet and wireless communications.

41 – Entertainment services, namely, a multimedia program series featuring comedy, action, drama and adventure distributed via various platforms across multiple forms of transmission media; providing online computer games.

---

(260) AM 2017 90186 A

(800) 1302877

(891) 2016 09 29

(731) Open-Type Joint Stock Company

"ROT FRONT"

2-oy Novokuznetskiy pereulok, d. 13/15B

RU-113184 Moscow, Russian Federation

(540)

## МАРИНКА

(591) Black, white

(511)

30 – Pastries; confectionery made of sugar, namely candy, sweets, pralines, chocolate, pastilles [confectionery], halvah, waffles.

---

(260) AM 2017 90187 A

(800) 1324439

(891) 2016 09 19

(731) Turner Broadcasting System, Inc.

One CNN Center, Atlanta GA 30303, USA

(540)

## SEARCH PARTY

(511)

9 – Audio visual recordings in all media, featuring entertainment in the nature of an on-going television series in the field of comedy, action, drama and adventure; downloadable television programming featuring comedy, action, drama and adventure distributed via the Internet and wireless communications.

41 – Entertainment services, namely, a multimedia program series featuring comedy, action, drama and adventure distributed via various platforms across multiple forms of transmission media; providing online computer games.

(260) AM 2017 90188 A  
 (800) 1324550  
 (891) 2016 08 24  
 (731) GLOBAL MESSAGE SERVICES AG  
 Bundesstrasse 5, CH-6300 Zug, Switzerland  
 (540)



(591) black and white  
 (511)

9 – Software (recorded programs); computer programs (downloadable software); recorded computer programs; computer hardware and software; software packages; servers for computer networks; interfaces (for computers).

35 – Advertising; dissemination of advertisements; updating of advertising material; rental of advertising material; publication of advertising texts; advertising agency services; computerized file management; rental of advertising space; collection of data in a central file; systematization of data in a central file; online advertising on a computer network; searches for information in computer databases for others; rental of advertising time on all communication media; writing of advertising texts; layout services for advertising purposes; marketing; search engine optimization; web site traffic optimization; postpaid per click advertising services; updating and maintenance of data in computer databases; commercial information via websites; commercial information and advice for consumers (consumer advice shop); presentation of goods on all communication media, for retail sale.

38 – Transmission of messages; telephone services; telephone communications; communications by computer terminals; computer-aided transmission of messages and images; electronic messaging; facsimile transmission; rental of message sending apparatus; communication by fiber-optic networks; rental of telecommunication apparatus; rental of telephones; connection by telecommunications to a global computer network; telecommunications routing and junction services; voice messaging services; transmission of digital files; provision of chat rooms on the Internet; rental of apparatus for wireless broadcasting services.

42 – Research and development services relating to computer hardware; programming for computers; software consultancy; software development (design); software installation; maintenance of computer software; software updating; analysis for the implementation of computer systems; design of computer systems; computer virus protection services; conversion of data or documents from physical to electronic media; creation and maintenance of

web sites for others; conversion of computer programs and data, other than physical conversion; digitization of documents (scanning); duplication of computer programs; hosting of computer sites (web sites); provision of Internet search engines; recovery of computer data; computer rental; rental of computer software; rental of web servers; research and development of new products for others.

(260) AM 2017 90190 A  
 (800) 1324642  
 (891) 2016 09 02  
 (731) VP BRANDS INTERNATIONAL S.A  
 Dunav bul. 5, BG-4000 Plovdiv, Bulgaria  
 (540)

## ABSTRACT

(591) black and white  
 (511)

33 – Alcoholic extracts, alcoholic essences, alcoholic beverages [except beer], alcoholic beverages containing fruit, anisette [liqueur], anise [liqueur], aperitifs, arak [arrack] arrack [arak], baijiu [chinese distilled alcoholic beverage], brandy, wine, kirsch, vodka, bitters, distilled beverages, gin, digesters [liqueurs and spirits], cocktails, perry, curacao, liqueurs, hydromel [mead] mead [hydromel], peppermint liqueurs, nira [sugarcane-based alcoholic beverage], rice alcohol, piquette, fruit extracts [alcoholic], pre-mixed alcoholic beverages, other than beer, based, rum, cider, sake, spirits [beverages], whisky.

(260) AM 2017 90191 A  
 (800) 1324648  
 (891) 2016 04 21  
 (731) AMAZON EUROPE HOLDING  
 TECHNOLOGIES S.À.R.L.  
 5, Rue Plaetls L-2338 Luxembourg,  
 Luxembourg  
 (540)



(591) black and white  
 (511)

35 – Advertising services; dissemination of advertising for others via an online electronic communications network; providing a searchable online advertising guide featuring the goods and services of others; market research and market research information services; business management services; business administration services; computerized database management services; providing office functions; online retail and retail store services in the nature of paints, varnishes, lacquers, bleaching preparations and other substances for laundry use,

cleaning, polishing, scouring preparations, pharmaceutical and sanitary preparations, disinfectants, fungicides, herbicides, hand tool and implements, cutlery, razors, computers, DVDs and other blank digital recording media, pre-recorded DVDs and other digital prerecorded media, computer software, fireworks, jewellery, horological and chronometric instruments, musical instruments, books, printed matter, stationery, photographs, adhesives for stationery or household purposes, paint brushes, packaging materials, leather and imitations of leather and goods made of these materials, namely animal skins, hides, trunks, travelling bags, umbrellas and parasols, walking sticks, furniture, mirrors, picture frames, household and kitchen utensils and containers, combs and sponges, brushes, articles for cleaning purposes, glassware, porcelain and earthenware, pots and pans for use in the kitchen, yarns and threads, textiles and textile goods, bed covers, table covers, clothing, footwear, headgear, lace and embroidery, ribbons and braid, buttons, hooks and eyes, pins and needles, carpet, rugs, mats and matting, linoleum, wall hangings, games and playthings, decorations for Christmas trees, candles, lights, bulbs, matches, electronic games, computer games, video games, electronic game software, computer game software, and video game software, streamed and downloadable pre-recorded electronic games, scientific, nautical, surveying, photographic, cinematographic, optical, weighing, measuring, signalling, checking, life-saving and teaching apparatus and instruments, apparatus and instruments for conducting, switching, transforming, accumulating, regulating or controlling electricity, apparatus for recording, transmission or reproduction of sound or images, magnetic data carriers, recording discs, compact discs, DVDs, high density optical discs and other digital recording media, mechanisms for coin-operated apparatus, cash registers, calculating machines, data processing equipment, computers, computer software, software, portable and handheld electronic devices for transmitting, storing, manipulating, recording, and reviewing text, images, audio, video and data, including via global computer networks, wireless networks, and electronic communications networks, tablet computers, electronic book readers, audio and video players, electronic personal organizers, personal digital assistants, and global positioning system devices, computer peripheral devices, monitors, displays, wires, cables, modems, printers, disk drives, adapters, adapter cards, cable connectors, plug-in connectors, electrical power connectors, docking stations, and drivers, battery chargers, battery packs, memory cards and memory card readers, speakers, microphones, and headsets, cases, covers, and stands for computers, cases, covers, and stands for portable and handheld electronic devices for transmitting, storing, manipulating, recording, and reviewing text, images, sound, audio, video and data, including via

global computer networks, tablet computers, electronic book readers, audio and video players, electronic personal organizers, personal digital assistants, and global positioning system devices and devices for the display of electronically published materials, namely, books, journals, newspapers, magazines, multimedia presentations, remote controls for portable and handheld electronic devices and computers, power adapters, USB cables, electronic docking stations, battery chargers, electrical connectors, wires, cables, and adaptors, wireless remote controls for portable electronic devices, headphones and earphones, data synchronization programs, and application development tool programs for personal and handheld computers, computer software for authoring, downloading, transmitting, receiving, editing, extracting, encoding, decoding, displaying, storing and organizing text, graphics, images, and electronic publications, downloadable pre-recorded audio and audiovisual content, information, and commentary, downloadable electronic books, magazines, periodicals, newsletters, newspapers, journals, and other publications, downloadable electronic publications in the nature of fiction, nonfiction, comics and screenplays via computer and communications networks, downloadable films and movies featuring fiction and non-fiction stories provided via computer and communications networks, downloadable templates for designing books, short stories, storyboards, screenplays, comics, audio and video files, computer software for the collection, editing, organizing, modifying, book marking, transmission, storage and sharing of data and information, downloadable audiobooks and digital audio files, software in the field of text, image and sound transmission and display, database management software, character recognition software, voice recognition software, electronic mail and messaging software, computer software for accessing, browsing and searching online databases and electronic bulletin boards, data synchronization software, application development software, bleaching preparations and other substances for laundry use, cleaning, polishing, scouring and abrasive preparations, soaps, perfumery, essential oils, cosmetics, hair lotions, dentifrices, pharmaceutical and veterinary preparations, sanitary preparations for medical purposes, dietetic substances adapted for medical use, food for babies, plasters, materials for dressings, material for stopping teeth, dental wax, disinfectants, preparations for destroying vermin, fungicides, herbicides, common metals and their alloys, goods of common metal, namely metal building materials, transportable buildings of metal, materials of metal for railway tracks, non-electric cables and wires of common metal, ironmongery, small items of metal hardware, pipes and tubes of metal, safes, ores, hand tools and implements (hand-operated), cutlery, side arms, razors, surgical, medical, dental and veterinary apparatus and instru-

ments, artificial limbs, eyes and teeth, orthopedic articles, suture materials, apparatus for lighting, heating, steam generating, cooking, refrigerating, drying, ventilating, water supply and sanitary purposes, vehicles, apparatus for locomotion by land, air or water, precious metals and their alloys, jewellery, precious stones, horological and chronometric instruments, musical instruments, fiction and non-fiction books on a variety of topics, series of fiction and non-fiction books, comic books, graphic novels, stories in illustrated form and comic book stories, storyboards, and artwork, periodicals in the field of comic book stories, storyboards, and artwork, paper, cardboard, printed matter and books, bookbinding material, photographs, stationery, stickers and adhesives for stationery or household purposes, artists' materials, paint brushes, typewriters and office requisites, instructional and teaching material, plastic materials for packaging, printers' type, printing blocks, printed matter in the field of computers, printed matter in the field of tablet computers, printed matter in the field of multi-media products, interactive products and online services, printed publications, books, magazines, newsletters, periodicals, brochures, booklets, pamphlets, manuals, journals, leaflets, greeting cards, advertising and promotional material, catalogues, catalogues relating to computer software, computer brochures, computer handbooks, computer hardware publications, computer hardware reference manuals, computer hardware users guide, computer instruction manuals, computer manuals, publications relating to technology, digital technology and gadgets, catalogues relating to musical apparatus and instruments, catalogues relating to telecommunications apparatus, mobile phones, handheld and mobile digital electronic devices for the sending and receiving of telephone calls, faxes, electronic mail, video, instant messaging, music, audiovisual and other multimedia works, and other digital data, music books, music instruction manuals, music magazines, desk accessories, telephone and address books, agendas, diaries, calendars, posters, mounted and unmounted photographs, printed patterns for T-shirts and sweatshirts, display materials, decals and bumper stickers, booklets for sale with audio tapes, parts and fittings for the aforesaid goods, leather and imitations of leather, and goods made of these materials, namely animal skins, hides, trunks and travelling bags, umbrellas, parasols and walking sticks, whips, harness and saddlery, furniture, mirrors, picture frames, goods of wood, cork, cane, wicker, horn, bone, shell, amber, mother-of-pearl, meerschaum and substitutes for all these materials, or of plastics, namely furniture, mirrors, picture frames, baskets, book rests, bottle racks, chopping blocks, coat hooks, containers for storage, cork for bottles, hampers, high chairs for babies, decorative mobiles, placards, trays, pillows, shower curtain hooks, hou-

ehold or kitchen utensils and containers, combs and sponges, brushes, brush-making materials, articles for cleaning purposes, steelwool, unworked or semiworked glass, glassware, porcelain and earthenware, textiles and textile goods, bed and table covers, clothing, footwear, headgear, games and playthings, gymnastic and sporting article, decorations for Christmas trees, meat, fish, poultry and game, meat extracts, preserved, frozen, dried and cooked fruits and vegetables, jellies, jams, compotes, eggs, milk and milk products, edible oils and fats, coffee, tea, cocoa, sugar, rice, tapioca, sago, artificial coffee, flour and preparations made from cereals, bread, pastry and confectionery, ices, honey, treacle, yeast, baking-powder, salt, mustard, vinegar, sauces (condiments), spices, ice, agricultural, horticultural and forestry products and grains, live animals, fresh fruits and vegetables, seeds, natural plants and flowers, foodstuffs for animals, malt, beers, mineral and aerated waters and other non-alcoholic drinks, fruit drinks and fruit juices, syrups and other preparations for making beverages and alcoholic beverages, telephones, mobile phones, videophones, cameras, monitors for television receiver, television receivers [TV sets] and television transmitters, remote controllers for television receiver [TV set], electronic notepads, magnetic data carriers, radio receivers, radio transmitters, video cameras, computer hardware and software, computer software and firmware, namely, operating system programs, data synchronization programs, in the nature of application development tool programs for personal and handheld computers and mobile digital electronic devices, telephony management software, mobile telephone, smartphone and tablet software, telephone-based information retrieval software and hardware, software for the redirection of messages, computer application software for mobile phones, smart phones and tablet devices featuring mobile phone functionality, computer application software and embedded computer application software for mobile phones, smart phones and tablet devices namely, software that enables photos and videos from cameras found on mobile phones, smart phones and tablet devices to be shared in social media for social networking purposes, computer programs for accessing, browsing and searching online databases, computer hardware and software for providing integrated telephone communication with computerized global information networks, parts and accessories for handheld and mobile digital electronic devices, parts and accessories for mobile telephones, smartphones and tablets in the nature of covers, cases, cases made of leather or imitations of leather, covers made of cloth or textile materials, batteries, rechargeable batteries, chargers, chargers for electric batteries, data cables, power cables, headphones, stereo headphones, in-ear headphones, stereo speakers, audio speakers, audio speakers for home, headsets for wireless communi-

cation apparatus, personal stereo speaker apparatus, microphones, car audio apparatus, apparatus for connecting and charging portable and handheld digital electronic devices, user manuals in electronically readable, machine readable or computer readable form for use with, and sold as a unit with, all the aforementioned goods, parts and fittings for all the aforesaid goods, downloadable software for accessing and managing of computer applications over a global computer network, character recognition software, electronic mail and messaging software, set-top boxes, bleaching preparations and other substances for laundry use, cleaning, polishing, scouring and abrasive preparations, soaps, perfumery, essential oils, cosmetics, hair lotions, dentifrices, pharmaceutical and veterinary preparations, sanitary preparations for medical purposes, dietetic substances adapted for medical use, food for babies, plasters, materials for dressings, material for stopping teeth, dental wax, disinfectants, preparations for destroying vermin, fungicides, herbicides, common metals and their alloys, goods of common metal, namely metal building materials, transportable buildings of metal, materials of metal for railway tracks, non-electric cables and wires of common metal, ironmongery, small items of metal hardware, pipes and tubes of metal, safes, ores, hand tools and implements (hand-operated), cutlery, side arms, razors, scientific, nautical, surveying, photographic, cinematographic, optical, weighing, measuring, signalling, checking (supervision), lifesaving and teaching apparatus and instruments, apparatus and instruments for conducting, switching, transforming, accumulating, regulating or controlling electricity, apparatus for recording, transmission or reproduction of sound or images, magnetic data carriers, recording discs, automatic vending machines and mechanisms for coin-operated apparatus, cash registers, calculating machines, data processing equipment and computers, fire-extinguishing apparatus, CDs, DVDs and high density optical discs, laptop computers, tablet computers, handheld electronic devices, personal digital assistants, digital music players, mobile telephone, smartphones, digital cameras and digital video cameras, ebook readers, wireless communications devices, surgical, medical, dental and veterinary apparatus and instruments, artificial limbs, eyes and teeth, orthopedic articles, suture materials, apparatus for lighting, heating, steam generating, cooking, refrigerating, drying, ventilating, water supply and sanitary purposes, vehicles, apparatus for locomotion by land, air or water, precious metals and their alloys, jewellery, precious stones, horological and chronometric instruments, musical instruments, fiction and non-fiction books on a variety of topics, series of fiction and non-fiction books, comic books, graphic novels, stories in illustrated form and comic book stories, storyboards, and artwork, periodicals in the field of comic book stories, storyboards, and

artwork, paper, cardboard, printed matter and books, bookbinding material, photographs, stationery, stickers and adhesives for stationery or household purposes, artists' materials, paint brushes, typewriters and office requisites, instructional and teaching material, plastic materials for packaging, printers' type, printing blocks, printed matter in the field of computers, printed matter in the field of tablet computers, printed matter in the field of multimedia products, interactive products and online services, printed publications, books, magazines, newsletters, periodicals, brochures, booklets, pamphlets, manuals, journals, leaflets, greeting cards, advertising and promotional material, catalogues, catalogues relating to computer software, computer brochures, computer handbooks, computer hardware publications, computer hardware reference manuals, computer hardware users guides, computer instruction manuals, computer manuals, publications relating to technology, digital technology and gadgets, catalogues relating to musical apparatus and instruments, catalogues relating to telecommunications apparatus, mobile phones, handheld and mobile digital electronic devices for the sending and receiving of telephone calls, faxes, electronic mail, video, instant messaging, music, audiovisual and other multimedia works, and other digital data, music books, music instruction manuals, music magazines, desk accessories, telephone and address books, agendas, diaries, calendars, posters, mounted and unmounted photographs, printed patterns for T-shirts and sweatshirts, display materials, decals and bumper stickers, booklets for sale with audio tapes, parts and fittings for the aforesaid goods, leather and imitations of leather, and goods made of these materials, namely animal skins, hides, trunks and travelling bags, umbrellas, parasols and walking sticks, whips, harness and saddlery, furniture, mirrors, picture frames, goods of wood, cork, cane, wicker, horn, bone, shell, amber, mother-of-pearl, meerschaum and substitutes for all these materials, or of plastics, namely furniture, mirrors, picture frames, baskets, book rests, bottle racks, chopping blocks, coat hooks, containers for storage, cork for bottles, hampers, high chairs for babies, decorative mobiles, placards, trays, pillows, shower curtain hooks, household or kitchen utensils and containers, combs and sponges, brushes, brush-making materials, articles for cleaning purposes, steelwool, unworked or semi-worked glass, glassware, porcelain and earthenware, textiles and textile goods, bed and table covers, clothing, footwear, headgear, games and playthings, gymnastic and sporting article, decorations for Christmas trees, meat, fish, poultry and game, meat extracts, preserved, frozen, dried and cooked fruits and vegetables, jellies, jams, compotes, eggs, milk and milk products, edible oils and fats, coffee, tea, cocoa, sugar, rice, tapioca, sago, artificial coffee, flour and preparations made from cereals, bread, pastry and confectionery, ices, honey,



treacle, yeast, baking-powder, salt, mustard, vinegar, sauces (condiments), spices, ice, agricultural, horticultural and forestry products and grains, live animals, fresh fruits and vegetables, seeds, natural plants and flowers, foodstuffs for animals, malt, beers, mineral and aerated waters and other non-alcoholic drinks, fruit drinks and fruit juices, syrups and other preparations for making beverages and alcoholic beverages; administration of a discount program enabling participants to obtain discounts on goods and services; online ordering services for third parties; marketing the goods and services of others from a searchable on-line database; administration of customer loyalty program services which enable participants to obtain discounts on goods and services, discounted shipping, expedited shipping, and early access to sales events; customer loyalty program services featuring rewards in the form of discounted shipping services; administration of a discount program enabling participants to obtain discounts on goods and services, discounted shipping, expedited shipping, and early access to sales events; provision of an on-line marketplace for buyers and sellers of goods and services; outsourcing services in the nature of arranging procurement of goods for others; providing an online commercial information directory; providing consumer-product information via the Internet or other computer or telecommunication networks; providing consumer product information from an online searchable database; arranging, managing and tracking commercial transactions for others, via online shops, in the form of credit card, debit card, gift card, pre-paid card, deferred payment card, and other forms of payment transactions; collection and systematization of business data through a web-based system and online portals in the field of consumer-to-business commerce for consumers to enter, manage, and modify their consumer preference information for use by merchants to enhance the retail experience and create and manage offers for delivery to consumers; preparing business reports for others regarding the sale of products and services of others; business information management, namely, electronic reporting of business analytics relating to payment processing, authentication, and tracking; management of online databases for others; data processing services; systematization of data in computer databases; updating and maintenance of data in computer databases; business organization of online promotions, sweepstakes and contests for others; business consulting services in the field of promotions, sweepstakes and contests.

(260) AM 2017 90192 A

(800) 1324675

(891) 2016 09 07

(731) MONTRES BREGUET S.A.

Place de la Tour 23, CH-1344 L'Abbaye,  
Switzerland

(540)

## BREGUET

(511)

9 – Apparatus for recording, transmission and reproduction of sound or images; electronic payment processing apparatus, apparatus for processing cashless payment transactions; magnetic recording media, sound recording disks; compact disks, DVDs and other digital recording media; apparatus enabling the playing of compressed sound files (MP3); calculating machines and data processing equipment, software; games for mobile telephones, for computers and for digital personal stereos; electronic game software for mobile telephones, for computers and for digital personal stereos; computers, portable computers, handheld computers, mobile computers, personal computers, wrist computers, smartwatches, electronic tablets and computerized and mobile devices, digital personal stereos, mobile telephones and new-generation mobile telephones with greater functionality (smartphones); telecommunication apparatus and instruments; apparatus for recording, transmission, reproduction of sound or images, particularly mobile telephones and new-generation mobile telephones with greater functionality (smartphones); hand-held electronic apparatus for accessing the Internet and sending, receiving, recording and storing short messages, electronic messages, telephone calls, faxes, video conferences, images, sound, music, text and other digital data; handheld electronic apparatus for wireless receiving, storing and transmitting of data or messages; handheld electronic apparatus for monitoring and organizing personal information; handheld electronic apparatus for global positioning (GPS) and displaying maps and transport information; handheld electronic devices for detecting, monitoring, storing, surveillance and transmitting data relating to the user activity, namely position, itinerary, distance traveled, heart rate; covers for computers, portable and mobile telephones; optical apparatus and instruments, particularly spectacles, sunglasses, magnifying glasses; cases for spectacles, sunglasses and magnifying glasses; batteries for electronic apparatus and computers, batteries for timepieces and chronometric instruments.

(260) AM 2017 90193 A

(800) 1304465

(891) 2016 09 29

(731) Closed Joint-Stock Company

"FABRIKA "RUSSKIY SHOKOLAD"

d. 29, str. 143, ul. VereyskayaБ RU-121357

Moscow, Russian Federation

(540)

## ДИСКОТЕКА 80-х

(511)  
30 – Waffles; confectionery for decorating Christmas trees; cakes; pastries; almond confectionery; peanut confectionery; sweetmeats [candy]; caramels [candy]; liquorice [confectionery]; peppermint sweets; crackers; pastilles [confectionery]; petit-beurre biscuits; biscuits; fondants [confectionery]; pralines; gingerbread; petits fours [cakes]; halvah; chocolate.

(260) AM 2017 90194 A

(800) 1324711

(891) 2016 09 27

(731) Товариство з обмеженою відповідальністю "Промислово-торгівельна компанія SHABO" Vul. Dzerzhynskogo, 10, s. Shabo, Bilgorod-Dnistrovskij r-n, Odeska obl. 67770, Ukraine

(540)



(591) black and white

(511)

33 – Alcoholic beverages (except beers); anise [liqueur]; anisette [liqueur]; aperitifs; arrack [arak]; baijiu [Chinese distilled alcoholic beverage]; alcoholic beverages, except beer; alcoholic beverages containing fruit; bitters; brandy; cider; cocktails; curacao; digesters [liqueurs and spirits]; distilled beverages; alcoholic essences; alcoholic extracts; fruit extracts, alcoholic; gin; hydromel [mead]; kirsch; liqueurs; nira [sugarcane-based alcoholic beverage]; peppermint liqueurs; perry; piquette; pre-mixed alcoholic beverages, other than beer-based; rice alcohol; rum; sake; spirits [beverages]; vodka; whisky; wine.

(260) AM 2017 90202 A

(800) 1324838

(891) 2016 07 26

(731) ETERNAL INK, INC.  
7987 Lochlin Drive, Brighton MI 48116,  
USA

(540)



(591) Black, white

(526) The trademark is protected as a whole. "Ink" shall not be subject to independent legal protection.

(511)

2 – Tattoo pigments, colors, dyes and inks.

(260) AM 2017 90203 A

(800) 1324891

(891) 2016 09 02

(731) VP BRANDS INTERNATIONAL S.A  
Dunav bul. 5, BG-4000 Plovdiv, Bulgaria

(540)

**TATTOO**

(591) Black, white

(511)

33 – Alcoholic beverages [except beer].

(260) AM 2017 90204 A

(800) 1324958

(891) 2016 08 24

(731) Limited liability company "GRANTTORG"  
Clubniy pereulok, 7, building 1, room 8,  
Leninsky district, Vidnoe, RU-142700  
Moscow region, Russian Federation

(540)



(591) Black, white

(511)

7 – Vending machines; welding machines, electric; welding apparatus, gas-operated; vulcanisation apparatus; acetylene cleaning apparatus; high pressure washers; apparatus for drawing up beer under pressure; apparatus for aerating water; apparatus for aerating beverages; electrical apparatus for sealing plastics [packaging]; electric arc cutting apparatus; electric arc welding apparatus; electric welding apparatus; inking apparatus for printing machines; soldering apparatus, electric; fittings for engine boilers; lawn aerators [machines]; expansion tanks [parts of machines]; drums [parts of machines]; reels, mechanical, for flexible hoses; brake shoes other than for vehicles; concrete mixers [machines]; bobbins for weaving looms; harrows; journal boxes [parts of machines]; bulldozers; hoppers [mechanical discharging]; mine borers; truck lifts; rolling mill cylinders; crank shafts; printing rollers for machines; transmission shafts, other than for land vehicles; valves [parts of machines]; valves being parts of machines; fans for motors and engines; saw benches [parts of machines]; winnowers; vibrators [machines] for in-

dustrial use; bearings [parts of machines]; water heaters [parts of machines]; bellows [parts of machines]; agitators; exhausts for motors and engines; drilling rigs, floating or non-floating; lawnmowers [machines]; card clothing [parts of carding machines]; emergency power generators; alternators; dynamos; bicycle dynamos; current generators; generators of electricity; hydraulic controls for machines, motors and engines; mufflers for motors and engines; drilling heads [parts of machines]; drilling bits [parts of machines]; cylinder heads for engines; soldering blow pipes, gas-operated; gas-operated blow torches; raking machines; stalk separators [machines]; sieves [machines or parts of machines]; mud catchers and collectors [machines]; tarring machines; hydraulic engines and motors; aeronautical engines; aeroplane engines; engines for air cushion vehicles; motors, other than for land vehicles; compressed air engines; jet engines other than for land vehicles; engines for boats; driving motors other than for land vehicles; de-aerators for feedwater; disintegrators; tympan [parts of printing presses]; holding devices for machine tools; turf removing ploughs; pump diaphragms; chisels for machines; jacks [machines]; rack and pinion jacks; moving pavements [sidewalks]; electric hand drills; crushers for kitchen use, electric; flues for engine boilers; reapers; reapers and binders; millstones; rakes for raking machines; shredders [machines] for industrial use; injectors for engines; incubators for eggs; tools [parts of machines]; hand-held tools, other than hand-operated; agricultural implements other than hand-operated; air condensers; control cables for machines, engines or motors; capstans; calendars; rotary steam presses, portable, for fabrics; ditchers [ploughs]; carburettors; carriages for knitting machines; crankcases for machines, motors and engines; steamrollers; pressure valves [parts of machines]; clack valves [parts of machines]; pressure reducers [parts of machines]; can openers, electric; cowlings [parts of machines]; machine wheels; freewheels other than for land vehicles; scale collectors for machine boilers; lasts for shoes [parts of machines]; brake pads other than for vehicles; piston segments; grease rings [parts of machines]; reapers and threshers; coal-cutting machines; air pumps [garage installations]; compressors for refrigerators; compressors [machines]; belt conveyors; conveyors [machines]; converters for steelworks; aerocondensers; steam condensers [parts of machines]; diggers [machines]; rams [machines]; thermic lances [machines]; mechanized livestock feeders; boxes for matrices [printing]; gear boxes other than for land vehicles; grease boxes [parts of machines]; housings [parts of machines]; harvesting machines; steam engine boilers; coffee grinders, other than hand-operated; taps [parts of machines, engines or motors]; roller bridges; cranes [lifting and hoisting apparatus]; water separators; spray guns for paint; cranks

[parts of machines]; potters' wheels; grindstones [parts of machines]; cultivators [machines]; soldering lamps; winches; ploughshares; belts for conveyors; lubricators [parts of machines]; igniting magnets; handling machines, automatic [manipulators]; churns; matrices for use in printing; machine flywheels; hair clipping machines for animals; paper machines; blowing machines; knitting machines; galvanizing machines; bending machines; ironing machines; mineworking machines; blowing machines for the compression, exhaustion and transport of gases; blowing machines or fans for the compression, sucking and carrying of grain; net hauling machines [fishing]; electroplating machines; bottle sealing machines; sealing machines for industrial purposes; embossing machines; engraving machines; finishing machines; garbage [waste] disposals; blade sharpening [stropping] machines; earth moving machines; cord making machines; lace making machines; butter machines; cigarette machines for industrial purposes; sausage making machines; stereotype machines; hosiery looms; grinding machines; dyeing machines; bottle washing machines; dishwashers; bottle filling machines; racket stringing machines; leather-working machines; dairy machines; glass-working machines; tobacco processing machines; grain husking machines; painting machines; oil refining machines; peeling machines; ore treating machines; printing machines for use on sheet metal; brewing machines; whitewashing machines; road sweeping machines, self-propelled; leather paring machines; bitumen making machines; papermaking machines; machines for making pasta; machines for the production of sugar; weeding machines; sifting machines; cinder sifters [machines]; puddling machines; notchers [machine tools]; bread cutting machines; road making machines; railroad constructing machines; machines for the textile industry; rail-laying machines; bottle capping machines; bottle stoppering machines; packaging machines; waste compacting machines; die-stamping machines; stamping machines; darning machines; milking machines; drainage machines; wrapping machines; grain separators; bookbinding apparatus and machines for industrial purposes; machines and apparatus for cleaning, electric; machines and apparatus for carpet shampooing, electric; machines and apparatus for polishing [electric]; sizing machines; kitchen machines, electric; foundry machines; smoothing presses; fleshing machines; rinsing machines; flour mill machines; type-setting machines [printing]; hemming machines; grating machines for vegetables; braiding machines; wringing machines for laundry; cutting machines; steam engines; printing machines; rotary printing presses; compressed air machines; trimming machines; spinning machines; filling machines; friezing machines; cutters [machines]; satinizing machines; agricultural machines; mixing machines; sorting machines for industry; stitching machines; washing

machines [laundry]; coin-operated washing machines; electric washing machines; clippers [machines]; spinning frames; spin driers [not heated]; looms; kneading machines; typographic machines; typesetting machines [photocomposition]; beating machines; beaters, electric; packing machines; filtering machines; molding machines; carding machines; sewing machines; typecasting machines; electromechanical machines for chemical industry; labellers [machines]; mills for household purposes, other than hand-operated; pepper mills other than hand-operated; mills [machines]; centrifugal mills; machine wheelwork; feeders [parts of machines]; forge bellows; blenders, electric, for household purposes; mixers [machines]; vacuum cleaner bags; threshing machines; pneumatic hammers; hammers [parts of machines]; tilt hammers; power hammers; reeling apparatus, mechanical; motorized cultivators; motors for boats; clutches other than for land vehicles; meat choppers [machines]; superchargers; brake linings other than for vehicles; guides for machines; vacuum cleaner attachments for disseminating perfumes and disinfectants; aerating pumps for aquaria; vacuum pumps [machines]; compressed air pumps; pumps for heating installations; beer pumps; lubricating pumps; pumps [machines]; self-regulating fuel pumps; fuel dispensing pumps for service stations; centrifugal pumps; pumps [parts of machines, engines or motors]; blades [parts of machines]; knives for mowing machines; chaff cutter blades; knives, electric; shears, electric; scissors, electric; pulverisers [machines]; axles for machines; steam traps; chucks [parts of machines]; drill chucks [parts of machines]; exhaust manifold for engines; soldering irons, gas-operated; soldering irons, electric; superheaters; gears, other than for land vehicles; reduction gears other than for land vehicles; drilling machines; saws [machines]; chain saws; glue guns, electric; compressed air guns for the extrusion of mastics; guns [tools using explosives]; carburetter feeders; feeding apparatus for engine boilers; loading ramps; ploughs; pneumatic transporters; pneumatic controls for machines, motors and engines; hangers [parts of machines]; anti-friction bearings for machines; roller bearings; self-oiling bearings; bearings for transmission shafts; ball-bearings; hoists; lifts, other than ski-lifts; elevators [lifts]; pulleys; saw blades [parts of machines]; shock absorber plungers [parts of machines]; pistons for engines; pistons [parts of machines or engines]; pistons for cylinders; catalytic converters; torque converters other than for land vehicles; fuel conversion apparatus for internal combustion engines; wine presses; basket presses; fodder presses; presses [machines for industrial purposes]; printing presses; typographic presses; swaging machines; pedal drives for sewing machines; cleaning appliances utilizing steam; food processors, electric; springs [parts of machines]; spinning wheels; punches for punching machines; vacuum cleaners; tam-

bours for embroidery machines; radiators [cooling] for motors and engines; sewage pulverizers; air brushes for applying colour; pressure regulators [parts of machines]; speed governors for machines, engines and motors; regulators [parts of machines]; cutting blow pipes, gas-operated; knives [parts of machines]; blade holders [parts of machines]; loom shafts; gears for weaving looms; belts for machines; elevator belts; fan belts for motors and engines; dynamo belts; belts for motors and engines; adhesive bands for pulleys; robots [machines]; kick starters for motorcycles; stuffing boxes [parts of machines]; paper feeders [printing]; whisks, electric, for household purposes; sparking plugs for internal combustion engines; glow plugs for diesel engines; brake segments other than for vehicles; tedding machines; separators; steam/oil separators; cream/milk separators; ball rings for bearings; sowers [machines]; snow ploughs; sheaf-binding machines; shaft couplings [machines]; fruit presses, electric, for household purposes; chaff cutters; teat cups [suction cups] for milking machines; stands for machines; machine tools; die-cutting and tapping machines; woodworking machines; sharpening machines; bicycle assembling machines; mortising machines; stone-working machines; metalworking machines; threading machines; planing machines; lathes [machine tools]; milling machines; trueing machines; metal drawing machines; rolling mills; starters for motors and engines; glaziers' diamonds [parts of machines]; tables for machines; derricks; slide rests [parts of machines]; couplings other than for land vehicles; heat exchangers [parts of machines]; transmissions for machines; transmissions, other than for land vehicles; boiler tubes [parts of machines]; wind turbines; hydraulic turbines; turbines other than for land vehicles; turbocompressors; connecting rods for machines, motors and engines; joints [parts of engines]; central vacuum cleaning installations; suction machines for industrial purposes; washing installations for vehicles; degreasers [machines]; dust exhausting installations for cleaning purposes; machines for the production of mineral water; pneumatic tube conveyors; dust removing installations for cleaning purposes; condensing installations; lifting apparatus; air suction machines; dividing machines; igniting devices for internal combustion engines; door closers, pneumatic; door closers, electric; washing apparatus; binding apparatus for hay; extractors for mines; door openers, hydraulic; door openers, pneumatic; door openers, electric; curtain drawing devices, electrically operated; adhesive tape dispensers [machines]; anti-pollution devices for motors and engines; beverage preparation machines, electromechanical; food preparation machines, electromechanical; elevator operating apparatus; control mechanisms for machines, engines or motors; shoe polishers, electric; machines and apparatus for wax-polishing, electric; air cushion devices for moving

loads; handling apparatus for loading and unloading; elevating apparatus; aprons [parts of machines]; filter presses; filters [parts of machines or engines]; filters for cleaning cooling air, for engines; molds [parts of machines]; printing plates; journals [parts of machines]; centrifugal machines; elevator chains [parts of machines]; driving chains other than for land vehicles; transmission chains other than for land vehicles; cylinders for motors and engines; cylinders for machines; printing cylinders; shuttles [parts of machines]; universal joints [Cardan joints]; pulleys [parts of machines]; vacuum cleaner hoses; dynamo brushes; brushes [parts of machines]; brushes, electrically operated [parts of machines]; carbon brushes [electricity]; ejectors; fuel economisers for motors and engines; excavators; shovels, mechanical; agricultural elevators; motors, electric, other than for land vehicles; electrodes for welding machines; electric hammers; parquet wax-polishers, electric; cartridges for filtering machines; moving staircases [escalators]; automatic grapnels for marine purposes.

11 – Lamp shades; steam accumulators; heat accumulators; defrosters for vehicles; distillation apparatus; desiccating apparatus; hydromassage bath apparatus; disinfectant apparatus; air deodorising apparatus; tanning apparatus [sun beds]; ionization apparatus for the treatment of air or water; hand drying apparatus for washrooms; fruit roasters; water purifying apparatus and machines; refrigerating apparatus and machines; drying apparatus and installations; freezers; drying apparatus; structural plates for ovens; coolers for furnaces; expansion tanks for central heating installations; flushing tanks; refining towers for distillation; bidets; boilers, other than parts of machines; bath tubs; bath tubs for sitz baths; spa baths [vessels]; waffle irons, electric; electric fans for personal use; fans [air-conditioning]; fans [parts of air-conditioning installations]; roasting spits; refrigerating display cabinets; water heaters; water heaters [apparatus]; water flushing installations; air reheaters; extractor hoods for kitchens; gas condensers, other than parts of machines; acetylene generators; hydrants; burners; acetylene burners; petrol burners; gas burners; germicidal burners; incandescent burners; oxyhydrogen burners; laboratory burners; oil burners; alcohol burners; hot water bottles; footwarmers, electric or non-electric; bed warmers; pocket warmers; warming pans; grills [cooking appliances]; lampshade holders; stills; showers; refrigerating containers; lighters; gas lighters; friction lighters for igniting gas; coils [parts of distilling, heating or cooling installations]; evaporators; torches for lighting; shower cubicles [enclosures (Am.)]; Turkish bath cabinets, portable; heating apparatus; refrigerating chambers; fireplaces, domestic; chimney flues; pressure cooking saucepans, electric; air valves for steam heating installations; level controlling valves in tanks; thermostatic valves

[parts of heating installations]; electrically heated carpets; light bulbs; light bulbs, electric; solar thermal collectors [heating]; distillation columns; furnace grates; ventilation hoods; ventilation hoods for laboratories; lamp globes; air conditioning apparatus; air conditioners for vehicles; gas boilers; laundry room boilers; heating boilers; coffee machines, electric; taps [faucets]; taps [cocks, spigots] [faucets (Am.)] for pipes; mixer taps for water pipes; forges, portable; lava rocks for use in barbecue grills; electric lights for Christmas trees; acetylene flares; safety lamps; gas lamps; curling lamps; germicidal lamps for purifying air; lamps for directional signals of automobiles; light bulbs for directional signals for vehicles; arc lamps; laboratory lamps; oil lamps; ultraviolet ray lamps, not for medical purposes; miners' lamps; electric lamps; chandeliers; barbecues; bread baking machines; watering machines for agricultural purposes; disposable sterilization pouches; footmuffs, electrically heated; heaters for baths; heaters for heating irons; immersion heaters; brackets for gas burners; anti-splash tap nozzles; heat pumps; filaments for electric lamps; magnesium filaments for lighting; heating filaments, electric; luminous house numbers; stoves; heating apparatus for defrosting windows of vehicles; bath fittings; loading apparatus for furnaces; kiln furniture [supports]; sauna bath installations; refrigerating appliances and installations; blankets, electric, not for medical purposes; fabric steamers; lamp reflectors; vehicle reflectors; hearths; steam boilers, other than parts of machines; pasteurisers; lamp mantles; sockets for electric lights; coffee percolators, electric; bakers' ovens; furnaces, other than for laboratory use; hot air ovens; kitchen ranges [ovens]; microwave ovens [cooking apparatus]; microwave ovens for industrial purposes; incinerators; kilns; stoves [heating apparatus]; solar furnaces; dental ovens; urinals [sanitary fixtures]; feeding apparatus for heating boilers; heating plates; cookers; hot plates; heaters, electric, for feeding bottles; aquarium heaters; heating cushions [pads], electric, not for medical purposes; clean chambers [sanitary installations]; water intake apparatus; deodorising apparatus, not for personal use; electric apparatus for dehydrating foodstuffs; fumigation apparatus, not for medical purposes; oil-scrubbing apparatus; glue-heating appliances; forage drying apparatus; water filtering apparatus; air purifying apparatus and machines; ice machines and apparatus; cooling appliances and installations; cooking apparatus and installations; lighting apparatus and installations; sanitary apparatus and installations; cooking rings; lighting apparatus for vehicles; light-emitting diodes [LED] lighting apparatus; heating apparatus for solid, liquid or gaseous fuels; hot air apparatus; heating apparatus, electric; steam facial apparatus [saunas]; safety accessories for water or gas apparatus and pipes; regulating accessories for water or gas apparatus and

pipes; regulating and safety accessories for water apparatus; regulating and safety accessories for gas pipes; roasting jacks; plate warmers; electric appliances for making yogurt; anti-dazzle devices for automobiles [lamp fittings]; anti-glare devices for vehicles [lamp fittings]; rotisseries; radiator caps; diving lights; washers for water taps; radiators [heating]; central heating radiators; radiators, electric; sinks; disinfectant dispensers for toilets; drip irrigation emitters [irrigation fittings]; light diffusers; nuclear reactors; heat regenerators; pressure water tanks; roasters; lamps; street lamps; ceiling lights; toilet seats; lighting installations for air vehicles; pressure cookers [autoclaves], electric; gas scrubbers [parts of gas installations]; lamp glasses; sterilizers; water sterilizers; air sterilisers; air dryers; laundry dryers, electric; hair dryers; malt roasters; tobacco roasters; heat exchangers, not parts of machines; bread toasters; discharge tubes, electric, for lighting; lamp chimneys; luminous tubes for lighting; flues for heating boilers; boiler pipes [tubes] for heating installations; pipes [parts of sanitary installations]; toilets [water-closets]; toilets, portable; humidifiers for central heating radiators; wash-hand basins [parts of sanitary installations]; toilet bowls; water conduits installations; bath installations; air conditioning installations; desalination plants; installations for processing nuclear fuel and nuclear moderating material; cooling installations for water; cooling installations for liquids; milk cooling installations; cooling installations for tobacco; water purification installations; gas scrubbing apparatus; purification installations for sewage; steam generating installations; water distribution installations; air filtering installations; swimming pool chlorinating apparatus; ventilation [air-conditioning] installations and apparatus; water softening apparatus and installations; cooling installations and machines; heating installations; heaters for vehicles; hot water heating installations; polymerisation installations; water supply installations; flare stacks for use in the oil industry; ash conveyor installations, automatic; whirlpool-jet apparatus; air cooling apparatus; aquarium filtration apparatus; cooking utensils, electric; flares; headlights for automobiles; vehicle headlights; filters for air conditioning; filters for drinking water; lights for automobiles; bicycle lights; motorcycle lights; pocket torches, electric; Chinese lanterns; lanterns for lighting; fountains; ornamental fountains; deep fryers, electric; fittings, shaped, for ovens; oven fittings made of fireclay; bread-making machines; refrigerators; chromatography apparatus for industrial purposes; kettles, electric; dampers [heating]; ice boxes; refrigerating cabinets; fuel economizers; heating elements.

(260) AM 2017 90205 A  
(800) 1324968  
(891) 2016 08 30

(731) HUAWEI TECHNOLOGIES CO., LTD.  
Administration Building Huawei Technologies Co., Ltd., Bantian, Longgang District  
Shenzhen, China

(540)

# HUAWEI Y7

(591) Black, white

(511)

9 – Smartwatches; wearable activity trackers; smart-glasses; selfie sticks (hand-held monopods); covers for smartphones; cases for smartphones; protective films adapted for screens for mobile phones; protective films adapted for computer screens; joysticks for use with computers, other than for video games; connected bracelets (measuring instruments); holograms; tablet computers; mobile phones; sleeves for laptops; modems; cabinets for loudspeakers; earphones; mobile power source (rechargeable batteries); network communication equipment; smartphones; cellular phones; video telephones; camcorders; portable media players; television apparatus; headphones; horns for loudspeakers; audio and video receivers.

(260) AM 2017 90207 A

(800) 1324969

(891) 2016 08 30

(731) HUAWEI TECHNOLOGIES CO., LTD.  
Administration Building Huawei Technologies Co., Ltd., Bantian, Longgang District  
Shenzhen, China

(540)

# HUAWEI Y3

(591) Black, white

(511)

9 – Smartwatches; wearable activity trackers; smart-glasses; selfie sticks (hand-held monopods); covers for smartphones; cases for smartphones; protective films adapted for screens for mobile phones; protective films adapted for computer screens; joysticks for use with computers, other than for video games; connected bracelets (measuring instruments); holograms; tablet computers; mobile phones; sleeves for laptops; modems; cabinets for loudspeakers; earphones; mobile power source (rechargeable batteries); network communication equipment; smartphones; cellular phones; video telephones; camcorders; portable media players; television apparatus; headphones; horns for loudspeakers; audio and video receivers.

(260) AM 2017 90208 A

(800) 1324970

(891) 2016 08 30

(731) HUAWEI TECHNOLOGIES CO., LTD.  
Administration Building Huawei  
Technologies Co., Ltd., Bantian, Longgang  
District Shenzhen, China

(540)

**HUAWEI Y5**

(591) Black, white

(511)

9 – Smartwatches; wearable activity trackers; smart-glasses; selfie sticks (hand-held monopods); covers for smartphones; cases for smartphones; protective films adapted for screens for mobile phones; protective films adapted for computer screens; joysticks for use with computers, other than for video games; connected bracelets (measuring instruments); holograms; tablet computers; mobile phones; sleeves for laptops; modems; cabinets for loudspeakers; earphones; mobile power source (rechargeable batteries); network communication equipment; smartphones; cellular phones; video telephones; camcorders; portable media players; television apparatus; headphones; horns for loudspeakers; audio and video receivers.

(260) AM 2017 90210 A

(800) 1325056

(891) 2016 11 17

(731) JANSSEN PHARMACEUTICA NV  
Turnhoutseweg 30, B-2340 Beerse, Belgium

(540)

**VANLUTO**

(511)

5 – Human pharmaceutical preparations.

(260) AM 2017 90211 A

(800) 1325075

(891) 2016 08 17

(731) ARSEUS LAB, naamloze vennootschap  
Mannebeekstraat 33, B-8790 Waregem,  
Belgium

(540)

**novux**

(591) Grey and different shades of purple.

(511)

7 – 3d printers; pin drilling apparatus; mechanical tools, in particular grinding, milling and polishing tools and grinding wheels, grinding wheels, cutting discs, shafts, drilling, milling, drilling and milling inserts; washing machines and washer systems (electrical) for dental apparatus and instruments; suction devices for rinsing purposes; bits for use in electrical

hand tools; rotating brushes [machines]; compressors for the dehumidification of machines; pressure pumps; pressure cleaners; electric hydraulic tools; electric steam cleaners; filtration machines, centrifuges and separators [machines]; pressure washers; couplings for machine tools; dry cleaning machines; machines for printing labels; pens for 3d printing; ultrasonic cleaning equipment for Industrial use.

9 – Software and hardware for data processing in equipment for the diagnosis in the field of orthodontics, and the dental field; electrical and data cables for devices for diagnosis and diagnosis in the field of orthodontics, and the dental field; management software in the dental field; electrical and electronic equipment for data transfer and input to laboratories; printers; digital analyzers, not for medical use; software for virtual reality; data processing equipment and computers; tablets; software; above mentioned products intended for dental offices and dental laboratories; hardware for the determination of data and dimensions with respect to the manufacture of artificial teeth.

10 – Dental apparatus and instruments; machinery and apparatus for analyzing dental occlusions; electronic analyzers for medical and dental use; physical analyzers for medical and dental use; diagnostic imaging devices for medical and dental use; ultrasonic diagnostic apparatus for dental use; detection equipment for medical and dental use; dental appliances; dental appliances for paralleling; dental appliances for milling; suction equipment for dental use; polymerization equipment for dental purposes; devices for use in orthodontics; tooth cleaning devices for use by dentists; medical instruments for use in the preparation of artificial teeth; medical devices for use in the preparation of dental prostheses; medical devices for use in the repair of teeth; medical devices for use by dental technicians and dental hygienists; medical instruments for fitting dentures; dental articulators; dental treatment lights; above mentioned products intended for dental offices and dental laboratories; electrical and electronic medical systems for detection of data, and for measuring data relating to the human body; digital analyzers for medical use.

(260) AM 2017 90213 A

(800) 1325082

(891) 2016 08 30

(731) BEAUTICK.BERGAMO S.R.L.  
Piazza Pontida, 22, I-24122 BERGAMO,  
Italy

(540)

**BEAUTICK.**

(591) Black, white

(511)  
44 – Beauty salons; hairdressing salons; consultancy services relating to beauty.

(260) AM 2017 90214 A  
(800) 1325085  
(891) 2016 10 21  
(731) MAST-JÄGERMEISTER SE  
Jägermeisterstraße 7 – 15, 38302  
Wolfenbüttel, Germany  
(540)

## JägerVibes

(511)  
33 – Preparations for making alcoholic beverages; alcoholic beverages (except beer), in particular herbal spirits; pre-mixed alcoholic beverages.

35 – Advertising, marketing and promotional services; commercial trading and consumer information services, namely auctioneering services, rental of vending machines, business contact services, collective buying services, commercial evaluation services, arranging of competitions for advertising purposes, import and export services, mediation and negotiation of commercial transaction for third parties, ordering services, price comparing services, procurement services for others, subscription services; retail and wholesale services in relation to pharmaceuticals, cosmetics and household goods, fuels, goods in the field of health, machines, tools and metal goods, building material, do-it-yourselfer and gardening articles, hobby requisites and craft supplies, electric goods and electronic goods, sound and data carriers, watches and jewellery, musical instruments, printed matter, paper and stationery, office requisites, bag makers' goods and saddlery, furnishings and decorative articles, clothing, footwear and textiles, playthings, sporting goods, foodstuffs and beverages, smokers' articles and other luxury foodstuffs; business assistance, management and administrative services; business analysis, research and information services; rental, hire and leasing in connection with the aforesaid, included in this class; advice, consultancy and information for the aforesaid, included in this class; all of the aforesaid services not related to vehicles and vehicle accessories.

41 – Publishing and reporting; education, entertainment and sports; translation and interpretation; rental, hire and leasing in connection with the aforesaid, included in this class; advice, consultancy and information for the aforesaid, included in this class; all of the aforesaid services not related to vehicles and vehicle accessories.

(260) AM 2017 90215 A  
(800) 1325137  
(891) 2016 08 30  
(731) RECHI PRECISION CO., LTD.  
No.943 Chenggong Road, Section 2,  
Guanyin District, Taoyuan City 328490  
Taiwan, China  
(540)



(591) Black, white  
(511)  
7 – Alternators; starters for motors and engines; motors, other than for land vehicles; pumps [parts of machines, engines or motors]; compressors [machines]; blowing machines for the compression, exhaustion and transport of gases; blowing engines; air suction machines; compressors for refrigerators; blowing machines.

(260) AM 2017 90216 A  
(800) 1325138  
(891) 2016 09 02  
(731) SHANGHAI TOBACCO GROUP CO.  
LTD.  
717 Chang Yang Road, Yangpu District  
Shanghai, China  
(540)



(591) Black, white  
(511)  
34 – Tobacco; chewing tobacco; cigarettes containing tobacco substitutes, not for medical purposes; cigarettes; electronic cigarettes; tobacco jars; ashtrays, for smokers; matches; lighters for smokers; cigarette paper.

(260) AM 2017 90217 A  
(800) 667714  
(891) 2016 11 29  
(731) SCA Hygiene Products AB  
SE-405 03 Göteborg, Sweden



(540)



(591) Black, white

(511)

3 – Préparations pour nettoyer, polir, abraser, lessiver et dégraisser (non comprises dans d'autres classes); préparations cosmétiques pour nettoyer et soigner la peau et les mains.

16 – Papier, produits en papier et en cellulose pour essuyer, sécher et nettoyer (non compris dans d'autres classes); couches en papier, serviettes en papier, essuie-tout, papier hygiénique et autres produits en papier et en cellulose non compris dans d'autres classes.

21 – Récipients, supports et distributeurs (non compris dans d'autres classes) pour tous les produits mentionnés dans les classes 3 et 16; matériel de nettoyage en papier ou en cellulose.

(260) AM 2017 90218 A

(800) 1325133

(891) 2016 08 30

(731) HUAWEI TECHNOLOGIES CO., LTD.

Administration Building Huawei Technologies Co., Ltd., Bantian, Longgang Dist. Shenzhen, China

(540)

## HUAWEI MateBook

(591) Black, white

(511)

9 – Computer hardware; data processing apparatus; computer keyboards; sleeves for laptops; computer programs (downloadable software); laptop computers; tablet computers; mobile phones; smartphones; cell phone straps; modems.

(260) AM 2017 90220 A

(800) 1325976

(891) 2016 10 07

(731) APPLE INC.

1 Infinite Loop, Cupertino CA 95014, USA

(540)

## MACINTOSH

(591) Black, white

9 – Computers; computer peripherals; computer hardware; flat panel display screens; keyboards; computer disk drives; hard disk drives; computer operating system software.

(260) AM 2017 90223 A

(800) 1326021

(891) 2016 07 28

(731) EGIS GYÓGYSZERGYÁR ZRT.

Keresztúri út 30-38, H-1106 Budapest, Hungary

(540)

## BOSAR

(511)

5 – Pharmaceutical preparations for human use.

(260) AM 2017 90224 A

(800) 1326022

(891) 2016 07 28

(731) EGIS GYÓGYSZERGYÁR ZRT.

Keresztúri út 30-38, H-1106 Budapest, Hungary

(540)

## ARBOSA

(511)

5 – Pharmaceutical preparations for human use.

(260) AM 2017 90225 A

(800) 1326028

(891) 2016 08 18

(731) ATAMANCHUK ALEKSANDR

VASILIEVICH PRIVATE BUSINESSMAN Veseliy per., 43, s. Belaya Glina, RU-353000 Krasnodarskiy Kray, Russian Federation

(540)

## EVGO

(591) Black, white

(511)

7 – Ironing machines; knitting machines; embossing machines; dishwashers; bottle washing machines; kitchen machines, electric; rinsing machines; hemming machines; wringing machines for laundry; washing machines [laundry]; sewing machines; lawnmowers [machines]; coffee grinders, other than hand-operated; vacuum cleaners; knives, electric; mills for household purposes, other than hand-operated; whisks, electric, for household purposes; blenders, electric, for household purposes; crushers for kitchen use, electric; fruit presses, electric, for household purposes; beverage preparation machines, electromechanical; food preparation machines, electromechanical; parquet wax-polishers, electric; high pressure washers; motorized cultivators; motors for boats; food processors, electric; washing installations for vehicles.

9 – Camcorders; radios; television apparatus; record players; compact disc players; cassette players; cameras [photography]; sound transmitting appara-

tus; sound reproduction apparatus; amplifiers; sound recording apparatus; video recorders; telephone apparatus; cordless telephones; video telephones; video cassettes; compact discs [audio-video]; Global Positioning System [GPS] apparatus; solar batteries.

11 – Cookers; microwave ovens [cooking apparatus]; kitchen ranges [ovens]; bakers' ovens; hair dryers; bread-making machines; refrigerators; refrigerating apparatus and machines; freezers; grills [cooking appliances]; heating apparatus, electric; heating apparatus; pressure cooking saucepans, electric; electric fans for personal use; air conditioning apparatus; water heaters [apparatus]; extractor hoods for kitchens; heaters for baths; water conduits installations; mixer taps for water pipes; taps [faucets]; ventilation hoods; laundry dryers, electric; water purification installations; air filtering installations; filters for air conditioning; filters for drinking water; air deodorising apparatus; ionization apparatus for the treatment of air or water; refrigerating display cabinets; gas boilers; heating boilers; cooling installations for water; water distribution installations; kettles, electric.

(260) AM 2017 90226 A  
(800) 1326048  
(891) 2016 09 23  
(731) Tovarystvo z obmezheniou vidpovidalnistiu  
"AVK KONFEKSHINERI"  
vul. Mezhyhirska, 82 A, Kyiv 04080,  
Ukraine  
(540)



(591) Black, white  
(511)  
30 – Coffee; chocolate; artificial coffee; coffee flavorings; coffee-based beverages; coffee beverages with milk; vegetal preparations for use as coffee substitutes; cocoa; cocoa beverages with milk; cocoa-based beverages; tea-based beverages; chocolate-based beverages; preparations for stiffening whipped cream; tea.

(260) AM 2017 90227 A  
(800) 1326054  
(891) 2016 11 24  
(731) JANSSEN PHARMACEUTICA NV  
Turnhoutseweg 30, B-2340 BEERSE,  
Belgium

(540)

## TONDELVA

(511)  
5 – Human pharmaceutical preparations.

(260) AM 2017 90228 A  
(800) 1325726  
(891) 2016 09 02  
(731) Open-Type Joint Stock Company  
"ROT FRONT"  
2-oy Novokuznetskiy pereulok, d. 13/15,  
RU-113184 Moscow, Russian Federation  
(540)

## СТЕПАШКА

(511)  
30 – Coffee; tea; cocoa; sugar; rice; tapioca; sago; artificial coffee; flour and preparations made from cereals; ice cream; honey; yeast; baking powder; salt; mustard; vinegar; sauces [condiments]; spices; edible ices; bread, pastries and confectionery.

(260) AM 2017 90229 A  
(800) 1325731  
(891) 2016 09 23  
(731) Open-Type Joint Stock Company  
"ROT FRONT"  
2-oy Novokuznetskiy pereulok, d. 13/15,  
RU-113184 Moscow, Russian Federation  
(540)

## ЛАДА

(511)  
30 – Coffee; tea; cocoa; sugar; rice; tapioca; sago; artificial coffee; flour and preparations made from cereals; ice cream; honey; yeast; baking powder; salt; mustard; vinegar; sauces [condiments]; spices; edible ices; bread, pastries and confectionery.

(260) AM 2017 90230 A  
(800) 1325735  
(891) 2016 09 16  
(731) Joint-Stock Company  
"KRASNYJ OCTYABR"  
ul. Malaya Krasnoselskaya, d. 7, str. 24  
RU-107140 Moscow, Russian Federation  
(540)

## ЛЮБИМЫЕ ЛЮБИМЫЕ

(511)  
30 – Caramels [candy]; sweetmeats [candy]; gingerbread; chocolate; pralines; waffles; pastries.

(260) AM 2017 90231 A

(800) 1326074

(891) 2016 08 04

(731) BIOFARMA

50 rue Carnot, F-92284 Suresnes cedex,  
France

(540)

**CARDIOSKIN**

(591) Black, white

(511)

9 – Scientific, optical, weighing, measuring, signaling, checking (supervision), life-saving and teaching apparatus and instruments; apparatus and instruments for conducting, switching, transforming, accumulating, regulating or controlling electricity; apparatus for recording, transmission or reproduction of sound or images; magnetic recording media; sound recording disks; data and information processing apparatus and equipment; software; computer programs; software recorded on magnetic media or downloaded from a remote computer network; software for monitoring physiological signals; software for the analysis, storage and monitoring of physiological data, including diagnostic, surveillance and warning tools; devices for capturing and transmitting physiological signals; devices, such as electro-conductive clothing, incorporating electro-textile sensors for capturing physiological signals; personal digital assistant; transmitters of electronic signals.

10 – Surgical, medical, dental and veterinary apparatus and instruments; orthopedic articles; apparatus and instruments for monitoring, diagnosis, surveillance and alerts relating to heart, neurological, respiratory and physiological disorders; medical devices and instruments; diagnostic devices for medical use.

25 – Clothing; underwear; footwear; headgear.

42 – Scientific and technological services as well as research and design services relating thereto; Industrial analysis and research services; design and development of computer hardware and software; services in research, design and development of devices in connection with the capture and transmission of physiological signals; services in research, design and development of software for monitoring physiological signals; services in research, design and development of electro-conductive textiles for capturing physiological signals.

44 – Medical services; medical diagnostic services via electronic and telematic means.

(260) AM 2017 90232 A

(800) 1325190

(891) 2016 08 17

(731) TWIN SET – SIMONA BARBIERI S.P.A.

Via del Commercio, 32 I-41012 CARPI

(MODENA), Italy;

TWIN SET – SIMONA BARBIERI S.P.A.

Via Della Chimica, 21, I-41012 CARPI

(Modena), Italy

(540)

**MY  
TWIN  
TWIN SET**

(591) black and white

(511)

18 – Leather and imitations of leather; bags; handbags; rucksacks; trunks and travelling bags; key cases; wallets; purses made of leather and imitation of leather; make-up bags sold empty; umbrellas.

25 – Clothing for men, women and children; skirts; trousers; shorts; jeans; shirts; blouses; jerseys; sweaters; T-shirts; vests; suits; tracksuits; cloaks; coats; overcoats; bomber jackets; tunics; jackets; anoraks; raincoats; stockings; socks; hats; headgear; scarves; gloves; neckties; swimsuits; belts; shoes; beach shoes; slippers; boots; gymnastic shoes; tennis shoes; bath robes; tights; underwear; sportswear; knitwear.

(260) AM 2017 90233 A

(800) 1325744

(891) 2016 09 27

(731) BIOFARMA, Société par actions simplifiée

50 rue Carnot, F-92284 SURESNES cedex,

France

(540)

**ДЕТРАГЕЛЬ**

(591) Black, white

(511)

5 – Pharmaceutical and veterinary products; sanitary products for medical purposes; dietetic food and substances for medical or veterinary use, food for babies; food supplements for humans and animals; plasters, materials for dressings; material for dental fillings and dental impressions; disinfectants; products for destroying vermin; fungicides, herbicides.

(260) AM 2017 90234 A

(800) 1326156

(891) 2016 09 23

(731) Tovarishchestvo s ogranitchennoi

otvetstvennostyu "ALMOL"

Krasnogvardeiskii trakt, 497 050030

Almaty, Kazakstan

(540)

**МЕЧ ДЖЕДАЯ**

(591) Black, white

(511)

29 – Meat; fish; poultry and game; meat extracts; preserved, dried, and cooked fruits and vegetables; jellies; jams; compotes; eggs; milk and milk products; edible oils and fats.

30 – Coffee; tea; cocoa; sugar; rice; tapioca; sago; artificial coffee; flour and preparations made from cereals; bread; pastry; confectionery; ice-cream; honey; treacle; yeast; baking-powder, salt; mustard; vinegar, sauces (condiments); spices; ice for refreshment.

(260) AM 2017 90235 A

(800) 1325748

(891) 2016 09 19

(731) "KYIV CARDBOARD AND PAPER MILL"

Private Joint-Stock Company

vul. Kyivska, 130, m. Obukhiv Kyivska

obl. 08700, Ukraine

(540)

**DIVOLINER**

(591) Black, white

(511)

16 – Fountain pens; albums; almanacs; banknotes; drawing pads; pamphlets; booklets; signboards of paper or cardboard; hygienic paper; covers of paper for flower pots; bibs of paper; printed matter; printed publications; labels, not of textile; magazines (periodicals); bookmarkers; note books; pads (stationery); calendars; tracing paper; office requisites, except furniture; stationery; wood pulp board (stationery); cardboard; cardboard tubes; self-adhesive tapes for stationery or household purposes; conical paper bags; carbon paper; copying paper (stationery); boxes of cardboard or paper; cases for stamps (seals); adhesive bands for stationery or household purposes; adhesive tapes for stationery or household purposes; absorbent sheets of paper or plastic for foodstuff packaging; humidity control sheets of paper or plastic for foodstuff packaging; flyers; bags (envelopes, pouches) of paper or plastics, for packaging; garbage bags of paper or of plastics; stuffing of paper or cardboard; waxed paper; handkerchiefs of paper; covers (stationery); printers' blankets, not of textile; cream containers of paper; packing (cushioning, stuffing) materials of paper or cardboard; paper ribbons; paper tapes and cards for the recordal of computer programmes; paper sheets (stationery); packing paper; paper for recording machines; wood pulp paper; paper; document files (stationery); folders for papers; writing cases (sets); writing paper; writing cases (stationery); coasters of paper; place mats of paper; bottle wrappers of cardboard or

paper; bottle envelopes of cardboard or paper; flags of paper; drawer liners of paper, perfumed or not; blotters; towels of paper; luminous paper; face towels of paper; tissues of paper for removing make-up; tablecloths of paper; loose-leaf binders; table linen of paper; table napkins of paper; tablemats of paper; placards of paper or cardboard; paper coffee filters; filter paper; filtering materials (paper).

(260) AM 2017 90236 A

(800) 1325191

(891) 2016 08 17

(731) TWIN SET – SIMONA BARBIERI S.P.A.

Via del Commercio, 32 I-41012 CARPI

(MODENA), Italy;

TWIN SET – SIMONA BARBIERI S.P.A.

Via Della Chimica, 21, I-41012 CARPI

(Modena), Italy

(540)

**TWIN SET**

(591) black and white

(511)

18 – Leather and imitations of leather; bags; handbags; rucksacks; trunks and travelling bags; key cases; wallets; purses made of leather and imitation of leather; make-up bags sold empty; umbrellas.

25 – Clothing for men, women and children; skirts; trousers; shorts; jeans; shirts; blouses; jerseys; sweaters; T-shirts; vests; suits; tracksuits; cloaks; coats; overcoats; bomber jackets; tunics; jackets; anoraks; raincoats; stockings; socks; hats; headgear; scarves; gloves; neckties; swimsuits; belts; shoes; beach shoes; slippers; boots; gymnastic shoes; tennis shoes; bath robes; tights; underwear; sportswear; knitwear.

(260) AM 2017 90237 A

(800) 1326158

(891) 2016 09 02

(731) Obshchestvo s ogranichennoy

otvetstvennostyu "MAY"

ul. Ozeraya, 1a, Fryazino, RU-141191

Moskovskoy obl., Russian Federation

(540)



(591) Light yellow, white, orange and brown  
(511)  
43 – Food and drink catering; café services; cafeteria services; canteen services; restaurant services; self-service restaurant services; snack-bar services; bar services.

(260) AM 2017 90238 A  
(800) 1325760  
(891) 2016 09 15  
(731) FURASHOV ANDREY GERMANOVICH  
prospect Oktyabrsky, d. 68, kv. 47  
RU-610017 Kirov, Russian Federation

(540)  
**ДЫМКА**

(591) Black, white  
(511)  
30 – Confectionery.  
35 – Sale of goods.

(260) AM 2017 90239 A  
(800) 1325196  
(891) 2016 10 10  
(731) Limited Liability Company  
"DIAMED-farma"  
Sovetskaya street, 31, Pervomayskiy  
community, Korolev city, RU-141069  
Moscow region, Russian Federation

(540)  
**MUCOSAT**

(591) black and white  
(511)  
5 – Pharmaceuticals and veterinary preparations; sanitary preparations for medical purposes; dietetic food and substances adapted for medical or veterinary use, food for babies; dietary supplements for humans and animals; plasters, materials for dressings; material for dental fillings and dental impressions; disinfectants; preparations for destroying noxious animals; fungicides, herbicides; acaricides; aconitine; alkaloids for medical purposes; alginates for pharmaceutical purposes; algicides; aldehydes for pharmaceutical purposes; dental amalgams of gold; dental amalgams; amino acids for veterinary purposes; amino acids for medical purposes; analgesics; anaesthetics; antibiotics; antiseptics; medicine cases, portable, filled; first-aid boxes, filled; aluminium acetate for pharmaceutical purposes; acetates for pharmaceutical purposes; germicides; balms for medical purposes; bandages for dressings; biocides; bracelets for medical purposes; anti-rheumatism bracelets; bromine for pharmaceutical purposes;

paper for mustard plasters; fly catching paper; reagent paper for medical or veterinary purposes; mothproofing paper; petroleum jelly for medical purposes; vaccines; oxygen baths; antiseptic cotton; aseptic cotton; absorbent cotton; wadding for medical purposes; cotton for medical purposes; dietetic substances adapted for medical use; radiological contrast substances for medical purposes; nutritive substances for microorganisms; radioactive substances for medical purposes; bismuth subnitrate for pharmaceutical purposes; melissa water for pharmaceutical purposes; sea water for medicinal bathing; mineral waters for medical purposes; thermal water; dietary fiber; molding wax for dentists; gases for medical purposes; guaiacol for pharmaceutical purposes; hematogen; hemoglobin; hydrastine; hydrastinine; glycerine for medical purposes; glycerophosphates; glucose for medical purposes; gentian for pharmaceutical purposes; hormones for medical purposes; mustard for pharmaceutical purposes; mustard plasters; mud for baths; medicinal mud; gamboge for medical purposes; gurjun [gurjon, gurjan] balsam for medical purposes; air deodorising preparations; deodorants, other than for human beings or for animals; deodorants for clothing and textiles; diastase for medical purposes; digitalin; mineral food supplements; nutritional supplements; albumin dietary supplements; dietary supplements for animals; alginate dietary supplements; glucose dietary supplements; casein dietary supplements; lecithin dietary supplements; linseed oil dietary supplements; propolis dietary supplements; protein dietary supplements; protein supplements for animals; royal jelly dietary supplements; pollen dietary supplements; wheat germ dietary supplements; linseed dietary supplements; enzyme dietary supplements; yeast for pharmaceutical purposes; gelatine for medical purposes; cod liver oil; isotopes for medical purposes; insecticides; iodine for pharmaceutical purposes; iodides for pharmaceutical purposes; alkaline iodides for pharmaceutical purposes; iodoform; calomel; tartar for pharmaceutical purposes; camphor for medical purposes; capsules for medicines; cachets for pharmaceutical purposes; hemostatic pencils; wart pencils; caustic pencils; headache pencils; carbolineum [parasiticide]; caustics for pharmaceutical purposes; cachou for pharmaceutical purposes; quassia for medical purposes; quebracho for medical purposes; oxygen for medical purposes; gallic acid for pharmaceutical purposes; acids for pharmaceutical purposes; adhesives for dentures; stem cells for veterinary purposes; stem cells for medical purposes; cocaine; collodion for pharmaceutical purposes; corn rings for the feet; anti-rheumatism rings; candy, medicated; angostura bark for medical purposes; barks for pharmaceutical purposes; cedar wood for use as an insect repellent; condurango bark for medical purposes; croton bark; mangrove bark for pharmaceutical purposes; myro-

balan bark for pharmaceutical purposes; quinquina for medical purposes; medicinal roots; rhubarb roots for pharmaceutical purposes; lint for medical purposes; starch for dietetic or pharmaceutical purposes; creosote for pharmaceutical purposes; blood for medical purposes; cultures of microorganisms for medical or veterinary use; curare; dental lacquer; liquorice for pharmaceutical purposes; lactose for pharmaceutical purposes; candy for medical purposes; adhesive plasters; medicines for alleviating constipation; lecithin for medical purposes; lotions for veterinary purposes; dog lotions; lotions for pharmaceutical purposes; personal sexual lubricants; magnesia for pharmaceutical purposes; liniments; ointments for pharmaceutical purposes; sunburn ointments; mercurial ointments; frostbite salve for pharmaceutical purposes; gauze for dressings; medicinal oils; mustard oil for medical purposes; camphor oil for medical purposes; castor oil for medical purposes; oil of turpentine for pharmaceutical purposes; dill oil for medical purposes; dental mastics; dental abrasives; dressings, medical; surgical dressings; drugs for medical purposes; medicines for veterinary purposes; serotherapeutic medicines; medicines for human purposes; medicines for dental purposes; menthol; medicinal drinks; moleskin for medical purposes; milk of almonds for pharmaceutical purposes; royal jelly for pharmaceutical purposes; milk ferments for pharmaceutical purposes; Irish moss for medical purposes; flour for pharmaceutical purposes; linseed meal for pharmaceutical purposes; fish meal for pharmaceutical purposes; fly glue; mint for pharmaceutical purposes; dietetic beverages adapted for medical purposes; malted milk beverages for medical purposes; narcotics; medicinal infusions; tincture of iodine; eucalyptol for pharmaceutical purposes; tinctures for medical purposes; opium; opodeldoc; decoctions for pharmaceutical purposes; antiparasitic collars for animals; stick liquorice for pharmaceutical purposes; sulfur sticks [disinfectants]; pastilles for pharmaceutical purposes; pectin for pharmaceutical purposes; pepsins for pharmaceutical purposes; peptones for pharmaceutical purposes; hydrogen peroxide for medical purposes; pesticides; food for babies; leeches for medical purposes; blood plasma; eyepatches for medical purposes; poultices; compresses; scapulars for surgical purposes; babies' diapers [napkins]; diapers for pets; bunion pads; breast-nursing pads; pomades for medical purposes; powder of cantharides; pyrethrum powder; belts for sanitary napkins [towels]; anti-uric preparations; bacterial preparations for medical and veterinary use; bacteriological preparations for medical and veterinary use; balsamic preparations for medical purposes; albuminous preparations for medical purposes; biological preparations for veterinary purposes; biological preparations for medical purposes; bismuth preparations for pharmaceutical purposes; vitamin preparations; diagnostic preparations for

medical purposes; therapeutic preparations for the bath; hemorrhoid preparations; preparations for calouses; preparations to facilitate teething; preparations for the treatment of burns; fumigation preparations for medical purposes; opotherapy preparations; air purifying preparations; eye-washes; bronchodilating preparations; preparations for reducing sexual activity; sterilising preparations; soil-sterilising preparations; corn remedies; pharmaceutical preparations for treating dandruff; herbicides; preparations for destroying dry rot fungus; larvae exterminating preparations; fly destroying preparations; preparations for destroying mice; slug exterminating preparations; vermin destroying preparations; pharmaceutical preparations for skin care; contact lens cleaning preparations; medicinal hair growth preparations; opiates; anticryptogamic preparations; aloe vera preparations for pharmaceutical purposes; preparations of trace elements for human and animal use; sulfonamides [medicines]; enzyme preparations for veterinary purposes; enzyme preparations for medical purposes; chemico-pharmaceutical preparations; chemical preparations for veterinary purposes; chemical preparations for the diagnosis of pregnancy; chemical preparations for medical purposes; chemical preparations to treat wheat blight [smut]; vine disease treating chemicals; chemical preparations to treat mildew; chemical preparations for treating phylloxera; chemical preparations for pharmaceutical purposes; chilblain preparations; mothproofing preparations; collyrium; lead water; chemical conductors for electrocardiograph electrodes; albuminous foodstuffs for medical purposes; dietetic foods adapted for medical purposes; by-products of the processing of cereals for dietetic or medical purposes; sanitary towels; sanitary pads; panty liners [sanitary]; propolis for pharmaceutical purposes; pearl powder for medical purposes; radium for medical purposes; hydrated chloral for pharmaceutical purposes; solvents for removing adhesive plasters; vaginal washes; solutions for contact lenses; chemical reagents for medical or veterinary purposes; gum for medical purposes; rubber for dental purposes; chewing gum for medical purposes; insect repellents; insect repellent incense; repellents for dogs; tissues impregnated with pharmaceutical lotions; sarsaparilla for medical purposes; sugar for medical purposes; asthmatic tea; fumigating sticks; linseed for pharmaceutical purposes; tobacco-free cigarettes for medical purposes; siccatives [drying agents] for medical purposes; syrups for pharmaceutical purposes; turpentine for pharmaceutical purposes; greases for veterinary purposes; greases for medical purposes; lacteal flour for babies; soporifics; bicarbonate of soda for pharmaceutical purposes; bath salts for medical purposes; salts for mineral water baths; salts for medical purposes; potassium salts for medical purposes; sodium salts for medical purposes; smelling salts; mineral water salts; malt for

pharmaceutical purposes; semen for artificial insemination; alcohol for pharmaceutical purposes; medicinal alcohol; alloys of precious metals for dental purposes; ergot for pharmaceutical purposes; cooling sprays for medical purposes; adjuvants for medical purposes; styptic preparations; vermifuges; disinfectants for hygiene purposes; disinfectants for chemical toilets; douching preparations for medical purposes; appetite suppressants for medical purposes; medical preparations for slimming purposes; parasiticides; mouthwashes for medical purposes; febrifuges; depuratives; animal washes; detergents for medical purposes; cattle washes; dog washes; vesicants; purgatives; remedies for perspiration; remedies for foot perspiration; chemical contraceptives; antiparasitic preparations; sedatives; laxatives; tonics [medicines]; nervines; digestives for pharmaceutical purposes; media for bacteriological cultures; steroids; strychnine; suppositories; serums; tanning pills; appetite suppressant pills; slimming pills; antioxidant pills; sanitary tampons; vulnerary sponges; thymol for pharmaceutical purposes; biological tissue cultures for veterinary purposes; biological tissue cultures for medical purposes; smoking herbs for medical purposes; medicinal herbs; pants, absorbent, for incontinents; sanitary panties; babies' napkin-pants [diaper-pants]; charcoal for pharmaceutical purposes; fennel for medical purposes; porcelain for dental prostheses; phenol for pharmaceutical purposes; enzymes for veterinary purposes; enzymes for medical purposes; ferments for pharmaceutical purposes; formic aldehyde for pharmaceutical purposes; phosphates for pharmaceutical purposes; quinine for medical purposes; chinoline for medical purposes; diabetic bread adapted for medical use; chloroform; flowers of sulfur for pharmaceutical purposes; cement for animal hooves; bone cement for surgical and orthopaedic purposes; dental cements; medicinal tea; herbal teas for medicinal purposes; eucalyptus for pharmaceutical purposes; tobacco extracts [insecticides]; extracts of hops for pharmaceutical purposes; elixirs [pharmaceutical preparations]; ethers for pharmaceutical purposes; esters for pharmaceutical purposes; cellulose esters for pharmaceutical purposes; cellulose ethers for pharmaceutical purposes; jujube, medicated; rat poison; poisons; bacterial poisons; jalap; cream of tartar for pharmaceutical purposes; adhesive tapes for medical purposes; lime-based pharmaceutical preparations; pharmaceutical preparations for treating sunburn; milking grease.

---

(260) AM 2017 90240 A

(800) 1325766

(891) 2016 09 16

(731) SKODA AUTO a.s.

Tr. Václava Klementa 869, CZ-293 01  
Mladá Boleslav, Czech Republic

(540)

## Columbus

(511)

9 – Vehicle radios, navigation apparatus for vehicles.

---

(260) AM 2017 90241 A

(800) 1325209

(891) 2016 09 08

(731) ALSTOM TRANSPORT TECHNOLOGIES

48 rue Albert Dhallenne, F-93400 Saint  
Ouen, France

(540)

## PRIMA H3

(591) black and white

(511)

12 – Land vehicles, namely, railway vehicles and their parts and spare parts; locomotives, in particular locomotives for transporting freight and/or passengers, their components and their spare parts; wagons, bogies, bodies, engines for railway vehicles.

37 – Repair and maintenance of railway vehicles and their parts, in particular bogies; construction, repair and maintenance of railways and all railway infrastructure.

39 – Rail transport of passengers; transport of freight by rail; rail transport of products; transport of freight containers by rail; information services related to railway transport.

42 – Railway engineering project study; technical evaluations related to design in the railway field (engineering works); design of railway vehicles (engineering works); technical expertise services in the railway field (engineering works); technical project studies in the railway field (engineering works); engineering in the field of railway transport.

---

(260) AM 2017 90242 A

(800) 1325767

(891) 2016 09 16

(731) SKODA AUTO a.s.

Tr. Václava Klementa 869, CZ-293 01  
Mladá Boleslav, Czech Republic

(540)

## BLUES

(511)

9 – Vehicle radios, navigation apparatus for vehicles.

---

(260) AM 2017 90244 A

(800) 1325768

(891) 2016 09 16

(731) ŠKODA AUTO a.s.  
Tř. Václava Klementa 869, CZ-293 60  
Mladá Boleslav, Czech Republic

(540)

## Swing

(511)

9 – Vehicle radios, navigation apparatus for vehicles.

(260) AM 2017 90245 A

(800) 477686

(891) 2016 12 12

(731) ALEXANDER BINZEL  
SCHWEISSTECHNIK GMBH & CO. KG  
Kiesacker 7-9, 35418 Buseck, Germany

(540)

## BINZEL

(511)

8 – Welding torches, as well as their protective gas connectors.

9 – Electric welding apparatus, control and regulation devices for welding processes, flue gas exhaust nozzles, welding accessories in the form of auxiliary apparatus, namely welding converters and rectifier welding sets, automatic reels for wire for gas-shielded arc welding, connecting tubes in the form of bundles for gas-shielded arc welding.

(260) AM 2017 90246 A

(800) 1325324

(891) 2016 08 01

(731) Obshchestvo s ogranichennoi  
otvetstvennostyu "VSK"  
ul. 50-let Oktyabrya, 113, g. Dimitrovgrad,  
RU-433502 Ulyanovskaya oblast, Russian  
Federation

(540)

## ТРЕХСОСЕНСКОЕ

(511)

32 – Aperitifs, non-alcoholic; waters [beverages]; kvass [non-alcoholic beverage]; cocktails, non-alcoholic; lemonades; non-alcoholic beverages; isotonic beverages; whey beverages; non-alcoholic fruit juice beverages; beer; syrups for lemonade; syrups for beverages; vegetable juices [beverages]; fruit juices; preparations for making aerated water; preparations for making liqueurs; preparations for making mineral water; preparations for making beverages; must; grape must, unfermented; beer wort; malt wort; pastilles for effervescing beverages; sherbets [beverages]; non-alcoholic fruit extracts; extracts of hops for making beer; essences for making beverages.

(260) AM 2017 90276 A

(800) 1325723

(891) 2016 07 28

(731) PIDILITE INDUSTRIES LIMITED  
Regent Chambers, 7th floor, Jammalal  
Bajaj, Marg, 208, Nariman Point, Mumbai  
400021, India

(540)

## US-PRO

(511)

1 – Adhesives used in industry.

(260) AM 2017 90296 A

(800) 1230930

(891) 2016 12 09

(731) WÖRWAG PHARMA GMBH & CO. KG  
Calwer Strasse 7, 71034 Böblingen,  
Germany

(540)

## Duloxgamma

(511)

5 – Pharmaceutical, veterinary and sanitary preparations; dietetic preparations adapted for medical use; nutritional supplements adapted for medical use; nutritional supplements adapted for medical use, with a base of vitamins, minerals and trace elements, with added substances of animal and vegetable origin, included in this class.

(260) AM 2017 90307 A

(800) 1327321

(891) 2016 09 14

(731) Aktsionernoe obshchestvo "ESSEN  
PRODUCTION AG"  
New Passage 3, of. 95, Avtozavodsky district,  
RU-445037 City of Tolyatti, Samara Region,  
Russian Federation

(540)

## ВЕЧЕРНИЙ ВАЛЬС

(591) Black, white

(511)

30 – Confectionery; peanut confectionery; almond confectionery; confectionery for decorating Christmas trees; sweetmeats; peppermint sweets; liquorice (confectionery); stick liquorice (confectionery); pastilles (confectionery); caramels (candy); chocolate; pastries; waffles; marzipan; almond biscuits; petits fours (cakes); biscuits; cookies; gingerbread; cakes; berry cakes; fruit cakes; pralines.



(260) AM 2017 90308 A  
 (800) 1327322  
 (891) 2016 09 14  
 (731) Aktsionernoe obshchestvo "ESSEN  
 PRODUCTION AG"  
 New Passage 3, of. 95, Avtozavodsky district,  
 RU-445037 City of Tolyatti, Samara Region,  
 Russian Federation

(540)



(591) Black, white

(511)

30 – Sweetmeats; peppermint sweets; liquorice (confectionery); pastilles (confectionery); caramels; chocolate.

(260) AM 2017 90310 A

(800) 1327363

(891) 2016 08 30

(731) HUAWEI TECHNOLOGIES CO., LTD.  
 Administration Building Huawei Technolo-  
 gies Co., Ltd., Bantian, Longgang District,  
 Shenzhen, China

(540)

# HUAWEI GT

(591) Black, white

(511)

9 – Laptop computers; couplers (data processing equipment); tablet computers; protective cases for tablet computers; supports for tablet computers; mouse (computer peripheral); magnetic encoded identification bracelets; computer keyboards; protective covers for tablet computers; pedometers; wearable activity trackers; electric batteries for mobile phones; cases for smartphones; telephone sheath; modems; cell phone straps; network communication equipment; routers; smartphones; covers for smartphones; headphones; television apparatus; set-top boxes; portable cabinets for loudspeakers; sound transmitting apparatus; camcorders; electric monitoring apparatus; portable media players; earphones; digital photo frames; screens for mobile phones.

(260) AM 2017 90312 A

(800) 1326220

(891) 2016 04 19

(731) CRRC CORPORATION LIMITED  
 No.16, Central West Fourth Ring Road,  
 Haidian District, 100038 Beijing, China

(540)

# CRRC

(591) black and white

(511)

7 – Woodworking machines; cranes [lifting and hoisting apparatus]; casting equipment; internal combustion engine [other than for land vehicles]; wind driven power equipment; wind driven power generation assembly; dynamos; generators of electricity; pistons [parts of machines or engines]; valves [parts of machines]; compressed air machines; shaft couplings [machines]; springs [parts of machines]; machine wheelwork; gears, other than for land vehicles; shock absorber [machine parts].

9 – Computers; measures; surveying apparatus and instruments; speed checking apparatus for vehicles; current rectifiers; distribution boxes [electricity]; distribution consoles [electricity]; batteries.

11 – Lights for vehicles; cooling appliances and installations; air cooling apparatus; ventilation [air-conditioning] installations for vehicles; air purifying apparatus and machines; boilers, other than parts of machines; disinfectant apparatus.

12 – Railway couplings; flanges for railway wheel tires; bogies for railway cars; railway cars; buffers for railway rolling stock; traction engines; locomotives; locomotive wheel; automobiles; shock absorbing springs for vehicles; shock absorbers for vehicles; gearing for land vehicles; brakes for land vehicles; driving motors for land vehicles; driving motors for land vehicles; bodies for vehicles; gear transmission devices for rail trains; brake devices for light rail or subway trains; brake devices for rail trains; brake devices for land vehicles; electric vehicles; carriages [railways]; ships.

36 – Insurance underwriting; financing services; real estate management; surety services; trusteeship; lending against security.

37 – Construction; heating equipment installation and repair; electric appliance installation and repair; vehicle maintenance; shipbuilding; rustproofing; rustproofing; dry cleaning; fire alarm installation and repair.

39 – Transport; boat rental; boat transport; vehicle rental; storage; courier services [messages or merchandise]; travel tour operating and organising services; travel guide and travel information services; transport by pipeline.

40 – Welding services; metal plating; metal treating; metal casting; textile treating; air purification; water treating.

41 – Instruction services; organization of competitions [education or entertainment]; mobile library

services; publication of books; production of radio and television programmes; entertainment; health club services [health and fitness training]; modelling for artists.

43 – Accommodation bureau services [hotels, boarding houses]; cafes; rental of transportable buildings; retirement home services; day-nursery services.

(260) AM 2017 90313 A

(800) 1326232

(891) 2016 07 28

(731) EGIS GYÓGYSZERGYÁR ZRT.

Keresztúri út 30-38, H-1106 Budapest,  
Hungary

(540)

**NYMABIS**

(511)

5 – Pharmaceutical preparations for human use.

(260) AM 2017 90314 A

(800) 1327384

(891) 2016 10 20

(731) LIMITED LIABILITY COMPANY

"PREMIORI"

Vul. Levanevskogo, 91, Bila Tserkva,  
Kyivska oblast 09100, Ukraine

(540)

**PREMIORI**  
Solara S Plus

(591) Black, white

(511)

12 – Automobile tires; casings for pneumatic tires; inner tubes for pneumatic tires; vehicle wheels; pneumatic tires; tires for vehicle wheels.

(260) AM 2017 90315 A

(800) 1326233

(891) 2016 07 28

(731) EGIS GYÓGYSZERGYÁR ZRT.

Keresztúri út 30-38, H-1106 Budapest,  
Hungary

(540)

**NOABSOR**

(511)

5 – Pharmaceutical preparations for human use.

(260) AM 2017 90316 A

(800) 1326260

(891) 2016 09 06

(731) COTTON CLUB INVESTMENT LLC

1 st Lipovy per., vl. 4, d. Sobolikha,

RU-143985 g. Balashiha, Moscow obl.,  
Russian Federation

(540)



(591) brown, white, red and black

(511)

3 – Cotton wool for cosmetic purposes; make-up; perfumes; ionone [perfumery]; cosmetic pencils; adhesives for affixing false hair; cosmetic dyes; cosmetic creams; skin whitening creams; creams for leather; nail polish; hair lotions; oils for perfumes and scents; oils for cosmetic purposes; oils for toilet purposes; essential oils of citron; essential oils of cedarwood; essential oils of lemon; essential oils; soap; disinfectant soap; deodorant soap; soap for brightening textile; cakes of toilet soap; medicated soap; almond soap; cosmetic kits; lipsticks; cosmetic preparations for baths; hair waving preparations; paint stripping preparations; lacquer-removing preparations; nail care preparations; make-up powder; false eyelashes; tissues impregnated with cosmetic lotions; eyebrow cosmetics; make-up preparations; cosmetic preparations for eyelashes; cosmetics; soap for foot perspiration; antiperspirants [toilettries]; talcum powder, for toilet use; shampoos; lip glosses; petroleum jelly for cosmetic purposes; toilet water; dental bleaching gels; hair spray; lotions for cosmetic purposes.

5 – Antiseptic cotton; absorbent cotton; wadding for medical purposes; dressings, medical; surgical dressings; corn remedies; sanitary pads; tissues impregnated with pharmaceutical lotions; remedies for perspiration; vulnerary sponges; sea water for medicinal bathing; mineral waters for medical purposes; thermal water; dietetic beverages adapted for medical purposes; breast-nursing pads; pomades for medical purposes; babies' napkin-pants [diaper-pants]; babies' diapers [napkins].

10 – Abdominal belts; hypogastric belts; abdominal corsets; childbirth mattresses; hearing aids; ear trumpets; clips, surgical; needles for medical purposes; suture needles; pessaries; hot air therapeutic apparatus; hot air vibrators for medical purposes; draw-sheets for sick beds; incontinence sheets; catheters; nursing appliances; radium tubes for medical purposes; teething rings; supportive bandages; splints, surgical; bandages, elastic; galvanic belts for medical purposes; X-ray apparatus for medical purposes; bed pans; basins for medical purposes; obstetric apparatus for cattle; feeding bottles; knives for surgical purposes; scalpels; boots for medical pur-

poses; bougies [surgery]; spittoons for medical purposes; catgut; stretchers, wheeled; ambulance stretchers; orthopedic articles; trusses; arch supports for footwear; strait jackets; cannulae; gloves for medical purposes; appliances for washing body cavities; belts for medical purposes; maternity belts; orthopedic belts; dentists' armchairs; castrating pincers; heating cushions [pads], electric, for medical purposes; orthopedic footwear; artificial teeth; surgical sponges; surgical apparatus and instruments; instrument cases for use by doctors; thread, surgical; anaesthetic apparatus; scissors for surgery; thermo-electric compresses [surgery]; compressors [surgical]; droppers for medical purposes; corn knives; esthetic massage apparatus; cushions for medical purposes; surgical cutting instruments; incubators for medical purposes; spoons for administering medicine; tongue scrapers; ear picks; dental burs; dental apparatus and instruments; pins for artificial teeth; dentures; lancets; mirrors for dentists; finger guards for medical purposes; syringes for injections; drainage tubes for medical purposes; water bags for medical purposes; radiology screens for medical purposes; electrocardiographs; probes for medical purposes; pumps for medical purposes; blood testing apparatus; armchairs for medical or dental purposes; dropper bottles for medical purposes; forceps; galvanic therapeutic appliances; gloves for massage; gastroscopes; ice bags for medical purposes; hemocytometers; hydrostatic [water] beds for medical purposes; hypodermic syringes; abdominal pads; inhalers; injectors for medical purposes; soporific pillows for insomnia; urological apparatus and instruments; insufflators; enema apparatus for medical purposes; ultraviolet ray lamps for medical purposes; lasers for medical purposes; breast pumps; lamps for medical purposes; vaporizers for medical purposes; urinals [vessels]; artificial jaws; anaesthetic masks; massage apparatus; medical apparatus and instruments; receptacles for applying medicines; cases fitted for medical instruments; artificial limbs; mirrors for surgeons; furniture especially made for medical purposes; obstetric apparatus; umbilical belts; ophthalmometers; ophthalmoscopes; hearing protectors; artificial skin for surgical purposes; tips for crutches for invalids; balling guns; condoms; sphygmomanometers; quartz lamps for medical purposes; apparatus and installations for the production of X-rays, for medical purposes; X-ray photographs for medical purposes; radiological apparatus for medical purposes; radiotherapy apparatus; resuscitation apparatus; X-ray tubes for medical purposes; protection devices against X-rays, for medical purposes; respirators for artificial respiration; apparatus for artificial respiration; saws for surgical purposes; artificial breasts; uterine syringes; vaginal syringes; stethoscopes; babies' pacifiers [teats]; supports for flat feet; apparatus for the treatment of deafness; suspensory bandages; suture materials; operating tables; trocars; urethral

probes; urethral syringes; cupping glasses; veterinary apparatus and instruments; bed vibrators; vibromassage apparatus; artificial eyes; aerosol dispensers for medical purposes; air pillows for medical purposes; air cushions for medical purposes; air mattresses, for medical purposes; syringes for medical purposes; elastic stockings for surgical purposes; stockings for varices; crutches; feeding bottle valves; feeding bottle teats; orthopedic soles; sterile sheets, surgical; beds, specially made for medical purposes; electrodes for medical use; belts, electric, for medical purposes; physical exercise apparatus, for medical purposes; incubators for babies; brushes for cleaning body cavities; dental apparatus, electric; filters for ultraviolet rays, for medical purposes; fumigation apparatus for medical purposes; corsets for medical purposes; contraceptives, non-chemical; blankets, electric, for medical purposes; hair prostheses; knee bandages, orthopedic; lenses [intraocular prostheses] for surgical implantation; pads [pouches] for preventing pressure sores on patient bodies; physiotherapy apparatus; spirometers [medical apparatus]; thermometers for medical purposes; acupuncture needles; clothing especially for operating rooms; diagnostic apparatus for medical purposes; electric acupuncture instruments; heart pacemakers; invalids' hoists; masks for use by medical personnel; plaster bandages for orthopedic purposes; surgical drapes; surgical implants comprised of artificial materials; commode chairs; defibrillators; dialyzers; medical guidewires; orthodontic appliances; traction apparatus for medical purposes; containers especially made for medical waste; slings [supporting bandages]; douche bags; love dolls [sex dolls]; microdermabrasion apparatus; body rehabilitation apparatus for medical purposes; pulse meters; stents; ear plugs [ear protection devices]; temperature indicator labels for medical purposes; walking frames for disabled persons; tomographs for medical purposes; apparatus for acne treatment; lice combs; quad canes for medical purposes; walking aids for medical purposes; endoscopy cameras for medical purposes; heart rate monitoring apparatus; compression garments; sex toys; brain pacemakers; implantable subcutaneous drug delivery devices; biodegradable bone fixation implants; tongue depressors for medical purposes; nasal aspirators; teeth protectors for dental purposes; menstrual cups; testing apparatus for medical purposes; thermal packs for first aid purposes.

16 – Steel letters; steel pens; adhesive tape dispensers [office requisites]; address stamps; addressing machines; paper; advertisement boards of paper or cardboard; franking machines for office use; staples for offices; pen clips; stapling presses [office requisites]; albums; pictures; prints [engravings]; cigar bands; pencil sharpening machines, electric or non-electric; bookends; hand-rests for painters; aquarelles; architects' models; document files [stationery]; writing slates; slate pencils; silver paper; modelling

clay; arithmetical tables; engravings; lithographic works of art; paintings [pictures], framed or unframed; pencils; newspapers; periodicals; atlases; loose-leaf binders; gummed tape [stationery]; mats for beer glasses; tickets; drawing pads; pads [stationery]; spools for inking ribbons; wristbands for the retention of writing instruments; pamphlets; embroidery designs [patterns]; drawing pins; moisteners [office requisites]; painters' brushes; blotters; stamps [seals]; sealing stamps; inking pads; sealing wax; sealing machines for offices; sealing compounds for stationery purposes; writing or drawing books; trays for sorting and counting money; tracing patterns; tracing paper; tracing cloth; finger-stalls [office requisites]; printing type; carbon paper; paper for recording machines; note books; square rulers; cards; teaching materials [except apparatus]; index cards [stationery]; paper sheets [stationery]; cardboard; hat boxes of cardboard; perforated cards for Jacquard looms; cardboard tubes; catalogues; tags for index cards; song books; rosaries; composing frames [printing]; folders for papers; painters' easels; numbers [type]; Indian inks; chromolithographs [chromos]; modelling wax, not for dental purposes; files [office requisites]; office perforators; toilet paper; books; compasses for drawing; type [numerals and letters]; composing sticks; letter trays; pencil leads; histological sections for teaching purposes; French curves; covers [stationery]; writing chalk; chalk for lithography; tailors' chalk; chalk holders; pencil holders; pencil lead holders; paper clasps; rollers for typewriters; transfers [decalcomanias]; graphic prints; graining combs; drawing boards; drawing materials; drawing instruments; diagrams; envelopes [stationery]; duplicators; etchings; wrapping paper; nibs; typewriters, electric or non-electric; pen cases; nibs of gold; erasing products; writing materials; shields [paper seals]; erasing shields; rubber erasers; electrocardiograph paper; punches [office requisites]; ink; inking ribbons; inkwells; envelope sealing machines, for offices; photographs [printed]; pen wipers; seals [stamps]; fabrics for bookbinding; drawing sets; ledgers [books]; indexes; figurines [statuettes] of papier mâché; filter paper; filtering materials [paper]; forms, printed; office requisites, except furniture; charcoal pencils; stencils [stationery]; galley racks [printing]; electrotypes; geographical maps; terrestrial globes; watercolor [watercolour] saucers for artists; graphic reproductions; graphic representations; scrapers [erasers] for offices; engraving plates; hectographs; printed timetables; moisteners for gummed surfaces [office requisites]; postcards; printed matter; hand labelling appliances; printers' blankets, not of textile; printing sets, portable [office requisites]; printed publications; manuals [handbooks]; writing paper; paperweights; tracing needles for drawing purposes; drawing pens; table linen of paper; lithographs; lithographic stones; booklets; luminous paper; papier mâché; manifolds [stationery]; marking

chalk; plastics for modelling; modelling materials; modelling paste; handkerchiefs of paper; inking sheets for duplicators; tablecloths of paper; blackboards; paper-clips; numbering apparatus; oleographs; binding strips [bookbinding]; sealing wafers; palettes for painters; pantographs [drawing instruments]; stationery; parchment paper; pastels [crayons]; sewing patterns; stencil cases; house painters' rollers; canvas for painting; paint boxes [articles for use in school]; plastic film for wrapping; apparatus for mounting photographs; photograph stands; photo-engravings; blueprints; folders [stationery]; fountain pens; stencil plates; stencils; portraits; covers of paper for flower pots; mimeograph apparatus and machines; paper tapes and cards for the recordal of computer programmes; prospectuses; paper for radiograms; drawing rulers; printers' galleys; bookbinding material; bookbindings; bookbinding cloth; cords for bookbinding; inking sheets for document reproducing machines; pens [office requisites]; magazines [periodicals]; paper ribbons; typewriter ribbons; bags [envelopes, pouches] of paper or plastics, for packaging; stamp pads; school supplies [stationery]; bookmarkers; greeting cards; steatite [tailor's chalk]; balls for ball-point pens; tablemats of paper; typewriter keys; holders for stamps [seals]; cases for stamps [seals]; postage stamps; stamp stands; transparencies [stationery]; vignetting apparatus; gluten [glue] for stationery or household purposes; adhesives [glues] for stationery or household purposes; adhesive tapes for stationery or household purposes; adhesive bands for stationery or household purposes; address plates for addressing machines; almanacs; calendars; starch paste [adhesive] for stationery or household purposes; paintbrushes; self-adhesive tapes for stationery or household purposes; elastic bands for offices; bibs of paper; wood pulp board [stationery]; wood pulp paper; boxes of cardboard or paper; stands for pens and pencils; bottle envelopes of cardboard or paper; coasters of paper; announcement cards [stationery]; plastic bubble packs for wrapping or packaging; flags of paper; paper shredders for office use; sheets of reclaimed cellulose for wrapping; cabinets for stationery [office requisites]; glue for stationery or household purposes; paper knives [cutters] [office requisites]; garbage bags of paper or of plastics; pencil sharpeners, electric or non-electric; tissues of paper for removing make-up; table napkins of paper; place mats of paper; drawing squares; drawing T-squares; penholders; writing cases [stationery]; inkstands; writing cases [sets]; handwriting specimens for copying; bottle wrappers of cardboard or paper; placards of paper or cardboard; towels of paper; face towels of paper; labels, not of textile; etching needles; viscose sheets for wrapping; gums [adhesives] for stationery or household purposes; gummed cloth for stationery purposes; isinglass for stationery or household purposes; bags for microwave cooking; paper coffee filters;

plastic cling film, extensible, for palletization; inking ribbons for computer printers; signboards of paper or cardboard; stickers [stationery]; bookbinding apparatus and machines [office equipment]; comic books; copying paper [stationery]; holders for checkbooks [cheque books]; ink sticks; ink stones [ink reservoirs]; musical greeting cards; newsletters; packaging material made of starches; waxed paper; writing instruments; credit card imprinters, non-electric; document laminators for office use; Xuan paper for Chinese painting and calligraphy; writing board erasers; clipboards; chart pointers, non-electronic; paper bows; molds for modelling clays [artists' materials]; money clips; trading cards other than for games; absorbent sheets of paper or plastic for foodstuff packaging; humidity control sheets of paper or plastic for foodstuff packaging; correcting tapes [office requisites]; paint trays; marking pens [stationery]; flyers; document holders [stationery]; page holders; polymer modelling clay; obliterating stamps; packing [cushioning, stuffing] materials of paper or cardboard; stuffing of paper or cardboard; banknotes; spray chalk; printed coupons; rice paper; posters; biological samples for use in microscopy [teaching materials]; printing blocks; correcting fluids [office requisites]; desk mats; passport cases; writing brushes; drawer liners of paper, perfumed or not.

21 – Drinking troughs; feeding troughs; steel wool for cleaning; washing boards; thermally insulated containers for food; carpet beaters [hand instruments]; glass bulbs [receptacles]; animal bristles [brushware]; poultry rings; nozzles for watering hose; watering devices; brushes; sprinklers; watering cans; bread baskets, domestic; rings for birds; bird baths; brooms; carpet sweepers; glass flasks [containers]; buckets; basins [receptacles]; cooking pot sets; spouts; currycombs; butter dishes; butter-dish covers; beer mugs; glass jars [carboys]; drinking vessels; heat-insulated containers for beverages; boxes for dispensing paper towels; soap boxes; tea caddies; bowls [basins]; demijohns; boot jacks; glass stoppers; corkscrews, electric and non-electric; glass bowls; bottles; insulating flasks; refrigerating bottles; bottle openers, electric and non-electric; cooking skewers of metal; nail brushes; toilet brushes; lamp-glass brushes; brush goods; material for brush-making; hair for brushes; perfume burners; cruets; cabarets [trays]; birdcages; sifters [household utensils]; heat-insulated containers; decanters; menu card holders; stew-pans; saucepan scourers of metal; cinder sifters [household utensils]; ceramics for household purposes; fly swatters; cauldrons; brushes for footwear; horse brushes; mangers for animals; combs for animals; combs; cloths for cleaning; china ornaments; molds [kitchen utensils]; apparatus for wax-polishing, non-electric; cocktail shakers; glue-pots; glasses [receptacles]; drinking horns; cosmetic utensils; strainers for household purposes; fruit cups; knife rests for the table; closures for pot lids; pot

lids; ironing board covers, shaped; tie presses; blenders, non-electric, for household purposes; sieves [household utensils]; crystal [glassware]; ice cube molds [moulds]; polishing leather; cooking pots; scoops [tableware]; cookery molds [moulds]; cleaning instruments, hand-operated; toothpicks; wash-tubs; plates to prevent milk boiling over; cutting boards for the kitchen; large-toothed combs for the hair; dusting apparatus, non-electric; flat-iron stands; powdered glass for decoration; toilet cases; toilet paper dispensers; soap dispensers; siphon bottles for carbonated water; shoe trees [stretchers]; funnels; spice sets; toilet sponges; sponge holders; furniture dusters; drying racks for laundry; buckets made of woven fabrics; comb cases; earthenware; holders for flowers and plants [flower arranging]; flower pots; whisks, non-electric, for household purposes; mops; frying pans; scrubbing brushes; fruit presses, non-electric, for household purposes; smoke absorbers for household purposes; mess-tins; glove stretchers; cake molds [moulds]; plate glass [raw material]; drinking bottles for sports; grills [cooking utensils]; grill supports; tar-brushes, long handled; powder puffs; glass, unworked or semi-worked, except building glass; insect traps; glass wool other than for insulation; pots; vegetable dishes; liqueur sets; basting spoons [cooking utensils]; majolica; kitchen grinders, non-electric; utensils for household purposes; crumb trays; mosaics of glass, not for building; mills for domestic purposes, hand-operated; wool waste for cleaning; nest eggs, artificial; egg cups; opal glass; opaline glass; scouring pads; bread boards; fitted picnic baskets, including dishes; trouser presses; paper plates; strainers; rolling pins, domestic; electric combs; pie servers; pipettes [wine-tasters]; ironing boards; trays for domestic purposes, of paper; earthenware saucepans; nozzles for watering cans; pepper mills, hand-operated; pepper pots; polishing apparatus and machines, for household purposes, non-electric; polishing materials for making shiny, except preparations, paper and stone; pig bristles; porcelain ware; vases; soap holders; chamber pots; pottery; dustbins; powder compacts; coolers [ice pails]; graters for kitchen use; rat traps; containers for household or kitchen use; napkin rings; salad bowls; salt cellars; syringes for watering flowers and plants; services [dishes]; dishes; tea services [tableware]; napkin holders; vessels of metal for making ices and iced drinks; saucers; shoe horns; soup bowls; eyebrow brushes; mouse traps; statues of porcelain, ceramic, earthenware or glass; sugar bowls; epergnes; cups; clothing stretchers; teapots; buttonhooks; piggy banks; toilet utensils; urns; tableware, other than knives, forks and spoons; perfume vaporizers; glass incorporating fine electrical conductors; painted glassware; glass for vehicle windows [semi-finished product]; mugs; aerosol dispensers, not for medical purposes; works of art of porcelain, ceramic, earthenware or glass; table pla-

tes; pressure cookers [autoclaves], non-electric; beaters, non-electric; heaters for feeding bottles, non-electric; shaving brushes; shaving brush stands; candle rings; boxes of glass; candy boxes; candelabra [candlesticks]; kettles, non-electric; tea infusers; toothbrushes; electric brushes, except parts of machines; busts of porcelain, ceramic, earthenware or glass; covers, not of paper, for flower pots; coffee grinders, hand-operated; coffee services [tableware]; coffee filters, non-electric; coffee percolators, non-electric; coasters, not of paper and other than table linen; abrasive pads for kitchen purposes; deep fryers, non-electric; non-electric portable coldboxes; water apparatus for cleaning teeth and gums; chamois leather for cleaning; wax-polishing appliances, non-electric, for shoes; cheese-dish covers; baskets for domestic use; trays for domestic purposes; cotton waste for cleaning; dish covers; trivets [table utensils]; pitchers; kitchen containers; kitchen utensils; cooking utensils, non-electric; toothpick holders; toothbrushes, electric; deodorising apparatus for personal use; brushes for cleaning tanks and containers; signboards of porcelain or glass; sponges for household purposes; feather-dusters; dusting cloths [rags]; vitreous silica fibers [fibres], not for textile use; fiberglass other than for insulation or textile use; figurines [statuettes] of porcelain, ceramic, earthenware or glass; fiberglass thread, not for textile use; coffeepots, non-electric; tea strainers; flasks; gloves for household purposes; tankards; cruet sets for oil and vinegar; polishing gloves; candle extinguishers; baby baths, portable; cages for household pets; cloth for washing floors; litter boxes [trays] for pets; fused silica [semi-worked product], other than for building; waffle irons, non-electric; bread bins; chopsticks; cleaning tow; clothes-pegs; cocktail stirrers; confectioners' decorating bags [pastry bags]; cookie [biscuit] cutters; cookie jars; cups of paper or plastic; drinking glasses; floss for dental purposes; gardening gloves; hot pots, not electrically heated; isothermic bags; lazy susans; lunch boxes; mixing spoons [kitchen utensils]; noodle machines, hand-operated; pastry cutters; plungers for clearing blocked drains; spatulas [kitchen utensils]; abrasive sponges for scrubbing the skin; garlic presses [kitchen utensils]; disposable table plates; towel rails and rings; toilet paper holders; indoor aquaria; aquarium hoods; indoor terrariums [vivariums]; mop wringers; waste paper baskets; window-boxes; drinking straws; tea cosies; make-up removing appliances; electric devices for attracting and killing insects; baking mats; boot trees [stretchers]; hip flasks; cosmetic spatulas; dripping pans; fly traps; candle jars [holders]; food steamers, non-electric; make-up sponges; crushers for kitchen use, non-electric; potholders; oven mitts; basting brushes; car washing mitts; make-up brushes; mop wringer buckets; tortilla presses, non-electric [kitchen utensils]; ski wax brushes; enamelled glass, not for building; dishwashing brus-

hes; indoor terrariums [plant cultivation]; bulb basters.

22 – Brattice cloth; tarpaulins; strips for tying-up vines; wood shavings; wood wool; sawdust; flock [stuffing]; raw silk; nets for camouflage; raw fibrous textile; fishing nets; camel hair; hemp; tow; hemp bands; schappe [raw silk waste]; coconut fiber [fibre]; cocoons; ropes, not of metal; ropes; whipcord; rope ladders; raw cotton; cotton tow; horsehair; down [feathers]; eiderdown; padding materials, not of rubber, plastics, paper or cardboard; packing string; upholstery wool [stuffing]; string; fibrous gaskets for ships; vitreous silica fibers [fibres] for textile use; twine made of paper; twine for nets; silk flock; wool flock; sheaf-binding yarns; hammocks; grasses for upholstering; ladder tapes for Venetian blinds; jute; kapok; snares [nets]; network; raw or treated wool; carded wool; combed wool; liber; wax ends; raw linen [flax]; feathers for bedding; awnings of textile; sails; wadding for filtering; wadding for padding and stuffing upholstery; straw for stuffing upholstery; feathers for stuffing upholstery; animal hair; ramie fibre; raffia; bags [sacks] for the transport and storage of materials in bulk; bags [envelopes, pouches] of textile, for packaging; esparto grass; tents; fleece wool; shorn wool; seaweed for stuffing; vehicle covers, not fitted; textile fibers [fibres]; sisal; wrapping or binding bands, not of metal; thread, not of metal, for wrapping or binding; braces, not of metal, for handling loads; straps, not of metal, for handling loads; slings, not of metal, for handling loads; cables, not of metal; covers for camouflage; binding thread, not of metal, for agricultural purposes; carbon fibers [fibres] for textile use; sash cords; cords for hanging pictures; cotton waste [flock] for padding and stuffing; packing rope; plastic fibers [fibres] for textile use; glass fibers [fibres] for textile use; nets; linters; awnings of synthetic materials; car towing ropes; mail bags; sails for ski sailing; bags for washing hosiery; body bags; purse seines; net pens for fish farming; canvas for sails; packing [cushioning, stuffing] materials, not of rubber, plastics, paper or cardboard; bindings, not of metal.

24 – Adhesive fabric for application by heat; fabric, impervious to gases, for aeronautical balloons; fabric of imitation animal skins; upholstery fabrics; bath linen, except clothing; banners; billiard cloth; fabric; bolting cloth; buckram; brocades; textile material; cloth; canvas for tapestry or embroidery; trellis [cloth]; hemp fabric; hemp cloth; hat linings, of textile, in the piece; lining fabric for shoes; fabric for footwear; table runners; cheviots [cloth]; oilcloth for use as tablecloths; velvet; felt; cotton fabrics; bed covers; mattress covers; tick [linen]; bed covers of paper; tablecloths, not of paper; travelling rugs [lap robes]; crepe [fabric]; crepon; damask; lingerie fabric; linings [textile]; sheets [textile]; shrouds; flags,

not of paper; bunting; drugget; eiderdowns [down coverlets]; elastic woven material; curtain holders of textile material; glass cloths [towels]; traced cloth for embroidery; flannel [fabric]; sanitary flannel; frieze [cloth]; cheese cloth; fustian; bath mitts; gauze [cloth]; gummed cloth, other than for stationery; haircloth [sackcloth]; covers [loose] for furniture; silk fabrics for printing patterns; printed calico cloth; jersey [fabric]; jute fabric; woollen cloth; linen cloth; bed linen; diapered linen; table linen, not of paper; household linen; towels of textile; ticks [mattress covers]; furniture coverings of plastic; table napkins of textile; moleskin [fabric]; handkerchiefs of textile; mosquito nets; pillowcases; plastic material [substitute for fabrics]; door curtains; ramie fabric; rayon fabric; curtains of textile or plastic; face towels of textile; silk [cloth]; tulle; esparto fabric; taffeta [cloth]; knitted fabric; net curtains; zephyr [cloth]; calico; coasters [table linen]; tablemats, not of paper; non-woven textile fabrics; bed clothes; sleeping bag liners; cloths for removing make-up; labels of cloth; wall hangings of textile; fiberglass fabrics, for textile use; filtering materials of textile; printers' blankets of textile; chenille fabric; pillow shams; place mats, not of paper; bed blankets; covers for cushions; fabrics for textile use; furniture coverings of textile; fitted toilet lid covers of fabric; shower curtains of textile or plastic; diaper changing cloths for babies; blankets for household pets; marabouts [cloth].

44 – Animal breeding; landscape gardening; public bath services for hygiene purposes; Turkish bath services; beauty salon services; medical clinic services; chiropractic; hairdressing; wreath making; convalescent home services; hospital services; health care; horticulture; gardening; farming equipment rental; massage; medical assistance; opticians' services; plant nursery services; physical therapy; sanatorium services; veterinary assistance; dentistry services; nursing home services; aerial and surface spreading of fertilizers and other agricultural chemicals; animal grooming; blood bank services; flower arranging; hospice services; lawn care; manicuring; midwife services; nursing, medical; pharmacy advice; plastic surgery; tree surgery; vermin exterminating for agriculture, horticulture and forestry; weed killing; pet grooming; hair implantation; services of a psychologist; rental of sanitation facilities; aromatherapy services; artificial insemination services; in vitro fertilization services; tattooing; telemedicine services; landscape design; sauna services; solarium services; health spa services; visagists' services; pharmacists' services to make up prescriptions; therapy services; tree planting for carbon offsetting purposes; aquaculture services; medical equipment rental; health center services; alternative medicine services; speech therapy services; health counselling; depilatory waxing; orthodontic services; medical advice for individuals with disabilities; body piercing; refores-

tation services; palliative care; rest home services; orthodontic services.

---

(260) AM 2017 90317 A  
 (800) 1327397  
 (891) 2016 11 16  
 (731) BAYERISCHE MOTOREN WERKE  
 Aktiengesellschaft Petuelring 130, 80809  
 München, Germany  
 (540)

**X8**

(511)  
 12 – Motor vehicles and parts thereof (except tyres and inner tubes for tyres).

---

(260) AM 2017 90318 A  
 (800) 1326279  
 (891) 2016 10 19  
 (731) KRKA, tovarna zdravil, d.d., Novo mesto  
 Šmarješka cesta 6, SI-8000 Novo mesto,  
 Slovenia  
 (540)

**OXALOXON**

(511)  
 5 – Pharmaceutical preparations.

---

(260) AM 2017 90319 A  
 (800) 1327411  
 (891) 2016 03 16  
 (731) SHANDONG YINBAO TYRE GROUP CO.,  
 LTD.  
 Taitou Town, Shouguang City, Shandong  
 Province, China  
 (540)

**ROADCRUZA**

(591) Black, white  
 (511)  
 12 – Vehicle wheel tires [tyres]; pneumatic tires [tyres]; automobile tires [tyres]; repair outfits for inner tubes; airplane tires; vehicles for locomotion by land, air, water or rail; bicycle tires [tyres]; automobile wheel; automobiles; automobile wheel rims.

---

(260) AM 2017 90320 A  
 (800) 1326281  
 (891) 2016 10 19  
 (731) KRKA, tovarna zdravil, d.d., Novo mesto  
 Šmarješka cesta 6, SI-8000 Novo mesto,  
 Slovenia  
 (540)

**ADOLAX**

(511)  
5 – Pharmaceutical preparations.

(260) AM 2017 90321 A

(800) 1326284

(891) 2016 09 08

(731) Obshchestvo s ogranichennoy  
otvetstvennostyu "SPETSIALNIE SISTEMY  
I TEHNOLOGII"  
Proektiruemy proezd 5274, str. 7,  
g. Mytishchi, RU-141008 Moskovskaya  
oblast, Russian Federation

(540)

**WARMON**

(591) black and white

(511)

6 – Aluminium; fittings of metal for building; white metal; beacons of metal, non-luminous; vats of metal; beams of metal; joists of metal; bottles [metal containers] for compressed gas or liquid air; tin cans; reels of metal, non-mechanical, for flexible hoses; beryllium [glucinium]; arbours [structures] of metal; blooms [metallurgy]; ingots of common metal; anchors; bolts of metal; eye bolts; casks of metal; mooring buoys of metal; barrels of metal; bronze; letters and numerals of common metal, except type; silos of metal; busts of common metal; vanadium; vice benches of metal; tungsten; hoppers of metal, non-mechanical; sleeves [metal hardware]; ferrules of metal for handles; signboards of metal; diving boards of metal; loading gauge rods, of metal, for railway waggons; nuts of metal; galena [ore]; hafnium [celtium]; nails; horseshoe nails; germanium; vice claws of metal; doors of metal; chimney pots of metal; memorial plates of metal; chimney shafts of metal; wall plugs of metal; troughs of metal for mixing mortar; packaging containers of metal; containers of metal for storing acids; jalousies of metal; iron strip; iron, unwrought or semi-wrought; roof gutters of metal; tinplate; door bolts of metal; window fasteners of metal; bolts, flat; binding screws of metal for cables; crampons of metal [cramps]; wheel clamps [boots]; rivets of metal; padlocks; box fasteners of metal; locks of metal for vehicles; closures of metal for containers; latches of metal; tension links; couplings of metal for chains; road signs, non-luminous and non-mechanical, of metal; signs, non-luminous and non-mechanical, of metal; fences of metal; buckles of common metal [hardware]; bronzes [works of art]; works of art of common metal; hardware of metal, small; indium; cabanas of metal; telephone booths of metal; cadmium; paint spraying booths of metal; ropes of metal; cornices of metal; water-pipe valves of metal; drain traps [valves] of metal; metal cages for wild animals; keys; mooring

bollards of metal; cobalt, raw; chill-molds [foundry]; manifolds of metal for pipelines; casings of metal for oilwells; chimney cowls of metal; sealing caps of metal; tent pegs of metal; copper rings; rings of metal; door fittings of metal; fittings of metal for windows; buildings of metal; buildings, transportable, of metal; steel buildings; containers of metal [storage, transport]; fittings of metal for compressed air lines; swimming pools [structures] of metal; identification bracelets of metal, for hospitals; bells for animals; bells; bird baths [structures] of metal; valves of metal, other than parts of machines; screws of metal; aviaries [structures] of metal; tacks [nails]; locks of metal for bags; locks of metal, other than electric; spring locks; gates of metal; bungs of metal; door bells of metal, non-electric; registration plates of metal; telfer cables; greenhouse frames of metal; skating rinks [structures] of metal; cermet; elbows of metal for pipes; bed casters of metal; furniture casters of metal; pillars of metal for building; bottle caps of metal; pegs of metal; split rings of common metal for keys; ferrules of metal; guard rails of metal; baskets of metal; tool boxes of metal, empty; stringers [parts of staircases] of metal; taps of metal for casks; tubing of metal; roofing of metal; turntables [railways]; manhole covers of metal; hooks [metal hardware]; pot hooks of metal; hooks of metal for clothes rails; clothes hooks of metal; chicken-houses of metal; brass, unwrought or semi-wrought; wrapping or binding bands of metal; scaffolding of metal; staircases of metal; ladders of metal; limonite; steel sheets; cast steel; magnesium; manganese; reinforcing materials, of metal, for concrete; reinforcing materials of metal for machine belts; reinforcing materials of metal for pipes; reinforcing materials of metal for building; railway material of metal; materials of metal for funicular railway permanent ways; building materials of metal; refractory construction materials of metal; masts of metal; steel masts; copper, unwrought or semi-wrought; German silver; sheets and plates of metal; common metals, unwrought or semi-wrought; pyrophoric metals; metals in powder form; molybdenum; door knockers of metal; pipe muffs of metal; monuments of bronze for tombs; tombs of metal; flashing of metal, for building; roof flashing of metal; fish plates [rails]; anvils; anvils [portable]; beak-irons [bick-irons]; ferrules of metal for walking sticks; handcuffs; jets of metal; duckboards of metal; belt stretchers of metal; stretchers for metal bands [tension links]; wire stretchers [tension links]; stretchers for iron bands [tension links]; nickel-silver; nickel; niobium; grease nipples; binding thread of metal for agricultural purposes; thread of metal for tying-up purposes; house numbers of metal, non-luminous; braces of metal for handling loads; laths of metal; palings of metal; crash barriers of metal for roads; tree protectors of metal; trellis of metal; windows of metal; ironwork for doors; ironwork for windows; tin; shuttering of



metal for concrete; filings of metal; poles of metal for power lines; props of metal; branching pipes of metal; monuments of metal; monuments of metal for tombs; wainscotting of metal; signalling panels, non-luminous and non-mechanical, of metal; building panels of metal; partitions of metal; lintels of metal; casement windows of metal; strap-hinges of metal; shims; rocket launching platforms of metal; transport pallets of metal; platforms, prefabricated, of metal; floor tiles of metal; anchor plates; grave slabs of metal; lead seals; loading pallets of metal; handling pallets of metal; firedogs [andirons]; armor-plating; paving blocks of metal; roof coverings of metal; linings of metal for building; steel strip; floors of metal; sills of metal; ceilings of metal; gold solder; silver solder; door closers, non-electric; door openers, non-electric; collars of metal for fastening pipes; winding spools of metal, non-mechanical, for flexible hoses; floating docks of metal, for mooring boats; aluminium wire; iron wire; wire of common metal; wire of common metal alloys, except fuse wire; barbed wire; copper wire, not insulated; soldering wire of metal; steel wire; springs [metal hardware]; rods of metal for welding; rods of metal for brazing and welding; rods of metal for brazing; window frames of metal; frames of metal for building; containers of metal for liquid fuel; containers of metal for compressed gas or liquid air; tanks of metal; floating containers of metal; rails of metal; grilles of metal; runners of metal for sliding doors; iron ores; ores of metal; chrome ores; tool handles of metal; door handles of metal; scythe handles of metal; knife handles of metal; knobs of metal; sheet piles of metal; lead, unwrought or semi-wrought; safes [strong boxes]; insect screens of metal; burial vaults of metal; foot scrapers; cable joints of metal, non-electric; junctions of metal for pipes; nozzles of metal; anti-friction metal; silver-plated tin alloys; alloys of common metal; sheaf binders of metal; bindings of metal; bottle closures of metal; shutters of metal; steel alloys; steel, unwrought or semi-wrought; tinfoil; statues of common metal; figurines [statuettes] of common metal; cask stands of metal; tombstone stelae of metal; advertisement columns of metal; posts of metal; telegraph posts of metal; railway points; slings of metal for handling loads; stair treads [steps] of metal; machine belt fasteners of metal; tombstone plaques of metal; identity plates of metal; tantalum [metal]; greenhouses of metal, transportable; titanium; wire cloth; tombac; mobile boarding stairs of metal for passengers; cables of metal, non-electric; wire rope; pipework of metal; penstock pipes of metal; water-pipes of metal; gutter pipes of metal; ducts of metal for ventilating and air conditioning installations; drain pipes of metal; chimneys of metal; pipes of metal; ducts of metal, for central heating installations; steel pipes; turnstiles of metal; angle irons; tinsplate packings; bicycle parking installations of metal; wind-driven bird-repelling devi-

ces made of metal; towel dispensers, fixed, of metal; tungsten iron; molybdenum iron; silicon iron; titanium iron; chrome iron; flanges of metal [collars]; weather- or wind-vanes of metal; aluminium foil; foils of metal for wrapping and packaging; ice moulds of metal; foundry molds [moulds] of metal; fittings of metal for coffins; fittings of metal for beds; fittings of metal for furniture; building or furniture fittings of nickel-silver; chromium; cattle chains; chains of metal; safety chains of metal; zinc; zirconium; cast iron, unwrought or semi-wrought; washers of metal; hinges of metal; poles of metal; cashboxes of metal; safety cashboxes; pulleys of metal, other than for machines; railroad ties of metal; window casement bolts; spurs; pins [hardware]; roller blinds of steel; badges of metal for vehicles; lock bolts; tool chests of metal, empty; boxes of common metal; letter boxes of metal; door frames of metal; brackets of metal for building; pitons of metal; hooks of metal for roofing slates; traps for wild animals; moldings of metal for cornices; canopies [building structures] of metal; rope thimbles of metal; wall claddings of metal for building; enclosures of metal for tombs; barrel hoops of metal; wall linings of metal for building; tiles of metal for building; iron slabs; tile floorings of metal; door panels of metal; straps of metal for handling loads; furnace fireguards of metal; window pulleys; broom handles of metal; outdoor blinds of metal; bars for metal railings; step stools of metal; chests of metal; door stops of metal; door fasteners of metal; stops of metal; sash fasteners of metal for windows; window stops of metal; clips of metal for cables and pipes; roofing tiles of metal; balls of steel; crampons [climbing irons]; chests of metal for food; cotter pins of metal; latch bars of metal.

9 – DVD players; ticket dispensers; coin-operated musical automata [juke boxes]; answering machines; fire engines; accumulators, electric; accumulators, electric, for vehicles; actinometers; alidades; altimeters; ammeters; anemometers; anodes; antennas; anticathodes; apertometers [optics]; high-frequency apparatus; testing apparatus not for medical purposes; remote control apparatus; electro-dynamic apparatus for the remote control of railway points; electro-dynamic apparatus for the remote control of signals; monitoring apparatus, electric; sound recording apparatus; Global Positioning System [GPS] apparatus; distillation apparatus for scientific purposes; diffraction apparatus [microscopy]; air analysis apparatus; apparatus to check franking; sound transmitting apparatus; apparatus for fermentation [laboratory apparatus]; breathing apparatus for underwater swimming; breathing apparatus, except for artificial respiration; apparatus and installations for the production of X-rays, not for medical purposes; cash registers; electric apparatus for commutation; intercommunication apparatus; stills for laboratory experiments; projection apparatus; radiolo-

gical apparatus for industrial purposes; X-ray apparatus not for medical purposes; blueprint apparatus; flashing lights [luminous signals]; stereoscopic apparatus; telephone apparatus; facsimile machines; phototelegraphy apparatus; igniting apparatus, electric, for igniting at a distance; acid hydrometers; salimeters; acidimeters for batteries; aerometers; beacons, luminous; battery jars; barometers; anode batteries; galvanic batteries; batteries for lighting; solar batteries; batteries, electric; balances [steelyards]; betatrons; binoculars; electronic tags for goods; magnetic tape units for computers; computer memory devices; fire hose nozzles; encoded identification bracelets, magnetic; safety tarpaulins; signalling buoys; life buoys; marking buoys; directional compasses; vacuum gauges; electrolyzers; variometers; verniers; scales; letter scales; weighbridges; precision balances; levelling staffs [surveying instruments]; camcorders; video cassettes; video telephones; video screens; viewfinders, photographic; sockets, plugs and other contacts [electric connections]; micrometer screws for optical instruments; viscosimeters; circuit closers; wavemeters; voltmeters; switchboxes [electricity]; current rectifiers; gas testing instruments; gasometers [measuring instruments]; galvanometers; hands-free kits for telephones; heliographic apparatus; hygrometers; hydrometers; weights; peepholes [magnifying lenses] for doors; holograms; plotters; sounding leads; plumb bobs; range finders; densimeters; densitometers; optical goods; detectors; smoke detectors; counterfeit [false] coin detectors; transparencies [photography]; slide projectors; diaphragms [photography]; dictating machines; dynamometers; light-emitting diodes [LED]; floppy disks; sound recording discs; disks, magnetic; optical discs; circular slide rules; disk drives for computers; juke boxes for computers; DNA chips; electronic notice boards; bullet-proof waistcoats [vests (Am.)]; life jackets; identification threads for electric wires; nose clips for divers and swimmers; locks, electric; bells [warning devices]; alarm bells, electric; electric door bells; signal bells; acoustic conduits; mirrors for inspecting work; road signs, luminous or mechanical; mechanical signs; signs, luminous; marine depth finders; probes for scientific purposes; buzzers; needles for record players; measures; pressure measuring apparatus; simulators for the steering and control of vehicles; inverters [electricity]; pressure indicators; temperature indicators; temperature indicator labels, not for medical purposes; incubators for bacteria culture; measuring instruments; cosmographic instruments; mathematical instruments; levelling instruments; instruments containing eyepieces; surveying instruments; azimuth instruments; interfaces for computers; ionization apparatus not for the treatment of air or water; spark-guards; coaxial cables; fibre [fiber (Am.)] optic cables; cables, electric; calipers; slide calipers; screw-tapping gauges; calculating machi-

nes; pocket calculators; decompression chambers; cinematographic cameras; electronic pens [visual display units]; holders for electric coils; identity cards, magnetic; video game cartridges; encoded magnetic cards; riding helmets; protective helmets; carriers for dark plates [photography]; automated teller machines [ATM]; cathodes; spools [photography]; choking coils [impedance]; coils, electric; electromagnetic coils; cinematographic film, exposed; computer keyboards; solenoid valves [electromagnetic switches]; wire connectors [electricity]; electronic agendas; push buttons for bells; magnetic encoders; anti-glare visors; collectors, electric; calibrating rings; protective suits for aviators; commutators; compact discs [audio-video]; comparators; marine compasses; computers; laptop computers; notebook computers; condensers [capacitors]; contacts, electric; wind socks for indicating wind direction; traffic cones; branch boxes [electricity]; distribution boxes [electricity]; junction boxes [electricity]; battery boxes; cabinets for loudspeakers; diving suits; galena crystals [detectors]; reflecting discs for wear, for the prevention of traffic accidents; covers for electric outlets; logs [measuring instruments]; lasers, not for medical purposes; lactodensimeters; lactometers; vacuum tubes [radio]; darkroom lamps [photography]; thermionic tubes; amplifying tubes; flashlights [photography]; head cleaning tapes [recording]; magnetic tapes; videotapes; surveying chains; fire escapes; rulers [measuring instruments]; slide-rules; lens hoods for cameras; woofers; mouse pads; compact discs [read-only memory]; fire-resistant flying suits; contact lenses; correcting lenses [optics]; optical lenses; optical condensers; sounding lines; electricity conduits; measuring spoons; magnifying glasses [optics]; thread counters; magnets; decorative magnets; crash test dummies; resuscitation mannequins [teaching apparatus]; pressure gauges; divers' masks; solderers' helmets; protective masks; materials for electricity mains [wires, cables]; voting machines; money counting and sorting machines; material testing instruments and machines; furniture especially made for laboratories; megaphones; portable media players; diaphragms [acoustics]; diaphragms for scientific apparatus; metal detectors for Industrial or military purposes; metronomes; rules [measuring instruments]; carpenters' rules; dressmakers' measures; mechanisms for coin-operated apparatus; mechanisms for counter-operated apparatus; coin-operated mechanisms for television sets; shutter releases [photography]; micrometers; microprocessors; microscopes; microtomes; microphones; modems; lightning conductors [rods]; monitors [computer hardware]; monitors [computer programs]; terminals [electricity]; junction sleeves for electric cables; teeth protectors; knee-pads for workers; headphones; surveyors' levels; sound recording carriers; magnetic data media; optical data media; socks, electrically

heated; computer software, recorded; sheaths for electric cables; identification sheaths for electric wires; weighing machines; punched card machines for offices; life saving apparatus and equipment; shoes for protection against accidents, irradiation and fire; objectives [lenses] [optics]; lenses for astrophotography; egg-candlers; fire extinguishers; electrified fences; limiters [electricity]; clothing for protection against accidents, irradiation and fire; clothing for protection against fire; asbestos clothing for protection against fire; clothing especially made for laboratories; ozonisers [ozonators]; octants; eyepieces; ohmmeters; wrist rests for use with computers; eyeglass frames; oscillographs; plumb lines; mirrors [optics]; eyeglasses; sunglasses; goggles for sports; signalling panels, luminous or mechanical; radio pagers; pince-nez; electronic pocket translators; transmitters [telecommunication]; telephone transmitters; transmitters of electronic signals; switches, electric; periscopes; gloves for divers; gloves for protection against accidents; gloves for protection against X-rays for industrial purposes; asbestos gloves for protection against accidents; furnaces for laboratory use; pipettes; pyrometers; planimeters; plane tables [surveying instruments]; plates for batteries; wafers for integrated circuits; printed circuit boards; compact disc players; cassette players; sound recording strips; X-ray films, exposed; films, exposed; life-saving rafts; laboratory trays; semi-conductors; polarimeters; fire pumps; measuring glassware; life belts; fuses; circuit breakers; converters, electric; telerupters; food analysis apparatus; diagnostic apparatus, not for medical purposes; distance recording apparatus; distance measuring apparatus; speed measuring apparatus [photography]; appliances for measuring the thickness of leather; apparatus for measuring the thickness of skins; speed checking apparatus for vehicles; teaching apparatus; time recording apparatus; hemline markers; apparatus and instruments for astronomy; surveying apparatus and instruments; weighing apparatus and instruments; nautical apparatus and instruments; navigational instruments; optical apparatus and instruments; apparatus and instruments for physics; chemistry apparatus and instruments; measuring apparatus; measuring devices, electric; boiler control instruments; meteorological instruments; naval signalling apparatus; observation instruments; navigation apparatus for vehicles [on-board computers]; satellite navigational apparatus; regulating apparatus, electric; precision measuring apparatus; audio- and video-receivers; prisms [optics]; printers for use with computers; retorts' stands; apparatus for changing record player needles; drainers for use in photography; cleaning apparatus for sound recording discs; fire beaters; telescopic sights for firearms; test tubes; pressure indicator plugs for valves; magnetic wires; telegraph wires; telephone wires; wires, electric; conductors, electric; copper wire, insulated; fuse

wire; computer programmes [programs], recorded; computer game software; computer programs [downloadable software]; computer operating programs, recorded; record players; processors [central processing units]; rods for water diviners; electronic publications, downloadable; distribution consoles [electricity]; control panels [electricity]; radar apparatus; masts for wireless aerials; transmitting sets [telecommunication]; radios; vehicle radios; sprinkler systems for fire protection; frames for photographic transparencies; screens for photoengraving; walkie-talkies; voltage surge protectors; voltage regulators for vehicles; stage lighting regulators; light dimmers [regulators], electric; speed regulators for record players; cell switches [electricity]; washing trays [photography]; marking gauges [joinery]; time switches, automatic; relays, electric; safety restraints, other than for vehicle seats and sports equipment; X-ray photographs, other than for medical purposes; rheostats; respirators for filtering air; respiratory masks, other than for artificial respiration; retorts; refractometers; refractors; grids for batteries; speaking tubes; horns for loudspeakers; saccharometers; optical fibers [fibres] [light conducting filaments]; traffic-light apparatus [signalling devices]; dog whistles; signalling whistles; sextants; inductors [electricity]; safety nets; nets for protection against accidents; fire alarms; signals, luminous or mechanical; sirens; scanners [data processing equipment]; integrated circuit cards [smart cards]; connections for electric lines; couplings, electric; connectors [electricity]; sonars; sound locating instruments; lighting ballasts; resistances, electric; spectrograph apparatus; spectroscopes; speed indicators; alcoholmeters; satellites for scientific purposes; protection devices for personal use against accidents; audiovisual teaching apparatus; radiotelegraphy sets; radiotelephony sets; spectacle lenses; anti-glare glasses; optical glass; personal stereos; stereoscopes; stands for photographic apparatus; stroboscopes; fire boats; sulfitometers; bags adapted for laptops; drying racks [photography]; spherometers; integrated circuits; printed circuits; counters; parking meters; kilometer recorders for vehicles; revolution counters; abacuses; egg timers [sandglasses]; taximeters; ear plugs for divers; tachometers; television apparatus; telegraphs [apparatus]; telescopes; telepromoters; teleprinters; cordless telephones; theodolites; thermometers, not for medical purposes; thermostats; thermostats for vehicles; crucibles [laboratory]; tone arms for record players; totalizers; transistors [electronic]; transponders; protractors [measuring instruments]; transformers [electricity]; step-up transformers; vehicle breakdown warning triangles; triodes; starter cables for motors; discharge tubes, electric, other than for lighting; capillary tubes; neon signs; Pitot tubes; X-ray tubes not for medical purposes; telephone receivers; gauges; quantity indicators; automatic indicators of low pressure in vehicle

tires [tyres]; gasoline gauges; water level indicators; electric loss indicators; light-emitting electronic pointers; slope indicators; levels [instruments for determining the horizontal]; mercury levels; spirit levels; urinometers; amplifiers; particle accelerators; electric installations for the remote control of industrial operations; steering apparatus, automatic, for vehicles; balancing apparatus; video recorders; sound reproduction apparatus; invoicing machines; tape recorders; protection devices against X-rays, not for medical purposes; railway traffic safety appliances; data processing apparatus; oxygen transvasing apparatus; theft prevention installations, electric; film cutting apparatus; drying apparatus for photographic prints; optical character readers; centering apparatus for photographic transparencies; dosage dispensers; battery chargers; chargers for electric batteries; acoustic [sound] alarms; sounding apparatus and machines; editing appliances for cinematographic films; cathodic anti-corrosion apparatus; couplers [data processing equipment]; anti-theft warning apparatus; computer peripheral devices; anti-interference devices [electricity]; demagnetizing apparatus for magnetic tapes; acoustic couplers; alarms; fog signals, non-explosive; whistle alarms; adding machines; readers [data processing equipment]; heat regulating apparatus; photocopiers [photographic, electrostatic, thermic]; bar code readers; downloadable ring tones for mobile phones; downloadable image files; downloadable music files; animated cartoons; filters [photography]; filters for respiratory masks; filters for ultraviolet rays, for photography; USB flash drives; magic lanterns; optical lamps; signal lanterns; cameras [photography]; glazing apparatus for photographic prints; shutters [photography]; darkrooms [photography]; photometers; flash-bulbs [photography]; digital photo frames; enlarging apparatus [photography]; photovoltaic cells; containers for contact lenses; eyeglass cases; containers for microscope slides; cases especially made for photographic apparatus and instruments; chromatography apparatus for laboratory use; chronographs [time recording apparatus]; laboratory centrifuges; cyclotrons; compasses [measuring instruments]; frequency meters; time clocks [time recording devices]; Petri dishes; sleeves for laptops; fire blankets; chips [integrated circuits]; jigs [measuring instruments]; pedometers; meteorological balloons; electrified rails for mounting spot lights; asbestos screens for firemen; fire hose; protective helmets for sports; cell phone straps; tripods for cameras; switchboards; distribution boards [electricity]; screens [photography]; workmen's protective face-shields; projection screens; radiology screens for industrial purposes; fluorescent screens; exposure meters [light meters]; ducts [electricity]; galvanic cells; epidiascopes; ergometers; armatures [electricity]; mouse [computer peripheral]; pince-nez mountings; eyeglass chains; eyeglass cords.

11 – Lamp shades; steam accumulators; heat accumulators; defrosters for vehicles; distillation apparatus; desiccating apparatus; hydromassage bath apparatus; disinfectant apparatus; air deodorising apparatus; tanning apparatus [sun beds]; ionization apparatus for the treatment of air or water; coffee roasters; beverage cooling apparatus; hand drying apparatus for washrooms; fruit roasters; water purifying apparatus and machines; refrigerating apparatus and machines; drying apparatus and installations; freezers; drying apparatus; structural plates for ovens; coolers for furnaces; expansion tanks for central heating installations; flushing tanks; refining towers for distillation; bidets; boilers, other than parts of machines; bath tubs; spa baths [vessels]; bath tubs for sitz baths; waffle irons, electric; fans [air-conditioning]; fans [parts of air-conditioning installations]; electric fans for personal use; roasting spits; refrigerating display cabinets; water heaters; water heaters [apparatus]; water flushing installations; air reheaters; extractor hoods for kitchens; gas condensers, other than parts of machines; acetylene generators; hydrants; burners; acetylene burners; petrol burners; gas burners; burners for lamps; germicidal burners; incandescent burners; oxyhydrogen burners; laboratory burners; oil burners; alcohol burners; hot water bottles; footwarmers, electric or non-electric; bed warmers; pocket warmers; warming pans; grills [cooking appliances]; lampshade holders; stills; showers; refrigerating containers; gas lighters; lighters; friction lighters for igniting gas; chimney blowers; coils [parts of distilling, heating or cooling installations]; furnace ash boxes; evaporators; torches for lighting; shower cubicles [enclosures (Am.)]; Turkish bath cabinets, portable; heating apparatus; refrigerating chambers; fireplaces, domestic; chimney flues; pressure cooking saucapans, electric; air valves for steam heating installations; level controlling valves in tanks; thermostatic valves [parts of heating installations]; electrically heated carpets; light bulbs; light bulbs, electric; solar thermal collectors [heating]; distillation columns; furnace grates; ventilation hoods; ventilation hoods for laboratories; lamp globes; air conditioning apparatus; air conditioners for vehicles; gas boilers; laundry room boilers; heating boilers; coffee machines, electric; taps [cocks, spigots] [faucets (Am.)] for pipes; taps [faucets]; mixer taps for water pipes; forges, portable; lava rocks for use in barbecue grills; electric lights for Christmas trees; acetylene flares; safety lamps; gas lamps; curling lamps; germicidal lamps for purifying air; lamps for directional signals of automobiles; light bulbs for directional signals for vehicles; arc lamps; laboratory lamps; oil lamps; ultraviolet ray lamps, not for medical purposes; miners' lamps; electric lamps; chandeliers; barbecues; watering machines for agricultural purposes; disposable sterilization pouches; footmuffs, electrically heated; heaters for baths; heaters for heating

irons; immersion heaters; brackets for gas burners; anti-splash tap nozzles; heat pumps; filaments for electric lamps; magnesium filaments for lighting; heating filaments, electric; luminous house numbers; stoves; heating apparatus for defrosting windows of vehicles; hot air bath fittings; bath fittings; loading apparatus for furnaces; kiln furniture [supports]; sauna bath installations; refrigerating appliances and installations; fabric steamers; lamp reflectors; vehicle reflectors; hearths; steam boilers, other than parts of machines; pasteurisers; lamp mantles; sockets for electric lights; coffee percolators, electric; stoves [heating apparatus]; bakers' ovens; hot air ovens; kitchen ranges [ovens]; microwave ovens [cooking apparatus]; microwave ovens for Industrial purposes; incinerators; kilns; solar furnaces; dental ovens; furnaces, other than for laboratory use; urinals [sanitary fixtures]; feeding apparatus for heating boilers; heating plates; cookers; hot plates; heaters, electric, for feeding bottles; aquarium heaters; aquarium lights; clean chambers [sanitary installations]; water intake apparatus; deodorising apparatus, not for personal use; apparatus for dehydrating food waste; fumigation apparatus, not for medical purposes; gas scrubbing apparatus; oil-scrubbing apparatus; glue-heating appliances; for age drying apparatus; water filtering apparatus; air purifying apparatus and machines; ice machines and apparatus; cooling appliances and installations; cooking apparatus and installations; lighting apparatus and installations; sanitary apparatus and installations; coking rings; lighting apparatus for vehicles; light-emitting diodes [LED] lighting apparatus; heating apparatus for solid, liquid or gaseous fuels; heating apparatus, electric; hot air apparatus; steam facial apparatus [saunas]; safety accessories for water or gas apparatus and pipes; regulating and safety accessories for gas apparatus; regulating accessories for water or gas apparatus and pipes; regulating and safety accessories for water apparatus; regulating and safety accessories for gas pipes; roasting jacks; plate warmers; electric appliances for making yogurt; anti-dazzle devices for automobiles [lamp fittings]; anti-glare devices for vehicles [lamp fittings]; rotisseries; radiator caps; diving lights; washers for water taps; radiators [heating]; central heating radiators; radiators, electric; sinks; disinfectant dispensers for toilets; drip irrigation emitters [irrigation fittings]; light diffusers; nuclear reactors; heat regenerators; pressure water tanks; roasters; lamps; street lamps; ceiling lights; toilet seats; lighting installations for air vehicles; pressure cookers [autoclaves], electric; gas scrubbers [parts of gas installations]; lamp glasses; sterilizers; water sterilizers; air sterilisers; air dryers; laundry dryers, electric; hair dryers; malt roasters; tobacco roasters; heat exchangers, not parts of machines; bread toasters; discharge tubes, electric, for lighting; lamp chimneys; luminous tubes for lighting; pipes [parts of sanitary ins-

tallations]; flues for heating boilers; boiler pipes [tubes] for heating installations; toilets [water-closets]; toilets, portable; humidifiers for central heating radiators; wash-hand basins [parts of sanitary installations]; toilet bowls; water conduits installations; air conditioning installations; desalination plants; installations for processing nuclear fuel and nuclear moderating material; watering installations, automatic; cooling installations for water; cooling installations for liquids; milk cooling installations; cooling installations for tobacco; water purification installations; purification installations for sewage; steam generating installations; water distribution installations; air filtering installations; swimming pool chlorinating apparatus; ventilation [air-conditioning] installations and apparatus; ventilation [air-conditioning] installations for vehicles; water softening apparatus and installations; cooling installations and machines; heating installations; heaters for vehicles; hot water heating installations; polymerisation installations; water supply installations; flare stacks for use in the oil industry; ash conveyor installations, automatic; whirlpool-jet apparatus; air cooling apparatus; aquarium filtration apparatus; cooking utensils, electric; flares; headlights for automobiles; vehicle headlights; filters for air conditioning; filters for drinking water; lights for automobiles; bicycle lights; motorcycle lights; lights for vehicles; pocket torches, electric; lanterns for lighting; Chinese lanterns; fountains; ornamenttal fountains; deep fryers, electric; fittings, shaped, for ovens; oven fittings made of fireclay; bread-making machines; refrigerators; chromatography apparatus for industrial purposes; kettles, electric; dampers [heating]; refrigerating cabinets; ice boxes; fuel economizers; carbon for arc lamps; heating elements; bread baking machines; blankets, electric, not for medical purposes; heating cushions [pads], electric, not for medical purposes; bath installations; air filters for household purposes; coffee filters.

17 – Asbestos; cellulose acetate, semi-processed; ballata; asbestos paper; paper for electrical capacitors; insulating paper; cotton wool for packing [caulking]; mineral wool [insulator]; asbestos felt; insulating felt; plastic fibers [fibres], not for textile use; carbon fibers [fibres], other than for textile use; asbestos fibers [fibres]; vulcanized fiber [fibre]; guttapercha; foam supports for flower arrangements [semi-finished products]; dielectrics [insulators]; floating anti-pollution barriers; lute; insulators; insulators for railway tracks; insulators for electric mains; insulators for cables; asbestos millboards; liquid rubber; synthetic rubber; rubber, raw or semi-worked; valves of india-rubber or vulcanized fiber [fibre]; clack valves of rubber; rings of rubber; watertight rings; insulating paints; insulating varnish; latex [rubber]; insulating tapes; adhesive bands, other than stationery and not for medical or household purposes; self-adhesive tapes, other than stationery and not for medical or household purposes; asbestos sheets; vis-

cose sheets, other than for wrapping; sheets of regenerated cellulose, other than for wrapping; insulating oils; insulating oil for transformers; reinforcing materials, not of metal, for pipes; weatherstripping compositions; caulking materials; brake lining materials, partly processed; soundproofing materials; insulating materials; insulating refractory materials; padding materials of rubber or plastics; rubber material for recapping tires [tyres]; non-conducting materials for retaining heat; boiler composition to prevent the radiation of heat; packing [cushioning, stuffing] materials of rubber or plastics; sealant compounds for joints; filtering materials [semi-processed foams or films of plastic]; compositions to prevent the radiation of heat; bags [envelopes, pouches] of rubber, for packaging; pipe muffers, not of metal; sleeves of rubber for protecting parts of machines; asbestos packing; clutch linings; threads of plastic for soldering; threads of plastic materials, not for textile use; threads of rubber, not for use in textiles; elastic threads, not for use in textiles; stops of rubber; insulating gloves; plastic substances, semi-processed; insulating plaster; plastic sheeting for agricultural purposes; plastic film, other than for wrapping; anti-dazzle films for windows [tinted films]; asbestos coverings; bark coverings for sound insulation; asbestos cloth; rubber stoppers; expansion joint fillers; cylinder jointings; washers of rubber or vulcanized fiber [fibre]; pipe gaskets; weatherstripping; gaskets; rubber solutions; mica, raw or partly processed; acrylic resins [semi-finished products]; synthetic resins [semi-finished products]; junctions, not of metal, for pipes; substances for insulating buildings against moisture; chemical compositions for repairing leaks; glass wool for insulation; fiberglass for insulation; asbestos fabrics; fiberglass [fibreglass] fabrics, for insulation; insulating fabrics; flexible hoses, not of metal; connecting hose for vehicle radiators; waterproof packings; rubber seals for jars; foils of metal for insulating; ebonite [vulcanite] molds [moulds]; asbestos slate; slag wool [insulator]; watering hose; canvas hose pipes; cords of rubber; asbestos safety curtains; ebonite [vulcanite]; shock-absorbing buffers of rubber; fittings, not of metal, for compressed air lines; hoses of textile material.

(260) AM 2017 90322 A  
 (800) 1327415  
 (891) 2016 04 08  
 (731) ADRIATICA S.p.A.  
 Strada Dogado no. 300/19-21, I-45017  
 Loreo (RO), Italy  
 (540)



(591) White and red  
 (511)

1 – Fertilizing preparations, fertilizer compositions, granular fertilizers, water soluble fertilizers, foliar fertilizers, compost and compost supplements, plant growth regulating preparations, biostimulants for the control of nutritional physiological disorders, nutrients for plants, manures.

(260) AM 2017 90324 A  
 (800) 1326325  
 (891) 2016 11 04  
 (731) GLOBAL FUNCTIONAL DRINKS AG  
 Dammstrasse 19, CH-6301 Zug, Switzerland  
 (540)



(591) Red, pink, burgundy, black and white  
 (554) Three-dimensional  
 (511)

32 – Non-alcoholic beverages, non-alcoholic aperitifs, non-alcoholic cocktails, syrups for beverages, vegetable juices (beverages), fruit juices, non-alcoholic fruit beverages, essences for preparing beverages, energy drinks.

(260) AM 2017 90325 A  
 (800) 1327421  
 (891) 2016 04 26  
 (731) LEDVANCE GmbH  
 Parkring 29-33, 85748 Garching, Germany  
 (540)

# 朗德万斯

(591) Black, white  
 (511)

9 – Scientific, nautical, surveying, photographic, cinematographic, optical, weighing, measuring, signalling, checking (supervision), life-saving and teaching apparatus and instruments; electrical apparatus and instruments as well as apparatus and instruments for conducting, switching, transforming, accumulating, regulating or controlling electricity; apparatus for recording, transmission or reproduction of ima-

ges; beamers; overhead projectors; magnetic data carriers; data processing devices and computers; computer programs and software of all kind (included in this class); software applications [apps] for electrical- and communication devices; LED (light emitting diodes) and laser diodes (also organic LEDs and laser diodes); light conductors, optical couplers, optical sensors, light barriers, LED lamp modules, also for signalling purposes; displays in LED-technology; electric and electronic devices and apparatus for the operation, regulation and control of lighting facilities, luminaires and lamps for central building control systems and for the regulation and control of building installations, especially interfaces for such apparatus and devices as well as transformers and electronic ballasts; miniature transformers, choking coils [impedance], electrical connecting and contact elements including plugs, terminals, sleeves, switches, breakers [switches]; parts of all the aforesaid goods included in this class.

10 – Surgical, medical, dental and veterinary apparatus and instruments, artificial limbs, eyes and teeth; orthopedic articles; suture material; medical radiation apparatus and lighting for medical use; parts of all the aforesaid goods included in this class.

11 – Lighting apparatus, especially electric lamps and luminaires; lighting apparatus and lighting systems consisting thereof, especially on the basis of light emitting diodes [LEDs], also organic LEDs; LED lamps and LED luminaires and parts thereof (included in this class); lamps and lighting apparatus as well as systems consisting thereof as well as their parts (included in this class) on the basis of light-emitting diodes [LED]; LED modules, namely modules based on LEDs (also based on organic LEDs) with light functions for lighting purposes.

16 – Printed matter, especially journals, newspapers, books, catalogues and prospectuses.

28 – Games and playthings; gymnastic and sporting articles, included in this class; Christmas tree decoration; parts of all the aforesaid goods, included in this class.

35 – Advertising, namely direct mail advertising, advertising for goods and services on websites, dissemination of advertisements, dissemination of advertisements for others, advertising by mail order; business management; office functions, namely data entry and data processing.

37 – Building constructions, repair and installation services for the construction of lighting systems and advisory services relating thereto; installation, repair and maintenance of solar systems, solar power plants and solar energy products, namely solar cells, solar cell units, solar panels, solar modules and solar connectors, solar power plants and power plants operated on the basis of fossil resources.

42 – Scientific and technological services; scientific and technological research and development as well as designer services related thereto; industrial analysis and research services; design and development of computer hardware and computer software; planning of lighting facilities and consultancy related thereto; architectural services as well as design of interior decor, especially in the field of illumination; providing of non-downloadable software, namely planning and simulation programs for illumination applications, also via the Internet.

(260) AM 2017 90326 A

(800) 1326326

(891) 2016 11 04

(731) GLOBAL FUNCTIONAL DRINKS AG

Dammstrasse 19, CH-6301 Zug, Switzerland

(540)



(591) Red, pink, burgundy, black and white

(554) Three-dimensional

(511)

32 – Non-alcoholic beverages, non-alcoholic aperitifs, non-alcoholic cocktails, syrups for beverages, vegetable juices (beverages), fruit juices, non-alcoholic fruit beverages, essences for preparing beverages, energy drinks.

(260) AM 2017 90337 A

(800) 1326327

(891) 2016 11 04

(731) GLOBAL FUNCTIONAL DRINKS AG

Dammstrasse 19, CH-6301 Zug, Switzerland

(540)





(591) Green, orange, yellow, red, black and white  
 (554) Three-dimensional  
 (511)  
 32 – Non-alcoholic beverages, non-alcoholic aperitifs, non-alcoholic cocktails, syrups for beverages, vegetable juices (beverages), fruit juices, non-alcoholic fruit beverages, essences for preparing beverages, energy drinks.

(260) AM 2017 90390 A  
 (800) 1326643  
 (891) 2016 06 09  
 (731) QIAGEN GmbH  
 Qiagen Str. 1, 40724 Hilden, Germany  
 (540)



(591) Light blue, blue, dark blue, red  
 (511)  
 1 – Chemical, biochemical and biotechnological products for industrial and scientific purposes, namely, diagnostic preparations except for human or veterinary medical purposes, non-medical chemical reagents, enzymes and chemicals solutions in the nature of buffer solutions for scientific and/or medical research use for sample preparation, modification and manipulation of cells and for marking, separating, isolating, purifying, duplicating, sequencing and/or for the analysis of biopolymers, in particular nucleic acids, proteins, macromolecules and biologically active substances, in particular reagents, enzymes and buffer solutions for nucleic acid purification, enrichment, amplification and sequencing; kits comprising chemicals for laboratory or research use for sample preparation, modification and manipulation of cells and for marking, separating, isolating, purifying, duplicating, sequencing and/or for the analysis of biopolymers, in particular nucleic acids, proteins, macromolecules and biologically active substances, in particular nucleic acids of biological or biochemical sample material, in particular comprising chemicals for reagents, enzymes and buffer solutions for nucleic acid purification, enrichment, amplification and sequencing.

5 – Diagnostic preparations for medical purposes; diagnostic preparations for veterinary purposes; diagnostic preparations for humans for medical purposes; preparations for medical and veterinary purposes, namely, diagnostic preparations, for sample preparation, modification and manipulation of cells and for marking, separating, isolating, purifying,

duplicating, sequencing and/or for the analysis of biopolymers, in particular nucleic acids, proteins, macromolecules and biologically active substances, in particular reagents, enzymes and buffer solutions for nucleic acid purification, enrichment, amplification and sequencing; chemical, biochemical and biotechnological preparations for medical and veterinary purposes, namely, diagnostic reagents, enzymes and diagnostic reagents in the nature of buffer solutions for sample preparation, modification and manipulation of cells and for marking, separating, isolating, purifying, duplicating, sequencing and/or for the analysis of biopolymers, in particular nucleic acids, proteins, macromolecules and biologically active substances, in particular reagents, enzymes and buffer solutions for nucleic acid purification, enrichment, amplification and sequencing; kits containing preparations for medical and veterinary diagnostic purposes primarily consisting of diagnostic preparations for sample preparation, modification and manipulation of cells and for marking, separating, isolating, purifying, duplicating, sequencing and/or for the analysis of biopolymers, in particular nucleic acids, proteins, macromolecules and biologically active substances, in particular reagents, enzymes and buffer solutions for nucleic acid purification, enrichment, amplification and sequencing.

9 – Scientific apparatuses, instruments and devices and their structural parts and components therefor for purifying, analyzing and sequencing biomolecules, namely nucleic acids; computer software for use in scientific and medical research for assisting in analyzing, purifying and sequencing biomolecules, namely nucleic acids; scientific apparatuses, instruments and devices for analysis of nucleic acids, namely laboratory robots, pipetting stations, machines for amplifying nucleic acids, detectors for nucleic acids, and nucleic acid sequencers.

(260) AM 2017 90392 A  
 (800) 1326652  
 (891) 2016 11 08  
 (731) Dr. Wild & Co. AG  
 Hofackerstrasse 8, CH-4132 Muttenz,  
 Switzerland  
 (540)

**TEBODONT**

(511)  
 21 – Dental floss; toothbrushes.  
 44 – Hygienic and beauty care.

(260) AM 2017 90393 A  
 (800) 1326664  
 (891) 2016 09 27  
 (731) L'OREAL, Société anonyme  
 14 rue Royale, F-75008 PARIS, France



(540)

## GARNIER BOTANIC SECRETS

(511)

3 – Cosmetic products for body care, cosmetic bath and shower products, hair treatments and preparations.

(260) AM 2017 90394 A

(800) 1115682

(891) 2016 11 24

(731) VAFO PRAHA, s.r.o.

K Brůdku 94, CZ-252 19 Chrášťany, Czech Republic

(540)

# Profine

(591) Black, white

(511)

5 – Vitamin and mineral supplements for pets.

29 – Meat and meat derivatives.

31 – Dry, semi-moist, wet complete and complementary pet food; pet snacks and treats.

(260) AM 2017 90395 A

(800) 1326731

(891) 2016 06 16

(731) CEMENTIR HOLDING S.p.A.

Corso di Francia, 200, I-00191 ROMA, Italy

(540)



(591) Red and white

(511)

19 – Cement; concrete; aggregate materials for use in concrete; lime; mortar.

(260) AM 2017 90396 A

(800) 1326748

(891) 2016 11 29

(731) RIGO TRADING S.A.

Route de Trèves 6 EBBC, Building E,  
L-2633 Senningerberg, Luxembourg

(540)

## STARMIX

(511)

30 – Confectionery.

(260) AM 2017 90398 A

(800) 1326755

(891) 2016 04 29

(731) ORIFLAME COSMETICS AG

c/o Oriflame Global Management AG,  
Bleicheplatz 3, CH-8200 Schaffhausen,  
Switzerland

(540)

## VENTURE

(511)

3 – Non-medicated conditioning and care preparations for application to the hair, scalp, skin and nails; soaps; perfumes; perfumery; eau de cologne; toilet waters; essential and herbal oils; cosmetics; make-up preparations; lipsticks; nail varnishes; nail varnish removers; non-medicated toilet preparations; hair lotions; hair sprays and hair gels; preparations for use in the bath or shower; bath and shower oils, gels, creams and foams; face and body masks; face and body scrubs; facial washes; skin cleansers and hydrators; skin toners; skin moisturizers; blemish creams and blemish gels; deodorants; antiperspirants; preparations for use before shaving and after shaving; shaving soaps; shaving creams; shaving gels; after-shave preparations; pre-shave preparations; talcum powders; toiletries; dentifrices; toothpastes.

(260) AM 2017 90399 A

(800) 1326785

(891) 2016 08 04

(731) HOUSE OF IPY LIMITED

c/o DMH Stallard LLP, 6 New Street  
Square, London EC4A 3BF, United Kingdom

(540)

## IPy

(511)

9 – Software; computer software; application software; application software for social networking services via internet; application software for mobile phones; application software for wireless devices; communication software; communication software for connecting computer network users; communications processing computer software; community software; computer application software; computer application software for mobile telephones; computer e-commerce software; computer programmes; computer programmes for data processing; computer programs [downloadable software]; computer search engine software; computer software applications, downloadable; computer software downloadable from global computer information networks; computer software downloaded from the internet; computer software for application and database integra-

tion; computer software for business purposes; computer software for creating searchable databases of information and data; computer software for organizing and viewing digital images and photographs; computer software for use in providing multiple user access to a global computer information network; computer software platforms; computer software [programmes]; computer software programs; computer software to enable the searching of data; data processing software; downloadable software; software applications for use with mobile devices; software for commerce over a global communications network; software for online messaging; software for tablet computers; computer software for searching, compiling, indexing and organizing information on computer networks; computer software for creating indexes of information, indexes of web sites and indexes of other information resources; holograms for genuine product certification; graphical user interface software; toolbar software for use with search engine software and websites; non printed, electronic and digital publications; software for downloading and for use on and with computers, communications devices and mobile communications devices; software for use in the searching for and retrieval of information; computer software and software development tools for use in developing further software and software applications in the field of e-commerce; computer software that provides web-based access to applications and services through a web operating system or portal interface; application programming interface (API) software; browser extension software; plug-in and add-on software components which add features to existing computer programs.

(260) AM 2017 90401 A

(800) 1195885

(891) 2016 07 22

(731) STUSSY, INC.

17426 Daimler Street, Irvine CA 92614, USA

(540)

**STUSSY**

(511)

31 – Animal foodstuffs; Bird food; Cat food; Cat litter; Dog food; Edible chews for dogs; Flower seeds; Foodstuffs for animals; Pet food; Pet treats (edible); Plant seeds; Wildlife seed mixtures.

(260) AM 2017 90402 A

(800) 1208672

(891) 2016 04 14

(731) AROMSA BESİN AROMA VE KATKI

MADDELERİ SANAYİ VE TİCARET

ANONİM ŞİRKETİ

Gebze Organize Sanayi Bölgesi, İhsan Dede

Caddesi PK.18, GEBZE-KOCAELI, Turkey

(540)



The logo for 'aromsa' features the word 'aromsa' in a lowercase, green, sans-serif font. To the right of the text is a stylized graphic consisting of three curved lines in red, orange, and green, resembling a rising arrow or a plant stem.

(591) Green, orange, red and white

(511)

5 – Pharmaceuticals for human and animal health, chemical preparations for medical purposes; pharmaceuticals, dietetic foods, dietary food supplements; dietary and nutritional supplements used for weight loss; food for babies; medicinal herb teas, herbs for medicinal purposes; products for dental purposes other than dental tools and equipment; hygienic products, hygienic pads for menstruation, disposable diapers for incontinence; plaster for medical purposes, bandages for dressings; babies diapers of paper; babies diapers of textile, babies nappies of paper, babies diapers of paper; preparations for destroying vermin; fungicides, herbicides, air purifying preparations, deodorants other than for personal purposes; disinfectant, antiseptics (for destroying germs), detergents for medical purposes; nutritional food additives for medical purposes in the nature of natural food extracts derived from fruits and herbs.

29 – Meat, fish, poultry, game, meat extracts, broth, pulses for food, namely, preserved or processed beans, chickpeas, lentil, soy beans; instant or pre-cooked soups, bouillon; processed olives, olive pastes, pickles; milk and milk products, namely milk, cheese, yoghurt, ayran (drink based on yoghurt), cream, milk powder, milk based beverages containing fruits; edible oils and fats, butter, margarine; dried, preserved, canned, frozen fruits and vegetables; processed fruits and vegetables; tomato puree, tomato paste; processed and roasted chickpeas, nuts, peanuts, walnuts, pistachio; peanut butter, hazelnut paste, tahini (sesame seed paste); jams, marmalades, fruit jellies; apple sauce, cranberry sauce; eggs, powdered eggs; potato chips.

30 – Coffee, tea, cocoa and artificial coffee; rice; flour and preparations made from cereals; bread, pastry and confectionery; sugar, crystal sugar, cubed sugar, powdered sugar, caramelized sugar, caramel sauce; honey, treacle; yeast, baking-powder; salt; mustard; vinegar, sauces (condiments); spices; ice creams; edible ice; flavorings, other than essential oils for food, for tobacco, for pharmaceutical purposes, for pet food, for animal feed, flavorings and seasonings; sauces, fruit sauce excluding cranberry sauce and apple sauce, fruit extracts used as flavoring (not essential oils); coffee extracts, cocoa extracts.

31 – Grains and agricultural, horticultural and forestry products not included in other classes; live animals; fresh fruits and vegetables; seeds; natural plants and flowers; foodstuffs for animals; malt.

35 – Advertising agencies services, marketing and publicity bureau services including commercial or advertisement exhibition and trade fair organization services; providing office functions; business management; business administration; import and export agencies; business investigations, evaluations, expert business appraisals; auctioneering.

(260) AM 2017 90404 A  
(800) 1242265  
(891) 2016 12 21  
(731) COTECNICA, S.C.C.L.  
Ctra. Nacional II – Km. 494,50. Bellpuig,  
E-25250 LLEIDA, Spain

(540)

**PYLKRON**

(511)  
31 – Products for animal consumption.

(260) AM 2017 90405 A  
(800) 1243252  
(891) 2016 12 21  
(731) COTECNICA, S.C.C.L.  
Ctra. Nacional II – Km. 494,50. Bellpuig,  
E-25250 LLEIDA, Spain

(540)

**BROKATON**

(511)  
31 – Products for animal consumption.

(260) AM 2017 90406 A  
(800) 1247024  
(891) 2016 12 22  
(731) ASTRAZENECA AB  
SE-151 85 Södertälje, Sweden

(540)



(591) Black, white  
(511)  
5 – Pharmaceutical preparations and substances.

(260) AM 2017 90407 A  
(800) 1315936  
(891) 2016 12 22  
(731) ASTRAZENECA AB  
SE-151 85 Södertälje, Sweden

(540)

**AEROSPHERE**

(511)  
5 – Pharmaceutical preparations and substances, namely preparations and substances used as a drug delivery agent for the administration of drugs to the respiratory system.

(260) AM 2017 90408 A  
(800) 1321920  
(891) 2016 12 22  
(731) ASTRAZENECA AB  
SE-151 85 Södertälje, Sweden

(540)

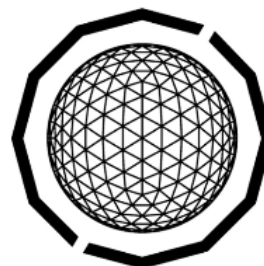

(591) Black, white  
(511)  
5 – Pharmaceutical preparations and substances.

(260) AM 2017 90661 A  
(800) 1328886  
(891) 2016 09 07  
(731) Cags Tobacco Tutun Ve Tutun Mamulleri  
Sanayi Ve Ticaret Anonim Sirketi  
Ankara Cad. Polat Is Merkezi, No:108/78  
Kartal, Istanbul, Turkey

(540)

**WATSON**

(591) red and white  
(511)  
34 – Tobacco; chewing tobacco; cigarettes; cigars; cigarette cases; tobacco pipes; cigar holders; cigarette holders; mouthpieces for cigarette holders; mouthpieces for cigar holders; smokers' articles namely, ashtrays for smokers, humidors, pocket machines for rolling cigarettes, cigarette paper, firestones, lighters for smokers; matches.

(260) AM 2017 90662 A  
(800) 1328898  
(891) 2016 10 25  
(731) BEIQI FOTON MOTOR CO., LTD.  
Laoniawan Village North, Shayang Road,  
Shahe Town, Changping District, 102206  
Beijing, China

(540)

**FOTON**

(591) black and white

(511)

36 – Financing loans; financial evaluation for insurance, banking and real estate; financing services; financial management; mortgage banking; savings banks; financial consultancy; stocks and bonds brokerage; stock exchange quotation; financial information.

(260) AM 2017 90668 A

(800) 1328923

(891) 2016 05 26

(731) BAYER INTELLECTUAL PROPERTY GMBH

Alfred-Nobel-Str. 10,40789 Monheim am Rhein, Germany

(540)

**QinRad**

(511)

9 – Quality management computer software system in the field of radiology.

38 – Communications via a global computer network or the Internet; electronic transfer of computer programs via the Internet.

42 – Scientific research in the field of medicine; development and providing of computer software on quality management in the field of medicine; scientific research and analysis of information in the field of medicine collected and obtained from quality management systems; consultancy services for radiologists in the field of quality management.

44 – Medical services in the field of radiology.

(260) AM 2017 90669 A

(800) 1328922

(891) 2016 05 23

(731) Obshchestvo s ogranichennoy otvetstvennost'yu "Koordiniroyushchy raspredelitel'ny tsentr "EFKO-Kaskad" ul. Frunze 4, g. Alekseevka, RU-309850 Belgorodskaya obl., Russian Federation

(540)



(591) color, vinous, light green, pink, red and black.

(511)

29 – Edible oils, namely sunflower oil for food.

35 – Advertising of edible oils, namely sunflower oil for food; sales promotion for others; retail and wholesale services for edible oils, namely sunflower oil for food.

(260) AM 2017 90670 A

(800) 1328927

(891) 2016 05 30

(731) OBSHESTVO S OGRANICHENNOY OTVETSTVENNOSTYU "RUSSKART" Yartsevskaya ul, d. 34, str. 1, off. 8, RU-121552 Moscow, Russian Federation

(540)



(591) Blue, red, white, navy-blue, yellow and black.

(511)

29 – Fruit and potato chips, including extruded chips and chips with taste fillers; snack food (ready meals), included in this class.

30 – Cereal preparations of corn and rice, including extruded; corn sticks; popcorn; chips [cereal foods] and mixtures thereof; rice-based foods; corn-based foods; muesli; cereal bars; air rice; cereal breakfast foods, including corn-based and rice-based; rice crackers (snack food); snack food, including rice-based and corn-based.

(260) AM 2017 90671 A

(800) 1328956

(891) 2015 12 22

(731) Open Joint-Stock Company "BLAGOVESHENSKAYA CONFECTORY FACTORY "ZEYA" ul. Lenina, 18, g. Blagoveschensk, RU-675002 Amurskaya oblast, Russian Federation

(540)



(591) Pink, dark pink, light purple, dark purple, purple and white.

(511)  
30 – Confectionery made of sugar, namely waffles, caramels, candy, fruit jellies [confectionery], marzipan; biscuits; toffee sweets; pralines; gingerbread; pastilles [confectionery]; marshmallows; waffle cakes; fruit cakes; halvah; chocolate; pastries; cocoa products, namely cocoa powder, cocoa mixes, cocoa spreads, cocoa-based beverages; chocolate-based beverages; ice cream; cereal preparations; crackers.

(260) AM 2017 90676 A

(800) 1328972

(891) 2016 06 09

(731) MAR-KO FLEISCHWAREN GMBH & CO.  
KG  
Waldecker Straße 15, 99444 Blankenhain,  
Germany

(540)

**MAR-KO**

(511)  
29 – Meat, fish, poultry and game, including ham; all aforementioned goods also further processed into charcuterie, also in preserved form; meat products, meatballs, sausages, charcuterie, uncooked charcuterie, also to be stored unrefrigerated; long-life charcuterie; salami in various forms, in particular mini salami; snacks made from the aforementioned products; beef-based snack products; meat extracts.

30 – Ready-made pastry rolls filled or topped with meat, charcuterie, ham, vegetables, sauces; ready-made dumplings filled or topped with meat, charcuterie, ham, vegetables, sauces; ready-made pita bread filled or topped with meat, charcuterie, ham, vegetables, sauces; ready-baked pastry rolls made of wheat flour dough filled with salami or salami-like sausage; snacks based on pasta products.

(260) AM 2017 90682 A

(800) 1328985

(891) 2016 07 27

(731) APPLE INC.  
1 Infinite Loop, Cupertino CA 95014, USA

(540)



(591) Black, white

(511)

9 – Computer software; cameras; computer hardware; computer peripheral devices; audio-video equipment; wearable computer hardware; wearable

computer peripherals; handheld computers; tablet computers; mobile telephones; peripherals for mobile devices; sound recording and reproducing apparatus; digital audio and video players and recorders; wireless communication devices for the transmission of voice, data, images, audio, video, and multimedia content.

(260) AM 2017 90683 A

(800) 1329041

(891) 2016 08 25

(731) KASK S.p.A.  
Via Firenze, 5, I-24060 CHIUDUNO (BG),  
Italy

(540)

**KASK**

(591) Black, white

(511)

9 – Safety clothing for protection against accident or injury; safety gloves for protection against accident or injury; anti crash protection screens; protective helmets, namely thermo resistant helmets, anti-crash helmets, sports helmets, leisure helmets; visors for such helmets; safety spectacles.

28 – Climbing harnesses.

(260) AM 2017 90721 A

(800) 1144020

(891) 2016 05 12

(731) KESENLER KOZMETİK PAZARLAMA  
SANAYİ VE TİCARET ANONİM ŞİRKETİ  
3. Organize Sanayi Bölgesi 18, Sokak No:7,  
Selçuklu, Konya, Turkey

(540)

**totex**

(591) Black, white

(511)

3 – Detergents for household use and laundry preparations, bleaching preparations for household use, laundry starch, fabric softeners for laundry use, lime removers for laundry use, granulated soaps, polishing preparations for household use; essential oils for personal use, perfumes and colognes, cosmetics and cosmetic preparations, namely, shaving lotions, shaving foam, shaving gel, non-medicated stimulating lotions for the skin, after-shave creams, cosmetic creams for skin care, depilatories, shower and bath gel, rose oil for cosmetic purposes, nail varnish for cosmetic purposes, nail polish remover, lipsticks, eyeliner pencils, cosmetic preparations for eyelashes.

hes, namely, mascaras, hair dyes, hair sprays and hair gels, hair care kits comprising non-medicated hair care preparations, namely, shampoo, conditioner; petroleum jelly for cosmetic purposes, depilatories, henna for cosmetic purposes, cosmetic preparations for slimming and for skin tanning; antiperspirants for personal use, deodorants and antiperspirants (including deodorants for human beings and animals); toothpastes, dentifrices in the form of chewing gum, dental bleaching gel, tooth powders, denture cleaning preparations, non-medicated mouth wash and rinse, tartar preventing toothpastes; emery paper, abrasive paste, pumice stones for personal use; leather polishes, polishes for metallic items, furniture polishes, floor polishes.

(260) AM 2017 90722 A

(800) 1263973

(891) 2017 01 19

(731) Dentons Group (a Swiss Verein)

Seestrasse 473, CH-8038 Zurich, Switzerland

(540)

**大成 DENTONS**

(591) Black, white

(511)

16 – Printed matter, namely, printed publications in the nature of brochures, manuals, books, booklets, newsletters, reports, and printed instructional and teaching materials other than apparatus and stationery, all of the aforesaid goods relating to legal matters, issues, affairs and services.

41 – Arranging and conducting of seminars and conferences in the field of legal matters, issues, affairs and services; education and training services, namely, classes in the field of legal matters, issues, affairs and services; providing educational information in the field of legal matters, issues, affairs and services; preparation of educational reports in the field of legal matters, issues, affairs and services; providing advisory services all relating to the aforesaid services.

45 – Legal services; legal research services; providing information relating to legal matters; issuing of legal information; providing legal advice; legal consultancy services; legal enquiry services; legal services relating to business; legal support services; public record investigation services; preparation of legal reports; patent and trademark agency services; company formation and registration services; provision of information, consultancy and advisory services relating to the aforesaid services.

(260) AM 2017 90897 A

(800) 869912

(891) 2016 11 09

(731) WENLING YOUNIO WATER METER CO., LTD.

South Side of Jiulong Street, Wenling Industrial Zone, Zhejiang, China

(540)

**YOUNIO**  
**甬岭水表**

(591) Black, white

(511)

9 – Water meters.

(260) AM 2017 90898 A

(800) 1330762

(891) 2016 11 29

(731) MİSBİS GIDA SANAYİ VE TİCARET ANONİM ŞİRKETİ

Selimpaşa Sanayi Bölgesi, Araptepe

Mevkii 5007, Sok. No:10 PK., TR-34930

Silivri – İstanbul, Turkey

(540)

**BISELLA**

(591) white, gray

(511)

30 – Confectionery, chocolate, biscuits, crackers, wafers.

(260) AM 2017 90899 A

(800) 1044608

(891) 2016 11 09

(731) JIANGYIN HITECH INDUSTRY CO., LTD

128 Furong Lu, Jiangyin 214400 Jiangsu, China

(540)

**LUBOND**

(591) Black, white

(511)

6 – Building boards of metal; aluminum-plastic boards, mainly aluminum.

(260) AM 2017 90900 A

(800) 1330788

(891) 2016 11 16

(731) MONTRES TUDOR SA

Rue François-Dussaud 3, CH-1211 Genève 26, Switzerland

(540)

**LHD**



(511)

14 – Timepieces, namely watches, wristwatches, component parts of timepieces and accessories for timepieces not included in other classes, clocks and other chronometric instruments, chronometers, chronographs (timepieces), apparatus for timing sports events, time measuring and marking apparatus and instruments not included in other classes; watch bands, dials (clock and watchmaking), cases and presentation cases for timepieces and jewelry, watch movements and their parts; jewelry; precious stones and semi-precious stones; precious metals and their alloys.

---

(260) AM 2017 90902 A

(800) 1330789

(891) 2016 11 22

(731) SANOFI BIOTECHNOLOGY, Société par actions simplifiée

54 rue La Boétie, F-75008 PARIS, France

(540)



(591) gray, yellow, orange, dark, green, light, green

(511)

5 – Pharmaceutical products.

---

---

**INTERNATIONAL TRADEMARKS PROTECTED IN GEORGIA**

(260) AM 2017 85361 A  
(800) 1279643  
(151) 2015 10 21  
(181) 2025 10 21  
(891) 2015 10 21  
(511) 39, 43

---

(260) AM 2017 85403 A  
(800) 1278509  
(151) 2015 11 24  
(181) 2025 11 24  
(891) 2015 11 24  
(511) 29

---

(260) AM 2017 85867 A  
(800) 753589  
(151) 2001 01 23  
(181) 2021 01 23  
(891) 2015 11 03  
(511) 29  
(551) Collective

---

(260) AM 2017 87540 A  
(800) 1298483  
(151) 2015 09 23  
(181) 2025 09 23  
(891) 2015 09 23  
(511) 01, 04, 06, 07, 08, 09, 11, 12, 14, 16, 17, 18,  
20, 21, 25, 28, 34, 35, 36, 37, 38, 41, 42

---

(260) AM 2017 87603 A  
(800) 1286370  
(151) 2015 12 18  
(181) 2025 12 18  
(891) 2016 03 23  
(511) 18, 29, 30, 32, 35, 36

---

(260) AM 2017 87725 A  
(800) 1299923  
(151) 2016 02 08  
(181) 2026 02 08  
(891) 2016 02 08  
(511) 07

---

(260) AM 2017 87734 A  
(800) 634614  
(151) 1995 04 20

(181) 2025 04 20  
(891) 2016 03 18  
(511) 05

---

(260) AM 2017 87735 A  
(800) 1299989  
(151) 2016 02 19  
(181) 2026 02 19  
(891) 2016 02 19  
(511) 05

---

(260) AM 2017 87738 A  
(800) 1174163  
(151) 2013 07 02  
(181) 2023 07 02  
(891) 2016 04 27  
(511) 12

---

(260) AM 2017 87739 A  
(800) 801204  
(151) 2002 11 19  
(181) 2022 11 19  
(891) 2016 03 29  
(511) 41, 43

---

(260) AM 2017 87750 A  
(800) 1197910  
(151) 2014 01 13  
(181) 2024 01 13  
(891) 2016 04 07  
(511) 37

---

(260) AM 2017 87771 A  
(800) 1287710  
(151) 2015 09 30  
(181) 2025 09 30  
(891) 2016 03 18  
(511) 07

---

(260) AM 2017 87772 A  
(800) 1294842  
(151) 2015 12 01  
(181) 2025 12 01  
(891) 2016 05 19  
(511) 12, 25, 28

---



(260) AM 2017 87824 A  
(800) 1277915  
(151) 2015 09 28  
(181) 2025 09 28  
(891) 2016 06 07  
(511) 03, 05, 10

---

(260) AM 2017 87924 A  
(800) 1301824  
(151) 2015 10 15  
(181) 2025 10 15  
(891) 2015 10 15  
(511) 18, 25, 35

---

(260) AM 2017 87931 A  
(800) 1301990  
(151) 2016 02 26  
(181) 2026 02 26  
(891) 2016 02 26  
(511) 01

---

(260) AM 2017 87932 A  
(800) 825114  
(151) 2004 04 14  
(181) 2024 04 14  
(891) 2016 03 25  
(511) 18, 25, 28

---

(260) AM 2017 87933 A  
(800) 883421  
(151) 2006 03 09  
(181) 2026 03 09  
(891) 2016 03 10  
(511) 19

---

(260) AM 2017 87935 A  
(800) 1098872  
(151) 2011 11 21  
(181) 2021 11 21  
(891) 2016 03 31  
(511) 05

---

(260) AM 2017 87944 A  
(800) 1301157  
(151) 2016 01 25  
(181) 2026 01 25  
(891) 2016 01 25  
(511) 12, 37, 39

---

(260) AM 2017 87951 A  
(800) 1301399  
(151) 2016 04 11

(181) 2026 04 11  
(891) 2016 04 11  
(511) 05

---

(260) AM 2017 87952 A  
(800) 1301400  
(151) 2016 04 11  
(181) 2026 04 11  
(891) 2016 04 11  
(511) 05

---

(260) AM 2017 87953 A  
(800) 1301451  
(151) 2015 12 11  
(181) 2025 12 11  
(891) 2015 12 11  
(511) 19

---

(260) AM 2017 87954 A  
(800) 1301462  
(151) 2016 02 22  
(181) 2026 02 22  
(891) 2016 02 22  
(511) 12

---

(260) AM 2017 87955 A  
(800) 1301463  
(151) 2016 02 22  
(181) 2026 02 22  
(891) 2016 02 22  
(511) 31

---

(260) AM 2017 87956 A  
(800) 1301467  
(151) 2016 02 22  
(181) 2026 02 22  
(891) 2016 02 22  
(511) 05

---

(260) AM 2017 87958 A  
(800) 1301498  
(151) 2015 12 11  
(181) 2025 12 11  
(891) 2015 12 11  
(511) 19

---

(260) AM 2017 87959 A  
(800) 1301511  
(151) 2016 03 03  
(181) 2026 03 03  
(891) 2016 03 03  
(511) 03, 05

---

(260) AM 2017 87960 A  
(800) 1301518  
(151) 2016 03 07  
(181) 2026 03 07  
(891) 2016 03 07  
(511) 05

---

(260) AM 2017 88039 A  
(800) 1302491  
(151) 2015 10 14  
(181) 2025 10 14  
(891) 2015 10 14  
(511) 12

---

(260) AM 2017 88048 A  
(800) 1239164  
(151) 2015 02 11  
(181) 2025 02 11  
(891) 2016 06 21  
(511) 03

---

(260) AM 2017 88053 A  
(800) 1302523  
(151) 2016 02 18  
(181) 2026 02 18  
(891) 2016 02 18  
(511) 25, 35

---

(260) AM 2017 88135 A  
(800) 1303956  
(151) 2016 04 13  
(181) 2026 04 13  
(891) 2016 04 13  
(511) 12

---

(260) AM 2017 88136 A  
(800) 1303974  
(151) 2016 02 11  
(181) 2026 02 11  
(891) 2016 02 11  
(511) 03, 05

---

(260) AM 2017 88137 A  
(800) 1304011  
(151) 2016 05 20  
(181) 2026 05 20  
(891) 2016 05 20  
(511) 03

---

(260) AM 2017 88143 A  
(800) 1225751  
(151) 2014 08 12

(181) 2024 08 12  
(891) 2016 05 31  
(511) 30, 35, 43

---

(260) AM 2017 88146 A  
(800) 1303668  
(151) 2016 04 19  
(181) 2026 04 19  
(891) 2016 04 19  
(511) 30

---

(260) AM 2017 88192 A  
(800) 1068061  
(151) 2010 07 22  
(181) 2020 07 22  
(891) 2016 04 11  
(511) 29, 30, 35

---

(260) AM 2017 88196 A  
(800) 1248336  
(151) 2015 03 09  
(181) 2025 03 09  
(891) 2016 04 12  
(511) 33

---

(260) AM 2017 88197 A  
(800) 1252908  
(151) 2015 03 25  
(181) 2025 03 25  
(891) 2016 07 07  
(511) 43

---

(260) AM 2017 88235 A  
(800) 1304443  
(151) 2016 05 02  
(181) 2026 05 02  
(891) 2016 05 02  
(511) 11

---

(260) AM 2017 88238 A  
(800) 1304468  
(151) 2016 04 08  
(181) 2026 04 08  
(891) 2016 04 08  
(511) 07, 08, 09, 11, 14

---

(260) AM 2017 88239 A  
(800) 1304549  
(151) 2016 03 01  
(181) 2026 03 01  
(891) 2016 03 01  
(511) 30

---

(260) AM 2017 88266 A  
(800) 1304727  
(151) 2016 03 25  
(181) 2026 03 25  
(891) 2016 03 25  
(511) 09

---

(260) AM 2017 88267 A  
(800) 1304801  
(151) 2016 04 21  
(181) 2026 04 21  
(891) 2016 04 21  
(511) 35, 36

---

(260) AM 2017 88294 A  
(800) 1304958  
(151) 2016 04 26  
(181) 2026 04 26  
(891) 2016 04 26  
(511) 09, 10, 11

---

(260) AM 2017 88295 A  
(800) 1304976  
(151) 2016 03 18  
(181) 2026 03 18  
(891) 2016 03 18  
(511) 03

---

(260) AM 2017 88296 A  
(800) 1305009  
(151) 2016 04 20  
(181) 2026 04 20  
(891) 2016 04 20  
(511) 03, 21

---

(260) AM 2017 88297 A  
(800) 1305368  
(151) 2016 03 08  
(181) 2026 03 08  
(891) 2016 03 08  
(511) 35

---

(260) AM 2017 88298 A  
(800) 1305379  
(151) 2016 05 05  
(181) 2026 05 05  
(891) 2016 05 05  
(511) 11

---

(260) AM 2017 88302 A  
(800) 1305400  
(151) 2016 04 25

(181) 2026 04 25  
(891) 2016 04 25  
(511) 24

---

(260) AM 2017 88303 A  
(800) 1305441  
(151) 2016 06 08  
(181) 2026 06 08  
(891) 2016 06 08  
(511) 29

---

(260) AM 2017 88365 A  
(800) 1305745  
(151) 2016 03 22  
(181) 2026 03 22  
(891) 2016 03 22  
(511) 10, 11

---

(260) AM 2017 88378 A  
(800) 780071  
(151) 2001 10 19  
(181) 2021 10 19  
(891) 2016 04 04  
(511) 29

---

(260) AM 2017 88384 A  
(800) 1206946  
(151) 2014 05 06  
(181) 2024 05 06  
(891) 2016 04 29  
(511) 06, 11, 19, 35

---

(260) AM 2017 88393 A  
(800) 1305769  
(151) 2016 03 28  
(181) 2026 03 28  
(891) 2016 03 28  
(511) 07

---

(260) AM 2017 88399 A  
(800) 1305890  
(151) 2016 02 11  
(181) 2026 02 11  
(891) 2016 02 11  
(511) 04, 35, 36, 42

---

(260) AM 2017 88418 A  
(800) 1306300  
(151) 2016 04 12  
(181) 2026 04 12  
(891) 2016 04 12  
(511) 36, 39

---

(260) AM 2017 88419 A  
(800) 1306970  
(151) 2016 02 16  
(181) 2026 02 16  
(891) 2016 02 16  
(511) 30

---

(260) AM 2017 88422 A  
(800) 1306315  
(151) 2016 04 12  
(181) 2026 04 12  
(891) 2016 04 12  
(511) 36, 39

---

(260) AM 2017 88425 A  
(800) 1306383  
(151) 2016 04 22  
(181) 2026 04 22  
(891) 2016 04 22  
(511) 05, 29, 30, 31, 32, 33, 35, 41, 43

---

(260) AM 2017 88428 A  
(800) 1307022  
(151) 2016 05 04  
(181) 2026 05 04  
(891) 2016 05 04  
(511) 07, 09

---

(260) AM 2017 88437 A  
(800) 1307055  
(151) 2016 05 17  
(181) 2026 05 17  
(891) 2016 05 17  
(511) 03

---

(260) AM 2017 88438 A  
(800) 1306425  
(151) 2016 06 06  
(181) 2026 06 06  
(891) 2016 06 06  
(511) 05, 10

---

(260) AM 2017 88440 A  
(800) 1306437  
(151) 2016 06 06  
(181) 2026 06 06  
(891) 2016 06 06  
(511) 05, 10

---

(260) AM 2017 88441 A  
(800) 1306665  
(151) 2016 03 08

(181) 2026 03 08  
(891) 2016 03 08  
(511) 12

---

(260) AM 2017 88445 A  
(800) 1306688  
(151) 2016 03 28  
(181) 2026 03 28  
(891) 2016 03 28  
(511) 12

---

(260) AM 2017 88446 A  
(800) 630934  
(151) 1995 01 12  
(181) 2025 01 12  
(891) 2016 07 29  
(511) 03, 05

---

(260) AM 2017 88451 A  
(800) 1306221  
(151) 2016 05 19  
(181) 2026 05 19  
(891) 2016 05 19  
(511) 32

---

(260) AM 2017 88492 A  
(800) 653539  
(151) 1996 03 22  
(181) 2026 03 22  
(891) 2016 03 23  
(511) 01, 05, 31

---

(260) AM 2017 88599 A  
(800) 1308105  
(151) 2016 07 12  
(181) 2026 07 12  
(891) 2016 07 12  
(511) 33

---

(260) AM 2017 88600 A  
(800) 1308128  
(151) 2016 07 26  
(181) 2026 07 26  
(891) 2016 07 26  
(511) 12

---

(260) AM 2017 88630 A  
(800) 1308728  
(151) 2014 09 17  
(181) 2024 09 17  
(891) 2014 09 17  
(511) 06, 09, 11, 21

---

(260) AM 2017 88631 A  
(800) 1308800  
(151) 2016 04 29  
(181) 2026 04 29  
(891) 2016 04 29  
(511) 03

---

(260) AM 2017 88632 A  
(800) 1308817  
(151) 2016 03 07  
(181) 2026 03 07  
(891) 2016 03 07  
(511) 39

---

(260) AM 2017 88635 A  
(800) 1308834  
(151) 2016 03 18  
(181) 2026 03 18  
(891) 2016 03 18  
(511) 09, 28, 35, 38, 41, 42

---

(260) AM 2017 88636 A  
(800) 1308844  
(151) 2016 04 12  
(181) 2026 04 12  
(891) 2016 04 12  
(511) 16, 35, 41

---

(260) AM 2017 88639 A  
(800) 1309349  
(151) 2016 06 09  
(181) 2026 06 09  
(891) 2016 06 09  
(511) 10

---

(260) AM 2017 88640 A  
(800) 1309375  
(151) 2016 07 15  
(181) 2026 07 15  
(891) 2016 07 15  
(511) 04

---

(260) AM 2017 88641 A  
(800) 1309377  
(151) 2016 07 15  
(181) 2026 07 15  
(891) 2016 07 15  
(511) 04

---

(260) AM 2017 88657 A  
(800) 1308959  
(151) 2016 04 12

(181) 2026 04 12  
(891) 2016 04 12  
(511) 30

---

(260) AM 2017 88683 A  
(800) 1309445  
(151) 2016 01 21  
(181) 2026 01 21  
(891) 2016 01 21  
(511) 09, 35, 38, 42

---

(260) AM 2017 88696 A  
(800) 1309525  
(151) 2016 05 13  
(181) 2026 05 13  
(891) 2016 05 13  
(511) 30

---

(260) AM 2017 88728 A  
(800) 1309718  
(151) 2016 06 07  
(181) 2026 06 07  
(891) 2016 06 07  
(511) 05

---

(260) AM 2017 88731 A  
(800) 1309724  
(151) 2016 05 17  
(181) 2026 05 17  
(891) 2016 05 17  
(511) 30

---

(260) AM 2017 88734 A  
(800) 1309819  
(151) 2016 02 03  
(181) 2026 02 03  
(891) 2016 02 03  
(511) 05

---

(260) AM 2017 88762 A  
(800) 1310108  
(151) 2016 03 28  
(181) 2026 03 28  
(891) 2016 03 28  
(511) 40

---

(260) AM 2017 88763 A  
(800) 1310404  
(151) 2016 06 03  
(181) 2026 06 03  
(891) 2016 06 03  
(511) 03, 25, 32

---

(260) AM 2017 88776 A  
(800) 1310569  
(151) 2016 02 01  
(181) 2026 02 01  
(891) 2016 02 01  
(511) 30

---

(260) AM 2017 88800 A  
(800) 1310635  
(151) 2016 03 21  
(181) 2026 03 21  
(891) 2016 03 21  
(511) 07

---

(260) AM 2017 88803 A  
(800) 1310666  
(151) 2016 06 01  
(181) 2026 06 01  
(891) 2016 06 01  
(511) 34

---

(260) AM 2017 88891 A  
(800) 1311937  
(151) 2016 07 19  
(181) 2026 07 19  
(891) 2016 07 19  
(511) 32

---

---

# OFFICIAL NOTIFICATIONS

## INVENTIONS

### RENEWAL OF PATENTS

**(11) P 2000 2067 B**

(73) Gela Chaduneli (GE)

**(54) External Apparatus For Bones**

DATE OF RENEWAL: 10 10 2017

---

**(11) P 2006 3810 B**

(73) BRF S.A. (BR)

**(54) FOOD COMPOSITION CONTAINING DIETARY FIBERS AND ITS USE OF FOOD TO PREPARE PRODUCTS**

DATE OF RENEWAL: 10 10 2017

---

## UTILITY MODELS

### RENEWAL OF PATENT

**(11) U 2014 1825 Y**

(73) Elguja Shapakidze (GE);

Vladimer Miruashvili (GE)

**(54) FIBRILLATION DEVICE FROM SILK PARK**

DATE OF RENEWAL: 10 10 2017

---

## CORRECTION OF PUBLISH INFORMATION

BULLETIN №	NUMBER OF APPLICATION (10)	PG.	COLUMN	PUBLISHED	MUST BE
16(476) 2017	AP 2017 14043 A	7	II	(57) Present invention provides nucleosides, nucleotides and analogs thereof, pharmaceutical compositions containing one or more nucleosides, nucleotides and analogs thereof, and the methods for said compounds and compositions synthesis. Present invention provides relief and/or treatment of viral infection of paramyxovirus by means of nucleoside, as well.	(57) Nucleosides, nucleotides and analogs thereof, pharmaceutical compositions on basis thereof and their usage at the treatment paramyxoviral infection.
18(478) 2017	AP 2017 14118	6	I	(74)	(74) Larisa Amirkhanyan

# TRADEMARKS

## RENEWAL OF REGISTRATIONS

(111) M 2007 17316 R1  
 (156) 2017 08 15  
 (186) 2027 02 27  
 (732) TSMU TBILISI STATE MEDICAL  
 UNIVERSITY  
 Vazha-Pshavelas gamz. 33, 0186, Tbilisi,  
 Georgia

(111) M 2007 17415 R1  
 (156) 2017 09 05  
 (186) 2027 04 13  
 (732) JSC "GEFA"  
 Sanapiros q. 6, Tbilisi, Georgia

(111) M 2007 17742 R1  
 (156) 2017 09 18  
 (186) 2027 09 18  
 (732) MANN-HUMMEL Filtration Technology  
 US LLC  
 1 Wix Way, Gastonia, NC 28054, USA

(111) M 2007 17992 R1  
 (156) 2017 11 13  
 (186) 2027 11 13  
 (732) LE SPORTSAC, Inc.  
 10471 Double R. Blvd., Suite C, Reno,  
 Nevada 89521, USA

(111) M 2007 18020 R1  
 (156) 2017 11 13  
 (186) 2027 11 13  
 (732) KIMBERLY-CLARK WORLDWIDE, INC.  
 NEENAH, WI 54956, USA

(111) M 2007 18023 R1  
 (156) 2017 11 13  
 (186) 2027 11 13  
 (732) NOVARTIS AG  
 CH-4002 Basel, Switzerland

(111) M 2007 18035 R1  
 (156) 2017 11 13  
 (186) 2027 11 13  
 (732) LTD "T&R DISTRIBUTION"  
 Chirnakhulis q. 2, Tbilisi, Georgia

(111) M 2007 18086 R1  
 (156) 2017 11 30  
 (186) 2027 11 30  
 (732) NOVARTIS AG  
 CH-4002 Basel, Switzerland

(111) M 2008 18570 R1  
 (156) 2018 07 01  
 (186) 2028 07 01  
 (732) TRANE INTERNATIONAL INC  
 800-E Beaty Street, Davidson, North  
 Carolina 28036, USA

(111) M 1997 4814 R2  
 (156) 2017 03 27  
 (186) 2027 03 27  
 (732) MASTERCARD EUROPE S.A.  
 Claussee de Tervuren 198 A, B-1410  
 Waterloo, Belgium

(111) M 1997 4948 R2  
 (156) 2017 04 04  
 (186) 2027 04 04  
 (732) MASTERCARD EUROPE S.A.  
 Claussee de Tervuren 198 A, B-1410  
 Waterloo, Belgium

(111) M 1997 5903 R2  
 (156) 2017 07 14  
 (186) 2027 07 14  
 (732) JANSSEN PHARMACEUTICA N.V.  
 Turnhoutseweg 30, B-2340 Beerse, Belgium

(111) M 1997 5927 R2  
 (156) 2017 07 15  
 (186) 2027 07 15  
 (732) JANSSEN PHARMACEUTICA N.V.  
 Turnhoutseweg 30, B-2340 Beerse, Belgium

(111) M 1997 6276 R2  
 (156) 2017 08 05  
 (186) 2027 08 05  
 (732) MÄURER & WIRTZ GmbH & Co., KG  
 Zweifaller Strasse 120, 52234 Stolberg,  
 Germany



(111) M 1997 6277 R2  
(156) 2017 08 05  
(186) 2027 08 05  
(732) MÄURER & WIRTZ GmbH & Co., KG  
Zweifaller Strasse 120, 52234 Stolberg,  
Germany

---

(111) M 1997 6278 R2  
(156) 2017 08 05  
(186) 2027 08 05  
(732) MÄURER & WIRTZ GmbH & Co., KG  
Zweifaller Strasse 120, 52234 Stolberg,  
Germany

---

(111) M 1997 6290 R2  
(156) 2017 08 06  
(186) 2027 08 06  
(732) MASTERCARD EUROPE S.A.  
Claussee de Tervuren 198 A, 1410  
Waterloo, Belgium

---

(111) M 1997 6496 R2  
(156) 2017 08 25  
(186) 2027 08 25  
(732) MÄURER & WIRTZ GmbH & Co., KG  
Zweifaller Strasse 120, 52234 Stolberg,  
Germany

---

(111) M 1997 6498 R2  
(156) 2017 08 25  
(186) 2027 08 25  
(732) MÄURER & WIRTZ GmbH & Co., KG  
Zweifaller Strasse 120, 52234 Stolberg,  
Germany

---

(111) M 1997 6499 R2  
(156) 2017 08 25  
(186) 2027 08 25  
(732) Dalli-Werke GmbH & Co.KG  
Zweifaller STr. 120,52224 Stolberg,  
Germany

---

(111) M 1997 6624 R2  
(156) 2017 09 03  
(186) 2027 09 03  
(732) NAF NAF  
6/10 Boulevard Foch, 93800 Epinay-Sur-  
Seine, France

---

(111) M 1997 6657 R2  
(156) 2017 09 04  
(186) 2027 09 04

(732) MOSCHINO S.P.A.  
San Giovanni in Marignano (RIMINI/RN),  
Italy, Via delle Querce 51 , Italy

---

(111) M 1997 6852 R2  
(156) 2017 09 19  
(186) 2027 09 19  
(732) JANSSEN PHARMACEUTICA N.V.  
Turnhoutseweg 30, B-2340 Beerse, Belgium

---

(111) M 1997 6855 R2  
(156) 2017 09 19  
(186) 2027 09 19  
(732) HEARTLAND CONSUMER PRODUCTS  
LLC  
14300 Clay Terrace Blvd., Suite 249, Carmel,  
Indiana 46032, USA

---

(111) M 1997 7168 R2  
(156) 2017 10 13  
(186) 2027 10 13  
(732) SSANGYONG MOTOR COMPANY  
150-3, Chilkoi-Dong, Pyungtaek-Si,  
Kyungki-do, Republic of Korea

---

## COMPLETE TRANSFER OF RIGHTS

(111) M 2007 017316 R1  
 (732) TSMU TBILISI STATE MEDICAL UNIVERSITY  
 Vazha-Pshavelas gamz. 33, 0186, Tbilisi, Georgia  
 (770) I. KUTATELADZE INSTITUTE OF PHARMACOCHEMISTRY  
 P. Sarajishvili St., 36 , 0159, Tbilisi, Georgia  
 (580) 2017 09 26

(111) M 2008 018263 R  
 (732) LTD "NIK-FARMA"  
 Griboedovis q. 21, 0108, Tbilisi, Georgia  
 (770) GIORGI GOGBAIDZE  
 Griboedovis 21, 0108, Tbilisi, Georgia  
 (580) 2017 09 27

(111) M 2010 020893 R  
 (732) LTD "NIK-FARMA"  
 Griboedovis q. 21, 0108, Tbilisi, Georgia  
 (770) GIORGI GOGBAIDZE  
 Griboedovis 21, 0108, Tbilisi, Georgia  
 (580) 2017 09 27

(111) M 2014 024911 R  
 (732) LG CHEM, LTD.  
 128, Yeoui-daero, Yeongdeungpo-gu, Seoul, Republic of Korea  
 (770) LG LIFE SCIENCES, LTD.  
 58, Saemunan-ro, Jongno-gu, Seoul, Republic of Korea  
 (580) 2017 09 27

(111) M 1997 006855 R2  
 (732) HEARTLAND CONSUMER PRODUCTS LLC  
 14300 Clay Terrace Blvd., Suite 249, Carmel, Indiana 46032, USA  
 (770) JANJSCEN PHARMACEUTICA N.V.  
 Turnhoutseweg 30, B-2340 Beerse, Belgium  
 (580) 2017 09 26

(111) M 2016 25816 R  
 (732) MERIAL, INC.  
 3239 Satellite Boulevard, Duluth, Georgia 30096, US  
 (770) MERIAL LIMITED  
 Sandringham House, Sandringham Avenue, Harlow Business Park, Harlow CM19 5QA, United Kingdom  
 (580) 2017 09 26

(111) M 2016 25817 R  
 (732) MERIAL, INC.  
 3239 Satellite Boulevard, Duluth, Georgia 30096, US  
 (770) MERIAL LIMITED  
 Sandringham House, Sandringham Avenue, Harlow Business Park, Harlow CM19 5QA, United Kingdom  
 (580) 2017 09 26

(111) M 2016 25868 R  
 (732) BAYER CONSUMER CARE AG  
 Peter Merian-Strasse 84, 4002 Basel, CH  
 (770) BAYER EAST COAST LLC  
 100 Bayer Boulevard, Whippany, New Jersey 07981, US  
 (580) 2017 09 26

(111) M 2016 25849 R  
 (732) THE GILLETTE COMPANY LLC  
 One Gillete Park, Boston, Massachusetts 02127, US  
 (770) THE GILLETTE COMPANY  
 One Gillete Park, Boston, Massachusetts 02127,US  
 (580) 2017 09 26

(111) M 2016 26479 R  
 (732) LLC "ROSSOFT CONSALTING"  
 Sh. Nutsubidzis Perdobi, mkr. IV, korp. 11, b. 90, Tbilisi, Georgia  
 (770) LTD "BESINI COMPANY"  
 Gamrekelis q. 19, Vake-Saburtalos raioni, 0160, Tbilisi, Georgia  
 (580) 2017 09 26

(111) M 2016 26066 R  
 (732) THE GILLETTE COMPANY LLC  
 One Gillete Park, Boston, Massachusetts 02127,US  
 (770) THE GILLETTE COMPANY  
 One Gillette Park, Boston Massachusetts 02127, US  
 (580) 2017 09 26

(111) M 2016 26481 R  
 (732) APPLE INC.  
 1 Infinite Loop, Cupertino, CA 95014, USA  
 (770) ROCKFORD CORPORATION

600 South Rockford Drive, Tempe,  
AZ 85281, USA  
(580) 2017 09 26

---

(111) M 2016 26128 R  
(732) LG CHEM, LTD.  
128, Yeoui-doero, Yeongdeungpo-gu,  
Seoul, Republic of Korea  
(770) LG LIFE SCIENCES, LTD.  
58, Jongno-gu, Saemunan-ro, Seoul, Republic  
of Korea  
(580) 2017 09 26

---

(111) M 2016 25997 R  
(732) NESTLE SKIN HEALTH S.A.  
Avenue Gratta-Paille 2, CH-1018  
Lausanne, CH  
(770) GALDERMA S.A.  
Zugerstrasse 8, CH-6330 CHAM, CH  
(580) 2017 09 26

---

(111) M 2016 26097 R  
(732) SUN PHARMACEUTICALS INDUSTRIES  
LIMITED  
SPARC, Tandalja, Vadodara - 390 020,  
Gujarat, India  
(770) RANBAXY LABORATORIES LIMITED  
Plot No.90, Sector-32, Gurgaon 122001,  
Haryana, India  
(580) 2017 09 26

---

(111) M 2016 26098 R  
(732) SUN PHARMACEUTICALS INDUSTRIES  
LIMITED  
SPARC, Tandalja, Vadodara - 390 020,  
Gujarat, India  
(770) RANBAXY LABORATORIES LIMITED  
Plot No.90, Sector-32, Gurgaon 122001,  
Haryana, India  
(580) 2017 09 26

---

(111) M 2016 26650 R  
(732) CELLO STATIONERY  
PRODUCTS PRIVATE LIMITED  
6, Vakil Industrial Estate, Walbhat  
Road, Goregaon (East), Mumbai –  
400063, Maharashtra, India  
(770) CELLO PLASTIC INDUSTRIAL WORKS  
5, Vakil Industrial Estate, Walbhat Road,  
Goregaon (E), Mumbai-400063, India  
(580) 2017 09 26

---

(111) M 2016 26368 R  
(732) THE GILLETTE COMPANY LLC  
One Gillette Park, Boston, Massachusetts  
02127, USA  
(770) THE GILLETTE COMPANY  
One Gillette Park, Boston Massachusetts  
02127, USA  
(580) 2017 09 26

---

(111) M 2016 26009 R  
(732) THE GILLETTE COMPANY LLC  
One Gillette Park, Boston, Massachusetts  
02127, USA  
(770) THE GILLETTE COMPANY  
One Gillette Park, Boston Massachusetts  
02127, USA  
(580) 2017 09 26

---

(111) M 2016 26406 R  
(732) THE GILLETTE COMPANY LLC  
One Gillette Park, Boston, Massachusetts  
02127, USA  
(770) THE GILLETTE COMPANY  
One Gillette Park, Boston Massachusetts  
02127, USA  
(580) 2017 09 26

---

(111) M 2016 26493 R  
(732) LLC "ROSSOFT CONSALTING"  
Sh. Nutsubidzis Perdobi, mkr. IV, korp. 11,  
b. 90, Tbilisi, Georgia  
(770) LTD "BESINI COMPANY"  
Gamrekelis q. 19, Vake-Saburtalos raioni,  
0160, Tbilisi, Georgia  
(580) 2017 09 26

---

(111) M 2016 26265 R  
(732) THE GILLETTE COMPANY LLC  
One Gillette Park, Boston, Massachusetts  
02127, USA  
(770) THE GILLETTE COMPANY  
One Gillette Park, Boston Massachusetts  
02127, USA  
(580) 2017 09 26

---

(111) M 2016 26270 R  
(732) THE GILLETTE COMPANY LLC  
One Gillette Park, Boston, Massachusetts  
02127, USA  
(770) THE GILLETTE COMPANY  
One Gillette Park, Boston Massachusetts  
02127, USA  
(580) 2017 09 26

---

(111) M 2016 26234 R  
(732) THE GILLETTE COMPANY LLC  
One Gillete Park, Boston, Massachusetts  
02127, USA  
(770) THE GILLETTE COMPANY  
One Gillette Park, Boston Massachusetts  
02127, USA  
(580) 2017 09 26

---

(111) M 2016 28373 R  
(732) NESTLE SKIN HEALTH S.A.  
Avenue Gratta-Paille 2, CH-1018  
Lausanne, Switzerland  
(770) GALDERMA S.A.  
Zugerstrasse 8, CH-6330 CHAM,  
Switzerland  
(580) 2017 09 26

---

(111) M 2016 26843 R  
(732) THE GILLETTE COMPANY LLC  
One Gillete Park, Boston, Massachusetts  
02127, USA  
(770) THE GILLETTE COMPANY  
One Gillette Park, Boston Massachusetts  
02127, USA  
(580) 2017 09 26

---

(111) M 2016 26928 R  
(732) THE GILLETTE COMPANY LLC  
One Gillete Park, Boston, Massachusetts  
02127, USA  
(770) THE GILLETTE COMPANY  
One Gillette Park, Boston Massachusetts  
02127, USA  
(580) 2017 09 26

---

(111) M 2016 27006 R  
(732) THE GILLETTE COMPANY LLC  
One Gillete Park, Boston, Massachusetts  
02127, USA  
(770) THE GILLETTE COMPANY  
One Gillette Park, Boston Massachusetts  
02127, USA  
(580) 2017 09 26

---

(111) M 2016 26861 R  
(732) Temur Kokhodze  
Vazha-Pshavelas 51, korp. 21, b. 7, 0177,  
Tbilisi, Georgia  
(770) INTERAVTO  
Sartitchalis q. 34, Isani-Samgoris r-ni, 0103,  
Tbilisi, Georgia  
(580) 2017 09 26

---

(111) M 2016 27334 R  
(732) LTD "KARTVELI"  
Kakhetis gzat. 110a, 0198, Tbilisi, Georgia  
(770) LTD "GEORGIAN BRENDIS COMPANY"  
Kakhetis gzat. 110a, 0198, Tbilisi, Georgia  
(580) 2017 09 26

---

(111) M 2016 27098 R  
(732) NESTLE SKIN HEALTH S.A.  
Avenue Gratta-Paille 2, CH-1018  
Lausanne, Switzerland  
(770) GALDERMA S.A.  
Zugerstrasse 8, 6330 CHAM, Switzerland  
(580) 2017 09 26

---

(111) M 2016 27245 R  
(732) LTD "KARMEN"  
D. Aghmasheneblis q. 34a, Batumi, Georgia  
(770) SAMVEL ABGARYAN  
D. Aghmasheneblis q. 34, Batumi, Georgia  
(580) 2017 09 26

---

(111) M 2016 27375 R  
(732) NESTLE SKIN HEALTH S.A.  
Avenue Gratta-Paille 2, CH-1018  
Lausanne, Switzerland  
(770) GALDERMA S.A.  
Zugerstrasse 8, 6330 CHAM, Switzerland  
(580) 2017 09 26

---

(111) M 2016 26151 R  
(732) JSC "KHRAMHES-2"  
Aghmasheneblis q.2a, 1300, Gardabani,  
Georgia  
(770) LTD "MTKVARI ENERGETIC"  
D. Aghmasheneblis q. 2, Gardabani, Georgia  
(580) 2017 09 26

---

(111) M 2016 27291 R  
(732) THE GILLETTE COMPANY LLC  
One Gillete Park, Boston, Massachusetts  
02127, USA  
(770) THE GILLETTE COMPANY  
One Gillette Park, Boston Massachusetts  
02127, USA  
(580) 2017 09 26

---

(111) M 2016 26023 R  
(732) LTD "TUTARCHELA"  
P. Ioselianis q. 37, 0171, Tbilisi, Georgia  
(770) LTD "CHELA"  
Mtkvris q. 6, 0105, Tbilisi, Georgia  
(580) 2017 09 26

---

(111) M 2016 26174 R  
(732) LTD "HIDELBERGBETON GEORGIA"  
G. Lortkipanidzis q. 4, Old Tbilisi r-n,  
Tbilisi, Georgia  
(770) LTD "TBILTCEMENT GROUP"  
Zahesi, 3306, Mtskheta, Georgia  
(580) 2017 09 26

---

(111) M 2016 26175 R  
(732) LTD "HIDELBERGBETON GEORGIA"  
G. Lortkipanidzis q. 4, Old Tbilisi r-n,  
Tbilisi, Georgia  
(770) LTD "TBILTCEMENT GROUP"  
Zahesi, 3306, Mtskheta, Georgia  
(580) 2017 09 26

---

(111) M 2016 26176 R  
(732) LTD "HIDELBERGBETON GEORGIA"  
G. Lortkipanidzis q. 4, Old Tbilisi r-n,  
Tbilisi, Georgia  
(770) LTD "TBILTCEMENT GROUP"  
Zahesi, 3306, Mtskheta, Georgia  
(580) 2017 09 26

---

(111) M 2016 26177 R  
(732) LTD "HIDELBERGBETON GEORGIA"  
G. Lortkipanidzis q. 4, Old Tbilisi r-n,  
Tbilisi, Georgia  
(770) LTD "TBILTCEMENT GROUP"  
Zahesi, 3306, Mtskheta, Georgia  
(580) 2017 09 26

---

(111) M 2016 26179 R  
(732) Mohammad Tudehalahah  
The fourth block, the fourth floor,  
Snow tower, shafagah street,  
Crossing the hormones, dandman  
Boulevard, Shahrak Gaharb 1466793611  
Tehran, Islamic Republic of Iran  
Alirez Tabriz; No.A7, Fujohesh  
Third Industrial Phase, 1594814636  
Kish, the Islamic Republic of Iran  
(770) LTD "FIX PIPELINE SOLUTIONS"  
Free Industrial zone  
(Navsadguris kopili ekstensiuri ganvitarebis  
zona), mitsis nakvetis shida №1B-7T/89,  
Poti, Georgia  
(580) 2017 09 26

---

(111) M 2016 27588 R  
(732) ASCENSIA DIABETES CARE HOLDINGS  
AG  
Peter Merian-Strasse 90, 4052 Basel, CH  
(770) BAYER HEALTHCARE LLC

100 Bayer Road, Pittsburgh, Pennsylvania  
15205, US  
(580) 2017 09 26

---

(111) M 2016 27595 R  
(732) ASCENSIA DIABETES CARE HOLDINGS  
AG  
Peter Merian-Strasse 90, 4052 Basel, CH  
(770) BAYER HEALTHCARE LLC  
100 Bayer Road, Pittsburgh, Pennsylvania  
15205, US  
(580) 2017 09 26

---

(111) M 2016 27393 R  
(732) LG CHEM, LTD.  
128, Yeoui-doero, Yeongdeungpo-gu, Seoul,  
Republic of Korea  
(770) LG LIFE SCIENCES, LTD.  
58, Jongno-gu, Saemunan-ro, Seoul, Republic  
of Korea  
(580) 2017 09 26

---

(111) M 2016 26330 R  
(732) ANDREAS STIHL AG & Co. KG.  
Badstrasse 115, 77336 Waiblingen, DE  
(770) LTD "ELEQTRONI"  
Gardabnis gzatk. 48, Tbilisi, Georgia  
(580) 2017 09 26

---

(111) M 2016 26468 R  
(732) LTD "ICR TRADE"  
Dighomi Training Trial Farm, 5th floor,  
Georgia  
(770) LTD "SAERTASORISO KORPORATSIA  
ICR"  
Aghmasheneblis gamz. 173, 0112, Tbilisi,  
Georgia  
(580) 2017 09 26

---

(111) M 2016 26469 R  
(732) LTD "ICR TRADE"  
Dighomi Training Trial Farm, 5th floor,  
Georgia  
(770) LTD "SAERTASORISO KORPORATSIA  
ICR"  
Aghmasheneblis gamz. 173, 0112, Tbilisi,  
Georgia  
(580) 2017 09 26

---

(111) M 2016 27854 R  
(732) ASCENSIA DIABETES CARE HOLDINGS  
AG  
Peter Merian-Strasse 90, 4052 Basel, CH

(770) BAYER HEALTHCARE LLC  
100 Bayer Road, Pittsburgh, Pennsylvania  
15205, US  
(580) 2017 09 26

(111) M 2016 26771 R  
(732) Leonardo Beraia  
Gumistis mas.8 b.21, Tbilisi, Georgia  
(770) LTD "KAKHETIAN TRADITIONAL  
WINEMAKING-AGRO-CHOKHATAURI"  
Sulkhan Tsintsadzis q. 12, 0160, Tbilisi,  
Georgia  
(580) 2017 09 26

(111) M 2016 26777 R  
(732) SEVENFRIDAY AG  
Staffelstrasse 10, 8045 Zurich, CH  
(770) LTD "SEVENFRIDAY CAUCASUS"  
Politkovskaias q. 9a, b. 41, 0187, Tbilisi,  
Georgia  
(580) 2017 09 26

(111) M 2016 27023 R  
(732) LTD "NINA ANANIASHVILI&WINE ART"  
Sop. Tsinandali, Telavis r-ni, Georgia  
(770) NINO ANANIASHVILI  
Metekhis aghmarti 6, Tbilisi, Georgia  
(580) 2017 09 26

(111) M 2016 27029 R  
(732) GRUND & MOBIL VERWALTUNGS AG  
Untermuli 7, Postfach 4440, CH-6304 Zug,  
CH  
(770) SHALVA KHETSURIANI  
Tamar Mepis gamz. 17, Tbilisi, Georgia  
(580) 2017 09 26

(111) M 2016 26988 R  
(732) Zurab Krizhanovsky  
G. Tsabadzis q. 4, b. 33, Tbilisi, Georgia  
(770) Irakli Kvantchakhadze  
Giorgi Akhvledianis q. 9, 0108, Tbilisi,  
Georgia  
(580) 2017 09 26

(111) M 2016 27041 R  
(732) Mohammad Tudehalahah  
The fourth block, the fourth floor,  
Snow tower, shafagah street,  
Crossing the hormones, dandman  
Boulevard, Shahrak Gaharb 1466793611  
Tehran, Islamic Republic of Iran  
Alirez Tabriz; No.A7, Fajohesh

Third Industrial Phase, 1594814636  
Kish, the Islamic Republic of Iran;  
Alirez Tabriz  
No.7, Fajoheshi Street, Third  
Industrial phase, 1594814636 Kish,  
Islamic Republic of Iran

(770) LTD "FIX PIPELINE SOLUTIONS"  
Free Industrial zone  
(Navsadguris kopili ekstensiuri ganvitarebis  
zona), mitsis nakvetis shida №1B-7T/89,  
Poti, Georgia  
(580) 2017 09 26

(111) M 2016 28031 R  
(732) EURO GAMES TECHNOLOGY LLC  
St. Marici N4, Ter. VARANIA-LOZEN-  
Triregnika, District. Pancharova; 0151,  
Bulgaria  
(770) RADOSTINA PETROVA VALCHEVA  
Industrializatsiis q. 8a, 0180, Tbilisi, Georgia  
(580) 2017 09 26

(111) M 2016 27933 R  
(732) EURO GAMES TECHNOLOGY LLC  
St. Marici N4, Ter. VARANIA-LOZEN-  
Triregnika, District. Pancharova; 0151,  
Bulgaria  
(770) RADOSTINA PETROVA VALCHEVA  
Industrializatsiis q. 8a, 0180, Tbilisi, Georgia  
(580) 2017 09 26

(111) M 2017 28337 R  
(732) შპს "VEGAPHARM-GEORGIA"  
A. Gakhokidzis q. 2-4, Iuri Gagarinis q. 5,  
s/p 6, Tbilisi, Georgia  
(770) LTD "UNIMED GRUP KORP"  
Saakadzis daghmarti 6, sart.,3, s/p 11, Tbilisi,  
Georgia  
(580) 2017 09 26

## CHANGES IN NAMES AND/OR ADDRESSES OF OWNERS

- 
- (111) M 2002 014569 R1  
(732) ALSTOM  
48 rue Albert Dralenne, 93400 Saint-Ouen,  
France  
(770) ALSTOM  
3, Avenue Andre Malraux, F-92300  
Levallois-Perret, France  
(580) 2017 09 28
- 
- (111) M 2003 015212 R1  
(732) JSC "GEFA"  
Sanapiros q. 6, 0108, Tbilisi, Georgia  
(770) JSC "G P C"  
Sanapiros q. 6, Dzveli Tbilisis r-ni, 0108,  
Tbilisi, Georgia  
(580) 2017 10 02
- 
- (111) M 2007 017415 R1  
(732) JSC "GEFA"  
Sanapiros q. 6, Tbilisi, Georgia  
(770) JSC "G P C"  
Marjanishvilis q. 26, 0102 , Tbilisi, Georgia  
(580) 2017 09 25
- 
- (111) M 2007 017742 R1  
(732) MANN-HUMMEL Filtration Technology US  
LLC  
1 Wix Way, Gastonia, NC 28054, USA  
(770) WIX FILTRATION CORP. LLC,  
1 Wix Way, Gastonia, NC 28054, USA  
(580) 2017 09 28
- 
- (111) M 2007 017992 R1  
(732) LE SPORTSAC, INC.  
10471 Double R. Blvd., Suite C, Reno,  
Navada 89521, USA  
(770) LE SPORTSAC, INC.  
9490 Gateway Drive, Suite 200, Reno,  
Navada 89521, USA  
(580) 2017 09 28
- 
- (111) M 2007 018035 R1  
(732) LTD "T& R DISTRIBUSHEN"  
Chirnaxulis q.2, Tbilisi, Georgia  
(770) LTD "T&R DISTRIBUTION"  
Ak. Tseretlis gamz. 114, 0119, Tbilisi,  
Georgia  
(580) 2017 09 26
- 
- (111) M 2008 018748 R  
(732) JSC "GEFA"  
Sanapiros q. 6, 0108, Tbilisi, Georgia  
(770) JSC "GPC",  
Marjanishvilis q. 26, 0102 , Tbilisi, Georgia  
(580) 2017 10 02
- 
- (111) M 2010 020335 R  
(732) ONTEX TUKETIM URUNLERI SANAYI  
VE TICARET ANONIM ŞİRKETİ  
Oruç Reis Mah., Tekstil Kent Cad. Koza  
Plaza A Blk, No:12B İç K.N:021-022-024  
Esenler-İstanbul, Turkey  
(770) ONTEX TUKETIM URUNLERI SANAYI  
VE TICARET ANONIM ŞİRKETİ  
YENİBOSNA MERKEZ MAH. ASENSA  
SOK. NO.2 BAHCELIEVLER, Turkey  
(580) 2017 09 28
- 
- (111) M 1997 004814 R2  
(732) MASTERCARD EUROPE S.A.  
Claussee de Tervuren 198 A, B-1410  
Waterloo, Belgium  
(770) MASTERCARD EUROPE SPRL  
Claussee de Tervuren 198 A, B-1410  
Waterloo, Belgium  
(580) 2017 09 27
- 
- (111) M 1997 004948 R2  
(732) MASTERCARD EUROPE S.A.  
Claussee de Tervuren 198 A, B-1410  
Waterloo, Belgium  
(770) MASTERCARD EUROPE SPRL  
Claussee de Tervuren 198 A, B-1410  
Waterloo, Belgium  
(580) 2017 09 27
- 
- (111) M 1997 006276 R2  
(732) MÄURER & WIRTZ GmbH & Co., KG  
Zweifaller Strasse 120, 52234 Stolberg,  
Germany  
(770) MAURER + WITZ GMBH & CO., KG  
Zweifaller Strasse 120, 52234 Stolberg,  
Germany  
(580) 2017 09 26
- 
- (111) M 1997 006277 R2  
(732) MÄURER & WIRTZ GmbH & Co., KG  
Zweifaller Strasse 120, 52234 Stolberg,  
Germany
-

---

(770) MAURER + WITZ GMBH & CO., KG  
Zweifaller Strasse 120, 52234 Stolberg,  
Germany  
(580) 2017 09 26

---

---

(770) MAURER+WIRTZ CmbH & CO KG  
Zweifaller Str. 120,52224 Stolberg,  
Germany  
(580) 2017 09 26

---

---

(111) M 1997 006278 R2  
(732) MAURER & WITZ GMBH & CO., KG  
Zweifaller Strasse 120, 52234 Stolberg,  
Germany  
(770) MAURER + WITZ GMBH & CO., KG  
Zweifaller Strasse 120, 52234 Stolberg,  
Germany  
(580) 2017 09 26

---

---

(111) M 1997 006290 R2  
(732) MASTERCARD EUROPE S.A.  
Claussee de Tervuren 198 A, 1410  
Waterloo, Belgium  
(770) EUROPAY INTERNATIONAL S.A.  
Claussee de Tervuren 198 A, B-1410  
Waterloo, Belgium  
(580) 2017 09 27

---

---

(111) M 1997 006290 R2  
(732) MASTERCARD EUROPE SPRL,  
Claussee de Tervuren 198 A, B-1410  
Waterloo, Belgium  
(770) MASTERCARD EUROPE S.A.  
Claussee de Tervuren 198 A, 1410  
Waterloo, Belgium  
(580) 2017 09 27

---

---

(111) M 1997 006290 R2  
(732) MASTERCARD EUROPE S.A.  
Claussee de Tervuren 198 A, 1410  
Waterloo, Belgium  
(770) MASTERCARD EUROPE SPRL  
Claussee de Tervuren 198 A, B-1410  
Waterloo, Belgium  
(580) 2017 09 27

---

---

(111) M 1997 006496 R2  
(732) MÄURER & WIRTZ GmbH & Co., KG  
Zweifaller Strasse 120, 52234 Stolberg,  
Germany  
(770) MAURER+WIRTZ GmbH & CO KG  
Zweifaller Str 120, 52224 Stolberg, Germany  
(580) 2017 09 26

---

---

(111) M 1997 006498 R2  
(732) MÄURER & WIRTZ GmbH & Co., KG  
Zweifaller Strasse 120, 52234 Stolberg,  
Germany

---



# CLASSIFICATION INDEXES

## INVENTIONS

### CONCORDANCE TABLE OF INTERNATIONAL CLASSIFICATION INDEX AND PUBLICATION NUMBERS

INTERNATIONAL CLASSIFICATION INDEXES (51)	NUMBER OF PUBLISHED APPLICATION (10)
A 61 K 9/00; A 61 K 31/00; A 61 K 31/164; A 61 K 31/4174; A 61 K 31/505; A 61 K 31/728; A 61 P 11/02	AP 2017 13662 A
A 61 K 9/20; A 61 K 9/28; A 61 K 9/50; A 61 K 31/4196; A 61 P 39/04	AP 2017 13929 A
C 07 D 401/14; C 07 D 405/14; C 07 D 401/12; A 61 K 31/513; A 61 K 31/501; A 61 K 31/497; A 61 P 25/00	AP 2017 14022 A
C 07 D 403/04; A 61 K 31/4178; A 61 K 31/4184; A 61 P 3/10	AP 2017 14070 A
C 12 G 3/00; C 12 H 1/22	AP 2017 14336 A
G 01 W 1/02; G 01 W 1/06; G 01 W 1/10	AP 2017 14155 A

### CONCORDANCE TABLE OF PUBLICATION NUMBERS AND INTERNATIONAL CLASSIFICATION INDEX

NUMBER OF PUBLISHED APPLICATION (10)	INTERNATIONAL CLASSIFICATION INDEXES (51)
AP 2017 13662 A	A 61 K 9/00; A 61 K 31/00; A 61 K 31/164; A 61 K 31/4174; A 61 K 31/505; A 61 K 31/728; A 61 P 11/02
AP 2017 13929 A	A 61 K 9/20; A 61 K 9/28; A 61 K 9/50; A 61 K 31/4196; A 61 P 39/04
AP 2017 14022 A	C 07 D 401/14; C 07 D 405/14; C 07 D 401/12; A 61 K 31/513; A 61 K 31/501; A 61 K 31/497; A 61 P 25/00
AP 2017 14070 A	C 07 D 403/04; A 61 K 31/4178; A 61 K 31/4184; A 61 P 3/10
AP 2017 14155 A	G 01 W 1/02; G 01 W 1/06; G 01 W 1/10
AP 2017 14336 A	C 12 G 3/00; C 12 H 1/22

### CONCORDANCE TABLE OF INTERNATIONAL CLASSIFICATION INDEX, PATENT NUMBERS AND PUBLICATION NUMBERS

INTERNATIONAL CLASSIFICATION INDEX (51)	NUMBER OF PATENT (11)	NUMBER OF PUBLISHED APPLICATION (10)
A 61 K 31/205; A 61 P 9/10; A 61 P 13/12	P 2017 6747 B	AP 2017 13706 A
A 61 M 15/00	P 2017 6746 B	AP 2017 13678 A
B 01 D 11/02	P 2017 6750 B	AP 2017 14233 A
C 07 D 295/096	P 2017 6749 B	AP 2017 13919 A
C 07 D 401/14; C 07 D 405/14; C 07 D 413/14; C 07 D 231/38; C 07 D 401/04; C 07 D 401/06; C 07 D 403/02; C 07 D 403/06; C 07 D 417/02; C 07 D 417/04; C 07 D 417/06; C 07 D 277/56; C 07 D 403/04; A 61 P 19/00; A 61 P 11/00	P 2017 6748 B	AP 2017 13757 A
C 07 D 498/00	P 2017 6745 B	AP 2017 13141 A
E 04 G 3/30	P 2017 6751 B	AP 2017 13150 A

**CONCORDANCE TABLE OF PATENT NUMBERS,  
PUBLICATION NUMBERS AND INTERNATIONAL CLASSIFICATION INDEX**

NUMBER OF PATENT (11)	NUMBER OF PUBLISHED APPLICATION (10)	INTERNATIONAL CLASSIFICATION INDEX (51)
P 2017 6745 B	AP 2017 13141 A	C 07 D 498/00
P 2017 6746 B	AP 2017 13678 A	A 61 M 15/00
P 2017 6747 B	AP 2017 13706 A	A 61 K 31/205; A 61 P 9/10; A 61 P 13/12;
P 2017 6748 B	AP 2017 13757 A	C 07 D 401/14; C 07 D 405/14; C 07 D 413/14; C 07 D 231/38; C 07 D 401/04; C 07 D 401/06; C 07 D 403/02; C 07 D 403/06; C 07 D 417/02; C 07 D 417/04; C 07 D 417/06; C 07 D 277/56; C 07 D 403/04; A 61 P 19/00; A 61 P 11/00
P 2017 6749 B	AP 2017 13919 A	C 07 D 295/096
P 2017 6750 B	AP 2017 14233 A	B 01 D 11/02
P 2017 6751 B	AP 2017 13150 A	E 04 G 3/30

**CONCORDANCE TABLE OF APPLICATION NUMBERS, PUBLICATION NUMBERS  
AND PATENTS**

NUMBER OF APPLICATION (21)	NUMBER OF PUBLISHED APPLICATION (10)	NUMBER OF PATENT (11)
AP 2011 013141	AP 2017 13141 A	P 2017 6745 B
AP 2013 013150	AP 2017 13150 A	P 2017 6751 B
AP 2013 013678	AP 2017 13678 A	P 2017 6746 B
AP 2013 013706	AP 2017 13706 A	P 2017 6747 B
AP 2013 013757	AP 2017 13757 A	P 2017 6748 B
AP 2014 013919	AP 2017 13919 A	P 2017 6749 B
AP 2016 014233	AP 2017 14233 A	P 2017 6750 B

## UTILITY MODELS

**CONCORDANCE TABLE OF INTERNATIONAL CLASSIFICATION INDEX  
AND PUBLICATION NUMBERS**

INTERNATIONAL CLASSIFICATION INDEXES (51)	NUMBER OF PUBLISHED APPLICATION (10)
A 23 L 2/00	AU 2017 14354 U
A 61 K 9/08; A 61 K 31/475	AU 2017 13995 U
E 04 B 1/00	AU 2017 14200 U

**CONCORDANCE TABLE OF PUBLICATION NUMBERS  
AND INTERNATIONAL CLASSIFICATION INDEX**

NUMBER OF PUBLISHED APPLICATION (10)	INTERNATIONAL CLASSIFICATION INDEXES (51)
AU 2017 13995 U	A 61 K 9/08; A 61 K 31/475
AU 2017 14200 U	E 04 B 1/00
AU 2017 14354 U	A 23 L 2/00

**DESIGNS**

**CONCORDANCE TABLE OF INTERNATIONAL CLASSIFICATION INDEX  
AND PUBLICATION NUMBERS**

INTERNATIONAL CLASSIFICATION INDEXES (51)	NUMBER OF PUBLISHED APPLICATION (10)
09-03	AD 2017 958 S

**CONCORDANCE TABLE OF PUBLICATION NUMBERS  
AND INTERNATIONAL CLASSIFICATION INDEX**

NUMBER OF PUBLISHED APPLICATION (10)	INTERNATIONAL CLASSIFICATION INDEXES (51)
AD 2017 958 S	09-03

**CONCORDANCE TABLE OF INTERNATIONAL CLASSIFICATION INDEX,  
PATENT NUMBERS AND PUBLICATION NUMBERS**

INTERNATIONAL CLASSIFICATION INDEX (51)	NUMBER OF PATENT (11)	NUMBER OF PUBLISHED APPLICATION (10)
25-01	D 2017 725 S	AD 2017 942 S

**CONCORDANCE TABLE OF PATENT NUMBERS,  
PUBLICATION NUMBERS AND INTERNATIONAL CLASSIFICATION INDEX**

NUMBER OF PATENT (11)	NUMBER OF PUBLISHED APPLICATION (10)	INTERNATIONAL CLASSIFICATION INDEX (51)
D 2017 725 S	AD 2017 942 S	25-01

CONCORDANCE TABLE OF APPLICATION NUMBERS, PUBLICATION NUMBERS  
AND PATENTS

NUMBER OF APPLICATION (21)	NUMBER OF PUBLISHED APPLICATION (10)	NUMBER OF PATENT (11)
AD 2017 000942	AD 2017 942 S	D 2017 725 S

**DESIGN REGISTERED ACCORDING TO THE ACCELERATED  
PROCEDURE**

CONCORDANCE TABLE OF INTERNATIONAL CLASSIFICATION INDEX  
AND PUBLICATION NUMBERS

INTERNATIONAL CLASSIFICATION INDEXES (51)	NUMBER OF PUBLISHED APPLICATION (11)
19-08	D 2017 724 S
32-00	D 2017 723 S

CONCORDANCE TABLE OF PUBLICATION NUMBERS  
AND INTERNATIONAL CLASSIFICATION INDEX

NUMBER OF PUBLISHED APPLICATION (11)	INTERNATIONAL CLASSIFICATION INDEXES (51)
D 2017 723 S	32-00
D 2017 724 S	19-08

CONCORDANCE TABLE OF APPLICATION NUMBERS,  
PUBLICATION NUMBERS AND PATENTS

NUMBER OF APPLICATION (21)	NUMBER OF PATENT (11)
AD 2017 983	D 2017 723 S
AD 2017 984	D 2017 724 S

## TRADEMARKS

### CONCORDANCE TABLE OF REGISTRATION NUMBERS, APPLICATION NUMBERS, PUBLICATION NUMBERS AND BULLETIN NUMBERS

NUMBER OF REGISTRATION (111)	NUMBER OF APPLICATIONS (210)	NUMBER OF PUBLISHED APPLICATIONS (260)	NUMBER OF BULLETIN
M 2017 28908 R	AM 94078	-	19(479)2017
M 2017 28909 R	AM 94179	-	19(479)2017
M 2017 28910 R	AM 94000	-	19(479)2017
M 2017 28911 R	AM 94217	-	19(479)2017
M 2017 28912 R	AM 94339	-	19(479)2017
M 2017 28913 R	AM 86757	AM 2017 86757 A	7(467)2017
M 2017 28914 R	AM 87015	AM 2017 87015 A	5(465)2017
M 2017 28915 R	AM 87509	AM 2017 87509 A	5(465)2017
M 2017 28916 R	AM 87539	AM 2017 87539 A	5(465)2017
M 2017 28917 R	AM 87886	AM 2017 87886 A	4(464)2017
M 2017 28918 R	AM 87890	AM 2017 87890 A	5(465)2017
M 2017 28919 R	AM 87906	AM 2017 87906 A	9(469)2017
M 2017 28920 R	AM 87908	AM 2017 87908 A	9(469)2017
M 2017 28921 R	AM 88000	AM 2017 88000 A	6(466)2017
M 2017 28922 R	AM 88227	AM 2017 88227 A	7(467)2017
M 2017 28923 R	AM 88320	AM 2017 88320 A	4(464)2017
M 2017 28924 R	AM 88321	AM 2017 88321 A	4(464)2017
M 2017 28925 R	AM 88407	AM 2017 88407 A	9(469)2017
M 2017 28926 R	AM 88487	AM 2017 88487 A	10(470)2017
M 2017 28927 R	AM 88488	AM 2017 88488 A	10(470)2017
M 2017 28928 R	AM 88584	AM 2017 88584 A	9(469)2017
M 2017 28929 R	AM 88586	AM 2017 88586 A	9(469)2017
M 2017 28930 R	AM 88587	AM 2017 88587 A	9(469)2017
M 2017 28931 R	AM 88602	AM 2017 88602 A	10(470)2017
M 2017 28932 R	AM 88653	AM 2017 88653 A	10(470)2017
M 2017 28933 R	AM 88691	AM 2017 88691 A	9(469)2017
M 2017 28934 R	AM 88693	AM 2017 88693 A	10(470)2017
M 2017 28935 R	AM 88709	AM 2017 88709 A	9(469)2017
M 2017 28936 R	AM 88713	AM 2017 88713 A	10(470)2017
M 2017 28937 R	AM 88718	AM 2017 88718 A	10(470)2017
M 2017 28938 R	AM 88721	AM 2017 88721 A	9(469)2017
M 2017 28939 R	AM 88723	AM 2017 88723 A	9(469)2017
M 2017 28940 R	AM 88725	AM 2017 88725 A	9(469)2017
M 2017 28941 R	AM 88727	AM 2017 88727 A	9(469)2017
M 2017 28942 R	AM 88729	AM 2017 88729 A	9(469)2017
M 2017 28943 R	AM 88732	AM 2017 88732 A	9(469)2017
M 2017 28944 R	AM 88735	AM 2017 88735 A	9(469)2017
M 2017 28945 R	AM 88737	AM 2017 88737 A	10(470)2017
M 2017 28946 R	AM 88738	AM 2017 88738 A	9(469)2017
M 2017 28947 R	AM 88835	AM 2017 88835 A	10(470)2017
M 2017 28948 R	AM 89050	AM 2017 89050 A	10(470)2017
M 2017 28949 R	AM 89095	AM 2017 89095 A	10(470)2017
M 2017 28950 R	AM 89096	AM 2017 89096 A	10(470)2017
M 2017 28951 R	AM 89099	AM 2017 89099 A	10(470)2017
M 2017 28952 R	AM 89102	AM 2017 89102 A	12(472)2017
M 2017 28953 R	AM 89103	AM 2017 89103 A	12(472)2017

1	2	3	4
M 2017 28954 R	AM 89178	AM 2017 89178 A	10(470)2017
M 2017 28955 R	AM 89179	AM 2017 89179 A	10(470)2017
M 2017 28956 R	AM 89429	AM 2017 89429 A	11(471)2017
M 2017 28957 R	AM 89430	AM 2017 89430 A	11(471)2017
M 2017 28958 R	AM 89538	AM 2017 89538 A	12(472)2017

CONCORDANCE TABLE OF PUBLICATION NUMBERS  
AND APPLICATION NUMBERS

NUMBER OF PUBLISHED APPLICATION (260)	NUMBER OF APPLICATION (210)	1	2
1	2		
AM 2017 87568 A	AM 87568 A	AM 2017 90779 A	AM 90779 A
AM 2017 88286 A	AM 88286 A	AM 2017 90863 A	AM 90863 A
AM 2017 88319 A	AM 88319 A	AM 2017 90929 A	AM 90929 A
AM 2017 88676 A	AM 88676 A	AM 2017 90930 A	AM 90930 A
AM 2017 89523 A	AM 89523 A	AM 2017 90962 A	AM 90962 A
AM 2017 89781 A	AM 89781 A	AM 2017 90964 A	AM 90964 A
AM 2017 89879 A	AM 89879 A	AM 2017 90977 A	AM 90977 A
AM 2017 90091 A	AM 90091 A	AM 2017 91002 A	AM 91002 A
AM 2017 90094 A	AM 90094 A	AM 2017 91003 A	AM 91003 A
AM 2017 90138 A	AM 90138 A	AM 2017 91006 A	AM 91006 A
AM 2017 90141 A	AM 90141 A	AM 2017 91025 A	AM 91025 A
AM 2017 90302 A	AM 90302 A	AM 2017 91052 A	AM 91052 A
AM 2017 90418 A	AM 90418 A	AM 2017 91053 A	AM 91053 A
AM 2017 90428 A	AM 90428 A	AM 2017 91062 A	AM 91062 A
AM 2017 90429 A	AM 90429 A	AM 2017 91065 A	AM 91065 A
AM 2017 90451 A	AM 90451 A	AM 2017 91068 A	AM 91068 A
AM 2017 90569 A	AM 90569 A	AM 2017 91070 A	AM 91070 A
AM 2017 90649 A	AM 90649 A	AM 2017 91071 A	AM 91071 A
AM 2017 90687 A	AM 90687 A	AM 2017 91072 A	AM 91072 A
AM 2017 90689 A	AM 90689 A	AM 2017 91075 A	AM 91075 A
AM 2017 90690 A	AM 90690 A	AM 2017 91076 A	AM 91076 A
AM 2017 90691 A	AM 90691 A	AM 2017 91078 A	AM 91078 A
AM 2017 90692 A	AM 90692 A	AM 2017 91089 A	AM 91089 A
AM 2017 90694 A	AM 90694 A	AM 2017 91129 A	AM 91129 A
AM 2017 90696 A	AM 90696 A	AM 2017 91136 A	AM 91136 A
AM 2017 90728 A	AM 90728 A	AM 2017 91152 A	AM 91152 A
AM 2017 90748 A	AM 90748 A	AM 2017 91153 A	AM 91153 A
AM 2017 90762 A	AM 90762 A	AM 2017 91155 A	AM 91155 A
AM 2017 90766 A	AM 90766 A	AM 2017 91178 A	AM 91178 A
AM 2017 90768 A	AM 90768 A	AM 2017 91180 A	AM 91180 A
AM 2017 90769 A	AM 90769 A	AM 2017 91183 A	AM 91183 A
AM 2017 90771 A	AM 90771 A	AM 2017 91188 A	AM 91188 A
AM 2017 90774 A	AM 90774 A	AM 2017 91189 A	AM 91189 A
AM 2017 90778 A	AM 90778 A	AM 2017 91190 A	AM 91190 A
		AM 2017 91191 A	AM 91191 A
		AM 2017 91194 A	AM 91194 A
		AM 2017 91195 A	AM 91195 A
		AM 2017 91198 A	AM 91198 A

CONCORDANCE TABLE OF INDEX OF GOODS AND/OR SERVICES  
AND APPLICATION NUMBERS

INDEX OF GOODS AND/OR SERVICES (511)	NUMBER OF PUBLISHED APPLICATIONS (26)	1	2
1	2		
1	AM 2017 91052 A	21	AM 2017 91052 A
1	AM 2017 91178 A	22	AM 2017 91052 A
1	AM 2017 91189 A	24	AM 2017 91052 A
1	AM 2017 91190 A	25	AM 2017 90692 A
2	AM 2017 91052 A	25	AM 2017 91003 A
2	AM 2017 91178 A	25	AM 2017 91052 A
4	AM 2017 90692 A	27	AM 2017 91052 A
4	AM 2017 91178 A	28	AM 2017 90692 A
5	AM 2017 89523 A	28	AM 2017 91052 A
5	AM 2017 89879 A	28	AM 2017 91136 A
5	AM 2017 90138 A	29	AM 2017 88676 A
5	AM 2017 90569 A	29	AM 2017 90691 A
5	AM 2017 90687 A	29	AM 2017 90930 A
5	AM 2017 90689 A	29	AM 2017 91006 A
5	AM 2017 90696 A	29	AM 2017 91025 A
5	AM 2017 90768 A	29	AM 2017 91052 A
5	AM 2017 90769 A	30	AM 2017 90691 A
5	AM 2017 90771 A	30	AM 2017 90930 A
5	AM 2017 90778 A	30	AM 2017 91052 A
5	AM 2017 90779 A	30	AM 2017 91180 A
5	AM 2017 90930 A	30	AM 2017 91191 A
5	AM 2017 91089 A	30	AM 2017 91052 A
5	AM 2017 91183 A	31	AM 2017 91052 A
5	AM 2017 91195 A	32	AM 2017 90302 A
5	AM 2017 91198 A	32	AM 2017 90690 A
6	AM 2017 91052 A	32	AM 2017 90962 A
7	AM 2017 90692 A	32	AM 2017 90964 A
7	AM 2017 91052 A	32	AM 2017 91025 A
8	AM 2017 91052 A	32	AM 2017 91052 A
9	AM 2017 90418 A	32	AM 2017 91180 A
9	AM 2017 90863 A	33	AM 2017 87568 A
10	AM 2017 90141 A	33	AM 2017 89781 A
10	AM 2017 91052 A	33	AM 2017 90091 A
11	AM 2017 90418 A	33	AM 2017 90094 A
11	AM 2017 91052 A	33	AM 2017 90451 A
12	AM 2017 91052 A	33	AM 2017 90762 A
14	AM 2017 91052 A	33	AM 2017 90929 A
15	AM 2017 91052 A	33	AM 2017 90962 A
16	AM 2017 90428 A	33	AM 2017 90964 A
16	AM 2017 90429 A	33	AM 2017 91002 A
16	AM 2017 91052 A	33	AM 2017 91052 A
16	AM 2017 91188 A	33	AM 2017 91129 A
16	AM 2017 91189 A	33	AM 2017 91152 A
16	AM 2017 91190 A	33	AM 2017 91153 A
18	AM 2017 91052 A	33	AM 2017 91194 A
19	AM 2017 91052 A	34	AM 2017 90649 A
20	AM 2017 91052 A	34	AM 2017 90728 A
		34	AM 2017 90748 A
		34	AM 2017 90766 A
		34	AM 2017 90977 A
		35	AM 2017 88286 A
		35	AM 2017 89781 A
		35	AM 2017 89879 A

1	2
35	AM 2017 90451 A
35	AM 2017 90649 A
35	AM 2017 90692 A
35	AM 2017 90694 A
35	AM 2017 90768 A
35	AM 2017 90769 A
35	AM 2017 90771 A
35	AM 2017 90774 A
35	AM 2017 90778 A
35	AM 2017 90779 A
35	AM 2017 90863 A
35	AM 2017 90962 A
35	AM 2017 90964 A
35	AM 2017 91003 A
35	AM 2017 91052 A
35	AM 2017 91178 A
35	AM 2017 91188 A
36	AM 2017 90774 A
36	AM 2017 91052 A
37	AM 2017 90774 A
37	AM 2017 91052 A
38	AM 2017 91052 A
38	AM 2017 91188 A
39	AM 2017 91052 A
39	AM 2017 91155 A

1	2
41	AM 2017 91052 A
41	AM 2017 91188 A
43	AM 2017 88286 A
43	AM 2017 88319 A
43	AM 2017 90649 A
43	AM 2017 91052 A
43	AM 2017 91053 A
43	AM 2017 91062 A
43	AM 2017 91065 A
43	AM 2017 91068 A
43	AM 2017 91070 A
43	AM 2017 91071 A
43	AM 2017 91072 A
43	AM 2017 91075 A
43	AM 2017 91076 A
43	AM 2017 91078 A
43	AM 2017 91155 A
44	AM 2017 90768 A
44	AM 2017 90769 A
44	AM 2017 90771 A
44	AM 2017 90778 A
44	AM 2017 90779 A
45	AM 2017 91052 A
45	AM 2017 91188 A

CONCORDANCE TABLE OF INDEX OF GOODS AND/OR SERVICES  
AND NUMBERS OF TRADEMARKS REGISTERED ACCORDING  
TO THE ACCELERATED PROCEDURE

INDEX OF GOODS AND/OR SERVICES (511)	NUMBERS OF REGISTERED ACCORDING TO THE ACCELERATED PROCEDURE (111)
5	M 2017 28910 R
5	M 2017 28912 R
33	M 2017 28909 R
34	M 2017 28908 R
41	M 2017 28911 R



# OFFICIAL BULLETIN OF THE INDUSTRIAL PROPERTY

## 19(479)

EDITOR-IN-CHIEF: N. Bebrishvili

EDITORS-TRANSLATORS: E. Gabunia

PROOFREADER: A. Shikhashvili

COMPUTER LAYOUT: M. Ordenidze  
K. Svanidze

[www.sakpatenti.org.ge](http://www.sakpatenti.org.ge)

E-mail: [info@sakpatenti.org.ge](mailto:info@sakpatenti.org.ge)