

# Official Bulletin of the Industrial Property

Inventions

Utility Models

Designs

Trademarks



საქართველოს ინტელექტუალური  
საკუთრების ეროვნული ცენტრი

**საქპატენტი**

**SAKPATENTI**

NATIONAL INTELLECTUAL PROPERTY  
CENTER OF GEORGIA

[www.sakpatenti.gov.ge](http://www.sakpatenti.gov.ge)

Date of Publication – 2020 10 26

**20(552)**

# INID CODES FOR IDENTIFICATION OF BIBLIOGRAPHIC DATA

## INVENTIONS, UTILITY MODELS

- (10) Number of publication for application, which has been examined
- (11) Number of patent and kind of document
- (21) Serial number of application
- (22) Date of filing of the application
- (23) Date of exhibition or the date of the earlier filing and the number of application, if any
- (24) Date from which patent may have effect
- (31) Number of priority application
- (32) Date of filing of priority application
- (33) Code of the country or regional organization allotting priority application number
- (44) Date of publication of application not granted, but examined and number of bulletin
- (45) Date of publication of registered document
- (51) International Patent Classification Index

- (54) Title of the invention
- (57) Abstract
- (60) Number of examined patent document granted by foreign patent office, date from which patent has effect and country code
- (62) Number of the earlier application and in case of divided application, date of filing an application
- (71) Name, surname and address of applicant (country code)
- (72) Name, surname of inventor (country code)
- (73) Name, surname and address of patent owner (country code)
- (74) Name, surname of representative or patent attorney
- (85) Date of commencement of the national phase of International Application
- (86) Number and date of filing of international application
- (87) Number and date of publication of international application
- (94) Calculated date of expiry of the SPC or the duration of the SPC

## DESIGNS

- (10) Number of publication for application
- (11) Number of patent and kind of document or number of registration
- (15) Date of registration/Date of patent renewal
- (18) Expected expiration date of patent or registration
- (21) Serial number of application
- (22) Date of filing of the application
- (23) Date of exhibition or the date of the earlier filing and the number of application, if any
- (24) Date from which patent may have effect
- (28) Number of designs included in the application
- (30) Data relating to priority (number of application, date of filing of application, two-letter code identifying the authority with whom the priority application was made)
- (31) Number of priority application
- (32) Date of filing of priority application
- (33) Code of the country or regional organization allotting priority application number
- (34) Two-letter code according to WIPO St.3 identifying the authority with which the priority application was made
- (44) Date of publication of design and number of bulletin (the first publication)
- (45) Date of publication of design registered by WIPO and number of bulletin

- (51) International Classification for designs (class and subclass of the Locarno Classification)
- (54) Title of the invention
- (55) Reproduction of the design
- (57) Description of characteristic features of the design including indication of colors
- (58) Date of recording of any kind of amendment in the Register
- (62) Number of the earlier application, registration and document number and if available the date of filing an application in case of divided application
- (71) Name, surname and address of applicant (country code)
- (72) Name, surname of creator (country code)
- (73) Name, surname and address of patent owner (country code)
- (74) Name, surname of representative or patent attorney
- (81) Contracting states concerned  
II designated contracting states according to the 1960 Act  
III designated contracting states according to the 1999 Act
- (85) Owner's permanent address
- (86) Owner's nationality
- (87) Owner's residence
- (88) State in which the owner has a real and effective industrial or commercial establishment

## TRADEMARKS

- (111) - Number of registration
- (151) - Date of registration
- (156) - Date of the renewal
- (181) - Expected expiration date of registration
- (186) - Renewal expiration date of registration
- (141) - Date of cancel of duration of the mark
- (210) - Serial number of application
- (220) - Date of filing of the application
- (230) - Data concerning exhibition
- (260) - Number of application, for which favorable decision of examination about registration has been taken (publication number)
- (310) - Number of the first application
- (320) - Date of filing of the first application
- (330) - Code, identifying national or regional Office where the first application was made
- (511) - International Classification of Goods and Services for the purposes of registration of trade marks and/or list of goods and/or services classified according thereto
- (526) - Disclaimer
- (531) - Description of figurative elements of Trade Marks according to the International Classification of the Figurative Elements of Marks

- (540) - Reproduction of Trade Mark
- (550) - Nature and kind of Trade Mark
- (551) - Indication to the effect that the mark is a collective mark, a certification mark or a guarantee mark
- (554) - Three-dimensional mark
- (580) - Date of recording of any kind changes in respect of applications or registrations
- (591) - Information concerning colors claimed
- (731) - Name and address of the applicant
- (732) - Name and address of the holder of the registration
- (740) - Name and address of the representative
- (750) - Addreses for correspondence
- (770) - Name and address of the previous applicant or holder in case of change in ownership
- (771) - Previous name and address of the applicant or holder in case of change in ownership
- (791) - Name and address of the licensee
- (793) - Indication of conditions and/or restrictions under the license (Type of license, number of license agreement, data of license, data of validity of license)
- (800) - Certain data relating to the international registration of Trade Marks under the Protocol Relating to Madrid Agreement (International registration number)
- (852) - Partial cancellation of the list of goods and services
- (891) - Date of subsequent designation

## CODES FOR PUBLICATION IN BULLETIN

- (21) AP 0000 000000 - serial number of application for invention
- (10) AP 0000 0000 A - number of published application for invention (first publication)
- (11) P 0000 0000 B - number of patent for invention (second publication)
- (21) API 0000 000000 - number of application for imported patent
- (11) PI 0000 0000 A - number of imported patent (first publication)
- (21) AU 0000 000000 - serial number of application for utility model
- (10) AU 0000 000 U - number of published application for utility model (first publication)
- (11) U 0000 000 Y - number of patent for utility model (second publication)
- (21) AD 0000 000000 - serial number of application for design
- (10) AD 0000 000 S - number of published application for design (first publication)
- (11) D 0000 000 S - registered design

## INTERNATIONAL PATENT CLASSIFICATION FOR INVENTIONS AND UTILITY MODELS

- SECTION A - HUMAN NECESSITIES
- SECTION B - PERFORMING OPERATIONS; TRANSPORTING
- SECTION C - CHEMISTRY; METALLURGY
- SECTION D - TEXTILES; PAPER
- SECTION E - FIXED CONSTRUCTIONS
- SECTION F - MECHANICAL ENGINEERING; LIGHTING; HEATING; WEAPONS; BLASTING
- SECTION G - PHYSICS
- SECTION H - ELECTRICITY

- 
- M - Trade Mark
  - (210) AM 0000 000000 - Serial number of application;
  - (260) AAM 0000 00000 A - Publication number of application;
  - (111) M 0000 00000 R - Number of registration;
  - (111) MMM0000 00000 Rn - Number of renewals, in which n=1,2,3;
  - (111) M 0000 00000 R(P) - Number of registration under partial assignment of rights
-

# Official Bulletin of the Industrial Property

Inventions

Utility Models

Designs

Trademarks

# CONTENTS

<b>PUBLISHED TITLES OF PROTECTION</b> .....	3
<b>INVENTIONS</b>	
▪ APPLICATIONS APPROVED FOR GRANTING PATENTS .....	4
▪ PATENTED INVENTIONS .....	7
<b>UTILITY MODELS</b>	
▪ APPLICATIONS APPROVED FOR GRANTING PATENTS .....	8
▪ PATENTED UTILITY MODELS .....	10
<b>DESIGNS</b>	
▪ APPLICATIONS APPROVED FOR REGISTRATION .....	11
▪ REGISTERED DESIGNS .....	16
▪ DESIGNS, WHICH HAVE BEEN REGISTERED WITH THE INTERNATIONAL BUREAU CLAIMING PRIORITY ON THE TERRITORY OF GEORGIA .....	17
<b>TRADEMARKS</b>	
▪ APPLICATIONS FILED UNDER THE NATIONAL PROCEDURE APPROVED FOR REGISTRATION .....	31
▪ REGISTERED TRADEMARKS .....	39
▪ TRADEMARKS REGISTERED ACCORDING TO THE ACCELERATED PROCEDURE .....	42
▪ INTERNATIONAL TRADEMARKS FOR WHICH A DECISION ON GRANTING PROTECTION IS TAKEN .....	43
▪ INTERNATIONAL TRADEMARKS PROTECTED IN GEORGIA .....	85
<b>OFFICIAL NOTIFICATIONS</b>	
<b>INVENTIONS</b>	
▪ EXPIRATION OF PATENTS RESTORATION .....	97
▪ ABOLITION OF PATENTS WITH THE RIGHT TO RESTORE .....	97
▪ EXPIRATION OF TERM OF RESTORATION OF PATENTS .....	98
▪ EXPIRATION OF PATENTS .....	99
▪ CHANGE OF NAME AND/OR ADDRESS OF PATENTOWNER .....	99
<b>UTILITY MODELS</b>	
▪ ABOLITION OF PATENT WITH THE RIGHT TO RESTORE .....	100
▪ EXPIRATION OF TERM OF RESTORATION OF PATENT .....	101
▪ TRANSFER OF RIGHT .....	102
<b>DESIGNS</b>	
▪ EXTENSION OF REGISTRATION OF DESIGNS .....	102
▪ CANCELLATION OF DESIGNS REGISTRATION .....	103
▪ EXTENSION OF REGISTRATION OF INTERNATIONAL DESIGNS .....	103
<b>TRADEMARKS</b>	
▪ RENEWAL OF REGISTRATIONS .....	107
▪ COMPLETE TRANSFER OF RIGHTS .....	110
▪ CHANGES OF NAMES AND/OR ADDRESSES OF OWNER .....	111
▪ TERMINATION OF TRADEMARKS REGISTRATION .....	114
▪ REGISTRATION OF LICENSE AGREEMENT .....	116
▪ CANCELLATION OF THE CLASS LIST IN A REGISTERED TRADEMARK ON THE BASIS OF COURT DECISION .....	116
<b>CLASSIFICATION INDEXES</b>	
INVENTIONS .....	117
UTILITY MODELS .....	118
DESIGNS .....	119
TRADEMARKS .....	121

## **PUBLISHED TITLES OF PROTECTION**

### **INVENTIONS**

- **APPLICATIONS APPROVED FOR GRANTING PATENT:**  
14976; 14527; 13221; 14935; 15136
- **PATENTED INVENTIONS:**  
7171, 7172

### **UTILITY MODELS**

- **APPLICATIONS APPROVED FOR GRANTING PATENT:**  
15116; 15127; 15253
- **PATENTED UTILITY MODELS:**  
2054, 2055

### **DESIGNS**

- **APPLICATIONS APPROVED FOR REGISTRATION:**  
1161; 1159
- **REGISTERED DESIGNS:**  
868, 869
- **DESIGNS, WHICH HAVE BEEN REGISTERED WITH THE INTERNATIONAL BUREAU CLAIMING PRIORITY ON THE TERRITORY OF GEORGIA:**  
206100; 206102; 206524

### **TRADEMARKS**

- **APPLICATIONS FILED UNDER THE NATIONAL PROCEDURE APPROVED FOR REGISTRATION:**  
104567\*; 106605; 106751, 106752; 107269; 107272-107282; 107294; 107311; 107470; 107480; 107490, 107491; 107497; 107499; 107552-107554; 107556; 107558; 107564, 107565; 107569-107572; 107574; 107579; 107583; 107651; 107653, 107654; 107670, 107671; 107814; 107817; 107923
- **REGISTERED TRADEMARKS:**  
33220-33247
- **TRADEMARKS REGISTERED ACCORDING TO THE ACCELERATED PROCEDURE:**  
33217-33219; 33248, 33249
- **INTERNATIONAL TRADEMARKS FOR WHICH A DECISION ON GRANTING PROTECTIONS IS TAKEN:**  
102286\*; 103606\*; 106146; 106200; 106232; 106342; 106347; 106395; 106438-106440; 106446-106450; 106452, 106453; 106460; 106462; 106466; 106476-106478; 106480-106486; 106493; 106501-106507; 106535; 106565-106568; 106580, 106581; 106583; 106631-106636; 106638, 106639; 106704; 106729; 106732-106736; 106743; 106746-106748; 106850, 106851; 106853, 106854; 106870; 106875, 106876; 106920-106925; 106927-106929; 106991; 106998; 107199; 107409-107413; 107415-107417; 107420; 107422
- **INTERNATIONAL TRADEMARKS PROTECTED IN GEORGIA:**  
102091; 102182; 102678; 102856; 103551; 103716; 103723; 104044; 104146; 104382; 104497; 104570; 104603, 104704; 104723; 104785-104787; 104790; 104796; 104843, 104844; 104852-104858; 104860-104862; 104868; 104870; 104872; 104874, 104875; 104878; 104946, 104947; 104950-104952; 104954-104957; 104959-104962; 104967-104978; 104983; 104988, 104989; 104991-104994; 105047; 105049-105053; 105061-105064; 105070, 105071; 105073-105076; 105079, 105080; 105090-105092; 105094-105098; 105100, 105101; 105103- 105108; 105113, 105114; 105160-105165; 105173; 105178, 105179; 105184, 105185; 105188; 105191; 105195; 105200; 105207; 105271; 105287; 105289-105291; 105295, 105296; 105300-105304; 105306; 105309; 105312; 105323-105326; 105386-105388; 105390-105392; 105487-105489; 105513-105516; 105567-105571; 105897, 105898; 105905; 105960; 106286; 106288; 106293; 106426

# INVENTIONS

## APPLICATIONS APPROVED FOR GRANTING PATENTS

The decision can be appealed at the Chamber of Appeal of Sakpatenti within 3 months from the publication or at the Mtskheta District Court Administrative Cases Board (Address: №17, Samkhedro str., Mtskheta), within 1 month following the publication.

### PART A

#### A 61

(10) AP 2020 14976 A (51) Int. Cl. (2006)

A 61 K 31/675

A 61 P 19/02

C 07 F 9/576

- (21) AP 2014 14976 (22) 2014 12 12  
(62) AP 2014 14203 2014 12 12  
(31) 61/915,937  
(32) 2013 12 13  
(33) US  
(71) Vertex Pharmaceuticals Incorporated (US)  
50 Northern Ave., Boston, MA 02210, USA (US)  
(72) KESHAVARZ-SHOKRI, Ali (US);  
HADIDA-RUAH, Sara, Sabina (US);  
ANDERSON, Corey (US);  
ZHANG, Beili (US);  
LITTLER, Benjamin, Joseph (US);  
GOLEC, Julian Marian, Charles (GB);  
BELMONT, Daniel, T. (US);  
ALCACIO, Tim, Edward (US)

(74) Shalva Gvaramadze

(85) 2018 12 27

(86) PCT/US2014/069916, 2014 12 12

(54) **PRODRUGS OF PYRIDONE AMIDES  
USEFUL AS MODULATORS OF SODIUM  
CHANNELS**

(57) A method for compound of formula (I)

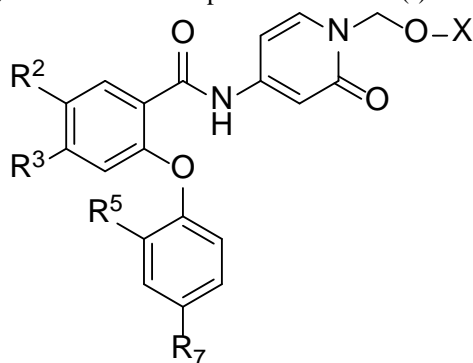

(I)

preparation.

Claims: 3 independents

26 dependents

Fig.: 6

(10) AP 2020 14527 A (51) Int. Cl. (2006)

A 61 K 31/7004

A 61 K 31/05

A 61 K 45/06

A 61 K 36/87

A 61 P 3/10

A 61 P 3/04

- (21) AP 2015 14527 (22) 2015 11 26  
(31) PI2014703552  
(32) 2014 11 27  
(33) MY  
(71) OMEGA PHARMA INOVATION &  
DEVELOPMENT NV (BE)  
Venekoveg 26, 9810, Nazareth, Belgium (BE)  
(72) CHONG, Pee Win (MY);  
TAN, Bee Kwan (MY)  
(74) Tamar Kochlamazashvili  
(85) 2017 06 26  
(86) PCT/MY2015/000098, 2015 11 26  
(54) **COMPOSITION COMPRISING  
PENTOSE AND POLYPHENOLIC  
COMPOUND**  
(57) Composition comprises L-arabinose and  
chacha extract tannins. Said composition is used to  
manage glucose and/or lipid level in blood.  
Claims: 16 independents  
13 dependents

## PART C

## C 07

- (10) AP 2020 13221 A (51) Int. Cl. (2006)  
C 07 D 215/227  
A 61 K 31/47  
A 61 P 35/00
- (21) AP 2012 13221 (22) 2012 02 10  
(31) 61/441,520; 61/441,527  
(32) 2011 02 10; 2011 02 10  
(33) US; US  
(71) EXELIXIS, INC. (US)  
210 East Grand Av., South San-Francisco,  
CA 94080 (US)  
(72) WILSON, Jo Ann (US)  
(74) Tamar Kochlamazashvili  
(85) 2013 09 10  
(86) PCT/US2012/024591, 2012 02 10  
(54) **PROCESSES FOR PREPARING  
QUINOLINE COMPOUNDS AND  
PHARMACEUTICAL COMPOSITIONS  
CONTAINING SUCH COMPOUNDS**  
(57) Compound of structural formula (IB),

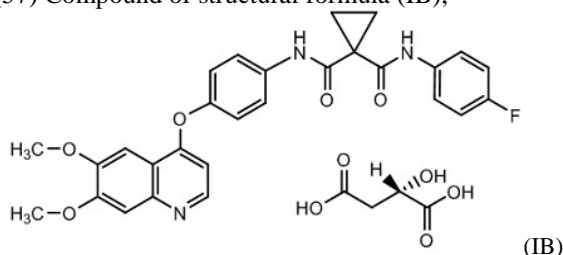

and capsule-shaped pharmaceutical compositions.

Claims: 2 independents

4 dependents

Table: 13

## PART E

## E 02

- (10) AP 2020 14935 A (51) Int. Cl. (2006)  
E 02 F 9/28  
E 02 F 9/28
- (21) AP 2017 14935 (22) 2017 05 11  
(31) 62/335,789; 62/441,779; 15/589,647  
(32) 2016 05 13; 2017 01 03; 2017 05 08  
(33) US; US; US  
(71) HENSLEY INDUSTRIES, INC. (US)  
2108 Joe Field Rd. Dallas, TX 75229, USA (US)  
(72) DIAZ, Isai (US);  
BILAL, Mohamad (US)  
(74) Giorgi Kartvelishvili  
(85) 2018 11 22  
(86) PCT/US2017/032242, 2017 05 11  
(54) **STABILIZING FEATURES IN WEAR  
MEMBER ASSEMBLY**

(57) Wear member assembly may include a nose attachable to bucket lip. The nose may include rear portion having planar first set passing through nose longitudinal axis. Planar first set includes first, second, and third subsets of surfaces. Third subset of surfaces may be angled and positioned between first and second subsets of surfaces. The nose may also include forward portion positioned forwardly adjacent to rear portion; at that, forward portion has second set of substantially planar surfaces including fourth, fifth, and sixth subset of surfaces. Sixth set of surfaces may be angled and positioned between fourth and fifth subsets of surfaces. Furthermore, the nose includes intermediate part located between front and rear portions; in addition, intermediate portion includes a number of surfaces in cross section, the number whereof differs from the number of front portion surfaces in front cross-section; at that, wear member has a cavity open in rear portion, and comprising bearing surfaces corresponding, at least, to some nose front and rear surfaces.

Claims: 19 independents

54 dependents

Fig.: 28

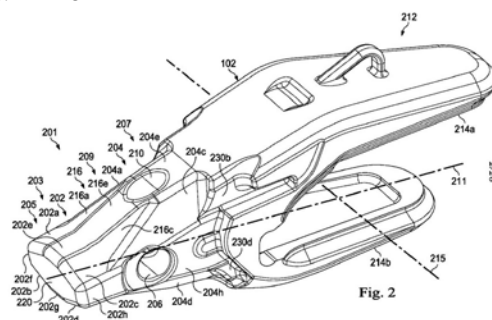

Fig. 2

**PART G****G 06**

(10) AP 2020 15136 A (51) Int. Cl. (2006)

G 06 F 17/10

G 10 L 19/02

G 10 L 19/22

G 10 L 19/24

G 10 L 19/26

(21) AP 2018 15136 (22) 2018 03 19

(31) 62/475,619

(32) 2017 03 23

(33) US

(71) DOLBY INTERNATIONAL AB (NL)

Apollo Bld., 3E Herikerbergweg 1-35,

Amsterdam Zuidoost, 1101 CN,

Netherlands (NL)

(72) EKSTRAND, Per (US);

VILLEMOES, Lars (US);

PURNHAGEN, Heiko (US)

(74) Tamar Kochlamazashvili

(85) 2019 07 12

(86) PCT/US2018/023183, 2018 03 19

(54) **BACKWARD-COMPATIBLE**

**INTEGRATION OF HARMONIC**

**TRANSPOSER FOR HIGH FRE-**

**QUENCY RECONSTRUCTION**

**OF AUDIO SIGNALS**

(57) A method for decoding of encoded audio bitstream is disclosed. The method includes receiving of encoded audio bitstream, and decoding of audio data to generate decoded lowband audio signal. The method further includes extracting high frequency reconstruction metadata, and filtering of decoded lowband audio signal with analysis filterbank to generate filtered lowband audio signal. The method also includes extracting of flag indicating whether either spectral translation or harmonic transposition is to be performed on audio data, and regenerating of highband portion of audio signal using filtered lowband audio signal, and high frequency reconstruction metadata in accordance with the flag.

Claims: 3 independents

14 dependents

Fig.: 7



---

# PATENTED INVENTIONS

## PART A

### A 61

- (11) P 2020 7172 B (51) Int. Cl. (2006)  
A 61 K 31/437  
C 07 D 471/04
- (10) AP 2020 14955 A (44) 13(545)/2020  
(21) AP 2017 14955  
(22) 2017 06 30  
(24) 2017 06 30  
(31) PA 2017 00236; PA 2016 00612;  
PA 2016 00397  
(32) 2017 04 04; 2016 10 11; 2016 07 04  
(33) DK; DK; DK  
(86) PCT/EP2017/066255, 2017 06 30  
(73) H. LUNDBECK A/S (DK)  
Ottliavej 9, Valby, DK-2500, Denmark (DK)
- (72) VITAL, Paulo, Jorge, Vieira (DK);  
MARIGO, Mauro (DK);  
CLEMENTSON, Carl, Martin, Sebastian (DK);  
JUHL, Karsten (DK);  
KEHLER, Jan (DK);  
RASMUSSEN, Lars, Kyhn (DK);  
LANGGÅRD, Morten (DK);  
JESSING, Mikkel (DK)
- (74) Tamaz Shilakadze
- (54) **1H-PYRAZOLO [4,3-B] PYRIDINES  
AS PDE1 INHIBITORS**
- 

## PART G

### G 06

- (11) P 2020 7171 B (51) Int. Cl. (2006)  
G 06 K 17/00  
G 06 K 7/00
- (10) AP 2020 15277 A (44) 13(545)/2020  
(21) AP 2020 15277  
(22) 2020 02 14  
(24) 2020 02 14  
(73) Davit Topchishvili (GE)  
Kostava St. II Lane 2, 0179, Tbilisi,  
Georgia (GE)
- (72) Davit Topchishvili (GE)
- (74) Davit Dzamukashvili
- (54) **METHOD FOR TRADE AND  
SYSTEM FOR IMPLEMENTATION  
THEREOF**
-

---

# UTILITY MODELS

## APPLICATIONS APPROVED FOR GRANTING PATENTS

The decision can be appealed at the Chamber of Appeal of Sakpatenti within 3 months from the publication or at the Mtskheta District Court Administrative Cases Board (Address: №17, Samkhedro str., Mtskheta), within 1 month following the publication.

### PART C

#### C 04

**(10) AU 2020 15116 U (51) Int. Cl. (2006)  
C 04 B 7/00**

- (21) AU 2019 15116 (22) 2019 06 18  
(71) Elena Shapakidze (GE)  
I. Chavchavadze Lane I, corp. 6, app. 7, 0179, Tbilisi, Georgia (GE);  
Marine Nadirashvili (GE)  
Khetagurov St. 6, 0102, Tbilisi, Georgia (GE);  
Vera Maisuradze (GE)  
Asastiani St. 10a, app. 36, 0186, Tbilisi, Georgia (GE);  
Ioseb Gejadze (GE)  
I. Chavchavadze Lane I, corp. 6, app. 7, Tbilisi, Georgia (GE);  
Marine Avaliani (GE)  
D. Chonkadze St. 10a, app. 13-14, 0108, Tbilisi, Georgia (GE);  
Tamar Petriashvili (GE)  
Vill. Zemo Nikozi, 1417, Gori, Georgia (GE);  
IV. JAVAKHISHVILI TBILISI STATE UNIVERCITY (GE)  
I. Chavchavadze Av. 1, 0179, Tbilisi, Georgia (GE);  
SH. RUSTAVELI NATIONAL SCIENCE FOUNDATION (GE)  
M. Aleksidze St. 1, 0193, Tbilisi, Georgia (GE)  
(72) Elena Shapakidze (GE);  
Marine Nadirashvili (GE);  
Vera Maisuradze (GE);  
Ioseb Gejadze (GE);  
Marine Avaliani (GE);  
Tamar Petriashvili (GE)  
(54) **GEOPOLYMERIC TIGHT MATERIAL CONTENT**  
(57) Geopolymeric tight material contains blast-furnace granuled cinder, ceramic plate treated up to 800°C, and NaOH solution of 30%; at that, additionally, it contains silicomanganese granuled cinder, in certain ratio of componentry (mass%):  
Claims: 1 independent  
Table: 4
- 

**(10) AU 2020 15127 U (51) Int. Cl. (2006)  
C 04 B 7/00**

- (21) AU 2019 15127 (22) 2019 07 04  
(71) Elena Shapakidze (GE)  
I. Chavchavadze Lane I, corp. 6, app. 7, 0179, Tbilisi, Georgia (GE);  
Razhden Skhvitaridze (GE)  
Ninoshvili St. 3, 0102, Tbilisi, Georgia (GE);  
Izolda Kamushadze (GE)  
Nutsbidze Plateau, IV mcr., corp. 28, app. 21, 0183, Tbilisi, Georgia (GE);  
Lamara Gabunia (GE)  
Toradze St., Dead End 5, 0108, Tbilisi, Georgia (GE);  
Ioseb Gejadze (GE)  
I. Chavchavadze Lane I, corp. 6, app. 7, Tbilisi, Georgia (GE);  
Marine Nadirashvili (GE)  
Khetagurov St. 6, 0102, Tbilisi, Georgia (GE);  
Vera Maisuradze (GE)  
Asastiani St. 10a, app. 36, 0186, Tbilisi, Georgia (GE);  
Tamar Petriashvili (GE)  
Vill. Zemo Nikozi, 1417, Gori, Georgia (GE);  
IV. JAVAKHISHVILI TBILISI STATE UNIVERCITY (GE)  
I. Chavchavadze Av. 1, 0179, Tbilisi, Georgia (GE);  
SH. RUSTAVELI NATIONAL SCIENCE FOUNDATION (GE)  
M. Aleksidze St. 1, 0193, Tbilisi, Georgia (GE)  
(72) Elena Shapakidze (GE);  
Razhden Skhvitaridze (GE);  
Izolda Kamushadze (GE);  
Lamara Gabunia (GE);  
Ioseb Gejadze (GE);  
Marine Nadirashvili (GE);  
Vera Maisuradze (GE);  
Tamar Petriashvili (GE)  
(54) **METHOD FOR CEMENT POZZOLANIC ADDITIVE PRODUCTION**  
(57) Polymineralic clay rocks (easy melted clays, argillites, clay plates) thermal modification method provides heating up to 600-800°C temperature, resting within 1-1.2 h-s on maximum temperature, and then – cooling; at that, cooling is executed quickly with cold air blowing of 5-10 m/s speed,

and backed rock temperature reducing with blowing with 30-35°C/min speed.

Claims: 1 independent

## PART F

### F 24

(10) AU 2020 15253 U (51) Int. Cl. (2006)  
F 24 C 3/00

(21) AU 2020 15253 (22) 2020 01 09

(71) Koba Kvachantiradze (GE)  
Zhvania St. 1, 0144, Tbilisi, Georgia (GE);  
Vakhtang Khechikashvili (GE)  
Monk Gabriel Salos Av., Lane VII, corp. 5,  
app. 7, 0121, Tbilisi, Georgia (GE)

(72) Koba Kvachantiradze (GE);  
Vakhtang Khechikashvili (GE)

(74) Khatuna Imnadze

(54) GAS STOVE

(57) A stove includes a case 1, burning chamber 2, a burner 5 having a fuse 22, air oven 3 placed in case air channel, the guides 7, 8 and 9 executed with partitions 10 in said air channel for passing exhaust gas, a latch 14 with a lever 23 inserted movable into a tube 21, exhausting pipe 12, burning chamber air supplying pipe 11 and control unit; furthermore, air flow reflector 15 and locking partition 17 are disposed in burning chamber 2, and, in addition, openings 20 together with lever tube 21 are placed on burning chamber front wall, to supply fuse with additional air, at latch pull out.

Claims: 1 independent

Fig.: 9

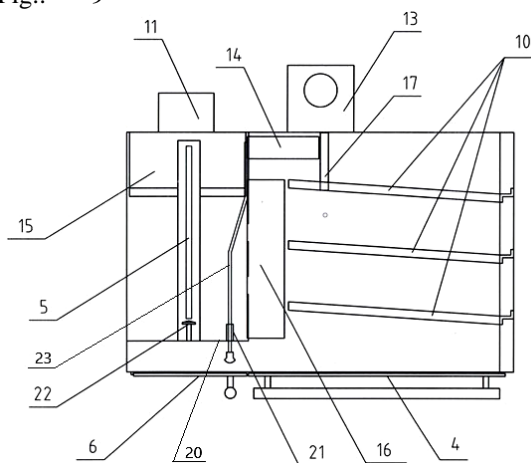

Fig. 2

## PATENTED UTILITY MODELS

### PART A

#### A 01

(11) U 2020 2055 Y (51) Int. Cl. (2006)

A 01 K 47/00

(10) AU 2020 15300 U (44) 13(545)/2020

(21) AU 2020 15300

(22) 2020 03 17

(24) 2020 03 17

(73) Nikoloz Osikmishvili (GE)

A. Tsereteli St. 9, 3800, Sagarejo,

Georgia (GE)

(72) Nikoloz Osikmishvili (GE)

(74) Nugzar Ksovreli

(54) **TRANSPARENT BEEHIVE**

---

#### A 23

(11) U 2020 2054 Y (51) Int. Cl. (2006)

A 23 L 1/314

(10) AU 2020 15214 U (44) 12(544)/2020

(21) AU 2019 15214

(22) 2019 11 08

(24) 2019 11 08

(73) Dodo Tavdidishvili (GE)

Varlamishvili St. 9, app. 30, 4600, Kutaisi,

Georgia (GE);

Tsira Khutsidze (GE)

Chabukiani St. 2, 4600, Kutaisi, Georgia (GE);

Davit Tsagareishvili (GE)

Lermontov 3<sup>rd</sup> Lane 5, 5400, Tskaltubo,

Georgia (GE);

Lela Marikishvili-Okreshidze (GE)

Kldiashvili St. 131, 4600, 4600, Kutaisi,

Georgia (GE);

Lana Kvirikashvili (GE)

Chkhobadze St. 13, app. 9, 4600, Kutaisi,

Georgia (GE)

(72) Dodo Tavdidishvili (GE);

Tsira Khutsidze (GE);

Davit Tsagareishvili (GE);

Lela Marikishvili-Okreshidze (GE)

Lana Kvirikashvili (GE)

(54) **DIETARY MINCED MEAT PRODUCT**

---

---

# DESIGNS

## APPLICATIONS APPROVED FOR REGISTRATION

The decision can be appealed at the Chamber of Appeal of Sakpatenti within 3 months from the publication or at the Mtskheta District Court Administrative Cases Board (Address: №17, Samkhedro str., Mtskheta), within 1 month following the publication.

- (10) **AD 2020 1161 S**      (51) **09-01**  
(21) AD 2020 1161      (22) 2020 06 24  
(28) 1  
(71) LLC "KVARELI CELLAR" (GE)  
    Vill. Chikaani, 4814, Kvareli, Georgia (GE)  
(72) Vazha Ghvaladze (GE)  
(74) Khatuna Imnadze (GE)  
(54) **BOTTLE**  
(55)



1.1

---

- (10) AD 2020 1159 S      (51) 19-04
- (21) AD 2020 1159      (22) 2020 06 18
- (28) 3
- (71) Teona Dalakishvili (GE)  
Gldani, III mcr., corp. 5, app. 36, 0167, Tbilisi, Georgia (GE)
- (72) Teona Dalakishvili (GE)
- (54) NOTEBOOK
- (55)



1.1

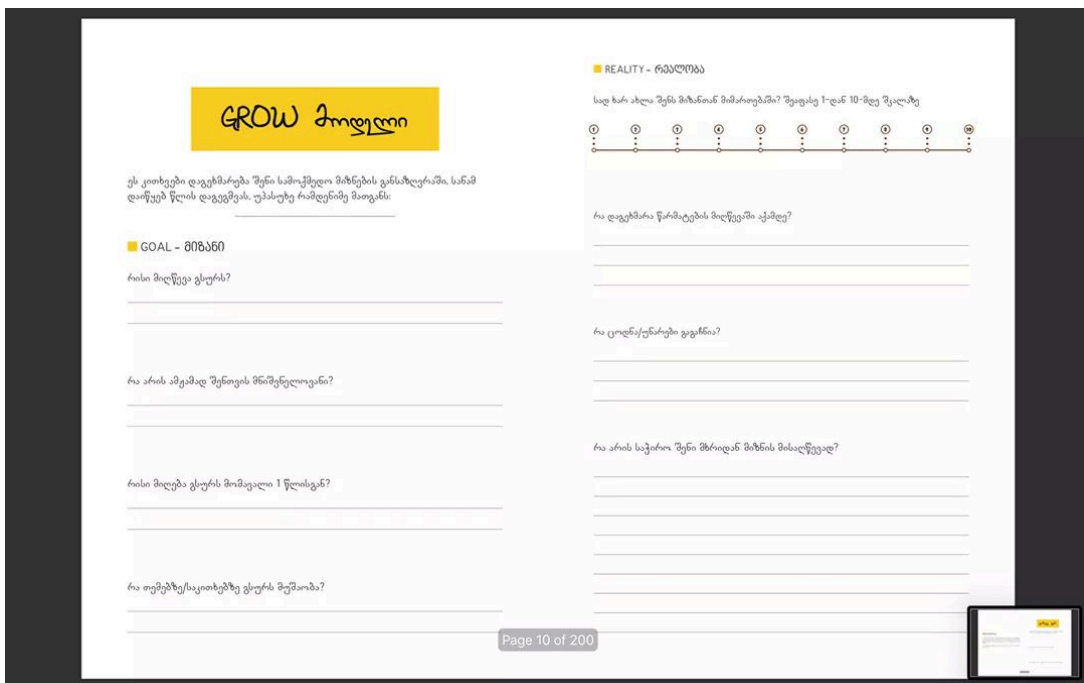

1.2



1.3

**ქნოვრების ზორზალი**

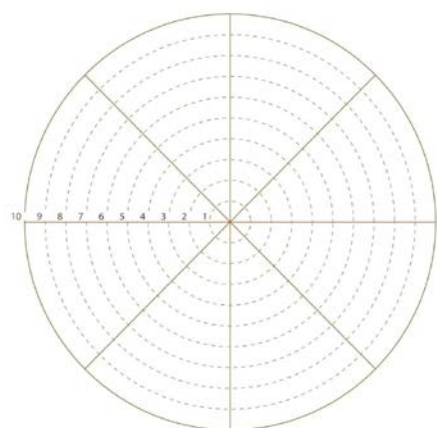

1.4

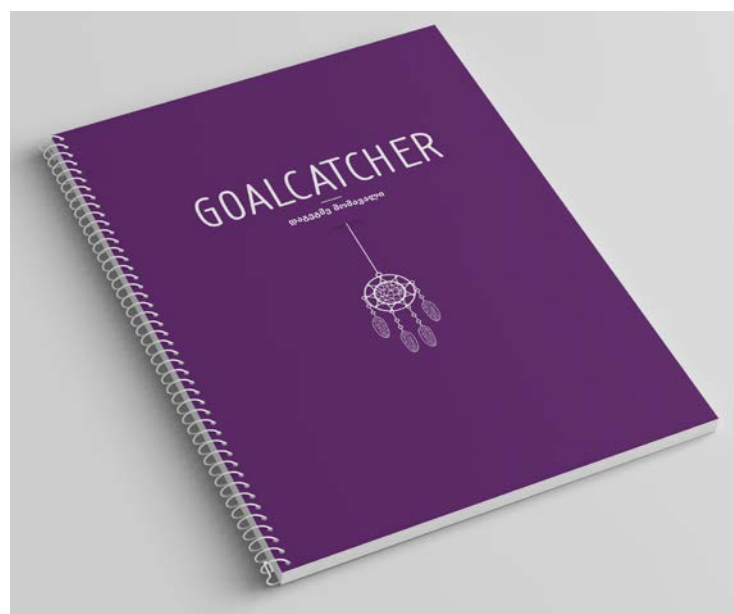

2.1

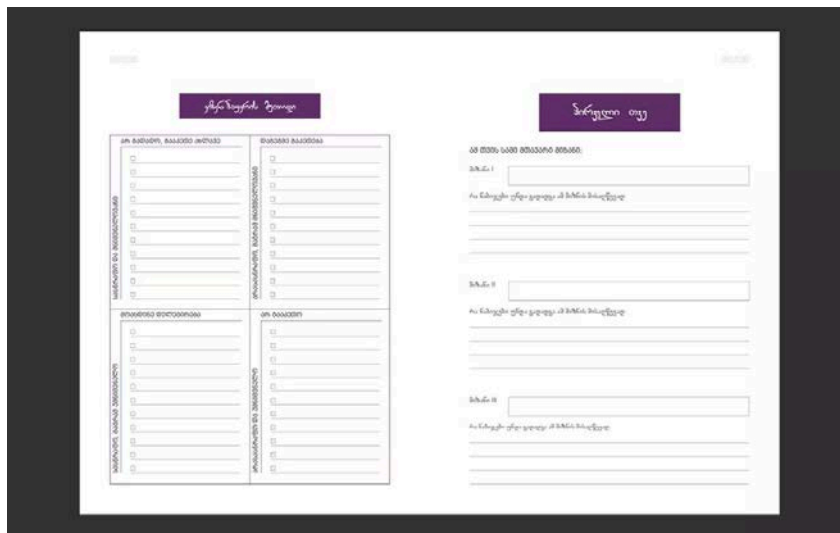

2.2

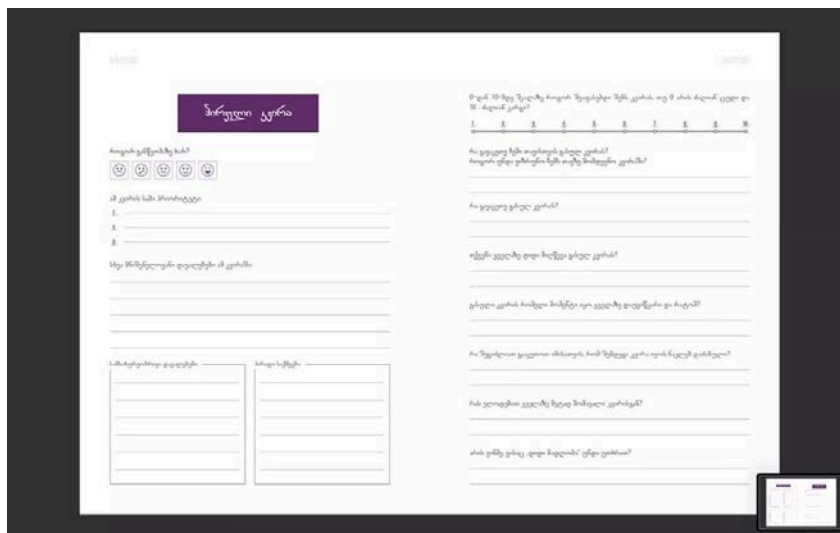

2.3

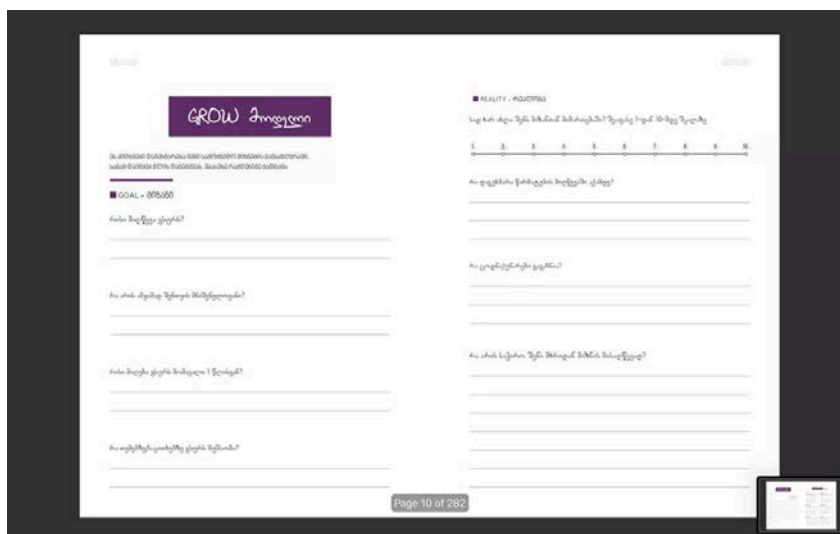

2.4



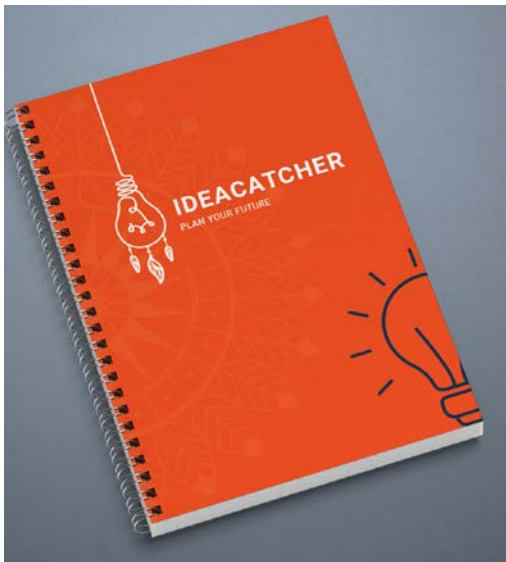

3.1

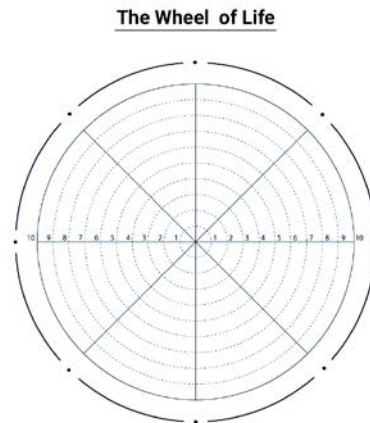

3.2

**Plan of the Year**

This year's professional goals: \_\_\_\_\_ Date: \_\_\_\_\_

① \_\_\_\_\_

② \_\_\_\_\_

③ \_\_\_\_\_

**1** QUARTER  
The main focus \_\_\_\_\_

**2** QUARTER  
The main focus \_\_\_\_\_

**3** QUARTER  
The main focus \_\_\_\_\_

**4** QUARTER  
The main focus \_\_\_\_\_

Personal goals for this year:

① \_\_\_\_\_

② \_\_\_\_\_

③ \_\_\_\_\_

3.3

14

Plan Your Future

**Upcoming Year SWOT analysis**

**S** STRENGTHS I WILL USE \_\_\_\_\_

**W** WEAKNESSES I WILL STRENGTHEN \_\_\_\_\_

**O** OPPORTUNITIES I WILL USE \_\_\_\_\_

**T** THREATS I WILL TRY TO AVOID \_\_\_\_\_

3.4

## REGISTERED DESIGNS

**(11) D 2020 869 S**      **(51) 11-01**  
(10) AD 2020 1146 S      (44) 2020 07 10 №13  
(21) AD 2020 1146  
(22) 2020 03 09  
(24) 2020 03 09  
(28) 1  
(18) 2025 03 09  
(73) Guliver Davituliani (GE)  
    Tabidze St. 3, 1100, Bolnisi, Georgia (GE)  
(72) Guliver Davituliani (GE)  
(54) **GEORGIAN CROSS**

---

**(11) D 2020 868 S**      **(51) 32-00**  
(10) AD 2020 1145 S      (44) 2020 07 10 №13  
(21) AD 2020 1145  
(22) 2020 03 04  
(24) 2020 03 04  
(28) 1  
(18) 2025 03 04  
(73) Nikoloz Nutsubidze (GE)  
    Z. Panaskerteli-Tsitsishvili St. 11, app. 68,  
    0194, Tbilisi, Georgia (GE)  
(72) Nikoloz Nutsubidze (GE)  
(54) **ORNAMENT**

---

**DESIGNS, WHICH HAVE BEEN REGISTERED WITH THE INTERNATIONAL  
BUREAU CLAIMING PRIORITY ON THE TERRITORY OF GEORGIA**

The decision can be appealed at the Chamber of Appeal of Sakpatenti within 3 months from the publication or at the Mtskheta District Court Administrative Cases Board (Address: №17, Samkhedro Str., Mtskheta), within 1 month following the publication.

- (11) **DM/206 100**                      (51) **11-01**  
 (15) 2020 02 10                      (44) 33/2020 (2020 08 14)  
 (22) 2020 02 10  
 (28) 6  
 (73) HARRY WINSTON SA  
       Chemin Du Tourbillon 8, 1228 Plan-les-Ouates (CH)  
 (85) CH  
 (86) CH  
 (87) CH  
 (88) CH  
 (89) CH  
 (81) II. MA III. AM, UA, AL, AZ, ME, BZ, MD, MC, SG, NO, MN, BA, CA, GE, OM, TR, MK, LI, KG, GB, TN, EM, CH  
 (72) 1; 3-5 Delphine ABDOURAHIM  
       C/o Harry Winston Inc. 718 Fifth Avenue, 10019, New York, NY (US);  
       2 Dominique RIVIERE  
       C/o Harry Winston Inc. 718 Fifth Avenue, 10019, New York, NY (US);  
       6 Rie YATSUGI-KANG  
       C/o Harry Winston Inc. 718 Fifth Avenue, 10019, New York, NY (US)  
 (74) The Swatch Group AG (The Swatch Group SA) (The Swatch Group Ltd.)  
       Faubourg Du Lac 6, 2501 Biel/Bienne (CH)  
 (54) 1. Finger ring, 2. Necklace, 3. Finger ring, 4. Pair of earrings, 5. Necklace, 6. Necklace  
 (55)



1.1



1.2



1.3



1.4



1.5



1.6



1.7



1.8

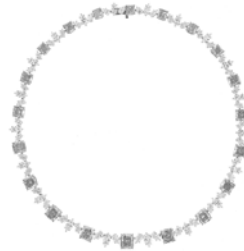

2.1



2.2



2.3



2.4



2.5



2.6



2.7



2.8



3.1



3.2



3.3



3.4



3.5



3.6



3.7



3.8



4.1



4.2



4.3



4.4



4.5



4.6



4.7



4.8



5.1



5.2



5.3



5.4



5.5



5.6



5.7

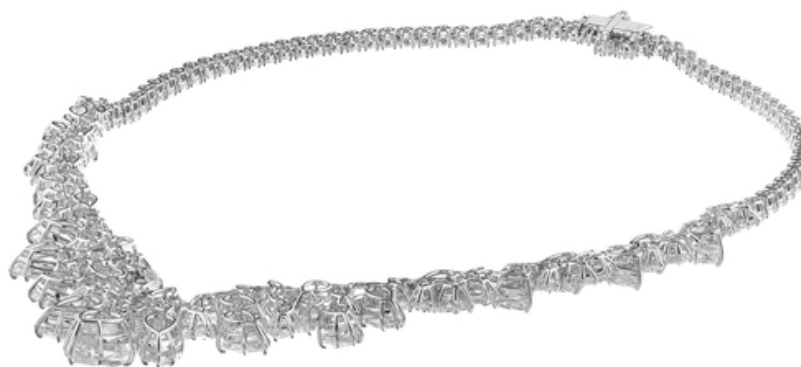

5.8

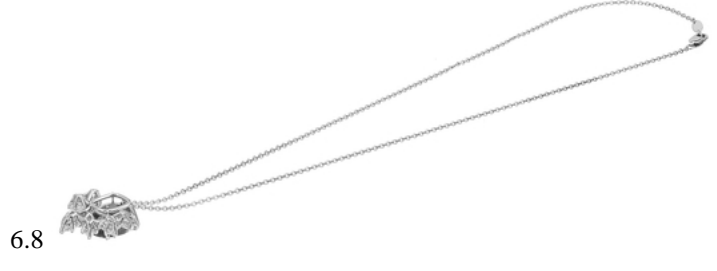
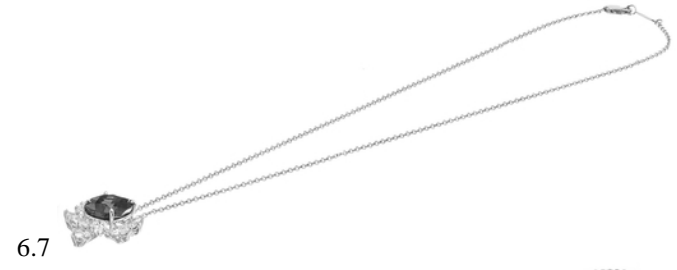
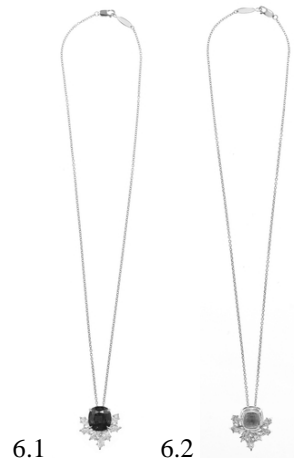



(11) DM/206 102

(51) 11-01

(15) 2020 02 13

(44) 33/2020 (2020 08 14)

(22) 2020 02 13

(28) 4

(73) HARRY WINSTON SA

Chemin Du Tourbillon 8, 1228 Plan-les-Ouates (CH)

(85) CH

(86) CH

(87) CH

(88) CH

(89) CH

(81) IL, MA, III, UA, AM, AL, AZ, BZ, ME, MD, MC, SG, NO, MN, BA, TR, CA, MK, OM, GE, LI, KG, GB, TN, EM, CH

(72) 1-2 Dominique RIVIERE

C/o Harry Winston Inc. 718 Fifth Avenue, 10019, New York, NY (US);

3-4 Rie YATSUGI-KANG

C/o Harry Winston Inc. 718 Fifth Avenue, 10019, New York, NY (US)

(74) The Swatch Group AG (The Swatch Group SA) (The Swatch Group Ltd.)

Faubourg Du Lac 6, 2501 Biel/Bienne (CH)

(54) 1. Pair of earrings, 2. Necklace, 3. Necklace, 4. Finger ring

(55)

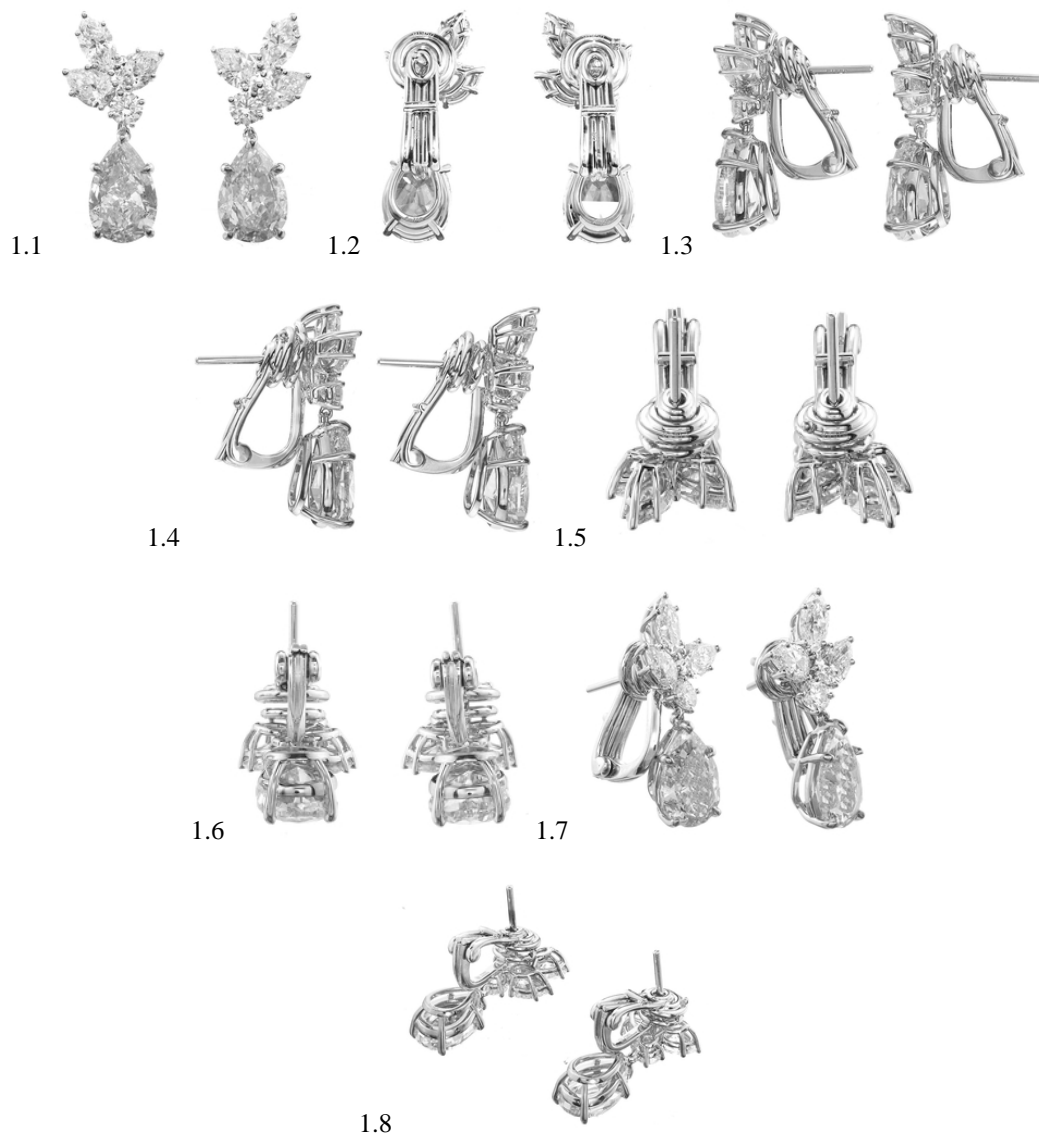



2.1



2.2



2.3



2.4



2.5



2.6



2.7



2.8



3.1



3.2



3.3



3.4



3.5



3.6



3.7



3.8



4.1



4.2



4.3



4.4



4.5



4.6

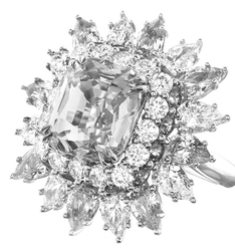

4.7



4.8

(11) DM/206 524

(51) 11-01

(15) 2020 02 24

(44) 35/2020 (2020 08 28)

(22) 2020 02 24

(28) 2

(73) HARRY WINSTON SA

Chemin Du Tourbillon 8, 1228 Plan-les-Ouates (CH)

(85) CH

(86) CH

(87) CH

(88) CH

(89) CH

(81) IL, MA, III, AM, UA, AL, AZ, ME, BZ, MD, MC, SG, NO, MN, BA, TR, CA, GE, OM, MK, LI, KG, GB, TN, EM, CH

(72) 1 Dominique RIVIERE

C/o Harry Winston Inc. 718 Fifth Avenue, 10019, New York (US);

2 Delphine ABDOURAHIM

C/o Harry Winston Inc. 718 Fifth Avenue, 10019, New York (US)

(74) The Swatch Group AG (The Swatch Group SA) (The Swatch Group Ltd.)

Faubourg Du Lac 6, 2501 Biel/Bienne (CH)

(54) 1. Necklace, 2. Necklace

(55)



1.1



1.2



1.3



1.4

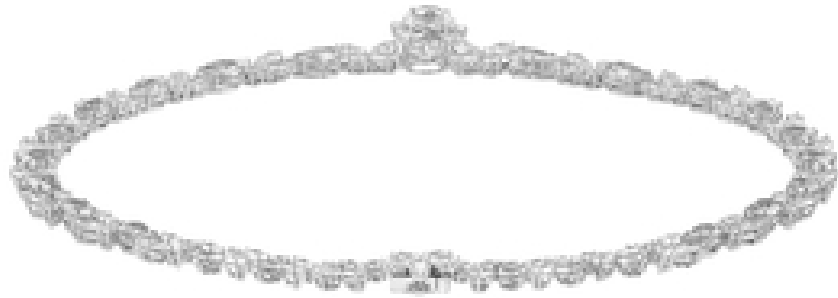

1.5



1.6



1.7



1.8



2.1



2.2



2.3



2.4



2.5



2.6



2.7



2.8

---



---

# TRADEMARKS

## APPLICATIONS FILED UNDER THE NATIONAL PROCEDURE APPROVED FOR REGISTRATION

The decision can be appealed at the Chamber of Appeal of Sakpatenti within 3 months from the publication or at the Mtskheta District Court Administrative Cases Board (Address: №17, Samkhedro St., Mtskheta), within 1 month following the publication.

(260) AM 2020 104567 A\*  
(210) AM 104567  
(220) 2019 08 22  
(731) JSC "Chateau Mukhrani"  
Vill. Mukhrani, 3309, Mtskheta, Georgia  
(740) Elene Totibadze;  
Irine Pilauri  
(540)



(591) Black, white, red  
(531) 07.01.01; 27.05.01; 27.05.19; 29.01.13  
(511) 33

---

(260) AM 2020 106605 A  
(210) AM 106605  
(220) 2020 01 15  
(731) Brams Institute  
Anna Politkovskaya St. 43, app. 43, 0186,  
Tbilisi Georgia  
(540)



(591) White, blue

(531) 01.15.23; 17.02.01; 17.02.02; 24.01.03; 24.01.05;  
24.01.07; 24.01.13; 24.01.15; 24.01.25;  
27.05.01; 27.05.10; 27.05.24; 27.07.24; 28.19;  
29.01.12  
(526) Borjgali  
(511) 42

---

(260) AM 2020 106751 A  
(210) AM 106751  
(220) 2020 01 24  
(731) IP Holdings UNLTD LLC  
1450 Broadway, 3<sup>rd</sup> Floor, New York, NY  
10018, USA  
(740) Tamaz Shilakadze  
(540)

## ECKO RED

(591) Black-white  
(511) 25

---

(260) AM 2020 106752 A  
(210) AM 106752  
(220) 2020 01 24  
(731) IP Holdings UNLTD LLC  
1450 Broadway, 3<sup>rd</sup> Floor, New York,  
NY 10018, USA  
(740) Tamaz Shilakadze  
(540)



(591) Black-white  
(531) 03.02.07; 26.01.02; 26.01.15; 26.01.24; 26.04.02;  
26.04.10; 26.04.24; 27.05.17  
(511) 25, 35

---

(260) AM 2020 107269 A  
(210) AM 107269  
(220) 2020 02 21  
(731) LTD "Global Cbs"  
Stanislavskiy St. 5, 0141, Tbilisi, Georgia

(540)



(591) White, lilac, sky-blue, black  
 (531) 19.03.03; 19.03.25; 26.04.09; 26.04.22; 26.11.02;  
 26.11.05; 27.05.10; 29.01.13  
 (511) 5

(260) AM 2020 107272 A  
 (210) AM 107272  
 (220) 2020 02 21  
 (731) LTD "Global Cbs"  
 Stanislavskiy St. 5, 0141, Tbilisi, Georgia  
 (540)

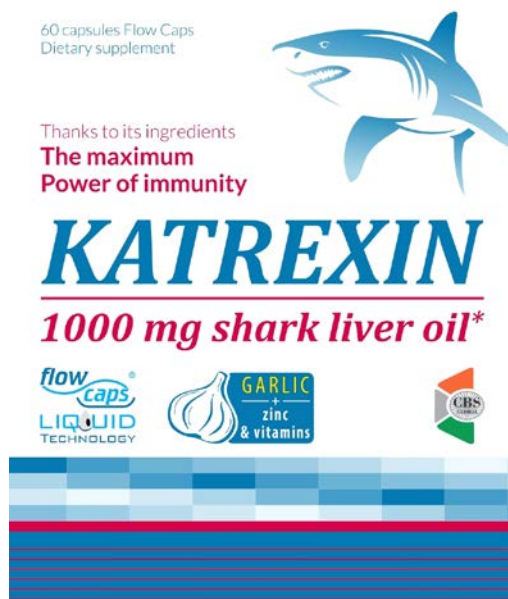

(591) Bordeaux, sky-blue, white  
 (531) 03.09.04; 05.09.06; 26.04.09; 26.11.08; 27.05.01;  
 27.05.09; 27.05.10; 27.07.01; 29.01.15  
 (511) 5

(260) AM 2020 107273 A  
 (210) AM 107273  
 (220) 2020 02 21  
 (731) LTD "Global Cbs"  
 Stanislavskiy St. 5, 0141, Tbilisi, Georgia

(540)



(591) Lemon color, blue, white  
 (531) 01.15.23; 01.15.24; 26.11.12; 26.13.25; 27.05.01;  
 27.05.09; 27.05.10; 27.05.17; 29.01.13  
 (511) 5

(260) AM 2020 107274 A  
 (210) AM 107274  
 (220) 2020 02 21  
 (731) LTD "Global Cbs"  
 Stanislavskiy St. 5, 0141, Tbilisi, Georgia  
 (540)

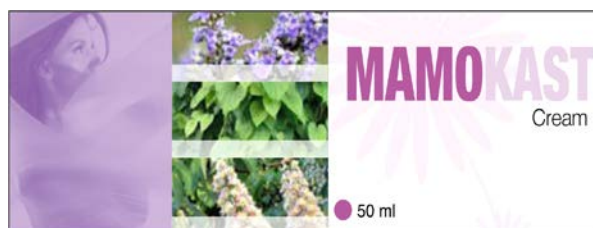

(591) Lilac, green, white, black  
 (531) 05.03.11; 05.03.16; 05.05.07; 27.05.01; 27.05.10;  
 27.05.17; 29.01.15  
 (511) 5

(260) AM 2020 107275 A  
 (210) AM 107275  
 (220) 2020 02 21  
 (731) LTD "Global Cbs"  
 Stanislavskiy St. 5, 0141, Tbilisi, Georgia  
 (540)



(591) Pink, carnelian, white  
 (531) 01.15.15; 26.11.12; 26.11.13; 27.05.01; 29.01.13  
 (511) 5

(260) AM 2020 107276 A  
 (210) AM 107276  
 (220) 2020 02 21  
 (731) LTD "Global Cbs"  
 Stanislavskiy St. 5, 0141, Tbilisi, Georgia

(540)

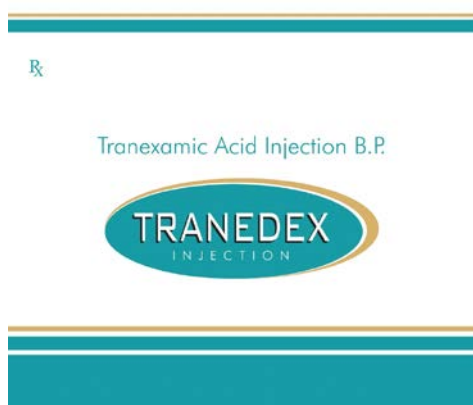

(591) Turquoise, white, sky-blue, green  
 (531) 26.01.02; 26.01.20; 26.01.24; 26.11.03; 26.11.05;  
 26.11.06; 26.11.08; 27.05.01; 27.05.10; 27.05.24;  
 29.01.13  
 (511) 5

(260) AM 2020 107277 A  
 (210) AM 107277  
 (220) 2020 02 21  
 (731) LTD "Global Cbs"  
 Stanislavskiy St. 5, 0141, Tbilisi, Georgia  
 (540)

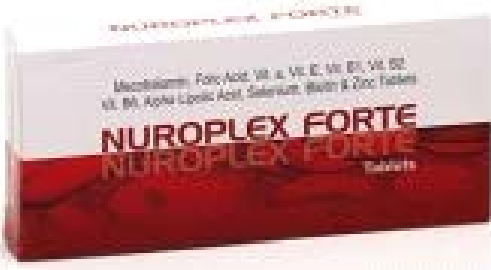

(591) Carnelian, white, black  
 (531) 19.03.03; 26.15.11; 27.05.01; 27.05.10; 29.01.13  
 (511) 5

(260) AM 2020 107278 A  
 (210) AM 107278  
 (220) 2020 02 21  
 (731) LTD "Global Cbs"  
 Stanislavskiy St. 5, 0141, Tbilisi, Georgia  
 (540)



(591) Red, blue, white, golden  
 (531) 02.09.01; 15.07.01; 15.07.03; 26.11.11; 27.05.09;  
 27.05.10; 27.05.17; 29.01.15  
 (511) 5

(260) AM 2020 107279 A  
 (210) AM 107279  
 (220) 2020 02 21  
 (731) LTD "Global Cbs"  
 Stanislavskiy St. 5, 0141, Tbilisi, Georgia  
 (540)



(591) Yellow, sky-blue, white  
 (531) 26.04.06; 26.04.22; 26.04.24; 26.13.25; 27.05.01;  
 27.05.10; 27.05.24; 27.07.01; 29.01.13  
 (511) 5

(260) AM 2020 107280 A  
 (210) AM 107280  
 (220) 2020 02 21  
 (731) LTD "Global Cbs"  
 Stanislavskiy St. 5, 0141, Tbilisi, Georgia  
 (540)



(591) Brown, white, black, yellow  
 (531) 08.01.19; 08.01.22; 26.04.06; 26.04.22; 26.04.24;  
 27.05.01; 27.05.24; 29.01.14  
 (511) 5

(260) AM 2020 107281 A  
 (210) AM 107281  
 (220) 2020 02 21  
 (731) LTD "Global Cbs"  
 Stanislavskiy St. 5, 0141, Tbilisi, Georgia  
 (540)

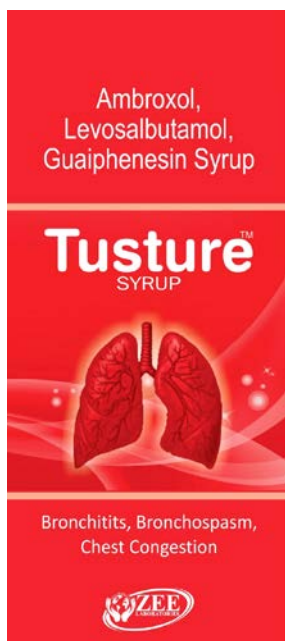

(591) Red, white  
 (531) 02.09.15; 02.09.24; 25.05.02; 25.05.25; 26.04.14;  
 26.04.22; 26.11.08; 27.05.01; 27.05.10;  
 27.05.24; 29.01.13  
 (511) 5

(260) AM 2020 107282 A  
 (210) AM 107282  
 (220) 2020 02 21  
 (731) LTD "Global Cbs"  
 Stanislavskiy St. 5, 0141, Tbilisi, Georgia  
 (540)



(591) Blue, white, green, black  
 (531) 26.01.02; 26.01.05; 26.01.19; 27.05.01; 27.05.10;  
 27.07.01; 29.01.14  
 (511) 5

(260) AM 2020 107294 A  
 (210) AM 107294  
 (220) 2020 02 25  
 (731) LEPL "Kutaisi International University"  
 Akhlagzrdoba Av. 5/7, 4600, Kutaisi, Georgia

(540)

 The logo consists of three blue circles of varying sizes on the left, and the Georgian text 'ქუთაისის საერთაშორისო უნივერსიტეტი' (Kutaisi International University) on the right.

(591) Blue, white  
 (531) 24.17.02; 26.11.09; 27.01.25; 27.05.21; 28.19;  
 29.01.12  
 (526) ქუთაისი  
 (511) 41

(260) AM 2020 107311 A  
 (210) AM 107311  
 (220) 2020 02 27  
 (731) LLC "WINEMAN LLC"  
 L. Gudiashvili St. 11, 0105, Tbilisi, Georgia  
 (740) Shalva Gvaramadze  
 (540)



IKHALTO  
 — GEORGIA —

(591) Golden, black  
 (531) 05.01.01; 07.01.03; 27.05.01; 27.05.10; 29.01.12  
 (526) IKHALTO GEORGIA  
 (511) 33

(260) AM 2020 107470 A  
 (210) AM 107470  
 (220) 2020 03 06  
 (731) Giorgi Dalakishvili  
 Vill. Mukhrani, 3309, Mtskheta District, Georgia  
 (540)



(591) White, blue, sky-blue, green  
 (531) 01.15.24; 24.17.01; 26.04.13; 26.04.22; 27.05.01;  
 29.01.13  
 (511) 5, 10, 31

(260) AM 2020 107480 A  
 (210) AM 107480  
 (220) 2020 03 10  
 (731) David Berishvili  
 Rezo Chkheidze St. 9, 0179, Tbilisi, Georgia

(540)



(591) Blue, yellow, white  
 (531) 26.13.25; 27.05.21; 28.19; 29.01.12  
 (511) 20, 24, 35

(260) AM 2020 107490 A  
 (210) AM 107490  
 (220) 2020 03 12  
 (731) Days Inns Worldwide, Inc.  
 22 Sylvan Wey, Parsippany, NJ 07054, USA  
 (740) Tamaz Shilakadze  
 (540)

**DAYS INN**

(591) Black-white  
 (511) 43

(260) AM 2020 107491 A  
 (210) AM 107491  
 (220) 2020 03 12  
 (731) Days Inns Worldwide, Inc.  
 22 Sylvan Wey, Parsippany, NJ 07054, USA  
 (740) Tamaz Shilakadze  
 (540)



(591) White, dark blue, sky-blue, dark yellow,  
 light yellow  
 (531) 01.03.01; 01.03.15; 01.03.17; 26.04.06; 26.04.22;  
 26.04.24; 27.05.24; 29.01.13  
 (511) 43

(260) AM 2020 107497 A  
 (210) AM 107497  
 (220) 2020 03 12  
 (731) LTD "GLAVSPIRTPROM"  
 Lilo Settlement 51, 0198, Tbilisi, Georgia  
 (540)

**ტოროლა**  
**Торола**  
**Torola**

(591) Black-white  
 (511) 33

(260) AM 2020 107499 A  
 (210) AM 107499  
 (220) 2020 03 13  
 (731) LTD "Berika"  
 I. Chavchavadze Av. 6, Lane I, app. 80, 0179,  
 Tbilisi Georgia  
 (540)

**სანატრელო**  
**sanatrelo**  
**санатрело**

(591) Black-white  
 (511) 33

(260) AM 2020 107552 A  
 (210) AM 107552  
 (220) 2020 03 13  
 (731) BEVERAGE PARTNERS INTERNATIONAL  
 (CRAFT) LTD  
 Unit 12, Kilkenny Retail Park, Smith Lands  
 South,  
 Kilkenny, Ireland  
 (740) Giorgi Meipariani  
 (540)

**RAYBU**

(591) Black-white  
 (511) 32

(260) AM 2020 107553 A  
 (210) AM 107553  
 (220) 2020 03 13  
 (731) Jadran – Galenski Laboratorij d.d.  
 Svilno 20, 51000, Rijeka, Croatia  
 (740) Pavle Meipariani  
 (540)

**OPTINOL**

(591) Black-white  
 (511) 3, 5

(260) AM 2020 107554 A  
 (210) AM 107554  
 (220) 2020 03 13  
 (731) Jadran – Galenski Laboratorij d.d.  
 Svilno 20, 51000, Rijeka, Croatia  
 (740) Pavle Meipariani  
 (540)

**ОПТИНОЛ**

(591) Black-white  
(511) 3, 5

(260) AM 2020 107556 A  
(210) AM 107556  
(220) 2020 03 14  
(731) Tamar Megrelishvili  
Kiacheli-Akhvlediani St. 12/9, Old Tbilisi, 0108,  
Tbilisi, Georgia  
(540)



**RKO**

(591) Brown, dark brown, orange, dark yellow  
(531) 05.03.02; 05.07.07; 27.05.01; 29.01.13  
(511) 25, 35

(260) AM 2020 107558 A  
(210) AM 107558  
(220) 2020 03 16  
(731) Storch-Ciret Holding GmbH  
Platz der Republik 6-8, 42107 Wuppertal,  
Germany  
(740) Giorgi Taktakishvili  
(540)

**E** **COLOR**<sup>®</sup>  
**EXPERT**



(591) Blue, yellow, green, red, black  
(531) 26.04.09; 26.04.24; 27.05.01; 27.05.10; 29.01.15  
(511) 7, 8, 16

(260) AM 2020 107564 A  
(210) AM 107564  
(220) 2020 03 16  
(731) KT & G Corporation  
71, Beotkkot-gil, Daedeok-gu, Daejeon,  
Republic of Korea  
(740) Pavle Meipariani

(540)

**THIS**

(591) Black-white  
(511) 34

(260) AM 2020 107565 A  
(210) AM 107565  
(220) 2020 03 16  
(731) KT & G Corporation  
71, Beotkkot-gil, Daedeok-gu, Daejeon,  
Republic of Korea  
(740) Pavle Meipariani  
(540)

**RAISON**

(591) Black-white  
(511) 34

(260) AM 2020 107569 A  
(210) AM 107569  
(220) 2020 03 17  
(731) LLC "Geo Olympus"  
R. Eristavi St. 16, Tbilisi, Georgia  
(540)



(591) Black-white  
(531) 26.11.01; 26.11.12; 27.05.01; 27.05.10  
(511) 5, 32, 35

(260) AM 2020 107570 A  
(210) AM 107570  
(220) 2020 03 17  
(731) LLC "Geo Olympus"  
R. Eristavi St. 16, Tbilisi, Georgia  
(540)



(591) Black-white  
(531) 27.05.08; 27.05.09; 27.05.17  
(511) 5, 32, 35

(260) AM 2020 107571 A  
 (210) AM 107571  
 (220) 2020 03 17  
 (731) LLC "Geo Olympus"  
 R. Eristavi St. 16, Tbilisi, Georgia  
 (540)



(591) Red, white, black  
 (531) 27.05.02; 27.05.22; 29.01.13  
 (511) 5, 32, 35

(260) AM 2020 107572 A  
 (210) AM 107572  
 (220) 2020 03 17  
 (731) LLC "Geo Olympus"  
 R. Eristavi St. 16, Tbilisi, Georgia  
 (540)



(591) Black-white  
 (531) 26.02.07; 26.11.12; 27.05.01; 27.05.10; 27.05.19  
 (511) 5, 32, 35

(260) AM 2020 107574 A  
 (210) AM 107574  
 (220) 2020 03 17  
 (731) LLC "Geo Olympus"  
 R. Eristavi St. 16, Tbilisi, Georgia  
 (540)



(591) Blue, golden  
 (531) 24.09.05; 24.09.25; 27.05.01; 27.05.02; 27.05.10;  
 27.05.22; 29.01.12  
 (511) 5, 35

(260) AM 2020 107579 A  
 (210) AM 107579  
 (220) 2020 03 18  
 (731) AVVA PHARMACEUTICALS LTD  
 Spyrou Kyprianou 23A, 4001 Limassol, Cyprus  
 (740) Merab Kvimsadze  
 (540)

**МИКРАЗИМ**

(591) Black-white  
 (531) 28.05  
 (511) 5

(260) AM 2020 107583 A  
 (210) AM 107583  
 (220) 2020 03 18  
 (731) Intercontinental Great Brands LLC  
 100 Deforest Avenue, East Hanover, New Jersey  
 07936, USA  
 (740) Giorgi Taktakishvili  
 (540)



(591) Blue, white  
 (531) 26.11.02; 26.11.12; 27.05.01; 29.01.04  
 (511) 29

(260) AM 2020 107651 A  
 (210) AM 107651  
 (220) 2020 03 24  
 (731) LTD "Aversi-Pharma"  
 Davit Agmashenebeli Av. 148, 0112, Tbilisi,  
 Georgia  
 (540)

**იმფლუნატი**

(591) Black-white  
 (511) 5

(260) AM 2020 107653 A  
 (210) AM 107653  
 (220) 2020 03 25  
 (731) UCL Co., Ltd  
 67, Eoeum 10-gil, Aewol-eup, Jeju-si, Jeju-do,  
 63038, Republic of Korea

(740) Merab Kvimsadze  
(540)

**A C C O J E**

(591) Black-white  
(531) 27.05.15  
(511) 3

(260) AM 2020 107654 A  
(210) AM 107654  
(220) 2020 03 25  
(731) Qatar Airways Group (Q.C.S.C)  
P.O Box 22550, Doha, Qatar  
(740) Merab Kvimsadze  
(540)



(591) Black, white, yellow, light brown  
(531) 26.04.02; 26.04.24; 26.11.12; 27.05.01; 27.05.10;  
27.05.24; 29.01.13  
(526) THE HEIGHT OF BUSINESS TRAVEL  
(511) 35, 39

(260) AM 2020 107670 A  
(210) AM 107670  
(220) 2020 03 31  
(310) 34871  
(320) 2020 03 13  
(330) AD  
(731) Philip Morris Products S.A.  
Quai Jeanrenaud 3, 2000 Neuchâtel, Switzerland  
(740) Shalva Gvaramadze  
(540)

**RUSSET**

(591) Black-white  
(511) 34

(260) AM 2020 107671 A  
(210) AM 107671  
(220) 2020 03 31  
(731) Glanbia Nutritional (Ireland) Limited  
Glanbia House, Kilkenny, Ireland  
(740) Giorgi Batlidze  
(540)



(591) Black-white  
(531) 24.15.13; 27.05.01; 27.05.09; 27.05.10  
(511) 5

(260) AM 2020 107814 A  
(210) AM 107814  
(220) 2020 04 08  
(731) Kristi Topuria  
Dighomi, VI quart., corp. 18, Tbilisi, Georgia  
(540)



**CleanLab**

სინკუბთავის ლაბორატორია

(591) Light sky-blue, white, yellow  
(531) 01.01.01; 01.01.03; 01.01.09; 11.07.01; 11.07.05;  
26.01.01; 26.01.06; 26.01.24; 26.04.02;  
26.04.09; 26.04.10; 26.04.24; 27.05.01; 28.19;  
29.01.13  
(511) 35, 37

(260) AM 2020 107817 A  
(210) AM 107817  
(220) 2020 04 08  
(731) LTD "Baraqa"  
Petre Kavtaradze St. 4, Lane III, app. 43, Vake  
District, Tbilisi, Georgia  
(740) Tamar Kharazishvili  
(540)

**ბარაქა**

(591) Black-white  
(511) 1, 5, 7, 35, 44

(260) AM 2020 107923 A  
(210) AM 107923  
(220) 2020 04 15  
(731) LTD "KRINTI"  
Vill. Kazreti, Madneuli St. 10, 1103, Bolnisi,  
Georgia  
(540)

**Kattolini**

(591) Black-white  
(511) 7, 11



## REGISTERED TRADEMARKS

(111) M 2020 33220 R  
 (151) 2020 10 12  
 (181) 2030 10 12  
 (260) AM 2019 102709 A  
 (220) 2019 11 13  
 (732) N(N)LE "Georgian Rugby Union"  
 Chabua Amirejibi Road. 6, mark 6.00,  
 office space 3, Tbilisi Georgia

Vazha-Pshavela Av., III kvart., corp. 21,  
 app. 1, 0186, Tbilisi, Georgia

(111) M 2020 33221 R  
 (151) 2020 10 12  
 (181) 2030 10 12  
 (260) AM 2019 102931 A  
 (220) 2019 05 02  
 (732) Enrico Beridze  
 T. Tabidze st. 10, Lane 1, Tbilisi, Georgia

(111) M 2020 33226 R  
 (151) 2020 10 12  
 (181) 2030 10 12  
 (260) AM 2019 105360 A  
 (220) 2019 10 17  
 (732) JSC "GEPHA"  
 Akaki Beliashvili St. 142, 0159, Tbilisi,  
 Georgia

(111) M 2020 33222 R  
 (151) 2020 10 12  
 (181) 2030 10 12  
 (260) AM 2019 103655 A  
 (220) 2019 06 14  
 (732) LTD "SANUS VITA"  
 Descent of Giorgi Saakadze 6, Commercial  
 Space 11, Vake-Saburtalo district, Tbilisi,  
 Georgia

(111) M 2020 33227 R  
 (151) 2020 10 12  
 (181) 2030 10 12  
 (260) AM 2019 105361 A  
 (220) 2019 10 17  
 (732) LTD "NEW FARMS"  
 Levan Gogoberidze St. 67b, 0165, Tbilisi,  
 Georgia

(111) M 2020 33223 R  
 (151) 2020 10 12  
 (181) 2030 10 12  
 (260) AM 2019 104216 A  
 (220) 2019 07 25  
 (732) Natalia Tatulashvili  
 Berbuli St. 10/19-21, block III, app. 22,  
 Tbilisi, Georgia

(111) M 2020 33228 R  
 (151) 2020 10 12  
 (181) 2030 10 12  
 (260) AM 2019 105448 A  
 (220) 2019 10 24  
 (732) ALIBABA GROUP HOLDING LIMITED  
 Fourth Floor, One Capital Place, P. O.  
 Box 847, George Town, Grand Cayman,  
 Cayman Islands

(111) M 2020 33224 R  
 (151) 2020 10 12  
 (181) 2030 10 12  
 (260) AM 2019 105223 A  
 (220) 2019 10 07  
 (732) LTD "ZEMELI"  
 V. Dolidze St., corp. 25, app. 71, 0171, Tbilisi,  
 Georgia

(111) M 2020 33229 R  
 (151) 2020 10 12  
 (181) 2030 10 12  
 (260) AM 2019 105456 A  
 (220) 2019 10 24  
 (732) N(N)LE Citizens' Political Union  
 "United National Movement"  
 Kakheti Rd. 45a, 0190, Tbilisi, Georgia

(111) M 2020 33225 R  
 (151) 2020 10 12  
 (181) 2030 10 12  
 (260) AM 2019 105233 A  
 (220) 2019 10 09  
 (732) LTD "OXIGEN"

(111) M 2020 33230 R  
 (151) 2020 10 12  
 (181) 2030 10 12  
 (260) AM 2019 105556 A  
 (220) 2019 10 29  
 (732) JSC "GEORGIAN BEER COMPANY"  
 Vill. Saguramo, 3311, Mtskheta, Georgia

(111) M 2020 33231 R  
 (151) 2020 10 12  
 (181) 2030 10 12

(111) M 2020 33231 R  
 (151) 2020 10 12  
 (181) 2030 10 12

(260) AM 2019 105739 A  
(220) 2019 11 08  
(732) AF Development Holding Limited  
Unit S317, Level 3, Emirates Financial  
Towers, Dubai International Financial  
Centre, P. O. Box 79947, Dubai, United  
Arab Emirates

---

(111) M 2020 33232 R  
(151) 2020 10 12  
(181) 2030 10 12  
(260) AM 2019 105751 A  
(220) 2019 11 11  
(732) PHILIP MORRIS BRANDS SÀRL  
Quai Jeanrenaud 3, Neuchâtel 2000,  
Switzerland

---

(111) M 2020 33233 R  
(151) 2020 10 12  
(181) 2030 10 12  
(260) AM 2019 105752 A  
(220) 2019 11 11  
(732) PHILIP MORRIS BRANDS SÀRL  
Quai Jeanrenaud 3, Neuchâtel 2000,  
Switzerland

---

(111) M 2020 33234 R  
(151) 2020 10 12  
(181) 2030 10 12  
(260) AM 2019 105753 A  
(220) 2019 11 11  
(732) PHILIP MORRIS BRANDS SÀRL  
Quai Jeanrenaud 3, Neuchâtel 2000,  
Switzerland

---

(111) M 2020 33235 R  
(151) 2020 10 12  
(181) 2030 10 12  
(260) AM 2019 105784 A  
(220) 2019 11 18  
(732) Industria de Diseño Textil, S.A. (Inditex, S.A.)  
Avenida de la Diputación, Edificio Inditex,  
Arteixo (A Coruña), Spain

---

(111) M 2020 33236 R  
(151) 2020 10 12  
(181) 2030 10 12  
(260) AM 2019 105785 A  
(220) 2019 11 18  
(732) Industria de Diseño Textil, S.A. (Inditex, S.A.)  
Avenida de la Diputación, Edificio Inditex,  
Arteixo (A Coruña), Spain

---

(111) M 2020 33237 R  
(151) 2020 10 12  
(181) 2030 10 12  
(260) AM 2019 105786 A  
(220) 2019 11 18  
(732) Industria de Diseño Textil, S.A. (Inditex, S.A.)  
Avenida de la Diputación, Edificio Inditex,  
Arteixo (A Coruña), Spain

---

(111) M 2020 33238 R  
(151) 2020 10 12  
(181) 2030 10 12  
(260) AM 2019 105787 A  
(220) 2019 11 18  
(732) Industria de Diseño Textil, S.A. (Inditex, S.A.)  
Avenida de la Diputación, Edificio Inditex,  
Arteixo (A Coruña), Spain

---

(111) M 2020 33239 R  
(151) 2020 10 12  
(181) 2030 10 12  
(260) AM 2019 105808 A  
(220) 2019 11 19  
(732) Industria de Diseño Textil, S.A. (Inditex, S.A.)  
Avenida de la Diputación, Edificio Inditex,  
Arteixo (A Coruña), Spain

---

(111) M 2020 33240 R  
(151) 2020 10 12  
(181) 2030 10 12  
(260) AM 2019 105809 A  
(220) 2019 11 19  
(732) JSC "GEORGIAN BEER COMPANY"  
Vill. Saguramo, 3311, Mtskheta, Georgia

---

(111) M 2020 33241 R  
(151) 2020 10 12  
(181) 2030 10 12  
(260) AM 2019 105810 A  
(220) 2019 11 19  
(732) STRADIVARIUS ESPAÑA, S.A.  
Polígono Industrial de Sabón Avenida de la  
Diputación s/n, 15142 Arteixo (A Coruña),  
Spain

---

(111) M 2020 33242 R  
(151) 2020 10 12  
(181) 2030 10 12  
(260) AM 2019 105814 A  
(220) 2019 11 20  
(732) NAUTICA APPAREL, INC.  
1411 Broadway, 4th Floor, New York,  
New York 10018, USA

---

---

(111) M 2020 33243 R  
(151) 2020 10 12  
(181) 2030 10 12  
(260) AM 2019 105992 A  
(220) 2019 12 05  
(732) PHILIP MORRIS BRANDS SÀRL  
Quai Jeanrenaud 3, Neuchâtel 2000,  
Switzerland

---

(111) M 2020 33244 R  
(151) 2020 10 12  
(181) 2030 10 12  
(260) AM 2018 99958 A  
(220) 2018 10 22  
(732) CORPORACION HABANOS, S.A.  
Carretera Vieja de Guanabacoa y Linea del  
Ferrocarril Final, Guanabacoa, La Habana,  
Cuba

---

(111) M 2020 33245 R  
(151) 2020 10 12  
(181) 2030 10 12  
(260) AM 2019 105032 A  
(220) 2019 09 25  
(732) Marine Tatarashvili  
Temka, IV mkr., corp. 1, app. 2, Tbilisi,  
Georgia

---

(111) M 2020 33246 R  
(151) 2020 10 12  
(181) 2030 10 12  
(260) AM 2019 106068 A  
(220) 2019 12 10  
(732) LTD "OROVELA"  
Vill. Chabinaani, 0910, Akhmeta district,  
Georgia

---

(111) M 2020 33247 R  
(151) 2020 10 12  
(181) 2030 10 12  
(260) AM 2019 103662 A  
(220) 2019 06 17  
(732) AMAZON EUROPE CORE S.À.R.L.  
38 avenue John F. Kennedy, L-1855  
Luxembourg, Luxembourg

---

## TRADEMARKS REGISTERED ACCORDING TO THE ACCELERATED PROCEDURE

The decision can be appealed at the Chamber of Appeal of Sakpatenti within 3 months from the publication.

(111) M 2020 33217 R  
 (151) 2020 10 05  
 (181) 2030 10 05  
 (210) AM 109914  
 (220) 2020 09 25  
 (732) Alamshah Gasanov  
 Vill. Sartichala, Mughanlo, Gardabani,  
 Georgia  
 (540)

### MANZI

(591) Black-white  
 (511) 25, 35

(111) M 2020 33218 R  
 (151) 2020 10 08  
 (181) 2030 10 08  
 (210) AM 110028  
 (220) 2020 10 05  
 (732) LLC "Kvareli Basement"  
 Vill. Chikaani, 4814, Kvareli, Georgia  
 (740) Khatuna Imnadze  
 (540)

### NINO'S

(591) Black-white  
 (511) 33

(111) M 2020 33219 R  
 (151) 2020 10 09  
 (181) 2030 10 09  
 (210) AM 109936  
 (220) 2020 09 29  
 (732) LTD "M.T.M"  
 Kaspi St. 3v, corp. 3v, app. 36, 0144, Tbilisi,  
 Georgia  
 (540)

### MYSA    მისა

(591) Grey  
 (511) 20

(111) M 2020 33248 R  
 (151) 2020 10 14  
 (181) 2030 10 14  
 (210) AM 110019  
 (220) 2020 10 02

(732) Noe Nikoleishvili  
 Vill. Kormaghali, Samtredia, Georgia  
 (540)



(591) Green, yellow, white, grey, red, brown, black  
 (531) 14.07.15; 14.07.18; 14.09.10; 15.01.01;  
 15.01.17; 15.01.25; 27.05.01; 29.01.15  
 (511) 7, 8

(111) M 2020 33249 R  
 (151) 2020 10 16  
 (181) 2030 10 16  
 (210) AM 109953  
 (220) 2020 09 30  
 (732) Baku International Tobacco, LLC  
 Nariman Narimanov Av., ap. 206, bl. 466,  
 Yasamal District, AZ1065, Baku, Azerbaijan  
 (740) Davit Dzmukashvili  
 (540)



(591) Red, grey, silver, golden, black, white  
 (531) 10.01.05; 10.01.16; 10.01.25; 19.03.03;  
 19.03.24; 24.01.15; 25.07.01; 25.07.15;  
 27.05.22; 29.01.13  
 (554) Three-dimensional  
 (526) CARBON, WHITE  
 (511) 34, 35

## INTERNATIONAL TRADEMARKS FOR WHICH A DECISION ON GRANTING PROTECTIONS IS TAKEN

The decision can be appealed at the Chamber of Appeal of Sakpatenti within 3 months from the publication or at the Mtskheta District Court Administrative Cases Board (Address: №17, Samkhedro str., Mtskheta), within 1 month following the publication.

(260) AM 2020 102286 A\*  
 (800) 1456499  
 (151) 2018 11 15  
 (891) 2018 11 15  
 (731) Europcar Mobility Group  
 13 Ter Boulevard Berthier F-75017 Paris,  
 France  
 (540)



(591) Black, white  
 (531) 27.05.10; 27.05.22; 29.01.03  
 (511)

12 – Vehicles; apparatus for locomotion by land, air or water; vehicles for locomotion by air, land or water; vehicles for travel by land, air, rail or water; motor vehicles for use in the transporting of people; automobiles for carrying goods; motor cars; cars for transporting people; cars for transporting goods; sports cars; touring cars; motor homes; mobile homes (caravans); motor caravans; vehicles in the nature of vans; motor vans; camper vans; camping cars; trucks being motor land vehicles; trucks for transporting; commercial trucks; industrial trucks; bicycles; motorcycles; lorries; coaches; buses.

35 – Advertising; business management; business administration; office functions; organisation, operation and supervision of loyalty and incentive schemes; advertising services provided via the internet; production of television and radio advertisements; accountancy; auctioneering; trade fairs; opinion polling; data processing; provision of business information; marketing services; promotion services; database management services; business information services provided online from a computer database or the internet; composing advertisements for use as web pages; market surveys; analysis of advertising response and market research; business management services relating to the rental of vehicles; business management services relating to transport fleet; cost analysis and business statistical analysis relating to vehicles; business enquiries; business investigations; demonstration of computer products; computerised file management; collection and systemization of data in a master file in the field of automobile adve-

rtising and vehicle rental; administration of customer loyalty programmes via customer club, for commercial, promotional and/or advertising purposes; organisation of exhibitions for advertising purposes relating to the automobile and vehicle rental fields; retail services connected with the sale of vehicles and apparatus for travel by land, air, rail or water; information and advice relating to the aforesaid services.

36 – Insurance; financial affairs; monetary affairs; credit services relating to motor vehicles; financial services relating to motor vehicles; financial services for the purchase of vehicles; provision of finance for the purchase of vehicles; financial services for the leasing of vehicles; insurance services relating to vehicles; financial services relating to the insurance of motor vehicles; lease purchase financing of vehicles; lease-financing consultancy; financial consultancy services relating to vehicle valuation and investment; information and advice relating to the aforesaid services.

39 – Transport; packaging and storage of goods; travel arrangement; transportation of persons or merchandise (by air, land or water); arranging for the transportation of persons or merchandise (by air, land or water); rental of vehicles for locomotion by air, land or water; rental of cars, bicycles, motorcycles, scooters, camping cars, trucks, lorries, vans, coaches, buses, caravans; vehicle leasing services; arranging for the rental of vehicles for locomotion by air, land or water; rental of vehicle equipment and accessories; vehicle and transport reservation services; chauffeur services; rental of chauffeur driven vehicles; car sharing; van sharing; bicycle sharing; car pooling; scooter pooling, transport management namely, fleet planning for transport; haulage services; courier services (messages or merchandise); vehicle towing services; hiring of transportation vehicles; information and advice relating to the aforesaid services.

(260) AM 2020 103606 A\*  
 (800) 1471639  
 (151) 2018 12 19  
 (891) 2018 12 19  
 (731) Perkins Holdings Limited  
 Eastfield, Peterborough PE1 5FQ,  
 United Kingdom

(540)



(591) Black, white

(531) 26.01.06; 26.04.03; 26.07.05

(511)

35 – Retail, wholesale and online retail services relating to vehicles, equipment and machines for use in agriculture, compaction, construction, demolition, earth conditioning, earth contouring, earth moving, forestry, landscaping, lawn care, lifting, marine propulsion, material handling, mining, mulching, oil and gas distribution, oil and gas exploration, oil and gas production, paving, pipelaying, power generation, road building and repair, site preparation and remediation, tunnel boring, and vegetation management, engines and motors, generators, machine tools, and parts therefor; retail, wholesale and online retail services relating to machines and vehicles for use in agriculture, compaction, construction, demolition, earth conditioning, earth contouring, earth moving, forestry, landscaping, lawn care, lifting, marine propulsion, material handling, mining, mulching, oil and gas distribution, oil and gas exploration, oil and gas production, paving, pipelaying, power generation, road building and repair, site preparation and remediation, tunnel boring, and vegetation management; retail, wholesale and online retail services relating to diesel engines, gas engines, electrical engines, internal combustion engines, marine engines, generators of electricity, current generators, alternators and parts, fittings and components therefor; retail, wholesale and online retail services relating to industrial oil and greases, lubricants and engine oils.

(260) AM 2020 106146 A

(800) 1095763

(151) 2011 09 29

(891) 2019 11 21

(731) MATALAN LIMITED

Matalan Head Office, Perimeter Road,  
Knowsley Industrial Park, Liverpool L33 7SZ,  
United Kingdom

(540)

## US ATHLETIC

(591) Black, white

(511)

25 – Articles of clothing; footwear; headgear.

(260) AM 2020 106200 A

(800) 1503711

(151) 2019 06 28

(891) 2019 06 28

(731) COSMETIC RESEARCH GROUP

Zone Industrielle de Carros, 1241 1ère  
Avenue, F-06510 CARROS, France

(540)

## SOSKIN

(591) Black, white

(511)

44 – Hygienic and beauty care for human beings; beauty salons; hairdressing salons; manicure salons; massage services, relaxation care; consulting services on beauty, makeup, nutrition and perfumery; fitness, aromatherapy, thalassotherapy, balneotherapy, chromotherapy and sound therapy services; fitness services using saunas, hammams and pressurized water sprays.

(260) AM 2020 106232 A

(800) 1504385

(151) 2019 10 10

(891) 2019 10 10

(731) Limited Liability Company "Vinokonyachny zavod "Alliance-1892"  
ul. Gogolya 9A, Chernyakhovsk, RU-238150  
Kaliningrad Region, Russian Federation

(540)

## Old Kenigsberg

(591) Black, white

(511)

33 – Alcoholic beverages, except beers; alcoholic preparations for making beverages.

(260) AM 2020 106342 A

(800) 1505331

(151) 2019 09 19

(891) 2019 09 19

(731) AE Solar GmbH

Messerschmittring 54, 86343 Königsbrunn,  
Germany

(540)



(591) Black, red, gold

(531) 26.01.01; 26.01.24; 26.11.01; 26.11.12;  
27.05.09; 27.05.10; 29.01.13

(511)

9 – Photovoltaic apparatus and installations for generating solar electricity; photovoltaic solar modules; solar cells; solar collectors; all the aforesaid goods for generating electricity; solar batteries.

(260) AM 2020 106347 A  
 (800) 1505389  
 (151) 2019 10 21  
 (891) 2019 10 21  
 (731) adp Gauselmann GmbH  
 Merkur-Allee 1-15, 32339 Espelkamp,  
 Germany  
 (540)

## Anuris

(591) Black, white  
 (511)  
 9 – Computer software; coin-operated mechanisms; computer and video games software; games software in particular for use on any computer platform, including electronic entertainment and games consoles; computer game programs; video games (software); computer games provided through a global computer network or supplied by means of multi-media electronic broadcast or through telecommunications or electronic transmission or via the internet; computer games, leisure and recreational software, video games and computer software, all being provided in the form of storage media; programs for operating electric and electronic apparatus for games, amusement and/or entertainment purposes; computer software for computer games on the internet; online games (software), in particular for online betting games, online prize games, online gambling games, online games of skill and online casino games; computer software in the form of an app for mobile devices and computers; software in particular for casino and/or amusement arcade games, for gaming machines and/or slot machines each one with or without prize payouts; gaming software that generates or displays wager outcomes of gaming machines; operational computer games software; computer software for managing of games (game collection); computer programs for video games; computer video game software.

28 – Games; toys; gaming apparatus (including coin-operated apparatus); coin-operated arcade games (machines); games for amusement arcades (included in this class); coin-operated video gaming apparatus; video games apparatus adapted for use with external screens or monitors only; casino fittings, namely roulette tables, roulette wheels; coin-operated automatic gaming machines and gaming machines, in particular for gaming arcades, with or without a prize payout; electronic or electrotechnical gaming apparatus, automatic gaming machines, gaming machines, slot machines operated by coins, tokens, banknotes, tickets or by means of electronic, magnetic or biometric storage media, in particular for commercial use in casinos and amusement arcades, with or without a prize payout; automatic gaming machines and gaming machines, in particular for commercial use in casinos and gaming arcades, with

or without a prize payout; coin-operated gaming machines and/or electronic money-based gaming apparatus (machines), with or without prizes; housings adapted for gaming machines, gaming apparatus and automatic gaming machines, operated by means of coins, tokens, tickets or by means of electronic, magnetic or biometric storage media, in particular for commercial use in casinos and gaming arcades, with or without a prize payout; electronic games; electronic game entertainment apparatus and parts thereof; video output game machines; drawing apparatus for prize games and lotteries, draws or raffles; housings of metal, plastic and/or wood adapted for coin-operated automatic amusement machines; apparatus for games (including video games), other than adapted for use with external screens or monitors only; electropneumatic and electric slot machines with pulling handles (gaming machines); gaming tables, in particular for table football, billiards, sliding games; flying discs (toys) and darts; gaming machines, namely electric, electronic or electromechanical apparatus for bingo games, lotteries or video lottery games and for betting offices, connected or unconnected to a computer network; LCD games consoles; automatic gaming machines; all the aforesaid automatic machines operating in networks; apparatus and devices for accepting and storing money, being fittings for the aforesaid automatic machines, included in this class; automatic lottery machines.

(260) AM 2020 106395 A  
 (800) 1399837  
 (151) 2017 09 18  
 (891) 2019 07 03  
 (731) LC WAIKIKI MAĞAZACILIK  
 HİZMETLERİ TİCARET ANONİM  
 ŞİRKETİ  
 Evren Mahallesi, Gülbahar Caddesi No:96,  
 Bağcılar, İstanbul, Turkey

(540)

## LCW MODEST

(591) Black, white  
 (531) 27.05.10  
 (511)  
 25 – Clothing, namely, trousers, jackets, overcoats, coats, skirts, suits, jerseys, waistcoats, shirts, ready-made leather linings (parts of clothing), T-shirts, sweatshirts, dresses, bermuda shorts, shorts, pajamas, pullovers, jeans, tracksuits, rainwear, beachwear, bathing suits, swimming suits; clothing for sports (for exclusive use for sports), clothing for babies, namely, shirts, pants, coats, dresses; underclothing, namely, boxer shorts, brassieres, briefs, pants; socks; footwear, namely shoes excluding orthopedic shoes, sandals, waterproof boots, walking boots, booties, sporting shoes, slippers; shoe parts, namely, heelpie-

ces, insoles for footwear, footwear uppers; headgear, namely caps, skull caps, sports caps, hats, berets; gloves (clothing), stockings, belts (clothing), camisoles, sarongs, scarves, neck scarves, shawls, collars, neckties, ties, suspender belts.

35 – Advertising, marketing and public relations; organization of exhibitions and trade fairs for commercial or advertising purposes; design of advertising materials; office functions; secretarial services; arranging newspaper subscriptions for others; compilation of statistics; rental of office machines; systemization of information into computer databases; telephone answering for unavailable subscribers; business management, business administration and business consultancy; accounting; commercial consultancy services; personnel recruitment, personnel placement, employment agencies, import-export agencies; temporary personnel placement services; auctioneering; the bringing together, for the benefit of others, of a variety of goods, namely, bleaching and cleaning preparations, detergents other than for use in manufacturing operations and for medical purposes, laundry bleach, fabric softeners for laundry use, stain removers, dishwasher detergents, perfumery, cosmetics (except medicated cosmetics), fragrances, deodorants for personal use and animals, soaps (except medicated soap), dental care preparations, dentifrices, denture polishes, tooth whitening preparations, mouth washes, not for medical purposes, abrasive preparations, emery cloth, sandpaper, pumice stone, abrasive pastes, polishing preparations for leather, vinyl, metal and wood, polishes and creams for leather, vinyl, metal and wood, wax for polishing, unworked or semi-worked leather and animal skins, imitations of leather, stout leather, leather used for linings, goods made of leather, imitations of leather or other materials, designed for carrying items, bags, wallets, boxes and trunks made of leather or stout leather, keycases, trunks [luggage], suitcases, umbrellas, parasols, sun umbrellas, walking sticks, whips, harness, saddlery, stirrups, straps of leather (saddlery), clothing, namely, trousers, jackets, overcoats, coats, skirts, suits, jerseys, waistcoats, shirts, ready-made leather linings (parts of clothing), T-shirts, sweatshirts, dresses, bermuda shorts, shorts, pajamas, pullovers, jeans, tracksuits, rainwear, beachwear, bathing suits, swimming suits, clothing for sports (for exclusive use for sports), clothing for babies, namely, shirts, pants, coats, dresses, underclothing, namely, boxer shorts, brassieres, briefs, pants, socks, footwear, namely shoes excluding orthopedic shoes, sandals, waterproof boots, walking boots, booties, sporting shoes, slippers, shoe parts, namely, heelpieces, insoles for footwear, footwear uppers, headgear, namely caps, skull caps, sports caps, hats, berets, gloves (clothing), stockings, belts (clothing), camisoles, sarongs, scarves, neck scarves, shawls, collars, neckties, ties, suspender belts, ena-

bling customers to conveniently view and purchase those goods, such services may be provided by retail stores, wholesale outlets, by means of electronic media or through mail order catalogues.

(260) AM 2020 106438 A

(800) 1506344

(151) 2019 11 12

(891) 2019 11 12

(731) Obshchestvo s ogranichenoy otvetstvennostyu "Mister Dez" prospekt Tovarishcheskii, dom 32, k. 1, kv. 237, RU-193231 Sankt-Peterburg, Russian Federation

(540)

**DREAM  
NATURE**

(591) Black, white

(511)

3 – Soap; beauty masks; cosmetic kits; cosmetics; cosmetic creams; lotions for cosmetic purposes; cleansing milk for toilet purposes; shampoos; perfumery; cosmetic preparations for skin care; after-shave lotions; hair conditioners.

(260) AM 2020 106439 A

(800) 1506405

(151) 2019 11 15

(891) 2019 11 15

(731) SOREMARTEC S.A.  
16 Route de Trèves, L-2633 Senningerberg,  
Luxembourg

(540)

**MURRAY**

(591) Black, white

(531) 27.05.01; 27.05.17; 27.05.24

(511)

30 – Biscuits.

(260) AM 2020 106440 A

(800) 1506421

(151) 2019 10 17

(891) 2019 10 17

(731) KIA MOTORS CORPORATION  
12, Heolleung-ro, Seocho-gu, Seoul, Republic  
of Korea



(540)

**KIA K5**

(591) Black, white

(511)

12 – Automobiles; sports cars; vans [vehicles]; trucks; motor buses; electric vehicles.

(260) AM 2020 106446 A

(800) 1506479

(151) 2019 08 09

(891) 2019 08 09

(731) WORLD MEDICINE İLAÇ SANAYİ VE

TİCARET ANONİM ŞİRKETİ

15 Temmuz Mah. Camiyolu Cad. No.50 K.2,

Güneşli Bağcılar, İstanbul, Turkey

(540)

**ТОФІК – ТОФІК**

(591) Black, white

(531) 24.17.01; 27.05.01; 28.05

(511)

5 – Pharmaceutical and veterinary preparations for medical purposes, chemical preparations for medical purposes, dietary supplements, including those adapted for medical purposes, dietary supplements for slimming purposes, food for babies, herbs and herbal beverages adapted for medicinal purposes, dental preparations and articles, sanitary preparations for medical use, hygienic pads, hygienic tampons, plasters, materials for dressings, diapers, including those made of paper and textiles, deodorants, other than for human beings or for animals, air deodorising preparations, disinfectants, antiseptics, detergents for medical purposes.

(260) AM 2020 106447 A

(800) 1506510

(151) 2019 11 28

(891) 2019 11 28

(731) Apple Inc.

One Apple Park Way, Cupertino CA 95014,  
USA

(540)

**PENCILKIT**

(591) Black, white

(511)

9 – Downloadable computer software used in developing other software applications; application development software.

42 – Design and development of computer software; computer software consulting services; support services in the nature of consultation services for developing computer systems, databases and applicati-

ons; providing computer software information online.

(260) AM 2020 106448 A

(800) 1506540

(151) 2019 11 06

(891) 2019 11 06

(731) ÇAĞATAY EVCİL HAYVAN MAMALARI

VE YEM ÜRÜNLERİ SANAYİ VE

TİCARET ANONİM ŞİRKETİ

Ümit Mahallesi, 7406/1 Sokak, No: 9,

Bornova – İzmir, Turkey

(540)



(591) Black, white

(531) 26.03.05; 26.03.19; 26.03.24; 27.05.02

(511)

31 – Food for animals; cat food; dog food; cat litter.

(260) AM 2020 106449 A

(800) 1506565

(151) 2019 09 27

(891) 2019 09 27

(731) CASEN RECORDATI, S.L.

Autovía de Logroño, Km. 13.300, E-50190

Utebo (Zaragoza), Spain

(540)

**CASENFIBRA**

(591) Black, white

(511)

5 – Pharmaceutical and veterinary products, sanitary products for medical use and intimate hygiene other than toiletries, dietetic substances for medical use, food for babies, plasters, materials for dressings, material for dental fillings and dental impressions, disinfectants, products for destroying vermin, fungicides, herbicides.

32 – Beers, mineral waters, carbonated beverages and other non-alcoholic beverages, syrups for making beverages, fruit juices, syrups.

(260) AM 2020 106450 A

(800) 1506653

(151) 2019 08 06

(891) 2019 08 06

(731) LEYLA BESEVLİ

ZIYA GÖKALP MAH., AĞAOĞLU MY

WORLD EUROPE SITESİ, D/ A6 NO:25,

BAŞAKŞEHİR, İSTANBUL, Turkey

(540)



(591) Black, white

(531) 26.04.18; 26.04.24

(511)

25 – Clothing, including underwear and outer clothing, other than special purpose protective clothing; socks, mufflers [clothing], shawls, bandanas, scarves, belts [clothing]; footwear, shoes, slippers, sandals; headgear, hats, caps with visors, berets, caps [headwear], skull caps.

35 – Advertising, marketing and public relations; organization of exhibitions and trade fairs for commercial or advertising purposes; design for advertising; provision of an online marketplace for buyers and sellers of goods and services; office functions; secretarial services; arranging newspaper subscriptions for others; compilation of statistics, rental of office machines; systemization of information into computer databases; telephone answering for unavailable subscribers; business management, business administration and business consultancy; accounting; commercial consultancy services; personnel recruitment, personnel placement, employment agencies, import-export agencies; temporary personnel placement services; auctioneering; the bringing together, for the benefit of others, of a variety of goods, namely, clothing, including underwear and outer clothing, other than special purpose protective clothing, socks, mufflers [clothing], shawls, bandanas, scarves, belts [clothing], footwear, shoes, slippers, sandals, headgear, hats, caps with visors, berets, caps [headwear], skull caps enabling customers to conveniently view and purchase those goods, such services may be provided by retail stores, wholesale outlets, by means of electronic media or through mail order catalogues.

(260) AM 2020 106452 A

(800) 1506738

(151) 2019 12 03

(891) 2019 12 03

(731) C&amp;U GROUP CO., LTD

No.515 Binhai 5th Road, Economic and Technological, Development Zone, Wenzhou, Zhejiang Province, China

(540)

# S&F

(591) Black, white

(531) 24.17.09; 24.17.25; 27.05.17

(511)

7 – Pumps [parts of machines, engines or motors]; valves [parts of machines]; fan belts for motors and engines; piston rings; belts for machines; filters for cleaning cooling air, for engines; aero condensers; universal joints [cardan joints]; compressors [machines]; vacuum cleaners; bearings [parts of machines].

(260) AM 2020 106453 A

(800) 1506755

(151) 2019 09 25

(891) 2019 09 25

(731) İSA TEKSTİL SANAYİ VE TİCARET LİMİTED ŞİRKETİ

Aksaray Mahallesi Küçüklanga, Caddesi No:61/A; Fatih, İstanbul, Turkey

(540)

# Freedom

(591) Black, white

(531) 27.05.17

(511)

24 – Woven or non-woven textile fabrics; textile goods for household use, not included in other classes: curtains, bed covers, sheets (textile), pillowcases, blankets, quilts, towels; flags, pennants, labels of textile; swaddling blankets.

(260) AM 2020 106460 A

(800) 1506897

(151) 2019 09 05

(891) 2019 09 05

(731) Sovmestnoe belorusko-polskoe predpriyatie "KAMAKO PLYUS" v forme obshchestva s ogranichennoy otvetstvennostyu ul. Morozova, d. 87, cabinet 1, liter B1/b, g. Borisov, 222514 Minskaya oblast, Belarus

(540)



(591) Dark-blue, yellow, orange and white

(531) 01.03.02; 01.03.13; 01.03.17; 27.05.01; 29.01.14

(511)

29 – Ajvar [preserved peppers]; aloe vera prepared for human consumption; alginates for culinary purposes; anchovy, not live; peanuts, prepared; artich-

kes, preserved; albumen for culinary purposes; white of eggs; beans, preserved; soya beans, preserved, for food; bouillon, broth; ginger jam; ham; fatty substances for the manufacture of edible fats; laver, preserved; edible birds' nests; peas, preserved; mushrooms, preserved; guacamole [mashed avocado]; game, not live; gelatine; meat jellies; jellies for food; fruit jellies; yolk of eggs; coconut fat; bone oil for food; lard; suet for food; edible fats; fruit-based snack food; milk substitutes; soya patties; tofu patties; charcuterie; cottage cheese fritters; raisins; caviar; eggplant paste, aubergine paste; vegetable marrow paste; fish roe, prepared; yogurt (yoghurt); galbi [grilled meat dish]; sauerkraut; kephir (kefir) [milk beverage]; kimchi [fermented vegetable dish]; isinglass for food; clams, not live; potato-based dumplings; klipfish [salted and dried cod]; milk shakes; black pudding, blood sausage; onion rings; arrangements of processed fruit; compotes; meat, tinned (canned (am.)); vegetables, tinned (canned (am.)); fish, tinned (canned (am.)); fruits, tinned (canned (am.)); bouillon concentrates, broth concentrates; corn dogs; gherkins; shrimps, not live; prawns, not live; buttercream; croquettes; silkworm chrysalis for human consumption; sweet corn, processed; kumys (koumiss) [milk beverage]; spiny lobsters, not live; lecithin for culinary purposes; salmon, not live; onions, preserved; margarine; marmalade; oils for food; peanut butter; cocoa butter for food; coconut oil for food; coconut butter; corn oil for food, maize oil for food; sesame oil for food; linseed oil for food, flaxseed oil for food; extra virgin olive oil for food; olive oil for food; palm oil for food; palm kernel oil for food; sunflower oil for food; colza oil for food, rape oil for food; butter; soya bean oil for food; shellfish, not live; almonds, ground; animal marrow for food; mussels, not live; milk; peanut milk, [non-alcoholic beverages]; peanut milk for culinary purposes; coconut milk; coconut milk for culinary purposes; almond milk [beverages]; almond milk for culinary purposes; oat milk; rice milk; rice milk for culinary purposes; condensed milk; soya milk; albumin milk, protein milk; powdered milk; fish meal for human consumption; vegetable mousses; fish mousses; fruit pulp; meat; meat, preserved; freeze-dried meat, lyophilized (Iyophilized) meat; milk beverages, milk predominating; peanut milk-based beverages; coconut milk-based beverages; almond milk-based beverages; edible insects, not live; sausage casings, natural or artificial; vegetables, preserved; freeze-dried vegetables, lyophilized (Iyophilized) vegetables; vegetables, cooked; vegetables, dried; potato fritters; olives, preserved; lobsters, not live; flavoured (flavored) nuts; candied nuts; coconut, desiccated; nuts, prepared; tomato puree; pressed fruit paste; liver pâté, liver pastes; pectin for culinary purposes; liver; pickles; jams; powdered eggs; milk products; fish-based foodstuffs; curd; prostokvasha [soured milk]; poultry, not live; bulgogi [Korean beef dish]; pollen

prepared as foodstuff; cranberry compote; apple purée; crayfish, not live; crustaceans, not live; fish, preserved; fish, not live; salted fish; ryazhenka [fermented baked milk]; vegetable salads; fruit salads; bacon; sardines, not live; pork; herrings, not live; seeds, prepared; sunflower seeds, prepared; whipped cream; cream [dairy products]; vegetable-based cream; fat-containing mixtures for bread slices; smetana [sour cream]; vegetable juices for cooking; lemon juice for culinary purposes; tomato juice for cooking; salted meats; sausages; sausages in batter; hot dog sausages; preparations for making bouillon; preparations for making soup; nut-based spreads; tripe; vegetable soup preparations; whey; cheese; tahini [sesame seed paste]; tofu; sea-cucumbers, not live; truffles, preserved; tuna, not live; oysters, not live; falafel; milk ferments for culinary purposes; rennet; fish fillets; dates; crystallized fruits, frosted fruits; frozen fruits; fruit, preserved; fruit, stewed; hazelnuts, prepared; potato flakes; hummus [chickpeas paste]; fruit peel; preserved garlic; lentils, preserved; potato chips (crisps); low-fat potato chips (crisps); fruit chips; non-alcoholic eggnog; seaweed extracts for food; meat extracts; escamoles [edible ant larvae, prepared]; yuba [tofu skin]; berries, preserved; eggs; snail eggs for consumption; yakitori.

30 – Aromatic preparations for foodstuffs and beverages, other than essential oils; vanilla flavourings (flavorings) for culinary purposes; flavorings (flavourings), other than essential oils, for cakes; flavorings (flavourings), other than essential oils, for beverages; coffee flavorings (flavourings); food flavorings (flavourings), other than essential oils; star aniseed; baozi [stuffed buns]; cereal bars; high-protein cereal bars; pancakes; freeze-dried dishes with the main ingredient being pasta, Iyophilized (Iyophilised) dishes with the main ingredient being pasta; freeze-dried dishes with the main ingredient being rice, Iyophilized (Iyophilised) dishes with the main ingredient being rice; noodle-based prepared meals; buns; bulgur; bread rolls; edible rice paper; edible paper; burritos; vanillin [vanilla substitute]; vareniki [stuffed dumplings]; waffles; vermicelli [noodles]; natural sweeteners; sausage binding materials; binding agents for ice cream; sea water for cooking; seaweed [condiment]; malt biscuits; cloves [spice]; mirror icing [mirror glaze]; cake frosting [icing]; glucose for culinary purposes; mustard; croutons (croutons); buckwheat, processed; gluten additives for culinary purposes; yeast; thickening agents for cooking foodstuffs; leaven; rice-based snack food; cereal-based snack food; artificial coffee; vegetal preparations for use as coffee substitutes; dressings for salad; zephyr (zefir) [confectionery]; fruit jellies [confectionery]; candy decorations for cakes; confectionery for decorating Christmas trees; cakes; pastries; peanut confectionery; almond confectionery; pasta; ginger [spice]; frozen yogurt (yoghurt) [con-

fectionery ices]; cocoa; cream of tartar for culinary purposes; capers; caramels [candy]; curry [spice]; ketchup [sauce]; gimhap [Korean rice dish]; kimchi-jeon [fermented vegetable pancakes]; quinoa, processed; quiches; gluten prepared as foodstuff; flour-based dumplings; sweetmeats [candy]; liquorice [confectionery]; peppermint sweets; mints for breath freshening; cinnamon [spice]; coffee; dulce de leche; unroasted coffee; starch for food; crackers; custard; hominy grits; semolina; oatmeal; crushed barley; groats for human food; ice cubes; corn, milled, maize, milled; corn, roasted, maize, roasted; meat pies; turmeric; couscous [semolina]; noodles, ribbon vermicelli; soba noodles; udon noodles; ice for refreshment; candy; ice, natural or artificial; edible ices; rice cakes; lomper [potato-based flatbread]; mayonnaise; macaroons [pastry]; macaroni; maltose; hominy; piccalilli; marinades; marzipan; honey; royal jelly; ice cream; bean meal; buckwheat flour; tapioca flour; potato flour; corn flour, corn meal; maize flour, maize meal; nut flours; flour, meal; wheat flour; soya flour; barley meal; dessert mousses [confectionery]; muesli; mint for confectionery; cocoa beverages with milk; coffee beverages with milk; coffee-based beverages; cocoa-based beverages; chamomile-based beverages; tea-based beverages; chocolate beverages with milk; chocolate-based beverages; crushed oats; husked oats; okonomiyaki [Japanese savoury (savory) pancakes]; onigiri [rice balls]; chocolate-coated nuts; nutmegs; stick liquorice [confectionery]; miso [condiment], soya bean paste [condiment]; pastila [confectionery]; pastilles [confectionery], lozenges [confectionery]; molasses for food; pâtés en croûte; pelmeni [dumplings stuffed with meat]; pepper; allspice; peppers [seasonings]; pesto [sauce]; cookies, biscuits; petit-beurre biscuits; bibimbap [rice mixed with vegetables and beef]; pies; pizzas; meat gravies; fondants [confectionery]; popcorn; powders for making ice cream; baking powder; mustard meal; pralines; condiments; meat tenderizers for household purposes; cereal preparations; oat-based food; propolis, bee glue; gingerbread; spices; petits fours [cakes]; puddings; cake powder; fruit, coulis [sauces]; ravioli; ramen [Japanese noodle-based dish]; chewing gum; chewing gum for breath freshening; relish [condiment]; rice; instant rice; wheat germ for human consumption; spring rolls; sago; sugar; palm sugar; sesame seeds [seasonings]; linseed for culinary purposes [seasoning], flaxseed for culinary purposes [seasoning]; processed seeds for use as a seasoning; aniseed; agave syrup [natural sweetener]; golden syrup; confectionery (sugar confectionery); batter mixes for okonomiyaki [Japanese savoury (savory) pancakes]; baking soda [bicarbonate of soda for cooking purposes]; malt for human consumption; cooking salt; salt for preserving foodstuffs; celery salt; sherbets [ices]; ham glaze; cranberry sauce [condiment]; soya sauce; tomato sauce; pasta sauce; sauces [condi-

ments]; apple sauce [condiment]; spaghetti; seasonings; chocolate-based spreads; chocolate spreads containing nuts; preparations for stiffening whipped cream; shaved ice with sweetened red beans; rusks; breadcrumbs; sushi; senbei [rice crackers]; sandwiches; tabbouleh; tacos; tapioca; tarts; dough; pastry dough; almond paste; rice pulp for culinary purposes; cake dough, cake batter; tortillas; garden herbs, preserved [seasonings]; chocolate decorations for cakes; vinegar; beer vinegar; ferments for pastes; halvah; bread; unleavened bread; corn flakes, maize flakes; oat flakes; chips [cereal products]; flowers or leaves for use as tea substitutes; hot dog sandwiches; jiaozi [stuffed dumplings]; chicory [coffee substitute]; tea; iced tea; chutneys [condiments]; minced garlic [condiment]; cheeseburgers [sandwiches]; chowchow [condiment]; saffron [seasoning]; chocolate; malt extract for food; essences for foodstuffs, except etheric essences and essential oils; husked barley.

(260) AM 2020 106462 A

(800) 1506932

(151) 2019 10 22

(891) 2019 10 22

(731) FURKAN KANTARCI

Esentepe Mah., Tasocagi Dikyol Sk. No:21

D:1, Eyup, Istanbul, Turkey

(540)



(591) Black and gold

(531) 24.09.07; 27.05.01; 29.01.12

(511)

25 – Clothing, including underwear and outer clothing, other than special purpose protective clothing, socks, mufflers [clothing], shawls, bandanas, scarves, belts [clothing], footwear, shoes, slippers, sandals, headgear, hats, caps with visors, berets, caps [headwear], skull caps.

(260) AM 2020 106466 A

(800) 1506990

(151) 2019 10 30

(891) 2019 10 30

(731) Limited Liability Company "TigRus"

Leningradskoye sh., 37, bldg. 1, apt. 171,

RU-125212 Moscow, Russian Federation

(540)

(591) Black, white

(531) 28.05

(511)

43 – Services for providing food and drink; snack-bar services; café services; cafeteria services; rental of tents; rental of transportable buildings; restaurant services; self-service restaurant services; canteen services; holiday camp services [lodging]; bar services; providing campground facilities; food and drink catering.

(260) AM 2020 106476 A

(800) 1507308

(151) 2019 10 08

(891) 2019 10 08

(731) WORLD VET İLAÇ SANAYİ VE TİCARET LİMİTED ŞİRKETİ  
15 TEMMUZ MAH.CAMI YOLU CAD.  
NO.50 KAT.1 BAĞCILAR İstanbul,  
Turkey

(540)

**FLORRELIEF – ФЛОРРЕЛИФ**

(591) Black, white

(531) 28.05

(511)

5 – Preparations for destroying vermin, herbicides, air deodorising preparations.

(260) AM 2020 106477 A

(800) 1507311

(151) 2019 11 22

(891) 2019 11 22

(731) Henkel AG & Co. KgaA  
Henkelstr. 67, 40589 Düsseldorf, Germany

(540)

**Together, for true beauty  
and a more beautiful world**

(591) Black, white

(511)

3 – Non-medicated soaps for personal use; perfumeries, essential oils; cosmetics; non-medicated hair lotions; non-medicated dentifrices.

41 – Education; providing of training; entertainment; sporting and cultural activities; arranging of competitions, particularly in the field of hairdressing.

44 – Hygienic and beauty care for human beings; hair salon services; beauty consultancy; beauty information services.

(260) AM 2020 106478 A

(800) 1507340

(151) 2019 11 18

(891) 2019 11 18

(731) Boguslavskaya Karina Irekovna  
ul. Bogataya, dom 1, d. Matyushino,  
Laishevsky municipal district, RU-422624  
Republic of Tatarstan, Russian Federation

(540)

**HAIRFOOD**

(591) Black, white

(531) 27.05.01; 27.05.17

(511)

3 – Abrasives; amber [perfume]; descaling preparations for household purposes; antistatic preparations for household purposes; aromatics [essential oils]; air fragrancing preparations; cake flavorings [essential oils]; flavorings for beverages [essential oils]; breath freshening sprays; canned pressurized air for cleaning and dusting purposes; balms, other than for medical purposes; lip glosses; polishing stones; abrasive paper; emery paper; polishing paper; petroleum jelly for cosmetic purposes; shoe wax; cobblers' wax; cotton wool for cosmetic purposes; sachets for perfuming linen; drying agents for dishwashing machines; adhesives for cosmetic purposes; scented water; javelle water; lavender water; toilet water; floor wax; non-slipping wax for floors; depilatory wax; mustache wax; tailors' wax; polish for furniture and flooring; shoemakers' wax; polishing wax; massage gels, other than for medical purposes; heliotropine; dental bleaching gels; geraniol; make-up; deodorants for pets; scented wood; perfumes; non-slipping liquids for floors; windshield cleaning liquids; greases for cosmetic purposes; volcanic ash for cleaning; perfumery; decorative transfers for cosmetic purposes; ionone [perfumery]; shaving stones [astringents]; smoothing stones; eyebrow pencils; cosmetic pencils; silicon carbide [abrasive]; carbides of metal [abrasives]; alum stones [astringents]; tripoli stone for polishing; adhesives for affixing false eyelashes; adhesives for affixing false hair; quilliaia bark for washing; corundum [abrasive]; beard dyes; colorants for toilet purposes; cosmetic dyes; laundry starch; laundry glaze; creams for leather; polishing creams; shoe polish; cosmetic creams; skin whitening creams; polishing rouge; incense; hair spray; nail polish; hair lotions; lotions for cosmetic purposes; after-shave lotions; beauty masks; oils for perfumes and scents; oils for cosmetic purposes; oils for toilet purposes; essential oils; essential oils of cedarwood; essential oils of lemon; essential oils of citron; oils

for cleaning purposes; bergamot oil; gaultheria oil; jasmine oil; lavender oil; almond oil; rose oil; oil of turpentine for degreasing; whitening; cleaning chalk; almond milk for cosmetic purposes; cleansing milk for toilet purposes; musk [perfumery]; soap; deodorant soap; shaving soap; soap for brightening textile; cakes of toilet soap; antiperspirant soap; soap for foot perspiration; almond soap; mint for perfumery; cosmetic kits; emery; nail art stickers; false nails; eau de Cologne; bases for flower perfumes; joss sticks; pastes for razor strops; dentifrices; pumice stone; hydrogen peroxide for cosmetic purposes; breath freshening strips; abrasive cloth; glass cloth [abrasive cloth]; lipsticks; pomades for cosmetic purposes; shaving preparations; cosmetic preparations for baths; toiletry preparations; hair waving preparations; laundry soaking preparations; grinding preparations; douching preparations for personal sanitary or deodorant purposes [toiletries]; smoothing preparations [starching]; color-removing preparations; leather bleaching preparations; polishing preparations; denture polishes; mouthwashes, not for medical purposes; cosmetic preparations for slimming purposes; starch glaze for laundry purposes; refurbishing preparations; fabric softeners for laundry use; laundry bleach; dry-cleaning preparations; paint stripping preparations; lacquer-removing preparations; make-up removing preparations; floor wax removers [scouring preparations]; varnish-removing preparations; nail care preparations; cleaning preparations; preparations for cleaning dentures; wallpaper cleaning preparations; preparations for unblocking drain pipes; laundry preparations; aloe vera preparations for cosmetic purposes; sunscreen preparations; color-brightening chemicals for household purposes [laundry]; shining preparations [polish]; make-up powder; diamantine [abrasive]; stain removers; scouring solutions; false eyelashes; tissues impregnated with cosmetic lotions; safrol; laundry blueing; turpentine for degreasing; potpourris [fragrances]; bleaching soda; washing soda, for cleaning; bath salts, not for medical purposes; bleaching salts; fumigation preparations [perfumes]; preservatives for leather [polishes]; ammonia [volatile alkali] [detergent]; astringents for cosmetic purposes; eyebrow cosmetics; make-up preparations; sun-tanning preparations [cosmetics]; hair dyes; neutralizers for permanent waving; preparations to make the leaves of plants shiny; cosmetic preparations for eyelashes; depilatory preparations; cosmetic preparations for skin care; shoe cream; cosmetics; cosmetics for animals; mascara; detergents, other than for use in manufacturing operations and for medical purposes; degreasers, other than for use in manufacturing processes; bleaching preparations [decolorants] for cosmetic purposes; antiperspirants [toiletries]; talcum powder, for toilet use; terpenes [essential oils]; emery cloth; cloths impregnated with a detergent for cleaning; henna [cosmetic dye]; shampoos; sham-

poos for pets; dry shampoos; sandpaper; soda lye; extracts of flowers [perfumes]; ethereal essences; badian essence; mint essence [essential oil].

(260) AM 2020 106480 A  
(800) 1507373  
(151) 2019 06 17  
(891) 2019 06 17  
(731) JINAN MEIDE CASTING CO., LTD.  
JINAN MEIDE TECHNOPARK,  
INDUSTRIAL PARK, PINGYIN, JINAN,  
SHANDONG PROVINCE, China  
(540)

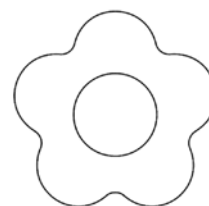

**PLUMNECT**

(591) Black, white  
(531) 05.05.19; 05.05.20  
(511)  
6 – Water-pipe valves of metal; ducts of metal, for central heating installations; valves of metal, other than parts of machines; elbows of metal for pipes; ducts of metal for ventilating and air conditioning installations; steel tubes; water-pipes of metal; tubes of metal; junctions of metal for pipes; pipework of metal; three direction pipe joint for water heating equipment; pipe joint for water heating equipment; pipes cross joints for heating installations.  
11 – Water-pipes for sanitary installations; cocks for pipes and pipelines; pipes [parts of sanitary installations]; pipe hoop for water heating equipment; faucets; pipe nozzles for water heating equipment.

(260) AM 2020 106481 A  
(800) 1507409  
(151) 2019 11 06  
(891) 2019 11 06  
(731) ÇAĞATAY EVCİL HAYVAN MAMALARI  
VE YEM ÜRÜNLERİ SANAYİ VE  
TİCARET ANONİM ŞİRKETİ  
Ümit Mahallesi, 7406/1 Sokak, No: 9,  
Bornova – İzmir, Turkey  
(540)

**micho**

KEÇİ MAMASI

(591) Black, white  
 (531) 26.04.01; 26.04.05; 26.04.18; 27.05.01;  
 27.05.09  
 (526) Kedi maması  
 (511)  
 31 – Food for animals; cat food.

(260) AM 2020 106482 A  
 (800) 1507496  
 (151) 2019 05 31  
 (891) 2019 05 31  
 (731) Hortex Spółka z ograniczoną  
 Odpowiedzialnością  
 ul. Mszczonowska 2, PL-02-337 Warszawa,  
 Poland  
 (540)



(591) White, red, green, grey and light grey  
 (531) 05.03.11; 05.03.13; 26.11.01; 26.11.12;  
 27.05.01; 29.01.14  
 (511)  
 29 – Meat, meat and butcher's products, sausages,  
 fish, poultry, venison, meat extracts, stocks, preser-  
 ved, dried and cooked fruits and vegetables, fruit and  
 vegetables preserved in alcohol, jellies, fruit jellies,  
 jams, compotes, eggs, powdered eggs, milk, milk  
 products, milk beverages, beverages containing pre-  
 dominating amount of milk, fruit, vegetable and mi-  
 xed fruit- vegetable smoothies containing predomi-  
 nating amount of milk products, yoghurts, kefir,  
 cheeses, edible oils and fats, butter, chocolate butter,  
 cocoa butter, coconut butter, margarine, lard, fruit  
 and vegetable products, frozen fruits and vegetables,  
 frozen fruit and vegetable blends, frozen ready made  
 vegetarian dishes and dishes with meat, fruit mou-  
 sses, fruit and vegetable pomaces, fruit and vege-  
 table salads, fruit peels, fruit pulp, gelatine for food,  
 fruit chips, tinned fruits and vegetables, candied  
 fruits, seafood, processed, soups, ingredients for ma-  
 king soups, preserved mushrooms, frozen mushro-  
 oms, tomato concentrates, pollen prepared as foods-  
 tuff, raisins, almonds, prepared; delicacies, namely  
 mixtures of dried and candied fruits and nuts; food  
 consisting primarily of fruits and vegetables, low fat  
 and cholesterol food consisting primarily of fruits  
 and vegetables, not for medical use.  
 32 – Beers; non-carbonated and carbonated water,  
 mineral water, table waters, soft drinks, flavored  
 mineral waters, essences, extracts and syrups for

making flavoured mineral water, non-alcoholic be-  
 verages, non-alcoholic honey-based beverages, non-  
 alcoholic beverages consisting of fruit juices, non-  
 alcoholic fruit extracts, non-alcoholic cocktails, fruit,  
 vegetable and mixed fruit-vegetable juices, bevera-  
 ges and nectars, condensed fruit and vegetable ju-  
 ices, fruit and vegetable, mixed fruit-vegetable puree  
 juices, low-energy juices and drinks, fruit, vegetable  
 and mixed fruit-vegetable juices, beverages and  
 nectars enriched with vitamins and/or calcium and/or  
 iron and/or other minerals, sorbets as beverages,  
 isotonic beverages, energy drinks, whey beverages,  
 lemonades, syrups for lemonades, syrups and pre-  
 parations for the preparation of beverages, essences  
 for beverages, extracts for beverages; fruit, vegetable  
 and mixed fruit-vegetable smoothies, smoothies with  
 or without grains, with or without plant extracts,  
 with or without milk products.

(260) AM 2020 106483 A  
 (800) 1507500  
 (151) 2019 06 26  
 (891) 2019 06 26  
 (731) AKTEK DIŞ TİCARET LİMİTED ŞİRKETİ  
 Yeşilbayır Mah. Şimşir Sok. No:20,  
 Hadımköy Arnavutköy, İstanbul, Turkey  
 (540)



(591) Black, white  
 (531) 04.05.03; 26.01.03; 26.01.14; 26.01.24;  
 27.05.01  
 (511)  
 9 – Apparatus and instruments used for measuring,  
 weighing and evaluation in the field of science,  
 laboratory, navigation, topography, meteorology, el-  
 ectricty, photography, cinematography; testing equi-  
 pment, testing apparatus and instruments; barome-  
 ters, ammeters, gas testing instruments, slide cali-  
 pers, hygrometers, thermometers, voltmeters, mi-  
 croscopes, magnifying glass (optic), telescopes, peri-  
 scopes; equipments used in laboratory; test tubes,  
 measuring tubes; furnaces for laboratory experi-  
 ments, furniture especially made for laboratories;  
 illuminated advertisement boards, scoreboards, elec-  
 tric notice boards; instruments for recording, trans-  
 mission or reproduction of sound or image (except  
 communication instruments); radios, televisions, vi-  
 deos, cameras, audio apparatus and instruments, ci-  
 nematographic instruments, remote control machi-  
 nes, headphones, loudspeakers, megaphones, diap-  
 hones, intercommunication apparatus, picture and  
 slide projectors; data processing equipments; com-  
 puters, computer software and hardware, printers for  
 use with computers, laser printers for use with com-

puters, scanners, cash registers, calculating machines, bar code readers, part and fittings for aforesaid goods, navigation apparatus for vehicles (on-board computers); magnetic and optic data carriers; cassettes, magnetic disks, floppy disks, CDs, films, exposed; all kinds of cameras (photography), parts and accessory of cameras, enlarging apparatus (photography); films (cinematography and photography), X-ray films; antennas, satellite antennas, amplifiers and parts thereof; electric apparatus for remote ignition; mechanisms for coin, card and token operated apparatus; coin operated photography machines, ticket automats, weighing automats, automatic money withdraw machines; electronic components for machines and instruments; conductors, electronic circuits, integrated chips, photocells, diodes, transistors, circuit cards, crystal oscillators, condensers (capacitors), interface circuits, relays, liquid crystal displays, hybrid circuits, thermistor, converters, magnetic heads, magnetic deviators; communication machines; telephones, facsimile machines, telefax, telex machine, telegraph machines, wireless telephones, switchboards; electric machines for copying and reproduction; photocopiers, blueprint machines; counters; counters for water and electricity, gasometers, parking meters, timers, egg timers (sand glass); electronic and magnetic cards; telephone cards, banking cards, automatic cards to open and close doors, electronic cards for counters, electronic tickets; weighing machines; precision balances, scales, balances (steelyards); detectors, roentgen apparatus not for medical purposes, X-ray machines not for medical purposes, radiological apparatus for industrial purposes; life saving and protecting instruments; life jackets, life buoys, respiratory masks, diving suits, divers' masks, safety restraints, safety nets, protective clothes, gloves, glasses and helmets; signaling whistles and lanterns, signaling buoys; eyeglasses; sunglasses, optical lenses, eyeglass and lens cases, parts and fittings of these goods; plugs, sockets, junction box, electric switches, circuit breakers, circuit closers, fuses, ballasts, starters, electric boards, elevator operating apparatus, clips, conduits, cable raceway, buttons, resistances, connectors (electric), instruments and apparatus for conducting, switching, transforming, accumulating, regulating or controlling electricity; adapters, chargers; electric doorbells, alarms (other than automobile alarms); sirens; cables and wires; all kinds of cables and wires used for electric and telephone lines, optical fibers, fiber optic cables; power suppliers; accumulators, solar batteries, batteries, continuous power suppliers; water level indicators for vehicles; fuel level indicators for vehicles; speed, oil, fuel and heat indicators, tachometers, taximeters; balancing apparatus; vehicle breakdown warning triangles, road signs (luminous or mechanical), mechanical or electrical equipment for traffic signalization, controlling equipment

for road junctions, flashing lights; fire beaters; fire buckets; fire blankets, fire-extinguishing apparatus; radar apparatus, sonars, night vision apparatus; lightning conductors; spirit levels, meters, measures, plumb bobs; dosage dispensers; satellites for scientific purposes; electrolyzers; anodes, cathodes; filters for computer and television screens; remote control mechanisms for vehicle doors; magnets, decorative magnets; ear plugs; solar energy collectors and devices.

11 – Lighting apparatus for indoors, outdoors and vehicles; lamps, bulbs, flashlights, chandelier, lamp glasses, electric light sockets, electric lamps; electric bulbs, headlamps, stopping lamps for vehicles, headlights for automobiles; back-up lights for land vehicles, vehicle reflectors, reflector lamps, apparatus for heating and steam production installations; boilers for stoves, central heating and natural gas installations as part of heating installation, steam boilers, exchangers, burners, apartment heating apparatus, water heaters used also as apartment heating installations, water heaters, radiators, heat pumps, electrical water boilers, solid, liquid and gas fuel and electric stoves, cook stoves, climatization and air-conditioning devices; air conditioners, fans (air blowers), ventilators, air conditioners including those for vehicles, air disinfecting and cleaning instruments and apparatus for places and parts and accessories thereof, cooling apparatus; refrigerators, deep-freezers, ice boxes, ice machines and devices, electric and gas apparatus, machines and devices used for cooking and boiling; sandwich grilling machines, toasters, deep fryers, grills, barbecue grills, ovens, stoves, pop-corn machines, autoclaves, coffee and tea machines, water boilers (kettles) and parts thereof, shower tubs, bidets, bath cubicles, shower cubicles, urinals, toilet seats, toilet bowls, sinks, wash basins, parts and fittings for the aforementioned, taps for water and gas installations, thermostatic valves as parts of heating installation, level control valves for tanks, regulators, cocks for automatic watering installations, shower handles and hoses, pipes as parts of sanitary installation, watering machines for agricultural purposes, water softening apparatus, water purifying apparatus, water purifying installations, sewage purifying installations, electric hair dryers, hot air blowers, hand drying apparatus, face saunas, solarium devices; electrical coverlets and electrical quilts not for medical purposes, electrically heated pillows, not for medical use, electrical or non-electrical foot heaters, hot water bottles (thermophore), lighters used in kitchen, lighters as parts of heating and cooking apparatus, filters and filtration apparatus for aquariums, industrial type ovens, industrial type drying installations, industrial type cooling installations, cooling towers, cold air depots, nuclear reactors, dust-elimination and dust-collection installations for industrial purposes, incandescent bur-



ners, acetylene burners and generators, pasteurisers and sterilizers, laundry dryers, cupola furnaces, fuel saving devices for the goods included in this class, filters for apparatus used at home, filters as parts of industrial equipment included in this class, heating apparatus for defrosting windows of vehicles.

(260) AM 2020 106484 A

(800) 1507516

(151) 2019 10 25

(891) 2019 10 25

(731) AFTERSHOKZ, LLC

1801 Burnet Avenue, Suite 102, Syracuse  
NY 13206, USA

(540)

**REVVEZ**

(591) Black, white

(511)

9 – Smartglasses; Smartwatches; Hands-free kits for telephones; Eyeglass cases; Sunglasses; Headphones; Virtual reality headsets; Goggles for sports; Sports glasses; Anti-glare glasses; Eyeglasses; Eyeglass frames; 3D spectacles; Portable media players.

(260) AM 2020 106485 A

(800) 1507600

(151) 2019 09 12

(891) 2019 09 12

(731) TOVARYSTVO Z OBMEZHENOIU

VIDPOVIDALNISTIU "PU DEVELOPERS"  
Vul. Kazymyra Malevycha, Bud. 86, Lit. D',  
Ofis 3.2, M. Kyiv 03150, Ukraine

(540)



(591) Black, white

(531) 26.11.06; 26.11.07; 27.05.01

(511)

9 – Steering apparatus, automatic, for vehicles; accumulators, electric; remote control apparatus; data processing apparatus; Global Positioning System (GPS) apparatus; audio- and video-receivers; audio-visual teaching apparatus; audio interlaces; batteries, electric; cordless telephones; computer memory devices; connected bracelets (measuring instruments); measuring instruments; measures; high-frequency apparatus; video screens; camcorders; video baby monitors; video telephones; hands-free kits for tele-

phones; virtual reality headsets; dictating machines; disk drives for computers; telerupters; transparencies (photography); screens (photography); electro-dynamic apparatus for the remote control of signals; electronic publications, downloadable; electronic pocket translators; electronic tags for goods; encoded identification bracelets, magnetic; electronic agendas; battery chargers; sound alarms; sound recording carriers; sound recording apparatus; sound transmitting apparatus; connections, electric; buzzers; readers (data processing equipment); bar code readers; interfaces for computers; cables, electric; integrated circuit cards (smart cards); cinematographic cameras; computers; computer hardware; computer game software, downloadable; computer software, recorded; joysticks for use with computers, other than for video games; computer keyboards; computer peripheral devices; printers for use with computers; magnetic tape units for computers; computer programs, downloadable; computer programs, recorded; computer operating programs, recorded; counters; magnetic data media; videotapes; materials for electricity mains (wires, cables); portable media players; mouse (computer peripheral); microprocessors; mobile telephones; cell phones; monitors (computer hardware); monitors (computer programs); notebook computers; limiters (electricity); eyeglasses; optical data media; selfie sticks (hand-held monopods); transmitters of electronic signals; switchboxes (electricity); amplifiers; tablet computers; DVD players; computer software applications, downloadable; weighing apparatus and instruments; video recorders; electronic book readers; record players; theft prevention installations, electric; central processing units (processors); control panels (electricity); radio pagers; downloadable ring tones for mobile phones; life saving apparatus and equipment; subwoofers; light-emitting diodes (LED); alarms; scanners (data processing equipment); smartwatches; smart rings; smartglasses; smartphones; solar batteries; bags adapted for laptops; television apparatus; telephone apparatus; transistors (electronic); tripods for cameras; downloadable music files; USB flash drives; cameras (photography); sleeves for laptops.

28 – Games, toys and playthings; video game apparatus; video game machines; drones (toys); remote-controlled toy vehicles; building games; board games; portable games with liquid crystal displays; apparatus for games; slot machines (gaming machines).

35 – Administrative processing of purchase orders; auctioneering; web indexing for commercial or advertising purposes; demonstration of goods; compilation of information into computer databases; computerized file management; marketing; provision of an on-line marketplace for buyers and sellers of goods and services; writing of publicity texts; updating and maintenance of data in computer databases;

web site traffic optimisation; organization of exhibitions for commercial or advertising purposes; organization of trade fairs for commercial or advertising purposes; shop window dressing; procurement services for others (purchasing goods and services for other businesses); data search in computer files for others; presentation of goods on communication media, for retail purposes; direct mail advertising; radio advertising; advertising; pay per click advertising; outdoor advertising; bill-posting; advertising by mail order; on-line advertising on a computer network; design of advertising materials; the bringing together, for the benefit of others, of a variety of goods such as steering apparatus automatic for vehicles, accumulators electric, remote control apparatus, data processing apparatus, Global Positioning System (GPS) apparatus, audio- and video-receivers, audio-visual teaching apparatus, audio interfaces, batteries electric, cordless telephones, computer memory devices, connected bracelets (measuring instruments), measuring instruments, measures, high-frequency apparatus, video screens, camcorders, video baby monitors, video telephones, hands-free kits for telephones, virtual reality headsets, dictating machines, disk drives for computers, telerupters, transparencies (photography), screens (photography), electro-dynamic apparatus for the remote control of signals, electronic publications downloadable, electronic pocket translators, electronic tags for goods, encoded identification bracelets magnetic, electronic agendas, battery chargers, sound alarms, sound recording carriers, sound recording apparatus, sound transmitting apparatus, connections, electric, buzzers, readers (data processing equipment), bar code readers, interfaces for computers, cables electric, integrated circuit cards (smart cards), cinematographic cameras, computers, computer hardware, computer game software downloadable, computer software recorded, joysticks for use with computers other than for video games, computer keyboards, computer peripheral devices, printers for use with computers, magnetic tape units for computers, computer programs downloadable, computer programs recorded, computer operating programs recorded, counters, magnetic data media, videotapes, materials for electricity mains (wires, cables), portable media players, mouse (computer peripheral), microprocessors, mobile telephones, cell phones, monitors (computer hardware), monitors (computer programs), notebook computers, limiters (electricity), eyeglasses, optical data media, selfie sticks (hand-held monopods), transmitters of electronic signals, switchboxes (electricity), amplifiers, tablet computers, DVD players, computer software applications downloadable, weighing apparatus and instruments, video recorders, electronic book readers, record players, theft prevention installations electric, central processing units (processors), control panels (electricity), radio pagers, downloadable ring tones for mobile phones, life saving apparatus

and equipment, subwoofers, light-emitting diodes (LED), alarms, scanners (data processing equipment), smartwatches, smart rings, smartglasses, smartphones, solar batteries, bags adapted for laptops, television apparatus, telephone apparatus, transistors (electronic), tripods for cameras, downloadable music files, USB flash drives, cameras (photography), sleeves for laptops, games, toys and playthings, video game apparatus, video game machines, drones (toys), remote-controlled toy vehicles, building games, board games, portable games with liquid crystal displays, apparatus for games, slot machines (gaming machines) (excluding the transportation thereof), enabling customers to conveniently view and purchase those goods; systemization of information into computer databases; sales promotion for others; production of teleshopping programs; production of advertising films; television advertising; telemarketing services.

36 – Actuarial services; financial analysis; banking; brokerage; repair costs evaluation (financial appraisal); issuance of credit cards; investment of funds; online banking; trusteeship; fiduciary; debt advisory services; electronic funds transfer; providing financial information via a web site; deposits of valuables; charitable fund raising; rent collection; capital investment; insurance consultancy; pawnbrokerage; providing rebates at participating establishments of others through use of a membership card; loans (financing); instalment loans; exchanging money; processing of debit card payments; processing of credit card payments; rental of real estate; rental of offices (real estate); rental of offices for co-working; real estate appraisal; fiscal valuation; jewellery appraisal; lending against security; real estate agency services; financing services; provident fund services; insurance information; insurance underwriting; factoring; financial information; financial management; financial management of reimbursement payments for others; financial consultancy; financial appraisals in responding to requests for proposals (RFPs); financial appraisals in responding to calls for tenders; financial evaluation (insurance, banking, real estate); financial sponsorship; financial research; financial customs brokerage services; hire-purchase financing; lease-purchase financing; business liquidation services, financial.

41 – Providing on-line videos, not downloadable; providing on-line electronic publications, not downloadable; providing on-line music, not downloadable; providing television programs, not downloadable, via video-on-demand services; providing films, not downloadable, via video-on-demand services; game services provided on-line from a computer network; toy rental; games equipment rental; on-line publication of electronic books and journals; entertainment services; production of radio and television programs; film production, other than advertising films.

42 – Computer system analysis; recovery of computer data; off-site data backup; duplication of computer programs; electronic data storage; providing information on computer technology and programming via a web site; providing search engines for the Internet; installation of computer software; computer programming; conversion of data or documents from physical to electronic media; conversion of computer programs and data, other than physical conversion; computer technology consultancy; computer software consultancy; computer security consultancy; consultancy in the design and development of computer hardware; information technology (IT) consultancy; web site design consultancy; monitoring of computer systems for detecting unauthorized access or data breach; monitoring of computer systems to detect breakdowns; monitoring of computer systems by remote access; maintenance of computer software; updating of computer software; data encryption services; computer virus protection services; software as a service (SaaS); computer software design; rental of web servers; computer rental; rental of computer software; unlocking of mobile phones; hosting computer sites (web sites); computer system design; creating and maintaining web sites for others; creating and designing website-based indexes of information for others (information technology services); technological consultancy; cloud computing; server hosting.

---

(260) AM 2020 106486 A

(800) 1507606

(151) 2019 07 29

(891) 2019 07 29

(731) Apple Inc.

One Apple Park Way; Cupertino CA 95014,  
USA

(540)

## APPLE NEWS+

(591) Black, white

(511)

35 – Retail store services in the field of books, magazines, periodicals, newsletters, journals and other publications on a wide range of topics of general interest, provided via the Internet and other computer, electronic and communications networks; subscription services, namely, providing subscriptions to text, data, image, audio, video, and multimedia content, provided via the Internet and other electronic and communications networks; online retail store services featuring downloadable pre-recorded text, data, image, audio, video, and multimedia content for a fee or pre-paid subscription, via the Internet and other electronic and communications networks.

(260) AM 2020 106493 A

(800) 964285

(151) 2007 10 19

(891) 2019 12 11

(731) SmithKline Beecham Limited

980 Great West Road, Brentford, Middlesex  
TW8 9GS, United Kingdom

(540)

## GLAXOSMITHKLINE

(591) Black, white

(511)

3 – Shampoos for the scalp and hair; non-medicated skincare and cleansing preparations; skin creams, skin lotions, soaps, cold cream; skin preparations; dentifrices and mouthwashes.

5 – Pharmaceutical and medicinal preparations and substances; vaccines.

10 – Surgical, medical and veterinary apparatus and instruments.

21 – Toothbrushes, electric toothbrushes, floss for dental purposes, toothpicks, toothpick holders (not of precious metal) and plastic containers for holding toothbrushes.

42 – Scientific and industrial research.

---

(260) AM 2020 106501 A

(800) 1353561

(151) 2017 03 29

(891) 2019 12 17

(731) Kushvara Oleh Mykhailovych

vul. Oleny Telihy, 35. kv. 146, m., Kyiv  
04086, Ukraine

(540)

# S

## CLASS

(591) Black, white

(531) 27.05.10; 27.05.21

(511)

32 – Beer; mineral and aerated waters and other non-alcoholic beverages; fruit drinks and fruit juices; syrups and other preparations for making beverages.

33 – Alcoholic beverages, except beer.

---

(260) AM 2020 106502 A

(800) 1385571

(151) 2017 09 27

(891) 2019 11 14

(731) KIRIN HOLDINGS KABUSHIKI KAISHA  
(also trading as Kirin Holdings Company,  
Limited)  
10-2, Nakano 4-Chome, Nakano-Ku, Tokyo  
164-0001, Japan

(540)



(591) Black, orange and yellow orange

(531) 01.15.15; 28.03; 29.01.12

(511)

32 – Beer; black beer [roasted malt beer]; stout; lager beer; ale; low malt beer; non-alcoholic beer flavored beverages; isotonic beverages; soft drinks for energy supply; non-alcoholic carbonated beverages; guarana drinks; cola drinks; soda pops; Ramune [Japanese soda pops]; ginger ale; lemon squash; aerated water; carbonated mineral water; mineral water [beverages]; drinking water; fruit flavored water; lemonades; carbonated drink mixes; concentrated soft drinks; soft drinks flavored with tea with milk; soft drinks [refreshing beverages]; non-alcoholic beer; non-alcoholic cocktails; fruit juices; concentrated fruit juices; vegetable juices [beverages]; non-alcoholic fruit extracts; powders used in the preparation of fruit-based beverages; powders for effervescing beverages; preparations for making aerated water; extracts of hops for making beer; malt wort; whey beverages; preparations for making liqueurs; syrups for beverages; preparations for making beverages; essences for making beverages.

33 – Alcoholic beverages, except beer; sake; Japanese sweet rice-based mixed liquor [Shiro-zake]; Japanese white liquor [Shochu]; distilled rice spirits [Awamori]; Naoshi [Japanese liquor]; Japanese Shochu-based mixed liquor [Mirin]; sake substitute; western liquors; alcoholic fruit beverages; Japanese Shochu-based beverages [Chuhai]; beer flavored liqueurs made with malt, barley or wheat; beer flavored alcoholic beverages, not made with malt, barley or wheat; spirits; gin; vodka; rum; spirits protected by the appellation of origin "Tequila"; whisky; brandy; brandy protected by the appellation of origin "Cognac"; wines; fortified wines; cooking wines; liqueurs; cocktails; curacao; kirsch; sparkling wines; cider; Chinese liquors; Laojiou [Chinese brewed alcoholic beverages]; Chinese rice wine [Shaoxing rice wine]; flavored tonic liquors; liquor flavored with Japanese plum extracts; distilled beverages.

43 – Providing temporary accommodation with hot-spring facilities; providing temporary accommoda-

tion; accommodation bureau services [brokering reservations for hotels, boarding houses]; providing information relating to menus, recipes or foodstuffs of foods and beverages; carry-out restaurants and providing information relating thereto; restaurants featuring home delivery and providing information relating thereto; preparation and provision of food and drink for immediate consumption and providing information relating thereto; food stall services and providing information relating thereto; providing foods and beverages at event sites and providing information relating thereto; providing information relating to popularity ranking of restaurants; providing information relating to status of booking of restaurants; providing information relating to places for providing foods and beverages via communications by computer terminals; providing information relating to places for providing foods and beverages; providing boxed lunch and providing information relating thereto; providing foods and beverages; rental of event sites and providing information relating thereto; providing assembly halls and providing information relating thereto; rental of conference rooms; rental of facilities for exhibitions; rental of drinking water dispensers; rental of beverage dispensers, electric, for household purposes and beverage dispensers for commercial use; rental of alcoholic beverage dispensers, electric, for household purposes and alcoholic beverage dispensers for commercial use; rental of beer dispensers, electric, for household purposes and beer dispensers for commercial use; rental of beverage dispensers, non-electric, for household purposes; rental of alcoholic beverage dispensers, non-electric, for household purposes; rental of beer dispensers, non-electric, for household purposes; rental of electric hot plates for household purposes; rental of electric toasters for household purposes; rental of microwave ovens for household purposes; rental of cooking equipment for industrial purposes; rental of kitchen worktops with integrated sinks for commercial use; rental of non-electric cooking heaters for household purposes; rental of kitchen worktops with integrated sinks for household purposes; rental of dishes.

(260) AM 2020 106503 A

(800) 1415314

(151) 2018 04 04

(891) 2019 12 12

(731) Dr. Kurt Wolff GmbH & Co. KG

Johanneswerkstraße 34- 36, 33611, Germany

(540)

## HYBRID

(591) Black, white

(511)

3 – Toiletries; body cleaning and beauty care preparations; hair preparations and treatments; hair cos-

metics; shampoo; hair dyes; hair lotions; hair tonic; preparations for the protection of the hair from the sun; preparations for protecting the scalp from the sun.

5 – Medical and veterinary preparations; dietetic preparations and dietary supplements; pharmaceuticals and natural remedies; medicated hair care preparations; capillary lotions (medicated-); medicated hair lotions; medicinal hair growth preparations.

(260) AM 2020 106504 A

(800) 1434583

(151) 2018 08 10

(891) 2019 08 09

(731) BARAN TEKSTİL TAŞIMACILIK GIDA  
TİCARET LIMITED ŞİRKETİ  
Meşrutiyet Mah., Nakiye Ergun Sok. No:4/A,  
Şişli, İstanbul, Turkey

(540)

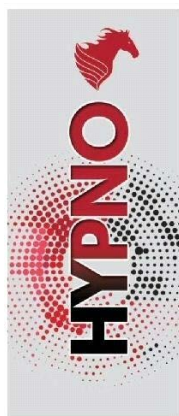

(591) Red and black

(531) 04.03.05; 25.07.07; 26.01.03; 26.04.05;  
26.04.15; 26.04.16; 26.04.18; 27.05.01;  
27.05.02; 29.01.13

(511)

32 – Beers; preparations for making beer; mineral water, spring water, table water, soda water; fruit and vegetable juices, fruit and vegetable concentrates and extracts for making beverages, non-alcoholic soft drinks; energy drinks.

(260) AM 2020 106505 A

(800) 1493601

(151) 2019 09 25

(891) 2019 12 10

(731) Nicoventures Holdings Limited  
Globe House, 1 Water Street, London  
WC2R 3LA, United Kingdom

(540)

vype

(591) Black, white

(531) 27.05.01

(511)

34 – Electronic cigarettes; cartridges for electronic cigarettes; liquids for electronic cigarettes; cigarettes containing tobacco substitutes; tobacco substitutes; cigarettes; tobacco; tobacco products; cigarette cases; cigarette boxes.

(260) AM 2020 106506 A

(800) 1494251

(151) 2019 07 17

(891) 2019 12 12

(731) FRAL S.R.L.

Via dell'Industria e dell'Artigianato, 22/C,  
I-35010 Carmignano di Brenta (PD), Italy

(540)



(591) Black, white

(531) 26.01.24; 26.03.23; 26.04.01; 26.04.05;  
26.04.12; 27.05.01

(511)

11 – Dehumidifiers; industrial dehumidifiers; electric dehumidifiers; air dehumidifiers; installations for dehumidifying; dehumidifiers for household use; ventilating fans; ventilating apparatus and installations; air-conditioning installations; air-conditioning apparatus.

(260) AM 2020 106507 A

(800) 1495159

(151) 2019 09 11

(891) 2019 12 12

(731) F. Hoffmann-La Roche AG

Grenzacherstrasse 124, CH-4070 Basel,  
Switzerland

(540)

SUSVIMO

(591) Black, white

(511)

5 – Drug delivery agents.

10 – Implantable devices for medicated substance delivery.

(260) AM 2020 106535 A

(800) 1507797

(151) 2019 11 15

(891) 2019 11 15

(731) BIOFARMA

50 rue Carnot, F-92284 SURESNES Cedex,  
France

(540)

**ДЕТРАЛЬФАТ**

(591) Black, white

(531) 28.05

(511)

5 – Pharmaceutical products; medical preparations; veterinary preparations; sanitary products for medical purposes; dietetic substances and foodstuffs for medical or veterinary use, food for babies; food supplements for humans and animals; plasters, materials for dressings; material for dental fillings and dental impressions; disinfectants; products for destroying vermin; fungicides, herbicides.

(260) AM 2020 106565 A

(800) 1508523

(151) 2019 09 14

(891) 2019 09 14

(731) YAZD TIRE RUBBER INDUSTRIES

COMPLEX Co.

1st Floor, No.113, Khorramshahr Street,  
Mohammadreza Eshghbaz Avenue, Nilofar,  
Shahid Ghandi, 1533856111 Tehran,  
Islamic Republic of Iran

(540)



(591) Yellow and black.

(531) 26.01.18; 27.05.02; 28.01; 29.01.12

(526) Yazd Tire, Yazd Rubber Industries Complex, Mojtaba Sanaye Lastik Yazd, Yazd tire mojtaba sanayelastik yazd tire yazd Ruldoer indu stries Complex

(511)

12 – Tires; motorcycle tires; bicycle tires; truck tires; automobile tires; lorry tires; wheelbarrows tires; inner tubes for vehicle tires; inner tubes for automobile tires; inner tubes for bicycle tires; inner tubes for motorcycle tires.

17 – Latex (rubber).

(260) AM 2020 106566 A

(800) 1508524

(151) 2019 11 11

(891) 2019 11 11

(731) Riedel Communications International GmbH

Uellendahler Str. 353, 42109 Wuppertal,  
Germany

(540)

**Tools4Pros.**

(591) Black, white

(511)

9 – Studio technology apparatus, namely apparatus for recording and playing and storing audio data; software, in particular software in the form of application software for mobile terminals; telecommunications equipment, in particular network components of a network for transmitting sound, images and/or information, signalling and inspecting apparatus and instruments, apparatus for recording, transmitting or reproducing sound or images; data processing equipment and computers, network data processing equipment and network computers, all for use in audio, video and telecommunications networks; audio, video and/or telecommunications networks and components therefor.

(260) AM 2020 106567 A

(800) 1508533

(151) 2019 12 03

(891) 2019 12 03

(731) Apple Inc.

One Apple Park Way, Cupertino CA 95014,  
USA

(540)



(591) The color(s) blue and black is/are claimed as a feature of the mark

(531) 03.07.16; 03.07.24; 26.04.04; 26.04.15;  
29.01.12

(511)

9 – Downloadable computer software for building user interfaces in software applications; downloadable computer software for application development; downloadable computer software used in developing other software applications.

(260) AM 2020 106568 A

(800) 1508555

(151) 2019 10 14

(891) 2019 10 14

(731) REHAU AG + Co

Rheniumhaus, Otto-Hahn-Strasse 2, 95111  
Rehau, Germany

(540)



(591) Black, white

(531) 26.03.06; 26.03.24; 27.05.24

(511)

17 – Wool (mineral -) [insulator]; compositions to prevent the radiation of heat; boiler composition to prevent the radiation of heat; paper for electrical capacitors; padding materials of rubber or plastics; packing [cushioning, stuffing] materials of rubber or plastics; mica, raw or partly processed; gum, raw or semi-worked; rubber, raw or semi-worked; fittings, not of metal, for rigid pipes; pipe jackets, not of metal; soundproofing materials; wool (slag -) [insulator]; hoses of textile material; flexible pipes, not of metal; threads of plastic for soldering; barriers (floating anti-pollution -); self-adhesive tapes, other than stationery and not for medical or household purposes; asbestos safety curtains; synthetic rubber; acrylic resins [semi-finished products]; synthetic resins [semi-finished products]; semi-processed plastics; cellulose acetate, semi-processed; door stops of rubber; washers of rubber or vulcanized fiber [fibre]; valves of india-rubber or vulcanized fiber [fibre]; connecting hoses for vehicle radiators; fittings, not of metal, for flexible pipes; bags [envelopes, pouches] of rubber, for packaging; viscose sheets, other than for wrapping; vulcanized fiber [fibre]; non-conducting materials for retaining heat; waterproof packings; cylinder jointings; rubber, raw or semi-worked; mica, raw or partly processed; gum, raw or semi-worked; unprocessed and semi-processed gutta-percha; unprocessed and semi-processed asbestos; substitutes for unprocessed and semi-processed rubber; substitutes for unprocessed and semi-processed gutta-percha; substitutes for unprocessed and semi-processed asbestos; substitutes for unprocessed and semi-processed mica; plastics in extruded form for use in manufacture; packing materials; stopping materials; threads of plastic for soldering; impact protection of rubber for docks; junctions, not of metal, for flexible pipes; compressed air pipe fittings, not of metal; asbestos; asbestos fibers [fibres]; asbestos felt; asbestos packing; asbestos fabrics; asbestos paper; asbestos millboards; slate asbestos; asbestos cloth; asbestos sheets; asbestos coverings; balata; bark coverings for sound insulation; cotton wool for packing [caulking]; flower arrangements (foam supports for -) [semi-finished products]; leaks

(chemical compositions for repairing -); joint packings; expansion joint fillers; duct tapes; weathers-tripping compositions; sealing rings; draught excluder strips; dielectrics [insulators]; elastic yarns, not for use in textiles; window stops of rubber; insulating buildings against moisture (substances for -); insulating refractory materials; filtering materials of semi-processed plastic foam; filtration materials of semi-processed films of plastic; liquid rubber; foil of regenerated cellulose, other than for packing; molds (ebonite -); sealants for joints; garden hoses; anti-dazzle films for windows [tinted films]; fibreglass fabrics for insulation; fibreglass for insulation; glass wool for insulation; tyres (rubber material for recapping -); rubber seals for jars; threads of rubber, not for use in textiles; clack valves of rubber; rubber solutions; sleeves of rubber for protecting parts of machines; stops of rubber; shock-absorbing buffers of rubber; rings of rubber; cords of rubber; rubber stoppers; gutta-percha; brake lining materials, partly processed; ebonite [vulcanite]; insulators for electric mains; railway tracks (insulators for -); insulators; insulating paints; insulating tapes; insulating felt; insulating varnish; insulation (metal foil for -); insulating fabrics; insulating gloves; insulating materials; cables (insulators for -); transformers (insulating oil for -); insulating oils; insulating paper; insulating plaster; lute; adhesive bands, other than stationery and not for medical or household purposes; carbon fibers [fibres], other than for textile use; plastic fibers [fibres], not for textile use; plastic filaments for 3d printers; plastic sheeting for agricultural purposes; caulking materials; plastic film, not for wrapping; threads of plastic materials, not for textile use; clutch linings; rubber; canvas hose pipes; reinforcing materials, not of metal, for pipes; pipe gaskets.

19 – Materials, not of metal, for building and construction; non-metallic rigid pipes for building; non-metallic transportable buildings; monuments, not of metal; gutter pipes, not of metal; bicycle parking installations, not of metal; branching pipes, not of metal; shutters, not of metal; non-metal window frames; prefabricated houses [kits]; refractory construction materials, not of metal; fire burrs; fireproof cement coatings; figurines of stone, concrete or marble; bagasses of cane (agglomerated -) [building material]; veneer wood; floors, not of metal; plaster; memorial plaques, not of metal; perches; timber mouldings; geotextiles; armored doors, not of metal; scaffolding, not of metal; framework for building, not of metal; non-metal cornices; horticultural frames, not of metal; foundry molds [moulds], not of metal; gypsum [building material]; latticework, not of metal; glass granules for road marking; tombs [monuments], not of metal; grave or tomb enclosures, not of metal; tombs, not of metal; burial vaults, not of metal; grave slabs, not of metal; gra-

vestones; tombstone stelaes, not of metal; tombstone plaques, not of metal; granite; rubber bearings for seismic isolation of buildings; folding doors, not of metal; blast furnaces (cement for -); wood for making household utensils; planks [wood for building]; xylolith; veneers; floor boards [of wood]; furrings of wood; wood pulp board for building; wood paving; wood panelling; chicken-houses, not of metal; insect screens, not of metal; insulating glass [building]; jalousies, not of metal; wall tiles, not of metal, for building; lime; calcareous marl; calcareous stone; chimney pots, not of metal; chimney cowls, not of metal; fireplace mantles, not of metal; plate glass [windows] for building; flashing, not of metal, for building; angle irons, not of metal; roof flashing, not of metal; gravel; silica [quartz]; stained-glass windows; drain traps (valves), not of metal or plastic; water-pipe valves, not of metal or plastic; floating docks, not of metal, for mooring boats; swing doors, not of metal; caissons for construction work under water; signs, not of metal (non-luminous and non-mechanical -); signalling panels, non-luminous and non-mechanical, not of metal; silver sand; silos, not of metal; hips for roofing; plywood; diving boards, not of metal; sheet piles, not of metal; stables, not of metal; statues of stone, concrete or marble; stone; coal tar; stonemasonry (works of -); street gutters, not of metal; road repair (binding material for -); roads (materials for making and coating -); signs, non-luminous and non-mechanical, not of metal, for roads; road coating materials; road marking sheets and strips of synthetic material; poles, not of metal, for power lines; props, not of metal; non-metal wainscoting; tanks of masonry; tar; tarred strips for building; wood, semi-worked; telephone booths, not of metal; telegraph posts, not of metal; terra cotta [building material]; clay; slate; potters' clay; non-metal gates; non-metal beams; non-metallic transportable buildings; greenhouses, transportable, not of metal; partitions, not of metal; staircases, not of metal; stair-treads [steps], not of metal; stringers [parts of staircases], not of metal; tufa; non-metal doors; door panels, not of metal; door casings, not of metal; linings, not of metal, for building; lengthening pieces, not of metal, for chimneys; vinyl siding; bird baths [structures, not of metal]; aviaries, not of metal (structure); aviaries, not of metal [structures]; platforms, prefabricated, not of metal; chimneys, not of metal; wall tiles, not of metal; wall linings, not of metal, for building; water-pipes, not of metal; fences, not of metal; cement; earth for bricks; bricks; earth for bricks; alabaster glass; mooring bollards, not of metal; aquaria [structures]; aquarium gravel; aquarium sand; reinforcing materials, not of metal, for building; asbestos mortar; asbestos cement; asphalt; asphalt paving; outdoor blinds, not of metal and not of textile; cladding, not of metal, for building; cabanas, not of metal; beacons, not of metal, non-luminous; girders, not of metal; balustrades, not

of metal; huts; felt for building; building glass; wood for building; building materials (non-metallic); building panels, not of metal; building stone; buildings, not of metal; plastic landscape edgings; tanks of masonry; rock crystal; concrete; concrete building elements; shuttering, not of metal, for concrete; binding agents for making stones; bitumen; bituminous products for building; building cardboard [asphalted]; bituminous coatings for roofing; tile floorings, not of metal; floor tiles, not of metal; letter boxes of masonry; rubble; busts of stone, concrete or marble; non-metal roof coverings; non-metal roofing; roofing, not of metal, incorporating solar cells; pantiles; gutters (roof -), not of metal; scantlings [carpentry]; roofing slates; roofing shingles; non-metal roofing tiles; mooring bollards, not of metal; stave wood; safety glass; drain pipes, not of metal; turnstiles, not of metal; penstock pipes, not of metal; brackets, not of metal, for building; alabaster; railway sleepers, not of metal; enamelled glass, for building; flagpoles, not of metal; folding doors, not of metal; paint spraying booths, not of metal; lintels, not of metal; non-metal windows; window glass, for building; window glass, except glass for vehicle windows; joists, not of metal; skating rinks [structures, not of metal]; works of art of stone, concrete or marble; artificial stone; laths, not of metal; arbours [structures not of metal]; floorboards; crash barriers, not of metal, for roads; ducts, not of metal, for ventilating and air-conditioning installations; luminous paving blocks; magnesia cement; macadam; porches, not of metal, for building; fair huts; marble; masts [poles], not of metal; wall claddings, not of metal, for building; mortar for building; mosaics for building; casement windows, not of metal; furnaces (cement for -); olivine for building; armour-plating, not of metal; building paper; building cardboard; parquet flooring; parquet floor boards; pitch; piles (non-metallic -); palisading, not of metal; paving slabs, not of metal; paving blocks made of non-metallic materials; cement posts; non-metal posts; advertisement columns, not of metal; cement slabs; slabs, not of metal, for building; porphyry [stone]; mouldable wood; agglomerated cork for building; moldings, not of metal, for building; coatings [building materials]; quartz; rocket launching platforms, not of metal; mouldings, not of metal, for cornices; chalk (raw -); sandstone tubes; rigid pipes, not of metal [building]; sand, except foundry sand; sandstone for building; pillars, not of metal, for building; manhole covers, not of metal; fireclay; schists; slate powder; reeds for building; slag [building material]; clinker stone; sawn timber; chimney cowls, not of metal; chimney pots, not of metal; lengthening pieces, not of metal, for chimneys; clinker ballast; pigsties, not of metal; sills, not of metal; swimming pools [structures, not of metal]; ceilings, not of metal; pitch, tar, bitumen and asphalt.



(260) AM 2020 106580 A  
 (800) 1332548  
 (151) 2016 06 10  
 (891) 2019 12 13  
 (731) KIA MOTORS CORPORATION  
 12, Heolleung-ro, Seocho-gu, Seoul,  
 Republic of Korea  
 (540)



(591) Black, white  
 (531) 26.01.18; 27.05.01; 29.01.12  
 (511)  
 4 – Engine oils; industrial grease; lubricating grease;  
 fuel oil; industrial oil; lubricating oils; motor oil.

7 – Air compressors; balance shafts for engines;  
 belts for engines; belts for machines; belts for motors;  
 power transmission belts for machines; timing  
 belts for engines; timing belts for machines; timing  
 belts for motors; fan belts for engines and motors;  
 timing belts for land vehicle engines; power operated  
 blowers; bellows [parts of machines]; machine  
 tools; tools (parts of machines); camshafts; canisters  
 for automobile engines; carburetors; catalytic converters;  
 injectors for engines; fuel injection devices  
 for internal combustion engines; compressors as  
 parts of machines, motors and engines; connecting  
 rods for engines and motors; pumps for cooling  
 engines; control mechanisms for machines, engines  
 or motors; fans for engines and motors; crankshafts;  
 automotive engine blocks; cylinder heads for engines;  
 cover for cylinder head and rocker for engines  
 and motors; cylinder liner (parts of engines); distributors  
 for vehicle engines; distributor caps for vehicle  
 engines; exhaust gas recirculation [EGR] coolers  
 for motors and engines; exhaust gas recirculation  
 [EGR] valves for motors and engines; engine mounting  
 insulator for motors and engines; exhaust pipes  
 for land vehicle engines; exhaust valves for land vehicle  
 engines; machine flywheels; fuel filters (parts  
 of engines); fuel filters (parts of machines); fuel injection  
 pumps for engines; fuel injectors for internal  
 combustion engines; fuel pumps for land vehicle  
 engines; pulleys [parts of machines]; pumps [machines];  
 glow plugs for diesel engines; idler being parts  
 of machines; idler pulleys being parts of machines;  
 ignition coils [parts of engines]; ignition coil harness  
 [parts of engines]; injection nozzle and holder [parts  
 of engines]; intake valve for engines and motors; inter  
 coolers for engines and motors; LPG pump drivers  
 for engines and motors; intake manifolds for  
 internal combustion engines; exhaust manifold for  
 engines; intake manifolds for engines; intake mani-

folds for motors; gas mixing machines; fuel mixer  
 (parts of engines); muffler pipes for motors and engines;  
 oil pumps for land vehicle engines; positive  
 crankcase ventilation [PCV] valves for motors and  
 engines; pistons [parts of machines or engines]; piston  
 rings; radiators [cooling] for motors and engines;  
 radiator shroud for motors and engines; rocker arms  
 for engines; rocker arm for motors; rocker arm lash  
 adjusters for motors and engines; sparking plugs for  
 internal combustion engines; sparking plug cables  
 for internal combustion engines; starters for motors  
 and engines; tensioners for machines, motors and  
 engines; throttle bodies for engines and motors; timing  
 belts for motors and engines; timing belt covers  
 for motors and engines; transmission mounting  
 insulator for motors and engines; turbochargers for  
 machines; valves [parts of machines]; vaporizers for  
 motors and engines; water separators; linear actuators;  
 hydraulic valve actuators; pneumatic valve actuators;  
 air cleaners [parts of engines]; air-cooled  
 condensers; air filters for automobile engines; forging  
 moulds for automobiles; regulators [parts of  
 machines]; metal engine gaskets for vehicles; gaskets,  
 not of metal, for vehicle engines; oil coolers for  
 engines and motors; oil filters for engines and motors;  
 motors for air conditioner blowers; motors for  
 gas condenser (other than parts of machines) cooling  
 fans; pulleys for compressors for automobiles air  
 conditioners; air intake surge tanks for automobile  
 engines; air tanks for automobile engines; oil pans  
 for automobiles; engine oil pan for automobiles; air  
 filter cartridges for land vehicle engines; oil filter  
 cartridges for land vehicle engines; generators for  
 automobiles; generator rectifier for automobiles; generator  
 rotors for automobiles; generator stator for  
 automobiles; engine gaskets for automobiles.

9 – Sensors [measurement apparatus], other than for  
 medical use; antennas; armatures [electricity]; anti-  
 theft warning apparatus; audio equipment; batteries;  
 battery cables; battery boxes; battery plates; electronic  
 control systems for machines; cameras; steering  
 apparatus, automatic, for vehicles; electrical controllers;  
 electronic process control units; fuel gauges;  
 temperature gauges; fuses; junction boxes [electricity];  
 navigational instruments; relays, electric; resonators;  
 speakers; speedometers; speedometer cables;  
 switches, electric; tachometers; thermostats; thermostat  
 cases; thermostat housing; time clocks; alarms;  
 transmitters [telecommunication]; blinkers [signalling  
 lights]; wires, electric; electronic apparatus for  
 parking information; lighting ballasts; emergency  
 light bars for vehicles; emergency signal transmitters;  
 pulse generators for automobiles.

11 – Fans [parts of air-conditioning installations];  
 filters for air purifiers; air conditioning units; air  
 dryers; hot air blowers; light bulbs; fans for gas  
 condensers, other than parts of machines; covers specially  
 adapted for gas condensers, other than parts of

machines; evaporators; electric heaters; lamps for automobiles; lamp glasses; lamp bulbs; dryers for industrial purposes; radiator caps; air filters for air conditioning units.

(260) AM 2020 106581 A

(800) 1433509

(151) 2018 05 11

(891) 2019 08 19

(731) ASSAN GIDA SANAYİ VE TİCARET

ANONİM ŞİRKETİ

Nispetiye Caddesi, Akmerkez Alışveriş  
Merkezi, B Blok, Kat. 5, Etiler, Beşiktaş,  
İstanbul, Turkey

(540)



The logo for ASSANFOODS features the word 'ASSAN' in red and 'FOODS' in green, with a red and white circular graphic element resembling a stylized 'S' or a drop to the right of the text.

(591) Red, green and white

(531) 01.15.15; 27.05.01; 29.01.13

(526) The Applicant wishes to disclaim protection for item "foods" apart from the trademark.

(511)

29 – Dried, preserved, frozen, cooked, smoked or salted fruits and vegetables; tomato paste; hazelnut spreads and peanut butter; tahini (sesame seed paste).

30 – Condiments for foodstuff, vanilla (flavoring), spices, sauces (condiments), tomato-based sauces, tomato sauce, tomato ketchup.

32 – Fruit and vegetable juices, fruit and vegetable concentrates and extracts for making beverages, tomato juice beverages, non-alcoholic soft drinks.

(260) AM 2020 106583 A

(800) 1463202

(151) 2019 03 04

(891) 2019 12 20

(731) FANG XIANGLI

NO. 59 YAN'AN ROAD, URUMQI,  
XINJIANG, China

(540)



(591) Black, white

(531) 15.07.01; 26.11.08; 27.05.19

(511)

12 – Air pumps [vehicle accessories]; vehicle chassis; gearing for land vehicles; clutches for land vehicles; axles for vehicles; brakes for land vehicles; driving motors for land vehicles; transmission shafts for land vehicles; inner tubes for vehicle tires; transmission chains for land vehicles.

(260) AM 2020 106631 A

(800) 1509272

(151) 2019 10 24

(891) 2019 10 24

(731) Richter Gedeon Nyrt

Gyömrői út 19-21, H-1103 Budapest, Hungary

(540)



The logo for НОЭМЕЛЛЕ consists of the word 'НОЭМЕЛЛЕ' in a bold, black, sans-serif font.

(591) Black, white

(531) 28.05

(511)

5 – Pharmaceutical preparations.

(260) AM 2020 106632 A

(800) 1509278

(151) 2019 12 13

(891) 2019 12 13

(731) HANGZHOU HANTOO ENTERPRISES,  
CO., LTD

Building4, No.9 8th Xiyuan Road, Sandun  
Town, Xihu District, Hangzhou, 310000  
Zhejiang, China

(540)



(591) Black, white

(531) 14.07.09; 25.01.09; 27.03.15

(511)

6 – Props of metal; screws of metal; chains of metal; ironmongery; hardware of metal, small; padlocks; cattle chains; door handles of metal.

7 – Spray guns for paint; centrifugal pumps; machine tools; stands for machines; holding devices for machine tools.

8 – Bits [parts of hand tools]; axes; riveters [hand tools]; wrenches [hand tools]; hunting knives; scissors; hammers [hand tools]; lifting jacks, hand-operated; carpenters' augers; pliers; files [tools]; frames for handsaws; saws [hand tools].

9 – Rulers [measuring instruments]; slide calipers; protective helmets.

(260) AM 2020 106633 A

(800) 1509304

(151) 2019 11 11

(891) 2019 11 11

(731) HUGEL INC.

61-20, Sinbuk-ro, Sinbuk-eup, Chuncheon-si,  
Gangwon-do, Republic of Korea

(540)

## HugelTox

(591) Black, white

(511)

5 – Pharmaceutical preparations for the treatment of spasm; pharmaceutical preparations for treating dystonia; muscle relaxants; pharmaceutical preparations for the treatment of hyperhidrosis; pharmaceutical preparations for animals; pharmaceutical preparations for the treatment of headache; pharmaceutical preparations used in cosmetic surgery; pharmaceutical preparations containing botulinum toxin; botulinum toxin; pharmaceutical preparations containing botulinum toxin for the treatment of wrinkles; pharmaceutical preparations containing botulinum toxin fragments for the treatment of wrinkles; pharmaceutical preparations for use in treating urogenital system diseases and conditions; bacterial toxins; pharmaceutical preparations for digestive system; pharmacological preparations for skin care; pharmaceutical preparations for treating neurological diseases and disorders; ophthalmic preparations; ointments for pharmaceutical purposes; chemical preparations for pharmaceutical purposes; pharmaceutical agents for epidermis; drugs for medical purposes; biological preparations for medical or veterinary purposes; microorganisms for medical purposes; cultures of microorganisms for medical or veterinary use; chemical reagents for medical or veterinary purposes; bacteriological preparations for medical and veterinary use; adjuvants for medical purposes; hyaluronic acid preparations for medical purposes; medicines for human purposes; pharmaceutical preparations for the treatment of psychiatric diseases and disorders; pharmaceutical preparations for use in orthopedics; pharmaceutical preparations; pharmaceutical preparations for the treatment of wrinkles; injectable dermal fillers, namely injectable pharmaceutical products for intradermal use; medicines for dental purposes; pharmaceutical preparations for the treatment of pain; pharmaceutical preparations for use in dermatology; pharmaceutical preparations for treating skin disorders; pharmaceutical preparations mainly based on hyaluronic acid; botulinum toxin for medical use for use in the treatment of excessive sweating, excessive eye blinking, neuropathy pain, facial wrinkles, headache, pain, spasm, dystonia, urogenital system diseases and conditions, skin disorders; therapeutic drugs and agents; pharmaceuticals.

(260) AM 2020 106634 A

(800) 1509348

(151) 2019 07 22

(891) 2019 07 22

(731) Chen Sheng

Rm.1201, Unit 2, Bldg 11, Zone A,  
Oujinghuayuan, Choujiang St., Yiwu,  
Zhejiang, China

(540)

## SIKAI

(591) Black, white

(531) 27.05.01

(511)

35 – Advertising; business intermediary services; personnel management consultancy; sales promotion for others; procurement services for others [purchasing goods and services for other businesses]; providing business information via a website; marketing; providing online marketplaces for buyers and sellers of goods and or services; business management assistance; commercial administration of the licensing of the goods and services of others; secretarial services; accounting.

36 – Lending against security; financial management; financial consultancy; insurance underwriting; loans [financing]; charitable fund raising; surety services; capital investments; real estate agencies; agents (terms too vague in the opinion of the International Bureau – Rule 13 (2) (b) of the Common Regulations).

(260) AM 2020 106635 A

(800) 1509368

(151) 2019 07 19

(891) 2019 07 19

(731) Stastnik Gesellschaft m.b.H.

Erlaaer Str. 187, A-1230 Wien, Austria

(540)

## STASTNIK

(591) Black, white

(511)

5 – Pharmaceutical and veterinary preparations; sanitary preparations for medical purposes; dietetic substances adapted for medical use, food for babies; plasters, materials for dressings; material for stopping teeth, dental wax; disinfectants; preparations for destroying vermin; fungicides, herbicides.

29 – Meat, fish, poultry and game; meat extracts; preserved, dried and cooked fruits and vegetables; jellies, jams, fruit sauces (term considered too vague by the International Bureau – Rule 13 (2) (b) of the Common Regulations); eggs, milk and milk products; edible oils and fats.

30 – Coffee, tea, cocoa, sugar, rice, tapioca, sago, artificial coffee; flour and preparations made from cereals, bread, pastry and confectionery, ices; honey, treacle; yeast, baking-powder; salt, mustard; vinegar, sauces (condiments); spices; ice.

(260) AM 2020 106636 A  
 (800) 1509371  
 (151) 2019 07 10  
 (891) 2019 07 10  
 (731) "OLIS LTD" LIMITED LIABILITY COMPANY  
 vul. Karpenka-Karoho, 47, m. Zaporizhzhia, Zaporizhka obl. 69014, Ukraine

(540)



(591) Yellow, black, gray, green and brown  
 (531) 04.05.21; 05.03.14; 08.07.11; 09.03.05; 26.11.08; 29.01.15

(511)

29 – Beans, preserved; bouillon; peas, preserved; mushrooms, preserved; fruit-based snack food; raisins; caviar; aubergine paste; vegetable marrow paste; fish roe, prepared; compotes; meat, tinned; vegetables, tinned; fish, tinned; fruits, tinned; bouillon concentrates; gherkins; sweet corn, processed; onions, preserved; corn oil for food; sesame oil for food; linseed oil for food; extra virgin olive oil for food; olive oil for food; condensed milk; vegetables, preserved; vegetables, dried; vegetables, cooked; olives, preserved; candied nuts; nuts, prepared; tomato paste; liver pastes; fruits and berries cooked in sugar syrup; cranberry purée; tomato purée; apple purée; fish, preserved; sardines, not live; sunflower seeds, prepared; fat-containing mixtures for bread slices; tomato juice for cooking; vegetable juices for cooking; preparations for making bouillon; preparations for making soup; truffles, preserved; fruit, preserved; fruit preserved in alcohol; fruit, stewed; hazelnuts, prepared; preserved garlic; berries, preserved.

30 – Cereal bars; vanillin [vanilla substitute]; vermicelli [noodles]; mustard; dressings for salad; pasta; capers; curry [spice]; ketchup [sauce]; crackers; corn flour; semolina; oatmeal; crushed barley; groats for human food; corn, milled; corn, roasted; turmeric; couscous [semolina]; noodles; mayonnaise; macar-

ni; piccalilli; marinades; bean meal; potato flour; maize flour; nut flours; groats for human food; wheat flour; soya flour; barley meal; tea beverages; nutmegs; pepper; allspice; peppers [seasonings]; pesto [sauce]; condiments; spices; cake powder; fruit coulis [sauces]; relish [condiment]; rice; instant rice; sugar; sesame seeds [seasonings]; processed seeds for use as a seasoning; aniseed; cooking salt; soya sauce; tomato sauce; sauces [condiments]; pasta sauce; spaghetti; flavourings; rusks; garden herbs, preserved [seasonings]; vinegar; chips [cereal products]; oat flakes; minced garlic [condiment]; chowchow [condiment]; saffron [seasoning].

(260) AM 2020 106638 A  
 (800) 1509403  
 (151) 2019 07 10  
 (891) 2019 07 10  
 (731) "OLIS LTD" LIMITED LIABILITY COMPANY  
 vul. Karpenka-Karoho, 47, m. Zaporizhzhia, Zaporizhka obl. 69014, Ukraine

(540)

**GUSTÓ**  
*at your service*

(591) Black, white

(531) 27.05.01; 27.05.09; 27.05.10

(511)

29 – Beans, preserved; bouillon; peas, preserved; mushrooms, preserved; fruit-based snack food; raisins; caviar; aubergine paste; vegetable marrow paste; fish roe, prepared; compotes; meat, tinned; vegetables, tinned; fish, tinned; fruits, tinned; bouillon concentrates; gherkins; sweet corn, processed; onions, preserved; corn oil for food; sesame oil for food; linseed oil for food; extra virgin olive oil for food; olive oil for food; condensed milk; vegetables, preserved; vegetables, dried; vegetables, cooked; olives, preserved; candied nuts; nuts, prepared; tomato paste; liver pastes; fruits and berries cooked in sugar syrup; cranberry purée; tomato purée; apple puree; fish, preserved; sardines, not live; sunflower seeds, prepared; fat-containing mixtures for bread slices; tomato juice for cooking; vegetable juices for cooking; preparations for making bouillon; preparations for making soup; truffles, preserved; fruit, preserved; fruit preserved in alcohol; fruit, stewed; hazelnuts, prepared; preserved garlic; berries, preserved.

30 – Cereal bars; vanillin [vanilla substitute]; vermicelli [noodles]; mustard; dressings for salad; pasta; capers; curry [spice]; ketchup [sauce]; crackers; corn

flour; semolina; oatmeal; crushed barley; groats for human food; corn, milled; corn, roasted; turmeric; couscous [semolina]; noodles; mayonnaise; macaroni; piccalilli; marinades; bean meal; potato flour; maize flour; nut flours; groats for human food; wheat flour; soya flour; barley meal; tea beverages; nutmegs; pepper; allspice; peppers [seasonings]; pesto [sauce]; condiments; spices; cake powder; fruit coulis [sauces]; relish [condiment]; rice; instant rice; sugar; sesame seeds [seasonings]; processed seeds for use as a seasoning; aniseed; cooking salt; soya sauce; tomato sauce; sauces [condiments]; pasta sauce; spaghetti; flavourings; rusks; garden herbs, preserved [seasonings]; vinegar; chips [cereal products]; oat flakes; minced garlic [condiment]; chowchow [condiment]; saffron [seasoning].

(260) AM 2020 106639 A

(800) 471656

(151) 1982 08 27

(891) 2019 12 05

(731) HEINEKEN ITALIA SPA

Località Autoporto, 11, POLLEIN (Aosta), Italy

(540)

**BIRRA MORETTI**

(591) Black, white

(531) 27.05.01

(511)

32 – Beer, ale and porter; mineral and aerated waters and other non-alcoholic beverages, syrups and other preparations for making beverages.

(260) AM 2020 106704 A

(800) 1509806

(151) 2019 11 26

(891) 2019 11 26

(731) Richter Gedeon Nyrt.

Gyömrői út 19-21, H-1103 Budapest, Hungary

(540)

**KLANDOLYN**

(591) Black, white

(511)

5 – Pharmaceutical preparations.

(260) AM 2020 106729 A

(800) 1510221

(151) 2019 11 13

(891) 2019 11 13

(731) Chernyshova Yuliia Serhiivna

Bulvar Tarasa Shevchenka, bud. 11 B, kv. 42, m. Kyiv 01004, Ukraine

(540)

**SPECIAL AROMA KAVA**

(591) Black, white

(531) 26.01.01; 26.01.19; 27.05.09; 27.05.10; 27.05.17

(511)

30 – Agave syrup [natural sweetener]; allspice; almond confectionery; almond paste; aniseed; aromatic preparations for food; artificial coffee; bread; bread rolls; cake dough; cake frosting [icing]; cake powder; cakes; candy; caramels [candy]; cereal-based snack food; cereal bars; cereal preparations; cheeseburgers [sandwiches]; chicory [coffee substitute]; chocolate; chocolate-based beverages; chocolate-based spreads; chocolate-coated nuts; chocolate beverages with milk; chocolate mousses; chocolate spreads containing nuts; cinnamon [spice]; cloves [spice]; cocoa; cocoa-based beverages; cocoa beverages with milk; coffee; coffee-based beverages; coffee beverages with milk; coffee flavourings; sugar confectionery; cookies; crushed barley; crushed oats; custard; dessert mousses [confectionery]; dough; flavourings, other than essential oils, for beverages; flour; flowers or leaves for use as tea substitutes; fondants [confectionery]; food flavorings, other than essential oils; frozen yoghurt [confectionery ices]; fruit jellies [confectionery]; garden herbs, preserved [seasonings]; gingerbread; ginger [spice]; golden syrup; honey; ice, natural or artificial; ice cream; ice cubes; iced tea; ice for refreshment; macaroons [pastry]; malt biscuits; natural sweeteners; pastries; pastry dough; peanut confectionery; petit-beurre biscuits; petits fours [cakes]; pies; pralines; puddings; pâtés en croûte; quiches; sandwiches; sorbets [ices]; soya flour; sugar; tarts; tea; tea-based beverages; unroasted coffee; vanilla flavourings for culinary purposes; vanillin [vanilla substitute]; vegetal preparations for use as coffee substitutes; waffles; zefir [confectionery].

43 – Bar services; cafeteria services; café services; canteen services; food and drink catering; food sculpting; providing campground facilities; reception services for temporary accommodation [management of arrivals and departures]; rental of chairs, tables, table linen, glassware; rental of cooking apparatus; rental of drinking water dispensers; rental of lighting apparatus; restaurant services; self-service restaurant services; snack-bar services; temporary accommodation reservations; udon and soba restaurant services; washoku restaurant services.

(260) AM 2020 106732 A

(800) 1510243

(151) 2019 07 16

(891) 2019 07 16

(731) Chernyshova Yuliia Serhiivna  
Bulvar Tarasa Shevchenka, bud. 11 B,  
kv. 42, m. Kyiv 01004, Ukraine

(540)



(591) Black, white

(531) 26.01.19; 26.11.01; 26.11.12; 27.05.09;  
27.05.10

(511)

30 – Agave syrup [natural sweetener]; allspice; almond confectionery; almond paste; aniseed; aromatic preparations for food; artificial coffee; bread; bread rolls; cake dough; cake frosting [icing]; cake powder; cakes; candy; caramels [candy]; cereal-based snack food; cereal bars; cereal preparations; cheeseburgers [sandwiches]; chicory [coffee substitute]; chocolate; chocolate-based beverages; chocolate-based spreads; chocolate-coated nuts; chocolate beverages with milk; chocolate mousses; chocolate spreads containing nuts; cinnamon [spice]; cloves [spice]; cocoa; cocoa-based beverages; cocoa beverages with milk; coffee; coffee-based beverages; coffee beverages with milk; coffee flavourings; sugar confectionery; cookies; crushed barley; crushed oats; custard; dessert mousses [confectionery]; dough; flavorings, other than essential oils, for beverages; flour; flowers or leaves for use as tea substitutes; fondants [confectionery]; food flavorings, other than essential oils; frozen yoghurt [confectionery ices]; fruit jellies [confectionery]; garden herbs, preserved [seasonings]; gingerbread; ginger [spice]; golden syrup; honey; ice, natural or artificial; ice cream; ice cubes; iced tea; ice for refreshment; macarons [pastry]; malt biscuits; natural sweeteners; pastries; pastry dough; peanut confectionery; petit-beurre biscuits; petits fours [cakes]; pies; pralines; puddings; pâtés en croûte; quiches; sandwiches; sorbets [ices]; soya flour; sugar; tarts; tea; tea-based beverages; unroasted coffee; vanilla flavourings for culinary purposes; vanillin [vanilla substitute]; vegetal preparations for use as coffee substitutes; waffles; zefir [confectionery].

(260) AM 2020 106733 A

(800) 1510253

(151) 2019 11 26

(891) 2019 11 26

(731) Richter Gedeon Nyrt.

Gyömrői út 19-21, H-1103 Budapest, Hungary

(540)

**BABARYD**

(591) Black, white

(511)

5 – Pharmaceutical preparations.

(260) AM 2020 106734 A

(800) 1510269

(151) 2019 10 23

(891) 2019 10 23

(731) YANTAI IRAY TECHNOLOGY CO., LTD.

Guiyang Street 11, Development Zone,

Yantai City, Shandong Province, China

(540)

**Xinfrared**

(591) Black, white

(511)

9 – Infrared cameras; telescopes; binoculars; lenses for telescopes; autocollimators; lorgnettes; telescopic sights for artillery; telescopic sights for firearms; zenith telescope; passive infrared detectors; infrared detectors; infrared sensors; optical sensors; photoelectric sensors; theft prevention installations, electric; electrical and electronic burglar alarms; optical inspection apparatus; thermal imaging monoculars and binoculars; night vision monoculars and binoculars; protection devices for personal use against accidents; infrared surveillance cameras; optical lenses; optical scanners; chips [integrated circuits]; temperature indicators; thermal imaging cameras; cameras [photography].

(260) AM 2020 106735 A

(800) 1510350

(151) 2019 09 27

(891) 2019 09 27

(731) Otkrytoe Aktsionernoe, Obshchestvo

"Sladonezh"

ul. 22 Partsiezda, 51, RU-644105 Omsk,

Russian Federation

(540)



(591) Blue, white and yellow

(531) 26.13.25; 28.05; 29.01.13

(511)

30 – Waffles; cake frosting [icing]; confectionery for decorating Christmas trees; pastries; peanut confectionery; almond confectionery; sweetmeats [candy]; liquorice [confectionery]; peppermint sweets; crac-

kers; custard; macaroons [pastry]; marzipan; dessert mousses [confectionery]; chocolate mousses; stick liquorice [confectionery]; pastilles [confectionery]; cookies; petit-beurre biscuits; fondants [confectionery]; pralines; gingerbread; petits fours [cakes]; puddings; cake powder; confectionery; tarts; almond paste; tortillas; halvah; chocolate; fruit jellies [confectionery]; cakes; caramels [candy]; cake dough.

(260) AM 2020 106736 A

(800) 1510351

(151) 2019 09 11

(891) 2019 09 11

(731) Tovarischestvo s ogranitchennoy otvetstvennostyu "FitOleum"  
ul. Mametova dom 25, g. Esik,  
Enbekshikazakhskiy raion, 040400  
Almatinskaya oblast, Kazakhstan

(540)

**FITOLEUM**

(591) Black, white

(511)

3 – Non-medicated cosmetics and toiletry preparations; non-medicated dentifrices; perfumery; essential oils; balms, other than for medical purposes; lip glosses; massage gels, other than for medical purposes; greases for cosmetic purposes; hair conditioners; cosmetic creams; skin whitening creams; hair lotions; lotions for cosmetic purposes; after-shave lotions; prophylactic phyto oils for gums and teeth; beauty masks; oils for perfumes and scents; oils for cleaning purposes; oils for cosmetic purposes; oils for cosmetic purposes for children; oils for toilet purposes; essential oils; essential oils of cedarwood; essential oils of lemon; essential oils of citron; bergamot oil; gaultheria oil; jasmine oil; lavender oil; almond oil; rose oil; oil of turpentine for degreasing; almond milk for cosmetic purposes; cleansing milk for toilet purposes; cakes of toilet soap; antiperspirant soap; soap for foot perspiration; almond soap; mint for perfumery; cosmetic kits; breath freshening strips; teeth whitening strips; lipsticks; pomades for cosmetic purposes; shaving preparations; cosmetic preparations for baths; bath preparations, not for medical purposes; leather bleaching preparations; mouthwashes, not for medical purposes; cosmetic preparations for slimming purposes; make-up removing preparations; nail care preparations; collagen preparations for cosmetic purposes; breath freshening preparations for personal hygiene; aloe vera preparations for cosmetic purposes; sunscreen preparations; exfoliant powders; baby wipes impregnated with cleaning preparations; tissues impregnated with cosmetic lotions; tissues impregnated with make-up removing preparations; massage candles for cosmetic purposes; potpourris [fragrances]; astringents for cosmetic purposes; cosmetic preparations for skin

care; cosmetics; cosmetics for children; cleansers for intimate personal hygiene purposes, non medicated; douching preparations for personal sanitary or deodorant purposes [toiletries]; detergents; toiletry preparations, antiperspirants [toiletries]; phytocosmetic preparations; cosmetic toners; shampoos; dry shampoos; peel preparations and scrub for cosmetic purposes.

5 – Pharmaceuticals, medical and veterinary preparations; sanitary preparations for medical purposes; dietetic food and substances adapted for medical or veterinary use, food for babies; dietary supplements for human beings and animals; analgesics; anaesthetics; antibiotics; antiseptics; balms for medical purposes; nutritional supplements; dietetic substances adapted for medical use; melissa water for pharmaceutical purposes; sea water for medicinal bathing; mineral waters for medical purposes; thermal water; dietary fiber; gentian for pharmaceutical purposes; vitamin supplement patches; mineral food supplements; nutritional supplements; albumin dietary supplements; glucose dietary supplements; casein dietary supplements; lecithin dietary supplements; linseed oil dietary supplements; propolis dietary supplements; protein dietary supplements; royal jelly dietary supplements; pollen dietary supplements; wheat germ dietary supplements; linseed dietary supplements; acai powder dietary supplements; dietary supplements with a cosmetic effect; enzyme dietary supplements; yeast for pharmaceutical purposes; gelatine for medical purposes; cod liver oil; capsules for medicines; cachets for pharmaceutical purposes, including phyto-cachets; candy, medicated; barks for pharmaceutical purposes; medicinal roots; rhubarb roots for pharmaceutical purposes; starch for dietetic or pharmaceutical purposes; liquorice for pharmaceutical purposes; medicines for alleviating constipation, medicated hair lotions; lotions for pharmaceutical purposes; medicated after-shave lotions; medicinal drinks, almond milk for pharmaceutical purposes; powdered milk for babies; royal jelly for pharmaceutical purposes; linseed meal for pharmaceutical purposes; liniments; ointments for pharmaceutical purposes; sunburn ointments; frostbite salve for pharmaceutical purposes; gauze for dressings; medicinal oils; oils, containing plant extracts; mustard oil for medical purposes; camphor oil for medical purposes; castor oil for medical purposes; oil of turpentine for pharmaceutical purposes; dill oil for medical purposes; dental mastics, drugs for medical purposes; disinfectant soap; medicated soap; mint for pharmaceutical purposes, dietetic beverages adapted for medical purposes; malted milk beverages for medical purposes; medicinal infusions, eucalyptol for pharmaceutical purposes; tinctures for medical purposes; decoctions for pharmaceutical purposes, stick liquorice for pharmaceutical purposes; pastilles for pharmaceutical purposes; medicated

dentifrices, pectin for pharmaceutical purposes; food for babies; babies' diapers; diapers for incontinence; pomades for medical purposes; anti-uric preparations; bacterial preparations for medical and veterinary use; bacteriological preparations for medical and veterinary use; balsamic preparations for medical purposes; albuminous preparations for medical purposes; vitamin preparations; pharmaceutical preparations for skin care; bath preparations for medical purposes; therapeutic preparations for the bath; hemorrhoid preparations, preparations for callouses; acne treatment preparations; preparations to facilitate teething; preparations for the treatment of burns; opotherapy preparations; air purifying preparations; bronchodilating preparations; corn remedies; pharmaceutical preparations for treating dandruff; vermin destroying preparations; chilblain preparations; medicated eye-washes; medicinal hair growth preparations; nutraceutical preparations for therapeutic or medical purposes; aloe vera preparations for pharmaceutical purposes; preparations of trace elements for human and animal use; pharmaceutical preparations; pharmaceutical preparations for treating sunburn; phytotherapy preparations for medical purposes; chemico-pharmaceutical preparations; chemical preparations for medical purposes; albuminous foodstuffs for medical purposes; dietetic foods adapted for medical purposes; by-products of the processing of cereals for dietetic or medical purposes, homogenized food adapted for medical purposes; freeze-dried food adapted for medical purposes; pharmaceuticals, propolis for pharmaceutical purposes; vaginal washes for medical purposes; tea species, including, asthmatic tea, cordial species, choleric species, nephric species, vessel cleaning species, gynecological species, immune stimulating species, sedative species, pectoral species, diabetic species, gastrointestinal species, urological species; massage candles for therapeutic purposes; linseed for pharmaceutical purposes, syrups for pharmaceutical purposes; greases for medical purposes; infant formula; soporifics; bath salts for medical purposes; alcohol for pharmaceutical purposes; medicinal alcohol; ergot for pharmaceutical purposes, cooling sprays for medical purposes; antibacterial handwashes; adjuvants for medical purposes; styptic preparations, astringents for medical purposes; vermifuges; disinfectants; disinfectants for hygiene purposes, douching preparations for medical purposes; appetite suppressants for medical purposes; medical preparations for slimming purposes; parasiticides; mouthwashes for medical purposes; febrifuges; depuratives, vesicants, purgatives; antiparasitic preparations; remedies for perspiration; remedies for foot perspiration; sedatives, laxatives; digestives for pharmaceutical purposes; tonics [medicines]; medicated toiletry preparations, nervines; suppositories; appetite suppressant pills; slimming pills; jujube, medicated; smoking herbs for medical purposes; medicinal herbs; fennel

for medical purposes; medicinal tea; herbal teas for medicinal purposes; medicated shampoos; medicated shampoos for pets; medicated dry shampoos, eucalyptus for pharmaceutical purposes; extracts of hops for pharmaceutical purposes; herbal extracts for medical purposes, plant extracts for pharmaceutical purposes; elixirs [pharmaceutical preparations]; ethers for pharmaceutical purposes; esters for pharmaceutical purposes; cellulose esters for pharmaceutical purposes; cellulose ethers for pharmaceutical purposes.

35 – Wholesale services for pharmaceutical, veterinary and sanitary preparations and medical supplies; retail services for pharmaceutical, veterinary and sanitary preparations and medical supplies; sales promotion for others; procurement services for others [purchasing goods and services for other businesses], sales of non-medicated cosmetics and toiletry preparations, non-medicated dentifrices, perfumery, essential oils, balms, other than for medical purposes, lip glosses, massage gels, other than for medical purposes, greases for cosmetic purposes, hair conditioners, cosmetic creams, skin whitening creams, hair lotions, lotions for cosmetic purposes, after-shave lotions, prophylactic phyto oils for gums and teeth, beauty masks, oils for perfumes and scents, oils for cleaning purposes, oils for cosmetic purposes, oils for cosmetic purposes for children, oils for toilet purposes, essential oils, essential oils of cedarwood, essential oils of lemon, essential oils of citron, bergamot oil, gaultheria oil, jasmine oil, lavender oil, almond oil, rose oil, oil of turpentine for degreasing, almond milk for cosmetic purposes, cleansing milk for toilet purposes, cakes of toilet soap, antiperspirant soap, soap for foot perspiration, almond soap, mint for perfumery, cosmetic kits, breath freshening strips, teeth whitening strips, lipsticks, pomades for cosmetic purposes, shaving preparations, cosmetic preparations for baths, bath preparations, not for medical purposes, leather bleaching preparations, mouthwashes, not for medical purposes, cosmetic preparations for slimming purposes, make-up removing preparations, nail care preparations, collagen preparations for cosmetic purposes, breath freshening preparations for personal hygiene, aloe vera preparations for cosmetic purposes, sunscreen preparations, exfoliant powders, baby wipes impregnated with cleaning preparations, tissues impregnated with cosmetic lotions, tissues impregnated with make-up removing preparations, massage candles for cosmetic purposes, potpourris [fragrances], astringents for cosmetic purposes, cosmetic preparations for skin care, cosmetics, cosmetics for children, cleansers for intimate personal hygiene purposes, non medicated, douching preparations for personal sanitary or deodorant purposes [toiletries], detergents, toiletry preparations, antiperspirants [toiletries], phyto-cosmetic preparations, cosmetic toners, shampoos,



dry shampoos, peel preparations and scrub for cosmetic purposes, pharmaceuticals, medical and veterinary preparations, sanitary preparations for medical purposes, dietetic food and substances adapted for medical or veterinary use, food for babies, dietary supplements for human beings and animals, analgesics, anaesthetics, antibiotics, antiseptics, balms for medical purposes, nutritional supplements, dietetic substances adapted for medical use, melissa water for pharmaceutical purposes, sea water for medicinal bathing, mineral waters for medical purposes, thermal water, dietary fiber, gentian for pharmaceutical purposes, vitamin supplement patches, mineral food supplements, nutritional supplements, albumin dietary supplements, glucose dietary supplements, casein dietary supplements, lecithin dietary supplements, linseed oil dietary supplements, propolis dietary supplements, protein dietary supplements, royal jelly dietary supplements, pollen dietary supplements, wheat germ dietary supplements, linseed dietary supplements, acai powder dietary supplements, dietary supplements with a cosmetic effect, enzyme dietary supplements, yeast for pharmaceutical purposes, gelatine for medical purposes, cod liver oil, capsules for medicines, cachets for pharmaceutical purposes, including phyto-cachets, candy, medicated, barks for pharmaceutical purposes, medicinal roots, rhubarb roots for pharmaceutical purposes, starch for dietetic or pharmaceutical purposes, liquorice for pharmaceutical purposes, medicines for alleviating constipation, medicated hair lotions, lotions for pharmaceutical purposes, medicated after-shave lotions, medicinal drinks, almond milk for pharmaceutical purposes, powdered milk for babies, royal jelly for pharmaceutical purposes, linseed meal for pharmaceutical purposes, liniments, ointments for pharmaceutical purposes, sunburn ointments, frostbite salve for pharmaceutical purposes, gauze for dressings, medicinal oils, oils, containing plant extracts, mustard oil for medical purposes, camphor oil for medical purposes, castor oil for medical purposes, oil of turpentine for pharmaceutical purposes, dilloil for medical purposes, dental mastics, drugs for medical purposes, disinfectant soap, medicated soap, mint for pharmaceutical purposes, dietetic beverages adapted for medical purposes, malted milk beverages for medical purposes, medicinal infusions, eucalyptol for pharmaceutical purposes, tinctures for medical purposes, decoctions for pharmaceutical purposes, stick liquorice for pharmaceutical purposes, pastilles for pharmaceutical purposes, medicated dentifrices, pectin for pharmaceutical purposes, food for babies, babies' diapers, diapers for incontinence, pomades for medical purposes, anti-uric preparations, bacterial preparations for medical and veterinary use, bacteriological preparations for medical and veterinary use, balsamic preparations for medical purposes, albuminous preparations for medical purposes, vitamin preparations, pharmaceutical preparations for

skin care, bath preparations for medical purposes, therapeutic preparations for the bath, hemorrhoid preparations, preparations for callouses, acne treatment preparations, preparations to facilitate teething, preparations for the treatment of burns, ophotherapy preparations, air purifying preparations, bronchodilating preparations, corn remedies, pharmaceutical preparations for treating dandruff, vermin destroying preparations, chilblain preparations, medicated eye-washes, medicinal hair growth preparations, nutraceutical preparations for therapeutic or medical purposes, aloe vera preparations for pharmaceutical purposes, preparations of trace elements for human and animal use, pharmaceutical preparations, pharmaceutical preparations for treating sunburn, phytotherapy preparations for medical purposes, chemico-pharmaceutical preparations, chemical preparations for medical purposes, albuminous foodstuffs for medical purposes, dietetic foods adapted for medical purposes, by-products of the processing of cereals for dietetic or medical purposes, homogenized food adapted for medical purposes, freeze-dried food adapted for medical purposes, pharmaceuticals, propolis for pharmaceutical purposes, vaginal washes for medical purposes, tea species, including, asthmatic tea, cordial species, choleric species, nephric species, vessel cleaning species, gynecological species, immune stimulating species, sedative species, pectoral species, diabetic species, gastrointestinal species, urological species, massage candles for therapeutic purposes, linseed for pharmaceutical purposes, syrups for pharmaceutical purposes, greases for medical purposes, infant formula, soporifics, bath salts for medical purposes, alcohol for pharmaceutical purposes, medicinal alcohol, ergot for pharmaceutical purposes, cooling sprays for medical purposes, antibacterial handwashes, adjuvants for medical purposes, styptic preparations, astringents for medical purposes, vermifuges, disinfectants, disinfectants for hygiene purposes, douching preparations for medical purposes, appetite suppressants for medical purposes, medical preparations for slimming purposes, parasiticides, mouthwashes for medical purposes, febrifuges, depuratives, vesicants, purgatives, antiparasitic preparations, remedies for perspiration, remedies for foot perspiration, sedatives, laxatives, digestives for pharmaceutical purposes, tonics [medicines], medicated toiletry preparations, nervines, suppositories, appetite suppressant pills, slimming pills, jujube, medicated, smoking herbs for medical purposes, medicinal herbs, fennel for medical purposes, medicinal tea, herbal teas for medicinal purposes, medicated shampoos, medicated shampoos for pets, medicated dry shampoos, eucalyptus for pharmaceutical purposes, extracts of hops for pharmaceutical purposes, herbal extracts for medical purposes, plant extracts for pharmaceutical purposes, elixirs [pharmaceutical preparations], ethers for pharmaceutical purposes, esters for pharmaceutical pur-

poses, cellulose esters for pharmaceutical purposes, cellulose ethers for pharmaceutical purposes.

(260) AM 2020 106743 A

(800) 1074351

(151) 2011 02 08

(891) 2020 01 08

(731) EXENA S.R.L.

Via Vincenzo Breda, 7/A, I-62012 Civitanova Marche (MC), Italy

(540)



(591) Black, white

(531) 03.05.05; 27.05.02

(511)

9 – Protective clothing; shoes for protection against accidents, irradiation and fire.

25 – Work wear; work footwear.

(260) AM 2020 106746 A

(800) 1416717

(151) 2018 01 05

(891) 2019 12 18

(731) H & M Hennes & Mauritz AB

Mäster Samuelsgatan 46A, SE-111 57 Stockholm, Sweden

(540)

**WEEKDAY**

(591) Black, white

(511)

9 – Sunglasses; headphones; cell phone case.

14 – Jewelry; pocket watches and wristwatches.

18 – Leather and imitations of leather, bags; trunks; rucksacks; travelling bags; umbrellas; parasols; wallets.

(260) AM 2020 106747 A

(800) 1418248

(151) 2017 12 27

(891) 2019 07 31

(731) DOĞTAŞ KELEBEK MOBİLYA SANAYİ VE TİCARET ANONİM ŞİRKETİ İDEALTEPE MAH. RIFKI TONGSİR CAD., NO:107 KÜÇÜKYALI, MALTEPE İSTANBUL, Turkey

(540)



(591) White, red and black

(531) 03.13.01; 26.04.15; 29.01; 29.01.13

(526) KELEBEK

(511)

20 – Furniture; made of any kind of material; mattresses; pillows; air mattresses and cushions; not for medical purposes; water beds; mirrors; beehives; artificial honeycombs and sections of wood for honeycombs; bouncing chairs for babies; playpens for babies; cradles; infant walkers; display boards; frames for pictures and paintings; identification labels made of wood or synthetic materials; packaging containers of wood or plastics; storage drums; chests; loading pallets and closures for the aforementioned goods of wood or plastics; small hardware goods of wood or synthetic materials included in this class; furniture fittings of wood or synthetic materials; opening and closing mechanisms of wood or synthetic materials; fishing baskets; kennels; nesting boxes and beds for household pets; portable ladders and mobile boarding stairs of wood or synthetic materials; bamboo curtains; roller indoor blinds [for interiors]; slatted indoor blinds; strip curtains; bead curtains for decoration; curtain hooks; curtain rings; curtain tie-backs; curtain rods; non-metal name plates; identification tags, not of metal; door nameplates, not of metal; casks, not made of metal; barrels, not of metal; tanks, not of metal nor of masonry; plastic boxes; storage containers, not of metal; transport containers not of metal; baskets, non-metallic.

(260) AM 2020 106748 A

(800) 1470751

(151) 2019 01 18

(891) 2019 12 11

(731) H & M Hennes & Mauritz AB

SE-106 38 Stockholm, Sweden

(540)

*& other Stories*

(591) Black, white

(531) 24.17.25; 27.05.01

(511)

3 – Non-medicated cosmetics and toiletry preparations; non-medicated dentifrices; perfumery, essential oils; bleaching preparations and other substances for laundry use; cleaning, polishing, scouring and abrasive preparations; soaps; perfumes; ethereal oils; cosmetics; hair care preparations; tooth-powder; toothpaste, dentifrices; nail polish; lacquer-removing preparations; toiletries; after-shave preparations; fa-

cial masks; face creams; facial washes [cosmetic]; anti-aging creams; baby oils; bath gel; bath salts; bath preparations, not for medical purposes; hair balm; bleaching preparations for the hair; cotton wool and cotton sticks for cosmetic purposes; eyebrow pencils; eyeliner; hair dyes; adhesives for affixing artificial fingernails; adhesives for affixing false eyelashes; false nails; cosmetic wipes; styling gels for the hair; hair styling waxes; hand creams; hair removal and shaving preparations; hair styling lotions; hair creams; hair waving preparations; skin care preparations; mouth washes, not for medical purposes; non-medicated mouth sprays; creams for cellulite reduction; body creams [cosmetics]; body scrub; body butter; make-up powder; non-medicated lip balm; lip gloss; lip liners; lipstick; adhesives for affixing false hair; false eyelashes; mascara; mousses [toiletries] for use in styling the hair; eyelid shadow; scented body spray; body cleaning and beauty care preparations; leather and shoe cleaning and polishing preparations; hair care preparations and treatments; talcum powder; rouges; tailors' and cobblers' wax; sun blocking lipsticks [cosmetics]; sunscreen preparations; make up foundation; bath gel, shower gel, skin moisturizing gel; incense; deodorants for human beings or for animals; cosmetics for animals; air fragrancing preparations; shampoo; hair conditioners; stain removers; creams for leather; smoothing stones; essential oils; air fragrance reed diffusers; scented room sprays; potpourris [fragrances].

4 – Candles; perfumed candles; Christmas tree decorations for illumination [candles]; industrial greases; petrol; illuminating grease; fuel; industrial wax; illuminating wax; dust removing preparations; electrical energy.

9 – Apparatus and instruments for conducting, switching, transforming, accumulating, regulating or controlling electricity; scientific, nautical, surveying, photographic, cinematographic, optical, weighing, measuring, signaling, checking (supervision), life-saving and teaching apparatus and instruments; apparatus for recording, transmission or reproduction of sound or images; magnetic data carriers, recording discs; compact discs, DVDs and other digital recording media; mechanisms for coin-operated apparatus; cash registers, calculating machines, data processing equipment, computers; computer software; fire-extinguishing apparatus; electronic publications, downloadable; downloadable mobile phone applications; selfie sticks; cases adapted for mobile phones; mobile telephone covers; chargers for mobile phones; auxiliary speakers for mobile phones; headphones; loudspeakers; eyeglass frames; ski goggles; swim goggles; cases for sunglasses; sunglasses; sleeves for laptops; bags adapted for laptops; bags for carrying photographic apparatus; eyeglasses; eyeglass cords; eyeglass chains; eyeglass cases; ru-

lers [measuring instruments]; power packs [batteries]; decorative magnets.

14 – Precious metals and their alloys; jewellery, precious and semi-precious stones; horological and chronometric instruments; gemstones, pearls and precious metals, and imitations thereof; charms [jewellery] of common metals; paste jewellery; jewellery charms; ornamental pins; diadems; rings [jewellery]; ankle bracelets; bracelets; necklaces; pendants; chains [jewellery]; tie pins; clocks; cufflinks; key rings [trinkets or fobs]; earrings; jewellery boxes and watch boxes; brooches [jewellery]; key chains as jewellery; jewellery boxes not of metal; precious metals, unwrought or semi-wrought; jewellery cases (caskets); ornaments (jewellery); cases for watches (presentation).

16 – Paper and cardboard; printed matter; book-binding material; photographs; stationery and office requisites, except furniture; adhesives for stationery or household purposes; drawing materials and materials for artists; paintbrushes; instructional and teaching materials; plastic sheets, films and bags for wrapping and packaging; printers' type, printing blocks; packaging materials made of cardboard; posters; face towels of paper; books; decorative paper centerpieces; table napkins of paper; decoration and art materials and media; office staplers; paperweights; figures made of paper; works of art and figurines of paper and cardboard, and architectural models; charts; cardboard boxes; handkerchiefs of paper; mail order catalogues; paper and plastic bags for packaging; paper, cardboard and plastic for wrapping and storage; wrapping paper; pens [office requisites]; writing instruments; pen holders; periodicals; printed publications, namely, books, magazines (periodicals), brochures, newsletters; pencil boxes; pen cases; paper boxes; art prints on canvas; Christmas cards; birthday cards; correspondence cards; table linen of paper; towels of paper; tissues of paper for removing make-up; tablemats of paper; catalogues; pictures; figurines (statuettes) of papier mâché; packing paper; boxes of cardboard; stationery; ink; sealing stamps; adhesives (glues) for stationery or household purposes; adhesive tapes for stationery and household purposes; drawing instruments; drawing materials; typewriters, electric or non-electric; teaching materials (except apparatus); tailors' chalk; modelling materials.

18 – Leather and imitations of leather; animal skins and hides; luggage; carrying bags; umbrellas and parasols; walking sticks; whips, harness; saddlery; leashes and clothing for animals; travelling bags; wallets; handbags; evening handbags; work bags; shoulder bags; canvas bags; shopping bags; cases for toiletries; hand bags; bags for carrying animals; card wallets; cosmetic purses; courier bags; leather laces; fanny packs; briefcases; rucksacks; athletics bags;

key wallets; vanity cases, not fitted; credit card holders; purses; trunks (luggage); card cases (notecases); trimmings of leather for furniture.

21 – Household or kitchen utensils and containers; cookware and tableware, except forks, knives and spoons; combs; sponges; brushes; brush-making materials; articles for cleaning purposes; unworked or semi-worked glass, except building glass; glassware, porcelain and earthenware; storage jars; cooking utensils, non-electric; thermally insulated containers for food and beverages; hair brushes; toothbrushes; toothbrush holders; toothbrush cases; trivet; vases; watering cans; dinnerware; plates; paper plates; napkin holders; tableware, other than knives, forks and spoons; figurines and works of art made of glass, earthenware or porcelain; toilet cases; dishwashing brushes; dish cloths; serving platters; gardening gloves; laundry bins; candlesticks; liquid soap holders; soap dispensers; cookie cutters; wastepaper baskets; tea pots; soap dishes; bowls [basins]; disposable dinnerware, namely plates and bowls; mugs; salt shakers; pepper grinders; pot holders; candle holders; containers for household or kitchen use; plastic storage containers for domestic use; glass vials (receptacles); ceramics for household purposes; drinking vessels; tea services (tableware); coffee services (tableware); toilet utensils; perfume burners; dental floss; heat insulated containers; cleaning instruments, hand-operated; steel wool for cleaning; crystal (glassware); cages for household pets; indoor aquaria; fly swatters; brushes; brushes for personal hygiene; make-up brushes; brushes for household purposes; cosmetic utensils; containers for cosmetics; applicators for cosmetics; racks for cosmetics; hand tools for the application of cosmetics.

(260) AM 2020 106850 A  
(800) 1510530  
(151) 2019 10 25  
(891) 2019 10 25  
(731) ZHEJIANG ZHONGBAI SPECIAL FIBER CO., LTD  
Office Building A, Yuewang Road NO.339,  
Shaoxing City, 312000 Zhejiang Province,  
China  
(540)



**Vline**

(591) Black, white  
(531) 09.01.01; 26.04.04; 26.04.12; 26.04.16;  
26.04.24; 26.11.25; 27.05.01

(511)  
23 – Yarn; cotton thread and yarn; elastic thread (for textile use); spun wool; filament yarns; elastic thread and yarn for textile use; rayon thread and yarn; silk thread and yarn; darning thread and yarn; polyethylene single thread.

(260) AM 2020 106851 A  
(800) 1510618  
(151) 2019 11 26  
(891) 2019 11 26  
(731) Richter Gedeon Nyrt.  
Gyömrői út 19-21, H-1103 Budapest, Hungary  
(540)

**AMABELL**

(591) Black, white  
(511)  
5 – Pharmaceutical preparations.

(260) AM 2020 106853 A  
(800) 1510646  
(151) 2019 11 26  
(891) 2019 11 26  
(731) Richter Gedeon Nyrt.  
Gyömrői út 19-21, H-1103 Budapest, Hungary  
(540)

**DOMORON**

(591) Black, white  
(511)  
5 – Pharmaceutical preparations.

(260) AM 2020 106854 A  
(800) 1510658  
(151) 2019 12 11  
(891) 2019 12 11  
(731) Acino Pharma AG  
Birsweg 2, CH-4253 Liesberg, Switzerland  
(540)

**Cerbelzen**

(591) Black, white  
(511)  
5 – Pharmaceutical products.

(260) AM 2020 106870 A  
(800) 1510955  
(151) 2019 12 16  
(891) 2019 12 16  
(731) Shenzhen Yi Fan Technology Ltd.  
Room; 209/211/213/215/219/221/223/225/229

2F, Building 424, Bagualing Industrial Zone,  
150 Bagua 3rd Rd, Hualin Community,  
Yuanling, Futian District, ShenZhen;  
Guangdong Province, China

(540)

# RAMPOW

(591) Black, white

(531) 27.05.01

(511)

9 – Smart watches (data processing equipment); selfie sticks [hand-held monopods]; headphones; loudspeakers; computer hardware; couplers [data processing equipment]; cases for smartphones; audio- and video-receivers; audio interfaces; cabinets for loudspeakers; portable media players; selfie lenses; materials for electricity mains [wires, cables]; chargers for electric batteries.

(260) AM 2020 106875 A

(800) 1511013

(151) 2019 11 18

(891) 2019 11 18

(731) Olenich Yana Viktorivna  
prov. Mukachivskiyi, 6, kv. 34, Odessa 65012,  
Ukraine

(540)

# Olēnich

(591) Black, white

(531) 27.05.01

(511)

9 – Spectacle cases; sunglasses; goggles for sports; spectacle frames; spectacle chains; spectacle cords; spectacles; smartglasses; spectacle lenses.

14 – Jewellery; amulets [jewellery]; bracelets [jewellery]; watches; precious stones; precious metals, unwrought or semi-wrought; jewellery findings; medals; coins; jewellery boxes; paste jewelry [costume jewelry].

18 – Valises; business card cases; key cases; purses; travelling trunks; chamois leather, other than for cleaning purposes; attaché cases; kid; haversacks; travelling sets [leatherware]; vanity cases, not fitted; clothing for pets, umbrellas; parasols; leather straps; shoulder belts [straps] of leather; briefcases; conference folders; rucksacks; shopping bags; travelling bags; handbags; beach bags; bags for sports; bags for campers; card cases [notecases]; fur; suitcases; umbrella covers; animal skins.

25 – Footwear; boots for sports; clothing; ready-made clothing; outerclothing; overalls; uniforms; underclothing; sashes for wear; belts [clothing]; gloves [clothing]; furs [clothing]; scarfs; headwear.

(260) AM 2020 106876 A

(800) 1511020

(151) 2019 11 15

(891) 2019 11 15

(731) MIRAPHYTOS HOLDING LTD

Spyrou Kyprianou 61, SK House, CY-4003  
Limassol, Cyprus

(540)



(591) Blue, light blue, sky-blue (azure), dark blue  
(mazarine), green and white

(531) 05.03.15; 26.15.01; 28.05; 29.01.13

(511)

5 – Analgesics; anaesthetics; antibiotics; germicides; bacterial preparations for medical and veterinary use; bacteriological preparations for medical and veterinary use; pharmaceutical preparations; veterinary preparations; hygienic preparations for medical use; dietetic substances adapted for medical use; dietetic foods adapted for medical purposes; baby (infant) food; disinfectants; nervines; medicines for human purposes; medicines for veterinary purposes; medicines for dental purposes; adhesive plasters; dressings, medical; laxatives light; dental impression materials; teeth filling material; soporifics; animal washes [insecticides]; fungicides; preparations for destroying noxious plants.

(260) AM 2020 106920 A

(800) 870597

(151) 2004 09 02

(891) 2020 01 09

(731) ECOVIS Europe AG

Ernst-Reuter-Platz 10, 10587 Berlin, Germany

(540)



(591) Red

(531) 25.05.02; 25.05.25; 26.01.12; 26.03.06;  
26.11.03; 26.11.05; 26.11.06; 26.11.08;  
26.11.12; 29.01.12

(511)

35 – Advertising; business management; business administration; office functions; drawing up of statements of accounts; book-keeping, auditing; internal and external auditing and accounting, research into business matters, providing of commercial and business information, costs analysis and consultancy relating thereto; consultancy and assistance in business management; consultancy in the field of secretarial services, corporate profitability services and marketing services; personnel management through selection, and recruitment; assisting employees in search for new employment after issue of notice (outplacement); consultancy in respect of mergers, acquisitions, franchising and business liquidations; tax investigation, tax preparation; management consultancy, including business management, corporate planning and development, project studies, corporate venture management, process management; accountancy for the purpose of providing attestation, including determination and research in respect of fraud; organization of office functions; market research and market surveys; business information on venture management; all the foregoing services, as far as included in this class.

36 – Insurance; financial affairs; monetary affairs; real estate affairs; consultation in respect of credit and debit note supervision, investments, subsidies and financing of loans; pension services; fiscal valuations; administration of real estate and property; financing of real estate and of property developments; customs brokerage and insurance services; financial services; consultation in respect of financial matters and taxation; corporate financing, including consultation in respect of finance matters, financial assessment and financial consultation; services of an actuary; venture management [financial affairs]; debt collection agencies; preparation of tax assessments and estimations; corporate financing, including corporate consultation in relation to company sales and acquisitions; consultancy in cases of business insolvency; insolvency administration; constitution or investment of capital for companies and investigation of companies; all the aforesaid goods, as far as included in this class.

41 – Education; providing of training; entertainment; sporting and cultural activities; schooling and training in respect of tax accounting, balance sheet preparation, fiscal valuations, individual aspects of attorney activity and legal consultation as well as in respect of business management, financial and management matters; publication of texts in respect of accounting, balance sheet matters, fiscal valuation, individual aspects of attorney activity and legal consultation as well as in respect of business, financial and management matters; organization of conferences, seminars, symposia and meetings in respect of business, financial and management matters; transla-

tion of formal contracts, legal certifications and legal documents (as far as included in this class).

42 – Scientific and technological services and research and design relating thereto; industrial analysis and research services; design and development of computer hardware and software, with the exception of the field of telecommunications; legal services; activity of an attorney; consultation in the sectors of information technology, expert assessments; services in relation to legal matters, including consultation, representation of interests, legal disputes and the handling of legal formalities; consultation in questions of taxation law; drafting of formal contracts, legal certifications and legal documents; the aforesaid services, as far as included in this class.

(260) AM 2020 106921 A

(800) 959897

(151) 2007 12 27

(891) 2019 11 21

(731) "KONTI-RUS" JOINT STOCK COMPANY  
13, ul. Zolotaia, RU-305000 Kursk, Russian  
Federation

(540)

# Belissimo

(591) Black, white

(511)

30 – Confectionery; peanut confectionery; pastries, including chocolate pastries; waffles; waffle cakes; dragées (confectionery); fruit jellies (confectionery); candied sweetmeats; cocoa-based beverages; caramels (candy); lozenges (confectionery); pastilles (confectionery); cakes; crackers; confectionery for decorating Christmas trees; liquorice (confectionery); candy for food; peppermint sweets; macaroons (pastry); almond confectionery; cookies; cookies covered with chocolate; fondants; gingerbread; rolled cakes (confectionery); sugar confectionery; rusks; petit-beurre biscuits; petits fours (cakes); halvah; farinaceous foods; sweetmeats (candy); chocolate; chocolate desserts; chocolate cream; chocolate sticks.

(260) AM 2020 106922 A

(800) 1042376

(151) 2010 05 17

(891) 2019 12 12

(731) NESSENS SA

Route du Muids 5, CH-1272 Genolier,  
Switzerland

(540)

# NESSENS

(591) Black, white

(511)

3 – Cosmetics, soaps, perfumery, essential oils; body deodorants; creams, milks, lotions, gels, powders, serums, masks and scrubs for cosmetic use for facial and body care; restructuring creams, lotions and serums for cosmetic use; cosmetic preparations for slimming purposes; cosmetic preparations for the shower and/or bath; tanning and after-sun milks, gels and oils; make-up; make-up removing preparations; depilatory preparations; hair-care and hair-cleansing preparations, particularly shampoos, creams, masks, serums, mousses; hair dyes; dentifrices.

5 – Pharmaceutical products and preparations; food and nutritional supplements for medical use, in solid, liquid, gel, cream or paste form; dietetic foods and beverages for medical use; protein-based food supplements for medical use; vitamin preparations.

44 – Medical services; veterinary services; hygienic and beauty care for human beings and animals; spa services, sauna services, massage services, manicure services, pedicure services, make-up services; physical therapy services; beauty salons; hygiene and beauty care consulting; providing beauty care information via the Internet; nutritional advice.

(260) AM 2020 106923 A

(800) 1088951

(151) 2011 06 20

(891) 2020 01 13

(731) ALMAFOOD Co. Ltd

4, str.1, Sadovniki str., RU-115487 Moscow,  
Russian Federation

(540)

## ALTA ROMA

(591) Black, white

(511)

29 – Meat, fish, poultry and game; meat extracts; preserved, dried and cooked fruits and vegetables; jellies, jams, compotes; eggs, milk and milk products; edible oils and fats; milk powder for nutritional purposes; non-alcoholic milk mix shakes, milk dominating; protein-based or vegetable-based coffee whitener; nut pastes (included in this class); dietetic foodstuffs and food supplements for non-medical use on the basis of proteins, fat and/or fat acids also incorporating vitamins, minerals, trace elements either alone or in combination, included in this class.

30 – Coffee, tea, cocoa, sugar, rice, tapioca, sago, artificial coffee; flour and preparations made from cereals; bread, pastry and confectionery, ices; honey, treacle; natural sweeteners; yeast, baking-powder; salt, mustard; vinegar, sauces (condiments); spices; ice; ice-cream powder and preparations for making ice-cream; fruit tea and herbal tea for non-medical purposes; chocolate, chocolate products, sweets and

candies; chewing gum for non-medical use; coffee beverages, tea beverages, fruit tea beverages, cocoa beverages; drinking chocolate; drinks containing caffeine, tea or cocoa, included in this class; beverage powders containing caffeine, cocoa and/or chocolate; hazelnut chocolate spread; cocoa and nut pastes; dietetic foodstuffs and food-supplements for non-medical use on the basis of carbohydrates and/or roughage, also incorporating vitamins, minerals, trace elements either alone or in combination, included in this class.

32 – Beers; mineral and aerated waters and other non-alcoholic drinks; fruit drinks and fruit juices; syrups and other preparations for making beverages; vegetable juices (beverages), fruit juice beverages; isotonic beverages; effervescent tablets and beverage powders for making non-alcoholic and isotonic beverages, also as food supplements for non-medical use, included in this class.

(260) AM 2020 106924 A

(800) 1350798

(151) 2017 02 24

(891) 2019 12 20

(731) SEMILLAS FITO, S.A.

Selva de Mar, 111, E-08019 BARCELONA,  
Spain

(540)



(591) Yellow; green

(531) 27.05.17; 27.05.22; 29.01.12

(511)

31 – Natural seeds; agricultural and hydroponic crops; horticultural and forestry products; foodstuffs and fodder for animals.

(260) AM 2020 106925 A

(800) 1372811

(151) 2017 09 08

(891) 2019 11 26

(731) SAMSUNG ELECTRONICS CO., LTD.

129, Samsung-ro, Yeongtong-gu, Suwon-si,  
Gyeonggi-do, Republic of Korea

(540)



(591) Black, white  
 (531) 01.15.15; 24.17.10; 24.17.12; 26.13.25  
 (511)

9 – Smartphones; mobile telephones; portable computers; tablet computers; interactive computer software enabling exchange of information; software for searching and retrieving information across a computer network; computer software to enable the provision of information via communications networks; computer communication software to allow customers to access bank account information and transact bank business; interactive computer software; interactive entertainment software for use with computers; computer programmes for interactive television and for interactive games and/or quizzes; interactive entertainment software for use with personal computers; interactive computer software that provides navigational and travel information; voice recognisers; voice processing systems; voice recognition software.

42 – Software as a service [SaaS]; application software service provider (ASP); providing temporary use of on-line non-downloadable operating software for accessing and using a cloud computing network; cloud computing services.

(260) AM 2020 106927 A  
 (800) 1438975  
 (151) 2018 10 12  
 (891) 2019 12 24  
 (731) JEON, Bok Soon  
 101-906, 10, Ahasan-ro 78-gil, Gwangjin-gu,  
 Seoul, Republic of Korea

(540)  
**Medi-Peel**

(591) Black, white  
 (531) 27.05.01  
 (511)  
 3 – Cosmetic creams for firming skin around eyes; cosmetic preparations for the hair and scalp; non-medicated lip balms; massage oil; nail polish; skin moisturizers used as cosmetics; moisturising lotions [cosmetic]; body and beauty care cosmetics; beauty balm creams; make-up for the face and body; face and body beauty creams; toothpastes.

(260) AM 2020 106928 A  
 (800) 1479796  
 (151) 2019 03 11  
 (891) 2020 01 15  
 (731) STUDDS ACCESSORIES LIMITED  
 23/7 mathura road, ballabgarh, Faridabad  
 121004, Haryana, India

(540)  
The logo for SMK HELMETS features the letters 'SMK' in a bold, italicized, black font with a white outline, set against a red and black shield-like background. Below the shield, the word 'HELMETS' is written in a smaller, black, sans-serif font.

(591) Black, white, red  
 (531) 26.03.06; 26.03.12; 26.03.19; 27.05.01;  
 29.01.13  
 (511)  
 9 – Protective helmets; helmets for motorcycle and cycle riders.

(260) AM 2020 106929 A  
 (800) 1503883  
 (151) 2019 10 30  
 (891) 2020 01 16  
 (731) Vasco Group nv  
 Kruishoefstraat 50, B-3560 Dilsen, Belgium  
 (540)

**БРУГМАН**

(591) Black, white  
 (531) 28.05  
 (511)  
 9 – Measuring, signalling and checking (supervision) apparatus and instruments; apparatus and instruments for conducting, switching, transforming, accumulating, regulating or controlling electricity; temperature controlling apparatus.

11 – Apparatus and installations for lighting, heating, steam generating, cooking, refrigerating, drying, ventilating and water supply; radiators, radiator seals and thermostatic valves (parts of heating installations); electric heaters; fans (air-conditioning); air conditioning installations and apparatus; filters and valves for ventilating installations; heat exchangers, not parts of machines; individual and replacement parts for all the aforesaid goods.

(260) AM 2020 106991 A  
 (800) 1512573  
 (151) 2019 09 20  
 (891) 2019 09 20  
 (731) INCYTE HOLDINGS CORPORATION  
 1801 Augustine Cut-Off, Wilmington DE  
 19803, USA  
 (540)

**Pemazyre** The logo for Pemazyre features the brand name in a bold, sans-serif font. To the right of the name is a stylized graphic of a diamond or gemstone with multiple facets, rendered in a dark grey color.



(591) Black, white

(531) 26.03.04

(511)

5 – Pharmaceutical preparations for the treatment of cancer; pharmaceutical preparations for the treatment of immunological disorders; pharmaceutical preparations for the treatment of hematological disorders; pharmaceutical preparations for the treatment of hypophosphatemia disorders; pharmaceutical preparations for the treatment of myeloproliferative disorders; pharmaceutical preparations for the treatment of skeletal or chondrocyte disorders.

(260) AM 2020 106998 A

(800) 1512790

(151) 2019 11 14

(891) 2019 11 14

(731) Zhejiang Geely Holding Group Co., Ltd.  
1760 Jiangling Road, Binjiang District,  
Hangzhou, Zhejiang, China

(540)

# Geometry

(591) Black, white

(531) 27.05.01

(511)

12 – Automobiles; automobile chassis; vehicle seats; brakes for vehicles; electric vehicles; vehicles for locomotion by land, air, water or rail; gear boxes for land vehicles; propulsion mechanisms for land vehicles; motorcycles; tyres for vehicle wheels.

37 – Motor vehicle maintenance and repair; automobile engine oil replacement services (on-site service); customized installation of automotive interiors; electric vehicles repair and maintenance; vehicle battery charging; vehicle service stations [refuelling and maintenance]; construction; machinery installation, maintenance and repair; retreading of tires; rubber tire repair.

(260) AM 2020 107199 A

(800) 1515023

(151) 2019 12 27

(891) 2019 12 27

(731) International Fruit Genetics, LLC  
8224 Espresso Drive, Suite 200, Bakersfield  
CA 93312, USA

(540)

## SWEET NECTAR

(591) Black, white

(511)

29 – Preserved, dried and cooked fruits and vegetables; jellies, jams and compotes; milk and milk products.

30 – Confectionary; ice cream, sorbets and other edible ices; seasonings, spices; sauces and other condiments.

31 – Fresh fruits and vegetables; grape vines, plants and plant propagating material.

(260) AM 2020 107409 A

(800) 1517599

(151) 2020 01 09

(891) 2020 01 09

(731) Pandora A/S

Havneholmen 17-19, DK-1561 Copenhagen  
V, Denmark

(540)

# PANDORA

## SOMETHING ABOUT YOU

(591) Black, white

(531) 24.09.02; 24.09.03; 24.09.05; 24.09.09;  
24.09.14; 27.05.01; 27.05.07

(511)

14 – Precious metals and their alloys; jewellery; precious and semi-precious stones; horological and chronometric instruments; paste jewellery; jewellery made of precious metals, gemstones, pearls, natural or artificial precious or semi-precious stones and imitations thereof; cufflinks; ornamental pins; watches; watch straps; watch chains; cases for jewellery and watches; charms for key rings; key rings; key chains; clasps for jewellery; jewellery boxes; tie pins; tie clips; jewel pendants; trinkets [jewellery]; ornaments [jewellery]; shoe jewellery; pet jewellery; key chains as jewellery [trinkets or fobs]; dress and bag ornaments in the nature of jewellery; decorative articles [trinkets or jewellery] for personal use.

(260) AM 2020 107410 A

(800) 1517648

(151) 2019 05 20

(891) 2019 05 20

(731) frostkrone Tiefkühlkost GmbH  
Konrad-Adenauer-Str. 28; 33397 Rietberg,  
Germany

(540)



(591) Green, white

(531) 24.17.25; 26.13.25; 27.05.10; 29.01.03

(511)

29 – Meat; fish; poultry; game; preserved, dried and cooked fruits and vegetables; milk; milk products; snack foods based on vegetables; meat-based appetisers; cottage cheese fritters; cheese sticks; French fries; frozen meals consisting of seafood; frozen prepared meals consisting principally of vegetables; potato snacks; potato fritters; cheese-based snack foods.

30 – Rice; edible ices; flour based savoury snacks; fruit fritters; pastries, cakes, tarts and biscuits (cookies); frozen pastries; pancakes; non-medicated flour confectionery; snack foods consisting principally of confectionery; cereal-based snack food; snacks made from potato flour; snack foods made from corn; rice-based snack food; rice-based prepared meals; ready-made dishes containing pasta; prepared meals containing [principally] pasta; flaky pastry containing ham; spring rolls; burritos; calzones; savory biscuits; croissants; confectionery in frozen form; prepared desserts [pastries]; pastries consisting of vegetables and fish; frozen pastry stuffed with meat and vegetables; frozen pastry filled with meat; frozen pastry stuffed with vegetables; filled pasta (frozen); ready-made dishes containing pasta; filo pastry; puff pastry; empanadas; enchiladas; fajitas; prepared pizza meals; sushi; wontons; wraps [sandwich]; vegetable fritters.

43 – Snack-bars and restaurants.

(260) AM 2020 107411 A

(800) 1517651

(151) 2019 05 20

(891) 2019 05 20

(731) frostkrone Tiefkühlkost GmbH  
Konrad-Adenauer-Str. 28, 33397 Rietberg,  
Germany

(540)



(591) Green, white

(531) 24.17.25; 26.13.25; 27.05.01; 29.01.12

(511)

29 – Meat; fish; poultry; game; preserved, dried and cooked fruits and vegetables; milk; milk products; snack foods based on vegetables; meat-based appetisers; cottage cheese fritters; cheese sticks; French fries; frozen meals consisting of seafood; frozen prepared meals consisting principally of vegetables; potato snacks; potato fritters; cheese-based snack foods.

30 – Rice; edible ices; flour based savoury snacks; fruit fritters; pastries, cakes, tarts and biscuits (cookies); frozen pastries; pancakes; non-medicated flour confectionery; snack foods consisting principally of confectionery; cereal-based snack food; snacks made from potato flour; snack foods made from corn; rice-based snack food; rice-based prepared meals; ready-made dishes containing pasta; prepared meals containing [principally] pasta; flaky pastry containing ham; spring rolls; burritos; calzones; savory biscuits; croissants; confectionery in frozen form; prepared desserts [pastries]; pastries consisting of vegetables and fish; frozen pastry stuffed with meat and vegetables; frozen pastry filled with meat; frozen pastry stuffed with vegetables; filled pasta (frozen); ready-made dishes containing pasta; filo pastry; puff pastry; empanadas; enchiladas; fajitas; prepared pizza meals; sushi; wontons; wraps [sandwich]; vegetable fritters.

43 – Snack-bars and restaurants.

(260) AM 2020 107412 A

(800) 1517660

(151) 2019 05 03

(891) 2019 05 03

(731) frostkrone Tiefkühlkost GmbH  
Konrad-Adenauer-Str. 28, 33397 Rietberg,  
Germany

(540)



(591) Green, white

(531) 24.17.25; 26.13.25; 27.05.10; 29.01.12

(511)

29 – Meat; fish; poultry; game; preserved, dried and cooked fruits and vegetables; milk; milk products; snack foods based on vegetables; meat-based appetisers; cottage cheese fritters; cheese sticks; French fries; frozen meals consisting of seafood; frozen prepared meals consisting principally of vegetables; potato snacks; potato fritters; cheese-based snack foods.

30 – Rice; edible ices; flour based savoury snacks; fruit fritters; pastries, cakes, tarts and biscuits (cookies); frozen pastries; pancakes; non-medicated flour confectionery; snack foods consisting principally of confectionery; cereal-based snack food; snacks made from potato flour; snack foods made from corn; rice-based snack food; rice-based prepared meals; ready-made dishes containing pasta; prepared meals con-

taining [principally] pasta; flaky pastry containing ham; spring rolls; burritos; calzones; savory biscuits; croissants; confectionery in frozen form; prepared desserts [pastries]; pastries consisting of vegetables and fish; frozen pastry stuffed with meat and vegetables; frozen pastry filled with meat; frozen pastry stuffed with vegetables; filled pasta (frozen); ready-made dishes containing pasta; filo pastry; puff pastry; empanadas; enchiladas; fajitas; prepared pizza meals; sushi; wontons; wraps [sandwich]; vegetable fritters.

43 – Snack-bars and restaurants.

(260) AM 2020 107413 A

(800) 1517690

(151) 2019 12 12

(891) 2019 12 12

(731) YUXINOU (CHONGQING) SUPPLY CHAIN MANAGEMENT CO.

604, No. 1-39, Western Logistics Center, Chongqing Road, Transportation (Group) Co., Ltd, Western Modern Logistics Park, Shapingba District, Chongqing, China

(540)

# 渝新欧

(591) Black, white

(531) 28.03

(511)

3 – Shampoos; cleaning preparations; polishing preparations; abrasive cloth; perfumery; cosmetics; dentifrices; incense; cosmetics for animals; air fragrancing preparations.

21 – Utensils for household purposes; glass flasks [containers]; ceramics for household purposes; China ornament; tea services [tableware]; toilet utensils; brushes; cosmetic utensils; heat-insulated containers; cleaning instruments, hand-operated.

29 – Meat; fish-based foodstuffs; fruit-based snack food; vegetables, preserved; eggs; milk products; edible fats.

30 – Honey; noodles; starch for food; ice cream; yeast; preparations for stiffening whipped cream; gluten prepared as foodstuff; meat tenderizers for household purposes; wheat flour; pastries; coffee; tea; tea-based beverages; sugar; candy; jiaozi [stuffed dumplings]; condiments; aromatic preparations for food; cereals, processed; groats for human food; cereal-based snack food; freeze-dried dishes with the main ingredient being rice; bulgur; instant rice.

31 – Undressed timber; grains [cereals]; plants; live animals; fruit, fresh; vegetables, fresh; seeds for pla-

ning; animal foodstuffs; malt for brewing and distilling.

32 – Beer; non-alcoholic fruit extracts; waters [beverages]; must; colas [soft drinks]; non-alcoholic beverages; syrups for beverages.

33 – Alcoholic beverages containing fruit; sake; cocktails; wine; baijiu [Chinese distilled alcoholic beverage]; fruit extracts, alcoholic; spirits [beverages]; rice alcohol.

43 – Accommodation bureau services [hotels, boarding houses]; café services; hotel services; bar services; providing campground facilities; retirement home services; day-nursery [crèche] services; boarding for animals; rental of chairs, tables, table linen, glassware; rental of drinking water dispensers.

45 – Monitoring of burglar and security alarms; escorting in society [chaperoning]; clothing rental; funerary undertaking; fire-fighting; dating services; adoption agency services; planning and arranging of wedding ceremony; rental of safes; intellectual property consultancy.

(260) AM 2020 107415 A

(800) 1517744

(151) 2019 11 22

(891) 2019 11 22

(731) Obshchestvo s ogranichennoy otvetstvennostyu "ProfHolod" territoria Agrokhim, str. 58, Shchelkovsky r-n, g. Shchelkovo, RU-141101 Moskovskaya oblast, Russian Federation

(540)



(591) Orange, blue, dark grey

(531) 26.11.03; 26.11.06; 26.11.09; 29.01.13

(511)

6 – Metal materials for building and construction; transportable buildings of metal; anchors; bolts of metal; eye bolts; valves of metal, other than parts of machines; screws of metal; sleeves [metal hardware]; nuts of metal; doors of metal; folding doors of metal; swing doors of metal; prefabricated houses [kits] of metal; wall plugs of metal; roof gutters of metal; street gutters of metal; door bolts of metal; rivets of metal; locks of metal, other than electric; spring locks; closures of metal for containers; plugs

of metal; latches of metal; paint spraying booths of metal; framework of metal for building; skating rinks [structures] of metal; door fittings of metal; fittings of metal for windows; buildings of metal; buildings, transportable, of metal; steel buildings; door frames of metal; roofing of metal; roofing of metal, incorporating photovoltaic cells; steel sheets; building materials of metal; refractory construction materials of metal; sheets and plates of metal; moldings of metal for building; porches [structures] of metal; flashing of metal for building; roof flashing of metal; duckboards of metal; wall claddings of metal for building; wall linings of metal for building; metal ramps for use with vehicles; wainscotting of metal; building panels of metal; partitions of metal; strap-hinges of metal; slabs of metal for building; roof coverings of metal; cladding of metal for building; linings of metal for building; sills of metal; ceilings of metal; door openers, non-electric; frames of metal for building; pigsties of metal; angle irons of metal; door fasteners of metal; aluminium foil; foils of metal for wrapping and packaging; zinc; washers of metal; latch bars of metal; labels of metal.

11 – Apparatus and installations for lighting, heating, cooling, steam generating, cooking, drying, ventilating, water supply and sanitary purposes; cool boxes, electric; refrigerating chambers; thermostatic valves [parts of heating installations]; cooling installations and machines; refrigerators, cooling apparatus and freezers for medical storage purposes; refrigerating cabinets; heating elements.

17 – Unprocessed and semi-processed rubber, gutta-percha, gum, asbestos, mica and substitutes for all these materials; plastics and resins in extruded form for use in manufacture; packing, stopping and insulating materials; flexible pipes, tubes and hoses, not of metal; mineral wool [insulator]; duct tapes; insulating tapes; weatherstripping compositions; sound-proofing materials; insulating materials; insulating refractory materials; non-conducting materials for retaining heat; boiler composition to prevent the radiation of heat; sealant compounds for joints; compositions to prevent the radiation of heat; pipe muffers, not of metal; glass wool for insulation; fiberglass for insulation; waterproof packings; foils of metal for insulating.

19 – Materials, not of metal, for building and construction; transportable buildings, not of metal; door frames, not of metal; buildings, not of metal; buildings, transportable, not of metal; wall claddings, not of metal, for building; wall linings, not of metal, for building; windows, not of metal; wainscotting, not of metal; building panels, not of metal; roof coverings, not of metal; roofing, not of metal, incorporating photovoltaic cells; linings, not of metal, for building; plywood.

35 – Advertising; business management; rental of advertising space; demonstration of goods; market studies; business information; commercial information and advice for consumers in the choice of products and services; business research; layout services for advertising purposes; marketing; design of advertising materials; providing business information via a web site; provision of an online marketplace for buyers and sellers of goods and services; presentation of goods on communication media, for retail purposes; media relations services; sales promotion for others; promotion of goods and services through sponsorship of sports events; publication of publicity texts; radio advertising; distribution of samples; dissemination of advertising matter; direct mail advertising; registration of written communications and data; bill-posting; advertising by mail order; television advertising; administrative processing of purchase orders.

37 – Building construction; repair; installation services; construction information; construction consultancy; building sealing; building insulating; riveting; roofing services; warehouse construction and repair; factory construction; building of fair stalls and shops; installation of doors and windows; freezing equipment installation and repair.

42 – Scientific and technological services and research and design relating thereto; industrial analysis and industrial research services; engineering; material testing; research in the field of building construction; research in the field of physics; chemical research; research and development of new products for others; scientific research; technological research; calibration [measuring]; provision of scientific information, advice and consultancy in relation to carbon offsetting; construction drafting; consultancy in the field of energy-saving; technical writing; chemistry services.

(260) AM 2020 107416 A

(800) 1517795

(151) 2019 11 26

(891) 2019 11 26

(731) Samsung Electronics Co., Ltd.

129, Samsung-ro, Yeongtong-gu, Suwon-si,  
Gyeonggi-do, Republic of Korea

(540)



(591) Black, white

(531) 01.15.15

(511)

7 – Robotic vacuum cleaners; dish washing machines for household purposes; washing machines for household purposes; vacuum cleaners; vacuum cleaner bags; daily chores helping robots for household purposes.

11 – LED lamps; LED light bulbs; electric clothes management apparatus in the nature of garment steamers for household purposes; electric clothes management machines for drying clothes for household purposes; electric cooking ovens; dehumidifiers for household use; air purifiers; filters for air purifiers; electric fans; air conditioners; electric refrigerators; electric ranges; electric laundry dryers; microwave ovens; apparatus for cooking, namely, cook-tops; outdoor condensers, namely, outdoor air condensers for air conditioners; cooking apparatus and installations; air humidifiers.

14 – Wristwatches; clocks; watchbands; parts and fittings for watches; electronic clocks and watches; control clocks (master clocks); bracelets (jewelry); watches incorporating cameras; watches incorporating MP3 players; watch straps; necklaces; rings (jewelry).

(260) AM 2020 107417 A

(800) 1517847

(151) 2020 01 13

(891) 2020 01 13

(731) Bayer Aktiengesellschaft

Kaiser-Wilhelm-Allee, 51373 Leverkusen,  
Germany

(540)



(591) Black, white

(531) 26.01.02; 26.01.05; 26.01.06

(511)

5 – Pharmaceutical preparations.

(260) AM 2020 107420 A

(800) 1518000

(151) 2020 01 31

(891) 2020 01 31

(731) KIA MOTORS CORPORATION

12, Heolleung-ro, Seocho-gu, Seoul 06797,  
Republic of Korea

(540)



(591) Black, white

(531) 26.04.19; 27.05.01; 27.05.02; 27.05.21;  
27.05.24

(511)

12 – Automobiles.

(260) AM 2020 107422 A

(800) 1518028

(151) 2019 09 09

(891) 2019 09 09

(731) HUILERIE CROIX VERTE

Z.A.de la Ronde, 138 rue de l'Aunay,  
F-49650 ALLONNES, France

(540)



(591) Blown, white

(531) 07.01.01; 07.01.24; 26.01.02; 26.01.03;  
26.01.16; 27.01.12; 29.01.05

(511)

29 – Edible oils and fats; spiced oils; flavored edible oils; vegetable oils for food use; olive oil; coconut oil; coconut oil; corn oil; sesame oil; chili oil; peanut oil; canola oil; soya oil; butter oil; nut oils; cooking oils; hardened oils [hydrogenated oil for food]; sunflower oil for food; palm oil for food; colza oil for food; rape oil for food; truffle oil; soybean oil for food; linseed oil for food; palm oil for food; mixing oil for food; rice bran oil for food; whale oil for food; perilla oil for culinary purposes; palm kernel oil for food; palm kernel oil for food; grape seed oil for food; camellia seed oil for food; linseed oil for food use; pumpkin seed oil for food; chia seed oil for food; edible bone oil; animal oils for food; hydrogenated oils for food; vegetables preserved in oil; olives stuffed with pesto in sunflower oil; olives stuffed with feta cheese in sunflower oil; butter.

30 – Aromatic preparations and seasonings; condiments; spices; salts; processed kitchen herbs; dried herbs; preserved herbs; chili oil for seasoning or condiment; coffee oil; vinegar; flavored vinegar; vinaigrettes (French dressings); mayonnaise; mayonnaise-based sauces; spreads made with mayonnaise; spreads made with mayonnaise and ketchup; prepa-

red foodstuffs in the form of sauces; sauce [for food]; food sauces; sauces [condiments]; concentrated sauce; spicy sauces; hot sauce; chili sauce; ketchup [sauce]; teriyaki sauce; satay sauce; spaghetti sauce; tomato sauce; barbecue sauce; tartar sauce; soy sauce; pesto [sauce]; Worcestershire sauce; remoulade; kebab sauce; sambal sauces; cheese sauce; sweet and sour sauce; oyster sauce; shrimp sauce; pasta sauce; sauces for rice; salad dressings; pizza sauces; curry sauce; chicken sauce; mushroom sauces; red pepper sauce; Fish sauces; horseradish sauce; pepper sauce; fish sauce; meat gravies; herb-based sauces; truffle cream sauces; powders for sauces; preparations for sauces; chocolate sauce; apple sauce [condiment]; fruit coulis [sauces]; ice cream sauces; cranberry sauce [condiment]; dry-fruit-flavored sauces; sauces with nuts; confectionery based on sesame oil; marinades; marinades containing seasonings; marinades containing herbs; sweet marinade [condiment]; marinated and preserved condiments [pickles].

---

---

**INTERNATIONAL TRADEMARKS PROTECTED  
IN GEORGIA**

(260) AM 2020 102091 A  
(800) 1454014  
(151) 2018 10 03  
(181) 2028 10 03  
(891) 2018 10 03  
(511) 01, 07, 16, 17, 19, 22, 24, 27

---

(260) AM 2020 104044 A  
(800) 1477166  
(151) 2019 05 16  
(181) 2029 05 16  
(891) 2019 05 16  
(511) 32

---

(260) AM 2020 102182 A  
(800) 1454950  
(151) 2019 01 28  
(181) 2029 01 28  
(891) 2019 01 28  
(511) 33

---

(260) AM 2020 104146 A  
(800) 1477693  
(151) 2019 05 16  
(181) 2029 05 16  
(891) 2019 05 16  
(511) 32

---

(260) AM 2020 102678 A  
(800) 946227  
(151) 2007 11 21  
(181) 2027 11 21  
(891) 2019 03 06  
(511) 30

---

(260) AM 2020 104382 A  
(800) 1480461  
(151) 2019 02 26  
(181) 2029 02 26  
(891) 2019 02 26  
(511) 09, 38, 39, 42

---

(260) AM 2020 102856 A  
(800) 1462587  
(151) 2018 11 20  
(181) 2028 11 20  
(891) 2018 11 20  
(511) 06, 09, 19, 20

---

(260) AM 2020 104497 A  
(800) 1481413  
(151) 2019 04 16  
(181) 2029 04 16  
(891) 2019 04 16  
(511) 05

---

(260) AM 2020 103551 A  
(800) 1177012  
(151) 2013 01 04  
(181) 2023 01 04  
(891) 2019 05 13  
(511) 20, 24, 35

---

(260) AM 2020 104570 A  
(800) 1482090  
(151) 2019 05 27  
(181) 2029 05 27  
(891) 2019 05 27  
(511) 30

---

(260) AM 2020 103716 A  
(800) 1472908  
(151) 2019 02 27  
(181) 2029 02 27  
(891) 2019 02 27  
(511) 05

---

(260) AM 2020 104603 A  
(800) 1482982  
(151) 2019 03 25  
(181) 2029 03 25  
(891) 2019 03 25  
(511) 03

---

(260) AM 2020 103723 A  
(800) 1473145  
(151) 2019 05 14  
(181) 2029 05 14  
(891) 2019 05 14  
(511) 09

---

(260) AM 2020 104704 A  
(800) 1484895  
(151) 2019 07 04  
(181) 2029 07 04  
(891) 2019 07 04  
(511) 09, 34

---

(260) AM 2020 104723 A  
(800) 1485251  
(151) 2019 05 15  
(181) 2029 05 15  
(891) 2019 05 15  
(511) 10, 42, 44

---

(260) AM 2020 104785 A  
(800) 1485790  
(151) 2019 03 24  
(181) 2029 03 24  
(891) 2019 03 24  
(511) 38, 41

---

(260) AM 2020 104786 A  
(800) 1485791  
(151) 2019 03 24  
(181) 2029 03 24  
(891) 2019 03 24  
(511) 38, 41

---

(260) AM 2020 104787 A  
(800) 1485870  
(151) 2019 05 31  
(181) 2029 05 31  
(891) 2019 05 31  
(511) 09

---

(260) AM 2020 104790 A  
(800) 1485962  
(151) 2019 06 27  
(181) 2029 06 27  
(891) 2019 06 27  
(511) 33

---

(260) AM 2020 104796 A  
(800) 1486143  
(151) 2019 05 10  
(181) 2029 05 10  
(891) 2019 05 10  
(511) 09, 28, 41

---

(260) AM 2020 104843 A  
(800) 1486329  
(151) 2018 12 22  
(181) 2028 12 22  
(891) 2018 12 22  
(511) 35, 36, 39, 42

---

(260) AM 2020 104844 A  
(800) 1486333  
(151) 2019 04 15  
(181) 2029 04 15

(891) 2019 04 15  
(511) 07, 09, 11, 12

---

(260) AM 2020 104852 A  
(800) 1486547  
(151) 2019 07 23  
(181) 2029 07 23  
(891) 2019 07 23  
(511) 09

---

(260) AM 2020 104853 A  
(800) 1486612  
(151) 2019 03 29  
(181) 2029 03 29  
(891) 2019 03 29  
(511) 32, 33

---

(260) AM 2020 104854 A  
(800) 1486637  
(151) 2019 06 27  
(181) 2029 06 27  
(891) 2019 06 27  
(511) 06, 09, 20, 22, 24, 25, 35, 37

---

(260) AM 2020 104855 A  
(800) 1486736  
(151) 2018 11 29  
(181) 2028 11 29  
(891) 2018 11 29  
(511) 03, 09, 14, 18, 24, 25

---

(260) AM 2020 104856 A  
(800) 1486739  
(151) 2019 06 06  
(181) 2029 06 06  
(891) 2019 06 06  
(511) 03, 05

---

(260) AM 2020 104857 A  
(800) 1486743  
(151) 2019 04 24  
(181) 2029 04 24  
(891) 2019 04 24  
(511) 41

---

(260) AM 2020 104858 A  
(800) 1486754  
(151) 2019 07 16  
(181) 2029 07 16  
(891) 2019 07 16  
(511) 41  
(551) Collective

---



(260) AM 2020 104860 A  
(800) 1486811  
(151) 2019 05 09  
(181) 2029 05 09  
(891) 2019 05 09  
(511) 32

---

(260) AM 2020 104861 A  
(800) 1486833  
(151) 2019 05 17  
(181) 2029 05 17  
(891) 2019 05 17  
(511) 28

---

(260) AM 2020 104862 A  
(800) 1486867  
(151) 2019 06 26  
(181) 2029 06 26  
(891) 2019 06 26  
(511) 29, 30

---

(260) AM 2020 104868 A  
(800) 1486983  
(151) 2019 05 10  
(181) 2029 05 10  
(891) 2019 05 10  
(511) 09, 28, 41

---

(260) AM 2020 104870 A  
(800) 1487005  
(151) 2019 05 10  
(181) 2029 05 10  
(891) 2019 05 10  
(511) 09, 28, 41

---

(260) AM 2020 104872 A  
(800) 1487024  
(151) 2019 07 15  
(181) 2029 07 15  
(891) 2019 07 15  
(511) 07, 37, 42

---

(260) AM 2020 104874 A  
(800) 1487032  
(151) 2019 05 27  
(181) 2029 05 27  
(891) 2019 05 27  
(511) 09, 12, 38, 39

---

(260) AM 2020 104875 A  
(800) 1487035  
(151) 2019 05 15  
(181) 2029 05 15

(891) 2019 05 15  
(511) 03, 05, 17

---

(260) AM 2020 104878 A  
(800) 1487082  
(151) 2019 06 12  
(181) 2029 06 12  
(891) 2019 06 12  
(511) 02

---

(260) AM 2020 104946 A  
(800) 1487196  
(151) 2019 03 12  
(181) 2029 03 12  
(891) 2019 03 12  
(511) 12

---

(260) AM 2020 104947 A  
(800) 1487267  
(151) 2019 05 10  
(181) 2029 05 10  
(891) 2019 05 10  
(511) 09, 28, 41

---

(260) AM 2020 104950 A  
(800) 1487305  
(151) 2019 03 04  
(181) 2029 03 04  
(891) 2019 03 04  
(511) 03, 05, 21

---

(260) AM 2020 104951 A  
(800) 1487309  
(151) 2019 07 18  
(181) 2029 07 18  
(891) 2019 07 18  
(511) 04

---

(260) AM 2020 104952 A  
(800) 1487318  
(151) 2019 07 26  
(181) 2029 07 26  
(891) 2019 07 26  
(511) 05, 10

---

(260) AM 2020 104954 A  
(800) 1487395  
(151) 2019 05 10  
(181) 2029 05 10  
(891) 2019 05 10  
(511) 09, 28, 41

---

(260) AM 2020 104955 A  
(800) 1487398  
(151) 2019 05 07  
(181) 2029 05 07  
(891) 2019 05 07  
(511) 06, 11, 12, 20, 21, 35

---

(260) AM 2020 104956 A  
(800) 1487417  
(151) 2019 05 10  
(181) 2029 05 10  
(891) 2019 05 10  
(511) 09, 28, 41

---

(260) AM 2020 104957 A  
(800) 1487472  
(151) 2019 05 27  
(181) 2029 05 27  
(891) 2019 05 27  
(511) 09, 12, 38, 39

---

(260) AM 2020 104959 A  
(800) 1487507  
(151) 2019 07 18  
(181) 2029 07 18  
(891) 2019 07 18  
(511) 04

---

(260) AM 2020 104960 A  
(800) 1487518  
(151) 2019 07 15  
(181) 2029 07 15  
(891) 2019 07 15  
(511) 29, 30, 32

---

(260) AM 2020 104961 A  
(800) 1487521  
(151) 2019 07 30  
(181) 2029 07 30  
(891) 2019 07 30  
(511) 09

---

(260) AM 2020 104962 A  
(800) 1487577  
(151) 2019 07 29  
(181) 2029 07 29  
(891) 2019 07 29  
(511) 34

---

(260) AM 2020 104967 A  
(800) 1487697  
(151) 2019 05 10  
(181) 2029 05 10

(891) 2019 05 10  
(511) 09, 28, 41

---

(260) AM 2020 104968 A  
(800) 1487739  
(151) 2019 05 31  
(181) 2029 05 31  
(891) 2019 05 31  
(511) 09

---

(260) AM 2020 104969 A  
(800) 1487792  
(151) 2019 05 02  
(181) 2029 05 02  
(891) 2019 05 02  
(511) 35, 36, 38, 41, 42, 45

---

(260) AM 2020 104970 A  
(800) 1487807  
(151) 2019 06 05  
(181) 2029 06 05  
(891) 2019 06 05  
(511) 05

---

(260) AM 2020 104971 A  
(800) 1487818  
(151) 2019 05 10  
(181) 2029 05 10  
(891) 2019 05 10  
(511) 09, 35, 38, 41, 42

---

(260) AM 2020 104972 A  
(800) 1487828  
(151) 2019 05 10  
(181) 2029 05 10  
(891) 2019 05 10  
(511) 09, 35, 38, 41, 42

---

(260) AM 2020 104973 A  
(800) 1487830  
(151) 2019 05 10  
(181) 2029 05 10  
(891) 2019 05 10  
(511) 09, 35, 38, 41, 42

---

(260) AM 2020 104974 A  
(800) 1487859  
(151) 2019 05 10  
(181) 2029 05 10  
(891) 2019 05 10  
(511) 09, 28, 41

---

(260) AM 2020 104975 A  
(800) 1487866  
(151) 2019 08 02  
(181) 2029 08 02  
(891) 2019 08 02  
(511) 11

---

(260) AM 2020 104976 A  
(800) 1487907  
(151) 2018 11 29  
(181) 2028 11 29  
(891) 2018 11 29  
(511) 03, 09, 14, 18, 24, 25

---

(260) AM 2020 104977 A  
(800) 1487924  
(151) 2019 04 02  
(181) 2029 04 02  
(891) 2019 04 02  
(511) 09, 38, 42, 45

---

(260) AM 2020 104978 A  
(800) 1487951  
(151) 2019 08 20  
(181) 2029 08 20  
(891) 2019 08 20  
(511) 03

---

(260) AM 2020 104983 A  
(800) 1488091  
(151) 2019 07 16  
(181) 2029 07 16  
(891) 2019 07 16  
(511) 09, 28

---

(260) AM 2020 104988 A  
(800) 1488170  
(151) 2019 05 10  
(181) 2029 05 10  
(891) 2019 05 10  
(511) 09, 28, 41

---

(260) AM 2020 104989 A  
(800) 249539  
(151) 1961 11 14  
(181) 2021 11 14  
(891) 2019 06 14  
(511) 05

---

(260) AM 2020 104991 A  
(800) 1050778  
(151) 2010 03 15  
(181) 2020 03 15

(891) 2019 08 30  
(511) 30

---

(260) AM 2020 104992 A  
(800) 1127500  
(151) 2012 04 05  
(181) 2022 04 05  
(891) 2019 06 26  
(511) 05

---

(260) AM 2020 104993 A  
(800) 1226773  
(151) 2014 10 02  
(181) 2024 10 02  
(891) 2019 06 20  
(511) 05

---

(260) AM 2020 104994 A  
(800) 1310972  
(151) 2016 04 21  
(181) 2026 04 21  
(891) 2019 06 17  
(511) 05

---

(260) AM 2020 105047 A  
(800) 1488241  
(151) 2019 06 07  
(181) 2029 06 07  
(891) 2019 06 07  
(511) 05

---

(260) AM 2020 105049 A  
(800) 1488260  
(151) 2019 04 24  
(181) 2029 04 24  
(891) 2019 04 24  
(511) 07, 12, 17, 20, 28

---

(260) AM 2020 105050 A  
(800) 1488271  
(151) 2019 04 24  
(181) 2029 04 24  
(891) 2019 04 24  
(511) 07, 12, 17, 20, 28

---

(260) AM 2020 105051 A  
(800) 1488294  
(151) 2019 04 18  
(181) 2029 04 18  
(891) 2019 04 18  
(511) 16, 18, 21, 25, 28, 29, 30, 32, 41

---

(260) AM 2020 105052 A  
(800) 1488334  
(151) 2019 04 24  
(181) 2029 04 24  
(891) 2019 04 24  
(511) 30

---

(260) AM 2020 105053 A  
(800) 1488338  
(151) 2019 07 22  
(181) 2029 07 22  
(891) 2019 07 22  
(511) 14, 18, 25, 26

---

(260) AM 2020 105061 A  
(800) 1488549  
(151) 2019 05 10  
(181) 2029 05 10  
(891) 2019 05 10  
(511) 09, 28, 41

---

(260) AM 2020 105062 A  
(800) 1488562  
(151) 2019 07 25  
(181) 2029 07 25  
(891) 2019 07 25  
(511) 03

---

(260) AM 2020 105063 A  
(800) 1488572  
(151) 2019 06 14  
(181) 2029 06 14  
(891) 2019 06 14  
(511) 33

---

(260) AM 2020 105064 A  
(800) 1488590  
(151) 2019 05 24  
(181) 2029 05 24  
(891) 2019 05 24  
(511) 02, 04, 06, 07, 08, 09, 11, 12, 20, 22

---

(260) AM 2020 105070 A  
(800) 1488690  
(151) 2019 05 10  
(181) 2029 05 10  
(891) 2019 05 10  
(511) 09, 28, 41

---

(260) AM 2020 105071 A  
(800) 1488708  
(151) 2019 05 10  
(181) 2029 05 10

(891) 2019 05 10  
(511) 09, 28, 41

---

(260) AM 2020 105073 A  
(800) 1488801  
(151) 2019 06 13  
(181) 2029 06 13  
(891) 2019 06 13  
(511) 05

---

(260) AM 2020 105074 A  
(800) 1488839  
(151) 2019 07 05  
(181) 2029 07 05  
(891) 2019 07 05  
(511) 09, 41

---

(260) AM 2020 105075 A  
(800) 1488861  
(151) 2019 07 24  
(181) 2029 07 24  
(891) 2019 07 24  
(511) 03, 05

---

(260) AM 2020 105076 A  
(800) 1488924  
(151) 2019 06 19  
(181) 2029 06 19  
(891) 2019 06 19  
(511) 09, 26

---

(260) AM 2020 105079 A  
(800) 1488963  
(151) 2019 08 16  
(181) 2029 08 16  
(891) 2019 08 16  
(511) 30

---

(260) AM 2020 105080 A  
(800) 1488982  
(151) 2019 08 07  
(181) 2029 08 07  
(891) 2019 08 07  
(511) 05

---

(260) AM 2020 105090 A  
(800) 1489267  
(151) 2019 05 09  
(181) 2029 05 09  
(891) 2019 05 09  
(511) 07, 11, 12, 18, 21, 28

---

(260) AM 2020 105091 A  
(800) 1489281  
(151) 2019 05 29  
(181) 2029 05 29  
(891) 2019 05 29  
(511) 16

---

(260) AM 2020 105092 A  
(800) 1489297  
(151) 2019 03 15  
(181) 2029 03 15  
(891) 2019 03 15  
(511) 03, 05

---

(260) AM 2020 105094 A  
(800) 1489311  
(151) 2019 07 03  
(181) 2029 07 03  
(891) 2019 07 03  
(511) 29

---

(260) AM 2020 105095 A  
(800) 1489325  
(151) 2019 04 01  
(181) 2029 04 01  
(891) 2019 04 01  
(511) 09, 16, 35, 41, 42

---

(260) AM 2020 105096 A  
(800) 1489375  
(151) 2019 04 05  
(181) 2029 04 05  
(891) 2019 04 05  
(511) 04, 06, 07, 08, 09, 11, 12, 18, 20, 21, 25, 30,  
37

---

(260) AM 2020 105097 A  
(800) 1489384  
(151) 2019 07 01  
(181) 2029 07 01  
(891) 2019 07 01  
(511) 02, 03, 06, 07, 08, 17, 19, 20, 21

---

(260) AM 2020 105098 A  
(800) 1489391  
(151) 2019 03 21  
(181) 2029 03 21  
(891) 2019 03 21  
(511) 07

---

(260) AM 2020 105100 A  
(800) 1489423  
(151) 2019 03 20

(181) 2029 03 20  
(891) 2019 03 20  
(511) 07, 08, 09, 11, 12, 20, 21, 28, 35, 36, 38, 41, 42

---

(260) AM 2020 105101 A  
(800) 1489432  
(151) 2019 03 20  
(181) 2029 03 20  
(891) 2019 03 20  
(511) 07, 08, 09, 11, 12, 20, 21, 28, 35, 36, 38, 41, 42

---

(260) AM 2020 105103 A  
(800) 1489556  
(151) 2019 08 12  
(181) 2029 08 12  
(891) 2019 08 12  
(511) 12

---

(260) AM 2020 105104 A  
(800) 1489560  
(151) 2019 04 09  
(181) 2029 04 09  
(891) 2019 04 09  
(511) 06, 07, 09, 11

---

(260) AM 2020 105105 A  
(800) 1489562  
(151) 2019 07 01  
(181) 2029 07 01  
(891) 2019 07 01  
(511) 06, 07

---

(260) AM 2020 105106 A  
(800) 1489565  
(151) 2019 04 16  
(181) 2029 04 16  
(891) 2019 04 16  
(511) 07, 08, 09, 10, 11, 12, 18, 20, 21, 25, 28, 37

---

(260) AM 2020 105107 A  
(800) 1489569  
(151) 2019 06 14  
(181) 2029 06 14  
(891) 2019 06 14  
(511) 33

---

(260) AM 2020 105108 A  
(800) 1489577  
(151) 2019 06 28  
(181) 2029 06 28  
(891) 2019 06 28  
(511) 03

---

(260) AM 2020 105113 A  
(800) 1229206  
(151) 2014 05 19  
(181) 2024 05 19  
(891) 2019 09 10  
(511) 09, 10, 37

---

(260) AM 2020 105114 A  
(800) 1346666  
(151) 2017 02 25  
(181) 2027 02 25  
(891) 2019 09 04  
(511) 36, 40

---

(260) AM 2020 105160 A  
(800) 1489598  
(151) 2019 05 23  
(181) 2029 05 23  
(891) 2019 05 23  
(511) 03, 05, 10, 32

---

(260) AM 2020 105161 A  
(800) 1489613  
(151) 2019 05 15  
(181) 2029 05 15  
(891) 2019 05 15  
(511) 21, 29, 30, 32, 35, 43

---

(260) AM 2020 105162 A  
(800) 1489651  
(151) 2019 08 01  
(181) 2029 08 01  
(891) 2019 08 01  
(511) 32

---

(260) AM 2020 105163 A  
(800) 1489681  
(151) 2019 07 30  
(181) 2029 07 30  
(891) 2019 07 30  
(511) 09

---

(260) AM 2020 105164 A  
(800) 1489745  
(151) 2019 07 10  
(181) 2029 07 10  
(891) 2019 07 10  
(511) 03, 05

---

(260) AM 2020 105165 A  
(800) 1489785  
(151) 2019 03 26  
(181) 2029 03 26

(891) 2019 03 26  
(511) 35, 36, 38, 39

---

(260) AM 2020 105173 A  
(800) 1489961  
(151) 2019 08 01  
(181) 2029 08 01  
(891) 2019 08 01  
(511) 33

---

(260) AM 2020 105178 A  
(800) 1490089  
(151) 2019 07 30  
(181) 2029 07 30  
(891) 2019 07 30  
(511) 05, 29, 30, 32

---

(260) AM 2020 105179 A  
(800) 1490095  
(151) 2019 05 10  
(181) 2029 05 10  
(891) 2019 05 10  
(511) 09, 28, 41

---

(260) AM 2020 105184 A  
(800) 1490240  
(151) 2019 08 15  
(181) 2029 08 15  
(891) 2019 08 15  
(511) 01, 05

---

(260) AM 2020 105185 A  
(800) 1490256  
(151) 2019 07 09  
(181) 2029 07 09  
(891) 2019 07 09  
(511) 05

---

(260) AM 2020 105188 A  
(800) 1490289  
(151) 2019 07 09  
(181) 2029 07 09  
(891) 2019 07 09  
(511) 05

---

(260) AM 2020 105191 A  
(800) 1490345  
(151) 2019 04 01  
(181) 2029 04 01  
(891) 2019 04 01  
(511) 01, 05, 31, 44

---

(260) AM 2020 105195 A  
(800) 1490620  
(151) 2019 07 22  
(181) 2029 07 22  
(891) 2019 07 22  
(511) 03, 05

---

(260) AM 2020 105200 A  
(800) 1199222  
(151) 2013 10 21  
(181) 2023 10 21  
(891) 2019 09 09  
(511) 07, 12

---

(260) AM 2020 105207 A  
(800) 1454952  
(151) 2019 02 01  
(181) 2029 02 01  
(891) 2019 08 20  
(511) 05

---

(260) AM 2020 105271 A  
(800) 1490884  
(151) 2019 07 01  
(181) 2029 07 01  
(891) 2019 07 01  
(511) 41

---

(260) AM 2020 105287 A  
(800) 1491484  
(151) 2019 06 24  
(181) 2029 06 24  
(891) 2019 06 24  
(511) 30

---

(260) AM 2020 105289 A  
(800) 1491562  
(151) 2019 04 01  
(181) 2029 04 01  
(891) 2019 04 01  
(511) 36

---

(260) AM 2020 105290 A  
(800) 1491588  
(151) 2019 09 02  
(181) 2029 09 02  
(891) 2019 09 02  
(511) 34

---

(260) AM 2020 105291 A  
(800) 1491592  
(151) 2019 08 09  
(181) 2029 08 09

(891) 2019 08 09  
(511) 01

---

(260) AM 2020 105295 A  
(800) 1491642  
(151) 2019 07 16  
(181) 2029 07 16  
(891) 2019 07 16  
(511) 25

---

(260) AM 2020 105296 A  
(800) 1491646  
(151) 2019 07 03  
(181) 2029 07 03  
(891) 2019 07 03  
(511) 35, 39, 42

---

(260) AM 2020 105300 A  
(800) 1491702  
(151) 2019 05 29  
(181) 2029 05 29  
(891) 2019 05 29  
(511) 03

---

(260) AM 2020 105301 A  
(800) 1491705  
(151) 2019 06 28  
(181) 2029 06 28  
(891) 2019 06 28  
(511) 16

---

(260) AM 2020 105302 A  
(800) 1491738  
(151) 2019 05 10  
(181) 2029 05 10  
(891) 2019 05 10  
(511) 09, 16, 35, 38, 41, 42

---

(260) AM 2020 105303 A  
(800) 1491750  
(151) 2019 05 10  
(181) 2029 05 10  
(891) 2019 05 10  
(511) 09, 28, 41

---

(260) AM 2020 105304 A  
(800) 1491769  
(151) 2019 06 24  
(181) 2029 06 24  
(891) 2019 06 24  
(511) 25, 35

---

(260) AM 2020 105306 A  
(800) 1491814  
(151) 2019 08 12  
(181) 2029 08 12  
(891) 2019 08 12  
(511) 09, 28

---

(260) AM 2020 105309 A  
(800) 1491850  
(151) 2019 05 10  
(181) 2029 05 10  
(891) 2019 05 10  
(511) 09, 28, 41

---

(260) AM 2020 105312 A  
(800) 1491935  
(151) 2019 08 05  
(181) 2029 08 05  
(891) 2019 08 05  
(511) 14

---

(260) AM 2020 105323 A  
(800) 1000010  
(151) 2008 09 19  
(181) 2028 09 19  
(891) 2019 08 16  
(511) 03, 35

---

(260) AM 2020 105324 A  
(800) 1143502  
(151) 2012 10 05  
(181) 2022 10 05  
(891) 2019 08 21  
(511) 29

---

(260) AM 2020 105325 A  
(800) 1350762  
(151) 2016 07 25  
(181) 2026 07 25  
(891) 2019 09 24  
(511) 35, 41, 42

---

(260) AM 2020 105326 A  
(800) 1376752  
(151) 2017 06 28  
(181) 2027 06 28  
(891) 2019 09 18  
(511) 21

---

(260) AM 2020 105386 A  
(800) 1492731  
(151) 2019 08 26  
(181) 2029 08 26

(891) 2019 08 26  
(511) 07, 11, 21

---

(260) AM 2020 105387 A  
(800) 1492789  
(151) 2019 05 14  
(181) 2029 05 14  
(891) 2019 05 14  
(511) 09, 36, 42

---

(260) AM 2020 105388 A  
(800) 1492802  
(151) 2019 08 01  
(181) 2029 08 01  
(891) 2019 08 01  
(511) 07, 11, 12

---

(260) AM 2020 105390 A  
(800) 1492830  
(151) 2019 08 15  
(181) 2029 08 15  
(891) 2019 08 15  
(511) 09

---

(260) AM 2020 105391 A  
(800) 1492851  
(151) 2019 07 08  
(181) 2029 07 08  
(891) 2019 07 08  
(511) 07, 11

---

(260) AM 2020 105392 A  
(800) 1492862  
(151) 2019 04 30  
(181) 2029 04 30  
(891) 2019 04 30  
(511) 29

---

(260) AM 2020 105487 A  
(800) 1494011  
(151) 2019 08 22  
(181) 2029 08 22  
(891) 2019 08 22  
(511) 39

---

(260) AM 2020 105488 A  
(800) 1494017  
(151) 2019 09 17  
(181) 2029 09 17  
(891) 2019 09 17  
(511) 09

---



(260) AM 2020 105489 A  
(800) 1494033  
(151) 2019 03 26  
(181) 2029 03 26  
(891) 2019 03 26  
(511) 04, 35, 43

---

(260) AM 2020 105513 A  
(800) 1494680  
(151) 2019 08 02  
(181) 2029 08 02  
(891) 2019 08 02  
(511) 01, 02, 06, 07, 08, 09, 16, 17, 19, 20, 24, 27,  
35, 37, 39, 42

---

(260) AM 2020 105514 A  
(800) 1494683  
(151) 2019 04 30  
(181) 2029 04 30  
(891) 2019 04 30  
(511) 07, 09, 11, 12, 37

---

(260) AM 2020 105515 A  
(800) 1494687  
(151) 2019 04 15  
(181) 2029 04 15  
(891) 2019 04 15  
(511) 09, 35, 36, 41, 42

---

(260) AM 2020 105516 A  
(800) 1494702  
(151) 2019 03 26  
(181) 2029 03 26  
(891) 2019 03 26  
(511) 07, 09, 11

---

(260) AM 2020 105567 A  
(800) 1494909  
(151) 2019 05 21  
(181) 2029 05 21  
(891) 2019 05 21  
(511) 05

---

(260) AM 2020 105568 A  
(800) 1494917  
(151) 2019 09 03  
(181) 2029 09 03  
(891) 2019 09 03  
(511) 12, 37

---

(260) AM 2020 105569 A  
(800) 1494988  
(151) 2019 09 12

(181) 2029 09 12  
(891) 2019 09 12  
(511) 12

---

(260) AM 2020 105570 A  
(800) 1495081  
(151) 2019 07 23  
(181) 2029 07 23  
(891) 2019 07 23  
(511) 36

---

(260) AM 2020 105571 A  
(800) 1495083  
(151) 2019 07 16  
(181) 2029 07 16  
(891) 2019 07 16  
(511) 19, 27

---

(260) AM 2020 105897 A  
(800) 1499861  
(151) 2019 10 11  
(181) 2029 10 11  
(891) 2019 10 11  
(511) 09, 34

---

(260) AM 2020 105898 A  
(800) 1499867  
(151) 2019 10 10  
(181) 2029 10 10  
(891) 2019 10 10  
(511) 09, 34

---

(260) AM 2020 105905 A  
(800) 1499889  
(151) 2019 09 24  
(181) 2029 09 24  
(891) 2019 09 24  
(511) 03

---

(260) AM 2020 105960 A  
(800) 1361021  
(151) 2017 05 23  
(181) 2027 05 23  
(891) 2019 10 15  
(511) 05

---

(260) AM 2020 106286 A  
(800) 1497260  
(151) 2019 08 28  
(181) 2029 08 28  
(891) 2019 08 28  
(511) 03, 05, 10

---

(260) AM 2020 106288 A  
(800) 1497326  
(151) 2019 09 05  
(181) 2029 09 05  
(891) 2019 09 05  
(511) 30, 32, 33

---

(260) AM 2020 106293 A  
(800) 1497350  
(151) 2019 07 23  
(181) 2029 07 23  
(891) 2019 07 23  
(511) 29, 30

---

(260) AM 2020 106426 A  
(800) 1498599  
(151) 2019 06 26  
(181) 2029 06 26  
(891) 2019 06 26  
(511) 41, 43

---

---

# OFFICIAL NOTIFICATIONS

## INVENTIONS

### EXPIRATION OF PATENT RESTORATION

(21) AP 2017 14522

**(11) P 2019 6993 B**

(73) Mariam Tsiskarishvili;  
Nino Jorbenadze

(54) **DEVICE FOR SPLITTING NUTS AND HAZELS**

DATE OF CANCELLATION OF PATENT: 2020 06 19

THE TERM OF RESTORATION OF PATENT: 2020 10 26

---

### ABOLITION OF PATENTS WITH THE RIGHT TO RESTORE

(21) AP 2011 13079

**(11) P 2016 6429 B**

(73) BOEHRINGER INGELHEIM INTERNATIONAL GMBH

(54) **CD33 BINDING AGENTS**

DATE OF CANCELLATION OF PATENT: 2020 10 04

THE TERM OF RESTORATION OF PATENT: 2021 10 04

---

(21) AP 2013 13246

**(11) P 2014 6173 B**

(73) Merab Dvali

(54) **ACCOMMODATIVE INTRAOCULAR CRYSTALLINE LENS**

DATE OF CANCELLATION OF PATENT: 2020 09 26

THE TERM OF RESTORATION OF PATENT: 2021 09 26

---

(21) AP 2013 13247

**(11) P 2019 6994 B**

(73) Ivane Beroshvili;

Abesalom Beroshvili;

Teimuraz Kechiani

(54) **METHOD FOR GAS INJECTION**

DATE OF CANCELLATION OF PATENT: 2020 09 27

THE TERM OF RESTORATION OF PATENT: 2021 09 27

---

(21) AP 2012 13457

**(11) P 2017 6608 B**

(73) TAKEDA PHARMACEUTICAL COMPANY LIMITED

(54) **1 - ARYL CARBONYL - 4 - OXY - PIPERIDINE COMPOUNDS USEFUL FOR THE TREATMENT OF NEURODEGENERATIVE DISEASES**

DATE OF CANCELLATION OF PATENT: 2020 10 03

THE TERM OF RESTORATION OF PATENT: 2021 10 03

---

(21) AP 2014 13592  
**(11) P 2016 6516 B**  
(73) LTD "GEORGIAN NATURAL PRODUCT"  
(54) **COMPOSITION OF INGREDIENTS FOR BIOACTIVE SUPPLEMENT "GRAIL"**  
DATE OF CANCELLATION OF PATENT: 2020 10 06  
THE TERM OF RESTORATION OF PATENT: 2021 10 06

---

(21) AP 2016 14294  
**(11) P 2018 6835 B**  
(73) Ilia Kherodinashvili  
(54) **METHOD FOR CITY OR VILLAGE COMMUNITY GAS SUPPLEMENT**  
DATE OF CANCELLATION OF PATENT: 2020 10 07  
THE TERM OF RESTORATION OF PATENT: 2021 10 07

---

(21) AP 2018 14895  
**(11) P 2020 7120 B**  
(73) Gocha Kurdadze  
(54) **METHOD FOR SILICO MANGANESE PRODUCTION**  
DATE OF CANCELLATION OF PATENT: 2020 10 05  
THE TERM OF RESTORATION OF PATENT: 2021 10 05

---

(21) AP 2003 8770  
**(11) P 2007 4059 B**  
(73) CO2 PAC LIMITED  
(54) **CONTAINER STRUCTURE FOR REMOVAL OF VACUUM PRESSURE**  
DATE OF CANCELLATION OF PATENT: 2020 09 30  
THE TERM OF RESTORATION OF PATENT: 2021 09 30

---

## EXPIRATION OF TERM OF RESTORATION OF PATENTS

(21) AP 2006 10671  
**(11) P 2011 5231 B**  
(73) NOVARTIS AG  
(54) **2-AMINO-7,8-DIHYDRO-6H-PYRIDO [4,3-D] PYRIMIDIN-5-ONES**  
DATE OF CANCELLATION OF PATENT: 2019 09 28  
THE TERM OF RESTORATION OF PATENT VALIDITY HAS EXPIRED: 2020 09 28

---

(21) AP 2009 12213  
**(11) P 2014 6131 B**  
(73) Incuron Inc.  
(54) **CARBAZOLE COMPOUNDS AND THERAPEUTIC USES THEREOF**  
DATE OF CANCELLATION OF PATENT: 2019 10 05  
THE TERM OF RESTORATION OF PATENT VALIDITY HAS EXPIRED: 2020 10 05

---

(21) AP 2013 13248  
**(11) P 2015 6297 B**  
(73) Tamaz Jincharadze;  
Teimuraz Mikeladze;  
Marina Mikeladze

(54) **BICYCLE**

DATE OF CANCELLATION OF PATENT: 2019 09 30

THE TERM OF RESTORATION OF PATENT VALIDITY HAS EXPIRED: 2020 09 30

---

(21) AP 2015 13943

**(11) P 2017 6625 B**

(73) LEPL Agricultural Research Center

(54) **AGGREGATE FOR JUICE EVAPORATION**

DATE OF CANCELLATION OF PATENT: 2019 09 24

THE TERM OF RESTORATION OF PATENT VALIDITY HAS EXPIRED: 2020 09 24

---

## EXPIRATION OF PATENT

(21) AP 2000 6466

**(11) P 2005 3538 B**

(73) Bristol-Myers Squibb Company

(54) **PHARMACEUTICAL COMPOSITION COMPRISING A COMBINATION OF METFORMIN AND GLYBURIDE**

EXPIRATION DATE OF THE PATENT: 13 10 2020

---

## CHANGE OF NAME AND/OR ADDRESS OF PATENTOWNER

(21) AP 2018 14846

**(11) P 2020 7135 B**

(54) **ANTIOXIDANT FOOD CONCENTRATE**

New name and/or address: LEPL Shota Rustaveli Georgian National Science Foundation (GE)

M. Aleksidze St. 1, 0193, Tbilisi, Georgia (GE);

Akaki Tsereteli State University (GE)

Tamar Mepe St. 59, 4600, Kutaisi, Georgia (GE);

Temur Ghvinianidze (GE)

Mgaloblishvili St. 14, 4600, Kutaisi, Georgia (GE);

Papuna Chikovani (GE)

F. Barnov St. 64, 4600, Kutaisi, Georgia (GE);

Teona Gvinianidze (GE)

Mgaloblishvili st. 14, 4600, Kutaisi, Georgia (GE)

Former name and/or address: Akaki Tsereteli State University (GE)

Tamar Mepe St. 59, 4600, Kutaisi, Georgia (GE);

Temur Ghvinianidze (GE)

Mgaloblishvili St. 14, 4600, Kutaisi, Georgia (GE);

Papuna Chikovani (GE)

F. Barnov St. 64, 4600, Kutaisi, Georgia (GE);

Teona Gvinianidze (GE)

Mgaloblishvili St. 14, 4600, Kutaisi, Georgia (GE)

Date of registration: 08 10 2020

---

## UTILITY MODELS

### ABOLITION OF PATENTS WITH THE RIGHT TO RESTORE

(21) AU 2013 13255

**(11) U 2016 1885 Y**

(73) Givi Papava;

Eldar Gugava;

Nora Dokhturishvili;

Nunu Maisuradze;

Nazi Gelashvili;

Marina Gurgenshvili;

Ketevan Papava;

Nanuli Khotenashvili;

Riva Liparteliani

(54) **METHOD FOR NITROGEN FERTILIZER PRODUCTION OF PROLONGED ACTIVITY**

DATE OF CANCELLATION OF PATENT: 2020 10 04

THE TERM OF RESTORATION OF PATENT: 2021 10 04

---

(21) AU 2013 13256

**(11) U 2016 1886 Y**

(73) Givi Papava;

Vitali Sherozia;

Eldar Gugava;

Nora Dokhturishvili;

Nunu Maisuradze;

Marina Gurgenshvili;

Ia Chitrekashvili;

Eter Gavashelidze;

Shalva Papava

(54) **METHOD FOR GRAPHITE COMPOSITION PRODUCTION PLATED WITH COPPER**

DATE OF CANCELLATION OF PATENT: 2020 10 04

THE TERM OF RESTORATION OF PATENT: 2021 10 04

---

(21) AU 2015 13948

**(11) U 2016 1905 Y**

(73) LEPL INSTITUTE "OPTIQUE"

(54) **OPTICAL DEVICE LENS FOR NIGHT VISION**

DATE OF CANCELLATION OF PATENT: 2020 10 01

THE TERM OF RESTORATION OF PATENT: 2021 10 01

---

(21) AU 2017 14596

**(11) U 2019 2000 Y**

(73) Mzia Tsitsagi;

Mariam Chkhaidze;

Ketevan Ebralidze;

Miranda Khachidze;

Manana Buzariashvili;

Imeda Rubashvili

(54) **METHOD FOR ANTHOCYANIN PREPARATION**

DATE OF CANCELLATION OF PATENT: 2020 09 28

THE TERM OF RESTORATION OF PATENT: 2021 09 28

---

(21) AU 2018 14890  
**(11) U 2019 2019 Y**  
(73) Sergo Jorbenadze  
(54) **TABLE-BED "SERMA"**  
DATE OF CANCELLATION OF PATENT: 2020 10 02  
THE TERM OF RESTORATION OF PATENT: 2021 10 02

---

(21) AU 2018 14892  
**(11) U 2019 2014 Y**  
(73) Sophio Kasradze;  
Marine Nikolaishvili  
(54) **THERAPEUTIC AGENT FROM EPILEPSY**  
DATE OF CANCELLATION OF PATENT: 2020 10 03  
THE TERM OF RESTORATION OF PATENT: 2021 10 03

---

(21) AU 2018 14893  
**(11) U 2019 2020 Y**  
(73) Zurab Dzneladze  
(54) **METHOD FOR STRONG ALCOHOLIC BEVERAGES PRODUCTION HAVING  
FEATURES OF HIGH-QUALITY WINES**  
DATE OF CANCELLATION OF PATENT: 2020 10 04  
THE TERM OF RESTORATION OF PATENT: 2021 10 04

---

## EXPIRATION OF TERM OF RESTORATION OF PATENTS

(21) AU 2013 13240  
**(11) U 2014 1820 Y**  
(73) Aleksandre Manukyan  
(54) **ORTHOPEDIC FOOTWEAR FOR SICKS WITH PANCREATIC DIABETES**  
DATE OF CANCELLATION OF PATENT: 2019 09 24  
THE TERM OF RESTORATION OF PATENT VALIDITY HAS EXPIRED: 2020 09 24

---

(21) AU 2014 13586  
**(11) U 2015 1882 Y**  
(73) Zurab Gagua  
(54) **DEVICE FOR FRUITS AND VEGETABLES DRAWING FROM CANS**  
DATE OF CANCELLATION OF PATENT: 2019 09 26  
THE TERM OF RESTORATION OF PATENT VALIDITY HAS EXPIRED: 2020 09 26

---

(21) AU 2016 14280  
**(11) U 2017 1942 Y**  
(73) Guram Kemerteladze  
(54) **WARM HOLLOW WALL**  
DATE OF CANCELLATION OF PATENT: 2019 09 26  
THE TERM OF RESTORATION OF PATENT VALIDITY HAS EXPIRED: 2020 09 26

---

(21) AU 2016 14285  
**(11) U 2018 1993 Y**  
(73) Teimuraz Rokva;  
Temur Chakhunashvili

(54) **ELECTRODES MARKING THERMAL PAINT**  
DATE OF CANCELLATION OF PATENT: 2019 09 29  
THE TERM OF RESTORATION OF PATENT VALIDITY HAS EXPIRED: 2020 09 29

---

## TRANSFER OF RIGHT

(21) AU 2019 15197

(11) U 2020 2046 Y

(54) **ANTIOXIDANT SPECIAL DESSERT WINE**

New name and/or address: Akaki Tsereteli State University (GE)  
Tamar Mepe St. 59, 4600, Kutaisi, Georgia (GE);  
Temur Ghvinianidze (GE)  
Mgaloblishvili St. 14, 4600, Kutaisi, Georgia (GE);  
LEPL Shota Rustaveli Georgian National Science Foundation (GE)  
M. Aleksidze St. 1, 0193, Tbilisi, Georgia (GE)

Former name and/or address: Akaki Tsereteli State University (GE)  
Tamar Mepe St. 59, 4600, Kutaisi, Georgia (GE);  
Temur Ghvinianidze (GE)  
Mgaloblishvili St. 14, 4600, Kutaisi, Georgia (GE)

Date of registration: 08 10 2020

---

## DESIGNS

### EXTENSION OF REGISTRATION OF DESIGNS

(11) D 2006 284 S

(73) Obshchestvo s Ogranichenoy Otveststvenostyu "OILExtraction Factory Southern Russia" (RU)  
Pl. Tolstogo, 8, Rostov-on-Don, 344037, Russian Federation (RU)

(54) **BOTTLE OF OIL**

(28) 1

(24) 2005 10 11

(18) 2025 10 11

(58) 2020 10 09

---

(11) D 2011 458 S

(73) Five Lakes Cyprus LTD (CY)  
Staticratos, 16, Fiduciana Business Center, 2nd Floor, Room / Office A, Nicosia, 1065,  
Cyprus (CY)

(54) **BOTTLE**

(28) 1

(24) 2010 05 24

(18) 2025 05 24

(58) 2020 10 07

---

(11) D 2011 473 S

(73) Archil Gavashelishvili (GE)  
Stalin St. 39, Oni, 3600, Georgia (GE)

---



(54) **CONTAINER FOR CHURCHKHELA**

(28) 2

(24) 2010 12 10

(18) 2025 12 10

(58) 2020 10 05

---

## CANCELLATION OF DESIGNS REGISTRATION

(11) **D 2005 263 S**

(73) Gocha Pipia (GE)

Vazha-Pshavela Av. 26, app. 22, 0177, Tbilisi, Georgia (GE)

(54) **BOTTLE**

(18) 2020 04 04

(58) 2020 10 13

---

(11) **D 2011 455 S**

(73) LTD "EMBAWOOD GEORGIA" (GE)

Marneuli St. 37, 0165, Tbilisi, Georgia (GE)

(54) **FURNITURE**

(18) 2020 03 26

(58) 2020 10 05

---

## EXTENSION OF REGISTRATION OF INTERNATIONAL DESIGNS

(11) DM/67051

(73) SWATCH AG (SWATCH SA) (SWATCH LTD.)

94, Rue Jakob Stämpfli, CH-2502 BIENNE (CH)

(15) 2005 09 02

(24) 2005 09 02

(18) 2025 09 02

(28) 1

(28') 1

(54) Wristwatch

---

(11) DM/67055

(73) SWATCH AG (SWATCH SA) (SWATCH LTD.)

94, Rue Jakob Stämpfli, CH-2502 BIENNE (CH)

(15) 2005 09 02

(24) 2005 09 02

(18) 2025 09 02

(28) 2

(28') 2

(54) Wristwatches

---

(11) DM/72947

(73) SWATCH AG (SWATCH SA)(SWATCH LTD)

Jakob-Stämpfli-Strasse 94, CH-2502 BIEL/BIENNE (CH)

(15) 2010 01 22  
(24) 2010 01 22  
(18) 2025 01 22  
(28) 5  
(28') 1  
(54) Wristwatches

---

(11) DM/73003  
(73) SWATCH AG (SWATCH SA)(SWATCH LTD)  
Jakob-Stämpfli-Strasse 94, CH-2502 BIEL/BIENNE (CH)  
(15) 2010 01 26  
(24) 2010 01 26  
(18) 2025 01 26  
(28) 5  
(28') 1  
(54) Wristwatches

---

(11) DM/73092  
(73) SWATCH AG (SWATCH SA)(SWATCH LTD)  
Jakob-Stämpfli-Strasse 94, CH-2502 BIEL/BIENNE (CH)  
(15) 2010 02 10  
(24) 2010 02 10  
(18) 2030 02 10  
(28) 8  
(28') 6  
(54) Wristwatches

---

(11) DM/73092  
(73) SWATCH AG (SWATCH SA)(SWATCH LTD)  
Jakob-Stämpfli-Strasse 94, CH-2502 BIEL/BIENNE (CH)  
(15) 2010 02 10  
(24) 2010 02 10  
(18) 2030 02 10  
(28) 8  
(28') 6  
(54) Wristwatches

---

(11) DM/73122  
(73) ALFRED KÄRCHER GMBH & CO. KG  
Alfred-Kärcher-Str. 28-40, 71364 Winnenden (DE)  
(15) 2010 02 08  
(24) 2010 02 08  
(18) 2025 02 08  
(28) 4  
(28') 2  
(54) High-Pressure-Cleaner (Parts of)

---

(11) DM/73382  
(73) SAVERGLASS  
3 rue de la Gare, F-60960 FEUQUIERES (FR)  
(15) 2010 04 02  
(24) 2010 04 02  
(18) 2025 04 02  
(28) 3

---

(28') 2  
(54) Bottles

---

(11) DM/73500  
(73) SWATCH AG (SWATCH SA) (SWATCH LTD.)  
94, Rue Jakob Stämpfli, CH-2502 BIENNE (CH)  
(15) 2010 04 15  
(24) 2010 04 15  
(18) 2025 04 15  
(28) 5  
(28') 1  
(54) Wristwatches

---

(11) DM/73592  
(73) THE SWATCH GROUP MANAGEMENT SERVICES AG (THE SWATCH GROUP MANAGEMENT SERVICES SA) (THE SWATCH GROUP MANAGEMENT SERVICES LTD.)  
Seevorstadt 6, BIEL (CH)  
(15) 2010 05 17  
(24) 2010 05 17  
(18) 2025 05 17  
(28) 2  
(28') 1  
(54) Watch, wristwatch

---

(11) DM/74104  
(73) VORTEX WIND TURBINES AG  
Stadelhoferstrasse 22, CH-8001 Zürich (CH)  
(15) 2010 07 21  
(24) 2010 07 21  
(18) 2025 07 21  
(28) 2  
(28') 2  
(54) Wind turbines

---

(11) DM/74131  
(73) SOREMARTEC S.A.  
Rue Joseph Netzer 5, B-6700 ARLON (BX)  
(15) 2010 08 23  
(24) 2010 08 23  
(18) 2025 08 23  
(28) 8  
(28') 8  
(54) Container for liquids, Packaging or containers for food products

---

(11) DM/74846  
(73) STEFAN RAAB  
Sülzburgstraße 97, 50937 Köln (DE)  
(15) 2010 10 01  
(24) 2010 10 01  
(18) 2025 10 01  
(28) 2  
(28') 2  
(54) Spray heads for showers

---

(11) DM/85719  
(73) SWATCH AG (SWATCH SA) (SWATCH LTD.)  
    Jakob-Stämpfli-Strasse 94, CH-2502 Biel/Bienne (CH)  
(15) 2015 02 24  
(24) 2015 02 24  
(18) 2025 02 24  
(28) 5  
(28') 2  
(54) Wristwatches

---

(11) DM/85928  
(73) JAPAN TOBACCO INC.  
    2-2-1 Toranomom, Minato-ku, Tokyo (JP)  
(15) 2015 02 27  
(24) 2015 02 27  
(18) 2025 02 27  
(28) 13  
(28') 3  
(54) Graphic designs

---

(11) DM/86169  
(73) SWATCH AG (SWATCH SA) (SWATCH LTD.)  
    Jakob-Stämpfli-Strasse 94, CH-2502 Biel/Bienne (CH)  
(15) 2015 04 14  
(24) 2015 04 14  
(18) 2025 04 14  
(28) 3  
(28') 1  
(54) Wristwatches

---

(11) DM/86245  
(73) SWATCH AG (SWATCH SA) (SWATCH LTD.)  
    Jakob-Stämpfli-Strasse 94, CH-2502 Biel/Bienne (CH)  
(15) 2015 04 20  
(24) 2015 04 20  
(18) 2025 04 20  
(28) 3  
(28') 1  
(54) Wristwatches

---

# TRADEMARKS

## RENEWAL OF REGISTRATIONS

(111) M 2000 13515 R2

(156) 2000 10 10

(186) 2030 10 10

(732) The Gillette Company LLC

One Gillette Park, Boston, Massachusetts  
02127, USA

980 Great West Road, Brentford, Middlesex  
TW8 9GS, United Kingdom

(111) M 2000 13545 R2

(156) 2000 10 27

(186) 2030 10 27

(732) MAKITA CORPORATION

11-8, 3-chome, Sumiyoshi-cho, Anjo-shi,  
Aichi-ken, Japan

(111) M 2010 20567 R1

(156) 2010 06 14

(186) 2030 06 14

(732) VEGIS-HUN Kft

Podmaniczky utca 13, Budapest 1065, Hungary

(111) M 2000 13546 R2

(156) 2000 10 27

(186) 2030 10 27

(732) MAKITA CORPORATION

11-8, 3-chome, Sumiyoshi-cho, Anjo-shi,  
Aichi-ken, Japan

(111) M 2010 20826 R1

(156) 2010 10 15

(186) 2030 10 15

(732) New Balance Athletics Inc.

100 Guest Street, Boston, MA 02135, USA

(111) M 2000 13613 R2

(156) 2000 10 27

(186) 2030 10 27

(732) MAKITA CORPORATION

11-8, 3-chome, Sumiyoshi-cho, Anjo-shi,  
Aichi-ken, Japan

(111) M 2011 21157 R1

(156) 2011 02 14

(186) 2031 02 14

(732) Trek Bicycle Corporation

801 West Madison, Waterloo, Wisconsin  
53594, USA

(111) M 2000 13619 R2

(156) 2000 11 28

(186) 2030 11 28

(732) DIAGEO NORTH AMERICA INC.

Three World Trade Center, 175 Greenwich  
Street, New York, NY 10007, USA

(111) M 2010 20910 R1

(156) 2010 11 12

(186) 2030 11 12

(732) Trek Bicycle Corporation

801 West Madison, Waterloo, Wisconsin  
53594, USA

(111) M 2000 13619 R2

(156) 2000 11 28

(186) 2030 11 28

(732) YKK Corporation, a Japanese Corporation

1, Kanda Izumi-cho, Chiyoda-ku, Tokyo  
101-8642, Japan

(111) M 2010 20872 R1

(156) 2010 10 25

(186) 2030 10 25

(732) Sea Lion S.r.l.

7, via Giovanni Ansaldo, Forli, Italy

(111) M 2001 13709 R2

(156) 2001 01 30

(186) 2031 01 30

(732) Kyocera Corporation

6 Takeda Tobadono-cho, Fushimi-ku, Kyoto  
612-8501, Japan

(111) M 2010 20914 R1

(156) 2010 11 12

(186) 2030 11 12

(732) The Body Shop International Limited

Watersmead, Littlehampton, West Sussex,  
BN17 6LS, United Kingdom

(111) M 2010 20835 R1

(156) 2010 10 20

(186) 2030 10 20

(732) GlaxoSmithKline Consumer Healthcare (UK)

IP Limited

(111) M 2010 20915 R1

(156) 2010 11 12

(186) 2030 11 12

(732) The Body Shop International Limited

---

Watersmead, Littlehampton, West Sussex, BN17 6LS, United Kingdom	(111) M 2010 21045 R1 (156) 2010 12 29 (186) 2030 12 29 (732) Noxell Corporation 11050 York Road, Hunt Valley, Maryland 21030-2098, USA
(111) M 2010 20916 R1 (156) 2010 11 12 (186) 2030 11 12 (732) The Body Shop International Limited Watersmead, Littlehampton, West Sussex, BN17 6LS, United Kingdom	(111) M 2011 21312 R1 (156) 2011 03 24 (186) 2031 03 24 (732) McDonald's International Property Company, Ltd., a corporation organized and existing under the laws of the State of Delaware 110 North Carpenter Street, Chicago, Illinois 60607, USA
(111) M 2010 21025 R1 (156) 2010 12 24 (186) 2030 12 24 (732) Gela Mikadze Lalioni Lane 5, 0101, Tbilisi, Georgia	(111) M 2011 21313 R1 (156) 2011 03 24 (186) 2031 03 24 (732) McDonald's International Property Company, Ltd., a corporation organized and existing under the laws of the State of Delaware 110 North Carpenter Street, Chicago, Illinois 60607, USA
(111) M 2010 20949 R1 (156) 2010 11 25 (186) 2030 11 25 (732) BIONORICA SE Kerschensteinerstr. 11-15, 92318 Neumarkt, Germany	(111) M 2011 21314 R1 (156) 2011 03 24 (186) 2031 03 24 (732) McDonald's International Property Company, Ltd., a corporation organized and existing under the laws of the State of Delaware 110 North Carpenter Street, Chicago, Illinois 60607, USA
(111) M 2010 20951 R1 (156) 2010 11 25 (186) 2030 11 25 (732) BIONORICA SE Kerschensteinerstr. 11-15, 92318 Neumarkt, Germany	(111) M 2011 21281 R1 (156) 2011 03 15 (186) 2031 03 15 (732) Unilever N.V. Weena 455, 3013 AL Rotterdam, Netherlands
(111) M 2011 21165 R1 (156) 2011 02 14 (186) 2031 02 14 (732) PT DJARUM Dl. Jend. A Yani N28, Kudus, 59317, Indonesia	(111) M 2011 21681 R1 (156) 2011 08 04 (186) 2031 08 04 (732) JCS "Teliani Valley" Tbilisis Gzat. 3, Telavi, 2200, Georgia
(111) M 2010 20995 R1 (156) 2010 12 13 (186) 2030 12 13 (732) Diversey Inc. 8310 16th Street, Sturtevant, Wisconsin 53177, USA	(111) M 2011 21682 R1 (156) 2011 08 04 (186) 2031 08 04 (732) JSC "Teliani Valley" Tbilisi Highway 3, Telavi, 2200, Georgia
(111) M 2010 20996 R1 (156) 2010 12 13 (186) 2030 12 13 (732) Diversey, Inc. 8310 16th Street, Sturtevant, Wisconsin 53177, USA	

---

(111) M 2010 20804 R1  
(156) 2010 10 06  
(186) 2030 10 06  
(732) LTD "Sewing Factory Laura Ghachava"  
Isani-samgori district, Tchirnakhuli Lane 7,  
0151, Tbilisi, Georgia

---

(111) M 2010 20962 R1  
(156) 2010 11 30  
(186) 2030 11 30  
(732) LTD "IBER-INFO"  
Vazha-Pshavela Av. 41, Floor 4, 0177, Tbilisi,  
Georgia

---

(111) M 2010 20963 R1  
(156) 2010 11 30  
(186) 2030 11 30  
(732) LTD "IBER-INFO"  
Vazha-Pshavela Av. 41, Floor 4, 0177, Tbilisi,  
Georgia

---

(111) M 2000 13451 R2  
(156) 2000 09 07  
(186) 2030 09 07  
(732) Link-Belt Cranes L.P. LLLP  
2651 Palumbo Drive, Lexington, Kentucky  
40583, USA

---

## COMPLETE TRANSFER OF RIGHTS

(111) M 2010 20567 R  
(732) VEGIS-HUN Kft  
Podmaniczky utca 13, Budapest 1065, Hungary  
(770) Товариство з обмеженою відповідальністю  
"ФРУТ МАЙСТЕР ФУДС"  
м. Бэрэгово, Закарпатська обл., 90200/вул.  
Б. Хмельницького, 163, Ukraine  
(580) 2020 10 07

---

(111) M 2010 20804 R  
(732) LTD "Sewing Factory Laura Ghatchava"  
Tchirnakhuli Lane 7, Isani-Samgori  
District, 0151, Tbilisi, Georgia  
(770) LTD "Sewing Factory Laura Ghatchava"  
Tchirnakhuli Lane 7, Isani-Samgori  
District, 0151, Tbilisi, Georgia  
(580) 2020 10 13

---

(111) M 2015 25634 R  
(732) JSC "Mineral and Chemical Company  
"EUROCHEM"  
Dubinskaya St, house 53, bldg. 6,  
Moscow, 115054, Russian Federation  
(770) LTD "P and G GROUP"  
Kostava Av. 1-17, 3700, Rustavi, Georgia  
(580) 2020 10 02

---



## CHANGES OF NAMES AND/OR ADDRESS OF OWNERS

(111) M 1998 10878 R  
 (732) SOREMARTEC S.A.  
 16 Route de Trèves, L - 2633, Senningerberg,  
 Luxembourg

(770) SOREMARTEC S.A.  
 Findel Business Center, Complexe B,  
 Rue de Treves, L-2632 Findel, Luxembourg  
 (580) 2020 09 07

(111) M 1997 6899 R  
 (732) SOREMARTEC S.A.  
 16 Route de Trèves, L - 2633, Senningerberg,  
 Luxembourg

(770) SOREMARTEC S.A.  
 Findel Business Center, Complexe B,  
 Rue de Treves, L-2632 Findel, Luxembourg  
 (580) 2020 09 07

(111) M 1998 10892 R  
 (732) SOREMARTEC S.A.  
 16 Route de Trèves, L - 2633,  
 Senningerberg, Luxembourg

(770) SOREMARTEC S.A.  
 Findel Business Center, Complexe B,  
 Rue de Treves, L-2632 Findel, Luxembourg  
 (580) 2020 09 07

(111) M 1998 10983 R  
 (732) SOREMARTEC S.A.  
 16 Route de Trèves, L - 2633,  
 Senningerberg, Luxembourg

(770) SOREMARTEC S.A.  
 Findel Business Center, Complexe B,  
 Rue de Treves, L-2632 Findel, Luxembourg  
 (580) 2020 09 07

(111) M 1998 8411 R  
 (732) SOREMARTEC S.A.  
 16 Route de Trèves, L - 2633,  
 Senningerberg, Luxembourg

(770) SOREMARTEC S.A.  
 Findel Business Center, Complexe B,  
 Rue de Treves, L-2632 Findel, Luxembourg  
 (580) 2020 09 07

(111) M 1996 2865 R  
 (732) SOREMARTEC S.A.  
 16 Route de Trèves, L - 2633,  
 Senningerberg, Luxembourg

(770) SOREMARTEC S.A.

Findel Business Center, Complexe B,  
 Rue de Treves, L-2632 Findel, Luxembourg  
 (580) 2020 09 07

(111) M 1996 2866 R  
 (732) SOREMARTEC S.A.  
 16 Route de Trèves, L - 2633,  
 Senningerberg, Luxembourg

(770) SOREMARTEC S.A.  
 Findel Business Center, Complexe B,  
 Rue de Treves, L-2632 Findel, Luxembourg  
 (580) 2020 09 07

(111) M 1996 3305 R  
 (732) SOREMARTEC S.A.  
 16 Route de Trèves, L - 2633,  
 Senningerberg, Luxembourg

(770) SOREMARTEC S.A.  
 Findel Business Center, Complexe B,  
 Rue de Treves, L-2632 Findel, Luxembourg  
 (580) 2020 09 07

(111) M 1997 7107 R  
 (732) SOREMARTEC S.A.  
 116 Route de Trèves, L - 2633,  
 Senningerberg, Luxembourg

(770) SOREMARTEC S.A.  
 Findel Business Center, Complexe B,  
 Rue de Treves, L-2632 Findel, Luxembourg  
 (580) 2020 09 07

(111) M 2010 20826 R  
 (732) New Balance Athletics, Inc.  
 100 Guest Street, Boston, MA 02135, USA  
 (770) NEW BALANCE ATHLETIC SHOE INC.  
 Brighton Landing, 20 Guest street, BOSTON,  
 MA 02135, USA

(580) 2020 09 24

(111) M 1999 11710 R  
 (732) SOREMARTEC S.A.  
 16 Route de Trèves, L - 2633,  
 Senningerberg, Luxembourg

(770) SOREMARTEC S.A.  
 Findel Business Center, Complexe B,  
 Rue de Treves, L-2632 Findel, Luxembourg  
 (580) 2020 09 07

(111) M 1999 11711 R  
(732) SOREMARTEC S.A.  
16 Route de Trèves, L - 2633,  
Senningerberg, Luxembourg  
(770) SOREMARTEC S.A.  
Findel Business Center, Complexe B,  
Rue de Treves, L-2632 Findel, Luxembourg  
(580) 2020 09 07

---

(111) M 1999 11712 R  
(732) SOREMARTEC S.A.  
16 Route de Trèves, L - 2633,  
Senningerberg, Luxembourg  
(770) SOREMARTEC S.A.  
Findel Business Center, Complexe B,  
Rue de Treves, L-2632 Findel, Luxembourg  
(580) 2020 09 07

---

(111) M 1997 5128 R  
(732) SOREMARTEC S.A.  
16 Route de Trèves, L - 2633,  
Senningerberg, Luxembourg  
(770) SOREMARTEC S.A.  
Findel Business Center, Complexe B,  
Rue de Treves, L-2632 Findel, Luxembourg  
(580) 2020 09 07

---

(111) M 1997 5129 R  
(732) SOREMARTEC S.A.  
16 Route de Trèves, L - 2633,  
Senningerberg, Luxembourg  
(770) SOREMARTEC S.A.  
Findel Business Center, Complexe B,  
Rue de Treves, L-2632 Findel, Luxembourg  
(580) 2020 09 07

---

(111) M 1997 5130 R  
(732) SOREMARTEC S.A.  
16 Route de Trèves, L - 2633,  
Senningerberg, Luxembourg  
(770) SOREMARTEC S.A.  
Findel Business Center, Complexe B,  
Rue de Treves, L-2632 Findel, Luxembourg  
(580) 2020 09 07

---

(111) M 1997 5131 R  
(732) SOREMARTEC S.A.  
16 Route de Trèves, L - 2633,  
Senningerberg, Luxembourg  
(770) SOREMARTEC S.A.  
Findel Business Center, Complexe B,  
Rue de Treves, L-2632 Findel, Luxembourg  
(580) 2020 09 07

---

(111) M 1997 5133 R  
(732) SOREMARTEC S.A.  
16 Route de Trèves, L - 2633,  
Senningerberg, Luxembourg  
(770) SOREMARTEC S.A.  
Findel Business Center, Complexe B,  
Rue de Treves, L-2632 Findel, Luxembourg  
(580) 2020 09 07

---

(111) M 1997 5210 R  
(732) SOREMARTEC S.A.  
16 Route de Trèves, L - 2633,  
Senningerberg, Luxembourg  
(770) SOREMARTEC S.A.  
Findel Business Center, Complexe B,  
Rue de Treves, L-2632 Findel, Luxembourg  
(580) 2020 09 07

---

(111) M 2015 25818 R  
(732) Soremartec S.A.  
16 Route de Trèves, L - 2633,  
Senningerberg, Luxembourg  
(770) Soremartec S.A., Findel Business Center,  
Complexe B, Rue de Treves, L-2632 Findel  
Luxembourg  
(580) 2020 09 07

---

(111) M 2015 25819 R  
(732) Soremartec S.A.  
16 Route de Trèves, L - 2633,  
Senningerberg, Luxembourg  
(770) Soremartec S.A., Findel Business Center,  
Complexe B, Rue de Trèves, L-2632 Findel  
Luxembourg  
(580) 2020 09 08

---

(111) M 2015 25820 R  
(732) Soremartec S.A., Findel Business Center,  
Complexe B, Rue de Trèves, L-2632 Findel  
16 Route de Trèves, L - 2633, Senningerberg,  
Luxembourg  
(770) Soremartec S.A., Findel Business Center,  
Complexe B, Rue de Trèves, L-2632 Findel  
Luxembourg  
(580) 2020 09 07

---

(111) M 1998 10774 R  
(732) SOREMARTEC S.A.  
16 Route de Trèves, L - 2633,  
Senningerberg, Luxembourg  
(770) SOREMARTEC S.A.  
Findel Business Center, Complexe B,  
Rue de Treves, L-2632 Findel, Luxembourg

---

(580) 2020 09 07

---

(111) M 1997 7661 R

(732) SOREMARTEC S.A.

16 Route de Trèves, L - 2633,  
Senningerberg, Luxembourg

(770) SOREMARTEC S.A.

Findel Business Center, Complexe B,  
Rue de Treves, L-2632 Findel, Luxembourg

(580) 2020 09 07

---

## TERMINATION OF TRADEMARKS REGISTRATION

(111) M 2000 13214 R (151) 2000 03 29 (732) UNILEVER N.V. Weena 455, NL-3013 AL Rotterdam, Netherlands (141) 2020 10 15	345 Park Avenue, New York, New York 10154, USA (141) 2020 10 15
(111) M 2000 13215 R (151) 2000 03 29 (732) UNILEVER N.V. Weena 455, NL-3013 AL Rotterdam, Netherlands (141) 2020 10 15	(111) M 2000 13207 R (151) 2000 03 29 (732) SANOFI 54, rue La Boétie, 75008 Paris, France (141) 2020 10 15
(111) M 2000 13217 R (151) 2000 03 29 (732) Merck Consumer Healthcare Limited Hedon Road, Marfleet, Hull HU9 5NJ, United Kingdom (141) 2020 10 15	(111) M 2000 13185 R (151) 2000 03 29 (732) British American Tobacco (Brands) Inc. 2711 Centerville Road, Suite 300, Wilmington, Delaware 19808, USA (141) 2020 10 15
(111) M 2000 13203 R (151) 2000 03 29 (732) PFIZER PRODUCTS INC. a Connecticut Corporation Eastern Point Road, Groton, Connecticut 06340, USA (141) 2020 10 15	(111) M 2000 13186 R (151) 2000 03 29 (732) MARS, INCORPORATED 6885 Elm Street Mclean, Virginia 22101-3883, USA (141) 2020 10 15
(111) M 2000 13204 R (151) 2000 03 29 (732) PFIZER PRODUCTS INC. a Connecticut Corporation Eastern Point Road, Groton, Connecticut 06340, USA (141) 2020 10 15	(111) M 2000 13187 R (151) 2000 03 29 (732) Oracle America, Inc. 500 Oracle Parkway, Redwood Shores, California 94065, USA (141) 2020 10 15
(111) M 2000 13205 R (151) 2000 03 29 (732) The Gillette Company LLC One Gillette Park, Boston, Massachusetts 02127, USA (141) 2020 10 15	(111) M 2000 13222 R (151) 2000 04 04 (732) IMPERIAL CHEMICAL INDUSTRIES LIMITED 26th Floor, Portland House, Bressenden Place, London SW1E 5BG, United Kingdom (141) 2020 10 19
(111) M 2000 13206 R (151) 2000 03 29 (732) BRISTOL-MYERS SQUIBB COMPANY, a Delaware Corporation	(111) M 2010 20361 R (151) 2010 03 26 (732) Göksan Kağıt San. Tic. Ltd. Şti. Merkez Mah. Yialanlitepe Cad. N11/2 Yanibosna/Bahçhelievler, Istanbul, Turkey (141) 2020 10 12
	(111) M 2010 20334 R (151) 2010 03 25 (732) Harrington Development Inc.

Elvira Mendez Street, Vallarino bldg.,  
3rd Floor, Panama, Republic of Panama  
(141) 2020 10 12

---

(111) M 2010 20337 R  
(151) 2010 03 25  
(732) Levan Potaskaev  
Karkhnis St. 20, 6600, Sokhumi, Georgia  
(141) 2020 10 12

---

(111) M 2010 20342 R  
(151) 2010 03 25  
(732) Gocha Gochashvili  
Tashkenti St. 18, app. 33, 0160, Tbilisi,  
Georgia  
(141) 2020 10 12

---

(111) M 2010 20343 R  
(151) 2010 03 25  
(732) LTD "Icon Group"  
Vill. Tsinsvla, Khelvachauri, 6417, Georgia  
(141) 2020 10 12

---

(111) M 2010 20344 R  
(151) 2010 03 25  
(732) LTD "Nomad Agriculture and Green House"  
Vill. Tsinsvla, Khelvachauri, 6417, Georgia  
(141) 2020 10 12

---

(111) M 2010 20345 R  
(151) 2010 03 25  
(732) LTD "Nomad Agriculture and Green House"  
Vill. Tsinsvla, Khelvachauri, 6417, Georgia  
(141) 2020 10 12

---

(111) M 2010 20346 R  
(151) 2010 03 25  
(732) The Coca-Cola Company  
One Coca-Cola Plaza, Atlanta, Georgia,  
30313, USA  
(141) 2020 10 12

---

(111) M 2010 20352 R  
(151) 2010 03 25  
(732) Levan Potaskaev  
Karkhnis St. 20, 6600, Sokhumi, Georgia  
(141) 2020 10 12

---

(111) M 2010 20566 R  
(151) 2010 06 14

(732) Товариство з обмеженою відповідальністю  
"ФРУТ МАЙСТЕР ФУДС"  
м. Бэрэгово, Закарпатська обл., 90200/вул.  
Б. Хмельницького, 163, Ukraine  
(141) 2020 10 07

---

(111) M 2010 20353 R  
(151) 2010 03 25  
(732) LTD "GLOBALPHARMI"  
Tamar Mepe Av. 7/13, 0112, Tbilisi, Georgia  
(141) 2020 10 12

---

(111) M 2010 20354 R  
(151) 2010 03 25  
(732) LTD "GLOBALPHARMI"  
Tamar Mepe Av. 7/13, 0112, Tbilisi, Georgia  
(141) 2020 10 12

---

(111) M 2010 20355 R  
(151) 2010 03 25  
(732) LTD "GLOBALPHARMI"  
Tamar Mepe Av. 7/13, 0112, Tbilisi, Georgia  
(141) 2020 10 12

---

(111) M 2000 13198 R  
(151) 2000 03 29  
(732) CENTRO DE INMUNOENSAYO  
Habana, Cuba  
(141) 2020 10 15

---

(111) M 2016 27124 R  
(151) 2016 05 25  
(732) LTD "EN-DUO-KONCEPT"  
C. Dadiani St. 26, / Chodrishvili St. 2, 0101,  
Tbilisi, Georgia  
(141) 2020 10 19

---

## REGISTRATION OF LICENSE AGREEMENT

(111) M 2020 33076 R  
(732) LTD "AMERI"  
Vill. Karaleti, 1414, Gori District, Georgia  
(791) LTD "STAR"  
Kindzmarauli St. 17, flow 3 Exit, 216, Nakaduli  
St. III Lane 216 (Plot 8/42), Samgori District,  
0145, Tbilisi, Georgia  
(793) №1609  
Validity period: from 09 09 2020 to 09 09 2025  
License type: Special  
Class: 34

---

## CANCELLATION OF THE CLASS LIST IN A REGISTERED TRADEMARK ON THE BASIS OF COURT DECISION

(111) M 2010 20475 R  
(210) 53335  
(732) KMG INTERNATIONAL N.V.  
Strawinskylaan 807, Tower A-8, 1077XX  
Amsterdam, Netherlands  
(540)

**Alto**

(852) 9

Grounds: Order №685/12 of Sakpatenti Chairman for enforcement of the decision of July 25, 2019, of Tbilisi City Court Civil Cases Board (Case №2/7398-19).

---

# CLASSIFICATION INDEXES

## INVENTIONS

### CONCORDANCE TABLE OF INTERNATIONAL CLASSIFICATION INDEX AND PUBLICATION NUMBERS

INTERNATIONAL CLASSIFICATION INDEXES (51)	NUMBER OF PUBLISHED APPLICATION (10)
A 61 K 31/675; A 61 P 19/02; C 07 F 9/576	AP 2020 14976 A
A 61 K 31/7004; A 61 K 31/05; A 61 K 45/06; A 61 K 36/87; A 61 P 3/10; A 61 P 3/04	AP 2020 14527 A
C 07 D 215/227; A 61 K 31/47; A 61 P 35/00	AP 2020 13221 A
E 02 F 9/28; E 02 F 9/28	AP 2020 14935 A
G 06 F 17/10; G 10 L 19/02; G 10 L 19/22; G 10 L 19/24; G 10 L 19/26	AP 2020 15136 A

### CONCORDANCE TABLE OF PUBLICATION NUMBERS AND INTERNATIONAL CLASSIFICATION INDEX

NUMBER OF PUBLISHED APPLICATION (10)	INTERNATIONAL CLASSIFICATION INDEXES (51)
AP 2020 13221 A	C 07 D 215/227; A 61 K 31/47; A 61 P 35/00
AP 2020 14527 A	A 61 K 31/7004; A 61 K 31/05; A 61 K 45/06; A 61 K 36/87; A 61 P 3/10; A 61 P 3/04
AP 2020 14935 A	E 02 F 9/28; E 02 F 9/28
AP 2020 14976 A	A 61 K 31/675; A 61 P 19/02; C 07 F 9/576
AP 2020 15136 A	G 06 F 17/10; G 10 L 19/02; G 10 L 19/22; G 10 L 19/24; G 10 L 19/26

### CONCORDANCE TABLE OF INTERNATIONAL CLASSIFICATION INDEX, PATENT NUMBERS AND PUBLICATION NUMBERS

INTERNATIONAL CLASSIFICATION INDEX (51)	NUMBER OF PATENT (11)	NUMBER OF PUBLISHED APPLICATION (10)
A 61 K 31/437; C 07 D 471/04	P 2020 7172 B	AP 2020 14955 A
G 06 K 17/00; G 06 K 7/00	P 2020 7171 B	AP 2020 15277 A

### CONCORDANCE TABLE OF PATENT NUMBERS, PUBLICATION NUMBERS AND INTERNATIONAL CLASSIFICATION INDEX

NUMBER OF PATENT (11)	NUMBER OF PUBLISHED APPLICATION (10)	INTERNATIONAL CLASSIFICATION INDEX (51)
P 2020 7171 B	AP 2020 15277 A	G 06 K 17/00; G 06 K 7/00
P 2020 7172 B	AP 2020 14955 A	A 61 K 31/437; C 07 D 471/04

**CONCORDANCE TABLE OF APPLICATION NUMBERS, PUBLICATION NUMBERS  
AND PATENTS**

NUMBER OF APPLICATION (21)	NUMBER OF PUBLISHED APPLICATION (10)	NUMBER OF PATENT (11)
AP 2017 14955	AP 2020 14955 A	P 2020 7172 B
AP 2020 15277	AP 2020 15277 A	P 2020 7171 B

**UTILITY MODELS**

**CONCORDANCE TABLE OF INTERNATIONAL CLASSIFICATION INDEX  
AND PUBLICATION NUMBERS**

INTERNATIONAL CLASSIFICATION INDEXES (51)	NUMBER OF PUBLISHED APPLICATION (10)
C 04 B 7/00	AU 2020 15116 U
C 04 B 7/00	AU 2020 15127 U
F 24 C 3/00	AU 2020 15253 U

**CONCORDANCE TABLE OF PUBLICATION NUMBERS  
AND INTERNATIONAL CLASSIFICATION INDEX**

NUMBER OF PUBLISHED APPLICATION (10)	INTERNATIONAL CLASSIFICATION INDEXES (51)
AU 2020 15116 U	C 04 B 7/00
AU 2020 15127 U	C 04 B 7/00
AU 2020 15253 U	F 24 C 3/00

**CONCORDANCE TABLE OF INTERNATIONAL CLASSIFICATION INDEX,  
PATENT NUMBERS AND PUBLICATION NUMBERS**

INTERNATIONAL CLASSIFICATION INDEX (51)	NUMBER OF PATENT (11)	NUMBER OF PUBLISHED APPLICATION (10)
A 01 K 47/00	U 2020 2055 Y	AU 2020 15300 U
A 23 L 1/314	U 2020 2054 Y	AU 2020 15214 U

**CONCORDANCE TABLE OF PATENT NUMBERS,  
PUBLICATION NUMBERS AND INTERNATIONAL CLASSIFICATION INDEX**

NUMBER OF PATENT (11)	NUMBER OF PUBLISHED APPLICATION (10)	INTERNATIONAL CLASSIFICATION INDEX (51)
U 2020 2054 Y	AU 2020 15214 U	A 23 L 1/314
U 2020 2055 Y	AU 2020 15300 U	A 01 K 47/00



**CONCORDANCE TABLE OF APPLICATION NUMBERS, PUBLICATION NUMBERS  
AND PATENTS**

NUMBER OF APPLICATION (21)	NUMBER OF PUBLISHED APPLICATION (10)	NUMBER OF PATENT (11)
AU 2019 15214	AU 2020 15214 U	U 2020 2054 Y
AU 2020 15300	AU 2020 15300 U	U 2020 2055 Y

**DESIGNS**

**CONCORDANCE TABLE OF INTERNATIONAL CLASSIFICATION INDEX  
AND PUBLICATION NUMBERS**

INTERNATIONAL CLASSIFICATION INDEXES (51)	NUMBER OF PUBLISHED APPLICATION (10)
09-01	AD 2020 1161 S
19-04	AD 2020 1159 S

**CONCORDANCE TABLE OF PUBLICATION NUMBERS  
AND INTERNATIONAL CLASSIFICATION INDEX**

NUMBER OF PUBLISHED APPLICATION (10)	INTERNATIONAL CLASSIFICATION INDEXES (51)
AD 2020 1159 S	19-04
AD 2020 1161 S	09-01

**CONCORDANCE TABLE OF INTERNATIONAL CLASSIFICATION INDEX,  
PATENT NUMBERS AND PUBLICATION NUMBERS**

INTERNATIONAL CLASSIFICATION INDEX (51)	NUMBER OF PATENT (11)	NUMBER OF PUBLISHED APPLICATION (10)
11-01	D 2020 869 S	AD 2020 1146 S
32-00	D 2020 868 S	AD 2020 1145 S

**CONCORDANCE TABLE OF PATENT NUMBERS,  
PUBLICATION NUMBERS AND INTERNATIONAL CLASSIFICATION INDEX**

NUMBER OF PATENT (11)	NUMBER OF PUBLISHED APPLICATION (10)	INTERNATIONAL CLASSIFICATION INDEX (51)
D 2020 868 S	AD 2020 1145 S	32-00
D 2020 869 S	AD 2020 1146 S	11-01

CONCORDANCE TABLE OF APPLICATION NUMBERS, PUBLICATION NUMBERS  
AND PATENTS

NUMBER OF APPLICATION (21)	NUMBER OF PUBLISHED APPLICATION (10)	NUMBER OF PATENT (11)
AD 2020 1145	AD 2020 1145 S	D 2020 868 S
AD 2020 1146	AD 2020 1146 S	D 2020 869 S

## TRADEMARKS

### CONCORDANCE TABLE OF REGISTRATION NUMBERS, APPLICATION NUMBERS, PUBLICATION NUMBERS AND BULLETIN NUMBERS

NUMBER OF REGISTRATION (111)	NUMBER OF APPLICATIONS (210)	NUMBER OF PUBLISHED APPLICATIONS (260)	NUMBER OF BULLETIN
M 2020 33217 R	AM 109914	–	20(552)2020
M 2020 33218 R	AM 110028	–	20(552)2020
M 2020 33219 R	AM 109936	–	20(552)2020
M 2020 33220 R	AM 102709	AM 2020 102709 A	12(544) 2020
M 2020 33221 R	AM 102931	AM 2020 102931 A	12(544) 2020
M 2020 33222 R	AM 103655	AM 2020 103655 A	11(543) 2020
M 2020 33223 R	AM 104216	AM 2020 104216 A	5(537) 2020
M 2020 33224 R	AM 105223	AM 2020 105223 A	10(542) 2020
M 2020 33225 R	AM 105233	AM 2020 105233 A	10(542) 2020
M 2020 33226 R	AM 105360	AM 2020 105360 A	12(544) 2020
M 2020 33227 R	AM 105361	AM 2020 105361 A	12(544) 2020
M 2020 33228 R	AM 105448	AM 2020 105448 A	11(543) 2020
M 2020 33229 R	AM 105456	AM 2020 105456 A	11(543) 2020
M 2020 33230 R	AM 105556	AM 2020 105556 A	12(544) 2020
M 2020 33231 R	AM 105739	AM 2020 105739 A	11(543) 2020
M 2020 33232 R	AM 105751	AM 2020 105751 A	12(544) 2020
M 2020 33233 R	AM 105752	AM 2020 105752 A	12(544) 2020
M 2020 33234 R	AM 105753	AM 2020 105753 A	12(544) 2020
M 2020 33235 R	AM 105784	AM 2020 105784 A	11(543) 2020
M 2020 33236 R	AM 105785	AM 2020 105785 A	11(543) 2020
M 2020 33237 R	AM 105786	AM 2020 105786 A	11(543) 2020
M 2020 33238 R	AM 105787	AM 2020 105787 A	11(543) 2020
M 2020 33239 R	AM 105808	AM 2020 105808 A	11(543) 2020
M 2020 33240 R	AM 105809	AM 2020 105809 A	12(544) 2020
M 2020 33241 R	AM 105810	AM 2020 105810 A	11(543) 2020
M 2020 33242 R	AM 105814	AM 2020 105814 A	11(543) 2020
M 2020 33243 R	AM 105992	AM 2020 105992 A	12(544) 2020
M 2020 33244 R	AM 99958	AM 2020 99958 A	7(539) 2020
M 2020 33245 R	AM 105032	AM 2020 105032 A	8(540) 2020
M 2020 33246 R	AM 106068	AM 2020 106068 A	12(544) 2020
M 2020 33247 R	AM 103662	AM 2020 103662 A	3(535) 2020
M 2020 33248 R	AM 110019	–	20(552)2020
M 2020 33249 R	AM 109953	–	20(552)2020

CONCORDANCE TABLE OF PUBLICATION NUMBERS  
AND APPLICATION NUMBERS

NUMBER OF PUBLISHED APPLICATION (260)	NUMBER OF APPLICATION (210)	1	2
1	2		
AM 2020 104567 A*	AM 104567	AM 2020 107491 A	AM 107491
AM 2020 106605 A	AM 106605	AM 2020 107497 A	AM 107497
AM 2020 106751 A	AM 106751	AM 2020 107499 A	AM 107499
AM 2020 106752 A	AM 106752	AM 2020 107552 A	AM 107552
AM 2020 107269 A	AM 107269	AM 2020 107553 A	AM 107553
AM 2020 107272 A	AM 107272	AM 2020 107554 A	AM 107554
AM 2020 107273 A	AM 107273	AM 2020 107556 A	AM 107556
AM 2020 107274 A	AM 107274	AM 2020 107558 A	AM 107558
AM 2020 107275 A	AM 107275	AM 2020 107564 A	AM 107564
AM 2020 107276 A	AM 107276	AM 2020 107565 A	AM 107565
AM 2020 107277 A	AM 107277	AM 2020 107569 A	AM 107569
AM 2020 107278 A	AM 107278	AM 2020 107570 A	AM 107570
AM 2020 107279 A	AM 107279	AM 2020 107571 A	AM 107571
AM 2020 107280 A	AM 107280	AM 2020 107572 A	AM 107572
AM 2020 107281 A	AM 107281	AM 2020 107574 A	AM 107574
AM 2020 107282 A	AM 107282	AM 2020 107579 A	AM 107579
AM 2020 107294 A	AM 107294	AM 2020 107583 A	AM 107583
AM 2020 107311 A	AM 107311	AM 2020 107651 A	AM 107651
AM 2020 107470 A	AM 107470	AM 2020 107653 A	AM 107653
AM 2020 107480 A	AM 107480	AM 2020 107654 A	AM 107654
AM 2020 107490 A	AM 107490	AM 2020 107670 A	AM 107670
		AM 2020 107671 A	AM 107671
		AM 2020 107814 A	AM 107814
		AM 2020 107817 A	AM 107817
		AM 2020 107923 A	AM 107923

CONCORDANCE TABLE OF INDEX OF GOODS AND/OR SERVICES  
AND APPLICATION NUMBERS

INDEX OF GOODS AND/OR SERVICES (511)	NUMBER OF PUBLISHED APPLICATIONS (26)	1	2
1	2	16	AM 2020 107558 A
1	AM 2020 107817 A	20	AM 2020 107480 A
3	AM 2020 107553 A	24	AM 2020 107480 A
3	AM 2020 107554 A	25	AM 2020 106751 A
3	AM 2020 107653 A	25	AM 2020 106752 A
5	AM 2020 107269 A	25	AM 2020 107556 A
5	AM 2020 107272 A	29	AM 2020 107583 A
5	AM 2020 107273 A	31	AM 2020 107470 A
5	AM 2020 107274 A	32	AM 2020 107552 A
5	AM 2020 107275 A	32	AM 2020 107569 A
5	AM 2020 107276 A	32	AM 2020 107570 A
5	AM 2020 107277 A	32	AM 2020 107571 A
5	AM 2020 107278 A	32	AM 2020 107572 A
5	AM 2020 107279 A	33	AM 2020 104567 A*
5	AM 2020 107280 A	33	AM 2020 107311 A
5	AM 2020 107281 A	33	AM 2020 107497 A
5	AM 2020 107282 A	33	AM 2020 107499 A
5	AM 2020 107470 A	34	AM 2020 107564 A
5	AM 2020 107553 A	34	AM 2020 107565 A
5	AM 2020 107554 A	34	AM 2020 107670 A
5	AM 2020 107569 A	35	AM 2020 106752 A
5	AM 2020 107570 A	35	AM 2020 107480 A
5	AM 2020 107571 A	35	AM 2020 107556 A
5	AM 2020 107572 A	35	AM 2020 107569 A
5	AM 2020 107574 A	35	AM 2020 107570 A
5	AM 2020 107579 A	35	AM 2020 107571 A
5	AM 2020 107651 A	35	AM 2020 107572 A
5	AM 2020 107671 A	35	AM 2020 107574 A
5	AM 2020 107817 A	35	AM 2020 107654 A
7	AM 2020 107558 A	35	AM 2020 107814 A
7	AM 2020 107817 A	35	AM 2020 107817 A
7	AM 2020 107923 A	37	AM 2020 107814 A
8	AM 2020 107558 A	39	AM 2020 107654 A
10	AM 2020 107470 A	41	AM 2020 107294 A
11	AM 2020 107923 A	42	AM 2020 106605 A
		43	AM 2020 107490 A
		43	AM 2020 107491 A
		44	AM 2020 107817 A

CONCORDANCE TABLE OF INDEX OF GOODS AND/OR SERVICES  
AND NUMBERS OF TRADEMARKS REGISTERED ACCORDING  
TO THE ACCELERATED PROCEDURE

INDEX OF GOODS AND/OR SERVICES (511)	NUMBERS OF REGISTERED ACCORDING TO THE ACCELERATED PROCEDURE (111)
7	M 2020 33248 R
8	M 2020 33248 R
20	M 2020 33219 R
25	M 2020 33217 R
33	M 2020 33218 R
34	M 2020 33249 R
35	M 2020 33217 R
35	M 2020 33249 R

# OFFICIAL BULLETIN OF THE INDUSTRIAL PROPERTY

**INVENTIONS  
UTILITY MODELS  
DESIGNS  
TRADEMARKS**

## **20(552)**

EDITOR-IN-CHIEF: N. Bebrishvili

EDITOR-TRANSLATOR: E. Gabunia

PROOFREADER: A. Shikhashvili

COMPUTER LAYOUT: M. Ordenidze  
K. Svanidze

[www.sakpatenti.gov.ge](http://www.sakpatenti.gov.ge)  
E-mail: [info@sakpatenti.org.ge](mailto:info@sakpatenti.org.ge)

**LIST OF CODES, IN ALPHABETIC SEQUENCE, AND THE CORRESPONDING (SHORT) NAMES OF STATES, OTHER ENTITIES AND INTERGOVERNMENTAL ORGANIZATIONS  
(WIPO STANDARD ST.3)**

AD	Andorra		for the Arab States of the Gulf (GCC)	NE	Niger
AE	United Arab Emirates	GD	Grenada	NG	Nigeria
AF	Afghanistan	GG	Guernsey	NI	Nicaragua
AG	Antigua and Barbuda	GH	Ghana	NL	Netherlands
AI	Anguilla	GI	Gibraltar	NO	Norway
AL	Albania	GT	Guatemala	NP	Nepal
AM	Armenia	GW	Guinea- Bissau	NR	Nauru
AN	Netherlands Antilles	GY	Guyana	NZ	New Zealand
AO	Angola	HK	The Hong Kong Special Administrative Region of the People's Republic of China	OA	African Intellectual Property Organization (OAPI)
AP	African Regional Intellectual Property Organization (ARIPO)	HN	Honduras	OM	Oman
AR	Argentina	HR	Croatia	PA	Panama
AT	Austria	HT	Haiti	PE	Peru
AU	Australia	HU	Hungary	PG	Papua New Guinea
AW	Aruba	IB	International Bureau of the World Intellectual Property Organization (WIPO)	PH	Philippines
AZ	Azerbaijan	ID	Indonesia	PK	Pakistan
BA	Bosnia and Herzegovina	IE	Ireland	PL	Poland
BB	Barbados	IL	Israel	PT	Portugal
BD	Bangladesh	IM	Isle of Man	PW	Palau
BE	Belgium	IN	India	PY	Paraguay
BF	Burkina Faso	IQ	Iraq	QA	Qatar
BG	Bulgaria	ID	Indonesia	QZ	Community Plant Variety Office (European Community) (CPVO)
BH	Bahrain	IE	Ireland	RO	Romania
BI	Burundi	IL	Israel	RS	Serbia
BJ	Benin	IM	Isle of Man	RU	Russian Federation
BM	Bermuda	IN	India	RW	Rwanda
BN	Brunei Darussalam	IQ	Iraq	SA	Saudi Arabia
BO	Bolivia	IR	Iran (Islamic Republic of)	SB	Solomon Islands
BR	Brazil	IS	Iceland	SC	Seychelles
BS	Bahamas	IT	Italy	SD	Sudan
BT	Bhutan	JE	Jersey	SG	Singapore
BV	Bouvet Island	JM	Jamaica	SH	Saint Helena
BW	Botswana	JO	Jordan	SI	Slovenia
BX	Benelux Office for Intellectual Property (BOIP)	JP	Japan	SK	Slovakia
BY	Belarus	KE	Kenya	SL	Sierra Leone
BZ	Belize	KG	Kyrgyzstan	SM	San Marino
CA	Canada	KH	Cambodia	SN	Senegal
CD	Democratic Republic of the Congo	KI	Kiribati	SO	Somalia
CF	Central African Republic	KM	Saint Kitts and Nevis	SR	Suriname
CG	Congo	KP	Democratic People's Republic of Korea	ST	Sao Tome and Principe
CH	Switzerland	KR	Republic of Korea	SV	El Salvador
CI	Cote d'Ivoire	KW	Kuwait	SY	Syrian Arab Republic
CK	Cook Islands	KY	Cayman Islands	SZ	Swaziland
CL	Chile	KZ	Kazakhstan	TC	Turks and Caicos Islands
CM	Cameroon	LA	Lao People's Democratic Republic	TD	Chad
CN	China	LB	Lebanon	TG	Togo
CO	Colombia	LC	Saint Lucia	TH	Thailand
CR	Costa Rica	LI	Liechtenstein	TJ	Tajikistan
CU	Cuba	LK	Sri Lanka	TL	Timor-Leste
CV	Cape Verde	LR	Liberia	TM	Turkmenistan
CY	Cyprus	LS	Lesotho	TN	Tunisia
CZ	Czech Republic	LT	Lithuania	TO	Tonga
DE	Germany	LU	Luxembourg	TR	Turkey
DJ	Djibouti	LV	Latvia	SE	Sweden
DM	Dominica	LY	Libyan Arab Jamahiriya	TT	Trinidad and Tobago
DO	Dominican Republic	MA	Morocco	TV	Tuvalu
DZ	Algeria	MC	Monaco	TW	Taiwan, Province of China
EA	Eurasian Patent Organization (EAPO)	MD	Republic of Moldova	TZ	United Republic of Tanzania
EC	Ecuador	ME	Montenegro	UA	Ukraine
EE	Estonia	MG	Madagascar	UG	Uganda
EG	Egypt	MK	The former Yugoslav Republic of Macedonia	US	United States of America
EH	Western Sahara	ML	Mali	UY	Uruguay
EM	Office for Harmonization in the Internal Market (Trademarks and Designs)(OHIM)	MM	Myanmar	UZ	Uzbekistan
EP	European Patent Office (EPO)	MN	Mongolia	VA	Holy See
ER	Eritrea	MO	Macao	VC	Saint Vincent and the Grenadines
ES	Spain	MP	Northern Mariana Islands	VE	Venezuela
ET	Ethiopia	MR	Mauritania	VG	Virgin Islands (British)
FI	Finland	MS	Montserrat	VN	Viet Nam
FJ	Fiji	MT	Malta	VU	Vanuatu
FK	Falkland Islands (Malvinas)	MU	Mauritius	WO	World Intellectual Property Organization (WIPO)
FO	Faroe Islands	MV	Maldives	WS	Samoa
FR	France	MW	Malawi	XN	Nordic Patent Institute (NPI)
GA	Gabon	MX	Mexico	YE	Yemen
GB	United Kingdom	MY	Malaysia	ZA	South Africa
GC	Patent Office of the Cooperation Council	MZ	Mozambique	ZM	Zambia
		NA	Namibia	ZW	Zimbabwe