

Official Bulletin of the Industrial Property

Inventions

Utility Models

Designs

Trademarks

Appellation of Origin of Goods



საქართველოს ინტელექტუალური
საკუთრების ეროვნული ცენტრი

საქპატენტი

SAKPATENTI

NATIONAL INTELLECTUAL PROPERTY
CENTER OF GEORGIA

www.sakpatenti.gov.ge

Date of Publication – 2023 10 25

20(623)

INID CODES FOR IDENTIFICATION OF BIBLIOGRAPHIC DATA

INVENTIONS, UTILITY MODELS

- (10) Number of publication of examined application/
Application publication number***
- (11) Patent number/ Patent number***
Registered utility model number***
- (21) Application number
- (22) Date of filing of the application
- (23) Date of exhibition priority
- (24) Date from which patent may have effect
- (31) Number of priority application
- (32) Date of filing of priority application
- (33) Code of the country or regional organization allotting application number
- (43) Date of publication of application, number of bulletin***
- (44) Date of publication of examined application, on which no grant has taken place and number of bulletin
- (45) Date of publication of patent/ Date of publication of patent***
Date of publication of registered utility model***
- (51) International Patent Classification Index
- (54) Title of the invention/title of the utility model
- (57) Abstract
- (60) Number of examined patent document granted by foreign patent office, date from which patent has effect and country code
- (62) Number and filing date of the earlier application in case of a divisional application
- (71) Name and address of applicant (country code)
- (72) Name of inventor (country code)
- (73) Name and address of patent owner/patent owner***/ registered utility model owner*** (country code)
- (74) Name of representative or patent attorney
- (85) Date of commencement of the national phase of international application (PCT)
- (86) Number and date of filing of international application (PCT)
- (87) Number and date of publication of international application (PCT)
- (94) Calculated date of expiry of the SPC or the duration of the SPC

DESIGNS

- (10) Number of publication for application
- (11) Number of patent and kind of document or number of registration
- (15) Date of registration/Date of patent renewal
- (18) Expected expiration date of patent or registration
- (21) Serial number of application
- (22) Date of filing of the application
- (23) Date of exhibition or the date of the earlier filing and the number of application, if any
- (24) Date from which patent may have effect
- (28) Number of designs included in the application
- (30) Data relating to priority (number of application, date of filing of application, two-letter code identifying the authority with whom the priority application was made)
- (31) Number of priority application
- (32) Date of filing of priority application
- (33) Code of the country or regional organization allotting priority application number
- (34) Two-letter code according to WIPO St.3 identifying the authority with which the priority application was made
- (44) Date of publication of design and number of bulletin (the first publication)
- (45) Date of publication of design registered by WIPO and number of bulletin
- (51) International Classification for designs (class and subclass of the Locarno Classification)
- (54) Title of the invention
- (55) Reproduction of the design
- (57) Description of characteristic features of the design including indication of colors
- (58) Date of recording of any kind of amendment in the Register
- (62) Number of the earlier application, registration and document number and if available the date of filing an application in case of divided application
- (71) Name, surname and address of applicant (country code)
- (72) Name, surname of creator (country code)
- (73) Name, surname and address of patent owner (country code)
- (74) Name, surname of representative or patent attorney
- (81) Contracting states concerned
II designated contracting states according to the 1960 Act
III designated contracting states according to the 1999 Act
- (85) Owner's permanent address
- (86) Owner's nationality
- (87) Owner's residence
- (88) State in which the owner has a real and effective industrial or commercial establishment

TRADEMARKS

- (111) – Number of registration
- (151) – Date of registration
- (156) – Date of the renewal
- (181) – Expected expiration date of registration
- (186) – Renewal expiration date of registration
- (141) – Date of cancel of duration of the mark
- (210) – Serial number of application
- (220) – Date of filing of the application
- (230) – Data concerning exhibition
- (260) – Number of application, for which favorable decision of examination about registration has been taken (publication number)
- (310) – Number of the first application
- (320) – Date of filing of the first application
- (330) – Code, identifying national or regional Office where the first application was made
- (511) – International Classification of Goods and Services for the purposes of registration of trade marks and/or list of goods and/or services classified according thereto
- (526) – Disclaimer
- (531) – Description of figurative elements of Trade Marks according to the International Classification of the Figurative Elements of Marks
- (540) – Reproduction of Trade Mark
- (550) – Nature and kind of Trade Mark
- (551) – Indication to the effect that the mark is a collective mark, a certification mark or a guarantee mark
- (554) – Three-dimensional mark
- (580) – Date of recording of any kind changes in respect of applications or registrations
- (591) – Information concerning colors claimed
- (731) – Name and address of the applicant
- (732) – Name and address of the holder of the registration
- (740) – Name and address of the representative
- (750) – Addreses for correspondence
- (770) – Name and address of the previous applicant or holder in case of change in ownership
- (771) – Previous name and address of the applicant or holder in case of change in ownership
- (791) – Name and address of the licensee
- (793) – Indication of conditions and/or restrictions under the license (Type of license, number of license agreement, data of license, data of validity of license)
- (800) – Certain data relating to the international registration of Trade Marks under the Protocol Relating to Madrid Agreement (International registration number
- (852) – Partial cancellation of the list of goods and services
- (891) – Date of subsequent designation

CODES FOR PUBLICATION IN BULLETIN

- (21) AP 0000 000000 – number of application for invention
- (10) AP 0000 0000 A – number of publication of application for invention
- (11) P 0000 0000 B – number of patent for invention/ patent number***
- (21) API 0000 000000 – number of application for imported patent
- (11) PI 0000 0000 A – number of imported patent
- (21) AU 0000 000000 – number of application for utility model
- (10) AU 0000 000 U – number of publication of application for utility model
- (11) U 0000 000 Y – number of patent for utility model/ registered utility model number***
- (21) AD 0000 000000 – serial number of application for design
- (10) AD 0000 000 S – number of published application for design (first publication)
- (11) D 0000 000 S – registered design

INTERNATIONAL PATENT CLASSIFICATION FOR INVENTIONS AND UTILITY MODELS

- SECTION A – HUMAN NECESSITIES
- SECTION B – PERFORMING OPERATIONS; TRANSPORTING
- SECTION C – CHEMISTRY; METALLURGY
- SECTION D – TEXTILES; PAPER
- SECTION E – FIXED CONSTRUCTIONS
- SECTION F – MECHANICAL ENGINEERING; LIGHTING; HEATING; WEAPONS; BLASTING
- SECTION G – PHYSICS
- SECTION H – ELECTRICITY

* Number of application published after the decision of Appellation Chamber of SAKPATENTI

** Number of application published after Court decision

*** Materials published according to the amendments of May 16, 2023 (No. 2883-XI0b-X03) to the Patent Law of Georgia

- M – Trade Mark
- (210) AM 0000 000000 – Serial number of application;
- (260) AAM 0000 00000 A – Publication number of application;
- (111) M 0000 00000 R – Number of registration;
- (111) MMM0000 00000 Rn – Number of renewals, in which n=1,2,3;
- (111) M 0000 00000 R(P) – Number of registration under partial assignment of rights

Official Bulletin of the Industrial Property

Inventions

Utility Models

Designs

Trademarks

Appellation of Origin of Goods

CONTENT

PUBLISHED TITLES OF PROTECTION	3
INVENTIONS	
▪ APPLICATIONS APPROVED FOR GRANTING PATENT	4
▪ PATENTED INVENTIONS	7
▪ APPLICATIONS***	10
UTILITY MODELS	
▪ APPLICATIONS APPROVED FOR GRANTING PATENT	14
▪ PATENTED UTILITY MODEL	16
DESIGNS	
▪ APPLICATIONS APPROVED FOR REGISTRATION	17
▪ DESIGNS, WICH HAVE BEEN REGISTERED WITH THE INTERNATIONAL BUREAU CLAIMING PRIORITY ON THE TERRITORY OF GEORGIA	20
TRADEMARKS	
▪ APPLICATIONS FILED UNDER THE NATIONAL PROCEDURE APPROVED FOR REGISTRATION	31
▪ REGISTERED TRADEMARKS	36
▪ TRADEMARKS REGISTERED ACCORDING TO THE ACCELERATED PROCEDURE	39
▪ INTERNATIONAL TRADEMARKS FOR WHICH A DECISION ON GRANTING PROTECTION IS TAKEN	42
▪ INTERNATIONAL TRADEMARK PROTECTED IN GEORGIA	114
APPELLATION OF ORIGIN OF GOODS	
AMENDMENTS TO REGISTERED APPELLATION OF ORIGIN OF GOODS	115
OFFICIAL NOTIFICATION	
INVENTIONS	
▪ RESTORATION OF PATENTS	116
▪ LAPSE OF PATENTS WITH THE RIGHT TO RESTORE	116
▪ EXPIRATION OF PATENTS RESTORATION TERM	117
▪ EXPIRATION OF PATENTS	118
UTILITY MODELS	
▪ RESTORATION OF PATENT	118
▪ LAPSE OF PATENT WITH THE RIGHT TO RESTORE	118
DESIGNS	
▪ EXTENSION OF TERM OF DESIGNS REGISTRATION	119
▪ CANCELLATION OF DESIGN REGISTRATION	119
▪ EXTENSION OF TERM OF INTERNATIONAL DESIGNS REGISTRATION	120
▪ CANCELLATION OF INTERNATIONAL DESIGNS REGISTRATION	122
TRADEMARKS	
▪ EXTENSION OF TERM OF TRADEMARKS REGISTRATION	125
▪ COMPLETE TRANSFER OF RIGHTS	128
▪ CHANGES OF NAME AND/OR ADDRESS OF TRADEMARKS OWNERS	130
▪ CANCELLATION OF TRADEMARKS REGISTRATION	133
CLASSIFICATION INDEXES	
INVENTIONS	135
UTILITY MODELS	138
DESIGNS	139
TRADEMARKS	140

PUBLISHED TITLES OF PROTECTION

INVENTIONS

- **APPLICATIONS APPROVED FOR GRANTING PATENT:**
16025; 15538; 15757; 15739; 15977; 16173; 15929; 16203
- **PATENTED INVENTIONS:**
7554-7563
- **APPLICATIONS:*****
16271; 16326; 16350; 16330, 16331; 16341; 16339, 16340

UTILITY MODELS

- **APPLICATIONS APPROVED FOR GRANTING PATENT:**
16251; 16069; 16194; 16234
- **PATENTED UTILITY MODEL:**
2157

DESIGNS

- **APPLICATIONS APPROVED FOR REGISTRATION:**
1313; 1315
- **DESIGNS, WHICH HAVE BEEN REGISTERED WITH THE INTERNATIONAL BUREAU CLAIMING PRIORITY ON THE TERRITORY OF GEORGIA:**
226330; 226429; 230351; 224576; 230479; 226738

TRADEMARKS

- **APPLICATIONS FILED UNDER THE NATIONAL PROCEDURE APPROVED FOR REGISTRATION:**
117543*, 117544*, 119106*, 121644; 121651; 121739; 121742; 121756, 121757; 121769; 121900; 121903; 121907; 121927; 121938; 122013; 122040; 122104; 122110, 122111; 122120; 122125; 122127; 122208; 122210, 122211; 122216, 122217; 122223; 122387; 122409; 122418
- **REGISTERED TRADEMARKS:**
37386-37404; 37418-37424
- **TRADEMARKS REGISTERED ACCORDING TO THE ACCELERATED PROCEDURE:**
37405-37417
- **INTERNATIONAL TRADEMARKS FOR WHICH A DECISION ON GRANTING PROTECTIONS IS TAKEN:**
120372; 121182-121184; 121199; 121205; 121252-121263; 121276-121281; 121283; 121291; 121294; 121353-121355; 121367-121372; 121379; 121383; 121385-121390; 121403-121408; 121463-121487; 121492-121497; 121567-121571; 121577-121582; 121585, 121586; 121605, 121606; 121617-121621; 121627, 121628; 121671; 121674-121676; 121678; 121689; 121699; 121710-121714; 121782-121785; 121817-121821; 121841; 121947; 121957; 121963; 121971; 121975; 121989; 121992; 121999; 122148; 122164, 122165
- **INTERNATIONAL TRADEMARK PROTECTED IN GEORGIA:**
119740

APPELLATION OF ORIGIN OF GOODS

KHVANCHKARA

INVENTIONS

APPLICATIONS APPROVED FOR GRANTING PATENT

The decision can be appealed at the Chamber of Appeal of Sakpatenti within 3 months from the publication or at the Mtskheta District Court Administrative Cases Board (Address: №17, Samkhedro St., Mtskheta), within 1 month following the publication.

PART A

A 61

(10) AP 2023 16025 A (51) Int. Cl. (2006)
A 61 K 9/00
A 61 K 31/58
A 61 K 47/10
A 61 K 47/02
A 61 K 31/573
A 61 K 31/167
A 61 K 31/137
A 61 P 11/00

(21) AP 2021 16025 (22) 2021 01 26
(31) 20153973.1; 20214091.9
(32) 2020 01 28; 2020 12 15
(33) EP; EP
(71) Chiesi Farmaceutici S.P.A. (IT)
Via Palermo 26/A, 43122 Parma, Italy (IT)

(72) ZAMBELLI, Enrico (IT)

(74) Shalva Gvaramadze

(85) 2022 08 17

(86) PCT/EP2021/051669, 2021 01 26

(54) PRESSURISED METERED DOSE INHALERS
COMPRISING A BUFFERED PHARMA-
CEUTICAL FORMULATION

(57) 213 can used in the pMDI device contains budesonide or beclomethasone dipropionate, formoterol fumarate, and HFA or HFO propellant selected from 1,1-difluoroethane (HFA152a) or 1,3,3,3-tetrafluoropropene (HFO-1234ze). The can is internally coated with fluoroethylene-propylene polymer (FEP) and equipped with valve provided with a pad made of cycloolefin copolymer (COC), EPDM (ethylene propylene diene monomer polymer) made of two pads or provided with two pads made of chlorobutyl polymer.

Claims: 3 independents
10 dependents

(10) AP 2023 15538 A (51) Int. Cl. (2006)
A 61 K 31/11
A 61 K 36/18
A 61 K 36/36
A 61 K 36/33
A 61 K 36/53
A 61 K 36/899

(21) AP 2018 15538 (22) 2018 10 17
(31) 2018/08522

(32) 2018 06 14

(33) TR

(71) Setonda, S.L (ES)
Joaquim Costa, 18-08390 Montgat (Barcelona)
08001, Spain (ES)

(72) YUSUBOV, Natig (AZ)

(74) Babulia Taliashvili

(85) 2021 01 18

(86) PCT/EP2018/078444, 2018 10 17

(54) HERBAL COMPOSITIONS FOR THE TREA-
TMENT OF UROLITHIASIS AND URINARY
TRACT INFECTIONS

(57) Composition contains aqueous extracts of horsetail – Equisetum arvense, Spargularia rubra, Peumus boldus, Opuntia ficus-indica, Sideritis angustifolia, rosemary – Rosmarinus officinalis, Glerita – Cynodon dactylon and lemon balm – Melissa officinalis.

Claims: 2 independents
8 dependents

(10) AP 2023 15757 A (51) Int. Cl. (2006)
A 61 K 31/137
A 61 K 31/42
A 61 K 31/506
A 61 K 31/551
A 61 K 31/7008
A 61 K 45/06

(21) AP 2018 15757 (22) 2018 04 26

(62) AP 2018 15226 2018 04 26

(31) 62/491,504; 62/558,814

(32) 2017 04 28; 2017 09 14

(33) US; US

(71) The Brigham & Women's Hospital Inc. (US)
75 Francis Street, Boston, MA 02115, USA (US)

(72) TARANTO-MONTEMURRO, Luigi (US);
WELLMAN, D. Andrew (US)

(74) Giorgi Kartvelishvili

(85) 2021 10 15

(86) PCT/US2018/029518, 2018 04 26

(54) METHODS AND COMPOSITIONS FOR
TREATING SLEEP APNEA

(57) Atomoxetine and fesoterodine usage for obstructive sleep apnea treatment.

Claims: 1 independent
7 dependents

Fig.: 13

- (10) AP 2023 15739 A (51) Int. Cl. (2006)
 A 61 K 31/593
 A 61 K 31/353
 A 61 K 31/235
 A 61 K 31/355
 A 61 K 31/4415
 A 61 P 35/00

(21) AP 2020 15739 (22) 2020 03 13

(31) 102019000003843

(32) 2019 03 15

(33) IT

(71) Lo.Li. Pharma S.R.L. (IT)

Via Sabatino Gianni 14, Roma, 00156, Italy(IT)

(72) UNFER, Vittorio (IT)

(74) Nikoloz Gogilidze

(85) 2021 09 21

(86) PCT/EP2020/056799, 2020 03 13

(54) TREATMENT OF FIBROIDS WITH VITAMIN D AND AN AGENT SUCH AS EPIGALLOLOCATECHIN GALLATE (EGCG)

(57) Vitamin D and one or more agent selected from epigallocatechin gallate (EGCG), catechin, gallocatechin and epicatechin gallate (ECG), for the prevention, control and/or treatment of fibroids in a subject.

Claims: 2 independents

9 dependents

Fig.: 9

- (10) AP 2023 15977 A (51) Int. Cl. (2006)
 A 61 K 31/5377
 A 61 K 31/4453
 A 61 P 17/00
 C 07 D 413/14
 C 07 D 405/14

(21) AP 2020 15977 (22) 2020 12 16

(31) 62/951,030; 63/108,602

(32) 2019 12 20; 2020 11 02

(33) US; US

(71) Pfizer Inc. (US)

66, Hudson Blvd. East, New York, N.Y. 10001-2192, USA (US)

(72) BAGLEY, Scott William (US);

CASIMIRO-GARCIA, Agustin (US);

CHENG, Xiayun (US);

DAVOREN, Jennifer Elizabeth (US);

DENNY, Rajiah Aldrin (US);

GERSTENBERGER, Brian Stephen (US);

LOVERING, Frank Eldridge (US);

PARIKH, Mihir Dineshkumar (US);

STROHBACH, Joseph Walter (US);

TRUJILLO, John Isidro (US)

(74) Shalva Gvaramadze

(85) 2022 06 16

(86) PCT/IB2020/062036, 2020 12 16

(54) BENZIMIDAZOLE DERIVATIVES

(57) Compound of formula (I),

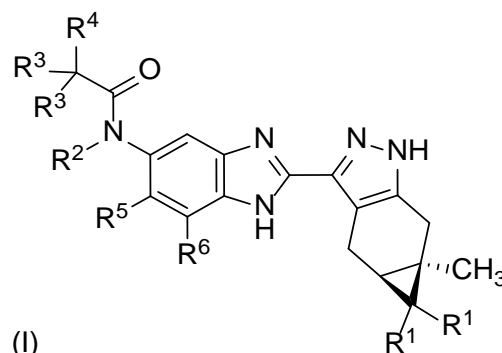

(I)

pharmaceutical compositions comprising them, and their usage for dermatological disorders treatment, supported with ITK inhibitor.

Claims: 6 independents

23 dependents

Fig.: 7

PART B

B 22

- (10) AP 2023 16173 A (51) Int. Cl. (2006)
 B 22 D 11/06

(21) AP 2023 16173 (22) 2023 02 22

(71) Giorgi Kevkhashvili (GE)

Burdzgia St. 100, ap. 39, 0160, Tbilisi, Georgia (GE);

Julieta Loria (GE)

Tsintsadze St. 77, ap. 60, 0160, Tbilisi, Georgia (GE);

LEPL "Shota Rustaveli National Science Foundation of Georgia" (GE)

M. Aleksidze St. II Lane 2, Tbilisi, Georgia (GE);

LEPL "Ferdinand Tavadze Metallurgy and Materials Science Institute" (GE)

Mindeli St. 10, 0160, Tbilisi, Georgia (GE);

Giorgi Parunashvili (GE)

Navtlughi St. 1/12, Tbilisi, Georgia (GE);

Vazha Ramishvili (GE)

Iosebidge St. 71, ap. 45, 0160, Tbilisi, Georgia (GE);

Teimuraz Namicheishvili (GE)

Mtskheta St. 17, ap. 6, 0179, Tbilisi, Georgia (GE)

(72) Giorgi Kevkhashvili (GE);

Julieta Loria (GE);

Giorgi Parunashvili (GE);

Vazha Ramishvili (GE);

Teimuraz Namicheishvili (GE)

(54) METHOD FOR OBTAINING COMPOSITE ARMOR PLATE

(57) A method provides connection of two side layers of relatively low toughness and high plasticity alumi-

num alloy and middle, high strength material bar during casting process by rolling, by using of roll-crystallizers, wherein middle, high strength material bar is shot before it enters the rolling zone. Furthermore, after supplying of relatively low viscosity and high plasticity aluminum alloy to the roll-crystallizers, before the layers and the middle bar are joined together by rolling, the bar is carried in low-melting slag layer on top of melt in roll-crystallizers, and then in hollow phase of mold already formed in roll-crystallizers, and clinch-joint-like connections between layers and bars are formed in the process of rolling.

Claims: 1 independent
2 dependents
Fig.: 2

PART G

G 01

(10) AP 2023 15929 A (51) Int. Cl. (2006)
G 01 N 27/00

(21) AP 2022 15929 (22) 2022 04 15

(71) Giorgi Nozadze (GE)
Zghvis Ubani IV m/r., bld. 6, ap. 37, 0178,
Tbilisi, Georgia (GE);
Karlo Tavlalashvili (GE)
Nutsbidze St. 193, ap. 12, Tbilisi,
Georgia (GE);
Giorgi Kartvelishvili (GE)
Vazha-Pshavela Av. 59, ap. 11, 0186, Tbilisi,
Georgia (GE)

(72) Giorgi Nozadze (GE);
Karlo Tavlalashvili (GE);
Giorgi Kartvelishvili (GE)

(54) SENSOR HEAD OF MAGNETOIN DUCTON
DEFECTOSCOPE FOR LONGITUDINAL
FERROMAGNETIC PRODUCTS

(57) A head of a new design of high resolution consisting of two pairs of semi-rings, where hall sensors are placed circularly and symmetrically on each pair ensuring generation and processing of multi-channel synchronous data is proposed. The break of internal rods that make up steel ropes and objectively evaluate the operational resource of existing steel rope is possible to determine with high accuracy, as a result of computer processing of relevant information.

Claims: 1 independent
Fig. 5

PART H

H 02

(10) AP 2023 16203 A (51) Int. Cl. (2006)
H 02 K 33/04

(21) AP 2023 16203 (22) 2023 04 03

(71) Gela Javakhishvili (GE)
Bukhaidze St. 18, Tbilisi, 0102, Georgia (GE);
Aleksandre Didebulidze (GE)
Merab Kostava St. 44, Entrance 1, ap. 5, 0179,
Tbilisi, Georgia (GE)

(72) Gela Javakhishvili (GE);
Aleksandre Didebulidze (GE)

(54) ANGULAR OSCILLATION EIGHT-POLE
ELECTROMAGNETIC VIBRATION
MACHINE

(57) A machine includes a stator 1 having equally disposed eight poles 1-1, 1-2, 1-3, 1-4, 1-5, 1-6, 1-7 and 1-8, and alternating current winding placed therewith coils creating two parallel branches, each wherefrom consists of coils and hub having eight poles 2-1, 2-2, 2-3, 2-4, 2-5, 2-6, 2-7 and 2-8 connected sequentially. The poles are located on the stator 1 and hub 2 so that the lines passing through the centers of opposite non-magnetic material gaps located between adjacent poles of parallel branches are the axes of symmetry. A winding placed on the poles of stator is directly switched to alternating current clamps 5-1, 5-2, and DC winding coils are placed on the poles of hub switched in sequence; furthermore, one branch coils of alternating current winding placed on stator poles, and direct current winding coils – on opposite armature poles are wound in parallel, and second branch alternating current winding coils placed on stator poles and, accordingly, opposite armature poles direct current winding coils are wound in parallel, that ensures constant current on the grips 5-3, 5-4 compensating self-induction EMF. Variable pole system is created as a whole so that capable to adjust of mechanical oscillations amplitude by changing the voltage on DC windings clamps.

Claims: 1 independent
Fig.: 1

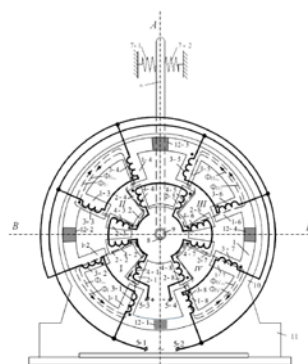

Fig. 1

PATENTED INVENTIONS

PART A

A 61

(11) P 2023 7556 B (51) Int. Cl. (2006)
 A 61 B 17/32
 A 61 B 17/34
 A 61 F 2/10

(10) AP 2023 15782 A (44) 11(614)/2023
 (21) AP 2021 15782
 (22) 2021 11 02
 (24) 2021 11 02
 (73) Tamaz Shioshvili (GE)
 Ir. Abashidze St. 46, ap. 17, 0179, Tbilisi,
 Georgia (GE)
 (72) Tamaz Shioshvili (GE)
 (54) DEVICE FOR ENGRAVEING AND
 TRANSPLANTING HAIR STRANDS

(11) P 2023 7561 B (51) Int. Cl. (2006)
 A 61 K 31/53
 A 61 P 35/00
 C 07 D 491/107
 C 07 D 471/10
 C 07 D 451/04
 C 07 D 403/04
 C 07 D 513/10
 C 07 D 401/14
 C 07 D 519/00

(10) AP 2023 15746 A (44) 13(616)/2023
 (21) AP 2020 15746
 (22) 2020 03 30
 (24) 2020 03 30
 (31) 62/828,356; 62/992,558
 (32) 2019 04 02; 2020 03 20
 (33) US; US
 (86) PCT/IB2020/053019, 2020 03 30
 (73) Array Biopharma Inc. (US)
 3200 Walnut Street, Boulder, CO 80301,
 USA (US)
 (72) BLAKE, James F. (US);
 COOK, Adam W. (US);
 CHICARELLI, Mark Joseph (US);
 ELSAYED, Mohamed S. A. (US);
 FELL, Jay Bradford (US);
 FISCHER, John P. (US);
 HINKLIN, Ronald Jay (US);
 MCNULTY, Oren T. (US);
 MEJIA, Macedonio J. (US);
 JIANG, Yutong (US);
 WONG, Christina E. (US);
 RODRIGUEZ, Martha E (US);
 BOYS, Mark Laurence (US)

(74) Tamar Kotchlamazashvili
 (54) PROTEIN TYROSINE PHOSPHATASE
 INHIBITORS

(11) P 2023 7554 B (51) Int. Cl. (2006)
 A 61 K 45/06
 A 61 K 31/5377
 A 61 K 31/496
 A 61 P 25/00

(10) AP 2023 15793 A (44) 12(615)/2023
 (21) AP 2020 15793
 (22) 2020 04 09
 (24) 2020 04 09
 (31) P1900121
 (32) 2019 04 10
 (33) HU
 (86) PCT/IB2020/053382, 2020 04 09

(73) Richter Gedeon Nyrt. (HU)
 Gyömrői út. 19-21, H-1103 Budapest,
 Hungary (HU)

(72) ROMÁN, Viktor (HU);
 ADHAM-PARANGI, Nika (HU);
 ROGER EARLEY, Willie (HU);
 PO-JEN YEUNG, Paul (HU);

(74) Liliana Darakhvelidze
 (54) CARBAMOYL CYCLOHEXANE DERIVA-
 TIVES FOR TREATING AUTISM SPEC-
 TRUM DISORDER

(11) P 2023 7562 B (51) Int. Cl. (2006)
 A 61 L 27/26
 A 61 L 27/36
 A 61 L 27/38
 A 61 L 27/54
 B 33 Y 70/00
 B 33 Y 80/00

(10) AP 2023 15860 A (44) 13(616)/2023
 (21) AP 2020 15860
 (22) 2020 07 21
 (24) 2020 07 21
 (31) 19461559.7; 19218191.5
 (32) 2019 07 22; 2019 12 19
 (33) EP; EP
 (86) PCT/IB2020/056856, 2020 07 21
 (73) LTD "Polbionica" (PL)
 ul. Rydygiera 8, Warszawa, 01-793, Poland (PL)
 (72) Grzegorz Tymicki (PL);
 Magdalena Gomolka (PL);
 Patrycja Kowalska (PL);
 Piotr Cywoniuk (PL);
 Tomasz Bryniarski (PL);
 Tomasz Dobrzanski (PL);
 Pawel Turowski (PL);
 Igor Zamora (PL);

Marta Klak (PL);
 Andrzej Berman (PL);
 Ewa Olender (PL);
 Radoslaw Olkowski (PL);
 Artur Kaminski (PL);
 Katarzyna Kosowska (PL);
 Michal Wszola (PL)

(74) Irakli Gvilia

(54) DETERGENT-FREE DECELLULARIZED
 EXTRACELLULAR MATRIX PREPARA-
 TION METHOD AND BIOINKS FOR 3D
 PRINTING

(11) P 2023 7560 B (51) Int. Cl. (2006)
 A 61 P 9/00
 A 61 P 25/28
 A 61 P 29/00
 A 61 P 35/00
 C 07 D 519/00
 C 07 D 487/04

(10) AP 2023 15761 A (44) 9(612)/2023

(21) AP 2019 15761

(22) 2019 07 03

(24) 2019 07 03

(62) AP 2019 15551 2019 07 03

(31) 62/694,138; 62/755,845

(32) 2018 07 05; 2018 11 05

(33) US; US

(86) PCT/US2019/040496, 2019 07 03

(73) Incyte Corporation (US)
 1801 Augustine Cut-Off Wilmington, DE 19803,
 USA (US)

(72) HOANG, Gia (US);

WANG, Xiaozhao (US);

CARLSEN, Peter Niels (US);

GAN, Pei (US);

LI, Yong (US);

QI, Chao (US);

WU, Liangxing (US);

YAO, Wenqing (US);

YU, Zhiyong (US);

ZHU, Wenyu (US)

(74) Tamaz Shilakadze

(54) FUSED PYRAZINE DERIVATIVES
 AS A2A / A2B INHIBITORS

PART C

C 07

(11) P 2023 7559 B (51) Int. Cl. (2006)
 C 07 D 403/00
 C 07 D 213/55

(10) AP 2023 15091 A (44) 9(612)/2023

(21) AP 2017 15091

(22) 2017 11 15

(24) 2017 11 15

(31) 62/423,126

(32) 2016 11 16

(33) US

(86) PCT/US2017/061875, 2017 11 15

(73) H. Lundbeck A/S (DK)

Ottliavej 9, Valby, DK-2500, Denmark (DK)

(72) GRICE, Cheryl A. (US);

JONES, Todd K. (US);

GRIMM, Kurt G. (US);

BLANKMAN, Jacqueline Lorayne (US);

BEALS, Channing Rodney (US)

(74) Tamaz Shilakadze

(54) CRYSTALLINE FORMS OF A MAGL
 INHIBITOR

C 09

(11) P 2023 7558 B (51) Int. Cl. (2006)
 C 09 D 133/02

(10) AP 2023 15889 A (44) 9(612)/2023

(21) AP 2019 15889

(22) 2019 08 01

(24) 2019 08 01

(86) PCT/SK2019/050008, 2019 08 01

(73) P E W A S S.R.O. (SK)

Vansovej 2, 811 03 Bratislava, Slovakia (SK)

(72) GELINGER, Viktor (SK);

VALENTIN, Marian (SK);

HORVÁTH, Ján (SK);

PETRA, Lukáš (SK)

(74) Shalva Gvaramadze

(54) SUPERABSORBENT-BASED SUSPENSION
 SUITABLE FOR HYDROSTIMULATORY
 COATING OF SEEDS AND METHOD OF
 COATING SEEDS WITH THE SUSPENSION

C 21

(11) P 2023 7563 B (51) Int. Cl. (2006)
 C 21 C 1/10
 C 21 C 7/06
 C 22 C 28/00
 C 22 C 33/00
 C 22 C 35/00

(10) AP 2023 15516 A (44) 13(616)/2023

- (21) AP 2019 15516
 (22) 2019 06 07
 (24) 2019 06 07
 (31) 20180804
 (32) 2018 06 11
 (33) NO
 (86) PCT/NO2019/050116, 2019 06 07
 (73) Elkem ASA (NO)
 Drammensveien 169, 0277 Oslo, Norway (NO)
 (72) DIEUDONNE, Amélie (FR);
 KLEVAN, Ole Svein (NO)
 (74) Tamaz Shilakadze
 (54) SILICON BASED ALLOY, METHOD FOR
 THE PRODUCTION THEREOF AND USE
 OF SUCH ALLOY

- Merab Aleksidze II Lane 2, 0193, Tbilisi,
 Georgia (GE)
 (72) Barbara Kilosanidze (GE);
 Giorgi Kakauridze (GE)
 (74) Shalva Gvaramadze
 (54) EQUIPMENT FOR POLARIZATION STATE
 AND CHANGE DETERMINATION AND
 USAGE THEREIN ELLIPSOMETRY

PART F

F 03

- (11) P 2023 7557 B (51) Int. Cl. (2006)
 F 03 D 9/00
 (10) AP 2023 15961 A (44) 11(614)/2023
 (21) AP 2022 15961
 (22) 2022 05 27
 (24) 2022 05 27
 (73) Tamaz Shioshvili (GE)
 Ir. Abashidze St. 46, ap. 17, 0179, Tbilisi,
 Georgia (GE)
 (72) Tamaz Shioshvili (GE)
 (54) WIND GEARLESS ELECTRIC MOTOR

PART G

G 01

- (11) P 2023 7555 B (51) Int. Cl. (2006)
 G 01 J 4/00
 G 01 N 21/21
 (10) AP 2023 15951 A (44) 11(614)/2023
 (21) AP 2022 15951
 (22) 2022 05 18
 (24) 2022 05 18
 (73) Barbara Kilosanidze (GE)
 Nutsbidze St. 48, bld. 3, ap. 4, 0186, Tbilisi,
 Georgia (GE);
 Giorgi Kakauridze (GE)
 Bichinashvili St. 3, 0180, Tbilisi, Georgia (GE);
 Georgian Technical University (GE)
 Merab Kostava St. 77, 0186, Tbilisi,
 Georgia (GE);
 Shota Rustaveli National Science Foundation
 of Georgia (GE)

APPLICATIONS***

PART A

A 61

(10) AP 2023 16271 A (51) A 61 K 31/439
 A 61 P 11/00
 A 61 P 43/00
 C 07 D 498/18
 C 07 D 498/22
 C 07 D 513/22

(43) 2023 10 25 №20

(21) AP 2021 16271

(22) 2021 11 17

(31) 63/115,552

(32) 2020 11 18

(33) US

(71) Vertex Pharmaceuticals Incorporated (US)
 50 Northern Avenue, Boston, MA, 02210,
 USA (US)

(72) CLEMENS, Jeremy J. (US);
 BECHARA, William Schulz (US);
 BOOKSER, Brett C. (US);
 CLEVELAND, Thomas (US);
 COON, Timothy (US);
 GALLANT, Michel (US);
 GROOTENHUIS, Peter Diederik Jan (US);
 HADIDA RUAH, Sara Sabina (US);
 LATERREUR, Julie (US);
 MILLER, Mark Thomas (US);
 PARASELLI, Prasuna (US);
 RAMTOHUL, Yeeman K. (US);
 REDDY, Thumkuntha Jagadeeswar (US);
 STURINO, Claudio (US);
 VALDEZ, Lino (US);
 ZHOU, Jinglan (US);
 BAEK, Minson (US)

(74) Nikoloz Gogilidze

(85) 2023 06 16

(86) PCT/US2021/072475, 2021 11 17

(54) MACROCYCLES CONTAINING A 1,3,4-OXA-
 DIA-ZOLE RING FOR USE AS MODULA-
 TORS OF CYSTIC FIBROSIS TRANSME-
 MBRANE CONDUCTANCE REGULATOR

(57) This disclosure provides modulators of Cystic Fibrosis Transmembrane Conductance Regulator (CFTR), pharmaceutical compositions containing at least one such modulator, methods of treatment of cystic fibrosis using such modulators and pharmaceutical compositions, and processes for making such modulators

(10) AP 2023 16326 A (51) A 61 K 31/519
 A 61 K 45/06
 A 61 K 31/517
 A 61 K 31/337
 A 61 K 31/4439
 A 61 P 35/00

(43) 2023 10 25 №20

(21) AP 2022 16326

(22) 2022 01 19

(31) 202121002487

(32) 2021 01 19

(33) IN

(71) Lupin Limited (IN)

Kalpataru Inspire, 3rd Fl., Off Western Express
 Highway, Santacruz (East), Maharashtra Mumbai
 400 055, India (IN)

(72) BHONDE, Mandar Ramesh (IN);

PATRA, Sukanya (IN);

PALLE, Venkata P. (IN);

KAMBOJ, Rajender Kumar (IN)

(74) Larisa Amirkhanyan

(85) 2023 08 16

(86) PCT/IB2022/050415, 2022 01 19

(54) PHARMACEUTICAL COMBINATIONS
 OF SOS1 INHIBITORS

(57) This disclosure relates to pharmaceutical combinations for treating and/or preventing cancer and methods and uses thereof. More particularly, provided is a pharmaceutical combination comprising a SOS1 Inhibitor and an additional active ingredient selected from a KRAS inhibitor such as a KRAS G12C inhibitor and a KRAS G12D inhibitor, KRAS G13C inhibitor, and pan KRAS inhibitor; an EGFR inhibitor; an ERK1/2 inhibitor; a BRAF inhibitor; a pan-RAF inhibitor; a MEK inhibitor; a AKT inhibitor; a SHP2 inhibitor; protein arginine methyltransferases (PRMTs) inhibitor such as a PRMT5 inhibitor and Type 1 PRMT inhibitor; a PI3K inhibitor; a cyclin -dependent kinase (CDK) inhibitor such as CDK4/6 inhibitor; a FGFR inhibitor; a c-Met inhibitor; a RTK inhibitor; a non-receptor tyrosine kinase inhibitor; a histone methyltransferases (HMTs) inhibitor; a DNA methyltransferases (DNMTs) inhibitor; a Focal Adhesion Kinase (FAK) inhibitor; a Bcr-Abl tyrosine kinase inhibitor; a mTOR inhibitor; a PD1 inhibitor; a PD-L1 inhibitor; CTLA4 inhibitor; and chemotherapeutic agents such as gemcitabine, doxorubicin, cisplatin, carboplatin, paclitaxel, docetaxel, topotecan, irinotecan and temozolomide.

- (10) AP 2023 16350 A (51) A 61 K 31/4985
A 61 P 3/04
A 61 P 3/08
A 61 P 43/00
A 61 P 5/10

(43) 2023 10 25 №20

(21) AP 2022 16350

(22) 2022 02 11

(31) 63/148,962

(32) 2021 02 12

(33) US

(71) Neuren Pharmaceuticals Limited (NZ)

Offices of Lowndes Jordan, Level 15, HSBC Tower, 188 Quay Street Auckland, 1010, New Zealand (NZ)

(72) GLASS, Lawrence Irwin (US);

COGRAM, Patricia (GB)

(74) Liliana Darakhvelidze

(85) 2023 09 11

(86) PCT/NZ2022/050017, 2022 02 11

(54) TREATMENTS OF PRADER-WILLI SYNDROME

(57) Present disclosure generally relates to methods of and uses for treating Prader-Willi Syndrome (PWS) in a subject, comprising administering to the subject a therapeutically effective amount of a compound of Formulas I, II, III or IV, or a pharmaceutically acceptable salt, hydrate, stereoisomer, or prodrug thereof, or for use in the manufacture of a medicament as described herein.

PART B

B 29

- (10) AP 2023 16330 A (51) B 29 C 39/02
C 08 J 7/04
C 08 L 95/00
C 10 C 3/14

(43) 2023 10 25 №20

(21) AP 2022 16330

(22) 2022 02 08

(31) 63/146,812; 17/665,522

(32) 2021 02 08; 2022 02 05

(33) US; US

(71) Philergos Group Foundation (CA)

201-309 1 Street East Cochrane, Alberta, T4C 1Z3, Canada (CA)

(72) GIANNELIA, Paul (CA)

(74) Shalva Gvaramadze

(85) 2023 08 24

(86) PCT/IB2022/051094, 2022 02 08

(54) METHODS OF PREPARING SOLID FORMATIONS OF NON-VOLATILE BITUMINOUS MATERIALS SUITABLE FOR REDUCING

CARBON DIOXIDE EMISSIONS DURING TRANSPORT

(57) A method of preparing non-volatile bituminous material in solid form includes first accessing molds having mold cavities defining an irregularly shaped brick having a plurality of non-planar surfaces and preparing the bituminous material for casting by heating it until it is suitably viscous for casting and optionally blending it with an additive. Then, the molds can be filled with the bituminous materials, preferably using a retractable conduit that progressively fills each mold cavity from its bottom to its top. Next, the bituminous material in the molds is solidified until substantially solid bricks are formed. Optionally, a skeleton with optional additional buoyant features can be placed in each mold cavity prior to casting so that the resulting brick has increased buoyancy throughout, and the skeleton and any buoyant features can be customized according to the needs of the customer. The resulting bricks can be removed for transport.

- (10) AP 2023 16331 A (51) B 29 C 55/10
E 01 C 11/16
E 01 C 11/00
E 01 C 3/00
E 01 C 3/04
E 02 D 31/00

(43) 2023 10 25 №20

(21) AP 2022 16331

(22) 2022 01 27

(31) 2101168.9

(32) 2021 01 28

(33) GB

(71) Tensar Technologies Limited (GB)

Sett End Road West, Shadsworth Business Park, Shadsworth, Blackburn Lancashire BBI 2PU, UK (GB)

(72) CURSON, Andrew (GB);

CAVANAUGH, Joe (GB);

GOLOS, Michal (GB);

KAWALEC, Jacek (GB)

(74) Tamaz Shilakadze

(85) 2023 08 25

(86) PCT/GB2022/050216, 2022 01 27

(54) ENGINEERING CONSTRUCTION WITH GEOGRID AND GEOTEXTILE, METHODS OF PRODUCING AND PROVIDING SUCH AND ITS USE

(57) An engineering construction comprising an integral multiaxial polymer geogrid at least partially embedded in a bound aggregate layer, wherein a geotextile is affixed to the geogrid, methods for producing such constructions, the constructions having improved fatigue life or reduced depth, and the use of multiaxial polymer geogrids to improve the fatigue life and/or reduce the depth of an engineering construction.

B 61

- (10) AP 2023 16341 A (51) B 61 D 3/16
B 63 B 25/00
B 65 D 88/74
C 10 C 3/14
- (43) 2023 10 25 №20
(21) AP 2022 16341
(22) 2022 02 08
(31) 63/146,812; 17/665,532
(32) 2021 02 08; 2022 02 05
(33) US; US
(71) Philergos Group Foundation (CA)
201-309 1 Street East Cochrane, Albereta
T4C 1Z3, Canada (CA)
(72) GIANNELIA, Paul (CA)
(74) Shalva Gvaramadze
(85) 2023 09 01
(86) PCT/IB2022/051091, 2022 02 08
(54) METHODS OF TRANSPORTING SOLID
FORMATIONS OF NON-VOLATILE
BITUMINOUS MATERIALS AND
REDUCING CARBON DIOXIDE
EMISSIONS
(57) A method of transporting non-volatile bituminous materials from a first location to a second location involves carrying a plurality of irregular bricks formed by the bituminous material in transport chambers carried by vehicles. Bricks are defined by a plurality of non-planar surface, which create gaps between adjacent bricks, and can further include polymer skeletons and other features that help them float. The bricks can travel by land, sea, air, or rail and need not be heated while in transit. Transport chambers have active or preferably passive environmental control systems to circulate cooling air, water, or other substances through the chamber and the gaps between adjacent bricks. In a preferred embodiment, ambient air circulates among the bricks during travel by land and ambient water circulates among the bricks during marine travel. The vehicles carrying the transport chambers can be low-emissions or zero-emission vehicles including fuel-cell powered trains and ships.

PART C**C 10**

- (10) AP 2023 16339 A (51) C 10 C 3/10
C 10 C 3/12
C 10 C 3/14
- (43) 2023 10 25 №20
(21) AP 2022 16339
(22) 2022 02 08
(31) 63/146,812; 17/665,531
(32) 2021 02 08; 2022 02 05
(33) US; US
(71) Philergos Group Foundation (CA)
201-309 1 Street East Cochrane, Albereta
T4C 1Z3, Canada (CA)
(72) GIANNELIA, Paul (CA)
(74) Shalva Gvaramadze
(85) 2023 09 01
(86) PCT/IB2022/051095, 2022 02 08
(54) RECEIVERS FOR SOLID FORMATIONS OF
NON-VOLATILE BITUMINOUS MATERIALS
SUITABLE FOR REDUCING CARBON
DIOXIDE EMISSIONS DURING
TRANSPORT
(57) A receiver for irregularly shaped bricks cast from non-volatile bituminous material includes a receiver with a specialized storage chamber that can receive viscous bituminous material and a concave lid preferably modified with a radiant heating system that can accept and melt or soften arriving bricks. The lid includes multiple openings or other delivery routes that funnel the melted bituminous material to the chamber below. The radiant heating system can be electrical where cables or grids are embedded in the lid or where conductive materials coat or are distributed throughout the lid. Alternatively, the radiant heating system can be hydronic where channels or conduits are embedded in the lid to circulate heated liquid such as water or water mixed with propylene glycol. The receiver can also include blenders, skimmers, and additional heaters to further skim, blend, or process the bituminous material collected in the chamber.

- (10) AP 2023 16340 A (51) C 10 C 3/14
(43) 2023 10 25 №20
(21) AP 2022 16340
(22) 2022 02 08
(31) 63/146,812; 17/665,520
(32) 2021 02 08; 2022 02 05
(33) US; US
(71) Philergos Group Foundation (CA)
201-309 1 Street East Cochrane, Albereta
T4C 1Z3, Canada (CA)
(72) GIANNELIA, Paul (CA)
(74) Shalva Gvaramadze
(85) 2023 09 01

(86) PCT/IB2022/051093, 2022 02 08

(54) SOLID FORMATIONS OF NON-VOLATILE
BITUMINOUS MATERIALS SUITABLE FOR
REDUCING CARBON DIOXIDE EMISSIONS
DURING TRANSPORT

(57) A substantially solid brick of non-volatile bituminous material has a shape that is defined by an irregular outer surface to minimize surface contact with nearby bricks when shipped in bulk. The overall shape is preferably that of a modified tetrahedron having three non-planar face surfaces, a top surface, and a surface or point. Both the top and bottom surfaces are preferably modified domed shapes comprised of several sections. The face sections are preferably modified concave surfaces comprised of several triangular sections that can be planar, concave, or convex. Curved edges connect the face sections to each other and can include several planar edge sections. The bituminous material can include additives, and the brick can further include a skeleton distributed throughout. The skeleton can be a customizable matrix, framework of fiber groups, or other structure and can include customizable buoyant features such as air pockets or capsules.

UTILITY MODELS

APPLICATIONS APPROVED FOR GRANTING PATENT

The decision can be appealed at the Chamber of Appeal of Sakpatenti within 3 months from the publication or at the Mtskheta District Court Administrative Cases Board (Address: №17, Samkhedro St., Mtskheta), within 1 month following the publication.

PART D

D 04

- (10) AU 2023 16251 U (51) Int. Cl. (2006)
D 04 H 17/10
- (21) AU 2023 16251 (22) 2023 05 17
- (71) Davit Tavkheldize (GE)
Ir. Abashidze St. 21, 0179, Tbilisi, Georgia (GE);
Nia Natbiladze (GE)
Al. Kazbegi Ave. 1, ap. 12, Tbilisi,
Georgia (GE);
Tinatini Iordanishvili (GE)
Vill. Mukhrani, Mtskheta, Georgia (GE);
Lia Lursmanashvili (GE)
Ir. Abashidze St. 44a, 0179, Tbilisi, Georgia (GE);
Olgha Rukhadze (GE)
Al. Duma St. 12, Tbilisi, Georgia (GE)
- (72) Davit Tavkheldize (GE);
Nia Natbiladze (GE);
Tinatini Iordanishvili (GE);
Lia Lursmanashvili (GE);
Olgha Rukhadze (GE)
- (54) DEVICE FOR TIGHTENING AND
STRAIGHTENING NON-WOVEN FABRIC
- (57) A device includes a frame 1, upper 4 and lower
componentry to place processed fabric between
them, and means to move upper component in verti-
cal plane, and fix it correspondingly to processed
fabric thickness. Upper component is made as a
drum, and fixed capable of free rotation on the
brackets 5 on the frame, where the drum is equipped
with annular grooves on torsional sides; furthermore,
lower component is made as a table 2, moveable
reverse-forward in the guides made on the frame; at
that, lower component is additionally equipped with
an actuator 3 that is reverse-forward mover on said
table horizontal plane.
- Claims: 1 independent
1 dependent

Fig.: 1

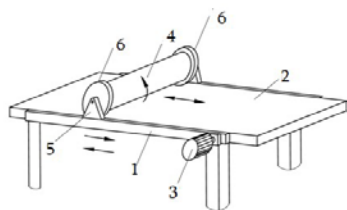

Fig. 1

PART E

E 21

- (10) AU 2023 16069 U (51) Int. Cl. (2006)
E 21 B 43/01
- (21) AU 2022 16069 (22) 2022 10 25
- (71) Georgian Technical University (GE)
Merab Kostava St. 77, Tbilisi, Georgia (GE)
- (72) Koba Kikabidze (GE);
Giorgi Abramishvili (GE);
Nugzar Iashvili (GE);
Nodari Dzidzikashvili (GE);
Shota Mestvirishvili (GE)
- (54) METHOD FOR EXTRACTION OF GASES
FLOWING INTO THE HYDROSPHERE
- (57) A method provides gas collection and reception
from gas-emitting areas using air leakage pipe, while
in order to collect it, the places of gas bubbles inlet
in the soil at the bottom of hydrosphere at a depth
of several meters are drilled, wherein perforated on the
sides the air leakage pipe is placed hermetically with
open lower end and is on the part of the length, for
the inflow of water and gas therein, and a separator
having a valve for the water and gas separation is
attached at upper end of gas pipe placed above the
bottom.
- Claims: 1 independent

PART F

F 28

- (10) AU 2023 16194 U (51) Int. Cl. (2006)
F 28 D 9/00
F 28 F 3/02
- (21) AU 2023 16194 (22) 2023 03 20
- (71) Merab Chirakadze (GE)
Ir. Abashidze St. 16, ap. 8, 0179, Tbilisi,
Georgia (GE)
- (72) Merab Chirakadze (GE)
- (54) AIR HEAT EXCHANGER WITH USING
NATURAL CONVECTION
- (57) An exchanger contains hollow body 1 with a
separator 2 and inlet and outlet holes 4 made on the
case for two current working environments of

various temperature and having opposite directions. The separator divides the case into two hermetically isolated upper and lower parts; at that, inlet and outlet holes 5 and 6 executed on lower part are intended for high temperature working environment, and inlet and outlet holes 4 and 3 executed on upper part – for low temperature working environment. Furthermore, the separator is formed with ribbed sheet material, and is located in the case so that the channels 9 and 10 formed in the space between the ribs are directed along the longitudinal axis of case.

Claims: 1 independent

2 dependents

Fig.: 4

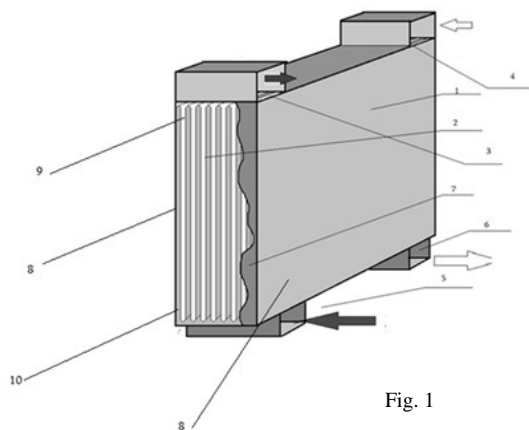
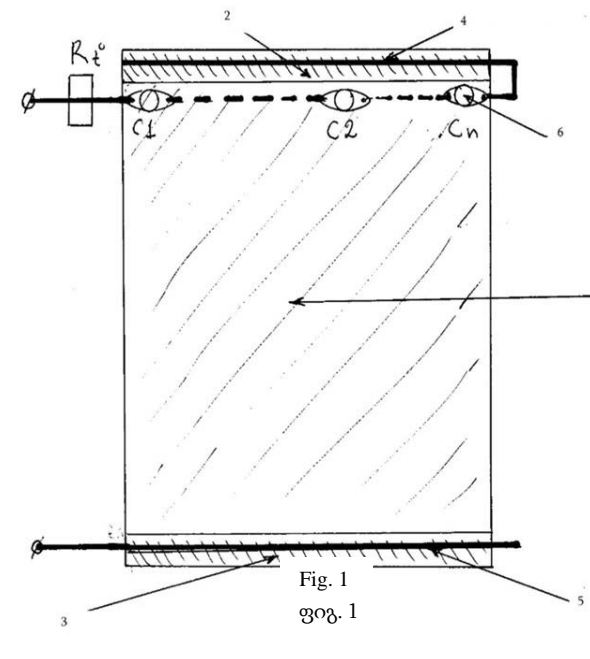

Fig. 1

Fig.: 1



PART H

H 05

(10) AU 2023 16234 U (51) Int. Cl. (2006)
H 05 B 3/00

(21) AU 2023 16234 (22) 2023 05 03

(71) Andro Gabisonia (GE)

Tamarashvili St. 8, ap. 27, 0162, Vake, Tbilisi,
Georgia (GE)

(72) Andro Gabisonia (GE)

(54) ELECTRICALLY HEATED GLASS

(57) Electrically heated glass contains sheet metal plate 1 with low-emissivity metal electroconductive coating, where metal electroconductive tracks 2 and 3 are formed on opposite sides of metal plate. The tracks are part of said coating, and wires 4 and 5 are switched there to be connected to the power source; at that, it is equipped with at least one thermal switch to ensure disconnection from the power source when the temperature of glass plate exceeds predetermined threshold value.

Claims: 1 independent

4 dependents

DESIGNS

APPLICATIONS APPROVED FOR REGISTRATION

The decision can be appealed at the Chamber of Appeal of Sakpatenti within 3 months from the publication or at the Mtskheta District Court Administrative Cases Board (Address: №17, Samkhedro str., Mtskheta), within 1 month following the publication.

- (10) AD 2023 1313 S (51) 11-01
(21) AD 2023 1313 (22) 2023 06 09
(28) 5
(71) Donara Berdzenishvili (GE)
Vill. Kvemo Erketi, 4900, Chokhatauri, Georgia (GE)
(72) Donara Berdzenishvili (GE)
(54) METAL AND THREAD COMBINED BRACELET
(55)





- (10) AD 2023 1315 S (51) 21-01
(21) AD 2023 1315 (22) 2023 06 17
(28) 1
(71) Konrad Adenauer Foundation Representative in Georgia (GE)
Tamar Chovelidze St. 4, Fl. 7, 0108, Old Tbilisi, Tbilisi, Georgia (GE)
(72) Sopio Kuridze (GE)
(74) Gela Chighoshvili (GE);
Tamta Muradashvili (GE)
(54) BOARD GAME
(55)



DESIGNS, WHICH HAVE BEEN REGISTERED WITH THE INTERNATIONAL BUREAU CLAIMING PRIORITY ON THE TERRITORY OF GEORGIA

The decision can be appealed at the Chamber of Appeal of Sakpatenti within 3 months from the publication or at the Mtskheta District Court Administrative Cases Board (Address: №17, Samkhedro St., Mtskheta), within 1 month following the publication.

- (11) DM/226 330
- (15) 2023 01 23
- (22) 2023 01 23
- (28) 1
- (73) Montres Breguet SA (Montres Breguet AG) (Montres Breguet Ltd)
Place de la Tour 23, 1344 L'Abbaye (CH)
- (85) CH
- (86) CH
- (87) CH
- (88) CH
- (89) CH
- (81) III. KG, LI, MK, OM, GE, TR, BA, MN, NO, RU, CH, EM, AL, AM, UA, SG, MA, MC, MD, ME, BZ, AZ, TN, GB
- (72) Vincenzo Laucella
Cco Montres Breguet SA (Montres Breguet AG) (Montres Breguet Ltd), Place de la Tour 23, 1344, L'Abbaye (CH)
- (74) The Swatch Group SA (The Swatch Group AG) (The Swatch Group Ltd.)
Faubourg du Lac 6, 2501 Biel / Bienne (CH)
- (46) 2023 07 28
- (54) 1. WATCH
- (55)

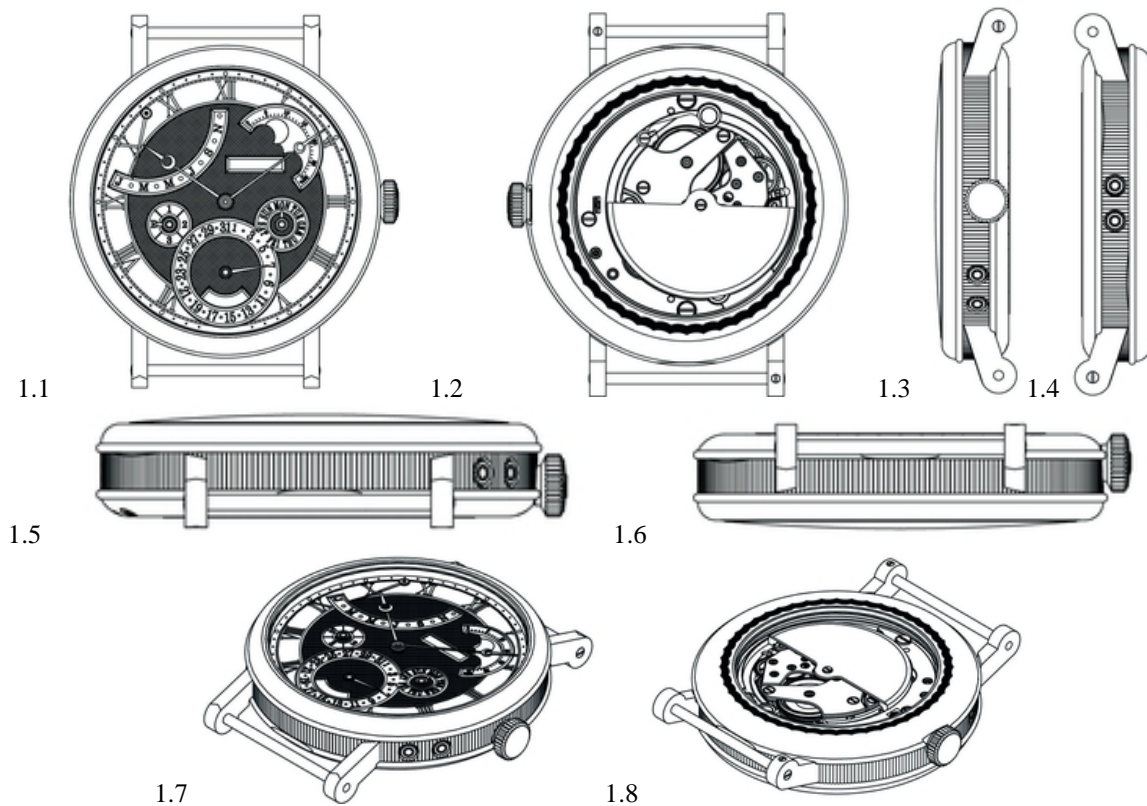

- (11) DM/226 429 (51) 10-02
 (15) 2023 01 25 (44) 30/2023 (2023 07 28)
 (22) 2023 01 25
 (28) 1
 (73) Harry Winston SA
 Chemin du Tourbillon 8, 1228 Plan-les-Ouates (CH)
 (85) CH
 (86) CH
 (87) CH
 (88) CH
 (89) CH
 (81) III. KG, LI, CA, MK, OM, GE, BA, NO, RU, EM, AM, MD, TN, GB, TR, MN, CH, AL, UA, MA, SG, MC,
 BZ, ME, AZ
 (72) Sandra GARSAUD
 c/o Harry Winston SA Chemin du Tourbillon 8, 1228, Plan-les-Ouates (CH)
 (74) The Swatch Group AG (The Swatch Group SA) (The Swatch Group Ltd.)
 Faubourg du Lac 6, 2501 Biel/Bienne (CH)
 (46) 2023 07 28
 (54) 1. WRIST WATCH
 (55)



1.1



1.2



1.3



1.4



1.5



1.6



1.7



1.8

- (11) DM/230 351 (51) 10-07
- (15) 2023 07 03 (44) 30/2023 (2023 07 28)
- (22) 2023 07 03
- (28) 1
- (30) No1: 23.03.2023; 2023-00180; CH
- (73) Rolex SA
Rue François-Dussaud 3-5-7, 1211 Genève 26 (CH)
- (85) CH
- (86) CH
- (87) CH
- (88) CH
- (89) CH
- (81) III. GE, CA, OM, NO, RS, RW, EM, MU, AM, BW, TJ, MD, VN, TN, SR, MN, JP, KR, UA, OA, MA, ME, AZ, SM, KG, WS, LI, MK, BA, EG, RU, JM, IS, BY, GB, KH, TR, ST, GH, IL, KP, AL, MX, BN, NA, SG, MC, BZ, TM
- (72) Giovanni SICILIANO
9, Chemin Docteur-Adolphe Pasteur, 1209, Genève (CH)
- (74) BUGNION SA
10, Route De Florissant, Case Postale 375, 1211 Genève 12 (CH)
- (46) 2023 07 28
- (54) 1. WATCH BRACELET WITH HORNS
- (55)

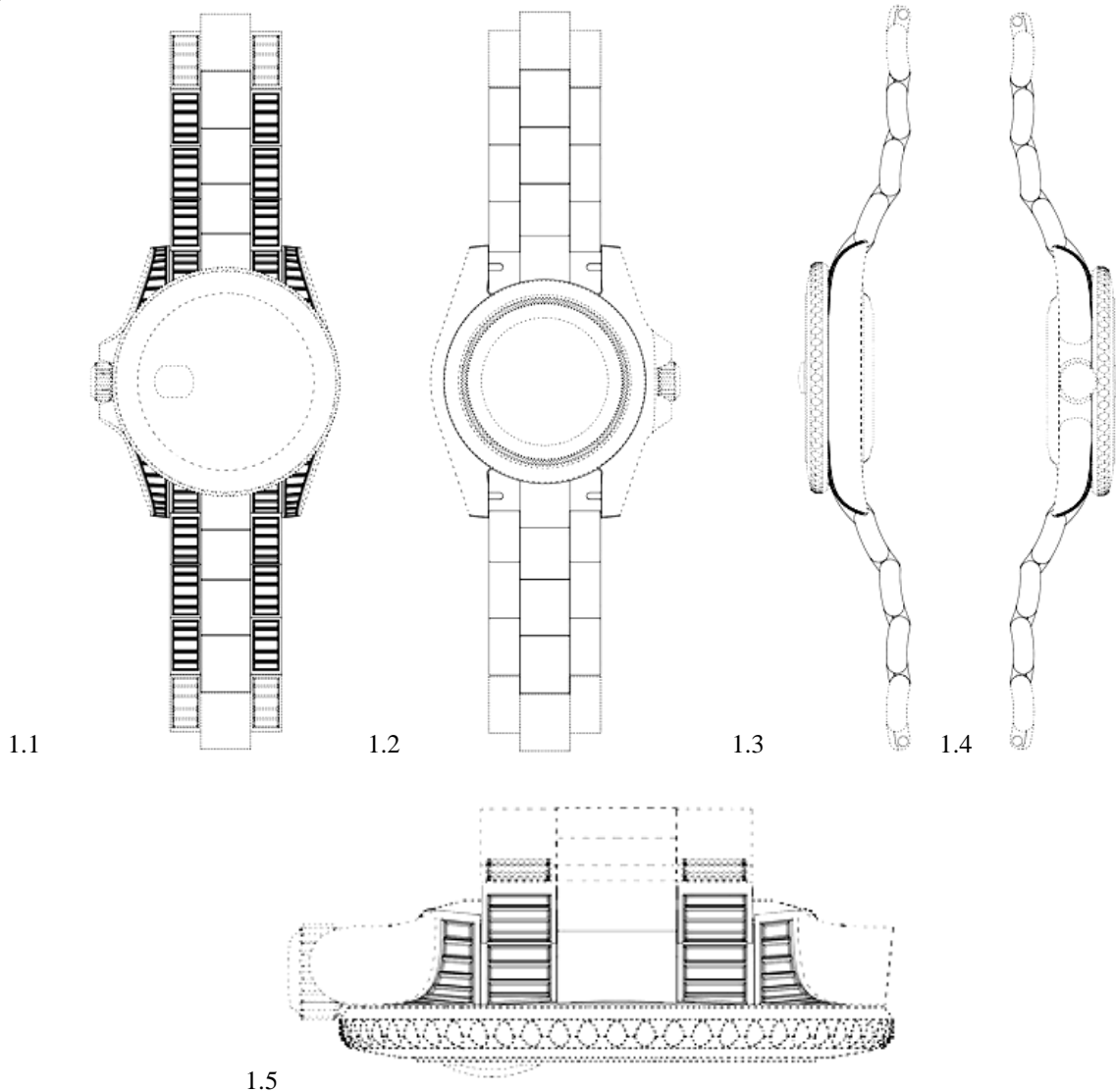

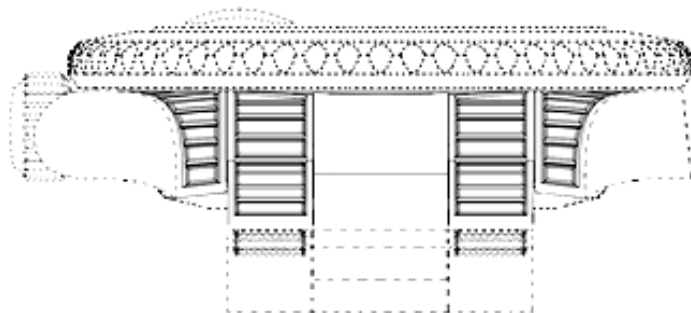

1.6

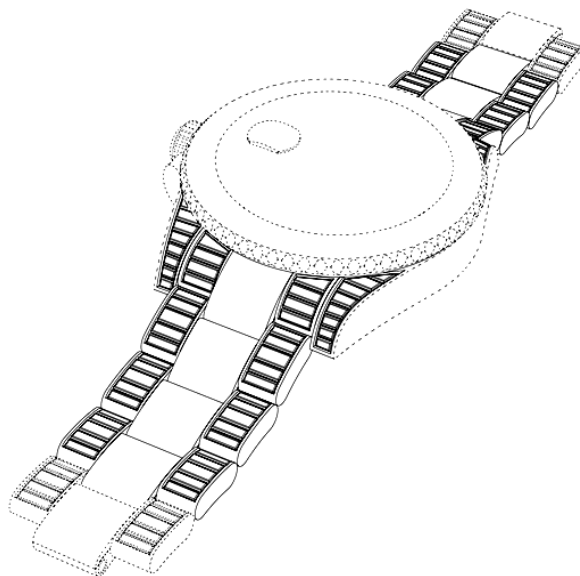

1.7

- (11) DM/224 576
- (15) 2022 07 27
- (22) 2022 07 27
- (28) 1
- (30) No1: 31.01.2022; 29825262; US
- (73) Colleen Carson Cota
43 Hoagland Road, 07825 Blirstown, NJ (US)
- (85) –
- (86) US
- (87) US
- (88) –
- (89) US
- (81) III. RO, CA, GE, EE, DE, RS, NO, FI, RU, JM, BG, DK, EM, AM, HU, ES, VN, TN, GB, PL, TR, SR, MN, KP, CH, JP, KR, HR, MX, CN, FR, UA, SG, SI, BZ, ME, SM
- (72) Colleen Carson Cota
43 Hoagland Road, 07825 Blirstown, NJ (US)
- (74) Diane Dunn Mckay
600 Alexander Road, Suite 2-1, 08540 Princeton, NJ (US)
- (46) 2023-07-28
- (54) 1. STICKER
- (55)

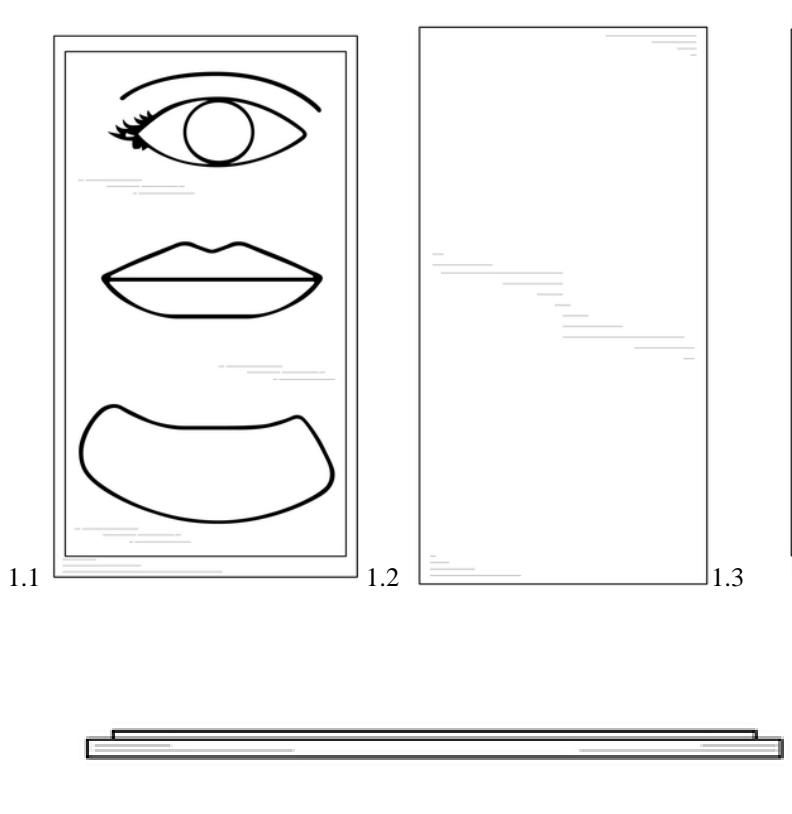

(11) DM/230 479

(51) 07-09

(15) 2023 06 16

(44) 31/2023 (2023 08 04)

(22) 2023 06 16

(28) 1

(85) –

(86) KR

(87) KR

(88) KR

(89) KR

(81) III. MK, CA, OM, US, GE, BA, RS, NO, EG, RU, BG, EM, IS, AM, BY, MD, VN, TN, GB, KH, TR, MN, GH, IL, CH, JP, AL, CN, MX, UA, OA, MA, SG, BX, AZ

(46) 2023 08 04

(54) 1. HOLDER FOR LID FOR SAUCEPAN AND JAR

(55)

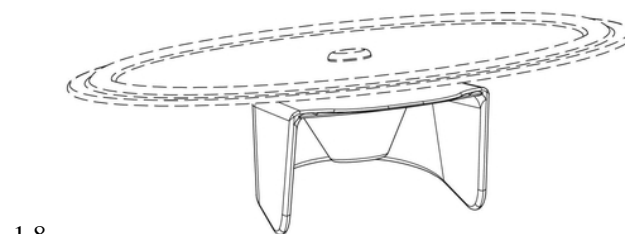
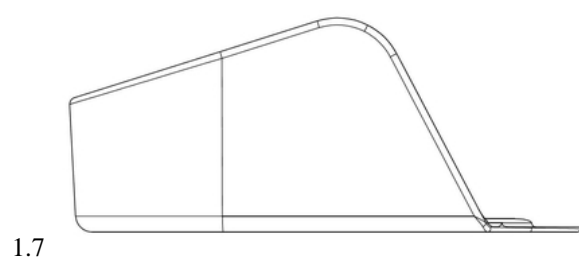
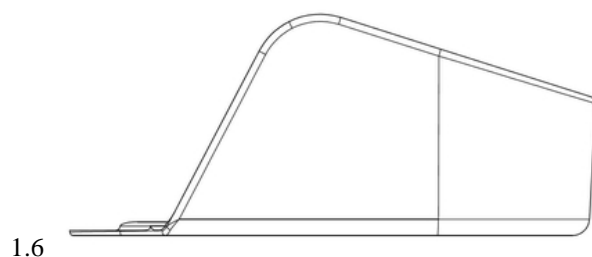
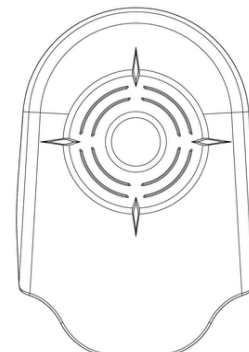
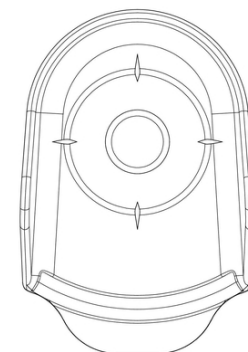
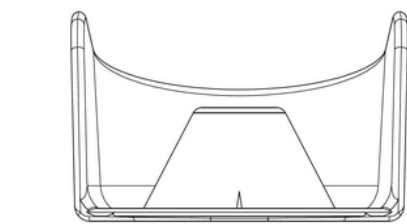
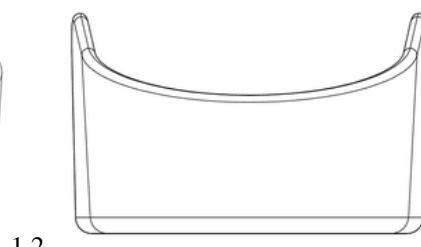
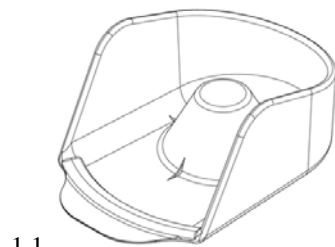

- (11) DM/226 738 (51) 11-01
 (15) 2023 02 10 (44) 32/2023 (2023 08 11)
 (22) 2023 02 10
 (28) 7
 (73) Harry Winston SA
 Chemin Du Tourbillon 8, 1228 Plan-les-Ouates (CH)
 (85) CH
 (86) CH
 (87) CH
 (88) CH
 (89) CH
 (81) III. KG, LI, TR, CA, GE, MK, OM, BA, MN, NO, CH, EM, AL, UA, AM, SG, MA, MC, MD, BZ, ME, AZ, TN, GB
 (72) 1; 5 Delphine ABDOURAHIM
 C/o Harry Winston Inc. 718 Fifth Avenue, 10019, New York (US);
 2; 4; 6-7 Rie YATSUGI-KANG
 C/o Harry Winston Inc. 718 Fifth Avenue, 10019, New York (US);
 3 Tobias WUEST
 C/o Harry Winston Inc. 718 Fifth Avenue, 10019, New York (US)
 (74) The Swatch Group AG (The Swatch Group SA) (The Swatch Group Ltd.)
 Faubourg Du Lac 6, 2501 Biel/Bienne (CH)
 (46) 2023 08 11
 (54) 1.-2. PAIR OF EARRINGS, 3.-4. NECKLACE, 5.-7. FINGER RING
 (55)

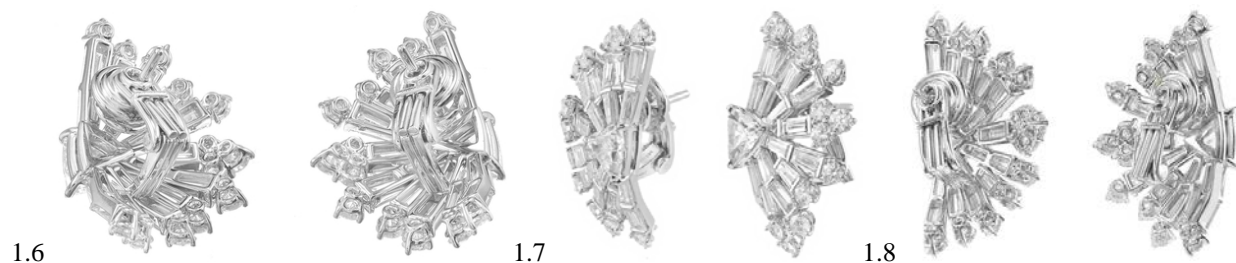
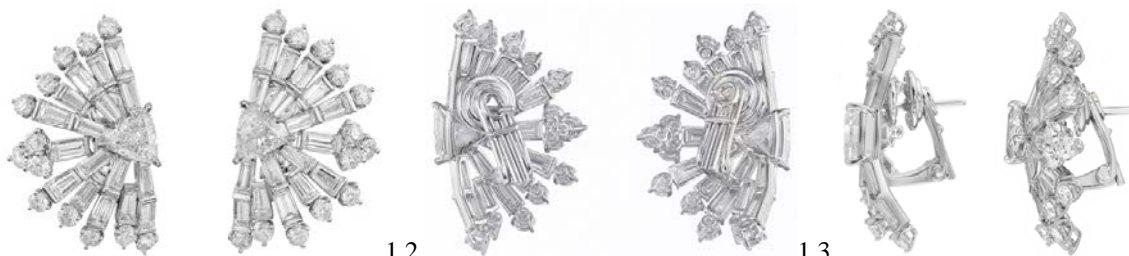



2.1

2.2

2.3



2.4

2.5



2.6

2.7

2.8



3.1



3.2



3.3



3.4



3.5



3.6



3.7



3.8



4.1



4.2



4.3



4.4



4.5



4.6



4.7



4.8



5.1



5.2



5.3



5.4



5.5



5.6



5.7



5.8



6.1



6.2



6.3



6.4



6.5



6.6



6.7



6.8

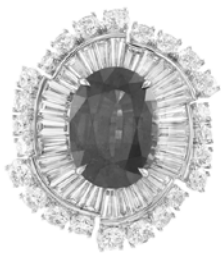

7.1



7.2



7.3



7.4



7.5



7.6



7.7



7.8

TRADEMARKS

APPLICATIONS FILED UNDER THE NATIONAL PROCEDURE APPROVED FOR REGISTRATION

The decision can be appealed at the Chamber of Appeal of Sakpatenti within 3 months from the publication or at the Mtskheta District Court Administrative Cases Board (Address: №17, Samkhedro St., Mtskheta), within 1 month following the publication.

(260) AM 2023 117543 A*

(210) AM 117543

(220) 2022 04 20

(310) 084625

(320) 2021 10 20

(330) JM

(731) Meta Platforms, Inc.

1601 Willow Road, Menlo Park, California
94025, USA

(740) Shalva Gvaramadze

(540)

META QUEST

(591) Black-white

(511) 35

(260) AM 2023 117544 A*

(210) AM 117544

(220) 2022 04 20

(310) 084627

(320) 2021 10 20

(330) JM

(731) Meta Platforms Inc.

1601 Willow Road, Menlo Park, California
94025, USA

(740) Shalva Gvaramadze

(540)

META HORIZON

(591) Black-white

(511) 35

(260) AM 2023 119106 A*

(210) AM 119106

(220) 2022 08 25

(731) LLC "Ori Nabiji"

Navtlughi St. 39-41, 0113, Isani District,
Tbilisi, Georgia

(540)



(591) Pink, white, light blue, dark blue

(531) 01.01.09; 03.01.15; 26.01.05; 26.01.19;

27.05.02; 27.05.03; 29.01.13

(511) 16

(260) AM 2023 121644 A

(210) AM 121644

(220) 2023 02 13

(731) Fine Agrochemicals Limited

Hill End House, Whittington, Worcester,
Worcestershire, WR5 2RQ, United Kingdom

(740) Giorgi Taktakishvili

(540)

ექსილბო

(591) Black-white

(511) 1, 5

(260) AM 2023 121651 A

(210) AM 121651

(220) 2023 02 15

(731) RK Chrela 2017

Vill. Lasuriashi, Tsageri Region, Georgia

(540)



(591) Brown, yellowish orange, light yellow, green

(531) 03.04.02; 25.01.09; 25.01.10; 26.01.15;

26.01.19; 28.19; 29.01.15

(526) ლეჩხუმი

(511) 29

(260) AM 2023 121739 A

(210) AM 121739

(220) 2023 02 20

(731) LLC "Biograph Living"

Merab Kostava St. 46, 0179, Tbilisi, Georgia

(540)



(591) Black-white
 (531) 02.09.14; 02.09.15; 03.07.08; 25.03.01;
 25.03.03; 26.11.13; 27.05.01; 27.05.24; 28.19
 (526) SAKENI, საკენი
 (511) 35, 36

(260) AM 2023 121742 A
 (210) AM 121742
 (220) 2023 02 21
 (731) Giorgi Gabodze
 Giorgi Saakadze St. 51, 2600, Kaspi, Georgia
 (540)



(591) 35B51E light green, 5B0C0C carnelian,
 1D5907 dark green
 (531) 05.03.13; 05.03.14; 27.05.08; 27.05.09;
 27.05.10; 28.19; 29.01.12
 (511) 29, 31, 35

(260) AM 2023 121756 A
 (210) AM 121756
 (220) 2023 02 22
 (731) LTD "Zearis"
 Richard Holbruk St. 13, Tbilisi, Georgia
 (540)

Alco Station
Алко Станция
ალკო სადგური

(591) Black-white
 (511) 43

(260) AM 2023 121757 A
 (210) AM 121757
 (220) 2023 02 22
 (731) LTD "Zearis"
 Richard Holbruk St. 13, Tbilisi, Georgia
 (540)

არტეფაქტი
Artefact
Артефакт

(591) Black-white
 (511) 32, 33

(260) AM 2023 121769 A
 (210) AM 121769
 (220) 2023 02 23
 (731) Salih Kemeroghlu
 Ilia Chavchavadze Av. 15, floor 2, Tbilisi,
 Georgia
 (540)



(591) Black-white
 (531) 27.05.01; 27.05.22; 27.05.23
 (511) 35

(260) AM 2023 121900 A
 (210) AM 121900
 (220) 2023 03 06
 (731) Intercontinental Great Brands LLC
 100 Deforest Avenue, East Hanover, New
 Jersey 07936, USA
 (740) Giorgi Taktakishvili
 (540)



(591) Green, brown
 (531) 27.05.01; 27.05.08; 29.01.12
 (511) 30

(260) AM 2023 121903 A
 (210) AM 121903
 (220) 2023 03 06
 (731) Nicoventures Holdings Limited
 Globe House 1 Water Street, London, WC2R
 3LA, United Kingdom
 (740) Tamar Kotchlamazashvili
 (540)

VUSE GO ZERO

(591) Black-white
 (511) 34

(260) AM 2023 121907 A
 (210) AM 121907
 (220) 2023 03 06
 (731) LLC "H Hookah"
 Khulo St. 23, 6010, Batumi, Georgia

(540)



(591) Black-white
 (531) 27.05.01; 27.05.04; 27.05.21
 (511) 34

(260) AM 2023 121927 A
 (210) AM 121927
 (220) 2023 03 07
 (731) Mon' delez Rus LLC
 10 oulitsa Franza Stollwercka, Petushinsky r-n,
 Vladimirskaia ob., Pokrov, 601123, Russian
 Federation
 (740) Giorgi Taktakishvili
 (540)



(591) White, yellow, red, green, sky-blue, lilac,
 brown
 (531) 01.15.01; 25.03.07; 26.04.06; 26.04.22;
 27.05.01; 29.01.15
 (511) 30

(260) AM 2023 121938 A
 (210) AM 121938
 (220) 2023 03 09
 (731) LTD "Tiriponi Fruit"
 Erekle Tatishvili St. 1, Gori, Georgia
 (740) Giorgi Taktakishvili
 (540)



(591) Green, red, white, black
 (531) 05.03.13; 05.03.14; 26.01.01; 26.01.04;
 27.05.01; 27.05.17; 29.01.14
 (511) 29, 31, 32, 33

(260) AM 2023 122013 A
 (210) AM 122013
 (220) 2023 03 10
 (731) Elizaveta Pakatsoshvili
 Mukha St. 1b, Tbilisi, Georgia
 (540)

MONAGARI
მონაგარი
МОНАГАРИ

(591) Black-white
 (511) 32, 33

(260) AM 2023 122040 A
 (210) AM 122040
 (220) 2023 03 16
 (731) LTD "Velistsikhuri"
 Vill. Velistsikhe, Gurjaani, Georgia
 (540)



ველისტიხური
Velistsikhuri

(591) White, light green, dark green
 (531) 26.01.12; 26.01.18; 26.01.19; 26.11.01;
 26.11.13; 28.19; 29.01.12
 (511) 29

(260) AM 2023 122104 A
 (210) AM 122104
 (220) 2023 03 17
 (731) Nino Chikvashvili
 Gelati St. 16-18, 4600, Kutaisi, Georgia
 (740) Giorgi Batlidze
 (540)



(591) FFFFFFF white, F9AB18 orange,
 F9C66D light orange
 (531) 01.05.01; 01.17.02; 26.01.01; 26.01.04;
 26.01.10; 26.01.16; 26.01.20; 26.01.21;
 27.05.01; 28.19; 29.01.12
 (511) 41

(260) AM 2023 122110 A
 (210) AM 122110
 (220) 2023 03 19
 (731) Jafar Guseinov
 G. Onashvili St., bld. 2, ap. 43, Isani District,
 Tbilisi, Georgia
 (740) Nino Bakhtadze
 (540)



(591) Black, white, orange
 (531) 26.04.12; 26.04.22; 26.04.24; 26.11.03;
 26.11.06; 26.11.12; 27.05.01; 27.05.24;
 29.01.13
 (511) 25

(260) AM 2023 122111 A
 (210) AM 122111
 (220) 2023 03 19
 (731) Jafar Guseinov
 G. Onashvili St., bld. 2, ap. 43, Isani District,
 Tbilisi, Georgia
 (740) Nino Bakhtadze
 (540)



(591) Dark blue, white
 (531) 26.04.02; 26.04.22; 26.04.24; 26.11.14;
 27.05.01; 27.05.09; 27.05.10; 29.01.12
 (511) 25

(260) AM 2023 122120 A
 (210) AM 122120
 (220) 2023 03 21
 (731) LTD "Akhali Ambebi"
 T. Iosebidge St. 49, 0160, Tbilisi, Georgia
 (540)



(591) ED1014 red, 0B35ED blue
 (531) 27.05.01; 27.05.09; 27.05.10; 27.05.23; 28.19;
 29.01.12
 (511) 16, 35, 38

(260) AM 2023 122125 A
 (210) AM 122125
 (220) 2023 03 21
 (731) LTD "Weimar"
 Vazha-Pshavela Av., V qu., bld. 4, ap. 103,
 0186, Tbilisi, Georgia
 (540)



(591) Black, orange
 (531) 25.01.13; 26.04.01; 26.04.08; 26.04.22;
 26.04.24; 27.05.01; 27.05.24; 29.01.12
 (511) 43

(260) AM 2023 122127 A
 (210) AM 122127
 (220) 2023 03 22
 (731) LLC "Maxtherm"
 Akaki Belashvili St. 149, 0159, Didube
 District, Tbilisi, Georgia
 (740) Lasha Maisuradze
 (540)



(591) A81817 red, white
 (531) 27.05.01; 27.05.21; 29.01.01
 (511) 11

(260) AM 2023 122208 A
 (210) AM 122208
 (220) 2023 03 27
 (731) LTD "Park Gida"
 Vill. Khutsubani, 5th District St. 46a, 6200,
 Municipality of Kobuleti, Georgia
 (740) Dato Jaiani
 (540)

EROS

(591) Black-white
 (511) 32

(260) AM 2023 122210 A
 (210) AM 122210
 (220) 2023 03 27
 (731) LTD "Kidstellar"
 Tbel Abuseridze St. 5a, Commercial Space 19,
 6004, Batumi, Georgia
 (540)



(591) Black-white
 (531) 26.01.02; 26.01.05; 26.01.06; 27.05.01
 (511) 41

(260) AM 2023 122211 A
 (210) AM 122211
 (220) 2023 03 27
 (731) Vazir Pashaev
 Vill. Mughanlo, 36th St. 10, Gardabani,
 Georgia
 (740) Nino Bakhtadze
 (540)

PARS GEAR

(591) Black-white
 (511) 25, 35

(260) AM 2023 122216 A
 (210) AM 122216
 (220) 2023 03 28
 (731) JSC "Tbilvino"
 Sarajishvili Av. 2, 0153, Tbilisi, Georgia
 (740) Giorgi Taktakishvili
 (540)

I V E R I U L I

(591) Black-white
 (531) 27.05.01
 (511) 33

(260) AM 2023 122217 A
 (210) AM 122217
 (220) 2023 03 28
 (731) JSC "Tbilvino"
 Sarajishvili Av. 2, 0153, Tbilisi, Georgia
 (740) Giorgi Taktakishvili
 (540)



(591) Black-white

(531) 27.05.01; 27.05.21; 28.19
 (511) 33

(260) AM 2023 122223 A
 (210) AM 122223
 (220) 2023 03 30
 (731) M.D.V.F. Media Design Vital Fashion Ltd.
 Krinon, 16, Limassol, CY-3110, Cyprus
 (740) Tamar Kotchlamazashvili
 (540)

BRIDGE PARK

БРИДЖ ПАРК

(591) Black-white
 (531) 28.05
 (511) 33

(260) AM 2023 122387 A
 (210) AM 122387
 (220) 2023 04 07
 (731) Société des Produits Nestlé S.A.
 1800 Vevey, Switzerland
 (740) Tamaz Shilakadze
 (540)

COMIDA

(591) Black-white
 (511) 5

(260) AM 2023 122409 A
 (210) AM 122409
 (220) 2023 04 11
 (731) LTD "Park Gida"
 Vill. Khutsubani, 5th District St. 46a, 6200,
 Municipality of Kobuleti, Georgia
 (740) Dato Jaiani
 (540)

Royal Honey

(591) Black-white
 (511) 5

(260) AM 2023 122418 A
 (210) AM 122418
 (220) 2023 04 13
 (731) SolaX Power Network Technology (Zhejiang)
 Co., Ltd.
 №288, Shizhu Road, Tonglu Economic
 Development Zone, Tonglu County, Hangzhou
 City, Zhejiang Province, People's Republic
 China
 (540)

SOLAX

(591) Black-white
 (531) 27.05.01; 27.05.17
 (511) 9

REGISTERED TRADEMARKS

(111) M 2023 37386 R
(151) 2023 10 05
(181) 2033 10 05
(260) AM 2022 120172 A
(220) 2022 11 03

(732) Güven Hastanesi Anonim Şirketi
Paris Caddesi, No:58, Çankaya, Ankara,
Türkiye

(111) M 2023 37387 R
(151) 2023 10 05
(181) 2033 10 05
(260) AM 2022 120353 A
(220) 2022 11 16

(732) Nicoventures Holdings Limited
Globe House, 1 Water Street, London, WC2R
3LA, United Kingdom

(111) M 2023 37388 R
(151) 2023 10 05
(181) 2033 10 05
(260) AM 2022 120354 A
(220) 2022 11 16

(732) Nicoventures Holdings Limited
Globe House, 1 Water Street, London, WC2R
3LA, United Kingdom

(111) M 2023 37389 R
(151) 2023 10 05
(181) 2033 10 05
(260) AM 2022 119198 A
(220) 2022 08 31

(732) Aparso (Fujian) Sportswear Co., LTD.
19F, Wuyi Center, 33 East Street, Gulou Dist.,
Fuzhou 350001, Fujian, People's Republic of
China

(111) M 2023 37390 R
(151) 2023 10 05
(181) 2033 10 05
(260) AM 2022 119374 A
(220) 2022 09 15

(732) GSH Trademarks Limited
Afroditis, 25, 2nd floor, flat/office 204, Nicosia,
Cyprus

(111) M 2023 37391 R
(151) 2023 10 05
(181) 2033 10 05
(260) AM 2022 119771 A

(220) 2022 10 07

(732) LTD "Udabno Village"
Merab Kostava St. 14, 0108, Tbilisi, Georgia

(111) M 2023 37392 R
(151) 2023 10 05
(181) 2033 10 05
(260) AM 2022 118941 A
(220) 2022 08 11

(732) Kraft Foods Sverige Intellectual Property AB
194 86 Upplands Väsby, Sweden

(111) M 2023 37393 R
(151) 2023 10 05
(181) 2033 10 05
(260) AM 2022 119074 A
(220) 2022 08 19

(732) Kraft Foods Danmark Intellectual
Property ApS
Ringager 2 A, 2, DK-2605 Brøndby, Denmark

(111) M 2023 37394 R
(151) 2023 10 05
(181) 2033 10 05
(260) AM 2022 119192 A
(220) 2022 08 29

(732) Oakley Inc.
One Icon, Foothill Ranch, CA 92610, USA

(111) M 2023 37395 R
(151) 2023 10 05
(181) 2033 10 05
(260) AM 2022 119267 A
(220) 2022 09 02

(732) Mikael Vardanyan
Bairon Str. 3, ap. 8, Yerevan, Armenia

(111) M 2023 37396 R
(151) 2023 10 05
(181) 2033 10 05
(260) AM 2022 119269 A
(220) 2022 09 02

(732) LLC "Grand Tobacco"
22 Hrant Vardanyan Str., 0061, Yerevan,
Armenia

(111) M 2023 37397 R
 (151) 2023 10 05
 (181) 2033 10 05
 (260) AM 2022 119270 A
 (220) 2022 09 02
 (732) Mikael Vardanyan
 Bairon Str. 3, ap. 8, Yerevan, Armenia

(111) M 2023 37403 R
 (151) 2023 10 05
 (181) 2033 10 05
 (260) AM 2022 120152 A
 (220) 2022 11 01
 (732) LLC Airline "Geo Sky"
 Arboshiki St. 2, 0144, Isani District, Tbilisi,
 Georgia

(111) M 2023 37398 R
 (151) 2023 10 05
 (181) 2033 10 05
 (260) AM 2022 119274 A
 (220) 2022 09 05
 (732) KT & G Corporation
 71, Beotkot-gil, Daedeok-gu, Daejeon,
 Republic of Korea

(111) M 2023 37404 R
 (151) 2023 10 05
 (181) 2033 10 05
 (260) AM 2022 120154 A
 (220) 2022 11 02
 (732) LLC Airline "Geo Sky"
 Arboshiki St. 2, 0144, Isani District, Tbilisi,
 Georgia

(111) M 2023 37399 R
 (151) 2023 10 05
 (181) 2033 10 05
 (260) AM 2022 119287 A
 (220) 2022 09 07
 (732) Augmented Reality Concepts Inc.
 344 S Warren St., Suite 200, Syracuse,
 New York 13202, USA

(111) M 2023 37418 R
 (151) 2023 10 17
 (181) 2033 10 17
 (260) AM 2022 120820 A
 (220) 2022 12 19
 (732) LLC "Vista Group"
 Liziko Kavtaradze St. 1, ap. 10, Tbilisi, Georgia

(111) M 2023 37400 R
 (151) 2023 10 05
 (181) 2033 10 05
 (260) AM 2022 119276 A
 (220) 2022 09 05
 (732) Barrister Spirits Limited
 c/o Coddan CPM LTD, 3rd Floor 120 Baker
 Street, London, England, W1U 6TU, United
 Kingdom

(111) M 2023 37419 R
 (151) 2023 10 17
 (181) 2033 10 17
 (260) AM 2022 120500 A
 (220) 2022 11 25
 (732) Sayidat Alsalam FZE
 Workstation No. S10123 O101 WS67,
 Jebel Ali Free Zone, Dubai, United Arab
 Emirates

(111) M 2023 37401 R
 (151) 2023 10 05
 (181) 2033 10 05
 (260) AM 2022 119197 A
 (220) 2022 08 31
 (732) Aparso (Fujian) Sportswear Co., LTD.
 19F, Wuyi Center, 33 East Street, Gulou Dist.,
 Fuzhou 350001, Fujian, People's Republic of
 China

(111) M 2023 37420 R
 (151) 2023 10 17
 (181) 2033 10 17
 (260) AM 2022 120861 A
 (220) 2022 12 22
 (732) PepsiCo Inc.
 700 Anderson Hill Road, Purchase, New York,
 10577, USA

(111) M 2023 37402 R
 (151) 2023 10 05
 (181) 2033 10 05
 (260) AM 2022 119605 A
 (220) 2022 09 27
 (732) LTD "Rapsberry Hell's Project"
 Otar Oniashvili St. 1, ap. 29, Tbilisi, Georgia

(111) M 2023 37421 R
 (151) 2023 10 17
 (181) 2033 10 17
 (260) AM 2022 120621 A
 (220) 2022 12 07
 (732) LTD "Podsi"
 Givi Kartozia St. 2, ap. 61, 0177, Saburtalo
 District, Tbilisi, Georgia

(111) M 2023 37422 R
(151) 2023 10 17
(181) 2033 10 17
(260) AM 2022 120823 A
(220) 2022 12 19
(732) LTD "Fierna"
M. Toidze St. 13, Tbilisi, Georgia

(111) M 2023 37423 R
(151) 2023 10 17
(181) 2033 10 17
(260) AM 2022 120619 A
(220) 2022 12 06
(732) LLC "FoodMart"
Tengiz Chantladze St. 40, Didi Lilo, Tetri
Khevi Settlement, 0109, Tbilisi, Georgia

(111) M 2023 37424 R
(151) 2023 10 17
(181) 2033 10 17
(260) AM 2022 118561 A
(220) 2022 07 14
(732) Enriko Beridze
G. Tsitsishvili Str. 18, Tbilisi, Georgia

TRADEMARKS REGISTERED ACCORDING TO THE ACCELERATED PROCEDURE

The decision can be appealed at the Chamber of Appeal of Sakpatenti within 3 months from the publication.

(111) M 2023 37405 R
(151) 2023 10 09
(181) 2033 10 09
(210) AM 124822
(220) 2023 09 26
(732) LTD "New Pharm Group"
Irodion Evdoshvili St. 18, Office Space 2,
0154, Tbilisi, Georgia
(540)

აღერიქსი
Allerix
Аллерикс

(591) 000000 Black-white
(511) 5

(111) M 2023 37406 R
(151) 2023 10 09
(181) 2033 10 09
(210) AM 124716
(220) 2023 09 14
(732) Unregistered Union (Union) Saguramo,
Village of Mtskheta District near Saguramo,
Georgia
(740) Giorgi Taktakishvili
(540)

საგურამო

(591) Black-white
(551) Collective
(511) 32

(111) M 2023 37407 R
(151) 2023 10 09
(181) 2033 10 09
(210) AM 124801
(220) 2023 09 22
(732) JSC "Miso Euro Credit"
Giorgi Saakadze St. Exit II 11, Saburtalo
District, Tbilisi, Georgia
(740) Giorgi Taktakishvili
(540)

ევროკრედიტი

(591) Black-white
(511) 36

(111) M 2023 37408 R
(151) 2023 10 09
(181) 2033 10 09
(210) AM 124945
(220) 2023 09 29
(732) LLC "Marneuli Food Factory"
Davit Aghmashenebeli St. 1, 3000, Marneuli,
Georgia
(540)



(591) F77A04 yellowish orange
(531) 05.07.24; 26.01.18; 26.01.19; 29.01.12
(526) მარნეული
(511) 29, 30

(111) M 2023 37409 R
(151) 2023 10 09
(181) 2033 10 09
(210) AM 124798
(220) 2023 09 22
(732) Davit Avazashvili
Nutsubidze Slope, II m/r., IV qu., bld. 2,
Residential Area 76, 0183, Tbilisi, Georgia
(540)

DAVID AVAZA

(591) Black-white
(531) 27.05.01
(511) 14, 18, 25, 28, 35

(111) M 2023 37410 R
(151) 2023 10 09
(181) 2033 10 09
(210) AM 124816
(220) 2023 09 26
(732) LTD "Kanda Agriculture"
Vill. Old Kanda, Mtskheta, Georgia
(540)



(591) 59893A dark green
(531) 27.05.21; 29.01.03
(511) 31

(111) M 2023 37411 R
(151) 2023 10 09
(181) 2033 10 09
(210) AM 124815
(220) 2023 09 26
(732) LTD "Kanda Agriculture"
Vill. Old Kanda, Mtskheta, Georgia
(540)



(591) 708E44 light green
(531) 27.05.01; 28.19; 29.01.03
(511) 31

(111) M 2023 37412 R
(151) 2023 10 12
(181) 2033 10 12
(210) AM 124786
(220) 2023 09 21
(732) LTD "STD Decor"
Vakhtang Gorgasli St. 149/29, b. 19, Batumi,
Georgia

(540)
სტუდიო კასა Studio Casa

(591) FFFFFFF white, 000000 black
(531) 27.05.01; 28.19
(511) 2, 11, 17, 37

(111) M 2023 37413 R
(151) 2023 10 16
(181) 2033 10 16
(210) AM 125030
(220) 2023 10 06
(732) JSC "Evex Clinics"
Vazha-Pshavela Av. 40, 0177, Tbilisi,
Georgia



(591) Green, white
(531) 27.05.01; 27.05.22; 29.01.12
(511) 41, 44

(111) M 2023 37414 R
(151) 2023 10 16
(181) 2033 10 16
(210) AM 125031
(220) 2023 10 06
(732) LLC "Georgian Wine & Spirits Beverage
Company"
Vill. Achinevili, 2200, Telavi, Georgia
(540)

ქიცი და ქიციმაცური

(591) Black-white
(511) 33

(111) M 2023 37415 R
(151) 2023 10 16
(181) 2033 10 16
(210) AM 125029
(220) 2023 10 06
(732) LLC "Pedagogika"
Chapaev St., I Lane 19, 0190, Nazaladevi
District, Tbilisi, Georgia
(740) Giorgi Tsatava;
Zurab Bezhashvili;
Ioane Iarajuli;
Lia Shikhiashvili

(540)



პედაგოგიკა

(591) Red, white, black
(531) 24.15.01; 24.15.21; 26.04.02; 26.04.11;
26.04.12; 28.19; 29.01.13
(511) 16

(111) M 2023 37416 R
(151) 2023 10 16
(181) 2033 10 16
(210) AM 124948
(220) 2023 10 02
(732) Cooperative Ktsia 2014
Vill. Avranlo, Tsalka, Georgia
(540)



(591) White, grey, yellow
(531) 25.01.10; 26.01.02; 26.01.17; 26.01.20;
28.19; 29.01.13

(526) ქვემო
(511) 29

(111) M 2023 37417 R
(151) 2023 10 16
(181) 2033 10 16
(210) AM 124828
(220) 2023 09 27
(732) KTD "Bono Pay Georgia"
Marjanishvili St. 6, 0102, Didube District,
Tbilisi, Georgia
(540)



Bono ბონო

(591) Yellow, red, green, lilac, blue, white
(531) 26.01.06; 26.13.25; 27.05.01; 28.19; 29.01.15
(511) 36

INTERNATIONAL TRADEMARKS FOR WHICH A DECISION ON GRANTING PROTECTIONS IS TAKEN

The decision can be appealed at the Chamber of Appeal of Sakpatenti within 3 months from the publication or at the Mtskheta District Court Administrative Cases Board (Address: №17, Samkhedro St., Mtskheta), within 1 month following the publication.

(260) AM 2023 120372 A

(800) 1695603

(151) 2022 09 15

(891) 2022 09 15

(731) Obshchestvo s ogranichennoi otvetstvennostyu

"Studia professionalnogo makijazha "ART-VISAGE"

ul. Kaliningradskaya, 16, room 47, Korolev,
RU-141076 Moskovskaya oblast, Russian
Federation

(540)



(591) Black, white

(531) 24.17.01; 26.04.07; 26.04.18; 26.04.24;
27.05.01

(511)

3 – Abrasives; amber [perfume]; descaling preparations for household purposes; antistatic preparations for household purposes; aromatics [essential oils]; air fragrancing preparations; cake flavourings [essential oils]; flavourings for beverages [essential oils]; food flavourings [essential oils]; breath freshening sprays; canned pressurized air for cleaning and dusting purposes; balms, other than for medical purposes; basma [cosmetic dye]; lip glosses; nail glitter; body glitter; polishing stones; abrasive paper; emery paper; polishing paper; petroleum jelly for cosmetic purposes; shoe polish; cobblers' wax; cotton wool for cosmetic purposes; cotton wool impregnated with make-up removing preparations; sachets for perfuming linen; drying agents for dishwashing machines; adhesives for cosmetic purposes; scented water; Javelle water; lavender water; micellar water; toilet water; wax for parquet floors; floor wax; non-slipping wax for floors; depilatory wax; moustache wax; shoe wax; tailors' wax; polish for furniture and flooring; shoemakers' wax; polishing wax; massage gels, other than for medical purposes; heliotropine; dental bleaching gels; geraniol; starch glaze for laundry purposes; make-up; deodorants for pets; depilatory preparations; air fragrance reed diffusers; scented wood; perfumes; non-slipping liquids for floors; windscreen cleaning liquids; greases for cosmetic purposes; volcanic ash for cleaning; perfumery; decorative transfers for cosmetic purposes; ionone [perfumery]; shaving stones [astringents]; smoothing stones; eyebrow pencils; cosmetic pencils; silicon carbide [abrasive]; carbides of metal

[abrasives]; alum stones [astringents]; tripoli stone for polishing; adhesives for affixing false eyelashes; adhesives for affixing false hair; hair conditioners; quillaia bark for washing; corundum [abrasive]; beard dyes; colorants for toilet purposes; cosmetic dyes; body paint for cosmetic purposes; starch for laundry purposes; shoe cream; creams for leather; polishing creams; cosmetic creams; skin whitening creams; essential oil-based creams for aromatherapy use; polishing rouge; incense; hair spray; nail varnish; liquid latex body paint for cosmetic purposes; hair lotions; lotions for cosmetic purposes; after-shave lotions; beauty masks; sheet masks for cosmetic purposes; disposable steam-heated masks, not for medical purposes; oils for perfumes and scents; oils for cosmetic purposes; oils for toilet purposes; essential oils; essential oils for aromatherapy use; essential oils of cedarwood; essential oils of lemon; essential oils of citron; oils for cleaning purposes; bergamot oil; gaultheria oil; jasmine oil; lavender oil; almond oil; rose oil; oil of turpentine for degreasing; whitening; cleaning chalk; almond milk for cosmetic purposes; cleansing milk for toilet purposes; musk [perfumery]; soap; deodorant soap; shaving soap; soap for brightening textile; cakes of toilet soap; antiperspirant soap; soap for foot perspiration; almond soap; mint for perfumery; cosmetic kits; emery; gel eye patches for cosmetic purposes; nail art stickers; double eyelid tapes; false nails; eau de Cologne; joss sticks; pastes for razor strops; toothpaste; pumice stone; lipstick cases; hydrogen peroxide for cosmetic purposes; dressings for nail reconstruction; breath freshening strips; teeth whitening strips; sandcloth; glass cloth [abrasive cloth]; lipsticks; pomades for cosmetic purposes; shaving preparations; cosmetic preparations for baths; bath preparations, not for medical purposes; hair straightening preparations; hair waving preparations; laundry soaking preparations; grinding preparations; smoothing preparations [starching]; colour-removing preparations; leather bleaching preparations; polishing preparations; denture polishes; mouthwashes, not for medical purposes; preparations to make the leaves of plants shiny; eye-washes, not for medical purposes; fabric softeners for laundry use; dry-cleaning preparations; paint stripping preparations; lacquer-removing preparations; make-up removing preparations; floor wax removers [scouring preparations]; varnish-removing preparations; rust removing preparations; nail care preparations; cleaning preparations; preparations for cleaning dentures; wall-paper cleaning preparations; preparations for unblock-

king drain pipes; chemical cleaning preparations for household purposes; collagen preparations for cosmetic purposes; bleaching preparations [decolorants] for household purposes; aloe vera preparations for cosmetic purposes; sunscreen preparations; colour-brightening chemicals for household purposes [laundry]; breath freshening preparations for personal hygiene; shining preparations [polish]; make-up powder; diamantine [abrasive]; stain removers; wax melts [fragrancing preparations]; nail varnish removers; vaginal washes for personal sanitary or deodorant purposes; scouring solutions; false eyelashes; antistatic dryer sheets; baby wipes impregnated with cleaning preparations; colour run prevention laundry sheets; tissues impregnated with cosmetic lotions; tissues impregnated with make-up removing preparations; safrol; massage candles for cosmetic purposes; laundry blueing; turpentine for degreasing; potpourris [fragrances]; bleaching soda; washing soda, for cleaning; bath salts, not for medical purposes; bleaching salts; fumigation preparations [perfumes]; leather preservatives [polishes]; ammonia [volatile alkali] [detergent]; cooling sprays for cosmetic purposes; astringents for cosmetic purposes; eyebrow cosmetics; make-up preparations; sun-tanning preparations [cosmetics]; hair dyes; neutralizers for permanent waving; laundry glaze; cosmetic preparations for eyelashes; laundry preparations; cosmetic preparations for skin care; dentifrices; cosmetics; cosmetics for children; cosmetics for animals; mascara; cleansers for intimate personal hygiene purposes, non medicated; douching preparations for personal sanitary or deodorant purposes [toiletries]; detergents, other than for use in manufacturing operations and for medical purposes; degreasers, other than for use in manufacturing processes; bleaching preparations [decolorants] for cosmetic purposes; laundry bleach; toiletry preparations; antiperspirants [toiletries]; phytocosmetic preparations; detergent tablets for coffee machines; talcum powder, for toilet use; cotton swabs for cosmetic purposes; terpenes [essential oils]; emery cloth; toners for cosmetic purposes; cloths impregnated with a detergent for cleaning; henna [cosmetic dye]; bath tea for cosmetic purposes; shampoos; shampoos for animals [non-medicated grooming preparations]; shampoos for pets [non-medicated grooming preparations]; dry shampoos; sandpaper; cosmetic stamps, filled; soda lye; herbal extracts for cosmetic purposes; extracts of flowers [perfumes]; ethereal essences; badian essence; mint essence [essential oil]; deodorants for human beings or for animals; cosmetic preparations for slimming purposes.

16 – Fountain pens; aquarelles; albums; almanacs; document laminators for office use; mimeograph apparatus and machines; atlases; banknotes; souvenir banknotes; banners of paper; paper bows, other than haberdashery or hair decorations; name badges [office requisites]; table linen of paper; tickets; baggage claim check tags of paper; forms, printed; announcement

cards [stationery]; glitter for stationery purposes; note books; pads [stationery]; drawing pads; wristbands for the retention of writing instruments; pamphlets; booklets; paper; paper sheets [stationery]; waxed paper; baking paper; paper for medical examination tables; origami folding paper; plantable seed paper [stationery]; paper for recording machines; paper for radiograms; papers for painting and calligraphy; electrocardiograph paper; drawer liners of paper, perfumed or not; wood pulp paper; carbon paper; copying paper [stationery]; parchment paper; writing paper; rice paper; luminous paper; toilet paper; wrapping paper; filter paper; washi; blotters; newsletters; rollers for typewriters; house painters' rollers; composing sticks; adhesives [glues] for stationery or household purposes; modelling wax, not for dental purposes; signboards of paper or cardboard; sewing patterns; bunting of paper; newspapers; electrotypes; hectographs; modelling clay; polymer modelling clay; terrestrial globes; drawing sets; engravings; slate pencils; pencil leads; document holders [stationery]; pencil holders; chalk holders; holders for cheque books; holders for stamps [seals]; page holders; name badge holders [office requisites]; diagrams; table runners of paper; engraving plates; writing slates; blackboards; magnetic boards being office requisites; galley racks [printing]; drawing boards; advertisement boards of paper or cardboard; duplicators; punches [office requisites]; cream containers of paper; correcting fluids [office requisites]; magazines [periodicals]; money clips; clips for name badge holders [office requisites]; tags for index cards; pen clips; bookmarks; etching needles; tracing needles for drawing purposes; periodicals; printed publications; paper shredders for office use; graphic representations; credit card imprinters, non-electric; paper creasers [office requisites]; graining combs; drawing instruments; calendars; tracing paper; tracing cloth; tracing patterns; gums [adhesives] for stationery or household purposes; lithographic stones; ink stones [ink reservoirs]; pencils; pencil lead holders; charcoal pencils; pictures; transfers [decalcomanias]; paintings [pictures], framed or unframed; colouring pictures; cardboard; wood pulp board [stationery]; hat boxes of cardboard; cards; index cards [stationery]; geographical maps; paper tapes and cards for the recordal of computer programmes; trading cards, other than for games; perforated cards for Jacquard looms; catalogues; spools for inking ribbons; flowerpot covers of paper; paintbrushes; painters' brushes; writing brushes; typewriter keys; glue for stationery or household purposes; isinglass for stationery or household purposes; gluten [glue] for stationery or household purposes; starch paste [adhesive] for stationery or household purposes; printing blocks; books; colouring books; manifolds [stationery]; comic books; drawing pins; mats of paper for beer glasses; cigar bands; envelopes [stationery]; boxes of paper or cardboard; cases for stamps [seals]; paint boxes for use in schools; printed coupons; stencils [stationery]; French cur-

ves; paper ribbons, other than haberdashery or hair decorations; gummed tape [stationery]; typewriter ribbons; barcode ribbons; adhesive tapes for stationery or household purposes; correcting tapes [office requisites]; inking ribbons; self-adhesive tapes for stationery or household purposes; square rulers for drawing; drawing rulers; flyers; absorbent sheets of paper or plastic for foodstuff packaging; humidity control sheets of paper or plastic for foodstuff packaging; viscose sheets for wrapping; sheets of reclaimed cellulose for wrapping; plastic bubble packs for wrapping or packaging; steel letters; type [numerals and letters]; lithographs; letter trays; paint trays; architects' models; postage stamps; plastics for modelling; graphic prints; modelling materials; teaching materials [except apparatus]; sealing compounds for stationery purposes; padding materials of paper or cardboard; book-binding material; packing [cushioning, stuffing] materials of paper or cardboard; packaging material made of starches; filtering materials of paper; addressing machines; pencil sharpening machines, electric or non-electric; bookbinding apparatus and machines [office equipment]; typewriters, electric or non-electric; franking machines for office use; chalk for lithography; writing chalk; tailors' chalk; marking chalk; spray chalk; bags [envelopes, pouches] of paper or plastics, for packaging; garbage bags of paper or of plastics; plastic bags for pet waste disposal; painters' easels; hand-rests for painters; printing sets, portable [office requisites]; bibs of paper; bibs, sleeved, of paper; floor decals; stickers [stationery]; fingerstalls for office use; writing cases [stationery]; cords for bookbinding; paper knives [letter openers]; printed sheet music; numbering apparatus; bottle envelopes of paper or cardboard; sealing wafers; covers [stationery]; passport holders; protective covers for books; plastic cling film, extensible, for palletization; embroidery designs [patterns]; handwriting specimens for copying; oleographs; musical greeting cards; greeting cards; postcards; etchings; conical paper bags; paper bags for use in the sterilization of medical instruments; bags for microwave cooking; palettes for painters; ink sticks; pantographs [drawing instruments]; loose-leaf binders; files [office requisites]; folders for papers; papier mâché; pastels [crayons]; modelling paste; pen cases; mezuzah parchments; pen wipers; office perforators; pens [office requisites]; nibs of gold; nibs; steel pens; drawing pens; song books; seals [stamps]; sealing stamps; posters; clipboards; address plates for addressing machines; handkerchiefs of paper; plastic film for wrapping; transparencies [stationery]; trays for sorting and counting money; coasters of paper; bookends; stamp stands; stands for pens and pencils; photograph stands; obliterating stamps; inking pads; stamp pads; binding strips [bookbinding]; face towels of paper; towels of paper; inking sheets for document reproducing machines; inking sheets for duplicators; cloth for bookbinding; gummed cloth for stationery purposes; printers' blankets, not of

textile; portraits; paperweights; writing cases [sets]; inkstands; office requisites, except furniture; writing materials; writing instruments; drawing materials; school supplies [stationery]; adhesive tape dispensers [office requisites]; hand labelling appliances; printed matter; lithographic works of art; prospectuses; printed timetables; ledgers [books]; printers' reglets; indexes; paper cutters [office requisites]; rubber erasers; elastic bands for offices; T-squares for drawing; graphic reproductions; retractable reels for name badge holders [office requisites]; penholders; marking pens [stationery]; tissues of paper for removing make-up; paper wipes for cleaning; dental tray covers of paper; place mats of paper; tablemats of paper; tablecloths of paper; paper clasps; document files [stationery]; scrapers [erasers] for offices; paper-clips; clips for offices; erasing products; biological samples for use in microscopy [teaching materials]; histological sections for teaching purposes; steatite [tailor's chalk]; writing board erasers; composing frames [printing]; carrier bags of paper or plastic; sealing wax; arithmetical tables; placards of paper or cardboard; writing or drawing books; fabrics for bookbinding; stationery; pencil sharpeners, electric or non-electric; stencil plates; stencils for decorating food and beverages; cardboard tubes; Indian inks; moisteners [office requisites]; moisteners for gummed surfaces [office requisites]; squares for drawing; chart pointers, non-electronic; bottle wrappers of paper or cardboard; envelope sealing machines for offices; sealing machines for offices; vignetting apparatus; apparatus for mounting photographs; stapling presses [office requisites]; manuals [handbooks]; figurines of papier mâché; paper coffee filters; flags of paper; flip charts; silver paper; moulds for modelling clays [artists' materials]; photo-engravings; photographs [printed]; mezuzah cases; stencil cases; canvas for painting; chromolithographs [chromos]; animation cels; compasses for drawing; numbers [type]; artists' watercolour saucers; ink; correcting ink [heliography]; inkwells; blueprints; stencils; erasing shields; balls for ball-point pens; desktop cabinets for stationery [office requisites]; printing type; address stamps; stamps [seals]; shields [paper seals]; prints [engravings]; labels of paper or cardboard.

35 – Computerized file management; book-keeping; invoicing; demonstration of goods; professional business consultancy; payroll preparation; data search in computer files for others; commercial intermediation services; providing business information; providing commercial information and advice for consumers in the choice of products and services; provision of an online marketplace for buyers and sellers of goods and services; providing user reviews for commercial or advertising purposes; sales promotion for others; publication of publicity texts; advertising; online advertising on a computer network; compilation of information into computer databases; business inquiries; systemization of information into computer databases; administration of consumer loyalty programs; admini-

nistrative processing of purchase orders; search engine optimization for sales promotion; price comparison services; procurement services for others [purchasing goods and services for other businesses]; online retail and wholesale services for goods; wholesale services for goods; retail services for goods; providing business information via a website; presentation of goods on communication media, for retail purposes.

41 – Academies [education]; rental of indoor aquaria; rental of artwork; rental of movie props; rental of sports grounds; rental of tennis courts; mobile library services; lending library services; booking of seats for shows; videotaping; physical education; production of music; discotheque services; animal training; dubbing; publication of books; research in the field of education; escape room [entertainment]; film distribution; movie studio services; health club services [health and fitness training]; nightclub services [entertainment]; layout services, other than for advertising purposes; microfilming; videotape editing; production of radio and television programmes; screenplay writing; music education; religious education; aikido instruction; gymnastic instruction; judo instruction; correspondence courses; practical training [demonstration]; training services provided via simulators; organization of balls; organization of exhibitions for cultural and educational purposes; providing recreation facilities; arranging and conducting of colloquiums; arranging and conducting of congresses; arranging and conducting of conferences; arranging and conducting of concerts; arranging and conducting of workshops [training]; arranging and conducting of in-person educational forums; arranging and conducting of seminars; arranging and conducting of symposiums; arranging and conducting of sports events; organization of competitions [education or entertainment]; arranging of beauty contests; organization of cosplay entertainment events; organization of lotteries; organization of fashion shows for entertainment purposes; organization of entertainment events; organization of electronic sports competitions; organization of shows [impresario services]; organization of sports competitions; vocational guidance [education or training advice]; amusement park services; sign language interpretation; language interpretation; transfer of business knowledge and know-how [training]; know-how transfer [training]; television entertainment; vocational retraining; directing of shows; providing online videos, not downloadable; providing information in the field of education; providing information relating to recreational activities; providing information in the field of entertainment; providing museum facilities; providing online music, not downloadable; providing television programmes, not downloadable, via video-on-demand services; providing films, not downloadable, via video-on-demand services; providing user reviews for entertainment or cultural purposes; providing golf facilities; providing user rankings for entertainment or cultural purposes; providing sports fa-

cilities; providing amusement arcade services; cinema presentations; providing online electronic publications, not downloadable; presentation of circus performances; presentation of variety shows; presentation of live performances; theatre productions; presenting museum exhibitions; conducting of entertainment events; conducting guided climbing tours; conducting fitness classes; educational examination; production of podcasts; film production, other than advertising films; rental of audio equipment; rental of video cameras; rental of video cassette recorders; rental of videotapes; rental of show scenery; rental of sound recordings; toy rental; rental of cinematographic apparatus; rental of motion pictures; games equipment rental; rental of stadium facilities; rental of lighting apparatus for theatrical sets or television studios; rental of radio and television sets; rental of skin diving equipment; rental of sports equipment, except vehicles; rental of stage scenery; rental of training simulators; rental of electronic book readers; electronic desktop publishing; online publication of electronic books and journals; publication of texts, other than publicity texts; radio entertainment; entertainment services; writing of texts; sado instruction [tea ceremony instruction]; zoological garden services; educational certification services, namely, providing training and educational examination; news reporters services; film directing, other than advertising films; party planning [entertainment]; music composition services; captioning; subtitling; tutoring; entertainer services; holiday camp services [entertainment]; gambling services; e-sports services; video editing services for events; video imaging services by drone; conducting guided tours; disc jockey services; sound engineering services for events; game services provided online from a computer network; games library services; personal trainer services [fitness training]; providing casino facilities [gambling]; calligraphy services; karaoke services; songwriting; cultural, educational or entertainment services provided by art galleries; multimedia library services; modelling for artists; teaching; educational services provided by special needs assistants; educational services provided by schools; orchestra services; translation; scriptwriting, other than for advertising purposes; physical fitness assessment services for training purposes; face painting; ticket agency services [entertainment]; educational examination for users to qualify to pilot drones; coaching [training]; lighting technician services for events; sport camp services; recording studio services; photographic imaging services by drone; nursery schools; photography; photographic reporting; timing of sports events; boarding school education; production of shows.

44 – Rental of bottles and containers containing gas for medical purposes; rental of hydrogen water generators for baths; rental of animals for gardening purposes; rental of gardening implements; rental of beehives; dietary and nutritional advice; art therapy; lan-

dscape architecture; public bath services for hygiene purposes; Turkish bath services; hospital services; re-forestation services; cultivation of plants; depilatory waxing; diagnosis of visual processing disorders; landscape design; health centre services; nursing home services; acupuncture; wreath making; hair implantation; medical advice for individuals with disabilities; consultancy in the field of viticulture; pharmacy advice; medical treatment using cultured cells; animal-assisted therapy; manicuring; massage; remote monitoring of medical data for medical diagnosis and treatment; music therapy; pruning of trees; horticulture; artificial insemination services; hairdressing; transplanting of trees; body piercing; midwife services; veterinary assistance; dentistry services; medical assistance; palliative care; tree planting for carbon offsetting purposes; providing community gardening facilities; providing service animals to individuals with disabilities; preparation of prescriptions by pharmacists; medical equipment rental; rental of hair styling apparatus; rental of sanitary installations; farming equipment rental; aerial and surface spreading of fertilizers and other agricultural chemicals; animal breeding; rehabilitation for substance abuse patients; gardening; landscape gardening; beauty salon services; medical screening; blood bank services; health care; health counselling; rental of surgical robots; flower arranging; tattooing; cupping therapy; chiropractic; speech therapy; dance therapy; vermin exterminating for agriculture, aquaculture, horticulture and forestry; weed killing; wildlife management; health spa services; human tissue bank services; cultured cell bank services for medical transplantation; barber shop services; aquaculture services; aromatherapy services; viticulture services; convalescent home services; beautician services; medical clinic services; medical analysis services for diagnostic and treatment purposes provided by medical laboratories; home-visit nursing care; alternative medicine services; opticians' services; orthodontic services; plant nursery services; pest control services for agriculture, aquaculture, horticulture and forestry; Attention Deficit Hyperactivity Disorder screening services; learning disability screening services; Attention Deficit Disorder screening services; hair dyeing services; in vitro fertilization services; health assessment services; postnatal care services; vaccination services; services of a psychologist; regenerative medicine services; sanatorium services; sauna services; solarium services; telemedicine services; therapy services; aesthetician services; nursing, medical; lawn care; animal grooming; pet grooming; physiotherapy; tree surgery; plastic surgery; hospice services; occupational therapy.

(260) AM 2023 121182 A
 (800) 1707335
 (151) 2022 09 20
 (891) 2022 09 20

(731) SWEEPEN
 109 Place Charles de Gaulle, F-74300 Cluses,
 France

(540)

SWEEPEN

(591) Black, white
 (511)

35 – Compiling directories for the publication thereof on a global computer network or on the Internet; commercial management of sports facilities; business management on behalf of professional athletes; business management for sports people; promotional management of sports personalities; provision of advertising space by electronic means and via global information networks; connecting qualified volunteers with non-profit organizations; promotional sponsorship; promoting sporting competitions and events; promotion of products and services through sponsorship of international sporting events; promotion of goods and services by means of sponsorship of sports events; promotion of third party products and services by agreeing with sponsors to associate their products and services with sporting events; promotion of third party products and services by agreeing with sponsors to associate their products and services with sporting events; promotion of third-party goods and services via computer and communication networks; online advertising via a computer communication network; advertising via mobile telephone networks; advertising, including promotion of third-party goods and services via sponsorship agreements and licensing agreements relating to international sports events; commercial information via the Internet, a cable network or other forms of data transfer; agency services for the promotion of sports personalities; talent agency services [business management of performing artists]; consulting in sponsorship search; marketing services provided by means of digital networks; online advertising services on computer communication networks; business networking services; professional networking services; retail services relating to sports articles; retail sale services concerning sports equipment; retail sale services concerning sports articles; auction services provided via telecommunication networks; wholesale services concerning sports equipment; retail sale of sports articles; auctioneering via telecommunication networks; marketing, advertising and promotional services in the field of sports; promoting the interests of people working in the field of sports; promoting sports competitions and races; promoting goods and services through sponsorship of sports races; advertising, including promotion of third-party goods and services by means of sponsoring agreements and license contracts relating to sporting events; promotion of third-party goods and services; promotional sponsorship of games, gamers and games events; promoting third party goods and services by placing advertisements in relation to electronic games and sports; designing advertisements and

advertising material for third parties; administration of team leagues and competitions in the field of e-sports and video games; managerial administration and coordination of recreational opportunities for individuals wishing to participate in team leagues in the field of e-sports and video games; advertising; commercial business management; commercial administration; dissemination of advertising material (leaflets, prospectuses, printed matter, samples); business management and organization consultancy; computer file management; organization of exhibitions for commercial or advertising purposes; online advertising on a computer network; rental of advertising time on all communication media; publication of advertising texts; rental of advertising space; dissemination of advertisements; public relations; online advertising services; e-commerce, providing information on goods or services via the Internet for advertising and sales purposes; talent agency services [business administration of sports people]; tracking and recruitment of sports talents; agency services concerning the booking of sports personalities for events; information with respect to sponsorship in relation to sports events.

41 – Personalized coaching, as an educational service; entertainment, sporting and cultural activities; sporting and cultural activities; refereeing of sports competitions; sports refereeing and officiating; sports training services [courses]; timing of sports events; sports club services [health and fitness training]; coaching [training]; conduct of sports events; arrangement of live sports events; sports courses; courses, coaching and training in the field of sport; assessment of disabilities for sports events; education, leisure and sports; teaching sports; sports teaching; sports training; training of sports players; training of sports instructors; providing information with respect to sporting activities; providing information concerning sporting events; provision of information relating to sport; providing information on sports; providing video entertainment via a website; management and organization of sporting events; rental of equipment for use at sporting events [except vehicles]; rental of sports equipment other than vehicles; rental of equipment intended for sports events; rental of sports grounds; providing non-downloadable television programs via video-on-demand services; provision of equipment and installations for ice sports; provision of equipment and facilities for sporting events, sports and athletic competitions and awards programs; provision of installations for sporting leisure activities; provision of sporting facilities for clubs; provision of sports club facilities; providing facilities for sports tournaments; providing sports facilities for figure skating championships; providing sports facilities; provision of facilities for sporting events; provision of sports entertainment via a website; providing social club services [entertainment]; providing non-downloadable videos online; organization of sporting activities and competitions; organization of sports and

cultural events for leisure purposes; organizing sports competitions for games which involves setting up teams of virtual sports with existing players [so-called fantasy sports]; organization of sports competitions; organization of fan clubs; organization of sports tournaments; organizing and conducting university sports competitions; providing prepaid ticket withdrawal service for tickets entertainment, sporting and cultural events; providing sporting and recreational services; production of video and sound recordings for educational purposes; production of sporting events for television; production of sports events; producing sports events for radio; producing sports events for cinema; videotape and videodisk production; production of entertainment in the nature of videos; production of training videos; booking of sports facilities; seat reservations for shows and sports events; audio and video editing services; digital video, audio and multimedia entertainment publishing services; post-production publishing services in the field of music, videos and films; education, entertainment and sports services; educational and training services relating to sports; sports education services; sports coaching services; audio, video, motion picture and televised recording services; automatic video recording services; sports coaching services; coaching services for sporting activities; information services concerning tickets for sports events; information services related to sports results; information services concerning motorsports; information services with respect to sports races; information services with respect to sports; online information services regarding computer and video game strategies; provided by telephone information services on sports races; ticket agency services for sports events; timing of sports events; sports club services; sports club services [physical exercise]; club services [entertainment or education]; social club services for entertainment purposes; advisory services with respect to organization of sporting events; training courses with respect to sports; handicap determination services for sports events; entertainment services via computer games and video games; entertainment services provided by private sports clubs [country clubs]; entertainment services, in the form of sharing of audio and video recordings; entertainment services consisting of matching users with audio and video recordings; sports entertainment services; sports park services; reservation of tickets for sports events; sports hall services; club education services; sports services; provision of information with respect to amateur and recreational sports provided via an Internet site; providing news and information with respect to amateur and recreational sports; sports activities relating to sports races; providing information in the field of sports races; organizing sports races; ticket agency and booking services for sports races; training services relating to recreational sports and training advice, recording of training sessions, and the statistical analysis thereof provided via an Internet site;

education; training; entertainment; sporting and cultural activities; information relating to entertainment or education; videotape film production; videotape editing; photography services; organization of competitions (education or entertainment); organization and conducting of colloquiums, conferences or congresses; organization of exhibitions for cultural or educational purposes; booking of seats for shows; electronic publication of books and journals online; electronic desktop publishing; entertainment services, namely, providing online games; entertainment services, namely, live streaming of electronic sports and game content via a website; entertainment services, namely, providing online videos featuring electronic games and sports played by third parties; organizing and conducting multiplayer and collaborative online games; entertainment services, namely, providing online video games via social networks; multimedia editing of games software; provision of temporary use of non-downloadable software for playing electronic games and sports; entertainment services, namely, live performances by video game players; entertainment services provided via a website where users can access and view game-related information, music, videos and animation; providing information and news relating to games and e-sports; blogs containing game articles and game-related activities; preparing and conducting competitions for video game and e-sports players; entertainment services, namely, preparing, organizing and producing live gaming events and competitions and e-sports; organizing, conducting and operating video game tournaments; organizing game competitions, namely, organizing electronic, computer and video game competitions; providing online news, information and commentary in the fields of e-sports, games, video games and video game players; entertainment services; namely, providing online video games via social networks; providing virtual environments in which users can interact for recreational, leisure or entertainment purposes; providing online publications in the nature of magazines, blogs and articles in the field of e-sports, video games and video game players; organizing competitions and lotteries; provision of information about tournaments and competitions in the fields of electronic games and sports provided to users via a website; entertainment services, namely, providing virtual environments in which users can interact through social, multi-player and collaborative electronic games and sports competitions.

45 – Computer dating services [online social networking]; meeting services by means of computers [online social networking]; dating services via an online social network; video dating services [online social networking]; online social networking services accessible by means of downloadable mobile applications; online social networking services; online social networking services; online social networking services provided via a sports community website on the Inter-

net; online social networking services in the field of sports; online social networking services provided on a sports community Internet site for recreational sports enthusiasts; online social networking services; online social networking services in the fields of entertainment and games; social networking services enabling users to participate in online electronic games and sports and online game competitions provided via a website.

(260) AM 2023 121183 A

(800) 1707352

(151) 2022 09 16

(891) 2022 09 16

(731) Limited Liability Company "Gexa – nonwoven materials"

Tsentralnaya street, dom 3, litera A, A1, A2,
a, pomeshchenie 304, d. Golievo,
g. Krasnogorsk, RU-143405 Moskovskaya
oblast, Russian Federation

(540)

AGROTEX

(591) Black, white

(531) 27.05.01

(511)

17 – Shock-absorbing buffers of rubber; fittings, not of metal, for compressed air lines; asbestos; cellulose acetate, semi-processed; balata; floating anti-pollution barriers; asbestos paper; paper for electrical capacitors; insulating paper; cotton wool for packing [caulking]; mineral wool [insulator]; asbestos felt; insulating felt; asbestos fibres; plastic fibres, other than for textile use; carbon fibres, other than for textile use; vulcanized fibre; gutta-percha; foam supports for flower arrangements [semi-finished products]; dielectrics [insulators]; lute; insulators; insulators for railway tracks; insulators for electric mains; insulators for cables; asbestos millboards; liquid rubber; synthetic rubber; rubber, raw or semi-worked; valves of india-rubber or vulcanized fibre; clack valves of rubber; rings of rubber; water-tight rings; insulating paints; insulating varnish; latex [rubber]; duct tapes; insulating bands; adhesive tapes, other than stationery and not for medical or household purposes; self-adhesive tapes, other than stationery and not for medical or household purposes; asbestos sheets; viscose sheets, other than for wrapping; foil of regenerated cellulose, other than for wrapping; insulating oils; insulating oil for transformers; reinforcing materials, not of metal, for pipes; weatherstripping compositions; caulking materials; brake lining materials, partly processed; soundproofing materials; insulating materials; insulating refractory materials; padding materials of rubber or plastics; rubber material for recapping tyres; non-conducting materials for retaining heat; boiler composition to prevent the radiation of heat; packing [cushioning, stuffing] materials of rubber or plastics; sea-

lant compounds for joints; filtering materials of semi-processed foams of plastic; filtering materials of semi-processed films of plastic; compositions to prevent the radiation of heat; bags [envelopes, pouches] of rubber, for packaging; pipe muffs, not of metal; rubber sleeves for protecting parts of machines; asbestos packing; clutch linings; threads of plastic for soldering; plastic filaments for 3D printing; threads of plastic materials, other than for textile use; threads of rubber, other than for textile use; elastic yarns, other than for textile use; door stops of rubber; window stops of rubber; stops of rubber; dock bumpers of rubber; insulating gloves; plastic substances, semi-processed; plastic sheeting for agricultural purposes; plastic film, other than for wrapping; anti-glare films for windows [tinted films]; asbestos coverings; bark coverings for sound insulation; asbestos cloth; rubber stoppers; expansion joint fillers; cylinder jointings; washers of rubber or vulcanized fibre; pipe gaskets; draught excluder strips; gaskets; rubber solutions; gum, raw or semi-worked; mica, raw or partly processed; acrylic resins, semi-processed; synthetic resins, semi-processed; junctions, not of metal, for pipes; substances for insulating buildings against moisture; chemical compositions for repairing leaks; acrylic glass, semi-processed; organic glass, semi-processed; glass wool for insulation; fibreglass for insulation; asbestos fabrics; fibreglass fabrics for insulation; insulating fabrics; flexible hoses, not of metal; hoses of textile material; connecting hose for vehicle radiators; waterproof packings; rubber seals for jars; fittings, not of metal, for flexible pipes; fittings, not of metal, for rigid pipes; foils of metal for insulating; ebonite moulds; insulating inks; asbestos slate; slag wool [insulator]; watering hose; canvas hose pipes; cords of rubber; asbestos safety curtains; insulating plaster; ebonite.

19 – Aquaria [structures]; alabaster; door frames, not of metal; asbestos cement; asphalt; beams, not of metal; balustrades, not of metal; huts; swimming pools [structures], not of metal; silos, not of metal; arbours [structures], not of metal; concrete; bitumen; plastic landscape edgings; joists, not of metal; telephone booths, not of metal; beacons, not of metal, non-luminous; building paper; busts of stone, concrete or marble; bird baths [structures], not of metal; binding agents for making briquettes; binding material for road repair; stained-glass windows; felt for building; aviaries [structures], not of metal; gates, not of metal; diving boards, not of metal; geotextiles; gypsum [building material]; plaster; potters' clay; earth for bricks; clay; roofing shingles; gravel; aquarium gravel; granite; tar; armoured doors, not of metal; doors, not of metal; swing doors, not of metal; accordion doors, not of metal; folding doors, not of metal; coal tar; chimney pots, not of metal; prefabricated houses [kits], not of metal; parquet floor boards; floating floor boards, not of metal; memorial plaques, not of metal; wood for making household utensils; veneer wood; mouldable wood; chimney shafts, not of metal; jalousies, not of

metal; roof gutters, not of metal; street gutters, not of metal; agglomerated bagasses of cane [building material]; road signs, non-luminous and non-mechanical, not of metal; non-luminous and non-mechanical signs, not of metal; limestone; lime; fences, not of metal; works of stonemasonry; works of art of stone, concrete or marble; cabanas, not of metal; soundproof booths, transportable, not of metal; stone; rubble; artificial stone; building stone; paint spraying booths, not of metal; gravestones; reeds for building; horticultural frames, not of metal; framework, not of metal, for building; greenhouse frames, not of metal; cornices, not of metal; bitumen paper for building; wood pulp board for building; paperboard for building; skating rinks [structures], not of metal; quartz; caissons for construction work under water; bricks; firebricks; water-pipe valves, not of metal or plastic; drain traps [valves], not of metal or plastic; cask wood; mooring bollards, not of metal; cement posts; pillars, not of metal, for building; chimney cowls, not of metal; brackets, not of metal, for building; buildings, not of metal; buildings, transportable, not of metal; stringers [parts of staircases], not of metal; silica [quartz]; roofing, not of metal; roofing, not of metal, incorporating photovoltaic cells; manhole covers, not of metal; xylolith; chicken-houses, not of metal; manufactured timber; sawn timber; building timber; wood, semi-worked; staircases, not of metal; road marking sheets and strips of synthetic material; reinforcing materials, not of metal, for building; bituminous products for building; road coating materials; materials for making and coating roads; fireclay; pitch; building materials, not of metal; refractory construction materials, not of metal; masts [poles], not of metal; raw chalk; calcareous marl; mosaics for building; mouldings, not of metal, for building; marble; slate powder; porches [structures], not of metal; tombs, not of metal; flashing, not of metal, for building; roof flashing, not of metal; perches; duckboards, not of metal; wall claddings, not of metal, for building; mouldings, not of metal, for cornices; coatings [building materials]; tomb or grave enclosures, not of metal; grave or tomb enclosures, not of metal; laths, not of metal; wood panelling; wall linings, not of metal, for building; palings, not of metal; crash barriers, not of metal, for roads; latticework, not of metal; windows, not of metal; olivine for building; shuttering, not of metal, for concrete; posts, not of metal, for power lines; props, not of metal; rubber bearings for seismic isolation of buildings; branching pipes, not of metal; fair huts; tombs [monuments], not of metal; monuments, not of metal; acoustic panels, not of metal; wainscotting, not of metal; signalling panels, non-luminous and non-mechanical, not of metal; building panels, not of metal; parquet flooring; partitions, not of metal; lintels, not of metal; casement windows, not of metal; aquarium sand; play sand; silver sand; sand, except foundry sand; sandstone for building; tarred strips for building; planks of wood for building; rocket launching platforms, not of

metal; platforms, prefabricated, not of metal; wall tiles, not of metal; floor tiles, not of metal; tiles, not of metal, for building; paving slabs, not of metal; cement slabs; grave slabs, not of metal; tile floorings, not of metal; slabs, not of metal, for building; scaffolding, not of metal; armour-plating, not of metal; asphalt paving; wood paving; paving blocks, not of metal; luminous paving blocks; macadam; fireproof cement coatings; bituminous coatings for roofing; roof coverings, not of metal; wooden floor boards; cladding, not of metal, for building; linings, not of metal, for building; fireplace mantles, not of metal; door panels, not of metal; floors, not of metal; sills, not of metal; porphyry [stone]; ceilings, not of metal; floating docks, not of metal, for mooring boats; agglomerated cork for building; window frames, not of metal; mortar for building; asbestos mortar; tanks of masonry; scantlings [carpentry]; furrings of wood; vinyl siding; pilings, not of metal; pigsties, not of metal; insect screens, not of metal; burial vaults, not of metal; schists; outdoor blinds, not of metal and not of textile; shutters, not of metal; statues of stone, concrete or marble; statuettes of stone, concrete or marble; alabaster glass; safety glass; glass granules for road marking; window glass for building; window glass, other than vehicle window glass; building glass; plate glass [windows] for building; insulating glass for building; enamelled glass, for building; tombstone stelae, not of metal; stables, not of metal; advertisement columns, not of metal; posts, not of metal; telegraph posts, not of metal; hips for roofing; stair-treads [steps], not of metal; tombstone plaques, not of metal; greenhouses, transportable, not of metal; terra-cotta [building material]; penstock pipes, not of metal; water-pipes, not of metal; gutter pipes, not of metal; ducts, not of metal, for ventilating and air-conditioning installations; drain pipes, not of metal; chimneys, not of metal; rigid pipes, not of metal, for building; sandstone pipes; turnstiles, not of metal; tufa; angle irons, not of metal; lengthening pieces, not of metal, for chimneys; bicycle parking installations, not of metal; plywood; figurines of stone, concrete or marble; flagpoles [structures], not of metal; foundry moulds, not of metal; rock crystal; cement for blast furnaces; cement for furnaces; magnesia cement; cement; pantiles, not of metal; roofing tiles, not of metal; slate; roofing slates; slag [building material]; slag stone; railway sleepers, not of metal; wood veneers; clinker ballast; concrete building elements; letter boxes of masonry.

20 – Picture frame brackets; recycling bins, not of metal; reels, not of metal, non-mechanical, for flexible hoses; sew-on tags of plastic or rubber for clothing; identification bracelets, not of metal; bolsters; screws, not of metal; removable covers for sinks; collars, not of metal, for fastening pipes; signboards of wood or plastics; nuts, not of metal; curtain holders, not of textile material; dowels, not of metal; kennels for household pets; birdhouses; keyboards for hanging keys; plugs [dowels], not of metal; display boards; packa-

ging containers of plastic; clips, not of metal, for cables and pipes; binding screws, not of metal, for cables; clips of plastic for sealing bags; rivets, not of metal; locks, not of metal, for vehicles; padlocks, other than electronic, not of metal; locks, other than electric, not of metal; door bolts, not of metal; closures, not of metal, for containers; latches, not of metal; numberplates, not of metal; wickerwork; hampers [baskets] for the transport of items; works of art of wood, wax, plaster or plastic; cabinet work; drain traps [valves] of plastic; water-pipe valves of plastic; valves, not of metal, other than parts of machines; plastic keys; mats for infant playpens; reusable baby changing mats; sleeping pads; mats, removable, for sinks; tent pegs, not of metal; waste dumpsters, not of metal, other than for medical use; containers, not of metal [storage, transport]; floating containers, not of metal; tool boxes, not of metal, empty; taps, not of metal, for casks; brackets, not of metal, for furniture; sash fasteners, not of metal, for windows; beds for household pets; nesting boxes for household pets; ladders of wood or plastics; furniture; runners, not of metal, for sliding doors; house numbers, not of metal, non-luminous; door stops, not of metal or rubber; window stops, not of metal or rubber; stakes, not of metal, for plants or trees; pet cushions; cushions for lining pet crates; bedding, except linen; sealing caps, not of metal; drawer organizers; reservoirs, not of metal nor of masonry; fodder racks; curtain rollers; door handles, not of metal; knobs, not of metal; vats, not of metal; honeycombs; plugs, not of metal; steps [ladders], not of metal; step stools, not of metal; placards of wood or plastics; nameplates, not of metal; door fasteners, not of metal; window fasteners, not of metal; window closers, not of metal, non-electric; door openers, not of metal, non-electric; window openers, not of metal, non-electric; winding spools, not of metal, non-mechanical, for flexible hoses; furniture fittings, not of metal; window fittings, not of metal; garment covers [storage]; hinges, not of metal; poles, not of metal; sneeze guards; labels of plastic; boxes of wood or plastic.

21 – Bird baths; pails; flower pots; sponges for household purposes; holders for flowers and plants [flower arranging]; containers for household or kitchen use; heat-insulated containers; ceramics for household purposes; cleaning instruments, hand-operated; flower-pot covers, not of paper; cages for household pets; birdcages; cages for collecting insects; disposable aluminium foil containers for household purposes; feeding troughs; watering cans; insect traps; material for brush-making; tablemats, not of paper or textile; brooms; isothermic bags; nozzles for watering cans; pouring spouts; nozzles for watering hose; fibreglass thread, other than for textile use; sprinklers; syringes for watering flowers and plants; oven mitts; animal grooming gloves; gloves for household purposes; polishing gloves; gardening gloves; barbecue mitts; dripping pans; drinking troughs; potholders; clothes-pegs; combs; sifters [household utensils]; broom handles;

blenders, non-electric, for household purposes; scoops for household purposes; fused silica [semi-worked product], other than for building; plate glass [raw material]; glass, unworked or semi-worked, except building glass; glass wool, other than for insulation; vitreous silica fibres, other than for textile use; fibre-glass, other than for insulation or textile use; indoor terrariums [plant cultivation]; indoor terrariums [vivariums]; electric devices for attracting and killing insects; watering devices; ultrasonic pest repellents; utensils for household purposes; kitchen utensils; mops; animal bristles [brushware]; brushes; barbecue tongs; decanter tags; nest eggs, artificial; window-boxes.

22 – String; tarpaulins; wadding for padding and stuffing upholstery; wadding for filtering; ropes; hemp fibres; carbon fibres for textile use; coconut fibre; plastic fibres for textile use; jute; ropes, not of metal; strips for tying-up vines; ladder tapes for Venetian blinds; wrapping or binding bands, not of metal; padding materials, not of rubber, plastics, paper or cardboard; packing [cushioning, stuffing] materials, not of rubber, plastics, paper or cardboard; bags [envelopes, pouches] of textile, for packaging; binding thread, not of metal, for agricultural purposes; thread, not of metal, for wrapping or binding; braces, not of metal, for handling loads; bindings, not of metal; tents; purse seines; straps, not of metal, for handling loads; hemp bands; nets; sisal; sheaf-binding yarns; outdoor blinds of textile; vitreous silica fibres for textile use; glass fibres for textile use; slings, not of metal, for handling loads; cables ties, not of metal; raw fibrous textile; awnings of synthetic materials; awnings of textile; network; cables, not of metal; dust sheets; cords for hanging pictures; sash cords; pig bristles.

24 – Banners of textile or plastic; sew-on tags of textile for clothing; adhesive tags of textile for bags; bunting of textile or plastic; table runners, not of paper; shower curtains of textile or plastic; curtains of textile or plastic; mats of textile for beer glasses; furniture coverings of textile; fabrics for textile use; filtering materials of textile; wall hangings of textile; non-woven textile fabrics; plastic material [substitute for fabrics]; textile material; tablemats of textile; bivouac sacks being covers for sleeping bags; blankets for household pets; picnic blankets; travelling rugs [lap robes]; coasters of textile; curtain holders of textile material; furniture coverings of plastic; hemp cloth; gummed cloth, other than for stationery purposes; cloth; mosquito nets; oilcloth for use as tablecloths; tablecloths, not of paper; lingerie fabric; fabric, impervious to gases, for aeronautical balloons; jute fabric; fabric for footwear; ramie fabric; esparto fabric; rayon fabric; fibreglass fabrics for textile use; adhesive fabric for application by heat; linen cloth; upholstery fabrics; hemp fabric; lining fabric for footwear; reusable wax coated fabrics for wrapping food; printed calico cloth; knitted fabric; cotton fabrics; woollen cloth; elastic woven fabrics; fabric; fabric

imitating animal skins; haircloth [sackcloth]; cheese cloth; flags of textile or plastic; trellis [cloth]; covers for cushions; fitted toilet lid covers of fabric; covers [loose] for furniture; pillow shams; labels of textile.

25 – Underwear; sweat-absorbent underwear; trousers; brassieres; adhesive bras; collars [clothing]; detachable collars; shirt yokes; waistcoats; hosiery; pockets for clothing; cap peaks; visors being headwear; tights; combinations [clothing]; suits; headscarves; jackets [clothing]; leggings [trousers]; camisoles; sports singlets; cuffs; face coverings [clothing], not for medical or sanitary purposes; heel protectors for shoes; ear muffs [clothing]; sweat-absorbent socks; footwear; paper clothing; outerclothing; ready-made clothing; latex clothing; waterproof clothing; clothing incorporating LEDs; uniforms; clothing; clothing containing slimming substances; overcoats; gloves [clothing]; headscarfs; scarfs; dresses; headbands [clothing]; ready-made linings [parts of clothing]; dress shields; soles for footwear; belts [clothing]; money belts [clothing]; non-slipping devices for footwear; shirts; wooden shoes; sandals; bath sandals; boots; inner soles; bath slippers; knitwear [clothing]; underpants; slippers; shoes; headwear; aprons [clothing]; tee-shirts; rash guards; dressing gowns; tips for footwear; stockings; sweat-absorbent stockings; paper hats [clothing]; shower caps; bathing caps.

(260) AM 2023 121184 A

(800) 1707353

(151) 2022 10 18

(891) 2022 10 18

(731) Dorsa Sabke Zendegie Beinolmelal
Unit 1, Floor 2, No. 1489, Shariati Avenue,
Tehran, Islamic Republic of Iran

(540)



DORSA

(591) Black, white

(531) 26.04.02; 26.04.12; 26.11.13; 26.11.25;
27.05.01; 28.19

(511)

3 – Perfumes; waxes for leather; shoe wax.

6 – Figurines [statuettes] of common metal.

9 – Glasses; computer bags; bags adapted for tablet computers; cases for cell phones; covers for cell phones; cases for eyeglasses.

11 – Chandeliers; lamp shades; gas lighters.

12 – Upholstery for vehicles; seat covers for vehicles.

14 – Jewellery; key rings [trinkets or fobs]; silver; gold; trinkets [jewellery].

16 – Writing instruments; postcards; pictures; gift boxes; paintings [pictures], framed or unframed.

18 – Sports bags; umbrellas; leather; shoulder belts of leather; leather bags; imitation leather; travel baggage; saddles for horses; bags.

20 – Curtain holders, not of textile material; dressing tables; chairs [seats]; statues of wood, wax, plaster or plastic; office furniture; mirrors [looking glasses]; furniture; mirrors; mirror frames; tables; desks; dressers; beds; flower-pot pedestals; photograph frames; commodes [chests of drawers]; showcases.

21 – Shoe trees [stretchers]; brooms; flower pots; spice sets; statues of porcelain, terra-cotta or glass; crystal [glassware]; earthenware; containers for household or kitchen use; brushes; tea sets; dishes, not of precious metal; towel rings; toilet bags, fitted; jars; candlesticks; baskets for household purposes; glass; pots.

24 – Towels of textile; curtains of textile or plastic; net curtains; fabric table runners.

25 – Scarfs; neckties; bandanas [neckerchiefs]; socks; slippers; corsets [underclothing]; hats; baby clothes; shawls; belts [clothing]; wedding dresses; shoes; fittings of metal for footwear; cuffs; clothing; leather clothing; sports clothing.

26 – Slide fasteners [zippers]; artificial flowers; buttons; hair slides.

27 – Carpets; carpet underlay; wallpaper; floor coverings; door mats; carpet runners.

28 – Sports equipment; billiard tables; toys; golf gloves; dolls; golf bags, with or without wheels.

42 – Interior design; industrial design; clothes design.

43 – Cafe and cafeteria services.

(260) AM 2023 121199 A

(800) 1707695

(151) 2022 08 11

(891) 2022 08 11

(731) OFFICINA PROFUMO FARMACEUTICA DI SANTA MARIA NOVELLA S.P.A.
VIA DELLA SCALA, 16, I-50123 FIRENZE,
Italy

(540)



(591) Black, white

(531) 01.01.01; 24.01.18; 24.01.25; 24.09.02;
24.09.05; 27.01.06

(511)

3 – Toiletry preparations; perfumery and fragrances; eau de Cologne; bath oil for cosmetic use; non-medicated massage oils; extracts of perfumes; extracts of flowers [perfumes]; perfumery; cosmetic preparations for the care of mouth and teeth; body and beauty care cosmetics; hair care preparations; make-up; bath soaps in liquid, solid or gel form; shower gels; after-shave gel; pre-shave gels; bath and shower preparations; body deodorants [perfumery]; skin care preparations; shaving preparations; cosmetics for animals; deodorants for animals; cleaning preparations; fragrance for household use; incense; potpourris [fragrances]; laundry preparations; cleaning preparations for leather; shoe creams and polishes.

4 – Wicks for candles for lighting; perfumed candles; candles for lighting.

5 – Pharmaceuticals and natural remedies; hygienic preparations for medical use; dietetic food supplements; dietary and nutritional supplements; air deodorizers; air purifying preparations; disinfectants and antiseptics; pharmaceutical preparations.

16 – Paintings; drawings; craft paper; carrier bags of paper or plastic; paper shopping bags; wrapping paper; gift wrap paper; paper gift tags; paper bows for gift wrapping; packaging materials of cardboard; packaging materials of paper; plastic materials for packaging; paper gift wrapping ribbons; gift bags of paper; paper bags; boxes of paper or cardboard; gift boxes; cardboard gift boxes; photographic albums; stationery writing paper and envelopes; paper stationery; writing tablets; envelopes; stationery; printed calendars; writing paper; letterhead paper; tickets; calendars; catalogues; printed price lists; journals [publications]; printed publications; printed advertising boards of paper or cardboard; paper gift tags.

18 – Vanity cases, not fitted; bags.

21 – Glassware, porcelain and earthenware articles; works of art of porcelain, terracotta or glass; ceramic tableware; cookware; household containers; cups; table plates; saucers; cosmetic utensils; perfume bottles; fitted toilet bags; cosmetic brushes; shaving brushes; combs; soap containers; hair brushes; sponges; vaporizers for perfume sold empty; soap boxes.

24 – Bath towels; face towels of textile; linen.

30 – Baked goods; chocolate; candy bars; sweets [candy]; chewing gum; tea, cocoa and substitutes therefor; infusions, not medicinal; sugar; natural sweeteners; sweet fillings; excluding ready meals.

33 – Alcoholic beverages, except beer.

35 – On-line retail store services for perfumery, candles, pharmaceutical, veterinary and sanitary preparations, razors, boxes of precious metals, jewellery, stationery, vanity cases, bags, mirrors; on-line wholesale store services for perfumery, candles, pharmaceutical,

veterinary and sanitary preparations, razors, boxes of precious metals, jewellery, stationery, vanity cases, bags, mirrors; retail and wholesale store services for perfumery, candles, pharmaceutical, veterinary and sanitary preparations, razors, boxes of precious metals, jewellery, stationery, vanity cases, bags, mirrors; on-line retail store services for tableware, other than knives, forks and spoons; on-line wholesale store services for tableware, other than knives, forks and spoons; retail and wholesale store services for tableware, other than knives, forks and spoons; on-line retail store services for linen, clothing, bath robes, headwear; on-line wholesale store services for table linen, clothing, bath robes, headwear; retail and wholesale store services for linen, clothing, bath robes, headwear; on-line retail store services for Christmas tree decorations; on-line wholesale store services for Christmas tree decorations; retail and wholesale store services for Christmas tree decorations; on-line retail store services for foodstuffs limited to jellies, jams, compotes, fruits and vegetable spreads, virgin olive oil, processed fruits, mushrooms and vegetables (including nuts and pulses), baked goods, chocolate, sweets (candy), candy bars and chewing gum, teas and cocoa and substitutes therefor, infusions, not medicinal, sugars, natural sweeteners, sweet coating and fillings; on-line wholesale store services for foodstuffs limited to jellies, jams, compotes, fruits and vegetable spreads, virgin olive oil, processed fruits, mushrooms and vegetables (including nuts and pulses), baked goods, chocolate, sweets (candy), candy bars and chewing gum, teas and cocoa and substitutes therefor, infusions, not medicinal, sugars, natural sweeteners, sweet coating and fillings; retail and wholesale store services for foodstuffs limited to jellies, jams, compotes, fruits and vegetable spreads, virgin olive oil, processed fruits, mushrooms and vegetables (including nuts and pulses), baked goods, chocolate, sweets (candy), candy bars and chewing gum, teas and cocoa and substitutes therefor, infusions, not medicinal, sugars, natural sweeteners, sweet coating and fillings; on-line retail store services for alcoholic and non-alcoholic beverages; on-line wholesale store services for alcoholic and non-alcoholic beverages; retail and wholesale store services for alcoholic and non-alcoholic beverages.

(260) AM 2023 121205 A

(800) 1218472

(151) 2014 07 21

(891) 2022 12 22

(731) HUILERIE VIGEAN

Les Varennes, F-36700 CLION-SUR-INDRE,
France

(540)

HUILERIE VIGEAN

(591) Black, white

(511)

29 – Meat, fish, poultry and game; meat extracts; preserved, frozen, dried and cooked fruits and vegetables; jellies, jams, compotes; eggs, milk and dairy products; edible oils and fats; fats for food; butter; charcuterie; salted meats; crustaceans (not live); canned meat or fish; cheeses; milk beverages, milk predominating.

30 – Coffee, tea, cocoa, sugar, rice, tapioca, sago, artificial coffee; flour and preparations made from cereals, bread, pastry and confectionery products, edible ices; honey, treacle; yeast, baking powder; salt, mustard; vinegar, mayonnaise, salad dressings; spices; ice for refreshment; sandwiches, pizzas; pancakes; cookies; cakes; rusks; sugar confectionery; chocolate; beverages based on cocoa, coffee, chocolate or tea.

(260) AM 2023 121252 A

(800) 1707852

(151) 2022 11 15

(891) 2022 11 15

(731) Richter Gedeon Nyrt.

Gyömrői út 19-21., H-1103 Budapest, Hungary

(540)

ВОДАРЕЛОН

(591) Black, white

(531) 28.05

(511)

5 – Pharmaceutical preparations.

(260) AM 2023 121253 A

(800) 1707883

(151) 2022 11 10

(891) 2022 11 10

(731) Honor Device Co., Ltd.

Suite 3401, Unit A, Building 6, Shum Yip
Sky Park, No. 8089, Hongli West Road,
Xiangmihu Street, Futian District, Shenzhen,
518040 Guangdong, China

(540)

HONOR Lens

(591) Black, white

(511)

9 – Personal digital assistants [PDAs]; interactive touch screen terminals; laptop computers; downloadable image files; computer software applications, downloadable; downloadable music files; programmable controllers; computer programs for processing digital music files; computer screen saver software, recorded or downloadable; computer software platforms, recorded or downloadable; tablet computers; smartwatches; smartglasses; application software for mobile phones; notebook computers; computers; computer peripheral devices; computer software for use in computer access control; computer software, recorded; computer keyboards; computer software for controlling the ope-

ration of audio and video devices; hand-held electronic dictionaries; compiler software; software for processing images, graphics and text; downloadable computer application software for cell phones; face recognition equipment; electronic agendas; weighing apparatus and instruments; measures; cell phones; smartphones; telephone apparatus; mobile telephone covers; hands-free kits for telephones; mobile telephones; switching apparatus for program-controlled telephones; wearable activity trackers; network communication devices; headphones; sound recording apparatus; sound recording carriers; cameras for cellular phones; wireless headsets for use with cellular phones; earphones; wireless earphones; virtual reality glasses; audio- and video-receivers; microphones; cameras [photography]; distance measuring apparatus; connected bracelets [measuring instruments]; distance recording apparatus; teaching robots; optical apparatus and instruments; optical lenses; video screens; computer chips; integrated circuits; sensors; batteries, electric; battery chargers; mobile power supply [rechargeable batteries]; computer software for processing digital images; computer software for watching, storing, organizing and playing audio and video contents; software for development of computer applications; protective films adapted for mobile telephone screens.

(260) AM 2023 121254 A

(800) 1707884

(151) 2022 11 10

(891) 2022 11 10

(731) Honor Device Co., Ltd.

Suite 3401, Unit A, Building 6, Shum Yip
Sky Park, No. 8089, Hongli West Road,
Xiangmihu Street, Futian District, Shenzhen,
518040 Guangdong, China

(540)

Magic Text

(591) Black, white

(511)

9 – Personal digital assistants [PDAs]; interactive touch screen terminals; laptop computers; downloadable image files; computer software applications, downloadable; downloadable music files; programmable controllers; computer programs for processing digital music files; computer screen saver software, recorded or downloadable; computer software platforms, recorded or downloadable; tablet computers; smartwatches; smartglasses; application software for mobile phones; notebook computers; computers; computer peripheral devices; computer software for use in computer access control; computer software, recorded; computer keyboards; computer software for controlling the operation of audio and video devices; hand-held electronic dictionaries; compiler software; software for processing images, graphics and text; downloadable computer application software for cell phones; face recognition equipment; electronic agendas; weighing ap-

paratus and instruments; measures; cell phones; smartphones; telephone apparatus; mobile telephone covers; hands-free kits for telephones; mobile telephones; switching apparatus for program-controlled telephones; wearable activity trackers; network communication devices; headphones; sound recording apparatus; sound recording carriers; cameras for cellular phones; wireless headsets for use with cellular phones; earphones; wireless earphones; virtual reality glasses; audio- and video-receivers; microphones; cameras [photography]; distance measuring apparatus; connected bracelets [measuring instruments]; distance recording apparatus; teaching robots; optical apparatus and instruments; optical lenses; video screens; computer chips; integrated circuits; sensors; batteries, electric; battery chargers; mobile power supply [rechargeable batteries]; computer software for processing digital images; computer software for watching, storing, organizing and playing audio and video contents; software for development of computer applications; protective films adapted for mobile telephone screens.

(260) AM 2023 121255 A

(800) 1707888

(151) 2022 12 06

(891) 2022 12 06

(731) TCL Technology Group Corporation

TCL Technology Building, 17 Huifeng

3rd Road, Zhongkai High Technology

Development District, Huizhou, 516000

Guangdong, China

(540)

INSPIRE GREATNESS

(591) Black, white

(531) 27.05.01

(511)

7 – Vacuum cleaners; washing machines [laundry]; blenders, electric, for household purposes; dishwashers; wringing machines for laundry; dry-cleaning machines; food preparation machines, electromechanical; juice extractors, electric; ironing machines; machines and apparatus for cleaning, electric.

9 – Television apparatus; soundbars; loudspeakers; mobile telephones; tablet computers; wireless headphones; digital door locks; smartglasses (data processing apparatus); smartphone software applications, downloadable; computer software applications, downloadable; encoded identification bracelets, magnetic; light emitting diode (LED) displays; video display screens; remote control apparatus; video projectors.

11 – Air-conditioning installations; refrigerators; air purifying apparatus and machines; microwave ovens [cooking apparatus]; air fryers; humidifiers for household purposes; fans [air-conditioning]; laundry drying machines; dehumidifiers for household purposes; electric fans for personal use; cooking utensils, electric;

kettles, electric; air humidifying apparatus; electric hair dryers; heating apparatus.

(260) AM 2023 121256 A
 (800) 1707891
 (151) 2022 12 05
 (891) 2022 12 05
 (731) Henan Shuanghui Investment & Development Co., Ltd.
 No. 288, Mudanjiang Road, Luohe City,
 Henan Province, China
 (540)



(591) Red; yellow; black; brown
 (531) 03.01.01; 03.01.24; 29.01.14
 (511)
 29 – Charcuterie; ham; sausages; meat, canned; quick-frozen instant dishes consisting primarily of fish, meat, fruits, vegetables or dairy products; oils for food; tofu products; fish sausages; prepared dishes consisting principally of meat; cooked meat products.

30 – Coffee-based beverages; pastries; relish for use as a condiment; rice-based prepackaged lunch with meat, fish or vegetables; instant rice; boxed lunches consisting primarily of noodles or rice and also containing fish, meat, fruits, vegetables or dairy products; cereal preparations; noodle-based prepared meals; seasonings; condiments.

(260) AM 2023 121257 A
 (800) 1707912
 (151) 2022 11 11
 (891) 2022 11 11
 (731) URSUS BRANDS S.R.L.
 76, CORSO MASSIMO D'AZEGLIO, I-10126
 TORINO (TO), Italy
 (540)

THE STANDARD 1894

(591) Black, white
 (511)
 33 – Vodka.

(260) AM 2023 121258 A
 (800) 1707914
 (151) 2022 12 01
 (891) 2022 12 01
 (731) Apple Inc.
 One Apple Park Way, Cupertino CA 95014,
 USA

(540)



(591) Black, white
 (531) 27.05.21
 (511)
 9 – Downloadable application development software; downloadable computer software for use as an application programming interface (API) for building software applications; downloadable software for processing, transmitting and displaying text, data, images, audio, audio visual content, and other multimedia content.

(260) AM 2023 121259 A
 (800) 1707916
 (151) 2022 12 02
 (891) 2022 12 02
 (731) Moschino S.p.A.
 Via delle Querce 51, I-47842 San Giovanni
 in Marignano (RN), Italy
 (540)

**MOSCHINO
 JEANS**

(591) Black, white
 (531) 27.05.01; 27.07.01
 (511)
 3 – Perfumes; cosmetics; antiperspirants [toilettries]; cosmetics.

9 – Sunglasses; prescription eyeglasses; spectacle frames, spectacle lenses; covers for glasses; cyclist's and motor cyclist's helmets; usb flash drives; usb adapters; usb chargers; cell phone covers; bags adapted for laptops; cases, for use in relation to the following goods: mini computers and tablet computers.

18 – Bags; handbags; clutches [purses]; pocket wallets; purses; suitcases; rucksacks.

25 – Articles of clothing for men, women and children; waist belts; footwear; boots.

(260) AM 2023 121260 A
 (800) 1707922
 (151) 2022 11 11
 (891) 2022 11 11
 (731) Mikhail Aleksandrovich Shipulin
 Slepneva str., building 4/2, app. 33, Gatchina,
 RU-188309 Leningrad oblast, Russian
 Federation

(540)

SCANDIC

(591) Black, white

(531) 27.05.02

(511)

30 – Caramels [candies]; candies; liquorice [confectionery]; peppermint sweets; mints for breath freshening; hard candy; stick liquorice [confectionery]; pastilles [confectionery]; fondants [confectionery]; chewing gum for breath freshening; chewing gum.

(260) AM 2023 121261 A

(800) 1707978

(151) 2022 11 09

(891) 2022 11 09

(731) HYUNDAI MOTOR COMPANY

12, Heolleung-ro, Seocho-gu, Seoul 06797,

Republic of Korea

(540)

 **HYUNDAI**

(591) Blue

(531) 26.01.18; 27.05.01; 29.01.04

(511)

36 – Financing relating to automobiles; automobile lease financing; financial guarantee services for the reimbursement of expenses incurred as a result of vehicle breakdown; financial guarantee services for the reimbursement of expenses incurred as a result of vehicle accident; hire purchase financing services; credit and debit card services; factoring; processing of credit card payments; agencies for rent collection of parking; agencies for charge of parking; financial services for the management of prepaid credit cards with membership card function; providing information relating to financial and monetary affairs; automobile insurance services; consultancy and brokerage services relating to vehicle insurance; automobile insurance information; motor vehicle insurance brokerage; virtual money brokerage; on-line financial transactions; financial brokerage services relating to blockchain-based non-fungible tokens (NFTs); financial customs brokerage services; automobile appraisal; appraisal of used automobiles; providing information relating to the appraisal of used automobiles; collection of monetary donations for charitable purposes; providing information relating to automobile appraisal; issuance of membership credit card; providing rebates at participating establishments of others through use of a membership card; vehicle insurance information; processing of payment transactions via the Internet; e-wallet payment services; electronic processing of payments; processing of payment transactions for electronic money; financial brokerage services relating to intellectual property rights; electronic payment for others.

(260) AM 2023 121262 A

(800) 1708063

(151) 2022 08 25

(891) 2022 08 25

(731) "EASYBOOKING" mas'uliyati cheklangan

Jamiyat

156, A.Temur ko'chasi, Samarqand shahri,

Samarqand viloyati, Uzbekistan

(540)



(591) Blue and white

(531) 01.15.23; 18.05.01; 18.05.03; 26.11.21;

27.05.10; 29.01.12

(526) EASYBOOKING, FLIGHT, HOTELS, TRANSFERS.

(511)

39 – Transport; travel arrangement.

(260) AM 2023 121263 A

(800) 1708083

(151) 2022 10 06

(891) 2022 10 06

(731) Euro Games Technology Ltd.

4, "Maritsa" Str., "Vranya-Lozen-Triugulnika",

BG-1151 Sofia, Bulgaria

(540)

Sea Wolf Riches

(591) Black, white

(511)

9 – Operating computer software for main frame computers; monitors (computer hardware); computer hardware; apparatus for recording images; monitors (computer programs); computer game programs; recorded computer game programs; apparatus for recording, transmission or reproduction of sound or images; communications servers (computer hardware); electronic components for gambling machines; computer application software featuring games and gaming; computer software for the administration of on-line games and gaming; computer hardware for games and gaming; hardware and software for gambling, gambling machines, gambling games on the Internet and via telecommunication network; computer systems; computer operating system software; computer terminals; interactive terminals; multimedia terminals; electronic terminals for generating lottery tickets; interactive touch screen terminals; computer touchscreens; electronic display panels; liquid crystal display screens; digital signage display panels; multimedia software; multimedia apparatus and instruments; interactive multimedia software for playing games; computer screens; LCD large-screen displays; liquid crystal displays [LCDs] for home theatres; media streaming software; computer application software for

streaming audio-visual media content via the Internet; software; computer gaming software; computer software packages; computer operating system software; computer software, recorded; software drivers; virtual reality software; games software; entertainment software for computer games; computer programs for network management; electronic lottery tickets; computer software platforms; operating systems; interactive computer systems; operating system programs; computer game software for use with on-line interactive games; games software for use with video game consoles.

28 – Gaming machines for gambling; chips for gambling; mah-jong; arcade games; gambling machines operating with coins, notes and cards; games; electronic games; parlor games; gaming chips; gaming tables; slot machines [gaming machines]; LCD game machines; slot machines and gaming devices; coin-operated amusement machines; roulette chips; poker chips; chips and dice [gaming equipment]; gaming equipment for casinos; roulette tables; gaming roulette wheels; casino games; gambling machines and amusement machines, automatic and coin-operated; coin-operated amusement machines and/or electronic coin-operated amusement machines with or without the possibility of gain; boxes for coin-operated amusement machines, slot machines and gaming machines; electronic or electrotechnical amusement machines and apparatus, gaming machines, coin-operated entertainment machines; housings for coin-operated amusement machines, gaming equipment, gaming machines, machines for gambling; electropneumatic and electrical gambling machines (slot machines); lottery games; electronic targets for games and sports; video game consoles.

41 – Gambling services; entertainment services related to gambling; gaming services for entertainment purposes; casino, gaming and gambling services; training in the development of software systems; provision of gaming equipment for gambling halls; providing casino equipment [gambling]; gaming machine entertainment services; providing casino facilities [gambling]; gaming hall services; games equipment rental; rental of gaming machines; providing amusement arcade services; rental of gaming machines with images of fruits; editing or recording of sounds and images; sound recording and video entertainment services; hire of sound reproducing apparatus; provision of gaming equipment for casinos; providing of gambling facilities; online gambling services; casino services; provision of gaming facilities and gaming hall facilities, Internet casinos and online gambling services; lottery services; organization of lotteries; provision of games by means of a computer based system; online interactive entertainment; on-line casino services; online game services through mobile devices; providing online entertainment in the nature of game tournaments; providing on-line information in the fi-

eld of computer gaming entertainment; sports betting services; online sports betting services; providing on-line games and games of chance; rental of video game consoles.

(260) AM 2023 121276 A

(800) 1708357

(151) 2022 09 01

(891) 2022 09 01

(731) NIPPON PAINT HOLDINGS SG PTE. LTD.
16 RAFFLES QUAY, #17-03 HONG LEONG
BUILDING, SINGAPORE 048581, Singapore

(540)



(591) Blue, red, white

(531) 26.04.04; 26.04.05; 26.04.18; 26.04.24;
27.05.02; 27.05.09; 27.05.17; 29.01.13

(511)

35 – Advertising; business management; business administration; office functions; administration of the business affairs of franchises; organising of business competitions; organising of trade competitions; arranging exhibitions for advertising purposes; arranging exhibitions for business purposes; arranging exhibitions for commercial purposes; arranging exhibitions for trade purposes; conducting exhibitions for advertising purposes; conducting exhibitions for business purposes; conducting exhibitions for commercial purposes; conducting exhibitions for trade purposes; event management services [organisation of exhibitions or trade fairs for commercial or advertising purposes]; arranging business shows; business auditing; business consultancy; online retail services; online retail store services; online wholesale services; online wholesale store services; presentation of goods on communication media, for retail purposes; retail services; retail store services; retail services for goods [by any means]; sales promotion services; online advertising on a computer network; presentation of goods on communication media, for retail purposes; television advertising; production of teleshopping programs; shop window dressing; production of advertising films; recruitment advertising; outdoor advertising; press advertising services; provision of an online marketplace for buyers and sellers of goods and services; import-export agency services; promotion of goods through influencers; influencer marketing; marketing.

(260) AM 2023 121277 A

(800) 1708360

(151) 2022 10 27

(891) 2022 10 27

(731) CASALASCO SOCIETA' AGRICOLA S.p.A.
Strada Provinciale 32, I-26036 RIVAROLO
DEL RE ED UNITI (CR), Italy

(540)

Pomi

(591) Black, white

(531) 27.05.17

(511)

29 – Peeled tomato; tomato preserves; canned tomatoes; crushed and strained tomatoes; tomato pulp; tomato paste; tomato puree and concentrates; tomato cubes; fillets and chunks of tomato; tomato extracts; processed tomatoes; condensed tomato; tomato juice for cooking; canned vegetables; vegetables based soups; cooked and preserved vegetables; jellies; marmalades; compotes.

30 – Sauces; tomato sauces; tomato-based sauces; sauces (condiments); pizza sauces; pasta sauces; tomato sauces; sauces with garlic, basil, cheese; tomato sauces with garlic; ketchup sauce; vegetable based seasonings; vegetable sauces; sauces for pasta and rice; pesto; red pesto sauce for pasta; food dressing (sauces); vegetable and legume-based seasonings.

32 – Tomato juice (beverages); fruit juices; vegetable juices; non-alcoholic drinks; fruit based beverages; fruit nectars, non-alcoholic; vegetable based beverages; syrups and other preparations for making beverages, also based on fruit or vegetables.

(260) AM 2023 121278 A

(800) 1708406

(151) 2022 12 14

(891) 2022 12 14

(731) Apple Inc.

One Apple Park Way, Cupertino CA 95015,
USA

(540)

PHOTONIC ENGINE

(591) Black, white

(511)

9 – Computer hardware sold as a component feature of a digital camera system incorporated in smartphones and handheld mobile electronic devices; preinstalled computer software for capturing, processing, and enhancing images and photos sold as a component feature of preinstalled digital camera software on smartphones and handheld mobile electronic devices.

(260) AM 2023 121279 A

(800) 1708415

(151) 2022 12 20

(891) 2022 12 20

(731) Apple Inc.

One Apple Park Way, Cupertino CA 95014,
USA

(540)

CLOUDKIT

(591) Black, white

(511)

42 – Electronic data storage services.

(260) AM 2023 121280 A

(800) 1708461

(151) 2022 10 21

(891) 2022 10 21

(731) VISMEDERI HOLDING S.R.L.

UNIPERSONALE

VIA FRANCO FERRINI, 53 -, LOC.

TOGNAZZA – SAN MARTINO, I-53035

MONTERIGGIONI (SI), Italy

(540)

VISMEDERI

(591) Black, white

(531) 27.05.01

(511)

42 – Conducting clinical trials for pharmaceuticals; laboratory research; laboratory testing; biological laboratory services; chemical and biological laboratory services; laboratory research in the field of bacteriology; laboratory research in the field of pharmaceuticals; medical research; medical and pharmacological research services; medical research laboratory services; scientific research for medical purposes; scientific and medical research and development; design and development of medical technology; pharmaceutical research; research and development services relating to vaccines and medicines; research and development services relating to vaccines.

44 – Laboratory analysis services relating to the treatment of persons; medical laboratory services for the analysis of samples taken from patients; medical testing; medical consultations; medical screening; pharmaceutical consultancy.

(260) AM 2023 121281 A

(800) 1708462

(151) 2022 11 15

(891) 2022 11 15

(731) ŚNIEŻKA TRADE OF COLOURS, SP.

Z O. O.

Ul. Chłodna 51, PL-00-867 Warszawa, Poland

(540)



(591) White, orange and burgundy

(531) 02.09.01; 24.17.25; 27.05.01; 27.05.09;
27.05.19; 27.05.24; 29.01.13

(511)

2 – Anti-corrosion preparations; lacquers; enamels for painting; wood preservatives; paints; bactericidal paints; ceramic paints; fireproof paints; watercolor paints; anti-fouling paints; coatings [paints]; thickeners for coatings; paint thickeners; thickeners for dyes; paint thinners; thinners for lacquers; protective preparations for metals; foils of metal for decorators; dyes; shoe dyes; metals in powder form for use in painting, decorating, printing and art; mordants; dyes for wood; anti-rust oils; anti-rust greases; fixatives [varnishes].

(260) AM 2023 121283 A

(800) 1708540

(151) 2022 07 14

(891) 2022 07 14

(731) Meito Sangyo Co., Ltd.

41, Sasazuka-cho 2-chome, Nishi-ku, Nagoya-shi, Aichi 451-8520, Japan

(540)



(591) Black, white

(531) 27.05.19; 27.05.22

(511)

1 – Enzymes for the food industry; enzymes for industrial purposes; ferments for chemical purposes; chemical additives for use in the manufacture of food; dextran; higher fatty acids; artificial sweeteners [chemical preparations]; flour for industrial purposes; fertilizers; unprocessed plastics in primary form.

29 – Rennet; edible oils and fats; milk products; processed fish products for human consumption; pre-cooked curry stew, stew and soup mixes; soy beans-based protein foodstuffs for human consumption.

30 – Yeast; leaven; ferments for pastes; baking powder; yeast extracts for human consumption; tea-based beverages; instant tea; coffee; cocoa; chocolate-based beverages; flavorings, other than essential oils, for beverages; flavorings, other than essential oils, for cakes; condiments; seasonings; ice [frozen water]; binding agents for ice cream; preparations for stiffening whipped cream; meat tenderizers for household purposes; instant confectionery mixes; sherbet mixes; ice cream mixes; instant pudding mixes; flavored jelly crystals for making jelly confectionery; confectionery; cakes; confectionery ices; ice cream; sherbet [confectionery]; custard; chocolate; sugar confectionery; chocolate syrups; high-protein cereal bars and cereal products; bread; boxed lunches consisting of rice, with added meat, fish or vegetables; cake powder; flour

and preparations made from cereals; sugar; honey; treacle.

(260) AM 2023 121291 A

(800) 1477689

(151) 2019 05 07

(891) 2022 12 30

(731) KALESERAMİK ÇANAKKALE

KALEBODUR, SERAMİK SANAYİ ANONİM ŞİRKETİ

LEVENT MAH. PROF. AHMET KEMAL

ARU, SK. KALE HOLDING 4 1, Beşiktaş, İstanbul, Türkiye

(540)

Kalesinterflex®

(591) Black, white

(531) 27.05.01

(511)

19 – Materials, not of metal, for building and construction; rigid pipes, not of metal, for building; asphalt, pitch, tar and bitumen; transportable buildings, not of metal; monuments, not of metal.

20 – Furniture, mirrors, picture frames; containers, not of metal, for storage or transport; unworked or semi-worked bone, horn, whalebone or mother-of-pearl; shells; meerscham; yellow amber.

(260) AM 2023 121294 A

(800) 1566943A

(151) 2020 07 29

(891) 2022 10 26

(731) Salesforce, Inc.

Salesforce Tower, 415 Mission Street, 3rd Floor, San Francisco CA 94105, USA

(540)



(591) Black, white

(531) 01.15.15; 24.17.03; 25.03.03

(511)

9 – Downloadable mobile application featuring software for use in group communication, namely, postings, memoranda and instant messaging, file sharing, calendar synchronization, and automated integrations with external service providers; downloadable computer software for sending messages via the Internet and for audio and video chat and conferencing; downloadable computer software for uploading, downloading, sharing and archiving images, messages, audio, video,

data and text content and files, for creating customized personal profiles and for providing search engines for use in group communication and collaboration platforms for businesses; downloadable computer software for integrating third party software applications; downloadable e-books, handbooks, and reports in the field of group communication, group collaboration, business communications and networking, and business application development; downloadable application programming interface (API) software for developing and customizing business computer software applications; downloadable computer software for data analytics for use in the field of group communication and collaboration for businesses; downloadable application with a searchable database featuring employee, office, team, organization, and project profiles and information; downloadable computer search engine software.

41 – Arranging and conducting business conferences in the field of group communication and collaboration for businesses and in the field of business application development; arranging and conducting educational conferences in the fields of group communication and collaboration and in the field of business application development; conducting seminars, workshops, and computer application training in the fields of group communication and collaboration for businesses and in the field of business application development; online publication of journals or diaries [blog services] and non-downloadable publications in the form of articles in the field of communication, collaboration, business communications and networking, and business application development, via a website.

42 – Platform as a service (PAAS) featuring computer software platforms for use in group communication, namely, postings, memoranda and instant messaging, file sharing, calendar synchronization, and automated integrations with external service providers; computer services, namely, creating virtual communities to organize groups, participate in discussions, get feedback from their peers, and engage in social networking and business collaboration and communication; file sharing services, namely, providing online facilities for others featuring technology enabling users to upload and download electronic files; Software as a service (SAAS) featuring software for uploading, downloading, sharing and archiving images, messages, audio, video, data and text content and files, for creating customized personal profiles, and for providing search engines for use in group communication and collaboration platforms for businesses; Software as a service (SAAS) featuring software for integrating third party software applications; Software as a service (SAAS) featuring application programming interface (API) software for developing and customizing business computer software applications; computer technical support services, namely, help desk services and

troubleshooting computer software and computer hardware technology problems; computer technology consultancy in the field of group communication and collaboration for businesses and in the field of business software application development; Software as a service (SAAS) featuring software for data analytics in the field of group communication and collaboration for businesses; Software as a service (SaaS) services featuring non-downloadable software for database management in the field of employee, office, team, organization, and project profiles and information; Software as a Service (SaaS) featuring online non-downloadable computer search engine software; Software as a service (SAAS) services featuring software for information sharing; design, development, implementation, customization, and configuration of computer software for others; data services, namely, migrating data and applications from one platform to another; data services in the nature of hosting of software as a service (SAAS), namely, providing software for use by others for automated integrations with external service providers and data sources.

(260) AM 2023 121353 A

(800) 1708604

(151) 2022 11 28

(891) 2022 11 28

(731) TURKTIPSAN SAĞLIK TURİZM EĞİTİM VE TİCARET A.Ş.
BÜĞDÜZ MAH., KAYMAKAM A.GALİP
KAYA CAD., TÜRK TIPSAN 28, Akyurt,
Ankara, Türkiye

(540)



(591) Blue, violet, white

(531) 01.15.15; 27.05.10; 29.01.04

(511)

5 – Pharmaceutical and veterinary preparations for medical purposes; chemical preparations for medical and veterinary purposes, chemical reagents for pharmaceutical and veterinary purposes; medicated cosmetics.

(260) AM 2023 121354 A

(800) 1708610

(151) 2022 12 15

(891) 2022 12 15

(731) Incyte Holdings Corporation
1801 Augustine Cut-Off, Wilmington
DE 19803, USA

(540)

WUNVI

(591) Black, white

(511)

5 – Pharmaceutical preparations for the treatment of cancer; pharmaceutical preparations for the treatment of immunological disorders; pharmaceutical preparations for the treatment of hematological disorders; pharmaceutical preparations for the treatment of hypophosphatemia disorders; pharmaceutical preparations for the treatment of myeloproliferative disorders; pharmaceutical preparations for the treatment of skeletal or chondrocyte disorders; pharmaceutical preparations for the treatment of dermatological disorders; pharmaceutical preparations for the treatment of graft versus host disorders.

44 – Providing healthcare information to physicians, patients and caregivers relating to diagnosis and treatment of medical diseases and disorders.

(260) AM 2023 121355 A

(800) 1708622

(151) 2022 09 01

(891) 2022 09 01

(731) TORRACCIA DEL PIANTAVIGNA S.R.L.

Via Romagnano 69/A, I-28074 GHEMME
(NO), Italy

(540)

Torraccia del Piantavigna

(591) Black, white

(511)

33 – Alcoholic beverages (except beer).

(260) AM 2023 121367 A

(800) 1709049

(151) 2022 12 19

(891) 2022 12 19

(731) Anke Dammert

Am Breilingsweg 3, 76709 Kronau, Germany

(540)

MUSWAY

(591) Black, white

(511)

9 – Electronic entertainment apparatus, namely apparatus for receiving, recording, transmission or reproduction of sound or images, including amplifiers, headphones, speakers, cabinets for loudspeakers and hi-fi systems; navigational equipment for vehicles, navigational instruments; multi-media apparatus; moniceivers, naviceivers; car radios; aerials, noise filters, buffer condensers, network, audio, video and multimedia cables, crossfade regulators, boosters, equalisers, the aforesaid goods being intended for motor vehicles; electric and electronic articles for motor vehicles, namely electric and electronic components; computers

and portable computers; monitors [computer hardware]; monitors [computer programs]; peripherals adapted for use with computers; recorded computer programs; computer programs [downloadable software]; recorded computer software; interfaces for computers.

(260) AM 2023 121368 A

(800) 1709062

(151) 2022 10 04

(891) 2022 10 04

(731) ALTONA COSMETICS TECHNOLOGY
SANAYİ VE TİCARET ANONİM ŞİRKETİ
KARAMEHMET MAH/SEMT AVRUPA,
SERBEST BÖLGESİ 13. SK. 8 1, ERGENE,
TEKİRDAĞ, Türkiye

(540)

Louis La Foret

(591) Black, white

(511)

3 – Non-medicated cosmetics and toiletry preparations; non-medicated dentifrices; perfumery, essential oils; soaps; hair lotions; bleaching preparations and other substances for laundry use; cleaning, polishing, scouring and abrasive preparations.

(260) AM 2023 121369 A

(800) 1709117

(151) 2022 08 26

(891) 2022 08 26

(731) SESA OTOMOTİV SANAYİ VE TİCARET
LİMİTED ŞİRKETİ
İvedik OSB Mahallesi, 1518. Sokak, No:16,
Yenimahalle, Ankara, Türkiye

(540)



(591) Dark yellow, white and black

(531) 26.04.02; 26.04.07; 26.04.22; 26.04.24;
27.05.10; 29.01.13

(511)

7 – Construction machines and robotic mechanisms (machines) for use in construction, bulldozers, excavators, loaders [earth moving machines], road construction and road paving machines, namely, drilling machines, rock drilling machines, road sweeping machines, vibrators [machines] for industrial use, concrete mixers [machines], machines and apparatus for polishing [electric], mechanical spreaders, snow plows, road rollers, snow ploughs, asphalt paving machines, stone cutting machines, high pressure washers, electric brooms; lifting, loading and transmission machines and robotic mechanisms (machines) for lifting, loading and transmission purposes: elevators, escalators, cranes, pressure valves [parts of machines],

pump control valves, pneumatic valve actuators, hydraulic controls for machines, motors and engines, pneumatic controls for machines, motors and engines, speed governors for machines, engines and motors, torque converters, other than for land vehicles, gears for machines, hydraulic oil filters, sealing joints [parts of engines], bearings (parts of machines), pressure reducers [parts of machines], flexible hoses for pneumatic or hydraulic machines [parts of machines], drums [parts of machines], roller bearings, ball-bearings; joints (parts of engines); hydraulic machines, bearings [parts of machines], grinding machines, rams [machines], cylinders for machines, rolling mill cylinders, hydraulic cylinders [parts of machines]; machines, machine tools and industrial robots for processing and shaping wood, metals, glass, plastics and minerals; engines and motors, other than for land vehicles, parts and fittings therefor, hydraulic and pneumatic controls for engines and motors, brakes other than for vehicles, brake linings for engines, crankshafts, transmission gears for machines, cylinders for engines, pistons for engines, turbines, not for land vehicles, filters for engines and motors, oil, air and fuel filters for land vehicle engines, exhausts for land vehicle engines, exhaust manifolds for land vehicle engines, engine cylinders for land vehicles, engine cylinder heads for land vehicles, pistons for land vehicle engines, carburetors for land vehicles, fuel conversion apparatus for land vehicle engines, injectors for land vehicle engines, fuel economisers for land vehicle engines, pumps for land vehicle engines, valves for land vehicle engines, starters for motors and engines, dynamos for land vehicle engines, sparking plugs for land vehicle engines; alternators, current generators, electric generators, current generators operated with solar energy; pumps other than parts of machines or engines, namely lubricating pumps, hydraulic pumps.

35 – The bringing together, for the benefit of others, of a variety of goods, namely, construction machines and robotic mechanisms (machines) for use in construction, bulldozers, excavators, loaders [earth moving machines], road construction and road paving machines, namely, drilling machines, rock drilling machines, road sweeping machines, vibrators [machines] for industrial use, concrete mixers [machines], machines and apparatus for polishing [electric], mechanical spreaders, snow plows, road rollers, snow ploughs, asphalt paving machines, stone cutting machines, high pressure washers, electric brooms, lifting, loading and transmission machines and robotic mechanisms (machines) for lifting, loading and transmission purposes, elevators, escalators, cranes, pressure valves [parts of machines], pump control valves, pneumatic valve actuators, hydraulic controls for machines, motors and engines, pneumatic controls for machines, motors and engines, speed governors for machines, engines and motors, torque converters, other than for land vehicles, gears for machines, hydraulic oil filters, sealing joints [parts of engines], bearings (parts of machines),

pressure reducers [parts of machines], flexible hoses for pneumatic or hydraulic machines [parts of machines], drums [parts of machines], roller bearings, ball-bearings, joints (parts of engines), hydraulic machines, bearings [parts of machines], grinding machines, rams [machines], cylinders for machines, rolling mill cylinders, hydraulic cylinders [parts of machines], machines, machine tools and industrial robots for processing and shaping wood, metals, glass, plastics and minerals, engines and motors, other than for land vehicles, parts and fittings therefor, hydraulic and pneumatic controls for engines and motors, brakes other than for vehicles, brake linings for engines, crankshafts, transmission gears for machines, cylinders for engines, pistons for engines, turbines, not for land vehicles, filters for engines and motors, oil, air and fuel filters for land vehicle engines, exhausts for land vehicle engines, exhaust manifolds for land vehicle engines, engine cylinders for land vehicles, engine cylinder heads for land vehicles, pistons for land vehicle engines, carburetors for land vehicles, fuel conversion apparatus for land vehicle engines, injectors for land vehicle engines, fuel economisers for land vehicle engines, pumps for land vehicle engines, valves for land vehicle engines, starters for motors and engines, dynamos for land vehicle engines, sparking plugs for land vehicle engines, alternators, current generators, electric generators, current generators operated with solar energy, pumps other than parts of machines or engines, namely lubricating pumps, hydraulic pumps, motor land vehicles and motors for land vehicles, vehicle bodies, tipping bodies for trucks, trailers [vehicles], trailers for tractors, frigorific bodies for land vehicles, trailer hitches for vehicles, garbage trucks, water vehicles, forklift trucks, go-karts [motorized vehicles], golf cars [vehicles], bicycles, motorcycles, off-road vehicles, vehicles for locomotion by water and their parts, other than their motors and engines, direction signals and arms for direction signals for vehicles, windscreen wipers and wiper arms for vehicles, inner and outer tires for vehicle wheels, tubeless tires, tire-fixing sets comprised of tire patches and tire valves for vehicles, windows for vehicles, safety windows for vehicles, rearview mirrors and wing mirrors for vehicles, luggage carriers for vehicles, bicycle and ski carriers for cars, saddles for bicycles or motorcycles, air pumps for vehicles, for inflating tires, anti-skid chains for vehicles, anti-theft alarms for vehicles, horns for vehicles, safety belts for vehicle seats, air bags (safety devices for automobiles), wheelbarrows, shopping carts, single or multi-wheeled wheelbarrows, shopping trolleys, grocery carts, handling carts, rail vehicles, locomotives, trains, trams, wagons, cable cars, chairlifts, excluding the transport thereof, enabling customers to conveniently view and purchase those goods, such services may be provided by retail stores, wholesale outlets, by means of electronic media or through mail order catalogues.

- (260) AM 2023 121370 A
 (800) 1709159
 (151) 2022 12 12
 (891) 2022 12 12
 (731) URSA Salgótarján Glass Wool Close Co., Ltd.
 Szépvölgyi út 41, 2/2, H-1037 Budapest,
 Hungary
 (540)



- (591) Blue and red
 (531) 03.01.14; 26.11.02; 26.11.08; 27.05.10;
 27.05.11; 27.05.17; 29.01.12
 (511)
 17 – Insulating, soundproofing and stopping materials; fabrics, felts, webs, plates, panels and sheets for use as insulation material; rubber or plastics for padding and stuffing; mineral wool, glass wool, stone wool, rock wool, slag wool and fiber glass for thermal or acoustic insulation; glass fibers for insulation; slag wool, glass wool blankets and panels for building insulation; wood fiber, plastic insulation materials, especially foamed plastic materials; insulation boards, made from polystyrene, especially made from extruded polystyrene; XPS (extruded polystyrene) material for packing and stuffing; XPS (extruded polystyrene) panels for insulation; plastic film, other than for packaging purposes; substances for insulating buildings against moisture; sealant compounds for joints; insulating paper, insulating tape and band, rubber, gutta-percha, gum, asbestos, mica; plastics in extruded form for use in manufacture; packing materials, joint packaging for flexible pipes, not of metal; membranes and insulating materials for air tightness and vapor barriers (membrane for moisture protection); vapor barriers; insulating adhesives for sealing and/or attaching or linking membranes of air tightness and/or vapor barriers (for moisture protection) to anything that has to pass through like carpentry, timber studs, tubes, chimney, parts used for ventilation, ducts; insulating adhesives, especially in the form of tapes to be used in combination with insulating material, like mineral wool and XPS (extruded polystyrene); adhesive tapes for industrial purposes; insulating material for buildings and glass mineral wool for insulation purposes together with the respective fixing material for fastening the insulation material and mineral wool for the building, namely warm frame construction, cold frame construction, wall/floor junction timber floor, cavity batts made of mineral fibers, pitched roof insulation, roof junctions for separating wall / attic space, roof junctions for separating wall / room in the roof.
 19 – Building materials (non-metallic), including panels and sheets of mineral fibers (especially fiber glass) for buildings; ducts for air conditioning, not of

metal; self-bearing duct designs made from mineral wool especially glass fiber panels used for HVAC (heating, ventilation and air conditioning); mineral wool panels with woven or non-woven facings or coverings; non-metallic rigid pipes for building; asphalt, pitch and bitumen; non-metallic transportable buildings; monuments, not of metal, waterproofing claddings.

- (260) AM 2023 121371 A
 (800) 1709165
 (151) 2022 12 13
 (891) 2022 12 13
 (731) KROLK Holding AG
 Baarerstrasse 8, CH-6300 Zug, Switzerland
 (540)

S O L K
 MADE TO FADE

- (591) Black, white
 (531) 27.05.10
 (511)
 25 – Shoes; clothing; footwear; headgear.

- (260) AM 2023 121372 A
 (800) 1709207
 (151) 2022 11 18
 (891) 2022 11 18
 (731) Japan Tobacco Inc.
 1-1, Toranomon 4-chome, Minato-ku, Tokyo,
 Japan
 (540)

WINSTON ORIGINAL RED

- (591) Black, white
 (511)
 34 – Tobacco, raw or manufactured; smoking tobacco, pipe tobacco, rolling tobacco, chewing tobacco, snus; cigarettes, electronic cigarettes, liquid for electronic cigarettes, tobacco vaporizer, cigars, cigarillos; snuff; smokers' articles included in class 34; cigarette paper, cigarette tubes and matches.

- (260) AM 2023 121379 A
 (800) 1709371
 (151) 2022 12 02
 (891) 2022 12 02
 (731) ANADOLU AKVARYUM VE PET
 ÜRÜNLERİ SANAYİ VE TİCARET
 ANONİM ŞİRKETİ
 BÜYÜKBAKKALKÖY MAH.
 ŞAMANDIRA, YOLU SK. 30 1, Maltepe,
 İstanbul, Türkiye
 (540)

PRONATURE

- (591) Black, white

(531) 27.05.01; 27.05.10

(511)

31 – Agricultural and horticultural products not included in other classes, seeds; forestry products not included in other classes; live animals; fertilized eggs for hatching; plants; dried plants for decoration; fresh garden herbs; dried garden herbs for decoration; animal foodstuffs; malt not for human consumption; sanded paper sheets for pet litter boxes; cat litters.

(260) AM 2023 121383 A

(800) 1709451

(151) 2022 07 26

(891) 2022 07 26

(731) Društvo za trgovija i usluge EVRO GEJMS
TEHNOLODŽI DOOEL Skopje
Ul. Boris Trajkovski br.214 A, 1000 Skopje,
The Republic of North Macedonia

(540)

Jungle

(591) Black, white

(511)

9 – Software; games software; computer gaming software; computer software packages; computer operating system software; computer software for the administration of on-line games and gaming; computer software, recorded; software drivers; virtual reality software; entertainment software for computer games; computer programs for network management; hardware and software for gambling, gambling machines, gambling games on the Internet and via telecommunication network; operating computer software for main frame computers; monitors (computer hardware); computer hardware; apparatus for recording images; monitors (computer programs); computer game programs; computer programs for recorded games; apparatus for recording, transmission or reproduction of sound or images; computer hardware for communication services; electronic components for gambling machines; computer application software featuring games and gaming; computer hardware for games and gaming.

28 – Games; chips for gambling; mah-jong; arcade games; gambling machines operating with coins, notes and cards; electropneumatic and electrical gambling machines (slot machines), electronic games; parlor games; gaming chips; gaming tables; slot machines [gaming machines]; LCD game machines; slot machines and gaming devices; coin-operated amusement machines; roulette chips; poker chips; chips and dice [gaming equipment]; equipment for casinos; roulette tables; gaming roulette wheels; casino games; automats and gambling machines; coin-operated machines and/or electronic coin-operated machines with or without the possibility of gain; boxes for coin-operated machines, slot machines and gaming machines; electronic or electrotechnical gaming devices, auto-

mats and machines, coin-operated machines; housings for coin-operated machines, gaming equipment, gaming machines, machines for gambling; gaming machines for gambling.

41 – Casino management services; operation of gaming establishments, gaming halls, internet casinos, online gambling sites; services related to gambling; gaming services for entertainment purposes; casino, gaming and gambling services; gambling; training in the development of software systems; provision of gaming equipment for gambling halls; providing casino equipment [gambling]; gaming machine entertainment services; providing casino facilities [gambling]; providing halls with gaming machines; amusement arcade services; games equipment rental; rental of gaming machines; providing amusement arcade services; rental of gaming machines with images of fruits; editing or recording of sounds and images; sound recording and video entertainment services; hire of sound reproducing apparatus; provision of gaming equipment for casinos; providing of casino facilities; online gambling services.

(260) AM 2023 121385 A

(800) 1709475

(151) 2022 12 10

(891) 2022 12 10

(731) CHINA TOBACCO INTERNATIONAL (HK)
COMPANY LIMITED
Room 1002, 10/F Tower A, China Life Center,
One Harbour Gate, 18 Hung Luen Rd, Hung
Hom, Kowloon, Hongkong, China

(540)

TRIGGER
— 摧擦 —

(591) Black, white

(531) 26.11.08; 27.05.01; 28.03

(511)

9 – Batteries for electronic cigarettes; smoke detectors; chargers for electronic cigarettes; battery chargers; computer programs, downloadable; all aforesaid goods relating to cigars and electronic cigarettes.

11 – Tobacco roasters; gas lighters; cooling installations for tobacco; fog machines; all aforesaid goods relating to cigars and electronic cigarettes.

34 – Cigars; cigar holders; tobacco jars; lighters for smokers; cigar cutters; flavourings, other than essential oils, for tobacco; cigarettes; tobacco pipes; cigarette cases; electronic cigarettes; liquid solutions for use in electronic cigarettes.

35 – Import-export agency services; outdoor advertising; sales promotion for others; procurement services for others [purchasing goods and services for other businesses]; book-keeping; commercial administrati-

on of the licensing of the goods and services of others; personnel recruitment; advertising; all aforesaid services relating to cigars, electronic cigarettes, chargers for electronic cigarettes, roasters for tobacco, lighters for tobacco and cooling installations for tobacco.

(260) AM 2023 121386 A
 (800) 1709476
 (151) 2022 12 10
 (891) 2022 12 10
 (731) CHINA TOBACCO INTERNATIONAL (HK) COMPANY LIMITED
 Room 1002, 10/F Tower A, China Life Center,
 One Harbour Gate, 18 Hung Luen Rd, Hung
 Hom, Kowloon, Hongkong, China

(540)

CTOM

(591) Black, white

(531) 27.05.01

(511)

34 – Cigars; cigar holders; tobacco jars; lighters for smokers; cigar cutters; flavourings, other than essential oils, for tobacco; cigarettes; tobacco pipes; cigarette cases; electronic cigarettes; liquid solutions for use in electronic cigarettes.

35 – Import-export agency services; outdoor advertising; sales promotion for others; procurement services for others [purchasing goods and services for other businesses]; book-keeping; commercial administration of the licensing of the goods and services of others; personnel recruitment; advertising; all aforesaid services relating to cigars and electronic cigarettes.

(260) AM 2023 121387 A
 (800) 1709509
 (151) 2022 03 23
 (891) 2022 03 23
 (731) High Level Building Ltd
 Shipchenska epopeya str. No. 31 A, BG-6100
 Kazanlak, Bulgaria

(540)

BUL-CEL

(591) Blue, white

(531) 26.04.18; 27.05.17; 27.05.24; 29.01.12

(511)

1 – Cellulose; acetate of cellulose unprocessed; cellulose for industrial purposes; pulp for use in the manufacture of paper; cellulose additives for use in dry construction mixtures, liquid mixtures, asphalt mixtures, chemical preparations for use in constructions.

5 – Diapers made of cellulose; babies' diaper-pants.

16 – Corrugated board.

17 – Cellulose acetate; cellulose acetate film used as packing material (other than for wrapping); cellulose acetate semi-processed.

31 – Animal feed.

(260) AM 2023 121388 A
 (800) 1709535
 (151) 2022 12 22
 (891) 2022 12 22
 (731) Songwon Industrial Co., Ltd.
 83, Jangsaengpo-ro, Nam-gu, Ulsan,
 Republic of Korea

(540)

SONGSTAB

(591) Black, white

(511)

1 – Chemicals and chemical mixtures used to stabilize PVC and PVC resins and protect them from degradation during processing and damage caused by heat or ultraviolet radiation.

(260) AM 2023 121389 A
 (800) 1709573
 (151) 2022 11 17
 (891) 2022 11 17
 (731) MASTELLI S.R.L.
 Via Bussana Vecchia 32, I-18038 SANREMO,
 IMPERIA, Italy

(540)

MASTELLI
 AESTHETICS
NEWEST

(591) Black, white

(531) 27.05.01; 27.05.09

(511)

3 – Perfumery, essential oils, cosmetics, hair lotions; dentifrices; abrasives; eau de Cologne; lavender water; toilet water; scented water; adhesives for cosmetic purposes; balms, other than for medical purposes; joss sticks; cotton swabs for cosmetic purposes; cosmetic creams; skin whitening creams; massage gels, other than for medical purposes; dental bleaching gels; hair spray; almond milk for cosmetic purposes; cleansing milk for toilet purposes; after-shave lotions; lotions for cosmetic purposes; mascara; beauty masks; oils for toilet purposes; oils for perfumes and scents; oils for cosmetic purposes; cotton wool for cosmetic purposes; pomades for cosmetic purposes; sun-tanning preparations [cosmetics]; cosmetic preparations for baths; preparations for personal or health care, intimate deodorants; cosmetic preparations for slimming purposes; cosmetic preparations for skin care; depilatory preparations; perfumery; antiperspirants [toilettries]; make-up preparations; nail care preparations; sha-

ving preparations; make-up removing preparations; perfumes; lipsticks; bath salts, not for medical purposes; deodorant soap; shampoos; astringents for cosmetic purposes; cosmetics; bleaching preparations [decolorants] for cosmetic purposes; vaginal washes for personal sanitary or deodorant purposes [toiletries]; cleansers for intimate personal hygiene purposes, non medicated; collagen preparations for cosmetic purposes; phytocosmetic preparations; douching preparations for personal sanitary or deodorant purposes [toiletries]; cakes of toilet soap; gel eye patches for cosmetic purposes; cosmetics containing polynucleotides; eye-washes, not for medical purposes.

5 – Pharmaceutical and veterinary products; sanitary preparations for medical purposes; plasters, materials for dressings; material for dental fillings and dental impressions; disinfectants; pharmaceuticals; dietetic foods adapted for medical purposes; dietetic substances adapted for medical use; food supplements for humans; tanning pills; nutritional supplements; vaginal washes; balms for medical purposes; dietetic beverages adapted for medical purposes; adhesive plasters; collyrium; cotton for medical purposes; disinfectants for hygiene purposes; balsamic preparations for medical purposes; medicinal mud; mud for baths; milk ferments for pharmaceutical purposes; medicines for dental purposes; medicinal oils; slimming pills; pomades for medical purposes; eye-washes; medical preparations for slimming purposes; therapeutic preparations for the bath; pharmaceutical preparations for skin care; remedies for perspiration; antibiotics; pre-filled syringes for medical use; antimicrobials for dermatological use; anti-dermo-infectives for dermatological use; gels, creams and solutions for dermatological use; antifungal preparations; antiseptics; collagen for medical purposes; dietary supplements with a cosmetic effect; lotions for pharmaceutical purposes; chemical preparations for pharmaceutical purposes; chemical preparations for medical purposes; medicated toiletry preparations; pharmaceutical preparations; antibacterial soap; disinfectant soap; pastilles for pharmaceutical purposes; chemico-pharmaceutical preparations; ointments for pharmaceutical purposes; alcohol for pharmaceutical purposes; antiseptic cotton; air deodorizing preparations; deodorants for clothing and textiles; detergents for medical purposes; medicines for human purposes; wadding for medical purposes; antibacterial handwashes; medicated soap; medicated shampoos; surgical dressings; tissues impregnated with pharmaceutical lotions; acetates for pharmaceutical purposes; acids for pharmaceutical purposes; ethers for pharmaceutical purposes; phosphates for pharmaceutical purposes; enzyme preparations for medical purposes; nutraceutical preparations for therapeutic or medical purposes; polynucleotides for pharmaceutical use; gel for dental use; protective and soothing oral mucosa gel; dressings, medical; plant extracts for pharmaceutical purposes; injectable dermal fillers; gelatine for medical purposes; phytothera-

py preparations for medical purposes; medicated eye-washes; pharmaceutical preparations for treating sunburn; acne treatment preparations; vulnerary sponges.

(260) AM 2023 121390 A

(800) 1709606

(151) 2022 08 01

(891) 2022 08 01

(731) TRUSSARDI S.P.A.

Piazza della Scala 5, I-20121 Milano, Italy

(540)



(591) Black, white

(531) 03.01.08; 03.01.16; 03.01.24

(511)

9 – Scientific, research, navigational, geodetic, photographic, cinematographic, audiovisual, optical, weighing, measuring, signaling, surveying, testing, inspection, rescue, and teaching apparatus and instruments; apparatus and instruments for conducting, distributing, transforming, accumulating, regulating, or controlling the distribution or consumption of electricity apparatus and instruments for recording, transmitting, reproducing or processing sound, images or data; recorded or downloadable media, computer software, digital media or similar blank recording and storage media; mechanisms for pre-payment devices; cash registers, calculating machines; computers and computer peripheral devices; diving suits, diving masks, diver's earplugs, diver's and swimmer's tongs, diver's gloves, self-contained underwater swimming apparatus; fire extinguishers; magnets; magnetic and digital recording media; electronic communication equipment and instruments; spectacles and their structural components; corrective spectacles; eyeglasses; optical lenses; spectacle cases; magnifiers [optics]; 3D glasses and headsets; virtual reality helmets; binoculars [optics]; binocular cases; monocular; pocket calculators; non-medical thermometers; video cameras; electronic processors; tablets (computers); electronic, graphic and digital tablets; portable telephones; electronic book readers; audio players for MP3 and other digital formats; DVD drives; radio sets; coin-operated or coin-operated music sets; boomboxes (large portable radio and CD player); televisions; video screens; remote controls; computer programs [downloadable]; software; electronic agendas; electronic notebooks; PDAs [personal digital assistance devices]; electronic publications [downloadable]; databases (electronic); downloadable music files; computer mice; mouse pads; keyboard grids; computer peripheral units; computer hardware; USB

hardware; USB sticks; computer [software] cartridges; keyboard wrist rests for computer use; bags, cases, and cases for cameras, camcorders, electronic processors, tablets (computers), tablets, digital and graphics, cellular phones, electronic book readers, MP3 and other audio digital players, DVD players; accessories for computers, tablets (computers), tablets, digital and graphics, cellular phones, electronic book readers, MP3 and other audio digital players, DVD players, viz: electric batteries, rechargeable batteries, battery and battery chargers, car chargers, cables, wires and electrical relays, USB cables, portable speakers, covers, protective films, screen protectors, privacy filters, memory cards, docking stations, optical pens, microphones, antennas, keyboards; desk phone holders; vehicle phone holders; cell phone straps; headphones for music; headphones for music; earphones; hands-free kits; loudspeakers; tripods for camera equipment; head protectors; helmets for horseback riding; bubble levels; magnets; squares [for measuring]; compasses for measuring; hourglasses; scales; meters [measuring instruments]; rows [measuring instruments]; measuring rods; measuring instruments; devices for measuring the thickness of leather and skin; GPS tracking system devices; compasses; pedometers [podiums]; multifunctional and personal electronic devices for viewing, measuring, recording, organizing, manipulating, analyzing, and receiving data, text, images, and audio files; wearable activity recording devices; smart jewelry items (i.e., smart rings, smart bracelets, smart necklaces, smart pendants, and smart earrings); smartwatches; downloadable computer software for blockchain technology; virtual reality software; virtual reality game software; virtual reality helmets adapted for use in video games; virtual reality models; virtual reality goggles; virtual reality gloves; augmented reality software; augmented reality game software; augmented reality computer hardware; all of the above products may be connected, intelligent, and/or artificial intelligence-based.

14 – Precious metals and their alloys; jewellery, paste jewellery, precious and semi-precious stones; horological and chronometric instruments; precious metal bullion; necklaces [jewellery]; bracelets [jewellery]; rings [jewellery]; earrings [paste jewellery]; pendants [jewellery]; brooches [jewellery]; coats of arms (paste jewellery); cufflinks (jewelry); pendants for watch chains; medallions [jewelry]; pendants for bracelets; tie clips; chains [jewelry]; jewelry boxes; watch boxes not made of precious metals; rolls to hold jewelry; watches and their structural components; wristwatches; watch bracelets [straps]; watch clips; watch dials; watch cases; watch chains; watch mechanisms; horological and chronometric intelligent instruments; watch and jewelry cases or caskets; key fobs [key rings with trinkets or charms]; smart key fobs; ornamental head and body jewelry; scarf rings (costume jewelry items); all of the above products may be connected, intelligent, and/or artificial intelligence-based.

16 – Paper and cardboard; printed matter; book covers; photographs; stationery and office requisites, except furniture; adhesives (adhesive materials) for stationery or household use; drawing materials and artists' materials; brushes, except paint brushes; instructional or teaching materials; sheets, films and envelopes made of plastics for packaging and wrapping purposes; typewriters adapted to produce typefaces; printed matter; printing fonts; paper; cardboard; cardboard or paper boxes; bags (envelopes, sachets) for packaging (of paper or plastics); packaging paper; albums; stationery items excluding adhesives (glue materials) for stationery or household use, self-adhesive labels and self-adhesive stickers (stationery items); hat boxes of paper; writing and drawing supplies; school supplies; office stationery; instructional or teaching materials (except apparatus); artists' materials; notepaper; envelopes [stationery]; notepads [stationery]; sheets [stationery]; sketch pads; notebooks; calendars; notebooks; index cards; covers [stationery]; desk diaries; diary covers; almanacs; writing and drawing instruments; smart writing and drawing instruments (including smart optical pens); pencils; pen holders; brackets for resting a pen; fountain pens; felt pens; felt pens; pen cases; pencil, drawing and writing instrument cases; inks; ink cartridge boxes for writing instruments; ink cartridge boxes for pens; pen holders; pen cases [pen cases]; supports for photographs; photographs; lithographs; lithographed art objects; posters; placeholders; books; booklets; periodicals; newspapers; periodicals [magazines]; magazines [periodicals]; publications; coloring albums; children's memory albums; bookends; bookmarks; book covers; cards; postcards; atlases; cards; banknote clips; price labels of paper; paperweights; paper cutters [office supplies]; mail separators; desk mats; mail baskets; empty pockets (desk holder sets); paper table linens; paper table sets; paper undercovers; paper tablecloths; tissue paper; scented paper; envelopes (for travel passports); check boxes; paper patterns for garment making; embroidery patterns; globes; smart stationery items; all of the above products may be connected, smart, and/or make use of artificial intelligence; paper pet bags; paper bags.

18 – Leather and imitations thereof; animal skins; luggage and carry-on bags; umbrellas and parasols; walking sticks; whips, harnesses and saddlery; collars, leashes and animal clothing; leather goods; imitations of leather; casual bags; handbags; travel bags; backpacks; beach bags; suitcases-lining for travel clothes; sports bags (except those suitable for the shape of the products they are intended to contain); diaper bags; wheeled shopping bags; camping bags; evening purses; minaudiere bags; handbags; leather bags [pouches, pouches] for packing; game bags [hunting accessories]; school satchels; purses; men's handbags; duffel bags; waist pouches and purses; document holders [leather goods]; protective cases for bags and shoes; leather shoulder straps for bags; baby carriers; wa-

llets; purses; card holders (leather goods); briefcases, pouches [leather goods]; key cases; leather pouches; saddlebags; trunks and suitcases; luggage handles; luggage tag holders; saddlery; grooming bags; riding saddles; saddle shafts; covers for horse saddles [liners]; pads for horse saddles [riding]; saddle boxes; bits; harnesses; bridles [harnesses]; bridles; bridoons; leather bridles and bridles (saddlery); reins [bridles]; stirrups; halters; girths of leather; attachment halters; turning halters; shin straps; equine leg wraps; kneepads for horses; polo straps (for horses); resting straps (for horses); horse noise helmets; chin straps [leather straps]; back shock absorbers for horses; stirrups; horseshoes; blankets for horses; whips; riding whips; girths (for horses); martingales; blinkers for horses; lanyards [leather]; leather cords; clothes for pets; collars and leashes for animals; muzzles; hand straps; rain guards; sun umbrellas; parasols and their parts; walking sticks; leather furniture trimmings; leather upholstery for furniture; cases and trunks designed to hold toiletries, (empty); beauty cases (empty); travel bags; cosmetic pouches; leather or cardboard-leather boxes; casual bags; smart luggage items; smart saddlery items (including smart riding saddles); smart umbrellas; smart canes; smart small leather items, that is, wallets, purses, card holders (leather goods), banknote holders, briefcases (leather goods), document holders, key cases, luggage tag holders; all of the above products may be connected, smart, and/or based on artificial intelligence; coin purses.

20 – Furniture, mirrors, picture frames; containers, not of metal, for storage or transportation; bone, horn, whalebone or mother-of-pearl, in raw or semi-finished state; shells; sea foam; yellow amber; non-metallic storage boxes made of textile materials; picture frames; caskets; mirrors (silvered glass); cushions; movable compositions [objects for decoration]; cushions, cots; animal kennels; porcelain knobs; wooden boxes; umbrella stands; lecterns [furniture]; magazine racks; hat racks; furniture; bedding; coat hangers [furniture]; screens [furniture]; partitions [furniture]; sliding-top desks; sideboard [sideboard] risers; shelving and library shelves; rolling buffets [furniture]; tables; dressing tables; dressers; desks; consoles [furniture]; center-foot tables; sideboards; bookcases [furniture]; stands; coat hangers; baskets, not of metal; table tops; chairs [seats]; armchairs; canapés; chairs [seats]; stools; steps; poufs; benches [furniture]; sets of seats; deck chairs; wooden artwork; wood figurines; wood carvings; wax carvings; ivory figurines; plastic carvings; plaster carvings; baskets for logs; birdhouses; elements for driving away birds; clothes cases [rearrangement]; clothes hangers and coat hangers; baskets, non-metal; wicker objects; billboards; non-metal door handles; door lifting devices; fishing baskets; picnic bags and baskets (empty); empty pockets made of textile materials; all of the above products may be connected, intelligent and/or based on artificial intelli-

gence; beds for animals; canapé; fans for personal use, non-electric.

24 – Fabrics and their substitutes; household linen; curtains made of textile or plastic materials; fabrics; interior decoration fabrics; soft furnishings materials; smart fabrics and textiles; textile cords; curtains of textile or plastic; linen; cushion and chair covers; slip-covers; bedspreads and bed covers; bed sheets; bed blankets; quilts; quilts [foot covers]; pillowcases; quilts [blankets]; children's footed whole pajamas; sleeping bags [sheets]; travel blankets; travel blankets; bath linens except garments; bath towels; textile towels; washing mitts; textile towels; beach towels; table covers [non-paper]; cloth tablecloths; cloth napkins; individual non-paper placemats; cloth underclothes; cloth handkerchiefs; textile labels; horse box wall hangings; all of the above products may be connected, intelligent, and/or AI-based.

25 – Articles of clothing, shoes, headgear; smart garments; smart shoes; smart headgear and knitwear; smart fashion accessories; made-up garments; sweaters; waistcoats; knitted garments; shirts; short-sleeved blouses; aprons; blouses; tee-shirts; polo shirts; pants; jackets; dresses [suits]; shorts [clothing]; skirts; coats; boleros; fleece garments; turtleneck sweaters; jackets; waterproof capes; down jackets; coats; gabardine [garments]; waterproof clothing; overcoats; parkas; ponchos; cloaks; leather and imitation leather garments; furs [garments]; boas [neck fur]; non-paper bibs; baby layettes; sportswear; nightwear; night masks; underwear; panties; shorts [swimwear]; swimsuits; bathrobes; kimonos; thongs; pareos; aprons [garments]; boots; booties; espadrilles; sandals; beach shoes; sports footwear; ski boots; slippers; shoe soles; hats; caps; berets [headphones]; visors (hats); headbands [clothing]; gloves [clothing]; mitten gloves; ski gloves; mittens [apparel]; ties; belts [apparel]; wallet belts [apparel]; pocket handkerchiefs [apparel]; foulards [handkerchiefs]; lavalliere ties; bow ties; scarves; shawls; stoles; socks; tights; gaiters; suspenders; all of the above products may be connected, intelligent, and/or AI-based.

27 – Carpets, doormats, mats, linoleum, and other floor coverings; upholstery, not made of textile materials; wallpaper; wallpaper borders; wall coverings; floor coverings; indoor and outdoor mats; bathmats; beach mats; sports mats; yoga mats; exercise mats; wellness mats; mats; smart mats; all of the above products may be connected, intelligent, and/or artificial intelligence-based.

30 – Coffee; tea; cocoa; coffee substitutes; rice; tapioca; sago; flours, preparations made from cereals; bread; pastry; confectionery; ice cream; sugar; honey; molasses syrup; yeast; baking powder; salt; mustard; vinegar; sauces (condiments); spices; ice.

33 – Alcoholic beverages (except beers).

35 – Advertising; management, organization, and administration of commercial affairs; clerical services; organization of fashion shows for promotional and commercial purposes; organization of events for commercial and advertising purposes; organization of events, exhibitions, fairs, and shows for commercial, promotional, and advertising purposes; promotion of special events; web sites traffic optimization; decorating storefronts including on an internet site; customer loyalty services for commercial, promotional and/or advertising purposes; card and loyalty program services; public relations services; news clipping services; retail services of downloadable virtual goods, digitized goods and downloadable digital files authenticated by non-fungible tokens [NFTs]; provision of computer application software for virtual reality game services; retailing services, including online, of perfumery and fragrance products, eau de toilette and eau de cologne, cosmetic products and preparations, non-medicinal toilet preparations, hygiene and beauty products, cosmetic lotions for body and hair, soaps for personal use, deodorants for personal use, essential oils for personal use, tissues impregnated with cosmetic lotions, shower gels, cosmetic preparations for bathing, shampoos, cosmetic creams, beauty masks, oils for cosmetic use, cosmetics for children, makeup products, makeup foundations, eyelid shadows, lipsticks and lip glosses, lip glosses, lipstick cases, mascaras, eyelash cosmetics, eyebrow cosmetics, make-up powder, belletto, make-up pencils, make-up removers, skin cleansing products, nail lacquers, nail gels, nail polish removers, nail and hand care products, mattifying make-up papers, sunscreen preparations, cosmetic preparations for skin tanning, shaving products and aftershave products, cosmetic nécessaires, potpourris [fragrance], scented paper and pads, room fragrances, home fragrances, frankincense, aromatic plant extracts, leather preservation and maintenance products (polishes); retailing services, including online, of leather and leather creams, footwear creams and polishes, shoemaker's wax, all of the above products may be connected, intelligent and/or make use of artificial intelligence; retail services, including online, of fuel and lighting products, lighting lamp oils, candles, scented candles, lamp wicks, nightlights (candles), common metals and their alloys, steel alloys, crude or semi-finished steel, silver-nickel alloy, aluminum, white metal, bronze, chromium, crude cobalt, crude or semi-finished copper, tin, crude or semi-finished iron, crude or semi-finished brass, magnesium, manganese, metallic ores, nickel, crude or semi-finished lead, tantalum, titanium, wolframium, zinc, ingots of base metals, metal barrels and vessels, flexible pipes, bones, metal building materials, metal trinkets and locks, closures for metal bags, handle-less suitcases and bags (leather goods), metal closures for leather goods, i.e., wallets, wallets with card cases, document holders, key purses, passport holders, travel bags, metal knobs [handles], padlocks, screw keys, bells, nails, metal do-

or handles, decorative mobile metal partitions for walls, protective door plates, all of the above products may be connected, intelligent and/or make use of artificial intelligence; retail services, including online, of hand-operated tools and implements, non-electrical cutlery items, blankets [knives, forks and spoons], silverware [knives, forks and spoons], clamps, nutcrackers, horse hoof wash brushes, white weapons, scissors, shaving and aftershave sets, manicure and pedicure cases, shoe lasts [shoemaker's tools], manually operated tools for gardening and DIY, all of the above products may be connected, intelligent and/or make use of artificial intelligence; retailing services, including online, of scientific, nautical, geodetic, optical, photographic, cinematographic, weighing, optical glasses, optical lenses, spectacle cases, magnifying glasses [optics], 3D glasses and headphones, virtual reality headsets, binoculars, binocular cases, monocular, pocket calculators, thermometers, not for medical use, video cameras, computers, tablets (computers), computer graphic tablets, digital and graphics, portable telephones, e-book readers, players for MP3 and other digital audio formats, DVD players, radios, coin-operated or coin-operated music equipment, boomboxes (large radio and portable CD player), televisions, video screens, remote controls, computer programs [downloadable software], software programs, electronic agendas, electronic notebooks, personal digital assistants, electronic publications, databases [electronic], downloadable music files, computer mice and mouse pads, keyboards, computer peripherals, hardware, USB hardware, USB flash drives, computer cartridges (software), wrist rests for computer equipment, bags, camera cases and purses, camcorders, computers, tablets (computers), computer graphic tablets, digital and graphics, portable telephones, readers for electronic books, readers for MP3 and other digital audio formats, DVD players, computer accessories, tablets (computers), computer graphics tablets, digital and graphics, portable telephones, readers for electronic books, readers for MP3 and other digital audio formats, DVD players, computer accessories, tablets (computers), computer graphics tablets, digital and graphics, portable telephones, readers for electronic books, readers for MP3 and other digital audio formats, DVD players, namely: electric batteries, rechargeable batteries, battery and battery chargers, car chargers, cables, electrical wires and relays, USB cables, portable speakers, hulls, chair covers, protective films, screen protectors, privacy filters, microchip cards, docking stations, pens, microphones, radio antennas, keyboards, office phone jacks, car mounts for phones, shoulder strap for portable phones, audio headphones, headphones; retail services, including online, of ear covers (clothing), hands-free phone kits, loudspeakers, camera feet, protective helmets, riding hats, bubble levels, magnets, squares (measuring instruments), compasses [measuring instruments], hourglasses, scales (steelyards), meters (measuring instruments), rows [measuring instruments], measuring spoons, devices for measuring leather and skin thickness, GPS tracking system devices, compasses, podiums (pedometers), portable and personal multifunctional

electronic display devices, measuring devices, recording, organizing, handling, analyzing and receiving data, texts, images and audio files, wearable devices for recording activities, perfumery, intelligent cosmetics and makeup products, intelligent hand-operated tools and instruments, intelligent lighting fixtures, intelligent vehicles and vehicle accessories, vehicle interior upholstery, leather accessories for vehicles, intelligent jewelry items (smart rings and smart bracelets), smart watches and smart timekeeping instruments, smartwatches, smart key fobs, smart keys, smart music boxes and instruments, smart stationery items, smart writing and drawing instruments (including smart optical pens), smart handbags, smart luggage and small leather goods, smart saddlery items (including smart riding saddles), smart umbrellas, smart parasols, smart canes, smart furniture and furnishings, smart household or kitchen utensils and receptacles, smart table and toiletries, smart textiles and fabrics, smart garments, smart shoes, smart headwear and knitwear, smart fashion accessories, smart carpets, smart toys and games, smart sporting goods, smart smoking articles, all of the above products may be connected, smart and/or resorting to artificial intelligence, smart and/or resorting to artificial intelligence; retailing services, including online, of lighting fixtures, lighting lamps, electric lamps, chandeliers, standing lamps, lamp caps, ceiling lamps, chandelier chains, nightlights, bulbs, vehicle headlights, fountains, all of the above products may be connected, intelligent and/or make use of artificial intelligence, ground, air or nautical apparatus of locomotion, vehicles, motorcycles, bicycles, boats, yachts, aircraft, helicopters, wheelchairs, children's driving vehicles (toys), all of the above products may be connected, intelligent and/or make use of artificial intelligence, measuring, navigational, signaling, control (inspection) apparatus and instruments, rescue (rescue) and teaching apparatus and instruments, apparatus for recording, transmission, reproduction of sound or images, magnetic and digital recording media, electronic communication equipment and instruments, spectacles and their structural components, corrective lenses, - precious metals and their alloys, as well as ingots made of precious metals, jewelry, precious stones, costume jewelry, necklaces [jewelry], necklaces (necklaces), necklaces (jewelry), bracelets [jewelry], rings (jewelry), earrings (costume jewelry), pendants [jewelry], brooches [jewelry], coats of arms (jewelry), cufflinks (jewelry), medallions [jewelry], medallions [jewelry], pendants [jewelry], necktie clips, chains [jewelry], jewelry boxes, non-precious metal watch cases, watches and chronometric instruments, watches and their structural components, wristwatches, watch bracelets (straps), watch buckles, watch dials, watch cases (wrist and pocket), watch chains, watch mechanisms, watch cases and caskets for watchmaking and costume jewelry, fancy key chains, decorative head and body jewelry, scarf rings (costume jewelry items), all of the abo-

ve products may be connected, intelligent and/or resort to artificial intelligence, toy music boxes, musical instruments, musical instrument cases, musical tapes, all of the above products may be connected, intelligent and/or resort to artificial intelligence; retail services, including online, of printed matter, printing typefaces, paper, cardboard, boxes, bags and sacks, envelopes and sachets for paper or plastic packaging, wrapping paper, scrapbooks, stationery items, excluding adhesives (adhesive materials) for stationery or household use, self-adhesive labels and stickers (stationery items), hat boxes [boxes], writing and drawing supplies, school supplies, office supplies, instructional and teaching supplies (except appliances), artists' supplies, writing paper, envelopes [stationery], notepads (stationery), sheets (stationery), sketch pads, notepads, calendars, notebooks, filing cabinets, covers (stationery), diaries, planner holders, yearbooks, drawing and writing instruments, pencils, pen holders, pen cases, fountain pens, felt tip pens, felt pens, small pen cases, pen cases, pen cases, for drawing and writing instruments, ink, ink cartridge boxes for writing instruments, ink cartridge boxes for pens, pencil cases, pencil cases, pencil holders, photo media, photographs, lithographs, lithographed art objects, place cards, posters, books, booklets, magazines, newspapers, periodicals, journals, publications, coloring albums, birth books, bookends, bookmarks, book covers, cards, postcards, atlases, cards, banknote clips, price tags, price labels, paperweights, paper cutters (office supplies), mail separators, under pocket folders, correspondence baskets, empty pockets (desk storage sets), magnets, paper table linens, paper placemats, paper coasters, paper tablecloths, paper towels, passport holders, checkbook cases, garment making patterns, embroidery patterns, globes, all of the above products may be connected, intelligent and/or use artificial intelligence; retailing services, including online, of leather and imitation leather handbags, handbags and travel bags, backpacks, beach bags, suitcases-liners for clothes [for travel], sports bags (except those suitable for the shape of the products they are intended to contain), bags with changing mats, roulette bags, camping bags, pouches [evening bags], cosmetic bags, mesh bags, animal transport bags, leather bags (pouches, sachets) for packing, game bags, shoulder bags, shopping bags (shoppers), handbags, saddlebags, shoulder bags, travel bags, fanny packs, leather purses, protective cases for bags and shoes, leather shoulder straps for bags, decorative accessories for bags (grigri), fanny packs, wallets and purses, leather card cases, briefcases, folders (leather goods), key cases [leather goods], leather pouches, wallets, trunks and suitcases, luggage handles, luggage tag holders, saddlery items, grooming bags, saddles for horses, saddle bows, saddle harnesses for horses [liners], saddle harnesses [riding], saddle boxes, saddle bits (harnesses, horse harnesses), bridles [harnesses], bridles, strap fastenings, leather bridles

and bridles (saddlery), reins (bridles), stirrups, bridles [harnesses], halters, leather straps, leading ropes, turning halters, shin straps, boots for horses, knee pads for horses, polo straps (for horses), resting straps (for horses), noise-reducing helmets for horses, chin straps [leather ribbons], back shock absorbers for horses, stirrups, horseshoes, blankets for horses, whips, whips, girths (for horses), martingales, blindfolds, leather cords, leather threads, animal clothing, animal collars and leashes, muzzles, hand straps, parasols, parasols and parts thereof, walking sticks, ornaments, leather upholstery for furniture, cases and trunks designed to hold toiletries, (empty), beauty cases (empty), travel bags, beauty-cases, cases for costume jewelry, leather or cardboard-leather boxes, all of the above products may be connected, intelligent and/or resort to artificial intelligence; retail services, including online furniture retail services, leather furniture trimmings, frames, non-metallic hoods, mirrors, cushions, movable arrangements [transportable decoration items as furniture accessories], non-metallic storage boxes made of textile materials, cushions, pet beds and baskets, pet kennels, wooden boxes, wooden crates, umbrella cases, bookcases, magazine racks, hat racks, non-metallic tidying cases made of textile materials, furniture, bedding, coat hangers (furniture), screens (furniture), partitions [furniture], writing desks, lifts [of sideboards], library shelving and shelves, rolling buffets [furniture], tables, toilet tables, drawers, desks [furniture], lecterns, command panels, bedside tables, sideboards, libraries, filing cabinets, coat hangers, baskets, table tops, seats, armchairs and lounge chairs, seats, pouffes, double ladders, seats, benches [furniture], benches, deckchairs, art objects, wooden, wooden figurines, wood carvings, wax carvings, ivory carvings, plastic carvings, plaster carvings, stables, nonmetallic trays, stump baskets, birdhouses, bird chasing elements, fans, clothes cases [rearrangement], clothes racks, non-metallic baskets, wicker objects, bottle racks, billboards, door handles, non-metallic, door wedges, fishing baskets, picnic bags and baskets (empty), empty-pockets made of textile materials, all of the above products may be connected, intelligent and/or resort to artificial intelligence; retailing services, including online, of household or kitchen utensils and receptacles, table and toilet, combs and sponges, brushes (except brushes), cases for combs and brushes, cleaning materials, make-up brushes, glassware, glassware, glassware (vessels), glassware for the table, porcelain for the table, majolica for the table, tableware, carafes, fruit plates, cups and bowls, jugs, salad bowls, saucers, tureens, sugar bowls, centerpieces, cups, coffee and tea services, non-electric teapots and coffee pots, timpani, that is, metal stemware, serving dishes, cups, cream jugs, saucers, cups, milk jugs, bowls, legume bowls, egg cups, liquor services, porcelain empties, soap dishes, soap dishes, powder boxes, coffee and tea boxes, glass boxes, of porcelain and ceramics, metal boxes

for distributing paper napkins, sugar jars, candle holders and candlesticks, candelabra, photophores, glass bottle stoppers, bottle openers, corkscrews, porcelain handles (grips), cutting blocks (tables), knife racks for the table, place card holders, menu stands, baskets for household use, trays for household use, tubs, cattle grids, jugs, covers for pots, [earthenware] pots, plant stands [floral decorations], vases, soliflor pots, non-paper pot covers, gardening gloves, laundry clips and tongs, animal combs, animal brushes, shoe horns, shoe brushes, shoe spreaders, isothermal bags, portable non-electric iceboxes, non-electric pot warmers, mosaic glassware, not for construction, towel racks, towel racks (rings and rods), non-metallic piggy banks, toothpick jars, ice buckets, ice buckets, porcelain, earthenware or glass art objects, busts, statues and figures (figurines) made of porcelain, of terracotta or glass, perfume vaporizers, perfume burning jars, all of the above products may be connected, intelligent and/or resort to artificial intelligence; retail services, including online, of tents, hammocks, bags for packing, for storage and transportation, bags and pouches (envelopes, sachets) for packing (made of textile materials), textile straps, ropes, strings, nets, tarpaulins, sails, padding materials (except rubber or plastics), raw fiber textiles, plastic yarns for textile uses, fibers (textile-), all of the above may be connected, intelligent and/or resort to artificial intelligence, textiles and textile materials, fabrics for interior decoration, furnishing fabrics, curtain cords made of textile materials, curtains, household linens, pillow and chair covers, slipcovers, curtains, bedding, blankets and bedding, bed covers, quilts (foot covers), pillowcases, sleeping bags (covers sewn in the shape of a sack replacing classic sheets), sleepsuits, sleeping bags [sack-shaped sheets], travel blankets, bath linen (excluding clothing), bath towels, toilet towels, washing cloths, cloth towels, beach towels, non-paper table linen, tablecloths made of textile materials, napkins (woven), individual non-paper placemats, coasters made of textile materials, handkerchiefs made of fabric, labels made of fabric, horse box wall hangings, all of the above products may be connected, intelligent and/or make use of artificial intelligence; retailing services, including online, of articles of clothing, shoes, headgear, made-up garments, sweaters, vests, knitted garments, shirts, blouses, blouses, polo shirts, T-shirts, pants, liners, costumes, shorts, skirts, dresses, bolero, sweatshirts, turtleneck sweaters, jackets, coats, down jackets, dresses, gabardine [garments], raincoats, overcoats, parkas, ponchos, cloaks, leather goods and imitations thereof, furs [garments], boas [neck fur], non-paper bibs, baby clothing, sportswear, nightwear, night masks, boxers [underwear], swim shorts, swimwear, bathrobes, kimonos, thongs, pareos, aprons [garments], boots, boots, sparto-soled shoes, sandals and beach shoes, sports shoes, ski boots, slippers, shoe soles, hats, caps [headwear], headphones, visors [headwear], headbands [clothing], gloves [clothing], mit-

tens, ski gloves, mufflers (clothing), ties, belts (clothing), wallet belts [clothing], pocket handkerchiefs, silk handkerchiefs, ascots, papillons, ascots, shawls, stoles, tights socks, gaiters, garters, all of the above products may be connected, intelligent and/or resort to artificial intelligence; retail services, including online, of lace, embroidery, ribbons and laces, accessories for women's clothing and shoes, buckles [clothing accessories], zippers and buttons, with hook and rings, fasteners for articles of clothing, brooches [clothing accessories], shoe buckles, shoe ornaments [not made of precious metals], belt buckles, belt clips, scarf loops (clothing accessories), hat ornaments [not made of precious metal], sewing articles, tailoring boxes (sewing boxes), artificial flowers, glove clips, decorative textile articles, hair wrapping ribbons, hair tying articles, hair clips, bun clips, tiaras, elastics for making ponytails, all of the above products may be connected, intelligent and/or resort to artificial intelligence, wall hangings not made of textile materials, wallpaper, wallpaper borders, wall coverings, floor coverings, indoor and outdoor mats, bath mats, beach mats, sports mats, yoga mats, exercise mats, wellness mats, mats, all of the above products can be connected, intelligent and/or resort to artificial intelligence; retail services, including online, of games and toys, playing cards and card games, cases and caskets for playing cards, board games, tokens for games [discs], rocking horses [toys], swings, children's huts (toys), rattles, board games, including puzzles, game balls, dominoes, chess sets, plush toys, puppets, furniture (toys), toy vehicles, spinning tops (toys), masks [toys], boomerangs, flying discs [toys], kites, video game consoles, electric games, electronic video game machines, sporting goods not included in other classes, roller skates, roller skates, surfboards, foosball tables, skateboards, fishing tackle, gloves (sporting accessories), golf gloves, bags for golf clubs with or without wheels, carpets for board games, educational mats, Christmas tree decorations, toys for pets, toy snow globes, stress balls, all of the above products can be connected, intelligent and/or resort to artificial intelligence, smoking items, cigar boxes and cases, cigarette boxes and cases, cigar and cigarette cases, ashtrays, electronic cigarettes, lighters, pipe cleaners, all of the above products can be connected, intelligent and/or resort to artificial intelligence.

36 – Financial, monetary and banking services; insurance services; real estate affairs; financial transactions via blockchain; electronic funds transfer provided via blockchain technology; virtual currency exchange; provision and rental of office space for co-working; crowdfunding; charitable fund raising; charitable fundraising by means of entertainment events.

41 – Teaching; training; entertainment services; sporting and cultural activities; club services [entertainment or education]; organization of competitions for cultural, educational, sports or entertainment purposes;

rental of sports equipment (except vehicles); organization of exhibitions for cultural, educational, sports or entertainment purposes; organization of fashion shows for entertainment purposes; organization and conducting of conferences, seminars, conventions, congresses and shows, for cultural, educational, sports or entertainment purposes; editing and publishing of texts, reviews, articles, illustrations, books, booklets, magazines, newspapers, periodicals, rotogravures, and publications of all kinds and in any form, including electronic and digital publications; editing and publishing information bulletins (newsletters) on third-party offerings available on the internet; creation, production of motion picture films, programs and events including sound and video; editing of videotapes; provision of recreational facilities; booking of seats for performances; game services offered online [starting from a computer network]; games services; bookstore services; services of virtual reality games available online from a computer network via an interactive web site; provision and rental of premises for events for cultural, educational, sports, or entertainment purposes.

43 – Catering services [food]; temporary accommodation; services for providing food and drink; cafeteria, restaurant, bar, bar-restaurant, and cafe services; tea rooms; hotel services; rental of furniture, linens, table settings, and equipment for the provision of food and drink; food preparation; consulting services concerning food; cooking consulting.

(260) AM 2023 121403 A

(800) 1442377

(151) 2018 05 03

(891) 2022 12 19

(731) Rimowa GmbH

Richard-Byrd-Straße 13, 50829 Köln, Germany

(540)



(591) Black, white

(531) 26.04.03; 26.04.18; 26.13.25

(511)

25 – Clothing; headgear for wear; footwear; tee-shirts; sweaters; knitwear [clothing]; sports jerseys; shirts; stockings; pullovers; polo shirts; bandanas [neckerchiefs]; scarves; neck scarves [mufflers]; sashes for wear; rainwear; caps [headwear]; baseball caps; sleep masks.

(260) AM 2023 121404 A
 (800) 1452467
 (151) 2018 05 03
 (891) 2022 12 19
 (731) Rimowa GmbH
 Richard-Byrd-Strasse 13, 50829 Köln,
 Germany

(540)

RIMOWA

(591) Black, white

(531) 27.05.01

(511)

25 – Clothing; headgear; footwear; tee-shirts; sweaters; knitwear [clothing]; sports jerseys; shirts; stockings; pullovers; polo shirts; bandanas [neckerchiefs]; scarves; neck scarves [mufflers]; sashes for wear; rainwear; caps [headwear]; baseball caps; sleep masks.

(260) AM 2023 121405 A

(800) 1503491

(151) 2019 07 22

(891) 2022 12 07

(731) BPerfect Ltd

Block E Knockmore Industrial Estate, Moira
 Road, Lisburn BT28 2EJ, United Kingdom

(540)

BPerfect Cosmetics

(591) Black, white

(511)

3 – Cosmetics; make-up; skin, nail and eye care preparations; eye make-up; eye shadows; eyebrow make-up, eyebrow pencils; eye liners; cheek colors; blush; rouge; lip balm; lipstick; lip gloss; false eyelashes; facial make-up; foundation; face powder; make-up setting sprays; make-up priming cream; multi functional make-up; skin care preparations; toiletries; essential oils; hair care preparations; body care preparations, perfumery; tanning preparations; self-tanning lotions, self-tanning oils; self-tanning mousse; self-tanning gels, sun care products, suntan lotions, suntan oils; suntan creams; suntan gels, sun block lotions, sun block oils, sun block creams, sun block gels; beauty masks; cotton wool for cosmetic purposes; cosmetic kits; adhesives for cosmetic purposes; false nails; nail art stickers.

21 – Cosmetic and toilet utensils; cosmetic applicators, applicators for applying tanning preparations, applicator sticks for applying make-up; mitts for applying tanning preparations; exfoliating mitts; exfoliating pads; cosmetic brushes; make-up brushes; make-up sponges; hair brushes; facial cleansing sponges; facial sponges for applying make-up; cosmetic cases sold filled with cosmetic brushes; parts and fittings for the aforesaid goods.

(260) AM 2023 121406 A

(800) 1505420

(151) 2019 09 03

(891) 2023 01 10

(731) BSH Hausgeräte GmbH

Carl-Wery-Str. 34, 81739 München,
 Germany

(540)

 Home Connect

(591) Black, white

(531) 01.15.21; 07.01.08; 07.01.09; 07.01.24

(511)

9 – Scientific, nautical, surveying, photographic, cinematographic, optical, weighing apparatus, measuring apparatus, signaling apparatus, checking apparatus, life-saving apparatus, teaching apparatus; optical, weighing instruments, measuring instruments, signaling instruments, checking instruments, life-saving instruments, teaching instruments; apparatus for conducting, switching, converting, storing, controlling, checking electricity; instruments for conducting, switching, converting, storing, controlling, checking electricity; apparatus for recording, transmission, processing, reproduction of sound, image, data; magnetic recording carriers; computer hardware for data processing; computers; computer software; recorded data carriers of all kinds (included in this class); unrecorded data carriers of all kinds (included in this class); computer programs (stored); electronically stored data (downloadable); electronic publications (downloadable); special installations for house and building technology, essentially consisting of computers including the associated software and/or essentially consisting of electronic apparatus and instruments (included in this class) for monitoring, controlling, operating miscellaneous electrical devices for house and building technology and for alarm systems, heating systems, climate systems, lighting systems, blind systems, monitoring systems, ventilation systems; access control systems; security systems; multimedia systems; automated control equipment for buildings; devices for communication and information technology and telecommunications, aforementioned goods included in this class.

38 – Telecommunications; provision of electronic online access to information databases and files sent via telecommunications media; provision of access to information on the Internet and via mobile terminals; electronic exchange of messages by means of chatlines, chatrooms and Internet forums; telecommunications by means of platforms and portals on the Internet and via mobile terminals; provision of access to an online interface for checking heating devices, water supply devices, lighting devices, sanitary devices, climate devices, ventilation devices and security devices; information and consulting in relation to all afo-

rementioned services; electronic message transmission.

(260) AM 2023 121407 A

(800) 1583796

(151) 2021 02 16

(891) 2023 01 10

(731) IPack B.V.

Cruquiusweg 98 W, NL-1019 AJ Amsterdam, Netherlands

(540)



(591) Blue, white, yellow, black and red

(531) 01.01.02; 01.03.02; 03.01.14; 03.01.26; 26.04.02; 29.01.14

(511)

32 – Ales; beers; wheat beer.

(260) AM 2023 121408 A

(800) 1648753

(151) 2021 11 18

(891) 2022 12 13

(731) YILDIZ HOLDİNG ANONİM ŞİRKETİ

Kısıklı Mahallesi, Çeşme Çıkmazı Sokak, No:6/1, Üsküdar, İstanbul, Türkiye

(540)



(591) Red and brown

(531) 27.05.01; 27.05.01; 27.05.09; 27.05.09; 29.01.12; 29.01.12

(511)

30 – Confectionery, chocolate, biscuits, crackers, wafers, cakes.

(260) AM 2023 121463 A

(800) 1710455

(151) 2022 10 24

(891) 2022 10 24

(731) GROSCHOPP AG Drives & More

Greefsaltee 49, 41747 Viersen, Germany

(540)

GroSol

(591) Black, white

(511)

9 – Accumulators for photovoltaic power; solar batteries; solar batteries for industrial use; solar batteries for domestic use; electrolyzers [electrolytic cells]; photovoltaic inverters; photovoltaic solar modules; photovoltaic apparatus and installations for generating solar electricity; photovoltaic installations for generating electricity [photovoltaic power plants]; calibrated photovoltaic reference cells; photovoltaic cells; solar energy collectors for electricity generation; solar panel arrays; photovoltaic modules; solar modules; crystalline silicon solar power cells; solar cells for electricity generation; solar cells; galvanic batteries; dry-cell batteries; solar panels; solar panels for the production of electricity; portable solar panels for generating electricity; photovoltaic apparatus for converting solar radiation to electrical energy; photovoltaic apparatus for generating electricity; electricity storage apparatus; apparatus and instruments for accumulating and storing electricity.

11 – Evacuated heat pipe solar collectors [heat exchangers]; solar thermal collectors [heating]; solar cell lighting apparatus; heat pumps.

35 – Retail services in relation to electricity storage apparatus; wholesale services in relation to electricity storage apparatus; online retail services in relation to electricity storage apparatus; retail services in relation to photovoltaic apparatus for converting solar radiation to electrical energy; wholesale services in relation to photovoltaic apparatus for converting solar radiation to electrical energy; online retail services in relation to photovoltaic apparatus for converting solar radiation to electrical energy; retail services in relation to solar panels; wholesale services in relation to solar panels; online retail services in relation to solar panels; retail services in relation to solar modules; wholesale services in relation to solar modules; online retail services in relation to solar modules; retail services in relation to solar cells for electricity generation; wholesale services in relation to solar cells for electricity generation; online retail services in relation to solar cells for electricity generation; retail services in relation to solar energy collectors for electricity generation; wholesale services in relation to solar energy collectors for electricity generation; online retail services in relation to solar energy collectors for electricity generation; retail services in relation to photovoltaic installations for generating electricity [photovoltaic power plants]; wholesale services in relation to photovoltaic installations for generating electricity [photovoltaic power plants]; online retail services in relation to photovoltaic installations for generating electricity [photovoltaic power plants]; retail services in relation to photovoltaic solar modules; wholesale services in relation to photovoltaic solar modules; online retail services in relation to photovoltaic solar modules; retail services in relation to solar batteries; wholesale services in relation to solar batteries; online re-

tail services in relation to solar batteries; provision of information relating to marketing; direct marketing; arranging and conducting of marketing events; distribution of advertising, marketing and promotional material.

37 – Installation of photovoltaic cells and modules; maintenance, repair and reconditioning of photovoltaic apparatus and installations; installation of residential solar panel power systems; installation of non-residential solar panel power systems.

42 – Energy auditing; consultancy in the field of energy-saving; conducting technical project studies.

(260) AM 2023 121464 A

(800) 1710483

(151) 2022 10 07

(891) 2022 10 07

(731) "FUNFRUIT" LLC

G. Hovsepyan str. 20, Norq-Marash, 0047
Yerevan, Armenia

(540)



(591) Black, apricot, light green, dark green and red

(531) 05.03.14; 05.07.13; 05.07.14; 05.07.15;
05.07.24; 27.05.17; 29.01.15

(526) FRUIT.

(511)

29 – Fruit, preserved; frozen fruits; fruits, tinned; fruit-based snack food; compotes; fruit, processed; fruit chips, dried fruits.

31 – Citrus fruit, fresh; berries, fresh; fruit, fresh; grapes, fresh.

32 – Non-alcoholic fruit extracts (extracts); non-alcoholic fruit juice beverage lemonades.

33 – Alcoholic extracts; cider; wine; kirsch; brandy; piquette; perry; alcoholic beverages containing fruit.

35 – Retail and wholesale services regarding fruit preserved, frozen fruits, fruits tinned, fruit-based snack food, compotes, fruit processed, fruit chips, dried fruits, citrus fruit fresh, berries fresh, fruit fresh, grapes fresh, non alcoholic fruits extracts, non-alcoholic fruit juice beverages, lemonades, fruits spirit extracts, cider, wine, kirsch, brandy, piquette, perry, alcoholic beverages containing fruit.

(260) AM 2023 121465 A

(800) 1710596

(151) 2022 09 19

(891) 2022 09 19

(731) Limited liability company "Suncity"

Zavodskoy dr., 1, apt. H13, 10 rm.,
RU-390013 Ryazan, Ryazan region, Russian
Federation

(540)



HAVVS

(591) Black, white

(531) 03.05.19; 03.05.20; 27.05.01

(511)

9 – Spectacle frames; spectacles; sunglasses; goggles for sports; spectacle lenses; spectacle cases; spectacle chains; spectacle cords.

18 – Pocket wallets; business card cases; credit card cases; chamois leather, other than for cleaning purposes; umbrellas; parasols; frames for umbrellas or parasols; frames for bags; card cases; cases of leather or leatherboard; valves of leather; imitation leather; leather, unworked or semi-worked; leatherboard; umbrella rings; hat boxes of leather; boxes of leather or leatherboard; boxes of vulcanized fiber; purses; chain mesh purses; bags (envelopes, pouches) of leather, for packaging; moleskin, imitation of leather; vanity cases, not fitted; collars for animals; leather leashes; clothing for pets; luggage tags; garment bags for travel; shoulder belts of leather; briefcases; fur; randsels (Japanese school satchels); haversacks; leather straps; umbrella handles; walking stick handles; suitcase handles; rucksacks; travelling bags; umbrella or parasol ribs; bags; handbags; beach bags; compression cubes adapted for luggage; bags for sports; bags for campers; reusable shopping bags; wheeled shopping bags; school bags; pouch baby carriers; trunks; walking sticks; umbrella sticks; key cases; whips; saddlery; suitcases; motorized suitcases; suitcases with wheels; valises; attaché cases; umbrella covers; kid; curried skins; animal skins; cattle skins; labels of leather.

25 – Wimples; bandanas; underwear; berets; overalls; boas; teddies; boxer shorts; ankle boots; breeches for wear; trousers; football shoes; brassieres; valenki (felted boots); mittens; collars; detachable collars; shirt yokes; veils; gabardines; galoshes; neckties; ascots; gaiters; leggings; boot uppers; corselets; jerseys; waistcoats; sports jerseys; hosiery; hoods; hat frames; pockets for clothing; scarves; caps being headwear; cap peaks; visors being headwear; tights; slips (underclothing); combinations; bodices; corsets (underclothing); suits; bathing suits; beach clothes; leotards; jackets (clothing); stuff jackets; leggings (trousers); camiso-

les; sports singlets; cuffs; short-sleeve shirts; mantillas; coats; sleep masks; furs (clothing); fingerless gloves; muffs (clothing); footmuffs, not electrically heated; bibs, not of paper; bibs, sleeved, not of paper; fur stoles; ear muffs; socks; footwear; beach shoes; sports shoes; clothing; paper clothing; outerclothing; embroidered clothing; ready-made clothing; motorists' clothing; cyclists' clothing; clothing for gymnastics; clothing of imitations of leather; clothing of leather; waterproof clothing; uniforms; fittings of metal for footwear; overcoats; knickers; parkas; pelerines; gloves (clothing); ski gloves; pyjamas; bathing trunks; shirt fronts; scarfs; pocket squares; dresses; headbands (clothing); garters; sock suspenders; stocking suspenders; ready-made linings; braces for clothing; half-boots; lace boots; ponchos; girdles; belts (clothing); money belts (clothing); sweaters; heelpieces for stockings; welts for footwear; shirts; wooden shoes; sandals; bath sandals; boots; jumper dresses; sarongs; footwear uppers; inner soles; bath slippers; knitwear; underpants; shoes; slippers; skull caps; turbans; headwear; aprons; tee-shirts; dressing gowns; bath robes; top hats; tips for footwear; stockings; shawls; paper hats (clothing); shower caps; bathing caps; hats; babies' pants; pelisses; espadrilles; skirts; petticoats; skorts.

(260) AM 2023 121466 A

(800) 1710624

(151) 2022 12 21

(891) 2022 12 21

(731) Kurzenev Dmitriy Aleksandrovich

Startovaya st.,18/1, 97 apt., RU-344092 Rostov-on-Don, Russian Federation

(540)

rDevice
r e a l D e v i c e

(591) Black, white

(531) 27.05.01; 27.05.10

(526) realDevice

(511)

9 – DVD players; aerials; remote control apparatus; monitoring apparatus, other than for medical purposes; Global Positioning System [GPS] apparatus; flashing lights [luminous signals]; telephone apparatus; igniting apparatus, electric, for igniting at a distance; electronic key fobs being remote control apparatus; camcorders; video telephones; video screens; hands-free kits for telephones; dictating machines; wearable video display monitors; electronic numeric displays; electronic interactive whiteboards; locks, electric; bells [warning devices]; alarm bells, electric; signal bells; signs, luminous; simulators for the steering and control of vehicles; pressure indicators; automatic indicators of low pressure in vehicle tyres; temperature indicators; interfaces for computers; rearview cameras

for vehicles; electronic book readers; electronic agendas; laptop computers; tablet computers; notebook computers; portable media players; digital weather stations; monitors [computer hardware]; computer hardware; signalling panels, luminous or mechanical; compact disc players; personal digital assistants [PDAs]; diagnostic apparatus, not for medical purposes; speed checking apparatus for vehicles; navigational instruments; measuring devices, electric; observation instruments; navigation apparatus for vehicles [on-board computers]; regulating apparatus, electric; audio- and video-receivers; record players; control panels [electricity]; vehicle radios; voltage regulators for vehicles; security surveillance robots; subwoofers; electronic access control systems for interlocking doors; smartglasses; smartphones; smartwatches; speed indicators; personal stereos; mileage recorders for vehicles; revolution counters; taximeters; tachometers; television apparatus; mobile telephones; interactive touch screen terminals; thermostats for vehicles; quantity indicators; petrol gauges; water level indicators; steering apparatus, automatic, for vehicles; video recorders; sound reproduction apparatus; theft prevention installations, electric; devices for the projection of virtual keyboards; acoustic alarms; anti-theft warning apparatus; computer peripheral devices; alarms; fog signals, non-explosive.

35 – Cost price analysis; computerized file management; demonstration of goods; business administration; opinion polling; market studies; providing business information; providing commercial information and advice for consumers in the choice of products and services; business investigations; business research; marketing research; professional business consultancy; marketing; business management services; organization of exhibitions for commercial or advertising purposes; organization of trade fairs for commercial or advertising purposes; shop window dressing; business appraisals; commercial intermediation services; presentation of goods on communication media, for retail purposes; economic forecasting; sales promotion for others; publication of publicity texts; radio advertising; distribution of samples; dissemination of advertising matter; direct mail advertising; advertising; online advertising on a computer network; outdoor advertising; advertising by mail order; television advertising; compilation of statistics; systemization of information into computer databases; office functions; administrative processing of purchase orders; procurement services for others [purchasing goods and services for other businesses].

37 – Providing information relating to repairs; vehicle maintenance; repair; motor vehicle maintenance and repair; burglar alarm installation and repair; electric appliance installation and repair; installation services; installation, maintenance and repair of computer hardware; machinery installation, maintenance and repair.

(260) AM 2023 121467 A
 (800) 1710668
 (151) 2022 12 16
 (891) 2022 12 16
 (731) HERMES INTERNATIONAL
 24, rue du Faubourg Saint Honoré, F-75008
 PARIS, France
 (540)



(591) Black, white
 (531) 26.01.03; 26.01.22; 27.05.01
 (511)
 3 – Perfumes, perfumery products, eau de toilette, eau de parfum, soaps for cosmetic use, shower gels, shampoos, cosmetic lotions for the hair, cosmetic lotions for the body, cosmetics, beauty creams for the body, deodorants for personal use.

(260) AM 2023 121468 A
 (800) 1710669
 (151) 2022 11 29
 (891) 2022 11 29
 (731) Swiss Pharma International AG
 Lindenstrasse 22, CH-8008 Zurich, Switzerland
 (540)

VIQUALPRO'D

(591) Black, white
 (511)
 5 – Pharmaceutical preparations; medical preparations; sanitary products for medical use; dietetic foods for medical use; dietetic substances for medical use; dietary supplements for human consumption; vitamins and vitamin preparations.
 40 – Custom manufacturing of pharmaceutical products to the order and requirements of a customer; Custom manufacturing services for others of pharmaceutical products to the order and requirements of a customer; treatment of materials, namely, pharmaceutical and chemical products and their components used in the manufacture of pharmaceuticals.
 42 – Testing, inspection of pharmaceuticals, or research in the field of pharmaceuticals; Pharmaceutical research and development; development of pharmaceutical preparations and medicines; laboratory research services relating to pharmaceuticals.

(260) AM 2023 121469 A
 (800) 1710703
 (151) 2022 12 02
 (891) 2022 12 02
 (731) Stiftung Ethereum (Foundation Ethereum)
 Zeughausgasse 7a, CH-6300 Zug,
 Switzerland
 (540)

GETH

(591) Black, white
 (511)
 9 – Computer application software for blockchain platforms, namely, software platforms for distributed applications and software using a consensus engine integrating blockchain technology for securing data with cryptographic information; software platforms for the development and construction of distributed software applications and distributed computing platforms; computer software platforms for block chain; software platforms for the development, construction and operation of distributed applications.
 42 – Software development services; design, development and implementation of software for distributed computing platforms; design, development and implementation of software in the field of block chains; research and development services for computer software; advice in software development and product development in the field of distributed computing platforms; advice in software development and product development in the field of block chains.

(260) AM 2023 121470 A
 (800) 1710761
 (151) 2022 11 10
 (891) 2022 11 10
 (731) KAWASAKI MOTORS, LTD.
 1-1, Kawasaki-cho, Akashi-shi, Hyogo
 673-8666, Japan
 (540)



(591) Black, white
 (531) 26.05.04; 26.13.25
 (511)
 12 – Vessels and their parts and fittings; automobiles and their parts and fittings; two-wheeled motor vehicles, bicycles and their parts and fittings; bicycles for children; motorcycles; electric vehicles; hybrid vehicles; hydroplanes; hydrogen fueled vehicles; personal watercraft; vehicles; vehicles for locomotion by

land, air or water; all-terrain vehicles; side by side vehicles; utility vehicles.

35 – Retail services or wholesale services for vessels and their parts and fittings; retail services or wholesale services for automobiles and their parts and fittings; retail services or wholesale services for two-wheeled motor vehicles, bicycles and their parts and fittings; retail services or wholesale services for bicycles for children; retail services or wholesale services for motorcycles; retail services or wholesale services for electric vehicles; retail services or wholesale services for hybrid vehicles; retail services or wholesale services for hydroplanes; retail services or wholesale services for hydrogen fueled vehicles; retail services or wholesale services for personal watercraft; retail services or wholesale services for vehicles; retail services or wholesale services for vehicles for locomotion by land, air or water; retail services or wholesale services for all-terrain vehicles; retail services or wholesale services for side by side vehicles; retail services or wholesale services for utility vehicles.

37 – Repair or maintenance of vessels and their parts and fittings; repair or maintenance of automobiles and their parts and fittings; repair or maintenance of two-wheeled motor vehicles, bicycles and their parts and fittings; repair or maintenance of bicycles for children; repair or maintenance of motorcycles; repair or maintenance of electric vehicles; repair or maintenance of hybrid vehicles; repair or maintenance of hydroplanes; repair or maintenance of hydrogen fueled vehicles; repair or maintenance of personal watercraft; repair or maintenance of vehicles; repair or maintenance of vehicles for locomotion by land, air or water; repair or maintenance of all-terrain vehicles; repair or maintenance of side by side vehicles; repair or maintenance of utility vehicles.

(260) AM 2023 121471 A

(800) 1710776

(151) 2022 08 26

(891) 2022 08 26

(731) SESAMI CASH MANAGEMENT TECHNOLOGIES CORPORATION
20th Floor, 1250 RENÉ-LÉVESQUE BLVD
WEST, Montreal, Q.C. H3B4W8, Canada

(540)

SESAMI

(591) Black, white

(511)

9 – Cash Recyclers (term considered too vague by the International Bureau – Rule 13 (2) (b) of the Regulations), safes (term considered too vague by the International Bureau – Rule 13 (2) (b) of the Regulations), software for processing, managing and reporting cash on hand.

39 – Armored car services, cash in transit services.

42 – Platform as a Service for processing, managing and reporting cash on hand by retailers and for banks to process, manage and monitor accounts.

(260) AM 2023 121472 A

(800) 1710825

(151) 2022 12 21

(891) 2022 12 21

(731) Closed Joint Stock Company "Sotex
"PharmFirm"
pos. Belikovo, d. 11, selskoe poselenie
Berezhnyakovskoe, Sergievo-Posadsky
municipal district, RU-141345 Moscow Region,
Russian Federation

(540)

Cereton

(591) Black, white

(531) 27.05.01

(511)

5 – Chemico-pharmaceutical preparations; medicines for human purposes; nutritional supplements; pharmaceutical preparations; suppositories; vitamin preparations.

(260) AM 2023 121473 A

(800) 1710826

(151) 2022 12 21

(891) 2022 12 21

(731) Closed Joint Stock Company, "Sotex
"PharmFirm"
pos. Belikovo, d. 11, selskoe poselenie
Berezhnyakovskoe, Sergievo-Posadsky
municipal district, RU-141345 Moscow
Region, Russian Federation

(540)

Цемелан

(591) Black, white

(531) 28.05

(511)

5 – Analgesics; anaesthetics; nutritional supplements; cachets for pharmaceutical purposes; chemico-pharmaceutical preparations; drugs for medical purposes; pastilles for pharmaceutical purposes; pomades for medical purposes; vitamin preparations; pharmaceutical preparations; suppositories.

(260) AM 2023 121474 A

(800) 1710872

(151) 2022 11 03

(891) 2022 11 03

(731) Haiyan Ouyate Automobile Fittings Co., Ltd
No.1, Jinping Road, Qinshan Town, Haiyan
County, Jiaying City, 314300 Zhejiang
Province, China

(540)



(591) Black, white

(531) 03.07.16; 03.07.24; 26.01.01; 26.01.12;
26.01.15; 26.13.25; 27.05.01; 28.03

(511)

12 – Brake segments for land vehicles; clutches for land vehicles.

(260) AM 2023 121475 A

(800) 1710918

(151) 2022 08 16

(891) 2022 08 16

(731) EMILIO PUCCI INTERNATIONAL S.r.l

Via Fieno 3, I-20123 Milan, Italy

(540)



(591) Black, white

(531) 03.09.01; 03.09.10; 03.09.24

(511)

9 – Non-electronic accessories for mobile telephones, earphones, computers, photographic devices, digital tablets and mp3 players, namely bags, pouches, cases, covers and hard covers specifically for mobile telephones, earphones, computers, photographic devices, digital tablets and mp3 player; straps for mobile telephones; usb flash drives; headsets; eyewear; spectacles, sunglasses and spectacle cases; spectacle frames; chains, cords or small chains for spectacles; ski helmets; sports helmets; sports glasses; software; augmented reality software; virtual reality software; downloadable virtual goods, namely computer programs representing glasses, eyewear, telephone and tablet accessories, jewelry items, timepieces, textiles, decorative objects for home, furniture, tableware, leather goods, clothing, shoes, headgear, fashion accessories, images, collectible images, paintings, texts, photographs, collectible cards, collectible stickers, works of art, digital collectibles, for use in virtual environments; computer software for managing transactions using blockchain technology; downloadable software featuring virtual goods, digital collectibles and digital trading cards; downloadable mobile applications; downloadable multimedia files authenticated by

non-fungible tokens [NFTs]; downloadable computer software used as a digital wallet; virtual reality headset; virtual reality glasses.

14 – Works of art of precious metal; precious metals and their alloys (other than for dental use); jewelry, jewelry items; jewelry articles for headwear; earrings; cuff links; bracelets; brooches; necklaces; chains [jewelry]; pendants; finger rings [jewelry]; rings [jewelry]; key rings (trinkets or fobs); charms for key rings; pins [jewelry]; tie pins; clasps for jewelry; medals; medallions [jewelry]; pearls, precious stones, semi-precious stones, gemstones [jewelry]; jewelry boxes; jewelry rolls; timepieces and chronometric instruments; watches; watch bands; watch cases.

18 – Leather and imitations of leather; luggage; traveling bags, traveling sets (leatherware), trunks and suitcases, garment bags for travel, luggage tags, vanity cases sold empty; backpacks, shoulder bags, handbags, shopping bags, beach bags, sports bags, belt bags, attaché cases, document cases and briefcases of leather; pouches, wallets, coin purses, purses, key cases, card cases, umbrellas.

20 – Furniture; armchairs, office armchairs, benches, chairs (seats), dining chairs, office chairs, office seats, divans, settees, sofas, stools, beds, cabinet work, CD storage racks, chest of drawers, desks, tables, dining tables, night tables, office tables, cabinets, display cabinets, racks, plate racks, bookcases, wardrobes, shoe cabinets, furniture chests, mirrors; all the aforesaid goods being made of wood or wood substitutes, metal, bamboo, cork, corozo, rattan, unworked or semi-worked, reed, unworked or semi-worked, horn, unworked or semi-worked, ivory, unworked or semi-worked and substitutes for all these materials, or of plastics; cushions, mattress pads, sleeping pads, seat pads.

21 – Household or kitchen utensils and containers; glasses [receptacles]; goblets, not of precious metal; figurines of porcelain, ceramic, earthenware, terracotta or glass; porcelain articles for decorative purposes; works of art of porcelain, ceramic, earthenware, terracotta or glass; boxes of porcelain; boxes of earthenware; enamel boxes; bowls for plants; brushes; flower pots; kitchen utensils; tableware, other than knives, forks and spoons; valet trays [receptacles for small objects] for household purposes; dishes; mugs; meal trays; laundry baskets; coasters (tableware); mixing spoons [kitchen utensils]; tealight burners; bottles; cookie jars; glass jars [carboys]; powder compacts; make-up brushes; combs; perfume bottles; sponges; bowls [basins]; cotton ball jars; towel baskets; china ornaments; coffee services [tableware]; tea services [tableware]; toilet utensils; table napkin holders; soap holders; candy boxes; earthenware; table plates; ice buckets; buckets; flower vases; pots; perfume burners; drinking vessels; decanters; epergnes; coupes; knife rests; candelabra [candlesticks].

24 – Lap robes; labels of textile materials; upholstery fabrics; sleeping bags for babies; bath linen except clothing; bed linen; household linen; curtains of textile or plastic; fabrics for textile use.

25 – Clothing; underwear; lingerie; sweaters; shirts; tee-shirts; scarves; neckties; shawls; vests; skirts; waterproof clothing; overcoats; coats; jackets; suspenders; trousers; denim pants; pullovers; dresses; combinations [clothing], sweatshirts; belts (clothing); headbands [clothing]; long scarves; gloves; tights; socks; bathing suits; sportswear; clothing for skiing; bathrobes; pajamas; nightgowns; shorts; footwear, shoes, boots, slippers; headwear; caps; stocking caps; hats; sleep masks.

28 – Games, toys and playthings; gymnastic and sporting articles; sporting and physical exercise equipment; sports games; sporting articles and equipment; gloves for sports; appliances for gymnastics; arm guards for sports use; bags adapted for carrying sporting articles; ball nets; balls for sports; gymnastic articles; punchbags; face masks for sports; exercise bikes; volley balls; volleyball equipment; jump ropes; kites; skis; ski skins; ski bindings; ski boards; ski bags; ski cases; ski covers; snowshoes; snowboards; snow sledges [playthings]; body boards; surf boards; surf skis; surfboards covers; fitted protective covers specially adapted for skis; sole coverings for skis; luges; golf bags; golf irons; golfing gloves; golf club covers; rackets; table tennis tables; table tennis bats; table tennis nets; tennis balls, tennis rackets; tennis nets; tennis racket covers; swimming equipment, namely swimming flippers, swimming belts, swimming jackets, swimming boards, swimming gloves, swimming floats; flippers for diving; inflatable swimming floats; inflatable swimming pools; kiteboards; sail boards; skim boards; wake boards; water skis.

(260) AM 2023 121476 A

(800) 1710929

(151) 2022 11 16

(891) 2022 11 16

(731) BYD COMPANY LIMITED

No. 1, Yan'an Road, Kuichong Street, Dapeng
New District, Shenzhen, Guangdong, China

(540)

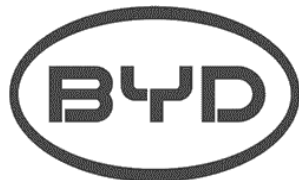

(591) Black, white

(531) 26.01.02; 26.01.03; 26.01.20; 27.05.01;
27.05.23

(511)

7 – Agricultural machines; rinsing machines; converters for steelworks; oil refining machines; agitators;

hydraulic turbines; piston rings; centrifugal pumps; connecting rods for machines, motors and engines.

9 – Computers; apparatus to check stamping mail; toner cartridges, unfilled, for printers and photocopiers; signal lanterns; particle accelerators; fire extinguishers; batteries, electric, for vehicles; alarm bells, electric; clothing for protection against accidents, irradiation and fire; conductors, electric; heat regulating apparatus.

11 – Lighting installations for air vehicles; gas lamps; roasting spits; freezers; hot air apparatus; hydrants; ventilation hoods; hot air bath fittings; water purification installations; friction lighters for igniting gas.

12 – Rolling stock for railways; forklift trucks; motor buses; cars / automobiles / motor cars; driverless cars [autonomous cars]; bicycles; vehicles for locomotion by land, air, water or rail; aerial conveyors; wheelchairs; horse-drawn carriages; tires for vehicle wheels; aircraft; boats; air pumps [vehicle accessories].

37 – Building construction supervision; asphaltting; mining extraction; cleaning of buildings [interior]; boiler cleaning and repair; electric appliance installation and repair; motor vehicle maintenance and repair; airplane maintenance and repair; shipbuilding; photographic apparatus repair; clock and watch repair; strong-room maintenance and repair; rustproofing; retreading of tires; furniture maintenance; laundering; disinfecting.

(260) AM 2023 121477 A

(800) 1710937

(151) 2022 07 27

(891) 2022 07 27

(731) Carlsberg Breweries A/S

J.C. Jacobsens Gade 1, DK-1799 Copenhagen
V, Denmark

(540)



(591) White, light green, green and red

(531) 02.01.02; 02.01.20; 02.01.23; 24.01.05;
24.01.15; 26.04.05; 26.04.18; 26.04.24;
27.05.01; 27.05.08; 27.05.10; 27.05.24;
29.01.13

(511)

32 – Beer; non-alcoholic beverages; mineral waters and carbonated waters; fruit juice beverages; fruit juice and other preparations for use in the manufacture of non-alcoholic beverages; non-alcoholic beer.

33 – Alcoholic beverages [except beers]; alcoholic preparations for making beverages; cider.

(260) AM 2023 121478 A

(800) 1710977

(151) 2022 11 14

(891) 2022 11 14

(731) Qingdao Daiyoujia Biological Technology Co., Ltd.

Room 1201, 12th Floor, Building 1, 19 Qinling Road, Laoshan District, Qingdao City, 266100 Shandong Province, China

(540)

KATO-KATO

(591) Black, white

(531) 27.05.01

(511)

3 – Cosmetics; cotton wool for cosmetic purposes; hair conditioner; hair dyes; shampoos; facial cleansing milk; teeth whitening strips; beauty masks; perfumes; essential oils.

(260) AM 2023 121479 A

(800) 1710983

(151) 2022 12 05

(891) 2022 12 05

(731) PJSC "Cherkizovo Group"

ul. Cherkizovskaya, d. 1, str. 1, kabinet 206, ter. Myasopererabotka, d. Topkanovo, g.o. Kashira, RU-142931 Moskovskaya oblast, Russian Federation

(540)



(591) Black and golden

(531) 02.09.01; 07.01.09; 07.01.24; 26.04.05;

26.04.16; 26.04.24; 26.11.01; 26.11.09;

27.05.01; 27.05.24; 28.05; 29.01.12

(526) PREMIUM

(511)

29 – Agar-agar for culinary purposes; aloe vera prepared for human consumption; alginates for culinary purposes; andouillettes; anchovy, not live; peanuts, prepared; artichokes, preserved; albumen for culinary purposes; white of eggs; beans, preserved; soya beans, preserved, for food; broth; ginger jam; ham; fatty substances for the manufacture of edible fats; laver, preserved; edible birds' nests; sea-cucumbers, not live; cabbage rolls stuffed with meat; peas, preserved; mushrooms, preserved; guacamole; game, not live; gelatine; meat jellies; jellies for food; fruit jellies; yolk of eggs; coconut fat; bone oil for food; lard; suet for food; edible fats; rennet; fruit-based snack food; milk substitutes; soya patties; tofu patties; charcuterie; raisins; caviar; aubergine paste; vegetable marrow pa-

ste; fish roe, prepared; ginger, preserved; crystallized ginger; pickled ginger; yogurt; sauerkraut; cassoulet; quark; kephir; kimchi; isinglass for food; clams, not live; potato-based dumplings; klipfish [salted and dried cod]; milk shakes; black pudding; onion rings; arrangements of processed fruit; compotes; meat, tinned; vegetables, tinned; fish, tinned; fruits, tinned; duck confits; broth concentrates; vegetable-based concentrate for cooking; fruit-based concentrate for cooking; corn dogs; gherkins; shrimps, not live; prawns, not live; buttercream; croquettes; silkworm chrysalis for human consumption; sweet corn, processed; koumiss; spiny lobsters, not live; lecithin for culinary purposes; edible ant larvae, prepared; salmon, not live; onions, preserved; margarine; marmalade; oils for food; peanut butter; cocoa butter for food; coconut oil for food; coconut butter; maize oil for food; sesame oil for food; linseed oil for food; extra virgin olive oil for food; olive oil for food; palm oil for food; palm kernel oil for food; sunflower oil for food; rape oil for food; butter; soya bean oil for food; mussels, not live; almonds, ground; animal marrow for food; molluscs, not live; milk; peanut milk; peanut milk for culinary purposes; coconut milk; coconut milk for culinary purposes; almond milk; almond milk for culinary purposes; oat milk; rice milk; rice milk for culinary purposes; albumin milk; condensed milk; soured milk; soya milk; powdered milk; fermented baked milk; fish meal for human consumption; vegetable mousses; fish mousses; fruit pulp; meat; meat, preserved; freeze-dried meat; lactic acid drinks; milk beverages, milk predominating; peanut milk-based beverages; coconut milk-based beverages; almond milk-based beverages; edible insects, not live; sausage casings, natural or artificial; vegetables, preserved; freeze-dried vegetables; vegetables, processed; vegetables, dried; vegetables, cooked; hash browns; potato fritters; olives, preserved; lobsters, not live; omelettes; flavoured nuts; candied nuts; coconut, desiccated; nuts, prepared; tomato paste; pressed fruit paste; liver pâté; pectin for culinary purposes; preserved peppers; liver; pickles; jams; powdered eggs; milk products; fish-based foodstuffs; poultry, not live; white pudding; bulgogi; pollen prepared as foodstuff; cranberry compote; tomato purée; apple purée; crayfish, not live; crustaceans, not live; shellfish, not live; ratatouille; fish, preserved; fish, not live; salted fish; vegetable salads; fruit salads; bacon; sardines, not live; satay; pork; herrings, not live; seeds, prepared; sunflower seeds, prepared; cream [dairy products]; whipped cream; vegetable-based cream; fat-containing mixtures for bread slices; smetana; lemon juice for culinary purposes; tomato juice for cooking; vegetable juices for cooking; salted meats; sausages; sausages in batter; hot dog sausages; preparations for making bouillon; preparations for making soup; tofu skin; vegetable-based spreads; nut-based spreads; tripe; soups; vegetable soup preparations; whey; cottage cheese fritters; cheese; tajine [prepared meat, fish or vegetable dish]; tahini; cottage

cheese; tofu; tempeh; truffles, preserved; tuna, not live; oysters, not live; falafel; milk ferments for culinary purposes; fish fillets; dates; crystallized fruits; frozen fruits; fruit, preserved; fruit, processed; fruit preserved in alcohol; fruit, stewed; hazelnuts, prepared; potato flakes; hummus; edible flowers, dried; fruit peel; preserved garlic; lentils, preserved; potato crisps; low-fat potato crisps; fruit chips; choucroute garnie; non-alcoholic eggnog; seaweed extracts for food; meat extracts; berries, preserved; snail eggs for consumption; eggs; yakitori.

(260) AM 2023 121480 A

(800) 1711040

(151) 2022 09 07

(891) 2022 09 07

(731) VP Holdings

Visbijas prospekts 7, LV-1014 Rīga, Latvia

(540)



(591) Black, white

(531) 26.04.05; 26.04.18; 27.05.01; 27.05.09

(511)

5 – Dietetic substances adapted for medical use; mineral waters for medical purposes; vitamin supplement patches; dietary supplements; mineral dietary supplements; albumin dietary supplements; dietary supplements consisting of vitamins; yeast dietary supplements; alginate dietary supplements; glucose dietary supplements; casein dietary supplements; lecithin dietary supplements; linseed oil dietary supplements; propolis dietary supplements; protein dietary supplements; royal jelly dietary supplements; pollen dietary supplements; wheat germ dietary supplements; linseed dietary supplements; acai powder dietetic supplements; enzyme dietary supplements; yeast for pharmaceutical purposes; starch for dietetic or pharmaceutical purposes; milk sugar for pharmaceutical purposes; almond milk for pharmaceutical purposes; powdered milk for babies; royal jelly for pharmaceutical purposes; milk ferments for pharmaceutical purposes; flour for pharmaceutical purposes; linseed meal for pharmaceutical purposes; fish meal for pharmaceutical purposes; freeze-dried meat adapted for medical purposes; dietetic beverages adapted for medical purposes; malted milk beverages for medical purposes; food for babies; albuminous foodstuffs for medical purposes; dietetic foods adapted for medical purposes; by-products of the processing of cereals for dietetic or medical purposes; homogenized food adapted for medical purposes; freeze-dried food adapted for medical purposes; lacteal flour for babies; infant formula; malt for pharmaceutical purposes.

30 – Flavourings, other than essential oils, for cakes; flavourings, other than essential oils, for beverages; food flavourings, other than essential oils; cereal bars; high-protein cereal bars; cereal bars enriched with vitamins and minerals, other than for medical or veterinary purposes; bulgur; edible paper; waffles; vermicelli; natural sweeteners; seawater for cooking; seaweed [condiment]; malt biscuits; glucose for culinary purposes; croutons; buckwheat, processed; gluten additives for culinary purposes; yeast; thickening agents for cooking foodstuffs; leaven; rice-based snack food; cereal-based snack food; coffee substitutes; vegetal preparations for use as coffee substitutes; zephyr being confectionery; fruit jellies [confectionery]; pastries; peanut confectionery; almond confectionery; pasta; frozen yogurt [confectionery ices]; cocoa; caramels [sweets]; quinoa, processed; gluten prepared as foodstuff; sweets; liquorice [confectionery]; peppermint sweets; dulce de leche; coffee; starch for food; crackers; custard; hominy grits; semolina; oatmeal; crushed barley; groats for human food; corn, milled; corn, roasted; couscous; noodles; lollipops [confectionery]; macaroni; maltose; marzipan; honey; royal jelly; ice cream; bean meal; buckwheat flour; tapioca flour; potato flour; corn flour; nut flours; flour; wheat flour; soya flour; barley meal; confectionery in the form of mousses; chocolate mousses; muesli; cocoa beverages with milk; coffee beverages with milk; coffee-based beverages; cocoa-based beverages; chamomile-based beverages; tea-based beverages; chocolate beverages with milk; chocolate-based beverages; infusions, not medicinal; crushed oats; husked oats; chocolate-coated nuts; stick liquorice [confectionery]; soya bean paste; pastila [confectionery]; lozenges [confectionery]; biscuits; popcorn; powders for making coffee-based beverages enriched with vitamins, minerals, protein, other than for medical or veterinary purposes; powders for making chocolate-based beverages enriched with vitamins, minerals, protein, other than for medical or veterinary purposes; powders for making tea beverages with milk enriched with vitamins, minerals, protein, other than for medical or veterinary purposes; powders for making ice cream; baking powder; aromatic preparations for food; condiments; cereal preparations; oat-based food; propolis; spices; rice pudding; puddings; cake powder; fruit colulis [sauces]; chewing gum; rice; instant rice; wheat germ for human consumption; sugar; palm sugar; sesame seeds [seasonings]; processed seeds for use as a seasoning; agave syrup [natural sweetener]; candy bars; cooking salt; sorbets [ices]; sauces [condiments]; spaghetti; chocolate-based spreads; chocolate spreads containing nuts; rusks; tarts; dough; almond paste; bread; chips [cereal products]; corn flakes; oat flakes; flowers or leaves for use as tea substitutes; chicory [coffee substitute]; tea; iced tea; chocolate; essences for foodstuffs, except etheric essences and essential oils; husked barley.

(260) AM 2023 121481 A

(800) 1711087

(151) 2022 11 04

(891) 2022 11 04

(731) Sichuan Luyi Tire Co., Ltd.

Building 2, No. 11, East Second Wuke Road,
Wuhou District, Chengdu City, 250101 Sichuan
Province, China

(540)

EOTUN

(591) Black, white

(531) 27.05.01; 27.05.17

(511)

12 – Automobiles; bicycle wheels; treads for retreading tires; automobile tires; tires for vehicle wheels; automobile wheel; pumps for bicycle tires; rims (for cars); pneumatic tires; inner tubes for pneumatic tires.

(260) AM 2023 121482 A

(800) 1711088

(151) 2022 12 05

(891) 2022 12 05

(731) Joint Stock Company "Chemiko-

pharmaceutical works "AKRIKHIN"

Bogorodsky g.o., Kirova street, 29, g., Staraya

Kupavna, RU-142450 Moskovskaya oblast',

Russian Federation

(540)



(591) Red, blue and white

(531) 26.01.04; 26.01.16; 29.01.13

(511)

3 – Creams for leather; cosmetic creams; hair lotions; lotions for cosmetic purposes; ethereal oils; soap; collagen preparations for cosmetic purposes; aloe vera preparations for cosmetic purposes; cosmetics; cosmetics for children; toiletry preparations; phytocosmetic preparations; shampoos.

5 – Amino acids for medical purposes; diagnostic biomarker reagents for medical purposes; vaccines; dietetic substances adapted for medical use; radiological contrast substances for medical purposes; mineral waters for medical purposes; hormones for medical purposes; mineral dietary supplements; nutritional supplements; immunostimulants; cachets for pharmaceutical purposes; medicated hair lotions; lotions for pharmaceutical purposes; liniments; ointments for pharmaceutical purposes; medicinal oils; drugs for medical purposes; medicines for human purposes; pastilles for pharmaceutical purposes; bacterial preparations

for medical and veterinary use; albuminous preparations for medical purposes; biological preparations for medical purposes; bismuth preparations for pharmaceutical purposes; vitamin preparations; diagnostic preparations for medical purposes; acne treatment preparations; preparations for the treatment of burns; pharmaceutical preparations for skin care; nutraceutical preparations for therapeutic or medical purposes; pharmaceutical preparations; enzyme preparations for medical purposes; phytotherapy preparations for medical purposes; chemico-pharmaceutical preparations; chemical preparations for medical purposes; dietetic foods adapted for medical purposes; pharmaceuticals; syrups for pharmaceutical purposes; suppositories; medicated shampoos; herbal extracts for medical purposes.

10 – Diagnostic apparatus for medical purposes; inhalers; injectors for medical purposes; aerosol dispensers for medical purposes; medical apparatus and instruments.

16 – Newsletters; graphic prints; teaching materials [except apparatus]; sealing compounds for stationery purposes; bookbinding material; packing [cushioning, stuffing] materials of paper or cardboard; plastic film for wrapping; prospectuses; stationery; labels of paper or cardboard.

35 – Demonstration of goods; providing commercial information and advice for consumers in the choice of products and services; provision of an online marketplace for buyers and sellers of goods and services; sales promotion for others; publicity; on-line advertising on a computer network; outdoor advertising; advertising by mail order; television advertising.

39 – Delivery of goods; packaging of goods; wrapping of goods; storage of goods; storage.

42 – Scientific research; technological research; quality control; conducting technical project studies; technical writing.

(260) AM 2023 121483 A

(800) 1711151

(151) 2023 01 05

(891) 2023 01 05

(731) Apple Inc.

One Apple Park Way, Cupertino CA 95014,
USA

(540)

MAGIC KEYBOARD FOLIO

(591) Black, white

(526) KEYBOARD

(511)

9 – Computer peripherals; computer keyboards; computer trackpads; accessory for a handheld mobile digital electronic device that functions as a protective and decorative case and a stand and incorporates a key-

board and trackpad; cases adapted for computers; covers for tablet computers.

(260) AM 2023 121484 A

(800) 1711201

(151) 2022 07 15

(891) 2022 07 15

(731) Tovarystvo z obmezheniou vidpovidalnistiu "Harchovi Technologii Zakarpattya" vul. Vatutina, 28, s. Velyki Komiaty, Berehivskiyi r-n, Zakarpatska obl. 90312, Ukraine

(540)



(591) Black, white

(531) 03.01.06; 03.01.08; 03.01.16; 03.01.24; 06.01.02; 06.01.04; 27.05.01

(511)

31 – Pet food.

35 – Advertising; file management; business administration; office functions.

(260) AM 2023 121485 A

(800) 1711218

(151) 2022 12 09

(891) 2022 12 09

(731) TOYOTA JIDOSHA KABUSHIKI KAISHA

(also trading as TOYOTA MOTOR CORPORATION)

1, Toyota-cho, Toyota-shi, Aichi-ken 471-8571, Japan

(540)

BZ3X

(591) Black, white

(511)

12 – Driving motors for land vehicles; engine mounts for land vehicles; engines for land vehicles; jet engines for land vehicles; motors for land vehicles; propulsion mechanisms for land vehicles; turbines for land vehicles; axle journals; axles for land vehicles; spindles for land vehicles; drive shafts for land vehicles; shaft couplings for land vehicles; axle bearings for land vehicles; wheel bearings for land vehicles; universal joints for land vehicles; drive chains for land vehicles; connecting rods for land vehicles, other than parts of motors and engines; gear boxes for land vehicles; gearing for land vehicles; hydraulic circuits for vehicles; reduction gears for land vehicles; torque converters for land vehicles; transmission chains for land vehicles; transmission shafts for land vehicles; transmissions for land vehicles; power transmission belts for land vehicles; brake discs for vehicles; brake

linings for vehicles; brake pads for automobiles; brake segments for vehicles; brake shoes for vehicles; brakes for vehicles; brake systems for vehicles; anti-theft alarms for vehicles; alarm systems for motor vehicles; AC motors for land vehicles, not including their parts; DC motors for land vehicles not including their parts; motors, electric, for land vehicles; automobiles and structural parts thereof; buses; structural parts for buses; trucks; structural parts for trucks; vans [vehicles]; sports utility vehicles; coaches; electric cars; hybrid cars; ambulances; racing cars; amphibious vehicles; snowmobiles; armored vehicles; fork lift trucks; camping cars; tractors; trailers; trolley buses; hearses; fuel cell cars; automobile bodies; automobile bonnets; automobile bumpers; automobile chassis; automobile dashboards; automobile doors; automobile door handles; automobile hoods; automobile horns; automobile seats; automobile seat covers; automobile sunroofs; automobile tires; automobile wheels; spokes for automobile wheels; inner tubes for automobile tires; automobile wheel rims; rearview mirrors for automobiles; automobile windows; automobile windshields; automobile windshields; automobile convertible tops; safety belts for automobile seats; safety harnesses for automobile racing; safety harnesses for automobile seats; security harness for automobile seats; steering wheels for automobiles; steering wheel covers for automobiles; air bags for automobiles, buses and trucks; seat belt pre-tensioners for automobiles; direction signals for automobiles; leather upholstery for automobile seats; leather upholstery for automobiles; cigar lighters for automobiles; shaped automobile covers; mudguards for automobiles; luggage carriers for automobiles; spare wheel holders for automobiles; automobile roof racks; headlight wipers; windscreen wipers; windscreen wiper blades; motor vehicle brake control systems for applying emergency braking at low vehicle speeds; electronic brake control apparatus for automobiles.

(260) AM 2023 121486 A

(800) 1711219

(151) 2022 12 09

(891) 2022 12 09

(731) TOYOTA JIDOSHA KABUSHIKI KAISHA

(also trading as TOYOTA MOTOR CORPORATION)

1, Toyota-cho, Toyota-shi, Aichi-ken 471-8571, Japan

(540)

BZ5X

(591) Black, white

(511)

12 – Driving motors for land vehicles; engine mounts for land vehicles; engines for land vehicles; jet engines for land vehicles; motors for land vehicles; propulsion mechanisms for land vehicles; turbines for land vehicles; axle journals; axles for land vehicles;

spindles for land vehicles; drive shafts for land vehicles; shaft couplings for land vehicles; axle bearings for land vehicles; wheel bearings for land vehicles; universal joints for land vehicles; drive chains for land vehicles; connecting rods for land vehicles, other than parts of motors and engines; gear boxes for land vehicles; gearing for land vehicles; hydraulic circuits for vehicles; reduction gears for land vehicles; torque converters for land vehicles; transmission chains for land vehicles; transmission shafts for land vehicles; transmissions for land vehicles; power transmission belts for land vehicles; brake discs for vehicles; brake linings for vehicles; brake pads for automobiles; brake segments for vehicles; brake shoes for vehicles; brakes for vehicles; brake systems for vehicles; anti-theft alarms for vehicles; alarm systems for motor vehicles; AC motors for land vehicles, not including their parts; DC motors for land vehicles not including their parts; motors, electric, for land vehicles; automobiles and structural parts thereof; buses; structural parts for buses; trucks; structural parts for trucks; vans [vehicles]; sports utility vehicles; coaches; electric cars; hybrid cars; ambulances; racing cars; amphibious vehicles; snowmobiles; armored vehicles; fork lift trucks; camping cars; tractors; trailers; trolley buses; hearses; fuel cell cars; automobile bodies; automobile bonnets; automobile bumpers; automobile chassis; automobile dashboards; automobile doors; automobile door handles; automobile hoods; automobile horns; automobile seats; automobile seat covers; automobile sunroofs; automobile tires; automobile wheels; spokes for automobile wheels; inner tubes for automobile tires; automobile wheel rims; rearview mirrors for automobiles; automobile windows; automobile windscreens; automobile windshields; automobile convertible tops; safety belts for automobile seats; safety harnesses for automobile racing; safety harnesses for automobile seats; security harness for automobile seats; steering wheels for automobiles; steering wheel covers for automobiles; air bags for automobiles, buses and trucks; seat belt pre-tensioners for automobiles; direction signals for automobiles; leather upholstery for automobile seats; leather upholstery for automobiles; cigar lighters for automobiles; shaped automobile covers; mudguards for automobiles; luggage carriers for automobiles; spare wheel holders for automobiles; automobile roof racks; headlight wipers; windscreen wipers; windscreen wiper blades; motor vehicle brake control systems for applying emergency braking at low vehicle speeds; electronic brake control apparatus for automobiles.

(260) AM 2023 121487 A

(800) 1711239

(151) 2022 10 26

(891) 2022 10 26

(731) ADESSO, INC.

20659 Valley Blvd., Walnut CA 91789, USA

(540)

ADESSO

(591) Black, white

(511)

9 – Computer cursor control devices, namely, computer mouse; computer cursor control devices, namely, light pens; computer cursor control devices, namely, touchpads; computer cursor control devices, namely, trackballs; computer hardware and computer peripheral devices; computer hardware and computer peripherals; computer hardware and computer software programs for the integration of text, audio, graphics, still images and moving pictures into an interactive delivery for multimedia applications; computer keypads; computer memories; computer network adapters; computer peripheral apparatus; computer peripheral devices; digital cameras; digital video cameras; headphones; headsets for use with computers; keyboards; microphones; mouse pads; PC tablets; remote cursor controls for computers; scanners; tablet computer; wireless computer mice; wireless computer peripherals.

(260) AM 2023 121492 A

(800) 1288763

(151) 2015 10 21

(891) 2023 01 19

(731) IMMERGAS S.p.A.

Via Cisa Ligure 95, I-42041 BRESCELLO
(R.E.), Italy

(540)

VICTRIX

(591) Black, white

(511)

11 – Heating boilers; feeding apparatus for heating boilers; flues for heating boilers; boiler pipes [tubes] for heating installations; boilers [other than parts of machines]; laundry room boilers; heaters for baths; air conditioning apparatus; ovens, not for experimental purposes, and cooking rings; heating installations; fans [air-conditioning]; sanitary apparatus and installations; cooking utensils electric; heating cushions [pads] electric, not for medical purposes; cooling appliances and installations.

(260) AM 2023 121493 A

(800) 1441499

(151) 2018 06 09

(891) 2022 09 01

(731) Semenov Denis Andreevich

Lomako st., 32, apt. 6, Kolchugino, RU-601787
Vladimirskaya oblast, Russian Federation

(540)



(591) Black, white

(531) 05.03.07; 05.03.13; 05.03.14; 26.11.02;
26.11.08; 27.05.01

(511)

4 – Coal briquettes for barbecue and hookah, including charcoal; coal briquettes for barbecue and hookah, including coconut shell charcoal.

34 – Flavorings, other than essential oils, for use in electronic cigarettes; flavorings, other than essential oils, for tobacco; gas containers for cigar lighters; absorbent paper for tobacco pipes; cigarette paper; liquid nicotine solutions for use in electronic cigarettes; lighters for smokers; tobacco pouches; books of cigarette papers; humidors; matchboxes; firestones; cigar cutters; cigar holders; cigarette holders; mouthpieces for cigarette holders; ashtrays for smokers; spittoons for tobacco users; pipe racks for tobacco pipes; pipe cleaners for tobacco pipes; cigarettes; cigarettes containing tobacco substitutes, not for medical purposes; cigarillos; cigars; tobacco jars; match holders; matches; oral vaporizers for smokers; tobacco; chewing tobacco; snuff; snuff boxes; herbs for smoking; tobacco pipes; pocket machines for rolling cigarettes; cigarette filters; cigarette tips; cigar cases; cigarette cases.

(260) AM 2023 121494 A

(800) 1540035

(151) 2020 05 29

(891) 2023 01 12

(731) KONCI Marketing GmbH

Baerler Strasse 100, 47441 Moers, Germany

(540)



(591) Black, white

(531) 26.01.03; 26.04.01; 26.04.05; 26.04.10;
26.04.24; 26.11.03; 26.11.06; 26.11.12

(511)

34 – Tobacco products [luxury articles], in particular cigarettes, filter-tipped cigarettes; cigars and cigarillos; smokers' articles; matches; tobacco sticks; tobacco

co products for the purpose of being heated; electric and electronic apparatus for heating tobacco products, in particular tobacco sticks, and tobacco substitutes; electric cigarettes; electronic cigarettes; electrically chargeable cigarette cases; cleaners, cleaning apparatus and cleaning brushes for electric and electronic cigarettes; liquids and nicotine liquids for electric and electronic cigarettes.

(260) AM 2023 121495 A

(800) 1540037

(151) 2020 05 29

(891) 2023 01 12

(731) KONCI Marketing GmbH

Baerler Strasse 100, 47441 Moers, Germany

(540)

(591) Black, white

(531) 27.05.01

(511)

34 – Tobacco products [luxury articles], in particular cigarettes, filter-tipped cigarettes; cigars and cigarillos; smokers' articles; matches; tobacco sticks; tobacco products for the purpose of being heated; electric and electronic apparatus for heating tobacco products, in particular tobacco sticks, and tobacco substitutes; electric cigarettes; electronic cigarettes; electrically chargeable cigarette cases; cleaners, cleaning apparatus and cleaning brushes for electric and electronic cigarettes; liquids and nicotine liquids for electric and electronic cigarettes.

(260) AM 2023 121496 A

(800) 1651307

(151) 2021 11 02

(891) 2022 12 20

(731) Carlsberg A/S

J.C. Jacobsens Gade 1, DK-1799 Copenhagen V, Denmark

(540)

(591) Black, white

(531) 05.03.06; 05.03.13; 05.03.14; 27.05.01;
27.05.04; 27.05.07

(511)

32 – Beers; non-alcoholic beverages; mineral and aerated waters; fruit beverages and fruit juices; syrups and other non-alcoholic preparations for making beverages.

33 – Alcoholic beverages, except beers; alcoholic preparations for making beverages.

(260) AM 2023 121497 A
 (800) 1666510
 (151) 2021 12 27
 (891) 2022 11 30
 (731) H & M Hennes & Mauritz AB
 SE-106 38 Stockholm, Sweden
 (540)

COS

(591) Black, white
 (511)

25 – Clothing; footwear; headgear; suits; bathing trunks; bathing suits; bath robes; bikinis; belts [clothing]; leather belts [clothing]; children's wear; babies' pants [underwear]; ballet suits; coveralls; pantsuits; pants; denim jeans; denim jeans; neckerchiefs; garters; gloves [clothing]; jackets [clothing]; shorts; skirts; sportswear; underwear; dresses; shrugs; short-sleeve shirts; hooded jumpers; pregnancy clothing; nightwear; coveralls; pocket squares; turtleneck shirts; sweaters; rainwear; scarves; shawls; shirts; neckties; beach clothes; tank tops; hosiery; tights; chasubles; sashes for wear; footless tights; stockings; tee-shirts; masquerade costumes; wedding dresses; waistcoats; tunics; mittens; outerclothing; coats; shoes; boots; ankle boots; sandals; slippers; running shoes; ballet slippers; hats; caps; bobble hats; visors; headbands [clothing]; shower caps; sleep masks; ready-made clothing; waterproof clothing; face mask [clothing].

35 – Advertising; public relations and marketing; business analysis services; business research; business information; commercial trading and consumer information services; business management; retail services, in relation the following goods: lamps, bulbs, candles, flowers, candles, non-medicated cosmetics and toiletry preparations, non-medicated dentifrices, perfume, essential oils, bleaches and preparations for washing, cleaning, polishing, scouring and grinding, soaps, cosmetics, hair lotions, teeth cleaning preparations, nail polish, lacquer-removing preparations, toiletries, after-shave, facial masks, facial creams, facial cleansers [cosmetic], anti-aging creams, baby oils, bath gel, salts for bath use, bath preparations other than for medical purposes, bath accessories, bath oil, anti-bacterial soap, hair conditioners, hair bleaching preparations, cosmetic cotton balls, swabs (toiletries), eyebrow sticks, eyeliner, hair color, adhesives for affixing artificial fingernails, adhesives for affixing false eyelashes, false nails, pre-moistened cosmetics towelettes, hair styling gels, hair styling wax, hand cream, hair removal and shaving preparations, hair styling lotions, creams for the hair, hair permanent wave preparations, skin care preparations, mouthwashes (not for medical purposes), non-medicated breath freshening sprays, make-up, creams for cellulite reduction, body cream, body scrubs, body butter, bronzing powder, lip balms (non-medicated), lip gloss, lip liner, lipstick, adhesives for affixing false hair, false eyelashes, lip pens, mousses [toiletries] for use in styling the hair,

eyeshadow, perfume body sprays, oral hygiene preparations, toothbrushes, teething gel, dental floss, preparations for cleaning the body and for beauty care, body care soap, body cleaning preparations, body gels, body glitter, body lotions, body sprays, body moisturisers, body scrub, body cleaning, preparations for leather cleaning and polishing, talcum powder for toilet use, blush, tailors' and cobblers' wax, sun blocking lipsticks (cosmetics), sun-tanning preparations, make-up foundations, bar soap, cakes of toilet soap, bath soap, deodorising soaps, hand soap cleaners, shaving soap, skin soap, bath gel, moisturising creams, lotions and gels, incenses, deodorants for human beings or for animals, air fragrancing preparations, shampoos, hair conditioner, stain removers, waxes for leather, pumice, scientific, nautical, surveying, photographic, cinematographic, optical, weighing, measuring, signalling, checking (supervision), life-saving and teaching apparatus and instruments, apparatus and instruments for the conduction, distribution, conversion, storage, regulation and control of electric current, apparatus for recording, transmission or reproduction of sound or images, magnetic data carriers, recording discs, compact discs, DVDs and other digital recording media, coin-operated mechanisms, cash registers, calculating machines, data processing equipment, computers, software for computers, fire extinguishing apparatus, downloadable electronic publications, downloadable software for mobile telephones, selfie sticks for use as smartphone accessories, covers adapted for mobile telephones, cell phone cases, battery chargers for mobile telephones, auxiliary speakers for mobile phones, on-ear headphones, loudspeakers, eyeglass frames, eyeglass chains, cords for eyeglasses, snow goggles, swim goggles, boxes [cases] for sunglasses, sunglasses, eyewear, laptop sleeves, bags adapted for portable media players, cases adapted for cameras and photographic apparatus, cases for glasses, in precious metals and their alloys, jewellery, precious and semi-precious stones, horological and other chronometric instruments, jewels, pearls and precious metals and imitations thereof, charms (jewellery) of common metal, jewellery, including paste jewellery, badges for wear, diadems, rings (jewellery), ankle bracelets, necklaces [jewellery], ornamental pendants, chains (jewellery), tie pins, bells, cufflinks, key fobs, earrings, jewellery cases and watch boxes, brooches [jewellery], key chains (jewellery), jewellery boxes not of metal, unwrought or semi-wrought precious metals, jewellery cases, ornaments [jewellery], cases for watches [presentation], office items, posters, printed publications, of books, magazines, leather and imitations of leather, animal skins, valises and travel vanity cases, umbrellas and parasols, walking sticks, whips, harness and saddlery, collars, waist belts and clothing for pets, suit and dress bags, pocket wallets, handbags, evening bags, work bags, shoulder bags, canvas bags, shopping bags, toiletry pouches, transport boxes for animals, card holders, make-up cases, courier bags, leat-

her straps, belt bags, briefcases (leatherware), rucksacks, bags for sports, leather key chains, cases for keys, vanity cases, not fitted, credit card cases, gut for making sausages, purses, trunks, card cases (notecases), leather trimmings for furniture, umbrellas, parasols, clothing for pets, furniture, mirrors, fabrics and textiles and substitutes therefor, household textiles, curtains of textile or of plastic, bed linen, tablemats of textile, beds, sheets (textile), pillow covers, covers for down quilts, bedspreads, plaids, bed skirts, bed blankets, fabric bed valances, table place setting mats of textile, table-cloths (not for paper), table linen, not of paper, oilcloth for use as tablecloths, fabric table runners, cloth napkins, linen, towels of textile, towels, kitchen towels, shower room curtains, coverings of plastic for furniture, furniture coverings of textile, cushion cases, felt cloth, quilts filled with stuffing materials, cloth, tags of textile materials, wall decorations of textile, felt, bath linen (except clothing), handkerchiefs of textile, mattress covers, loose covers for furniture, toilet seat covers of textile, clothing, footwear, headgear, suits, bathing drawers, bathing suits, beach robes, bikinis, belts, belts and leather, clothing for children, babies' pants, ballet suits, coveralls, pantsuits, trousers, jeans, denim jeans, bandannas, garters, gloves for clothing, jackets, board shorts, skirts, sportswear, underwear, dresses, cardigans, short-sleeve shirts, hooded sweaters, pregnancy clothing, nightwear, coveralls, pocket squares, polo shirts, pullovers, rainproof clothing, scarves, shawls, shirts, ties (clothing), beach cover-ups, camisoles, hosiery, tights, chasubles, scarves, footless tights, socks, t-shirts, masquerade costumes, wedding dresses, vests, tunics, mitts, outerwear, coats, dresses, footwear, boots, ankle boots, sandals: slippers, jogging shoes, ballet flats, hats, chaps, bobble hats, canopies, headbands (clothing), shower caps, sleep masks, ready-made clothing, waterproof clothing, dental retractors, lace, embroidery, ribbons and braid, buttons, hooks and eyes, pins, sewing needles, embroidering crochet hooks, knitting needles, artificial flowers, decorative articles for the hair, false hair, hair rollers, other than hand implements, accessories for apparel, sewing articles and decorative textile articles, hair bands, hair grips, hair nets, hair barrettes, badges for wear, not of precious metal, decorative fashion buttons, fashion pins (not of precious metal), other than jewellery, tassels (haberdashery), of books and magazines, games, toys, gymnastics and sporting articles, decorations for Christmas trees, sports equipment.

(260) AM 2023 121567 A

(800) 1711974

(151) 2023 01 09

(891) 2023 01 09

(731) International Fruit Genetics, LLC

8224 Espresso Drive, Suite 200, Bakersfield
CA 93312, USA

(540)

CHEERY CUPID

(591) Black, white

(511)

31 – Fresh fruits and fresh vegetables; live plants, namely, live cherry trees; live plants and live propagating material, namely, live cuttings, live plant tissue, and live plant clones, all for growing live plants.

(260) AM 2023 121568 A

(800) 1711999

(151) 2022 09 15

(891) 2022 09 15

(731) BEIJING NIU TECHNOLOGY CO., LTD.

No. 1 Building, No. 195 Huilongguan East
Road, Changping District, 102208 Beijing,
China

(540)

HAVION

(591) Black, white

(511)

7 – Sweeping and cleaning machines; electric cleaning apparatus for household use; vacuum cleaners; robotic vacuum cleaners; robots for household cleaning; personal household robots for use in cleaning, laundry and food processing; industrial robots; floor cleaning machines; dust exhausting installations for cleaning purposes; vacuum cleaner bags; vacuum cleaner brushes; vacuum cleaner filters; vacuum cleaner hoses; switched-reluctance motors; parts and fittings for the aforesaid goods.

9 – Charging stands for vacuum cleaners; rechargeable charging holders for rechargeable vacuum cleaners; chargers for electric vacuum cleaners; rechargeable batteries; battery charging equipment; remote controls for vacuum cleaners and robotic cleaning devices; remote controls for electronic and robotic machines for use in the fields of interior maintenance of household and commercial buildings; remote controls for drones; digital controls for robot machines, in particular robot vacuum cleaners; digital controls for drones; computer software and hardware for the control of vacuum cleaners, household robots and industrial robots; computer software and hardware for the control of drones; intelligent sensors; remotely controlled robotic systems comprised of computer hardware, computer software, monitors, sensors and/or cameras to gather information and transmit or display audio and video communications and other electronic data; downloadable electronic publications; downloadable computer software applications for use in controlling household appliances and drones; downloadable smartphone application software for use in controlling household appliances and drones; gesture recognition software; apparatus for the recording, transmission and reproduction of sound and images; operating systems for robots; computer hardware and soft-

ware; downloadable mobile applications for starting and stopping, scheduling, customizing and monitoring vacuum cleaners, household robots, industrial robots and drones; infrared remote control apparatus; software and sensors that allow a robotic device to sense and respond to environmental inputs; communication devices and software for use with robots; cameras; camera mounts; cameras [photography]; video cameras; cases especially made for photographic apparatus and instruments; navigation systems for use in robotic vacuum cleaners.

12 – Unmanned aerial vehicles; drones; camera drones; electric vehicles; remote control vehicles, other than toys; propellers for air vehicles; propeller blade protectors for aircraft; parts and fittings for the aforesaid goods.

28 – Toys, games and playthings; toy robots; smart robot toys; motorized toy robots; remote controlled toy robots; toy vehicles; remote controlled flying toys, particularly remote controlled helicopters and quadcopters; drones [toys].

38 – Communication by electronic means; providing access to databases; transmission of data via satellite and cloud; transmission of electronic mail; message sending; transmission of information; providing access to information on the Internet; transmission of information signals; interactive communication services; communication services for the remote control of electronic devices; electronic transmission of data and documents via computer terminals and electronic devices; signal transmission for electronic commerce via telecommunications systems and data communication systems; providing access to electronic communications networks and electronic databases; provision of communication facilities for the interchange of digital data; communication of data by means of telecommunications; transmission of data, including by audiovisual apparatus; transmission of sound, picture, video and data signals; data bank interconnection services.

(260) AM 2023 121569 A

(800) 1712003

(151) 2022 09 15

(891) 2022 09 15

(731) Clinical Services Corporate Operations, Inc.
271 Waverly Oaks Rd. Suite 208, Waltham
MA 02452, USA

(540)

ALLUCENT CONSULTING

(591) Black, white

(511)

35 – Data management, namely, abstraction and collection of medical data from clinical tests for business purposes; market research and business marketing consulting services in the pharmaceutical, biotechnology, medical device, and diagnostics industries.

42 – Programming of software for managing and collecting patient-generated health data for scientific research purposes; cloud computing featuring software that allows users to collect, review, analyze and report on clinical research; technical support services, namely, installation and remote administration of software, and troubleshooting of software problems and hosted software applications, all for use in connection with medical research and product regulatory approval, environmental health, health care, and in relation to the design, research, development, and testing of new medical products and devices; cloud computing featuring software for providing telehealth, telemedicine, remote care and virtual health care services to patients; cloud computing featuring software that allows users to collect, track, retrieve, validate, summarize, statistically analyze and present data used in the areas of medical research and product regulatory approval, environmental health, health care, and in relation to the design, research, development, and testing of new medical products and devices; cloud computing featuring software to aggregate, integrate, transfer and manage data generated from home health and remote monitoring devices and applications and health-related smart-phone applications; cloud computing featuring software that provides integrated workflows, analytics, visualizations, and reporting features to deliver, process, analyze, elevate, and display patient-generated health data; cloud computing featuring software that integrates remotely collected health data into databases, systems, platforms, applications, and software that inform clinical research, remote monitoring, and care management; hosting of web-based portal for study sponsors and contract research organizations (CROS) to build programs, enroll members, automate actions, and visualize/analyze data in connection with clinical studies; technical consulting services, namely, evaluating the safety of pharmaceutical, medical, cosmetic and consumer devices and products in clinical development or in commercial production; consulting services for others in the field of design, planning, and implementation project management of clinical trials; analysis of statistical data relating to clinical trials for pharmaceuticals, biotechnology, medical devices and diagnostics for scientific research.

45 – Development of regulatory compliance strategies in the field of medical research, namely, regulatory compliance in drug, biologic, cosmetic and medical device development.

(260) AM 2023 121570 A

(800) 1712005

(151) 2022 09 15

(891) 2022 09 15

(731) Clinical Services Corporate Operations, Inc.
271 Waverly Oaks Rd. Suite 208, Waltham
MA 02452, USA

(540)

ALLUCENT RESEARCH

(591) Black, white

(511)

35 – Data management, namely, abstraction and collection of medical data from clinical tests for business purposes; market research and business marketing consulting services in the pharmaceutical, biotechnology, medical device, and diagnostics industries.

42 – Programming of software for managing and collecting patient-generated health data for scientific research purposes; cloud computing featuring software that allows users to collect, review, analyze and report on clinical research; technical support services, namely, installation and remote administration of software, and troubleshooting of software problems and hosted software applications, all for use in connection with medical research and product regulatory approval, environmental health, health care, and in relation to the design, research, development, and testing of new medical products and devices; cloud computing featuring software for providing telehealth, telemedicine, remote care and virtual health care services to patients; cloud computing featuring software that allows users to collect, track, retrieve, validate, summarize, statistically analyze and present data used in the areas of medical research and product regulatory approval, environmental health, health care, and in relation to the design, research, development, and testing of new medical products and devices; cloud computing featuring software to aggregate, integrate, transfer and manage data generated from home health and remote monitoring devices and applications and health-related smart-phone applications; cloud computing featuring software that provides integrated workflows, analytics, visualizations, and reporting features to deliver, process, analyze, elevate, and display patient-generated health data; cloud computing featuring software that integrates remotely collected health data into databases, systems, platforms, applications, and software that inform clinical research, remote monitoring, and care management; hosting of web-based portal for study sponsors and contract research organizations (CROS) to build programs, enroll members, automate actions, and visualize/analyze data in connection with clinical studies; technical consulting services, namely, evaluating the safety of pharmaceutical, medical, cosmetic and consumer devices and products in clinical development or in commercial production; consulting services for others in the field of design, planning, and implementation project management of clinical trials; analysis of statistical data relating to clinical trials for pharmaceuticals, biotechnology, medical devices and diagnostics for scientific research.

45 – Development of regulatory compliance strategies in the field of medical research, namely, regulatory

compliance in drug, biologic, cosmetic and medical device development.

(260) AM 2023 121571 A

(800) 1712006

(151) 2022 09 15

(891) 2022 09 15

(731) Clinical Services Corporate Operations, Inc.
271 Waverly Oaks Rd. Suite 208, Waltham
MA 02452, USA

(540)

ALLUCENT CRO

(591) Black, white

(511)

35 – Data management, namely, abstraction and collection of medical data from clinical tests for business purposes; market research and business marketing consulting services in the pharmaceutical, biotechnology, medical device, and diagnostics industries.

42 – Programming of software for managing and collecting patient-generated health data for scientific research purposes; cloud computing featuring software that allows users to collect, review, analyze and report on clinical research; technical support services, namely, installation and remote administration of software, and troubleshooting of software problems and hosted software applications, all for use in connection with medical research and product regulatory approval, environmental health, health care, and in relation to the design, research, development, and testing of new medical products and devices; cloud computing featuring software for providing telehealth, telemedicine, remote care and virtual health care services to patients; cloud computing featuring software that allows users to collect, track, retrieve, validate, summarize, statistically analyze and present data used in the areas of medical research and product regulatory approval, environmental health, health care, and in relation to the design, research, development, and testing of new medical products and devices; cloud computing featuring software to aggregate, integrate, transfer and manage data generated from home health and remote monitoring devices and applications and health-related smart-phone applications; cloud computing featuring software that provides integrated workflows, analytics, visualizations, and reporting features to deliver, process, analyze, elevate, and display patient-generated health data; cloud computing featuring software that integrates remotely collected health data into databases, systems, platforms, applications, and software that inform clinical research, remote monitoring, and care management; hosting of web-based portal for study sponsors and contract research organizations (CROS) to build programs, enroll members, automate actions, and visualize/analyze data in connection with clinical studies; technical consulting services, namely, evaluating the safety of pharmaceutical,

medical, cosmetic and consumer devices and products in clinical development or in commercial production; consulting services for others in the field of design, planning, and implementation project management of clinical trials; analysis of statistical data relating to clinical trials for pharmaceuticals, biotechnology, medical devices and diagnostics for scientific research.

45 – Development of regulatory compliance strategies in the field of medical research, namely, regulatory compliance in drug, biologic, cosmetic and medical device development.

(260) AM 2023 121577 A

(800) 1712253

(151) 2022 11 22

(891) 2022 11 22

(731) Shenzhen Jiwu Business Intelligence Technology Co., Ltd

701-A9, Floor B7, Building 4, Shenzhen Software Industry Base, No. 19, 17, 18, Haitian 1st Road, Binhai Community, Yuehai Street, Nanshan District, Shenzhen, Guangdong, China

(540)

JNR

(591) Black, white

(531) 27.05.17; 27.05.23

(511)

34 – Electronic cigarettes; ashtrays for smokers; lighters for smokers; cigarette tips; cigarettes; tobacco pipes; flavourings, other than essential oils, for tobacco; matchboxes; cigarette filters; snuff boxes.

(260) AM 2023 121578 A

(800) 1712293

(151) 2022 12 01

(891) 2022 12 01

(731) Wuxi Shengbao Electric Bicycle Manufacturing Co., Ltd.

No. 208, Furong Middle 4 Road, Xishan Economic Development Zone, Wuxi City, Jiangsu Province, China

(540)

OPAI

(591) Black, white

(531) 27.05.01; 27.05.17

(511)

12 – Electric vehicles; electric bicycles; motorcycles; mopeds; motorized bicycle.

(260) AM 2023 121579 A

(800) 1712305

(151) 2022 11 18

(891) 2022 11 18

(731) Chery Automobile Co., Ltd.

8 Changchun Road, Economy & Technology Development Zone, Wuhu City, 241009 Anhui Province, China

(540)

OMODA

(591) Black, white

(531) 27.05.01

(511)

12 – Upholstery for vehicles; vehicles for locomotion by land, air, water or rail; motor coaches; lorries; waggons; automobiles; motor homes; propulsion mechanisms for land vehicles; electric vehicles; tyres for vehicle wheels.

(260) AM 2023 121580 A

(800) 1712308

(151) 2022 11 18

(891) 2022 11 18

(731) Chery Automobile Co., Ltd.

8 Changchun Road, Economy & Technology Development Zone, Wuhu City, 241009 Anhui Province, China

(540)

OMODA

(591) Black, white

(531) 27.05.01

(511)

37 – Installation, maintenance and repair of computer hardware; vehicle maintenance; vehicle breakdown repair services; leather care, cleaning and repair; vehicle battery charging; motor vehicle maintenance and repair; vehicle service stations [refuelling and maintenance]; rebuilding engines that have been worn or partially destroyed; heating equipment installation and repair.

(260) AM 2023 121581 A

(800) 1712309

(151) 2022 11 28

(891) 2022 11 28

(731) Guangdong Dongtai Hardware Precision Manufacturing Co., Ltd

Industry Road, Leliu Port, Leliu, Shunde, Foshan, Guangdong, China

(540)

DTC

(591) Black, white

(531) 27.05.17; 27.05.23

(511)

20 – Racks [furniture]; coat hangers; plate racks; chests of drawers; bottle racks; coatstands; shelves for storage; furniture of metal; display stands; sideboards; furniture; trays, not of metal; mirrors [looking glasses]; window fittings, not of metal; door fittings, not of metal.

(260) AM 2023 121582 A
 (800) 1712320
 (151) 2023 01 12
 (891) 2023 01 12
 (731) BEIJING YING TIAN KE DI
 INTELLECTUAL PROPERTY RIGHTS
 AGENCY CO., LTD.
 Room C502, Tower C, No. 76, East 4th Ring
 Middle Road, Chaoyang District, Beijing,

China

(540)



(591) Black, white
 (531) 26.01.03; 26.01.12; 26.01.18; 26.01.24;
 26.02.03; 26.02.05; 26.02.24; 27.05.01;
 27.05.09; 27.05.24

(511)

45 – Intellectual property consultancy; copyright management; legal research; legal document preparation services; legal services in relation to the negotiation of contracts for others; legal watching services; legal services relating to licenses; legal conveyancing; mediation; alternative dispute resolution services.

(260) AM 2023 121585 A

(800) 1712333

(151) 2023 01 17

(891) 2023 01 17

(731) Johnson & Johnson

Johnson & Johnson, One Johnson & Johnson
 Plaza, New Brunswick NJ 08933, USA

(540)

JOHNSON & JOHNSON

(591) Black, white

(511)

5 – Pharmaceuticals and medical preparations; dietetic food and substances adapted for medical use; dietary supplements for human beings.

10 – Surgical and medical apparatus and instruments; artificial limbs, eyes and teeth; orthopaedic articles; suture materials.

(260) AM 2023 121586 A

(800) 1712335

(151) 2023 01 17

(891) 2023 01 17

(731) Johnson & Johnson

Johnson & Johnson, One Johnson & Johnson
 Plaza, New Brunswick NJ 08933, USA

(540)

J&J

(591) Black, white

(511)

5 – Pharmaceuticals and medical preparations; dietetic food and substances adapted for medical use; dietary supplements for human beings.

10 – Surgical and medical apparatus and instruments; artificial limbs, eyes and teeth; orthopaedic articles; suture materials.

(260) AM 2023 121605 A

(800) 1712802

(151) 2022 11 04

(891) 2022 11 04

(731) Biotta AG

Pflanzbergstrasse 8, CH-8274 Tägerwilten,
 Switzerland

(540)

BREUSS

(591) Black, white

(511)

35 – Advertising; commercial business management; commercial administration; office functions; advertising, marketing and promotional services; commercial information and advice for consumers (in-store consumer advice); business support and management services and administrative services; analysis, research and information services relating to business; retail and wholesale services; mail order retail sale; provision of sales areas online for sellers and buyers of goods; marketing and market research.

(260) AM 2023 121606 A

(800) 1712829

(151) 2022 11 24

(891) 2022 11 24

(731) VG Global

"Yagoda" Str. 6, BG-8600 Yambol, Bulgaria

(540)

Vellea home

(591) Black, white

(511)

20 – Furniture; furniture and furniture parts; integrated furniture; sales counters [furniture]; school furniture; credenzas [furniture]; upholstered furniture; leather furniture; dressing tables; racks [furniture]; space dividers [furniture]; composable furniture; mirrors [furniture]; cocktail units [furniture]; tables [furniture]; furniture chests; pouffes [furniture]; consoles [furniture]; furniture for kitchens; dressers [furniture]; lawn furniture; pedestal units [furniture]; antique furniture; benches [furniture]; showcases [furniture]; desks; shelving units; freestanding partitions [furniture]; arbours [furniture]; consignment shelving [furniture]; portable partitions [furniture]; living room furniture; furniture for caravans; hanging storage racks [furniture]; furniture parts; stationery cabinets [furniture]; work stations [furniture]; seating furniture; li-

ving room furniture; household furniture; mobile partitions [furniture]; wooden racks [furniture]; doors for furniture; furniture shelves; sectional non-metallic units [furniture]; patio furniture; wall units [furniture]; transformable furniture; arm rests for furniture; furniture for camping; feet for furniture; furniture for use in auditoria; office requisites [furniture]; upholstered convertible furniture; bathroom furniture; glass furniture; drafting tables; computer furniture; prefabricated shelves [furniture]; furniture partitions; drawers [furniture parts]; office furniture; chairs being office furniture; non-metal casters; corner units [furniture]; wooden furniture; wooden shelving [furniture]; furniture moldings; modular desks [furniture]; furniture for shops; furniture for children; high stools [furniture]; index cabinets [furniture]; screens [furniture]; bedroom furniture; sectional metal units [furniture]; non-metallic wall shelves [furniture]; modular shelving [furniture]; storage drawers [furniture]; temporary casters, not of metal; storage modules [furniture]; fitted kitchen furniture; mobile stools [furniture]; boot trays [furniture]; bathroom vanities [furniture]; partitions of plastics [furniture]; bentwood furniture; pet furniture; desk racks [furniture]; stackable furniture; furniture incorporating beds; fitted bedroom furniture; computer cabinets [furniture]; cupboards being furniture; furniture fittings, not of metal; furniture for doors [non-metallic]; hat racks [furniture]; furniture casters, not of metal; flower-stands [furniture]; furniture for displaying goods; canteen furniture; garden furniture made of metal; furniture handles of plastic; furniture joints (non-metallic -); trolleys for computers [furniture]; mobile bar units [furniture]; personal computer work stations [furniture]; door furniture made of wood; garden furniture manufactured from wood; recliners [furniture]; sliding doors for furniture; height adjustable kitchen furniture; wall screening [furniture] for offices; drawer slides [furniture parts]; domestic furniture made of wood; furniture made from substitutes for wood; furniture being convertible into beds; furniture for house, office and garden; doors made of non-metallic materials for furniture; shelves being nursery furniture; filing cabinets in the nature of furniture; bathroom vanities [furniture]; bathroom vanities being furniture; bathroom furniture; furniture for use in rest rooms; multiposition stands [furniture]; decorative edging strips of plastic for use with furniture; seat pads being parts of furniture; furniture adapted for use by those with mobility difficulties; furniture parts sold in kits for assembly; non-metal safety gates for babies, children, and pets; clothes hangers, clothes stands [furniture] and clothes hooks.

39 – Furniture moving; storage of furniture; delivery of furniture; carting of furniture; transporting furniture; removal of domestic furniture; transportation of furniture of others by trucks.

40 – Stripping of furniture; custom manufacture of furniture; manufacture of furniture to order and spe-

cification of others; cabinet-making (custom manufacture).

42 – Design services for furniture; office furniture design; information services relating to the combination of colours, paints and furnishings for interior design; information services relating to the harmonisation of colours, paints and furnishings for interior design.

(260) AM 2023 121617 A

(800) 1454204

(151) 2018 12 11

(891) 2023 01 10

(731) WUHAN JINGCHEN INTELLIGENT IDENTIFICATIONTECHNOLOGY CO., LTD 1201-2-1, MARS SPACE NO. 366, HENGAN ROAD, HONGSHAN DISTRICT, WUHAN CITY, 430070 HUBEI PROVINCE, China

(540)

NiiMbot

(591) Blue

(531) 27.05.01; 29.01.04

(511)

9 – Electronic tags for goods; radio-frequency identification [RFID] tags; thermal printers.

16 – Heat sensitive paper; label paper; printed paper labels.

42 – Software as a service [SaaS]; rental of application software; design and development of computer software.

(260) AM 2023 121618 A

(800) 1527978

(151) 2020 01 13

(891) 2022 12 30

(731) TEKSÜT SÜT MAMÜLLERİ SANAYİ VE TİCARET ANONİM ŞİRKETİ HASANBEY MAH. KÖY ALTI SK. TEK SÜT BLOK NO: 83 İÇ KAPI NO: 1, GÖNEN / BALIKESİR, Türkiye

(540)



(591) The colors green, dark green and white are claimed as a feature of the mark

(531) 25.05.02; 25.05.25; 27.05.02; 29.01.13

(511)

29 – Meat, fish, poultry and game; processed meat products; dried pulses; soups, bouillon; processed olives, olive paste; milks of animal origin; milks of her-

bal origin; milk products; butter; edible oils; dried, preserved, frozen, cooked, smoked or salted fruits and vegetables; tomato paste; prepared nuts and dried fruits as snacks; hazelnut spreads and peanut butter; tahini (sesame seed paste); eggs and powdered eggs; potato chips.

(260) AM 2023 121619 A

(800) 1577985

(151) 2020 12 07

(891) 2022 12 29

(731) Barabanov Artem Sergeevich

proezd Akulovskiy, 6 d., 2 kv., mkr. Yantarny,
g. Balashikha, RU-143912 oblast Moskovskaya,
Russian Federation

(540)



(591) Black, white and orange

(531) 26.01.03; 26.01.17; 27.05.01; 27.07.01;
29.01.13

(511)

5 – Pharmaceutical and veterinary preparations; sanitary preparations for medical purposes; dietetic food and substances adapted for medical use, food for babies; dietary supplements for human beings and animals; plasters, materials for dressings; material for stopping teeth, dental wax; disinfectants; preparations for destroying vermin; fungicides, herbicides; acaricides; aconitine; alkaloids for medical purposes; algicides; aldehydes for pharmaceutical purposes; dental amalgams of gold; dental amalgams; amino acids for veterinary purposes; amino acids for medical purposes; analgesics; anaesthetics; antibiotics; antiseptics; aluminium acetate for pharmaceutical purposes; acetates for pharmaceutical purposes; germicides; balms for medical purposes; bandages for dressings; biocides; bromine for pharmaceutical purposes; paper for mustard plasters; paper for mustard poultices; fly catching paper; mothproofing paper; mothproof paper; petroleum jelly for medical purposes; vaccines; oxygen baths; antiseptic cotton; aseptic cotton; absorbent cotton; absorbent wadding; wadding for medical purposes; radiological contrast substances for medical purposes; nutritive substances for microorganisms; radioactive substances for medical purposes; bismuth subnitrate for pharmaceutical purposes; melissa water for pharmaceutical purposes; sea water for medicinal bathing; mineral waters for medical purposes; thermal water; dietary fiber; dietary fibre; molding wax for dentists; moulding wax for dentists; gases for medical purposes; guaiacol for pharmaceutical purposes; hematogen; haematogen; hemoglobin; haemoglobin; hydrastine; hydrastinine; glycerine for medical purposes;

glycerophosphates; glucose for medical purposes; gentian for pharmaceutical purposes; hormones for medical purposes; mustard for pharmaceutical purposes; mustard plasters; mustard poultices; mud for baths; medicinal mud; medicinal sediment [mud]; gamboge for medical purposes; gurjun balsam for medical purposes; air deodorising preparations; deodorants, other than for human beings or for animals; deodorants for clothing and textiles; diastase for medical purposes; digitalin; mineral food supplements; nutritional supplements; albumin dietary supplements; dietary supplements for animals; yeast dietary supplements; alginate dietary supplements; glucose dietary supplements; casein dietary supplements; lecithin dietary supplements; linseed oil dietary supplements; flaxseed oil dietary supplements; propolis dietary supplements; protein dietary supplements; protein supplements for animals; royal jelly dietary supplements; pollen dietary supplements; wheat germ dietary supplements; linseed dietary supplements; flaxseed dietary supplements; acai powder dietary supplements; dietary supplements with a cosmetic effect; enzyme dietary supplements; yeast for pharmaceutical purposes; gelatine for medical purposes; cod liver oil; isotopes for medical purposes; insecticides; iodine for pharmaceutical purposes; iodides for pharmaceutical purposes; alkaline iodides for pharmaceutical purposes; iodoform; cream of tartar for pharmaceutical purposes; tartar for pharmaceutical purposes; camphor for medical purposes; capsules for medicines; cachets for pharmaceutical purposes; hemostatic pencils; haemostatic pencils; caustic pencils; carbolineum [parasiticide]; caustics for pharmaceutical purposes; cachou for pharmaceutical purposes; quassia for medical purposes; quebracho for medical purposes; oxygen for medical purposes; gallic acid for pharmaceutical purposes; acids for pharmaceutical purposes; adhesives for dentures; cocaine; collodion for pharmaceutical purposes; corn rings for the feet; medicated candies; medicated sweets; angostura bark for medical purposes; barks for pharmaceutical purposes; cedar wood for use as an insect repellent; condurango bark for medical purposes; croton bark; mangrove bark for pharmaceutical purposes; myrobalan bark for pharmaceutical purposes; quinquina for medical purposes; cinchona for medical purposes; medicated animal feed; medicinal roots; rhubarb roots for pharmaceutical purposes; lint for medical purposes; starch for dietetic or pharmaceutical purposes; creosote for pharmaceutical purposes; blood for medical purposes; cultures of microorganisms for medical or veterinary use; curare; dental lacquer; liquorice for pharmaceutical purposes; adhesive plasters; sticking plasters; medicines for alleviating constipation; adhesive tapes for medical purposes; adhesive bands for medical purposes; lecithin for medical purposes; lotions for veterinary purposes; lotions for pharmaceutical purposes; lupulin for pharmaceutical purposes; magnesia for pharmaceutical purposes; liniments; ointments for pharmaceutical

purposes; sunburn ointments; mercurial ointments; frostbite salve for pharmaceutical purposes; gauze for dressings; medicinal oils; mustard oil for medical purposes; camphor oil for medical purposes; castor oil for medical purposes; oil of turpentine for pharmaceutical purposes; dill oil for medical purposes; dental mastics; dental abrasives; dental impression materials; teeth filling material; dressings, medical; surgical dressings; drugs for medical purposes; medicines for veterinary purposes; serotherapeutic medicines; medicines for human purposes; medicines for dental purposes; menthol; medicinal drinks; moleskin for medical purposes; almond milk for pharmaceutical purposes; royal jelly for pharmaceutical purposes; milk ferments for pharmaceutical purposes; irish moss for medical purposes; flour for pharmaceutical purposes; meal for pharmaceutical purposes; linseed meal for pharmaceutical purposes; flaxseed meal for pharmaceutical purposes; fish meal for pharmaceutical purposes; fly glue; fly catching adhesives; mint for pharmaceutical purposes; dietetic beverages adapted for medical purposes; malted milk beverages for medical purposes; narcotics; medicinal infusions; tincture of iodine; eucalyptol for pharmaceutical purposes; tinctures for medical purposes; opium; opodeldoc; decoctions for pharmaceutical purposes; antiparasitic collars for animals; stick liquorice for pharmaceutical purposes; sulfur sticks [disinfectants]; pectin for pharmaceutical purposes; pepsins for pharmaceutical purposes; peptones for pharmaceutical purposes; hydrogen peroxide for medical purposes; food for babies; leeches for medical purposes; blood plasma; eyepatches for medical purposes; poultices; compresses; scapulars for surgical purposes; diapers for incontinence; bunion pads; breast-nursing pads; pomades for medical purposes; powder of cantharides; pyrethrum powder; anti-uric preparations; bacterial preparations for medical and veterinary use; bacteriological preparations for medical and veterinary use; balsamic preparations for medical purposes; albuminous preparations for medical purposes; biological preparations for veterinary purposes; biological preparations for medical purposes; veterinary preparations; bismuth preparations for pharmaceutical purposes; vitamin preparations; diagnostic preparations for medical purposes; bath preparations for medical purposes; therapeutic preparations for the bath; hemorrhoid preparations; haemorrhoid preparations; preparations for callouses; preparations to facilitate teething; preparations for the treatment of burns; fumigation preparations for medical purposes; ophotherapy preparations; organotherapy preparations; air purifying preparations; bronchodilating preparations; sterilising preparations; sterilizing preparations; soil-sterilising preparations; soil-sterilizing preparations; corn remedies; pharmaceutical preparations for treating dandruff; preparations for destroying noxious animals; herbicides; weedkillers; preparations for destroying noxious plants; preparations for destroying dry rot fungus; larvae exterminating preparations; fly

destroying preparations; preparations for destroying mice; slug exterminating preparations; vermin destroying preparations; pharmaceutical preparations for skin care; contact lens cleaning preparations; preparations of microorganisms for medical or veterinary use; lime-based pharmaceutical preparations; medicinal hair growth preparations; opiates; anticryptogamic preparations; preparations of trace elements for human and animal use; sulfonamides [medicines]; pharmaceutical preparations; pharmaceutical preparations for treating sunburn; enzyme preparations for veterinary purposes; enzyme preparations for medical purposes; chemico-pharmaceutical preparations; chemical preparations for veterinary purposes; chemical preparations for the diagnosis of pregnancy; chemical preparations for medical purposes; chemical preparations for treating wheat blight; chemical preparations for treating wheat smut; chemical preparations for treating diseases affecting vine plants; chemical preparations for treating mildew; chemical preparations for treating phylloxera; chemical preparations for pharmaceutical purposes; chilblain preparations; mothproofing preparations; collyrium; lead water; goulard water; chemical conductors for electrocardiograph electrodes; albuminous foodstuffs for medical purposes; dietetic foods adapted for medical purposes; by-products of the processing of cereals for dietetic or medical purposes; sanitary towels; sanitary napkins; sanitary pads; panty liners [sanitary]; radium for medical purposes; hydrated chloral for pharmaceutical purposes; solvents for removing adhesive plasters; vaginal washes for medical purposes; solutions for contact lenses; solutions for use with contact lenses; chemical reagents for medical or veterinary purposes; gum for medical purposes; rubber for dental purposes; chewing gum for medical purposes; insect repellents; insect repellent incense; repellents for dogs; tissues impregnated with pharmaceutical lotions; sarsaparilla for medical purposes; sugar for medical purposes; asthmatic tea; fumigating sticks; fumigating pastilles; suppositories; linseed for pharmaceutical purposes; flaxseed for pharmaceutical purposes; tobacco-free cigarettes for medical purposes; siccatives [drying agents] for medical purposes; syrups for pharmaceutical purposes; turpentine for pharmaceutical purposes; milking grease; greases for veterinary purposes; greases for medical purposes; soporifics; bicarbonate of soda for pharmaceutical purposes; bath salts for medical purposes; salts for mineral water baths; salts for medical purposes; potassium salts for medical purposes; sodium salts for medical purposes; smelling salts; mineral water salts; malt for pharmaceutical purposes; semen for artificial insemination; medicinal alcohol; alloys of precious metals for dental purposes; ergot for pharmaceutical purposes; adjuvants for medical purposes; vermifuges; anthelmintics; disinfectants for hygiene purposes; disinfectants for chemical toilets; appetite suppressants for medical purposes; medical preparations for slimming purposes; parasiticides;

mouthwashes for medical purposes; febrifuges; depuratives; detergents for medical purposes; vesicants; purgatives; evacuants; remedies for perspiration; remedies for foot perspiration; chemical contraceptives; antiparasitic preparations; sedatives; tranquilizers; laxatives; tonics [medicines]; digestives for pharmaceutical purposes; nervines; media for bacteriological cultures; bouillons for bacteriological cultures; bacteriological culture mediums; steroids; headache relief sticks; strychnine; serums; jujube, medicated; sanitary tampons; menstruation tampons; vulnerary sponges; thymol for pharmaceutical purposes; smoking herbs for medical purposes; medicinal herbs; transplants [living tissues]; surgical implants comprised of living tissues; pants, absorbent, for incontinence; sanitary panties; menstruation knickers; sanitary knickers; sanitary pants; charcoal for pharmaceutical purposes; fennel for medical purposes; porcelain for dental prostheses; phenol for pharmaceutical purposes; enzymes for veterinary purposes; enzymes for medical purposes; ferments for pharmaceutical purposes; formic aldehyde for pharmaceutical purposes; phosphates for pharmaceutical purposes; fungicides; quinine for medical purposes; chinoline for medical purposes; diabetic bread adapted for medical use; chloroform; flowers of sulfur for pharmaceutical purposes; cement for animal hooves; bone cement for surgical and orthopaedic purposes; bone cement for surgical and orthopedic purposes; dental cements; herbal teas for medicinal purposes; eucalyptus for pharmaceutical purposes; tobacco extracts [insecticides]; extracts of hops for pharmaceutical purposes; elixirs [pharmaceutical preparations]; ethers for pharmaceutical purposes; esters for pharmaceutical purposes; cellulose esters for pharmaceutical purposes; cellulose ethers for pharmaceutical purposes; rat poison; poisons; bacterial poisons; jalap.

35 – Advertising; business management; business administration; office functions; arranging subscriptions to telecommunication services for others; import-export agency services; commercial information agency services; advertising agencies; publicity agencies; cost price analysis; rental of advertising space; employment agency services; computerized file management; book-keeping; accounting; invoicing; demonstration of goods; transcription of communications [office functions]; opinion polling; market studies; business investigations; marketing research; personnel recruitment; business management and organization consultancy; business organization consultancy; business management consultancy; personnel management consultancy; professional business consultancy; layout services for advertising purposes; business management of performing artists; business management of sports people; writing of resumes for others; writing of curriculum vitae for others; news clipping services; updating of advertising material; word processing; organization of exhibitions for commercial or advertising purposes; arranging newspaper subscrip-

tions for others; shop window dressing; business appraisals; payroll preparation; data search in computer files for others; sponsorship search; business management assistance; commercial or industrial management assistance; commercial intermediation services; providing business information; providing commercial information and advice for consumers in the choice of products and services; presentation of goods on communication media, for retail purposes; economic forecasting; auctioneering; sales promotion for others; promotion of goods and services through sponsorship of sports events; production of advertising films; office machines and equipment rental; rental of advertising time on communication media; publicity material rental; rental of vending machines; rental of photocopying machines; publication of publicity texts; radio advertising; distribution of samples; dissemination of advertising matter; writing of publicity texts; publicity; online advertising on a computer network; outdoor advertising; advertising by mail order; television advertising; compilation of statistics; compilation of information into computer databases; business inquiries; systemization of information into computer databases; tax preparation; drawing up of statements of accounts; psychological testing for the selection of personnel; interim business management; business management of hotels; commercial administration of the licensing of the goods and services of others; administrative processing of purchase orders; administrative services for the relocation of businesses; public relations; modelling for advertising or sales promotion; typing; price comparison services; secretarial services; procurement services for others [purchasing goods and services for other businesses]; shorthand; outsourcing services [business assistance]; telephone answering for unavailable subscribers; photocopying services; business efficiency expert services; organization of trade fairs for commercial or advertising purposes.

39 – Transportation logistics; hauling; car transport; portorage; transport brokerage; stevedoring; unloading cargo; packaging of goods; wrapping of goods; courier services [messages or merchandise]; transport.

41 – Correspondence courses; practical training [demonstration]; organization of exhibitions for cultural or educational purposes; arranging and conducting of colloquiums; arranging and conducting of congresses; arranging and conducting of conferences; arranging and conducting of workshops [training]; arranging and conducting of in-person educational forums; arranging and conducting of seminars; arranging and conducting of symposiums; organization of competitions [education or entertainment]; vocational retraining; conducting fitness classes; educational examination; providing museum facilities [presentation, exhibitions]; teaching.

(260) AM 2023 121620 A

(800) 1581477

(151) 2021 01 22

(891) 2023 01 23

(731) F.DIVELLA S.P.A.

Largo Domenico Divella 1, I-70018 Rutigliano
(Bari), Italy

(540)

DIVELLA

(591) Black, white

(511)

29 – Meat; jams; hazelnut spread; vegetable extracts for food; vegetables, tinned; vegetables, dried; vegetables, cooked; vegetables, preserved; fruit, preserved; fruit jellies; fruit preserves; fruit-based snack food; dried fruit; mushrooms, preserved; canned peanuts; milk; marmalade; oils for food; olive oil; extra virgin olive oil for food; preserved vegetables; potato crisps; game, not live; tomato preserves; peeled tomatoes; tinned tomatoes; tomato purée; dips; birds eggs and egg products; yoghurt.

30 – Vinegar; sugar; natural sweeteners; frostings; sweet glazes and fillings; honey; tortellini; pasta sauce; sauces for rice; coffee substitutes [artificial coffee or vegetable preparations for use as coffee]; spaghetti; flour based savory snacks; snack foods consisting principally of bread; pasta sauce; sauces for pizzas; salts, seasonings, flavourings and condiments; rice; ravioli; dried pasta; bakery goods; cake mixes; pizzas; prepared meals containing [principally] pasta; couscous [semolina]; pasta; dried pasta; puff pastry; fresh pasta; pasta; pasta containing eggs; pasta containing stuffings; pasta containing stuffings; wholemeal pasta; fresh bread; wholemeal bread; crisp breads; rusks; bread and buns; cookie mixes; flour mixtures for use in baking; mixed flour for food; flour mixes; yeast and leavening agents; pizza flour; flour ready for baking; rusks; flour; enriched farina [meal]; iced cakes; tea cakes; breakfast cake; buns; croissants; coffee [roasted, powdered, granulated, or in drinks]; cocoa beverages with milk; cocoa [roasted, powdered, granulated, or in drinks]; bread biscuits; rice biscuits; biscuits [sweet or savoury]; biscuits; prepared cocoa and cocoa-based beverages; flavourings for foods; fresh pasties; long-life pastry; croûtons; polenta; pesto [sauce].

(260) AM 2023 121621 A

(800) 1647891

(151) 2021 12 27

(891) 2023 01 06

(731) TIANNENG BATTERY GROUP CO., LTD.

Meishan Industrial Park, Changxing, Huzhou,
Zhejiang, China

(540)



(591) Blue, red and black

(531) 01.15.03; 26.07.25; 27.05.01; 29.01.13

(511)

9 – Batteries, electric; battery chargers; control panels [electricity].

(260) AM 2023 121627 A

(800) 1682300

(151) 2022 05 18

(891) 2023 01 24

(731) STAR MICRONICS CO., LTD.

20-10, Nakayoshida, Suruga-Ku, Shizuoka-
Shi, Shizuoka 422-8654, Japan

(540)



(591) Black, white

(531) 01.01.02; 01.01.14; 27.05.01; 27.05.02;
27.05.08; 27.05.17

(511)

42 – Providing computer programs in data networks for electronic point-of-sale systems that generate and issue electronic receipts; providing computer programs in data networks for monitoring and controlling the status of printers, machine tools, and computer peripheral equipment connected to cloud computing networks; providing computer programs in data networks for electronic point-of-sale systems that issue and manage coupons through cloud computing networks; providing computer programs in data networks for sending printing data to printers connected to cloud computing networks; providing computer programs in data networks for managing and controlling the distribution of data to mobile computer terminals and computer peripheral equipment connected to cloud computing networks; monitoring of computer systems by remote access for printers, machine tools, and computer peripheral equipment connected to cloud computing networks.

(260) AM 2023 121628 A

(800) 1686560

(151) 2022 06 16

(891) 2023 01 24

(731) F. Divella S.p.A.

Largo Domenico Divella, 1, I-70018 Rutigliano
(BA), Italy

(540)



(591) Red and white
(531) 26.04.02; 26.04.22; 26.04.24; 27.05.24;
29.01.12

(511)
29 – Meat; jams; hazelnut spread; vegetable extracts for food; vegetables, tinned; vegetables, dried; vegetables, cooked; vegetables, preserved; canned pulses; pre-cooked soup; fruit, preserved; fruit jellies; fruit preserves; fruit-based snack food; dried fruit; mushrooms, preserved; canned peanuts; milk; marmalade; oils for food; olive oil; extra virgin olive oil for food; preserved vegetables; potato crisps; game, not live; tomato preserves; peeled tomatoes; tinned tomatoes; tomato purée; vegetable-based dips; cheese dips; tomato dips; birds eggs and egg products; yoghurt.

30 – Vinegar; sugar; natural sweeteners; frostings; sweet glazes and fillings; honey; tortellini; pasta sauce; sauces for rice; vegetal preparations for use as coffee substitutes; spaghetti; flour based savory snacks; snack foods consisting principally of bread; sauces for pizzas; salts, seasonings, flavourings and condiments; rice; ravioli; dried pasta; bakery goods; cake mixes; pizzas; prepared meals containing [principally] pasta; couscous [semolina]; pasta; puff pastry; fresh pasta; pasta containing eggs; pasta containing stuffings; wholemeal pasta; fresh bread; wholemeal bread; crisp breads; rusks; bread and buns; cookie mixes; flour mixtures for use in baking; mixed flour for food; flour mixes; yeast and leavening agents; pizza flour; flour ready for baking; flour; enriched farina [meal]; iced cakes; tea cakes; breakfast cake; buns; croissants; coffee [roasted, powdered, granulated, or in drinks]; cocoa beverages with milk; cocoa [roasted, powdered, granulated, or in drinks]; bread biscuits; rice biscuits; biscuits [sweet or savoury]; biscuits; prepared cocoa and cocoa-based beverages; flavourings for foods; fresh pasties; long-life pastry; sponge fingers [cakes]; croutons; polenta; pesto [sauce]; cereal preparations.

(260) AM 2023 121671 A
(800) 1710904
(151) 2022 11 22
(891) 2022 11 22
(731) Mehrdad Aalipour Herisi
unit 10, no 1, hooshyar alley, north west wings
of seid khandan bridge, 1541947435 Tehran,
Islamic Republic of Iran

(540)

Panter

(591) Red
(531) 27.05.01; 29.01.01
(511)

35 – Distribution of samples; arranging and conducting of auction sales; modeling for advertising or sales promotion; import and export agencies; sales promotion for others; import-export agencies.

39 – Arranging for the distribution of goods.

(260) AM 2023 121674 A
(800) 1712939
(151) 2022 08 26
(891) 2022 08 26
(731) Dalian No.1 Instrument Transformer Co., Ltd.
No.29, Haiwan Road, Pulandian District,
Dalian City, Liaoning, China

(540)



(591) Black, white
(531) 26.04.05; 26.04.12; 26.04.18; 26.04.24;
26.13.25; 27.05.24

(511)

9 – Electric cable; electric line; instruments for transforming electricity; sensor; voltage regulator; fuse; transformer; distribution box; current collector; insulated tubular bus-bar.

(260) AM 2023 121675 A
(800) 1712952
(151) 2022 12 16
(891) 2022 12 16
(731) TOPANEL PRODUCTION PANELS S.A.
Str Uzinei nr. 63. Stolniceni, Râmnicu Vâlcea,
Jud. Vâlcea, Romania

(540)



(591) Orange and grey
(531) 26.05.02; 26.05.04; 26.05.24; 27.05.01;
27.05.09; 29.01.12

(511)

6 – Metal building materials; transportable buildings of metal; materials of metal for railway tracks; non-electric cables and wires of common metal; ironmongery, small items of metal hardware; pipes and tubes of metal; safes; goods of common metal not included in other classes; ores.

19 – Building materials (non-metallic); non-metallic rigid pipes for building; asphalt, pitch and bitumen; non-metallic transportable buildings; monuments, not of metal.

37 – Building construction; repair; installation services in relation with metal and non-metallic building materials.

42 – Scientific and technological services and research and design relating thereto; industrial analysis and research services; design and development of computer hardware and software.

45 – Legal services; security services for the protection of property and individuals

(260) AM 2023 121676 A

(800) 1712953

(151) 2022 12 05

(891) 2022 12 05

(731) PJSC "Cherkizovo Group"

ul. Cherkizovskaya, d. 1, str. 1, kabinet 206,
ter. Myasopererabotka, d. Topkanovo, g.o.
Kashira, RU-142931 Moskovskaya oblast,
Russian Federation

(540)

Онежская

(591) Black, white

(531) 28.05

(511)

29 – Alginates for culinary purposes; peanuts, prepared; bacon; albumen for culinary purposes; white of eggs; broth concentrates; broth; preparations for making bouillon; consommés; ham; game, not live; gelatine; meat jellies; jellies for food; yolk of eggs; frozen fruits; raisins; caviar; yogurt; protein milk for culinary purposes; potato fritters; potato chips; kephir; clams, not live; coconut, desiccated; black pudding; charcuterie; meat, tinned; gherkins; shrimps, not live; prawns, not live; croquettes; koumiss; spiny lobsters, not live; salmon, not live; marmalade; mussels, not live; almonds, ground; molluscs, not live; milk; whey; milk beverages, milk predominating; fruit pulp; meat extracts; meat, preserved; vegetable juices for cooking; lobsters, not live; nuts, prepared; tomato paste; liver pâté; liver; pickles; powdered eggs; poultry, not live; pollen prepared as foodstuff; crayfish, not live; crustaceans, not live; shellfish, not live; fish, not live; salted fish; fish meal for human consumption; fish fillets; salo being cured slabs of fatback; pork; cream [dairy products]; whipped cream; fruit chips; seaweed extracts for food; eggs; snail eggs for consumption.

(260) AM 2023 121678 A

(800) 1713065

(151) 2022 12 13

(891) 2022 12 13

(731) Myovant Sciences GmbH

Aeschengraben 27, CH-4051 Basel,
Switzerland

(540)



(591) Black, white

(531) 02.09.01; 26.13.25

(511)

5 – Pharmaceutical preparations for human use; biologic preparations for medical and therapeutic use.

44 – Providing health and medical information; Providing information relating to the diagnostic, prophylactic and therapeutic properties of pharmaceutical and biologic preparations for the prevention and treatment of diseases, disorders and conditions.

(260) AM 2023 121689 A

(800) 1713540

(151) 2022 12 26

(891) 2022 12 26

(731) Limited Liability Company "Al'tomore"

ul. Sportivnaya, d. 62, kv. 140, g. Kaliningrad,
RU-236010 Kaliningradskaya obl., Russian
Federation

(540)



Sergey Kirsanov

(591) Lilac and white

(531) 26.01.03; 26.01.18; 27.05.24; 29.01.12

(511)

29 – Fish, not live; fish, preserved; salted fish; isinglass for food; shrimps, not live; fish, tinned; spiny lobsters, not live; salmon, not live; mussels, not live; molluscs, not live; food products made from fish; sardines, not live; herrings, not live; tuna fish; fish fillets; caviar; fish roe, prepared; fish meal for human consumption; fish mousses; lobsters, not live; oysters, not live; crayfish, not live; meat, poultry and game; preserved, frozen, dried and cooked fruits and vegetables; jellies, jams, compotes; eggs, milk and milk products; oils and fats for food.

30 – Coffee, tea, cocoa and coffee substitutes; rice; tapioca and sago; flour and preparations made from cereals; bread, pastries and confectionery; ice cream; sugar, honey, treacle; yeast, baking-powder; salt; mustard; vinegar, sauces [condiments]; spices; edible ices.

(260) AM 2023 121699 A

(800) 1713803

(151) 2022 07 26

(891) 2022 07 26

(731) Društvo za trgovija i usluge EVRO GEJMS

TEHNOLODŽI DOOEL Skopje

Ul. Boris Trajkovski br.214 A, 1000 Skopje,

The Republic of North Macedonia

(540)

Flames

(591) Black, white

(511)

41 – Casino management services in the nature of organizing gambling activities in casinos; operation of gaming establishments, gaming halls, Internet casinos, online gambling sites; services related to gambling; gaming services for entertainment purposes; casino, gaming and gambling services; gambling; training in the development of software systems; provision of gaming equipment for gambling halls; providing casino equipment [gambling]; gaming machine entertainment services; providing casino facilities [gambling]; providing halls with gaming machines; amusement arcade services; games equipment rental; rental of gaming machines; providing amusement arcade services; rental of gaming machines with images of fruits; editing or recording of sounds and images; sound recording and video entertainment services; hire of sound reproducing apparatus; provision of gaming equipment for casinos; providing of casino facilities; online gambling services.

(260) AM 2023 121710 A

(800) 1408878

(151) 2017 12 27

(891) 2023 01 31

(731) PPG INDUSTRIES OHIO, INC.

3800 West 143rd Street, Cleveland OH 44111,

USA

(540)

GLADIATOR

(591) Black, white

(511)

2 – Primers; thickeners for paints; thickeners for lacquers; thinners for paints; agglutinants for paints; paint additives in the nature of binders; binding preparations for paints; paint sealers; sealant primers; protective coatings with sealing qualities for use on metals [paints]; protective coatings for metals [paints]; protective surface coatings [paints]; clear protective coatings for vehicles; protective coating compositions [paints]; varnishes; binders for varnishes; automotive paints; thinners for varnishes; coatings; paints and washes; colour bases for paints; transparent finishes in the nature of paint; paints for protection against corrosion; water repellent fungicidal wood stains; preparations for drying varnishes; mordants [fixatives] in

the nature of varnishes; undercoating for surfaces to be painted; enamels [varnishes]; automotive enamels; pottery enamels; colorants; anti-fouling paints; dyes-tuffs for use in industry; mordants; natural dyes; wood stains; dyes, colorants, pigments and inks; anti-corrosive waxes; wood preservatives; anti-rust preparations; thinners and thickeners for coatings, dyes and inks; preservatives for cement [paints]; raw natural resins; resin-based colorants; polymer colours; coating compositions having waterproofing properties [paints or oils]; transparent coating compositions [paints]; paint drying compositions; automotive undercoat compounds; undercoating for vehicle chassis; coating compositions in the nature of paint; preservatives; preservatives for metals [paints]; diluents for vehicle refinishes; thinners for lacquers; primer thinners; siccatives [drying agents] for paints; pigment siccatives; fixatives [varnishes]; fixatives for dyes-tuffs; metal in foil and powder form; anti-corrosive bands; powders in the nature of paint for use as coatings; anti-corrosive preparations; protective preparations for metals; stabilising preparations in the nature of coatings; resins for coating purposes; epoxy coatings; glazes.

(260) AM 2023 121711 A

(800) 1490398

(151) 2019 06 28

(891) 2023 01 24

(731) Star Micronics Co., Ltd.

20-10, Nakayoshida, Suruga-Ku, Shizuoka-Shi,

Shizuoka 422-8654, Japan

(540)

STAR MICRONICS

(591) Black, white

(511)

9 – Telecommunications apparatus and equipment; telecommunications transmitters and receivers; computer peripherals for telecommunications; interface hardware for use in computer printers; network interface hardware for controlling cash register drawers for use in point-of-sale systems; computer peripherals; computer printers; computer programs for controlling computer printers and computer peripherals; computer programs for use in electronic cash register systems; computer software for managing computer printers and computer peripherals; electronic card readers; electronic card writers; computer software for digitizing printed data on purchase receipts, transmitting the data to the purchaser's mobile devices, smartphones and personal computers, storing the data in the servers, managing and analyzing the purchase history, and distributing advertisements, offers, rewards, coupons, and direct mail campaign information; computer software for generating, displaying, transmitting, receiving, saving, and managing electronic receipts; computer programs for use in printing data received from a cloud server; computer software for use in printing

data from mobile devices, smartphones, and personal computers connected to a cloud computing network; computer software for use in remote monitoring of computers, computer printers, computer systems, CNC lathes, and machine tools connected to a cloud computing network; computer software for issuance and management of point cards and coupons for promotional purposes; computer software for operating computer peripherals connected to a cloud computing network; computer programs for configuration and control of computer printers; computer programs for monitoring machine tools operation; electronic cash registers; electronic cash register drawers; electronic cash register drawers with built-in printers for use in point-of-sale systems.

42 – Providing temporary use of on-line non-downloadable computer software for generating, issuing, displaying, transmitting, receiving, saving, and managing electronic receipts; providing temporary use of on-line non-downloadable software for issuance and management of point cards and coupons for promotional purposes using a cloud computing network; providing temporary use of on-line non-downloadable software for use in transmitting data to printers connected to a cloud computing network for printing; providing temporary use of on-line non-downloadable software for use in printing data from mobile devices, smartphones and personal computers connected to a cloud computing network; providing temporary use of on-line non-downloadable software for use in remote monitoring of computers, computer printers, computer systems, CNC lathes, and metal working machines connected to a cloud computing network; providing temporary use of on-line non-downloadable computer software for operating and controlling computer printers and computer peripherals; providing temporary use of on-line non-downloadable computer software for operating and controlling machine tools and CNC lathes.

(260) AM 2023 121712 A

(800) 1494131

(151) 2019 09 10

(891) 2023 02 02

(731) Sovereign Brands, L.L.C.

1300 Old Skokie Valley Road, Highland Park
IL 60035, USA

(540)

THE DEACON

(591) Black, white

(511)

3 – Alcoholic beverages (except beer), in particular whiskey.

(260) AM 2023 121713 A

(800) 1565719

(151) 2020 11 17

(891) 2023 01 30

(731) Wirtgen GmbH

Reinhard-Wirtgen-Str. 2, 53578 Windhagen,
Germany

(540)

HT11

(591) Black, white

(511)

7 – Parts for machines, namely chisels, picks, chisel holders, pick holders, holders for chisel holders and holders for pick holders; parts for machines, namely quick change chisel holders for holding chisels used in machines; parts for machines, namely quick change pick holders for holding picks used in machines; parts for machines, namely holders for quick change chisel holders for holding chisels used in machines; parts for machines, namely holders for quick change pick holders for holding picks used in machines; parts for machines, namely tools, tool holders and holders for tool holders; parts for machines, namely seals for tools, seals for tool holders and seals for holders for tool holders; parts for machines, namely adapted covers for machine parts; parts for machines, namely threaded fasteners for fastening machine parts; parts and fittings for all the aforesaid goods, included in this class.

(260) AM 2023 121714 A

(800) 1565728

(151) 2020 11 17

(891) 2023 01 30

(731) Wirtgen GmbH

Reinhard-Wirtgen-Str. 2, 53578 Windhagen,
Germany

(540)

HT3

(591) Black, white

(511)

7 – Parts for machines, namely chisels, picks, chisel holders, pick holders, holders for chisel holders and holders for pick holders; parts for machines, namely quick change chisel holders for holding chisels used in machines; parts for machines, namely quick change pick holders for holding picks used in machines; parts for machines, namely holders for quick change chisel holders for holding chisels used in machines; parts for machines, namely holders for quick change pick holders for holding picks used in machines; parts for machines, namely tools, tool holders and holders for tool holders; parts for machines, namely seals for tools, seals for tool holders and seals for holders for tool holders; parts for machines, namely adapted covers for machine parts; parts for machines, namely threaded fasteners for fastening machine parts; parts and

fittings for all the aforesaid goods, included in this class.

(260) AM 2023 121782 A

(800) 1714353

(151) 2022 12 17

(891) 2022 12 17

(731) PALMIYE İLAÇ KİMYA VE GIDA SANAYİ
TİCARET ANONİM ŞİRKETİ
Orta Mah. Ordu Sk. İZPARK C Blok 26 28,
Kartal, İSTANBUL, Türkiye

(540)



(591) Green, brown, white

(531) 26.04.07; 26.04.18; 26.04.24; 27.05.01;
27.05.09; 27.05.10; 27.05.24; 29.01.13

(511)

5 – Pharmaceutical and veterinary preparations for medical purposes; chemical preparations for medical and veterinary purposes, chemical reagents for pharmaceutical and veterinary purposes, medicated cosmetics, dietetic food and substances adapted for medical or veterinary use, sanitary products for medical purposes; dietetic substances and foodstuffs for medical use, food for babies, food supplements for humans, vitamins, amino acids for nutrition for medical purposes, dietary fiber to aid digestion, dietary supplements and dietetic preparations, dietary and nutritional supplements, dietary and nutritional supplements containing fish oils, food supplements containing fish oils, liquid fish oil, containing fatty acids and vitamins, dietary and nutritional supplements, dietary and nutritional supplements used for weight loss, enzyme food supplements, food supplements, food supplements consisting of amino acids, food supplements for sportsmen, food supplements in liquid form, herbal supplements, meal replacement shakes adapted for medical use, mineral supplements, nutritional supplement shakes, nutritional supplements, nutritional supplements for boosting energy, nutritional supplements for support of the immune system, nutritional supplements for bone and joint support, nutritional supplements, namely, probiotic compositions, nutritional and dietary supplements formed and packaged as bars, protein dietary supplements, protein supplement shakes, herbs and herbal beverages adapted for medicinal purposes, deodorants, other than for human beings or for animals; air purifying preparations; air deodorising preparations; disinfectants; antiseptics; detergents for medical purposes; medicated soaps; disinfectant soaps; antibacterial hand lotions.

(260) AM 2023 121783 A

(800) 1714435

(151) 2022 12 12

(891) 2022 12 12

(731) Incyte Holdings Corporation
1801 Augustine Cut-Off, Wilmington
DE 19803, USA

(540)

VUFYSO

(591) Black, white

(511)

5 – Pharmaceutical preparations for the treatment of cancer; pharmaceutical preparations for the treatment of immunological disorders; pharmaceutical preparations for the treatment of hematological disorders; pharmaceutical preparations for the treatment of hypophosphatemia disorders; pharmaceutical preparations for the treatment of myeloproliferative disorders; pharmaceutical preparations for the treatment of skeletal or chondrocyte disorders; pharmaceutical preparations for the treatment of dermatological disorders; pharmaceutical preparations for the treatment of graft versus host disorders.

44 – Providing healthcare information to physicians, patients and caregivers relating to diagnosis and treatment of medical diseases and disorders.

(260) AM 2023 121784 A

(800) 1714473

(151) 2023 01 25

(891) 2023 01 25

(731) Dart Industries Inc.
14901 S. Orange Blossom Trail, Orlando
FL 32837, USA

(540)

TWIST & FRESH

(591) Black, white

(511)

21 – Containers for household or kitchen use.

(260) AM 2023 121785 A

(800) 1714516

(151) 2022 11 16

(891) 2022 11 16

(731) S. Tous, S.L.
Carretera de Vic, El Guix, 3, E-08243
MANRESA (Barcelona), Spain

(540)

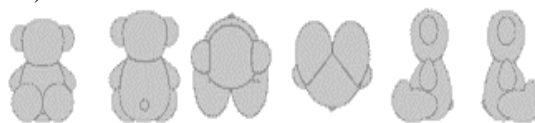

(591) Black, white

(531) 03.01.14; 03.01.24; 21.01.25

(554) Three Dimensional

(511)

9 – Scientific, nautical, surveying, electric, photographic, cinematographic and optical, weighing, measuring, signaling, checking (supervision), emergency (life-saving) and teaching apparatus and instruments; apparatus for recording, transmission and reproduction of sound or images; magnetic recording media, recording disks; mechanisms for coin-operated apparatus; cash registers, calculating machines, data processing equipment and computers; software; downloadable computer applications; covers for mobile telephones; support rings for mobile telephones; straps for mobile telephones; covers for laptops; cases for mobile phones made of leather; USB connectors and earphones; spectacles and spectacle frames; spectacle cases; cases for contact lenses; spectacles for children; sunglasses; lenses for sunglasses; temples for spectacles; spectacle cords; chains for spectacles and for sunglasses; pouches for spectacles; mounts for spectacles; downloadable virtual products, specifically, preparations for bleaching and other substances for laundry use, preparations for cleaning, preparations for polishing, preparations for degreasing, preparations for scraping, soaps; downloadable virtual products, specifically, perfumery products and fragrances, perfumes, scented toilet waters, eau de cologne, micellar water, essential oils, bath oils, cosmetics, hair lotions, dentifrices, shampoos, lip conditioners, hair conditioners; downloadable virtual products, specifically, decorative transfers for cosmetic use, potpourris, bath salts other than for medical use, after-shave lotions, after-shave creams and gels, toiletries, lip balms, beauty masks, lip gloss, body cream, shower cream, cosmetic creams, exfoliants, bath gels, make-up kits, cosmetic masks, body masks, hair masks; downloadable virtual products, specifically, face masks, hydrating masks; downloadable virtual products, specifically, scientific, nautical, surveying, electric, photographic, cinematographic and optical, weighing, measuring, signaling, checking (supervision), emergency (life-saving) and teaching apparatus and instruments; downloadable virtual products, specifically, apparatus for recording, transmission and reproduction of sound or images, magnetic recording media, recording disks, automatic vending machines and mechanisms for coin-operated apparatus, cash registers, calculating machines, data processing equipment and computers, software, downloadable computer applications; downloadable virtual products, specifically, covers for mobile telephones, support rings for mobile telephones, straps for mobile telephones, covers for laptops, leather covers for portable telephones, USB connectors and earphones; downloadable virtual products, specifically, spectacles and spectacle frames, spectacle cases, cases for contact lenses, spectacles for children, sunglasses, lenses for sunglasses, temples for spectacles, spectacle cords, chains for spectacles and for sunglasses, pouches for spectacles, mounts for spectacles; downloadable virtual products,

specifically, precious metals and their alloys, jewelry articles, precious and semi-precious stones, horological and chronometric instruments, unwrought or semi-wrought jet, watch cases, clocks, decorative charms for mobile telephones, jewelry cases, earrings, rings, medallions, brooches, necklaces, pendants, bracelets, chokers; downloadable virtual products, specifically, decorative pins, namely, jewelry pins (all jewelry articles); downloadable virtual products, specifically, tie pins, cuff links, watches of precious and semi-precious stones, watches, wedding rings, clasps for necklaces, clasps for bracelets, parts and fittings for jewelry, key rings; downloadable virtual products, specifically, leather and imitation leather, hides and imitation of skins, trunks and traveling bags, umbrellas, parasols and walking sticks, whips and saddlery, leather bags, shoulder bags, handbags, beach bags, changing bags, evening bags, leather wallets, purses, billfolds, belt bags, briefcases, backpacks, attaché cases; downloadable virtual products, specifically, business card holders, card cases [notecases], traveling cases of leather, handbags, key wallets, school satchels, vanity cases [empty], cases for toiletries, harness fittings, luggage, bags, wallets and other carriers; downloadable virtual products, specifically, articles of clothing, footwear, headwear, neck scarves, foulards, belts, beachwear, bathing suits, pajamas, socks, shirts, t-shirts, jackets, trousers, jerseys, ties, skirts, gloves, dresses, underwear, turbans, scarves, foulards, shawls, shoes, slippers, caps, berets, bibs; downloadable virtual products, specifically, layettes for babies', babies' clothing, masks [clothing] for covering the face other than for medical or hygienic use, bath robes, fittings of metal for footwear.

14 – Precious metals and their alloys; jewelry articles, precious and semi-precious stones; timepieces and chronometric instruments; unwrought or semi-wrought jet; watch cases; watches; jewelry charms for mobile telephones; jewelry cases [caskets]; earrings; rings; medallions; brooches; necklaces; pendants; bracelets; chokers; decorative pins, namely, jewelry pins, (all jewelry articles); tie pins; cuff links; watches of precious and semi-precious stones; wedding rings; closures for necklaces; clasps for bracelets; parts and accessories for jewelry; key rings.

35 – Retail, wholesale and online sale services for preparations for bleaching and other substances for laundry use, preparations for cleaning, preparations for polishing, preparations for degreasing, preparations for scraping, soaps, perfumery products and fragrances, perfumes, scented toilet waters, eau de cologne, micellar water, essential oils, bath oils, cosmetics, hair lotions, dentifrices, shampoos, lip conditioners, hair conditioners; retail, wholesale and online sale services for decorative transfers for cosmetic use, potpourris, bath salts other than for medical use, after-shave lotions, after-shave creams and gels, toiletries, lip balms, beauty masks, lip gloss, body cream, sho-

wer cream, cosmetic creams, exfoliants, bath gels, make-up kits, cosmetic masks, body masks; retail, wholesale and online sale services for hair masks, face masks, hydrating masks; retail, wholesale and online sale services for scientific, nautical, surveying, electric, photographic, cinematographic and optical, weighing, measuring, signaling, checking (supervision), emergency (life-saving) and teaching apparatus and instruments; retail, wholesale and online sale services for apparatus for recording, transmission and reproduction of sound or images, magnetic recording media, recording disks, automatic vending machines and mechanisms for coin-operated apparatus, cash registers, calculating machines, data processing equipment and computers, software, downloadable computer applications; retail, wholesale and online sale services for covers for mobile telephones, support rings for mobile telephones, straps for mobile telephones, covers for laptops, leather covers for portable telephones, USB connectors and earphones; retail, wholesale and online sale services for spectacles and spectacle frames, spectacle cases, cases for contact lenses, spectacles for children, sunglasses, lenses for sunglasses, temples for spectacles, spectacle cords, chains for spectacles and for sunglasses, pouches for spectacles, mounts for spectacles; retail, wholesale and online sale services for precious metals and their alloys, jewelry articles, precious and semi-precious stones, horological and chronometric instruments, unwrought or semi-wrought jet, watch cases, clocks, decorative charms for mobile telephones, jewelry cases, earrings, rings, medallions, brooches, necklaces, pendants, bracelets, chokers; retail, wholesale and online sale services for decorative pins, namely, jewelry pins, (all jewelry articles); retail, wholesale and online sale services for tie pins, cuff links, watches of precious and semi-precious stones, watches, wedding rings, clasps for necklaces, clasps for bracelets, parts and fittings for jewelry, key rings; retail, wholesale and online sale services for leather and imitation leather, hides and imitation of skins, trunks and traveling bags, umbrellas, parasols and walking sticks, whips and saddlery, leather bags, shoulder bags, handbags, beach bags, changing bags, evening bags, leather wallets, purses, billfolds, belt bags, briefcases, backpacks, attaché cases; retail, wholesale and online sale services for business card holders, card cases [notecases], traveling cases of leather, handbags, key wallets, school satchels, vanity cases [empty], cases for toiletries, harness fittings, luggage, bags, wallets and other carriers; retail, wholesale and online sale services for articles of clothing, footwear, headwear, neck scarves, foulards, belts, beachwear, bathing suits, pajamas, socks, shirts, t-shirts, jackets, trousers, jerseys, ties, skirts, gloves, dresses, underwear, turbans, scarves, foulards, shawls, shoes, slippers, caps, berets, bibs; retail, wholesale and online sale services for layettes for babies', babies' clothing, masks [clothing] for covering the face other than for medical or hygienic use, bath ro-

bes, fittings of metal for footwear; provision of an online marketplace for buyers and sellers of downloadable and non-downloadable virtual products, specifically, preparations for bleaching and other substances for laundry use, preparations for cleaning, preparations for polishing, preparations for degreasing, preparations for scraping, soaps, perfumery products and fragrances, perfumes, scented toilet waters, eau de cologne, micellar water, essential oils, bath oils, cosmetics, hair lotions, dentifrices; provision of an online marketplace for buyers and sellers of downloadable and non-downloadable virtual products, specifically, shampoos, lip conditioners, hair conditioners, decorative transfers for cosmetic use, potpourris, bath salts other than for medical use, after-shave lotions, after-shave creams and gels, toiletries, lip balms, beauty masks, lip gloss, body cream, shower cream; provision of an online marketplace for buyers and sellers of downloadable and non-downloadable virtual products, specifically, cosmetic creams, exfoliants, bath gels, make-up kits, cosmetic masks, body masks, hair masks, face masks, hydrating masks; provision of an online marketplace for buyers and sellers of downloadable and non-downloadable virtual products, specifically, scientific, nautical, surveying, electric, photographic, cinematographic and optical, weighing, measuring, signaling, checking (supervision), emergency (life-saving) and teaching apparatus and instruments; provision of an online marketplace for buyers and sellers of downloadable and non-downloadable virtual products, specifically, apparatus for recording, transmission and reproduction of sound or images, magnetic recording media, recording disks, automatic vending machines and mechanisms for coin-operated apparatus, cash registers, calculating machines, data processing equipment and computers, software, downloadable computer applications; provision of an online marketplace for buyers and sellers of downloadable and non-downloadable virtual products, specifically, covers for mobile telephones, support rings for mobile telephones, straps for mobile telephones, covers for laptops, leather covers for portable telephones, USB connectors and earphones; provision of an online marketplace for buyers and sellers of downloadable and non-downloadable virtual products, specifically, spectacles and spectacle frames, spectacle cases, cases for contact lenses, spectacles for children, sunglasses, lenses for sunglasses, temples for spectacles, spectacle cords, chains for spectacles and for sunglasses, pouches for spectacles, mounts for spectacles; provision of an online marketplace for buyers and sellers of downloadable and non-downloadable virtual products, specifically, precious metals and their alloys, jewelry articles, precious and semi-precious stones, horological and chronometric instruments, unwrought or semi-wrought jet, watch cases, clocks, decorative charms for mobile telephones, jewelry cases, earrings, rings, medallions, brooches, necklaces, pendants, bracelets, chokers; provision of an online mar-

ketplace for buyers and sellers of downloadable and non-downloadable virtual products, specifically, decorative pins, namely, jewelry pins, (all jewelry articles); provision of an online marketplace for buyers and sellers of downloadable and non-downloadable virtual products, specifically, tie pins, cuff links, watches of precious and semi-precious stones, watches, wedding rings, clasps for necklaces, clasps for bracelets, parts and fittings for jewelry, key rings; provision of an online marketplace for buyers and sellers of downloadable and non-downloadable virtual products, specifically, leather and imitation leather, hides and imitation of skins, trunks and traveling bags, umbrellas, parasols and walking sticks, whips and saddlery, leather bags, shoulder bags, handbags, beach bags, changing bags, evening bags, leather wallets, purses, billfolds, belt bags, briefcases, backpacks, attaché cases; provision of an online marketplace for buyers and sellers of downloadable and non-downloadable virtual products, specifically, business card holders, card cases [notecases], traveling cases of leather, handbags, key wallets, school satchels, vanity cases [empty], cases for toiletries, harness fittings, luggage, bags, wallets and other carriers; provision of an online marketplace for buyers and sellers of downloadable and non-downloadable virtual products, specifically, articles of clothing, footwear, headwear, neck scarves, foulards, belts, beachwear, bathing suits, pajamas, socks, shirts, t-shirts, jackets, trousers, jerseys, ties, skirts, gloves, dresses, underwear, turbans, scarves, foulards, shawls, shoes, slippers, caps, berets, bibs; provision of an online marketplace for buyers and sellers of downloadable and non-downloadable virtual products, specifically, layettes for babies', babies' clothing, masks [clothing] for covering the face other than for medical or hygienic use, bath robes, fittings of metal for footwear; retail, wholesale and online sale services for downloadable virtual products, specifically, preparations for bleaching and other substances for laundry use, preparations for cleaning, preparations for polishing, preparations for degreasing, preparations for scraping, soaps; retail, wholesale and online sale services for perfumery products and fragrances, perfumes, scented toilet waters, eau de cologne, micellar water, essential oils, bath oils, cosmetics, hair lotions, dentifrices, shampoos, lip conditioners, hair conditioners; retail, wholesale and online sale services for downloadable virtual products, specifically, decorative transfers for cosmetic use, potpourris, bath salts other than for medical use, after-shave lotions, after-shave creams and gels, toiletries, lip balms, beauty masks, lip gloss; retail, wholesale and online sale services for downloadable virtual products, specifically, body cream, shower cream, cosmetic creams, exfoliants, bath gels, make-up kits, cosmetic masks, body masks, hair masks; retail, wholesale and online sale services for downloadable virtual products, specifically, face masks, hydrating masks; retail, wholesale and online sale services for downloadable virtual pro-

ducts, specifically, scientific, nautical, surveying, electric, photographic, cinematographic and optical, weighing, measuring, signaling, checking (supervision), emergency (life-saving) and teaching apparatus and instruments; retail, wholesale and online sale services for downloadable virtual products, specifically, apparatus for recording, transmission and reproduction of sound or images, magnetic recording media, recording disks, automatic vending machines and mechanisms for coin-operated apparatus, cash registers, calculating machines, data processing equipment and computers, software, downloadable computer applications; retail, wholesale and online sale services for downloadable virtual products, specifically, covers for mobile telephones, support rings for mobile telephones, straps for mobile telephones, covers for laptops, leather covers for portable telephones, USB connectors and earphones; retail, wholesale and online sale services for downloadable virtual products, specifically, spectacles and spectacle frames, spectacle cases, cases for contact lenses, spectacles for children, sunglasses, lenses for sunglasses, temples for spectacles, spectacle cords, chains for spectacles and for sunglasses, pouches for spectacles, mounts for spectacles; retail, wholesale and online sale services for downloadable virtual products, specifically, precious metals and their alloys, jewelry articles, precious and semi-precious stones, horological and chronometric instruments, unwrought or semi-wrought jet, watch cases, clocks, decorative charms for mobile telephones, jewelry cases, earrings, rings, medallions, brooches, necklaces, pendants, bracelets, chokers; retail, wholesale and online sale services for downloadable virtual products, specifically, decorative pins, namely, jewelry pins, (all jewelry articles); retail, wholesale and online sale services for downloadable virtual products, specifically, tie pins, cuff links, watches of precious and semi-precious stones, watches, wedding rings, clasps for necklaces, clasps for bracelets, parts and fittings for jewelry, key rings; retail, wholesale and online sale services for downloadable virtual products, specifically, leather and imitation leather, hides and imitation of skins, trunks and traveling bags, umbrellas, parasols and walking sticks, whips and saddlery, leather bags, shoulder bags, handbags, beach bags, changing bags, evening bags, leather wallets, purses, billfolds, belt bags, briefcases, backpacks, attaché cases; retail, wholesale and online sale services for downloadable virtual products, specifically, business card holders, card cases [notecases], traveling cases of leather, handbags, key wallets, school satchels, vanity cases [empty], cases for toiletries, harness fittings, luggage, bags, wallets and other carriers; retail, wholesale and online sale services for downloadable virtual products, specifically, articles of clothing, footwear, headwear, neck scarves, foulards, belts, beachwear, bathing suits, pajamas, socks, shirts, t-shirts, jackets, trousers, jerseys, ties, skirts, gloves, dresses, underwear, turbans, scarves, foulards, shawls, shoes, slippers,

caps, berets, bibs; retail, wholesale and online sale services for downloadable virtual products, specifically, layettes for babies', babies' clothing, masks [clothing] for covering the face other than for medical or hygienic use, bath robes, fittings of metal for footwear.

(260) AM 2023 121817 A

(800) 1715391

(151) 2022 10 24

(891) 2022 10 24

(731) Lashify, Inc.

11437 Chandler Blvd, North Hollywood
CA 91601, USA

(540)

LASHIFY

(591) Black, white

(511)

3 – Cosmetics; cosmetic preparations for eyelashes; false eyelashes and eyelash extensions; adhesives and sealers for cosmetic use; adhesives for false eyelashes and eyelash extensions; artificial eyelash kits comprised primarily of artificial eyelashes, artificial eyelash adhesive, and sealer for affixing false eyelashes; skin-care preparations; make-up and false eyelash and eyelash extension removing preparations.

(260) AM 2023 121818 A

(800) 1715424

(151) 2022 12 14

(891) 2022 12 14

(731) "SABYRZHAN GROUP" Limited Liability
Partnership (KZ)

ulitsa Rozybakiyeva, 4, Almalinskiy raion,
050009 gorod Almaty, Kazakhstan

(540)



(591) Black, white

(531) 24.15.01; 25.01.25; 26.13.25; 27.05.01

(511)

33 – Vodka.

(260) AM 2023 121819 A

(800) 1715490

(151) 2022 12 06

(891) 2022 12 06

(731) LEDGER

1 rue du Mail, F-75002 PARIS, France

(540)

LEDGER STAX

(591) Black, white

(511)

9 – Peripheral devices with secure microprocessor for computers; data processing apparatus and equipment; downloadable electronic wallet.

(260) AM 2023 121820 A

(800) 1715575

(151) 2022 11 07

(891) 2022 11 07

(731) ROYAL ARMENIA JV LTD

Haghtanak 1 street, 1st lane, 16, 0036 Yerevan,
Armenia

(540)

CAFEOPIA

(591) Black, white

(511)

30 – Coffee; coffee-based beverages; coffee beverages with milk; unroasted coffee; coffee flavorings; bread rolls; bread; buns; cakes; chocolate; chocolate beverages with milk; chocolate-based beverages; cocoa beverages with milk; cocoa-based beverages; condiments; confectionery; cookies; croissants; ice cream; iced tea; pains au chocolat; pancakes; pastries; peppers [seasonings]; sandwiches; seasonings; candies; tea beverages with milk; tea; tea-based beverages; waffles.

35 – Retail services for food, beverages, ice cream, stationery, tableware, clothing, footwear and headwear.

43 – Café services; cafeteria services; food and drink catering; restaurant services; self-service restaurant services; snack bar services.

(260) AM 2023 121821 A

(800) 1715585

(151) 2022 11 21

(891) 2022 11 21

(731) Aktsionernoe Obshchestvo "Nizhegorodsky
khimiko-farmatsevtichesky zavod"

Salganskaya St., 7, Nizhny Novgorod,
RU-603105 Nizhegorodskaya obl.,
Russian Federation

(540)

РЕПРОДОЗ

(591) Black, white

(531) 28.05

(511)

5 – Pharmaceuticals, medical and veterinary preparations; sanitary preparations for medical purposes; dietetic food and substances adapted for medical or veterinary use, food for babies; dietary supplements for human beings and animals; nutritional supplements;

plasters, materials for dressings; material for dental fillings and dental impressions; disinfectants; preparations for destroying noxious animals; fungicides, herbicides; acaricides; aconitine; alkaloids for medical purposes; alginates for pharmaceutical purposes; algicides; aldehydes for pharmaceutical purposes; dental amalgams of gold; dental amalgams; amino acids for veterinary purposes; amino acids for medical purposes; analgesics; anaesthetics; antibiotics; antiseptics; medicine cases, portable, filled; first-aid boxes, filled; aluminium acetate for pharmaceutical purposes; acetates for pharmaceutical purposes; germicides; oxygen cylinders, filled, for medical purposes; balms for medical purposes; bandages for dressings; diagnostic biomarker reagents for medical purposes; biocides; bracelets impregnated with insect repellent; bromine for pharmaceutical purposes; paper for mustard plasters; fly catching paper; reagent paper for veterinary purposes; reagent paper for medical purposes; moth-proofing paper; petroleum jelly for medical purposes; vaccines; oxygen baths; antiseptic cotton; aseptic cotton; absorbent cotton; wadding for medical purposes; cotton for medical purposes; dietetic substances adapted for medical use; radiological contrast substances for medical purposes; nutritive substances for microorganisms; radioactive substances for medical purposes; bismuth subnitrate for pharmaceutical purposes; melissa water for pharmaceutical purposes; seawater for medicinal bathing; mineral waters for medical purposes; thermal water; dietary fibre; moulding wax for dentists; gases for medical purposes; guaiacol for pharmaceutical purposes; massage gels for medical purposes; sexual stimulant gels; haematogen; haemoglobin; hydrastine; hydrastinine; glycerine for medical purposes; glycerophosphates; glucose for medical purposes; gentian for pharmaceutical purposes; hormones for medical purposes; mustard for pharmaceutical purposes; mustard plasters; mud for baths; medicinal mud; contraceptive sponges; gamboge for medical purposes; gurjun balsam for medical purposes; deodorizers for litter trays; air deodorizing preparations; deodorants, other than for human beings or for animals; deodorants for clothing and textiles; diastase for medical purposes; digitalin; vitamin supplement patches; mineral dietary supplements; dietary supplements; albumin dietary supplements; dietary supplements for animals; yeast dietary supplements; alginate dietary supplements; glucose dietary supplements; casein dietary supplements; lecithin dietary supplements; linseed oil dietary supplements; propolis dietary supplements; protein dietary supplements; protein supplements for animals; royal jelly dietary supplements; pollen dietary supplements; wheat germ dietary supplements; linseed dietary supplements; acai powder dietary supplements; dietary supplements with a cosmetic effect; enzyme dietary supplements; yeast for pharmaceutical purposes; gelatine for medical purposes; cod liver oil; isotopes for medical purposes; immunostimulants; insecticides; iodine for pharma-

ceutical purposes; iodides for pharmaceutical purposes; alkaline iodides for pharmaceutical purposes; iodoform; calomel [fungicide]; cream of tartar for pharmaceutical purposes; tartar for pharmaceutical purposes; camphor for medical purposes; capsules for medicines; cachets for pharmaceutical purposes; capsules made of dendrimer-based polymers, for pharmaceuticals; haemostatic pencils; wart pencils; caustic pencils; carbolineum [parasiticide]; caustics for pharmaceutical purposes; cachou for pharmaceutical purposes; quassia for medical purposes; quebracho for medical purposes; oxygen for medical purposes; gallic acid for pharmaceutical purposes; acids for pharmaceutical purposes; adhesives for dentures; surgical glues; stem cells for veterinary purposes; stem cells for medical purposes; cocaine for medical purposes; collagen for medical purposes; collodion for pharmaceutical purposes; corn rings for the feet; cannabis for medical purposes; medicated sweets; angostura bark for medical purposes; barks for pharmaceutical purposes; cedar wood for use as an insect repellent; condurango bark for medical purposes; croton bark; mangrove bark for pharmaceutical purposes; myrobalan bark for pharmaceutical purposes; quinquina for medical purposes; medicated animal feed; medicinal roots; rhubarb roots for pharmaceutical purposes; lint for medical purposes; starch for dietetic or pharmaceutical purposes; creosote for pharmaceutical purposes; blood for medical purposes; biological tissue cultures for veterinary purposes; biological tissue cultures for medical purposes; cultures of microorganisms for medical or veterinary use; curare; dental lacquer; liquorice for pharmaceutical purposes; milk sugar for pharmaceutical purposes; adhesive plasters; medicines for alleviating constipation; adhesive tapes for medical purposes; lecithin for medical purposes; lotions for veterinary purposes; medicated hair lotions; lotions for pharmaceutical purposes; medicated after-shave lotions; personal sexual lubricants; lupulin for pharmaceutical purposes; magnesia for pharmaceutical purposes; liniments; ointments for pharmaceutical purposes; sunburn ointments; mercurial ointments; frostbite salve for pharmaceutical purposes; gauze for dressings; medicinal oils; mustard oil for medical purposes; camphor oil for medical purposes; castor oil for medical purposes; oil of turpentine for pharmaceutical purposes; dill oil for medical purposes; dental mastics; dental abrasives; dressings, medical; surgical dressings; drugs for medical purposes; medicines for veterinary purposes; serotherapeutic medicines; medicines for human purposes; medicines for dental purposes; menthol; medicinal drinks; moleskin for medical purposes; almond milk for pharmaceutical purposes; powdered milk for babies; royal jelly for pharmaceutical purposes; milk ferments for pharmaceutical purposes; Irish moss for medical purposes; flour for pharmaceutical purposes; linseed meal for pharmaceutical purposes; fish meal for pharmaceutical purposes; fly glue; antibacterial soap; disin-

fectant soap; medicated soap; freeze-dried meat adapted for medical purposes; mint for pharmaceutical purposes; dietetic beverages adapted for medical purposes; malted milk beverages for medical purposes; injectable dermal fillers; bone void fillers comprised of living tissues; narcotics; medicinal infusions; tincture of iodine; eucalyptol for pharmaceutical purposes; tinctures for medical purposes; opium; opodeldoc; decoctions for pharmaceutical purposes; antiparasitic collars for animals; cotton swabs for medical purposes; cotton wool swabs for medical purposes; stick liquorice for pharmaceutical purposes; sulfur sticks [disinfectants]; pastilles for pharmaceutical purposes; medicated toothpaste; pectin for pharmaceutical purposes; pepsins for pharmaceutical purposes; peptones for pharmaceutical purposes; hydrogen peroxide for medical purposes; pesticides; leeches for medical purposes; blood plasma; nicotine patches for use as aids to stop smoking; eyepatches for medical purposes; poultices; compresses; scapulars for surgical purposes; babies' diapers; diapers for pets; swim diapers, reusable, for babies; swim diapers, disposable, for babies; diapers for incontinence; diaper changing mats, disposable, for babies; bunion pads; breast-nursing pads; pomades for medical purposes; powder of cantharides; pyrethrum powder; anti-uric preparations; bacterial preparations for medical and veterinary use; bacteriological preparations for medical and veterinary use; balsamic preparations for medical purposes; albuminous preparations for medical purposes; biological preparations for veterinary purposes; biological preparations for medical purposes; bismuth preparations for pharmaceutical purposes; vitamin preparations; diagnostic preparations for veterinary purposes; diagnostic preparations for medical purposes; douching preparations for medical purposes; bath preparations for medical purposes; therapeutic preparations for the bath; haemorrhoid preparations; preparations for callouses; lice treatment preparations [pediculicides]; acne treatment preparations; preparations to facilitate teething; preparations for the treatment of burns; fumigation preparations for medical purposes; ophoterapy preparations; air purifying preparations; bronchodilating preparations; preparations for reducing sexual activity; sterilizing preparations; soil-sterilizing preparations; corn remedies; pharmaceutical preparations for treating dandruff; vermin destroying preparations; herbicides; preparations for destroying dry rot fungus; larvae exterminating preparations; fly destroying preparations; preparations for destroying mice; slug exterminating preparations; pharmaceutical preparations for skin care; contact lens cleaning preparations; preparations of microorganisms for medical or veterinary use; lime-based pharmaceutical preparations; styptic preparations; medicated eye-washes; medicinal hair growth preparations; nutraceutical preparations for therapeutic or medical purposes; opiates; anticryptogamic preparations; aloe vera preparations for pharmaceutical purposes; preparations of trace

elements for human and animal use; sulfonamides [medicines]; pharmaceutical preparations for treating sunburn; enzyme preparations for veterinary purposes; enzyme preparations for medical purposes; phytotherapy preparations for medical purposes; chemico-pharmaceutical preparations; chemical preparations for veterinary purposes; chemical preparations for the diagnosis of pregnancy; chemical preparations for medical purposes; chemical preparations for treating diseases affecting cereal plants; chemical preparations for treating wheat blight; chemical preparations for treating diseases affecting vine plants; chemical preparations for treating mildew; chemical preparations for treating phylloxera; chemical preparations for pharmaceutical purposes; chilblain preparations; mothproofing preparations; collyrium; lead water; chemical conductors for electrocardiograph electrodes; albuminous foodstuffs for medical purposes; dietetic foods adapted for medical purposes; by-products of the processing of cereals for dietetic or medical purposes; homogenized food adapted for medical purposes; freeze-dried food adapted for medical purposes; pharmaceuticals; sanitary towels; panty liners [sanitary]; propolis for pharmaceutical purposes; pearl powder for medical purposes; radium for medical purposes; hydrated chloral for pharmaceutical purposes; solvents for removing adhesive plasters; vaginal washes for medical purposes; solutions for contact lenses; chemical reagents for medical or veterinary purposes; gum for medical purposes; rubber for dental purposes; chewing gum for medical purposes; nicotine gum for use as an aid to stop smoking; insect repellents; insect repellent incense; repellents for dogs; tissues impregnated with pharmaceutical lotions; sarsaparilla for medical purposes; sugar for medical purposes; crystallized rock sugar for medical purposes; asthmatic tea; fumigating sticks; massage candles for therapeutic purposes; linseed for pharmaceutical purposes; tobacco-free cigarettes for medical purposes; siccatives [drying agents] for medical purposes; syrups for pharmaceutical purposes; turpentine for pharmaceutical purposes; milking grease; greases for veterinary purposes; greases for medical purposes; lacteal flour for babies; infant formula; soporifics; bicarbonate of soda for pharmaceutical purposes; bath salts for medical purposes; salts for mineral water baths; salts for medical purposes; potassium salts for medical purposes; sodium salts for medical purposes; smelling salts; mineral water salts; malt for pharmaceutical purposes; semen for artificial insemination; alcohol for pharmaceutical purposes; medicinal alcohol; alloys of precious metals for dental purposes; ergot for pharmaceutical purposes; cooling sprays for medical purposes; antibacterial handwashes; adjuvants for medical purposes; astringents for medical purposes; vermifuges; disinfectants for hygiene purposes; disinfectants for chemical toilets; appetite suppressants for medical purposes; medical preparations for slimming purposes; parasiticides; mouthwashes for medical purposes;

medicated dentifrices; febrifuges; depuratives; animal washes [insecticides]; detergents for medical purposes; cattle washes [insecticides]; dog washes [insecticides]; insecticidal veterinary washes; vesicants; purgatives; remedies for perspiration; remedies for foot perspiration; chemical contraceptives; antiparasitic preparations; sedatives; laxatives; tonics [medicines]; medicated toiletry preparations; digestives for pharmaceutical purposes; nervines; bouillons for bacteriological cultures; steroids; headache relief sticks; strychnine; suppositories; serums; tanning pills; appetite suppressant pills; slimming pills; jujube, medicated; antioxidant pills; sanitary tampons; vulnerary sponges; thymol for pharmaceutical purposes; smoking herbs for medical purposes; medicinal herbs; transplants [living tissues]; surgical implants comprised of living tissues; pants, absorbent, for incontinence; sanitary panties; babies' diaper-pants; charcoal for pharmaceutical purposes; fennel for medical purposes; porcelain for dental prostheses; phenol for pharmaceutical purposes; enzymes for veterinary purposes; enzymes for medical purposes; ferments for pharmaceutical purposes; formic aldehyde for pharmaceutical purposes; phosphates for pharmaceutical purposes; quinine for medical purposes; chinoline for medical purposes; diabetic bread adapted for medical use; chloroform; flowers of sulfur for pharmaceutical purposes; cement for animal hooves; bone cement for surgical and orthopaedic purposes; dental cements; medicinal tea; herbal teas for medicinal purposes; insecticidal animal shampoos; medicated shampoos; medicated shampoos for pets; pediculicidal shampoos; medicated dry shampoos; pre-filled syringes for medical purposes; eucalyptus for pharmaceutical purposes; herbal extracts for medical purposes; plant extracts for pharmaceutical purposes; tobacco extracts [insecticides]; extracts of hops for pharmaceutical purposes; elixirs [pharmaceutical preparations]; ethers for pharmaceutical purposes; esters for pharmaceutical purposes; cellulose esters for pharmaceutical purposes; cellulose ethers for pharmaceutical purposes; rat poison; poisons; bacterial poisons; jalap; angioprotectors; antiplatelet agents; anticoagulants; anti-inflammatory preparations; antithrombotic agents; decongestants; pharmaceutical preparations for the treatment of nervous system diseases; pharmaceutical preparations for the treatment of articular-ligamentous disorders; pharmaceutical preparations for the treatment of musculoskeletal disorders; pharmaceutical preparations for the treatment of various diseases; pharmaceutical preparations for treating injuries; pharmaceuticals for the treatment of thrombophlebitis; anti-itch pharmaceutical preparations; venotonic pharmaceuticals; pharmaceutical preparations for the treatment of venous system diseases; pharmaceutical preparations for the treatment of lymphatic system diseases; pharmaceutical preparations for the treatment of rheumatic lesion; pharmaceutical preparations for treatment and prevention of vaginal infections; phar-

maceutical preparations for normalization of vaginal flora; preparations for normalization of vaginal pH; pharmaceutical preparations for treatment of bacterial infections; preparations for relief of menopause symptoms; fertility enhancement preparations.

(260) AM 2023 121841 A

(800) 1469662

(151) 2019 03 29

(891) 2022 12 14

(731) Obshchestvo s ogranichennoy otvetstvennostyu "Al'kor i Ko"
prospekt Leninskiy, 72/2, RU-119261 Moscow,
Russian Federation

(540)



(591) Pink, light blue, yellow, white, black, lilac and dark yellow

(531) 01.15.01; 02.09.01; 02.09.08; 02.09.14;
05.07.18; 10.05.15; 11.03.01; 16.03.13;
17.02.01; 29.01.15

(511)

3 – Abrasives; amber [perfume]; descaling preparations for household purposes; antistatic preparations for household purposes; aromatics [essential oils]; air fragrancing preparations; cake flavorings [essential oils]; flavorings for beverages [essential oils]; food flavourings [essential oils]; food flavorings [essential oils]; breath freshening sprays; canned pressurized air for cleaning and dusting purposes; balms, other than for medical purposes; lip glosses; polishing stones; abrasive paper; emery paper; polishing paper; petroleum jelly for cosmetic purposes; shoe polish; cobblers' wax; cotton wool for cosmetic purposes; sachets for perfuming linen; drying agents for dishwashing machines; adhesives for cosmetic purposes; scented water; Javelle water; lavender water; toilet water; wax for parquet floors; floor wax; non-slipping wax for floors; depilatory wax; mustache wax; tailors' wax; creams for leather; polish for furniture and flooring; shoemakers' wax; polishing wax; massage gels, other than for medical purposes; heliotropine; dental bleaching gels; geraniol; make-up; deodorants for pets; deodorants for human beings or for animals; depilatory preparations; air fragrance reed diffusers; scented wood; perfumes; non-slipping liquids for floors; windshield cleaning liquids; greases for cosmetic purposes; volcanic ash for cleaning; perfumery; decorative transfers for cosmetic purposes; ionone [perfumery]; shaving stones [astringents]; smoothing stones; eyebrow pencils; cosmetic pencils; silicon carbide

[abrasive]; carbides of metal [abrasives]; alum stones [astringents]; tripoli stone for polishing; adhesives for affixing false eyelashes; adhesives for affixing false hair; hair conditioners; quillaia bark for washing; corundum [abrasive]; beard dyes; colorants for toilet purposes; cosmetic dyes; laundry starch; laundry glaze; shoe cream; polishing creams; cosmetic creams; skin whitening creams; polishing rouge; incense; hair spray; nail polish; lotions for cosmetic purposes; after-shave lotions; beauty masks; oils for perfumes and scents; oils for cosmetic purposes; oils for toilet purposes; essential oils; essential oils of cedarwood; essential oils of citron; oils for cleaning purposes; bergamot oil; gaultheria oil; jasmine oil; lavender oil; almond oil; rose oil; oil of turpentine for degreasing; whitening; cleaning chalk; almond milk for cosmetic purposes; cleansing milk for toilet purposes; musk [perfumery]; deodorant soap; shaving soap; soap for brightening textile; cakes of toilet soap; antiperspirant soap; soap for foot perspiration; soap; almond soap; mint for perfumery; cosmetic kits; emery; nail art stickers; false nails; eau de Cologne; bases for flower perfumes; joss sticks; pastes for razor strops; dentifrices; pumice stone; lipstick cases; hydrogen peroxide for cosmetic purposes; breath freshening strips; teeth whitening strips; abrasive cloth; glass cloth [abrasive cloth]; lipsticks; pomades for cosmetic purposes; shaving preparations; cosmetic preparations for baths; bath preparations, not for medical purposes; hair straightening preparations; hair waving preparations; laundry soaking preparations; grinding preparations; smoothing preparations [starching]; color-removing preparations; leather bleaching preparations; polishing preparations; denture polishes; mouthwashes, not for medical purposes; cosmetic preparations for slimming purposes; starch glaze for laundry purposes; furbishing preparations; eye-washes, not for medical purposes; fabric softeners for laundry use; laundry bleach; dry-cleaning preparations; paint stripping preparations; lacquer-removing preparations; make-up removing preparations; floor wax removers [scouring preparations]; varnish-removing preparations; rust removing preparations; nail care preparations; cleaning preparations; preparations for cleaning dentures; wall-paper cleaning preparations; preparations for unblocking drain pipes; chemical cleaning preparations for household purposes; collagen preparations for cosmetic purposes; bleaching preparations [decolorants] for household purposes; laundry preparations; aloe vera preparations for cosmetic purposes; sunscreen preparations; color-brightening chemicals for household purposes [laundry]; breath freshening preparations for personal hygiene; shining preparations [polish]; make-up powder; diamantine [abrasive]; stain removers; nail varnish removers; vaginal washes for personal sanitary or deodorant purposes; scouring solutions; false eyelashes; tissues impregnated with cosmetic lotions; tissues impregnated with make-up removing preparations; safrol; massage candles for cosmetic

purposes; laundry blueing; turpentine for degreasing; potpourris [fragrances]; bleaching soda; washing soda, for cleaning; bath salts, not for medical purposes; bleaching salts; fumigation preparations [perfumes]; preservatives for leather [polishes]; ammonia [volatile alkali] [detergent]; astringents for cosmetic purposes; eyebrow cosmetics; make-up preparations; sun-tanning preparations [cosmetics]; hair dyes; neutralizers for permanent waving; preparations to make the leaves of plants shiny; cosmetic preparations for eyelashes; cosmetic preparations for skin care; shoe wax; cosmetics; cosmetics for children; cosmetics for animals; mascara; cleansers for intimate personal hygiene purposes, non medicated; douching preparations for personal sanitary or deodorant purposes [toilettries]; detergents, other than for use in manufacturing operations and for medical purposes; degreasers, other than for use in manufacturing processes; bleaching preparations [decolorants] for cosmetic purposes; antiperspirants [toilettries]; toiletry preparations; phyto-cosmetic preparations; talcum powder, for toilet use; cotton sticks for cosmetic purposes; terpenes [essential oils]; emery cloth; cloths impregnated with a detergent for cleaning; henna [cosmetic dye]; shampoos for animals [non-medicated grooming preparations]; shampoos for pets [non-medicated grooming preparations]; dry shampoos; shampoos; sandpaper; herbal extracts for cosmetic purposes; extracts of flowers [perfumes]; ethereal essences; badian essence; mint essence [essential oil].

(260) AM 2023 121947 A

(800) 1717252

(151) 2022 10 21

(891) 2022 10 21

(731) WORLD MEDICINE İLAÇ SAN.VE TİC.A.Ş.
15 TEMMUZ MAH. CAMİ YOLU CAD. 50,
Bağcılar, İstanbul, Türkiye

(540)

COVIDAL–КОВИДАЛ

(591) Black, white

(531) 28.05

(511)

5 – Pharmaceutical and veterinary preparations for medical purposes; chemical preparations for medical and veterinary purposes, chemical reagents for pharmaceutical and veterinary purposes, dietary supplements for pharmaceutical and veterinary purposes; dietary supplements; nutritional supplements; medical preparations for slimming purposes; food for babies; herbs and herbal beverages adapted for medicinal purposes, dental preparations: teeth filling material, dental impression material, dental adhesives and material for repairing teeth, sanitary preparations for medical use; hygienic pads; hygienic tampons; plasters; materials for dressings; diapers made of paper and textiles for babies, adults and pets, preparations for destroying

vermin; herbicides, fungicides, preparations for destroying rodents, deodorants, other than for human beings or for animals; air purifying preparations; air deodorising preparations, disinfectants; antiseptics; detergents for medical purposes.

(260) AM 2023 121957 A

(800) 1717515

(151) 2022 11 08

(891) 2022 11 08

(731) Euro Games Technology Ltd.

4, "Maritsa" Str., "Vranya-Lozen-Triugulnika",
BG-1151 Sofia, Bulgaria

(540)

Burning Barrel

(591) Black, white

(511)

9 – Operating computer software for main frame computers; monitors (computer hardware); computer hardware; apparatus for recording images; monitors (computer programs); computer game programs; computer programs for recorded games; apparatus for recording, transmission or reproduction of sound or images; communications servers [computer hardware]; electronic components for gambling machines; computer application software featuring games and gaming; computer software for the administration of on-line games and gaming; computer hardware for games and gaming; computer hardware and software for gambling, gambling machines, gambling games on the Internet and via telecommunication network; computer systems; computer operating system software; computer terminals; interactive terminals; multimedia terminals; electronic terminals for generating lottery tickets; interactive touch screen terminals; computer touchscreens; electronic display panels; liquid crystal display screens; digital signage display panels; multimedia software; multimedia apparatus and instruments; interactive multimedia software for playing games; computer screens; LCD large-screen displays; liquid crystal displays [LCDs] for home theatres; media streaming software; computer application software for streaming audio-visual media content via the Internet; software; computer gaming software; computer software packages; computer operating system software; computer software, recorded; software drivers; virtual reality software; games software; entertainment software for computer games; computer programs for network management; electronic lottery tickets; computer software platforms; operating systems; interactive computer systems; operating system programs; computer game software for use with on-line interactive games; games software for use with video game consoles.

28 – Gaming machines for gambling; chips for gambling; mah-jong; arcade games; gambling machines operating with coins, notes and cards; games; electro-

nic games; parlor games; gaming chips; gaming tables; slot machines [gaming machines]; LCD game machines; slot machines and gaming devices; coin-operated amusement machines; roulette chips; poker chips; chips and dice [gaming equipment]; gaming equipment for casinos; roulette tables; gaming roulette wheels; casino games; gambling machines and amusement machines, automatic and coin-operated; coin-operated amusement machines and/or electronic coin-operated amusement machines with or without the possibility of gain; boxes for coin-operated amusement machines, slot machines and gaming machines; electronic or electrotechnical amusement machines and apparatus, gaming machines, coin-operated entertainment machines; housings for coin-operated amusement machines, gaming equipment, gaming machines, machines for gambling; electropneumatic and electrical gambling machines (slot machines); lottery games; electronic targets for games and sports; video game consoles.

41 – Gambling; entertainment services related to gambling; gaming services for entertainment purposes; casino, gaming and gambling services; training in the development of software systems; provision of gaming equipment for gambling halls; providing casino equipment [gambling]; gaming machine entertainment services; providing casino facilities [gambling]; amusement arcade services; games equipment rental; rental of gaming machines; providing amusement arcade services; rental of gaming machines with images of fruits; editing or recording of sounds and images; sound recording and video entertainment services; hire of sound reproducing apparatus; provision of gaming equipment for casinos; providing of casino facilities; online gambling services; casino management services; provision of gaming facilities, gaming hall facilities, Internet casinos and online gambling services; lottery services; organization of lotteries; provision of games by means of a computer based system; online interactive entertainment; on-line casino services; on-line game services through mobile devices; providing online entertainment in the nature of game tournaments; providing on-line information in the field of computer gaming entertainment; sports betting services; online sports betting services; providing on-line computer games and games of chance; rental of video game consoles.

(260) AM 2023 121963 A

(800) 1717646

(151) 2023 01 26

(891) 2023 01 26

(731) TOYOTA JIDOSHA KABUSHIKI KAISHA

(also trading as TOYOTA MOTOR
CORPORATION)

1, Toyota-cho, Toyota-shi, Aichi-ken 471-8571,
Japan

(540)

BZ2C

(591) Black, white

(511)

12 – Driving motors for land vehicles; engine mounts for land vehicles; engines for land vehicles; jet engines for land vehicles; motors for land vehicles; propulsion mechanisms for land vehicles; turbines for land vehicles; drive chains for land vehicles; connecting rods for land vehicles, other than parts of motors and engines; gear boxes for land vehicles; gearing for land vehicles; hydraulic circuits for automobiles; reduction gears for land vehicles; torque converters for land vehicles; transmission chains for land vehicles; transmission shafts for land vehicles; transmissions for land vehicles; power transmission belts for land vehicles; brake discs for land vehicles; brake linings for land vehicles; brake pads for automobiles; brake segments for land vehicles; brake shoes for land vehicles; brakes for land vehicles; brake systems for land vehicles; AC motors for land vehicles, not including their parts; DC motors for land vehicles not including their parts; motors, electric, for land vehicles; automobiles and structural parts thereof; buses; structural parts for buses; trucks; structural parts for trucks; dune buggies [vehicles]; vans [vehicles]; sports utility vehicles; coaches; electrically powered motor vehicles; electric cars; hybrid cars; electric tricycles; ambulances; racing cars; amphibious vehicles; snowmobiles; armored vehicles; fork lift trucks; camping cars; tractors; trailers; trolley buses; hearses; fuel cell cars; automobile bodies; automobile bonnets; automobile bumpers; automobile chassis; automobile dashboards; automobile doors; automobile door handles; automobile hoods; automobile horns; automobile seats; automobile seat covers; automobile sunroofs; automobile tires; automobile wheels; spokes for automobile wheels; inner tubes for automobile tires; automobile wheel rims; rearview mirrors for automobiles; automobile windows; automobile windscreens; automobile windshields; automobile convertible tops; safety belts for automobile seats; safety harnesses for automobile racing; safety harnesses for automobile seats; security harness for automobile seats; steering wheels for automobiles; steering wheel covers for automobiles; air bags for automobiles, buses and trucks; seat belt pre-tensioners for automobiles; brake pedals for land vehicles; direction signals for automobiles; leather upholstery for automobile seats; leather upholstery for automobiles; cigar lighters for automobiles; shaped automobile covers; mudguards for automobiles; luggage carriers for automobiles; spare wheel holders for automobiles; automobile roof racks; headlight wipers; windscreen wipers; windscreen wiper blades; motor vehicle brake control systems for applying emergency braking at low vehicle speeds; electronic brake control apparatus for automobiles; two-wheeled motor vehicles; structural parts for two-wheeled mo-

tor vehicles; bicycles; structural parts for bicycles; motorcycles; structural parts for motorcycles.

(260) AM 2023 121971 A

(800) 1717763

(151) 2023 02 20

(891) 2023 02 20

(731) Bradken Resources Pty Limited

20 McIntosh Drive, Mayfield West NSW 2304, Australia

(540)

FUSED

(591) Black, white

(511)

17 – Rubber-like material for use in the manufacture of wear solutions for mining equipment.

(260) AM 2023 121975 A

(800) 1717856

(151) 2023 02 08

(891) 2023 02 08

(731) Estetra, société à responsabilité limitée

Rue Saint-Georges 5, Liège; B-4000, Belgium

(540)

FYLREVVY

(591) Black, white

(511)

5 – Pharmaceutical preparations and substances; medicinal preparations and substances; medicines for human use; biochemical medicines for human use; dietetic substances for medicinal use; pharmaceuticals in the field of gynecology and female health; estrogen preparations for therapeutic purposes; pharmaceutical preparations containing estrogen; pharmaceutical preparations for the treatment of female hormonal dysfunction; pharmaceutical preparations for use in hormone replacement therapy; pharmaceutical preparations for the treatment of menopausal symptoms, conditions and disorders.

(260) AM 2023 121989 A

(800) 1718080

(151) 2022 09 30

(891) 2022 09 30

(731) Otkrytoe aktsionernoe obshchestvo "Brestsky myasokombinat"

ul. Pisatelya Smirnova, 4, 224034 Brest, Belarus

(540)

ДЕРЕВЕНСКИЙ ГОСТИНЕЦ

(591) Black, white

(531) 28.05

(511)

29 – Meat, fish, poultry, game and foods made therefrom; meat, preserved, dried, smoked; cooked meat;

meat, tinned [canned (Am.)]; meat products; charcuterie; sausages; small sausages; smoked foods [meat, fish, poultry, game]; ham; bacon; tripe and foods made therefrom; liver; pork, lard, speck (bacon), ribs and foods made therefrom; meat extracts; meat pastes; liver pastes; pastes made from tripe products; semi-prepared foods made from meat, poultry, game, tripe.

30 – Bakery products, confectionery; precooked foods made from dough with filling; precooked foods made from dough and meat; pelmeni; vareniki [stuffed dumplings]; pies; pasties; meat pies; pancakes; pizzas.

(260) AM 2023 121992 A
(800) 962559
(151) 2008 04 02
(891) 2023 02 16
(731) Dr. Theiss Naturwaren GmbH
Michelinstr. 10, 66424 Homburg, Germany
(540)

LACALUT

(591) Red and pink
(531) 27.05.01; 27.05.17; 29.01.12
(511)
3 – Cosmetics; dentifrices; dental bleaching gels; preparations for cleaning dentures; mouth and teethridge washes, not for medical purposes.
5 – Pharmaceutical preparations; mouth and teethridge washes for medical purposes; mouthwashes for medical purposes; chewing gum for medical purposes.
21 – Toothbrushes, including electrical toothbrushes; interdental toothbrushes; floss for dental purposes, also in a holder; toothpicks.

(260) AM 2023 121999 A
(800) 1635615
(151) 2021 11 19
(891) 2023 02 23
(731) Diego Mauricio Orbe Garcés
Via Aretina 267, I-50136 Firenze, Italy
(540)



Welf Bräu

(591) Black; black relief; light gold 467c and dark gold 872c
(531) 24.01.15; 24.01.18; 24.01.19; 24.09.03; 24.09.05; 27.01.12; 27.05.01; 27.05.09; 27.05.10; 27.05.22; 27.05.24; 29.01.13
(511)
32 – Beers.

(260) AM 2023 122148 A
(800) 1719715
(151) 2023 01 25
(891) 2023 01 25
(731) Oy Karl Fazer Ab
Fazerintie 6, FI-01230 Vantaa, Finland
(540)



(591) Gold, white
(531) 24.09.01; 24.09.12; 24.09.13; 29.01.12
(511)
30 – Cocoa; flour and preparations made from cereals; bread, pastry and confectionery; biscuits; fruit jellies [confectionery]; chocolate; ice creams, frozen yogurts, sorbets, edible ices; sugar, honey, treacle; ice for refreshment; foodstuffs made from cereals; chips [cereal products]; muesli.

(260) AM 2023 122164 A
(800) 1720307
(151) 2022 11 23
(891) 2022 11 23
(731) Dermifant GmbH
Am Grundwasserssee 1, 82402 Seeshaupt, Germany
(540)

(591) Black, white
(511)
3 – Substances for laundry use; bleaching preparations; soaps; perfumery; essential oils; cosmetics; dermatological cosmetic products; hair lotions; dentifrices.
5 – Pharmaceutical preparations; healthcare preparations; medical and disinfecting soaps and detergents; medical cosmetics; medical and pharmaceutical preparations for the treatment of and for protection of, care and prevention of the skin internally and externally; dental preparations and products; medical dentifrices; sanitary preparations and sanitary articles for medical purposes; dietetic food and substances adapted for medical use; food for babies; dietary supplements for humans; plasters; medical dressings; disinfectants; preparations for destroying vermin; fungicides, herbicides.

10 – Surgical, medical and dental apparatus and instruments; medical furniture and bedding; medical clothing, in particular medical suits, medical protective suits and medical overalls for babies and infants with neurodermatitis and/or atopic eczema; diagnostic

apparatus, instruments and devices, in particular test kits and rapid tests; medical apparatus, devices and instruments for treatment of and prevention of allergies and skin diseases; inhalation devices for treatment of respiratory complaints, in particular of asthma and chronic bronchitis (all goods as far as included in this class).

25 – Headgear; clothing [other than for medical use], in particular suits, protective suits and overalls for babies and infants with neurodermatitis and/or atopic eczema.

(260) AM 2023 122165 A

(800) 1720323

(151) 2023 01 31

(891) 2023 01 31

(731) Jacobs Douwe Egberts DE GmbH
Langemarckstraße 4-20, 28199 Bremen,
Germany

(540)

SINFONIE

(591) Black, white

(511)

30 – Coffee, coffee extracts, coffee substitutes.

INTERNATIONAL TRADEMARK PROTECTED IN GEORGIA

(260) AM 2023 119740 A

(800) 1688040

(151) 2022 01 19

(181) 2032 01 19

(891) 2022 01 19

(511) 01, 03, 04, 05, 06, 07, 09, 10, 11, 17, 21, 37, 40, 42

AMENDMENTS TO REGISTERED APPELLATIONS OF ORIGIN OF GOODS

KHVANCHKARA

(Reg. № 1: Date: 14 07 2005)

Under the authority of Order №8335/06 issued on September 29, 2023 by the Head of Department of Trademarks, Geographical Indications and Designs of the LEPL National Intellectual Property Center of Georgia "Sakpatenti", amendment was made to the specification for production of Appellation of Origin (AO) wine "Khvanchkara", which is registered at the LEPL National Intellectual Property Center of Georgia "Sakpatenti".

According to the Law of Georgia "On Appellations of Origin of Goods and Geographical Indications", the aforementioned information shall be published in the Official Bulletin of Industrial Property of Georgia, as well as in one central and one local newspaper. Any notes and additional information submitted to Sakpatenti within 3 months following the publication of the materials will be forwarded for review to the Ministry of Environmental Protection and Agriculture of Georgia.

If Sakpatenti does not receive any information within the specified 3-month period, the published material regarding the Production Specification of Appellation of Origin (AO) wine "Khvanchkara" will be properly recorded in the State Register of Appellations of Origin and Geographical Indications.

Article 15 of the Specification shall be formed as follows:

15. Transitional Provisions

Despite the requirements of Paragraph 9 of the Product Specification, grape processing and wine production are allowed even outside the Khvanchkara Microzone, within the territory of Georgia, until December 2024.

OFFICIAL NOTIFICATIONS

INVENTIONS

RESTORATION OF PATENTS

(21) AP 2013 13247
(11) P 2019 6994 B
(73) Ivane Beroshvili;
Abesalom Beroshvili;
Teimuraz Kechiani
(54) METHOD FOR GAS INJECTION
DATE OF PATENT LAPSE: 2023 09 27
DATE OF PATENT RESTORATION: 2023 10 25

(21) AP 2013 13632
(11) P 2017 6716 B
(73) Cantab Biopharmaceuticals Patents Limited
(54) OPTIMISED SUBCUTANEOUS THERAPEUTIC AGENTS
DATE OF PATENT LAPSE: 2023 04 16
DATE OF PATENT RESTORATION: 2023 10 25

(21) AP 2018 14792
(11) P 2019 7023 B
(73) Giorgi Loladze
(54) METHOD FOR MAKING HEATEFFICIENT CONSTRUCTION COMPONENT
DATE OF PATENT LAPSE: 2023 05 22
DATE OF PATENT RESTORATION: 2023 10 25

LAPSE OF PATENTS WITH THE RIGHT TO RESTORE

(21) AP 2011 13083
(11) P 2017 6607 B
(73) Obshchestvo s Ogranichenoy Otvetstvennostyu "Niarmedik Plus"
(54) METHOD FOR PRODUCING AND USING COPOLYMER OF SODIUM CARBOXYMETHYL
CELLULOSE AND GOSSYPOL
DATE OF PATENT LAPSE: 2023 10 06
PATENT RESTORATION TERM: 2024 10 06

(21) AP 2014 13592
(11) P 2016 6516 B
(73) LTD "Botanisti"
(54) COMPOSITION OF INGREDIENTS FOR BIOACTIVE SUPPLEMENT "GRAIL"
DATE OF PATENT LAPSE: 2023 10 06
PATENT RESTORATION TERM: 2024 10 06

(21) AP 2014 14138
(11) P 2018 6813 B
(73) KIRLOSKAR ENERGEN PRIVATE LIMITED
(54) IN-PIPE TURBINE AND HYDROELECTRIC POWER GENERATION SYSTEM

DATE OF PATENT LAPSE: 2023 09 29
PATENT RESTORATION TERM: 2024 09 29

(21) AP 2016 14738
(11) P 2020 7087 B
(73) Red Leaf Resources Inc.
(54) STAGED ZONE HEATING OF HYDROCARBONS BEARING MATERIALS
DATE OF PATENT LAPSE: 2023 09 29
PATENT RESTORATION TERM: 2024 09 29

(21) AP 2019 15600
(11) P 2023 7492 B
(73) Troikaa Pharmaceuticals Limited
(54) OROMUCOSAL SOLUTIONS OF ZOLPIDEM OR PHARMACEUTICALLY ACCEPTABLE SALTS
THEREOF
DATE OF PATENT LAPSE: 2023 10 04
PATENT RESTORATION TERM: 2024 10 04

EXPIRATION OF PATENTS RESTORATION TERM

(21) AP 2018 14895
(11) P 2020 7120 B
(73) Gocha Kurdadze
(54) METHOD FOR SILICO MANGANESE PRODUCTION
DATE OF PATENT LAPSE: 2022 10 05
DATE OF EXPIRATION OF PATENT RESTORATION TERM: 2023 10 05

(21) AP 2017 15076
(11) P 2021 7269 B
(73) BAYER AKTIENGESELLSCHAFT;
BAYER PHARMA AKTIENGESELLSCHAFT
(54) SUBSTITUTED 6-(1H-PYRAZOL-1-YL)PYRIMIDIN-4-AMINE DERIVATIVES AND USES THEREOF
DATE OF PATENT LAPSE: 2022 10 09
DATE OF EXPIRATION OF PATENT RESTORATION TERM: 2023 10 09

(21) AP 2017 15081
(11) P 2020 7184 B
(73) Janny Sarl
(54) DEVICE FOR SELECTING GASES FOR A CONTAINER FORSTORING PERISHABLE PRODUCTS
DATE OF PATENT LAPSE: 2022 10 13
DATE OF EXPIRATION OF PATENT RESTORATION TERM: 2023 10 13

(21) AP 2003 8770
(11) P 2007 4059 B
(73) CO2 PAC LIMITED
(54) CONTAINER STRUCTURE FOR REMOVAL OF VACUUM PRESSURE
DATE OF PATENT LAPSE: 2022 09 30
DATE OF EXPIRATION OF PATENT RESTORATION TERM: 2023 09 30

EXPIRATION OF PATENTS

(21) AP 2003 10254
(11) P 2011 5347 B
(73) Syngenta Participations AG
(54) HETEROCYCLOCARBOXAMIDE DERIVATIVES
DATE OF EXPIRATION OF PATENT: 2023 10 14

(21) AP 2003 8803
(11) P 2008 4500 B
(73) Syngenta Participations AG
(54) HETEROCYCLOCARBOXAMIDE DERIVATIVES
DATE OF EXPIRATION OF PATENT: 2023 10 14

UTILITY MODELS RESTORATION OF PATENT

(21) AU 2021 15699
(11) U 2022 2119 Y
(73) Revaz Giorganashvili;
Zezva Jaiani
(54) VEHICLE INTERNAL COMBUSTION ENGINE EXHAUST GASES DISPOSAL DEVICE
DATE OF PATENT LAPSE: 2023 07 19
DATE OF PATENT RESTORATION: 2023 10 25

LAPSE OF PATENT WITH THE RIGHT TO RESTORE

(21) AU 2017 14607
(11) U 2019 2002 Y
(73) Nana Nebulishvili
(54) MEANS AGAINST HYPERHIDROSIS AND SWEAT SMELL
DATE OF PATENT LAPSE: 2023 10 13
PATENT RESTORATION TERM: 2024 10 13

DESIGNS**EXTENSION OF TERM OF DESIGNS REGISTRATION**

(11) D 2019 811 S
(73) LTD "Zarapkhana" (GE)
Lublyana St. 15, 0159, Tbilisi, Georgia (GE)
(54) 1.-5. CHESS
(28) 5
(24) 2018 11 07
(18) 2028 11 07
(58) 2023 10 18

(11) D 2019 817 S
(73) LTD "Zarapkhana" (GE)
Lublyana St. 15, 0159, Tbilisi, Georgia (GE)
(54) 1.-15. JEWELRY PRODUCTS
(28) 15
(24) 2018 12 18
(18) 2028 12 18
(58) 2023 10 18

(11) D 2008 366 S
(73) JSC "Tskali Margebeli" (GE)
Vill. Nabeghlavi, 4900, Chokhatauri Region, Georgia (GE)
(54) BOTTLE
(28) 1
(24) 2008 01 28
(18) 2028 01 28
(58) 2023 10 12

(11) D 2018 759 S
(73) Giorgi Gomelauri (GE)
Gia Tchanturia St. 14, 0900, Akhmeta, Georgia (GE)
(54) GLASS POT FOR HONEY
(28) 1
(24) 2017 08 03
(18) 2027 08 03
(58) 2023 10 12

CANCELLATION OF DESIGN REGISTRATION

(11) D 2008 365 S
(73) JSC "Elmavalmshebely" (GE)
Davit Guramishvili Av. 84, 0141, Tbilisi, Georgia (GE)
(54) EIGHT-AXLE MAINLINE ELECTRIC LOCOMOTIVE
(18) 2023 04 07
(58) 2023 10 16

EXTENSION OF TERM OF INTERNATIONAL DESIGNS REGISTRATION

(11) DM/102701
(73) SAVERGLASS
3 rue de la Gare, F-60960 FEUQUIERES (FR)
(15) 2018 08 31
(24) 2018 08 31
(18) 2028 08 31
(28) 1
(28') 1
(54) BOTTLE

(11) DM/102702
(73) SAVERGLASS
3 rue de la Gare, F-60960 FEUQUIERES (FR)
(15) 2018 08 31
(24) 2018 08 31
(18) 2028 08 31
(28) 1
(28') 1
(54) BOTTLE

(11) DM/103 371
(73) Hamilton International AG (Hamilton International SA) (Hamilton International Ltd)
Mattenstrasse 149 Biel/Bienne, CH-2503 (CH)
(15) 2018 09 28
(24) 2018 09 28
(18) 2028 09 28
(28) 1
(28') 1
(54) 1. WATCH WITHOUT HANDS

(11) DM/201 514
(73) OMP Trade GmbH
Ruthensteinstraße 6, 4522 Sierning, AT (AT)
(15) 2018 08 10
(24) 2018 08 10
(18) 2028 08 10
(28) 2
(28') 2
(54) 1.-2. ACCESSORY FOR AGRICULTURAL MACHINES

(11) DM/64341
(73) SWATCH AG (SWATCH SA) (SWATCH LTD.)
94, Rue Jakob Stämpfli 2502 BIENNE (CH)
(15) 2003 09 15
(24) 2003 09 15
(18) 2028 09 15
(28) 24
(28') 2
(54) JEWELRY

(11) DM/70678
(73) SWATCH AG (SWATCH SA)(SWATCH LTD)
 Jakob-Stämpfli-Strasse 94, CH-2502 BIEL/BIENNE (CH)
(15) 2008 09 08
(24) 2008 09 08
(18) 2028 09 08
(28) 3
(28') 3
(54) WRISTWATCHES

(11) DM/70749
(73) MONTRES TUDOR SA
 Rue François-Dussaud 3, CH-1211 Genève 26 (CH)
(15) 2008 09 30
(24) 2008 09 30
(18) 2028 09 30
(28) 1
(28') 1
(54) MONTRE

(11) DM/81688
(73) THE SWATCH GROUP MANAGEMENT SERVICES AG (THE SWATCH GROUP MANAGEMENT SERVICES SA) (THE SWATCH GROUP MANAGEMENT SERVICES LTD.)
 Seevorstadt 6, CH-2502 BIEL/BIENNE (CH)
(15) 2013 09 06
(24) 2013 09 06
(18) 2028 09 06
(28) 7
(28') 1
(54) WATCH CASE, WATCH CASES, WATCH CASES WITH BRACELETS, WATCH CASE WITH BRACELET

(11) DM/81782
(73) SWATCH AG (SWATCH SA) (SWATCH LTD.)
 Jakob-Stämpfli-Strasse 94, CH-2502 Biel/Bienne (CH)
(15) 2013 09 17
(24) 2013 09 17
(18) 2028 09 17
(28) 1
(28') 1
(54) WATCH CASE

(11) DM/81784
(73) SWATCH AG (SWATCH SA) (SWATCH LTD.)
 Jakob-Stämpfli-Strasse 94, CH-2502 Biel/Bienne (CH)
(15) 2013 09 18
(24) 2013 09 18
(18) 2028 09 18
(28) 2
(28') 2
(54) WRISTWATCHES

CANCELLATION OF INTERNATIONAL DESIGNS REGISTRATION

(11) DM/79562
(73) ALFRED KÄRCHER GMBH & CO. KG
Alfred-Kärcher-Straße 28-40, 71364 Winnenden (DE)
DATE OF CANCELLATION OF REGISTRATION: 2022 11 15
(58) 2023 10 12

(11) DM/79570
(73) RUNDPACK AG
Rheinstraße 38, CH-9444 Diepoldsau (CH)
DATE OF CANCELLATION OF REGISTRATION: 2022 11 07
(58) 2023 10 12

(11) DM/79650
(73) TOMIL S.R.O.
Gen. Svatoně 149/IV, CZ-566 01 Vysoké Mýto (EM)
DATE OF CANCELLATION OF REGISTRATION: 2022 12 06
(58) 2023 10 12

(11) DM/79658
(73) CERTINA AG (CERTINA SA) (CERTINA LTD.)
17, chemin des Tourelles, CH-2400 LE LOCLE (CH)
DATE OF CANCELLATION OF REGISTRATION: 2022 11 29
(58) 2023 10 12

(11) DM/79775
(73) ALFRED KÄRCHER GMBH & CO. KG
Alfred-Kärcher-Straße 28-40, 71364 Winnenden (DE)
DATE OF CANCELLATION OF REGISTRATION: 2022 12 18
(58) 2023 10 12

(11) DM/79841
(73) TOWL CONCEPTS B.V.
Krammer 8, NL-3232 HE Brielle (NL)
DATE OF CANCELLATION OF REGISTRATION: 2022 12 21
(58) 2023 10 12

(11) DM/79850
(73) SWATCH AG (SWATCH SA)(SWATCH LTD.)
Jakob-Stämpfli-Strasse 94, CH-2502 Biel/Bienne (CH)
DATE OF CANCELLATION OF REGISTRATION: 2023 01 07
(58) 2023 10 12

(11) DM/79905
(73) ALFRED KÄRCHER GMBH & CO. KG
Alfred-Kärcher-Straße 28-40, 71364 Winnenden (DE)
DATE OF CANCELLATION OF REGISTRATION: 2023 01 14
(58) 2023 10 12

(11) DM/79919
(73) MONTRES JAQUET DROZ SA (MONTRES JAQUET DROZ AG) (MONTRES JAQUET DROZ LTD)
Allée du Tourbillon 2, CH-2300 La Chaux-de-Fonds (CH)
DATE OF CANCELLATION OF REGISTRATION: 2023 01 08
(58) 2023 10 12

(11) DM/79944
(73) THE SWATCH GROUP MANAGEMENT SERVICES AG (THE SWATCH GROUP MANAGEMENT SERVICES SA) (THE SWATCH GROUP MANAGEMENT SERVICES LTD)
Seevorstadt 6, CH-2502 Biel/Bienne (CH)
DATE OF CANCELLATION OF REGISTRATION: 2023 01 11
(58) 2023 10 12

(11) DM/79964
(73) SWATCH AG (SWATCH SA)(SWATCH LTD.)
Jakob-Stämpfli-Strasse 94, CH-2502 Biel/Bienne (CH)
DATE OF CANCELLATION OF REGISTRATION: 2023 01 10
(58) 2023 10 12

(11) DM/79965
(73) SWATCH AG (SWATCH SA)(SWATCH LTD.)
Jakob-Stämpfli-Strasse 94, CH-2502 Biel/Bienne (CH)
DATE OF CANCELLATION OF REGISTRATION: 2023 01 15
(58) 2023 10 12

(11) DM/79999
(73) SWATCH AG (SWATCH SA)(SWATCH LTD.)
Jakob-Stämpfli-Strasse 94, CH-2502 Biel/Bienne (CH)
DATE OF CANCELLATION OF REGISTRATION: 2023 01 25
(58) 2023 10 12

(11) DM/80049
(73) Microsoft Mobile OY
Keilalahdentie 2-4 Espoo FI-02150 (FI)
DATE OF CANCELLATION OF REGISTRATION: 2023 01 15
(58) 2023 10 12

(11) DM/80075
(73) GLASHÜTTER UHRENBETRIEB GMBH
Altenberger Str. 1, 01768 Glashütte (DE)
DATE OF CANCELLATION OF REGISTRATION: 2023 02 05
(58) 2023 10 13

(11) DM/80087
(73) MONTRES JAQUET DROZ SA (MONTRES JAQUET DROZ AG) (MONTRES JAQUET DROZ LTD.)
Allée du Tourbillon 2, CH-2300 La Chaux-de-Fonds (CH)
DATE OF CANCELLATION OF REGISTRATION: 2023 02 01
(58) 2023 10 13

(11) DM/80149
(73) BONGRAIN S.A.
42 rue Rieussec, F-78220 VIROFLAY (FR)
DATE OF CANCELLATION OF REGISTRATION: 2023 02 14
(58) 2023 10 13

(11) DM/96484
(73) PEUGEOT CITROËN AUTOMOBILES SA
Route de Gisy, F-78140 VELIZY-VILLACOUBLAY (FR)
DATE OF CANCELLATION OF REGISTRATION: 2022 06 14
(58) 2023 10 13

(11) DM/97867
(73) JOSPER S.A.
Gutenberg, 11, Pol. Ind. Mas Roger, E-08397 Pineda de Mar, Barcelona (ES)
DATE OF CANCELLATION OF REGISTRATION: 2022 09 26
(58) 2023 10 13

TRADEMARKS**EXTENSION OF TERM OF TRADEMARKS REGISTRATION**

(111) M 2003 15283 R2
(151) 2003 10 15
(186) 2033 10 15
(732) Akzo Nobel Coatings International B.V.
Velperweg 76, 6824 BM Arnhem, Netherlands

(111) M 2003 15319 R2
(151) 2003 11 14
(186) 2033 11 14
(732) Alza Corporation (a wholly owner
subsidiary of Jonson & Johnson manufacturers
and merchants)
700 Eubanks Drive, Vacaville, CA 95688,
USA

(111) M 2013 23602 R1
(151) 2013 04 18
(186) 2033 04 18
(732) Aleksandre Natchkebia
SPB, Prosveshcheniya Av. 46-1-618,
Sankt-Petersburg, Russian Federation

(111) M 2013 23570 R1
(151) 2013 04 12
(186) 2033 04 12
(732) Laboratorios Casasco S.A.I.C.
Boyaca 237, Buenos Aires, Argentina

(111) M 2013 23571 R1
(151) 2013 04 12
(186) 2033 04 12
(732) Laboratorios Casasco S.A.I.C.
Boyaca 237, Buenos Aires, Argentina

(111) M 2013 23572 R1
(151) 2013 04 12
(186) 2033 04 12
(732) Laboratorios Casasco S.A.I.C.
Boyaca 237, Buenos Aires, Argentina

(111) M 2013 24025 R1
(151) 2013 09 17
(186) 2033 09 17
(732) Loxa Holding Sp. Z o.o.
Ul. Eugeniusza Kwiatkowskiego 13,
27-200 Starachowice, Poland

(111) M 2013 23551 R1
(151) 2013 04 08
(186) 2033 04 08
(732) Mamuka Gabritchidze
Shiomghvime Monastery, 3300, Mtskheta,
Georgia

(111) M 2013 23978 R1
(151) 2013 09 02
(186) 2033 09 02
(732) Diageo Brands B.V.
10-12 Molenwerf, 1014 BG Amsterdam,
Netherlands

(111) M 2013 23987 R1
(151) 2013 09 02
(186) 2033 09 02
(732) R & A Bailey & Co Unlimited Company
Nangor House, Western Estate,
Nengor Road, Dublin 12, Ireland

(111) M 2013 24042 R1
(151) 2013 09 17
(186) 2033 09 17
(732) Millennium end Copthorne International
Limited
9 Raffles Place, #12-01, Republic Plaza,
Singapore 048619, Singapore

(111) M 2013 24043 R1
(151) 2013 09 17
(186) 2033 09 17
(732) Millennium end Copthorne International
Limited
9 Raffles Place, #12-01, Republic Plaza,
Singapore 048619, Singapore

(111) M 2013 24045 R1
(151) 2013 09 17
(186) 2033 09 17
(732) Millennium end Copthorne International
Limited
9 Raffles Place, #12-01, Republic Plaza,
Singapore 048619, Singapore

(111) M 2013 24048 R1
(151) 2013 09 17
(186) 2033 09 17
(732) Millennium end Cophthorne International Limited
9 Raffles Place, #12-01 Republic Plaza,
048619, Singapore

(111) M 2013 24053 R1
(151) 2013 09 17
(186) 2033 09 17
(732) General Motors LLC
300 Renaissance Center, City of Detroit,
State of Michigan 48265-3000, USA

(111) M 2013 24221 R1
(151) 2013 11 04
(186) 2033 11 04
(732) LLC "Wine Thieves"
E. Bezhanishvili St. 25, ap. 10, Nadzaladevi
District, Tbilisi, Georgia

(111) M 2013 24115 R1
(151) 2013 09 30
(186) 2033 09 30
(732) Limited Liability Company "Russian
Cosmetic"
Vokzalnaya St. 53, Litera C, office 2,
Odintsovo, Moscow Region, Russian
Federation

(111) M 2014 24598 R1
(151) 2014 03 31
(186) 2034 03 31
(732) Ford Motor Company
One American Road, Dearborn, Michigan
48126, USA

(111) M 2013 24180 R1
(151) 2013 10 17
(186) 2033 10 17
(732) Kahala Franchising LLC
9311 E. Via De Ventura, Scottsdale, Arizona
85258, USA

(111) M 2014 24540 R1
(151) 2014 03 12
(186) 2034 03 12
(732) Toyota Jidosha Kabushiki Kaisha
(also trading as Toyota Motor Corporation)
1, Toyota-Cho, Toyota-Shi, Aichi-Ken, Japan

(111) M 2013 24394 R1
(151) 2013 12 30
(186) 2033 12 30
(732) Kahala Franchising LLC
9311 E. Via De Ventura, Scottsdale, Arizona
85258, USA

(111) M 2013 24300 R1
(151) 2013 11 18
(186) 2033 11 18
(732) Mitsubishi Jidosha Kogyo Kabushiki Kaisha
33-8, Shiba 5-chome, Minato-ku, Tokyo, Japan

(111) M 2013 24301 R1
(151) 2013 11 18
(186) 2033 11 18
(732) Mitsubishi Jidosha Kogyo Kabushiki Kaisha
1-21, Shibaura 3-chome, Minato-ku, Tokyo
108-8410, Japan

(111) M 2013 24302 R1
(151) 2013 11 18
(186) 2033 11 18
(732) Mitsubishi Jidosha Kogyo Kabushiki Kaisha
1-21, Shibaura 3-chome, Minato-ku, Tokyo
108-8410, Japan

(111) M 2014 24508 R1
(151) 2014 02 18
(186) 2034 02 18
(732) Canon Kabushiki Kaisha
30-2, 3-chome, shimomaruko, Ohta-ku, Tokyo,
Japan

(111) M 2014 25125 R1
(151) 2014 09 01
(186) 2034 09 01
(732) Sun Pharmaceuticals Industries Limited
Sparc, Tandalja, Vadodara - 390 020,
Gujarat, India

(111) M 2014 25126 R1
(151) 2014 09 01
(186) 2034 09 01
(732) Sun Pharmaceuticals Industries Limited
Sparc, Tandalja, Vadodara - 390 020,
Gujarat, India

(111) M 2014 24818 R1
(151) 2014 05 30
(186) 2034 05 30
(732) Sun Pharmaceuticals Industries Limited

Sparc, Tandalja, Vadodara - 390 020,
Gujarat, India

(111) M 2014 24756 R1
(151) 2014 05 07
(186) 2034 05 07
(732) Southern Liqueur Company Limited,
a South African limited Liability Company
Aan-de-Wagenweg, Stellenbosch, South
Africa

(111) M 2014 25205 R1
(151) 2014 09 10
(186) 2034 09 10
(732) Andeli Group Co., Ltd.
Λ№208 Weiqi Road, Yueqing Economic
Development Zone, Yueqing, Zhejiang
325600, China

(111) M 2013 24248 R1
(151) 2013 11 11
(186) 2033 11 11
(732) Vitabiotics (UK) Ltd.
№1 Apsley, Way, London NW2 7HF England,
United Kingdom

(111) M 2013 24375 R1
(151) 2013 12 23
(186) 2033 12 23
(732) Limited Liability Company "Russian
Cosmetic Uniset - M"
Iskra St., Dom 31, Stroenie 5, Moskow,
129344, Russian Federation

COMPLETE TRANSFER OF RIGHTS

(111) M 2019 32162 R
(732) LTD "Valenta-Intellect"
ul. Ryabinovaya, d. 26, str. 10, k. 6-26,
Moscow, 121471, Russian Federation
(770) Orion Corporation
Orionintie 1, 02200 Espoo, Finland
(580) 2023 09 15

(111) M 2020 33018 R
(732) LTD "Valenta-Intellect"
ul. Ryabinovaya, d. 26, str. 10, k. 6-26,
Moscow, 121471, Russian Federation
(770) Orion Corporation
Orionintie 1, 02200 Espoo, Finland
(580) 2023 09 15

(111) M 2020 33019 R
(732) LTD "Valenta-Intellect"
ul. Ryabinovaya, d. 26, str. 10, k. 6-26,
Moscow, 121471, Russian Federation
(770) Orion Corporation
Orionintie 1, 02200 Espoo, Finland
(580) 2023 09 15

(111) M 2021 33629 R
(732) LTD "Valenta-Intellekt"
ul. Ryabinovaya, d. 26, str. 10, k. 6-26,
Moscow, 121471, Russian Federation
(770) Orion Corporation
Orionintie 1, 02200 Espoo, Finland
(580) 2023 09 15

(111) M 2021 33630 R
(732) LTD "Valenta-Intellect"
ul. Ryabinovaya, d. 26, str. 10, k. 6-26,
Moscow, 121471, Russian Federation
(770) Orion Corporation
Orionintie 1, 02200 Espoo, Finland
(580) 2023 09 15

(111) M 2023 36824 R
(732) RK Nekreseli
Vill. Shilda, Kvareli Region, Georgia
(770) Levan Nekreselashvili
Vill. Gombori, Sagarejo, Georgia
(580) 2023 09 20

(111) M 1999 12732 R
(732) LTD "Valenta-Intellect"
ul. Ryabinovaya, d. 26, str. 10, k. 6-26,
Moscow, 121471, Russian Federation
(770) Orion Corporation
Orionintie 1, 02200 Espoo, Finland
(580) 2023 09 15

(111) M 2004 15498 R
(732) LLC "Askaneli Winery & Distiller"
Kakheti Highway 110a, 0190, Samgori
District, Tbilisi, Georgia
(770) LLC "Askaneli Brothers"
Kakheti Highway 110a, 0190, Samgori
District, Tbilisi, Georgia
(580) 2023 09 28

(111) M 2008 18778 R
(732) JC Master Distribution Limited
Kildress House, Pembroke Row Dublin 2,
D02 H008, Ireland
(770) Becle, S.A.B. de C.V.
Guillermo Gonzalez Camarena No. 800, Piso 4,
Colonia Santa Fe, Delegacion Alvaro Obregon,
Mexico City, C.P., 01210, Mexico
(580) 2023 09 12

(111) M 2008 18951 R
(732) JC Master Distribution Limited
Kildress House, Pembroke Row Dublin 2,
D02 H008, Ireland
(770) Becle, S.A.B. de C.V.
Guillermo Gonzalez Camarena No. 800, Piso 4,
Colonia Santa Fe, Delegacion Alvaro Obregon,
Mexico City, C.P., 01210, Mexico
(580) 2023 09 12

(111) M 2008 18952 R
(732) JC Master Distribution Limited
Kildress House, Pembroke Row Dublin 2,
D02 H008, Ireland
(770) Becle, S.A.B. de C.V.
Guillermo Gonzalez Camarena No. 800, Piso 4,
Colonia Santa Fe, Delegacion Alvaro Obregon,
Mexico City, C.P., 01210, Mexico
(580) 2023 09 12

(111) M 1996 3306 R
(732) AB InBev UK Limited
Bureau, 90 Fetter Lane London EC4A 1EN,
United Kingdom
(770) Pioneer Brewing Company Limited
Porter Tun House, 500 Capability Green
Luton Bedfordshire LU1 3LS, United
Kingdom
(580) 2023 10 02

(111) M 2019 31062 R
(732) Amazon Technologies Inc.
410 Terry Avenue North, Seattle,
Washington 98109, USA
(770) Amazon.com, Inc.
251, Litl Fols Draivi, 19808 Uilmingtoni,
Delaveris Shtati 19808, USA
(580) 2023 08 31

(111) M 2013 24025 R
(732) Loxa Holding SP. Z O.O.
Ul. Eugeniusza Kwiatkowskiego 13,
27-200 Starachowice, Poland
(770) Gerda 2 Sp.z.o.o.
Ul. 1-go maja 12, PL-27-200 Starachowice,
Poland
(580) 2023 09 27

(111) M 2014 25317 R
(732) LLC "Askaneli Winery & Distiller"
Kakheti Highway 110a, 0190, Samgori
District, Tbilisi, Georgia
(770) LLC "Askaneli Brothers"
Kakheti Highway 110a, 0190, Samgori
District,
Tbilisi, Georgia
(580) 2023 09 28

(111) M 2016 27180 R
(732) LLC "Askaneli Winery & Distiller"
Kakheti Highway 110a, 0190, Samgori Dstrict,
Tbilisi, Georgia
(770) LLC "Askaneli Brothers"
Kakheti Highway 110a, 0190, Samgori Dstrict,
Tbilisi, Georgia
(580) 2023 09 28

(111) M 2017 28506 R
(732) LLC "Askaneli Winery & Distiller"
Kakheti Highway 110a, 0190, Samgori
District, Tbilisi, Georgia
(770) LLC "Askaneli Group"
Kakheti Highway 110a, (Plot01/016), 0190,
Tbilisi, Georgia
(580) 2023 09 28

CHANGES OF NAME AND/OR ADDRESS OF TRADEMARKS OWNERS

(111) M 1998 11243 R
(732) Wyeth LLC
66 Hudson Boulevard East, New York,
NY 10001-2192, USA

(770) Wyeth LLC
235 East 42nd Street, New York,
NY 10017, USA
(580) 2023 10 05

(111) M 1998 11261 R
(732) Wyeth LLC
66 Hudson Boulevard East, New York,
NY 10001-2192, USA

(770) Wyeth LLC
235 East 42nd Street, New York,
NY 10017, USA
(580) 2023 10 05

(111) M 1999 12660 R
(732) Wyeth LLC
66 Hudson Boulevard East, New York,
NY 10001-2192, USA

(770) Wyeth LLC
235 East 42nd Street, New York,
NY 10017, USA
(580) 2023 10 05

(111) M 1999 12797 R
(732) Wyeth LLC
66 Hudson Boulevard East, New York,
NY 10001-2192, USA

(770) Wyeth Holdings LLC
235 East 42nd Street, New York,
NY 10017, USA
(580) 2023 10 05

(111) M 1995 692 R
(732) Wyeth Holdings LLC
66 Hudson Boulevard East, New York,
NY 10001-2192, USA

(770) Wyeth LLC
235 East 42nd Street, New York,
NY 10017, USA
(580) 2023 10 06

(111) M 1995 696 R
(732) Wyeth Holdings LLC
66 Hudson Boulevard East, New York,
NY 10001-2192, USA

(770) Wyeth Holdings LLC
235 East 42nd Street, New York,
NY 10017, USA

(580) 2023 10 06

(111) M 1995 694 R
(732) Wyeth Holdings LLC
66 Hudson Boulevard East, New York,
NY 10001-2192, USA

(770) Wyeth Holdings LLC
235 East 42nd Street, New York,
NY 10017, USA
(580) 2023 10 06

(111) M 1995 690 R
(732) Wyeth Holdings LLC
66 Hudson Boulevard East, New York,
NY 10001-2192, USA

(770) Wyeth Holdings LLC
235 East 42nd Street, New York,
NY 10017, USA
(580) 2023 10 06

(111) M 2001 13751 R
(732) Wyeth LLC
66 Hudson Boulevard East, New York,
NY 10001-2192, USA

(770) Wyeth LLC
235 East 42nd Street, New York,
NY 10017, USA
(580) 2023 10 05

(111) M 2001 14182 R
(732) Wyeth Holdings LLC
66 Hudson Boulevard East, New York,
NY 10001-2192, USA

(770) Wyeth Holdings LLC
235 East 42nd Street, New York,
NY 10017, USA
(580) 2023 10 06

(111) M 2002 14378 R
(732) Genetics Institute LLC
66 Hudson Boulevard East, New York,
NY 10001-2192, USA

(770) Genetics Institute, LLC
235 East 42nd Street, New York,
NY 10017, USA
(580) 2023 10 05

(111) M 2004 15473 R
(732) Wyeth LLC
66 Hudson Boulevard East, New York,
NY 10001-2192, USA
(770) Wyeth LLC
235 East 42 nd Street, New York,
NY 10017, USA
(580) 2023 10 05

(111) M 2004 15474 R
(732) Wyeth LLC
66 Hudson Boulevard East, New York,
NY 10001-2192, USA
(770) Wyeth LLC
235 East 42 nd Street, New York,
NY 10017, USA
(580) 2023 10 05

(111) M 2004 15494 R
(732) Wyeth LLC
66 Hudson Boulevard East, New York,
NY 10001-2192, USA
(770) Wyeth LLC
235 East 42 nd Street, New York,
NY 10017, USA
(580) 2023 10 05

(111) M 2004 15570 R
(732) Wyeth LLC
66 Hudson Boulevard East, New York,
NY 10001-2192, USA
(770) Wyeth LLC
235 East 42 nd Street, New York,
NY 10017, USA
(580) 2023 10 05

(111) M 2004 15712 R
(732) Wyeth LLC
66 Hudson Boulevard East, New York,
NY 10001-2192, USA
(770) Wyeth LLC
235 East 42 nd Street, New York,
NY 10017, USA
(580) 2023 10 05

(111) M 2004 15713 R
(732) Wyeth LLC
66 Hudson Boulevard East, New York,
NY 10001-2192, USA
(770) Wyeth LLC
235 East 42 nd Street, New York,
NY 10017, USA
(580) 2023 10 05

(111) M 2006 16663 R
(732) Wyeth LLC
66 Hudson Boulevard East, New York,
NY 10001-2192, USA
(770) Wyeth LLC
235 East 42 nd Street, New York,
NY 10017, USA
(580) 2023 10 05

(111) M 2007 17224 R
(732) Wyeth LLC
66 Hudson Boulevard East, New York,
NY 10001-2192, USA
(770) Wyeth LLC
235 East 42 nd Street, New York,
NY 10017, USA
(580) 2023 10 05

(111) M 2007 17400 R
(732) Vicuron Holdings LLC,
a Delaware limited liability company
66 Hudson Boulevard East, New York,
NY 10001-2192, USA
(770) Vicuron Holdings LLC,
a Delaware limited liability company
235 East 42 Street, New York, New York
10017-5755, USA
(580) 2023 10 06

(111) M 2007 17775 R
(732) Wyeth LLC
66 Hudson Boulevard East, New York,
NY 10001-2192, USA
(770) Wyeth LLC
235 East 42 nd Street, New York,
NY 10017, USA
(580) 2023 10 05

(111) M 2008 18421 R
(732) Wyeth LLC
66 Hudson Boulevard East, New York,
NY 10001-2192, USA
(770) Wyeth LLC
235 East 42 nd Street, New York,
NY 10017, USA
(580) 2023 10 05

(111) M 2009 19432 R
(732) Wyeth LLC
66 Hudson Boulevard East, New York,
NY 10001-2192, USA
(770) Wyeth LLC

235 East 42 nd Street, New York,
NY 10017, USA
(580) 2023 10 05

(111) M 2009 19898 R
(732) Wyeth LLC
66 Hudson Boulevard East, New York,
NY 10001-2192, USA
(770) Wyeth LLC
235 East 42 nd Street, New York,
NY 10017, USA
(580) 2023 10 05

(111) M 2010 20537 R
(732) Wyeth LLC
66 Hudson Boulevard East, New York,
NY 10001-2192, USA
(770) Wyeth LLC
235 East 42 nd Street, New York,
NY 10017, USA
(580) 2023 10 05

(111) M 2010 20707 R
(732) Wyeth LLC
66 Hudson Boulevard East, New York,
NY 10001-2192, USA
(770) Wyeth LLC
235 East 42 nd Street, New York,
NY 10017, USA
(580) 2023 10 05

(111) M 2010 20708 R
(732) Wyeth LLC
66 Hudson Boulevard East, New York,
NY 10001-2192, USA
(770) Wyeth LLC
235 East 42 nd Street, New York,
NY 10017, USA
(580) 2023 10 05

(111) M 2010 20709 R
(732) Wyeth LLC
66 Hudson Boulevard East, New York,
NY 10001-2192, USA
(770) Wyeth LLC
235 East 42 nd Street, New York,
NY 10017, USA
(580) 2023 10 05

(111) M 2013 24008 R
(732) Noucor Health S.A.
Avinguda Camí Reial, 51-57, Palau-
Solità i Plegamans, Barcelona, Spain
(770) J. Uriach Y Compañia, S.A.
Pol. Ind. Riera de Caldes. Av. Camí
Reial, 51-57, 08184 Palau-Solità i Plegamans,
Barcelona, Spain
(580) 2023 10 11

CANCELLATION OF TRADEMARKS REGISTRATION

(111) M 2013 23555 R

(151) 2013 04 12

(732) British American Tobacco Western
Europe Commercial Trading Limited
Globe House, 1 Water Street, London,
WC2R 3LA, United Kingdom

(141) 2023 10 18

(111) M 2013 23556 R

(151) 2013 04 12

(732) British American Tobacco Western
Europe Commercial Trading Limited
Globe House, 1 Water Street, London,
WC2R 3LA, United Kingdom

(141) 2023 10 18

(111) M 2013 23562 R

(151) 2013 04 12

(732) Janssen Sciences Ireland UC
Eastgate Village, Eastgate, Little Island,
County Cork, Ireland

(141) 2023 10 18

(111) M 2013 23567 R

(151) 2013 04 12

(732) Home Box Office Inc.
30 Hudson Yards, New York, New York
10001, USA

(141) 2023 10 18

(111) M 2013 23569 R

(151) 2013 04 12

(732) LLC "Istanbul-Textile"
Davit Aghmashenebeli alley, 7th kilometer,
0131, Tbilisi, Georgia

(141) 2023 10 18

(111) M 2013 23573 R

(151) 2013 04 12

(732) LTD "Unimed Group Corp"
Ad. Mickevich St. 29, ap. 61, 0194, Tbilisi,
Georgia

(141) 2023 10 18

(111) M 2013 23574 R

(151) 2013 04 12

(732) OOO "Petrosojuz TM"
ul. Arsenalnaya, dom 1, corp. 2, 195009,
Sankt-Peterburg, Russian Federation

(141) 2023 10 18

(111) M 2013 23575 R

(151) 2013 04 12

(732) Evon Products Inc.
World Headquarters, 1345 Avenue of the
Americas, New York, NY 10105-0196, USA

(141) 2023 10 18

(111) M 2013 23577 R

(151) 2013 04 12

(732) Cinsay Inc. a Nevada corporation
13355 Noel Road, Suite 400, Dallas,
Texas 75240, USA

(141) 2023 10 18

(111) M 2013 23578 R

(151) 2013 04 12

(732) Cinsay Inc., a Nevada corporation
13355 Noel Road, Suite 400, Dallas,
Texas 75240, USA

(141) 2023 10 18

(111) M 2013 23579 R

(151) 2013 04 12

(732) Cinsay Inc., a Nevada corporation
13355 Noel Road, Suite 400, Dallas,
Texas 75240, USA

(141) 2023 10 18

(111) M 2013 23580 R

(151) 2013 04 12

(732) Cinsay, Inc., a Nevada corporation
13355 Noel Road, Suite 400, Dallas,
Texas 75240, USA

(141) 2023 10 18

(111) M 2013 23581 R

(151) 2013 04 12

(732) LTD "Unimed Group Corp"
Ad. Mickevich St. 29, ap. 61, 0194, Tbilisi,
Georgia

(141) 2023 10 18

(111) M 2013 23598 R

(151) 2013 04 12

(732) David Khoridze
Rodeni St. 4, 0179, Tbilisi, Georgia

(141) 2023 10 18

(111) M 2013 23582 R
(151) 2013 04 12
(732) LTD "Great Corrigio"
Rodeni St. 4, 0179, Tbilisi, Georgia
(141) 2023 10 18

(111) M 2013 23583 R
(151) 2013 04 12
(732) OOO Rusinvest
Novomytishchenskiy prospekt 41, corp. 1,
Mytishchi, Moskovskaya oblast, 141018,
Russian Federation
(141) 2023 10 18

(111) M 2013 23584 R
(151) 2013 04 12
(732) LTD "Marigold"
Davit Aghmashenebeli Av. 71, 0102, Tbilisi,
Georgia
(141) 2023 10 18

(111) M 2013 23585 R
(151) 2013 04 12
(732) Nissan Jidosha Kabushiki Kaisha
(also trading as Nissan Motor Co., Ltd.)
No.2 Takaracho, Kanagawa-ku, Yokohama-
shi, Kanagawa-ken, Japan
(141) 2023 10 18

(111) M 2013 23589 R
(151) 2013 04 12
(732) LTD "Pharmaceutical House +"
Lviv St. 92, Tbilisi, Georgia
(141) 2023 10 18

(111) M 2013 23591 R
(151) 2013 04 12
(732) JSC "Lomisi"
Vill. Natakhtari, 3308, Mtskheta, Georgia
(141) 2023 10 18

(111) M 2013 23535 R
(151) 2013 03 27
(732) LTD "Bokola"
Mukhiani, IVa m/r, bld. 3, ap. 50, 0172,
Tbilisi, Georgia
(141) 2023 10 16

(111) M 2013 23592 R
(151) 2013 04 12
(732) Cinsay Inc., a Nevada Corporation
13355 Noel Road, Suite 400, Dallas,
Texas 75240, USA
(141) 2023 10 18

(111) M 2013 23595 R
(151) 2013 04 12
(732) JSC "Lomisi"
Vill. Natakhtari, 3308, Mtskheta, Georgia
(141) 2023 10 18

(111) M 2013 23596 R
(151) 2013 04 12
(732) JSC "Hotel and Restaurant Management
Group - M/Group"
Marshall Gelovani Av. 2, 0159, Tbilisi,
Georgia
(141) 2023 10 18

(111) M 2013 23549 R
(151) 2013 03 29
(732) LTD "Schukhmann-Wines Georgia"
Vill. Kisiskhevi, 2200, Telavi Region, Georgia
(141) 2023 10 09

(111) M 2013 23550 R
(151) 2013 03 29
(732) LTD "Dani"
Al. Kazbegi Av. 19a, 0160, Tbilisi, Georgia
(141) 2023 10 09

(111) M 2013 23553 R
(151) 2013 04 11
(732) Inga Khutsishvili
Freedom Square 6, 0600, Akhgori, Georgia
(141) 2023 10 18

CLASSIFICATION INDEXES

INVENTIONS

CONCORDANCE TABLE OF INTERNATIONAL CLASSIFICATION INDEX AND PUBLICATION NUMBERS

INTERNATIONAL CLASSIFICATION INDEXES (51)	NUMBER OF PUBLISHED APPLICATION (10)
A 61 K 9/00; A 61 K 31/58; A 61 K 47/10; A 61 K 47/02; A 61 K 31/573; A 61 K 31/167; A 61 K 31/137; A 61 P 11/00	AP 2023 16025 A
A 61 K 31/11; A 61 K 36/18; A 61 K 36/36; A 61 K 36/33; A 61 K 36/53; A 61 K 36/899	AP 2023 15538 A
A 61 K 31/137; A 61 K 31/42; A 61 K 31/506; A 61 K 31/551; A 61 K 31/7008; A 61 K 45/06	AP 2023 15757 A
A 61 K 31/593; A 61 K 31/353; A 61 K 31/235; A 61 K 31/355; A 61 K 31/4415; A 61 P 35/00	AP 2023 15739 A
A 61 K 31/5377; A 61 K 31/4453; A 61 P 17/00; C 07 D 413/14; C 07 D 405/14	AP 2023 15977 A
B 22 D 11/06	AP 2023 16173 A
G 01 N 27/00	AP 2023 15929 A
H 02 K 33/04	AP 2023 16203 A

CONCORDANCE TABLE OF PUBLICATION NUMBERS AND INTERNATIONAL CLASSIFICATION INDEX

NUMBER OF PUBLISHED APPLICATION (10)	INTERNATIONAL CLASSIFICATION INDEXES (51)
AP 2023 15538 A	A 61 K 31/11; A 61 K 36/18; A 61 K 36/36; A 61 K 36/33; A 61 K 36/53; A 61 K 36/899
AP 2023 15739 A	A 61 K 31/593; A 61 K 31/353; A 61 K 31/235; A 61 K 31/355; A 61 K 31/4415; A 61 P 35/00
AP 2023 15757 A	A 61 K 31/137; A 61 K 31/42; A 61 K 31/506; A 61 K 31/551; A 61 K 31/7008; A 61 K 45/06
AP 2023 15929 A	G 01 N 27/00
AP 2023 15977 A	A 61 K 31/5377; A 61 K 31/4453; A 61 P 17/00; C 07 D 413/14; C 07 D 405/14
AP 2023 16025 A	A 61 K 9/00; A 61 K 31/58; A 61 K 47/10; A 61 K 47/02; A 61 K 31/573; A 61 K 31/167; A 61 K 31/137; A 61 P 11/00
AP 2023 16173 A	B 22 D 11/06
AP 2023 16203 A	H 02 K 33/04

**CONCORDANCE TABLE OF INTERNATIONAL CLASSIFICATION INDEX,
PATENT NUMBERS AND PUBLICATION NUMBERS**

INTERNATIONAL CLASSIFICATION INDEX (51)	NUMBER OF PATENT (11)	NUMBER OF PUBLISHED APPLICATION (10)
A 61 B 17/32; A 61 B 17/34; A 61 F 2/10	P 2023 7556 B	AP 2023 15782 A
A 61 K 31/53; A 61 P 35/00; C 07 D 491/107; C 07 D 471/10; C 07 D 451/04; C 07 D 403/04; C 07 D 513/10; C 07 D 401/14; C 07 D 519/00	P 2023 7561 B	AP 2023 15746 A
A 61 K 45/06; A 61 K 31/5377; A 61 K 31/496; A 61 P 25/00	P 2023 7554 B	AP 2023 15793 A
A 61 L 27/26; A 61 L 27/36; A 61 L 27/38; A 61 L 27/54; B 33 Y 70/00; B 33 Y 80/00	P 2023 7562 B	AP 2023 15860 A
A 61 P 9/00; A 61 P 25/28; A 61 P 29/00; A 61 P 35/00; C 07 D 519/00; C 07 D 487/04	P 2023 7560 B	AP 2023 15761 A
C 07 D 403/00; C 07 D 213/55	P 2023 7559 B	AP 2023 15091 A
C 09 D 133/02	P 2023 7558 B	AP 2023 15889 A
C 21 C 1/10; C 21 C 7/06; C 22 C 28/00; C 22 C 33/00; C 22 C 35/00	P 2023 7563 B	AP 2023 15516 A
F 03 D 9/00	P 2023 7557 B	AP 2023 15961 A
G 01 J 4/00; G 01 N 21/21	P 2023 7555 B	AP 2023 15951 A

**CONCORDANCE TABLE OF PATENT NUMBERS,
PUBLICATION NUMBERS AND INTERNATIONAL CLASSIFICATION INDEX**

NUMBER OF PATENT (11)	NUMBER OF PUBLISHED APPLICATION (10)	INTERNATIONAL CLASSIFICATION INDEX (51)
P 2023 7554 B	AP 2023 15793 A	A 61 K 45/06; A 61 K 31/5377; A 61 K 31/496; A 61 P 25/00
P 2023 7555 B	AP 2023 15951 A	G 01 J 4/00; G 01 N 21/21
P 2023 7556 B	AP 2023 15782 A	A 61 B 17/32; A 61 B 17/34; A 61 F 2/10
P 2023 7557 B	AP 2023 15961 A	F 03 D 9/00
P 2023 7558 B	AP 2023 15889 A	C 09 D 133/02
P 2023 7559 B	AP 2023 15091 A	C 07 D 403/00; C 07 D 213/55
P 2023 7560 B	AP 2023 15761 A	A 61 P 9/00; A 61 P 25/28; A 61 P 29/00; A 61 P 35/00; C 07 D 519/00; C 07 D 487/04
P 2023 7561 B	AP 2023 15746 A	A 61 K 31/53; A 61 P 35/00; C 07 D 491/107; C 07 D 471/10; C 07 D 451/04; C 07 D 403/04; C 07 D 513/10; C 07 D 401/14; C 07 D 519/00
P 2023 7562 B	AP 2023 15860 A	A 61 L 27/26; A 61 L 27/36; A 61 L 27/38; A 61 L 27/54; B 33 Y 70/00; B 33 Y 80/00
P 2023 7563 B	AP 2023 15516 A	C 21 C 1/10; C 21 C 7/06; C 22 C 28/00; C 22 C 33/00; C 22 C 35/00

**CONCORDANCE TABLE OF APPLICATION NUMBERS,
PUBLICATION NUMBERS AND PATENTS**

NUMBER OF APPLICATION (21)	NUMBER OF PUBLISHED APPLICATION (10)	NUMBER OF PATENT (11)
AP 2017 15091	AP 2023 15091 A	P 2023 7559 B
AP 2019 15516	AP 2023 15516 A	P 2023 7563 B
AP 2020 15746	AP 2023 15746 A	P 2023 7561 B
AP 2019 15761	AP 2023 15761 A	P 2023 7560 B
AP 2021 15782	AP 2023 15782 A	P 2023 7556 B
AP 2020 15793	AP 2023 15793 A	P 2023 7554 B
AP 2020 15860	AP 2023 15860 A	P 2023 7562 B
AP 2019 15889	AP 2023 15889 A	P 2023 7558 B
AP 2022 15951	AP 2023 15951 A	P 2023 7555 B
AP 2022 15961	AP 2023 15961 A	P 2023 7557 B

APPLICATION***

**CONCORDANCE TABLE OF INTERNATIONAL CLASSIFICATION INDEX
AND PUBLICATION NUMBERS**

INTERNATIONAL CLASSIFICATION INDEXES (51)	NUMBER OF PUBLISHED APPLICATION (10)
A 61 K 31/439; A 61 P 11/00; A 61 P 43/00; C 07 D 498/18; C 07 D 498/22; C 07 D 513/22	AP 2023 16271 A
A 61 K 31/519; A 61 K 45/06; A 61 K 31/517; A 61 K 31/337; A 61 K 31/4439; A 61 P 35/00	AP 2023 16326 A
A 61 K 31/4985; A 61 P 3/04; A 61 P 3/08; A 61 P 3/08; A 61 P 43/00; A 61 P 5/10	AP 2023 16350 A
B 29 C 39/02; C 08 J 7/04; C 08 L 95/00; C 10 C 3/14	AP 2023 16330 A
B 29 C 55/10; E 01 C 11/16; E 01 C 11/00; E 01 C 3/00; E 01 C 3/04; E 02 D 31/00	AP 2023 16331 A
B 61 D 3/16; B 63 B 25/00; B 65 D 88/74; C 10 C 3/14	AP 2023 16341 A
C 10 C 3/10; C 10 C 3/12; C 10 C 3/14	AP 2023 16339 A
C 10 C 3/14	AP 2023 16340 A

**CONCORDANCE TABLE OF PUBLICATION NUMBERS
AND INTERNATIONAL CLASSIFICATION INDEX**

NUMBER OF PUBLISHED APPLICATION (10)	INTERNATIONAL CLASSIFICATION INDEXES (51)
AP 2023 16271 A	A 61 K 31/439; A 61 P 11/00; A 61 P 43/00; C 07 D 498/18; C 07 D 498/22; C 07 D 513/22
AP 2023 16326 A	A 61 K 31/519; A 61 K 45/06; A 61 K 31/517; A 61 K 31/337; A 61 K 31/4439; A 61 P 35/00
AP 2023 16330 A	B 29 C 39/02; C 08 J 7/04; C 08 L 95/00; C 10 C 3/14
AP 2023 16331 A	B 29 C 55/10; E 01 C 11/16; E 01 C 11/00; E 01 C 3/00; E 01 C 3/04; E 02 D 31/00
AP 2023 16339 A	C 10 C 3/10; C 10 C 3/12; C 10 C 3/14
AP 2023 16340 A	C 10 C 3/14
AP 2023 16341 A	B 61 D 3/16; B 63 B 25/00; B 65 D 88/74; C 10 C 3/14
AP 2023 16350 A	A 61 K 31/4985; A 61 P 3/04; A 61 P 3/08; A 61 P 3/08; A 61 P 43/00; A 61 P 5/10

UTILITY MODELS

**CONCORDANCE TABLE OF INTERNATIONAL CLASSIFICATION INDEX
AND PUBLICATION NUMBERS**

INTERNATIONAL CLASSIFICATION INDEXES (51)	NUMBER OF PUBLISHED APPLICATION (10)
D 04 H 17/10	AU 2023 16251 U
E 21 B 43/01	AU 2023 16069 U
F 28 D 9/00; F 28 F 3/02	AU 2023 16194 U
H 05 B 3/00	AU 2023 16234 U

**CONCORDANCE TABLE OF PUBLICATION NUMBERS
AND INTERNATIONAL CLASSIFICATION INDEX**

NUMBER OF PUBLISHED APPLICATION (10)	INTERNATIONAL CLASSIFICATION INDEXES (51)
AU 2023 16069 U	E 21 B 43/01
AU 2023 16194 U	F 28 D 9/00; F 28 F 3/02
AU 2023 16234 U	H 05 B 3/00
AU 2023 16251 U	D 04 H 17/10

**CONCORDANCE TABLE OF INTERNATIONAL CLASSIFICATION INDEX,
PATENT NUMBERS AND PUBLICATION NUMBERS**

INTERNATIONAL CLASSIFICATION INDEX (51)	NUMBER OF PATENT (11)	NUMBER OF PUBLISHED APPLICATION (10)
C 04 B 35/45; H 01 L 39/00	U 2023 2157 Y	AU 2023 16020 U

**CONCORDANCE TABLE OF PATENT NUMBERS,
PUBLICATION NUMBERS AND INTERNATIONAL CLASSIFICATION INDEX**

NUMBER OF PATENT (11)	NUMBER OF PUBLISHED APPLICATION (10)	INTERNATIONAL CLASSIFICATION INDEX (51)
U 2023 2157 Y	AU 2023 16020 U	C 04 B 35/45; H 01 L 39/00

**CONCORDANCE TABLE OF APPLICATION NUMBERS,
PUBLICATION NUMBERS AND PATENTS**

NUMBER OF APPLICATION (21)	NUMBER OF PUBLISHED APPLICATION (10)	NUMBER OF PATENT (11)
AU 2022 16020	AU 2023 16020 U	U 2023 2157 Y

DESIGNS

**CONCORDANCE TABLE OF INTERNATIONAL CLASSIFICATION INDEX
AND PUBLICATION NUMBERS**

INTERNATIONAL CLASSIFICATION INDEXES (51)	NUMBER OF PUBLISHED APPLICATION (10)
11-01	AD 2023 1313 S
21-01	AD 2023 1315 S

**CONCORDANCE TABLE OF PUBLICATION NUMBERS
AND INTERNATIONAL CLASSIFICATION INDEX**

NUMBER OF PUBLISHED APPLICATION (10)	INTERNATIONAL CLASSIFICATION INDEXES (51)
AD 2023 1313 S	11-01
AD 2023 1315 S	21-01

TRADEMARKS

CONCORDANCE TABLE OF REGISTRATION NUMBERS, APPLICATION NUMBERS, PUBLICATION NUMBERS AND BULLETIN NUMBERS

NUMBER OF REGISTRATION (111)	NUMBER OF APPLICATIONS (210)	NUMBER OF PUBLISHED APPLICATIONS (260)	NUMBER OF BULLETIN
M 2023 37386 R	AM 120172	AM 2023 120172 A	12(615)2023
M 2023 37387 R	AM 120353	AM 2023 120353 A	12(615)2023
M 2023 37388 R	AM 120354	AM 2023 120354 A	12(615)2023
M 2023 37389 R	AM 119198	AM 2023 119198 A	8(611)2023
M 2023 37390 R	AM 119374	AM 2023 119374 A	7(610)2023
M 2023 37391 R	AM 119771	AM 2023 119771 A	9(612)2023
M 2023 37392 R	AM 118941	AM 2023 118941 A	7(610)2023
M 2023 37393 R	AM 119074	AM 2023 119074 A	7(610)2023
M 2023 37394 R	AM 119192	AM 2023 119192 A	7(610)2023
M 2023 37395 R	AM 119267	AM 2023 119267 A	7(610)2023
M 2023 37396 R	AM 119269	AM 2023 119269 A	7(610)2023
M 2023 37397 R	AM 119270	AM 2023 119270 A	7(610)2023
M 2023 37398 R	AM 119274	AM 2023 119274 A	7(610)2023
M 2023 37399 R	AM 119287	AM 2023 119287 A	7(610)2023
M 2023 37400 R	AM 119276	AM 2023 119276 A	7(610)2023
M 2023 37401 R	AM 119197	AM 2023 119197 A	8(611)2023
M 2023 37402 R	AM 119605	AM 2023 119605 A	9(612)2023
M 2023 37403 R	AM 120152	AM 2023 120152 A	12(615)2023
M 2023 37404 R	AM 120154	AM 2023 120154 A	12(615)2023
M 2023 37405 R		-	20(623)2023
M 2023 37406 R		-	20(623)2023
M 2023 37407 R		-	20(623)2023
M 2023 37408 R		-	20(623)2023
M 2023 37409 R		-	20(623)2023
M 2023 37410 R		-	20(623)2023
M 2023 37411 R		-	20(623)2023
M 2023 37412 R		-	20(623)2023
M 2023 37413 R		-	20(623)2023
M 2023 37414 R		-	20(623)2023
M 2023 37415 R		-	20(623)2023
M 2023 37416 R		-	20(623)2023
M 2023 37417 R		-	20(623)2023
M 2023 37418 R	AM 120820	AM 2023 120820 A	13(616)2023
M 2023 37419 R	AM 120500	AM 2023 120500 A	12(615)2023
M 2023 37420 R	AM 120861	AM 2023 120861 A	13(616)2023
M 2023 37421 R	AM 120621	AM 2023 120621 A	13(616)2023
M 2023 37422 R	AM 120823	AM 2023 120823 A	13(616)2023
M 2023 37423 R	AM 120619	AM 2023 120619 A	13(616)2023
M 2023 37424 R	AM 118561	AM 2023 118561 A	7(610)2023

**CONCORDANCE TABLE OF PUBLICATION NUMBERS
AND APPLICATION NUMBERS**

NUMBER OF PUBLISHED APPLICATION (260)	NUMBER OF APPLICATION (210)	1	2
1	2		
AM 2023 117543 A*	AM 117543	AM 2023 121938 A	AM 121938
AM 2023 117544 A*	AM 117544	AM 2023 122013 A	AM 122013
AM 2023 119106 A*	AM 119106	AM 2023 122040 A	AM 122040
AM 2023 121644 A	AM 121644	AM 2023 122104 A	AM 122104
AM 2023 121651 A	AM 121651	AM 2023 122110 A	AM 122110
AM 2023 121739 A	AM 121739	AM 2023 122111 A	AM 122111
AM 2023 121742 A	AM 121742	AM 2023 122120 A	AM 122120
AM 2023 121756 A	AM 121756	AM 2023 122125 A	AM 122125
AM 2023 121757 A	AM 121757	AM 2023 122127 A	AM 122127
AM 2023 121769 A	AM 121769	AM 2023 122208 A	AM 122208
AM 2023 121900 A	AM 121900	AM 2023 122210 A	AM 122210
AM 2023 121903 A	AM 121903	AM 2023 122211 A	AM 122211
AM 2023 121907 A	AM 121907	AM 2023 122216 A	AM 122216
AM 2023 121927 A	AM 121927	AM 2023 122217 A	AM 122217
		AM 2023 122223 A	AM 122223
		AM 2023 122387 A	AM 122387
		AM 2023 122409 A	AM 122409
		AM 2023 122418 A	AM 122418

**CONCORDANCE TABLE OF INDEX OF GOODS AND/OR SERVICES
AND APPLICATION NUMBERS**

INDEX OF GOODS AND/OR SERVICES (511)	NUMBER OF PUBLISHED APPLICATIONS (260)	1	2
1	2		
1	AM 2023 121644 A	32	AM 2023 121938 A
5	AM 2023 121644 A	32	AM 2023 122013 A
5	AM 2023 122387 A	32	AM 2023 122208 A
5	AM 2023 122409 A	33	AM 2023 121757 A
9	AM 2023 122418 A	33	AM 2023 121938 A
11	AM 2023 122127 A	33	AM 2023 122013 A
16	AM 2023 119106 A*	33	AM 2023 122216 A
16	AM 2023 122120 A	33	AM 2023 122217 A
25	AM 2023 122110 A	33	AM 2023 122223 A
25	AM 2023 122111 A	34	AM 2023 121903 A
25	AM 2023 122211 A	34	AM 2023 121907 A
29	AM 2023 121651 A	35	AM 2023 117543 A*
29	AM 2023 121742 A	35	AM 2023 117544 A*
29	AM 2023 121938 A	35	AM 2023 121739 A
29	AM 2023 122040 A	35	AM 2023 121742 A
30	AM 2023 121900 A	35	AM 2023 121769 A
30	AM 2023 121927 A	35	AM 2023 122120 A
31	AM 2023 121742 A	35	AM 2023 122211 A
31	AM 2023 121938 A	36	AM 2023 121739 A
32	AM 2023 121757 A	38	AM 2023 122120 A
		41	AM 2023 122104 A
		41	AM 2023 122210 A
		43	AM 2023 121756 A
		43	AM 2023 122125 A

CONCORDANCE TABLE OF INDEX OF GOODS AND/OR SERVICES
AND NUMBERS OF TRADEMARKS REGISTERED ACCORDING
TO THE ACCELERATED PROCEDURE

INDEX OF GOODS AND/OR SERVICES (511)	NUMBERS OF REGISTERED ACCORDING TO THE ACCELERATED PROCEDURE (111)
2	M 2023 37412 R
5	M 2023 37405 R
11	M 2023 37412 R
14	M 2023 37409 R
16	M 2023 37415 R
17	M 2023 37412 R
18	M 2023 37409 R
25	M 2023 37409 R
28	M 2023 37409 R
29	M 2023 37408 R
29	M 2023 37416 R
30	M 2023 37408 R
31	M 2023 37410 R
31	M 2023 37411 R
32	M 2023 37406 R
33	M 2023 37414 R
35	M 2023 37409 R
36	M 2023 37407 R
36	M 2023 37417 R
37	M 2023 37412 R
41	M 2023 37413 R
44	M 2023 37413 R

OFFICIAL BULLETIN OF THE INDUSTRIAL PROPERTY

INVENTIONS

UTILITY MODELS

DESIGNS

TRADEMARKS

APPELLATION OF ORIGIN OF GOODS

20(623)

EDITOR-IN-CHIEF: N. Bebrishvili

EDITOR-TRANSLATOR: E. Gabunia

PROOFREADER: A. Shikhashvili

COMPUTER LAYOUT: M. Ordenidze
K. Svanidze

ISSN 2720-8486

info@sakpatenti.gov.ge
www.sakpatenti.gov.ge