



**NATIONAL INTELLECTUAL PROPERTY CENTER OF GEORGIA
SAKPATENTI**

**OFFICIAL BULLETIN
OF THE INDUSTRIAL PROPERTY**

21(481)

**2017
TBILISI**

INID CODES FOR IDENTIFICATION OF BIBLIOGRAPHIC DATA

INVENTIONS, UTILITY MODELS

- (10) Number of publication for application, which has been examined
- (11) Number of patent and kind of document
- (21) Serial number of application
- (22) Date of filing of the application
- (23) Date of exhibition or the date of the earlier filing and the number of application, if any
- (24) Date from which patent may have effect
- (31) Number of priority application
- (32) Date of filing of priority application
- (33) Code of the country or regional organization allotting priority application number
- (44) Date of publication of application not granted, but examined and number of bulletin
- (45) Date of publication of registered document
- (51) International Patent Classification Index
- (54) Title of the invention
- (57) Abstract
- (60) Number of examined patent document granted by foreign patent office, date from which patent has effect and country code
- (62) Number of the earlier application and in case of divided application, date of filing an application
- (71) Name, surname and address of applicant (country code)
- (72) Name, surname of inventor (country code)
- (73) Name, surname and address of patent owner (country code)
- (74) Name, surname of representative or patent attorney
- (85) Date of commencement of the national phase of International Application
- (86) Number and date of filing of international application
- (87) Number and date of publication of international application

DESIGNS

- (10) Number of publication for application
- (11) Number of patent and kind of document or number of registration
- (15) Date of registration/Date of patent renewal
- (18) Expected expiration date of patent or registration
- (21) Serial number of application
- (22) Date of filing of the application
- (23) Date of exhibition or the date of the earlier filing and the number of application, if any
- (24) Date from which patent may have effect
- (28) Number of designs included in the application
- (30) Data relating to priority (number of application, date of filing of application, two-letter code identifying the authority with whom the priority application was made)
- (31) Number of priority application
- (32) Date of filing of priority application
- (33) Code of the country or regional organization allotting priority application number
- (34) Two-letter code according to WIPO St.3 identifying the authority with which the priority application was made
- (44) Date of publication of design and number of bulletin (the first publication)
- (45) Date of publication of design registered by WIPO and number of bulletin
- (51) International Classification for designs (class and subclass of the Locarno Classification)
- (54) Title of the invention
- (55) Reproduction of the design
- (57) Description of characteristic features of the design including indication of colors
- (58) Date of recording of any kind of amendment in the Register
- (62) Number of the earlier application, registration and document number and if available the date of filing an application in case of divided application
- (71) Name, surname and address of applicant (country code)
- (72) Name, surname of creator (country code)
- (73) Name, surname and address of patent owner (country code)
- (74) Name, surname of representative or patent attorney
- (81) Contracting states concerned
 - II designated contracting states according to the 1960 Act
 - III designated contracting states according to the 1999 Act
- (85) Owner's permanent address
- (86) Owner's nationality
- (87) Owner's residence
- (88) State in which the owner has a real and effective industrial or commercial establishment

TRADEMARKS

- (111) - Number of registration
- (151) - Date of registration
- (156) - Date of the renewal
- (181) - Expected expiration date of registration
- (186) - Renewal expiration date of registration
- (141) - Date of cancel of duration of the mark
- (210) - Serial number of application
- (220) - Date of filing of the application
- (230) - Date concerning exhibition
- (260) - Number of application, for which favorable decision of examination about registration has been taken (publication number)
- (310) - Number of the first application
- (320) - Date of filing of the first application
- (330) - Code, identifying national or regional Office where the first application was made
- (511) - International Classification of Goods and Services for the purposes of registration of trade marks and/or list of goods and/or services classified according thereto
- (531) - Description of figurative elements of Trade Marks according to the International Classification of the Figurative Elements of Marks
- (540) - Reproduction of Trade Mark
- (550) - Nature and kind of Trade Mark
- (580) - Date of recording of any kind changes in respect of applications or registrations
- (591) - Information concerning colors claimed
- (731) - Name and address of the applicant
- (732) - Name and address of the holder of the registration
- (740) - Name and address of the representative
- (750) - Address for correspondence
- (770) - Name and address of the previous applicant or holder in case of change in ownership
- (771) - Previous name and address of the applicant or holder in case of change in ownership
- (791) - Name and address of the licensee
- (793) - Indication of conditions and/or restrictions under the license (Type of license, number of license agreement, data of license, data of validity of license)
- (800) - Certain data relating to the international registration of Trade Marks under the Protocol Relating to Madrid Agreement (International registration number)

CODES FOR PUBLICATION IN BULLETIN

- (21) AP 0000 000000 - serial number of application for invention
- (10) AP 0000 0000 A - number of published application for invention (first publication)
- (11) P 0000 0000 B - number of patent for invention (second publication)
- (21) API 0000 000000 - number of application for imported patent
- (11) PI 0000 0000 A - number of imported patent (first publication)
- (21) AU 0000 000000 - serial number of application for utility model
- (10) AU 0000 000 U - number of published application for utility model (first publication)
- (11) U 0000 000 Y - number of patent for utility model (second publication)
- (21) AD 0000 000000 - serial number of application for design
- (10) AD 0000 000 S - number of published application for design (first publication)
- (11) D 0000 000 S - number of patent for design (second publication)

INTERNATIONAL PATENT CLASSIFICATION FOR INVENTIONS AND UTILITY MODELS

- SECTION A - HUMAN NECESSITIES
- SECTION B - PERFORMING OPERATIONS; TRANSPORTING
- SECTION C - CHEMISTRY; METALLURGY
- SECTION D - TEXTILES; PAPER
- SECTION E - FIXED CONSTRUCTIONS
- SECTION F - MECHANICAL ENGINEERING; LIGHTING; HEATING; WEAPONS; BLASTING
- SECTION G - PHYSICS
- SECTION H - ELECTRICITY

-
- M - Trade Mark
 - (210) AM 0000 000000 - Serial number of application;
 - (260) AAM 0000 00000 A - Publication number of application;
 - (111) M 0000 00000 R - Number of registration;
 - (111) MMM0000 00000 Rn - Number of renewals, in which n=1,2,3;
 - (111) M 0000 00000 R(P) - Number of registration under partial assignment of rights
-

LIST OF CODES, IN ALPHABETIC SEQUENCE, AND THE CORRESPONDING (SHORT) NAMES OF STATES, OTHER ENTITIES AND INTERGOVERNMENTAL ORGANIZATIONS
(WIPO STANDARD ST.3)

AD	Andorra		for the Arab States of the Gulf (GCC)	NE	Niger
AE	United Arab Emirates	GD	Grenada	NG	Nigeria
AF	Afghanistan	GG	Guernsey	NI	Nicaragua
AG	Antigua and Barbuda	GH	Ghana	NL	Netherlands
AI	Anguilla	GI	Gibraltar	NO	Norway
AL	Albania	GT	Guatemala	NP	Nepal
AM	Armenia	GW	Guinea- Bissau	NR	Nauru
AN	Netherlands Antilles	GY	Guyana	NZ	New Zealand
AO	Angola	HK	The Hong Kong Special Administrative Region of the People's Republic of China	OA	African Intellectual Property Organization (OAPI)
AP	African Regional Intellectual Property Organization (ARIPO)	HN	Honduras	OM	Oman
AR	Argentina	HR	Croatia	PA	Panama
AT	Austria	HT	Haiti	PE	Peru
AU	Australia	HU	Hungary	PG	Papua New Guinea
AW	Aruba	IB	International Bureau of the World Intellectual Property Organization (WIPO)	PH	Philippines
AZ	Azerbaijan	ID	Indonesia	PK	Pakistan
BA	Bosnia and Herzegovina	IE	Ireland	PL	Poland
BB	Barbados	IL	Israel	PT	Portugal
BD	Bangladesh	IM	Isle of Man	PW	Palau
BE	Belgium	IN	India	PY	Paraguay
BF	Burkina Faso	IQ	Iraq	QA	Qatar
BG	Bulgaria	ID	Indonesia	QZ	Community Plant Variety Office (European Community) (CPVO)
BH	Bahrain	IE	Ireland	RO	Romania
BI	Burundi	IL	Israel	RS	Serbia
BJ	Benin	IM	Isle of Man	RU	Russian Federation
BM	Bermuda	IN	India	RW	Rwanda
BN	Brunei Darussalam	IQ	Iraq	SA	Saudi Arabia
BO	Bolivia	IR	Iran (Islamic Republic of)	SB	Solomon Islands
BR	Brazil	IS	Iceland	SC	Seychelles
BS	Bahamas	IT	Italy	SD	Sudan
BT	Bhutan	JE	Jersey	SG	Singapore
BV	Bouvet Island	JM	Jamaica	SH	Saint Helena
BW	Botswana	JO	Jordan	SI	Slovenia
BX	Benelux Office for Intellectual Property (BOIP)	JP	Japan	SK	Slovakia
BY	Belarus	KE	Kenya	SL	Sierra Leone
BZ	Belize	KG	Kyrgyzstan	SM	San Marino
CA	Canada	KH	Cambodia	SN	Senegal
CD	Democratic Republic of the Congo	KI	Kiribati	SO	Somalia
CF	Central African Republic	KM	Saint Kitts and Nevis	SR	Suriname
CG	Congo	KP	Democratic People's Republic of Korea	ST	Sao Tome and Principe
CH	Switzerland	KR	Republic of Korea	SV	El Salvador
CI	Cote d'Ivoire	KW	Kuwait	SY	Syrian Arab Republic
CK	Cook Islands	KY	Cayman Islands	SZ	Swaziland
CL	Chile	KZ	Kazakhstan	TC	Turks and Caicos Islands
CM	Cameroon	LA	Lao People's Democratic Republic	TD	Chad
CN	China	LB	Lebanon	TG	Togo
CO	Colombia	LC	Saint Lucia	TH	Thailand
CR	Costa Rica	LI	Liechtenstein	TJ	Tajikistan
CU	Cuba	LK	Sri Lanka	TL	Timor-Leste
CV	Cape Verde	LR	Liberia	TM	Turkmenistan
CY	Cyprus	LS	Lesotho	TN	Tunisia
CZ	Czech Republic	LT	Lithuania	TO	Tonga
DE	Germany	LU	Luxembourg	TR	Turkey
DJ	Djibouti	LV	Latvia	SE	Sweden
DM	Dominica	LY	Libyan Arab Jamahiriya	TT	Trinidad and Tobago
DO	Dominican Republic	MA	Morocco	TV	Tuvalu
DZ	Algeria	MC	Monaco	TW	Taiwan, Province of China
EA	Eurasian Patent Organization (EAPO)	MD	Republic of Moldova	TZ	United Republic of Tanzania
EC	Ecuador	ME	Montenegro	UA	Ukraine
EE	Estonia	MG	Madagascar	UG	Uganda
EG	Egypt	MK	The former Yugoslav Republic of Macedonia	US	United States of America
EH	Western Sahara	ML	Mali	UY	Uruguay
EM	Office for Harmonization in the Internal Market (Trademarks and Designs)(OHIM)	MM	Myanmar	UZ	Uzbekistan
EP	European Patent Office (EPO)	MN	Mongolia	VA	Holy See
ER	Eritrea	MO	Macao	VC	Saint Vincent and the Grenadines
ES	Spain	MP	Northern Mariana Islands	VE	Venezuela
ET	Ethiopia	MR	Mauritania	VG	Virgin Islands (British)
FI	Finland	MS	Montserrat	VN	Viet Nam
FJ	Fiji	MT	Malta	VU	Vanuatu
FK	Falkland Islands (Malvinas)	MU	Mauritius	WO	World Intellectual Property Organization (WIPO)
FO	Faroe Islands	MV	Maldives	WS	Samoa
FR	France	MW	Malawi	XN	Nordic Patent Institute (NPI)
GA	Gabon	MX	Mexico	YE	Yemen
GB	United Kingdom	MY	Malaysia	ZA	South Africa
GC	Patent Office of the Cooperation Council	MZ	Mozambique	ZM	Zambia
		NA	Namibia	ZW	Zimbabwe

**NATIONAL INTELLECTUAL PROPERTY CENTER OF GEORGIA
SAKPATENTI**

**OFFICIAL BULLETIN
OF THE INDUSTRIAL PROPERTY**

21(481)

**INVENTIONS
UTILITY MODELS
DESIGNS
TRADEMARKS**

DATE OF PUBLICATION
2017 11 10

CONTENTS

PUBLISHED TITLES OF PROTECTION	3
INVENTIONS	
▪ APPLICATIONS APPROVED FOR GRANTING PATENT	4
▪ PATENTED INVENTIONS	7
UTILITY MODELS	
▪ APPLICATION APPROVED FOR GRANTING PATENT	8
▪ PATENTED UTILITY MODEL	9
DESIGNS	
▪ REGISTERED DESIGNS	10
▪ DESIGNS, WHICH HAVE BEEN REGISTERED WITH THE INTERNATIONAL BUREAU CLAIMING PRIORITY ON THE TERRITORY OF GEORGIA	11
TRADEMARKS	
▪ APPLICATIONS FILED UNDER THE NATIONAL PROCEDURE APPROVED FOR REGISTRATION	79
▪ REGISTERED TRADEMARKS	86
▪ TRADEMARKS REGISTERED ACCORDING TO THE ACCELERATED PROCEDURE	90
▪ INTERNATIONAL TRADEMARKS FOR WHICH A DECISION ON GRANTING PROTECTION IS TAKEN	93
▪ INTERNATIONAL TRADEMARKS PROTECTED IN GEORGIA	142
OFFICIAL NOTIFICATIONS	
TRADEMARKS	
▪ RENEWAL OF REGISTRATIONS	149
▪ COMPLETE TRANSFER OF RIGHTS	153
▪ CHANGES IN NAMES AND/OR ADDRESSES OF OWNERS	154
CLASSIFICATION INDEXES	
INVENTIONS	156
UTILITY MODELS	157
DESIGNS	158
TRADEMARKS	160

PUBLISHED TITLES OF PROTECTION

INVENTIONS

- **APPLICATIONS APPROVED FOR GRANTING PATENT:**
14278; 14025; 13578; 14382; 14111; 14095; 14130; 14294
- **PATENTED INVENTIONS:**
6767-6770

UTILITY MODELS

- **APPLICATION APPROVED FOR GRANTING PATENT:**
14281
- **PATENTED UTILITY MODEL:**
1955

DESIGNS

- **REGISTERED DESIGNS:**
728-732
- **DESIGNS, WHICH HAVE BEEN REGISTERED WITH THE INTERNATIONAL BUREAU CLAIMING PRIORITY ON THE TERRITORY OF GEORGIA:**
94484; 96863; 96865; 96898; 94524, 94525; 96547; 96948; 96957, 96958; 96968; 96997; 97015; 97039; 94672; 94765; 97109; 97158

TRADEMARKS

- **APPLICATIONS FILED UNDER THE NATIONAL PROCEDURE APPROVED FOR REGISTRATION:**
87774; 88989; 89341; 90303; 90695; 90780; 90793, 90794; 90867; 90869-90871, 90871; 90879; 90901; 90904; 90914; 90956; 90996; 91096, 91097; 91106; 91109, 91110; 91160, 91164; 91166-91169; 91181; 91226; 91273; 91296; 91379; 91405, 91406; 91431; 91531; 91533; 91536; 91540; 92212; 92215
- **REGISTERED TRADEMARKS:**
29046-29087
- **TRADEMARKS REGISTERED ACCORDING TO THE ACCELERATED PROCEDURE:**
29032-29045
- **INTERNATIONAL TRADEMARKS FOR WHICH A DECISION ON GRANTING PROTECTIONS IS TAKEN:**
83602*; 86354*; 86356*; 86629*; 86776*; 90297; 90300; 90341; 90343-90348; 90351-90356; 90358; 90361; 90367-90369; 90374-90377; 90379-90383; 90386-90388; 90409; 90431-90435; 90437-90442; 90444-90446; 90448; 90453-90457; 90459; 90461; 90463; 90465-90468; 90473; 90500-90503; 90506-90508; 90513; 90520; 90524; 90529; 90540; 90543; 90548; 90550; 90552; 90555; 90574, 90575; 90578-90584; 90619; 90674; 90698-90702; 90792; 90803-90808; 90888, 90889; 90891; 90893; 90895, 90896; 90905; 90908; 90919, 90920; 90943-90947; 90950, 90951; 91081; 91098-91101; 91103, 91104
- **INTERNATIONAL TRADEMARKS PROTECTED IN GEORGIA:**
87870; 88200; 88261; 88361; 88517; 88521; 88589-88591; 88596; 88603; 88610; 88613-88615; 88617-88619; 88623, 88624; 88626-88628; 88643; 88667; 88736; 88748, 88749; 88758; 88773, 88774; 88802; 88804-88807; 88821-88825; 88830, 88831; 88833; 88852-88854; 88858-88861; 88863, 88864; 88866; 88898; 88905; 88912-88915; 88942; 89031, 89032; 89034-89037; 89039; 89041; 89045; 89054; 89108; 89118; 89120, 89121; 89123, 89124; 89126; 89128, 89129; 89131-89133; 89135, 89136; 89311; 89314-89316; 89318, 89319; 89322-89326; 89328; 89332, 89333; 89336

INVENTIONS

APPLICATIONS APPROVED FOR GRANTING PATENTS

The decision can be appealed at the Chamber of Appeal of Sakpatenti within 3 months from the publication or at the Mtskheta District Court Administrative Cases Board (Address: №17, Samkhedro str., Mtskheta), within 1 month following the publication.

PART A

A 61

(10) AP 2017 14278 A (51) Int. Cl. (2006)
A 61 K 9/00
A 61 K 47/02
A 61 K 31/135

(21) AP 2015 014278 (22) 2015 02 26

(31) MI 2014 A 000306

(32) 2014 02 27

(33) IT

(71) SINTETICA S.A. (CH)

Via Penate, 5 CH-6850 Mendrisio (CH)

(72) MITIDIERI, Augusto (CH);

DONATI, Elisabetta (IT);

CARONZOLO, Nicola (IT)

(74) Shalva Gvaramadze

(85) 2016 09 23

(86) PCT/EP2015/054021, 2015 02 26

(54) **PROCESS FOR PRODUCING
A STABLE LOW CONCENTRATION,
INJECTABLE SOLUTION OF
NORADRENALINE**

(57) A method includes dissolving noradrenaline and optionally excipient in deoxygenated or degassed water, filtrating resulting noradrenaline solution in a nitrogen current, distributing of solution in a nitrogen current, and sterilization.

Claims: 3 independent

13 dependent

(10) AP 2017 14025 A (51) Int. Cl. (2006)
A 61 K 9/20
A 61 K 31/00

(21) AP 2014 014025 (22) 2014 07 24

(31) 2470/MUM/2013

(32) 2013 07 25

(33) IN

(71) CADILA HEALTHCARE LIMITED (IN)

Zydus Tower, Satellite Cross Roads

Ahmedabad 380015 Gujarat (IN)

(72) PATEL, Jitendre, D. (IN);

DAVADRA, Prakash (IN);

PATEL, Snehal (IN);

SHEIKH, Shafiq (IN)

(74) Aleksandre Gegechkori

(85) 2015 12 23

(86) PCT/IN2014/000489, 2014 07 24

(54) **FORMULATION COMPRISING
HYPOLIPIDEMIC AGENT**

(57) Pharmaceutical composition contains compound of formula (I),

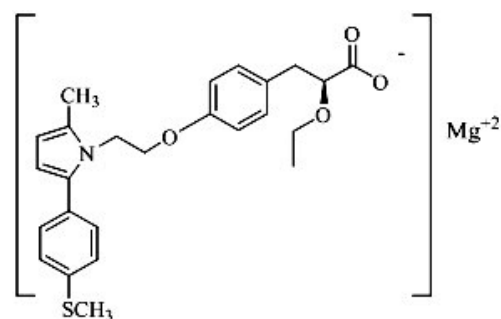

(I) alkalizer or pH modifiers, wherein value of pH composition is supported higher of 7, stabilizer and one or more another pharmaceutically acceptable excipient.

Claims: 2 independent

11 dependent

Table: 5

Fig.: 1

(10) AP 2017 13578 A (51) Int. Cl. (2006)

A 61 K 9/107

A 61 K 33/22

A 61 K 47/10

A 61 K 47/18

A 61 K 47/26

A 61 K 47/34

(21) AP 2013 013578 (22) 2013 02 22

(31) 12156652.5; 61/602,369

(32) 2012 02 23; 2012 02 23

(33) EP; US

(71) SANTEN SAS (FR)

1 rue Pierre Fontaine Bâtiment Genavenir IV

F-91000 Evry (FR)

(72) GARRIGUE, Jean-Sébastien (FR);

LALLEMAND, Frédéric (FR);

PHILIPS, Betty (FR)

(74) Tamar Kochlamazashvili

(85) 2014 09 22

(86) PCT/EP2013/053556, 2013 02 22

(54) **SELF-PRESERVED OIL
DISPERSIONS COMPRISING BORIC**

(57) Self-preserved oil dispersion is provided; especially, this, which includes dispersed oil phase, aqueous phase and at least one surfactant. At that, oil dispersion comprises boric acid in amount ranging from 0.005% to 0.075% in weight of the total weight of oil dispersion, which amount is effective to give oil dispersion the preservative activity.

Claims: 5 independent
11 dependent

(10) AP 2017 14382 A (51) Int. Cl. (2006)
A 61 K 31/355
A 61 P 11/02
A 61 P 37/08
A 61 K 9/00
A 61 K 45/06

(21) AP 2015 014382 (22) 2015 04 17

(31) MI2014A001332

(32) 2014 07 22

(33) IT

(71) BIO.LO.GA. S.R.L. (IT)

Via Giuseppe Lazzarin, 66 I-31015

Conegliano (TV) (IT)

(72) PANIN, Giorgio (IT);

LAMPRECHT, Jürgen (DE)

(74) Nugzar Ksovreli

(85) 2017 01 16

(86) PCT/EP2015/058368, 2015 04 17

(54) **COMPOSITION COMPRISING
ESTER OF ALPHA-TOCOPHEROL FOR
PREVENTION AND TREATMENT
OF ALLERGIC RHINITIS**

(57) Composition of local action comprising ester of alpha-tocopherol, and oil carrier are used to prevent and treat allergic rhinitis.

Claims: 1 independent
7 dependent

PART C

C 07

(10) AP 2017 14111 A (51) Int. Cl. (2006)
C 07 C 67/29
C 07 C 69/18
C 07 F 7/18
C 12 P 41/00
C 07 C 47/565
C 07 C 47/575
C 07 C 51/377
C 07 C 59/72

(21) AP 2013 014111 (22) 2013 05 22

(62) AP 2013 13668

(31) 61/650,836; 12172191.4

(32) 2012 05 23; 2012 06 15

(33) US; EP

(71) SCIPHARM SÀRL (LU)

26-28, rue Edward Steichen L-2540 (LU)

(72) JAIN, Nareshkumar F. (US);

KIRKUP, Michael P. (US);

MARELLA, Michael A. (US);

GHONE, Sanjeevani, A. (US)

(74) Liliana Darakhvelidze

(85) 2016 04 04

(86) PCT/EP2013/060472, 2013 05 22

(54) **INTERMEDIATE PRODUCT FOR
TREPROSTINIL SYNTHESIS AND
METHODS FOR PREPARATION
THEREOF**

(57) An invention relates to intermediate compounds preparation methods for treprostinil synthesis, wherein diastereoselective division is executed with enzymatic method.

Claims: 4 independent
5 dependent

(10) AP 2017 14095 A (51) Int. Cl. (2006)
C 07 D 207/267
C 07 D 213/40
C 07 D 233/58
C 07 D 239/34
C 07 D 277/28
C 07 D 401/04
C 07 D 401/06
C 07 D 401/12
C 07 D 405/12
C 07 D 409/04
C 07 D 409/14
C 07 D 413/04
C 07 D 413/12
C 07 D 417/04
C 07 D 417/06
C 07 D 417/12
C 07 D 471/04
C 07 D 487/04

C 07 D 491/048
 C 07 D 491/052
 C 07 D 491/20
 C 07 D 495/14
 A 61 K 31/33
 A 61 K 31/14

- (21) AP 2014 014095 (22) 2014 08 19
 (31) 61/945,048; 61/868,519
 (32) 2013 08 21; 2014 02 26
 (33) US; US
 (71) ALIOS BIOPHARMA, INC. (US)
 260 E. Grand Avenue, 2nd Floor South
 San Francisco, CA 94080 (US)
 (72) WANG, Guangyi (US);
 BEIGELMAN, Leonid (US);
 TRUONG, Anh (US);
 NAPOLITANO, Carmela (IT);
 ANDREOTTI, Daniele (IT);
 STEIN, Karin, Ann (US);
 HE, Haiying (CN)
 (74) Aleksandre Gegechkori
 (85) 2016 03 18
 (86) PCT/US2014/051642, 2014 08 19
 (54) **ANTIVIRAL COMPOUNDS**
 (57) New antiviral compounds, pharmaceutical
 compositions on basis thereof and their usage for
 paramyxovirus infection treatment.
 Claims: 4 independent
 133 dependent

(10) AP 2017 14130 A (51) Int. Cl. (2006)
 C 07 J 7/00
 C 07 J 41/00
 C 07 J 51/00

- (21) AP 2014 014130 (22) 2014 10 01
 (31) P1300566
 (32) 2013 10 01
 (33) HU
 (71) Richter Gedeon Nyrt. (HU)
 Gyömrői út.19-21, H-1103,
 Budapesht (HU)
 (72) Sándor MAHÓ (HU);
 Csaba SÁNTA (HU);
 János CSÖRGEI (HU);
 János HORVÁTH (HU);
 Antal Aranyi (HU);
 Zoltán BÉNI (HU)
 (74) Liliana Darakhvelidze
 (85) 2016 04 28
 (86) PCT/IB2014/064979, 2014 10 01
 (54) **PROCESS FOR SYNTHESIS OF
 ULIPRISTAL ACETATE AND ITS
 4'-ACETYL ANALOGUE**
 (57) A method for synthesis of compound of
 formula (I),

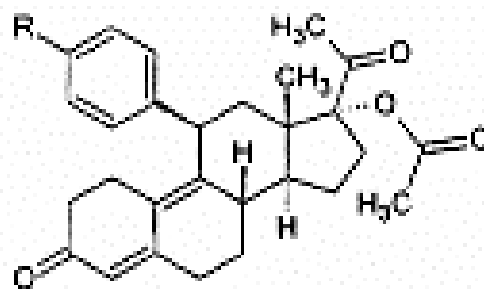

(I)

wherein R substitute is dimethylamino group or
 acetyl group and intermediate compounds for
 synthesis thereof.

Claims: 2 independent
 8 dependent

PART F

F 17

(10) AP 2017 14294 A (51) Int. Cl. (2006)
 F 17 D 1/04

- (21) AP 2016 014294 (22) 2016 10 07
 (71) Ilia Kherodinashvili (GE)
 Zh. Shartavas q. 18a, b. 21, 0160, Tbilisi (GE)
 (72) Ilia Kherodinashvili (GE)
 (54) **METHOD FOR CITY OR VILLAGE
 COMMUNITY GAS SUPPLEMENT**

(57) A method for city or village community gas
 supplement provides distributive pipeline system
 arrangement and supplement therewith gas control
 points; at that, the pipes of pipeline system are
 made with polyethylene and covered with casing.
 Gas supplement is provided after distributive
 system arrangement and supplement therewith gas
 control points; at that, one step gas pressure control
 is executed and the pressure is kept within the
 diapason of 0.3-0.6 MPa, as well.

Claims: 1 independent

PATENTED INVENTIONS

PART A

A 61

(11) P 2017 6769 B (51) **Int. Cl. (2006)**
A 61 K 9/00
A 61 K 47/36
A 61 K 47/38
A 61 K 9/16
 (10) AP 2017 13898 A (44) 14(474)/2017
 (21) AP 2014 013898
 (22) 2014 01 14
 (24) 2014 01 14
 (31) 13075002.9
 (32) 2013 01 15
 (33) EP
 (86) PCT/EP2014/000091, 2014 01 14
 (73) ASTELLAS PHARMA EUROPE LTD (GB)
 2000 Hillswood Drive Chertsey,
 Surrey KT16 0RS (GB)
 (72) MURAKAMI, Yoshiyuki (JP);
 SAITO, Hikaru (JP)
 (74) Shalva Gvaramadze
 (54) **COMPOSITION OF TIACUMICIN**
COMPOUNDS

(11) P 2017 6767 B (51) **Int. Cl. (2006)**
A 61 K 9/14
A 61 K 31/167
A 61 K 31/57
A 61 P 11/00
A 61 P 11/06
 (10) AP 2017 13532 A (44) 14(474)/2017
 (21) AP 2013 013532
 (22) 2013 01 23
 (24) 2013 01 23
 (31) 12152392.2
 (32) 2012 01 25
 (33) EP
 (86) PCT/EP2013/051187, 2013 01 23
 (73) CHIESI FARMACEUTICI S.P.A. (IT)
 Via Palermo, 26/A I-43100 Parma (IT)
 (72) MONARI, Elisa (IT);
 CANTARELLI, Anna Maria (IT);
 COCCONI, Daniela (IT);
 PASQUALI, Irene (IT)
 (74) Shalva Gvaramadze
 (54) **DRY POWDER FORMULATION**
COMPRIING A CORTICOSTEROID
AND A BETA-ADRENERGIC FOR
ADMINISTRATION BY INHALATION

(11) P 2017 6770 B (51) **Int. Cl. (2006)**
A 61 F 6/06
A 61 F 6/04
B 29 C 65/20
 (10) AP 2017 13991 A (44) 14(474)/2017
 (21) AP 2014 013991
 (22) 2014 01 10
 (24) 2014 01 10
 (31) PI2013001552
 (32) 2013 04 30
 (33) MY
 (86) PCT/IB2014/058166, 2014 01 10
 (73) TANG, John Ing Ching (MY)
 37 Jalan Pedada, Sibul, Sarawak, 96000
 Sibul (MY)
 (72) TANG, John Ing Ching (MY)
 (74) Pavle Meipariani
 (54) **FEMALE CONDOM WITH**
ADHERING SHIELD AND METHOD
OF MANUFACTURE

(11) P 2017 6768 B (51) **Int. Cl. (2006)**
A 61 K 31/232
 (10) AP 2017 13705 A (44) 14(474)/2017
 (21) AP 2013 013705
 (22) 2013 06 28
 (24) 2013 06 28
 (31) 61/666,447
 (32) 2012 06 29
 (33) US
 (86) PCT/US2013/048559, 2013 06 28
 (73) AMARIN PHARMACEUTICALS
 IRELAND LIMITED (IE)
 2 Pembroke House Upper Pembroke Street
 28-32 Dublin, 2 (IE)
 (72) SONI, Paresh (US)
 (74) Aleksandre Gegechkori
 (54) **METHODS OF REDUCING THE**
RISK OF A CARDIOVASCULAR EVENT
IN A SUBJECT ON STATIN THERAPY

UTILITY MODELS

APPLICATION APPROVED FOR GRANTING PATENT

The decision can be appealed at the Chamber of Appeal of Sakpatenti within 3 months from the publication or at the Mtskheta District Court Administrative Cases Board (Address: №17, Samkhedro str., Mtskheta), within 1 month following the publication.

PART C

C 25

(10) AU 2017 14281 U (51) Int. Cl. (2006)

C 25 B 11/12

C 25 B 1/21

(21) AU 2016 014281 (22) 2016 09 27

(71) Zhiuli Keadze (GE)

Nutsubidzis me-3 mkr., kvart. 2, korp. 2,

b. 69, 0183, Tbilisi (GE)

(72) Zhiuli Keadze (GE);

Tsisana Gagnidze (GE);

Medea Bolotashvili (GE);

Temur Chakhunashvili (GE);

Ketevan Ugrelidze (GE);

Liana Kakuria (GE)

(54) **BOX ELECTROLYTIC CELL FOR
RECEIVING MANGANESE DIOXIDE
AND HYDROGEN**

(57) Only first and the last electrodes are switched into the power supply disposed vertically and in parallel to each other in box electrolytic cell to receive manganese dioxide and hydrogen.

Claims: 1 independent

Table: 1

DESIGNS

REGISTERED DESIGNS

(11) D 2017 728 S (10) AD 2017 939 S (21) AD 2017 000939 (22) 2017 02 06 (24) 2017 02 06 (28) 1 (18) 2022 02 06 (73) Nino Dumbadze (GE) Paliashvilis q. 66, b. 3, 0179, Tbilisi (GE) (72) Nino Dumbadze (GE) (54) JIGULINE	(51) 07-01 (44) 14(474)/2017	(11) D 2017 732 S (10) AD 2017 938 S (21) AD 2017 000938 (22) 2017 02 01 (24) 2017 02 01 (28) 1 (18) 2022 02 01 (31) 2016-018007 (32) 2016 08 08 (33) JP (73) MIKASA CORPORATION (JP) 1, Kuti, Asa-to, Asakita-ku, Hiroshima-shi, Hiroshima, 731-3362 (JP) (72) Sudzo Matsuno (JP); Ryutaro Ogawa (JP) (74) Tamar Kochlamazashvili (54) SPORTS BALL	(51) 21-02 (44) 14(474)/2017
(11) D 2017 729 S (10) AD 2017 940 S (21) AD 2017 000940 (22) 2017 02 06 (24) 2017 02 06 (28) 1 (18) 2022 02 06 (73) Nino Dumbadze (GE) Paliashvilis q. 66, b. 3, 0179, Tbilisi (GE) (72) Nino Dumbadze (GE) (54) JIGULINE	(51) 07-01 (44) 14(474)/2017		
(11) D 2017 730 S (10) AD 2017 951 S (21) AD 2017 000951 (22) 2017 03 28 (24) 2017 03 28 (28) 4 (18) 2022 03 28 (73) Archil Gavashelishvili (GE) Nutsubidzis perd., mkr. IV, korp. 29, b. 43, 0183, Tbilisi (GE) (72) Archil Gavashelishvili (GE) (54) VASE CROSS, ORNAMENTAL	(51) 11-01 (44) 14(474)/2017		
(11) D 2017 731 S (10) AD 2017 944 S (21) AD 2017 000944 (22) 2017 02 15 (24) 2017 02 15 (28) 12 (18) 2022 02 15 (73) Tamar Chekurishvili (GE) Zvaretis q. 32, 0180, Tbilisi (GE) (72) Tamar Chekurishvili (GE) (54) 1.-12. ZODIAC DECORS	(51) 11-01 (44) 14(474)/2017		

DESIGNS, WHICH HAVE BEEN REGISTERED WITH THE INTERNATIONAL BUREAU CLAIMING PRIORITY ON THE TERRITORY OF GEORGIA

The decision can be appealed at the Chamber of Appeal of Sakpatenti within 3 months from the publication or at the Mtskheta District Court Administrative Cases Board (Address: №17, Samkhedro Str., Mtskheta), within 1 month following the publication.

(11) DM/094484

(51) 10-07

(15) 2017 01 26

(45) 2017/29 (2017 07 28)

(22) 2017 01 26

(28) 3

(73) BLANCPAIN SA

Le Rocher 12, CH-1348 LE BRASSUS (CH)

(85) CH

(86) CH

(87) CH

(88) CH

(89) CH

(81) II. BZ, MA III. AL, AM, AZ, BA, CH, EM, GE, KG, LI, MC, MD, ME, MK, MN, NO, OM, SG, TN, TR, UA

(72) Patrice NANGA

Avenue Dapples 26, 1006 Lausanne, Suisse

(54) 1.-3. Dials

(55)

1.1



1.2

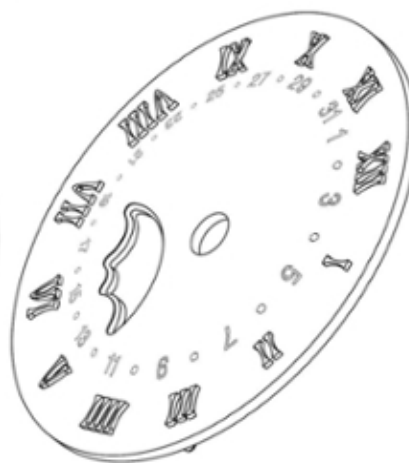

2.1



2.2

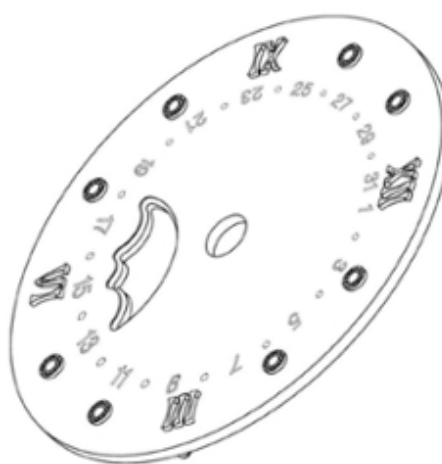

3.1

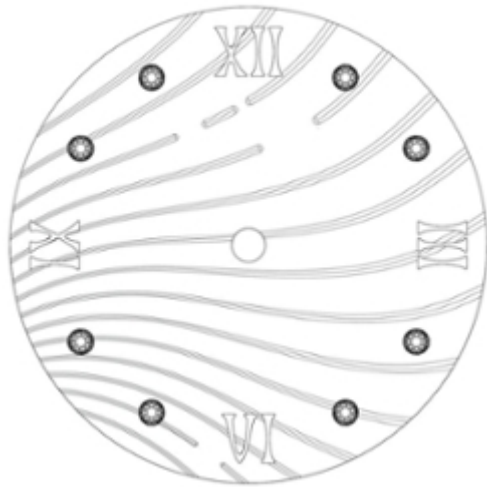

3.2

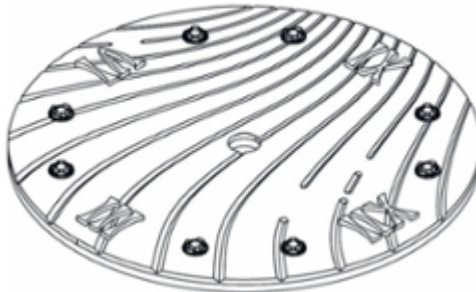

(11) DM/096863

(15) 2017 07 11

(22) 2017 07 11

(28) 5

(73) VALENTINO S.P.A.

Via Turati, 16/18, I-20121 MILANO (IT)

(85) -

(86) IT, EM

(87) IT, EM

(88) IT, EM

(89) EM

(81) III. AZ, EM, GE, JP, KG, KR, TJ, TR, UA

(72) SASSI Stefano

c/o VALENTINO S.p.A., Via Turati, 16/18, I-20121 Milano, Italy

(54) 1.-5. Bags

(55)

1.1



1.2



1.3



1.4



1.5

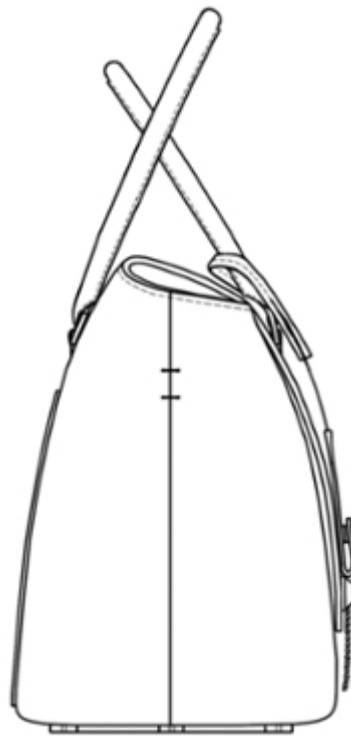

1.6

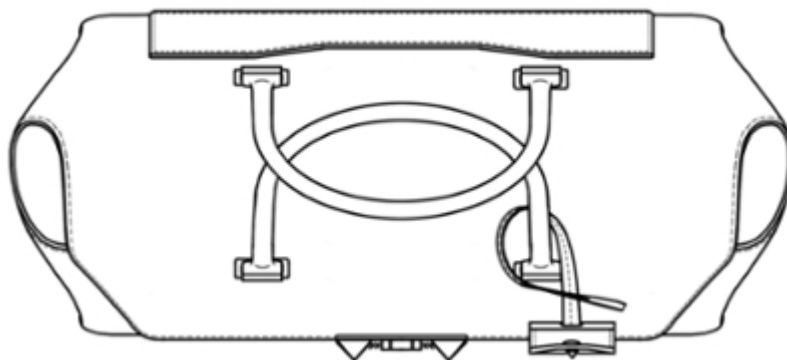

1.7

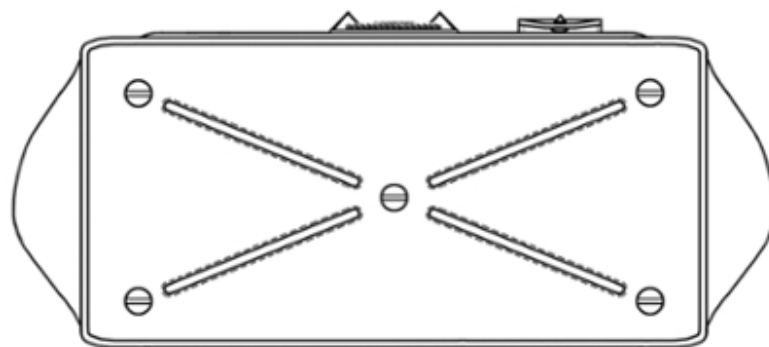

2.1



2.2



2.3



2.4



2.5

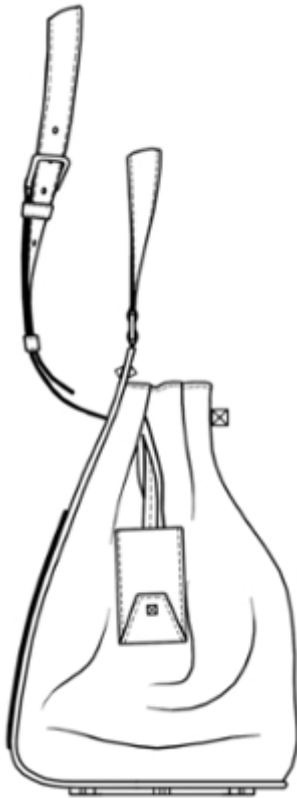

2.6

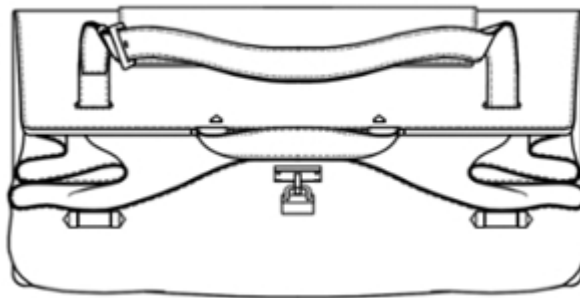

3.1

2.7

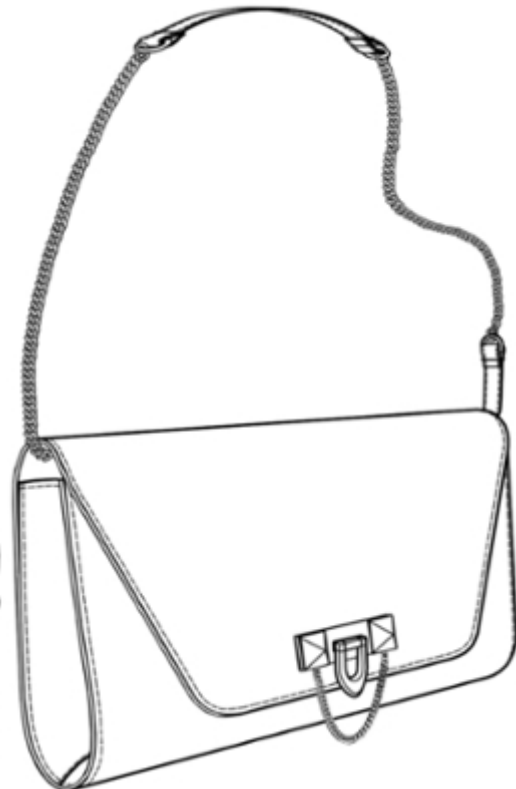
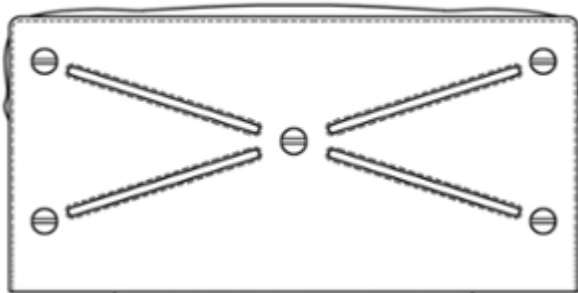

3.2

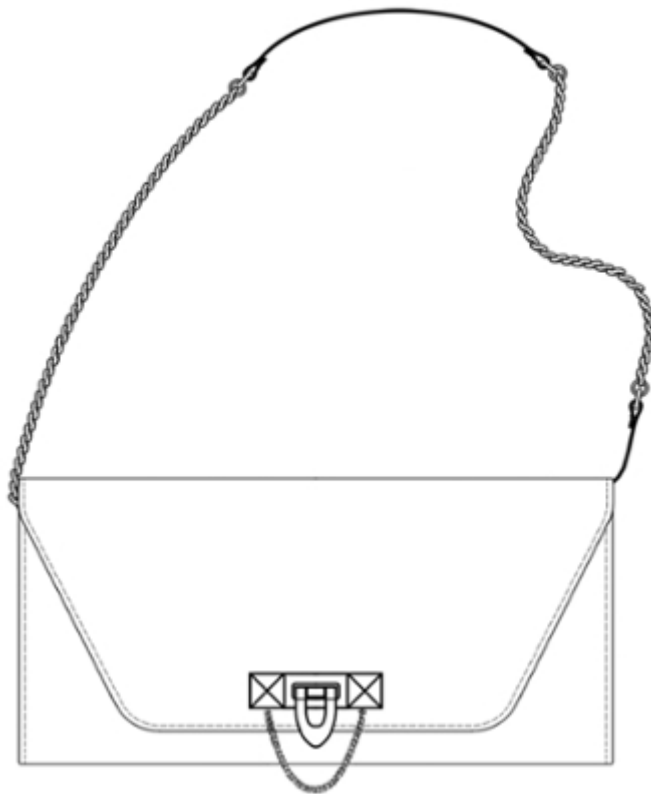

3.3

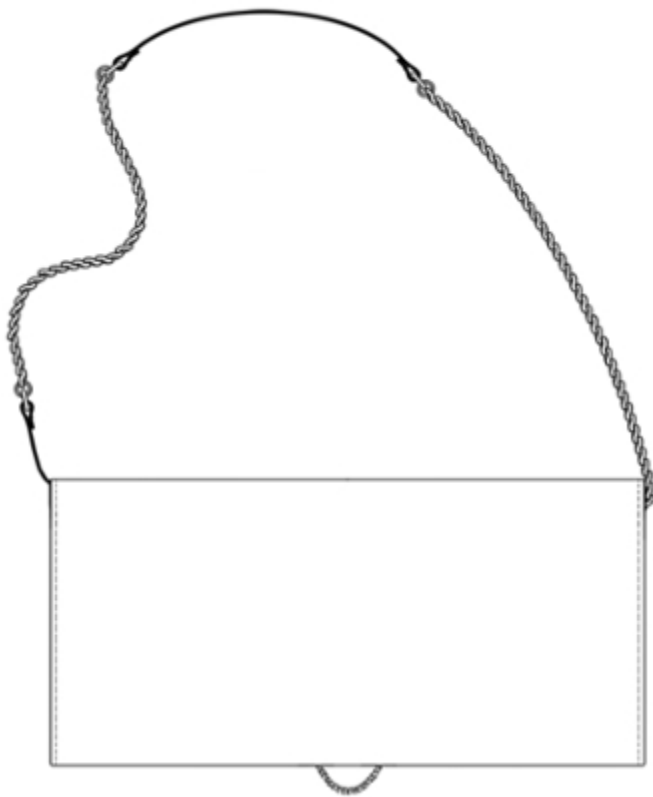

3.4



3.5



3.6



4.1

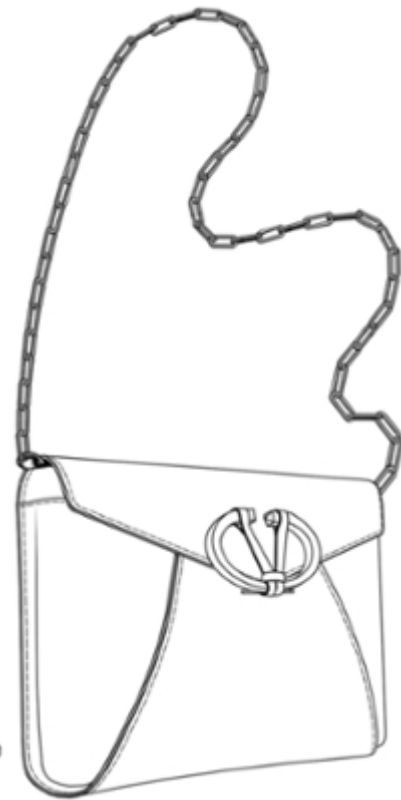

3.7



4.2

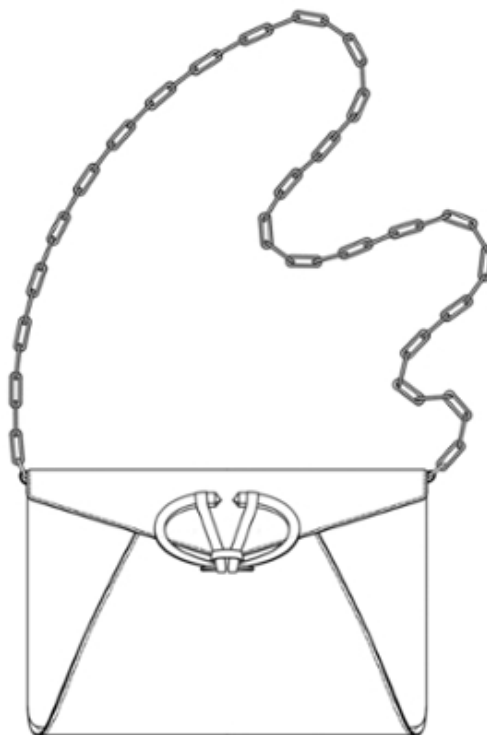

4.3

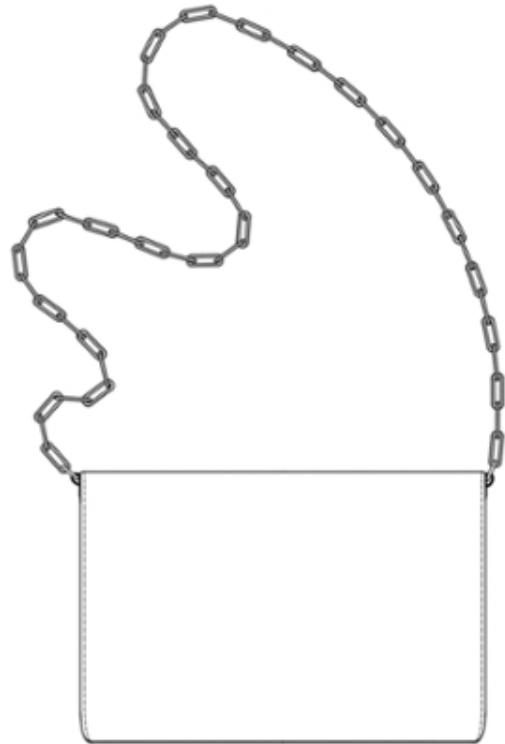

4.4

4.5



4.6



4.7



5.1



5.2



5.3



5.4

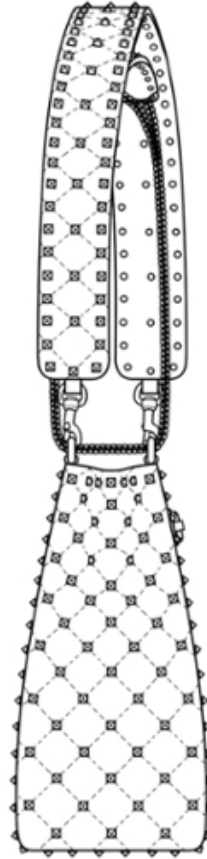

5.5

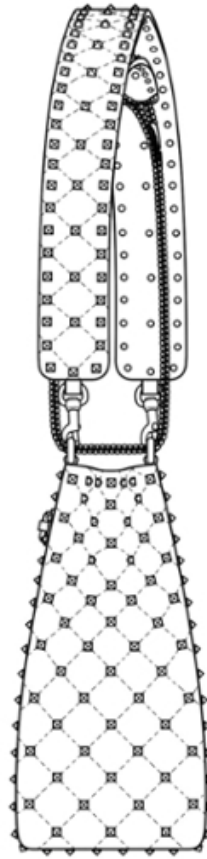

5.6

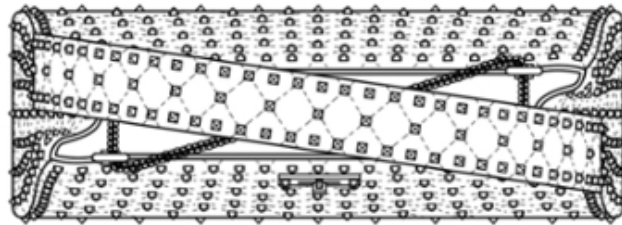

5.7

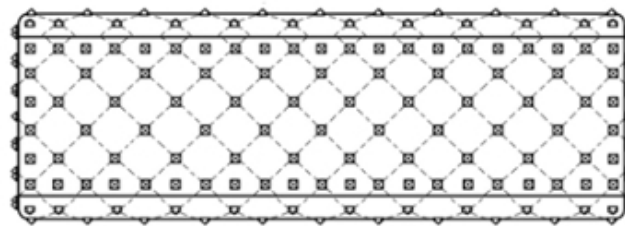

(11) DM/096865**(51) 26-06**

(15) 2017 03 27

(45) 2017/29 (2017 07 28)

(22) 2017 03 27

(28) 3

(30) No. 1: 27.09.2016; 003396555-0001; EM;

No. 2: 27.09.2016; 003396555-0002; EM;

No. 3: 27.09.2016; 003396555-0003; EM

(73) SEAT S.A.

Autovía A-2, Km. 585, E-08760 Martorell (Barcelona) (ES)

(85) ES, EM

(86) ES, EM

(87) ES, EM

(88) ES, EM

(89) ES

(81) III. AZ, BA, CH, EG, GE, IS, LI, MD, MK, NO, OM, RS, SG, TN, TR, UA

(72) JUAN JOSE ADRADOS HERRERO

Autovía A-2, km 585, 08760 MARTORELL, España

(54) 1.-3. Fog lamps for vehicles

(55)

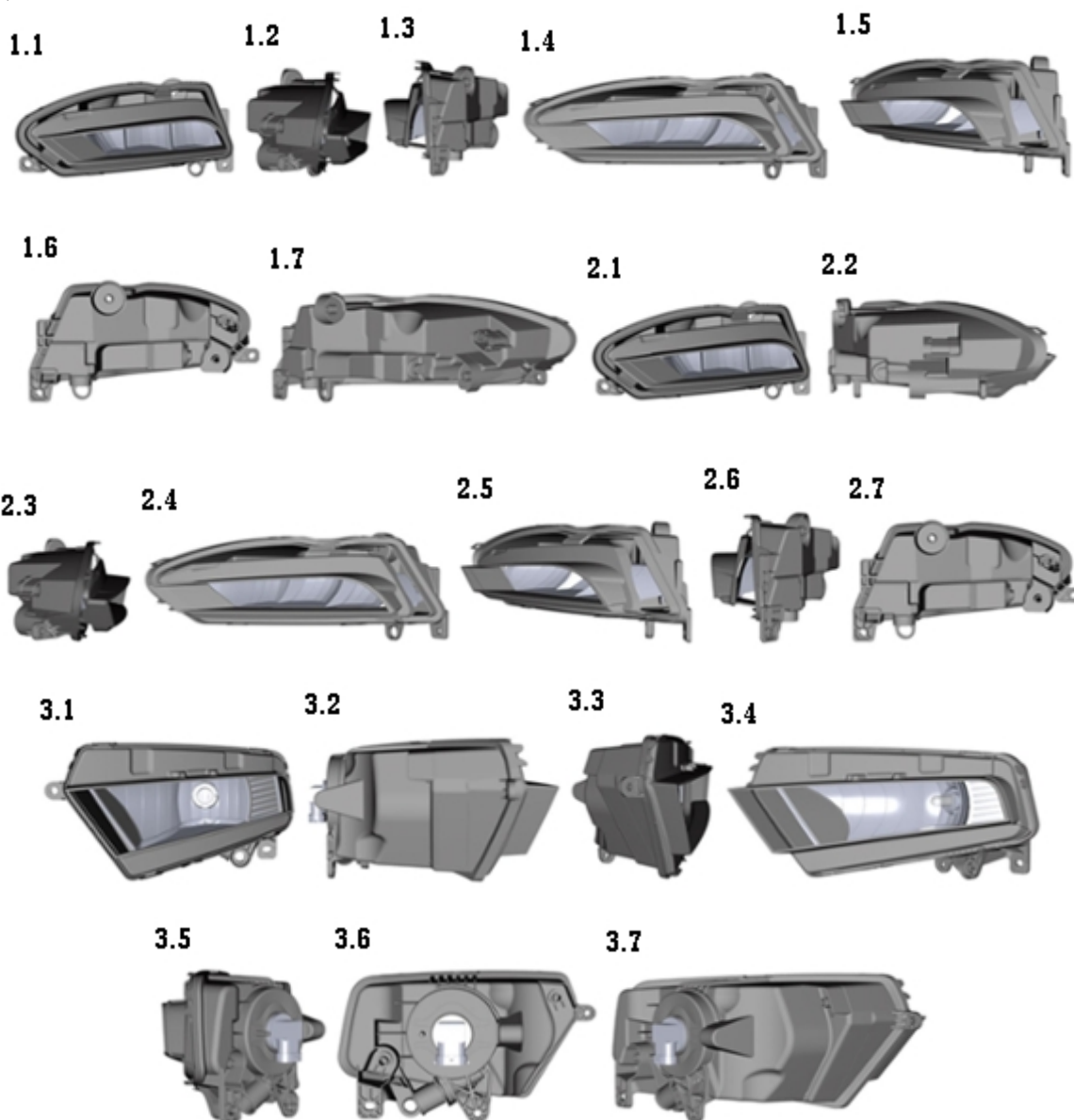

(11) DM/096898

(51) 13-03

(15) 2016 08 04

(45) 2017/29 (2017 07 28)

(22) 2016 08 04

(28) 8

(73) DERNEK GRUP ELEKTRİK ELEKTRONİK DIŞ TİCARET VE SANAYİ LİMİTED ŞİRKETİ İstanbul
Trakya Serbest Bölgesi, Ferhatpaşa SB Mahallesi, Sümbül Sokak, No: 5/41, Çatalca - İstanbul (TR)

(85) TR

(86) TR

(87) TR

(88) TR

(89) TR

(81) III. AL, AM, AZ, BA, BG, EG, EM, ES, FR, GE, GH, HU, KG, LT, LV, ME, MK, MN, NA, OA, OM, PL,
RO, RS, SI, SY, TJ, UA

(72) TUNCAY CEYRAN

Istanbul Trakya Serbest Bölgesi Ferhatpaşa Sb Mah. Sümbül Sk. No:5/41 Çatalca, ISTANBUL, TURKEY

(54) 1. Socket; 2.-3. Switches; 4. Socket; 5. Switch; 6.-7. Sockets; 8. Switch

(55)

1.1

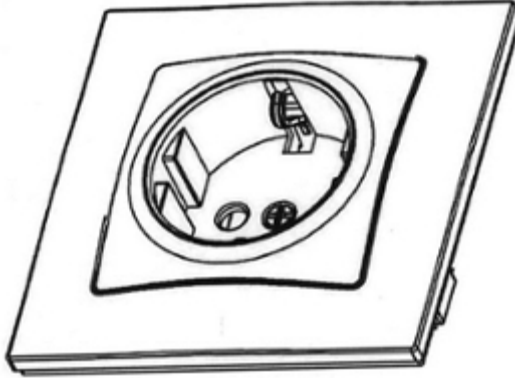

1.2

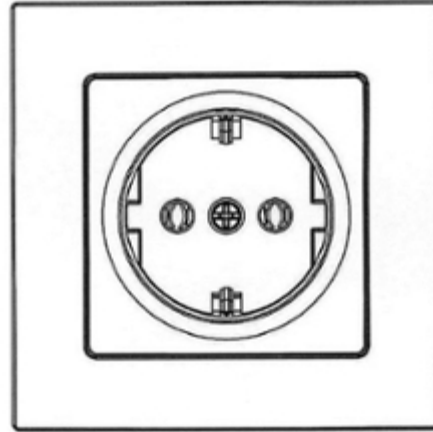

1.3

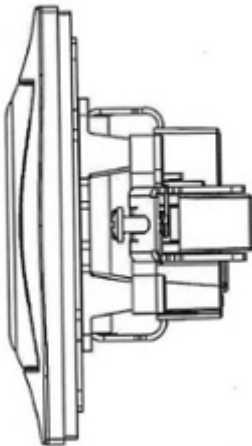

1.4

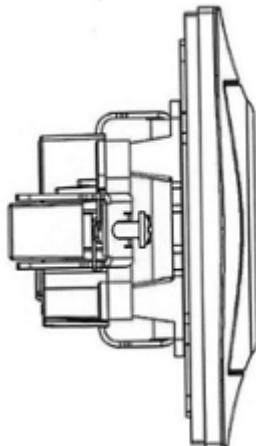

1.5

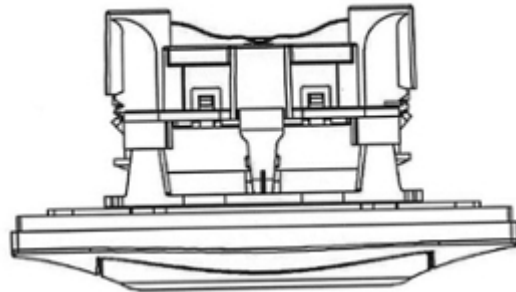

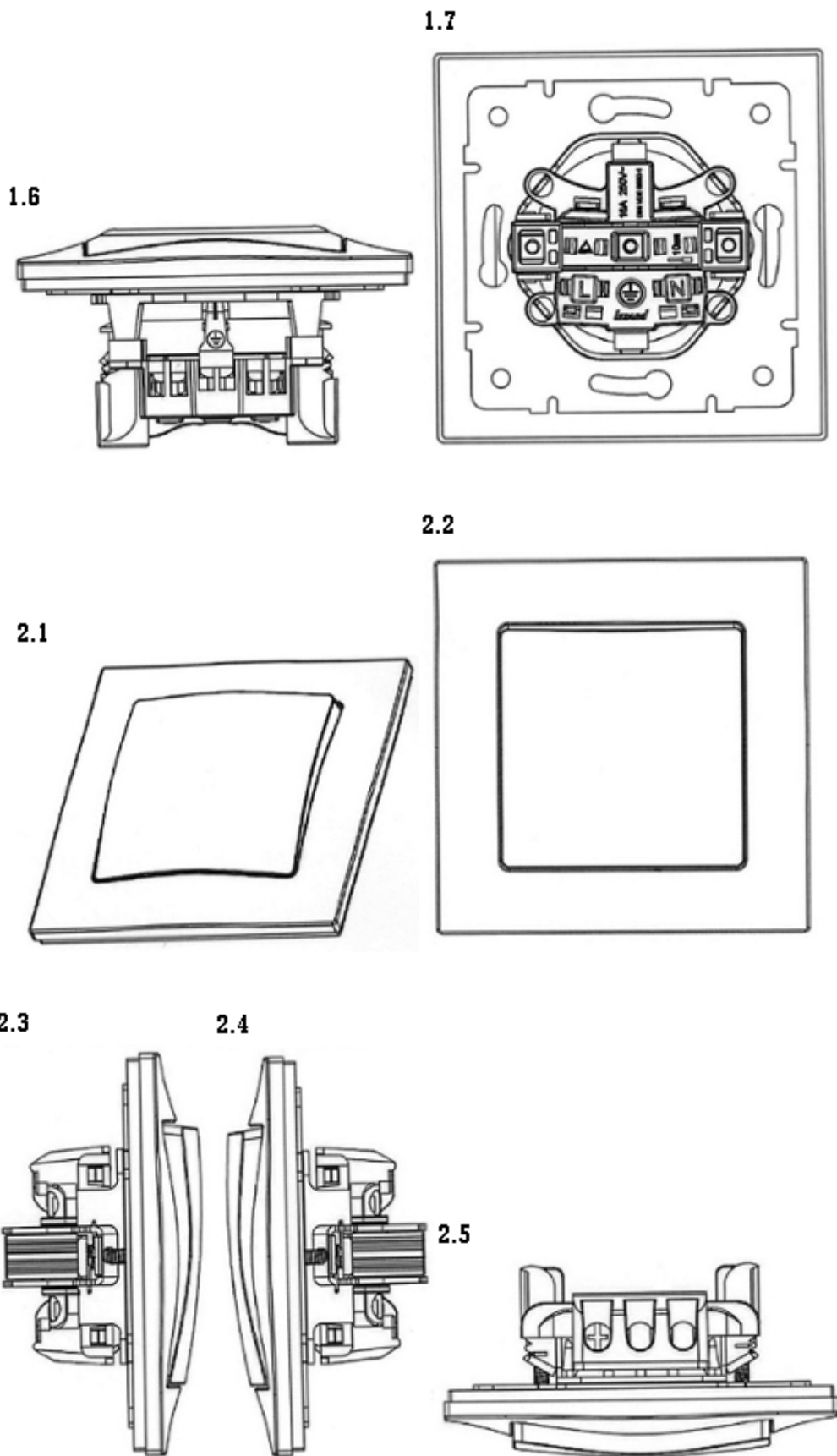

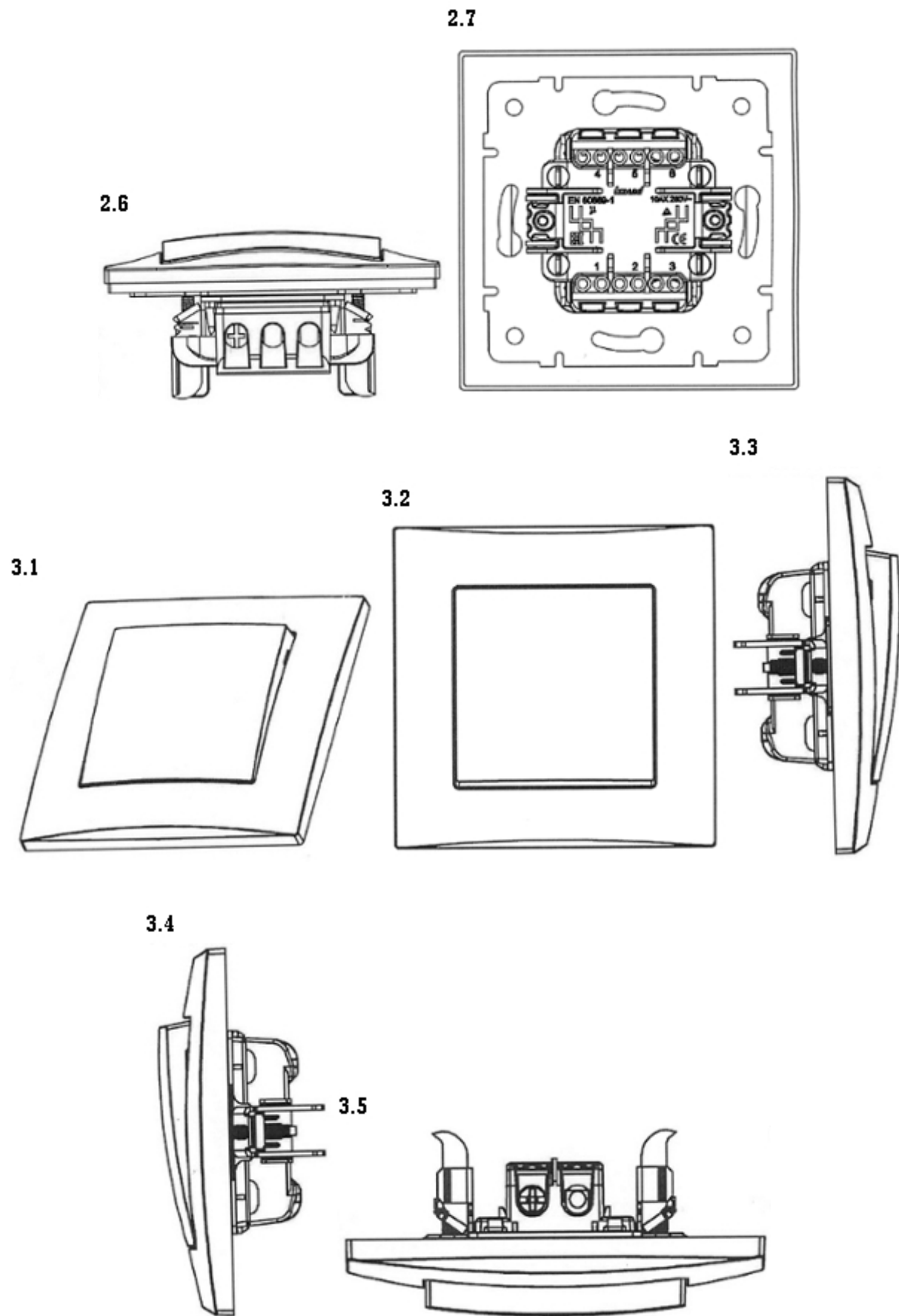

3.6

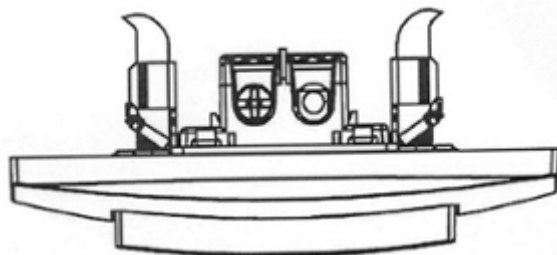

3.7

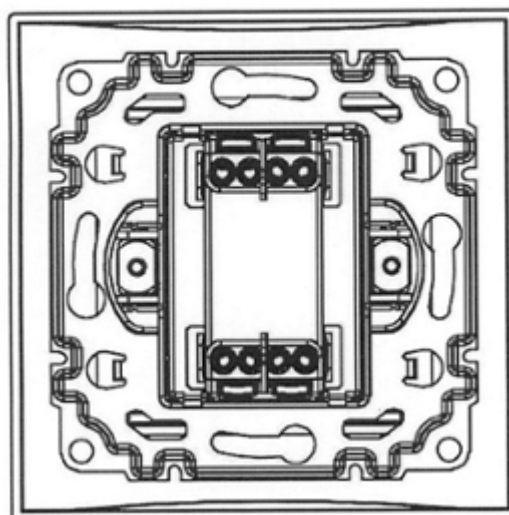

4.1

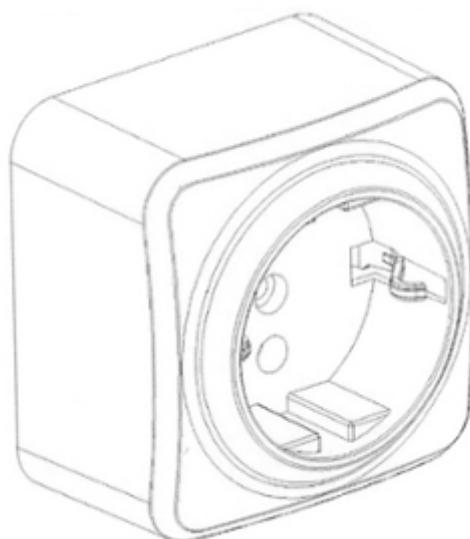

4.2

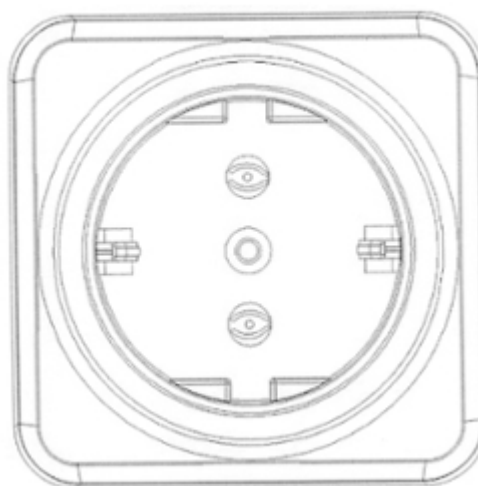

4.3

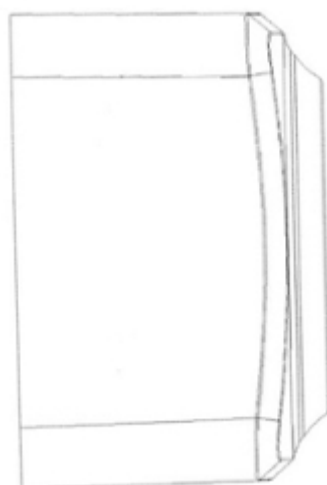

4.4

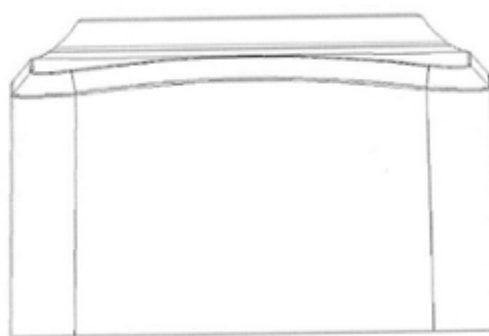

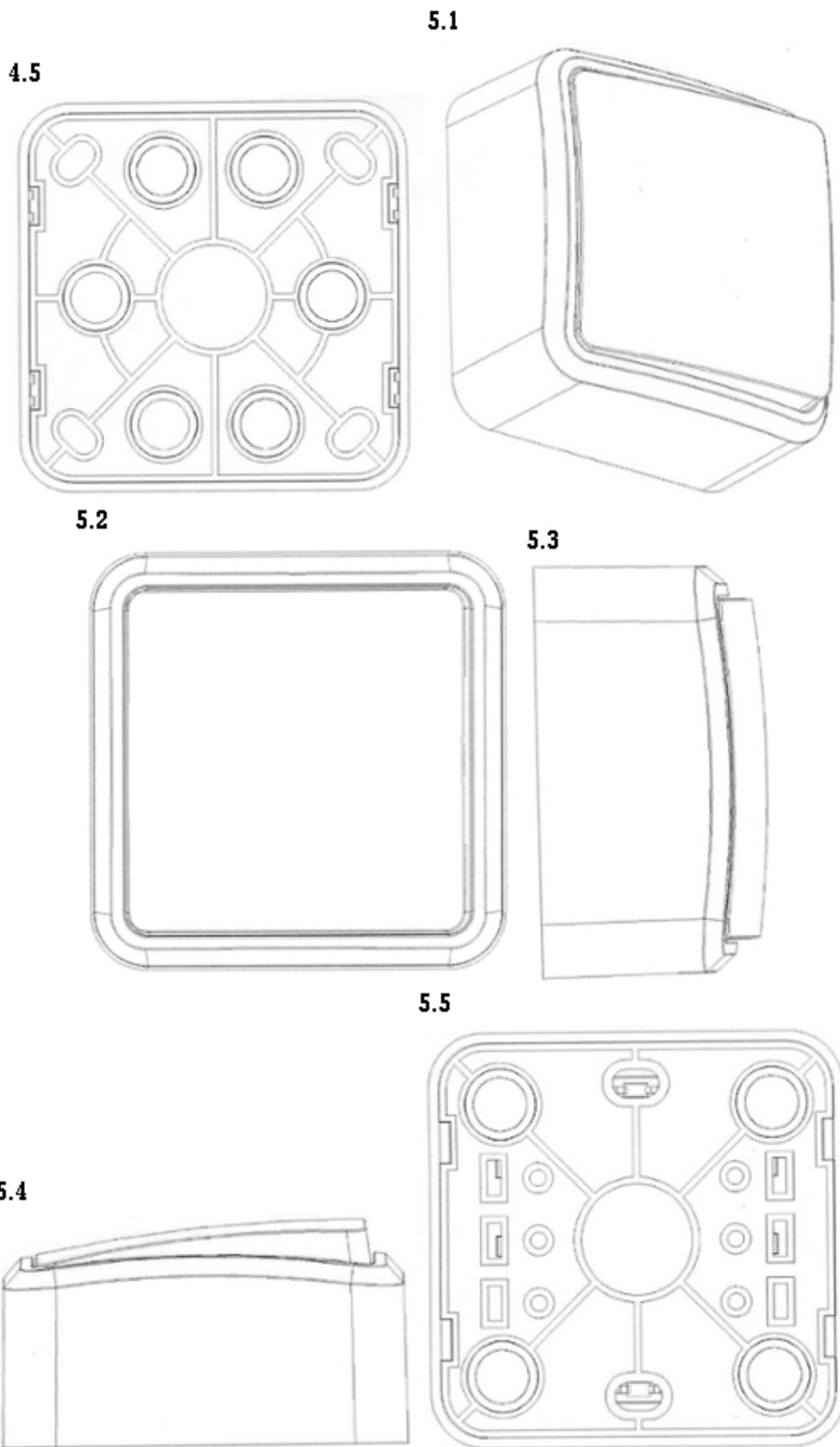

6.1

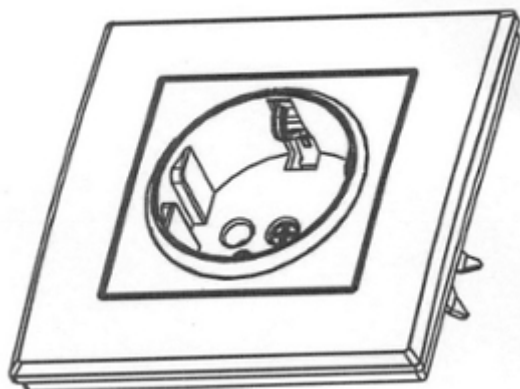

6.2

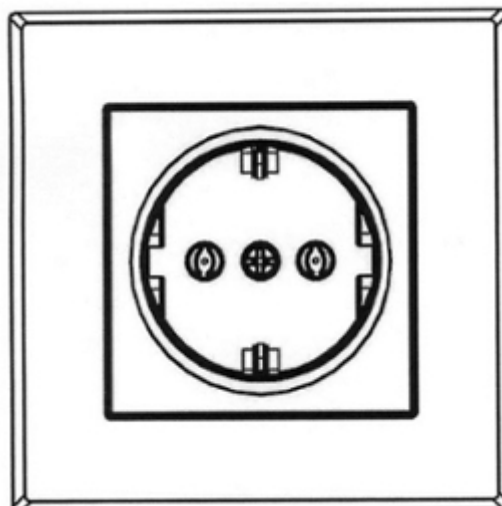

6.4

6.3

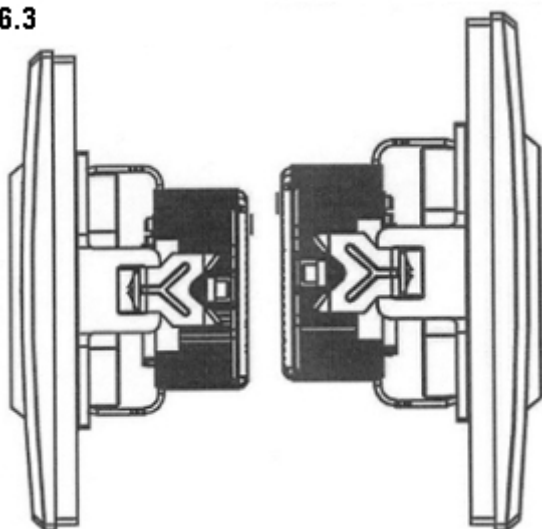

6.5

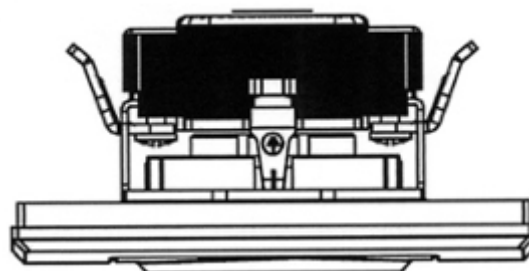

6.7

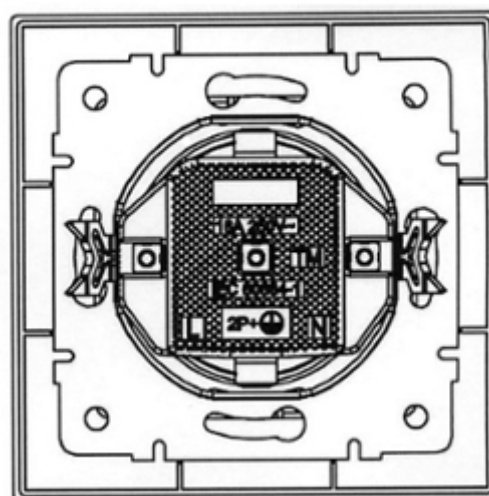

6.6

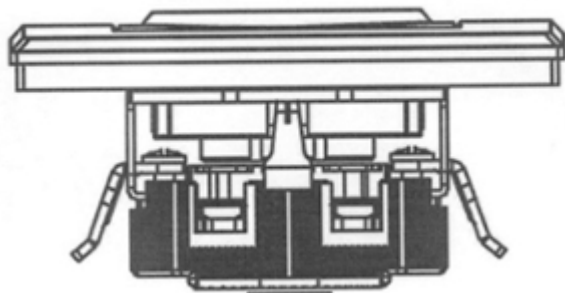

7.1

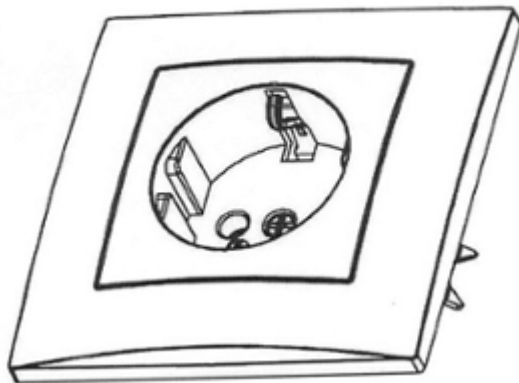

7.2

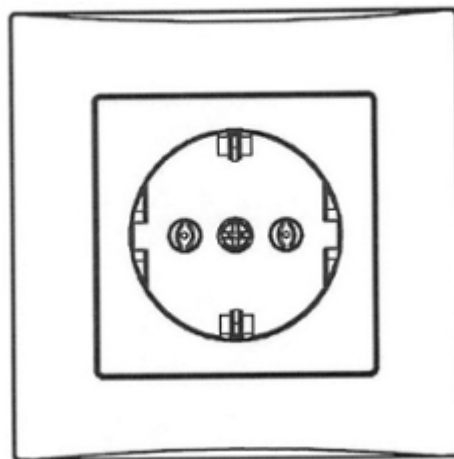

7.3

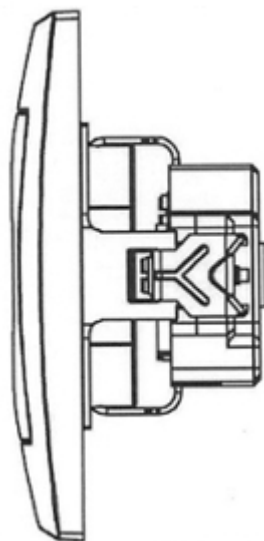

7.4

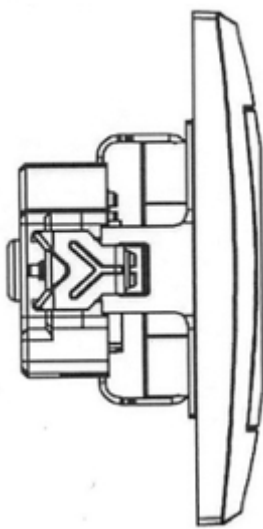

7.5

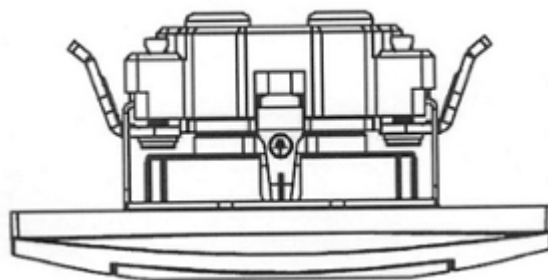

7.7

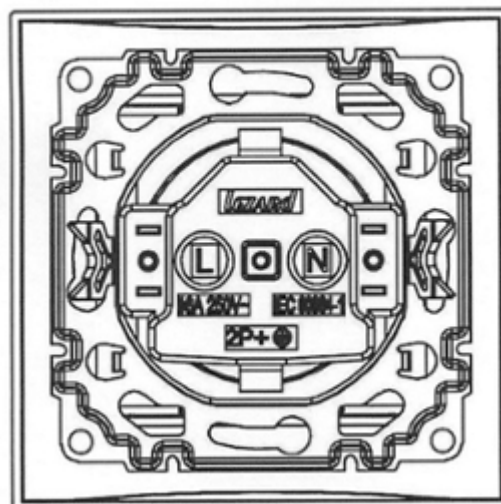

7.6

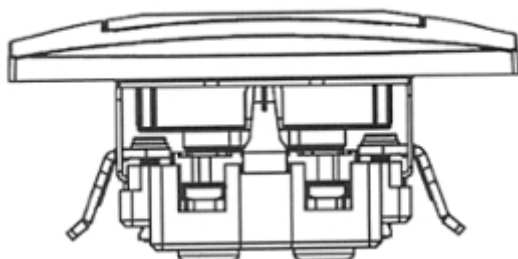

8.1

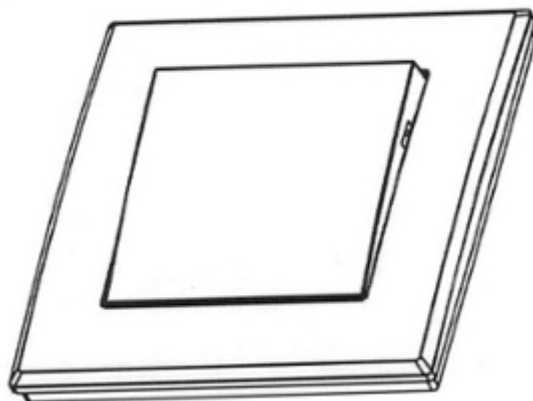

8.2

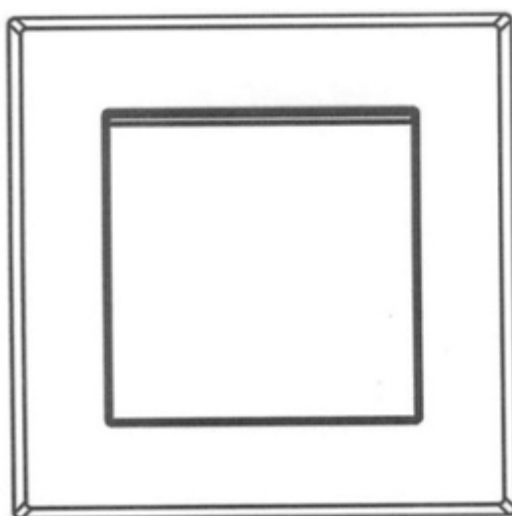

8.3

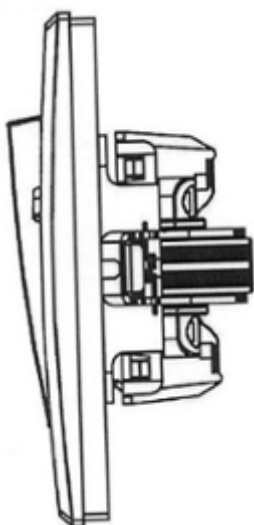

8.4

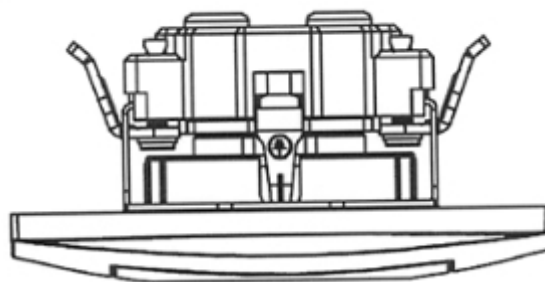

8.5

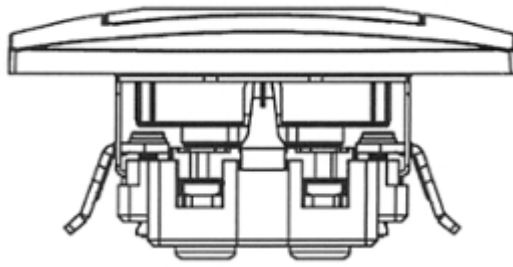

8.6

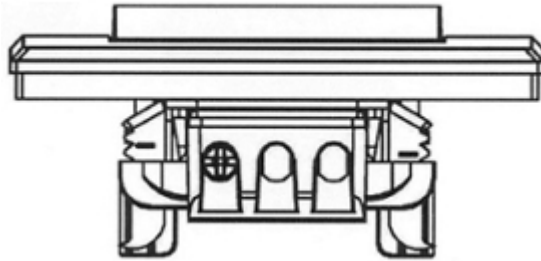

8.7

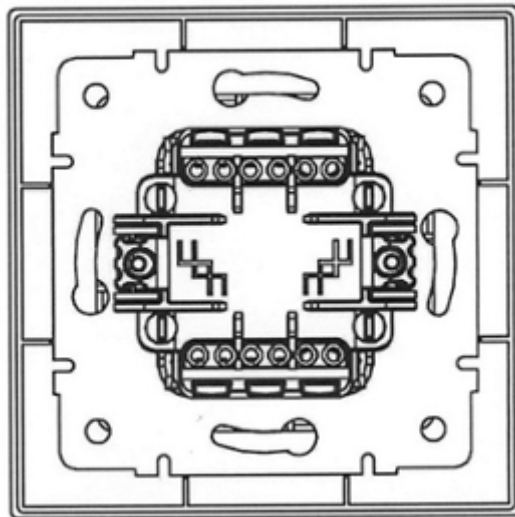

(11) DM/094524

(51) 10-07

(15) 2017 01 31

(45) 2017/30 (2017 08 04)

(22) 2017 01 31

(28) 4

(73) MONTRES JAQUET DROZ SA (MONTRES JAQUET DROZ AG)
(MONTRES JAQUET DROZ LTD.)

Allée du Tourbillon 2, CH-2300 La Chaux-de-Fonds (CH)

(85) CH

(86) CH

(87) CH

(88) CH

(89) CH

(81) II. BZ, MA III. AL, AM, AZ, BA, CH, EM, GE, KG, LI, MC, MD, ME, MK, MN, NO, OM, SG, TN,
TR, UA

(72) Christian LATTMANN

Chemin de Château-Neuf 17, 1125 Monnaz, Suisse;

Yann LEIGGENER

Avenue Léopold-Robert 11, 2300 La Chaux-de-Fonds, Suisse

(54) 1.-4. Dials

(55)

1.1



1.2



1.3

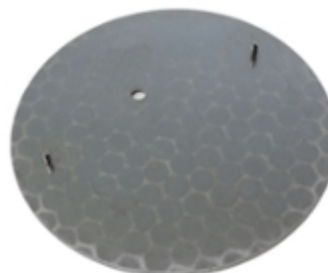

2.1



2.2



2.3

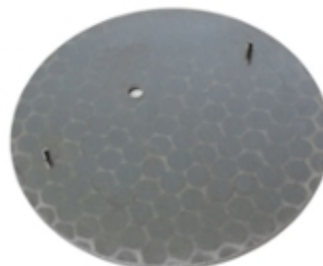

3.1



3.2



3.3

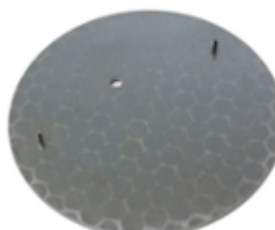

4.1

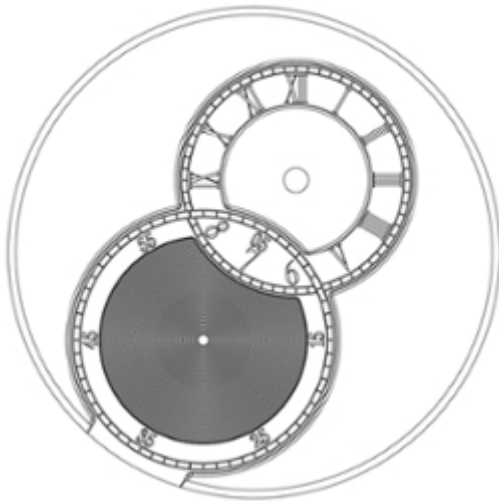

4.2

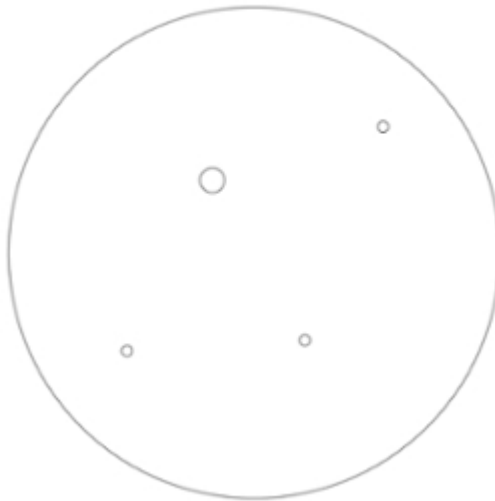

4.3



4.4



4.5



4.6



4.7

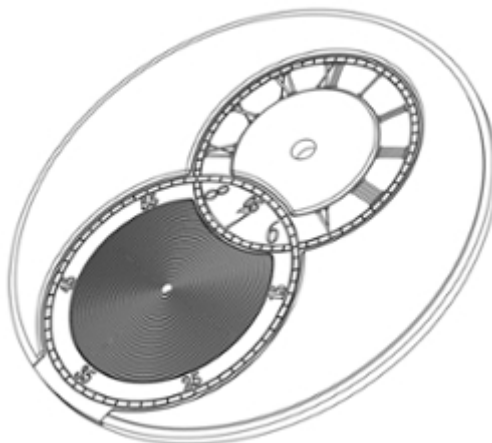

(11) DM/094525

(15) 2017 01 31

(22) 2017 01 31

(28) 13

(73) ETA SA MANUFACTURE HORLOGÈRE SUISSE

Schild-Rust-Strasse 17, CH-2540 Grenchen (CH)

(85) CH

(86) CH

(87) CH

(88) CH

(89) CH

(81) II. MA III. CH, EM, GE, NO, TR, UA

(72) 1,4-8,10-11: Milko BOYAROV

Birmensdorferstrasse 197, 8003 Zürich, Suisse;

2-3: Michaela KOCH

Mauschbacher Steig 33, 13437 Berlin, Allemagne;

9: Véronique STOLL

Chemin de la Marnière 14A, 2504 Biel/Bienne, Suisse;

12-13: Damien GOYET

45, rue Principale, 68480 Winkel, France

(54) 1.-13. Wristwatches

(55)



7



8



9



10



11



12



13



(11) DM/096547

(51) 12-08

(15) 2017 01 31

(45) 2017/30 (2017 08 04)

(22) 2017 01 31

(28) 3

(73) PEUGEOT CITROËN AUTOMOBILES SA

Route de Gisy, F-78140 VELIZY-VILLACOUBLAY (FR)

(85) FR, EM

(86) FR, EM

(87) FR, EM

(88) FR, EM

(89) FR

(81) II. BJ, BX, BZ, CI, GA, GR, IT, MA, ML, NE, SN, SR III. AL, AM, AZ, BA, BG, BN, BW, CH, DE, DK, EE, EG, ES, FI, FR, GE, GH, HR, HU, IS, JP, KG, KP, KR, LI, LT, LV, MC, MD, ME, MK, MN, NA, NO, OA, OM, PL, RO, RS, RW, SG, SI, ST, SY, TJ, TM, TN, TR, UA

(72) Jean-Pierre Ploué

Route de Gisy, 78140 VELIZY-VILLACOUBLAY, France

(54) 1.-3. Motor cars

(55)

1.1



1.2



1.3



1.4



1.5



2.1



2.2



2.3



3.1



3.2



(11) DM/096948

(51) 02-04

(15) 2017 07 11

(45) 2017/30 (2017 08 04)

(22) 2017 07 11

(28) 4

(73) VALENTINO S.P.A.

Via Turati, 16/18, I-20121 MILANO (IT)

(85) -

(86) IT, EM

(87) IT, EM

(88) IT, EM

(89) EM

(81) III. AZ, EM, GE, JP, KG, KR, TJ, TR, UA

(72) SASSI Stefano

c/o VALENTINO S.p.A., Via Turati, 16/18, I-20121 Milano, Italy

(54) 1.-4. Shoes

(55)

1.1



1.2



1.3

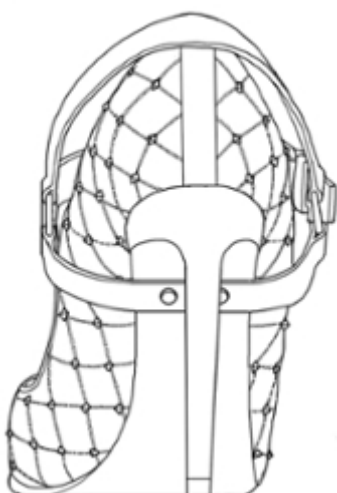

1.4

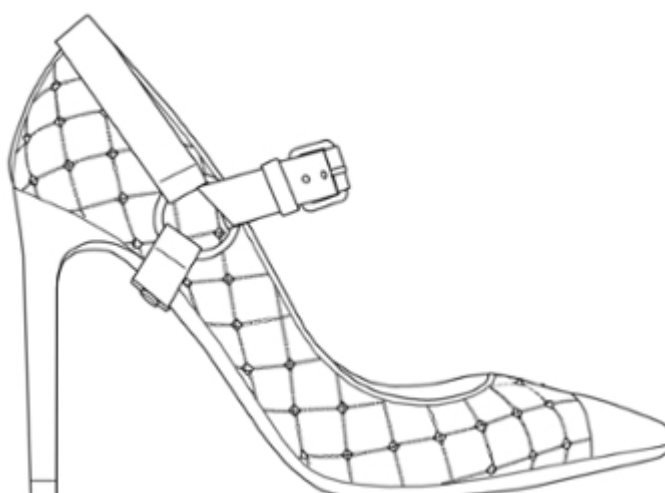

1.5



1.6



1.7

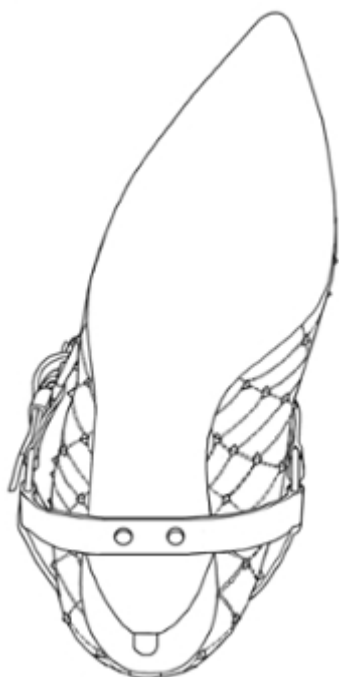

2.1

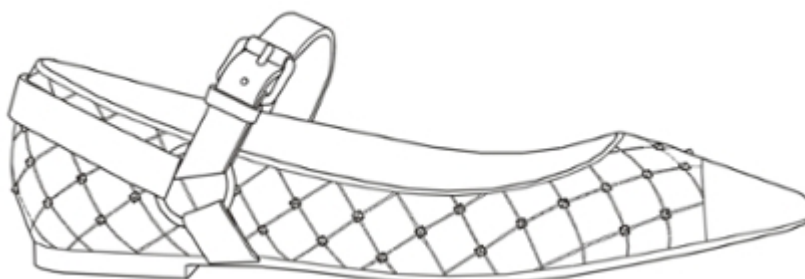

2.2

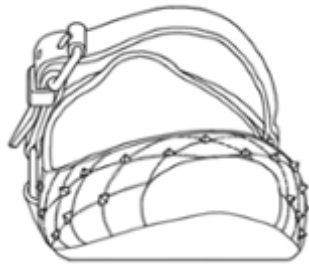

2.3

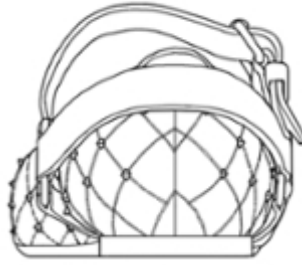

2.4

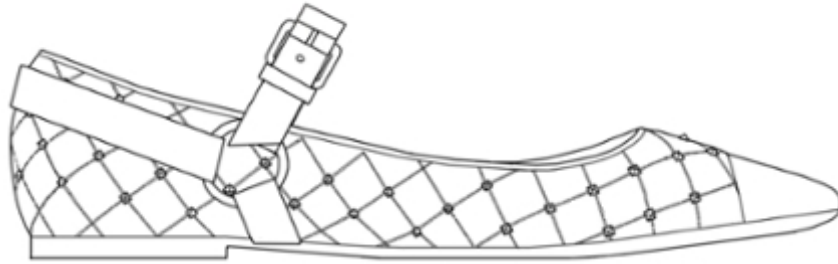

2.6

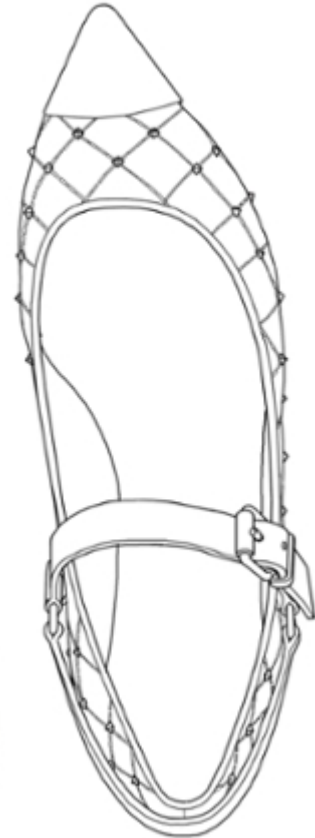

2.5

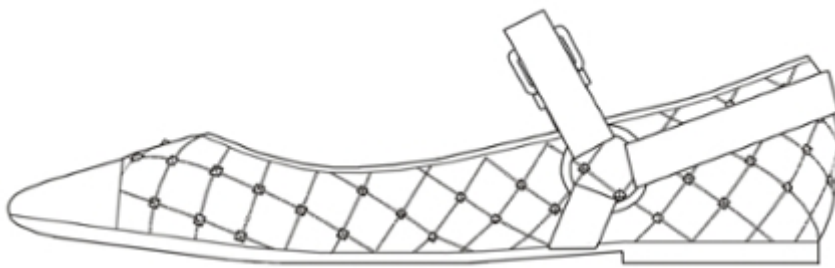

2.7

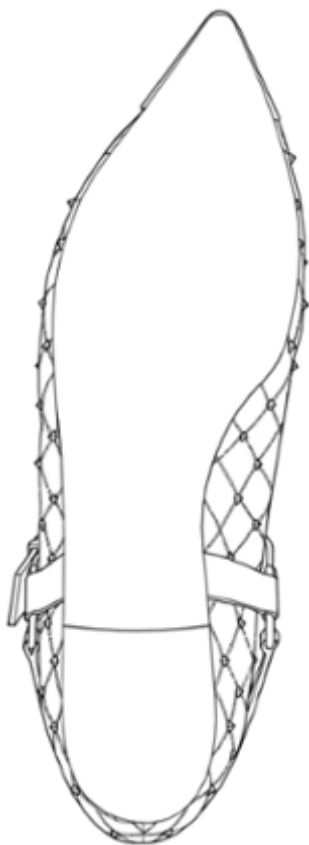

3.1



3.2

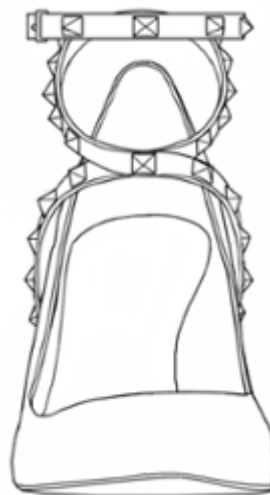

3.3

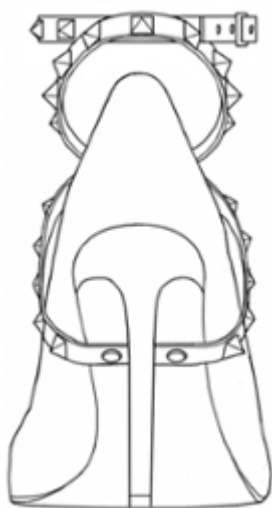

3.4



3.5

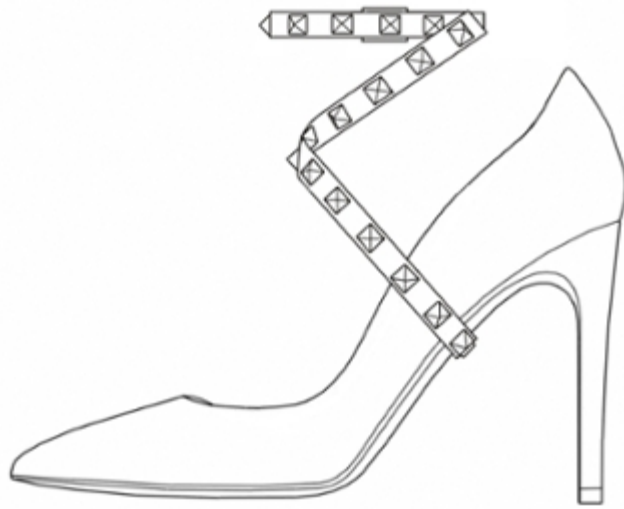

3.6



3.7



4.1

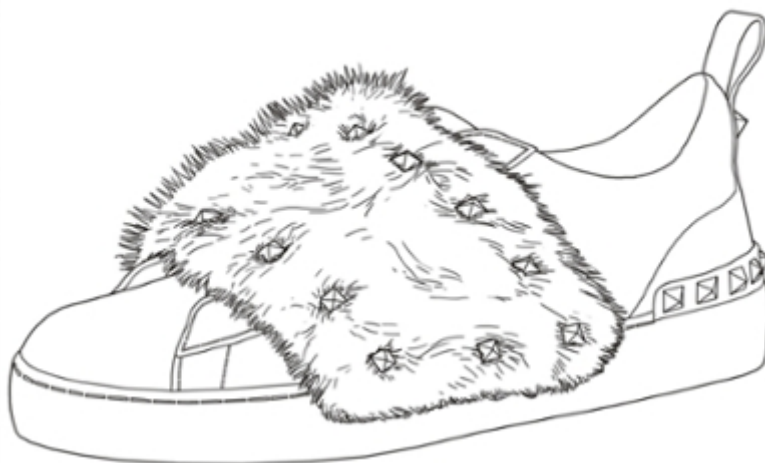

4.2



4.3

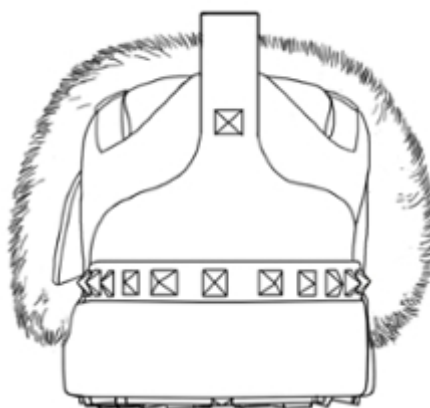

4.4

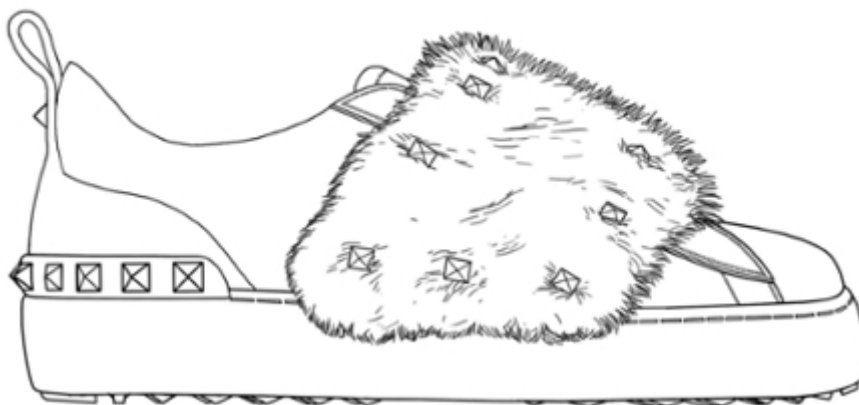

4.5

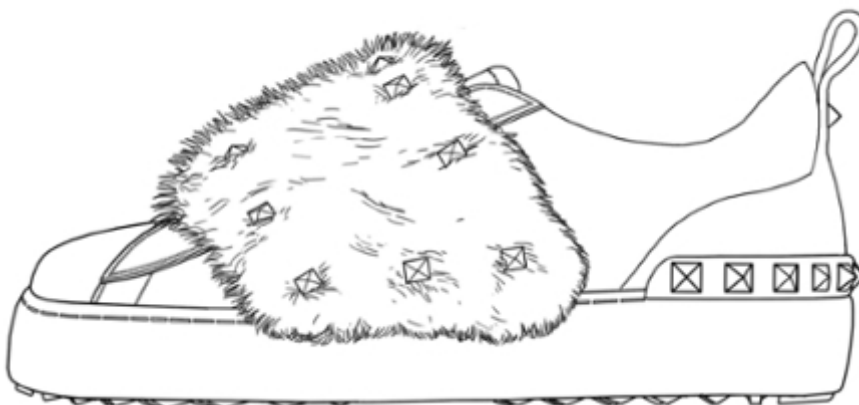

4.6



4.7

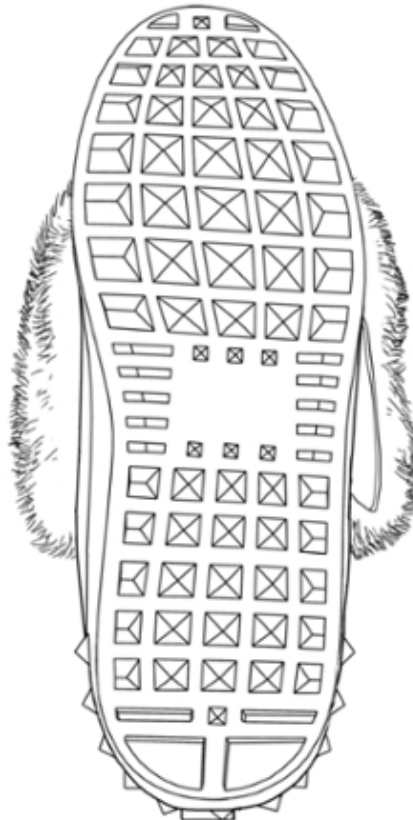

(11) DM/096957**(51) 09-02**

(15) 2017 07 19

(45) 2017/30 (2017 08 04)

(22) 2017 07 19

(28) 1

(30) No. 1: 06.04.2017; 003844679-0001; EM

(73) TOTAL SA

2 Place Jean Millier, La Défense 6, F-92400 COURBEVOIE (FR)

(85) EM

(86) FR, EM

(87) FR, EM

(88) FR, EM

(89) FR

(81) II. BZ, MA, SR III. AL, AM, AZ, BA, BN, CH, EG, GE, IS, JP, KG, KH, KP, KR, LI, MC, MD, ME, MK, MN, NO, OM, RS, SG, SY, TJ, TM, TN, TR, UA

(72) SALOTTI Béatrice

14, Avenue Félix Faure, 75015 PARIS, France

(54) 1. Can

(55)

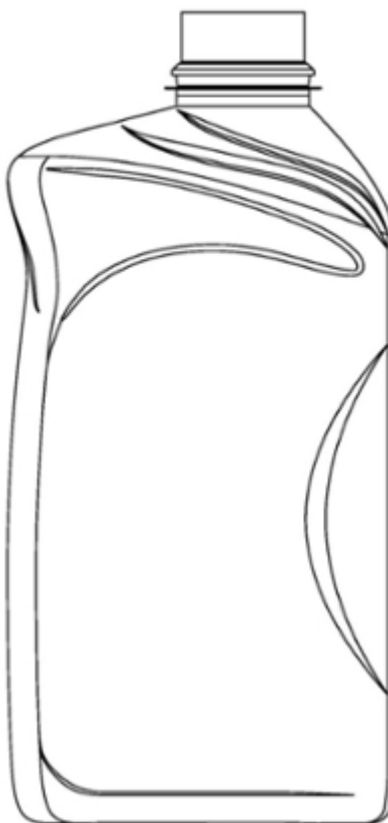
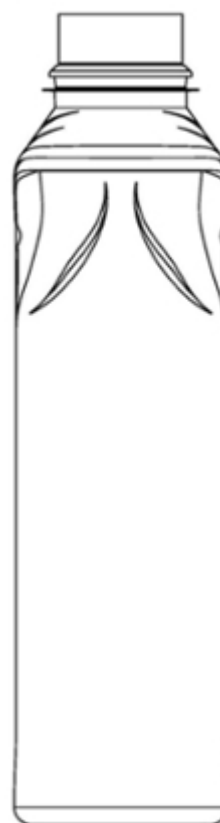
1.1**1.2****1.3**

1.4



1.5

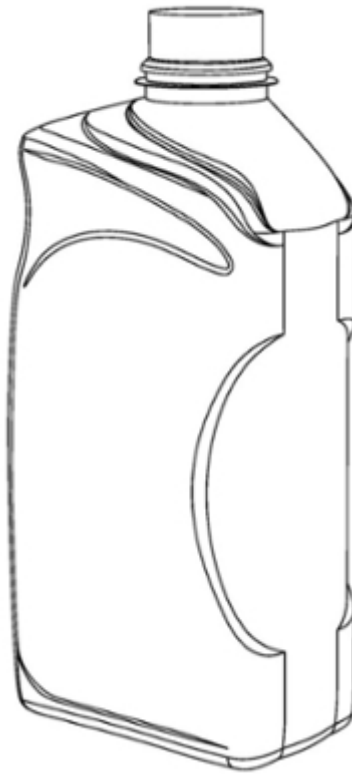

1.6



(11) DM/096958**(51) 09-02**

(15) 2017 07 19

(45) 2017/30 (2017 08 04)

(22) 2017 07 19

(28) 1

(30) No. 1: 06.04.2017; 003844687-0001; EM

(73) TOTAL SA

2 Place Jean Millier, La Défense 6, F-92400 COURBEVOIE (FR)

(85) EM

(86) FR, EM

(87) FR, EM

(88) FR, EM

(89) FR

(81) II. BZ, MA, SR III. AL, AM, AZ, BA, BN, CH, EG, GE, IS, JP, KG, KH, KP, KR, LI, MC, MD, ME, MK, MN, NO, OM, RS, SG, SY, TJ, TM, TN, TR, UA

(72) SALOTTI Béatrice

14, Avenue Félix Faure, 75015 PARIS, France

(54) 1. Can

(55)

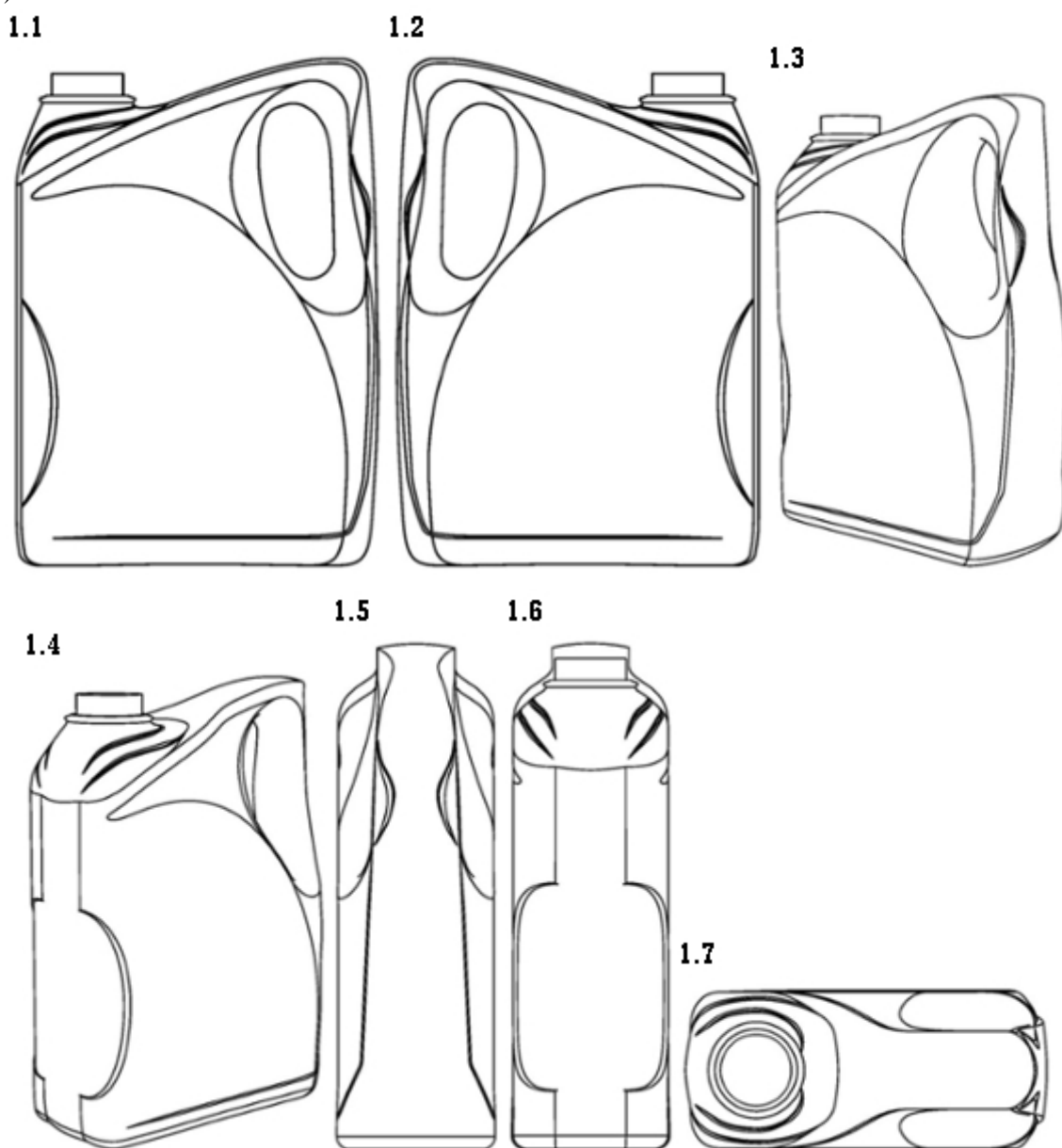

(11) DM/096968

(15) 2017 02 06

(22) 2017 02 06

(28) 6

(73) BUDMAT WIĘCEK BOGDAN

ul. Otolńska 25, PL-09-407 Plock (PL)

(85) PL, EM

(86) PL, EM

(87) PL, EM

(88) PL, EM

(89) PL

(81) III. AL, AM, AZ, BA, BN, BW, CH, EG, EM, GE, GH, IS, JP, KG, KP, KR, LI, MC, MD, ME, MK, MN, NA, OA, OM, RS, RW, SG, ST, SY, TJ, TM, TN, TR, UA, US

(72) Bogan WIECEK

ul. Otolinska 25, 09-407 Plock, Poland

(54) 1.-6. Metal roof panels

(55)

(51) 25-01

(45) 2017/30 (2017 08 04)

1.1



1.2

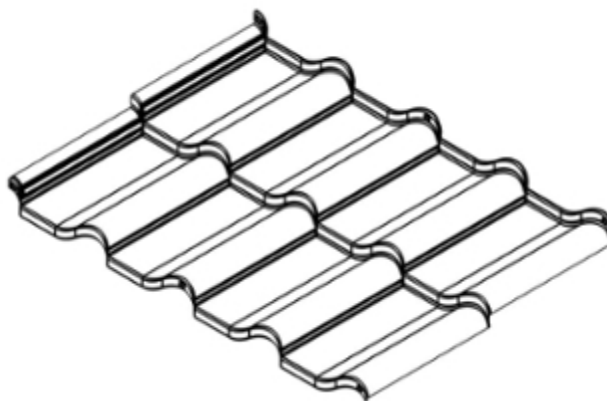

1.3

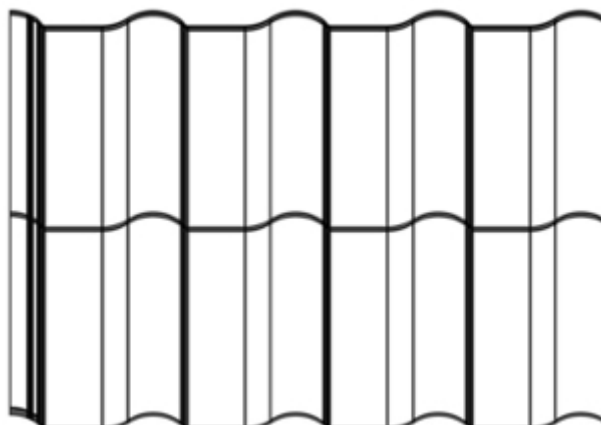

1.4



1.5



1.6

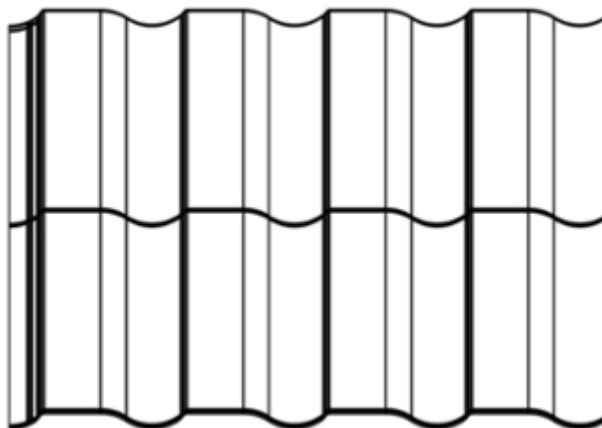

1.7

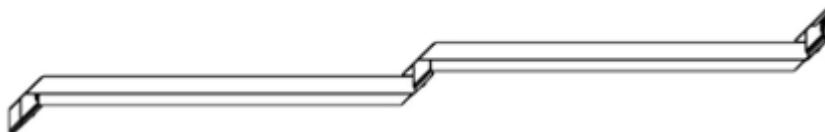

2.1



2.2



2.3

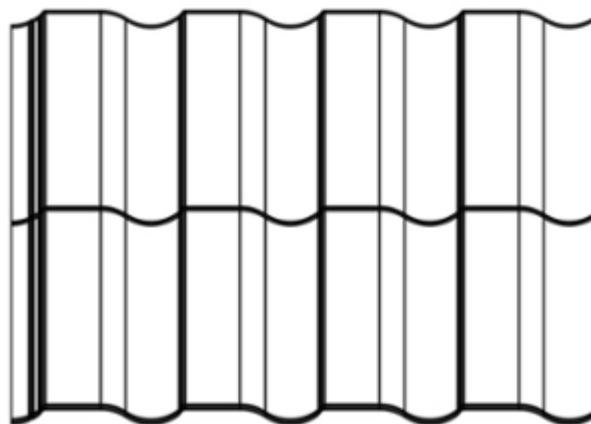

2.4

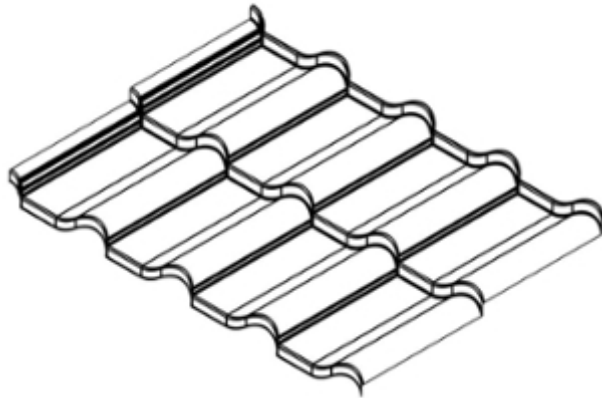

2.5



2.6

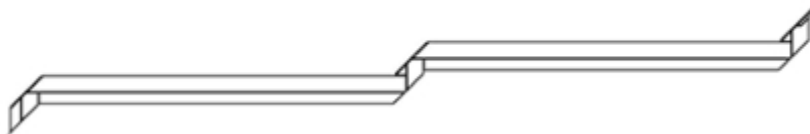

2.7

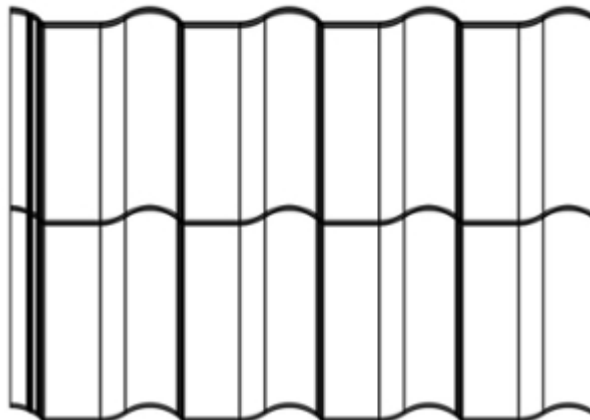

3.1



3.2

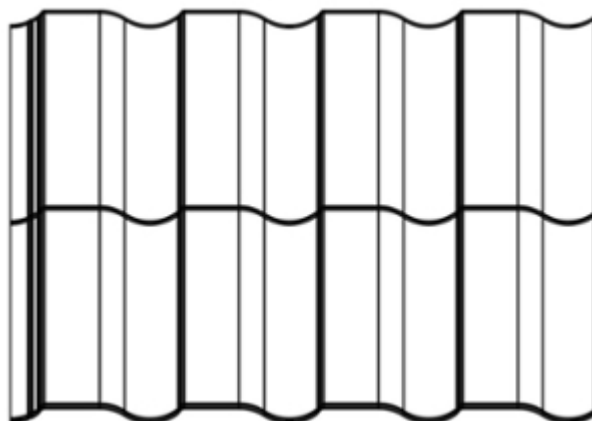

3.3



3.4

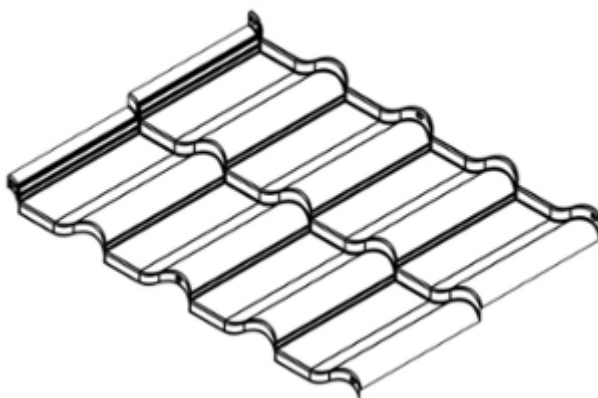

3.5



3.6

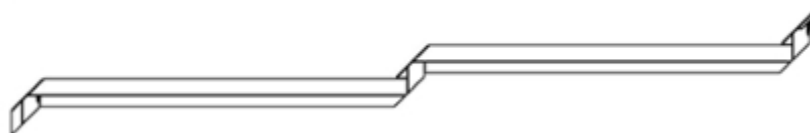

3.7

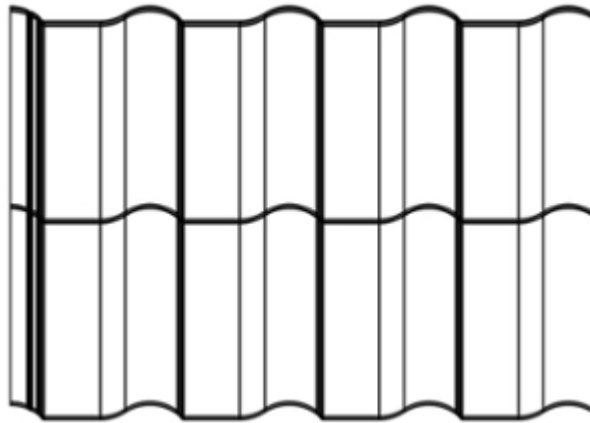

4.1



4.2



4.3

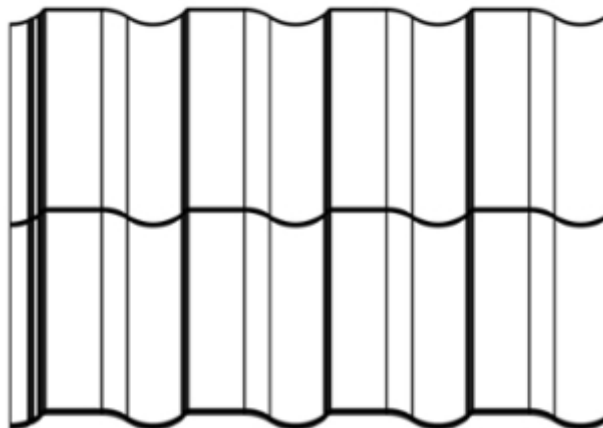

4.4



4.5

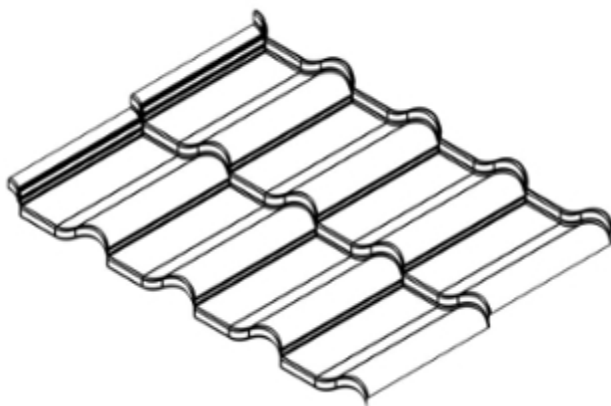

4.6

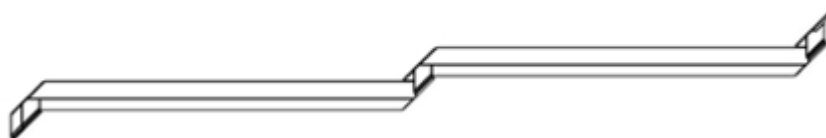

4.7

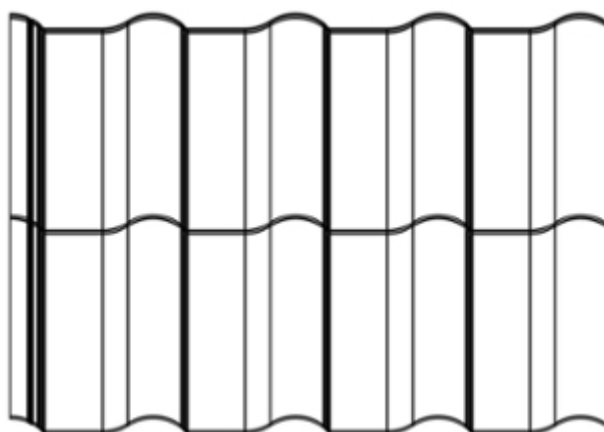

5.1



5.2

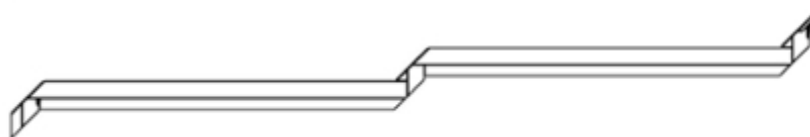

5.3

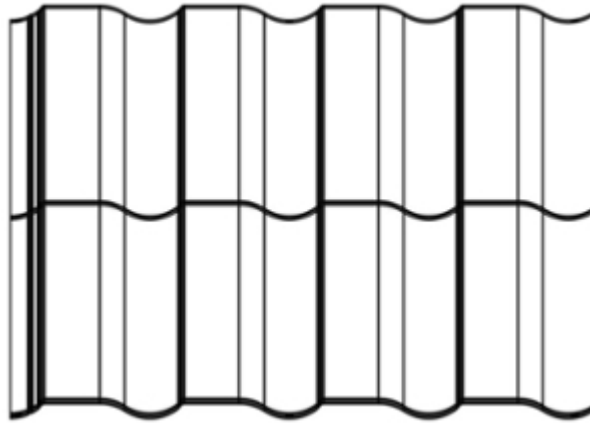

5.4

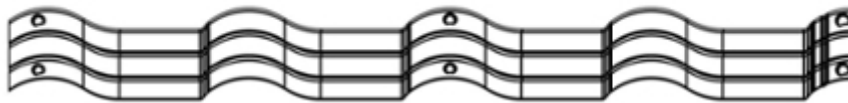

5.5



5.6

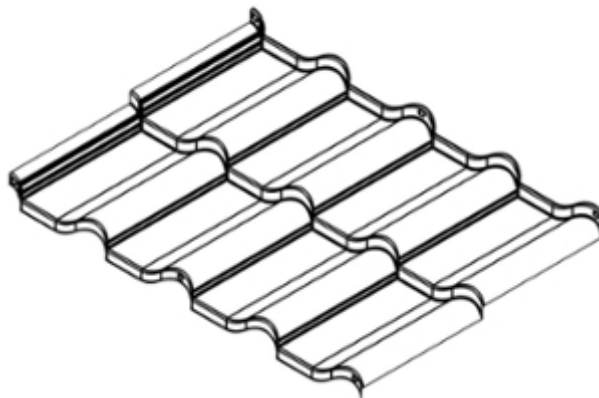

5.7

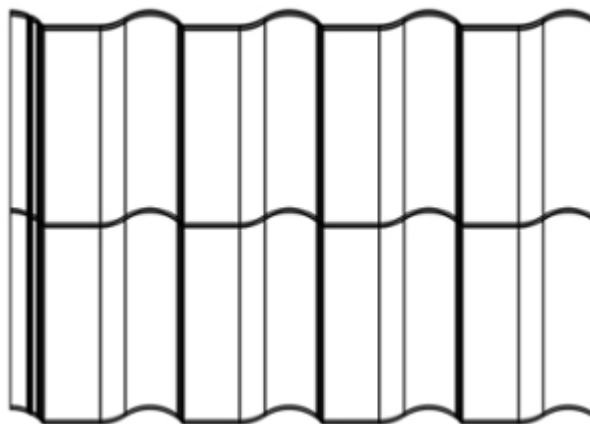

6.1



6.2



6.3

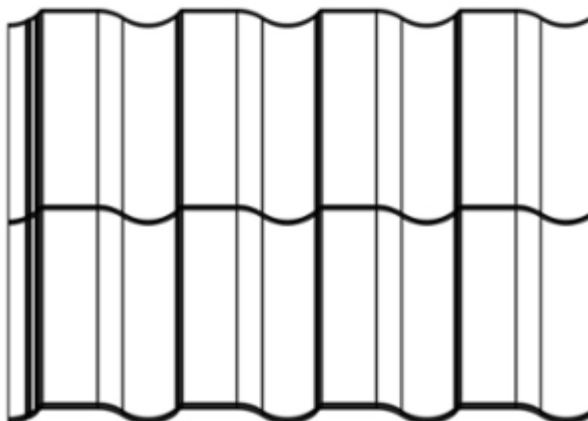

6.4

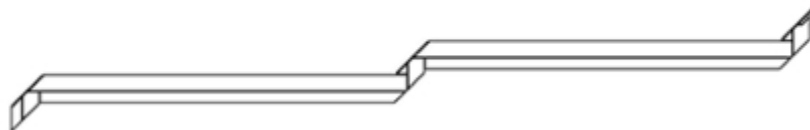

6.5

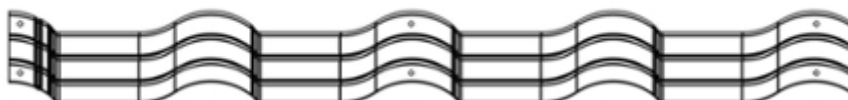

6.6

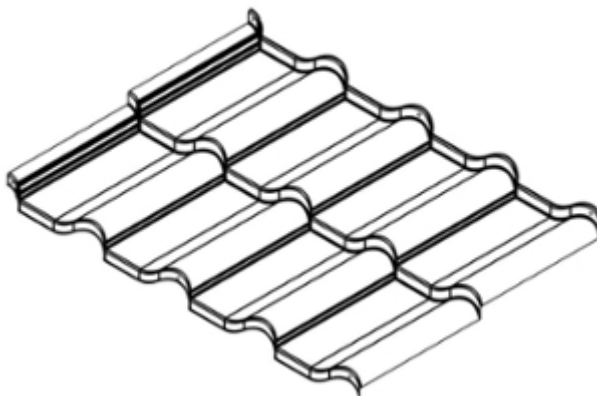

6.7

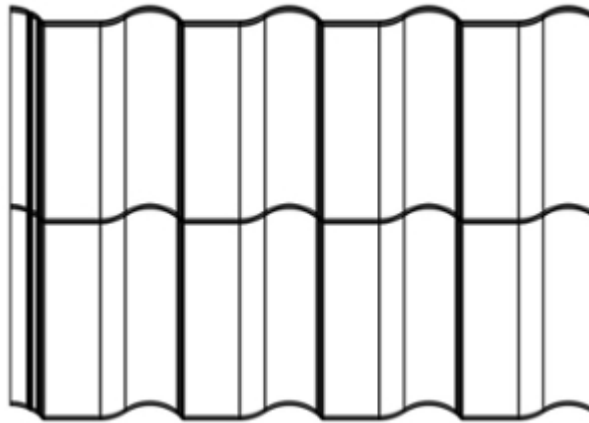

(11) DM/096997

(15) 2017 03 23

(22) 2017 03 23

(28) 1

(30) No. 1: 06.01.2017; 29/590,129; US

(73) ANTSY LABS LLC

Dacono CO 80514 (US)

(85) US

(86) US

(87) US

(88) US

(89) US

(81) III. AL, AM, AZ, BA, BG, BN, BW, CH, DE, DK, EE, EG, EM, ES, FI, FR, GE, GH, HR, HU, IS, KG, KH, LI, LT, LV, MC, MD, ME, MK, MN, NA, NO, OA, OM, PL, RS, RW, SG, SI, ST, TJ, TM, TN, TR, UA

(72) McLachlan, Matthew

3078 Meadowbrook Place, 80514, Dacono CO, US; McLachlan, Mark, 5739 Prairie Circle, 80504, Frederick, CO, US

(54) 1. Toy

(55)

(51) 21-01

(45) 2017/30 (2017 08 04)

1.1

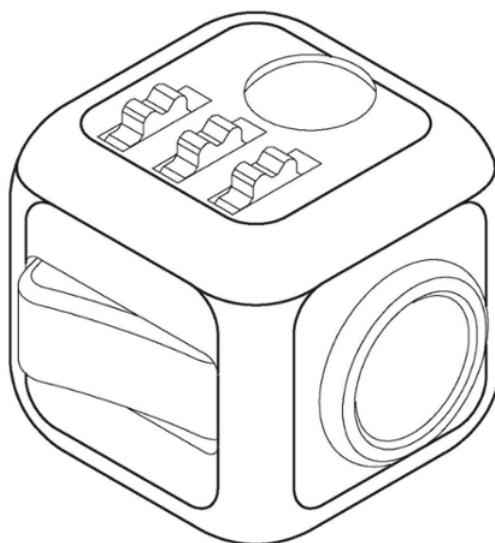

1.2

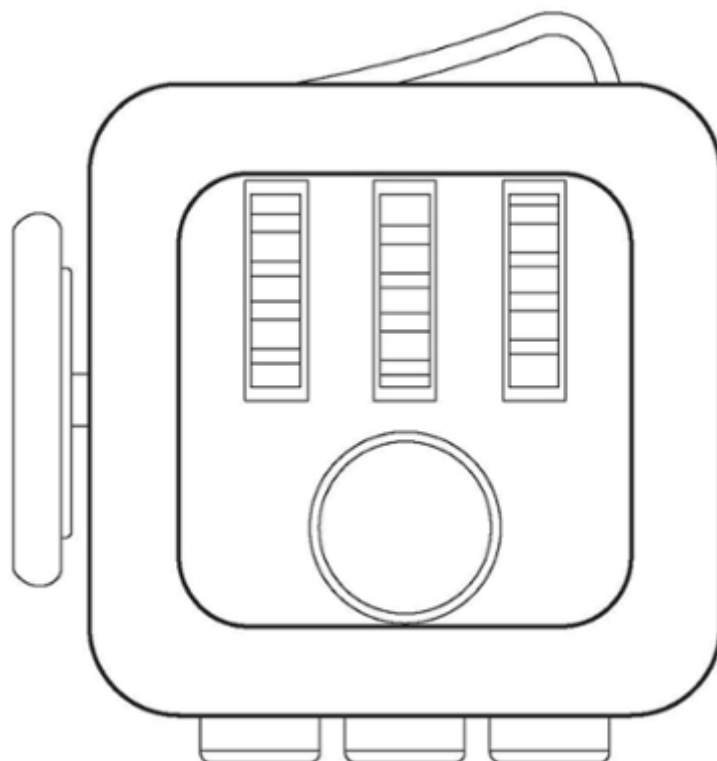

1.3

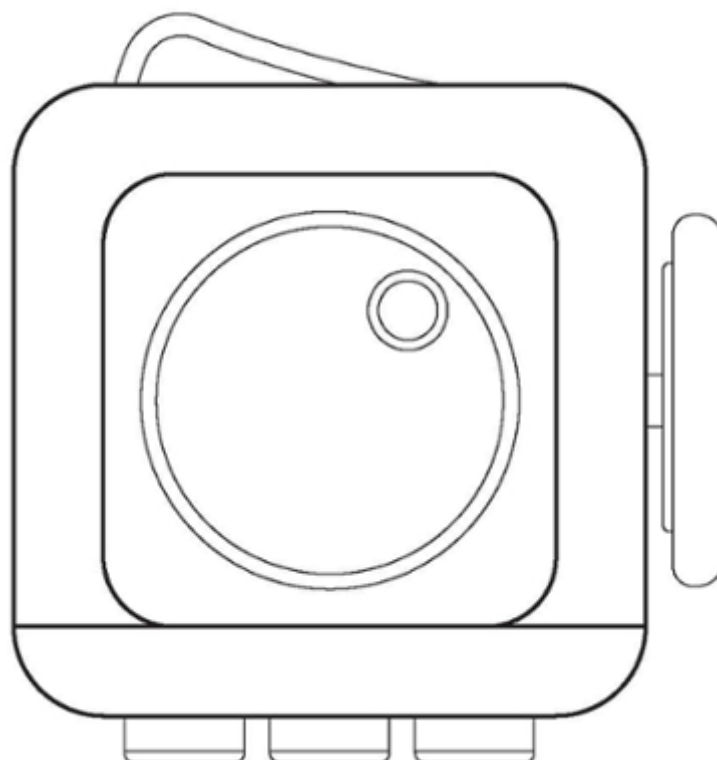

1.4

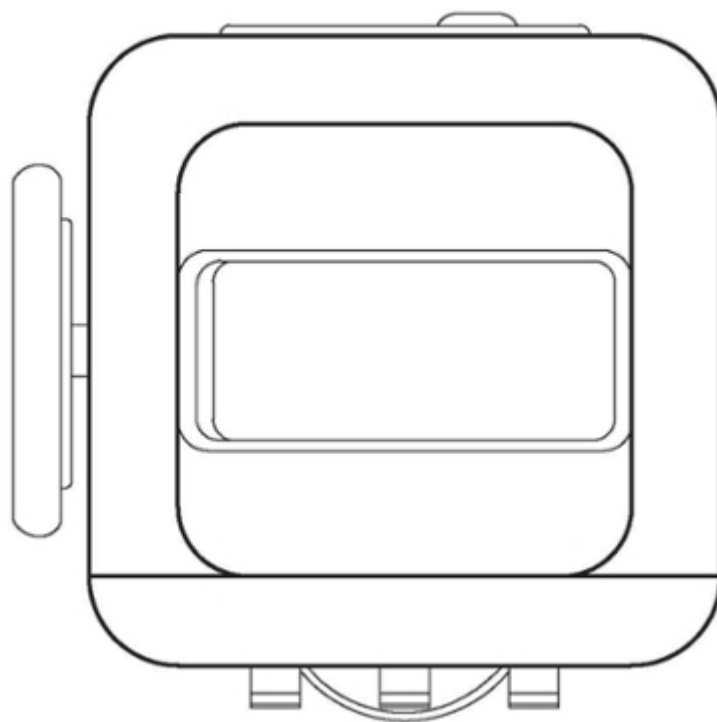

1.5

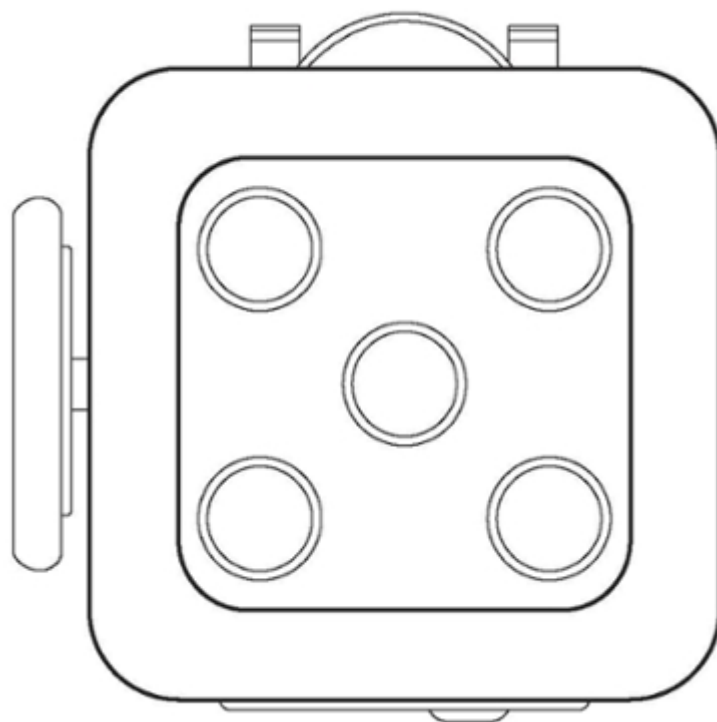

1.6

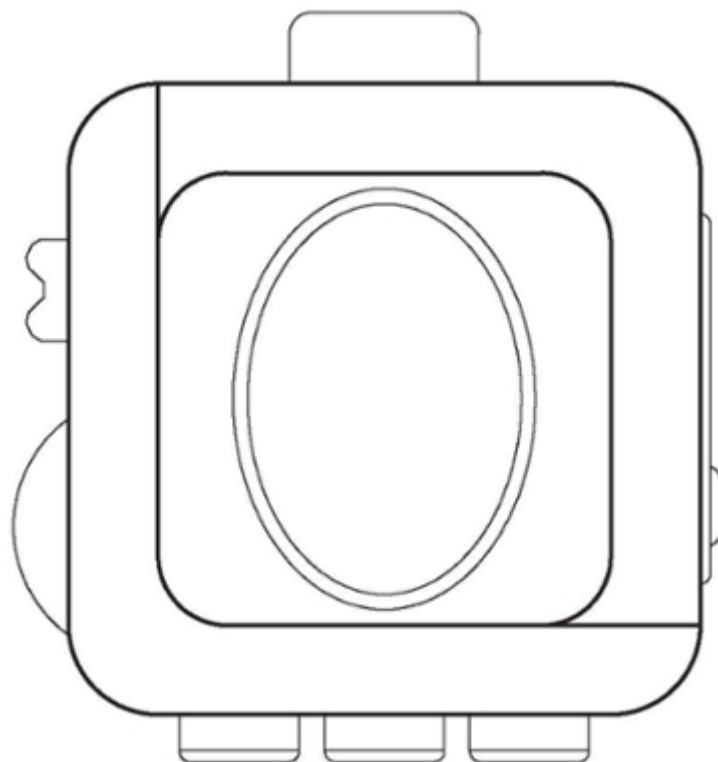

1.7

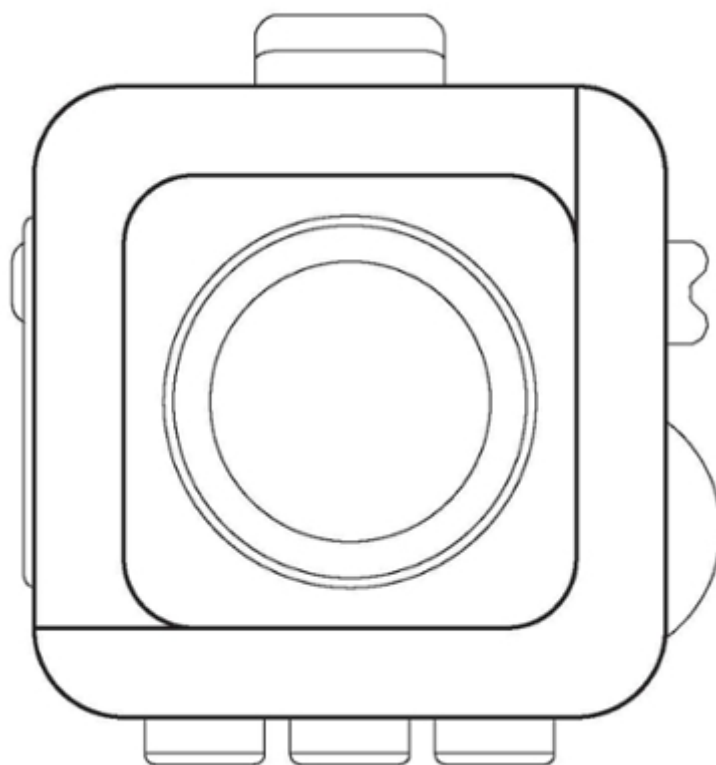

(11) DM/097015

(51) 07-02

(15) 2017 05 11

(45) 2017/30 (2017 08 04)

(22) 2017 05 11

(28) 8

(73) FEMAF METAL SANAYI VE TICARET ANONIM ŞİRKETİ

Organize Sanayi Bölgesi 9. Cad. No: 17 Melikgazi, TR-38070 Kayseri (TR)

(85) TR

(86) TR

(87) TR

(88) TR

(89) TR

(81) III. AL, AM, AZ, BA, BN, BW, CH, EG, EM, GE, GH, IS, KG, KH, KR, LI, MC, MD, ME, MK, MN, NA, NO, OA, OM, RS, RW, SG, ST, SY, TJ, TM, TN, TR, UA

(72) ALI ERKAN MAMUR

Organize Sanayi Bölgesi 9. Cadde No:17 Melikgazi, 38070 Kayseri, Turkey

(54) 1.-2. Kitchen stoves; 3. Cooktop; 4.-5. Grates for cooktop; 6.-8. Cooktops

(55)

1.1



1.2

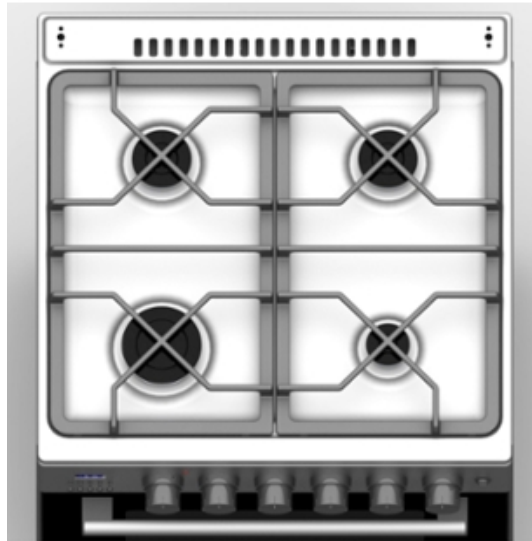

2.1



2.2



3



4

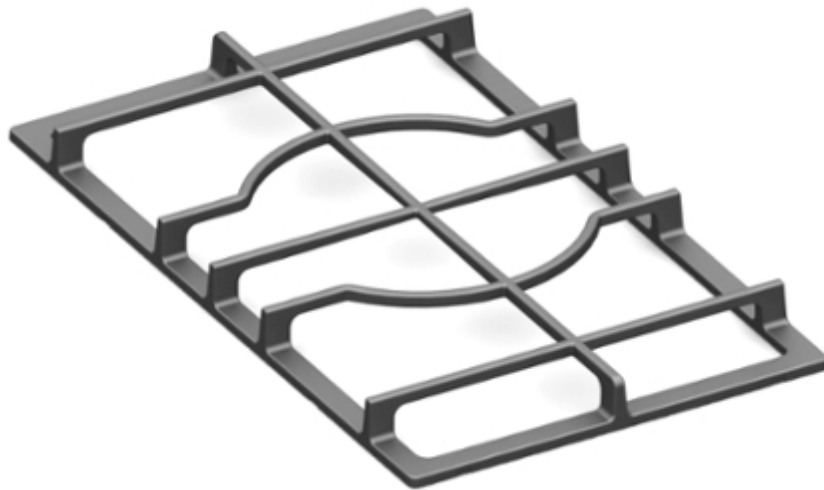

5

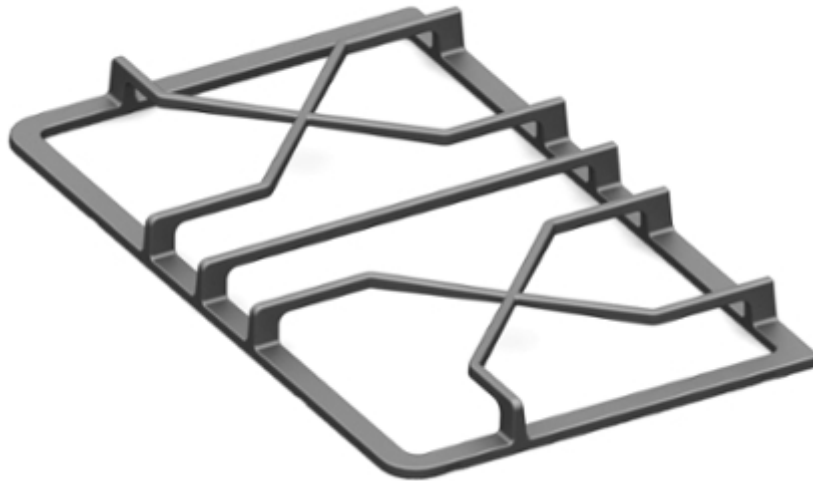

6



7



8



(11) DM/097039

(15) 2017 05 26

(22) 2017 05 26

(28) 1

(30) No. 1: 28.02.2017; 003773696-0001; EM

(73) EAGLE INVESTMENT SICAV PLC, ACTING ON BEHALF OF ITT FUND

Alpine House, Naxxar Road, San Gwann SGN9032 (MT)

(85) EM

(86) EM

(87) EM

(88) EM

(89) EM

(81) III. AL, AM, BA, BW, CH, GE, IS, JP, KH, KR, LI, MC, MD, ME, MK, NA, NO, OA, RS, RW, UA, US

(72) Jan Zelinka

Prítkovská 1645, 41501 Teplice, Czech Republic

(54) 1. Automatic machine for games

(55)

(51) 21-03

(45) 2017/30 (2017 08 04)

1.1



1.2



1.3



1.4



1.5



1.6

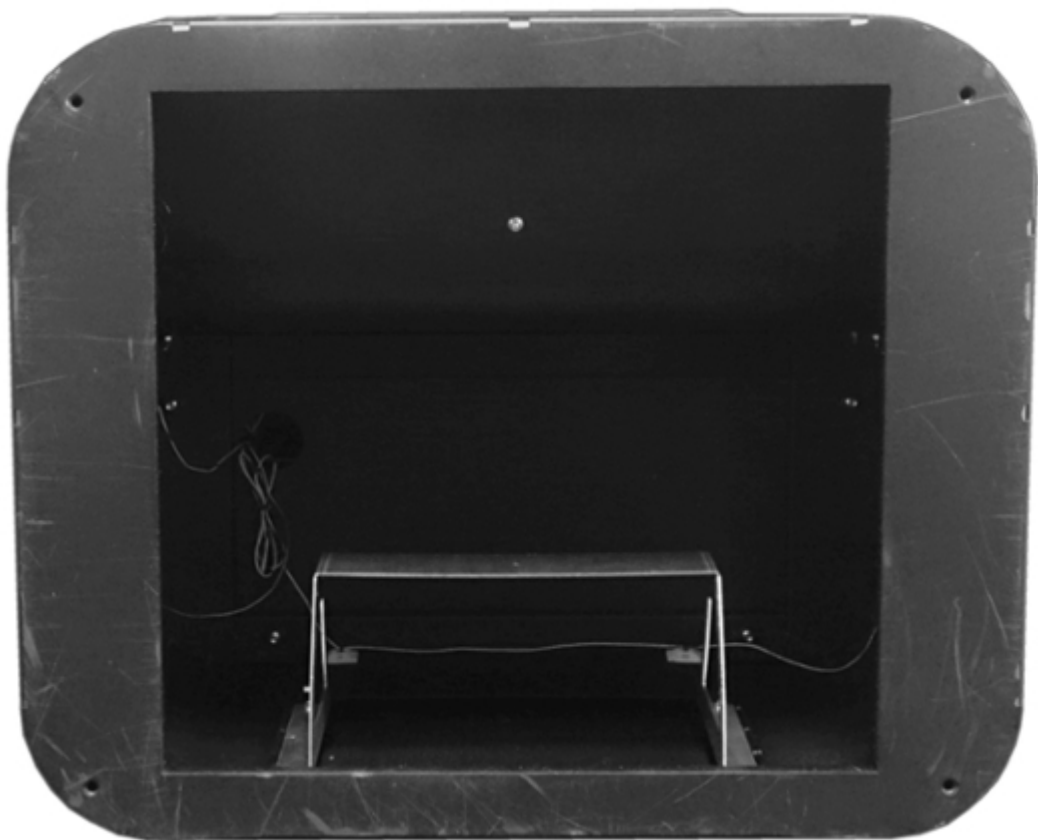

(11) DM/094672

(15) 2017 02 09

(22) 2017 02 09

(28) 3

(73) OMEGA SA (OMEGA AG) (OMEGA LTD.)

Jakob-Stämpfli-Strasse 96, CH-2502 Biel/Bienne (CH)

(85) CH

(86) CH

(87) CH

(88) CH

(89) CH

(81) II. BZ, MA III. AL, AM, AZ, BA, CH, EM, GE, KG, LI, MC, MD, ME, MK, MN, NO, OM, SG, TN, TR, UA

(72) The Swatch Group AG (The Swatch Group SA) (The Swatch Group Ltd.)

Faubourg du Lac 6, CH-2501 Biel/Bienne

(54) 1.-2. Finger rings; 3. Pendant

(55)

(51) 11-01

(45) 2017/31 (2017 08 11)



(11) DM/094765

(15) 2017 02 06

(22) 2017 02 06

(28) 4

(30) Nos. 1, 2, 3, 4: 08.08.2016; 4; US

(73) SEXY BACK BRA LLC

100 Whitefish Hills Dr, Whitefish MT 59937 (US)

(85) -

(86) US

(87) -

(88) -

(89) US

(81) III. AL, AM, AZ, BA, BN, BW, CH, EG, EM, GE, GH, IS, JP, KG, KR, LI, MC, MD, ME, MK, MN, NA, NO, OA, OM, RS, RW, SG, ST, SY, TJ, TM, TN, TR, UA

(72) Gordana GEHLHAUSEN

8137 Manitoba Street, Apartment N2 , Playa del Rey, California, United States of America;

Skye Drynan

100 Whitefish Hills Drive, Whitefish, Montana, United States of America

(54) 1.-4. Brassieres

(55)

(51) 02-01

(45) 2017/31 (2017 08 11)

1.1

1.2

1.3

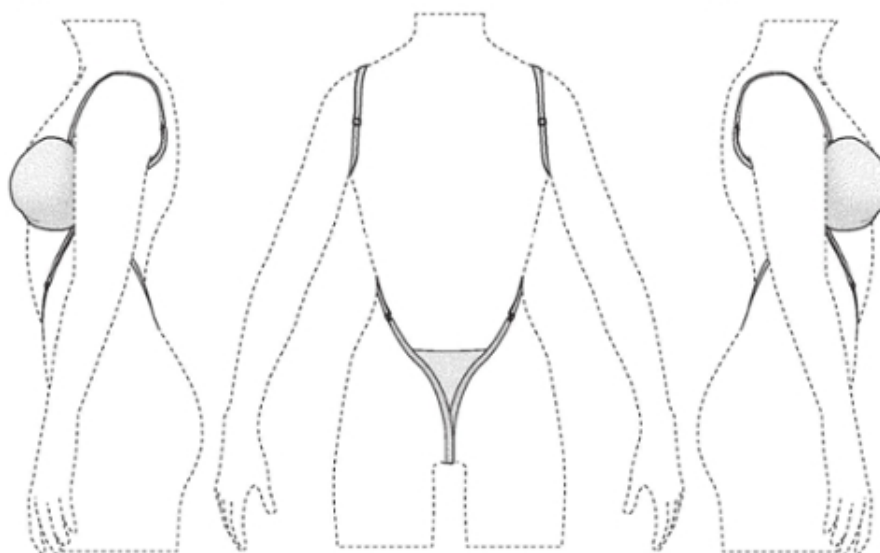

1.5

1.4

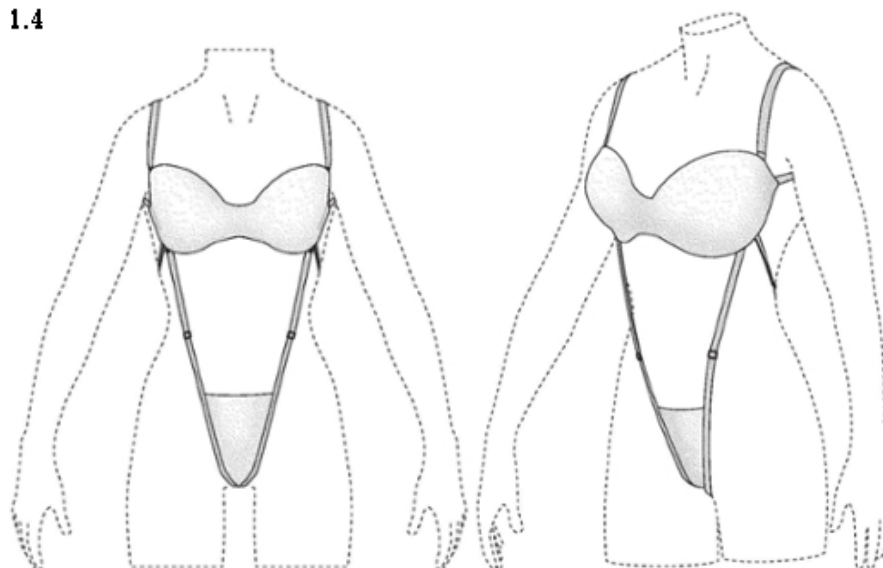

1.6

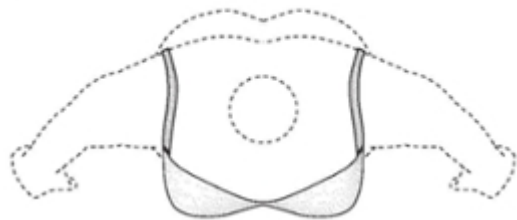

1.7

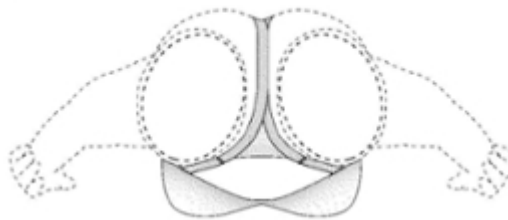

2.1

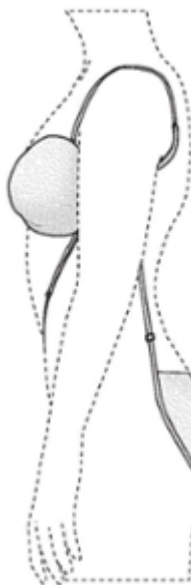

2.2

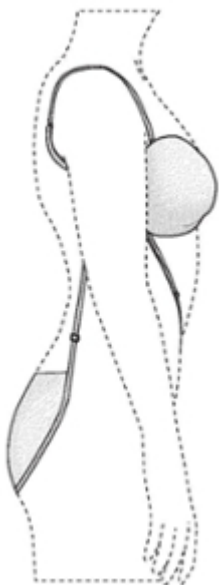

2.3

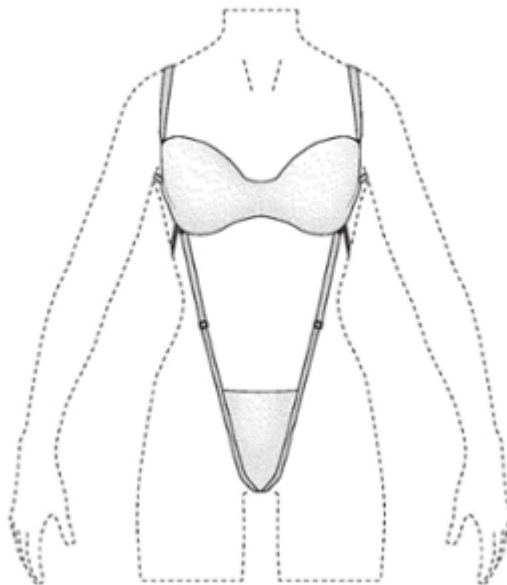

2.5

2.4

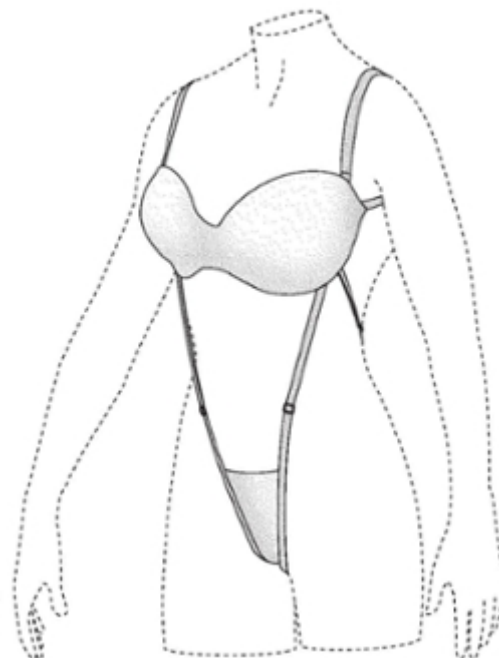
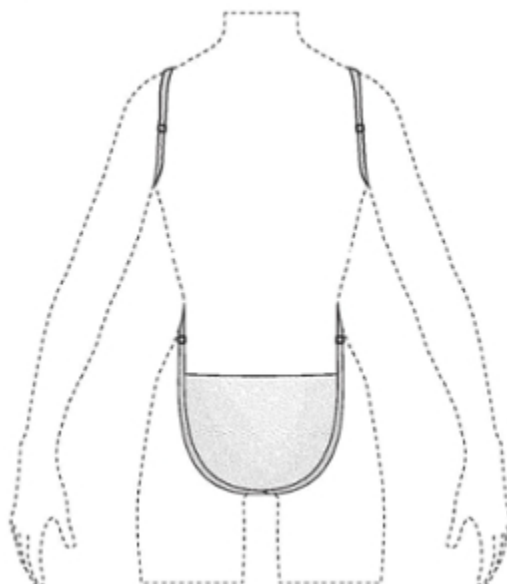

2.6

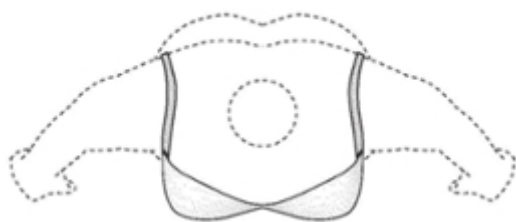

2.7

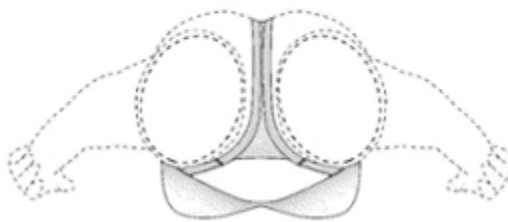

3.1

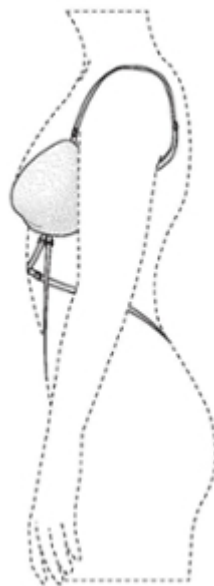

3.2

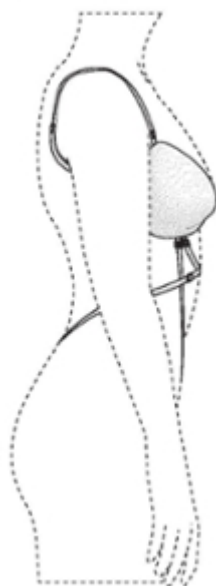

3.3

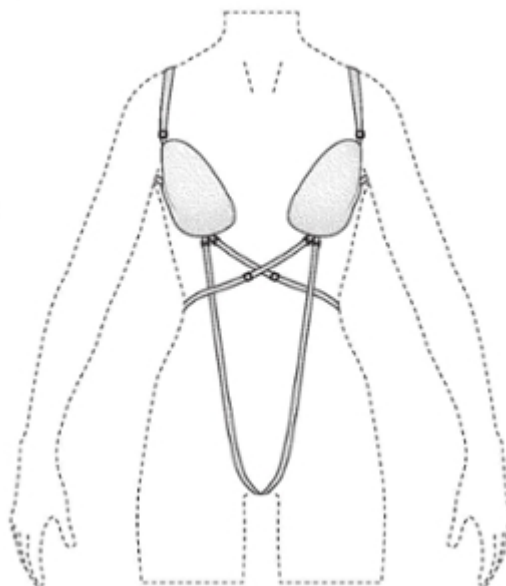

3.5

3.4

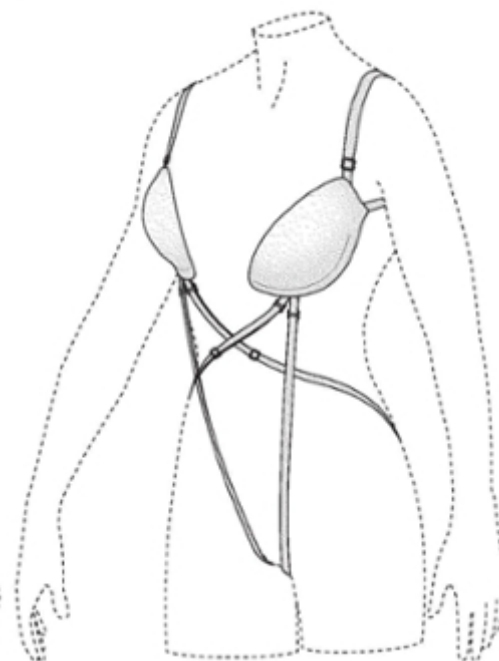
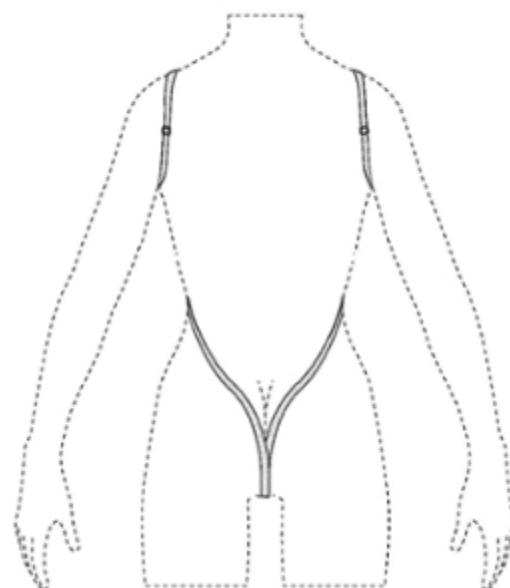

3.6

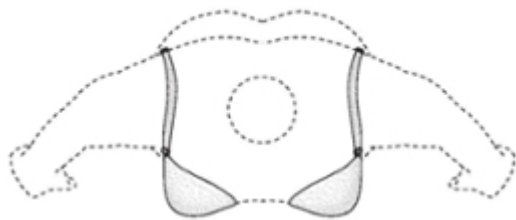

3.7

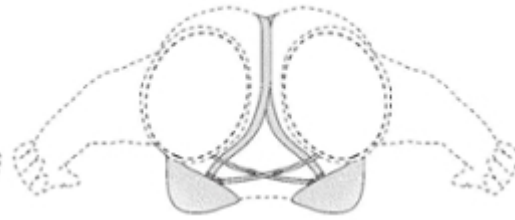

4.1

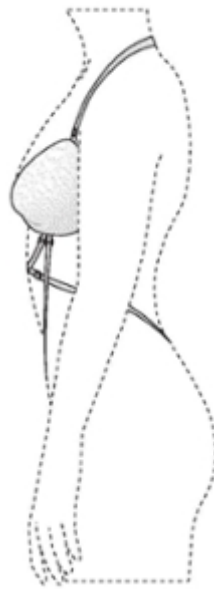

4.2

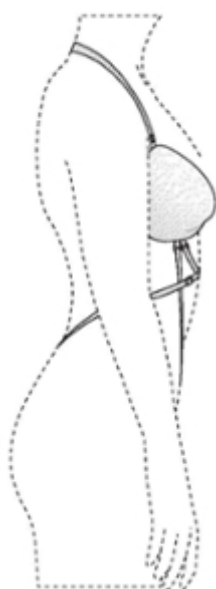

4.3

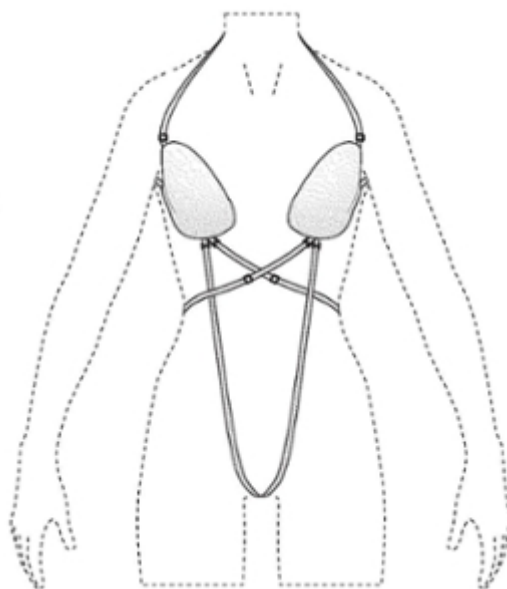

4.5

4.4

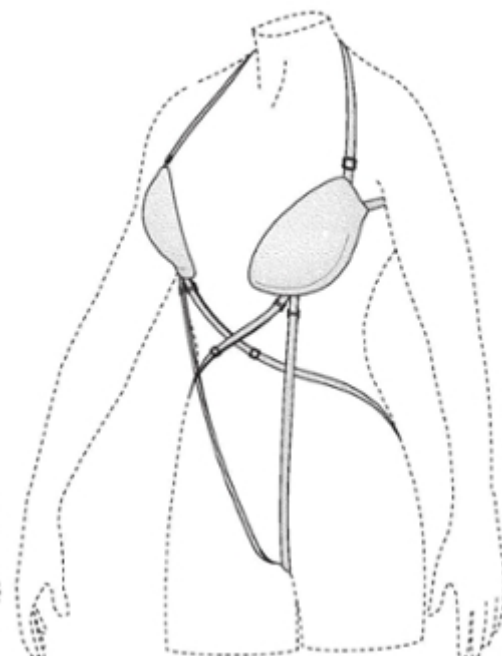
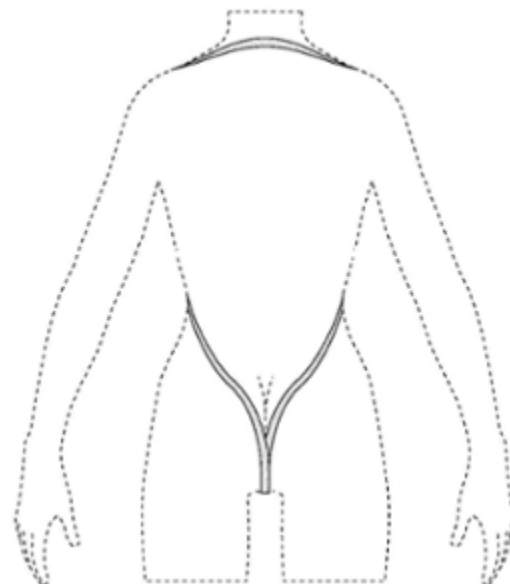

4.6

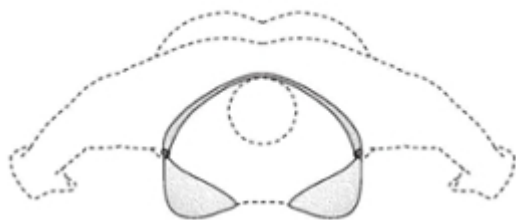

4.7

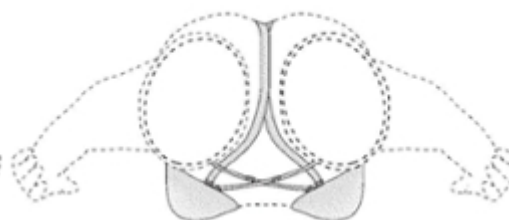

(11) DM/097109

(15) 2017 07 18

(22) 2017 07 18

(28) 1

(73) VALENTINO S.P.A.

Via Turati, 16/18, I-20121 MILANO (IT)

(85) –

(86) EM, IT

(87) EM, IT

(88) EM, IT

(89) EM

(81) III. AZ, EM, GE, JP, KG, KR, TJ, TR, UA, US

(72) SASSI Stefano

c/o VALENTINO S.p.A., Via Turati, 16/18, I-20121 Milano, Italy

(54) 1. Shoe

(55)

(51) 02-04

(45) 2017/31 (2017 08 11)

1.1



1.2



1.3



1.4

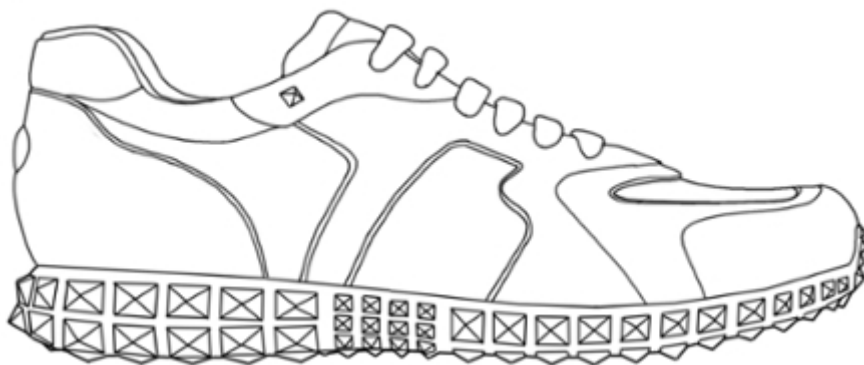

1.5



1.6

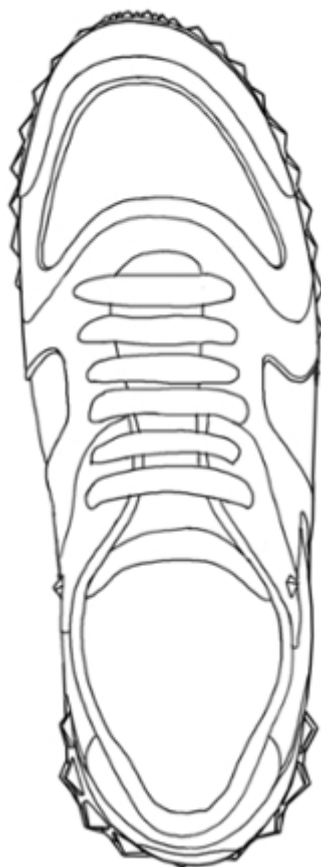

1.7

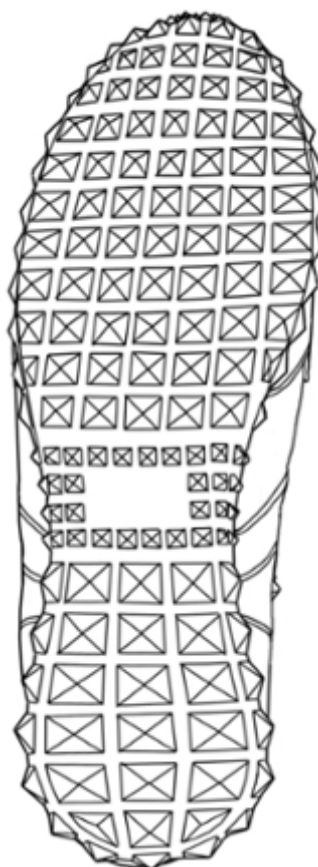

(11) DM/097158

(15) 2017 03 27

(22) 2017 03 27

(28) 28

(30) No. 1: 27.09.2016; 003396423-0001; EM;
 No. 2: 27.09.2016; 003396423-0002; EM;
 No. 3: 27.09.2016; 003396423-0003; EM;
 No. 4: 27.09.2016; 003396423-0004; EM;
 No. 5: 27.09.2016; 003396423-0005; EM; No.
 6: 27.09.2016; 003396423-0006; EM;
 No. 7: 27.09.2016; 003396423-0007; EM;
 No. 8: 27.09.2016; 003396423-0008; EM;
 No. 9: 27.09.2016; 003396423-0009; EM; No.
 10: 27.09.2016; 003396423-0010; EM;
 No. 11: 27.09.2016; 003396423-0011; EM;
 No. 12: 27.09.2016; 003396423-0012; EM;
 No. 13: 27.09.2016; 003396423-0013; EM;
 No. 14: 27.09.2016; 003396423-0014; EM;
 No. 15: 27.09.2016; 003396423-0015; EM;
 No. 16: 27.09.2016; 003396423-0016; EM;
 No. 17: 27.09.2016; 003396423-0017; EM;
 No. 18: 27.09.2016; 003396423-0018; EM;
 No. 19: 27.09.2016; 003396423-0019; EM;
 No. 20: 27.09.2016; 003396423-0020; EM;
 No. 21: 27.09.2016; 003396423-0021; EM;
 No. 22: 27.09.2016; 003396423-0022; EM;
 No. 23: 27.09.2016; 003396423-0023; EM;
 No. 24: 27.09.2016; 003396423-0024; EM;
 No. 25: 27.09.2016; 003396423-0025; EM;
 No. 26: 27.09.2016; 003396423-0026; EM;
 No. 27: 27.09.2016; 003396423-0027; EM;
 No. 28: 27.09.2016; 003396423-0028; EM

(73) SEAT S.A.

Autovía A-2, Km. 585, E-08760 Martorell (Barcelona) (ES)

(85) ES, EM

(86) ES, EM

(87) ES, EM

(88) ES, EM

(89) ES

(81) III. AZ, BA, CH, EG, GE, IS, LI, MD, MK, NO, OM, RS, SG, TN, TR, UA

(72) JUAN JOSE ADRADOS HERRERO

Autovía A-2, km 585, 08760 MARTORELL, España

(54) 1.-12. Vehicle wheel rims; 13. Door frame trim; 14.-15. Vehicle grilles; 16.-20. Vehicle bumpers;
 21. Closed vehicle grille cover; 22. Open vehicle grille cover; 23.-24. Vehicle bumpers; 25. Vehicle grille;
 26.-28. Vehicle bumpers

(55)



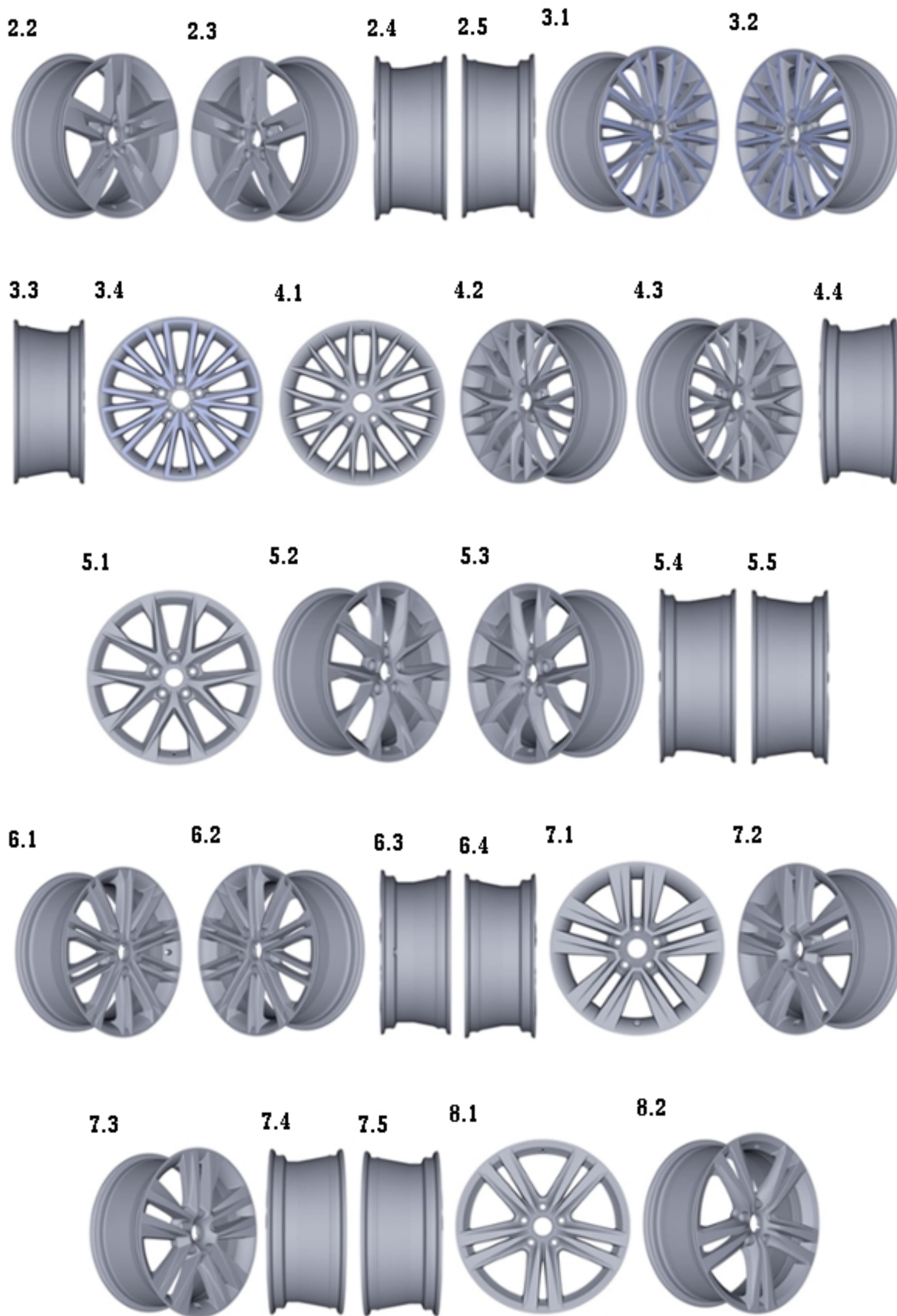

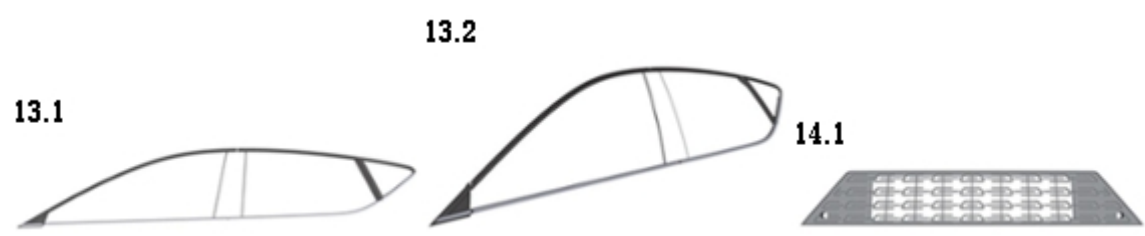
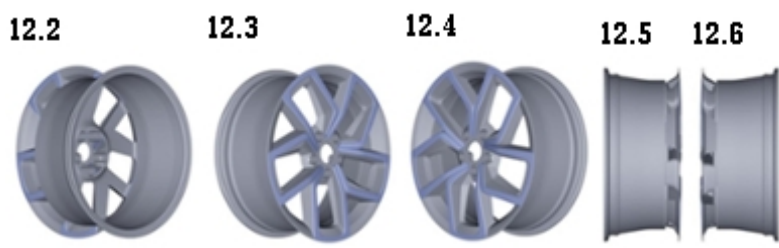
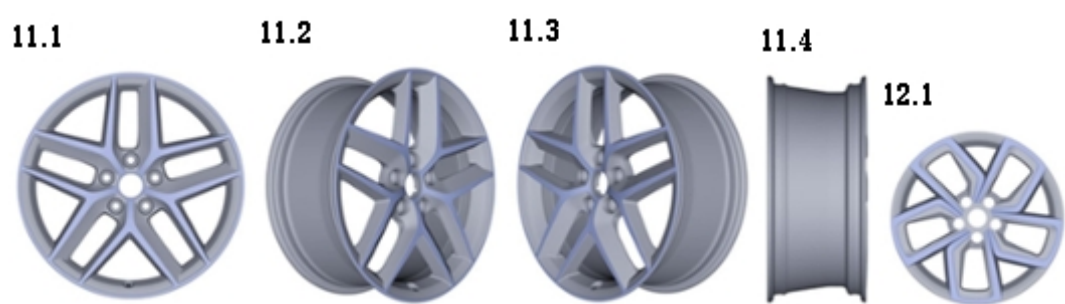
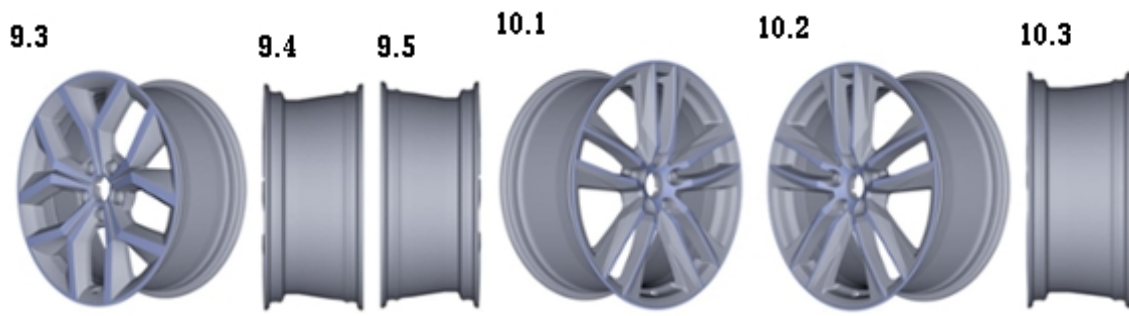
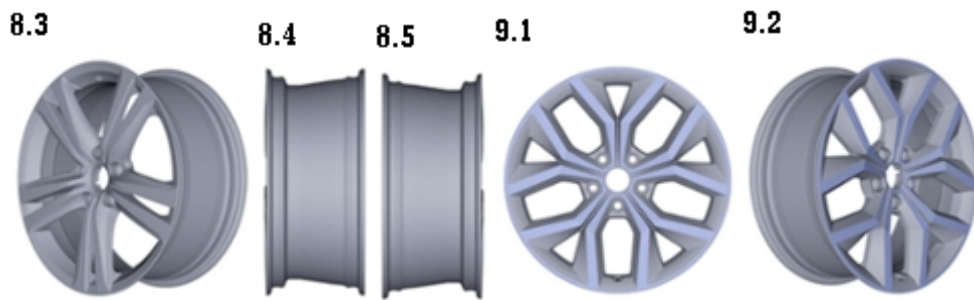

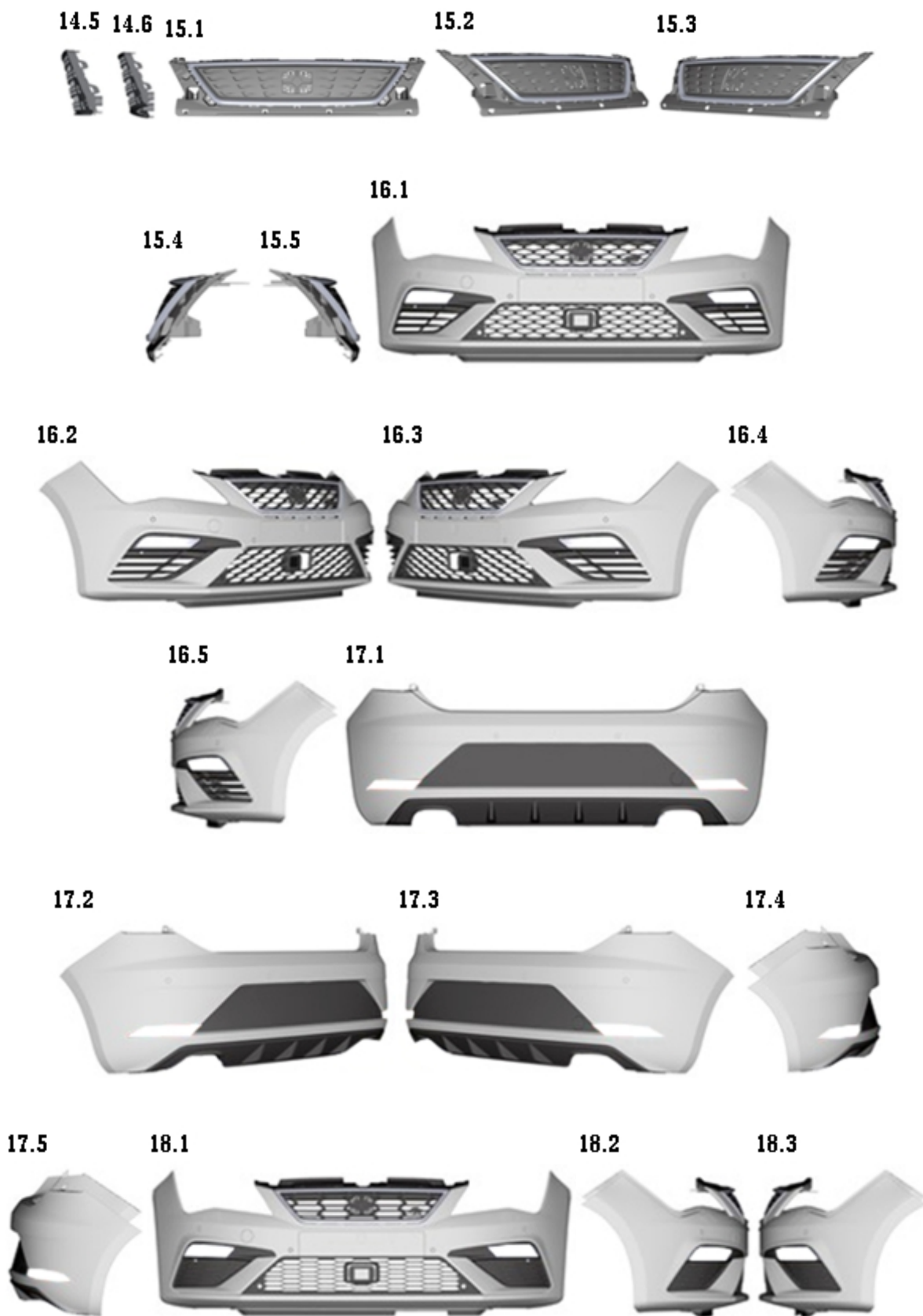

18.4



18.5



19.1



19.2



19.3



19.4



19.5



20.1



20.2



20.3



20.4



20.5



21.1



21.2



21.3



21.4

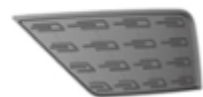

21.5



22.1



22.2



22.3



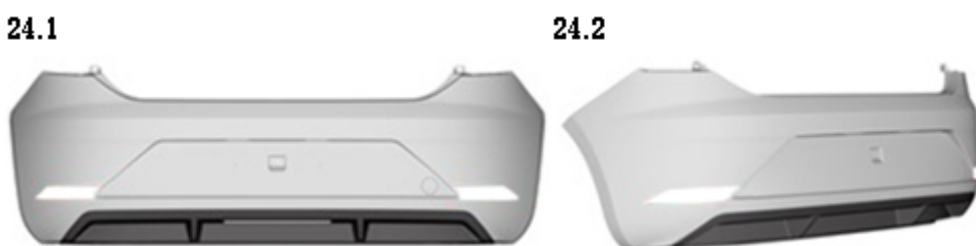

26.1



26.2



26.3



26.4



26.5



27.1



27.2



27.3



27.4



27.5



28.1



28.2



28.3

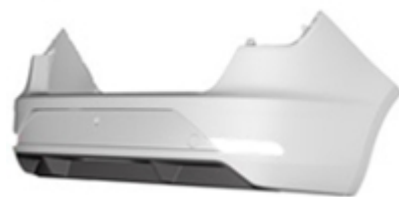

28.4



28.5



TRADEMARKS

APPLICATIONS FILED UNDER THE NATIONAL PROCEDURE APPROVED FOR REGISTRATION

The decision can be appealed at the Chamber of Appeal of Sakpatenti within 3 months from the publication or at the Mtskheta District Court Administrative Cases Board (Address: №17, Samkhedro St., Mtskheta), within 1 month following the publication.

(260) AM 2017 87774 A
(210) AM 87774
(220) 2016 06 29
(731) LTD "GEORGIAN LEGEND"
Gogebashvilis me-3 shes., 4, b. 20, 0179,
Tbilisi, Georgia
(740) Giorgi Tevzadze
(540)

RIRAVO ПИРАВО

(511) 29, 30, 32, 33

(260) AM 2017 88989 A
(210) AM 88989
(220) 2016 10 13
(731) JSC "TERMA"
Budapeshtis q. 10, 1 sart., 0160, Tbilisi,
Georgia
(740) Giorgi Kapanadze
(540)

Terma retail

(511) 35, 37, 42

(260) AM 2017 89341 A
(210) AM 89341
(220) 2016 11 08
(731) LTD "MARNISKARI"
Sh. Askuravas q. 17, Tbilisi, Georgia
(740) Davit Gogidze
(540)

Грузинский Акцент

(511) 33

(260) AM 2017 90303 A
(210) AM 90303
(220) 2017 01 06
(731) BİLEŞİM KİMYA TEMİZLİK ÜRÜNLERİ
SANAYİ VE TİCARET LİMİTED ŞİRKETİ
Cihangir M.amb.dol.t.Ş.piy.er Yavuz Bahar
No:5, Avclar İSTANBUL, Turkey
(740) Merab Kvimsadze

(540)



(591) White, sky-blue
(531) 24.07.23, 26.04.04, 26.04.24, 26.11.13,
27.05.24
(511) 5

(260) AM 2017 90695 A
(210) AM 90695
(220) 2017 02 06
(731) Ana Bukia
K. Marksis q. 12, b. 39, Sokhumi, Georgia
(740) Ana Bukia
(540)

კოპეშია Copeshia Копешиа

(511) 35, 41, 43

(260) AM 2017 90780 A
(210) AM 90780
(220) 2017 02 10
(330) GE
(731) Khatuna Atashyan
Kvemo Alekseevki das., qucha me-3, b. 5a,
0158, Tbilisi, Georgia
(740) Khatuna Atashiani
(540)

LUKEN

(511) 25, 35

(260) AM 2017 90793 A
 (210) AM 90793
 (220) 2017 02 13
 (731) LTD "EUROLINE"
 Stanislavskis q. 5, 0119, Tbilisi, Georgia
 (740) Mamuka Kakushadze
 (540)



(591) Black, white
 (531) 26.01.04, 26.04.24, 27.01.06, 27.05.24
 (511) 35

(260) AM 2017 90794 A
 (210) AM 90794
 (220) 2017 02 13
 (731) LTD "EUROLINE"
 Stanislavskis q. 5, 0119, Tbilisi, Georgia
 (740) Mamuka Kakushadze
 (540)



(591) Black, white
 (531) 26.11.08, 27.01.25
 (511) 35

(260) AM 2017 90867 A
 (210) AM 90867
 (220) 2017 02 16
 (731) LTD "Georgian Engineering Academy
 Scientific Technical Center"
 Mindelis q. 3, Vake-saburtalos raioni, Tbilisi,
 Georgia
 (740) Shalva Gvaramadze
 (540)



(591) Red, white, blue, green, yellow, blue,
 brown, brick, different tones violet
 (531) 24.15.03, 24.15.15, 24.17.21, 26.03.23,
 26.04.09, 29.01.15
 (511) 7, 11

(260) AM 2017 90869 A
 (210) AM 90869
 (220) 2017 02 16
 (731) LTD "GARDABANI THERMAL PLANT2"
 D. Aghmasheneblis q. 2b, 1300, Gardabani,
 Georgia
 (540)



(591) Blue, sky-blue
 (531) 01.15.03, 27.05.21, 27.05.01, 28.19, 29.01.04
 (526) The trademark is protected as a whole. "გარ-
 დაბნის" shall not be subject to independent legal
 protection.
 (511) 4, 40

(260) AM 2017 90870 A
 (210) AM 90870
 (220) 2017 02 17
 (731) JSC "JOKER CLUB 1927"
 Mazniashvilis q. 25, 3000, Narneuli, Georgia
 (540)



JOKER CLUB1927.COM

(591) Golden, white and dark blue
 (531) 24.17.08, 26.15.07, 29.01.13
 (511) 36, 37, 38, 39, 40, 41, 42, 43, 44, 45

(260) AM 2017 90871 A
 (210) AM 90871
 (220) 2017 02 17
 (731) LTD "ORI NABIJI"
 Navtlughis q. 39/41, Tbilisi, Georgia
 (740) Aleksandre Gabunia
 (540)



(591) Dark brown, light brown, white and red
 (531) 29.01.13, 01.03.15, 03.07.03, 08.07.11, 28.19
 (511) 29

(260) AM 2017 90879 A
 (210) AM 90879
 (220) 2017 02 17
 (731) Swiss Pharma International AG
 Waldmannstrasse 8, 8001 Zurich,
 Switzerland
 (740) Tamar Kochlamazashvili
 (540)

ГАЛАЗОЛИН

(511) 5

(260) AM 2017 90901 A
 (210) AM 90901
 (220) 2017 02 20
 (731) LTD "TBILISI FREE UNIVERSITY"
 D. Aghmasheneblis kheivani 240, Tbilisi,
 Georgia
 (740) Maguli Kamadadze
 (540)

თავისუფალი უნივერსიტეტი

(511) 41

(260) AM 2017 90904 A
 (210) AM 90904
 (220) 2017 02 20
 (731) LTD "TBILISI AGRARIAN UNIVERSITY"
 D. Aghmasheneblis kheivani 240, Tbilisi,
 Georgia
 (740) Maguli Kamadadze
 (540)

აგრარული უნივერსიტეტი

(511) 41

(260) AM 2017 90914 A
 (210) AM 90914
 (220) 2017 02 20
 (731) PREMIUM TOBACCO FZ LTD
 P.O. Box: 31291, Al-Jazeera Al-Hamra, Ras
 Al Khaimah, UAE, United Arab Emirates
 (740) Liliana Darakhvelidze
 (540)



(591) White, black
 (531) 24.09.01, 26.04.24, 27.05.24, 28.01
 (511) 34

(260) AM 2017 90956 A
 (210) AM 90956
 (220) 2017 02 22
 (731) KALESAN SAĞLIK VE HIJYEN
 ÜRÜNLERİ SANAYİ VE TİCARET
 LIMITED ŞİRKETİ
 3. Organize Sanayi Bölgesi, Kamil Şerbetçi
 Bulvarı, No.46, Şehitkamil /Gaziantep/,
 Turkey
 (740) Pavle Meipariani
 (540)



(591) Lilac, yellow, green, sky-blue, white
 (531) 27.05.02, 29.01.15
 (511) 5

(260) AM 2017 90996 A
 (210) AM 90996
 (220) 2017 02 24
 (731) LTD "ALGETI GEORGIA"
 Bolo Aghmartis q. 1, Tbilisi, Georgia
 (740) Shalva Gvaramadze
 (540)



(591) Red, white, green, yellow, grey, black
 (531) 05.05.04, 05.13.09, 26.01.18, 26.01.20,
 29.01.15, 25.01.09
 (526) The trademark is protected as a whole. "AL-
 GETI" shall not be subject to independent legal
 protection.
 (511) 29, 30, 35

(260) AM 2017 91096 A
 (210) AM 91096
 (220) 2017 03 01
 (731) LTD "G-M-P"
 Sop. Ponitchala 65, 0165, Tbilisi, Georgia
 (740) Nugzar Ksovreli

(540)

ქელი- ვიტი
Желли-Вит
Jelly-Vit

(511) 5

(260) AM 2017 91097 A
(210) AM 91097
(220) 2017 03 02
(731) NOVARTIS AG
4002 Basel, Switzerland
(740) Pavle Meipariani
(540)

ALGRIRI

(511) 5

(260) AM 2017 91106 A
(210) AM 91106
(220) 2017 03 02
(731) KONINKLIJKE DOUWE EGBERTS B.V.
OosterdokJSCtraat 80, NL-1011 DK
Amsterdam, Netherlands
(740) Giorgi Taktakishvili
(540)

L'OR

(511) 5, 30

(260) AM 2017 91109 A
(210) AM 91109
(220) 2017 03 02
(731) PJSC "Oil Company "Rosneft"
Sophiiskaya Naberezhnaya, d. 26/1, 115035,
Moskow, Russian Federation
(740) Shalva Gvaramadze
(540)



(591) White, blue
(531) 26.04.04, 26.04.07, 26.11.09, 27.05.22,
27.05.24, 29.01.12
(511) 1, 4

(260) AM 2017 91110 A
(210) AM 91110
(220) 2017 03 02
(731) PJSC "Oil Company "Rosneft"
Sophiiskaya Naberezhnaya, d. 26/1, 115035,
Moskow, Russian Federation
(740) Shalva Gvaramadze
(540)

TNK

(511) 1, 4

(260) AM 2017 91160 A
(210) AM 91160
(220) 2017 03 07
(731) Irakli Sebiskveradze
David Aghmasheneblis kheivani me-12 km.
korp. 2, b. 47, 0131, Tbilisi, Georgia
(740) Irakli Sebiskveradze
(540)

ლიბრა

(591) Red
(531) 28.19, 29.01.01
(511) 16, 37

(260) AM 2017 91164 A
(210) AM 91164
(220) 2017 03 07
(731) LTD "AGROBEST GEORGIA"
Varketili 3, I m/r-ni, korp. 2, b. 68, Tbilisi,
Georgia
(740) Giorgi Taktakishvili
(540)

პატამილი
Patamil

(511) 5

(260) AM 2017 91166 A
(210) AM 91166
(220) 2017 03 07
(731) LTD "AGROBEST GEORGIA"
Varketili 3, I m/r-ni, korp. 2, b. 68, Tbilisi,
Georgia
(740) Giorgi Taktakishvili
(540)

ფულპასი
Fulpass

(511) 5

(260) AM 2017 91167 A
 (210) AM 91167
 (220) 2017 03 07
 (731) LTD "AGROBEST GEORGIA"
 Varketili 3, I m/r-ni, korp. 2, b. 68, Tbilisi,
 Georgia
 (740) Giorgi Taktakishvili
 (540)

სონრაუნდი Sonround

(511) 5

(260) AM 2017 91168 A
 (210) AM 91168
 (220) 2017 03 07
 (731) LTD "AGROBEST GEORGIA"
 Varketili 3, I m/r-ni, korp. 2, b. 68, Tbilisi,
 Georgia
 (740) Giorgi Taktakishvili
 (540)

ზონდერი Zonder

(511) 5

(260) AM 2017 91169 A
 (210) AM 91169
 (220) 2017 03 07
 (731) LTD "AGROBEST GEORGIA"
 Varketili 3, I m/r-ni, korp. 2, b. 68, Tbilisi,
 Georgia
 (740) Giorgi Taktakishvili
 (540)

ვიდაგერი Weedager

(511) 5

(260) AM 2017 91181 A
 (210) AM 91181
 (220) 2017 03 07
 (731) COLGATE-PALMOLIVE COMPANY
 a Delaware corporation
 300 Park Avenue, New York, New York
 10022, USA
 (740) Shalva Gvaramadze
 (540)

ДРЕВНИЕ СЕКРЕТЫ

(511) 21

(260) AM 2017 91226 A
 (210) AM 91226
 (220) 2017 03 13
 (731) JSC "KOTEKHI-GURJAANI WINE FACTORY"
 K. Koroghlishvilis q. 38, 1500, Gurjaani,
 Georgia
 (740) Dimitri Dzamukashvili
 (540)



GUREMANI CELLAR

(591) Red, black
 (531) 24.01.03, 24.01.18, 27.05.11
 (511) 33

(260) AM 2017 91273 A
 (210) AM 91273
 (220) 2017 03 14
 (731) David Chichinadze
 Mirza Gelovanis q., I shesak., kor. 2, b. 3,
 0114, Okrokana, 0105, Tbilisi, Georgia
 (740) Tamaz Shilakadze
 (540)

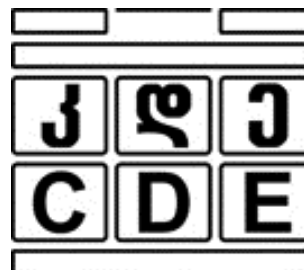

(591) Black, white
 (531) 26.04.09, 26.04.18, 27.05.21, 28.19
 (511) 20, 35

(260) AM 2017 91296 A
 (210) AM 91296
 (220) 2017 03 21
 (731) JSC "BIA"
 Kostavas q. 47/57, 0179, Tbilisi, Georgia
 (540)



(591) Yellow, grey, white
 (531) 26.11.12, 27.05.21, 28.19, 29.01.13
 (511) 35, 42

(260) AM 2017 91379 A
 (210) AM 91379
 (220) 2017 03 23
 (731) Aleksandr Levakov
 N. Kipshidzis q. 3b, b. 80, 0162, Tbilisi,
 Georgia
 (740) Shalva Gvaramadze
 (540)

ТБИЛРАНИ ТБИЛРАНИ

(511) 33

(260) AM 2017 91405 A
 (210) AM 91405
 (220) 2017 03 28
 (731) JSC "LEKHIM"
 Shota Rustaveli q. 23, 01033, Kyiv, Ukraine
 (740) Giorgi Meipariani
 (540)

Pechaevskie BIFOLAK

(511) 5

(260) AM 2017 91406 A
 (210) AM 91406
 (220) 2017 03 28
 (731) LTD "SAGA IMPEX"
 Beliashvilis q. 145, 0159, Tbilisi, Georgia
 (740) Mikheil Gaprindashvili
 (540)



(591) White and red
 (531) 01.15.05, 24.17.07, 27.05.21, 27.07.24,
 29.01.12
 (511) 11, 37

(260) AM 2017 91431 A
 (210) AM 91431
 (220) 2017 03 28

(731) LTD "MERIKIPE"
 V. Nozadzis q. 35, 031, Tbilisi, Georgia
 (540)



(591) Green and bordeaux
 (531) 05.07.10, 19.09.01, 19.09.02, 29.01.12
 (511) 33

(260) AM 2017 91531 A
 (210) AM 91531
 (220) 2017 03 31
 (731) GREM SPÓŁKA Z OGRANICZONĄ
 ODPOWIEDZIALNOŚCIĄ SPÓŁKA
 KOMANDYTOWA
 Majdan 88 D, 05-462 Wiązowna, Poland
 (740) Liliana Darakhvelidze

(540)

GRYCAN

(511) 30, 43

(260) AM 2017 91533 A
 (210) AM 91533
 (220) 2017 03 31
 (731) Bolero&Company
 Kuchishvilis q.12-14-16, Tbilisi, Georgia
 (740) Mamuka Potolashvili
 (540)

ტარელი
ТАРИЕЛИ
TARIELI

(511) 33

(260) AM 2017 91536 A
 (210) AM 91536
 (220) 2017 03 31
 (731) LTD "ZHITS TBILISI"
 Nutsubidzis q. 14b, 0186, Tbilisi, Georgia

(540)

zhitz

(591) Black, white

(531) 27.05.17

(511) 33

(260) AM 2017 91540 A

(210) AM 91540

(220) 2017 03 31

(731) ALTERA CORPORATION

101 Innovation drive, San Jose, California
95134, USA

(740) Tamaz Shilakadze

(540)

HYPERFLEX

(511) 9

(260) AM 2017 92212 A

(210) AM 92212

(220) 2017 05 18

(732) LTD "GEORGIAN WINE HOUSE"

Sop. Zegaani, Gurjaani, Georgia

(740) Amza Kakauridze

(540)

Сухой Мост

(591) Black, white

(511) 33

(260) AM 2017 92215

(210) AM 92215

(220) 2017 05 18

(732) LTD "GEORGIAN WINE HOUSE"

Sop. Zegaani, Gurjaani, Georgia

(740) Amza Kakauridze

(540)

Dry Bridge

(591) Black, white

(511) 33

REGISTERED TRADEMARKS

(111) M 2017 29046 R
(151) 2017 11 06
(181) 2027 11 06
(260) AM 2017 84435 A
(220) 2015 11 02
(732) Anzori Kurasbediani
Machablis q. 3, Tbilisi, Georgia

(111) M 2017 29047 R
(151) 2017 11 06
(181) 2027 11 06
(260) AM 2017 85027 A
(220) 2015 12 04
(732) JSC "CORPORATION KINDZMARAULI"
Ilia Tchavtchavadzis q. 55, 4800, kvareli,
Georgia

(111) M 2017 29048 R
(151) 2017 11 06
(181) 2027 11 06
(260) AM 2017 86336 A
(220) 2016 02 25
(732) Vladimer Darchiashvili
I. Tchavtchavadzis gamz. 78, korp. 5, b. 5,
0179, Tbilisi, Georgia
Shalva Kurdadze
I. Tchavtchavadzis gamz. 80, korp. 5,
b. 11, 0179, Tbilisi, Georgia

(111) M 2017 29049 R
(151) 2017 11 06
(181) 2027 11 06
(260) AM 2017 86876 A
(220) 2016 04 04
(732) LTD "DUGLADZE WINE COMPANY"
Orkhevi, Akhvledianis chikhi 8, 0109, Tbilisi,
Georgia

(111) M 2017 29050 R
(151) 2017 11 06
(181) 2027 11 06
(260) AM 2017 87105 A
(220) 2016 04 25
(732) LTD "ALL PROPERTY GE"
Besikis q. 4, nakveti 46/10, 0108, Tbilisi,
Georgia

(111) M 2017 29051 R
(151) 2017 11 06
(181) 2027 11 06
(260) AM 2017 88157 A
(220) 2016 08 03
(732) LTD "BIOAGRO-PLANT BIOLOGICAL
PROTECTION CENTER"
Georgi Brtskinvales q. 5, b. 75, Tbilisi, Georgia

(111) M 2017 29052 R
(151) 2017 11 06
(181) 2027 11 06
(260) AM 2017 88274 A
(220) 2016 08 15
(732) LTD "GREEN TRAVEL"
Dadianis q. 20, Dzveli Tbilisis raioni, Tbilisi,
Georgia

(111) M 2017 29053 R
(151) 2017 11 06
(181) 2027 11 06
(260) AM 2017 88326 A
(220) 2016 08 17
(732) LEPL "WINE NATIONAL AGENCY"
Marshal Gelovanis gamz. 6, 0159, Tbilisi,
Georgia

(111) M 2017 29054 R
(151) 2017 11 06
(181) 2027 11 06
(260) AM 2017 88338 A
(220) 2016 08 18
(732) LTD "TETRADA GEORGIA"
Stanislavskis q. 5, 0119, Tbilisi, Georgia

(111) M 2017 29055 R
(151) 2017 11 06
(181) 2027 11 06
(260) AM 2017 88339 A
(220) 2016 08 18
(732) LTD "TETRADA GEORGIA"
Stanislavskis q. 5, 0119, Tbilisi, Georgia

(111) M 2017 29056 R
(151) 2017 11 06
(181) 2027 11 06
(260) AM 2017 88340 A
(220) 2016 08 18
(732) LTD "TETRADA GEORGIA"
Stanislavskis q. 5, 0119, Tbilisi, Georgia

(111) M 2017 29057 R
 (151) 2017 11 06
 (181) 2027 11 06
 (260) AM 2017 88341 A
 (220) 2016 08 18
 (732) LTD "TETRADA GEORGIA"
 Stanislavskis q. 5, 0119, Tbilisi, Georgia

(111) M 2017 29058 R
 (151) 2017 11 06
 (181) 2027 11 06
 (260) AM 2017 88482 A
 (220) 2016 09 02
 (732) LTD "KOPALA"
 Chekhovis q. 8/10, 0103, Tbilisi, Georgia

(111) M 2017 29059 R
 (151) 2017 11 06
 (181) 2027 11 06
 (260) AM 2017 88507 A
 (220) 2016 09 07
 (732) LTD "MACRO TOURISM"
 V. Gorgaslis q. 9, 0105, Tbilisi, Georgia

(111) M 2017 29060 R
 (151) 2017 11 06
 (181) 2027 11 06
 (260) AM 2017 88516 A
 (220) 2016 09 07
 (732) LTD "G-M-P"
 Sop. Ponitchala 65, 0165, Tbilisi, Georgia

(111) M 2017 29061 R
 (151) 2017 11 06
 (181) 2027 11 06
 (260) AM 2017 88524 A
 (220) 2016 09 09
 (732) HARRINGTON DEVELOPMENT INC.
 Elvira Mendez Street, Vallarino Bldg,
 3-rd Floor, Panama, Republic of Panama

(111) M 2017 29062 R
 (151) 2017 11 06
 (181) 2027 11 06
 (260) AM 2017 88525 A
 (220) 2016 09 09
 (732) HARRINGTON DEVELOPMENT INC.
 Elvira Mendez Street, Vallarino Bldg,
 3-rd Floor, Panama, Republic of Panama

(111) M 2017 29063 R
 (151) 2017 11 06
 (181) 2027 11 06

(260) AM 2017 88583 A
 (220) 2016 09 14
 (732) ASTRAZENECA UK LIMITED
 Cambridge Biomedical Campus, 1 Francis
 Crik Avenue, Cambridge, CB2 0AA, United
 Kingdom

(111) M 2017 29064 R
 (151) 2017 11 06
 (181) 2027 11 06
 (260) AM 2017 88593 A
 (220) 2016 09 15
 (732) GUANGDONG SAIMAN INVESTMENT CO.,
 LTD.
 Room 310, Zibian Building 2, No.48 Chenjiaci
 Avenue, Liwan Road, Liwan District,
 Guangzhou, China

(111) M 2017 29065 R
 (151) 2017 11 06
 (181) 2027 11 06
 (260) AM 2017 88606 A
 (220) 2016 09 15
 (732) Pharmaceutical Chemical Cosmetic
 industry ALKALOID AD – Skopje
 Bul. Aleksandar Makedonski, 12, 1000 Skopje,
 The Former Yugoslav Republic of Macedoni

(111) M 2017 29066 R
 (151) 2017 11 06
 (181) 2027 11 06
 (260) AM 2017 88714 A
 (220) 2016 09 28
 (732) NSAR GENERAL TRADING L.L.C
 P.O.Box 171611-Dubai, United Arab Emirates,
 United Arab Emirates

(111) M 2017 29067 R
 (151) 2017 11 06
 (181) 2027 11 06
 (260) AM 2017 88819 A
 (220) 2016 10 05
 (732) LTD "CORPORATION GEORGIAN WINE"
 S. Chikovanis q. 35, 0171 Tbilisi, Georgia

(111) M 2017 29068 R
 (151) 2017 11 06
 (181) 2027 11 06
 (260) AM 2017 88856 A
 (220) 2016 10 06
 (732) LTD "GEORGIAN FRUIT COMPANY"
 Krtsanisis shes, 17, Isani-Samgoris r-ni,
 Tbilisi, Georgia

(111) M 2017 29069 R (151) 2017 11 06 (181) 2027 11 06 (260) AM 2017 89088 A (220) 2016 10 20 (732) UBER TECHNOLOGIES, INC. a Delaware corporation 1455 Market Street, 4th Floor, San Francisco, California 94103, USA	(111) M 2017 29075 R (151) 2017 11 06 (181) 2027 11 06 (260) AM 2017 89258 A (220) 2016 11 03 (732) LTD "G-M-P" Sop. Ponitchala 65, 0165, Tbilisi, Georgia
(111) M 2017 29070 R (151) 2017 11 06 (181) 2027 11 06 (260) AM 2017 89114 A (220) 2016 10 25 (732) Inga Grigolia Veris me-2 shesak., I sad., b.38, 0179, Tbilisi, Georgia	(111) M 2017 29076 R (151) 2017 11 06 (181) 2027 11 06 (260) AM 2017 89259 A (220) 2016 11 03 (732) LTD "G-M-P" Sop. Ponitchala 65, 0165, Tbilisi, Georgia
(111) M 2017 29071 R (151) 2017 11 06 (181) 2027 11 06 (260) AM 2017 89191 A (220) 2016 10 27 (732) LTD „A-B-C" PHARMACY Sanapiros q. 10, Tbilisi, Georgia	(111) M 2017 29077 R (151) 2017 11 06 (181) 2027 11 06 (260) AM 2017 89269 A (220) 2016 11 03 (732) LTD "G-M-P" Sop. Ponitchala 65, 0165, Tbilisi, Georgia
(111) M 2017 29072 R (151) 2017 11 06 (181) 2027 11 06 (260) AM 2017 89209 A (220) 2016 10 31 (732) HYUNDAI MOBIS CO., LTD. 203 Teheran-ro (Yeoksam-dong), Gangnam-gu, Seoul, Republic of Korea	(111) M 2017 29078 R (151) 2017 11 06 (181) 2027 11 06 (260) AM 2017 89454 A (220) 2016 11 15 (732) KOÇ HOLDING A.Ş. Nakkaştepe, Azizbey Sok. No:1, Kuzguncuk, Istanbul, Turkey
(111) M 2017 29073 R (151) 2017 11 06 (181) 2027 11 06 (260) AM 2017 89211 A (220) 2016 10 31 (732) OAKLEY, INC. One Icon, Foothill Ranch, CA 92610, USA	(111) M 2017 29079 R (151) 2017 11 06 (181) 2027 11 06 (260) AM 2017 89557 A (220) 2016 11 22 (732) LTD "ARTPHARMA" Gamrekelis q. 19 (512), 0160, Tbilisi, Georgia
(111) M 2017 29074 R (151) 2017 11 06 (181) 2027 11 06 (260) AM 2017 89216 A (220) 2016 10 31 (732) OAKLEY, INC. One Icon, Foothill Ranch, CA 92610, USA	(111) M 2017 29080 R (151) 2017 11 06 (181) 2027 11 06 (260) AM 2017 89572 A (220) 2016 11 22 (732) THE PROCTER & GAMBLE COMPANY One Procter & Gamble Plaza, Cincinnati, Ohio 45202, USA

(111) M 2017 29081 R
(151) 2017 11 06
(181) 2027 11 06
(260) AM 2017 89606 A
(220) 2016 11 22
(732) SSIP "GEORGIAN NATIONAL ARCHIVE"
Vazha-Pshavelas gamz. 1, 0160, Tbilisi,
Georgia

(111) M 2017 29087 R
(151) 2017 11 06
(181) 2027 11 06
(260) AM 2017 90422 A
(220) 2017 01 13
(732) LTD "G-M-P"
Sop. Ponitchala 65, 0165, Tbilisi, Georgia

(111) M 2017 29082 R
(151) 2017 11 06
(181) 2027 11 06
(260) AM 2017 89637 A
(220) 2016 11 25
(732) P.K. Overseas (P) LTD.
4039/3, Naya Bazar, Lahori Gate, Delhi-110
006, India

(111) M 2017 29083 R
(151) 2017 11 06
(181) 2027 11 06
(260) AM 2017 89736 A
(220) 2016 11 30
(732) LTD "ASB"
P. Khalvashis gamz. 235, Batumi, Georgia

(111) M 2017 29084 R
(151) 2017 11 06
(181) 2027 11 06
(260) AM 2017 89852 A
(220) 2016 12 07
(732) Private Industrial-Trading Company
"KRIOLIT - DNEPR"
49022, Dnipro, ul. Okeanskaya 4, Ukraine

(111) M 2017 29085 R
(151) 2017 11 06
(181) 2027 11 06
(260) AM 2017 89999 A
(220) 2016 12 16
(732) LTD "ARTPHARMA"
Gamrekelis q. 19 (512), 0160, Tbilisi, Georgia

(111) M 2017 29086 R
(151) 2017 11 06
(181) 2027 11 06
(260) AM 2017 90212 A
(220) 2017 01 04
(732) LTD "MY JPS"
N. Bokhuas q. 6, 0159, Tbilisi, Georgia

TRADEMARKS REGISTERED ACCORDING TO THE ACCELERATED PROCEDURE

The decision can be appealed at the Chamber of Appeal of Sakpatenti within 3 months from the publication.

(111) M 2017 29032 R
(151) 2017 10 25
(181) 2027 10 25
(210) AM 94570
(220) 2017 10 12
(732) LTD "KARTVELI"
Kakhetis gzat. 110a, Isani-Samgoris r-ni,
0151, Tbilisi, Georgia
(740) Davit Dzamukashvili
(540)

JIMSHER

(591) Black, white
(511) 33

(111) M 2017 29033 R
(151) 2017 10 26
(181) 2027 10 26
(210) AM 94204
(220) 2017 09 18
(732) SWISS PHARMA INTERNATIONAL AG
Waldmannstrasse 8, 8001 Zurich, Switzerland
(740) Shalva Gvaramadze
(540)

BRIGLAU PPH

(591) Black, white
(511) 5

(111) M 2017 29034 R
(151) 2017 10 26
(181) 2027 10 26
(210) AM 94696
(220) 2017 10 18
(732) LTD "NEW MOTORS"
Vazha-Pshavelas q. 2, Chikhi 3, 1100, Bolnisi,
Georgia
(740) Anzor Sakhtarov
(540)



(591) Black and green
(531) 26.04.09, 28.19, 29.01.12
(511) 19

(111) M 2017 29035 R
(151) 2017 10 30
(181) 2027 10 30
(210) AM 94359
(220) 2017 09 29
(732) LTD "ALIUD UNITAS GEORGIA"
I. Tchavtchavadzis q. 78/88, 6010, Batumi,
Georgia
(540)



(531) 26.04.02, 26.04.24, 27.05.01, 27.05.19,
27.05.24, 29.01.12
(511) 41

(111) M 2017 29036 R
(151) 2017 10 30
(181) 2027 10 30
(210) AM 94600
(220) 2017 10 13
(732) LTD "TS TEVEVIT"
Broses q. 2, Office 21, 0108, Tbilisi, Georgia
(740) Tamar Cicishvili
(540)



(591) Light green, light brown and dark brown
(531) 05.03.15, 29.01.13
(511) 1

(111) M 2017 29037 R
 (151) 2017 10 31
 (181) 2027 10 31
 (210) AM 94686
 (220) 2017 10 18
 (732) LTD "CHAMPIONS 111"
 I. Tchavtchavadzis Gamz. 29, 5 Fl.,
 0179, Tbilisi, Georgia
 (740) Giorgi Katamadze
 (540)



(591) Golden, dark brown
 (531) 21.03.01, 29.01.02
 (511) 41

(111) M 2017 29038 R
 (151) 2017 10 31
 (181) 2027 10 31
 (210) AM 94688
 (220) 2017 10 18
 (732) LTD "CHAMPIONS 111"
 I. Tchavtchavadzis Gamz. 29, 5 Fl.,
 0179, Tbilisi, Georgia
 (740) Giorgi Katamadze
 (540)



(591) Orange, grey
 (531) 26.03.04, 29.01.12
 (511) 41

(111) M 2017 29039 R
 (151) 2017 11 01
 (181) 2027 11 01
 (210) AM 94569
 (220) 2017 10 12
 (732) JSC "LOCOMOTIVEBUILDER"
 Davit Guramishvilis gamz. 84, 0141, Tbilisi,
 Georgia
 (740) Davit Natidze
 (540)



(591) Red, black, blue
 (531) 24.15.01, 27.05.10, 28.19, 29.01.14
 (511) 12, 37

(111) M 2017 29040 R
 (151) 2017 11 01
 (181) 2027 11 01
 (210) AM 94585
 (220) 2017 10 13
 (732) LTD "ALAZANI"
 Sop. Kardenakhi, Gurjaanis raioni, 1509,
 Georgia
 (740) Davit Tchkonია
 (540)



(591) Black, sky-blue and golden
 (531) 02.01.01, 02.01.18, 11.03.01, 29.01.13
 (511) 33

(111) M 2017 29041 R
 (151) 2017 11 02
 (181) 2027 11 02
 (210) AM 94774
 (220) 2017 10 25
 (732) LTD "S MARKETS"
 Burdzglas q. 56, Vake-Saburtalos r-ni,
 0194, Tbilisi, Georgia
 (540)



(591) Red, white, black
 (531) 26.04.18, 27.05.05, 27.05.21, 28.19, 29.01.13
 (511) 35, 43

(111) M 2017 29042 R
 (151) 2017 11 02
 (181) 2027 11 02
 (210) AM 94704
 (220) 2017 10 18

(732) LTD "SUMELA-XXI"
A. Tseretlis gamz. 1, 0112, Tbilisi, Georgia
(540)



(591) White, black, red, yellow, brown and orange
(531) 03.03.03, 19.03.24, 27.05.02, 29.01.13
(511) 34

(111) M 2017 29043 R
(151) 2017 11 02
(181) 2027 11 02
(210) AM 94713
(220) 2017 10 19
(732) JSC "GEPHA"
Sanapiros q. 6, 0108, Tbilisi, Georgia
(740) Salome Jeladze
(540)

ATTIRANCE
natural cosmetics

(591) Black
(531) 27.05.10
(511) 3, 5, 35, 44

(111) M 2017 29044 R
(151) 2017 11 02
(181) 2027 11 02
(210) AM 94714
(220) 2017 10 19
(732) JSC "GEPHA"
Sanapiros q. 6, 0108, Tbilisi, Georgia
(740) Salome Jeladze
(540)

Attirance

(591) Grey
(531) 27.05.01, 27.05.19
(511) 3, 5, 35, 44

(111) M 2017 29045 R
(151) 2017 11 03
(181) 2027 11 03
(210) AM 94723
(220) 2017 10 20
(732) LTD "METI DEVELOPMENT"
Tabukashvilis q. 47, Dzveli Tbilisis r-ni,
0160, Tbilisi, Georgia
(740) Ani Mtchedlidze
(540)

M E T I
DEVELOPMENT >

(591) Black, white
(531) 27.05.01, 27.05.10, 27.05.17
(511) 37

INTERNATIONAL TRADEMARKS FOR WHICH A DECISION ON GRANTING PROTECTIONS IS TAKEN

The decision can be appealed at the Chamber of Appeal of Sakpatenti within 3 months from the publication or at the Mtskheta District Court Administrative Cases Board (Address: №17, Samkhedro str., Mtskheta), within 1 month following the publication.

(260) AM 2017 83602 A*
(800) 1261499
(891) 2015 06 24
(731) OTSUKA PHARMACEUTICAL CO., LTD.
2-9, Kanda-Tsukasamachi, Chiyoda-ku, Tokyo
101-8535, Japan

(540)



(591) Gold and green
(511)
5 – Pharmaceutical preparations for the treatment and prevention of central nervous system diseases and disorders; pharmaceutical preparations.

(260) AM 2017 86354 A*
(800) 1258056
(891) 2016 01 22
(731) CAPBRAN HOLDINGS, LLC
11601 Wilshire Blvd., Suite 2300, Los Angeles CA 90025, USA

(540)

NUTRIBULLET

(511)
7 – Electric food blenders; Electric food processors.

(260) AM 2017 86356 A*
(800) 1258079
(891) 2016 01 22
(731) CAPBRAN HOLDINGS, LLC
11601 Wilshire Blvd., Suite 2300, Los Angeles CA 90025 (US), USA

(540)

MAGIC BULLET

(591) Black, white
(511)
7 – Electronic appliances, namely, kitchen food processors.

(260) AM 2017 86629 A*
(800) 1291475
(891) 2016 01 22
(731) CAPBRAN HOLDINGS, LLC
11601 WILSHIRE BLVD., SUITE 2300,
LOS ANGELES CA 90025, USA

(540)

NUTRIBULLET

(591) black and white
(511)
7 – Kitchen appliances, namely, electronic food blenders.

(260) AM 2017 86776 A*
(800) 1293959
(891) 2016 01 15
(731) YILDIZ HOLDİNG ANONİM ŞİRKETİ
Kısıklı Mahallesi Çeşme Çıkmaşı, Sokak
No:6/1, Üsküdar İstanbul, Turkey

(540)

ÜLKER METRO

(591) Black, white
(511)
30 – Confectionery, chocolate, biscuits, crackers, wafers.

(260) AM 2017 90297 A
(800) 1299262
(891) 2016 09 16
(731) MORANDO S.P.A.
Via Chieri, 61, ANDEZENO (TORINO), Italy

(540)

(591) Black, white
(511)
21 – Litter boxes for pets.

31 – Foodstuff and feeds for animals; biscuits, bones, bars, sticks, chips and edible articles for chewing by domestic animals; and products for animal litter; catnip.

35 – Retail services relating to veterinary preparations and substances, dietary supplements for animals, additives and supplements for animal feed, antiparasitic preparations for animals, detergents for animals, foodstuff and feeds for animals, biscuits, bones, bars, sticks, chips and edible articles for chewing by domestic animals, litter boxes for pets and products for animal litter, catnip; wholesaling services relating to veterinary preparations and substances, dietary supplements for animals, additives and supplements for animal feed, antiparasitic preparations for animals, detergents for animals, foodstuff and feeds for animals, biscuits, bones, bars, sticks, chips and edible articles for chewing by domestic animals, litter boxes for pets and products for animal litter, catnip; online store services relating to veterinary preparations and substances, dietary supplements for animals, additives and supplements for animal feed, antiparasitic preparations for animals, detergents for animals, foodstuff and feeds for animals, biscuits, bones, bars, sticks, chips and edible articles for chewing by domestic animals, litter boxes for pets and products for animal litter, catnip; online store services relating to veterinary preparations and substances, dietary supplements for animals, additives and supplements for animal feed, antiparasitic preparations for animals, detergents for animals, foodstuff and feeds for animals, biscuits, bones, bars, sticks, chips and edible articles for chewing by domestic animals, litter boxes for pets and products for animal litter, catnip.

(260) AM 2017 90300 A

(800) 1299353

(891) 2016 09 16

(731) MORANDO S.P.A.

Via Chieri, 61, ANDEZENO (TORINO), Italy

(540)



The logo for 'Miglior gatto' features the word 'Miglior' in a large, bold, serif font with a slight shadow effect. Below it, the word 'gatto' is written in a smaller, lowercase, sans-serif font, also with a shadow effect. The two words are positioned to appear as if they are part of a single, stylized brand mark.

(591) Black, white

(511)

21 – Litter boxes for pets.

31 – Foodstuff and feeds for animals; biscuits, bones, bars, sticks, chips and edible articles for chewing by domestic animals; and products for animal litter; catnip.

35 – Retail services relating to veterinary preparations and substances, dietary supplements for animals, additives and supplements for animal feed, antiparasitic preparations for animals, detergents for animals, foodstuff and feeds for animals, biscuits, bones, bars, sticks, chips and edible articles for chewing by domestic animals, litter boxes for pets and products for animal litter, catnip; wholesaling services relating to veterinary preparations and substances, dietary supplements for animals, additives and supplements for animal feed, antiparasitic preparations for animals, detergents for animals, foodstuff and feeds for animals, biscuits, bones, bars, sticks, chips and edible articles for chewing by do-

mestic animals, litter boxes for pets and products for animal litter, catnip; online store services relating to veterinary preparations and substances, dietary supplements for animals, additives and supplements for animal feed, antiparasitic preparations for animals, detergents for animals, foodstuff and feeds for animals, biscuits, bones, bars, sticks, chips and edible articles for chewing by domestic animals, litter boxes for pets and products for animal litter, catnip.

(260) AM 2017 90341 A

(800) 1326410

(891) 2016 07 19

(731) PHILIP MORRIS PRODUCTS S.A.

Quai Jeanrenaud 3, CH-2000 Neuchâtel,
Switzerland

(540)

HEETS

(511)

9 – Batteries for electronic cigarettes; batteries for electronic devices that are used for heating tobacco, chargers for electronic devices that are used for heating tobacco; USB chargers for electronic devices that are used for heating tobacco; car chargers for electronic cigarettes; car chargers for devices that are used for heating tobacco; battery chargers for electronic cigarettes.

11 – Electronic vaporizers except electronic cigarettes; apparatus for heating liquids; apparatus for generating vapor.

34 – Wired vaporizers for electronic cigarettes and electronic smoking devices; tobacco, raw or manufactured; tobacco products, including cigars, cigarettes, cigarillos, tobacco for roll-your-own cigarettes, pipe tobacco, chewing tobacco, snuff tobacco, kretek; snus; tobacco substitutes (not for medical purposes); smokers' articles, including cigarette paper and tubes, cigarette filters, tobacco tins, cigarette cases and ashtrays, pipes, pocket apparatus for rolling cigarettes, lighters; matches; tobacco sticks, tobacco products for the purpose of being heated, electronic devices and their parts for the purpose of heating cigarettes or tobacco in order to release nicotine-containing aerosol for inhalation; liquid nicotine solutions for use in electronic cigarettes; electronic smoking devices; electronic cigarettes; electronic cigarettes as substitute for traditional cigarettes; electronic devices for the inhalation of nicotine-containing aerosol; oral vaporizing devices for use by smokers, tobacco products and tobacco substitutes; smokers' articles for electronic cigarettes; parts and fittings for the aforesaid products included in this class; extinguishers for heated cigarettes and cigars as well as heated tobacco sticks; electronic rechargeable cigarette cases.

(260) AM 2017 90343 A

(800) 1326513

(891) 2016 04 19

(731) CRRC CORPORATION LIMITED

No.16, Central West Fourth Ring Road,
Haidian District, 100038 Beijing, China

(540)



(591) black and white

(511)

7 – Woodworking machines; cranes [lifting and hoisting apparatus]; casting equipment; internal combustion engine [other than for land vehicles]; wind driven power equipment; wind driven power generation assembly; dynamos; generators of electricity; pistons [parts of machines or engines]; valves [parts of machines]; compressed air machines; shaft couplings [machines]; springs [parts of machines]; machine wheelwork; gears, other than for land vehicles; shock absorber [machine parts].

9 – Computers; measures; surveying apparatus and instruments; speed checking apparatus for vehicles; current rectifiers; distribution boxes [electricity]; distribution consoles [electricity]; batteries.

11 – Lights for vehicles; cooling appliances and installations; air cooling apparatus; ventilation [air-conditioning] installations for vehicles; air purifying apparatus and machines; boilers, other than parts of machines; disinfectant apparatus.

12 – Railway couplings; flanges for railway wheel tires; bogies for railway cars; railway cars; buffers for railway rolling stock; traction engines; locomotives; locomotive wheel; automobiles; shock absorbing springs for vehicles; shock absorbers for land vehicles; gearing for land vehicles; brakes for land vehicles; driving motors for land vehicles; bodies for vehicles; gear transmission devices for rail trains; brake devices for light rail or subway trains; brake devices for rail trains; brake devices for land vehicles; electric vehicles; carriages [railways]; ships.

35 – Presentation of goods on communication media, for retail purposes; business management and organization consultancy; import-export agency services; rental of sales stands; drug retail or wholesale services.

36 – Insurance underwriting; financing services; real estate management; surety services; trusteeship; lending against security.

37 – Construction; heating equipment installation and repair; electric appliance installation and repair; vehicle maintenance; shipbuilding; rustproofing; rustproofing; dry cleaning; fire alarm installation and repair.

39 – Transport; boat rental; boat transport; vehicle rental; storage; courier services [messages or merchandise]; travel tour operating and organising services; travel guide and travel information services; transport by pipeline.

40 – Welding services; metal plating; metal treating; metal casting; textile treating; air purification; water treating.

41 – Instruction services; organization of competitions [education or entertainment]; mobile library services; publication of books; production of radio and television programmes; entertainment; health club services [health and fitness training]; modelling for artists.

42 – Research and development of new products for others; quality control; vehicle roadworthiness testing; industrial design; computer programming; computer software design; rental of computer software; computer software consultancy; engineering; technical research.

43 – Accommodation bureau services [hotels, boarding houses]; cafes; rental of transportable buildings; retirement home services; day-nursery services.

(260) AM 2017 90344 A

(800) 1326521

(891) 2016 08 31

(731) JAPAN TOBACCO INC.

2-2-1 Toranomom, Minato-ku, Tokyo, Japan

(540)



(591) Blue

(511)

34 – Tobacco, raw or manufactured; smoking tobacco, pipe tobacco, rolling tobacco, chewing tobacco, snus; cigarettes, electronic cigarettes, cigars, cigarettos; snuff; smokers' articles included in this class; cigarette paper, cigarette tubes and matches.

(260) AM 2017 90345 A
 (800) 1326522
 (891) 2016 09 01
 (731) JAPAN TOBACCO INC.
 2-2-1 Toranomon, Minato-ku, Tokyo, Japan
 (540)



(591) Gray, blue
 (511)
 34 – Tobacco, raw or manufactured; smoking tobacco, pipe tobacco, rolling tobacco, chewing tobacco, snus; cigarettes, electronic cigarettes, cigars, cigari-
 llos; snuff; smokers' articles included in this class;
 cigarette paper, cigarette tubes and matches.

(260) AM 2017 90346 A
 (800) 1326525
 (891) 2016 10 25
 (731) SOCIETE BIC
 14 rue Jeanne d'Asnières, F-92110 Clichy,
 France
 (540)

FLEX HYBRID

(511)
 8 – Electric or non-electric razors; beard clippers; electric or non-electric depilation apparatus; razor blades.

(260) AM 2017 90347 A
 (800) 1326566
 (891) 2016 04 22
 (731) DUEMMEI S.r.l.
 Via Carlo d'Adda, 9/A, I-20143 MILANO,
 Italy
 (540)



(591) black and white
 (511)
 14 – Jewelry findings; rings (jewelry); rings (jewelry) made of non-precious metals; jewelry items made of semi-precious materials; jewelry items to be worn; jewelry items; costume jewelry items; costume jewelry items made of precious metals; costume jewelry items made of precious stones; jewelry items for clothing; costume jewelry; bracelets (jewelry); chains (jewelry); pendants (jewelry); jewelry caskets; necklaces; threads of precious metals; tie tacks; wedding rings; tiaras; diamonds; metal threads made of precious materials; cufflinks and tie tacks; jewelry items containing precious stones; jewels, gold jewelry; earrings; art objects made of precious metals; jewelry ornaments; costume jewelry ornaments; jewelry cases; key rings made of precious metals; brooches (jewelry items); caskets for watchmaking items.

18 – Bags; leather bags; canvas bags; purses, wallets, portfolio cases; suitcases; trunks; bags and haversacks; rucksacks; umbrellas; walking sticks.

25 – Weather-resistant outerclothing; evening clothing; men's clothing; fur clothing; leather clothing; waterproof clothing items; women's outerclothing; shoes; parkas; jackets; coats; scarves; shrugs; hats; dressing gowns; shirts; blouses; tunics; belts; wind jackets; hooded wind jackets; jackets; trousers; waistcoats for men and women; skirts; sweaters; capes; shawls; foulards.

(260) AM 2017 90348 A
 (800) 1326591
 (891) 2016 08 16
 (731) FRESH TRADING LIMITED
 Fruit Towers, 342 Ladbrooke Grove, London
 W10 5BU, United Kingdom
 (540)



(591) black and white
 (511)
 29 – Dairy products; milk and milk products; drinks consisting of dairy products; fromage frais; cheese; eggs; meat-based mousses; vegetable mousses; fish mousses; dairy desserts; preserved, dried and cooked fruits and vegetables; jellies; jams; yoghurts; yoghurt products; yoghurt drinks; products consisting wholly

of or principally wholly of yoghurt; yoghurts incorporating jellies, jams, fruits, fruit sauces, fruit purees, chocolate, nuts, cereals, cereal products or cereal preparations as a condiment, flavouring or ingredient thereof; meat, fish, poultry and game and products made predominantly therefrom; pate; snack foods consisting principally of vegetables; soup; prepared meals containing meat, fish, poultry and game.

30 – Cereals; preparations made from cereals; flour; preparations made from flour; sausage rolls; quiches; sandwiches; confectionery; bread; pastry; ices; ice cream; ice cream products and frozen confections; preparations for making ices, ice cream, ice cream products and frozen confections; chocolate; products made or containing chocolate; mousses; flapjacks; shortbreads; honey and treacle; sugar; puddings; flavourings other than non-essential oils; cheese cake; sauces; chutneys; tea products; tea beverages; fruit teas; iced tea; chocolate based drinks; green tea; coffee; cocoa; rice; tapioca; spices; bread; yeast; baking powder; biscuits; cakes; products made primarily from chocolate; pasta; pastry and pastry products; meat pies, vegetable pies, fruit pies; fruit crumbles; pie mixes; fruit sauces; vinaigrettes; dressings; salad dressings; prepared meals containing pasta, bread, cereals, rice and /or pastry; desserts containing any of the above products; meringues.

32 – Non-alcoholic drinks; fruit drinks; fruit juices; mineral water; aerated beverages; syrups and other preparations for making beverages; beers; smoothies; fruit smoothies; coconut water.

(260) AM 2017 90351 A
(800) 1326806
(891) 2016 07 04
(731) QINGDAO GENCO INDUSTRIAL GROUP CO., LTD
2nd Floor, No.2, Building 5, Tianyue Business Center, No.49 Beijing Road, Qingdao Free Trade Zone, Qingdao City, 266000 Shandong Province, China

(540)



(591) Black, white
(511)

12 – Vehicle wheel tires; tires for vehicle wheels; tires, solid, for vehicle wheels; automobile tires; air-

plane tire; tires for bicycles, cycles; casings for pneumatic tires; inner tubes for bicycles, cycles; tubeless tires for bicycles, cycles; inner tubes for pneumatic tires.

(260) AM 2017 90352 A
(800) 1326807
(891) 2016 07 11
(731) EBIC Tools Co., Ltd.
Room 302, 3rd Building, No.119 Ruan Jian Avenue, Yuhuatai District Nanjing, China

(540)

FIXTEC

(591) Black, white
(511)

8 – Spanners [hand tools]; scraping tools [hand tools]; hollowing bits [parts of hand tools]; cutting tools [hand tools]; bits [parts of hand tools]; mitre boxes [hand tools]; tool belts [holders]; guns, hand-operated, for the extrusion of mastics; spatulas [hand tools]; graving tools [hand tools]; trowels [gardening]; pruning shears; secateurs; tree pruners.

9 – Weighing apparatus and instruments; jigs [measuring instruments]; measures; rulers [measuring instruments]; detectors; measuring apparatus; surveying apparatus and instruments; precision measuring apparatus; measuring instruments; distance measuring apparatus; telemeters; levelling staffs [surveying instruments]; rods [surveying instruments]; clinometers; slope indicators; gradient indicators; surveyors' levels; levels [instruments for determining the horizontal]; levelling instruments; planimeters; laser alignment telescope; balancing apparatus; optical apparatus and instruments.

(260) AM 2017 90353 A
(800) 1326892
(891) 2015 12 23
(731) MATRIZE Handels-GmbH
Ferdinandstr. 25-27, 20095 Hambourg, Germany

(540)

KRÖNWERK

(591) Red
(511)

6 – Vice benches of metal; booths of metal for spraying paint; staircases of metal; anvils; transport pallets of metal; rods of metal for brazing and welding; rods of metal for brazing; steps [ladders] of metal; cables of metal, non-electric; boxes of common metal; tool chests of metal, empty.

7 – Machines and machine tools; welding machines, electric; welding apparatus, gas-operated; concrete

mixers [machines]; lawnmowers [machines]; alternators; dynamos; compressors [machines]; harvesting machines; rinsing machines; pumps [machines]; presses [machines for industrial purposes]; air brushes for applying colour; metalworking machines; handling apparatus for loading and unloading; tools [parts of machines]; drilling heads [parts of machines]; drilling bits [parts of machines]; soldering blow pipes, gas-operated; gas-operated blow torches; jacks [machines]; hand-held tools, other than hand-operated; sharpening wheels [parts of machines]; chucks [parts of machines]; soldering irons, gas-operated; soldering irons, electric; agricultural implements other than hand-operated; grass trimmers, electric; compressed air guns in the nature of compressed air blow guns; bags for hand-held tools, other than hand-operated; straps for hand-held tools, other than hand-operated; cases for hand-held tools, other than hand-operated.

8 – Hand tools and implements, hand-operated; parts of hand-operated hand tools and implements; attachments for hand tools; bags for hand tools; tool belts [holders]; waistcoats for holding hand tools and instruments; wall mounted holders for hand tools and instruments; cutlery.

9 – Weighing apparatus and instruments; measuring apparatus; protective helmets; solderers' helmets; protective masks; knee-pads for workers; headphones; gloves for protection against accidents; respiratory masks, other than for artificial respiration; respirators for filtering air.

20 – Tool handles, not of metal; knife handles, not of metal; broom handles, not of metal; work benches; chairs [seats].

(260) AM 2017 90354 A
(800) 1326906
(891) 2016 05 27
(731) EVOLET HEALTHCARE PVT LTD
d985 new friends colony, New Delhi 110025,
India
(540)



(591) Black, white
(511)
5 – Pharmaceutical, medicinal preparations and dietetic substances adapted for medical use.

(260) AM 2017 90355 A
(800) 1326908
(891) 2016 04 16
(731) DRINKSTAR GMBH
Äußere Oberaustrasse 36/5, 83026 Rosenheim,
Germany
(540)

(591) Black, white
(511)
32 – Mineral and sparkling mineral waters, non-alcoholic beverages as well as bases and essences for making the aforesaid drinks; preparations or essences for making alcoholic beverages.
33 – Alcoholic beverages.

(260) AM 2017 90356 A
(800) 1326913
(891) 2016 07 22
(731) Dimitar Hristov BALEV
Blvd. Vitosha No.137, apt. 17 BG-1408 Sofia,
Bulgaria
(540)



(591) Black, white
(511)
3 – Soaps; perfumery; essential oils; aromatics [essential oils]; ionone [perfumery]; extracts of flowers [perfumes]; potpourris [fragrances]; air fragrancing preparations; fragrances for household purposes; fragrances for automobiles; sachets for perfuming linen; scented wood; scented water; tissues impregnated with cosmetic lotions; cloths impregnated with a detergent for cleaning; bath salts, not for medical purposes.
5 – Salts for mineral water baths; air purifying preparations; air deodorizers and air purifiers; deodorants for clothing and textiles; air deodorising preparations; moist wipes impregnated with a pharmaceutical lotion; disposable sanitizing wipes; babies' napkins [diapers]; sanitary napkins for household use.

(260) AM 2017 90358 A
(800) 1326959
(891) 2016 11 01

(731) APPLE INC.
1 Infinite Loop, Cupertino CA 95014, USA
(540)

SIRIKIT

(591) Black, white
(511)

42 – Design and development of computer software; computer software consulting services; support and consultation services for developing computer systems, databases and applications; providing computer software information online.

(260) AM 2017 90361 A
(800) 1326960
(891) 2016 10 18
(731) BOLERO Co. Ltd.

Dragalevska str. No.1, office 2, Lozenetz,
BG-1407 SOFIA, Bulgaria

(540)



(591) Black, white
(511)

5 – Dietetic substances adapted for medical use; vitamin drinks; vitamin preparations; nutritional additives for medical purposes.

21 – Household or kitchen utensils and containers; combs and sponges; brushes (except paintbrushes); unworked or semi-worked glass (except glass used in building); glassware, porcelain and earthenware; kitchen utensils not of precious metal; tableware, cookware and containers; cups and mugs; tableware not of precious metal; tableware made of terra-cotta; decanters; mugs; glasses (receptacles); bottles; drinking bottles for sports; siphon bottles for carbonated water; squeeze bottle [empty]; reusable plastic water bottles sold empty; reusable stainless steel water bottles sold empty; thermal insulated containers for food or beverage; ice buckets and coolers for wine and champagne; insulated bottles; cool bags; refrigerating bottles; portable coolers; corkscrews, bottle openers; picnic baskets, including dishes; plate holders; trivets (table utensils); non-electric coffee percolators; candlesticks not of precious metal; vases not of precious metal, lunch boxes; oil and vinegar cruets.

25 – Headgear, clothing, footwear; T-shirts; caps.

30 – Coffee, teas and substitutes therefor.

32 – Beers; mineral and aerated waters and other non-alcoholic drinks; fruit drinks and fruit juices; syrups and other preparations for making beverages.

33 – Alcoholic beverages (except beers).

41 – Education; providing of training; entertainment; sporting and cultural activities.

43 – Services for providing food and drink.

(260) AM 2017 90367 A
(800) 1326962
(891) 2016 11 01
(731) APPLE INC.

1 Infinite Loop, Cupertino CA 95014, USA

(540)

SIRIKIT

(591) Black, white
(511)

9 – Computer software used in developing other software applications; application development software.

(260) AM 2017 90368 A
(800) 1326982
(891) 2016 11 23
(731) SAGARO LIMITED

Suite 23, Portland House, Glacis Road
Gibraltar, United Kingdom

(540)

RELATIONSHIPS WITH BENEFITS

(511)

45 – Computer dating services; matchmaking services; social introduction agencies.

(260) AM 2017 90369 A
(800) 1327030
(891) 2016 10 13
(731) NEXUS AUTOMOTIVE INTERNATIONAL
SA
Chemin du Château-Bloch 11, CH-1219 Le
Lignon, Switzerland

(540)

NEXUSAUTO

(511)

12 – Vehicles; apparatus for locomotion by land, air or water, excluding bicycles, parts and components of bicycles as well as two-wheeled and three-wheeled motor vehicles.

37 – Maintenance and repair of motor vehicles; re-building of worn or partially destroyed engines; repair information; retreading of tires; rustproofing; wheel balancing services; vehicle lubrication [greasing]; vehicle washing; vehicle polishing; vehicle service stations [refueling and maintenance]; vehicle maintenance (servicing); vehicle cleaning; repair services in the case of vehicle breakdown; charging of vehicle batteries; vulcanization of tires [repair]; warehouse construction and repair.

(260) AM 2017 90374 A

(800) 1327426

(891) 2016 04 05

(731) ALEKSANDR NIKOLAEVICH KOVAL
14, building 1, kv. 131, Fermskoe shosse,
RU-197341 St. Petersburg, Russian Federation

(540)

Nika

(591) Blue

(511)

6 – Bed casters of metal; furniture casters of metal; hooks of metal for clothes rails; clothes hooks of metal; staircases of metal; ladders of metal; step stools of metal; slings of metal for handling loads; stair treads [steps] of metal.

12 – Bicycles; cycles; pushchair hoods; hoods for baby carriages; hoods for vehicles; pushchairs; prams [baby carriages]; strollers; baby carriages; sleighs [vehicles]; kick sledges; safety seats for children, for vehicles; vehicle seats; snowmobiles; snow scooters [vehicles]; tricycles; delivery tricycles; carrier tricycles; saddlebags adapted for bicycles; wheelbarrows; handling carts; two-wheeled trolleys; luggage trucks; sack-barrows; stroller covers [pushchairs]; pushchair covers; covers for baby carriages; fitted perambulator covers; saddle covers for bicycles or motorcycles; seat covers for vehicles; sled-pushchairs.

16 – Albums; scrapbooks; posters; forms, printed; drawing pads; loose-leaf binders; pamphlets; booklets; newsletters; signboards of paper or cardboard; writing slates; drawing boards; magazines [periodicals]; bookmarkers; periodicals; printed publications; graphic representations; calendars; pictures; transfers [decalcomanias]; decalcomanias; catalogues; graphic prints; painters' easels on metal frame made of bent pipes; stickers [stationery]; musical greeting cards; greeting cards; postcards; printed matter; prospectuses; photographs [printed]; shields [paper seals]; labels, not of textile.

20 – Coat hangers of metal; clothes hangers of metal; coatstands of metal; shoulder poles of metal [yokes]; furniture casters, not of metal; metal furni-

ture made of bent pipes; metal furniture for children, including the bent pipe; outdoor furniture on the metal frame for summer house; sleeping bags for camping; seats on metal frame; steps [ladders], not of metal; metal folding chairs for fisherman and summer visitor; stools on metal frame, including made of bent pipes; easy chairs.

21 – Ironing boards; flat-iron stands; utensils for household purposes; ironing board covers, shaped.

28 – Toy vehicles; snow tubes; skis; equipment for snow tubing; scooters [toys]; sleds [sports articles]; bob-sleighs; seats for sliding on snow and ice; snow scooters [toys]; snowshoes; slides [playthings].

35 – Arranging subscriptions to telecommunication services for others; the bringing together and placement, for the benefit of others, of a variety of goods, included in classes 06, 12, 16, 20, 21, enabling customers to conveniently view and purchase those goods in retail and wholesale stores, mail-order catalogs, TV shops, on websites.

(260) AM 2017 90375 A

(800) 1327438

(891) 2016 06 07

(731) VASU HEALTHCARE PRIVATE LIMITED
967 / 4, gidc, makarpura, vadodara, gujarat
390010, India

(540)

TRICHUP

تریشوب



(591) Black, white

(511)

3 – Cosmetics, hair conditioner, hair pack, hair serum, hair soap, face soap, hair oil, hair lotions, hair cream, shampoo, body creams and lotions for cosmetic purposes, soap, henna.

(260) AM 2017 90376 A

(800) 1327459

(891) 2016 06 01

(731) ATLASJET HAVACILIK ANONİM ŞİRKETİ
Eski Halkali Yolu Yesilyurt, Mahallesi Alacati
Evleri Yani No:5/B, Florya, Istanbul, Turkey

(540)



(591) Red and white

(511)

16 – Paint brushes; typewriters and office requisites (except furniture).

35 – Advertising; business management; business administration; office functions.

39 – Transport; packaging and storage of goods; travel arrangement.

41 – Education; providing of training; entertainment; sporting and cultural activities.

42 – Scientific and technological services and research and design relating thereto; industrial analysis and research services; design and development of computer hardware and software.

(260) AM 2017 90377 A

(800) 1327464

(891) 2016 06 09

(731) VICTORY 2000 EOOD

G.S. Rakovski Str. 32, BG-5250 SVISHTOV,
Bulgaria

(540)

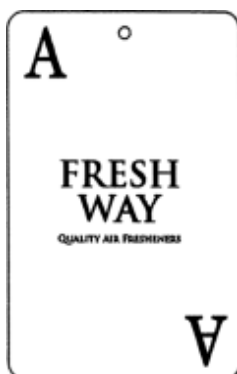

(591) Black, white

(511)

3 – Perfumery; cosmetics; air fragrancing preparations; aromatic (essential oils); scented wood; scented water; oils for cleaning purposes; air freshening sprays; sachets for perfuming linen; toilet water; tissues impregnated with cosmetic lotions; ethereal essences; extracts of flowers (perfumes); canned pressurized air for cleaning and dusting purposes; wind-screen cleaning liquids; preparation for air fragrancing, not included in other classes.

5 – Deodorants, other than for human beings or for animals; air deodorizing preparations; preparation for odor absorbing materials; deodorants for clothing and textiles; air deodorizing preparation for car, automobiles; shoe deodorizers.

(260) AM 2017 90379 A

(800) 1327476

(891) 2016 03 03

(731) COMITÉ INTERNATIONAL OLYMPIQUE

Château de Vidy, CH-1007 Lausanne,
Switzerland

(540)



(591) Black, white

(511)

35 – Advertising; dissemination of advertising matter via all media, in particular in the form of thematic messages centered on human values; advertising by sponsoring; commercial business management; commercial administration; office functions; promoting the goods and services of others, by means of contractual agreements, in particular sponsoring and licensing agreements, enabling them to gain additional notoriety and/or enhanced image and/or a surge of sympathy derived from the notoriety and/or enhanced image resulting from cultural and sporting events, in particular international events, and/or a surge of sympathy generated by the above; promoting the goods and services of others by means of what is referred to as the initial interest factor leading the public to consider, among a multitude of competitors, goods or services presented to the public bearing signs, emblems or messages able to capture its attention; promoting the goods and services of others by means of the so-called image transfer; rental of advertising space of all type and on all media, whether digital or not; business administration of the participation of national teams to an international athletic competition, and promoting the support to said teams with the public and the concerned circles; inventory management services; consultation relating to stock monitoring services; advertising by means of direct marketing for others consisting in marketing of databases; consultation for advertising by means of direct marketing for others consisting in marketing of databases; consultation services in connection with business reorganization; truck and automobile fleet management services, namely billing and consulting in connection with the administrative management of truck and automobile fleets; business administration consultancy; administrative management of power plants of others; business consultation in connection with the management of power plants, commercial services, namely administration of contracts for repair and servicing, supply chain management services and consulting services relating to the purchase and supply of chemical services and products, supply management and product inventory, limitation of costs; consulting, marketing, analysis of prices and costs concerning devices for electrochemical purification of liquids for industrial use; administrative, commercial and technical management of computer

files; data input and processing services; retail sale of electric and electronic machines and apparatus (the bringing together, for the benefit of others, of a range of goods so as to enable customers to view and purchase said goods at their convenience in a retail store carrying electrical goods), information concerning the sale of raw materials, commercial information, commercial information agencies, rental of photocopiers; promoting the sale of goods and services of others including by means of advertisements, promotional competitions, awarding of prizes and bonuses in the form of promotional lotteries, discounts, reduction tokens and value-added offers in connection with the use of payment cards; promoting sporting competitions and events for use by others; promoting concerts and cultural events for others, organization of exhibitions for commercial or advertising purposes; provision of documentation, namely direct mail advertising, distribution of advertising material, distribution of samples, reproduction of documents; advertising concerning the promotion of commercial sales of goods and services for retail sale purposes; provision of information in connection with e-commerce and electronic retail sale; provision of information concerning the purchase of goods and services on line via the Internet and other computer networks; tourist documentation services through tourist agencies, namely advertising concerning transport, travel, hotels, accommodation, food and meals, sports, entertainment and sightseeing tours; maintenance of computerized databases; computerized file management, namely, digital file management comprising a portfolio of images and video sequences intended for use under license in traditional advertising and in the promotion of behavior (moral advertising); retail services or wholesale services for tires; retail services or wholesale services for sports goods; retail services or wholesale services for bicycles and parts and fittings for bicycles.

41 – Educational services; training; entertainment; sporting and cultural activities, televised sporting and cultural entertainment; organization of exhibitions for cultural and educational purposes; organization of lotteries and competitions; betting and gambling services in connection with or relating to sports; entertainment services provided during sporting events or concerning sporting events; organization of sporting and cultural events and activities; organization of real or virtual sporting competitions; management of sports facilities; rental of audio and video equipment, production of films, other than advertising films; production of sound and video recordings; presentation and distribution of films and of sound and video recordings; rental of films and of sound and video recordings; rental and/or provision via a computer network of interactive education and entertainment products, namely interactive compact discs, CD-ROMs, computer games; entertainment,

namely presentation of interactive education and entertainment products, namely interactive compact discs, CD-ROMs, computer games; radio and television coverage of sporting events; production of television and radio programs and of videotapes; production of cartoons; production of animated programs for television; reservation of tickets for sporting events and shows; timing of sports events; organization of beauty contests; interactive entertainment; on-line betting services; provision of games on the Internet; provision of raffle services; information concerning entertainment or education, provided on line from a data bank or the Internet; electronic game services provided by means of the Internet; providing on line electronic publications; publication of books, magazines, texts (other than advertising texts) and periodicals; online publication of electronic books, magazines, texts (other than advertising texts) and periodicals; provision of digital music from the Internet; provision of digital music from MP3 web sites; provision of sporting results; information services concerning sports and sporting events; rental of recorded sounds and images; audio production services; information services concerning sporting events provided on line from a computer database or the Internet; editing and publishing services; provision of digital music (non-downloadable); offering digital music by means of telecommunications; publication of statistics regarding sporting results and audience ratings for sporting competitions; training in the use and operation of systems for signaling and notification of crossings for the railway and transit industries; education services in the field of medical imaging and diagnosis, namely conducting of seminars, conferences, symposiums or workshops concerning the pharmaceutical industry, intended for medical practitioners and employees of pharmaceutical companies; education services, namely conducting of seminars, conferences, symposiums or workshops in the field of life sciences and biotechnology for scientists and researchers; conducting of seminars on problems in connection with industrial water treatment; training services in all the aforesaid fields; training services in the field of management and medicine by means of the use of instructions and demonstrations provided on line, via the Internet, intranets and extranets; education services, namely conducting of practical training workshops, courses and seminars including demonstrations in the field of medicine and management; design, conducting and hosting of courses, seminars and all training activities in the field of information technology; organization and performance of concerts; booking of seats for shows; movie presentations; entertainment information; film production; show production; theater production services; operation of golf facilities; health club services (fitness training); sports camp services; presentation of live performances; film projection; organization of

shows (impresario services); holiday camp services [entertainment]; movie studios; news reporters services; provision of on-line electronic publications, not downloadable; music hall services; education services, namely conducting of courses, seminars, presentations, video presentations; provision of educational material, namely dissemination of material in the field of financial knowledge; education services in the field of tourism; information services in the field of tourism, namely information services regarding reservation of tickets for recreational events; information services in the field of tourism, namely information services regarding entertainment; information services in the field of tourism, namely information services regarding planned sporting, cultural and recreational activities; services in connection with entertainment for tourist assistance; tourist reservation services, namely activity and entertainment reservation services; assistance services for tourists concerning reservation of tickets for recreational events; assistance services for tourists concerning planned sporting, cultural and recreational activities; presenting of prizes rewarding the authors of exceptional acts or performances; organization and conducting of ceremonies in connection with the awarding of prizes and rewards.

(260) AM 2017 90380 A
(800) 629576
(891) 2016 12 02
(731) MARIE BRIZARD WINE & SPIRITS
19 boulevard Paul Vaillant Couturier,
F-94200 IVRY SUR SEINE, France
(540)

SOBIESKI

(511)
33 – Alcoholic beverages (except beers).

(260) AM 2017 90381 A
(800) 719344
(891) 2016 10 17
(731) BAYERISCHE MOTOREN WERKE
AKTIENGESELLSCHAFT
Petuelring 130, 80809 München, Germany
(540)

X5

(511)
12 – Motor vehicles and parts thereof (with the exception of tires), motors and engines for land vehicles; couplings and transmission components for land vehicles; vehicle accessories, namely, towropes, tow rods, trailer hitches, burglar alarms, anti-theft devices, bicycles racks, bicycle lifts, baggage carriers, carrying systems, anti-skid chains, straps and clamps, head rests, air pumps, mudguards, safety belts, safety cushions, safety seats for children, sun visors, heat-insulating windshield, roller sun blinds,

tanks, warning signs, hazard warning lamps, wind deflectors, body trims, body stripes, protective net for storage area; apparatus for locomotion by land, air or water.

(260) AM 2017 90382 A
(800) 1065780
(891) 2016 11 24
(731) VAFO PRAHA, s.r.o.
K Brůdku 94, CZ-252 19 Chrášťany, Czech
Republic
(540)



(591) Black, white
(511)
5 – Vitamin and mineral supplements for pets.

29 – Meat and meat derivatives.

31 – Dry, semi-moist, wet complete and complementary pet food; pet treats.

(260) AM 2017 90383 A
(800) 1115564
(891) 2016 11 24
(731) VAFO PRAHA, s.r.o.
K Brůdku 94, CZ-252 19 Chrášťany, Czech
Republic
(540)

Let's Bite

(511)
5 – Vitamin and mineral supplements for pets.

29 – Meat and meat derivatives.

31 – Dry, semi-moist, wet complete and complementary pet food; pet snacks and treats.

(260) AM 2017 90386 A
(800) 1326595
(891) 2016 08 26
(731) GILEAD SCIENCES, INC.
Attn. Gretchen R. Stroud 333 Lakeside Drive,
Foster City, California 94404, USA
(540)



(591) black and white

(511)

5 – Antiviral pharmaceutical preparations; anti-infective pharmaceutical preparations; antifungal preparations; pharmaceutical preparations for treatment and prevention of HIV and AIDS; pharmaceutical preparations for the treatment of hepatic diseases and disorders; pharmaceutical preparations for the treatment of hematological diseases and disorders; pharmaceutical preparations for the treatment of oncological diseases and disorders; pharmaceutical preparations for treatment of myelofibrosis, myeloma, leukemia, and lymphoma; pharmaceutical preparations for the treatment of cardiovascular diseases and disorders; pharmaceutical preparations for the treatment of inflammatory diseases and disorders; pharmaceutical preparations for the treatment of respiratory and pulmonary diseases and disorders; anti-biotic pharmaceutical preparations.

44 – Providing health and medical information by telephone and the internet; providing health and medical information regarding care, prevention, and treatment of infections, diseases, and medical conditions; counseling and charitable services for patients, namely, providing information and assistance with respect to obtaining prescription medications.

(260) AM 2017 90387 A

(800) 1326614

(891) 2016 05 02

(731) LEDVANCE GmbH

Parkring 29-33, 85748 Garching, Germany

(540)

ЛЕДВАНС

(591) black and white

(511)

9 – Scientific, nautical, surveying, photographic, cinematographic, optical, weighing, measuring, control, life-saving and teaching apparatus and instruments; signal apparatus and instruments; electrical apparatus and instruments as well as apparatus and instruments for conducting, switching, transforming, accumulating, regulating or controlling electricity; apparatus for recording, transmission or reproduction of images; beamer, picture projectors, magnetic data carriers, data processing devices and computers; computer programs and software of all kind (included in this class), software applications [Apps] for electrical and communication devices; LED (light emitting diodes) and laser diodes (also organic LEDs and laser diodes); light conductors, optical couplers, optical sensors, light barriers, LED lamp modules, also for signaling purposes; displays in LED-technology; electric and electronic devices and apparatus for the operation, regulation and control of lighting facilities, luminaires and lamps for central building

control systems and for the regulation and control of building installations, especially interfaces for such apparatus and devices as well as transformers and electronic ballasts; miniature transformers, choking contact elements including plugs, clips, sleeves, switch gears, interrupters; parts of all the aforesaid goods included in this class.

10 – Surgical, medical, dental and veterinary apparatus and instruments, artificial limbs, eyes and teeth; orthopedic articles; chirurgical suture material; medial irradiation apparatus and lighting apparatus; parts of all the aforesaid goods included in this class.

11 – Lighting apparatus, especially electric lamps and luminaires; lighting apparatus and lighting systems on basis consisting thereof, especially on basis of LEDs (also organic LEDs) LED-lamps and LED-luminaires (included in this class) and their parts; lighting lamps and apparatus and devices and systems consisting thereof as well as their parts (included in this class) on basis of LED; LED modules, namely modules based on LEDs (also based on organic LEDs) with light functions for lighting purposes.

16 – Printed matters especially journals, newspapers, books, catalogues and advertising material.

28 – Games, toys; gymnastic and sports articles, included in this class; Christmas tree decoration; parts of all the aforesaid goods included in this class.

35 – Advertising; business management; enterprise administration; office functions.

37 – Building constructions, repair and installation works for the construction of lighting systems and advisory service thereto; installation, repair and maintenance of solar systems, solar power plants and products on the field of solar energy, namely solar cells, solar units, solar panels, solar modules and solar connectors, solar power plants and power plant operated on basis of fossil resources.

42 – Scientific and technological services, science, research and development works as well as designer services therefor; industrial analysis and science services; industrial science and research services; creation and development of computer hardware and computer software; planning of lighting facilities and counseling therefore, services of an architect as well as services of an indoor architect, especially in the field of illumination; providing of planning and simulation programs for illumination applications also via the Internet.

(260) AM 2017 90388 A

(800) 1326631

(891) 2016 04 08

(731) MEIZU TECHNOLOGY CO., LTD.

Meizu Technology Building, Technology & Innovation Coast, Zhuhai, Guangdong, China

(540)

MEIZU

(591) black and white

(511)

9 – Computer operating programs, recorded; data processing apparatus; computer hardware; computer software applications downloadable; downloadable image files; computer peripheral devices; tablet computers; time recording apparatus; photocopiers [photographic, electrostatic, thermic]; scales; measures; electronic notice boards; smartphones; hands free kits for phones; Global Positioning System [GPS] apparatus; network communication equipment; transponders; cases for telephone; electro-dynamic apparatus for the remote control of signals; branch boxes [electricity]; switchboards; monitoring apparatus, electric; television apparatus; headphones; earphones; camcorders; portable media players; cabinets for loudspeakers; audio-and video-receivers; cameras [photography]; air analysis apparatus; material for electricity mains [wires, cables]; power plug converter; plugs, sockets and other contacts [electric connections]; remote control apparatus; switches, electric; time switches, automatic; protection devices for personal use against accidents; theft prevention installations, electric; eyeglasses; power bank (rechargeable battery); batteries, electric; chargers for electric batteries.

11 – Lamps; automobile lights; microwave ovens [cooking apparatus]; refrigerators; air conditioning installations; air filtering installations; air purifying apparatus and machines; gas scrubbing apparatus; electric fans for personal use; electrical drier with a blower; heating apparatus, electric; heating installations; bath fittings; solar water heater; heaters for baths; water purification installations; water filtering apparatus; disinfectant apparatus; radiators, electric; light bulbs.

35 – Demonstration of goods; advertising; on-line advertising on a computer network; presentation of goods on communication media, for retail purposes; pay per click advertising; organization of exhibitions for commercial or advertising purposes; providing business information via a web site; commercial administration of the licensing of the goods and services of others; marketing studies; sales promotion for others; provision of an on-line marketplace for buyers and sellers of goods and services; employment agencies; systemization of information into computer databases; search engine optimization; web site traffic optimization; updating and maintenance of data in computer databases; arranging subscriptions to telecommunication services for others; accounting; rental of vending machines; import-export agencies.

38 – Television broadcasting; radio broadcasting; message sending; cellular telephone communication; communications by computer terminals; computer aided transmission of messages and images; electronic bulletin board services [telecommunications services]; providing telecommunications connections to a global computer network; providing internet chat-rooms; providing online forums; telecommunications routing and junction services; videoconferencing services; streaming of data; radio communication; providing telecommunication channels for teleshop- ping services; voice mail services; providing access to databases; rental of message sending apparatus; transmission of digital files; telephone services.

(260) AM 2017 90409 A

(800) 1324063

(891) 2016 12 16

(731) BEAUTY ENTREPRISE

66 avenue des Champs-Élysées, F-75008
PARIS, France

(540)



(591) Black, white

(511)

3 – Soaps; perfumes, essential oils, cosmetics, hair lotions.

4 – Candles, wicks for lighting; perfumed candles.

5 – Deodorants other than for personal use; air purifying products; disinfectants; bath salts for therapeutic use; deodorants for clothing or textile materials.

(260) AM 2017 90431 A

(800) 1327067

(891) 2016 02 08

(731) Obshchestvo s ogranichennoy

otvetstvennostyu "SKANDI LINE"

Kaliningradsky pr-d, d.1, Korolev RU-141076
Moskovskaya obl., Russian Federation

(540)



(591) Black, white

(511)

3 – Bleaching preparations and other substances for laundry use; cleaning, polishing, scouring and abrasive preparations; soaps; perfumery, essential oils, cosmetics, hair lotions; dentifrices; abrasives; amber [perfume]; scale removing preparations for household purposes; antistatic preparations for household purposes; aromatics [essential oils]; air fragrancing preparations; cake flavourings [essential oils]; flavourings for beverages [essential oils]; breath freshening sprays; canned pressurized air for cleaning and dusting purposes; balms other than for medical purposes; lip glosses; polishing stones; abrasive paper; emery paper; polishing paper; petroleum jelly for cosmetic purposes; shoe polish; cobblers' wax; cotton wool for cosmetic purposes; sachets for perfuming linen; drying agents for dishwashing machines; adhesives for cosmetic purposes; scented water; javelle water; lavender water; toilet water; laundry wax; floor wax; non-slipping wax for floors; depilatory wax; mustache wax; tailors' wax; creams for leather; polish for furniture and flooring; shoemakers' wax; polishing wax; massage gels other than for medical purposes; heliotropine; dental bleaching gels; geraniol; make-up; deodorants for pets; deodorants for human beings or for animals; depilatories; scented wood; perfumes; non-slipping liquids for floors; windscreen cleaning liquids; greases for cosmetic purposes; volcanic ash for cleaning; toiletries; decorative transfers for cosmetic purposes; ionone [perfumery]; shaving stones [astringents]; smoothing stones; eyebrow pencils; cosmetic pencils; silicon carbide [abrasive]; carbides of metal [abrasives]; alum stones [astringents]; tripoli stone for polishing; adhesives for affixing false eyelashes; adhesives for affixing false hair; quillaia bark for washing; corundum [abrasive]; beard dyes; colorants for toilet purposes; cosmetic dyes; starch for laundry purposes; laundry glaze; waxes for leather; polishing creams; cosmetic creams; cream for whitening the skin; polishing rouge; incense; hair spray; nail polish; lotions for cosmetic purposes; after-shave lotions; beauty masks; oils for perfumes and scents; oils for cosmetic purposes; oils for toilet purposes; essential oils of cedarwood; essential oils of lemon; essential oils of citron; oils for cleaning purposes; bergamot oil; galutheria oil; jasmine oil; lavender oil; almond oil; rose oil; oil of turpentine for degreasing; whitening; cleaning chalk; almond milk for cosmetic purposes;

cleansing milk for toilet purposes; musk [perfumery]; disinfectant soap; deodorant soap; shaving soap; soap for brightening textile; cakes of soap; medicated soap; antiperspirant soap; soap for foot perspiration; almond soap; mint for perfumery; cosmetic kits; emery; nail art stickers; false nails; eau de cologne; bases for flower perfumes; cotton sticks for cosmetic purposes; joss sticks; pastes for razor strops; pumice stone; lipstick cases; hydrogen peroxide for cosmetic purposes; breath freshening strips; abrasive cloth; glass cloth; lipsticks; pomades for cosmetic purposes; shaving preparations; cosmetic preparations for baths; bath preparations, not for medical purposes; hair straightening preparations; waving preparations for the hair; preparations for soaking laundry; grinding preparations; douching preparations for personal sanitary or deodorant purposes [toiletries]; smoothing preparations [starching]; color-removing preparations; leather bleaching preparations; denture polishes; mouth washes, not for medical purposes; cosmetic preparations for slimming purposes; starch glaze for laundry purposes; refurbishing preparations; fabric softeners for laundry use; laundry bleach; dry-cleaning preparations; paint stripping preparations; lacquer-removing preparations; make-up removing preparations; floor wax removers [scouring preparations]; varnish-removing preparations; rust removing preparations; nail care preparations; preparations for cleaning dentures; wallpaper cleaning preparations; preparations for unblocking drain pipes; laundry preparations; aloe vera preparations for cosmetic purposes; sunscreen preparations; color-brightening chemicals for household purposes [laundry]; shining preparations [polish]; make-up powder; diamantine [abrasive]; stain removers; scouring solutions; false eyelashes; tissues impregnated with cosmetic lotions; tissues impregnated with make-up removing preparations; safrol; laundry blueing; turpentine, for degreasing; potpourris [fragrances]; bleaching soda; washing soda, for cleaning; bath salts, not for medical purposes; bleaching salts; fumigation preparations [perfumes]; preservatives for leather [polishes]; ammonia [volatile alkali] [detergent]; astringents for cosmetic purposes; eyebrow cosmetics; make-up preparations; sun-tanning preparations [cosmetics]; hair colorants; neutralizers for permanent waving; preparations to make the leaves of plants shiny; cosmetic preparations for eyelashes; depilatory preparations; cosmetic preparations for skin care; shoe wax; cosmetics; cosmetics for animals; mascara; detergents other than for use in manufacturing operations and for medical purposes; degreasers other than for use in manufacturing processes; bleaching preparations [decolorants] for cosmetic purposes; antiperspirants [toiletries]; talcum powder, for toilet use; terpenes [essential oils]; emery cloth; cloths impregnated with a detergent for cleaning; henna [cosmetic dye]; shampoos; shampoos for pets; dry shampoos; glass paper;

soda lye; extracts of flowers [perfumes]; ethereal essences; badian essence; mint essence [essential oil].

5 – Pharmaceutical and veterinary preparations; sanitary preparations for medical purposes; dietetic food and substances adapted for medical or veterinary use, food for babies; dietary supplements for humans and animals; plasters, materials for dressings; material for stopping teeth, dental wax; disinfectants; preparations for destroying vermin; fungicides, herbicides; acaricides; aconitine; alkaloids for medical purposes; alginates for pharmaceutical purposes; algicides; aldehydes for pharmaceutical purposes; dental amalgams of gold; dental amalgams; amino acids for veterinary purposes; amino acids for medical purposes; analgesics; anaesthetics; antibiotics; antiseptics; medicine cases, portable, filled; first-aid boxes, filled; aluminium acetate for pharmaceutical purposes; acetates for pharmaceutical purposes; germicides; balms for medical purposes; bandages for dressings; diagnostic biomarker reagents for medical purposes; biocides; bracelets for medical purposes; anti-rheumatism bracelets; bromine for pharmaceutical purposes; paper for mustard plasters; fly catching paper; reagent paper for medical or veterinary purposes; mothproofing paper; petroleum jelly for medical purposes; vaccines; oxygen baths; antiseptic cotton; aseptic cotton; absorbent cotton; wadding for medical purposes; cotton for medical purposes; dietetic substances adapted for medical use; radiological contrast substances for medical purposes; nutritive substances for microorganisms; radioactive substances for medical purposes; bismuth subnitrate for pharmaceutical purposes; melissa water for pharmaceutical purposes; sea water for medicinal bathing; mineral waters for medical purposes; thermal water; dietary fiber; molding wax for dentists; gases for medical purposes; guaia-col for pharmaceutical purposes; hematogen; hemoglobin; hydrastine; hydrastinine; glycerine for medical purposes; glycerophosphates; glucose for medical purposes; gentian for pharmaceutical purposes; hormones for medical purposes; mustard for pharmaceutical purposes; mustard plasters; mud for baths; medicinal mud; gamboge for medical purposes; gurjun [gurjon, gurjan] balsam for medical purposes; air deodorising preparations; deodorants, other than for human beings or for animals; deodorants for clothing and textiles; diastase for medical purposes; digitalin; mineral food supplements; nutritional supplements; albumin dietary supplements; dietary supplements for animals; yeast dietary supplements; alginate dietary supplements; glucose dietary supplements; casein dietary supplements; lecithin dietary supplements; linseed oil dietary supplements; propolis dietary supplements; protein dietary supplements; protein supplements for animals; royal jelly dietary supplements; pollen dietary supplements; wheat germ dietary supplements; linseed dietary supplements; enzyme dietary supplements; yeast for phar-

maceutical purposes; gelatine for medical purposes; cod liver oil; isotopes for medical purposes; insecticides; iodine for pharmaceutical purposes; iodides for pharmaceutical purposes; alkaline iodides for pharmaceutical purposes; iodoform; calomel; cream of tartar for pharmaceutical purposes; tartar for pharmaceutical purposes; camphor for medical purposes; capsules for medicines; cachets for pharmaceutical purposes; hemostatic pencils; wart pencils; caustic pencils; headache pencils; carbolineum [parasiticide]; caustics for pharmaceutical purposes; cachou for pharmaceutical purposes; quassia for medical purposes; quebracho for medical purposes; oxygen for medical purposes; gallic acid for pharmaceutical purposes; acids for pharmaceutical purposes; adhesives for dentures; surgical glues; adhesive tapes for medical purposes; stem cells for veterinary purposes; stem cells for medical purposes; cocaine; collodion for pharmaceutical purposes; corn rings for the feet; anti-rheumatism rings; candy, medicated; angostura bark for medical purposes; barks for pharmaceutical purposes; cedar wood for use as an insect repellent; condurango bark for medical purposes; croton bark; mangrove bark for pharmaceutical purposes; myrobalan bark for pharmaceutical purposes; quinquina for medical purposes; medicated animal feed; medicinal roots; rhubarb roots for pharmaceutical purposes; lint for medical purposes; starch for dietetic or pharmaceutical purposes; creosote for pharmaceutical purposes; blood for medical purposes; biological tissue cultures for veterinary purposes; biological tissue cultures for medical purposes; cultures of microorganisms for medical and veterinary use; curare; dental lacquer; liquorice for pharmaceutical purposes; lactose for pharmaceutical purposes; candy for medical purposes; medicines for alleviating constipation; adhesive bands for medical purposes; lecithin for medical purposes; lotions for veterinary purposes; dog lotions; lotions for pharmaceutical purposes; personal sexual lubricants; lupulin for pharmaceutical purposes; magnesia for pharmaceutical purposes; liniments; ointments for pharmaceutical purposes; sunburn ointments; mercurial ointments; frostbite salve for pharmaceutical purposes; gauze for dressings; medicinal oils; mustard oil for medical purposes; camphor oil for medical purposes; castor oil for medical purposes; oil of turpentine for pharmaceutical purposes; dill oil for medical purposes; dental mastics; dental abrasives; dental impression materials; dressings, medical; surgical dressings; drugs for medical purposes; medicines for veterinary purposes; serotherapeutic medicines; medicines for human purposes; medicines for dental purposes; menthol; medicinal drinks; moleskin for medical purposes; milk of almonds for pharmaceutical purposes; royal jelly for pharmaceutical purposes; milk ferments for pharmaceutical purposes; irish moss for medical purposes; flour for pharmaceutical purposes; linseed meal for pharmaceutical purposes; fish

meal for pharmaceutical purposes; fly catching adhesives; mint for pharmaceutical purposes; dietetic beverages adapted for medical purposes; malted milk beverages for medical purposes; narcotics; medicinal infusions; tincture of iodine; eucalyptol for pharmaceutical purposes; tinctures for medical purposes; opium; opodeldoc; decoctions for pharmaceutical purposes; antiparasitic collars for animals; cotton swabs for medical purposes; stick liquorice for pharmaceutical purposes; sulphur sticks [disinfectants]; pastilles for pharmaceutical purposes; pectin for pharmaceutical purposes; pepsins for pharmaceutical purposes; peptones for pharmaceutical purposes; hydrogen peroxide for medical purposes; pesticides; leeches for medical purposes; blood plasma; eyepatches for medical purposes; poultices; compresses; scapulars for surgical purposes; babies' napkins [diapers]; diapers for pets; bunion pads; breast-nursing pads; pomades for medical purposes; powder of cantharides; pyrethrum powder; belts for sanitary napkins [towels]; anti-uric preparations; bacterial preparations for medical and veterinary use; bacteriological preparations for medical and veterinary use; balsamic preparations for medical purposes; albuminous preparations for medical purposes; biological preparations for veterinary purposes; biological preparations for medical purposes; bismuth preparations for pharmaceutical purposes; vitamin preparations; diagnostic preparations for veterinary purposes; diagnostic preparations for medical purposes; therapeutic preparations for the bath; hemorrhoid preparations; preparations for callouses; acne treatment preparations; preparations to facilitate teething; preparations for the treatment of burns; fumigation preparations for medical purposes; organotherapy preparations; air purifying preparations; eye-washes; bronchodilating preparations; preparations for reducing sexual activity; sterilising preparations; soil-sterilising preparations; corn remedies; pharmaceutical preparations for treating dandruff; preparations for destroying noxious animals; preparations for destroying dry rot fungus; larvae exterminating preparations; fly destroying preparations; preparations for destroying mice; slug exterminating preparations; vermin destroying preparations; pharmaceutical preparations for skin care; contact lens cleaning preparations; preparations of lime for pharmaceutical purposes; bath preparations for medical purposes; medicinal hair growth preparations; opiates; anticryptogamic preparations; aloe vera preparations for pharmaceutical purposes; preparations of trace elements for human and animal use; sulphonamides [medicines]; sunburn preparations for pharmaceutical purposes; enzyme preparations for veterinary purposes; enzyme preparations for medical purposes; chemico-pharmaceutical preparations; chemical preparations for veterinary purposes; chemical preparations for the diagnosis of pregnancy; chemical preparations for medical purposes; chemical preparations to treat

wheat smut; vine disease treating chemicals; chemical preparations to treat mildew; chemical preparations for treating phylloxera; chemical preparations for pharmaceutical purposes; chilblain preparations; mothproofing preparations; collyrium; lead water; chemical conductors for electrocardiograph electrodes; albuminous foodstuffs for medical purposes; dietetic foods adapted for medical purposes; by-products of the processing of cereals for dietetic or medical purposes; sanitary napkins; napkins for incontinents; sanitary pads; panty liners [sanitary]; propolis for pharmaceutical purposes; pearl powder for medical purposes; radium for medical purposes; hydrated chloral for pharmaceutical purposes; solvents for removing adhesive plasters; vaginal washes; solutions for contact lenses; chemical reagents for medical or veterinary purposes; gum for medical purposes; rubber for dental purposes; chewing gum for medical purposes; insect repellents; insect repellent incense; repellents for dogs; tissues impregnated with pharmaceutical lotions; sarsaparilla for medical purposes; sugar for medical purposes; asthmatic tea; fumigating sticks; suppositories; linseed for pharmaceutical purposes; tobacco-free cigarettes for medical purposes; siccatives [drying agents] for medical purposes; syrups for pharmaceutical purposes; turpentine for pharmaceutical purposes; milking grease; greases for veterinary purposes; greases for medical purposes; lacteal flour for babies; soporifics; bicarbonate of soda for pharmaceutical purposes; bath salts for medical purposes; salts for mineral water baths; salts for medical purposes; potassium salts for medical purposes; sodium salts for medical purposes; smelling salts; mineral water salts; malt for pharmaceutical purposes; semen for artificial insemination; alcohol for pharmaceutical purposes; medicinal alcohol; alloys of precious metals for dental purposes; ergot for pharmaceutical purposes; cooling sprays for medical purposes; adjuvants for medical purposes; styptic preparations; anthelmintics; disinfectants for hygiene purposes; disinfectants for chemical toilets; douching preparations for medical purposes; appetite suppressants for medical purposes; medical preparations for slimming purposes; parasiticides; mouthwashes for medical purposes; depuratives; animal washes; detergents for medical purposes; cattle washes; dog washes; vesicants; articles for headache; evacuants; remedies for perspiration; remedies for foot perspiration; chemical contraceptives; antiparasitic preparations; sedatives; tranquillizers; laxatives; tonics [medicines]; digestives for pharmaceutical purposes; nervines; bouillons for bacteriological cultures; steroids; strychnine; serums; tanning pills; appetite suppressant pills; slimming pills; jujube, medicated; antioxidant pills; sanitary tampons; vulnerary sponges; thymol for pharmaceutical purposes; smoking herbs for medical purposes; medicinal herbs; surgical implants comprised of living tissues; pants, absorbent, for

incontinents; sanitary pants; babies' napkin-pants; charcoal for pharmaceutical purposes; fennel for medical purposes; porcelain for dental prostheses; phenol for pharmaceutical purposes; enzymes for veterinary purposes; enzymes for medical purposes; ferments for pharmaceutical purposes; formic aldehyde for pharmaceutical purposes; phosphates for pharmaceutical purposes; quinine for medical purposes; chinoline for medical purposes; diabetic bread adapted for medical use; chloroform; flowers of sulphur for pharmaceutical purposes; cement for animal hooves; bone cement for surgical and orthopaedic purposes; dental cements; medicinal tea; herbal teas for medicinal purposes; eucalyptus for pharmaceutical purposes; tobacco extracts [insecticides]; extracts of hops for pharmaceutical purposes; elixirs [pharmaceutical preparations]; ethers for pharmaceutical purposes; esters for pharmaceutical purposes; cellulose esters for pharmaceutical purposes; cellulose ethers for pharmaceutical purposes; rat poison; poisons; bacterial poisons; jalap.

35 – Advertising; business management; business administration; office functions; arranging subscriptions to telecommunication services for others; import-export agencies; commercial information agencies; advertising agencies; cost price analysis; rental of advertising space; business auditing; employment agencies; computerized file management; accounting; invoicing; business efficiency expert services; demonstration of goods; transcription of communications [office functions]; opinion polling; marketing studies; business information; commercial information and advice for consumers [consumer advice shop]; business investigations; business research; marketing research; personnel recruitment; business management and organization consultancy; business organization consultancy; business management consultancy; personnel management consultancy; professional business consultancy; layout services for advertising purposes; marketing; business management of performing artists; business management of sports people; writing of curriculum vitae for others; news clipping services; updating of advertising material; updating and maintenance of data in computer databases; word processing; organization of exhibitions for commercial or advertising purposes; arranging newspaper subscriptions for others; organization of fashion shows for promotional purposes; organization of trade fairs for commercial or advertising purposes; shop window dressing; design of advertising materials; business appraisals; payroll preparation; data search in computer files for others; sponsorship search; business management assistance; commercial or industrial management assistance; presentation of goods on communication media, for retail purposes; economic forecasting; auctioneering; retail or wholesale services for pharmaceutical, veterinary and sanitary preparations and medical supplies; sales promotion for others; production of ad-

vertising films; office machines and equipment rental; rental of advertising time on communication media; publicity material rental; rental of billboards [advertising boards]; rental of vending machines; rental of sales stands; rental of photocopying machines; publication of publicity texts; radio advertising; distribution of samples; dissemination of advertising matter; direct mail advertising; writing of publicity texts; on-line advertising on a computer network; outdoor advertising; bill-posting; advertising by mail order; television advertising; document reproduction; compilation of statistics; compilation of information into computer databases; business inquiries; systemization of information into computer databases; advisory services for business management; negotiation and conclusion of commercial transactions for third parties; tax preparation; drawing up of statements of accounts; telemarketing services; psychological testing for the selection of personnel; outsourced administrative management for companies; business management of hotels; business management for freelance service providers; commercial administration of the licensing of the goods and services of others; business management of reimbursement programs for others; business project management services for construction projects; administrative processing of purchase orders; public relations; modelling for advertising or sales promotion; typing; relocation services for businesses; tax filing services; search engine optimisation; web site traffic optimisation; pay per click advertising; price comparison services; secretarial services; procurement services for others [purchasing goods and services for other businesses]; shorthand; outsourcing services [business assistance]; telephone answering for unavailable subscribers; photocopying services.

(260) AM 2017 90432 A

(800) 1327072

(891) 2016 05 17

(731) SUNECHO LIMITED

Julia House, 3 Themistokli Dervi Street
CY-1066 Nicosia, Cyprus

(540)



(591) brown, black, brown and orange.

(526) The trademark is protected as a whole. "ВКУСНО И ВЫГОДНО" shall not be subject to independent legal protection.

(511)

29 – Meat, fish, poultry and game; meat extracts; preserved, frozen, dried and cooked fruits and vegetables; jellies, jams, compotes; eggs; milk and milk products; edible oils and fats; ajvar [preserved peppers]; aloe vera prepared for human consumption; alginates for culinary purposes; anchovy; peanuts, prepared; artichokes, preserved; albumen for culinary purposes; white of eggs; beans, preserved; soya beans, preserved, for food; bouillon, including instant bouillon; ginger jam; ham; fatty substances for the manufacture of edible fats; toasted laver; edible birds' nests; peas, preserved; mushrooms, preserved; gelatine; meat jellies; jellies for food; fruit jellies; yolk of eggs; coconut fat; bone oil, edible; lard; suet for food; curd; fruit-based snack food; charcuterie; raisins; caviar; aubergine paste; vegetable marrow paste; fish roe, prepared; yogurt; sauerkraut; kephir [milk beverage]; kimchi [fermented vegetable dish]; isinglass for food; clams, not live; milk shakes; black pudding [blood sausage]; meat, tinned; fish, tinned; bouillon concentrates; gherkins; shrimps, not live; prawns, not live; buttercream; croquettes; silk-worm chrysalis, for human consumption; kumys [kumyss] [milk beverage]; spiny lobsters, not live; lecithin for culinary purposes; salmon, not live; onions, preserved; margarine; piccalilli; marmalade; peanut butter; cocoa butter; colza oil for food; coconut butter; corn oil; sesame oil; linseed oil for culinary purposes; olive oil for food; palm oil for food; palm kernel oil for food; sunflower oil for food; coconut oil; butter; shellfish, not live; almonds, ground; animal marrow for food; mussels, not live; peanut milk for culinary purposes; milk of almonds for culinary purposes; rice milk [milk substitute]; albumin milk; condensed milk; soya milk [milk substitute]; fish meal for human consumption; vegetable mousses; fish mousses; fruit pulp; meat, preserved; milk beverages, milk predominating; potato fritters; olives, preserved; lobsters, not live; coconut, desiccated; nuts, prepared; tomato paste; liver pastes; pectin for culinary purposes; liver; pickles; powdered eggs; foods made from fish; prostokvasha [soured milk]; pollen prepared as foodstuff; cranberry sauce [compote]; poultry, not live; tomato purée; apple purée; crayfish, not live; crustaceans, not live; fish, preserved; fish, not live; salted fish; ryazhenka [fermented baked milk]; vegetable salads; fruit salads; bacon; sardines, not live; pork; herrings, not live; seeds, prepared; sunflower seeds, prepared; cream [dairy products]; whipped cream; fat-containing mixtures for bread slices; smetana [sour cream]; tomato juice for cooking; vegetable juices for cooking; salted meats; sausages; sausages in batter; preparations for making bouillon including instant bouillon; preparations for making soup including instant soup; soups, including instant soups; tripe; vegetable soup preparations including instant soup; whey; cheese; tahini [sesame seed paste]; tofu; sea-

cucumbers, not live; truffles, preserved; tuna fish, not live; oysters, not live; milk ferments for culinary purposes; rennet; fish fillets; dates; crystallized fruits; potato flakes; mashed potatoes; hummus [chick-pea paste]; fruit peel; preserved garlic; lentils, preserved; potato chips; low-fat potato chips; fruit chips; non-alcoholic eggnog; seaweed extracts for food; snail eggs for consumption.

30 – Coffee, tea, cocoa and artificial coffee; tapioca and sago; flour and preparations made from cereals; bread, pastry and confectionery; edible ices; sugar, honey, treacle; yeast, baking-powder; salt; mustard; vinegar, sauces (condiments); spices; ice for refreshment; aromatic preparations for food; flavorings [flavourings], other than essential oils, for cakes; flavorings [flavourings], other than essential oils, for beverages; coffee flavorings [flavourings]; food flavourings, other than essential oils; star aniseed; cereal bars; high-protein cereal bars; pancakes; noodle-based prepared meals; buns; bread rolls; vanillin [vanilla substitute]; vanilla [flavoring]; vareniki [stuffed dumplings]; waffles; vermicelli [noodles], including instant noodles; natural sweeteners; sausage binding materials; binding agents for ice cream [edible ices]; sea water for cooking; seaweed [condiment]; malt biscuits; cloves [spice]; cake frosting [icing]; glucose for culinary purposes; gluten additives for culinary purposes; thickening agents for cooking foodstuffs; leaven; rice-based snack food; cereal-based snack food; vegetal preparations for use as coffee substitutes; dressings for salad; fruit jellies [confectionery]; candy decorations for cakes; confectionery for decorating Christmas trees; cakes; pastries; peanut confectionery; almond confectionery; pasta including instant pasta; ginger [spice]; frozen yogurt [confectionery ices]; capers; caramels [candy]; curry [spice]; ketchup [sauce]; quiches; gluten prepared as foodstuff; sweetmeats [candy]; liquorice [confectionery]; peppermint sweets; cinnamon [spice]; unroasted coffee; starch for food; crackers; custard; hominy grits; semolina; oatmeal; crushed barley; pepper; allspice; peppers [seasonings]; pesto [sauce]; biscuits; petit-beurre biscuits; pies; pizzas; meat gravies; fondants [confectionery]; popcorn; powders for ice cream; mustard meal; pralines; meat tenderizers, for household purposes; cereal preparations; oat-based food; propolis; gingerbread; petits fours [cakes]; rice pudding; puddings; cake powder; fruit coulis [sauces]; ravioli; chewing gum; relish [condiment]; rice including instant rice; wheat germ for human consumption; spring rolls; palm sugar; aniseed; linseed for human consumption; golden syrup; cake dough; baking soda [bicarbonate of soda for cooking purposes]; malt for human consumption; salt for preserving foodstuffs; cooking salt; celery salt; sorbets [ices]; ham glaze; soya sauce; tomato sauce; pasta sauce; spaghetti including instant spaghetti; seasonings; preparations for stiffening whipped cream; rusks; breadcrumbs; sandwiches; tab-

bouleh; tacos; cream of tartar for culinary purposes; tarts; dough; pastry dough; almond paste; tortillas; garden herbs, preserved [seasonings]; beer vinegar; ferments for pastes; halvah; unleavened bread; chips [cereal products]; corn flakes; oat flakes; chicory [coffee substitute]; iced tea; chutneys [condiments]; cheeseburgers [sandwiches]; chow-chow [condiment]; saffron [seasoning]; chocolate; malt extract for food; essences for foodstuffs, except etheric essences and essential oils; husked barley.

(260) AM 2017 90433 A

(800) 1327076

(891) 2016 10 05

(731) Obshchestvo s ogranichennoy
otvetstvennost'yu "Koordiniroyushchy
raspredelitel'ny tsentr "EFKO-Kaskad"
ul. Frunze 4, g. Alekseevka RU-309850
Belgorodskaya obl., Russian Federation

(540)



(591) White, light beige, beige, yellow, green,
black, blue and light grey.

(511)

29 – Milk products, in particular yogurts, sour cream, curd desserts.

35 – Promoting the goods of others; retail and wholesale services for all the above-mentioned milk products.

(260) AM 2017 90434 A

(800) 1327100

(891) 2016 08 24

(731) CAGS TOBACCO TUTUN VE TUTUN
MAMULLERI SANAYI VE TICARET
ANONIM SIRKETI
Ankara Cad. Polat Is Merkezi, No:108/78
Kartal Istanbul, Turkey

(540)



(591) white, Blue, Light blue

(526) The trademark is protected as a whole. "TOBACCO" shall not be subject to independent legal protection.

(511)

34 – Tobacco; chewing tobacco; cigarettes; cigars; cigarette cases; tobacco pipes; cigar holders; cigarette holders; mouthpieces for cigarette holders; mouthpieces for cigar holders; smokers' articles namely, ashtrays for smokers, humidors, pocket machines for rolling cigarettes, cigarette paper, firestones, lighters for smokers; matches.

(260) AM 2017 90435 A

(800) 1327133

(891) 2016 06 21

(731) Excellent Brands JMI Limite
Excellent Brands JMI Limited
Oberneuhofstrasse 1, CH-6341 Baar,
Switzerland

(540)



(591) Gold

(511)

29 – Fat-containing mixtures for bread slices; fish; fish fillets; foods made from fish; canned fish; meat; canned meat; meat products; fruit preserved in alcohol; crystallized fruits; fruit salads; fruit-based snack food; cheese; jams; marmalade; milk; milk beverages, milk predominating; milk shakes; milk products; whey; processed fruits; cooked fruits; preserved fruits; frozen fruits; edible oils; sausages, namely bratwurst, boiled sausage; charcuterie.

30 – Sweetmeats (candy); bread; rolls (bread), pastries; sandwiches; edible ices; tea-based beverages; coffee-based beverages; cocoa-based beverages; chocolate based beverages; honey; coffee; unroasted coffee; coffee flavourings; artificial coffee; vegetal preparations for use as coffee substitutes; cocoa; sugar; rock candy for food purposes; biscuits; cakes; gingerbread; marzipan; farinaceous foods; chocolate; tarts; tea; confectionery; ice cream; chocolate bars; sugar-free confectionaries.

33 – Alcoholic beverages (except beers); sparkling wines; spirits (beverages); wine.

43 – Restaurant, café, cafeteria and snack-bar services; food and drink preparation for takeaway ser-

vices; bar services; services for providing food and drink in cafés and cafeterias; catering.

(260) AM 2017 90437 A
(800) 1327173
(891) 2016 10 14
(731) ASTELLAS PHARMA INC.
5-1, Nihonbashi-Honcho 2-chome, Chuo-ku
Tokyo 103-8411, Japan

(540)

XOSPATA

(591) Black, white

(511)

5 – Pharmaceutical preparations for the treatment of cancer.

(260) AM 2017 90438 A
(800) 1327174
(891) 2016 10 14
(731) ASTELLAS PHARMA INC.
5-1, Nihonbashi-Honcho 2-chome, Chuo-ku
Tokyo 103-8411, Japan

(540)

VYLOY

(591) Black, white

(511)

5 – Pharmaceutical preparations for the treatment of cancer.

(260) AM 2017 90439 A
(800) 1327175
(891) 2016 10 14
(731) ASTELLAS PHARMA INC.
5-1, Nihonbashi-Honcho 2-chome, Chuo-ku
Tokyo 103-8411, Japan

(540)

SELGILTA

(591) Black, white

(511)

5 – Pharmaceutical preparations for the treatment of cancer.

(260) AM 2017 90440 A
(800) 1327176
(891) 2016 10 14
(731) ASTELLAS PHARMA INC.
5-1, Nihonbashi-Honcho 2-chome, Chuo-ku
Tokyo 103-8411, Japan

(540)

ILTAGA

(591) Black, white

(511)

5 – Pharmaceutical preparations for the treatment of cancer.

(260) AM 2017 90441 A
(800) 1327205
(891) 2016 01 15
(731) COMITÉ INTERNATIONAL OLYMPIQUE
Château de Vidy, CH-1007 Lausanne,
Switzerland

(540)

BEIJING 2022



(591) Blue, yellow, black, green and red.

(511)

35 – Advertising; dissemination of advertising matter via all media, particularly in the form of thematic messages focused on human values; advertising by sponsoring; commercial business management; commercial administration; office functions; promotion of the goods and services of others, by means of contractual agreements, particularly sponsoring and licensing agreements, enabling them to gain additional notoriety and/or enhanced image and/or a surge of sympathy derived from the notoriety and/or enhanced image resulting from cultural and sporting events, particularly international events, and/or a surge of sympathy generated by the above; promotion of the goods and services of others by means of what is referred to as the initial interest factor leading the public to consider, among a multitude of competitors, goods or services presented to the public by means of signs, emblems or messages aimed at capturing its attention; promotion of the goods and services of others by means of the so-called image transfer; rental of advertising space of all type and on all media, whether digital or not; commercial administration of the participation of national teams to an international athletic competition, and promotion of the support to said teams with the public and concerned circles; inventory management services; consultation relating to stock monitoring services; advertising by means of direct marketing for others consisting in marketing of databases; consultation for advertising by means of direct marketing for others consisting in marketing of databases; consultation services in connection with business reorganization; truck and automobile fleet management services, namely billing and consulting in connection with the administrative management of truck and automobile fleets; business administration consultancy; administrative management of power plants of others; business consultation in connection with the

management of power plants, commercial services, namely administration of contracts for repair and servicing, supply chain management services and consulting services relating to the purchase and supply of chemical services and products, supply management and product inventory, limitation of costs; consulting, marketing, analysis of prices and costs concerning devices for electrochemical purification of liquids for industrial use; administrative, commercial and technical management of computer files; data input and processing services; retail sale of electric and electronic machines and apparatus (the bringing together, for the benefit of others, of a range of goods so as to enable customers to view and purchase said goods at their convenience in a retail store carrying electrical goods), information concerning the sale of raw materials, commercial information, commercial information agencies, rental of photocopiers; promotion of the sale of goods and services of others including by means of advertisements, promotional competitions, awarding of prizes and bonuses in the form of promotional lotteries, discounts, reduction tokens and value-added offers in connection with the use of payment cards; promoting sporting competitions and events for use by others; promoting concerts and cultural events for others, organization of exhibitions for commercial or advertising purposes; provision of documentation, namely direct mail advertising, distribution of advertising material, distribution of samples, reproduction of documents; advertising concerning the promotion of commercial sales of goods and services for retail sale purposes; provision of information in connection with e-commerce and electronic retail sale; provision of information concerning the purchase of goods and services on line via the Internet and other computer networks; tourist documentation services through tourist agencies, namely advertising concerning transport, travel, hotels, accommodation, food and meals, sports, entertainment and sightseeing tours; maintenance of computerized databases; computerized file management, namely, digital file management comprising a portfolio of images and video sequences intended for use under license in traditional advertising and in the promotion of behavior (moral advertising); retail services or wholesale services for tires; retail services or wholesale services for sports goods; retail services or wholesale services for bicycles and parts and fittings for bicycles.

41 – Educational services; training; entertainment; sporting and cultural activities, televised sporting and cultural entertainment; organization of exhibitions for cultural and educational purposes; organization of lotteries and competitions; betting and gambling services in connection with or relating to sports; entertainment services provided during sporting events or concerning sporting events; organization of sporting and cultural events and activities; organization of real or virtual sporting competitions;

operation of sports facilities; rental of audio and video equipment, production of films, other than advertising films; production of sound and video recordings; presentation and distribution of films and of sound and video recordings; rental of sound and video recordings; rental and/ or provision via a computer network of interactive education and entertainment products, namely interactive compact discs, CD-ROMs, computer games; entertainment, namely presentation of interactive education and entertainment products, namely interactive compact discs, CD-ROMs, computer games; coverage of radio broadcast and televised sports events; production of television and radio programs and of videotapes; production of cartoons; production of animated programs for television; reservation of tickets for sporting events and shows; timing of sports events; organization of beauty contests; interactive entertainment; on-line betting services; provision of games on the Internet; provision of raffle services; information concerning entertainment or education, provided on line from a data bank or the Internet; electronic game services provided by means of the Internet; providing on line electronic publications; publication of books, magazines, texts (other than advertising texts) and periodicals; online publication of electronic books, magazines, texts (other than advertising texts) and periodicals; provision of digital music from the Internet; provision of digital music from MP3 web sites; provision of sporting results; information services concerning sports and sporting events; rental of recorded sounds and images; audio production services; information services concerning sporting events provided on line from a computer database or the Internet; editing and publishing services; provision of digital music (non-downloadable); offering digital music by means of telecommunications; publication of statistics regarding sporting results and audience ratings for sporting competitions; training in the use and operation of systems for signaling and notification of crossings for the railway and transit industries; education services in the field of medical imaging and diagnosis, namely conducting of seminars, conferences, symposiums or workshops concerning the pharmaceutical industry, intended for medical practitioners and employees of pharmaceutical companies; education services, namely conducting of seminars, conferences, symposiums or workshops in the field of life sciences and biotechnology for scientists and researchers; conducting of seminars on problems in connection with industrial water treatment; training services in all the aforesaid fields; training services in the field of management and medicine by means of the use of instructions and demonstrations provided on line, via the Internet, intranets and extranets; education services, namely conducting of practical training workshops, courses and seminars including demonstrations in the field of medicine and management; de-

sign, conducting and hosting of courses, seminars and all training activities in the field of information technology; organization and performance of concerts; booking of seats for shows; movie presentations; entertainment information; film production; show production; theater production services; operation of golf facilities; health club services (fitness training); sports camp services; presentation of live performances; film projection; organization of shows (impresario services); holiday camp services [entertainment]; movie studios; news reporters services; provision of online electronic publications, not downloadable; music hall services; education services, namely conducting of courses, seminars, presentations, video presentations; provision of educational material, namely dissemination of material in the field of financial knowledge; education services in the field of tourism; information services in the field of tourism, namely information services regarding reservation of tickets for recreational events; information services in the field of tourism, namely information services regarding entertainment; information services in the field of tourism, namely information services regarding planned sporting, cultural and recreational activities; services in connection with entertainment for tourist assistance; tourist reservation services, namely activity and entertainment reservation services; assistance services for tourists concerning reservation of tickets for recreational events; assistance services for tourists concerning planned sporting, cultural and recreational activities; presenting of prizes rewarding the authors of exceptional acts or performances; organization and conducting of ceremonies in connection with the awarding of prizes and rewards.

(260) AM 2017 90442 A

(800) 1327207

(891) 2016 03 03

(731) COMITÉ INTERNATIONAL OLYMPIQUE
Château de Vidy, CH-1007 Lausanne,
Switzerland

(540)

 LOS ANGELES 2024

(591) Black, white

(511)

35 – Advertising; dissemination of advertising matter via all media, in particular in the form of thematic messages centered on human values; advertising by sponsoring; commercial business management; commercial administration; office functions; promoting the goods and services of others, by means of contractual agreements, in particular sponsoring and licensing agreements, enabling them to gain additional notoriety and/or enhanced image and/or a surge of sympathy derived from the notoriety and/or enhanced image resulting from cultural and sporting

events, in particular international events, and/or a surge of sympathy generated by the above; promoting the goods and services of others by means of what is referred to as the initial interest factor leading the public to consider, among a multitude of competitors, goods or services presented to the public bearing signs, emblems or messages able to capture its attention; promoting the goods and services of others by means of the so-called image transfer; rental of advertising space of all type and on all media, whether digital or not; business administration of the participation of national teams to an international athletic competition, and promoting the support to said teams with the public and the concerned circles; inventory management services; consultation relating to stock monitoring services; advertising by means of direct marketing for others consisting in marketing of databases; consultation for advertising by means of direct marketing for others consisting in marketing of databases; consultation services in connection with business reorganization; truck and automobile fleet management services, namely billing and consulting in connection with the administrative management of truck and automobile fleets; business administration consultancy; administrative management of power plants of others; business consultation in connection with the management of power plants, commercial services, namely administration of contracts for repair and servicing, supply chain management services and consulting services relating to the purchase and supply of chemical services and products, supply management and product inventory, limitation of costs; consulting, marketing, analysis of prices and costs concerning devices for electrochemical purification of liquids for industrial use; administrative, commercial and technical management of computer files; data input and processing services; retail sale of electric and electronic machines and apparatus (the bringing together, for the benefit of others, of a range of goods so as to enable customers to view and purchase said goods at their convenience in a retail store carrying electrical goods), information concerning the sale of raw materials, commercial information, commercial information agencies, rental of photocopiers; promotion of the sale of goods and services of others including by means of advertisements, promotional competitions, awarding of prizes and bonuses in the form of promotional lotteries, discounts, reduction tokens and value-added offers in connection with the use of payment cards; promoting sporting competitions and events for use by others; promoting concerts and cultural events for others, organization of exhibitions for commercial or advertising purposes; provision of documentation, namely direct mail advertising, distribution of advertising material, distribution of samples, reproduction of documents; advertising concerning the promotion of commercial sales of goods and services for retail sale purposes; provision of

information in connection with e-commerce and electronic retail sale; provision of information concerning the purchase of goods and services on line via the Internet and other computer networks; tourist documentation services through tourist agencies, namely advertising concerning transport, travel, hotels, accommodation, food and meals, sports, entertainment and sightseeing tours; maintenance of computerized databases; computerized file management, namely, digital file management comprising a portfolio of images and video sequences intended for use under license in traditional advertising and in the promotion of behavior (moral advertising); retail services or wholesale services for tires; retail services or wholesale services for sports goods; retail services or wholesale services for bicycles and parts and fittings for bicycles.

41 – Educational services; training; entertainment; sporting and cultural activities, televised sporting and cultural entertainment; organization of exhibitions for cultural and educational purposes; organization of lotteries and competitions; betting and gambling services in connection with or relating to sports; entertainment services provided during sporting events or concerning sporting events; organization of sporting and cultural events and activities; organization of real or virtual sporting competitions; management of sports facilities; rental of audio and video equipment, production of films, other than advertising films; production of sound and video recordings; presentation and distribution of films and of sound and video recordings; rental of films and of sound and video recordings; rental and/or provision via a computer network of interactive education and entertainment products, namely interactive compact discs, CD-ROMs, computer games; entertainment, namely presentation of interactive education and entertainment products, namely interactive compact discs, CD-ROMs, computer games; radio and television coverage of sporting events; production of television and radio programs and of videotapes; production of cartoons; production of animated programs for television; reservation of tickets for sporting events and shows; timing of sports events; organization of beauty contests; interactive entertainment; on-line betting services; provision of games on the Internet; provision of raffle services; information concerning entertainment or education, provided on line from a data bank or the Internet; electronic game services provided by means of the Internet; providing on line electronic publications; publication of books, magazines, texts (other than advertising texts) and periodicals; online publication of electronic books, magazines, texts (other than advertising texts) and periodicals; provision of digital music from the Internet; provision of digital music from MP3 web sites; provision of sporting results; information services concerning sports and sporting events; rental of recorded sounds and images; audio

production services; information services concerning sporting events provided on line from a computer database or the Internet; editing and publishing services; provision of digital music (non-downloadable); offering digital music by means of telecommunications; publication of statistics regarding sporting results and audience ratings for sporting competitions; training in the use and operation of systems for signaling and notification of crossings for the railway and transit industries; education services in the field of medical imaging and diagnosis, namely conducting of seminars, conferences, symposiums or workshops concerning the pharmaceutical industry, intended for medical practitioners and employees of pharmaceutical companies; education services, namely conducting of seminars, conferences, symposiums or workshops in the field of life sciences and biotechnology for scientists and researchers; conducting of seminars on problems in connection with industrial water treatment; training services in all the aforesaid fields; training services in the field of management and medicine by means of the use of instructions and demonstrations provided on line, via the Internet, intranets and extranets; education services, namely conducting of practical training workshops, courses and seminars including demonstrations in the field of medicine and management; design, conducting and hosting of courses, seminars and all training activities in the field of information technology; organization and performance of concerts; booking of seats for shows; movie presentations; entertainment information; film production; show production; theater production services; operation of golf facilities; health club services (fitness training); sports camp services; presentation of live performances; film projection; organization of shows (impresario services); holiday camp services [entertainment]; movie studios; news reporters services; provision of on-line electronic publications, not downloadable; music hall services; education services, namely conducting of courses, seminars, presentations, video presentations; provision of educational material, namely dissemination of material in the field of financial knowledge; education services in the field of tourism; information services in the field of tourism, namely information services regarding reservation of tickets for recreational events; information services in the field of tourism, namely information services regarding entertainment; information services in the field of tourism, namely information services regarding planned sporting, cultural and recreational activities; services in connection with entertainment for tourist assistance; tourist reservation services, namely activity and entertainment reservation services; assistance services for tourists concerning reservation of tickets for recreational events; assistance services for tourists concerning planned sporting, cultural and recreational activities; presenting of prizes rewarding the authors of ex-

ceptional acts or performances; organization and conducting of ceremonies in connection with the awarding of prizes and rewards.

(260) AM 2017 90444 A
(800) 1327225
(891) 2016 10 21
(731) PHARMA MAR, S.A.

Polígono Industrial La Mina Norte, Avda. de Los Reyes, 1 E-28770 Colmenar Viejo (Madrid), Spain

(540)

IZELCAN

(511)

5 – Pharmaceutical and veterinary preparations; sanitary preparations for medical purposes; dietetic substances adapted for medical use, food for babies; plasters, materials for dressings; material for stopping teeth, dental wax; disinfectants; preparations for destroying vermin; fungicides, herbicides.

(260) AM 2017 90445 A
(800) 1327255
(891) 2015 11 13

(731) CONG TY TRACH NHIEM HUU HAN
HOANG PHUC QUOC TE (Also known as
HOANG PHUC INTERNATIONAL
COMPANY LIMITED)
137 Nguyen Trai, Phuong Ben Thanh, Quan 1
Thanh Pho Ho Chi Minh, Viet Nam

(540)

NINU & NICK

(511)

25 – Ready-made clothing, namely T-shirts, shirts, jackets (clothing), suits, pants, trousers, breeches for wear, shorts, skirts and dresses; footwear; headgear for wear, namely, caps and hats; ties (clothing); neckties; belts (clothing); underwear; socks; stocking.

(260) AM 2017 90446 A
(800) 1327262
(891) 2016 08 30
(731) DOOSHION GARMENT CO., LTD
Bldg. 24, Sanfengli, Chaowai Street,
Chaoyang District Beijing, China

(540)

MISUN

(591) Black, white

(511)

18 – Leather, unworked or semi-worked; wallets (pocket -); travelling sets [leatherware]; shopping bags; furniture coverings of leather; laces (leather -); umbrellas; canes; saddlery; gut for making sausages.

24 – Cloth; labels of cloth; tapestry [wall hangings], of textile; felt; towels of textile; bed clothes; furniture (loose covers for -); curtains of textile or plastic; hada (a piece of silk used as a greeting gift among the zang and mongol nationalities); banners.

25 – Clothing; shoes; hats; hosiery; gloves [clothing]; neckties; belts [clothing]; sashes for wear; sleep masks; wedding dress.

35 – Presentation of goods on communication media, for retail purpose; administration (commercial -) of the licensing of the goods and services of others; sales promotion [for others]; personnel recruitment; relocation services for businesses; administrative processing of purchase orders; drawing up of statements of accounts; rental of vending machines; rental of sale display; retail and wholesale services for pharmaceutical, veterinary and sanitary preparations, and medical supplies.

(260) AM 2017 90448 A
(800) 1327292
(891) 2016 08 29
(731) POLFARMEX S.A
ul. Józefów 9 PL-99-300 Kutno, Poland

(540)

falsigra

(591) Black, white

(511)

5 – Pharmaceutical preparations, including pharmaceutical preparations for the treatment of erectile dysfunctions.

(260) AM 2017 90453 A
(800) 1328057
(891) 2016 01 19
(731) SALMAN KHAN
3 Galaxy Apartments, B.J. Road, Bandstand,
Bandra (West), Mumbai 400050, Maharashtra,
India

(540)

BEING HUMAN

(511)

3 – Essential oils, hair oils, talcum powder and beauty creams, petroleum jelly for cosmetic purposes, soaps; detergents; tooth paste, shampoos, body wash, face wash, shaving creams, after shave lotion, hair lotions, ethereal essence (or badian, mint essence), potpourris [fragrances] and perfumery products, bath gels (cosmetic gels), bleaching preparations and other substances for laundry use; cleaning, polishing, scouring and abrasive preparation; dentifrices.

9 – Sunglasses, glasses, frames for glasses; headphones, USB flash drives, USB modems, tablets, eye-glass cases and eyeglass chains, data card; tele-

communication devices and apparatus, parts and accessories; carrying cases for ipod; wireless computer peripherals and wireless communication apparatus; telephones, electrical and electronic devices and parts therefor in this class; computers, computer programmes, computer apparatus, floppy disks, compact disks, hard disks for computers and digital video disks, computer software, computer hardware and peripherals.

14 – Watches, clocks, timepieces, components and parts thereof, horological instruments; cuff links; precious metals and their alloys and goods made therefrom; jewellery, costume jewellery, precious stones and ornaments (jewellery).

18 – Leather and imitations of leather; leather purses, leather bags, travelling bags, sports bags, hand bags, shoulder bags, school bags, brief cases, shopping bags, trunks, suitcases, wallets, articles made from leather, skins, hides, umbrellas, parasols and walking sticks, whips, harness, saddlery, articles of leather and luggage tags and travelling sets.

25 – Clothing and apparel (clothing, footwear, headgear) including hosiery, underclothing, undergarments, footwear, headgear, sportswear and kids wear; caps, socks, t-shirts, shirts, trousers, suits, blazers, neckties, waist belts, gloves, jackets, belts of leather (clothing), ready-made clothing, windcheaters, scarves, stoles.

35 – Services relating to retail sale of clothing and apparel (clothing, footwear, headgear), hosiery, footwear, headgear, t-shirts, belts, bags, articles made from leather and imitation of leather, luggage tags and travelling sets, watches, timepieces, sunglasses, jewellery, imitation jewellery; the bringing together for the benefit of others of a variety of the aforementioned goods thereby enabling customers to conveniently view and purchase those goods in a mall, store, retail outlet; organizing/arranging exhibitions for commercial or advertising purposes.

(260) AM 2017 90454 A
(800) 1327498
(891) 2016 09 16
(731) Joint Stock Company "YASNAYA POLYANA"
Odojevskoye shosse, 83, RU-300036 g. Tula,
Russian Federation

(540)
МИСС ЯГОДКА

(591) black and white

(511)

30 – Confectionery; sweetmeats [candy]; boiled sweets; pralines; chocolate; crackers; gingerbread; cookies; malt biscuits; waffles; confectionery; ice cream; bread, pastries and confectionery.

(260) AM 2017 90455 A
(800) 1327500
(891) 2016 10 26
(731) SATIUS LLC
ofis 192, etaj 2, korp. 3, d. 38, prospect
Andropova, RU-115487 Moscow, Russian
Federation

(540)

ENTEROTEST

(591) black and white

(511)

10 – Surgical, medical, dental and veterinary apparatus and instruments; diagnostic apparatus for medical purposes; blood testing apparatus; testing apparatus for medical purposes; diagnostic devices for medical purposes.

(260) AM 2017 90456 A
(800) 1327501
(891) 2016 10 26
(731) SATIUS LLC
ofis 192, etaj 2, korp. 3, d. 38, prospect
Andropova, RU-115487 Moscow, Russian
Federation

(540)

ANGIOTEST

(591) black and white

(511)

10 – Surgical, medical, dental and veterinary apparatus and instruments; diagnostic apparatus for medical purposes; blood testing apparatus; testing apparatus for medical purposes; diagnostic devices for medical purposes.

(260) AM 2017 90457 A
(800) 1327502
(891) 2016 10 26
(731) SATIUS LLC
ofis 192, etaj 2, korp. 3, d. 38, prospect
Andropova, RU-115487 Moscow, Russian
Federation

(540)

CARDIATEST

(591) black and white

(511)

10 – Surgical, medical, dental and veterinary apparatus and instruments; diagnostic apparatus for medical purposes; blood testing apparatus; testing apparatus for medical purposes; diagnostic devices for medical purposes.

(260) AM 2017 90459 A
 (800) 1327503
 (891) 2016 10 26
 (731) SATIUS LLC
 ofis 192, etaj 2, korp. 3, d. 38, prospect
 Andropova, RU-115487 Moscow, Russian
 Federation

(540)

GRIPPATEST

(591) black and white

(511)

10 – Surgical, medical, dental and veterinary apparatus and instruments; diagnostic apparatus for medical purposes; blood testing apparatus; testing apparatus for medical purposes; diagnostic devices for medical purposes.

(260) AM 2017 90461 A
 (800) 1327504
 (891) 2016 10 26
 (731) SATIUS LLC
 ofis 192, etaj 2, korp. 3, d. 38, prospect
 Andropova, RU-115487 Moscow, Russian
 Federation

(540)

SEPTITEST

(511)

10 – Surgical, medical, dental and veterinary apparatus and instruments; diagnostic apparatus for medical purposes; blood testing apparatus; testing apparatus for medical purposes; diagnostic devices for medical purposes.

(260) AM 2017 90463 A
 (800) 1327508
 (891) 2016 11 03
 (731) KRKA, tovarna zdravil, d.d., Novo mesto
 Šmarješka cesta 6, SI-8000 Novo mesto,
 Slovenia

(540)

EXDIAR

(511)

5 – Pharmaceutical preparations.

(260) AM 2017 90465 A
 (800) 1327509
 (891) 2016 11 03
 (731) KRKA, tovarna zdravil, d.d.
 Šmarješka cesta 6, SI-8501 Novo mesto,
 Slovenia

(540)

FRIDIAR

(511)

5 – Pharmaceutical preparations.

(260) AM 2017 90466 A
 (800) 1327524
 (891) 2016 09 23
 (731) Open-Type Joint Stock Company
 "CONFECTIONARY CONCERN
 BABAYEVSKY"
 ul. Malaya Krasnoselskaya, d. 7, RU-107140
 Moscow, Russian Federation

(540)

ТИГРЕНОК

(591) black and white

(511)

30 – Confectionery.

(260) AM 2017 90467 A
 (800) 1327561
 (891) 2016 09 14
 (731) MOVADO WATCH COMPANY S.A.
 Bettlachstrasse 8, CH-2540 Grenchen,
 Switzerland

(540)

MOVADO

(511)

9 – Smart watches; portable digital electronic devices for the detection, recording, storage, transmission and reception of text, data, audio, images and video files via communication networks, including devices which communicate with smartphones, computers, computer peripherals, personal digital assistants (PDA), apparatus for recording and reproducing sound and Internet sites; software and electronic apparatus relating to the aforesaid goods, as well as software and electronic apparatus for monitoring, processing, indicating, storing and transmitting data related to a user's physical activity, compliance with health and fitness programs, geolocation, direction, distance, altitude, speed, steps taken, level of activity, calories burned, navigation information, weather information and biometric data; computer software providing access to databases and for searching in databases concerning all the aforesaid.

(260) AM 2017 90468 A
 (800) 1327563
 (891) 2016 09 08
 (731) ALSTOM
 48 rue Albert Dhalenne, F-93400
 Saint – Ouen, France

(540)

ALSTOM PRIMA

(591) black and white

(511)

12 – Land vehicles, namely, railway vehicles and their parts and spare parts; locomotives, in particular

locomotives for transporting freight and/or passengers, their components and their spare parts; wagons, bogies, bodies, engines for railway vehicles.

37 – Repair and maintenance of railway vehicles and their parts, in particular bogies; construction, repair and maintenance of railways and all railway infrastructure.

39 – Rail transport of passengers; transport of freight by rail; rail transport of products; transport of freight containers by rail; information services related to railway transport.

42 – Study of railway engineering projects; technical evaluations related to design in the railway field (engineering works); design of railway vehicles (engineering works); technical expertise services in the railway field (engineering works); technical project studies in the railway field (engineering works); engineering in the field of railway transport.

(260) AM 2017 90473 A
(800) 1328091
(891) 2016 06 21
(731) EXCELLENT BRANDS JMI LIMITED
Oberneuhofstrasse 1 CH-6341 Baar,
Switzerland
(540)

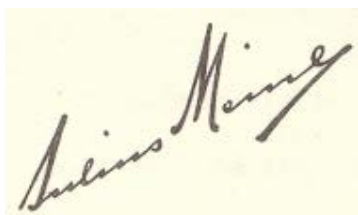

(591) Brown and beige
(511)

29 – Fat-containing mixtures for bread slices; fish; fish fillets; foods made from fish; canned fish; meat; canned meat; meat products; fruit preserved in alcohol; crystallized fruits; fruit salads; fruit-based snack food; cheese; jams; marmalade; milk; milk beverages, milk predominating; milk shakes; milk products; whey; processed fruits; cooked fruits; preserved fruits; frozen fruits; edible oils; sausages, namely bratwurst, boiled sausage; charcuterie.

30 – Sweetmeats (candy); bread; rolls (bread), pastries; sandwiches; edible ices; tea-based beverages; coffee-based beverages; cocoa-based beverages; chocolate based beverages; honey; coffee; unroasted coffee; coffee flavourings; artificial coffee; vegetal preparations for use as coffee substitutes; cocoa; sugar; rock candy for food purposes; biscuits; cakes; gingerbread; marzipan; farinaceous foods; chocolate; tarts; tea; confectionery; ice cream; chocolate bars; sugar-free confectionaries.

33 – Alcoholic beverages (except beers); sparkling wines; spirits (beverages); wine.

43 – Restaurant, café, cafeteria and snack-bar services; takeaway food and drink services; bar services; services for providing food and drink in cafés and cafeterias; catering.

(260) AM 2017 90500 A
(800) 664022
(891) 2016 11 24
(731) DANCERIA AG
Rämistrasse 3, CH-8024 Zurich, Switzerland
(540)

BOLCHOJ

(511)
33 – Alcoholic beverages (except for beers).

(260) AM 2017 90501 A
(800) 759374
(891) 2016 12 26
(731) LABORATOIRE INNOTECH
INTERNATIONAL
22 avenue Aristide Briand, F-94110 Arcueil,
France
(540)

DERMOBACTER

(511)
5 – Pharmaceutical, veterinary and sanitary products, dietetic substances for medical use, food for babies, plasters, material for dressings, material for dental fillings and dental impressions, disinfectants.

(260) AM 2017 90502 A
(800) 1228500
(891) 2016 12 22
(731) CHAOYANG LONG MARCH TYRE CO., LTD.
No.1, Xiangyang Road, Longcheng District,
Chaoyang Liaoning Province, China
(540)



(591) Black, white
(511)
12 – Vehicle wheel tires [tyres].

(260) AM 2017 90503 A
(800) 1271773
(891) 2016 11 15
(731) NOVARTIS AG
CH-4002 Basel, Switzerland
(540)

NOVARTIS ACCESS

(511)
5 – Pharmaceutical and veterinary products; sanitary products for medical purposes; dietetic food and

substances for medical or veterinary use, food for babies; food supplements for humans and animals; plasters, materials for dressings; material for dental fillings and dental impressions; disinfectants; products for destroying vermin; fungicides, herbicides.

10 – Surgical, medical, dental and veterinary apparatus and instruments, artificial limbs, eyes and teeth; orthopedic articles; suture material.

35 – Retail sale or wholesale services; business consultancy services; business management; business administration; office functions; advertising; operation and management of a charity organization; all the aforesaid services relating to pharmaceutical products and medicines; retail sale of pharmaceutical products; provision of information and advice for consumers in connection with the selection of pharmaceutical products for acquisition.

36 – Charitable fund collection services.

41 – Medical and sanitary training and further education.

44 – Medical and health care services; provision of information relating to medical services.

(260) AM 2017 90506 A
(800) 1327725
(891) 2016 10 21
(731) PHARMA MAR, S.A.

Polígono Industrial La Mina Norte, Avda.
de los Reyes, 1 E-28770 Colmenar Viejo
(Madrid), Spain

(540)

ZEPSYRE

(511)

5 – Pharmaceutical and veterinary preparations; sanitary preparations for medical purposes; dietetic substances adapted for medical use, food for babies; plasters, materials for dressings; material for stopping teeth, dental wax; disinfectants; preparations for destroying vermin; fungicides, herbicides.

(260) AM 2017 90507 A
(800) 1327727
(891) 2016 10 11
(731) TURNER NETWORK TELEVISION, INC.
One CNN Center, 10N, Atlanta GA 30303, USA
(540)

THE LAST SHIP

(511)

9 – Audio visual recordings in all media, featuring entertainment in the nature of an on-going television series in the field of comedy, drama, action, and adventure; downloadable television programming featuring comedy, drama, action, and adventure distributed via the Internet and wireless communications.

41 – Entertainment services, namely, a multimedia program series featuring comedy, action, drama and adventure distributed via various platforms across multiple forms of transmission media.

(260) AM 2017 90508 A
(800) 1327728
(891) 2016 10 11
(731) TURNER NETWORK TELEVISION, INC.
One CNN Center, Atlanta GA 30303, USA
(540)

GOOD BEHAVIOR

(511)

9 – Audio visual recordings in all media, featuring entertainment in the nature of an on-going television series in the field of comedy, action, drama and adventure; downloadable television programming featuring comedy, action, drama and adventure distributed via the Internet and wireless communications.

41 – Entertainment services, namely, a multimedia program series featuring comedy, action, drama and adventure distributed via various platforms across multiple forms of transmission media; providing on-line computer games.

(260) AM 2017 90513 A
(800) 1327869
(891) 2016 09 02
(731) Open-Type Joint Stock Company
"ROT FRONT"
2-oy Novokuznetskiy pereulok, d. 13/15
RU-115184 Moscow, Russian Federation
(540)



(591) Dark yellow, dark blue and white.

(526) The trademark is protected as a whole. "КОФЕТЫ" shall not be subject to independent legal protection.

(511)

30 – Confectionery, namely, sweets.

(260) AM 2017 90520 A
(800) 1327872
(891) 2016 08 26

(731) Open-Type Joint Stock Company
"CONFECTIONARY CONCERN BABAYEVSKY"
d. 7, ul. Malaya Krasnoselskaya RU-107140
Moscow, Russian Federation

(540)

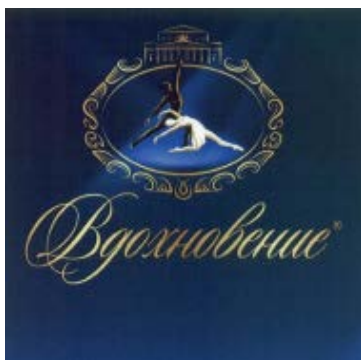

(591) Dark blue, blue, light blue, gold, white and black

(526) The trademark is protected as a whole. "®" shall not be subject to independent legal protection.

(511)

30 – Cakes; confectionery for decorating Christmas trees; peppermint sweets; sweetmeats [candy]; fondants [confectionery]; petits fours [cakes]; confectionery; liquorice [confectionery]; almond confectionery; peanut confectionery; candy; halvah; chocolate; custard tarts; fruit jellies [confectionery]; caramels [candy]; crackers; pastilles [confectionery]; pralines; chocolate paste; fruit cakes.

(260) AM 2017 90524 A

(800) 1327884

(891) 2016 10 31

(731) ROJA PARFUMS HOLDINGS LIMITED
41 New England Street, New England Quarter
Brighton BN1 4GQ, United Kingdom

(540)

ROJA PARFUMS

(511)

3 – Bleaching preparations and other substances for laundry use; cleaning, polishing, scouring and abrasive preparations; soaps; perfumery; essential oils; cosmetics; hair lotions; dentifrices; perfumes and perfumery products; aromatic substances for use in the manufacture of perfumes; fine fragrance; perfumed bath foam preparations; perfumed bath salts; perfumed milks; perfumed lotions; perfumed sprays; perfumed creams; perfumed soaps.

(260) AM 2017 90529 A

(800) 1327900

(891) 2016 09 23

(731) Closed Joint-Stock Company "PENZA
CONFECTIONERY FACTORY"
ul. Kalinina, d. 112a RU-440034 Penza,
Russian Federation

(540)



(591) Dark green, light green and white.

(526) The trademark is protected as a whole. "фруктовый фреш" shall not be subject to independent legal protection.

(511)

30 – Buns; bread rolls; waffles; waffle sandwiches; rice-based snack food; cereal-based snack food; crispbread; confectionery for decorating Christmas trees; fruit jellies [confectionery]; cakes; peanut confectionery; almond confectionery; fondants [confectionery]; non-medicated lozenges [confectionery]; cocoa; caramels [candy]; sweetmeats [candy]; peppermint sweets; liquorice [confectionery]; crackers; pastries; candy; marzipan; honey; ice cream; sherbets [ices]; muesli; petits fours [cakes]; cookies; popcorn; pralines; gingerbread; chewing gum; confectionery; Turkish delight; chocolate paste; tea; chocolate; halvah; chips [cereal products].

(260) AM 2017 90540 A

(800) 1327930

(891) 2016 05 03

(731) ZHEJIANG LIPER LIGHTING TECHNOLOGY
CO., LTD.

Fifth floor, Building 1, No. 233 Haitin Road,
Wenzhou Eco&Tech Development Zone,
Wenzhou City Zhejiang, China

(540)



(591) Black, white

(511)

11 – Lamps; sockets for electric lights; lighting apparatus and installations; vehicles (lights for-); electric water heater; fans[air-conditioning]; taps [faucets]; sanitary apparatus and installations; drinking water supplying device; radiators, electric.

(260) AM 2017 90543 A

(800) 1327931

(891) 2016 06 13

(731) TONTARELLI – S.P.A.

Via Camerano, 5, I-60022 CASTELFIDARDO,
Italy

(540)

Tontarelli

(591) Black, white

(511)

35 – The bringing together, for the benefit of others, of a variety of goods, excluding the transport thereof, – namely holders for discs, music cassettes, cassettes and compact discs, coat hangers, containers and boxes, stools, washstands [furniture], corks for bottles and cans, bottle racks, laundry bins for household purposes, food trolleys, chests, bowls and buckets, baskets for domestic use, pots for children, toilet seat adaptors for babies, food containers, storage tins, cake plates, salad spinners, soup bowls, salad bowls, drinking glasses, table plates, flatware, small dishes, decanters, ice cube moulds, citrus presses, roll holders, napkin rings, cutlery trays, mats for sinks, vases, drip mats, funnels, colander, cutlery drainers, laundry stands, trays, dustbins, clothes-pests, furniture, cabinets, shoe racks, dressers, fruit boxes with collapsible walls, all the aforesaid goods made of plastic – enabling customers to conveniently view and purchase those goods; on-line retail and wholesale store services featuring holders for discs, music cassettes, cassettes and compact discs, coat hangers, containers and boxes, stools, washstands [furniture], corks for bottles and cans, bottle racks, laundry bins for household purposes, food trolleys, chests, bowls and buckets, baskets for domestic use, pots for children, toilet seat adaptors for babies, food containers, storage tins, cake plates, salad spinners, soup bowls, salad bowls, drinking glasses, table plates, flatware, small dishes, decanters, ice cube moulds, citrus presses, roll holders, napkin rings, cutlery trays, mats for sinks, vases, drip mats, funnels, colander, cutlery drainers, laundry stands, trays, dustbins, clothes-pests, furniture, cabinets, shoe racks, dressers, fruit boxes with collapsible walls, all the aforesaid goods made of plastic; presentation of goods on communication media, for retail purposes; business merchandising display services; sales promotion for others; organization of events, exhibitions, fairs and shows for commercial, promotional and advertising purposes; advertising, including on-line advertising on a computer network; business administration; office functions.

(260) AM 2017 90548 A

(800) 1327943

(891) 2016 09 22

(731) RED MOON Srl

Via della Mendola, 21, I-39100 BOLZANO,
Italy

(540)

SWINGO
natural more

(591) Brown, green and white.

(511)

29 – Processed apples; preserved, dried and cooked fruit and vegetables; fruit jams; fruit jellies.

31 – Fresh fruit; fresh apples; fruit plants; fruit trees; rootstocks for fruit tree grafting; scions for fruit tree grafting.

(260) AM 2017 90550 A

(800) 1327985

(891) 2016 06 10

(731) FREQUENTIS AG

Innovationsstrasse 1 A-1100 Wien, Austria

(540)

FREQUENTIS

(591) Blue

(511)

9 – Air traffic control and flight monitoring installations and equipment; telecommunications apparatus and instruments; checking (supervision) apparatus and terminals for air traffic controllers; digital speech and data communications installations and apparatus; private mobile radio and bundled radio installations and apparatus, analogue and digital exchanges and switchboards for data transmission installations and apparatus and for radio and telephone installations and apparatus; electric and electronic apparatus and installations for flight traffic control centres, radio operations centres, traffic safety centres, telecommunications systems and networks, monitors, computer software, computer hardware, electric and electronic monitoring installations and apparatus; coastal radio installations and apparatus, mobile radio installations and apparatus, train radio installations and apparatus, speech communications installations and apparatus.

37 – Installation, maintenance and servicing of air traffic control and flight monitoring installations, flight traffic control centres, radio stations, radio operations centres, traffic safety centres, telecommunications systems and networks, coastal radio installations, mobile radio installations, train radio installations, radio networks and speech communications installations.

42 – Project planning of air traffic control and flight monitoring installations, flight traffic control cent-

res, radio stations, radio operations centres, traffic safety centres, telecommunications systems and networks, coastal radio installations, mobile radio installations, train radio installations, radio networks and speech communications installations.

(260) AM 2017 90552 A
 (800) 1327989
 (891) 2016 07 30
 (731) WINE & SPIRIT EDUCATION TRUST
 39-45 Bermondsey Street, London SE1 3XF,
 United Kingdom

(540)



WSET

(591) Black, white

(511)

9 – Pre-recorded magnetic data carriers featuring information about alcoholic beverages; compact discs featuring information about alcoholic beverages; downloadable electronic publications in the nature of manuals, newsletters, magazine articles, presentation packs and books in the field of alcoholic beverages; electronic publications (downloadable), namely, books, magazines and manuals featuring information about alcoholic beverages recorded on computer media; photographic slide transparencies featuring information about alcoholic beverages; pre-recorded video tapes featuring alcoholic beverages.

16 – Printed matter and publications, namely newsletters featuring the promotion of wine and spirits and the wine and spirit trade, awards, charts, emblems, forms, guides for wine and spirit appreciation, invitations, seminar notes, and survey answer sheets; printed instructional and teaching materials, namely, lesson plans, plastic overhead transparencies, paper and plastic overhead transparencies, course books, reference and text books and manuals, assessment material, examination papers, paper awards, certificates, diplomas, scholarship certificates, and paper badges, all for the promotion of wine and spirit appreciation and the wine and spirit trade.

41 – Educational services, namely, conducting classes, seminars, conferences, workshops, lecture series, distance learning programmes and tutorials in the field of the wine and spirit appreciation trade and distributing course materials therewith; educational services, namely, conducting on-line exhibitions and displays and interactive exhibits in the field of wine and spirit trade; publication of education course materials for others; educational services, namely, providing incentives to people and organizations to

demonstrate excellence in the field of wine and spirit appreciation through the issuance of awards.

(260) AM 2017 90555 A
 (800) 1328031
 (891) 2016 09 29
 (731) TELEFÓNICA, S.A.
 Gran Vía, 28 E-28013 MADRID,
 Spain

(540)

MATILDE

(511)

38 – Telecommunication services; transmission of digital information; electronic transmission of data and documents via computer terminals and electronic devices; website dissemination services; provision of transmission services via wireless application protocol including those using secure communication channels; communication services consisting in providing access to multiple users to a computerized global information network (Internet/intranet) for the transmission and dissemination of any type of information, image or sound; interactive communication and broadcasting services; routing and connection services for telecommunications; communications via fiber-optic networks; communications by computer terminals; computer-assisted transmission of messages and images; satellite transmission, information on telecommunications; telephone services; mobile telecommunication services; providing access to an Internet portal; services and operation of chat rooms; forums [chat rooms] for social network systems, electronic mail services; broadcasting services for television and radio programs; broadcasting services for television programs by subscription; providing access to the Internet; rental of telecommunication devices; provision of communications via the use of telephone cards or debit cards.

(260) AM 2017 90574 A
 (800) 1328460
 (891) 2016 09 15
 (731) BROUWERIJEN ALKEN-MAES, naamloze
 vennootschap
 Blarenberglaan 3, Stephenson Plaza – Blok C,
 B-2800 Mechelen, Belgium

(540)

MORT SUBITE

(511)

32 – Beers.

(260) AM 2017 90575 A
 (800) 1328490
 (891) 2016 10 18
 (731) Aktsionernoe obshchestvo "Essen production AG"
 New passage, 3, of. 95, Avtozavodsky district, City of Tolyatti, RU-445037 Samara Region Russian Federation

(540)



(591) Black, white
 (511)
 30 – Confectionery; baked goods.

(260) AM 2017 90578 A
 (800) 1328501
 (891) 2016 06 23
 (731) Otkrytoe aktsionernoe obshchestvo "NEVSKAYA KOSMETIKA"
 prospect Oboukhovskoy oborony, 80, RU-192029 Saint-Petersburg, Russian Federation

(540)



(591) Black, white
 (511)
 3 – Abrasives; scale removing preparations for household purposes; aromatics [essential oils]; air fragrancing preparations; breath freshening sprays; canned pressurized air for cleaning and dusting purposes; balms other than for medical purposes; lip glosses; petroleum jelly for cosmetic purposes; cotton wool for cosmetic purposes; sachets for perfuming linen; drying agents for dishwashing machines; toilet water; laundry wax; massage gels other than for medical purposes; dental bleaching gels; perfumes; windshield cleaning liquids; windscreen cleaning liquids; perfumery; quillaia bark for washing; colorants for toilet purposes; cosmetic dyes; creams for leather; waxes for leather; cosmetic creams; skin

whitening creams; hair spray; nail polish; hair lotions; lotions for cosmetic purposes; after-shave lotions; beauty masks; oils for perfumes and scents; oils for cosmetic purposes; oils for toilet purposes; essential oils of citron; oils for cleaning purposes; bergamot oil; gaultheria oil; jasmine oil; lavender oil; almond oil; rose oil; oil of turpentine for degreasing; almond milk for cosmetic purposes; cleansing milk for toilet purposes; soap; disinfectant soap; deodorant soap; shaving soap; cakes of toilet soap; medicated soap; antiperspirant soap; soap for foot perspiration; almond soap; cosmetic kits; cotton sticks for cosmetic purposes; dentifrices; breath freshening strips; lipsticks; pomades for cosmetic purposes; shaving preparations; cosmetic preparations for baths; toiletries; laundry soaking preparations; douching preparations for personal sanitary or deodorant purposes [toiletries]; denture polishes; mouthwashes, not for medical purposes; refurbishing preparations; fabric softeners for laundry use; laundry bleach; dry-cleaning preparations; make-up removing preparations; nail care preparations; cleaning preparations; preparations for cleaning dentures; laundry preparations; aloe vera preparations for cosmetic purposes; sunscreen preparations; scouring solutions; tissues impregnated with cosmetic lotions; potpourris [fragrances]; bleaching soda; washing soda, for cleaning; bath salts, not for medical purposes; bleaching salts; cosmetic preparations for skin care; mascara; detergents other than for use in manufacturing operations and for medical purposes; cloths impregnated with a detergent for cleaning; shampoos; ethereal essences.

5 – Balms for medical purposes; antiseptic cotton; wadding for medical purposes; glycerine for medical purposes; air deodorising preparations; deodorants for clothing and textiles; lotions for pharmaceutical purposes; sunburn ointments; babies' diapers [napkins]; pomades for medical purposes; aloe vera preparations for pharmaceutical purposes; sanitary towels; sanitary pads; panty liners [sanitary]; chewing gum for medical purposes; tissues impregnated with pharmaceutical lotions; mouthwashes for medical purposes; detergents for medical purposes; babies' napkin-pants.

(260) AM 2017 90579 A
 (800) 1328558
 (891) 2016 09 05
 (731) BOJAN RADULOVIĆ
 Bulevar Arsenija Čarnojevića 94, 11070 Novi Beograd, Serbia

(540)



(591) Bleu et vert

(511)

9 – Medium of data obtained by means of a program, machine-readable; computer programs and software; magnetic data carriers, namely, magnetic tapes, magnetic disks, magnetic wafers and magnetic cards; software, namely, ERP software solutions, CRM software solutions, BI software solutions (financial analysis, business analysis), Social Network program, Social Collaboration program, Social Media Management, E-Business (B2C, B2B), Time & Attendance, Work Force Management, People Counting Software Solution, computer hardware, including touch screen apparatus, computer peripheral apparatus, computer hardware, telecommunications material.

16 – Printed materials for software and data processing programs, namely, manuals, catalogs, user manuals, work manuals and instructions.

35 – Systematization of data and information into computer databases available on the Internet, including data and information relating to the development, creating, programming, production, performance, distribution, application, use, operating, handling, modification, sale, maintenance, rental, updating, design and outsourcing of computer programs and software; Business Research, business evaluation of business data and data of business companies; organizational analysis and business analysis of business data; general office functions such as word processing, electronic mail and archiving.

38 – Internet services, namely, providing access to data and information on the Internet, including data and information relating to the development, creation, design, programming, performance, distribution, application, use, mode of operation, handling, modification, sale, maintenance, rental, updating, design and outsourcing of computer programs and software; access to interactive telecommunications services on the network or on the Internet for the provision of all the services mentioned in this list of services.

41 – Training on the use and application of data processing programs; training for the programming, design, development, use and application of computer programs and software; training in the field of electronic data processing.

42 – Design and development of computer hardware and software; programming, design and development of computer programs and software, particularly for internal function areas such as financial management and control, production and materials management, quality and installations maintenance management, sale and distribution, human resources and project management; implementation, providing services, rental, updating, outsourcing and maintenance of computer programs and software; consulting and advice regarding programming, design, de-

velopment, use and application of computer programs and software; research in the field of computer programs and software; preparation and provision of data and information on the Internet relating to the development, creating, programming, performance, sharing, sale, distribution, application, use, operating, handling, modification, maintenance, rental, updating, design and outsourcing of computer programs and software.

(260) AM 2017 90580 A

(800) 1328598

(891) 2016 09 16

(731) LES LABORATOIRES SERVIER,
Société par actions simplifiée
50 rue Carnot, F-92284 Suresnes Cedex,
France

(540)

СЕРБЪЕ

(591) Black, white

(511)

3 – Soaps; perfumery, essential oils, cosmetics, hair lotions; dentifrices.

5 – Pharmaceutical preparations; veterinary preparations; sanitary products for medical purposes; implants for pharmaceutical use; implantable medicines; dietetic substances for medical use; dietetic substances for veterinary use; food for babies; dietetic preparations and food supplements; food supplements for animals; plasters, materials for dressings; teeth filling material; dental impression materials; disinfectants; products for destroying vermin; fungicides; herbicides.

10 – Surgical, medical, dental and veterinary apparatus and instruments, artificial limbs, eyes and teeth; orthopedic articles; suture material.

(260) AM 2017 90581 A

(800) 1328600

(891) 2016 11 02

(731) Global Functional Drinks AG
Dammstrasse 19, CH-6301 Zug, Switzerland

(540)

Reach Peach

(511)

32 – Non-alcoholic beverages, non-alcoholic aperitifs, non-alcoholic cocktails, syrups for beverages, vegetable juices (beverages), fruit juices, non-alcoholic fruit beverages, essences for making beverages, energy drinks, carbonated waters, products for making aerated waters, mineral waters (beverages).

(260) AM 2017 90582 A
 (800) 1328601
 (891) 2016 11 02
 (731) GLOBAL FUNCTIONAL DRINKS AG
 Dammstrasse 19, CH-6301 Zug, Switzerland
 (540)

Lime Time

(511)
 32 – Non-alcoholic beverages, non-alcoholic aperitifs, non-alcoholic cocktails, syrups for beverages, vegetable juices (beverages), fruit juices, non-alcoholic fruit beverages, essences for making beverages, energy drinks, carbonated waters, products for making aerated waters, mineral waters (beverages).

(260) AM 2017 90583 A
 (800) 1328654
 (891) 2016 09 02
 (731) DCNS
 40-42 rue du Docteur Finlay, F-75015
 PARIS, France
 (540)



(591) Blue reference Pantone 301C and
 red reference Pantone 185C

(511)
 7 – Machine tools; motors and engines (other than for land vehicles); couplings and transmissions (except motors and engines for land vehicles); agricultural implements, egg incubators; motors and engines for water vehicles, components and parts of these motors and engines, autonomous energy generators for underwater propulsion; turbines for energy production; alternators for energy production; turbines for wind turbines; wind turbine motors and engines; robots (machines); devices for handling on-board helicopters; airborne wind turbine, wind turbines; underwater turbine generators; devices for the production of electricity, blades and rotors for wind turbines.

9 – Apparatus and instruments for computer-assisted design of weapons systems or ships, for the use and control of ships, navigation instruments; electric systems and circuits for power generation and distribution for marine and submarine vehicles and naval weapon systems; sound, electronic and electromagnetic apparatus and instruments for naval systems; scientific (other than for medical use), nautical, surveying, photographic, cinematographic, optical, weighing, measuring, signaling, checking (supervision), life-saving and teaching apparatus and instruments; apparatus and instruments for conducting, switching, transforming, accumulating, regulating and controlling electricity; apparatus for non-medical analysis;

apparatus and instruments for optronics, detection, data collection, classification, testing, recording, interpreting, signalling, simulation, reproduction, processing, transmission, visualization of sound and images; communication and telecommunication apparatus; magnetic recording media, optical or digital sound recording disks; calculators, consoles, computers, software or recorded computer programs, software packages, magnetic or computer interfaces, data media; magnetic data media; data processing devices (augmented reality devices), data processing apparatus or equipment, computer peripheral devices; electric batteries; simulation devices for naval field training; study and training simulators; electronic and computer devices for managing and controlling of torpedo launching; radar apparatus, sonars; electrical installations for the control of naval installations; cabins reproducing simulation environments, means for immersion (cabins, platforms, footbridges), means for reproduction of all or part of premises with their functional, environmental, visual and dynamic aspects (movement cabins); simulation software for the control of platforms, combat devices, navigation devices; software reproducing the movement of platforms and hardware environment; software for environment and equipment simulation used by surface vessels, submarines, nuclear reactors, naval aviation taking into account the physical phenomena relating to the environment (electromagnetic propagation, sound propagation, thermodynamics, restitution of visual and sound environments); tools (software) for modeling of equipment for controlling platform installations in the field of propulsion systems, electric stations, nuclear reactors, nuclear and civil installation safety; tools (software) for modeling navigation equipment; on-board dynamic control equipment for naval platforms; computer programs and software in the field of hydrodynamics, fluid mechanics, automated systems and optimization; devices for the automatic steering of marine crafts or vessels; dynamic positioning devices; vessel movement stabilization devices; automated systems for supervising vessel navigation; measurement or test benches in the laboratory or real life; energy converters activated by the movement of the sea, wind, or water temperature; energy sensors; floating periscopes; electronic or electromechanical decoy devices (countermeasures) for defense use; computer or electronic devices (software) (equipment for data processing) for combat management and navigation control support; commutators; sensors, namely, devices and apparatus for capturing information; signal sensors; apparatus and instruments for encryption; computer devices (software) or electronic devices (equipment for data processing) for combat management or the planning of combat or navigation missions; air and marine navigation devices; electronic devices and software for combat management and control support.

11 – Submerged modules for producing nuclear energy (installations for processing nuclear fuel and moderators); transportable nuclear power plants (installations for processing nuclear fuel and moderators); equipment for producing nuclear or non-nuclear energy; modules for producing nuclear or non-nuclear energy.

12 – Vehicles, apparatus for locomotion by land, air or water; watercraft and underwater vehicles; towed devices for watercraft and underwater vehicles; supply vessels; drones for use on water, underwater or in the air; automated seaborne recovery devices for manned and unmanned vehicles.

13 – Firearms, ammunition and projectiles; explosives, fireworks; built-in combat devices for submarines generating and ensuring the use of weaponry such as missiles, torpedoes, mines; missile or torpedo launching modules; electronic sub-sets for management and control of modules for launching missiles or torpedoes or for firing ammunition; sub-sets for ammunition handling and reloading in modules; built-in combat devices for submarines; built-in combat devices for submarines managing and ensuring the use of weaponry such as missiles, torpedoes or mines; pyrotechnic devices for destruction, pyrotechnic devices for neutralization or decoy; self-powered naval aviation targets (decoys).

37 – Shipbuilding; naval base construction; repair and maintenance of vessels, submarines, combat systems, drones, underwater nuclear power production modules, wind turbines, underwater generators, equipment or modules for the production of nuclear or non-nuclear energy, electricity production systems; installation and commissioning of systems for combat, drones, underwater modules for nuclear energy production, wind turbines, underwater generators, equipment or modules for the production of nuclear or non-nuclear energy, electricity production systems; work supervision of combat systems; assembly and maintenance of combat systems, systems and components mounted onto vessels or platforms; assembly and maintenance of vessels, submarines, underwater modules for producing nuclear energy, wind turbines, underwater generators, equipment or modules for the production of nuclear or non-nuclear energy, electricity production systems; installation, repair and maintenance of scientific, nautical apparatus and instruments, apparatus and instruments for conducting, distributing, transforming, accumulating, regulating and controlling electricity, underwater or non-underwater modules for producing nuclear or non-nuclear energy or transportable nuclear power plants; installation, maintenance and repair of systems carried on vessels and watercraft.

38 – Telecommunications; computer terminal communication, via any type of networks and any mean and technical procedures; communication by fiber-

optic networks; provision of access to databases; providing systems for communication between calculators, fixed or on-board (telecommunications); broadband data transmissions via radio relay, acoustic means or via satellite; transmission of digital files; rental of access time to a database server center.

41 – Education; training, training of personnel particularly as regards providing technical assistance; organization of practical personnel training on simulators and on-board systems; providing services for training and training of personnel (crew) using simulators, relating to the naval, nuclear, civil, naval aviation fields and in the energy field (training); individual and group training services, operational training for the operation and maintenance of platform, combat, navigation, nuclear installations, using simulators; organization of contests, competitions, games for education or entertainment purposes; organization and conducting of colloquiums, conferences or congresses; publishing services (including on-line electronic publishing services).

42 – Engineering works, such as research and development of new products (for third parties), research in the field of augmented reality as well as design and development of new products relating thereto (for third parties); technical advice and systems expertise, technical projects studies; ship design; naval architecture; scientific and technological services as well as research, design and development services relating in particular to the naval, nuclear, naval aviation and civilian fields, as well as relating to energy; industrial analysis and research services in the fields of scientific, nautical, electric, electronic, computer apparatus as well as in the naval, nuclear, civil, naval-air, augmented reality and energy fields; evaluations, assessments and research in the fields of science and technology provided by engineers; software design, development, installation, maintenance, updating or rental; design and development of computers; programming for computers, memory cards, electronic cards, data bases or networks; conversion of computer programs and data (other than physical conversion); conversion of documents from a physical medium to an electronic medium; creation (design) and development of software in the fields of naval architecture and engineering, simulation software, software simulating the operation of nuclear installations, vessels, combat systems and energy production installations; maintenance services in connection with the operational condition of systems for personnel practice and training in the naval, nuclear, naval aviation, civilian and energy fields; creation (design), development, updating and maintenance of software for aerodynamics, hydrodynamics and improved multidisciplinary design; computer programming and use of databases in the field of hydrodynamics; expert appraisals in the fields of on-

board measurements, the laws of control and digital simulation, docking and recovery of drones; inspection of naval or underwater structures.

(260) AM 2017 90584 A
 (800) 1315918
 (891) 2016 11 15
 (731) PEARSON EDUCATION LIMITED
 80 Strand London WC2R 0RL, United Kingdom
 (540)

BUG CLUB

(511)
 9 – Educational teaching, instruction or research apparatus and instruments; electronic apparatus and instruments for teaching, instruction, training, research, education, testing, examination and assessment purposes; electronic storage media bearing electronic publications and data; electronic publications.

16 – Printed matter; educational materials.

41 – Provision of training, teaching, academic education, instruction, educational examination, testing and assessment services.

(260) AM 2017 90619 A
 (800) 1329045
 (891) 2016 09 07
 (731) CAGS TOBACCO TUTUN VE TUTUN MAMULLERI SANAYI VE TICARET ANONIM SIRKETI
 Ankara Cad. Polat Is Merkezi, No:108/78 Kartal, Istanbul, Turkey
 (540)



(591) Black, light brown
 (526) ROLLING PAPERS
 (511)
 34 – Tobacco; chewing tobacco; cigarettes; cigars; cigarette cases; tobacco pipes; cigar holders; cigarette holders; mouthpieces for cigarette holders; mouthpieces for cigar holders; smokers' articles namely, ashtrays for smokers, humidors, pocket machines for rolling cigarettes, cigarette paper, firestones, lighters for smokers; matches.

(260) AM 2017 90674 A
 (800) 1328971
 (891) 2016 06 08
 (731) LEI GUI BIN
 No.13 Dafen Village, Liangang Management Zone, Zhouxin, Qingcheng District, Qingyuan Guangdong, China
 (540)

ROMOSS

(591) Black, white
 (511)
 9 – Computers; electronic agendas; apparatus to check stamping mail; counterfeit (false) coin detectors; ticket dispensers; electronic tags for goods; weighing machines; mechanical signs; fiber optic cables; cameras (photography); measuring instruments; telescopes; material for electricity mains [wires, cables]; semi-conductors; integrated circuits; condensers [capacitors]; transformers [electricity]; fluorescent screens; remote control apparatus; electric apparatus for commutation; lightning arresters; fire extinguishing apparatus; radiological apparatus for industrial purposes; protection devices for personal use against accidents; fire alarms; batteries, electric; animated cartoons; socks, electrically heated.

(260) AM 2017 90698 A
 (800) 1329845
 (891) 2016 06 10
 (731) PARMADDELLO S.R.L.
 Strada Cairoli, 15 I-43121 PARMA, Italy
 (540)



(591) Black, white
 (511)
 7 – Machines and installations for the food, canning and fish industries, and fittings therefor; juice and puree extractors; sterile packaging installations; vacuum fillers; non-revolving can seamers, revolving can seamers; heat exchangers (parts of machines) exclusively for use in the food industry, and in particular in the canning industry; installations and machines for processing of foodstuffs, vegetables, fruit, beverages, fish, and accessories therefor; machines and installations for the production of tomato concentrate; complete production lines for the production of tomato concentrate; complete production lines for processing of vegetables; machines and installations for the production of whole peeled toma-

toes; machines and installations for the production of tomato pulp in cubes; machines and installations for the production of tomato pulp; machines for the production of tomato juice for drinking; machines for the production of tomato ketchup; complete production lines for the production of potato chips; turbo extractors; filling machines and equipment; washing machines and equipment; machines and equipment for peeling fruits and vegetables; machines and equipment for automated distribution of tomatoes; centrifugal machines for the production of butter; grinders [machines]; machines for extracting puree; cutting machines; cleaning machines including machines for washing and machines for removing dirt from vegetables; steam peelers; complete production lines for the production of powdered milk; complete production lines for the production of long-life milk, condensed milk, fresh milk.

11 – Cooking and distilling installations and machines and fittings therefor; installations for the heat treatment of food products, for the purpose of producing concentrates; evaporators; thin film evaporators; machines and installations for uht treatment of milk and vegetables; machines and installations for freezing and cooling of foodstuffs, vegetables, cooked and raw foodstuffs and fish; machines and installations for pasteurising foodstuffs, vegetables, tinned goods, cheese, ricotta; machines and installations for making ice-cream, yoghurt and frozen kefir; complete production lines for cooking and distillation of foodstuffs, vegetables, fruits; refrigerating appliances and installations; installations and machines for drying; evaporators, concentrators; machine and installations for freezing foodstuffs; cooling apparatus and installations.

29 – Meat, other than ham; fish; seafood and shellfish; birds eggs and egg products; oils and fats; arrangements of processed fruit, i.e. fruit preserved, fruit pulp, fruit purees, frost of fruits; processed mushrooms and vegetables (including nuts and legumes); prepared meals consisting primarily of meat, fish, poultry or vegetables, including soups; dried fruit-based snacks; dairy products and goods derived therefrom, other than hard cheeses; tomato purée; tomato purée; jams; margarine; butter; stock; croquettes; fruit desserts; desserts made from milk products; chilled foods consisting predominately of fish; condensed tomatoes; vegetable burgers; potato dumplings; omelets; soup concentrates; powdered milk for food purposes; prepared snails [escargot]; prepared salads; vegetable soup preparations; ready cooked meals consisting wholly or substantially wholly of poultry; cooked meat dishes; frozen cooked fish; french fries; prepared meals consisting substantially of seafood; prepared meals consisting primarily of meat substitutes; frozen prepared meals consisting principally of vegetables; pre-packaged dinners consisting primarily of game; pre-packaged dinners con-

sisting primarily of seafood; cooked meals consisting principally of fish; chilled meals made from fish; dips; potato pancakes; fish cakes; instant miso soup; custard style yoghurts; organic nut and seed-based snack bars; vegetable-based snack foods; potato-based snack foods; nut-based snack foods; snack foods based on legumes; pre-cooked soup; chowder; pre-cooked miso soup; marmalade; jellies, jams, compotes, fruit and vegetable spreads; tinned foods containing vegetables; soup pastes; spreads consisting of hazelnut paste.

30 – Coffee, teas and cocoa and substitutes therefor; processed grains, starches, and goods made thereof, baking preparations and yeasts; ice, ice creams, frozen yogurts and sorbets; baked goods, confectionery, chocolate and desserts; salts, seasonings, flavourings and condiments; sugars, natural sweeteners, sweet coatings and fillings, bee products; herbal infusions; herbal preparations for making beverages; aromatic preparations for making non-medicated infusions; roasted barley and malt for use as substitute for coffee; preparations for making beverages [cocoa based]; aromatic preparations for making non-medicated tisanes; preparations for making beverages [coffee based]; tea; tomato sauce; food flavourings; mayonnaise; dressings for salad; pizza; vinegar; royal jelly; honey; sponge cake; salts, seasonings, flavourings and condiments; capers; marinades; mustard preparations for food; sweet pickle [condiment]; sauces; crackers; cereal bars; focaccia [bread]; popcorn; hamburgers contained in bread rolls; hot dog sandwiches; lasagne; rice salad; flour; cereal flour; filled bread rolls; pasta containing stuffings; pies [sweet or savoury]; ready-made dishes containing pasta; pizza; canned pasta foods; tinned foods containing cereals; cereal-based snack food; cereal-based snack food; tarts; prepared pasta; farinaceous food pastes; lemon juice (condiments); cheeseburgers; chocolate desserts; fruit sugar; sweeteners (natural -); honey; royal jelly; sugar, honey, treacle; bee glue; propolis for food purposes; sugar; natural ripe honey; natural honey; herbal honey; biological honey for human consumption; sweet spreads [honey]; invert sugar cream [artificial honey]; foodstuffs made of sugar for making a dessert; chocolate-based sweet glazes and chocolate-based fillings; chocolate decorations for cakes; sugar confectionery; cake frosting [icing]; chocolate flavoured coatings; cereals; yeast and leavening agents; dried and fresh pastas, noodles and dumplings; synthetic thickeners for foodstuffs; doughs, batters, and mixes therefor; ferments for pastes; potato flour; processed sorghum; tapioca; baking spices; food preparations based on grains; preparations for making bakery products; aromatic preparations for cakes; aromatic preparations for pastries; pies; hot dog sandwiches; hamburgers being cooked and contained in a bread roll; filled bread rolls; lasagne; spring rolls; pasta salad; pizza crust; rice salad; savory pastries; meals

consisting primarily of rice; pasta-based prepared meals; pastries consisting of vegetables and fish; pastries consisting of vegetables and poultry; pastries consisting of vegetables and meat; frozen pastry stuffed with vegetables; pasta containing stuffings; fresh pizza; dry and liquid ready-to-serve meals, mainly consisting of rice; prepared meals containing [principally] pasta; ravioli; snack food products made from rusk flour; snack food products made from cereal starch; canned pasta foods; pre-packaged lunches consisting primarily of rice, and also including meat, fish or vegetables; boxed lunches consisting of rice, with added meat, fish or vegetables, other than ham; pizza; snacks manufactured from muesli; snack foods made from corn; snack foods made from wheat; cereal-based snack food; sandwiches; crisps made of cereals; salted tarts; fresh pies; canned spaghetti in tomato sauce; rice-based snack food; tortilla snacks; snack food products consisting of cereal products; vegetable pies; tomato ketchup; catsup; pastries, cakes, tarts and biscuits (cookies); thin breadsticks; croutons; cheese curls [snacks].

31 – Horticultural products not included in other classes; agricultural products not included in other classes; mushrooms, fresh; mushrooms, fresh, for food; fresh fruits; fresh vegetables.

32 – Beer and non-alcoholic beverages; preparations for making beverages; preparations for making beverages; concentrates for making fruit drinks; concentrates for use in the preparation of soft drinks; squashes [non-alcoholic beverages]; lime juice cordial; fruit syrups and juices; tomato juice [beverage].

35 – Advertising; advertising; advertising and marketing; management on behalf of industrial and commercial enterprises in terms of supplying them with office requisites; office management services [for others]; business administration; administration of business affairs; business assistance; business consultation and management regarding marketing activities; business advisory and information services; business management for shops; operation of businesses [for others]; business examinations services; business strategy services; business efficiency expert services; hotel management service [for others]; writing of business project reports.

43 – Snack-bars; restaurant services; cafeterias; snack-bars; catering for the provision of food and beverages; catering in fast-food cafeterias; catering services for the provision of food; catering for food and drink.

(260) AM 2017 90699 A

(800) 1329857

(891) 2016 07 11

(731) BOCONCEPT A/S

Fabriksvej 4, DK-6870 Ølgod, Denmark

(540)

BoConcept[®]
Business
 Urban Danish Design since 1952

(591) Black, white

(511)

20 – Furniture; mirrors; picture frames; mattresses; clothes hooks, not of metal; coat hangers; coatstands; decorative wall plaques, made of plastic or wood; baskets, not of metal; trays, not of metal; works of art of wood, wax, plaster or plastic; pillows; cushions.

21 – Glassware; porcelain; earthenware; earthenware not included in other classes; dishes; plates; jars; bowls; mugs; cups; glass candlesticks; candlesticks.

35 – Retail services in respect of furniture, mirrors, picture frames, pillows and cushions, mattresses, clothes hooks, coat hangers, coatstands, decorative wall plaques, not of textile, baskets, trays, works of art, containers for household use, glassware, porcelain and earthenware, candlesticks, lamps, bed covers, carpets and other home and office furnishings; advertising; business management; business administration; office functions; administrative processing of purchase orders; commercial information and advice for consumers [consumer advice shop]; demonstration of goods; distribution of samples; on-line advertising on a computer network; organization of exhibitions for commercial or advertising purposes; demonstration of goods for promotional purposes; organisation and conducting of product presentations; presentation of goods on communication media, for retail purposes; presentation of goods on communication media, for wholesale purposes; distribution of samples; customer club services, for commercial, promotional and/or advertising purposes; customer loyalty services for commercial, promotional and/or advertising purposes; organization, operation and supervision of sales and promotional incentive schemes; demonstration of goods and services by electronic means, also for the benefit of the so-called teleshopping and homeshopping services; advertisement via mobile phone networks; advertising; advertising and marketing; advertising in periodicals, brochures and newspapers; advertising in the popular and professional press; advertising particularly services for the promotion of goods; advertising, including on-line advertising on a computer network; advertising services provided via the internet; advertising services for the promotion of e-commerce; brand positioning services; arranging of product launches; computerised business promotion; market campaigns; electronic commerce services, namely, providing information about products via telecommunication networks for advertising and sales purposes; product launch services; product marketing; sales promotion; administration relating

to sales methods; administrative processing of purchase orders; administrative processing and organising of mail order services; advice and information about customer services and product management and prices on internet sites in connection with purchases made over the internet; retail store services related to sale of furniture, mirrors, picture frames, pillows and cushions, mattresses, clothes hooks, coat hangers, coatstands, decorative wall plaques, not of textile, baskets, trays, works of art, containers for household use, glassware, porcelain and earthenware, candlesticks, lamps, bed covers, carpets and other home and office furnishings; retail services connected with the sale of furniture, mirrors, picture frames, pillows and cushions, mattresses, clothes hooks, coat hangers, coatstands, decorative wall plaques, not of textile, baskets, trays, works of art, containers for household use, glassware, porcelain and earthenware, candlesticks, lamps, bed covers, carpets and other home and office furnishings; mail order retail services connected to the sale of furniture, mirrors, picture frames, pillows and cushions, mattresses, clothes hooks, coat hangers, coatstands, decorative wall plaques, not of textile, baskets, trays, works of art, containers for household use, glassware, porcelain and earthenware, candlesticks, lamps, bed covers, carpets and other home and office furnishings; advertising, marketing and promotional services; business assistance, management and administrative services; retail services in relation to furniture, mirrors, picture frames, pillows and cushions, mattresses, clothes hooks, coat hangers, coatstands, decorative wall plaques, not of textile, baskets, trays, works of art, containers for household use, glassware, porcelain and earthenware, candlesticks, lamps, bed covers, carpets and other home and office furnishings; organization of trade fairs for commercial or advertising purposes; presentation of goods on communication media, for retail purposes; shop window dressing; systemization of information into computer databases; wholesale services in relation to furniture, mirrors, picture frames, pillows and cushions, mattresses, clothes hooks, coat hangers, coatstands, decorative wall plaques, not of textile, baskets, trays, works of art, containers for household use, glassware, porcelain and earthenware, candlesticks, lamps, bed covers, carpets and other home and office furnishings; wholesale services connected with the sale of furniture, mirrors, picture frames, pillows and cushions, mattresses, clothes hooks, coat hangers, coatstands, decorative wall plaques, not of textile, baskets, trays, works of art, containers for household use, glassware, porcelain and earthenware, candlesticks, lamps, bed covers, carpets and other home and office furnishings; mail order wholesale services connected to the sale of furniture, mirrors, picture frames, pillows and cushions, mattresses, clothes hooks, coat hangers, coatstands, decorative wall plaques, not of textile, baskets, trays, works

of art, containers for household use, glassware, porcelain and earthenware, candlesticks, lamps, bed covers, carpets and other home and office furnishings.

(260) AM 2017 90700 A

(800) 1329959

(891) 2016 08 16

(731) BIOIBERICA, S.A.U.

Carretera NII, Km. 688, Zona Industrial,
E-08389 PALAFOLLS, Spain

(540)



(591) Blue, white and orange

(511)

1 – Chemical ingredients for use in the pharmaceutical, dietetic and food industry.

5 – Pharmaceutical products; dietetic products; nutraceutical products as dietary supplements.

35 – Advertising services; import and export services; wholesale, retail sale in stores and via global computer networks, mail order sale, catalog sale, sales promotion for others, all relating to pharmaceutical, dietetic and nutraceutical products.

(260) AM 2017 90701 A

(800) 1329168

(891) 2016 07 27

(731) PIDILITE INDUSTRIES LIMITED

Regent Chambers, 7th floor, Jammalal
Bajaj Marg, 208, Nariman Point, Mumbai
400021, India

(540)

1K PUR

(511)

1 – Chemicals used in industry, unprocessed artificial resins, unprocessed plastics; tempering and soldering preparations; tanning substances; adhesives used in industry; cement for mending broken articles; cement-waterproofing chemicals, except paints; waterproofing chemicals all included in this class.

(260) AM 2017 90702 A

(800) 1329170

(891) 2016 08 29

(731) POLFARMEX S.A

ul. Józefów 9, PL-99-300 Kutno, Poland

(540)

simvacor

(591) black and white

(511)
5 – Pharmaceutical preparations (pharmaceuticals, medicines for pharmaceutical purposes).

(260) AM 2017 90792 A

(800) 1329612

(891) 2016 12 06

(731) Omega SA (Omega AG) (Omega Ltd.)

Jakob-Stämpfli-Strasse 96, CH-2502

Biel/Bienne, Switzerland

(540)

OMEGA LE COUSSIN

(511)

14 – Precious metals and their alloys, jewelry, jewelry boxes, jewelry cases, precious stones; timepieces and chronometric instruments, watch chains, presentation cases for timepieces, cases for timepieces.

(260) AM 2017 90803 A

(800) 1329615

(891) 2016 09 06

(731) RADO UHREN AG (RADO WATCH

CO.LTD.) (MONTRES RADO SA)

Bielstrasse 45, CH-2543 Lengnau, Switzerland

(540)

RADO

(511)

9 – Apparatus for recording, transmission and reproduction of sound or images; electronic payment processing apparatus, apparatus for processing cashless payment transactions; magnetic recording media, sound recording disks; compact disks, DVDs and other digital recording media; apparatus used for playing compressed sound files (MP3 files); calculating machines and data processing equipment, software; games for mobile telephones, for computers and for digital personal stereos; electronic game software for mobile telephones, for computers and for digital personal stereos; computers, portable computers, handheld computers, mobile computers, personal computers, wrist computers, electronic tablets and computerized and mobile devices, digital personal stereos, mobile telephones and new-generation mobile telephones featuring greater functionality (smartphones); telecommunication apparatus and instruments; apparatus for recording, transmission, reproduction of sound or images, particularly mobile telephones and new-generation mobile telephones with greater functionality (smartphones); hand-held electronic apparatus for accessing the Internet and sending, receiving, recording and storing short messages, electronic messages, telephone calls, faxes, video conferences, images, sound, music, text and other digital data; handheld electronic apparatus for wireless reception, storage and transmission of data or messages; handheld electronic apparatus for mo-

onitoring or organizing personal information; hand-held electronic apparatus for global positioning [GPS] and displaying maps and transport information; handheld electronic devices for detection, storage, monitoring, surveillance and transmission of data relating to user activity, namely position, itinerary, distance traveled, heart rate; covers for computers, portable and mobile telephones; optical apparatus and instruments, particularly spectacles, sunglasses, magnifying glasses; cases for spectacles, sunglasses and magnifying glasses; batteries for electronic apparatus and computers, batteries for timepieces and chronometric instruments.

(260) AM 2017 90804 A

(800) 1329617

(891) 2016 07 27

(731) PIDILITE INDUSTRIES LIMITED

Regent Chambers, 7th floor, Jammalal

Bajaj Marg, 208, Nariman Point Mumbai

400021, India

(540)

UNITINT

(511)

2 – Coatings, namely, stains and clear finishes for exterior and interior use on a variety of substrates.

(260) AM 2017 90805 A

(800) 1329625

(891) 2016 10 10

(731) Private businessman ATAMANCHUK

ALEKSANDR VASILIEVICH

Vesely per., 43, s. Belaya Glina RU-353000

Krasnodarskiy kray, Russian Federation

(540)

СЛАВДА

(591) Black, white

(511)

7 – Washing machines [laundry]; ironing machines; knitting machines; sewing machines; hemming machines; lawnmowers [machines]; kitchen machines, electric; coffee grinders, other than hand-operated; vacuum cleaners; knives, electric; mills for household purposes, other than hand-operated; dishwashers; whisks, electric, for household purposes; blenders, electric, for household purposes; fruit presses, electric, for household purposes; food preparation machines, electromechanical; beverage preparation machines, electromechanical; parquet wax-polishers, electric; crushers for kitchen use, electric.

9 – Camcorders; radios; television apparatus; record players; cassette players; compact disc players; cameras [photography]; computers; sound transmitting apparatus; sound reproduction apparatus; amplifiers; sound recording apparatus; video recorders; telep-

hone apparatus; cordless telephones; video telephones.

11 – Cookers; microwave ovens [cooking apparatus]; hair dryers; refrigerators; freezers; coffee roasters; rotisseries; heating apparatus, electric; heating apparatus; cooking rings; radiators, electric; kettles, electric; coffee machines, electric; pressure cooking saucepans, electric; electric fans for personal use; extractor hoods for kitchens; heaters for baths; water conduits installations; mixer taps for water pipes; laundry dryers, electric; water purification installations; air filtering installations; filters for air conditioning; filters for drinking water; water heaters [apparatus].

(260) AM 2017 90806 A

(800) 1329626

(891) 2016 10 10

(731) Private businessman ATAMANCHUK
ALEKSANDR VASILIEVICH
Veseliy per., 43, s. Belaya Glina RU-353000
Krasnodarskiy kray, Russian Federation

(540)

RENOVA

(591) Black, white

(511)

7 – Washing machines [laundry]; ironing machines; knitting machines; sewing machines; hemming machines; lawnmowers [machines]; kitchen machines, electric; coffee grinders, other than hand-operated; vacuum cleaners; knives, electric; mills for household purposes, other than hand-operated; dishwashers; whisks, electric, for household purposes; blenders, electric, for household purposes; crushers for kitchen use, electric; fruit presses, electric, for household purposes; food preparation machines, electro-mechanical; beverage preparation machines, electro-mechanical; parquet wax-polishers, electric.

9 – Camcorders; radios; television apparatus; record players; cassette players; compact disc players; cameras [photography]; computers; laptop computers; sound transmitting apparatus; sound reproduction apparatus; amplifiers; sound recording apparatus; video recorders; telephone apparatus; cordless telephones; video telephones; phonograph records; compact discs [audio-video]; video cassettes.

11 – Cookers; microwave ovens [cooking apparatus]; hair dryers; refrigerating apparatus and machines; refrigerators; freezers; coffee roasters; rotisseries; heating apparatus, electric; heating apparatus; cooking rings; radiators, electric; kettles, electric; coffee machines, electric; electric pressure cooking saucepans; electric fans for personal use; water heaters [apparatus]; extractor hoods for kitchens; heaters for baths; water conduits installations; mixer taps for water pipes; ventilation hoods; laundry dry-

ers, electric; water purification installations; air filtering installations; filters for air conditioning; filters for drinking water.

(260) AM 2017 90807 A

(800) 1329639

(891) 2016 09 09

(731) ALTER FARMACIA, S.A.

Avenida de Burgos, 121,E-28050 Madrid,
Spain

(540)

NUTRIBEN

(511)

29 – Meat, fish, poultry and game; meat extracts; preserved, frozen, dried and cooked fruit and vegetables; jellies, jams, compotes; eggs; milk and dairy products; edible oils and fats.

30 – Coffee, tea, cocoa and artificial coffee; rice; tapioca and sago; flour and preparations made from cereals; bread, pastry and confectionery products; edible ices; sugar, honey, golden syrup; yeast, baking-powder; salt; mustard; vinegar, sauces (condiments); spices; ice.

32 – Beers; mineral waters and other non-alcoholic beverages; beverages based on fruits and fruit juices, syrups and other preparations for making beverages.

(260) AM 2017 90808 A

(800) 1329644

(891) 2016 09 13

(731) TELIA COMPANY AB

Stjärntorget 1, SE-169 79 Solna, Sweden

(540)



(591) White and purple "(Pantone 527 C)".

(511)

37 – Computer hardware and telecommunication apparatus installation, maintenance and repair; advisory services relating to the installation of security and safety equipment; repair of electrical equipment and electrotechnical installations; construction of telecommunication towers; installation of communications network instruments; installing of electronic communications networks; installation of cellular communications systems; installation and repair of telecommunications networks; maintenance and repair of telecommunications networks, apparatus, and instruments.

38 – Transmission and reception (transmission) of database information via the telecommunications network; communications by fiber optic networks; automatic transfer of digital data using telecommunications channels; high bit-rate data transmission

services for telecommunication network operators; data transmission services over telecommunications networks; information, consultancy and advisory services relating to telecommunications; providing video conferencing services; video communication services; providing facilities and equipment for video conferencing; teleconferencing and video conferencing services; telecommunications services provided via fiber optic, wireless and cable networks; rental of telecommunications apparatus and installations; rental of computer communication apparatus and instruments; rental of communication apparatus and implements; computer communication and internet access; provision and rental of telecommunications facilities and equipment; operating of electronic communications networks; operation of wide-band telecommunications networks; operating of electronic communications systems; operation of a telecommunications network; transmission of information by electronic communications networks; providing access to electronic communications networks; provision of central switching services for electronic communications networks; providing high speed access to computer and communication networks; providing telecommunications connections to a global communication network or databases; providing access to the internet and other communications networks; transmission of messages, data and content via the internet and other communications networks; providing access to websites on the internet or any other communications network; leasing of cellular communications equipment; transmission of short messages [sms], images, speech, sound, music and text communications between mobile telecommunications devices; satellite transmission; communication services by satellite; radio communication; information about telecommunication; telecommunications services between computer networks; telecommunication gateway services; data transmission services over telecommunications networks; operation of a telecommunications network; telecommunications routing and junction services; telecommunications services provided via fiber optic, wireless and cable networks.

42 – Computer programming; IT security services in the nature of protection and recovery of computer data; computer systems integration services; configuration of computer software; diagnosis of faults in computer software; computer software design; computer software research; repair of computer software; updating of computer software; hosting services and software as a service and rental of software; data duplication and conversion services, data coding services; computer programming for data processing and communication systems; computer programming for telecommunications; analytical services relating to computer programmes; it consultancy, advisory and information services; monitoring of telecommunication signals; analysis of telecommunica-

tion signals; telecommunications technology consultancy; technical design and planning of telecommunications networks.

(260) AM 2017 90888 A

(800) 1330678

(891) 2016 09 27

(731) Tovarishchestvo s ogranichennoi otvetstvennostyu "ALMOL" Krasnogvardeiskii trakt, 497, 050030 Almaty, Kazakstan

(540)



(591) Blue, white, red, green, brown, orange, pink and beige

(511)

30 – Natural sweeteners; binding agents for ice cream [edible ices]; ice cream; powders for making ice cream; confectionery; sherbets [ices]; chocolate.

(260) AM 2017 90889 A

(800) 1331654

(891) 2016 10 21

(731) GUCCIO GUCCI S.P.A. Via Tornabuoni, 73/R, I-50123 FIRENZE, Italy

(540)



(591) Black, white

(511)

14 – Precious metals and their alloys; precious stones; jewellery including chains, necklaces, rings, bracelets, ear clips or pendants, brooches, charms; horological and chronometric instruments; clocks; watches; jewellery boxes and watch boxes; bracelets for watches; key ring and chain; cufflinks; shoe ornaments of precious metal.

(260) AM 2017 90891 A
 (800) 1331690
 (891) 2016 05 16
 (731) Huian County Zhangban Shengfeng
 woodcarving Arts &Crafts Plant
 Shangtang Qianyin Village, Zhangban Town,
 Huian County, Quanzhou City, 362123 Fujian
 Province, China

(540)



(591) Black, white
 (511)
 20 – Works of art of wood, wax, plaster or plastic;
 busts of wood, wax, plaster or plastic; cork crafts.

(260) AM 2017 90893 A
 (800) 785256
 (891) 2017 02 01
 (731) BAYER INTELLECTUAL PROPERTY
 GMBH
 Alfred-Nobel-Straße 10, 40789 Monheim
 am Rhein, Germany

(540)

SIVANTO

(511)
 1 – Chemicals used in agriculture, horticulture and
 forestry; chemical preparations for the treatment of
 seeds (included in this class); fertilizers.

5 – Preparations for killing weeds and destroying
 vermin; insecticides, herbicides, fungicides.

(260) AM 2017 90895 A
 (800) 1330720
 (891) 2016 10 03
 (731) Obschestvo s ogranichennoy otvetstvennostyu
 "PYAT OZER"
 19, ul. 70 let Ocyabrya, RU-644074 Omsk,
 Russian Federation

(540)

СИББИТТЕР

(591) black and white
 (511)
 33 – Alcoholic beverages (except beers); aperitifs;
 arrack [arak]; baijiu [chinese distilled alcoholic be-
 verage]; brandy; wine; piquette; whisky; vodka; ani-
 sette [liqueur]; kirsch; gin; digesters [liqueurs and
 spirits]; cocktails; curacao; anise [liqueur]; liqueurs;

pre-mixed alcoholic beverages, other than beer-ba-
 sed; alcoholic beverages containing fruit; spirits [be-
 verages]; distilled beverages; mead [hydromel]; pep-
 permint liqueurs; bitters; nira [sugarcane-based alco-
 holic beverage]; rum; sake; perry; cider; rice alco-
 hol; alcoholic extracts; fruit extracts, alcoholic; al-
 coholic essences.

(260) AM 2017 90896 A
 (800) 863898
 (891) 2016 10 10
 (731) LARA TEKSTİL SANAYİ VE TİCARET
 LİMİTED ŞİRKETİ
 Soğanağa Cad. Derinkuyu Sok. No:5, Laleli-
 Eminönü İstanbul, Turkey

(540)



donella

(591) Black, white
 (511)
 25 – Underwear; clothing; socks; footwear; headwe-
 ar; hats, berets, caps, scarfs.

(260) AM 2017 90905 A
 (800) 1121928
 (891) 2016 10 05
 (731) Izabella Michalak ROLLEN POLSKA-
 STUDIO FIGURA MICHALAK IZABELLA
 Lusówko, ul. Wiązowa 56, PL-62-080
 Tarnowo Podgórze, Poland

(540)

studio figura

(511)
 5 – Dietetic foods adapted for medical purposes,
 bath preparations, medicated, medicinal herbs and
 oils, slimming preparations, plasters for medical pur-
 poses.

10 – Physical exercise apparatus for medical purpo-
 ses, massage apparatus, lamps for medical purposes.

44 – Aromatherapy, massage, beauty salons, physi-
 otherapy, rehabilitation involving physical move-
 ment, biological regeneration, nutrition consultancy.

(260) AM 2017 90908 A
 (800) 1281220
 (891) 2017 01 30
 (731) BAVARIA N.V.
 de Stater 1, NL-5737 RV Lieshout,
 Netherlands

(540)



(591) Green, white, gold and red
(511)
32 – Beers; non-alcoholic beers.

(260) AM 2017 90919 A

(800) 1330889

(891) 2016 10 11

(731) Obshestvo s ogranichennoi otvetstvennostyu
"YETAZHI"
ul. Lenina, d. 38/1, of. 5, g, RU-625000
Tyumen', Russian Federation

(540)



(591) White and red-brown
(511)
35 – Employment agency services; presentation of goods on communication media, for retail purposes; promotion of the goods [for third parties].
36 – Safe deposit services; deposits of valuables; real estate agency services.
37 – Construction information.
42 – Computer software consultancy; computer software upgrades; maintenance of computer software; computer software design; computer programming.

(260) AM 2017 90920 A

(800) 1330929

(891) 2016 04 28

(731) PHARMACEUTICAL INDUSTRY
"NI-THE", NIC.A.THEOFILIS & SON LTD.
52 Psychari Street, GR-111 41 Athens, Greece

(540)

NO-CALM

(511)
5 – Pharmaceutical preparations, medical and veterinary preparations; sanitary preparations for medical purposes; dietetic food and substances adapted for medical or veterinary use, food for babies; dietary supplements for humans and animals; plasters, materials for dressings; material for stopping teeth, dental wax; disinfectants; fungicides, herbicides.

(260) AM 2017 90943 A

(800) 1331268

(891) 2016 08 08

(731) Chastnoe torgovoe unitarnoe predpriyatie
"SLAVNET"
kom.22, d.28, ul. Platonova, 220005 g. Minsk,
Belarus

(540)



(591) black and white

(511)

3 – Bleaching preparations and other substances for laundry use; cleaning, polishing, scouring and abrasive preparations; soaps; perfumery, essential oils, cosmetics, hair lotions; dentifrices.

5 – Pharmaceutical and veterinary preparations; sanitary preparations for medical purposes; dietetic food and substances adapted for medical or veterinary use, food for babies; dietary supplements for humans and animals; plasters, materials for dressings; material for stopping teeth, dental wax; disinfectants; preparations for destroying vermin; fungicides, herbicides.

35 – Advertising; business management; business administration; office functions.

(260) AM 2017 90944 A

(800) 1331290

(891) 2016 10 24

(731) L'OREAL

14, rue Royale, F-75008 Paris, France

(540)

**PROFESSIONAL MAKEUP**

(591) black and white

(511)

3 – Cosmetics; make-up preparations.

35 – Retail store services relating to cosmetics, makeup, nail polish, cosmetic bags, cosmetic cases, smetic sponges, make-up brush holders, and make-up brushes.

(260) AM 2017 90945 A

(800) 1331340

(891) 2016 05 26

(731) COSENTINO. S.A.U.
Ctra. A-334, Km. 59, E-04850 Cantoria
(Almeria), Spain

(540)



(591) black and white

(511)

11 – Apparatus for lighting, heating, steam generating, cooking, refrigerating, drying, ventilating, water distribution, as well as sanitary installations; sinks, wash-hand basins, bathtubs, bidets, toilets, bath linings, shower cubicles; partitions not of metal for shower trays; shower trays.

19 – Marble and stone for building, stone agglomerate materials, non-metallic coverings for building, prefabricated concrete and ceramic tiles, non-metallic building materials; textured surfaces for walls (not of metal); textured wall surfaces; textured surfaces for ceilings; granite, quartz.

27 – Carpets, rugs, mats and matting, linoleum and other materials for covering existing floors; wall hangings not of textile materials; products used for covering floors, namely floor coverings; wall coverings included in this class; coverings for floors and artificial coverings for surfaces.

260) AM 2017 90946 A

(800) 1331342

(891) 2016 07 01

(731) INDUSTRIA DE DISEÑO TEXTIL,
S.A. (Inditex, S.A.)
Avenida de la Diputación, Edificio Inditex,
E-15142 Arteixo (A Coruña), Spain

(540)

OYSHO WEARE THE CHANGE

(511)

3 – Bleaching preparations and other substances for laundry use; cleaning, polishing, degreasing and abrasive preparations; soaps; perfumery products, essential oils, cosmetics, hair lotions; dentifrices; polish, cream and cobblers' wax for footwear; tailors' wax; shoemakers' wax; wax for leather; depilatory wax; laundry wax; parquet floor wax; shampoos; cosmetic kits; depilatory products; make-up removing preparations; deodorants for personal use (per-

fumery); lipstick; cosmetic pencils; hair spray and nail polish; nail polish removing products; tissues impregnated with cosmetic lotions; cloths impregnated with a detergent for cleaning; after-shave lotions; lotions for cosmetic use; make-up products; pomades for cosmetic use; stain removers; sachets for perfuming linen; nail care products; bleaches for cosmetic use; flower extracts (perfumery); incense; scented wood; decorative patterns for cosmetic use; false eyelashes and nails; pumice stone; fragrant potpourris; cosmetic preparations for slimming; cosmetic preparations for baths; hair waving preparations; detergents for launderettes; non-medicated toiletries; oral hygiene products other than for medical use; bath salts other than for medical use; oils for toiletry purposes; sunscreen products; eau de Cologne; deodorant soaps; talcum powder for toiletry purposes; adhesives for cosmetic use; greases for cosmetic use; abrasive papers; sandpaper; abrasive granules; shaving products; color-brightening chemicals for household use (laundry); cotton sticks for cosmetic use; beauty masks; mustache wax; bleaching products for laundry use; leather bleaching products; whitening gels for dental use; products for whitening (bleach); hair colorants; eyebrow cosmetics; cleaning chalk; shampoos for pets; cosmetics for animals; cosmetic creams; disinfectant soaps; bars of soap; soap for foot perspiration; detergents other than for use in manufacturing operations and for medical use; laundry starch; cleansing milk for toilet purposes; Javelle water; dry-cleaning products; scented water; perfumes; cosmetic preparations for eyelashes; cosmetic products for skin care; make-up powder; adhesives for affixing hairpieces; fabric softeners for laundry use; cosmetic dyes; dye-removing products; toilet waters.

25 – Clothing, footwear, headgear; clothing for motorists and cyclists; bibs not of paper; headbands [clothing]; bath robes; bathing suits; bathing caps and sandals; boas [mufflers]; sports shoes and beach shoes; hoods [clothing]; shawls; belts [clothing]; money belts [clothing]; wet suits for water-skiing; neckties; corsets; girdles [corsets]; fur stoles; scarves; caps [headwear]; caps; gloves [clothing]; raincoats; girdles [underwear]; body linen [garments]; mantillas; stockings; socks; neckerchiefs; furs [clothing]; pajamas; soles for footwear; heels; veils [clothing]; suspenders; baby clothing; capes; sports jerseys; mittens; ear muffs [clothing]; inner soles; cuffs; dress shields; beach wear; dressing gowns, housecoats [overalls]; pockets for clothing; sock suspenders; stocking suspenders; petticoats; tights; leotards; aprons [clothing]; costumes; uniforms; visors [headwear]; wooden shoes; caps; coats; esparto for shoes or sandals; non-slip devices for footwear; bath gowns (bathrobes); bath slippers; caps (headwear); blouses; teddies [undergarments]; berets; footmuffs, not electrically heated; lace boots; boots; boot uppers; studs for football boots; half-boots; fittings of

metal for footwear; toe caps for footwear; heelpieces for footwear; shirts; shirt yokes; shirt fronts; T-shirts; short-sleeved tee-shirts; bodices [lingerie]; vests; jackets; fishing vests; stuff jackets; slips [undergarments]; ready-made clothing; detachable collars and collars; clothing of leather; clothing of imitation leather; shower caps; slippers; skirts; trousers; ready-made linings [parts of clothing]; top coats; gabardines [clothing]; gymnastic shoes; jerseys [clothing]; pullovers; sweaters; liveries; muffs [clothing]; footwear uppers; pocket squares [clothing]; parkas; pelerines; pelisses; leggings and tights; knitwear [clothing]; clothing for gymnastics; underwear; sandals; saris; underpants; hats; wimples [clothing]; togas; trouser straps; suits; turbans; dresses; slippers; shoes.

26 – Lace and embroidery, ribbons and braid; buttons, hooks and eyes, pins and needles; artificial flowers; boxes for needles; pin and needle cushions; ornaments for footwear and hats (not of precious metal); haberdashery (except thread); hair bands; armbands; reins for guiding children; brooches (clothing accessories); sewing boxes; belt clasps; shoe laces; wreaths of artificial flowers; ornamental badges; thimbles (for sewing); needle cases; buckles (clothing accessories); buckles (for footwear); shoulder pads for clothing; hair pins; badges for wear not of precious metal; tinsels (trimmings for clothing); numerals or letters for marking linen; bodkins; barrettes (hair slides); lace trimmings; feathers (clothing accessories); top-knots (pompoms); picot (lace); zipper fasteners (haberdashery); competitors' numbers; heat-adhesive patches for decorating textile articles [haberdashery]; rug hooks; snap fasteners; ostrich feathers (clothing accessories); whalebones for corsets; prize ribbons; rimming cords for clothing; tassels (haberdashery); expanding bands for holding sleeves; hair ornaments; hairpieces; hair nets; shoe eyelets; chenille (passementerie); frills (lacework); pant clips for cyclists; fastenings for clothing; hook-and-pile fastening tapes; elastic ribbons; tapes for curtain headings; cords for clothing; collar supports; false hems; rosettes (passementerie); festoons (embroidery); fringes; artificial fruit; braids; hair coloring caps; artificial garlands; darning lasts; trimmings for clothing; tresses of hair; wigs; silver embroidery; edgings for clothing; rosettes (haberdashery); suspender clips [fasteners]; skirt flounces; braids; toupees; shoe hooks, hooks.

(260) AM 2017 90947 A

(800) 1331454

(891) 2016 07 29

(731) HENKEL AG & CO. KGAA

Henkelstrasse 67, 40589 Düsseldorf, Germany

(540)

EXTRA DUR

(511)

2 – Coatings [paints]; anti-rust preparations; paints, varnishes, lacquers; preservatives against rust and against deterioration of wood; dyes; mordants; mastic [natural resin], binding agents for paints, anti-corrosive preparations, primers (lacquers and paints).

17 – Packing, stopping and insulating materials; sealant compounds for joints, caulking materials, weatherstripping compositions, silicone compounds for sealing purposes, heat protection and insulating materials, self-adhesive seals.

19 – Packing, stopping and insulating materials; sealant compounds for joints, caulking materials, weatherstripping compositions, silicone compounds for sealing purposes, heat protection and insulating materials, self-adhesive seals.

(260) AM 2017 90950 A

(800) 1331054

(891) 2016 10 11

(731) PHILIP MORRIS PRODUCTS S.A.

Quai Jeanrenaud 3, CH-2000 Neuchâtel,
Switzerland

(540)



(591) Turquoise, blue and light blue

(511)

9 – Batteries for electronic cigarettes; batteries for electronic devices that are used for heating tobacco, chargers for electronic devices that are used for heating tobacco; USB chargers for electronic devices that are used for heating tobacco; car chargers for electronic cigarettes; car chargers for devices that are used for heating tobacco; battery chargers for electronic cigarettes.

34 – Wired vaporizers for electronic cigarettes and electronic smoking devices; tobacco, raw or manufactured; tobacco products, including cigars, cigarettes, cigarillos, tobacco for roll-your-own cigarettes, pipe tobacco, chewing tobacco, snuff tobacco, kretek; snus; tobacco substitutes (not for medical purposes); smokers' articles, including cigarette paper and tubes, cigarette filters, tobacco tins, cigarette cases and ashtrays, pipes, pocket apparatus for rolling cigarettes, lighters; matches; tobacco sticks, tobacco products for the purpose of being heated, electronic devices and their parts for the purpose of heating cigarettes or tobacco in order to release nicotine-containing aerosol for inhalation; liquid nicotine solutions for use in electronic cigarettes; electronic

smoking devices; electronic cigarettes; electronic cigarettes as substitute for traditional cigarettes; electronic devices for the inhalation of nicotine-containing aerosol; oral vaporizing devices for use by smokers, tobacco products and tobacco substitutes; smokers' articles for electronic cigarettes; parts and fittings for the aforesaid products included in this class; extinguishers for heated cigarettes and cigars as well as heated tobacco sticks; electronic rechargeable cigarette cases.

(260) AM 2017 90951 A
 (800) 1331058
 (891) 2016 10 10
 (731) SOCIETE BIC, société anonyme
 14 rue Jeanne d'Asnières, F-92110 Clichy, France
 (540)

RollerGlide

(591) Black, white
 (511)
 16 – Paper, cardboard and goods made of these materials not included in other classes, namely sheets of paper for printers, calendars, writing or drawing books, note books, envelopes, notepads, removable self-stick notes, labels not of textile, adhesive labels; stationery; writing and drawing instruments and refills therefor, pens, ball-point pens, fountain pens, pen nibs, pencils, pencil sharpeners, propelling pencils, color pencils, writing and coloring felt-tip pens, markers, highlighters, writing inks, ink cartridges, leads for pencils, chalks; drawing rulers, drawing compasses, writing slates; adhesives for stationery, and particularly office glues, adhesive tapes; correction products for stationery, correction fluids, correction pens, correction tape, eraser pens; artists' materials; paintbrushes; instructional or teaching material (excluding apparatus).

(260) AM 2017 91081 A
 (800) 1332678
 (891) 2016 09 12
 (731) VALIO LTD
 Meijeritie 6, FI-00370 Helsinki, Finland
 (540)



(591) Red, blue, yellow, green, beige and white.
 (511)
 29 – Meat, fish, poultry and game; meat extracts; preserved, frozen, dried and cooked fruits and vegetables; jellies, jams, compotes; eggs; milk and milk products; edible oils and fats; dairy substitutes; smetana [sour cream]; prostokvasha [soured milk]; whey; milk powders, dried whey products and whey powders, yogurt; yogurt drinks; drinks made from dairy products; cheese; drinking yogurts; whiteners [dairy] for beverages; double cream; milk ferments for culinary purposes; cheese spreads; peanut milk for culinary purposes; beverages made from or containing milk; butter; lactic acid bacteria drinks; fruit purees, vegetable purees; prepared meals and snacks containing any of the aforesaid goods.

(260) AM 2017 91098 A
 (800) 706558
 (891) 2016 09 12
 (731) BK GIULINI GMBH
 Giulinistraße 2, 67065 Ludwigshafen,
 Germany
 (540)

Fibrodin

(511)
 1 – Chemicals used in industry, namely chemical substances for preserving foodstuffs, keeping the colors and improving the taste of foodstuffs, manures, scale removing preparations.

(260) AM 2017 91099 A
 (800) 1097920
 (891) 2016 12 15
 (731) BEYER GLOBAL HEALTHCARE GMBH
 Edisonstr. 6 59199 Bönen, Germany
 (540)



(591) White, red, blue
 (511)
 3 – Cosmetics, skin-care preparations (cosmetics), soaps, essential oils and essences, dentifrices, makeup remover, anti-perspirants (toiletries), skin cream, skin whitening creams, bleaching preparations for cosmetic purposes, deodorants for personal use (perfumery articles), disinfectant and deodorant soap, toilet waters, greases for cosmetic purposes, jasmine oil, lavender oil and lavender water, lipsticks, lotions for cosmetic purposes, beauty masks, medical soaps, oral care products, not for medical purposes; cos-

metic oils, for cosmetic and cleansing purposes, oils for perfumes and scents and perfumery, perfumes, cleansing milk for cosmetic purposes, cosmetic slimming preparations, sunscreens (sun-tanning preparations), toiletries, toilet soaps, toilet water; cloths, impregnated with cosmetic lotions, petroleum jelly for cosmetic purposes, hydrogen peroxide for cosmetic purposes, cotton wool and cotton sticks for cosmetic purposes, mascara, cosmetic plasters.

5 – Pharmaceutical and veterinary preparations and sanitary preparations for medical purposes, dietetic substances adapted for medical use, food for babies, purgatives, medical preparations for slimming purposes, aldehydes for pharmaceutical purposes, medicinal alcohol, aluminium acetate for pharmaceutical purposes, analgesics, anaesthetics, antiparasitic preparations, anti-rheumatism bracelets, medicines for human purposes, medicines for dental purposes, asthmatic tea, ethers for pharmaceutical purposes, caustics for pharmaceutical purposes, eye-wash, acetates for pharmaceutical purposes, food for babies, bath salts for medical purposes, medicated bath preparations, therapeutic preparations for the bath, bacterial preparations for medical use, bacteriological preparations for medical use, balms for medical purposes, balsamic preparations for medical use, sedatives, biological preparations for pharmaceutical purposes, haematogens, depuratives, confectionery, medicated, chemical preparations for medical purposes, chemical preparations for pharmaceutical purposes, chemico-pharmaceutical preparations, quinquina for medical purposes, quinine for medical purposes, chinoline for medical purposes, disinfectants for hygiene purposes, detergents for medical purposes, diagnostic preparations for medical purposes, dietetic beverages adapted for medical purposes, dietetic substances adapted for medical use, drugs for medical purposes, albuminous foodstuffs for medical purposes, albuminous preparations for medical purposes, elixirs, gentian for pharmaceutical purposes, bath preparations for colds and cold remedies, esters for pharmaceutical purposes, eucalyptol for pharmaceutical purposes, eucalyptus for pharmaceutical purposes, fennel for medical purposes, ferments for pharmaceutical purposes, greases for medical purposes, febrifuges, formic aldehyde for pharmaceutical purposes, chilblain preparations, frostbite salve for pharmaceutical purposes, gelatine for medical purposes, royal jelly (for medical purposes), beverages for medical use, poisons, glucose for medical purposes, glycerine for medical purposes, flu remedies, haemoglobin, haemorrhoid preparations, nucleic acid, pharmaceutical preparations for skin care, yeast for pharmaceutical purposes, herb teas for medicinal purposes, extracts of hops for pharmaceutical purposes, hormones for medical purposes, cough remedies, drops and sweets, vaccines, preparations of lime for pharmaceutical purposes, camphor for medical use, capsules for medicines, germicides, silica (in

tablet form), contraceptives, headache pencils, herbs for medical use, lecithin for medical purposes, lozions for pharmaceutical purposes, vitamin and mineral lozenges, magnesia for pharmaceutical purposes, malt for pharmaceutical purposes, medicinal drinks, medicinal herbal teas, medicinal tea, menthol, articles for headaches, mineral salts, albuminous foodstuffs for medical purposes, food supplements, for medical purposes, with a base of amino acids, minerals, trace elements and vitamins, sodium salts for medical purposes, nervines, medicinal oils, pastilles for pharmaceutical purposes, pectin for pharmaceutical purposes, pepsins for pharmaceutical purposes, peptones for pharmaceutical purposes, mint for pharmaceutical purposes, pharmaceutical preparations, phenol for pharmaceutical purposes, phosphates for pharmaceutical purposes, pills for pharmaceutical purposes, castor oil for medical purposes, radiological contrast substances for medical purposes, ointments for pharmaceutical purposes, sal ammoniac lozenges, soporifics, reducing tea for medical purposes, cold remedies, mustard oil for medical purposes, serums, serotherapeutic medicines, syrups for pharmaceutical purposes, sunburn ointments, sunburn preparations for pharmaceutical purposes, sulphonamides, suppositories, tinctures for medical purposes, tonics (medicinal), glucose for medical purposes, petroleum jelly for medical purposes, digestives for pharmaceutical purposes, vitamin preparations, tartar for pharmaceutical purposes, bismuth preparations for pharmaceutical purposes, medicinal roots, sugar for medical purposes; all the aforesaid goods exclusively for human use; patches for medical purposes; food supplements for medical purposes, with a base of fats, fatty acids, with added vitamins, minerals, trace elements, either singly or in combination; food supplements containing algae and/or vitamins; food supplements, for medical purposes, with a base of proteins, with added vitamins, minerals, trace elements, either singly or in combination, included in this class.

29 – Jellies, weed extracts for food, alginates for food, protein for food, fruit jellies, jellies for food, pectin for foods, pollen for food, proteins for food.

(260) AM 2017 91100 A

(800) 1131365

(891) 2016 08 27

(731) GREAT WALL MOTOR COMPANY LIMITED

2266 Chaoyang South Street, Baoding, 071000 Hebei, China

(540)



(591) Black, grey

(511)
37 – Vehicle service stations (refueling and maintenance); motor vehicle maintenance and repair; vehicle maintenance; anti-rust treatment for vehicle; vehicle breakdown assistance (repair); vehicle lubrication (greasing); vehicle cleaning; vehicle wash; vehicle polishing.

plements for humans and animals; plasters, materials for dressings; material for slopping teeth, dental wax; disinfectants; preparations for destroying vermin; fungicides, herbicides.

(260) AM 2017 91101 A
(800) 1142625
(891) 2017 01 27
(731) ENTERPRISE HOLDINGS, INC.
600 Corporate Park, Drive St. Louis MO
63105, USA

(540)



(591) Black, white

(511)
39 – Vehicle rental and leasing services; and reservation services for the rental and leasing of vehicles, namely, rental reservations for automobiles, trucks, cars, land vehicles.

(260) AM 2017 91103 A
(800) 1236214
(891) 2017 02 01
(731) SAM ASH MUSIC CORPORATION
278 Duffy Avenue Hicksville NY 11801,
USA

(540)

JEAN BAPTISTE

(511)
15 – Woodwind and brass instruments and mouthpieces, carrying cases for musical instruments, and repair and replacement parts thereof.

(260) AM 2017 91104 A
(800) 1278787
(891) 2016 12 19
(731) DEVA HOLDİNG AŞ
Halkali Merkez mah. Basın, Ekspres cad.
No:1, Küçükçekmece/İstanbul, Turkey

(540)

İmatis

(591) Black, white

(511)
5 – Pharmaceutical and veterinary preparations; dietetic food and substances adapted for medical or veterinary use, food for babies; medical dietary sup-

INTERNATIONAL TRADEMARKS PROTECTED IN GEORGIA

(260) AM 2017 87870 A
(800) 1300447
(151) 2016 02 26
(181) 2026 02 26
(891) 2016 02 26
(511) 30

(260) AM 2017 88200 A
(800) 1299946
(151) 2016 03 08
(181) 2026 03 08
(891) 2016 07 13
(511) 03, 05

(260) AM 2017 88261 A
(800) 1305072
(151) 2016 05 04
(181) 2026 05 04
(891) 2016 05 04
(511) 29, 30, 35

(260) AM 2017 88361 A
(800) 1305611
(151) 2016 04 13
(181) 2026 04 13
(891) 2016 04 13
(511) 30

(260) AM 2017 88517 A
(800) 1307439
(151) 2016 04 26
(181) 2026 04 26
(891) 2016 04 26
(511) 28, 41, 42

(260) AM 2017 88521 A
(800) 1307513
(151) 2016 04 06
(181) 2026 04 06
(891) 2016 04 06
(511) 43

(260) AM 2017 88589 A
(800) 1307846
(151) 2016 06 03
(181) 2026 06 03

(891) 2016 06 03
(511) 05, 29, 30

(260) AM 2017 88590 A
(800) 1307851
(151) 2016 02 19
(181) 2026 02 19
(891) 2016 02 19
(511) 09, 12

(260) AM 2017 88591 A
(800) 1307860
(151) 2016 03 07
(181) 2026 03 07
(891) 2016 03 07
(511) 05

(260) AM 2017 88596 A
(800) 1308061
(151) 2016 02 29
(181) 2026 02 28
(891) 2016 02 29
(511) 33

(260) AM 2017 88603 A
(800) 1308187
(151) 2016 03 21
(181) 2026 03 21
(891) 2016 03 21
(511) 09, 28, 41, 42

(260) AM 2017 88610 A
(800) 1271355
(151) 2015 07 30
(181) 2025 07 30
(891) 2016 05 30
(511) 03

(260) AM 2017 88613 A
(800) 1309243
(151) 2016 03 24
(181) 2026 03 24
(891) 2016 03 24
(511) 03, 05, 21

(260) AM 2017 88614 A
(800) 1308370
(151) 2015 02 25

(181) 2025 02 25
(891) 2015 02 25
(511) 01, 04, 06, 07, 09, 11, 12, 16, 17, 19, 21, 25,
35, 37, 39, 40, 41, 42, 45

(260) AM 2017 88615 A
(800) 1308389
(151) 2016 03 24
(181) 2026 03 24
(891) 2016 03 24
(511) 03, 05, 21

(260) AM 2017 88617 A
(800) 1308489
(151) 2016 05 20
(181) 2026 05 20
(891) 2016 05 20
(511) 28

(260) AM 2017 88618 A
(800) 1309265
(151) 2016 05 23
(181) 2026 05 23
(891) 2016 05 23
(511) 03

(260) AM 2017 88619 A
(800) 1308509
(151) 2016 03 08
(181) 2026 03 08
(891) 2016 03 08
(511) 12

(260) AM 2017 88623 A
(800) 1309295
(151) 2016 05 20
(181) 2026 05 20
(891) 2016 05 20
(511) 12

(260) AM 2017 88624 A
(800) 1309296
(151) 2016 06 02
(181) 2026 06 02
(891) 2016 06 02
(511) 29, 30, 41

(260) AM 2017 88626 A
(800) 1309319
(151) 2016 06 23
(181) 2026 06 23

(891) 2016 06 23
(511) 42

(260) AM 2017 88627 A
(800) 1308631
(151) 2016 05 13
(181) 2026 05 13
(891) 2016 05 13
(511) 09, 35, 38, 41, 45

(260) AM 2017 88628 A
(800) 1308643
(151) 2016 04 21
(181) 2026 04 21
(891) 2016 04 21
(511) 09, 35, 41

(260) AM 2017 88643 A
(800) 1246321
(151) 2015 03 11
(181) 2025 03 11
(891) 2016 07 08
(511) 33

(260) AM 2017 88667 A
(800) 1309242
(151) 2016 03 07
(181) 2026 03 07
(891) 2016 03 07
(511) 05, 09, 11, 34

(260) AM 2017 88736 A
(800) 1309995
(151) 2016 02 26
(181) 2026 02 26
(891) 2016 02 26
(511) 16

(260) AM 2017 88748 A
(800) 1310243
(151) 2016 04 05
(181) 2026 04 05
(891) 2016 04 05
(511) 32

(260) AM 2017 88749 A
(800) 1310251
(151) 2016 04 03
(181) 2026 04 03
(891) 2016 04 03
(511) 06

(260) AM 2017 88758 A
(800) 1310085
(151) 2016 03 21
(181) 2026 03 21
(891) 2016 03 21
(511) 03

(260) AM 2017 88773 A
(800) 1310482
(151) 2016 06 20
(181) 2026 06 20
(891) 2016 06 20
(511) 35

(260) AM 2017 88774 A
(800) 1310539
(151) 2016 08 11
(181) 2026 08 11
(891) 2016 08 11
(511) 09, 42

(260) AM 2017 88802 A
(800) 1310665
(151) 2016 04 28
(181) 2026 04 28
(891) 2016 04 28
(511) 03

(260) AM 2017 88804 A
(800) 1310683
(151) 2016 05 24
(181) 2026 05 24
(891) 2016 05 24
(511) 32

(260) AM 2017 88805 A
(800) 860910
(151) 2005 01 28
(181) 2025 01 28
(891) 2016 07 04
(511) 30, 32

(260) AM 2017 88806 A
(800) 929116
(151) 2007 05 30
(181) 2027 05 30
(891) 2016 03 15
(511) 25, 35

(260) AM 2017 88807 A
(800) 1295194
(151) 2015 11 13
(181) 2025 11 13

(891) 2016 04 04
(511) 33

(260) AM 2017 88821 A
(800) 1310727
(151) 2016 04 07
(181) 2026 04 07
(891) 2016 04 07
(511) 35

(260) AM 2017 88822 A
(800) 1310764
(151) 2016 05 26
(181) 2026 05 26
(891) 2016 05 26
(511) 30

(260) AM 2017 88823 A
(800) 1310778
(151) 2016 05 24
(181) 2026 05 24
(891) 2016 05 24
(511) 35

(260) AM 2017 88824 A
(800) 1310779
(151) 2016 05 27
(181) 2026 05 27
(891) 2016 05 27
(511) 06, 40

(260) AM 2017 88825 A
(800) 1310783
(151) 2016 04 27
(181) 2026 04 27
(891) 2016 04 27
(511) 05

(260) AM 2017 88830 A
(800) 1310884
(151) 2016 03 14
(181) 2026 03 14
(891) 2016 03 14
(511) 03, 05

(260) AM 2017 88831 A
(800) 1310885
(151) 2016 03 14
(181) 2026 03 14
(891) 2016 03 14
(511) 03, 05

(260) AM 2017 88833 A
(800) 1310939
(151) 2016 03 31
(181) 2026 03 31
(891) 2016 03 31
(511) 20

(260) AM 2017 88852 A
(800) 1311081
(151) 2015 11 17
(181) 2025 11 17
(891) 2015 11 17
(511) 16, 21, 25, 33

(260) AM 2017 88853 A
(800) 1311086
(151) 2016 02 08
(181) 2026 02 08
(891) 2016 02 08
(511) 01, 03, 05, 07, 09, 11, 16, 21, 23, 35, 37, 38,
42, 44

(260) AM 2017 88854 A
(800) 1311096
(151) 2016 03 15
(181) 2026 03 15
(891) 2016 03 15
(511) 09, 16, 41, 42, 44

(260) AM 2017 88858 A
(800) 1311134
(151) 2016 03 29
(181) 2026 03 29
(891) 2016 03 29
(511) 12

(260) AM 2017 88859 A
(800) 1311161
(151) 2016 05 03
(181) 2026 05 03
(891) 2016 05 03
(511) 09, 16, 35

(260) AM 2017 88860 A
(800) 1311168
(151) 2016 06 10
(181) 2026 06 10
(891) 2016 06 10
(511) 25

(260) AM 2017 88861 A
(800) 1311172
(151) 2016 04 29
(181) 2026 04 29

(891) 2016 04 29
(511) 05

(260) AM 2017 88863 A
(800) 1311180
(151) 2016 07 15
(181) 2026 07 15
(891) 2016 07 15
(511) 01, 30

(260) AM 2017 88864 A
(800) 1311186
(151) 2016 06 30
(181) 2026 06 30
(891) 2016 06 30
(511) 05

(260) AM 2017 88866 A
(800) 1311232
(151) 2016 06 06
(181) 2026 06 06
(891) 2016 06 06
(511) 39

(260) AM 2017 88898 A
(800) 1312003
(151) 2016 07 26
(181) 2026 07 26
(891) 2016 07 26
(511) 01, 05

(260) AM 2017 88905 A
(800) 1261116
(151) 2015 06 25
(181) 2025 06 25
(891) 2016 07 15
(511) 44

(260) AM 2017 88912 A
(800) 1312745
(151) 2016 04 22
(181) 2026 04 22
(891) 2016 04 22
(511) 09

(260) AM 2017 88913 A
(800) 1312779
(151) 2016 04 18
(181) 2026 04 18
(891) 2016 04 18
(511) 03

(260) AM 2017 88914 A
(800) 1312804
(151) 2016 05 13
(181) 2026 05 13
(891) 2016 05 13
(511) 29, 30

(260) AM 2017 88915 A
(800) 1312842
(151) 2016 06 17
(181) 2026 06 17
(891) 2016 06 17
(511) 09, 11

(260) AM 2017 88942 A
(800) 1283505
(151) 2015 10 22
(181) 2025 10 22
(891) 2016 07 13
(511) 07, 37, 40, 42

(260) AM 2017 89031 A
(800) 1314138
(151) 2016 04 18
(181) 2026 04 18
(891) 2016 04 18
(511) 06

(260) AM 2017 89032 A
(800) 1314146
(151) 2016 05 30
(181) 2026 05 30
(891) 2016 05 30
(511) 25

(260) AM 2017 89034 A
(800) 1314186
(151) 2016 06 14
(181) 2026 06 14
(891) 2016 06 14
(511) 16

(260) AM 2017 89035 A
(800) 1314195
(151) 2016 07 20
(181) 2026 07 20
(891) 2016 07 20
(511) 09

(260) AM 2017 89036 A
(800) 1314198
(151) 2016 07 08
(181) 2026 07 08

(891) 2016 07 08
(511) 05

(260) AM 2017 89037 A
(800) 1314213
(151) 2016 06 23
(181) 2026 06 23
(891) 2016 06 23
(511) 29

(260) AM 2017 89039 A
(800) 1314245
(151) 2016 08 01
(181) 2026 08 01
(891) 2016 08 01
(511) 32

(260) AM 2017 89041 A
(800) 838831
(151) 2004 09 01
(181) 2024 09 01
(891) 2016 07 04
(511) 16, 28

(260) AM 2017 89045 A
(800) 1124762
(151) 2012 02 03
(181) 2022 02 03
(891) 2016 09 22
(511) 36

(260) AM 2017 89054 A
(800) 1313224
(151) 2016 06 01
(181) 2026 06 01
(891) 2016 06 01
(511) 29, 30

(260) AM 2017 89108 A
(800) 1315082
(151) 2016 05 05
(181) 2026 05 05
(891) 2016 05 05
(511) 11

(260) AM 2017 89118 A
(800) 465655
(151) 1982 01 11
(181) 2022 01 11
(891) 2016 08 05
(511) 03

(260) AM 2017 89120 A
(800) 589580
(151) 1992 07 16
(181) 2022 07 16
(891) 2016 09 23
(511) 05

(260) AM 2017 89121 A
(800) 841511
(151) 2004 09 22
(181) 2024 09 22
(891) 2016 08 05
(511) 30

(260) AM 2017 89123 A
(800) 892993
(151) 2006 06 01
(181) 2026 06 01
(891) 2016 10 05
(511) 12

(260) AM 2017 89124 A
(800) 893216
(151) 2006 05 05
(181) 2026 05 05
(891) 2016 06 10
(511) 09, 16, 18, 25, 28, 30

(260) AM 2017 89126 A
(800) 920726
(151) 2006 07 19
(181) 2026 07 19
(891) 2016 07 20
(511) 07, 11

(260) AM 2017 89128 A
(800) 996587
(151) 2008 11 25
(181) 2018 11 25
(891) 2016 06 30
(511) 18, 25, 28

(260) AM 2017 89129 A
(800) 1052532
(151) 2010 06 28
(181) 2020 06 28
(891) 2016 07 11
(511) 01, 02, 17, 19

(260) AM 2017 89131 A
(800) 1076091
(151) 2011 03 31

(181) 2021 03 31
(891) 2016 09 30
(511) 10

(260) AM 2017 89132 A
(800) 1091811
(151) 2011 06 01
(181) 2021 06 01
(891) 2016 07 18
(511) 09

(260) AM 2017 89133 A
(800) 1146690
(151) 2012 12 25
(181) 2022 12 25
(891) 2016 08 10
(511) 05

(260) AM 2017 89135 A
(800) 1179549
(151) 2013 06 17
(181) 2023 06 17
(891) 2016 08 01
(511) 29

(260) AM 2017 89136 A
(800) 1233947
(151) 2014 11 06
(181) 2024 11 06
(891) 2016 07 11
(511) 02, 19

(260) AM 2017 89311 A
(800) 1316138
(151) 2015 11 04
(181) 2025 11 04
(891) 2015 11 04
(511) 36

(260) AM 2017 89314 A
(800) 1316244
(151) 2016 05 25
(181) 2026 05 25
(891) 2016 05 25
(511) 44

(260) AM 2017 89315 A
(800) 1316270
(151) 2016 05 31
(181) 2026 05 31
(891) 2016 05 31
(511) 21

(260) AM 2017 89316 A
(800) 1316347
(151) 2016 07 11
(181) 2026 07 11
(891) 2016 07 11
(511) 05, 29, 30

(260) AM 2017 89318 A
(800) 1316384
(151) 2016 02 15
(181) 2026 02 15
(891) 2016 02 15
(511) 33

(260) AM 2017 89319 A
(800) 1316392
(151) 2016 02 22
(181) 2026 02 22
(891) 2016 02 22
(511) 05, 31

(260) AM 2017 89322 A
(800) 629484
(151) 1994 11 18
(181) 2024 11 18
(891) 2016 07 25
(511) 24, 25

(260) AM 2017 89323 A
(800) 646981
(151) 1995 11 22
(181) 2025 11 22
(891) 2016 08 16
(511) 07, 09

(260) AM 2017 89324 A
(800) 670875
(151) 1997 01 24
(181) 2027 01 24
(891) 2016 08 25
(511) 32, 33

(260) AM 2017 89325 A
(800) 703050
(151) 1998 10 15
(181) 2018 10 15
(891) 2016 08 23
(511) 30

(260) AM 2017 89326 A
(800) 893341
(151) 2006 05 08

(181) 2026 05 08
(891) 2016 06 23
(511) 09

(260) AM 2017 89328 A
(800) 1098121
(151) 2011 11 08
(181) 2021 11 08
(891) 2016 06 06
(511) 12

(260) AM 2017 89332 A
(800) 1157961
(151) 2013 03 21
(181) 2023 03 21
(891) 2016 07 22
(511) 03, 05, 08, 09, 10

(260) AM 2017 89333 A
(800) 1197644
(151) 2013 09 19
(181) 2023 09 19
(891) 2016 08 23
(511) 03

(260) AM 2017 89336 A
(800) 1214085
(151) 2013 09 30
(181) 2023 09 30
(891) 2016 09 02
(511) 24, 27, 35

OFFICIAL NOTIFICATIONS

TRADEMARKS

RENEWAL OF REGISTRATIONS

(111) M 2007 17731 R1

(156) 2017 09 18

(186) 2027 09 18

(732) LTD "AVERSI-PHARMA"

Davit Agmasheneblis gamz. 148/2, 0112,
Tbilisi, Georgia

(111) M 2007 17994 R1

(156) 2017 11 13

(186) 2027 11 13

(732) MASTERCARD INTERNATIONAL

INCORPORATED, a Delaware Corporation
2000 Purchase Street, Purchase, New York
10577-2509, USA

(111) M 2007 17783 R1

(156) 2017 10 02

(186) 2027 09 18

(732) LTD "WINE COMPANY SHUMI"

Solomon Lionidzis q. 33, 2200, Telavi,
Georgia

(111) M 2007 17995 R1

(156) 2017 11 13

(186) 2027 11 13

(732) MASTERCARD INTERNATIONAL

INCORPORATED, a Delaware Corporation
2000 Purchase Street, Purchase, New York
10577-2509, USA

(111) M 2007 17877 R1

(156) 2017 10 03

(186) 2027 10 03

(732) MOTİF KUYUMCULUK SANAYİ

VE TİCARET ANONİM ŞİRKETİ
Vezirhan Caddesi, No:101 Çemberlitaş –
Eminönü - Istanbul, Turkey

(111) M 2007 18077 R1

(156) 2017 11 30

(186) 2027 11 30

(732) WYETH LLC

235 East 42nd Street New York, New York
10017, USA

(111) M 2007 17883 R1

(156) 2017 10 10

(186) 2027 10 10

(732) ONOMENTO CO LTD

2-4 Arch. Makariou III Avenue, CAPITAL
CENTER, 9th floor, 1065 Nicosia, Cyprus

(111) M 2008 18654 R1

(156) 2018 08 29

(186) 2028 08 29

(732) OJSC "CONCERN ENERGOMER"

Ul. Lenina 415a, 355035, Stavropol,
Russian Federation

(111) M 2007 17976 R1

(156) 2017 10 29

(186) 2027 10 29

(732) PAKSHOO INDUSTRIAL GROUP

Beheshti ave., Pakistan st., 29, second alley,
Tehran, Iran (Islamic Republic of)

(111) M 1997 6241 R2

(156) 2017 08 01

(186) 2027 08 01

(732) AURELIUS RHO GTM DEVELOPMENT
LIMITED

35 Rosemount Business Park, Ballycoolin,
Dublin 11, Ireland

(111) M 2007 17977 R1

(156) 2017 10 29

(186) 2027 10 29

(732) PAKSHOO INDUSTRIAL GROUP

Beheshti ave., Pakistan st., 29, second alley,
Tehran, Iran (Islamic Republic of)

(111) M 1997 6565 R2

(156) 2017 08 29

(186) 2027 08 29

(732) MALESCI ISTITUTO

FARMACOBIOLOGICO S.P.A.
Via Lunga l'Emma 7, Loc. Ponte a Emma, Bagno
a Ripoli (FI), Italy

(111) M 1997 6592 R2
 (156) 2017 09 02
 (186) 2027 09 02
 (732) MACK TRUCKS, INC.
 7900 Natoinal Service Road, Greensboro,
 North Carolina 27409, USA

(111) M 1997 6649 R2
 (156) 2017 09 04
 (186) 2027 09 04
 (732) DAVIDE CAMPARI-MILANO S.p.A.
 Via Franco Sacchetti, 20, I-20099 Sesto
 San Giovanni, Milan, Italy

(111) M 1997 6651 R2
 (156) 2017 09 04
 (186) 2027 09 04
 (732) DAVIDE CAMPARI-MILANO S.p.A.
 Via Franco Sacchetti, 20, I-20099 Sesto
 San Giovanni, Milan, Italy

(111) M 1997 6688 R2
 (156) 2017 09 08
 (186) 2027 09 08
 (732) CoomScope, Inc. of North Carolina
 1100 CoomScope Place, SE, Hickory, North
 Carolina 28602, USA

(111) M 1997 6728 R2
 (156) 2017 09 10
 (186) 2027 09 10
 (732) ANADOLU EFES BİRACILIK VE MALT
 SANAYİİ A.Ş.
 Istanbul, Turkey

(111) M 1997 6847 R2
 (156) 2017 09 19
 (186) 2027 09 19
 (732) MERCK SHARP & DOHME CORP.
 One Merck Drive, Whitehouse Station, New
 Jersey 08889, USA

(111) M 1997 6918 R2
 (156) 2017 09 24
 (186) 2027 09 24
 (732) ANTONIO PUIG S.A.
 Plaza Europa 46-48, 08902 L'Hospitalet de
 Lobregot, Barcelona, Spain

(111) M 1997 6949 R2
 (156) 2017 09 25
 (186) 2027 09 25

(732) DORMEUIL FRERES
 3 Avenue Jeanne Garnerin, Air Park Paris
 Sud 91320 WISSOUS, France

(111) M 1997 6950 R2
 (156) 2017 09 25
 (186) 2027 09 25
 (732) DORMEUIL FRERES
 3 Avenue Jeanne Garnerin, Air Park Paris
 Sud 91320 WISSOUS, France

(111) M 1997 6951 R2
 (156) 2017 09 25
 (186) 2027 09 25
 (732) DORMEUIL FRERES;
 3 Avenue Jeanne Garnerin, Air Park Paris
 Sud 91320 WISSOUS, France

(111) M 1997 6952 R2
 (156) 2017 09 25
 (186) 2027 09 25
 (732) DORMEUIL FRERES
 3 Avenue Jeanne Garnerin, Air Park Paris
 Sud 91320 WISSOUS, France

(111) M 1997 7009 R2
 (156) 2017 09 30
 (186) 2027 09 30
 (732) AAK Turkey Gıda Sanayi ve Ticaret Ltd. Şti
 Meclis Mahallesi Boğaziçi Caddesi Seheryeli
 Sokak Karsan Plaza No 1/2, Sancaktepe –
 Istanbul, Turkey

(111) M 1997 7024 R2
 (156) 2017 10 01
 (186) 2027 10 01
 (732) Ford Motor Company
 One American Road, Dearborn, Michigan
 48126, USA

(111) M 1997 7040 R2
 (156) 2017 10 06
 (186) 2027 10 06
 (732) MOVADO WATCH COMPANY A.G.
 Bettlachstrasse 8, 2540 Grenchen,
 Switzerland

(111) M 1997 7079 R2
 (156) 2017 10 08
 (186) 2027 10 08
 (732) L' OREAL
 14 Rue Royale, 75008 Paris, France

(111) M 1997 7111 R2
(156) 2017 10 09
(186) 2027 10 09
(732) ETONIC HOLDINGS, LLC
287 Bowman Avenue, Purchase, NY 10577,
USA

(111) M 1997 7131 R2
(156) 2017 10 09
(186) 2027 10 09
(732) PUIG FRANCE, Societe par Actions
Simplifíee
65-67 Avenue des Champs Elysées, 75008
Paris, France

(111) M 1997 7132 R2
(156) 2017 10 09
(186) 2027 10 09
(732) PUIG FRANCE, Societe par Actions
Simplifíee
65-67 Avenue des Champs Elysées, 75008
Paris, France

(111) M 1997 7154 R2
(156) 2017 10 10
(186) 2027 10 10
(732) MALESCI ISTITUTO
FARMACOBIOLOGICO S.P.A.
Via Lunga l'Ema 7, Loc. Ponte a Ema, Bagno
a Ripoli (FI), Italy

(111) M 1997 7173 R2
(156) 2017 10 13
(186) 2027 10 13
(732) L'OREAL
14, rue Royale, F-75008 Paris, France

(111) M 1997 7270 R2
(156) 2017 10 21
(186) 2027 10 21
(732) TOYOTA JIDOSHA KABUSHIKI KAISHA
(TOYOTA MOTOR CORPORATION)
1, Toyota-Cho, Toyota-Shi, Aichi-Ken, Japan

(111) M 1997 7311 R2
(156) 2017 10 28
(186) 2027 10 28
(732) SONY CORPORATION
1-7-1 Konan, Minato-ku, Tokyo, Japan

(111) M 1997 7313 R2
(156) 2017 10 28
(186) 2027 10 28

(732) SONY CORPORATION
1-7-1 Konan, Minato-ku, Tokyo, Japan

(111) M 1997 7336 R2
(156) 2017 10 29
(186) 2027 10 29
(732) BACARDI & COMPANY LIMITED
Aeulestrasse 5, 9490 Vaduz, Liechtenstein,
Liechtenstein

(111) M 1997 7338 R2
(156) 2017 10 29
(186) 2027 10 29
(732) BACARDI & COMPANY LIMITED
Aeulestrasse 5, 9490 Vaduz, Liechtenstein,
Liechtenstein

(111) M 1997 7339 R2
(156) 2017 10 29
(186) 2027 10 29
(732) BACARDI & COMPANY LIMITED
Aeulestrasse 5, 9490 Vaduz, Liechtenstein,
Liechtenstein

(111) M 1997 7368 R2
(156) 2017 11 04
(186) 2027 11 04
(732) PUIG FRANCE, Societe par Actions
Simplifíee
65-67 Avenue des Champs Elysées, 75008
Paris, France

(111) M 1997 7389 R2
(156) 2017 11 05
(186) 2027 11 05
(732) SONY CORPORATION
1-7-1 Konan, Minato-ku, Tokyo, Japan

(111) M 1997 7395 R2
(156) 2017 11 05
(186) 2027 11 05
(732) SONY CORPORATION
1-7-1 Konan, Minato-ku, Tokyo, Japan

(111) M 1997 7531 R2
(156) 2017 11 17
(186) 2027 11 17
(732) BARRY CALLEBAUT AG
Westpark, Pfingstweidstrasse 60, 8005 Zurich,
Switzerland

(111) M 1997 7532 R2
(156) 2017 11 17
(186) 2027 11 17
(732) BARRY CALLEBAUT AG
Westpark, Pfingstweidstrasse 60, 8005 Zurich,
Switzerland

(111) M 1997 7656 R2
(156) 2017 11 21
(186) 2027 11 21
(732) FRUIT OF THE LOOM, INC.
One Fruit of the Loom Drive, Bowling
Green, Kentucky 42103, USA

(111) M 1997 7663 R2
(156) 2017 11 21
(186) 2027 11 21
(732) JOHNSON & JOHNSON (a corporation the
state of New Jersey)
One Johnson & Johnson Plaza, New
Brunswick, New Jersey, USA

(111) M 1997 7737 R2
(156) 2017 11 28
(186) 2027 11 28
(732) Federacion Nacional de Cafeteros
de Colombia
8-13 Bogota, Columbia, Colombia

(111) M 1997 7747 R2
(156) 2017 11 28
(186) 2027 11 28
(732) NUTRICHEM COMPANY LIMITED
No.27 Life Science Park Road, Changping
District, Beijing, 102206, China

(111) M 1997 7849 R2
(156) 2017 12 15
(186) 2027 12 15
(732) BLUE BOX TOY FACTORY LIMITED
Hong-Kong, The Hong Kong Special
Administrative Region of the people's
republic of China

COMPLETE TRANSFER OF RIGHTS

(111) M 2001 013820 R1
(732) AMAZON EUROPE CORE S.À.R.L.
5, rue Plaetis, L-2338 Luxembourg,
Luxembourg
(770) AMAZON EUROPE HOLDING
TECHNOLOGIES S.À.R.L.
5, rue Plaetis, L-2338 Luxembourg,
Luxembourg
(580) 2017 10 26

(111) M 2014 025039 R
(732) LTD "METAL CONSTRUCTION
GEORGIA"
Leonidzis q. 2, b. 64, Rustavi, Georgia
(770)) LTD " NEWSTAR"
Paliashvili-Mosashvilis q. 85/24, Vake-
Saburtalos r-ni, 0160, Tbilisi, Georgia
(580) 2017 10 26

(111) M 2015 025699 R
(732) LTD G and G COOPERATION
Oniashvilis q. 54, 0160, Tbilisi, Georgia
(770) LIA GELIASHVILI
Galis q. 1, 0179, Tbilisi, Georgia
(580) 2017-10-26

(111) M 2016 26730 R
(732) Levan Gachechiladze
Il. Chavchavadzis gamz. 50a, 0179,
Tbilisi, Georgia
(770) GIORGI SALAKAIA
Gazapkhulis q. 15, 0177, Tbilisi, Georgia
(580) 2017 11 03

CHANGES IN NAMES AND/OR ADDRESSES OF OWNERS

(111) M 2001 013820 R1
(732) AMAZON EUROPE HOLDING
TECHNOLOGIES S.À.R.L.
2-8 avenue, Charles de Gaulle, L-1653
Luxembourg, Luxembourg
(770) AMAZON EUROPE HOLDING
TECHNOLOGIES, SCS
2-8 avenue, Charles de Gaulle, L-1653
Luxembourg, Luxembourg
(580) 2017 10 26

(111) M 2001 013820 R1
(732) AMAZON EUROPE HOLDING
TECHNOLOGIES S.À.R.L.
5, rue Plaetis, L-2338 Luxembourg,
Luxembourg
(770) AMAZON EUROPE HOLDING
TECHNOLOGIES S.À.R.L.
2-8 avenue, Charles de Gaulle, L-1653
Luxembourg, Luxembourg
(580) 2017 10 26

(111) M 2007 017883 R1
(732) ONOMENTO CO LTD
2-4 Arch. Makariou III Avenue, CAPITAL
CENTER, 9th floor, 1065 Nicosia, Cyprus
(770) ONOMENTO CO LTD
Karaiskaki, 38, Kanika Alexander CTR, 2-nd
Floor, office 213C, P.C.3032, Limassol,
Cyprus
(580) 2017 10 26

(111) M 2007 018077 R1
(732) WYETH LLC
235 East 42nd Street New York, New York
10017, USA
(770) WYETH HOLDINGS LLC
Five Giralda Farms, Madison, New Jersey
07940-0874, USA
(580) 2017 10 26

(111) M 1997 006565 R2
(732) MALESCI ISTITUTO
FARMACOBIOLOGICO S.P.A.
Via Lunga l'Ema 7, Loc. Ponte a Ema, Bagno
a Ripoli (FI), Italy
(770) MALESCI ISTITUTO
FARMACOBIOLOGICO S.P.A.
Via N.Porpora 22-24, Firenze, Italy
(580) 2017 10 27

(111) M 1997 006592 R2
(732) MACK TRUCKS, INC.
7900 Natoinal Service Road, Greensboro,
North Carolina 27409, USA
(770) MACK TRUCKS, INC.
2100 Mack Boulevard, Allentown, PA 18105,
USA
(580) 2017 10 26

(111) M 1997 006649 R2
(732) MACK TRUCKS, INC.
2100 Mack Boulevard, Allentown, PA 18105,
USA
(770) DAVIDE CAMPARI-MILANO S.p.A.
Via Filippo Turati 27, 20121 Milano, Italy
(580) 2017 10 30

(111) M 1997 006651 R2
(732) DAVIDE CAMPARI-MILANO S.p.A.
Via Franco Sacchetti, 20, I-20099 Sesto San
Giovanni, Milan, Italy
(770) DAVIDE CAMPARI-MILANO S.p.A.
Via Filippo Turati 27, 20121 Milano, Italy
(580) 2017 10 30

(111) M 1997 006918 R2
(732) ANTONIO PUIG S.A.
Plaza Europa 46-48, 08902 L'Hospitalet de
Lobregot, Barcelona, Spain
(770) ANTONIO PUIG S.A.
Travesera de Gracia 9, 08021 Barselona,
Spain
(580) 2017 10 26

(111) M 1997 006949 R2
(732) DORMEUIL FRERES
3 Avenue Jeanne Garnerin, Air Park Paris
Sud 91320 WISSOUS, France
(770) DORMEUIL FRERES
14, avenue du 1er Mai, 91120 Palaiseau, France
(580) 2017 10 26

(111) M 1997 006950 R2
(732) DORMEUIL FRERES
3 Avenue Jeanne Garnerin, Air Park Paris
Sud 91320 WISSOUS, France
(770) DORMEUIL FRERES
14, avenue du 1er Mai, 91120 Palaiseau, France
(580) 2017 10 26

(111) M 1997 006951 R2
(732) DORMEUIL FRERES
3 Avenue Jeanne Garnerin, Air Park Paris
Sud 91320 WISSOUS, France
(770) DORMEUIL FRERES
14, avenue du 1er Mai, 91120 Palaiseau,
France
(580) 2017 10 26

(111) M 1997 006952 R2
(732) DORMEUIL FRERES
3 Avenue Jeanne Garnerin, Air Park Paris
Sud 91320 WISSOUS, France
(770) DORMEUIL FRERES
14, avenue du 1er Mai, 91120 Palaiseau,
France
(580) 2017 10 26

(111) M 1997 007024 R2
(732) FORD MOTOR COMPANY
One American Road, Dearborn, Michigan
48126, USA
(770) FORD MOTOR COMPANY
The American Road, Dearborn, Michigan
48121, USA
(580) 2017 10 26

(111) M 1997 007131 R2
(732) PUIG FRANCE, Societe par Actions
Simpliffee
65-67 Avenue des Champs Elysées, 75008
Paris, France
(770) PUIG FRANCE, Societe par Actions
Simpliffee
6, Boulevard du Parc, 92200 Neuilly-Sur-
Seine, France
(580) 2017 10 26

(111) M 1997 007132 R2
(732) PUIG FRANCE, Societe par Actions
Simpliffee
65-67 Avenue des Champs Elysées, 75008
Paris, France
(770) PUIG FRANCE, Societe par Actions
Simpliffee
65-67 Avenue des Champs Elysées, 75008
Paris, France
(580) 2017 10 26

(111) M 1997 007154 R2
(732) MALESCI ISTITUTO
FARMACOBIOLOGICO S.P.A.
Via Lunga l'Ema 7, Loc. Ponte a Ema,
Bagno a Ripoli (FI), Italy

(770) MALESCI ISTITUTO
FARMACOBIOLOGICO S.P.A.
Via N.Porpora 22-24, Firenze, Italy
(580) 2017 10 27

(111) M 1997 007368 R2
(732) PUIG FRANCE, Societe par Actions
Simpliffee
65-67 Avenue des Champs Elysées, 75008
Paris, France
(770) PUIG FRANCE, Societe par Actions
Simpliffee
6, Boulevard du Parc, 92200 Neuilly-Sur-
Seine, France
(580) 2017 10 26

CLASSIFICATION INDEXES

INVENTIONS

CONCORDANCE TABLE OF INTERNATIONAL CLASSIFICATION INDEX AND PUBLICATION NUMBERS

INTERNATIONAL CLASSIFICATION INDEXES (51)	NUMBER OF PUBLISHED APPLICATION (10)
A 61 K 9/00; A 61 K 47/02; A 61 K 31/135	AP 2017 14278 A
A 61 K 9/20; A 61 K 31/00	AP 2017 14025 A
A 61 K 9/107; A 61 K 33/22; A 61 K 47/10; A 61 K 47/18; A 61 K 47/26; A 61 K 47/34	AP 2017 13578 A
A 61 K 31/355; A 61 P 11/02; A 61 P 37/08; A 61 K 9/00; A 61 K 45/06	AP 2017 14382 A
C 07 C 67/29; C 07 C 69/18; C 07 F 7/18; C 12 P 41/00; C 07 C 47/565; C 07 C 47/575; C 07 C 51/377; C 07 C 59/72	AP 2017 14111 A
C 07 D 207/267; C 07 D 213/40; C 07 D 233/58; C 07 D 239/34; C 07 D 277/28; C 07 D 401/04; C 07 D 401/06; C 07 D 401/12; C 07 D 405/12; C 07 D 409/04; C 07 D 409/14; C 07 D 413/04; C 07 D 413/12; C 07 D 417/04; C 07 D 417/06; C 07 D 417/12; C 07 D 471/04; C 07 D 487/04; C 07 D 491/048; C 07 D 491/052; C 07 D 491/20; C 07 D 495/14; A 61 K 31/33; A 61 K 31/14	AP 2017 14095 A
C 07 J 7/00; C 07 J 41/00; C 07 J 51/00	AP 2017 14130 A
F 17 D 1/04	AP 2017 14294 A

CONCORDANCE TABLE OF PUBLICATION NUMBERS AND INTERNATIONAL CLASSIFICATION INDEX

NUMBER OF PUBLISHED APPLICATION (10)	INTERNATIONAL CLASSIFICATION INDEXES (51)
AP 2017 13578 A	A 61 K 9/107; A 61 K 33/22; A 61 K 47/10; A 61 K 47/18; A 61 K 47/26; A 61 K 47/34
AP 2017 14025 A	A 61 K 9/20; A 61 K 31/00
AP 2017 14095 A	C 07 D 207/267; C 07 D 213/40; C 07 D 233/58; C 07 D 239/34; C 07 D 277/28; C 07 D 401/04; C 07 D 401/06; C 07 D 401/12; C 07 D 405/12; C 07 D 409/04; C 07 D 409/14; C 07 D 413/04; C 07 D 413/12; C 07 D 417/04; C 07 D 417/06; C 07 D 417/12; C 07 D 471/04; C 07 D 487/04; C 07 D 491/048; C 07 D 491/052; C 07 D 491/20; C 07 D 495/14; A 61 K 31/33; A 61 K 31/14
AP 2017 14111 A	C 07 C 67/29; C 07 C 69/18; C 07 F 7/18; C 12 P 41/00; C 07 C 47/565; C 07 C 47/575; C 07 C 51/377; C 07 C 59/72
AP 2017 14130 A	C 07 J 7/00; C 07 J 41/00; C 07 J 51/00
AP 2017 14278 A	A 61 K 9/00; A 61 K 47/02; A 61 K 31/135
AP 2017 14294 A	F 17 D 1/04
AP 2017 14382 A	A 61 K 31/355; A 61 P 11/02; A 61 P 37/08; A 61 K 9/00; A 61 K 45/06

**CONCORDANCE TABLE OF INTERNATIONAL CLASSIFICATION INDEX,
PATENT NUMBERS AND PUBLICATION NUMBERS**

INTERNATIONAL CLASSIFICATION INDEX (51)	NUMBER OF PATENT (11)	NUMBER OF PUBLISHED APPLICATION (10)
A 61 K 9/00; A 61 K 47/36; A 61 K 47/38; A 61 K 9/16	P 2017 6769 B	AP 2017 13898 A
A 61 K 9/14; A 61 K 31/167; A 61 K 31/57; A 61 P 11/00; A 61 P 11/06	P 2017 6767 B	AP 2017 13532 A
A 61 F 6/06; A 61 F 6/04; B 29 C 65/20	P 2017 6770 B	AP 2017 13991 A
A 61 K 31/232	P 2017 6768 B	AP 2017 13705 A

**CONCORDANCE TABLE OF PATENT NUMBERS,
PUBLICATION NUMBERS AND INTERNATIONAL CLASSIFICATION INDEX**

NUMBER OF PATENT (11)	NUMBER OF PUBLISHED APPLICATION (10)	INTERNATIONAL CLASSIFICATION INDEX (51)
P 2017 6767 B	AP 2017 13532 A	A 61 K 9/14; A 61 K 31/167; A 61 K 31/57; A 61 P 11/00; A 61 P 11/06
P 2017 6768 B	AP 2017 13705 A	A 61 K 31/232
P 2017 6769 B	AP 2017 13898 A	A 61 K 9/00; A 61 K 47/36; A 61 K 47/38; A 61 K 9/16
P 2017 6770 B	AP 2017 13991 A	A 61 F 6/06; A 61 F 6/04; B 29 C 65/20

**CONCORDANCE TABLE OF APPLICATION NUMBERS, PUBLICATION NUMBERS
AND PATENTS**

NUMBER OF APPLICATION (21)	NUMBER OF PUBLISHED APPLICATION (10)	NUMBER OF PATENT (11)
AP 2013 013532	AP 2017 13532 A	P 2017 6767 B
AP 2013 013705	AP 2017 13705 A	P 2017 6768 B
AP 2014 013898	AP 2017 13898 A	P 2017 6769 B
AP 2014 013991	AP 2017 13991 A	P 2017 6770 B

UTILITY MODELS

**CONCORDANCE TABLE OF INTERNATIONAL CLASSIFICATION INDEX
AND PUBLICATION NUMBERS**

INTERNATIONAL CLASSIFICATION INDEXES (51)	NUMBER OF PUBLISHED APPLICATION (10)
C 25 B 11/12, 1/21	AU 2017 14281 U

**CONCORDANCE TABLE OF PUBLICATION NUMBERS
AND INTERNATIONAL CLASSIFICATION INDEX**

NUMBER OF PUBLISHED APPLICATION (10)	INTERNATIONAL CLASSIFICATION INDEXES (51)
AU 2017 14281 U	C 25 B 11/12, 1/21

**CONCORDANCE TABLE OF INTERNATIONAL CLASSIFICATION INDEX,
PATENT NUMBERS AND PUBLICATION NUMBERS**

INTERNATIONAL CLASSIFICATION INDEX (51)	NUMBER OF PATENT (11)	NUMBER OF PUBLISHED APPLICATION (10)
A 61 K 47/06, 9/06	U 2017 1955 Y	AU 2017 14232 U

**CONCORDANCE TABLE OF PATENT NUMBERS,
PUBLICATION NUMBERS AND INTERNATIONAL CLASSIFICATION INDEX**

NUMBER OF PATENT (11)	NUMBER OF PUBLISHED APPLICATION (10)	INTERNATIONAL CLASSIFICATION INDEX (51)
U 2017 1955 Y	AU 2017 14232 U	A 61 K 47/06, 9/06

**CONCORDANCE TABLE OF APPLICATION NUMBERS, PUBLICATION NUMBERS
AND PATENTS**

NUMBER OF APPLICATION (21)	NUMBER OF PUBLISHED APPLICATION (10)	NUMBER OF PATENT (11)
AU 2016 014232	AU 2017 14232 U	U 2017 1955 Y

DESIGNS

**CONCORDANCE TABLE OF INTERNATIONAL CLASSIFICATION INDEX,
PATENT NUMBERS AND PUBLICATION NUMBERS**

INTERNATIONAL CLASSIFICATION INDEX (51)	NUMBER OF PATENT (11)	NUMBER OF PUBLISHED APPLICATION (10)
07-01	D 2017 728 S	AD 2017 939 S
07-01	D 2017 729 S	AD 2017 940 S
11-01	D 2017 730 S	AD 2017 951 S
11-01	D 2017 731 S	AD 2017 944 S
21-02	D 2017 732 S	AD 2017 938 S

**CONCORDANCE TABLE OF PATENT NUMBERS,
PUBLICATION NUMBERS AND INTERNATIONAL CLASSIFICATION INDEX**

NUMBER OF PATENT (11)	NUMBER OF PUBLISHED APPLICATION (10)	INTERNATIONAL CLASSIFICATION INDEX (51)
D 2017 728 S	AD 2017 939 S	07-01
D 2017 729 S	AD 2017 940 S	07-01
D 2017 730 S	AD 2017 951 S	11-01
D 2017 731 S	AD 2017 944 S	11-01
D 2017 732 S	AD 2017 938 S	21-02

**CONCORDANCE TABLE OF APPLICATION NUMBERS, PUBLICATION NUMBERS
AND PATENTS**

NUMBER OF APPLICATION (21)	NUMBER OF PUBLISHED APPLICATION (10)	NUMBER OF PATENT (11)
AD 2017 000938	AD 2017 938 S	D 2017 732 S
AD 2017 000939	AD 2017 939 S	D 2017 728 S
AD 2017 000940	AD 2017 940 S	D 2017 729 S
AD 2017 000944	AD 2017 944 S	D 2017 731 S
AD 2017 000951	AD 2017 951 S	D 2017 730 S

TRADEMARKS

CONCORDANCE TABLE OF REGISTRATION NUMBERS, APPLICATION NUMBERS, PUBLICATION NUMBERS AND BULLETIN NUMBERS

NUMBER OF REGISTRATION (111)	NUMBER OF APPLICATIONS (210)	NUMBER OF PUBLISHED APPLICATIONS (260)	NUMBER OF BULLETIN
M 2017 29032R	AM 94570	-	21(481)2017
M 2017 29033R	AM 94204	-	21(481)2017
M 2017 29034R	AM 94696	-	21(481)2017
M 2017 29035R	AM 94359	-	21(481)2017
M 2017 29036R	AM 94359	-	21(481)2017
M 2017 29037R	AM 94686	-	21(481)2017
M 2017 29038R	AM 94688	-	21(481)2017
M 2017 29039R	AM 94569	-	21(481)2017
M 2017 29040R	AM 94585	-	21(481)2017
M 2017 29041R	AM 94774	-	21(481)2017
M 2017 29042R	AM 94704	-	21(481)2017
M 2017 29043R	AM 94713	-	21(481)2017
M 2017 29044R	AM 94714	-	21(481)2017
M 2017 29045R	AM 94723	-	21(481)2017
M 2017 29046 R	AM 84435	AM 2017 84435 A	6(466)2017
M 2017 29047 R	AM 85027	AM 2017 85027 A	3(463)2017
M 2017 29048 R	AM 86336	AM 2017 86336 A	7(467)2017
M 2017 29049 R	AM 86876	AM 2017 86876 A	7(467)2017
M 2017 29050 R	AM 87105	AM 2017 87105 A	13(473)2017
M 2017 29051 R	AM 8157	AM 2017 88157 A	9(469)2017
M 2017 29052 R	AM 88274	AM 2017 88274 A	8(468)2017
M 2017 29053 R	AM 88326	AM 2017 88326 A	9(469)2017
M 2017 29054 R	AM 88338	AM 2017 88338 A	8(468)2017
M 2017 29055 R	AM 88339	AM 2017 88339 A	8(468)2017
M 2017 29056 R	AM 88340	AM 2017 88340 A	8(468)2017
M 2017 29057 R	AM 88341	AM 2017 88341 A	8(468)2017
M 2017 29058 R	AM 88482	AM 2017 88482 A	10(470)2017
M 2017 29059 R	AM 88507	AM 2017 88507 A	9(469)2017
M 2017 29060 R	AM 88516	AM 2017 88516 A	14(474)2017
M 2017 29061 R	AM 88524	AM 2017 88524 A	8(468)2017
M 2017 29062 R	AM 88525	AM 2017 88525 A	8(468)2017
M 2017 29063 R	AM 88583	AM 2017 88583 A	11(471)2017
M 2017 29064 R	AM 88593	AM 2017 88593 A	13(473)2017
M 2017 29065 R	AM 88606	AM 2017 88606 A	11(471)2017
M 2017 29066 R	AM 88714	AM 2017 88714 A	9(469)2017
M 2017 29067 R	AM 88819	AM 2017 88819 A	11(471)2017
M 2017 29068 R	AM 88856	AM 2017 88856 A	13(473)2017
M 2017 29069 R	AM 89088	AM 2017 89088 A	12(472)2017
M 2017 29070 R	AM 89114	AM 2017 89114 A	10(470)2017
M 2017 29071 R	AM 89191	AM 2017 89191 A	9(469)2017
M 2017 29072 R	AM 89209	AM 2017 89209 A	10(470)2017
M 2017 29073 R	AM 89211	AM 2017 89211 A	10(470)2017
M 2017 29074 R	AM 89216	AM 2017 89216 A	10(470)2017
M 2017 29075 R	AM 89258	AM 2017 89258 A	13(473)2017
M 2017 29076 R	AM 89259	AM 2017 89259 A	13(473)2017
M 2017 29077 R	AM 89269	AM 2017 89269 A	13(473)2017

1	2	3	4
M 2017 29078 R	AM 89454	AM 2017 89454 A	12(472)2017
M 2017 29079 R	AM 89557	AM 2017 89557 A	13(473)2017
M 2017 29080 R	AM 89572	AM 2017 89572 A	11(471)2017
M 2017 29081 R	AM 89606	AM 2017 89606 A	13(473)2017
M 2017 29082 R	AM 89637	AM 2017 89637 A	12(472)2017
M 2017 29083 R	AM 89736	AM 2017 89736 A	13(473)2017
M 2017 29084 R	AM 89852	AM 2017 89852 A	13(473)2017
M 2017 29085 R	AM 89999	AM 2017 89999 A	13(473)2017
M 2017 29086 R	AM 90212	AM 2017 90212 A	14(474)2017
M 2017 29087 R	AM 90422	AM 2017 90422 A	14(474)2017

**CONCORDANCE TABLE OF PUBLICATION NUMBERS
AND APPLICATION NUMBERS**

NUMBER OF PUBLISHED APPLICATION (260)	NUMBER OF APPLICATION (210)	1	2
		1	2
AM 2017 87774 A	AM 87774 A	AM 2017 91097 A	AM 91097 A
AM 2017 88989 A	AM 88989 A	AM 2017 91106 A	AM 91106 A
AM 2017 89341 A	AM 89341 A	AM 2017 91109 A	AM 91109 A
AM 2017 90303 A	AM 90303 A	AM 2017 91110 A	AM 91110 A
AM 2017 90695 A	AM 90695 A	AM 2017 91160 A	AM 91160 A
AM 2017 90780 A	AM 90780 A	AM 2017 91164 A	AM 91164 A
AM 2017 90793 A	AM 90793 A	AM 2017 91166 A	AM 91166 A
AM 2017 90794 A	AM 90794 A	AM 2017 91167 A	AM 91167 A
AM 2017 90867 A	AM 90867 A	AM 2017 91168 A	AM 91168 A
AM 2017 90869 A	AM 90869 A	AM 2017 91169 A	AM 91169 A
AM 2017 90870 A	AM 90870 A	AM 2017 91181 A	AM 91181 A
AM 2017 90871 A	AM 90871 A	AM 2017 91226 A	AM 91226 A
AM 2017 90879 A	AM 90879 A	AM 2017 91273 A	AM 91273 A
AM 2017 90901 A	AM 90901 A	AM 2017 91296 A	AM 91296 A
AM 2017 90904 A	AM 90904 A	AM 2017 91379 A	AM 91379 A
AM 2017 90914 A	AM 90914 A	AM 2017 91405 A	AM 91405 A
AM 2017 90956 A	AM 90956 A	AM 2017 91406 A	AM 91406 A
AM 2017 90996 A	AM 90996 A	AM 2017 91431 A	AM 91431 A
AM 2017 91096 A	AM 91096 A	AM 2017 91531 A	AM 91531 A
		AM 2017 91533 A	AM 91533 A
		AM 2017 91536 A	AM 91536 A
		AM 2017 91540 A	AM 91540 A
		AM 2017 92212 A	AM 92212 A
		AM 2017 92215 A	AM 92215 A

**CONCORDANCE TABLE OF INDEX OF GOODS AND/OR SERVICES
AND APPLICATION NUMBERS**

INDEX OF GOODS AND/OR SERVICES (511)	NUMBER OF PUBLISHED APPLICATIONS (26)	1	2
1	2		
1	AM 2017 91109 A	33	AM 2017 89341 A
1	AM 2017 91110 A	33	AM 2017 91226 A
4	AM 2017 90869 A	33	AM 2017 91379 A
4	AM 2017 91109 A	33	AM 2017 91431 A
4	AM 2017 91110 A	33	AM 2017 91533 A
5	AM 2017 90303 A	33	AM 2017 91536 A
5	AM 2017 90879 A	33	AM 2017 92212 A
5	AM 2017 90956 A	33	AM 2017 92215 A
5	AM 2017 91096 A	34	AM 2017 90914 A
5	AM 2017 91097 A	35	AM 2017 88989 A
5	AM 2017 91106 A	35	AM 2017 90695 A
5	AM 2017 91164 A	35	AM 2017 90780 A
5	AM 2017 91166 A	35	AM 2017 90793 A
5	AM 2017 91167 A	35	AM 2017 90794 A
5	AM 2017 91168 A	35	AM 2017 90996 A
5	AM 2017 91169 A	35	AM 2017 91273 A
5	AM 2017 91405 A	35	AM 2017 91296 A
7	AM 2017 90867 A	36	AM 2017 90870 A
9	AM 2017 91540 A	37	AM 2017 88989 A
11	AM 2017 90867 A	37	AM 2017 90870 A
11	AM 2017 91406 A	37	AM 2017 91160 A
16	AM 2017 91160 A	37	AM 2017 91406 A
20	AM 2017 91273 A	38	AM 2017 90870 A
21	AM 2017 91181 A	39	AM 2017 90870 A
25	AM 2017 90780 A	40	AM 2017 90869 A
29	AM 2017 87774 A	40	AM 2017 90870 A
29	AM 2017 90871 A	41	AM 2017 90695 A
29	AM 2017 90996 A	41	AM 2017 90870 A
30	AM 2017 87774 A	41	AM 2017 90901 A
30	AM 2017 90996 A	41	AM 2017 90904 A
30	AM 2017 91106 A	42	AM 2017 88989 A
30	AM 2017 91531 A	42	AM 2017 90870 A
32	AM 2017 87774 A	42	AM 2017 91296 A
33	AM 2017 87774 A	43	AM 2017 90695 A
		43	AM 2017 90870 A
		43	AM 2017 91531 A
		44	AM 2017 90870 A
		45	AM 2017 90870 A

CONCORDANCE TABLE OF INDEX OF GOODS AND/OR SERVICES
AND NUMBERS OF TRADEMARKS REGISTERED ACCORDING
TO THE ACCELERATED PROCEDURE

INDEX OF GOODS AND/OR SERVICES (511)	NUMBERS OF REGISTERED ACCORDING TO THE ACCELERATED PROCEDURE (111)
1	M 2017 29036 R
3	M 2017 29043 R
3	M 2017 29044 R
5	M 2017 29033 R
5	M 2017 29043 R
5	M 2017 29044 R
12	M 2017 29039 R
19	M 2017 29034 R
33	M 2017 29032 R
33	M 2017 29040 R
34	M 2017 29042 R
34	M 2017 29088 R
35	M 2017 29041 R
35	M 2017 29043 R
35	M 2017 29044 R
37	M 2017 29039 R
37	M 2017 29045 R
41	M 2017 29035 R
41	M 2017 29037 R
41	M 2017 29038 R
43	M 2017 29041 R
44	M 2017 29043 R
44	M 2017 29044 R

OFFICIAL BULLETIN OF THE INDUSTRIAL PROPERTY

21(481)

EDITOR-IN-CHIEF: N. Bebrishvili

EDITORS-TRANSLATORS: E. Gabunia

PROOFREADER: A. Shikhashvili

COMPUTER LAYOUT: M. Ordenidze
K. Svanidze

www.sakpatenti.org.ge

E-mail: info@sakpatenti.org.ge