



**NATIONAL INTELLECTUAL PROPERTY CENTER OF GEORGIA
SAKPATENTI**

**OFFICIAL BULLETIN
OF THE INDUSTRIAL PROPERTY**

21(505)

**2018
TBILISI**

INID CODES FOR IDENTIFICATION OF BIBLIOGRAPHIC DATA

INVENTIONS, UTILITY MODELS

- (10) Number of publication for application, which has been examined
- (11) Number of patent and kind of document
- (21) Serial number of application
- (22) Date of filing of the application
- (23) Date of exhibition or the date of the earlier filing and the number of application, if any
- (24) Date from which patent may have effect
- (31) Number of priority application
- (32) Date of filing of priority application
- (33) Code of the country or regional organization allotting priority application number
- (44) Date of publication of application not granted, but examined and number of bulletin
- (45) Date of publication of registered document
- (51) International Patent Classification Index
- (54) Title of the invention
- (57) Abstract
- (60) Number of examined patent document granted by foreign patent office, date from which patent has effect and country code
- (62) Number of the earlier application and in case of divided application, date of filing an application
- (71) Name, surname and address of applicant (country code)
- (72) Name, surname of inventor (country code)
- (73) Name, surname and address of patent owner (country code)
- (74) Name, surname of representative or patent attorney
- (85) Date of commencement of the national phase of International Application
- (86) Number and date of filing of international application
- (87) Number and date of publication of international application

DESIGNS

- (10) Number of publication for application
- (11) Number of patent and kind of document or number of registration
- (15) Date of registration/Date of patent renewal
- (18) Expected expiration date of patent or registration
- (21) Serial number of application
- (22) Date of filing of the application
- (23) Date of exhibition or the date of the earlier filing and the number of application, if any
- (24) Date from which patent may have effect
- (28) Number of designs included in the application
- (30) Data relating to priority (number of application, date of filing of application, two-letter code identifying the authority with whom the priority application was made)
- (31) Number of priority application
- (32) Date of filing of priority application
- (33) Code of the country or regional organization allotting priority application number
- (34) Two-letter code according to WIPO St.3 identifying the authority with which the priority application was made
- (44) Date of publication of design and number of bulletin (the first publication)
- (45) Date of publication of design registered by WIPO and number of bulletin
- (51) International Classification for designs (class and subclass of the Locarno Classification)
- (54) Title of the invention
- (55) Reproduction of the design
- (57) Description of characteristic features of the design including indication of colors
- (58) Date of recording of any kind of amendment in the Register
- (62) Number of the earlier application, registration and document number and if available the date of filing an application in case of divided application
- (71) Name, surname and address of applicant (country code)
- (72) Name, surname of creator (country code)
- (73) Name, surname and address of patent owner (country code)
- (74) Name, surname of representative or patent attorney
- (81) Contracting states concerned
 - II designated contracting states according to the 1960 Act
 - III designated contracting states according to the 1999 Act
- (85) Owner's permanent address
- (86) Owner's nationality
- (87) Owner's residence
- (88) State in which the owner has a real and effective industrial or commercial establishment

TRADEMARKS

- (111) – Number of registration
- (151) – Date of registration
- (156) – Date of the renewal
- (181) – Expected expiration date of registration
- (186) – Renewal expiration date of registration
- (141) – Date of cancel of duration of the mark
- (210) – Serial number of application
- (220) – Date of filing of the application
- (230) – Date concerning exhibition
- (260) – Number of application, for which favorable decision of examination about registration has been taken (publication number)
- (310) – Number of the first application
- (320) – Date of filing of the first application
- (330) – Code, identifying national or regional Office where the first application was made
- (511) – International Classification of Goods and Services for the purposes of registration of trade marks and/or list of goods and/or services classified according thereto
- (531) – Description of figurative elements of Trade Marks according to the International Classification of the Figurative Elements of Marks
- (540) – Reproduction of Trade Mark
- (550) – Nature and kind of Trade Mark
- (580) – Date of recording of any kind changes in respect of applications or registrations
- (591) – Information concerning colors claimed
- (731) – Name and address of the applicant
- (732) – Name and address of the holder of the registration
- (740) – Name and address of the representative
- (750) – Address for correspondence
- (770) – Name and address of the previous applicant or holder in case of change in ownership
- (771) – Previous name and address of the applicant or holder in case of change in ownership
- (791) – Name and address of the licensee
- (793) – Indication of conditions and/or restrictions under the license (Type of license, number of license agreement, data of license, data of validity of license)
- (800) – Certain data relating to the international registration of Trade Marks under the Protocol Relating to Madrid Agreement (International registration number)

CODES FOR PUBLICATION IN BULLETIN

- (21) AP 0000 000000 – serial number of application for invention
- (10) AP 0000 0000 A – number of published application for invention (first publication)
- (11) P 0000 0000 B – number of patent for invention (second publication)
- (21) API 0000 000000 – number of application for imported patent
- (11) PI 0000 0000 A – number of imported patent (first publication)
- (21) AU 0000 000000 – serial number of application for utility model
- (10) AU 0000 000 U – number of published application for utility model (first publication)
- (11) U 0000 000 Y – number of patent for utility model (second publication)
- (21) AD 0000 000000 – serial number of application for design
- (10) AD 0000 000 S – number of published application for design (first publication)
- (11) D 0000 000 S – number of patent for design (second publication)

INTERNATIONAL PATENT CLASSIFICATION FOR INVENTIONS AND UTILITY MODELS

- SECTION A – HUMAN NECESSITIES
- SECTION B – PERFORMING OPERATIONS; TRANSPORTING
- SECTION C – CHEMISTRY; METALLURGY
- SECTION D – TEXTILES; PAPER
- SECTION E – FIXED CONSTRUCTIONS
- SECTION F – MECHANICAL ENGINEERING; LIGHTING; HEATING; WEAPONS; BLASTING
- SECTION G – PHYSICS
- SECTION H – ELECTRICITY

-
- M – Trade Mark
 - (210) AM 0000 000000 – Serial number of application;
 - (260) AAM 0000 00000 A – Publication number of application;
 - (111) M 0000 00000 R – Number of registration;
 - (111) MMM0000 00000 Rn – Number of renewals, in which n=1,2,3;
 - (111) M 0000 00000 R(P) – Number of registration under partial assignment of rights
-

**LIST OF CODES, IN ALPHABETIC SEQUENCE, AND THE CORRESPONDING (SHORT) NAMES OF STATES, OTHER ENTITIES AND INTERGOVERNMENTAL ORGANIZATIONS
(WIPO STANDARD ST.3)**

AD	Andorra		for the Arab States of the Gulf (GCC)	NE	Niger
AE	United Arab Emirates	GD	Grenada	NG	Nigeria
AF	Afghanistan	GG	Guernsey	NI	Nicaragua
AG	Antigua and Barbuda	GH	Ghana	NL	Netherlands
AI	Anguilla	GI	Gibraltar	NO	Norway
AL	Albania	GT	Guatemala	NP	Nepal
AM	Armenia	GW	Guinea- Bissau	NR	Nauru
AN	Netherlands Antilles	GY	Guyana	NZ	New Zealand
AO	Angola	HK	The Hong Kong Special Administrative Region of the People's Republic of China	OA	African Intellectual Property Organization (OAPI)
AP	African Regional Intellectual Property Organization (ARIPO)	HN	Honduras	OM	Oman
AR	Argentina	HR	Croatia	PA	Panama
AT	Austria	HT	Haiti	PE	Peru
AU	Australia	HU	Hungary	PG	Papua New Guinea
AW	Aruba	IB	International Bureau of the World Intellectual Property Organization (WIPO)	PH	Philippines
AZ	Azerbaijan	ID	Indonesia	PK	Pakistan
BA	Bosnia and Herzegovina	IE	Ireland	PL	Poland
BB	Barbados	IL	Israel	PT	Portugal
BD	Bangladesh	IM	Isle of Man	PW	Palau
BE	Belgium	IN	India	PY	Paraguay
BF	Burkina Faso	IQ	Iraq	QA	Qatar
BG	Bulgaria	ID	Indonesia	QZ	Community Plant Variety Office (European Community) (CPVO)
BH	Bahrain	IE	Ireland	RO	Romania
BI	Burundi	IL	Israel	RS	Serbia
BJ	Benin	IM	Isle of Man	RU	Russian Federation
BM	Bermuda	IN	India	RW	Rwanda
BN	Brunei Darussalam	IQ	Iraq	SA	Saudi Arabia
BO	Bolivia	IR	Iran (Islamic Republic of)	SB	Solomon Islands
BR	Brazil	IS	Iceland	SC	Seychelles
BS	Bahamas	IT	Italy	SD	Sudan
BT	Bhutan	JE	Jersey	SG	Singapore
BV	Bouvet Island	JM	Jamaica	SH	Saint Helena
BW	Botswana	JO	Jordan	SI	Slovenia
BX	Benelux Office for Intellectual Property (BOIP)	JP	Japan	SK	Slovakia
BY	Belarus	KE	Kenya	SL	Sierra Leone
BZ	Belize	KG	Kyrgyzstan	SM	San Marino
CA	Canada	KH	Cambodia	SN	Senegal
CD	Democratic Republic of the Congo	KI	Kiribati	SO	Somalia
CF	Central African Republic	KM	Saint Kitts and Nevis	SR	Suriname
CG	Congo	KP	Democratic People's Republic of Korea	ST	Sao Tome and Principe
CH	Switzerland	KR	Republic of Korea	SV	El Salvador
CI	Cote d'Ivoire	KW	Kuwait	SY	Syrian Arab Republic
CK	Cook Islands	KY	Cayman Islands	SZ	Swaziland
CL	Chile	KZ	Kazakhstan	TC	Turks and Caicos Islands
CM	Cameroon	LA	Lao People's Democratic Republic	TD	Chad
CN	China	LB	Lebanon	TG	Togo
CO	Colombia	LC	Saint Lucia	TH	Thailand
CR	Costa Rica	LI	Liechtenstein	TJ	Tajikistan
CU	Cuba	LK	Sri Lanka	TL	Timor-Leste
CV	Cape Verde	LR	Liberia	TM	Turkmenistan
CY	Cyprus	LS	Lesotho	TN	Tunisia
CZ	Czech Republic	LT	Lithuania	TO	Tonga
DE	Germany	LU	Luxembourg	TR	Turkey
DJ	Djibouti	LV	Latvia	SE	Sweden
DM	Dominica	LY	Libyan Arab Jamahiriya	TT	Trinidad and Tobago
DO	Dominican Republic	MA	Morocco	TV	Tuvalu
DZ	Algeria	MC	Monaco	TW	Taiwan, Province of China
EA	Eurasian Patent Organization (EAPO)	MD	Republic of Moldova	TZ	United Republic of Tanzania
EC	Ecuador	ME	Montenegro	UA	Ukraine
EE	Estonia	MG	Madagascar	UG	Uganda
EG	Egypt	MK	The former Yugoslav Republic of Macedonia	US	United States of America
EH	Western Sahara	ML	Mali	UY	Uruguay
EM	Office for Harmonization in the Internal Market (Trademarks and Designs)(OHIM)	MM	Myanmar	UZ	Uzbekistan
EP	European Patent Office (EPO)	MN	Mongolia	VA	Holy See
ER	Eritrea	MO	Macao	VC	Saint Vincent and the Grenadines
ES	Spain	MP	Northern Mariana Islands	VE	Venezuela
ET	Ethiopia	MR	Mauritania	VG	Virgin Islands (British)
FI	Finland	MS	Montserrat	VN	Viet Nam
FJ	Fiji	MT	Malta	VU	Vanuatu
FK	Falkland Islands (Malvinas)	MU	Mauritius	WO	World Intellectual Property Organization (WIPO)
FO	Faroe Islands	MV	Maldives	WS	Samoa
FR	France	MW	Malawi	XN	Nordic Patent Institute (NPI)
GA	Gabon	MX	Mexico	YE	Yemen
GB	United Kingdom	MY	Malaysia	ZA	South Africa
GC	Patent Office of the Cooperation Council	MZ	Mozambique	ZM	Zambia
		NA	Namibia	ZW	Zimbabwe

**NATIONAL INTELLECTUAL PROPERTY CENTER OF GEORGIA
SAKPATENTI**

**OFFICIAL BULLETIN
OF THE INDUSTRIAL PROPERTY**

21(505)

INVENTIONS

UTILITY MODELS

DESIGNS

TRADEMARKS

**APPELLATIONS OF ORIGIN AND GEOGRAPHICAL
INDICATIONS OF GOODS**

DATE OF PUBLICATION

2018 11 12

CONTENTS

PUBLISHED TITLES OF PROTECTION	3
INVENTIONS	
▪ APPLICATIONS APPROVED FOR GRANTING PATENTS	4
▪ PATENTED INVENTIONS	7
UTILITY MODELS	
▪ APPLICATIONS APPROVED FOR GRANTING PATENT	10
▪ PATENTED UTILITY MODELS	11
DESIGNS	
▪ REGISTERED DESIGNS	12
▪ DESIGNS, WICH HAVE BEEN REGISTERED WITH THE INTERNATIONAL BUREAU CLAIMING PRIORITY ON THE TERRITORY OF GEORGIA	13
TRADEMARKS	
▪ APPLICATIONS FILED UNDER THE NATIONAL PROCEDURE APPROVED FOR REGISTRATION	64
▪ REGISTERED TRADEMARKS	74
▪ TRADEMARKS REGISTERED ACCORDING TO THE ACCELERATED PROCEDURE	76
▪ INTERNATIONAL TRADEMARKS FOR WHICH A DECISION ON GANTING PROTECTION IS TAKEN	81
▪ INTERNATIONAL TRADEMARKS PROTECTED IN GEORGIA	155
APPELLATIONS OF ORIGIN AND GEOGRAPHICAL INDICATIONS OF GOODS	
▪ AO WINE SPECIFICATION	171
OFFICIAL NOTIFICATIONS	
INVENTIONS	
▪ RENEWAL OF PATENTS	178
▪ CANCELLATION OF PATENTS	178
▪ CHANGES IN NAMES AND/OR ADDRESSES OF OWNERS	179
UTILITY MODEL	
▪ CANCELLATION OF PATENTS	182
DESIGNS	
▪ RENEWAL OF REGISTRATION	182
▪ CANCELLATION OF REGISTRATIONS	183
▪ CHANGES IN NAMES AND/OR ADDRESSES OF OWNERS	183
TRADEMARKS	
▪ RENEWAL OF REGISTRATION	184
▪ TRANSFER OF RIGHTS	193
▪ CHANGES IN NAMES AND/OR ADDRESSES OF OWNERS	194
▪ CHANGE OF THE LIST OF GOODS AND/OR SERVICES OF TRADEMARKS	196
CLASSIFICATION INDEXES	
INVENTIONS	197
UTILITY MODELS	199
DESIGNS	200
TRADEMARKS	202

PUBLISHED TITLES OF PROTECTION

INVENTIONS

- **APPLICATIONS APPROVED FOR GRANTING PATENT:**
14124; 14557; 14212; 14619; 14179; 14410; 14433
- **PATENTED INVENTIONS:**
6915-6927

UTILITY MODELS

- **APPLICATION APPROVED FOR GRANTING PATENTS:**
14602
- **PATENTED UTILITY MODELS:**
1990-1993

DESIGNS

- **REGISTERED DESIGNS:**
779-783
- **DESIGNS WHICH HAVE BEEN REGISTERED WITH THE INTERNATIONAL BUREAU CLAIMING PRIORITY ON THE TERRITORY OF GEORGIA:**
99908; 99912; 99999; 102050; 102055; 99859; 99860; 102199; 100099, 100100; 100102; 100453; 102275; 102389

TRADEMARKS

- **APPLICATIONS FILED UNDER THE NATIONAL PROCEDURE APPROVED FOR REGISTRATION:**
87187*; 87189*; 92380; 92452*; 92994; 93532; 93707; 94716; 94928; 95172, 95173; 95360; 95408; 96167, 96168; 96679; 96709, 96710; 96732-96734; 96763, 96764; 96766, 96767; 96770; 96810, 96811; 96817; 96841; 96863; 96867, 96868; 96886-96889; 96905; 96916; 96919; 96971; 96974- 96976; 97001; 97003; 97005; 97013; 97020; 97023, 97024; 97063; 97070; 97074; 97164, 97165; 97193; 97195; 97197; 97216; 97226; 97233; 97369; 97371
- **REGISTERED TRADEMARKS:**
30333-30353
- **TRADEMARKS REGISTERED ACCORDING TO THE ACCELERATED PROCEDURE:**
30354-300381
- **INTERNATIONAL TRADEMARKS FOR WHICH A DECISION ON GRANTING PROTECTIONS IS TAKEN:**
93745; 95264; 95464-95466; 95607; 95630; 95693; 95770; 95820; 95837; 95846; 95848; 95850; 95853; 95855; 95897; 95907; 95910; 95917-95919; 95921; 95923-95925; 95953, 95954; 95963; 95966; 95968; 95971; 95979; 96010, 96011; 96014; 96017-96020; 96031-96040; 96043; 96045; 96090-96092; 96095; 96100; 96109-96111; 96114; 96125; 96127, 96128; 96131-96133; 96136-96138; 96142, 96143; 96145; 96196-96198; 96214; 96223, 96224; 96230; 96232; 96246; 96248; 96250, 96251; 96254; 96256; 96263-96266; 96270; 96282; 96290; 96314-96316; 96342; 96344; 96346, 96347; 96355; 96357-96359; 96361; 96365, 96366; 96395; 96399; 96415, 96416; 96418; 96420, 96421; 96423; 96425; 96466-96471; 96527-96529; 96541; 96584-96587; 96589-96593; 96607; 96615, 96616; 96623- 96625; 96638, 96639; 96653; 96655; 96660, 96661; 96665-96668; 96689, 96690; 96716-96718; 96724, 96725; 96727-96729
- **INTERNATIONAL TRADEMARKS PROTECTED IN GEORGIA:**
92001; 92041; 92086; 92216; 92285; 92651; 92922; 93258; 93732; 93742, 93743; 93763; 93789; 93802; 93882; 93886, 93887; 93890; 93892; 93894; 93896, 93897; 93997; 93999; 94038, 94039; 94096-94102; 94104-94108; 94110-94112; 94116; 94124; 94130-94137; 94139-94149; 94151-94161; 94198-94200; 94203; 94206-94208; 94210; 94212; 94214; 94228; 94233, 94234; 94236-94239; 94243- 94245; 94248-94252; 94272; 94274-94277; 94279-94282; 94285-94288; 94290-94293; 94295; 94307, 94308; 94354, 94355; 94357; 94365; 94368-94370; 94373-94377; 94381, 94382; 94387; 94390-94393; 94395; 94397; 94404-94415; 94417, 94418; 94420, 94421; 94423, 94424; 94426-94428; 94430, 94431; 94434; 94444--94446; 94448-94450; 94501, 94502; 94507- 94510; 94516-94518; 94520; 94522; 94668-94670; 94672, 94673; 94675, 94676; 94678; 94683; 94685; 94747; 94762; 94768; 94837; 94851; 94853, 94854; 94859-94864; 94866- 94868; 94870; 94903; 94907; 94934, 94935; 94938, 94939; 94941; 95015; 95022; 95044; 95046; 95062; 95243, 95244; 95246-95248; 95250; 95266, 95267; 95273; 95275; 95398; 95416; 95441; 95459

APPELLATIONS OF ORIGIN AND GEOGRAPHICAL INDICATIONS OF GOODS

- **AO WINE SPECIFICATION:**
1533/06

INVENTIONS

APPLICATIONS APPROVED FOR GRANTING PATENTS

The decision can be appealed at the Chamber of Appeal of Sakpatenti within 3 months from the publication or at the Mtskheta District Court Administrative Cases Board (Address: №17, Samkhedro str., Mtskheta), within 1 month following the publication.

PART A

A 61

(10) AP 2018 14124 A (51) Int. Cl. (2006)
A 61 K 31/44
C 07 D 455/02
A 01 N 43/90

- (21) AP 2014 14124 (22) 2014 09 26
(31) 61/883,463; AP 2014 14124
(32) 2013 09 27; 2014 09 26
(33) US; GE
(71) MERCK SHARP & DOHME CORP. (US)
126 East Lincoln Avenue, Rahway, NJ
07065-0907 (US)
(72) YU, Tao (US);
ZHANG, Yonglian (US);
WADDELL, Sherman Tim (US);
STAMFORD, Andrew (US);
WAI, John, S. (CN);
COLEMAN, Paul, J. (US);
SANDERS, John, M. (US);
FERGUSON, Ronald (US)
(74) Shalva Gvaramadze
(85) 2016 04 22
(86) PCT/US2014/057572, 2014 09 26
(54) **SUBSTITUTED QUINOLIZINE
DERIVATIVES USEFUL AS HIV
INTEGRASE INHIBITORS**
(57) Compound of formula (I),

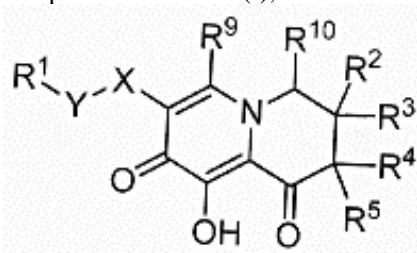

wherein values of substitutes R^1 , R^2 , R^3 , R^4 , R^5 , R^9 , R^{10} , X, Y are provided in the claims or their pharmaceutically acceptable salt, pharmaceutical composition on a basis thereof, and their usage for prevention or treatment of HIV-infection or AIDS.

Claims: 21 independents

16 dependents

Table: 6

(10) AP 2018 14557 A (51) Int. Cl. (2006)
A 61 K 31/416
A 61 K 31/4174
A 61 K 45/06
A 61 P 31/10

- (21) AP 2016 14557 (22) 2016 01 08
(31) 15150904.9
(32) 2015 01 13
(33) EP
(71) AZIENDE CHIMICHE RIUNITE
ANGELINI FRANCESCO A.C.R.A.F.
S.P.A. (IT)
Viale Amelia 70, I-00181 Roma (IT)
(72) MILANESE, Claudio (IT);
CAPEZZONE DE JOANNON,
Alessandra (IT);
TONGIANI, Serena (IT);
DONATI, Luca (IT)
(74) Liliana Darakhvelidze
(85) 2017 08 03
(86) PCT/EP2016/050272; 2016 01 08
(54) **PHARMACEUTICAL COMPOSITI-
ON FOR THE TREATMENT OF
MYCOSIS**
(57) Combination of benzydamine and imidazole –
antimycotic for the treatment of mycosis caused
with Candida.
Claims: 1 independent
14 dependents
Fig.: 2

(10) AP 2018 14212 A (51) Int. Cl. (2006)
A 61 K 35/10

- (21) AP 2016 14212 (22) 2016 07 19
(71) Aleksandre Ustiashvii (GE)
Adigenis q. 2, 0102, Tbilisi (GE);
Tamar Iarajuli (GE)
Adigenis q. 2, 0102, Tbilisi (GE)
(72) Aleksandre Ustiashvii (GE);
Tamar Iarajuli (GE)
(54) **HUMIC PROANTHOCYANIDIN
SUBSTANCE**
(57) Food additive – humic proanthocyanidin
substance contains grape seeds extract 65-75% and
combination of humic substance extracts 25-35%;
at that, humic substance extracts is prepared by peat
and/or brown coals treatment.
Claims: 1 independent
1 dependent

PART B**B 26**

(10) AP 2018 14619 A (51) Int. Cl. (2006)
B 26 B 21/24

(21) AP 2017 14619 (22) 2017 10 29

(71) Temur Maisuradze (GE)

Mukhianis I mkr., korp. 10, b. 139,
0172, Tbilisi (GE)

(72) Temur Maisuradze (GE)

(54) **CHANGEABLE CARTRIDGE
OF SHAVING MACHINE**

(57) Shaving machine changeable cartridge 1 includes executed as durable-flexible concave arche-shaped frame the base 2, longitudinal sides 3 and 4 whereof are completed at least with one section 5 triangle-shaped on crosscut, and having round or flat with round angles, smooth head 6 and flat or convex bottom 7. Shaving blades 8 are fixed on each section head, crosswisely. Throughout channels 11, wherein upper and lower rigid platformes 12, 13 are inserted, are executed onto durable base cross sides 9, 10. Flexible durable componentry 14 are placed into durable-flexible base longitudinal componentry, below the blades, and are inserted into rigid platformes 12, 13. Blind perforation 15 is provided in upper platforme 13 ends, wherein manual lever 16 detachable bent ends 17 and cavities 18 crosswise relative to platforme are inserted. At least, one cavity 19, 20 wherein lubricant storages 21, 22 are placed is provided on each base crosswise component; and a knot 23 fixing cartridge onto shaving machine handle is executed in the middle of the base 2, from lower side.

Claims: 1 independent
5 dependents

Fig.: 7

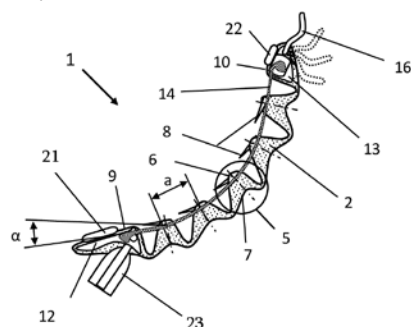

Fig. 1

PART C**C 07**

(10) AP 2018 14179 A (51) Int. Cl. (2006)
C 07 D 471/04

C 07 D 473/34

C 07 D 473/38

C 07 D 487/04

A 61 K 31/4162

A 61 K 31/52

(21) AP 2014 14179 (22) 2014 12 17

(31) 13197986.6

(32) 2013 12 18

(33) EP

(71) CHIESI FARMACEUTICI S.P.A. (IT)

Via Palermo, 26/A I-43100 Parma (IT)

(72) BIAGETTI, Matteo (IT);

CAPELLI, Anna Maria (IT);

ACCETTA, Alessandro (IT);

CARZANIGA, Laura (IT)

(74) Shalva Gvaramadze

(85) 2016 06 17

(86) PCT/EP2014/078288, 2014 12 17

(54) **ISOCHROMENE DERIVATIVES AS
PHOSPHOINOSITIDE 3-KINASES
INHIBITORS**

(57) Compound of formula (I),

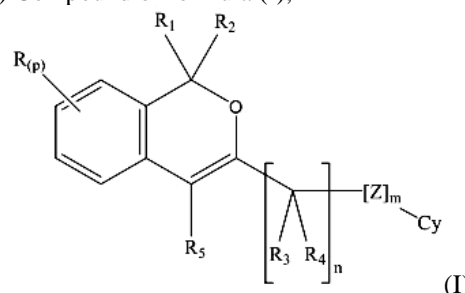

wherein values of substitutes R, R₁, R₂, R₃, R₄, R₅, Z, Cy and variables m, n, p are provided in the claims or their pharmaceutically acceptable salts, pharmaceutical composition on a basis thereof and usage therefor medicine preparation for disorders related with enzymes P13K, such as respiratory diseases, thoracic tumours, etc.

Claims: 4 independents

8 dependents

Table: 29

(10) AP 2018 14410 A (51) Int. Cl. (2006)
C 07 D 487/04

A 61 K 31/5025

A 61 K 9/00

A 61 P 11/00

A 61 P 25/00

A 61 P 27/02

(21) AP 2015 14410 (22) 2015 07 23

(31) 62/033,684; 62/157,129

(32) 2014 08 06; 2015 05 05

(33) US; US

(71) PFIZER INC. (US)

235 East 42nd Street New York,
NY 10017 (US)

(72) CHAPPIE, Thomas Allen (US);

HAYWARD, Matthew Merrill (US);

HELAL, Christopher John (US);

LACHAPPELLE, Erik Alphonse (US);

PATEL, Nandini Chaturbhai (US);

SCIABOLA, Simone (IT);

VERHOEST, Patrick Robert (US);

YOUNG, Joseph Michael (US)

(74) Tamar Kochlamazashvili

(85) 2017 02 06

(86) PCT/IB2015/055597, 2015 07 23

(54) **IMIDAZOPYRIDAZINE COMPOUNDS**

(57) Compound of formula (I),

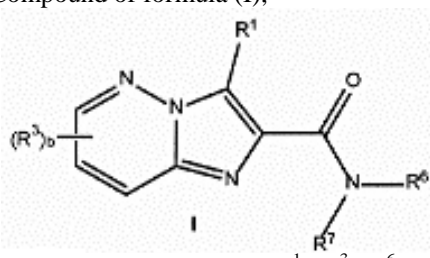

wherein values of substitutes R^1 , R^3 , R^6 , R^7 and variable b are provided in the claims or or their pharmaceutically acceptable salt, pharmaceutical composition on a basis thereof and usage therefor the treatment of the diseases caused with PDE4B isoform, such as schizophrenia, alert, inflammation, apoplexy, etc.

Claims: 9 independents

18 dependents

Table: 3

PART E

E 02

(10) AP 2018 14433 A (51) Int. Cl. (2006)

E 02 B 5/02

E 02 B 3/16

(21) AP 2015 14433

(22) 2015 07 30

(31) MI2014A001393

(32) 2014 07 31

(33) IT

(71) CARPI TECH B.V. (NL)

Sporhaven 88, NL-2651 AV Berkel
en Rodenijs (NL)

(72) SCUERO, Alberto, Maria (NL)

(74) Liliana Darakhvelidze

(85) 2017 02 27

(86) PCT/EP2015/067505, 2015 07 30

(54) **METHOD, WATERPROOF LINER AND WATERPROOF PANELS FOR INSTALLATION IN BASINS AND CANALS**

(57) A method, a waterproof liner and waterproof panels for installations in basins and canals (10) both dry and with stationary and flowing water. The liner consists of a plurality of prefabricated panels (14; 14A) comprising at least one flexible waterproof membrane (16), made of geosynthetic material, provided with side anchor bands (23) for anchoring to the ground and with side sealing flaps (26); the panels (14; 14A) that are rolled up into rolls are sequentially unrolled and extended by fixing provisionally along at least one anchor band (23), by joining simultaneously the flaps (26) of adjoining panels (14; 14A) by means of an intermediate zip fastener (28). Subsequently, the individual panels (14; 14A) are firmly anchored by friction to the bottom (11) and/or to the banks (12) of the basin or canal (10), by means of a permanent ballast (30). According to a first solution, the panels (14) comprise superimposed waterproof membranes (16, 17) made of geosynthetic material, and are configured with filling chambers or cells (18) into which a ballast cementitious mixture is injected; in a second solution each panel (14) consisting of a single flexible membrane (16) made of geosynthetic material, permanently ballasted by prefabricated blocks of concrete (49); in a third solution the panels (14A) comprises a first waterproof membrane (16) and a second waterproof membrane (50) folded in a tubular shape and welded to the first watertight membrane (16). The individual panels (14; 14A) can be removed and replaced by operating underwater, restoring the seal between panels (14; 14A) of the entire waterproof liner.

Claims: 3 independents

30 dependents

Fig.: 21

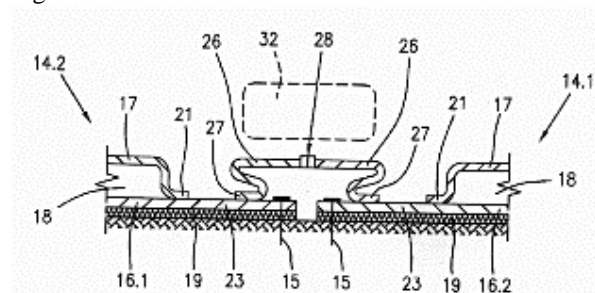

Fig. 4

PATENTED INVENTIONS

PART A

A 61

(11) P 2018 6919 B (51) **Int. Cl. (2006)**
A 61 G 5/04

- (10) AP 2018 14258 A (44) 6(490)/2018
(21) AP 2016 14258
(22) 2016 09 02
(24) 2016 09 02
(73) Giorgi Lekvinadze (GE)
Tsiskris q. 10, 0103, Tbilisi (GE)
(72) Giorgi Lekvinadze (GE)
(54) **INDIVIDUAL ALL-TERRAIN
VEHICLE**

(11) P 2018 6916 B (51) **Int. Cl. (2006)**
A 61 K 31/444

- A 61 K 9/08**
A 61 K 47/04
A 61 K 47/12
A 61 K 47/18
A 61 K 47/34
A 61 P 27/02
A 61 P 27/06
- (10) AP 2018 14216 A (44) 14(498)/2018
(21) AP 2015 14216
(22) 2015 01 08
(24) 2015 01 08
(31) 2014-002809
(32) 2014 01 10
(33) JP
(86) PCT/JP2015/050333, 2015 01 08
(73) SANTEN PHARMACEUTICAL CO.,
LTD (JP)
9-19, Shimoshinjo 3-chome, Higashiyodo-
gawa-ku, Osaka-shi, Osaka 5338651 (JP)
(72) ENDO, Yoko (JP)
(74) Shalva Gvaramadze
(54) **PYRIDYLAMINOACETIC ACID
COMPOUND AND POLYOXYETHYLE-
NE CASTOR OIL-CONTAINING
PHARMACEUTICAL COMPOSITION**

(11) P 2018 6917 B (51) **Int. Cl. (2006)**
A 61 K 31/444

- A 61 P 27/02**
A 61 P 27/06
- (10) AP 2018 14239 A (44) 14(498)/2018
(21) AP 2015 14239
(22) 2015 01 08
(24) 2015 01 08

- (31) 61/925,882
(32) 2014 01 10
(33) US
(86) PCT/JP2015/050366, 2015 01 08
(73) SANTEN PHARMACEUTICAL CO.,
LTD (JP)
9-19, Shimoshinjo 3-chome, Higashiyodo-
gawa-ku, Osaka-shi, Osaka 5338651 (JP)
(72) SHAMS, Naveed (US);
KROON, Henk-Andre (US);
KAWATA Hisashi (JP);
KAWABATA Noriko (JP)
(74) Tamar Kochlamazashvili
(54) **PHARMACEUTICAL PREPARATION
INCLUDING PYRIDYLAMINO ACETIC
ACID COMPOUND**

(11) P 2018 6918 B (51) **Int. Cl. (2006)**
A 61 N 2/00

- A 61 N 2/02**
- (10) AP 2018 14256 A (44) 13(497)/2018
(21) AP 2016 14256
(22) 2016 09 01
(24) 2016 09 01
(73) Besik Surguladze (GE)
Baratashvilis q. 6/10, b. 48, 0107,
Tbilisi (GE)
(72) Besik Surguladze (GE)
(74) Davit Dzamukashvili
(54) **INDUCTION HEATING SYSTEM
UNIT FOR LOCATOR HYPERTHERMIA
DEVICE AND METHOD FOR
HYPERTHERMIA**

PART B

B 66

(11) P 2018 6926 B (51) **Int. Cl. (2006)**
B 66 B 9/00

- (10) AP 2018 14428 A (44) 9(493)/2018
(21) AP 2017 14428
(22) 2017 02 17
(24) 2017 02 17
(73) Giorgi Lekvinadze (GE)
Tsiskris q. 10, 0103, Tbilisi (GE)
(72) Giorgi Lekvinadze (GE)
(54) **LIFT**

PART C**C 03**

- (11) P 2018 6924 B** (51) **Int. Cl. (2006)**
C 03 C 25/10
C 03 C 25/24
C 03 C 25/50
F 16 D 69/02
- (10) AP 2018 14373 A (44) 10(494)/2018
(21) AP 2016 14373
(22) 2016 12 30
(24) 2016 12 30
(73) Paata Gogoladze (GE)
Kutuzovis q. 3, 0194, Tbilisi (GE)
(72) Paata Gogoladze (GE)
(54) **METHOD FOR BRAKE BLOCKS
BASALT TEXTILE FIBER
PRODUCTION**

- (11) P 2018 6920 B** (51) **Int. Cl. (2006)**
C 07 D 403/12
A 61 K 31/506
A 61 P 25/00
- (10) AP 2018 14286 A (44) 11(495)/2018
(21) AP 2015 014286
(22) 2015 03 27
(24) 2015 03 27
(31) PA 2014 00194
(32) 2014 04 04
(33) DK
(86) PCT/EP2015/056713, 2015 03 27
(73) H. LUNDBECK A/S (DK)
Ottiliavej 9 DK-2500 Valby (DK)
(72) KEHLER, Jan (DK);
RASMUSSEN, Lars Kyhn (DK);
LANGGÅRD, Morten (DK)
(74) Tamaz Shilakadze
(54) **HALOGENATED QUINAZOLIN-
THF-AMINES AS PDE1 INHIBITORS**

C 07

- (11) P 2018 6927 B** (51) **Int. Cl. (2006)**
C 07 D 401/14
A 61 K 31/454
A 61 P 29/02
A 61 P 37/08
- (10) AP 2018 14455 A (44) 13(497)/2018
(21) AP 2015 14455
(22) 2015 09 22
(24) 2015 09 22
(31) 62/209,124; 62/110,048; 62/055,811
(32) 2015 08 24; 2015 01 30; 2014 09 26
(33) US; US; US
(86) PCT/IB2015/057314, 2015 09 22
(73) PFIZER INC. (US)
235 East 42nd Street New York, NY 10017 (US)
(72) FLICK, Andrew Christopher (US);
JONES, Peter (GB);
KAILA, Neelu (US);
MENTE, Scot Richard (US);
SCHNUTE, Mark Edward (US);
TRZUPEK, John David (US);
VAZQUEZ, Michael L. (US);
XING, Li (US);
ZHANG, Liying (CN);
WENNERSTÅL, Göran Mattias (SE);
ZAMARATSKI, Edouard (SE)
(74) Shalva Gvaramadze
(54) **METHYL-AND TRIFLUOROMETHYL-
SUBSTITUTED PYRROLOPYRIDINE
MODULATORS OF RORC2 AND
METHODS OF USE THEREOF**

- (11) P 2018 6922 B** (51) **Int. Cl. (2006)**
C 07 D 409/14
C 07 D 453/02
A 61 K 31/439
A 61 P 11/00
- (10) AP 2018 14338 A (44) 14(498)/2018
(21) AP 2015 14338
(22) 2015 06 03
(24) 2015 06 03
(31) 14171266.1
(32) 2014 06 05
(33) EP
(86) PCT/EP2015/062417, 2015 06 03
(73) CHIESI FARMACEUTICI S.P.A. (IT)
Via Palermo, 26/A I-43100 Parma (IT)
(72) ARMANI, Elisabetta (IT);
AMARI, Gabriele (IT);
CAPALDI, Carmelida (IT);
BLACKABY, Wesley (IT);
LINNEY, Ian (IT);
VAN DE PÖEL, Hervé (IT);
BAKER-GLENN, Charles (IT);
TRIVEDI, Naimisha (IT)
(74) Shalva Gvaramadze
(54) **AMINOESTER DERIVATIVES**

- (11) P 2018 6923 B** (51) **Int. Cl. (2006)**
C 07 D 417/12
A 61 K 31/506
A 61 P 35/00
- (10) AP 2018 14361 A (44) 14(498)/2018
(21) AP 2015 14361
(22) 2015 05 26
(24) 2015 05 26
(31) P1400264
(32) 2014 05 26

(33) HU
 (86) PCT/HU2015/000049, 2015 05 26
 (73) EGIS GYÓGYSZERGYÁR ZRT. (HU)
 Keresztúri út 30-38. 1106 Budapest (HU)
 (72) MÁRVÁNYOS, Ede László (HU);
 VIRÁG, Attila (HU);
 GREGOR, Tamás (HU);
 VOLK, Balázs (HU);
 TÓTHNÉ LAURITZ, Mária (HU);
 PONGÓ, László (HU);
 PEREGI, Balázs (HU);
 LUKÁCS, Gyula (HU);
 VARGA, Zoltán (HU);
 DANCSÓ, András (HU)
 (74) Shalva Gvaramadze
 (54) **DASATINIB SALTS**

(11) P 2018 6921 B **(51) Int. Cl. (2006)**
C 07 D 471/04
C 07 D 487/04
A 61 K 31/4162
A 61 P 35/00

(10) AP 2018 14322 A (44) 14(498)/2018
 (21) AP 2015 14322
 (22) 2015 04 30
 (24) 2015 04 30
 (31) 61/993,138
 (32) 2014 05 14
 (33) US
 (86) PCT/IB2015/053174, 2015 04 30
 (73) PFIZER INC. (US)
 235 East 42nd Street New York, NY 10017 (US)
 (72) COE, Jotham Wadsworth (US);
 DEHNHARDT, Christoph Martin (CA);
 JONES, Peter (GB);
 SABNIS, Yogesh Anil (IN);
 STROHBACH, Joseph Walter (US);
 WAKENHUT, Florian Michel (DE);
 WHITLOCK, Gavin Alistair (GB)
 (74) Tamar Kochlamazashvili
 (54) **PYRAZOLOPYRIDINES AND**
PYRAZOLOPYRIMIDINES

C 10

(11) P 2018 6915 B **(51) Int. Cl. (2006)**
C 10 J 3/12

(10) AP 2018 14569 A (44) 9(493)/2018
 (21) AP 2017 14569
 (22) 2017 08 15
 (24) 2017 08 15
 (73) LTD "EKOI" (GE)
 K. Shevardenidzis q. 5, b. 46, 0160,
 Tbilisi, (GE)
 (72) Levan Sharikadze (GE)
 (74) Nugzar Ksovreli

(54) **DEVICE FOR SYNTHETIC GAS**
PRODUCTION

PART G

G 01

(11) P 2018 6925 B **(51) Int. Cl. (2006)**
G 01 N 23/222
G 01 V 5/00

(10) AP 2018 14394 A (44) 10(494)/2018
 (21) AP 2015 14394
 (22) 2015 08 06
 (24) 2015 08 06
 (31) 62/033,691
 (32) 2014 08 06
 (33) US
 (86) PCT/US2015/044085, 2015 08 06
 (73) RESEARCH TRIANGLE INSTITUTE (US)
 3040 East Cornwallis Road Research Triangle
 Park, NC 27709 (US)
 (72) BALDASARO, Nicholas, Guy (US)
 (74) Tamaz Shilakadze
 (54) **HIGH EFFICIENCY NEUTRON**
CAPTURE PRODUCTS PRODUCTION

UTILITY MODELS

APPLICATION APPROVED FOR GRANTING PATENT

The decision can be appealed at the Chamber of Appeal of Sakpatenti within 3 months from the publication or at the Mtskheta District Court Administrative Cases Board (Address: №17, Samkhedro str., Mtskheta), within 1 month following the publication.

PART F

F 24

(10) AU 2018 14602 U (51) Int. Cl. (2006)

F 24 D 19/00

F 24 H 9/00

(21) AU 2017 14602 (22) 2017 10 04

(71) Giorgi Tsiramua (GE)

Nutsubidzis II mkr., I kv., korp. 5, b. 7,

0183, Tbilisi (GE);

Davit Tsiramua (GE)

Nutsubidzis II mkr., I kv., korp. 5, b. 7,

0183, Tbilisi (GE)

(72) Giorgi Tsiramua (GE);

Davit Tsiramua (GE)

(54) **HEAT-INSULATING BOX FOR
CENTRAL HEATING BOILER**

(57) A box includes a frame and connected thereto the door having a lock, at least, two sides and a head; at that, box door, sides and head are executed as sandwich panels consisting of metal I and II 8 sheets, upper angles whereof are cut, and rectangular cavities 3 are executed on the webbing 2 formed because of cut; at that, rectangular cavities 9 are executed on II sheet lower end, as well. A ledge 10 created between the cavities 9 is rectangularly bent relative to metal II sheet surface. Overlapped to each other I and II sheetes both edge on sheetes whole length and upper side thereof, on sheet whole width, on corresponding bent lines 4 and 5 the couples of rectangular bends are formed; at that, II edge longitudinal and cross bends 7 are formed rectangular relative to I longitudinal and cross bends 6, and are directed to sheet inner side, in the case of I sheet, and to outer side, in the case of II sheet, so that heat-insulating material would be placed between them; and sandwich panels lower parts are placed in II-shaped cross cut metal component.

Claims: 1 independent

8 dependents

Fig.: 5

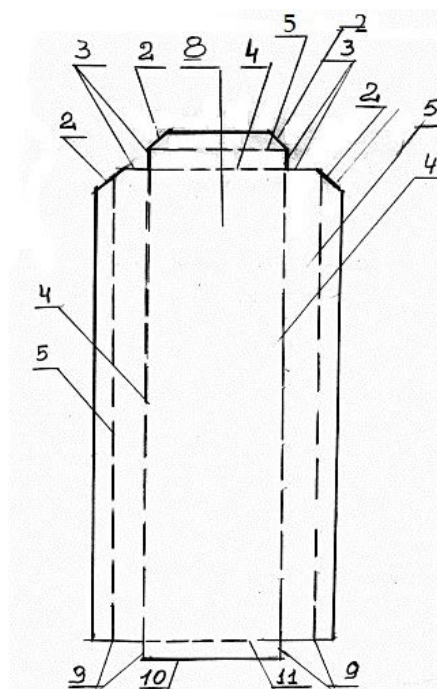

Fig. 2

PATENTED UTILITY MODELS

PART A

A 47

- (11) U 2018 1992 Y** **(51) Int. Cl. (2006)**
A 47 K 10/38
- (10) AU 2018 14170 U (44) 14(498)/2018
 (21) AU 2014 014170
 (22) 2014 11 17
 (24) 2014 11 17
 (31) 2013/13362
 (32) 2013 11 18
 (33) TR
 (86) PCT/TR2014/000436, 2014 11 17
 (73) EJZAJIBASHI TUQETIM URUNLERI
 SANAI VE TIJARET ANONIM
 SHIRQETI (TR)
 Toqmaq Qoiu Qavaq Mevqi, Qaramursel,
 77700 Ialova (TR)
 (72) ŞİMŞİR Boğaç (TR)
 (74) Larisa Amirkhanyan
 (54) **DISPENSER ENABLING THE
 PRODUCT LEVEL REMAINING
 THEREIN TO BE SEEN**

A 61

- (11) U 2018 1991 Y** **(51) Int. Cl. (2006)**
A 61 K 35/50
A 61 K 47/46
- (10) AU 2018 14053 U (44) 11(495)/2018
 (21) AU 2016 014053
 (22) 2016 02 08
 (24) 2016 02 08
 (73) Alesha Bakuridze (GE)
 L. Sharashidzis q. 2/4, b. 41, 0179,
 Tbilisi (GE);
 Zurab Kakabadze (GE)
 Al. Kazbegis gamz. 6, b. 31, 0160,
 Tbilisi (GE)
 (72) Alesha Bakuridze (GE);
 Zurab Kakabadze (GE)
 (54) **BIO-DIFFUSE MATRIX
 FOR DRUGS TRANSDERMAL
 DELIVERY**

- (11) U 2018 1990 U** **(51) Int. Cl. (2006)**
A 61 K 35/76
- (10) AU 2018 14570 U (44) 13(497)/2018
 (21) AU 2017 14570
 (22) 2017 08 16
 (24) 2017 08 16
 (73) Taras Gabisonia (GE)
 I. Chavchavadzis gamz. 39b, 0162,
 Tbilisi (GE);
 G. Eliava Institute of Bacteriophages,
 Microbiology and Virology (GE)
 Gotuas q. 3, Tbilisi (GE)
 (72) Taras Gabisonia (GE)
 (54) **METHOD FOR BACTERIOPHAGE
 DRUGS PREPARATION TO USE
 THEREIN VETERINARY MEDICINE**

PART C

C 09

- (11) U 2018 1993 Y** **(51) Int. Cl. (2006)**
C 09 D 5/18
C 09 D 1/00
- (10) AU 2018 14285 U (44) 10(494)/2018
 (21) AU 2016 014285
 (22) 2016 09 29
 (24) 2016 09 29
 (73) Teimuraz Rokva (GE)
 Vazha-Pshavelas V kvart., korp. 1, b. 32,
 0186, Tbilisi (GE);
 Temur Chakhunashvili (GE)
 Panaskertelis q., korp. 17, b. 15, 0194,
 Tbilisi (GE)
 (72) Teimuraz Rokva (GE);
 Temur Chakhunashvili (GE)
 (54) **ELECTRODES MARKING THERMAL
 PAINT**

DESIGNS

REGISTERED DESIGNS

(11) D 2018 780 S **(51) 09-02**
(10) AD 2018 1002 S (44) 14(498)2018
(21) AD 2017 1002
(22) 2017 11 09
(24) 2017 11 09
(28) 1
(18) 2022 11 09
(31) 2017502318
(32) 2017 05 19
(33) RU
(73) PJSC (Public Joint-Stock Company)
"OIL COMPANY LUKOIL" (RU)
Sretensky Blvd. 11, 101000, Moscow (RU)
(72) Sergey Ivashkin (RU)
(74) Irakli Gvilia (GE)
(54) **CAN**

(11) D 2018 783 S **(51) 02-03**
(10) AD 2018 1019 S (44) 14(498)2018
(21) AD 2018 1019
(22) 2018 01 31
(24) 2018 01 31
(28) 1
(18) 2023 01 31
(73) Tamar Zautashvili (GE)
T. Tabidzis q. 39, b. 18, 0162, Tbilisi (GE)
(72) Tamar Zautashvili (GE)
(54) **CAP**

(11) D 2018 782 S **(51) 11-01**
(10) AD 2018 1018 S (44) 14(498)2018
(21) AD 2018 1018
(22) 2018 01 31
(24) 2018 01 31
(28) 1
(18) 2023 01 31
(73) Tamar Zautashvili (GE)
T. Tabidzis q. 39, b. 18, 0162, Tbilisi (GE)
(72) Tamar Zautashvili (GE)
(54) **EARRING**

(11) D 2018 781 S **(51) 13-03**
(10) AD 2018 1014 S (44) 14(498)2018
(21) AD 2018 1014
(22) 2018 01 14
(24) 2018 01 14
(28) 1
(18) 2023 01 14

(73) Ekaterine Demetrashvili (GE)
Vazha Pshavelas V kv., korp. I, b. 88, 0186,
Tbilisi (GE)
(72) Ekaterine Demetrashvili (GE)
(54) **PARABOLIC MIRRORS FOLLOWING
SUN RAYS AXES DISPOSITION**

(11) D 2018 779 S **(51) 21-01**
(10) AD 2018 1030 S (44) 14(498)2018
(21) AD 2018 1030
(22) 2018 03 16
(24) 2018 03 16
(28) 3
(18) 2023 03 16
(73) Vadim Evgenievich Pravednikov (RU)
Ul. Vorovskogo d. 4, b. 23, 354000, Sochi,
Krasnodarsky Krai (RU);
Irakli Tchapanidze (GE)
J. Rapavas q. 37, 2100, Zugdidi (GE);
Nikolay Genadovich Spesivtsev (RU)
Ul. Alpiyskaya d.70, 354000, Sochi,
Krasnodarsky Krai (RU)
(72) Vadim Evgenievich Pravednikov (RU)
(74) Shalva Gvaramadze (GE)
(54) **1.-3. DICE**

DESIGNS, WHICH HAVE BEEN REGISTERED WITH THE INTERNATIONAL BUREAU CLAIMING PRIORITY ON THE TERRITORY OF GEORGIA

The decision can be appealed at the Chamber of Appeal of Sakpatenti within 3 months from the publication or at the Mtskheta District Court Administrative Cases Board (Address: №17, Samkhedro Str., Mtskheta), within 1 month following the publication.

(11) DM/99908

(15) 2018 02 06

(22) 2018 02 06

(28) 4

(73) THE SWATCH GROUP MANAGEMENT SERVICES AG (THE SWATCH GROUP MANAGEMENT SERVICES SA) (THE SWATCH GROUP MANAGEMENT SERVICES LTD)

Seevorstadt 6, CH-2502 Biel/Bienne (CH)

(85) CH

(86) CH

(87) CH

(88) CH

(89) CH

(81) II. BZ, MA III. AL, AM, AZ, BA, CH, EM, GE, KG, LI, MC, MD, ME, MK, MN, NO, OM, SG, TN, TR, UA

(72) 1-2: Lucile GIBELLO

43 bis Chemin des Fins Nord, F-74000 Annecy, France;

3-4: Adeline ROBERTO

Chaussée de la Boine 49, CH-2000 Neuchâtel, Suisse

(54) 1.-2. Wristwatches; 3.-4. Dials

(55)

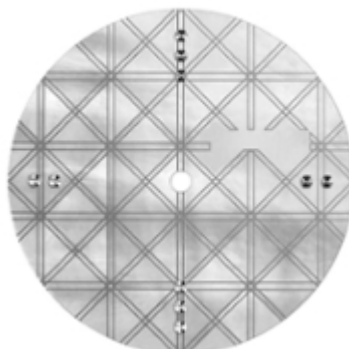
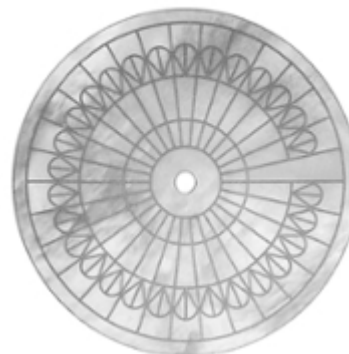
1.1**1.2****1.3****2.1****2.2****2.3****3****4**

(11) DM/99912

(51) 10-07

(15) 2018 02 08

(45) 2018/31 (2018 08 10)

(22) 2018 02 08

(28) 5

(73) BLANCPAIN SA

Le Rocher 12, CH-1348 LE BRASSUS (CH)

(85) CH

(86) CH

(87) CH

(88) CH

(89) CH

(81) II. BZ, MA III. AL, AM, AZ, BA, CH, EM, GE, KG, LI, MC, MD, ME, MK, MN, NO, OM, SG, TN, TR, UA

(72) 1-3,5: Nicolas DEBAUD

Route du village 10D, CH-1070 Puidoux, Suisse;

4: Daniel VILLARD

Chemin de la Fauvette 1, CH-1185 Mont-sur-Rolle, Suisse

(54) 1.-5. Dials

(55)

1.1



1.2

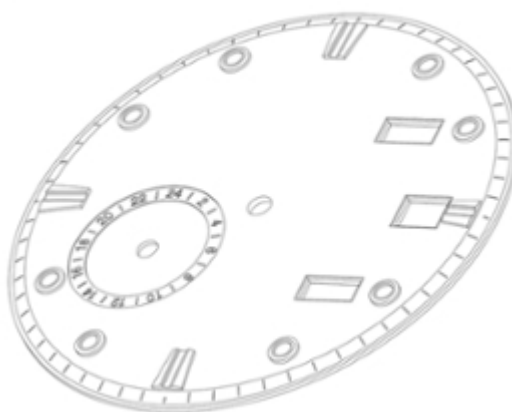

2.1



2.2

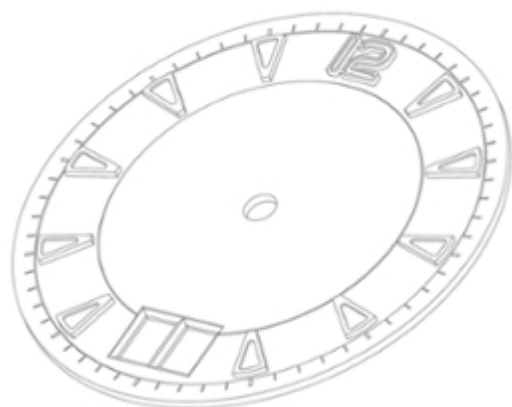

3.1



3.2



4.1



4.2

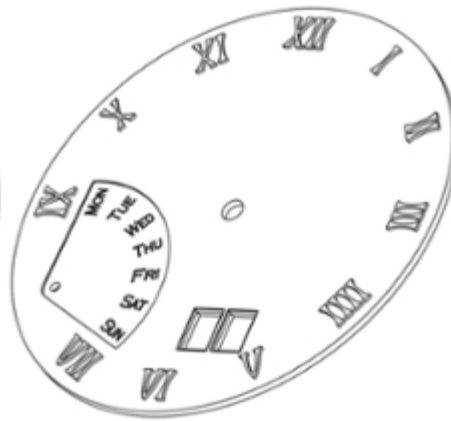

5.1



5.2



(11) DM/99999

(51) 11-01

(15) 2018 02 06

(45) 2018/31 (2018 08 10)

(22) 2018 02 06

(28) 9

(73) OMEGA SA (OMEGA AG) (OMEGA LTD)

Jakob-Stämpfli-Strasse 96, CH-2502 Biel/Bienne (CH)

(85) CH

(86) CH

(87) CH

(88) CH

(89) CH

(81) II. BZ, MA III. AL, AM, AZ, BA, CH, EM, GE, KG, LI, MC, MD, ME, MK, MN, NO, OM, SG, TN, TR, UA

(72) Jean-Claude Monachon

Rue Alice-de-Chambrier 1, 2022 Bevaix, Suisse

(54) 1. Pendant; 2. Finger ring; 3. Earrings; 4.-5. Bracelets; 6. Finger ring; 7.-8. Bracelets; 9. Finger ring

(55)

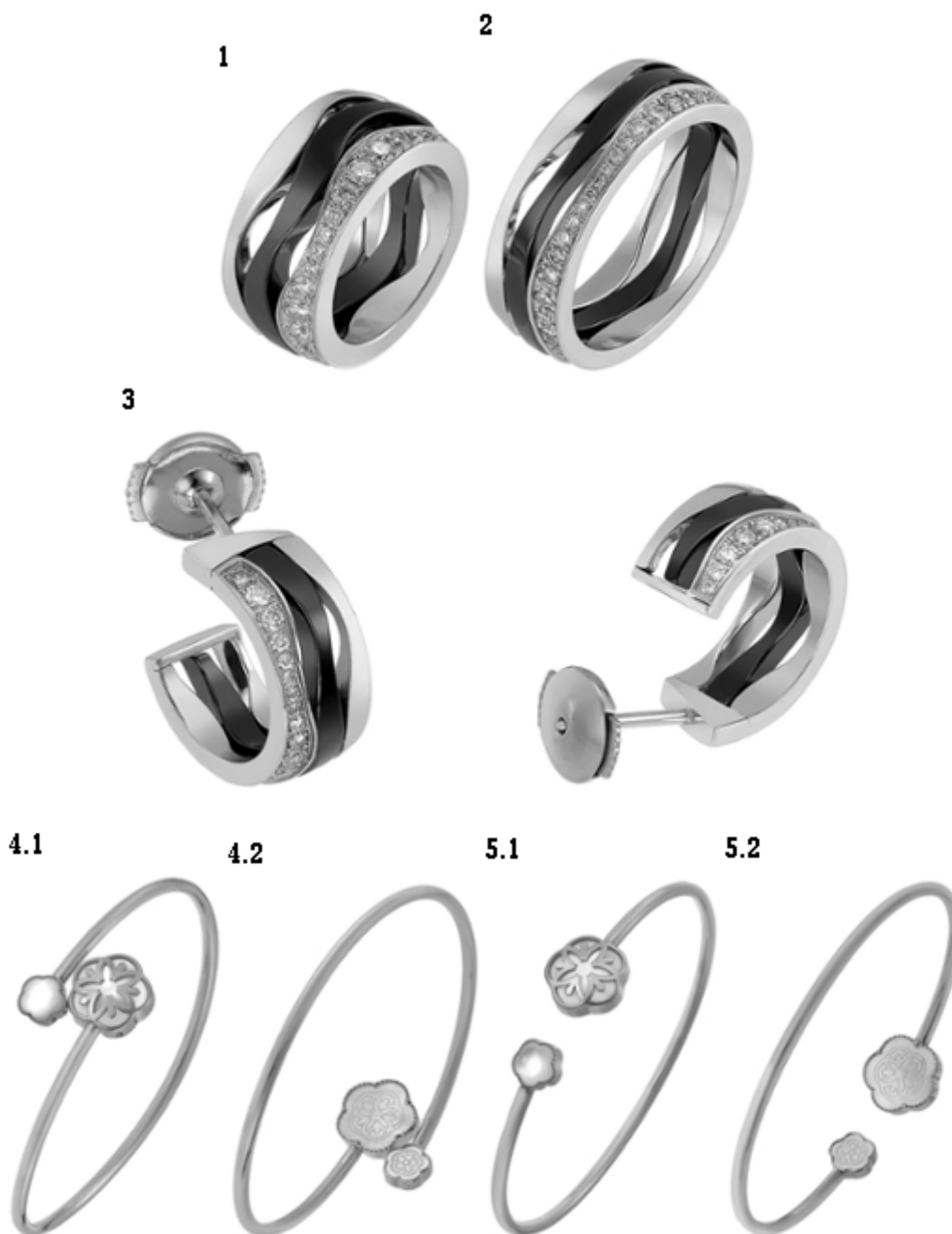

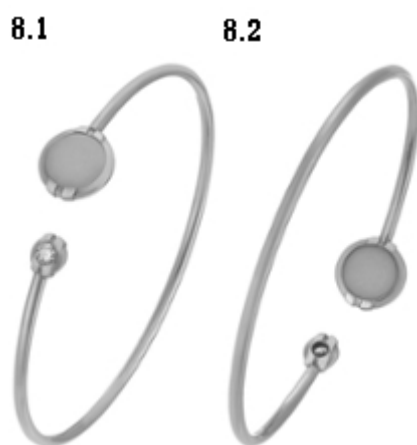

(11) DM/102050

(15) 2018 04 04

(22) 2018 04 04

(28) 3

(73) ZAKHARIN SERHII

Yakubovskoho St., 4, apt 8, Kyiv 03191 (UA)

(85) –

(86) UA

(87) UA

(88) –

(89) UA

(81) III. EM, GE, TR, US

(72) Zakharin Serhi

Yakubovskoho St., 4, apt 8, 03191 Kyiv, Ukraine

(54) 1.-3. Safes

(55)

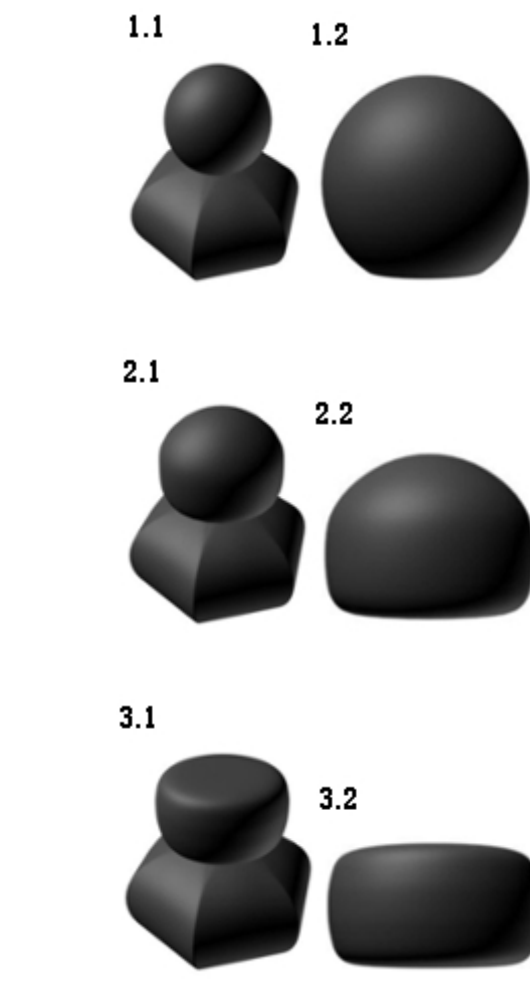

(11) DM/102055

(15) 2018 07 21

(22) 2018 07 21

(28) 7

(73) BALEV EOOD

blvd. Vladislav Varnenchik No.256, BG-9009 Varna (BG);

BALEV CORPORATION EOOD

blvd. Vladislav Varnenchik No.260, BG-9009 Varna (BG);

DIMITAR HRISTOV BALEV

Blvd. Vitosha No.137, apt. 17, BG-1408 Sofia (BG)

(85) BG, EM

(86) BG, EM

(87) BG, EM

(88) BG, EM

(89) BG

(81) II. MA III. AL, AM, AZ, BA, CH, EG, EM, GE, IS, KG, MD, ME, MK, MN, NO, RS, RU, TJ, TM, TN, TR, UA

(72) Dimitar Hristov Balev

Blvd. Vitosha No.137, apt. 17, 1408 Sofia, Bulgaria

(54) 1.-2. Air fresheners [other than apparatus]; 3.-7. Parts for air fresheners [other than apparatus]

(55)

1.1**1.2****1.3**

1.4

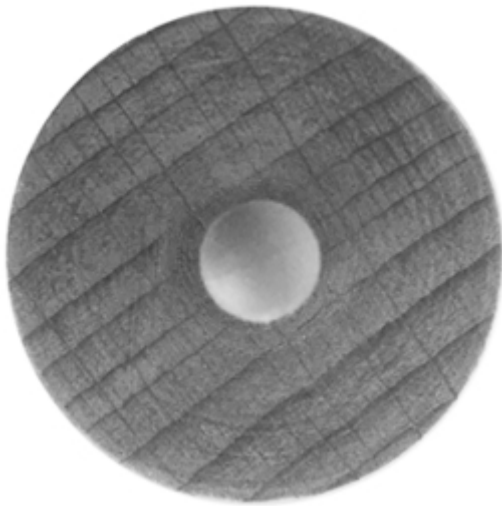

1.5



2.1



2.2



2.3



3.1



3.2



3.3

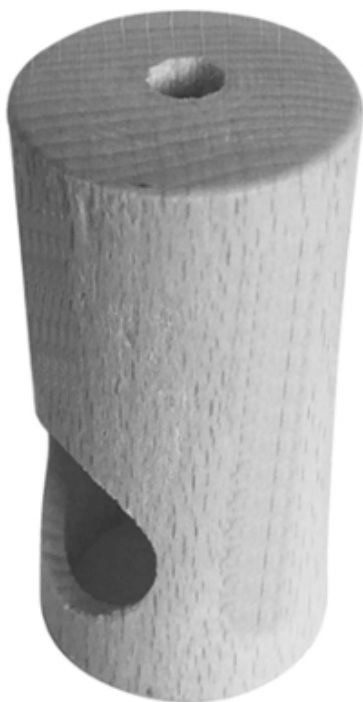

3.4

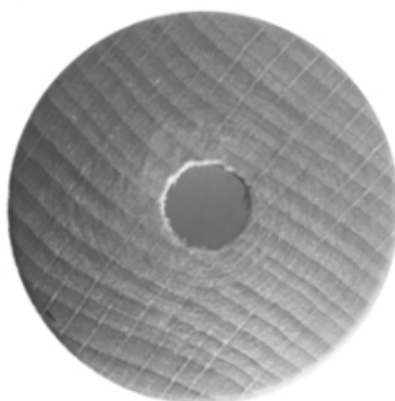

3.5

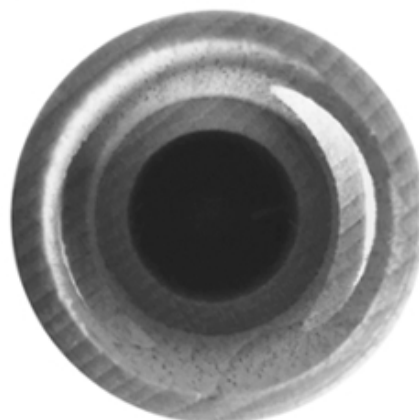

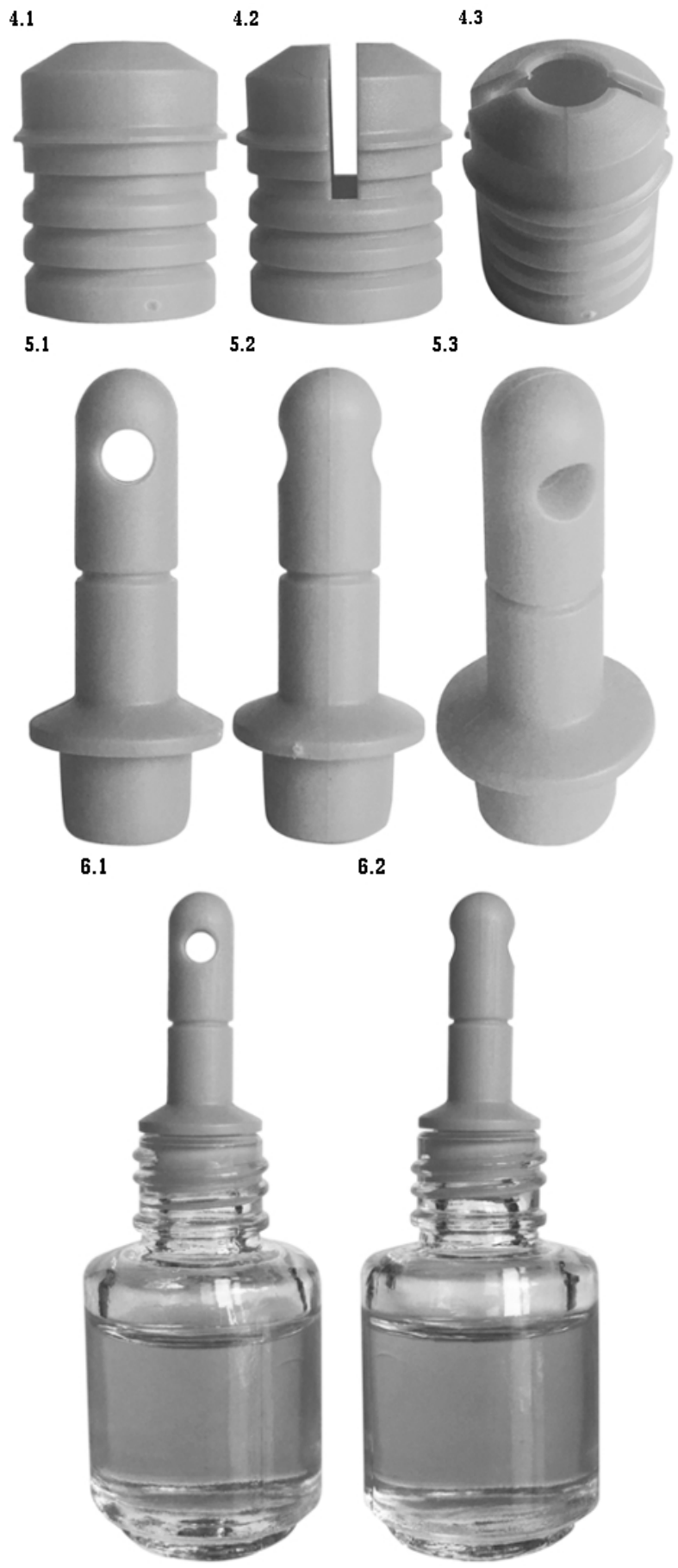

7.1



7.2



7.3



7.4

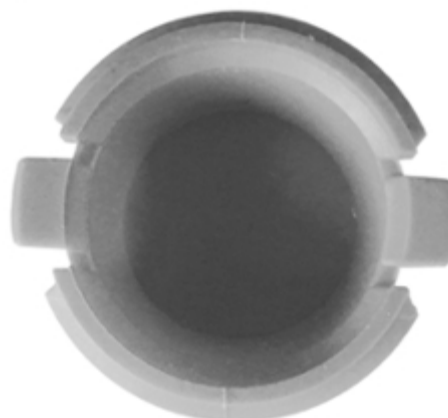

7.5



(11) DM/099859

(51) 10-02, 07

(15) 2018 02 12

(45) 2018/32 (2018 08 17)

(22) 2018 02 12

(28) 6

(73) MONTRES JAQUET DROZ SA (MONTRES JAQUET DROZ AG)
(MONTRES JAQUET DROZ LTD)

Allée du Tourbillon 2, CH-2300 La Chaux-de-Fonds (CH)

(85) CH

(86) CH

(87) CH

(88) CH

(89) CH

(81) II. BZ, MA III. AL, AM, AZ, BA, CH, EM, GE, KG, LI, MC, MD, ME, MK, MN, NO, OM, SG, TN, TR, UA

(72) Christian Lattmann

Chemin du Château-Neuf 17, CH-1125 Monnaz, Suisse;

1,6: Le Ngoc Thanh

1 rue du Clos de la Fontaine, F-25500 Le Belieu, France;

2-5: Philippe Willemin

Grand-Chêne 16, CH-2854 Bassecourt, Suisse

(54) 1. Dial; 2. Watch; 3. Watch case; 4. Dial; 5. Oscillating weight; 6. Dial

(55)

1.1



1.2



1.3 1.4 1.5



1.6 1.7



1.8

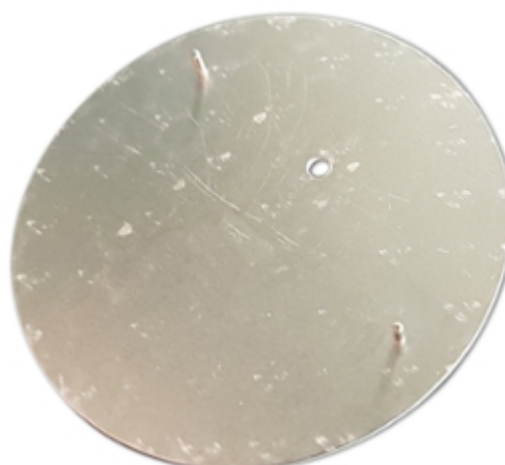

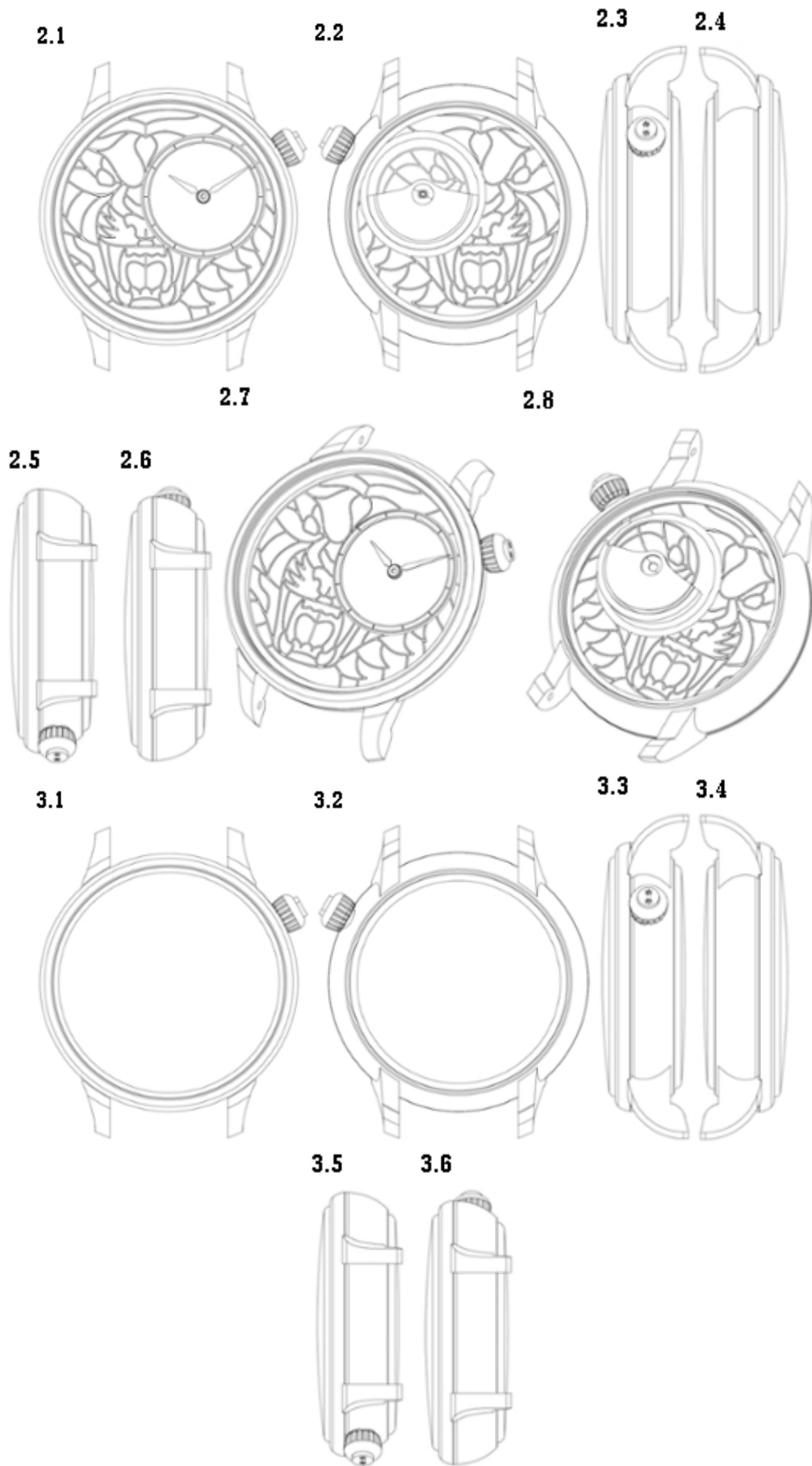

3.7

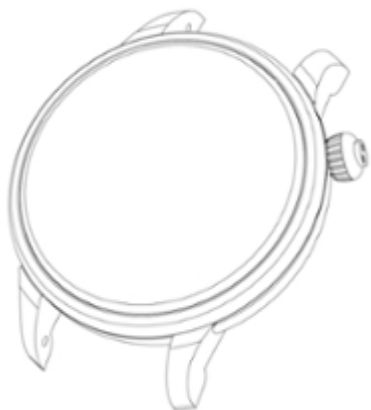

3.8



4.1



4.2



4.3



4.4



4.5



4.6



4.7



4.8



5.1



5.2



5.3



5.4



5.5



5.6



5.7



5.8

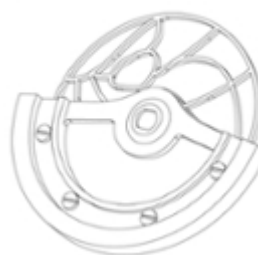

6.1



6.2

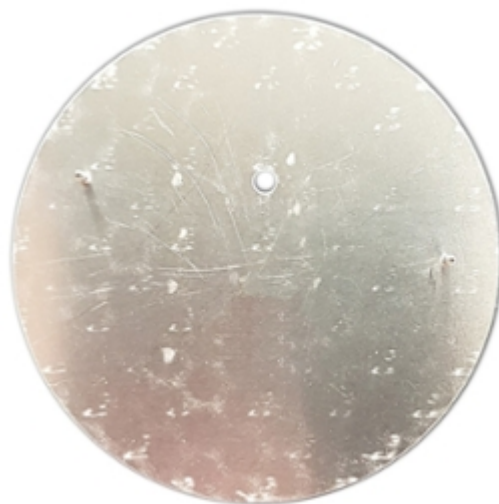

6.3



6.4



6.5



6.6



6.7



6.8

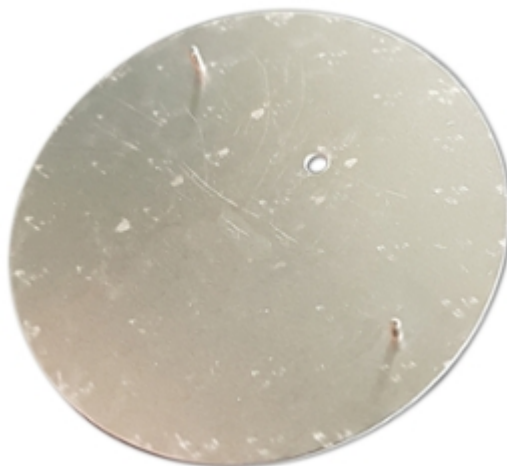

(11) DM/099860

(51) 10-02, 07

(15) 2018 02 12

(45) 2018/32 (2018 08 17)

(22) 2018 02 12

(28) 8

(73) MONTRES JAQUET DROZ SA (MONTRES JAQUET DROZ AG) (MONTRES JAQUET DROZ LTD)
Allée du Tourbillon 2, CH-2300 La Chaux-de-Fonds (CH)

(85) CH

(86) CH

(87) CH

(88) CH

(89) CH

(81) II. BZ, MA III. AL, AM, AZ, BA, CH, EM, GE, KG, LI, MC, MD, ME, MK, MN, NO, OM, SG, TN, TR, UA

(72) Christian LATTMANN

Chemin du Château-Neuf 17, CH-1125 Monnaz, Suisse;

Yann LEIGGENER

Rue du Nord 47, CH-2300 La Chaux-de-Fonds, Suisse

(54) 1. Watch; 2.-3. Watch cases; 4.-5. Dials; 6. Watch movement; 7.-8. Oscillating weights

(55)

1.1



1.2



1.3



1.4



2.1

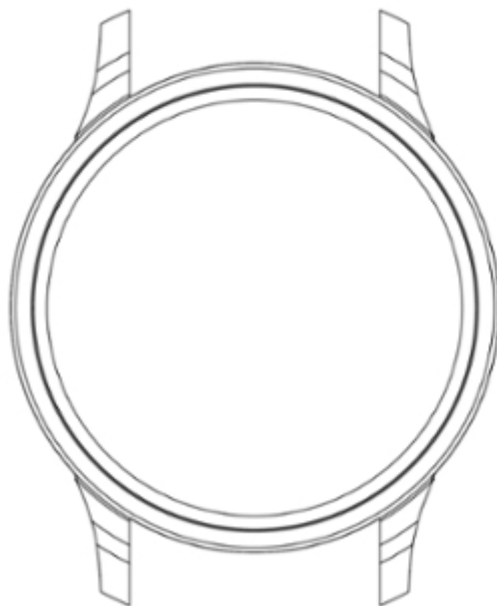

2.2

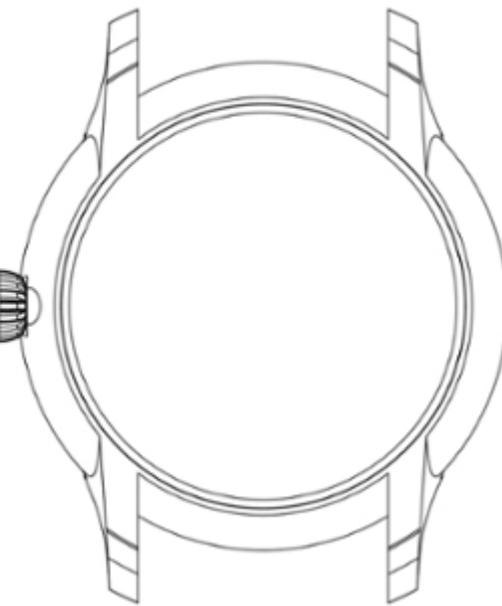

2.3

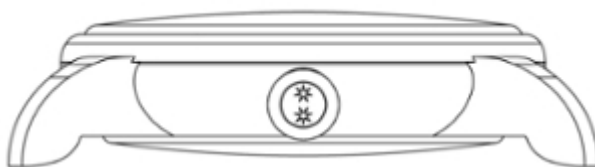

2.4

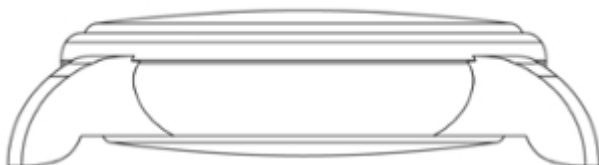

2.5

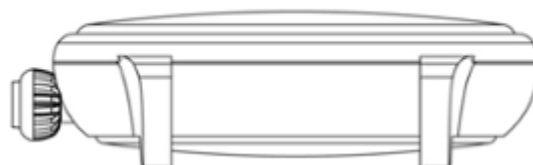

2.7

2.6

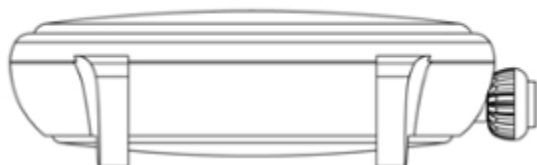

2.8

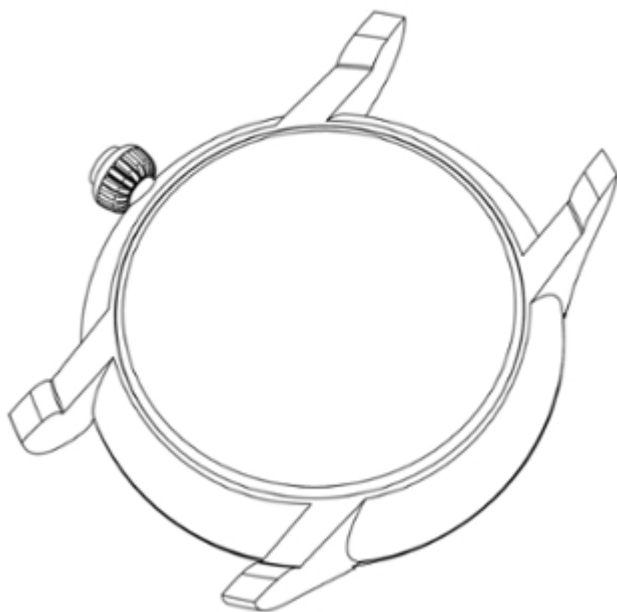

3.1

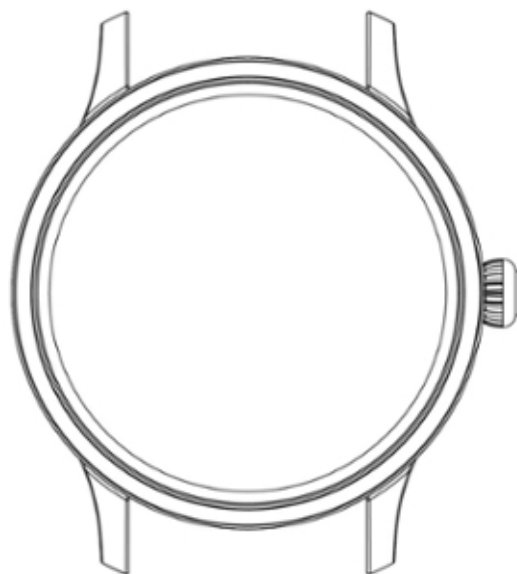

3.2

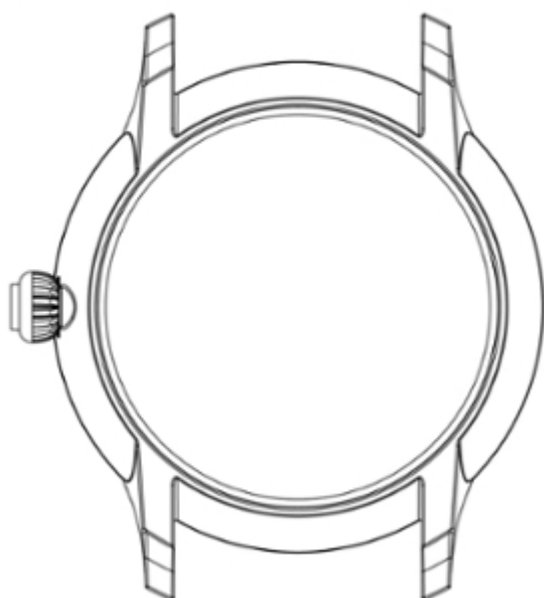

3.3

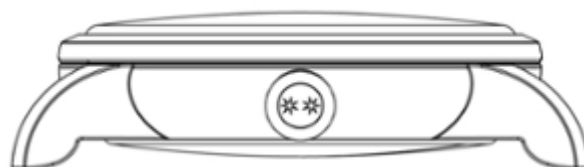

3.4

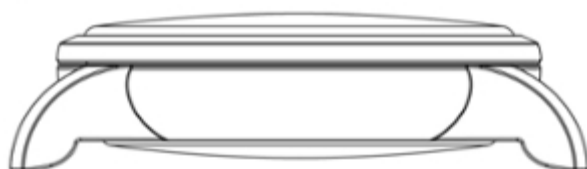

3.5

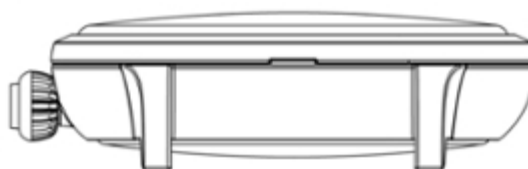

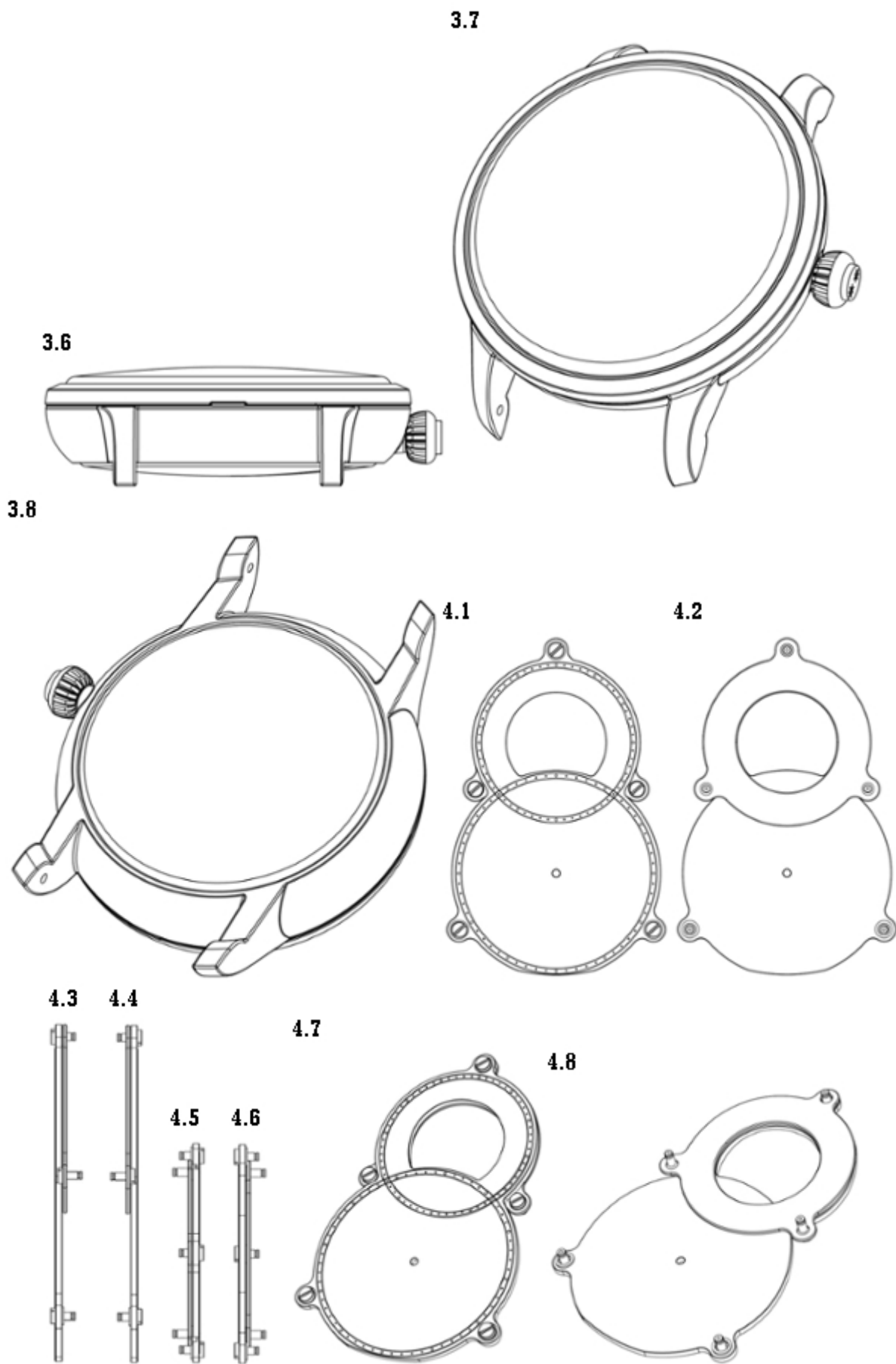

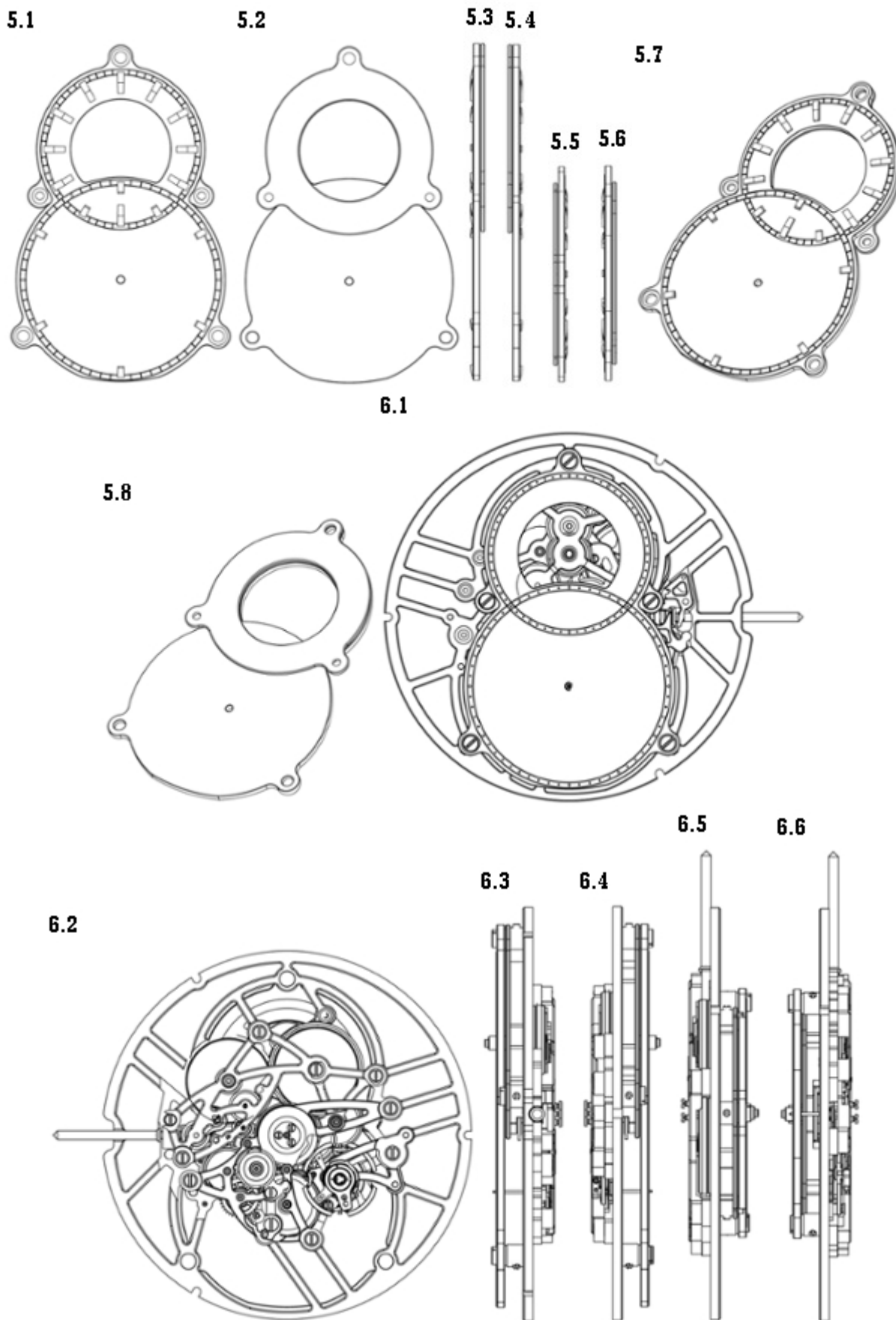

6.7

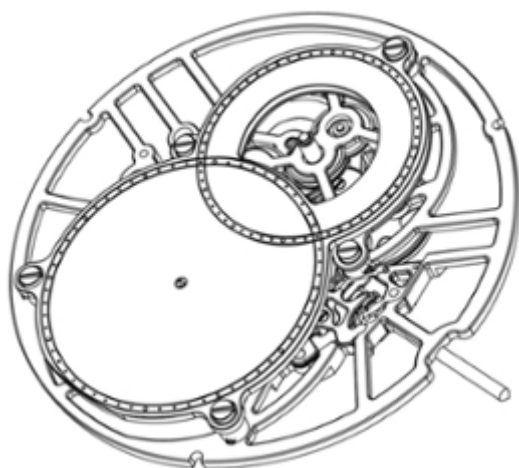

6.8

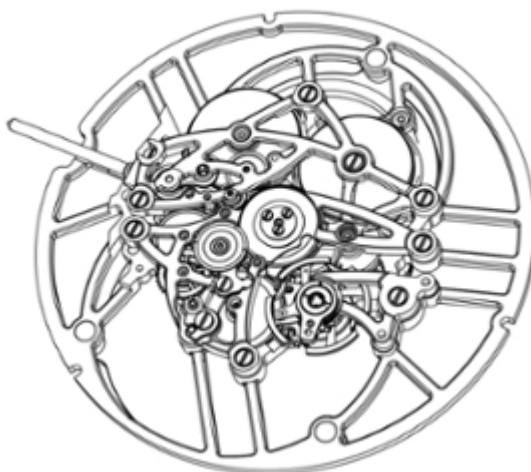

7.1

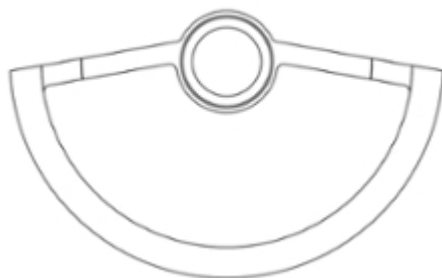

7.2

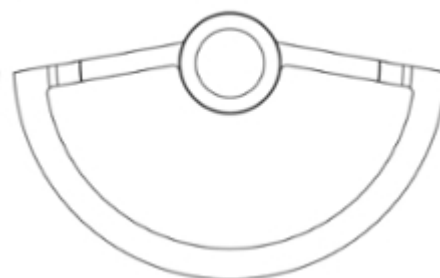

7.3 7.4



7.5 7.6



7.7

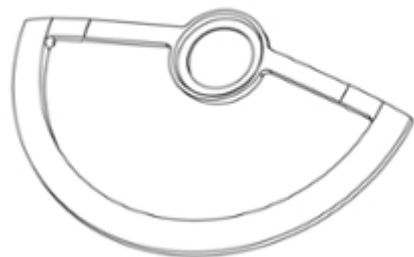

7.8

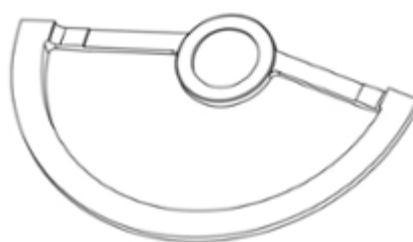

8.1

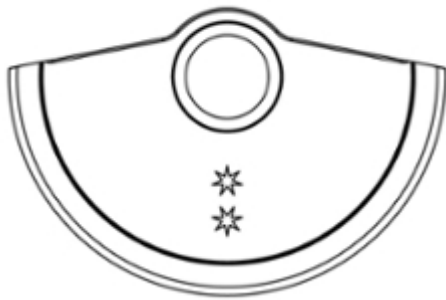

8.2

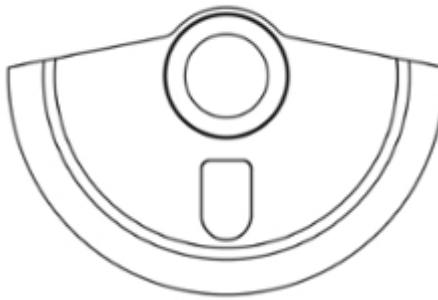

8.3



8.4



8.5



8.6



8.7



8.8

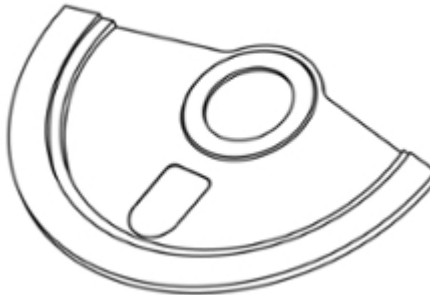

(11) DM/102199

(15) 2018 06 05

(22) 2018 06 05

(28) 5

(73) GIACOMO TRENZ

7, Bisserweg, L-1238 Luxembourg (LU)

(85) –

(86) DE, EM

(87) –

(88) –

(89) DE

(81) II. BJ, BZ, MA, SR III. AL, AM, AZ, BA, BG, BN, BW, CH, EG, GE, GH, JP, KG, KH, KP, KR, LI, MC, MD, ME, MK, MN, NA, OA, OM, RS, RU, RW, SG, ST, SY, TJ, TM, TN, TR, UA, US

(72) Giacomo Trenz

Bisserweg 7, 1238, Luxembourg

(54) 1.-5. Sachets [packaging]

(55)

1.1



1.2



2.1



2.2



3.1



3.2



4.1



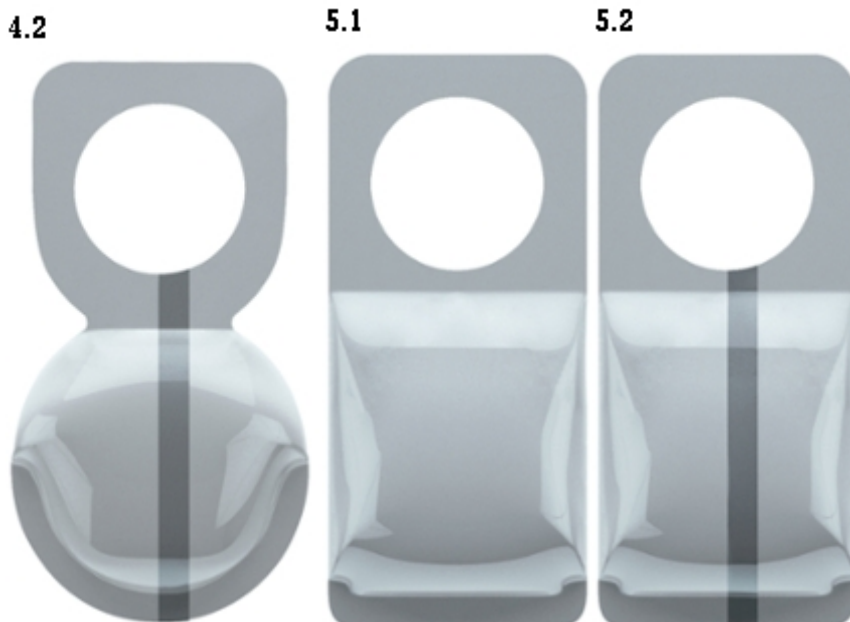

(11) DM/100099

(15) 2018 02 21

(22) 2018 02 21

(28) 5

(73) MONTRES JAQUET DROZ SA (MONTRES JAQUET DROZ AG) (MONTRES JAQUET DROZ LTD)
Allée du Tourbillon 2, CH-2300 La Chaux-de-Fonds (CH)

(85) CH

(86) CH

(87) CH

(88) CH

(89) CH

(81) II. BZ, MA III. AL, AM, AZ, BA, CH, EM, GE, KG, LI, MC, MD, ME, MK, MN, NO, OM, SG, TN, TR, UA

(72) Christian LATTMANN

Chemin du Château-Neuf 17, CH-1125 Monnaz, Suisse;

Yann LEIGGENER

Rue du Nord 47, CH-2300 La Chaux-de-Fonds, Suisse

(54) 1.-5. Dials

(55)

(51) 10-07

(45) 2018/33 (2018 08 24)

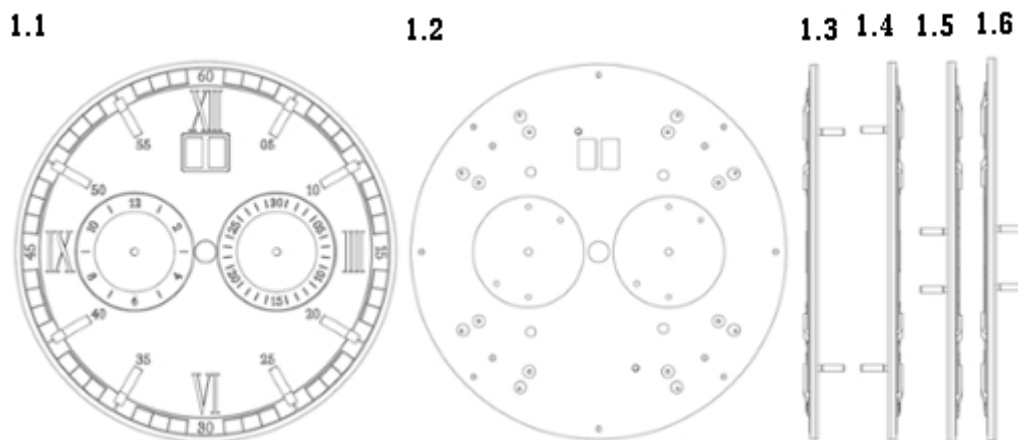

1.7

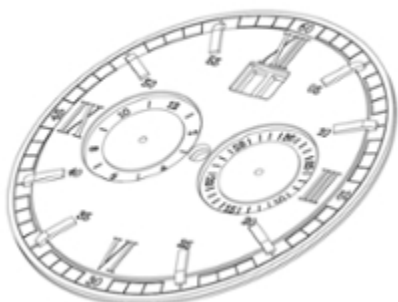

1.8

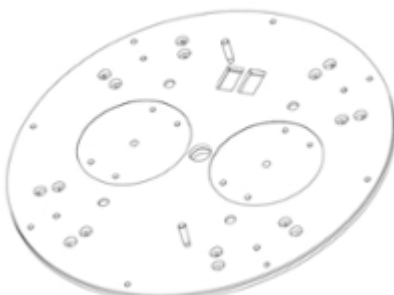

2.1

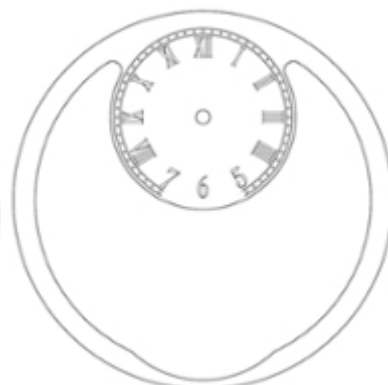

2.2



2.3 2.4 2.5 2.6 2.7

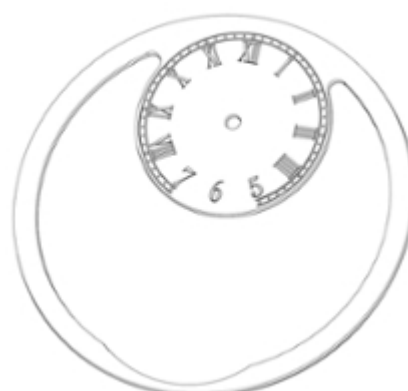

2.8



3.1

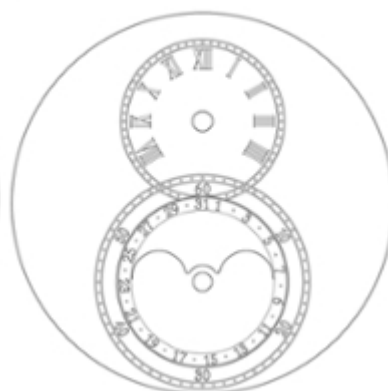

3.2



3.3 3.4 3.5 3.6

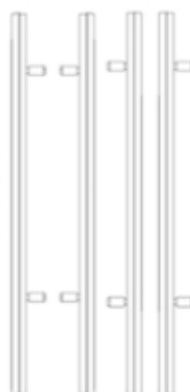

3.7

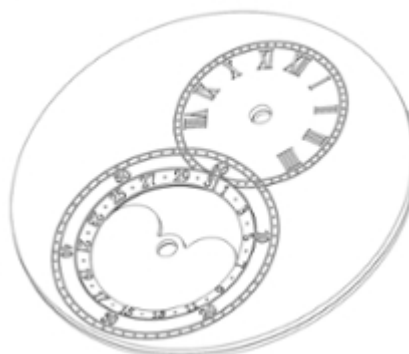

3.8

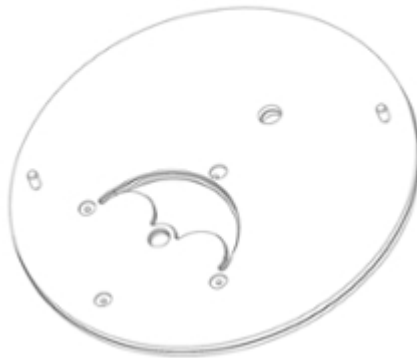

4.1

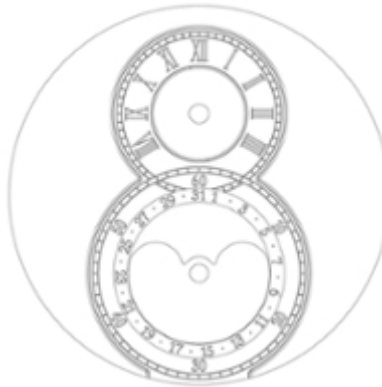

4.2



4.3



4.4



4.5



4.6



4.7

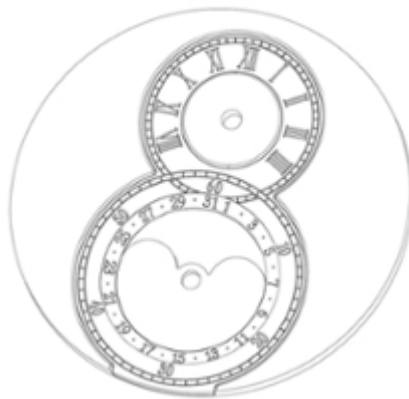

4.8



5.1



5.2





5.7



5.8



(11) DM/100100

(51) 10-02, 07

(15) 2018 02 21

(45) 2018/33 (2018 08 24)

(22) 2018 02 21

(28) 8

(73) MONTRES JAQUET DROZ SA (MONTRES JAQUET DROZ AG) (MONTRES JAQUET DROZ LTD)
Allée du Tourbillon 2, CH-2300 La Chaux-de-Fonds (CH)

(85) CH

(86) CH

(87) CH

(88) CH

(89) CH

(81) II. BZ, MA III. AL, AM, AZ, BA, CH, EM, GE, KG, LI, MC, MD, ME, MK, MN, NO, OM, SG, TN, TR, UA

(72) Christian LATTMANN

Chemin du Château-Neuf 17, CH-1125 Monnaz, Suisse;

Yann LEIGGENER

Rue du Nord 47, CH-2300 La Chaux-de-Fonds, Suisse

(54) 1. Montre-bracelet; 2.-4. Boîtes de montres; 5. Masse oscillante; 6.-7. Bracelets de montres;

8. Boucle de bracelet de montre / 1. Wristwatch; 2.-4. Watch cases; 5. Oscillating weight;

6.-7. Watch bracelets; 8. Watch-bracelet clasp

(55)

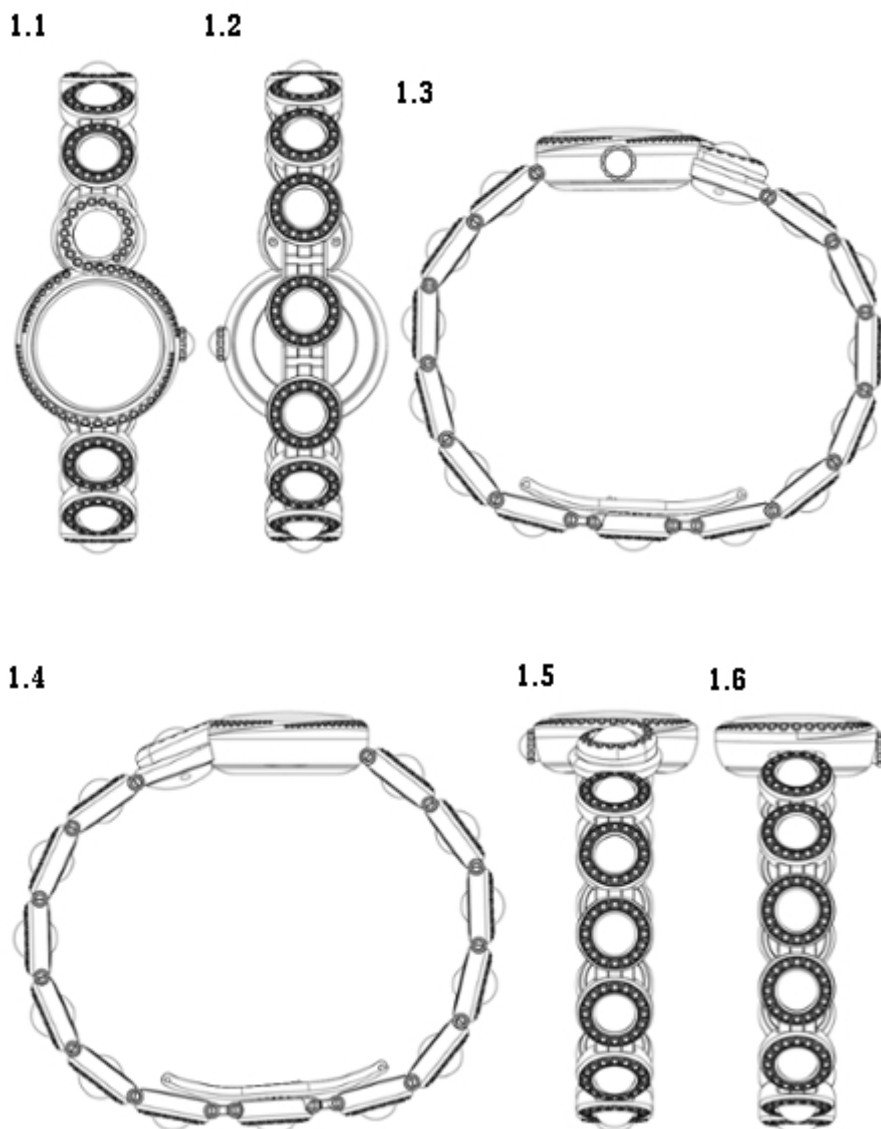

1.7



1.8



2.1



2.2



2.3

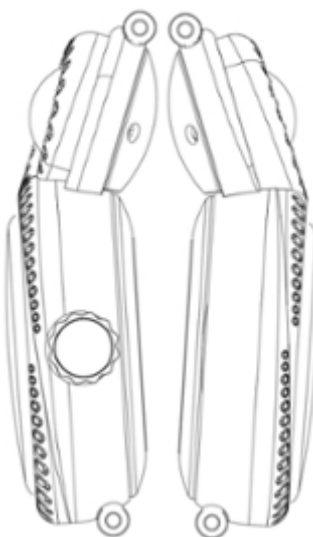

2.4



2.5

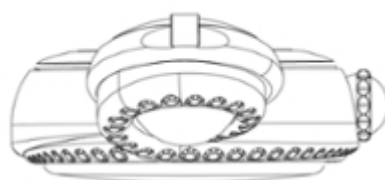

2.7



2.6

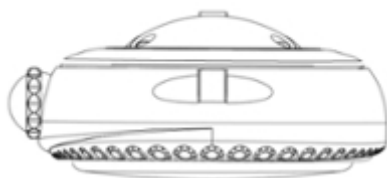

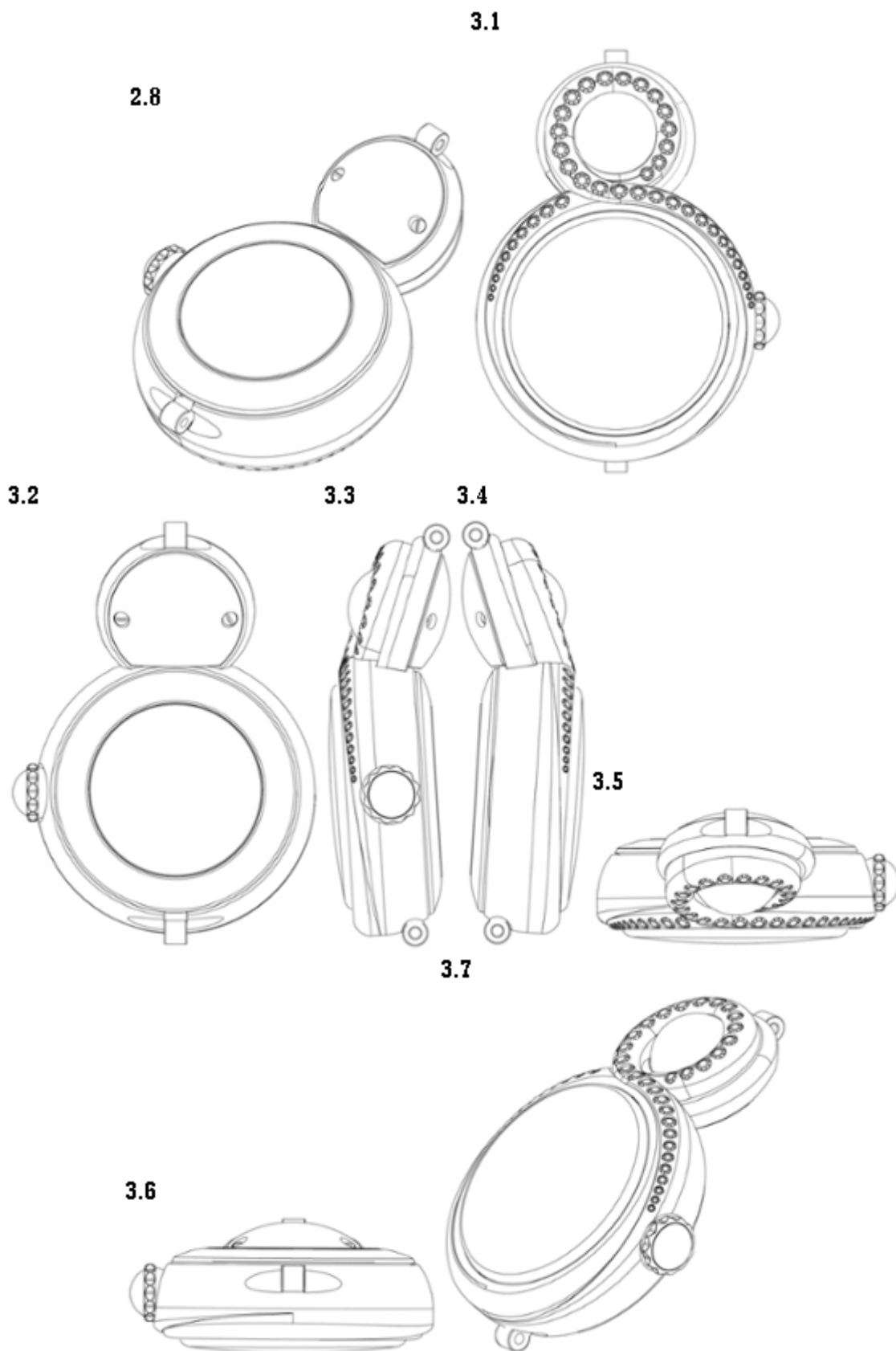

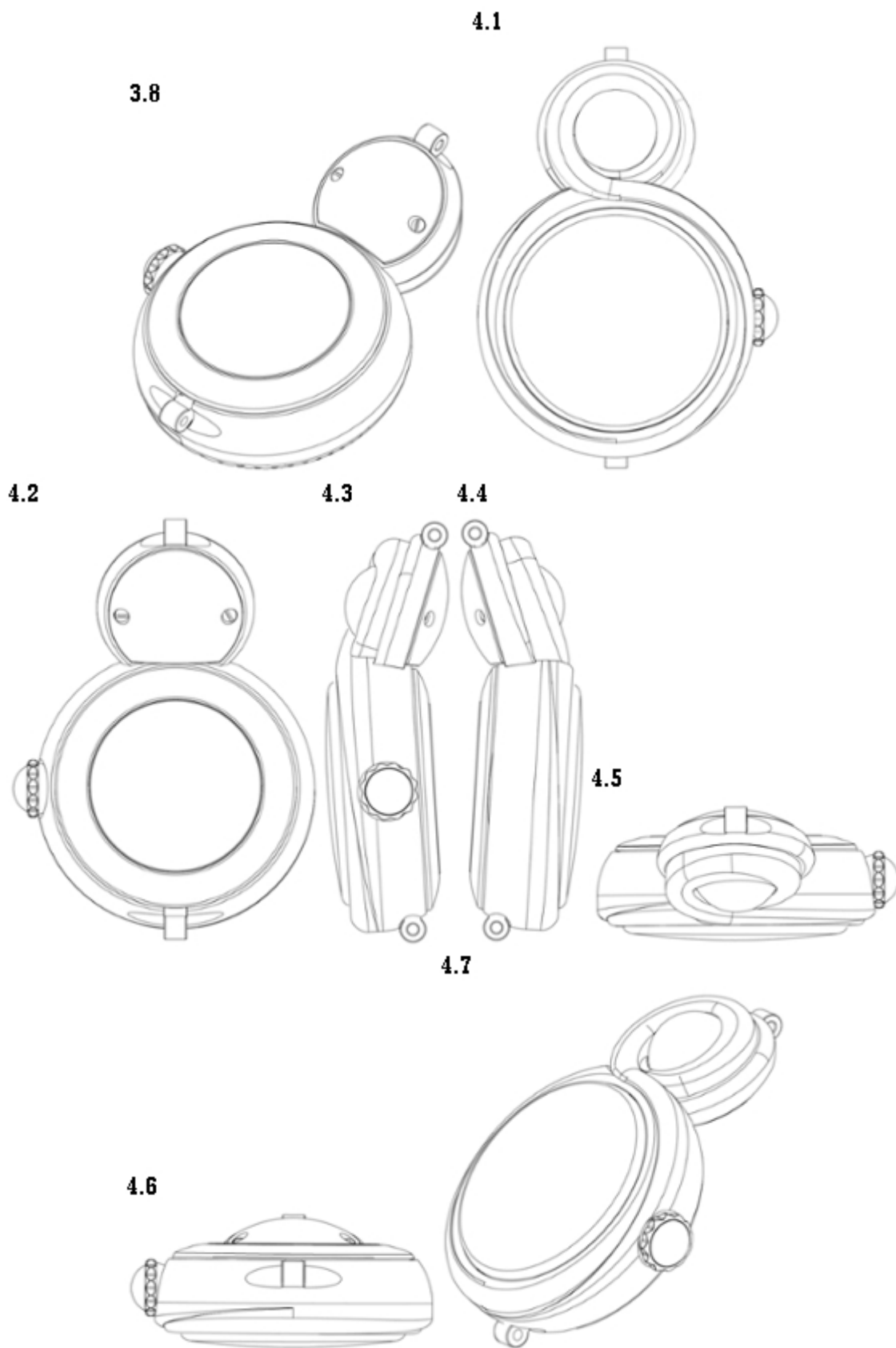

4.8



5.1



5.2

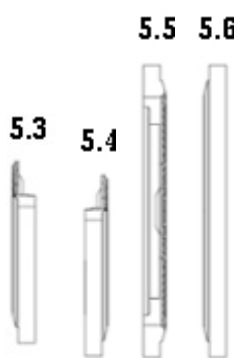

5.7

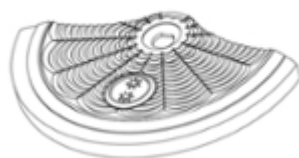

5.8



6.1 6.2 6.3 6.4

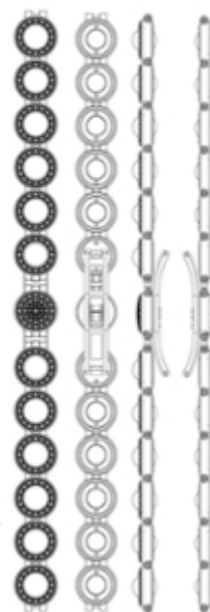

6.5 6.6



6.8

6.7



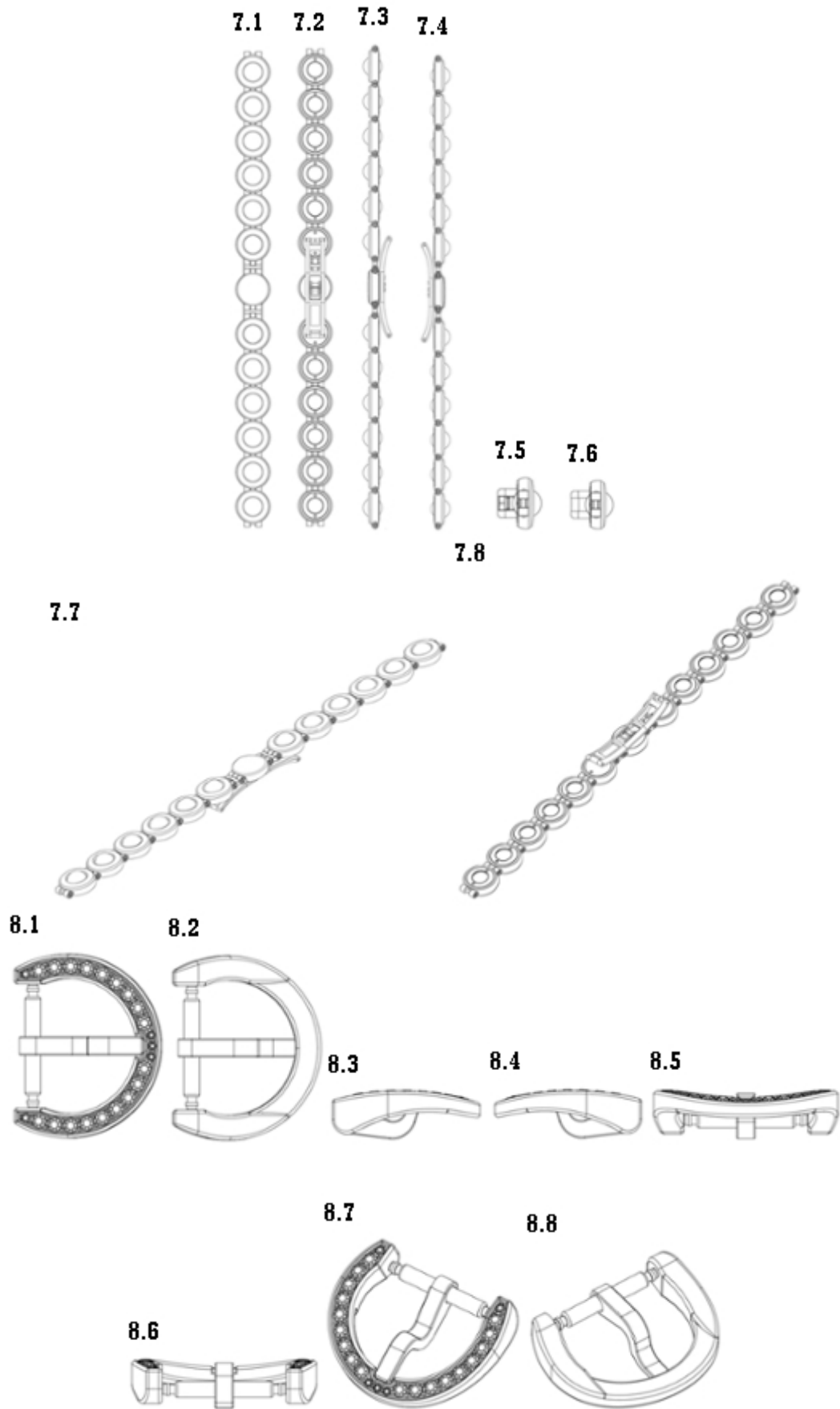

(11) DM/100102

(15) 2018 02 22

(22) 2018 02 22

(28) 1

(73) MIDO AG (MIDO SA) (MIDO LTD)

Chemin des Tourelles 17, CH-2400 Le Locle (CH)

(85) CH

(86) CH

(87) CH

(88) CH

(89) CH

(81) II. BZ, MA III. AL, AM, AZ, BA, CH, EM, GE, KG, LI, MC, MD, ME, MK, MN, NO, OM, SG, TN, TR, UA

(72) Johan REBETEZ

Ch. De Gratte-Semelle 33, CH-2000 Neuchâtel, Suisse

(54) 1. Wristwatch

(55)

(51) 10-02

(45) 2018/33 (2018 08 24)

1.1



1.2



1.3



1.4



1.5

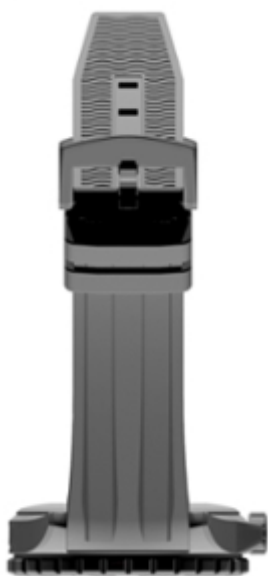

1.6



1.7



(11) DM/100453

(51) 10-02, 07

(15) 2018 02 20

(45) 2018/33 (2018 08 24)

(22) 2018 02 20

(28) 16

(73) HARRY WINSTON SA

Chemin du Tourbillon 8, CH-1228 Plan-les-Ouates (CH)

(85) CH

(86) CH

(87) CH

(88) CH

(89) CH

(81) II. BZ, MA III. AL, AM, AZ, BA, CH, EM, GE, KG, LI, MC, MD, ME, MK, MN, NO, OM, SG, TN, TR, UA

(72) 1-2,4: Steve KAMILINDI

Chemin de Frémis 33, CH-1241 Puplinge, Suisse;

3,7-8: Coralie BLOOTACKER

45 route du Battoir Le hameau des Templiers, F-74520 Vulbens, France;

5-6: Sophie VALZAN

Rue Jean Violette 30, CH-1205 Genève, Suisse;

9-12: Christophe LASSERRE

12 Rue François-Grast, CH-1208 Genève, Suisse;

13-16: Emmanuelle DOMINGUEZ

285 Rue de la Luchette, F-74580 Viry, France

(54) 1. Watch case; 2.-5. Dials; 6. Oscillating weight; 7.-9. Dials; 10. Oscillating weight; 11. Watch case; 12. Dial; 13. Wristwatch; 14. Dial; 15. Wristwatch; 16. Dial

(55)

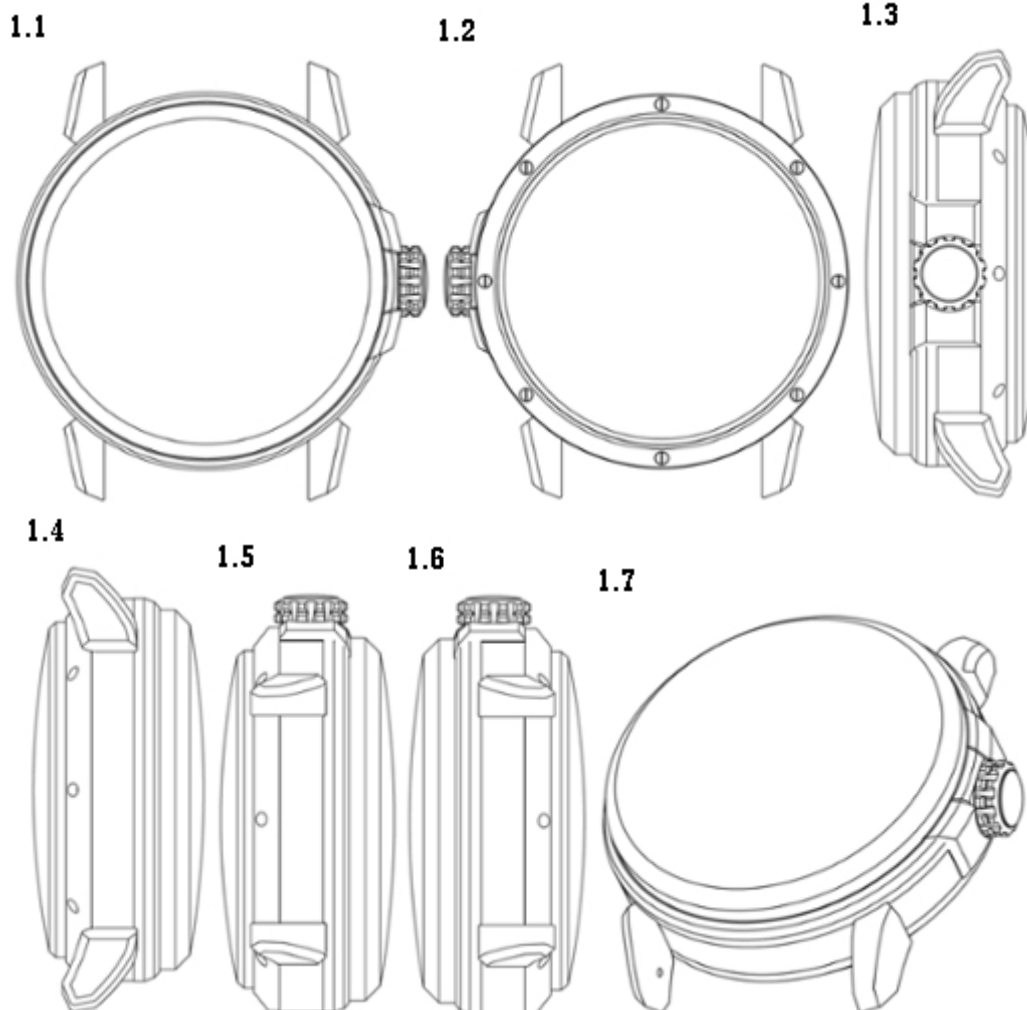

1.8

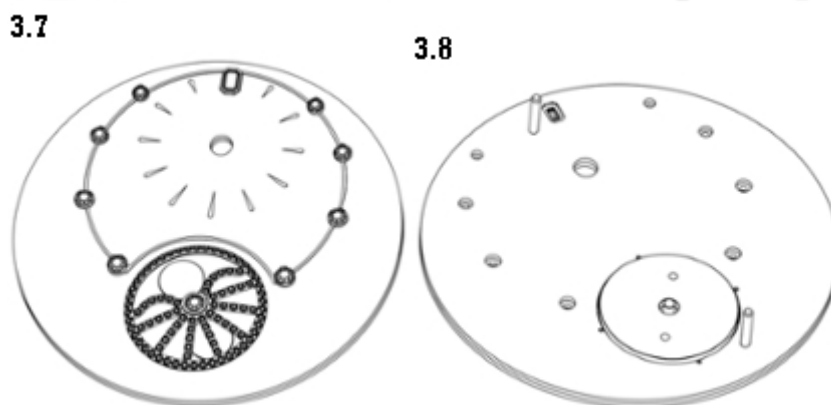
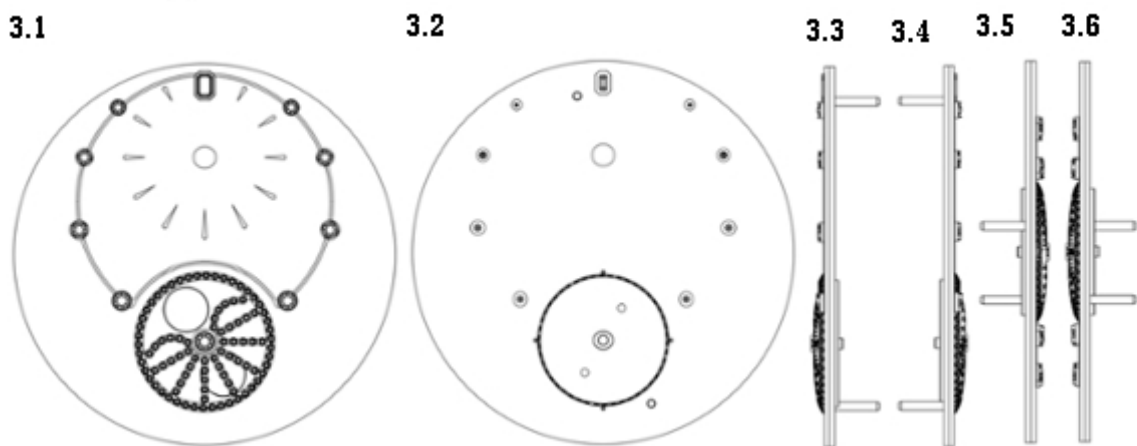
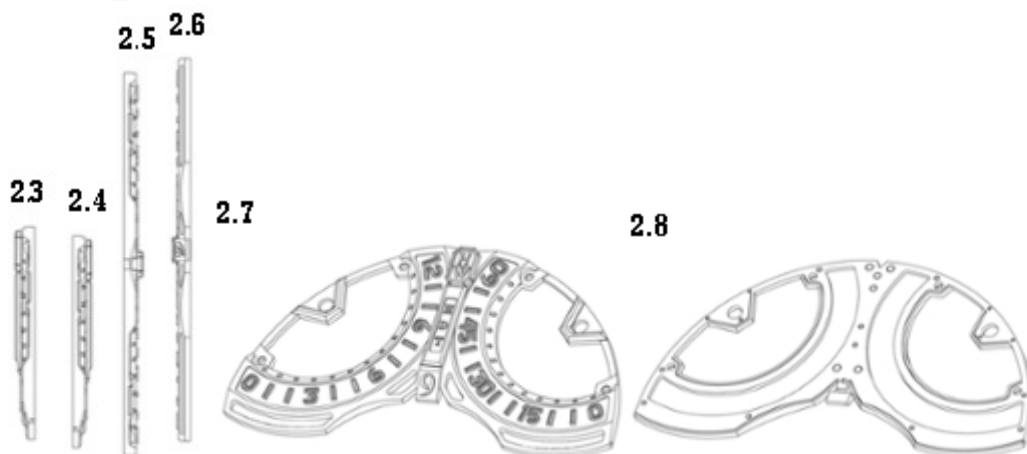
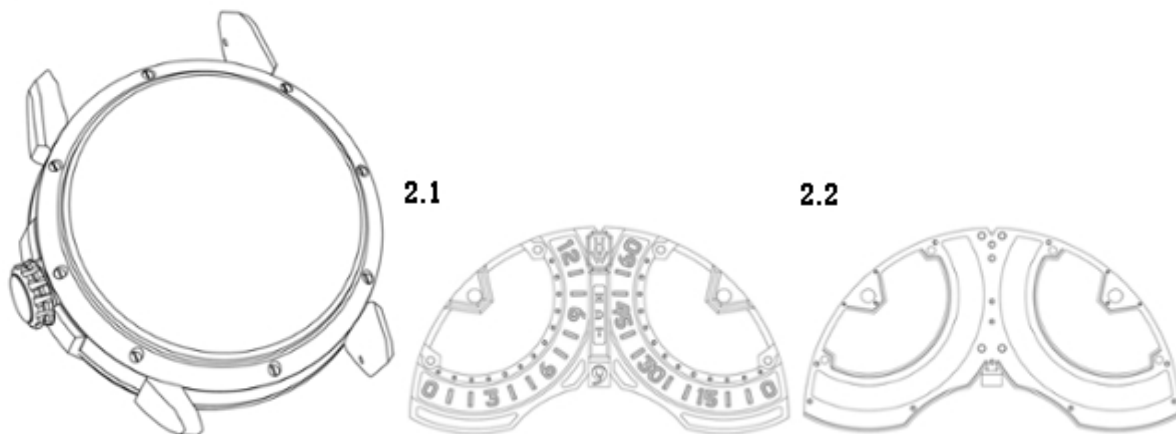

4.1



4.2

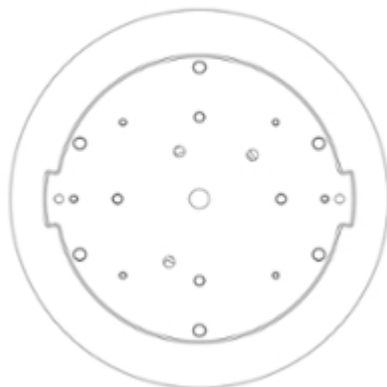

4.3 4.4 4.5 4.6

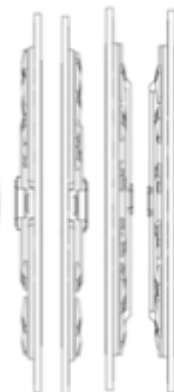

4.7



4.8

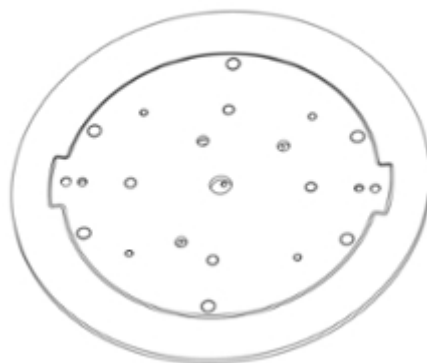

5.1

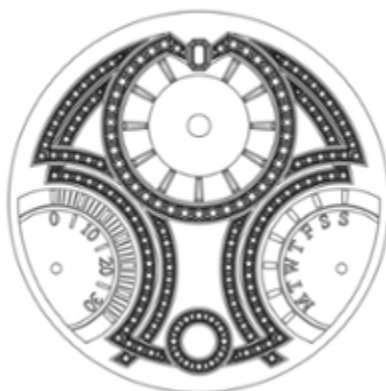

5.2

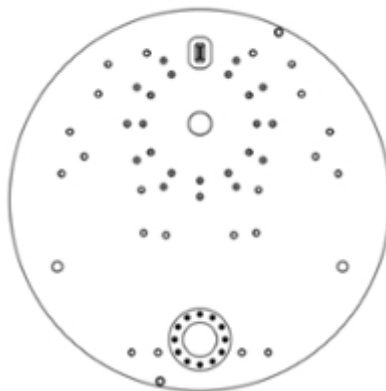

5.3 5.4 5.5 5.6

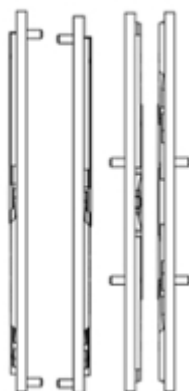

5.7

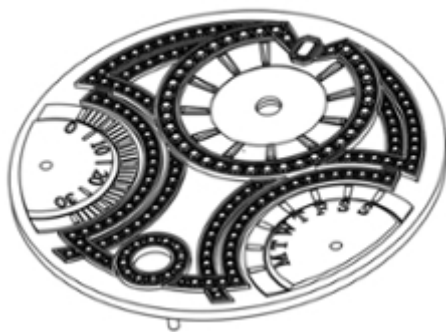

5.8

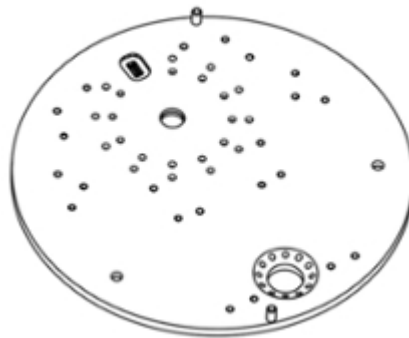

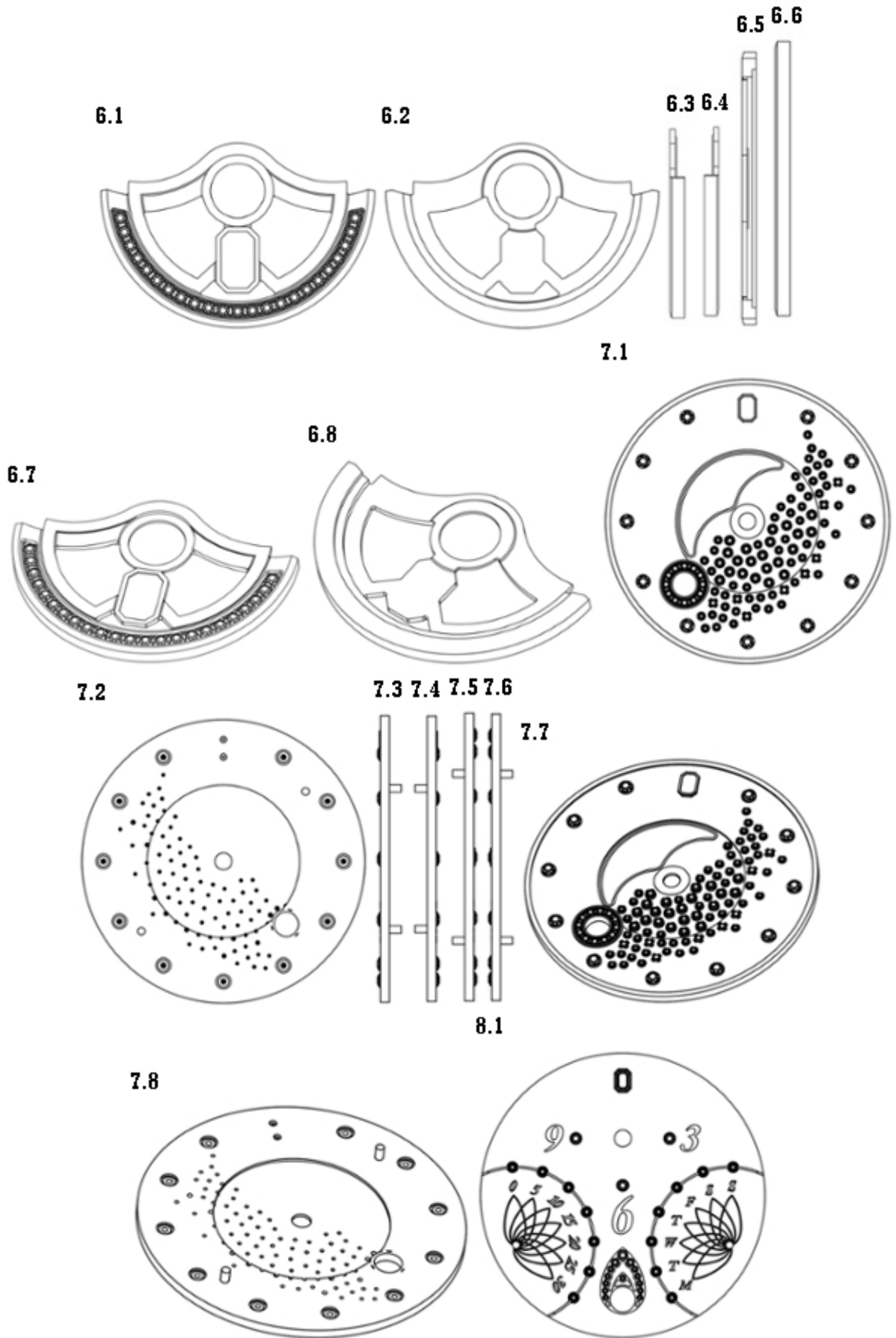

8.2

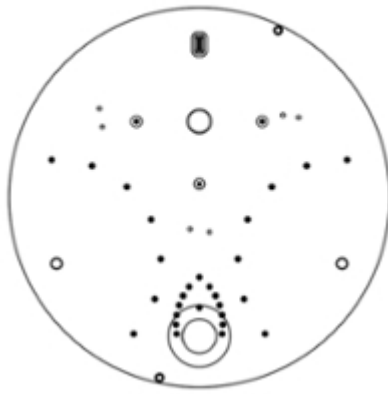

8.3 8.4 8.5 8.6

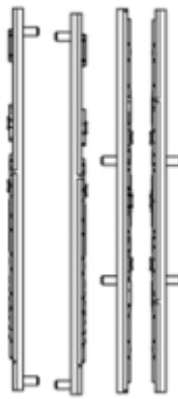

8.7

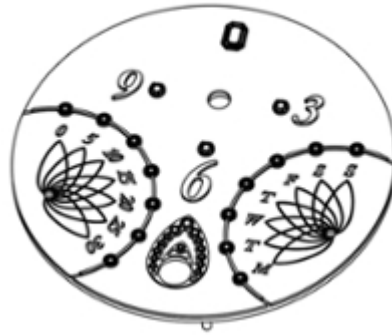

9.1

9.2

8.8

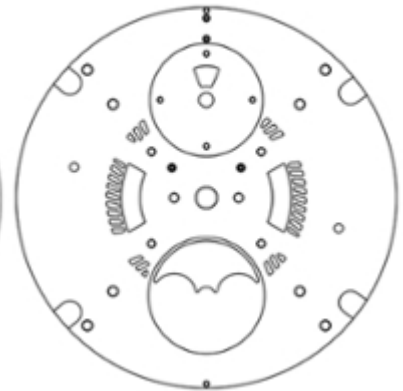

9.3 9.4 9.5 9.6

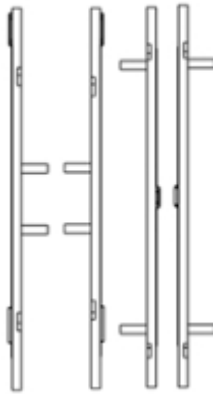

9.7



9.8

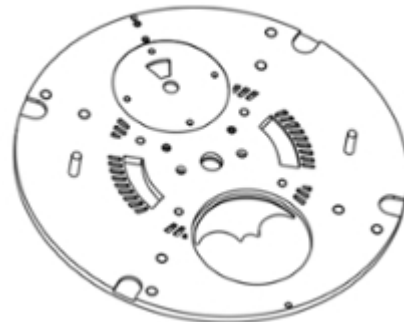

10.5 10.6

10.1



10.2



10.3 10.4



10.7



10.8



11.1

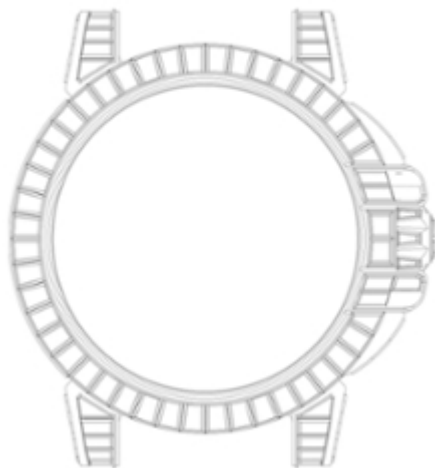

11.2



11.3

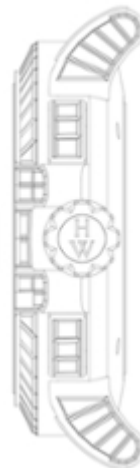

11.4



11.5



11.6



11.7



11.8

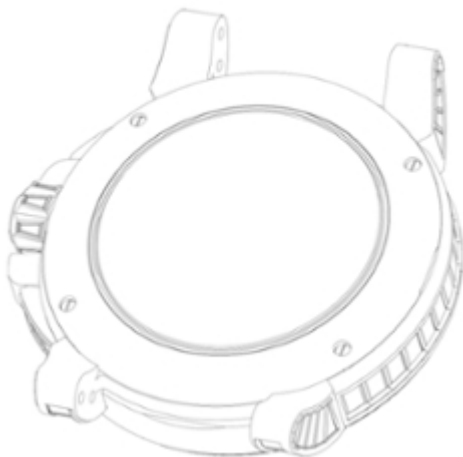

12.1

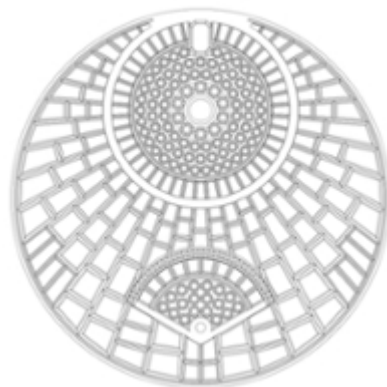

12.2



12.3 12.4 12.5 12.6



12.7

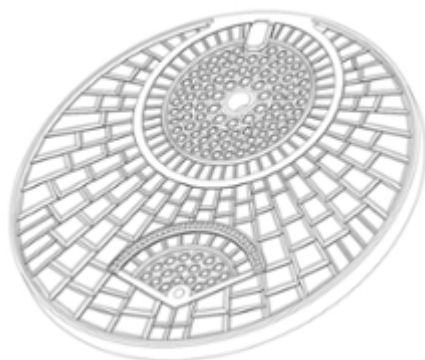

12.8



13.1



13.2

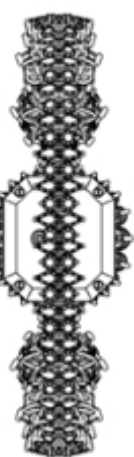

13.3



13.4



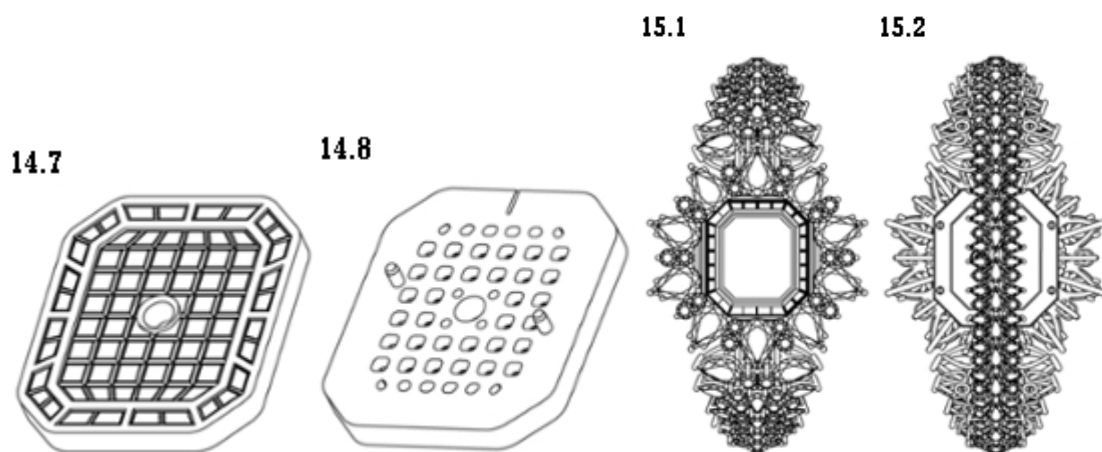
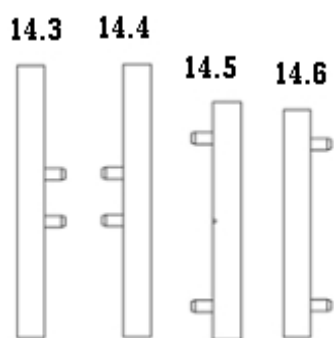
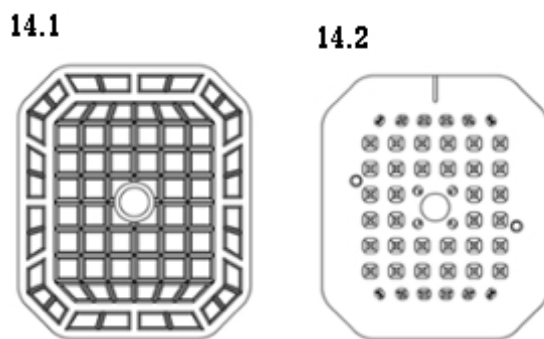

15.3



15.4



15.5



15.6



15.7



15.8

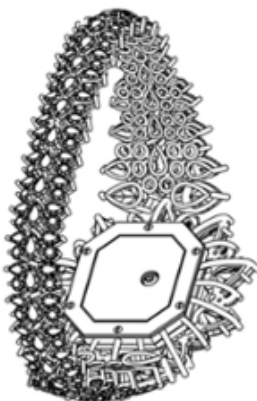

16.1

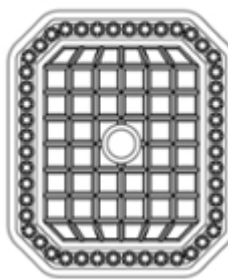

16.2

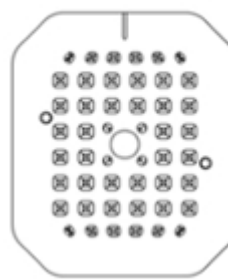

16.3 16.4

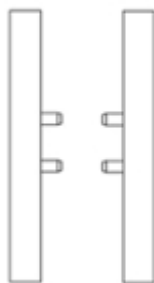

16.5 16.6

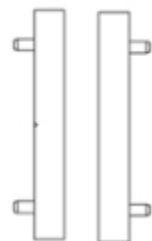

16.7

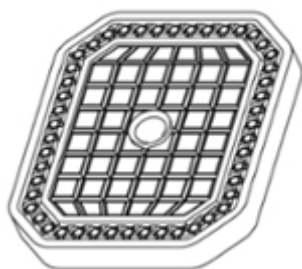

16.8

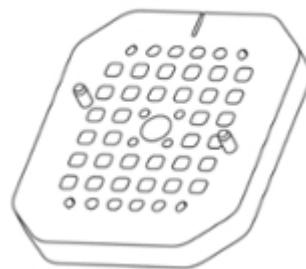

(11) DM/102275

(15) 2018 07 17

(22) 2018 07 17

(28) 2

(73) VALENTINO S.P.A.

Via Turati, 16/18, I-20121 MILANO (IT)

(85) –

(86) EM, IT

(87) EM, IT

(88) EM, IT

(89) EM

(81) III. AZ, EM, GE, JP, KG, KR, RU, TJ, TR, UA

(72) SASSI Stefano

c/o VALENTINO S.p.A. Via Turati, 16/18, I-20121 Milano, Italy

(54) 1.-2. Shoes

(55)

(51) 02-04

(45) 2018/33 (2018 08 24)

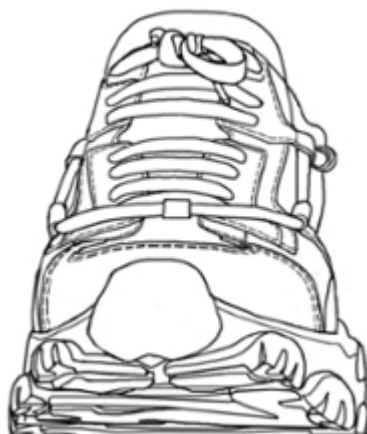
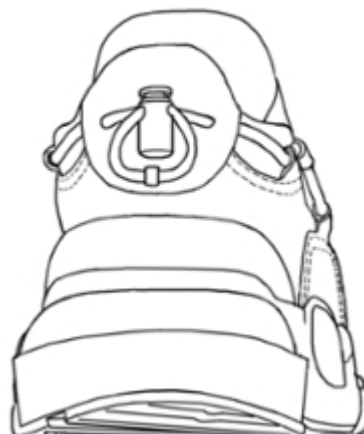
1.1**1.2****1.3**

1.4

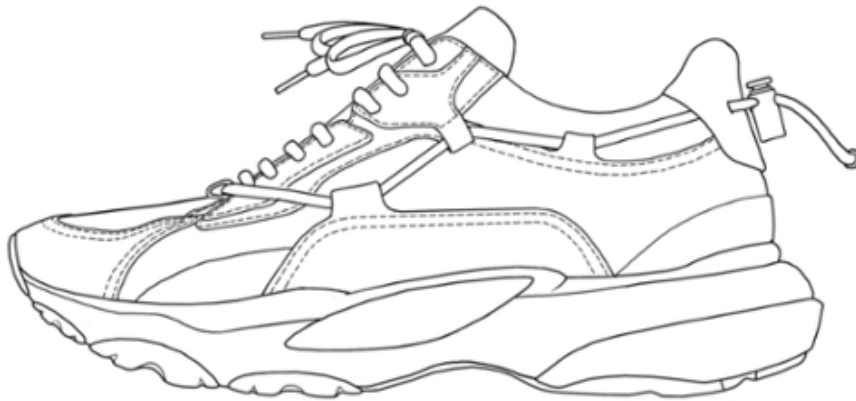

1.5

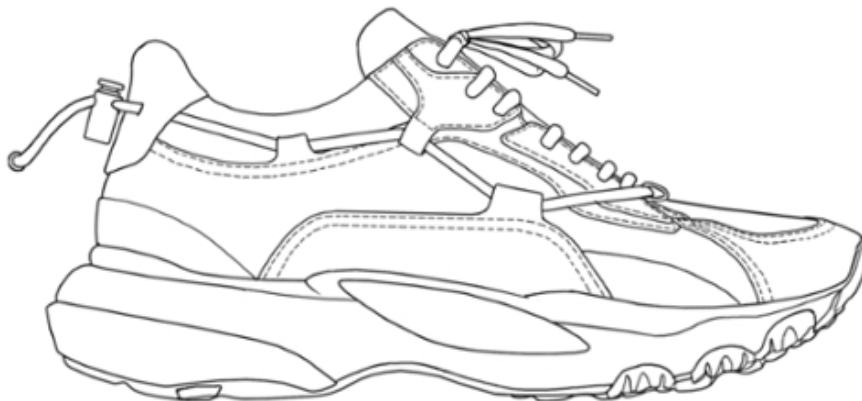

1.6

1.7

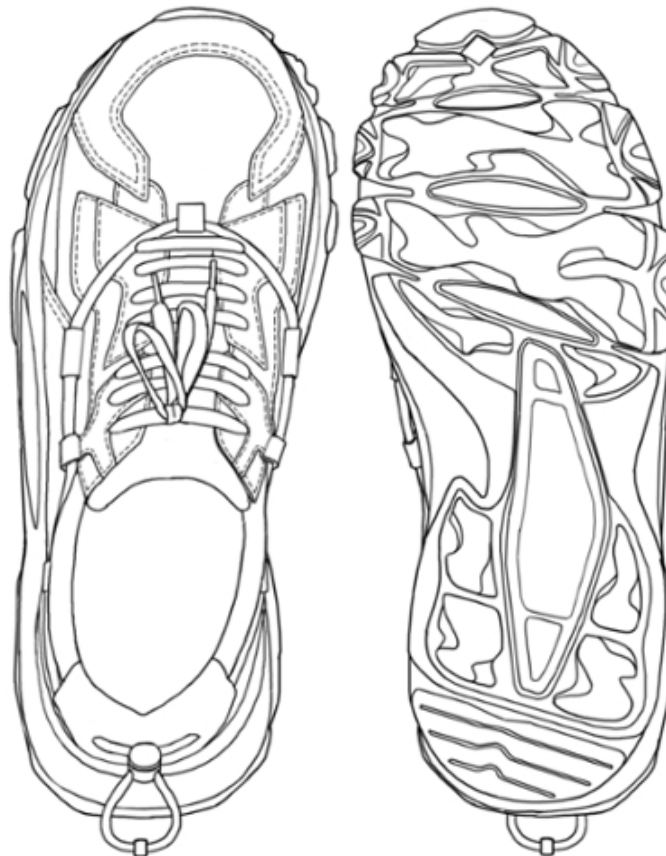

2.1



2.2



2.3



2.4



2.5



2.6

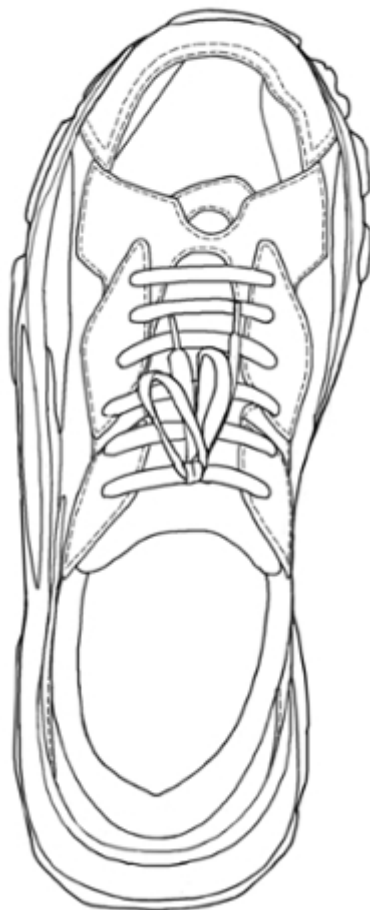

2.7



(11) DM/102389

(51) 09-03

(15) 2017 10 08

(45) 2018/34 (2018 08 31)

(22) 2017 10 08

(28) 10

(73) EVELINE COSMETICS BRAND CONCEPT DEVELOPMENT SP. Z O.O.

ul. Wierzbowa nr 18, PL-90-245 Łódź (PL)

(85) –

(86) –

(87) –

(88) PL, EM (89) PL

(81) III. AZ, BA, BG, GE, HR, KG, ME, RS, UA

(72) EVELINE COSMETICS BRAND CONCEPT DEVELOPMENT sp. z o.o.

ul. Wierzbowa, nr 18, 90-245 Łódź, Poland

(54) 1.-10. Graphic designs for packaging

(55)



1



2



3



4



5



6



7



8



9



10

TRADEMARKS

APPLICATIONS FILED UNDER THE NATIONAL PROCEDURE APPROVED FOR REGISTRATION

The decision can be appealed at the Chamber of Appeal of Sakpatenti within 3 months from the publication or at the Mtskheta District Court Administrative Cases Board (Address: №17, Samkhedro St., Mtskheta), within 1 month following the publication.

(260) AM 2018 87187 A**
(210) AM 87187
(220) 2016 05 05
(731) E. I. DU PONT DE NEMOURS AND
COMPANY
Chestnut Run Plaza, 974 Centre Road,
Wilmington, DE 19805, USA
(740) Tamaz Shilakadze
(540)

ლანატი

(511) 5

(260) AM 2018 87189 A**
(210) AM 87189
(220) 2016 05 05
(731) E. I. DU PONT DE NEMOURS AND
COMPANY
Chestnut Run Plaza, 974 Centre Road,
Wilmington, DE 19805, USA
(740) Tamaz Shilakadze
(540)

Ланнат

(511) 5

(260) AM 2018 92380 A
(210) AM 92380
(220) 2017 05 25
(731) INPHA LLP Representative Office in Georgia
Besikis q. 4 (nakveti 46/10), 0108, Tbilisi,
Georgia
(740) Keso Anteladze
(540)

ნორმოკიდ ფიტო

Нормокид фито

Normokid Phyto

(511) 5

(260) AM 2018 92452 A*
(210) AM 92452
(220) 2017 05 30

(731) BAHLSEN GMBH & CO. KG
Podbielskistrasse 11, 30163 Hannover,
Germany
(740) Pavle Meipariani
(540)



(591) Yellow, red, green, blue, white
(531) 26.04.18; 27.05.02; 27.05.22; 29.01.15
(511) 30

(260) AM 2018 92994 A
(210) AM 92994
(220) 2017 06 26
(731) LTD "GMP"
Sop. Ponitchala 65, 0165, Tbilisi, Georgia
(740) Nugzar Ksovreli
(540)

სავექსილო
САВЕКСИЛ
SAVEXIL

(511) 5

(260) AM 2018 93532 A
(210) AM 93532
(220) 2017 07 27
(731) LTD "VINIKO"
Kuchishvilis q. 9, b. 24, 0179, Tbilisi, Georgia
(540)

შატო გრემი
Château Gremi
Chato Gremi
Schato Gremi
Шато Грeми

(591) Black, white

(526) გრემი Gremi Грeми
(511) 29, 30, 32, 35, 43

(260) AM 2018 93707 A
(210) AM 93707
(220) 2018 02 20
(731) LTD "GURME"
Z. Paliashvilis q. 53, 0169, Tbilisi, Georgia
(540)

გრემე

(591) Black, white
(511) 43

(260) AM 2018 94716 A
(210) AM 94716
(220) 2017 10 20
(731) THE GEORGE BALANCHINE TRUST
20 Lincoln Center, New York, New York
10023, USA
(740) Giorgi Taktakishvili
(540)

BALANCHINE

(591) Black, white
(511) 41, 45

(260) AM 2018 94928 A
(210) AM 94928
(220) 2017 11 06
(731) ARTUR KARTSHIKYAN
5a, Arami Str., 375002, Yerevan, Armenia
(740) Mariana Restakyan
(540)



(591) Blue, white
(531) 01.01.09; 26.01.01; 26.01.03; 26.01.20;
26.01.24; 27.05.01; 27.05.10; 27.05.24;
29.01.12
(526) Tbilisi
(511) 35, 41

(260) AM 2018 95172 A
(210) AM 95172
(220) 2017 11 22

(731) LTD "GEORGIAN WINE HOUSE"
S. Zegaani, 1514, Gurjaani, Georgia
(740) Sopio Vacheishvili
(540)

Legends of Kakheti

(526) Kakheti
(511) 33

(260) AM 2018 95173 A
(210) AM 95173
(220) 2017 11 22
(731) LTD "GEORGIAN WINE HOUSE"
S. Zegaani, 1514, Gurjaani, Georgia
(740) Sopio Vacheishvili
(540)

Легенды Кахети

(526) Кахети
(511) 33

(260) AM 2018 95360 A
(210) AM 95360
(220) 2017 12 05
(731) MCDONALD'S INTERNATIONAL
PROPERTY COMPANY, LTD.
110 North Carpenter Street, Chicago, Illinois,
60607, USA
(740) Shalva Gvaramadze
(540)

HAPPY STUDIO

(591) Black, white
(511) 9, 41

(260) AM 2018 95408 A
(210) AM 95408
(220) 2017 12 07
(731) THE GEORGE BALANCHINE TRUST
20 Lincoln Center, New York, New York
10023, USA
(740) Giorgi Taktakishvili
(540)

БАЛАНЧИН

(591) Black, white
(511) 41, 45

(260) AM 2018 96167 A
(210) AM 96167
(220) 2018 01 31
(731) LTD "LASARE"
Aeroportis mimdebare teritoria, 0158, Tbilisi,
Georgia

(540)



(591) Red, blue

(531) 26.02.01; 26.02.03; 27.01.01; 27.01.09;
29.01.12(511) 1, 2, 3, 4, 5, 6, 7, 8, 9, 10, 11, 12, 11, 12, 13,
14, 15, 16, 17, 18, 19, 20, 21, 22, 23, 24, 25,
26, 27, 28, 29, 30, 31, 32, 34, 35, 36, 37, 38,
39, 40, 41, 42, 43, 44, 45

(260) AM 2018 96168 A

(210) AM 96168

(220) 2018 01 31

(731) LTD "LASARE"

Aeroportis mimdebare teritoria, 0158, Tbilisi,
Georgia

(540)



(591) Red, blue

(531) 26.02.01; 26.02.03; 27.01.09; 27.05.17;
29.01.12(511) 1, 2, 3, 4, 5, 6, 7, 8, 9, 10, 11, 12, 11, 12, 13,
14, 15, 16, 17, 18, 19, 20, 21, 22, 23, 24, 25,
26, 27, 28, 29, 30, 31, 32, 34, 35, 36, 37, 38,
39, 40, 41, 42, 43, 44, 45

(260) AM 2018 96679 A

(210) AM 96679

(220) 2018 03 06

(731) LTD "KUKU STAR"

Romanoz Khomlelis q., korp. 7, b. 89, 0182,
Tbilisi, Georgia

(740) Giorgi Taktakishvili

(540)

KUKU STAR**კუკუ სტარ****КУКУ СТАР**

(591) Black, white

(511) 14, 18, 25

(260) AM 2018 96709 A

(210) AM 96709

(220) 2018 03 08

(731) NOVARTIS AG

4002 Basel, Switzerland

(740) Pavle Meipariani

(540)

Экзоролфин

(591) Black, white

(511) 5

(260) AM 2018 96710 A

(210) AM 96710

(220) 2018 03 08

(731) DECIEM BEAUTY GROUP INC.

517 Richmond Street East, Toronto, Ontario
M5A 1R4, Canada

(740) Pavle Meipariani

(540)

DECIEM

(591) Black, white

(511) 3, 35

(260) AM 2018 96732 A

(210) AM 96732

(220) 2018 03 09

(731) LTD "AVERSI- PHARMA"

Davit Aghmasheneblis qamz. 148/2, 0112,
Tbilisi, Georgia

(540)

აპიჯელი**Апиджели****Apijelly**

(591) Black, white

(511) 5

(260) AM 2018 96733 A

(210) AM 96733

(220) 2018 03 09

(731) ENERGIZER BRANDS II LLC

533 Maryville University Drive, St. Louis,
Missouri 63141, USA

(740) Giorgi Meipariani

(540)

CALIFORNIA SCENTS

(591) Black, white

(511) 3

(260) AM 2018 96734 A

(210) AM 96734

(220) 2018 03 09

(731) ENERGIZER BRANDS II LLC

533 Maryville University Drive, St. Louis,
Missouri 63141, USA

(740) Giorgi Meipariani
(540)

CALIFORNIA SCENTS

(591) Black, white
(511) 5

(260) AM 2018 96763 A
(210) AM 96763
(220) 2018 03 12

(731) MONSTER ENERGY COMPANY
a Delaware corporation
1 Monster Way, Corona, California 92879,
USA

(740) Shalva Gvaramadze
(540)

UNLEASH THE ULTRA BEAST!

(511) 32

(260) AM 2018 96764 A
(210) AM 96764
(220) 2018 03 12

(731) HANKOOK TIRE CO., LTD
133, Teheran-ro (Yeoksam-dong), Gangnam-gu,
Seoul, Republic of Korea

(740) Merab Kvimsadze
(540)

Technodome

(591) Black, white
(531) 27.05.10
(511) 36, 42

(260) AM 2018 96766 A
(210) AM 96766
(220) 2018 03 12

(731) HANKOOK TIRE CO., LTD
133, Teheran-ro (Yeoksam-dong), Gangnam-gu,
Seoul, Republic of Korea

(740) Merab Kvimsadze
(540)

Technotrac

(591) Black, white
(531) 27.05.10
(511) 36, 42

(260) AM 2018 96767 A
(210) AM 96767
(220) 2018 03 12

(731) MONSTER ENERGY COMPANY
a Delaware corporation

1 Monster Way, Corona, California 92879,
USA

(740) Shalva Gvaramadze
(540)

MONSTER ENERGY ULTRA

(591) Black, white
(511) 32

(260) AM 2018 96770 A
(210) AM 96770
(220) 2018 03 12

(731) HANKOOK TIRE CO., LTD
133, Teheran-ro (Yeoksam-dong), Gangnam-gu,
Seoul, Republic of Korea

(740) Merab Kvimsadze
(540)

Technoring

(591) Black-white
(531) 27.05.10
(511) 36, 42,

(260) AM 2018 96810 A
(210) AM 96810
(220) 2018 03 14

(731) LTD "TIFLIS TEXTILE"
Gr. Lortkipanidzis g. 81a, 0145, Tbilisi,
Georgia

(540)



TIFLISTEX
თიფლისთექსტი

(591) Black, white
(531) 26.13.25; 27.05.01; 28.19
(511) 25

(260) AM 2018 96811 A
(210) AM 96811
(220) 2018 03 14

(731) LTD "AEROSOFT"
Davit Aghmasheneblis gamz. 124, 0102,
Tbilisi, Georgia

(540)

ძობა

(591) Black, white
(511) 9

(260) AM 2018 96817 A
(210) AM 96817
(220) 2018 03 14
(731) DECIEM BEAUTY GROUP INC.
517 Richmond Strit Isti, Toronto, Ontario
M5A 1R4, Canada
(740) Pavle Meipariani
(540)

THE ABNORMAL BEAUTY COMPANY

(591) Black, white
(511) 3, 35

(260) AM 2018 96841 A
(210) AM 96841
(220) 2018 03 15
(731) ABBOTT POINT OF CARE INC.
(a corporation of the State of Delaware)
400 College Road East, New Jersey,
Princeton, 08540, USA
(740) Tamar Kochlamazashvili
(540)

TNI-NX

(591) Black, white
(511) 1

(260) AM 2018 96863 A
(210) AM 96863
(220) 2018 03 15
(731) LEVAN TORADZE
Chubinishvilis q.9/51, 0112, Tbilisi, Georgia
(540)



(591) Black, white
(531) 02.07.15; 02.07.19; 02.07.21; 02.07.23;
27.05.10
(511) 43

(260) AM 2018 96867 A
(210) AM 96867
(220) 2018 03 16
(731) JSC Insurance Company "PRIME"
Al. Kazbegis Gamz. 32a, sad. I, sart. 2,

Komerциული Parti 8, 0177, Tbilisi, Georgia
(740) Nina Javakhishvili
(540)

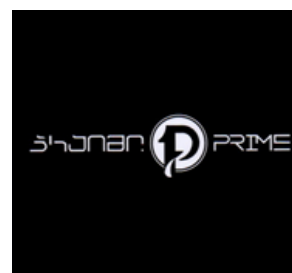

(591) Black, white
(531) 26.01.01; 26.01.03; 26.01.18; 26.01.19;
26.04.10; 26.04.24; 27.05.01; 27.05.21;
27.05.24
(511) 36

(260) AM 2018 96868 A
(210) AM 96868
(220) 2018 03 16
(731) GOLDEN LEAF (MACAU) TOBACCO'S
MANUFACTURING LIMITED
Rua Dos Pesquadores, N66, Bloqo II , 30andar-a,
Makao, Macao
(740) Shalva Gvaramadze
(540)



(591) Black, white
(531) 07.01.16; 27.03.15; 27.05.08
(511) 34

(260) AM 2018 96886 A
(210) AM 96886
(220) 2018 03 16
(731) Bosnalijeki D.d., Farmaceutikal End
Qemikal Industri, Joint Stok Kompani
71000 Sarajevo, Jukićeva 53, Bosnia and
Herzegovina
(740) Giorgi Kankava
(540)

BRONCHOBOS

(591) Black, white
(511) 5

(260) AM 2018 96887 A
(210) AM 96887
(220) 2018 03 16
(731) Bosnalijeki D.d., Farmaceutikal End
Qemikal Industri, Joint Stok Kompani
71000 Sarajevo, Jukićeva 53, Bosnia and
Herzegovina

(740) Giorgi Kankava
(540)

PHARYNGAL

(591) Black, white
(511) 5

(260) AM 2018 96888 A
(210) AM 96888
(220) 2018 03 16
(731) Bosnalijeki D.d., Farmaceutikal End
Qemikal Industri, Joint Stok Kompani
71000 Sarajevo, Jukićeva 53, Bosnia and
Herzegovina

(740) Giorgi Kankava
(540)

STOMATIDIN

(591) Black, white
(511) 5

(260) AM 2018 96889 A
(210) AM 96889
(220) 2018 03 19
(731) LTD "BORUN LIGHT"
Marneulis q. 44, Kvemo Ponitchala, 0165,
Tbilisi, Georgia

(540)

Ledex

(591) Black, white
(511) 11

(260) AM 2018 96905 A
(210) AM 96905
(220) 2018 03 20
(731) AL-ZAID IND. & COMM INVESTMENTS
CO. LTD
King Abdullah II Industrial Estate, Sahab,
Jordan

(740) Merab Kvimsadze
(540)

سینٹ
SCENT

(591) Black, white
(531) 27.05.01; 28.01
(511) 34

(260) AM 2018 96916 A
(210) AM 96916
(220) 2018 03 20
(731) LTD "AGRONOM"
L. Gotuas q. 12a, 0160, Tbilisi, Georgia

(540)

SHYAMCHEM

Shyam Chemicals Pvt. Ltd.

(591) Black, white
(531) 27.05.10
(511) 5

(260) AM 2018 96919 A
(210) AM 96919
(220) 2018 03 20
(731) GULBAHAR TOBACCO
INTERNATIONAL FZE
P.O. Box 61401, Jebel Ali Free Zone, Dubai,
United Arab Emirates
(740) Giorgi Meipariani
(540)

mond

(591) Black, white
(531) 27.05.01
(511) 34

(260) AM 2018 96971 A
(210) AM 96971
(220) 2018 03 21
(731) VISTROS INTL-F.Z.E
Makateb Biznes Senters, ofis №26, Al Shorafa
Kompleqs, Sh Khalifa Bin Zaied Roud, P.o.
Boqs 380, Ajmani, United Arab Emirates
(740) Merab Kvimsadze
(540)



(591) Black, white
(531) 03.07.01; 03.07.02; 24.01.15; 24.01.17;
24.01.18; 25.01.01

(511) 34

(260) AM 2018 96974 A
 (210) AM 96974
 (220) 2018 03 21
 (731) LTD "LIGA+"
 Golovinis q.19, Isnis r-ni, 0103, Tbilisi,
 Georgia
 (740) Nino Bakhtadze
 (540)



(591) Black, white, red
 (531) 02.03.01; 26.01.05; 26.01.14; 26.04.06;
 27.05.01; 28.19; 29.01.13
 (511) 30

(260) AM 2018 96975 A
 (210) AM 96975
 (220) 2018 03 21
 (731) LTD "LIGA+"
 Golovinis q.19, Isnis r-ni, 0103, Tbilisi,
 Georgia
 (740) Nino Bakhtadze
 (540)



(591) Black, white, red, brown
 (531) 02.03.01; 19.03.24; 26.01.01; 26.01.05;
 26.01.14; 26.04.06; 28.19; 29.01.15
 (511) 30

(260) AM 2018 96976 A
 (210) AM 96976
 (220) 2018 03 22
 (731) SANRIO COMPANY, LTD.
 1-6-1 Osaki, Shinagawa-ku, Tokyo, Japan
 (740) Giorgi Taktakishvili

(540)

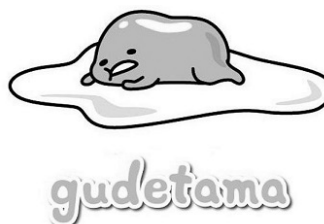

(591) Black, white
 (531) 04.05.12; 27.05.01; 27.05.02
 (511) 3, 9, 14, 16, 18, 20, 21, 25, 28, 30, 32, 41, 42, 43

(260) AM 2018 97001 A
 (210) AM 97001
 (220) 2018 03 23
 (731) LTD "TRAVEL TO GEORGIA 2010"
 Z. Paliashvilis q.10/Barnovis q. 83a, b. 8,
 Tbilisi, Georgia
 (740) Tamar Kharazishvili
 (540)

Let's start Batuming

(591) Black, white
 (511) 36, 37, 39, 43

(260) AM 2018 97003 A
 (210) AM 97003
 (220) 2018 03 26
 (731) LTD "BORAN LIGHT"
 Marneulis q. 44, Kvemo Ponitchala, Tbilisi,
 Georgia
 (540)

LINUS

(591) Black, white
 (511) 1, 2, 3, 4, 5, 6, 7, 8, 9, 10, 12, 13, 14, 15, 16, 17,
 18, 19, 20, 21, 22, 23, 24, 25, 26, 27, 28, 29,
 30, 31, 32, 33, 34, 35, 36, 37, 38, 39, 40, 41,
 42, 43, 44, 45

(260) AM 2018 97005 A
 (210) AM 97005
 (220) 2018 03 26
 (731) LTD "MOBIVEI"
 I. Chavchavadzis q. 67, 4600, Kutaisi, Georgia
 (540)



(591) Orange, sky-blue, lilac
 (531) 27.05.01; 27.05.22; 28.19; 29.01.13
 (511) 35

(260) AM 2018 97013 A
 (210) AM 97013
 (220) 2018 03 27
 (731) CILAG GMBH INTERNATIONAL
 Gubelstrasse 34, CH-6300, Zug, Switzerland
 (740) Giorgi Taktakishvili
 (540)



(591) Black, white
 (531) 01.13.15; 01.15.15; 05.07.12; 05.07.22;
 05.13.01; 27.05.10; 28.05
 (511) 5

(260) AM 2018 97020 A
 (210) AM 97020
 (220) 2018 03 27
 (731) NEW PHARM GROUP LTD
 D. Aghmasheneblis Kheiv. XII km, korp. 2,
 b. 43, Vake-Saburtalos r-ni, 0131, Tbilisi,
 Georgia
 (540)

Sugrel
სუგრელი
Сугрел

(511) 5

(260) AM 2018 97023 A
 (210) AM 97023
 (220) 2018 03 27
 (731) NEW PHARM GROUP LTD
 D. Aghmasheneblis Kheiv. XII km, korp. 2,
 b. 43, Vake-Saburtalos r-ni, 0131, Tbilisi,
 Georgia
 (540)

ლორისპრეი
Lorispray
Лориспрей

(511) 5

(260) AM 2018 97024 A
 (210) AM 97024
 (220) 2018 03 27
 (731) JSC "LAMARIA CAPITAL"
 Sh. Nucubidzis perdobi, IV mkr., korp. 14,
 b. 25, 0183, Tbilisi, Georgia
 (540)



(591) Red, grey, blak
 (531) 24.07.01; 24.07.13; 24.07.23; 25.01.25;
 29.01.14
 (511) 36, 43

(260) AM 2018 97063 A
 (210) AM 97063
 (220) 2018 03 29
 (731) LTD "BIOPOLUS"
 Noneshvilis q. 65, 6000, Batumi, Georgia
 (740) Salome Chikovani
 (540)

КОКАВИТЕКС
COCAVITEX
კოკავიტექსი

(591) Black, white
 (511) 5

(260) AM 2018 97070 A
 (210) AM 97070
 (220) 2018 03 29
 (731) LTD "BIOPOLUS"
 Noneshvilis q. 65, 6000, Batumi, Georgia
 (740) Salome Chikovani
 (540)

ЭЛКАРОН
ELCARON
ელკარონი

(591) Black, white
 (511) 5

(260) AM 2018 97074 A
 (210) AM 97074
 (220) 2018 03 29
 (731) LTD "BIOPOLUS"
 Noneshvilis q. 65, 6000, Batumi, Georgia

(740) Salome Chikovani
(540)

DUOTAM
DUOTAM
დუოტამი

(591) Black, white
(511) 5

(260) AM 2018 97164 A
(210) AM 97164
(220) 2018 03 30
(731) BEIJING XIAOXIYANG TECHNOLOGY DEVELOPMENT CO., LTD.
1-27, HUOXING 3RD ST., SOUTH AREA, TONGZHOU ECONOMIC & TECHNOLOGICAL DEVELOPMENT ZONE, BEIJING, China
(740) Giorgi Taktakishvili
(540)

ZULIZA 

(591) Black, white
(531) 02.01.16; 26.03.14; 26.03.24; 27.05.01
(511) 24, 26, 39, 40

(260) AM 2018 97165 A
(210) AM 97165
(220) 2018 03 30
(731) SMYK GLOBAL ASSETS GMBH
Schwanengasse 5/7, 3011 Berne, Switzerland
(740) Giorgi Taktakishvili
(540)



(591) White, red
(531) 25.01.10; 26.04.04; 26.04.24; 28.19; 29.01.12
(511) 25, 26, 35

(260) AM 2018 97193 A
(210) AM 97193
(220) 2018 04 09
(731) NOVARTIS AG
4002 Basel, Switzerland
(740) Pavle Meipariani
(540)

DUTACOMP

(591) Black, white
(511) 5

(260) AM 2018 97195 A
(210) AM 97195
(220) 2018 04 10
(731) Obshchestvo S Ogranichennoi Otvetstvennostiu "IUNISET-M"
129344, Moskovi, Iskris q. d. 31, str. 5, Russian Federation
(740) Givi Akopashvili
(540)

ჩანჩქერი

ЧАНЧКЭРИ

CHANCHQERI

(591) Black, white
(511) 33

(260) AM 2018 97197 A
(210) AM 97197
(220) 2018 04 10
(731) MARSA YAÐ SANAYÝ VE TÝCARET ANONYM ÞYRKETÝ
Ramazanoglu Mah. Mahmut Bairam Jad. – No: 9 Sheihli 34758 Fendiq, Stamboli, Turkey
(740) Tamaz Shilakadze
(540)

BUTTER DREAMS

(591) Black, white
(511) 29

(260) AM 2018 97216 A
(210) AM 97216
(220) 2018 04 11
(731) MONSTER ENERGY COMPANY
a Delaware corporation
1 Monster Uei, Korona, Kaliforniis Shtati 92879, USA
(740) Shalva Gvaramadze

(540)

RULE YOUR KINGDOM!

(591) Black, white

(511) 32

(260) AM 2018 97226 A

(210) AM 97226

(220) 2018 04 13

(731) LTD "NAIL CLUB"

Atskuris q. 3b, b. 23, 0144, Tbilisi, Georgia

(540)

Nail Club

(591) White, grey

(531) 27.05.01; 27.05.19

(511) 44

(260) AM 2018 97233 A

(210) AM 97233

(220) 2018 04 16

(731) BIOCON LIMITED

20 K.m., Hosur Roud, Elektronik Siti P.o.,
Bangalori, 560100, India

(740) Merab Kvimsadze

(540)

CANHERA

(591) Black, white

(531) 27.05.01

(511) 5

(260) AM 2018 97369 A

(210) AM 97369

(220) 2018 04 19

(731) THE BABCOCK & WILCOX
COMPANY20 S. Van Buren Aveniu, Barbertoni, Ohaio,
44203, USA

(740) Tamaz Shilakadze

(540)

B&W

(591) Black, white

(511) 11, 37, 42

(260) AM 2018 97371 A

(210) AM 97371

(220) 2018 04 19

(731) LTD "MEGA MOL"

Lilos Dasak. kvart. V, korp. 2, b. 108, Tbilisi,
Georgia

(740) Tamar Lomashvili

(540)

MEGAMALL 

(591) Red, black, white

(531) 20.05.15; 26.05.18; 27.05.01; 27.05.21;

29.01.13

(511) 35

REGISTERED TRADEMARKS

(111) M 2018 30333 R
(151) 23 10 2018
(181) 23 10 2028
(260) AM 2017 92481 A
(220) 30 05 2017

(732) BAGI PROFESSIONAL PRODUCTS LTD
194 Derech Acco St'27000 KIRIAT BIALIK,
Israel

(111) M 2018 30334 R
(151) 23 10 2018
(181) 23 10 2028
(260) AM 2017 92586 A
(220) 06 06 2017

(732) LTD "VIVO MEDICAL GROUP"
Lublianas q. 5, 0159, Tbilisi, Georgia

(111) M 2018 30335 R
(151) 23 10 2018
(181) 23 10 2028
(260) AM 2017 93054 A
(220) 28 06 2017

(732) Al-Mawared Natural Beauty Products
Corporation (A Jordanian Company)
Ofise 601, 6th Floor, 193, Khalid Bin Walid
St., Jabal Hussien Area, P.O. Box 921417,
Amman 11192, Jordan

(111) M 2018 30336 R
(151) 23 10 2018
(181) 23 10 2028
(260) AM 2017 93531 A
(220) 27 07 2017

(732) LTD "VINIKO"
Kuchishvilis q. 9, b. 24, 0179, Tbilisi, Georgia

(111) M 2018 30337 R
(151) 23 10 2018
(181) 23 10 2028
(260) AM 2017 93556 A
(220) 31 07 2017

(732) LTD "URBAN GREENS"
Nino Zhvanias q. 2, 0179, Tbilisi, Georgia

(111) M 2018 30338 R
(151) 23 10 2018
(181) 23 10 2028
(260) AM 2017 93834 A
(220) 21 08 2017

(732) LTD "ALLIANSE"
Kobaladzis q. 2, 6004, Batumi, Georgia

(111) M 2018 30339 R
(151) 23 10 2018
(181) 23 10 2028
(260) AM 2017 93835 A
(220) 21 08 2017

(732) LTD "ALLIANSE"
Kobaladzis q. 2, 6004, Batumi, Georgia

(111) M 2018 30340 R
(151) 23 10 2018
(181) 23 10 2028
(260) AM 2017 93836 A
(220) 21 08 2017

(732) LTD "ALLIANSE"
Kobaladzis q. 2, 6004, Batumi, Georgia

(111) M 2018 30341 R
(151) 23 10 2018
(181) 23 10 2028
(260) AM 2017 94547 A
(220) 10 10 2017

(732) LTD "TRADE IMPEX"
Dadianis q. 261/30, 0180, Tbilisi, Georgia

(111) M 2018 30342 R
(151) 23 10 2018
(181) 23 10 2028
(260) AM 2017 94577 A
(220) 12 10 2017

(732) BEAM SUNTORY UK LIMITED
2 Longuok Roudi, Stokli Parki, Aqsbriji,
Midlseqs, UB11 1BA, England, United
Kingdom

(111) M 2018 30343 R
(151) 23 10 2018
(181) 23 10 2028
(260) AM 2017 94926 A
(220) 03 11 2017

(732) LTD "OXYGEN"
Vazha Pshavelas gamz. , kvart. III, korp. 21
b. 1, 0186, Tbilisi, Georgia

(111) M 2018 30344 R
(151) 23 10 2018
(181) 23 10 2028
(260) AM 2017 95066 A
(220) 14 11 2017

(732) LTD "OXYGEN"
Vazha Pshavelas gamz. , kvart. III, korp. 21
b. 1, 0186, Tbilisi, Georgia

(111) M 2018 30345 R
(151) 23 10 2018
(181) 23 10 2028
(260) AM 2017 95346 A
(220) 04 12 2017
(732) LTD "GMP"
Sop. Ponitchala 65, 0165, Tbilisi, Georgia

(111) M 2018 30346 R
(151) 23 10 2018
(181) 23 10 2028
(260) AM 2017 95347 A
(220) 04 12 2017
(732) LTD "GMP"
Sop. Ponitchala 65, 0165, Tbilisi, Georgia

(111) M 2018 30347 R
(151) 23 10 2018
(181) 23 10 2028
(260) AM 2017 95348 A
(220) 04 12 2017
(732) LTD "GMP"
Sop. Ponitchala 65, 0165, Tbilisi, Georgia

(111) M 2018 30348 R
(151) 23 10 2018
(181) 23 10 2028
(260) AM 2017 95349 A
(220) 04 12 2017
(732) LTD "GMP"
Sop. Ponitchala 65, 0165, Tbilisi, Georgia

(111) M 2018 30349 R
(151) 23 10 2018
(181) 23 10 2028
(260) AM 2017 95350 A
(220) 04 12 2017
(732) LTD "GMP"
Sop. Ponitchala 65, 0165, Tbilisi, Georgia

(111) M 2018 30350 R
(151) 23 10 2018
(181) 23 10 2028
(260) AM 2017 95352 A
(220) 04 12 2017
(732) LTD "GMP"
Sop. Ponitchala 65, 0165, Tbilisi, Georgia

(111) M 2018 30351 R
(151) 23 10 2018
(181) 23 10 2028
(260) AM 2017 95554 A
(220) 18 12 2017

(732) LTD "AGROHAB"
Krtsanisis q. 8, korp. 2, b. 23, 0114, Tbilisi,
Georgia

(111) M 2018 30352 R
(151) 24 10 2018
(181) 24 10 2028
(260) AM 2017 90882 A
(220) 17 02 2017
(732) LTD "DI +"
Gldani-Nadzaladevis r-ni, m/r 8, korp. 17,
b. 46, Tbilisi, Georgia

(111) M 2018 30353 R
(151) 24 10 2018
(181) 24 10 2028
(260) AM 2017 92050 A
(220) 08 05 2017
(732) LTD "OSSO +"
Gldanis masivi, VII m/r, korp.17b, shenoba 6,
Gldani-Nadzaladevis r-ni, 0107, Tbilisi, Georgia

TRADEMARKS REGISTERED ACCORDING TO THE ACCELERATED PROCEDURE

The decision can be appealed at the Chamber of Appeal of Sakpatenti within 3 months from the publication.

(111) M 2018 30354 R
 (151) 24 10 2018
 (181) 24 10 2028
 (210) AM 99646
 (220) 29 09 2018
 (732) LTD "K-MOTORS"
 Kindzmaraulis q.7, Tbilisi, Georgia
 (740) Giorgi Amiranashvili
 (540)



(591) Orange, black, white
 (531) 26.03.23; 26.04.11; 26.04.24; 27.05.01;
 27.05.21; 29.01.13
 (511) 37

(111) M 2018 30355 R
 (151) 24 10 2018
 (181) 24 10 2028
 (210) AM 99647
 (220) 29 09 2018
 (732) LTD "K-MOTORSI"
 Kindzmaraulis q. 7, Tbilisi, Georgia
 (740) Giorgi Amiranashvili
 (540)



(591) Red, orange, black, white, yellow
 (531) 26.04.09; 26.11.12; 27.05.10; 29.01.14
 (511) 4, 12

(111) M 2018 30356 R
 (151) 24 10 2018
 (181) 24 10 2028

(210) AM 99648
 (220) 29 09 2018
 (732) LTD "K-MOTORS"
 Kindzmaraulis q.7, Tbilisi, Georgia
 (740) Giorgi Amiranashvili
 (540)



(591) Orange, black, white
 (531) 26.03.23; 26.04.11; 26.04.18; 26.04.22;
 26.04.24; 27.05.01; 29.01.13
 (511) 12

(111) M 2018 30357 R
 (151) 26 10 2018
 (181) 26 10 2028
 (210) AM 97998
 (220) 11 06 2018
 (732) WOLT ENTERPRISES OY
 Köydenpunojankatu 2a "D", 00180 Helsinki,
 Finland
 (740) Natalia Babakishvili
 (540)



(591) Blue
 (531) 27.05.01; 27.05.19; 29.01.04
 (511) 9, 41, 42

(111) M 2018 30358 R
 (151) 26 10 2018
 (181) 26 10 2028
 (210) AM 99866
 (220) 15 10 2018
 (732) LTD "LEDO"

Varketili 3, III mkr., korp. 312, Isani-Samgoris
r-ni, 0163, Tbilisi, Georgia

(540)



(591) Black, yellow

(531) 02.09.01; 03.13.04; 03.13.24; 27.05.01; 28.19;
29.01.12

(511) 5

(111) M 2018 30359 R

(151) 26 10 2018

(181) 26 10 2028

(210) AM 99781

(220) 11 10 2018

(732) JSC "M² Real Estate"I. Chavchavadzis Gamz. 29, sart. 3,
0179, Tbilisi, Georgia

(740) Nikoloz Jalaghania

(540)

ინტურისტი

(591) Black, white

(511) 36, 37

(111) M 2018 30360 R

(151) 26 10 2018

(181) 26 10 2028

(210) AM 99782

(220) 11 10 2018

((732) JSC "M² Real Estate"I. Chavchavadzis Gamz. 29, sart. 3,
0179, Tbilisi, Georgia

(740) Nikoloz Jalaghania

(540)

Intourist

(591) Black, white

(511) 36, 37

(111) M 2018 30361 R

(151) 26 10 2018

(181) 26 10 2028

(210) AM 99790

(220) 11 10 2018

(732) JSC "M² Real Estate"I. Chavchavadzis Gamz. 29, sart. 3,
0179, Tbilisi, Georgia

(740) Nikoloz Jalaghania

(540)

ამფორა ჰოტელს

(591) Black, white

(511) 33, 35, 36, 37, 43

(111) M 2018 30362 R

(151) 26 10 2018

(181) 26 10 2028

(210) AM 99791

(220) 11 10 2018

(732) JSC "M² Real Estate"I. Chavchavadzis Gamz. 29, sart. 3,
0179, Tbilisi, Georgia

(740) Nikoloz Jalaghania

(540)

Amphora Hotels

(591) Black, white

(511) 33, 35, 36, 37, 43

(111) M 2018 30363 R

(151) 26 10 2018

(181) 26 10 2028

(210) AM 99793

(220) 11 10 2018

((732) JSC "M² Real Estate"I. Chavchavadzis Gamz. 29, sart. 3,
0179, Tbilisi, Georgia

(740) Nikoloz Jalaghania

(540)

ამფორა კოლექშენ

(591) Black, white

(511) 33, 35, 36, 37, 43

(111) M 2018 30364 R

(151) 26 10 2018

(181) 26 10 2028

(210) AM 99794

(220) 11 10 2018

(732) JSC "M² Real Estate"I. Chavchavadzis Gamz. 29, sart. 3,
0179, Tbilisi, Georgia

(740) Nikoloz Jalaghania

(540)

Amphora Collection

(591) Black, white

(511) 33, 35, 36, 37, 43

(111) M 2018 30365 R

(151) 26 10 2018

(181) 26 10 2028

(210) AM 99796

(220) 11 10 2018

(732) JSC "M² Real Estate"
I. Chavchavadzis Gamz. 29, sart. 3,
0179, Tbilisi, Georgia
(740) Nikoloz Jalaghania
(540)

ჰარალე

(591) Black, white
(511) 33, 35, 36, 37, 43

(111) M 2018 30366 R
(151) 26 10 2018
(181) 26 10 2028
(210) AM 99797
(220) 11 10 2018
(732) JSC "M² Real Estate"
I. Chavchavadzis Gamz. 29, sart. 3,
0179, Tbilisi, Georgia
(740) Nikoloz Jalaghania
(540)

Harale

(591) Black, white
(511) 33, 35, 36, 37, 43

(111) M 2018 30367 R
(151) 30 10 2018
(181) 30 10 2028
(210) AM 99873
(220) 16 10 2018
(732) LTD "VEON GEORGIA"
Bambis Rigi 8, 0105, Tbilisi, Georgia
(740) Levan Nanobashvili
(540)

იმპულს მობაილ Impulse Mobile

(591) Black, white
(511) 9, 16, 18, 25, 35, 36, 37, 38, 41, 42, 44

(111) M 2018 30368 R
(151) 30 10 2018
(181) 30 10 2028
(210) AM 99874
(220) 16 10 2018
(732) LTD "VEON GEORGIA"
Bambis Rigi 8, 0105, Tbilisi, Georgia
(740) Levan Nanobashvili
(540)

გოუ ონ მობაილ go on mobile

(591) Black, white
(511) 9, 16, 18, 25, 35, 36, 37, 38, 41, 42, 44

(111) M 2018 30369 R
(151) 30 10 2018
(181) 30 10 2028
(210) AM 99875
(220) 16 10 2018
(732) LTD "VEON GEORGIA"
Bambis Rigi 8, 0105, Tbilisi, Georgia
(740) Levan Nanobashvili
(540)

ვაიბ მობაილ vibe mobile

(591) Black, white
(511) 9, 16, 18, 25, 35, 36, 37, 38, 41, 42, 44

(111) M 2018 30370 R
(151) 30 10 2018
(181) 30 10 2028
(210) AM 99877
(220) 16 10 2018
(732) LTD "VEON GEORGIA"
Bambis Rigi 8, 0105, Tbilisi, Georgia
(740) Levan Nanobashvili
(540)



(591) Purple, white
(531) 14.01.01; 25.03.01; 25.03.03; 27.05.01;
27.05.24; 29.01.12
(511) 9, 16, 18, 25, 35, 36, 37, 38, 41, 42, 44

(111) M 2018 30371 R
(151) 30 10 2018
(181) 30 10 2028
(210) AM 99878
(220) 16 10 2018
(732) LTD "VEON GEORGIA"
Bambis Rigi 8, 0105, Tbilisi, Georgia
(740) Levan Nanobashvili
(540)



(591) Purple, white
 (531) 14.01.01; 25.03.01; 25.03.03; 28.19; 29.01.12
 (511) 9, 16, 18, 25, 35, 36, 37, 38, 41, 42, 44

(111) M 2018 30372 R
 (151) 30 10 2018
 (181) 30 10 2028
 (210) AM 99879
 (220) 16 10 2018
 (732) LTD "VEON GEORGIA"
 Bambis Rigi 8, 0105, Tbilisi, Georgia
 (740) Levan Nanobashvili
 (540)



(591) Purple, blue, yellow
 (531) 01.15.15; 26.01.24; 27.01.01; 27.01.10;
 29.01.14
 (511) 9, 16, 18, 25, 35, 36, 37, 38, 41, 42, 44

(111) M 2018 30373 R
 (151) 30 10 2018
 (181) 30 10 2028
 (210) AM 99880
 (220) 16 10 2018
 (732) LTD "VEON GEORGIA"
 Bambis Rigi 8, 0105, Tbilisi, Georgia
 (740) Levan Nanobashvili
 (540)



(591) Purple, blue, yellow
 (531) 01.15.15; 26.01.01; 26.01.24; 28.19; 29.01.14
 (511) 9, 16, 18, 25, 35, 36, 37, 38, 41, 42, 44

(111) M 2018 30374 R
 (151) 30 10 2018
 (181) 30 10 2028
 (210) AM 99881
 (220) 16 10 2018
 (732) LTD "VEON GEORGIA"
 Bambis Rigi 8, 0105, Tbilisi, Georgia
 (740) Levan Nanobashvili
 (540)



(591) Purple, purple – differens tone,
 blue – differens tone
 (531) 26.03.23; 27.01.01; 27.01.25; 27.05.21;
 29.01.12
 (511) 9, 16, 18, 25, 35, 36, 37, 38, 41, 42, 44

(111) M 2018 30375 R
 (151) 30 10 2018
 (181) 30 10 2028
 (210) AM 99882
 (220) 16 10 2018
 (732) LTD "VEON GEORGIA"
 Bambis Rigi 8, 0105, Tbilisi, Georgia
 (740) Levan Nanobashvili
 (540)



(591) Purple, blue – differens tone, purple –
 differens tone
 (531) 26.15.11; 27.01.25; 27.05.21; 29.01.12
 (511) 9, 16, 18, 25, 35, 36, 37, 38, 41, 42, 44

(111) M 2018 30376 R
 (151) 31 10 2018
 (181) 31 10 2028
 (210) AM 99889
 (220) 17 10 2018
 (732) LTD "IVOLI"
 Apakidzis q. 11 b. 61, Vake-Saburtalos
 r-ni, 0160, Tbilisi, Georgia
 (540)



(591) White, blue, green
 (531) 26.11.02; 26.11.12; 27.05.10; 27.05.21;
 29.01.13
 (511) 36

(111) M 2018 30377 R
 (151) 01 11 2018
 (181) 01 11 2028
 (210) AM 100045
 (220) 26 10 2018
 (732) AKAKI CHKHAIDZE
 Mtatsmindis shesak.7a, b.14, 0108, Tbilisi,
 Georgia
 (540)

მანკა

(591) Black, white
 (511) 43

(111) M 2018 30378 R
 (151) 01 11 2018
 (181) 01 11 2028
 (210) AM 100007
 (220) 23 10 2018
 (732) TEA GZIRISHVILI
 Gamsakhurdias gamz.7, b.17-18, Tbilisi,
 Georgia
 (740) Mariam Pirskhalava
 (540)

სონდოვანი

(591) White, green
 (531) 27.05.22; 29.01.03
 (511) 44

(111) M 2018 30379 R
 (151) 02 11 2018
 (181) 02 11 2028
 (210) AM 99867

(220) 15 10 2018
 (732) LTD "GLAVTORG"
 Sop. Dunta, 4000, Sachkheris r-ni, Georgia
 (740) Garegin Aivaziyan
 (540)



(591) Red, yellow, white
 (531) 02.01.01; 02.01.04; 26.01.04; 26.01.14; 28.05;
 29.01.13
 (511) 30

(111) M 2018 30380 R
 (151) 02 11 2018
 (181) 02 11 2028
 (210) AM 99435
 (220) 19 09 2018
 (732) LTD "CITY LOFT"
 26 Maisis sakhelobis moedani, 0171, Tbilisi,
 Georgia
 (740) Giorgi Taktakishvili
 (540)

Aviator™

(591) Black, white
 (531) 27.05.01
 (511) 39, 41, 43

(111) M 2018 30381 R
 (151) 02 11 2018
 (181) 02 11 2028
 (210) AM 99436
 (220) 19 09 2018
 (732) LTD "CITY LOFT"
 26 Maisis sakhelobis moedani, 0171, Tbilisi,
 Georgia
 (740) Giorgi Taktakishvili
 (540)

სკოპოლი™

(591) Black, white
 (531) 28.19
 (511) 39, 41, 43

INTERNATIONAL TRADEMARKS FOR WHICH A DECISION ON GRANTING PROTECTIONS IS TAKEN

The decision can be appealed at the Chamber of Appeal of Sakpatenti within 3 months from the publication or at the Mtskheta District Court Administrative Cases Board (Address: №17, Samkhedro str., Mtskheta), within 1 month following the publication.

(260) AM 2018 93745 A

(800) 1359234

(151) 2017 04 07

(891) 2017 04 07

(731) Eagle Investment SICAV plc, acting on behalf of ITT FUND

Alpine House, Naxxar Road SGN 9032 San Gwann, Malta

(540)

SMILING Joker

(591) Black and white

(511)

9 – Games software; software programs for video games; interactive video game programs; software cartridges for computer games; software cartridges for video games; software; educational software; application software; community software; computer telephony software; interactive computer software; communication software; programs for computers; electronic components for gambling machines; games cartridges for use with electronic games apparatus; juke boxes; automated teller machines.

28 – Games; sports games; manipulative games; mechanical games; musical games; electronic games; parlor games; board games; quiz games; apparatus for games; arcade games; skill and action games; electronic hand-held game units; handheld computer games; lottery wheels; lottery tickets; slot machines; automatic gaming machines; coin-operated amusement machines; bill-operated gaming equipment; LCD game machines; counters for games; amusement apparatus for use in arcades.

41 – Gambling; operating lotteries; prize draws; organizing and conducting lotteries; games equipment rental; casino services; leasing of casino games; providing of casino and gaming facilities; casino, gaming and gambling services; providing amusement arcade services; video arcade services.

(260) AM 2018 95264 A

(800) 1375823

(151) 2017 03 14

(891) 2017 03 14

(731) DENTSPLY SIRONA Inc.

Susquehanna Commerce Center,
221 West Philadelphia Street, York PA
17401-2991, USA

(540)

DENTSPLY SIRONA: THE DENTAL SOLUTIONS COMPANY

(591) Black and white

(511)

3 – Dental preparations and compounds, namely, tooth whitening compounds, tooth conditioning gels and polishing materials.

5 – Pharmaceuticals and preparations for health care in the field of dental medicine; preparations, compounds, substances and materials for dental use; material for stopping teeth, dental wax; embedding compounds and dental cement; adhesives for dental ceramics and teeth; dental lacquers; matt lacquers for the optical surveying of teeth; composite material for dental purposes; duplicating compositions for dental and prophylactic dental purposes; crown and bridge material for dental and prophylactic dental purposes; dental ceramic material; material for tooth crowns and tooth bridges for dental and dental technical purposes; chemical preparations for dental purposes; chemical reagents for dental purposes; medical and dental anesthetics; rubber sheets for dental purposes; dental gel; amalgams for use in dentistry; alloys for dental purposes; glass ionomers; linings and cements for dental purposes; filling and bonding materials for use in dentistry; dental restorative materials; root canal sealer; mouthwashes for medical purposes; chewing gum for medical purposes; cleaners [preparations] for sterilizing dental instruments; sterilizing preparations; medical dental rinses; lubricants for use in dentistry; disinfectants; adhesives for dental purposes; dental adhesives; first aid kits; all the aforementioned goods for dental applications; dental preparations and compounds, namely, dental etching materials, pit and fissure sealants, prophylaxis gels and pastes, topical fluoride gel, core build-up material, hybrid composites, dental acrylics and filling materials, partial denture alloys, separating agents, denture base relines and repair materials, denture base resins and acrylics, insulating pastes, dental porcelains, tins and opaques, impression materials, bite registration materials, gypsum for dental purposes and material for dental prostheses, casting ring liner material, lab and model plasters, abrasive grit, tissue treatment material, periodontal scaling gel and surgical dressings,

endodontic restorative materials, gutta percha for dental procedures, local anesthetics for dental procedures, dental instrument pre-soak and dental instrument cleaners, sanitizing pre-soak for dental use, all-purpose surface disinfectant, electropolishing solutions for dental purposes, silicone spray for dental use; wax for dental purposes; biological bone tissue for subsequent implantation (biological tissue culture for medical purposes); custom impression materials.

9 – Software for use with medical and dental apparatus and instruments, or for the medical and dental sector; darkrooms [photography] for the film processing with dental images for chairside use; computerized charting and treatment planning system comprised primarily of monitor, printer, keyboard and processing unit (computer hardware).

42 – Medical and dental services, namely, scientific and technological research, design and development of medical diagnostic apparatus and technology, software solution services, installation, maintenance and repair services; research and development services for others, dental research laboratory services; services of an engineer, creating programs for data processing in the field of dentistry, material and raw material inspection.

(260) AM 2018 95464 A

(800) 1378900

(151) 2017 07 18

(891) 2017 07 18

(731) KUSTO GROUP PTE. LTD.

80 Raffles Place, #32-01 UOB Plaza
Singapore 048624, Singapore

(540)

KUSTO

(591) Black and white

(511)

36 – Lease of real estate; management of real estate; real estate brokerage; real estate financing; real estate consultancy; real estate agency services; investment; banking and financing services; financing of real estate or property developments; real estate services relating to real estate or property development.

41 – Education; educational seminars; management in the nature of arranging and conducting of educational events; training; training consultancy; teaching; organization of seminars; organisation of training courses; arranging and conducting of conferences; conducting training seminars; conducting training workshops; conducting of exhibitions for educational purposes; publication services.

(260) AM 2018 95465 A

(800) 1378931

(151) 2017 09 08

(891) 2017 09 08

(731) BESTWAY INFLATABLES & MATERIAL CORP.

3065 Cao An Road Shanghai 201812, China

(540)

HYDRO FORCE

(591) Black and white

(511)

6 – Metal swimming pools.

9 – Nautical, life-saving apparatus and instruments; divers' suits and gloves; divers' earplugs; wetsuits for diving; life buoys; life belts; breathing apparatus for underwater swimming; goggles; spectacles; spectacle glasses; sunglasses.

10 – Swimmers' earplugs.

12 – Inflatable boats; rubber boats; canoes; kayaks; inflatable boats made of PVC with electric motor; rudders; jet skis.

19 – Pools (swimming -) [structures, not of metal]; fitted swimming pool covers (terms considered too vague by the International Bureau – rule 13.2.b) of the Common Regulations).

28 – Bathing floats; inflatable toys in PVC materials, namely puppets, animals, fishes, birds, trains, planes, utensils; swimming pools [play articles]; balls for sports; arm floats for swimming; ring floats for swimming; swimming floats for recreational use in the form of mattresses, armchairs or seats; swimming jackets; volleyball net frames; jumping tube gym; soccer goal frames; playing house; ride-ons in the shape of animals and fishes; stand-up paddle boards.

(260) AM 2018 95466 A

(800) 1378955

(151) 2017 09 11

(891) 2017 09 11

(731) DELTA MEDICAL PROMOTIONS AG

Oetenbachgasse 26 CH-8001 Zurich,
Switzerland

(540)

ZEST

(591) Black and white

(531) 27.05.17

(511)

10 – Medical apparatus and instruments; dental apparatus and instruments; surgical apparatus and instruments; aerosol dispensers for medical purposes; ambulance stretchers; anaesthetic apparatus; apparatus for artificial respiration; apparatus and installations for the production of X-rays, for medi-

cal purposes; arterial blood pressure measuring apparatus; blankets, electric, for medical purposes; blood testing apparatus; bracelets for medical purposes; brain pacemakers; condoms; contraceptives, non-chemical; cushions for medical purposes; dental apparatus, electric; diagnostic apparatus for medical purposes; droppers for medical purposes; ear plugs [ear protection devices]; electric acupuncture instruments; electrocardiographs; esthetic massage apparatus; gloves for massage; hearing aids; heating pads, electric, for medical purposes; hydrostatic [water] beds for medical purposes; incubators for medical purposes; inhalers; injectors for medical purposes; invalids' hoists; lamps for medical purposes; lasers for medical purposes; physical exercise apparatus for medical purposes; physiotherapy apparatus; quartz lamps for medical purposes; resuscitation apparatus; soporific pillows for insomnia; syringes for injections; testing apparatus for medical purposes; vibromassage apparatus.

(260) AM 2018 95607 A

(800) 1378374

(151) 2017 07 03

(891) 2017 07 03

(731) Obshchestvo s ogranichennoy otvetstvennostyu "SAMSON-MED"
Moskovskoe shosse, 13, RU-196158
Sankt-Peterburg, Russian Federation

(540)

SAMSON-MED

(591) Black, white

(531) 27.05.17

(511)

3 – Balms other than for medical purposes; massage gels other than for medical purposes; toiletry preparations; hair conditioners; cosmetic creams; beauty masks; oils for cosmetic purposes; cleansing milk for toilet purposes; dentifrices; cosmetic preparations for baths; bath preparations, not for medical purposes; tissues impregnated with cosmetic lotions; astringents for cosmetic purposes; cosmetics; shampoos.

5 – Balms for medical purposes; vaccines; hemato-gen; protein dietary supplements; enzyme dietary supplements; yeast for pharmaceutical purposes; liniments; ointments for pharmaceutical purposes; medicinal oils; medicated soap; drugs for medical purposes; pepsins for pharmaceutical purposes; peptones for pharmaceutical purposes; anti-uric preparations; bacterial preparations for medical and veterinary use; bacteriological preparations for medical and veterinary use; balsamic preparations for medical purposes; biological preparations for veterinary purposes; biological preparations for medical purposes; veterinary preparations; vitamin preparations; contact lens cleaning preparations; pharma-

ceutical preparations for skin care; pharmaceutical preparations; enzyme preparations for veterinary purposes; chemico-pharmaceutical preparations; solutions for contact lenses; tissues impregnated with pharmaceutical lotions; suppositories; greases for medical purposes; digestives for pharmaceutical purposes; enzymes for veterinary purposes; phenol for pharmaceutical purposes.

35 – Presentation of goods on communication media, for retail purposes; auctioneering; retail or wholesale services for pharmaceutical, veterinary and sanitary preparations and medical supplies; sales promotion for others; distribution of samples; dissemination of advertising matter; on-line advertising on a computer network.

42 – Clinical trials; research and development of new products for others; scientific research; scientific laboratory services.

(260) AM 2018 95630 A

(800) 1378881

(151) 2017 07 10

(891) 2017 07 10

(731) Best Cheese Company for Dairy Products
S.A.E
1, El Obour Buildings, Salah Salem street,
Nars City Cairo, Egypt

(540)



(591) Red, white and light brown

(531) 02.03.11; 02.05.03; 02.05.05; 09.07.01;
09.07.19; 09.07.25; 25.01.05; 27.05.24; 28.01;
29.01.13

(511)

29 – milk and milk products.

(260) AM 2018 95693 A

(800) 1380709

(151) 2017 10 27

(891) 2017 10 27

(731) ADP GAUSELMANN GMBH
Mercur-Allee 1-15, 32339 Espelkamp,
Germany

(540)

Magic Roulette

(591) Black, white

(511)

9 – computer games provided through a global computer network or supplied by means of multi-media electronic broadcast or through telecommunications or electronic transmission or via the Internet; computer games, leisure and recreational software, video games and computer software, all being provided in the form of storage media; programs for operating electric and electronic apparatus for games, amusement and/or entertainment purposes; automatic lottery machines; computer software for computer games on the Internet; online games (software), in particular for online betting games, online prize games, online gambling games, online games of skill and online casino games; computer software in the form of an app for mobile devices and computers; operational computer games software; computer software for managing of games (game collection); collection of video games.

(260) AM 2018 95770 A

(800) 1380176

(151) 2017 09 08

(891) 2017 09 08

(731) SAĞLIKLI GIDA ÜRÜNLERİ SANAYİ VE TİCARET A.Ş.

Celaliye Mahallesi Bağlarbaşı, Caddesi No:55
B. Cekmece Istanbul, Turkey

(540)



(591) Red, white, light blue and dark blue

(531) 03.07.05; 03.07.24; 27.05.03; 27.05.09; 27.05.10; 27.05.24; 29.01.14

(526) ENERGY DRINK

(511)

32 – Energy drinks (non-alcoholic).

(260) AM 2018 95820 A

(800) 1175820

(151) 2013 07 16

(891) 2017 10 31

(731) CASEN RECORDATI, S.L.

Autovía Logroño, Km. 13,300, E-50180
UTEBO (Zaragoza), Spain

(540)

ADULAX

(591) Black, white

(511)

10 – Surgical, medical, dental and veterinary apparatus and instruments, as well as artificial limbs, eyes and teeth; orthopedic articles; suture material, including enemas for medical use, enema apparatus and enema syringes.

(260) AM 2018 95837 A

(800) 1381685

(151) 2017 07 06

(891) 2017 07 06

(731) CAREGEN CO., LTD

46-38, LS-Ro 91 beon-gil, Dongan-gu,
Anyang-si Gyeonggi-do, Republic of Korea

(540)



(591) Deep blue and red

(531) 26.11.12; 27.05.17; 29.01.12

(511)

5 – Seaweed-based health supplement food for diabetics; vegetables-based health supplement food for diabetics; health supplement food for diabetics based on Chinese matrimony wine; health supplement food for diabetics based on the root of arrowroots; health supplement food for diabetics based on solomon's seal; meat-based health supplement food for diabetics; whey-based health supplement food for diabetics; health supplement food for diabetics based on processed oils and fats for food; health supplement feed for diabetics based on preserved fish; health supplement food for diabetics based on processed algae.

(260) AM 2018 95846 A

(800) 1381892

(151) 2017 09 04

(891) 2017 09 04

(731) Union des Associations Européennes de

Football (UEFA)

Route de Genève 46 CH-1260 Nyon,
Switzerland

(540)



(591) Black and white

(531) 24.17.10; 26.13.25

(511)

4 – Lubricants; engine oils and fuels, including gasoline, diesel oil, gases and bio-fuels; candles; waxes; greases; natural gas; liquid gases; industrial oils

and greases; lubricating oils and greases; carburants; liquefied petroleum gas; non-chemical additives for fuel, lubricants and greases; dust absorbing, wetting and binding compositions; lighting fuel; lubricants, oils and greases, and lubricating preparations for industrial use; cutting oils for industrial use; milling oils.

9 – Exposed films, slides, video game disks; software (recorded programs), including game software; computer databases and programs; recorded or downloaded sounds, images or data; videotapes, magnetic tapes, magnetic disks, DVDs, mini-disks, diskettes, optical disks, compact disks, CD-ROMs, videodisks, memory cards, USB flash drives, whether blank or prerecorded with music, sound or images (which may be animated cartoons); holograms; electronic publications provided by means of CD-ROMs, databases and the Internet; spectacles, sunglasses, diving and swimming goggles; cases, cords and chains for sunglasses and spectacles; binoculars; magnets and decorative magnets; directional compasses; sound and image recording, transmitting and reproducing apparatus; satellite dishes; decoders, namely, electronic hardware and software which can convert, supply and transmit audio and video data; television sets; flat screens, liquid crystal display screens, high-definition screens and plasma screens; radios; home cinema systems; video recorders; CD players; DVD players; MP3 players; cassette players; mini-disk players; digital music players; loudspeakers; headphones, earphones; computers, including laptop computers and electronic tablets; karaoke systems; systems for editing sounds and for mixing sounds; systems for editing video images, and for mixing video images; apparatus for computer data processing; computer keyboards; computer screens; modems; accessories for computers included in this class; computer mice, mouse pads; navigation apparatus; personal digital assistants (PDAs); electronic pocket translators; dictating machines; electronic agendas; scanners; printers; photocopiers; facsimile machines; telephones; answering machines; video telephones; cellular telephones; cellular telephone accessories included in this class, namely cases for cellular telephones, hands-free apparatus for using cellular telephones, earphones and headsets for cellular telephones, keypads for cellular telephones, straps for cellular telephones, special cases for carrying cellular telephones, cameras and video cameras integrated in cellular telephones, and mobile telephone covers; remote controls for television sets and video systems; teleconferencing systems; calculating machines; credit card readers; currency converting machines; automated teller machines; video cameras, portable video cameras with built-in videocassette recorders (camcorders); photographic equipment, photographic apparatus, cameras (cinematographic apparatus), projectors, flash lamps, special cases and cords for photographic apparatus and

instruments, electric cells and batteries; screen saver programs for computers; magnetic, digital or analog recording media, recorded or not, for sounds or images; magnetic cards (encoded); memory cards; integrated circuit cards (smart cards); microchip or magnetic credit cards, microchip or magnetic telephone cards, microchip or magnetic cards for cash dispensers, microchip or magnetic cards for automated teller machines and money exchange machines, prepaid microchip or magnetic cards for cellular telephones, microchip or magnetic travel and show admission cards, microchip or magnetic check guarantee cards and microchip or magnetic debit cards; alarms; wind socks (for indicating wind direction); distance measuring equipment; equipment for measuring and displaying speed; protective gloves; audio receivers, sound amplifiers; television tubes; cathode ray tubes; decoders, namely computer hardware and software which can convert, supply and transmit audio and video data; disk drives for computers; protected semi-conductors; integrated circuits containing programs for processing audio, visual or computer data; rechargeable batteries; audio and video data processors and converters; data transmission cables; payment apparatus for electronic commerce; protective helmets for sports; magnetic identification bracelets; electronic instrument assemblies; fuel/air coefficient analyzers; remote control devices for locking cars; photovoltaic cells; video game cassettes; computer game joysticks; voice-activated or manually operated computer game joysticks.

12 – Bicycles, motorcycles, motor cars, trucks, vans, utility vehicles, buses, camper vans, refrigerated vehicles; airplanes and boats; air balloons, dirigible balloons [airships]; vehicle accessories, namely sun visors, pneumatic tires, tire covers, luggage racks, ski racks, rims and hub caps for wheels; seat linings, vehicle covers, baby carriages, strollers, safety seats for infants and children (for vehicles); engines and motors for land vehicles; bull bars; headlamp covers; steering wheels for vehicles; trailers.

16 – Coloring and drawing books; activity books; magazines; newspapers; books and journals, including those concerning sportsmen, sportswomen or sports events; bookmarks; printed teaching material; score sheets; event programs; albums for events; photograph albums; autograph books; printed timetables; pamphlets; collectible photographs of players; bumper stickers, stickers, albums, sticker albums; posters; photographs; tablecloths of paper; napkins of paper; bags of paper; invitation cards; greeting cards; gift wrapping paper; coasters and place mats of paper; garbage bags of paper or of plastics; food wrapping paper; small bags for preserving foodstuffs; coffee filters of paper; labels (not of textile); hand towels of paper; wet hand-wipes of paper; toilet paper; napkins for removing make-up; handkerchief boxes of paper and cardboard; tissues

of paper; stationery and instructional and teaching material (except apparatus); typewriter paper; copying paper; envelopes; notepads; folders for papers; tissue paper; writing books; paper sheets for note-taking; writing paper; binder paper; files; covering paper; luminous paper; adhesive paper for notes; paperweights; crêpe paper; tissue paper; badges or insignia of paper; flags of paper; pennants (flags) of paper; writing instruments; fountain pens; pencils; ballpoint pens; ballpoint pen and pencil sets; felt-tip pens (marking pens); fiber-tip pens and felt-tip pens; marking pens; ink, inking pads, rubber stamps; typewriters (electric or non-electric); lithograph prints, lithographic works of art; paintings (pictures), framed or unframed; paint boxes, paints and colored pencils; chalks; pencil ornaments [stationery]; printing blocks; address books; diaries (planners); personal organizers of paper; road maps; tickets, entry tickets; checks; comic books; calendars; postcards; advertising boards, banners and material included in this class; transfers (decalcomanias); sticking labels; office requisites (except furniture); correction fluids; rubber erasers; pencil sharpeners; stands for pens and pencils; paper clips; thumbtacks; rulers; adhesive tapes for stationery purposes, adhesive tape dispensers; staples; stencils; document holders (stationery); paper clips; holders for notepads; bookends; stamps (seals); postage stamps; credit cards, telephone cards, ATM cards, cards for traveling and for shows, check guarantee cards and debit cards, non-magnetic, and of paper or cardboard; baggage tags of paper; passport cases; travelers' checks; holders for checkbooks; money clips of metal; letter trays.

18 – Identity card holders.

25 – Clothing; shoes and footwear; headgear; shirts; knitwear (clothing); pullovers; slippers; T-shirts; vests; singlets; sleeveless jerseys, dresses; skirts; underwear; swimsuits; bath robes; shorts; trousers; sweaters; caps (bonnets); caps; hats; sashes for wear; scarves, shawls; peaked caps; tracksuits; sweatshirts; jackets, sports jackets, stadium jackets (jumpers); blazers; waterproof clothing; coats; uniforms; neckties; wrist bands; headbands; gloves; aprons; bibs (not of paper); pajamas; play suits for infants and children; socks and stockings; garters; belts; suspenders.

26 – Braids; tassels (haberdashery); ribbons; buttons; needles; sewing boxes; badges for clothing (other than of precious metal); brooches (clothing accessories); decorative pins and needles not of precious metal; ornament pins for hats not of precious metal; hair nets, hair bands; barrettes (hair slides); hair pins; hair ribbons; pins not of precious metal; cords; bands for clothing (strips); competitors' numbers for advertising use; shoe ornaments not of precious metal; other decorative articles for the hair included in this class; badges of all kinds not of precious metal

(including numbers and letters); plastic badges; badges and lapel pins (badges not of precious metal).

28 – Games and toys; sports balls; play balloons; board games; tables for indoor football; dolls and plush toys; vehicles (toys); jigsaw puzzles; balloons; inflatable toys; play disks (pogs); playing cards; confetti; gymnastic and sporting articles; football equipment, namely balls for football, gloves, knee guards, elbow guards, shoulder guards, shin guards; football goals; sports bags and containers (adapted to objects) for carrying sports articles; party hats (toys); small electronic games designed for use with a television set; video game apparatus; game consoles; electronic games other than those designed to be used only with a television set; steering wheels for video games and mats for video games (for dancing upon); hands made of rubber or foam (toys); entertainment robots; appliances for gymnastics; kites; roller skates; scooters; skateboards; coin-operated video games for game halls (arcade games); electronic games with liquid crystal display; joysticks for video games, manually or voice-activated joysticks for video games; lottery tickets; lottery cards, scratch tickets for lottery games.

32 – Non-alcoholic beverages; syrups and powders for making non-alcoholic beverages; mineral and aerated waters; isotonic beverages; fruit and vegetable beverages; fruit and vegetable juices; iced fruit beverages; beers; strong dark beers; lagers and ales; non-alcoholic or low-alcohol beers.

35 – Employment agencies; personnel recruitment; advertising services; services provided by an agency publishing advertising texts; advertising agency services; advertising agency services on a global computer network (the Internet) or via wireless electronic communication devices; dissemination of advertisements; rental of advertising space; rental of advertising time in film credits; television advertising, radio advertising; advertising in the form of animated cartoons; promotion agency services, promotion agency services for sports and public relations; promotion of football events; market study services; market research services; public opinion polling services; organization of exhibitions for commercial or advertising purposes; organization of advertising for trade fairs; compilation and systematization of data in data banks; data bank management services; compilation of statistics; advertising for sports events in the field of football; retail sale services for and bringing together of various goods for the benefit of others (excluding the transport thereof), namely clothing, footwear, headgear, sports articles, stationery, apparatus for recording, transmission and reproduction of sound and images, books, newspapers, magazines, publications, video games, toys, dolls, badges of all kinds, key rings, tickets, watches and jewelry, souvenir items in connection with football, bags, luggage, briefcases, umbrellas, flags and pennants,

alcoholic and non-alcoholic beverages, confectionery, medical apparatus and instruments, vehicles and accessories for motor cars; retail sale services for solvents, paraffin, waxes, bitumen and petroleum; bringing together of the following goods for the benefit of others (excluding transport thereof) to enable customers to conveniently view and purchase these goods in a store or on a global computer network (the Internet) or via wireless electronic communication devices, namely clothing, footwear, headgear, sports articles, stationery, apparatus for recording, transmission and reproduction of sound and images, books, newspapers, magazines, publications, video games, toys, dolls, badges of all kinds, key rings, tickets, watches and jewelry, souvenir items in connection with football, bags, luggage, briefcases, umbrellas, flags and pennants, alcoholic and non-alcoholic beverages, confectionery, medical apparatus and instruments, vehicles and accessories for motor cars; advertising and promotion services, information services with regard to advertising and promotion, commercial information agencies, all the aforesaid services provided on-line from a computer database or via a global computer network (the Internet) or via wireless electronic communication devices; design and compilation of advertisements for use as a web site on a global computer network (the Internet) or via wireless electronic communication devices; provision of space on web sites, for advertising of goods and services; auctioneering on a global computer network (the Internet) or via wireless electronic communication devices; collection of directories for publication on the Internet and on wireless electronic communication networks; business administration services for processing commercial services on a global computer network (Internet) or via wireless electronic communication devices; compilation, creation and management of databases, namely collection of domain names in a register; sales promotion, namely creation of preferential programs for customers; implementation of bonus programs for customers in stadiums by distributing encoded loyalty and membership cards which can contain the personal data of the user; development, launch and administration of loyalty programs, namely issuing loyalty cards to fans, containing personal information on the identity of the card holder; electronic commerce (e-commerce) services, namely provision of information on goods via telecommunication networks for advertising or sales purposes; compilation of data into a computer database, especially still or animated images; e-commerce services, namely online services for providing contracts for the purchase and sale of goods on behalf of others; promotion of sports events in the field of football; promotion of the goods and services of others, through contractual agreements, particularly partnership (sponsoring) and licensing agreements, providing them with increased notoriety and enhanced image derived from cultural

and sporting events, particularly international events; compilation and recording of data and information on sporting performances; provision of personnel, particularly for selling beverages and foods; promotion of football events; retail sale of interactive educational and entertainment products, interactive compact disks, CD-ROMs and computer games; retail sale services, particularly on a global computer network, for interactive educational and entertainment products, interactive compact disks, CD-ROMs and computer games; presentation of computer programs for retail sale purposes; procurement services for others [purchasing goods and services for other businesses]; procurement services for others [purchasing goods and services for other businesses] for sports events or entertainment; promotion of the goods and services of others, through contractual agreements, particularly partnership (sponsoring) and licensing agreements, providing them with increased notoriety and/or enhanced image and/or affinity derived from cultural and sporting events, particularly international events.

36 – Issuance and management of credit cards and travelers' checks; financial services; banking, credit and investment services; insurance services; lease-purchase financing; hire-purchase services; financial sponsorship of sports events; information services related to finance and insurance, provided from a computer database or the Internet or on all wireless electronic communication networks; home banking services; banking services on the Internet or on all wireless electronic communication networks; payment services, including services provided from a computer database or via the Internet or via mobile telephones; safe deposit services; issue of vouchers, namely issue of loyalty cards to fans, which contain personal data on the identity of the cardholder and are used for access control at sports stadiums; financial promotion of events in the field of football; financial payment services for electronic commerce, namely transfer of funds, all via electronic communication networks; financial payment services for electronic commerce in connection with the purchase of goods and services provided by others, all via electronic communication networks, and clearing and settlement of financial transactions via electronic communication networks; issue of vouchers in the form of travel vouchers; financial sponsorship search for football competitions.

38 – Telecommunication services; communication by mobile telephones; communication by telex; communication via electronic computer terminals linked to telecommunication networks, data banks and the Internet or via wireless electronic communication devices; communication by telegraphs; communication by telephones; communications by facsimile; paging services; telephone or video conferencing services; television program broadcasting; broadcast-

ting of cable television programs; radio program broadcasting; radio and television broadcasting of sports and sporting events; news and press agency services; other message transmission services; rental of telephones, facsimile machines and other telecommunication apparatus; transmission of commercial Internet pages online or via wireless electronic communication devices; services for transmitting and broadcasting television and radio programs provided via the Internet or via any wireless electronic communication network; electronic transmission of messages; simultaneous broadcasting of film recordings and sound and video recordings; provision of access to telematic servers and real-time chat forums; computer-aided transmission of messages and images; telecommunication via fiber-optic networks; provision of access to a global computer network or interactive communication technologies for access to private and commercial purchasing and ordering services; transmission of information and other data via websites and computers; transmission of information (including sites by telematic means) via telecommunication, computer programs and other data; transmission of information, computer programs and other data by telematic means; electronic mail services; provision of access via the Internet or on any wireless electronic communication network (telecommunication services); providing connections for telecommunications with a global computer network (the Internet) or data banks; provision of access to websites offering digital music on the Internet by means of a global computer network or via wireless electronic communication devices; rental of access time to MP3 websites on the Internet, via a global computer network or via wireless electronic communication devices; rental of access time to a database server center (telecommunication services); rental of access time to a computer database (telecommunication services); transmission of digital music by telecommunications; online transmission of electronic publications; digital music transmission via the Internet or on any wireless electronic communication network; digital music transmission via MP3 Internet sites; simultaneous broadcasting and/or netcasting of film recordings and sound and video recordings (telecommunications); simultaneous broadcasting and/or netcasting of interactive educational and entertainment products, interactive compact disks, CD-ROMs, computer programs and computer games (telecommunications); provision of access to blackboards (notice and advertisement boards) and chat rooms in real time via a global computer network; rental and provision of access time to blackboards (boards for displaying information and advertisements) and to chat rooms in real time by means of a global computer network (communication services); telecommunication services dedicated to retail sale by means of interactive communications with customers; multimedia telecommunication; vi-

deotext and teletext transmission services; information transmission via communication satellite, microwave or by electronic, digital or analog means; transmission of digital information by cable, wire or fiber; transmission of information by mobile telephones, telephones, facsimile and telex; telecommunication services for receiving and exchanging information, messages, images and data; telecommunication services for setting up discussion groups on the Internet and on any wireless electronic communication network; provision of access to search engines for obtaining data and information on global networks.

39 – Operation of a travel agency, namely travel organization and reservation; ticket reservation and information services for travel; transport by airplane, railway, bus and truck; boat transport; boat travel services; tourist travel services; vehicle rental; rental of parking spaces; taxi services; boat transport services for goods; distribution of water, heat, gas or electricity; distribution of newspapers, magazines and books; postal services, mail delivery and courier services; storage of goods; delivery of solvents, paraffins, waxes, bitumens and oil products, excluding liquid gas; distribution (delivery) of films and sound and image recordings; distribution (delivery) of interactive educational and entertainment products, interactive compact disks, CD-ROMs, computer programs and computer games; advice relating to power and electricity distribution.

41 – Education; training; entertainment; organization of lotteries, raffles and competitions; betting and gaming services in connection with sports; hospitality services (sports, entertainment), namely providing entry tickets and information brochures for sports for VIPs, as well as guiding and gathering VIPs during sports or entertainment events; hospitality services, namely customer reception services (entertainment services), including providing access tickets during sports or entertainment events; entertainment services relating to sporting events; entertainment services in the form of public gatherings during the retransmission of sports events; sporting and cultural activities; organization of sporting and cultural events and activities; organization of sports competitions; organization of events in the field of football; sports camp services; provision of sports facilities; rental of video and audiovisual installations; production, presentation, distribution and/or rental of film recordings and sound and video recordings; presentation, distribution and/or rental of interactive educational and entertainment products, interactive compact disks, CD-ROMs, and computer games; coverage of radio broadcast and televised sports events; production services for radio, television programs and video films; ticket reservation services and information services for sports or entertainment events; timing services relating to sports events; or-

ganization of beauty contests; interactive entertainment; on-line betting and gaming services on the Internet or on any wireless electronic communication network; information in the field of entertainment (including in the field of sports), provided on-line from a computer database or via the Internet or via any wireless electronic communication network; electronic game services transmitted via the Internet or on mobile telephones; editing of books; publication of books and electronic journals on-line; audio and video recording services; production of animated cartoons for the cinema, production of animated cartoons for television; rental of sound and image recordings for entertainment purposes; information in the field of education provided on-line from a computer database or via the Internet or any wireless electronic communication network; translation services; photography services; provision of entertainment infrastructure; ticket agencies in connection with sports events.

43 – Providing food and drink, snack-bars; hospitality services, namely provision of food and drink; catering services; hotel services; providing accommodation and food and drink, booking hotels and temporary accommodation; hospitality services, namely provision of food and drink during sports or entertainment events.

(260) AM 2018 95848 A

(800) 1382353

(151) 2017 11 06

(891) 2017 11 06

(731) APPLE INC.

One Apple Park Way, Cupertino CA 95014, USA

(540)

BEDDIT

(591) Black, white

(511)

9 – Electric or electronic sensors used to measure, collect and track environmental variables, namely, temperature, and air quality during sleep; computer software, and software applications for mobile devices used for collection and analysis of variables related to sleep, general well-being, health and environmental variables, namely, temperature, air quality, and ambient noise during sleep; computer software and monitoring software used to collect, measure, analyze, and track data for sleep research; software used for promoting sleep hygiene, healthy living, general health, and for measuring environmental variables, namely, computer software to organize personal sleep data or featuring information in the field of sleep hygiene, healthy living, general health, and for measuring environmental variables, namely, temperature, air quality, and ambient noise during sleep; general wellness devices, namely, electronic storage

device in the nature of memory media for storing collected information on sleep patterns, well-being, health and environmental variables, namely, temperature, light, air quality, and ambient noise during sleep for scientific purposes; measuring, detecting and monitoring instruments, indicators and controllers for use in detecting physiological conditions indicative of a user's sleep cycle, sleep patterns and general wellness; tracking devices for use in detecting physiological conditions indicative of a user's sleep cycle, sleep patterns and general wellness; portable sensors and detectors for use in detecting physiological conditions indicative of a user's sleep cycle, sleep patterns and general wellness; portable monitoring instruments for use in detecting physiological conditions indicative of a user's sleep cycle, sleep patterns and general wellness.

(260) AM 2018 95850 A

(800) 1381896

(151) 2017 09 06

(891) 2017 09 06

(731) Open-Type Joint Stock Company

"ROT FRONT"

2-oy Novokuznetskiy pereulok, d. 13/15

RU-113184 Moscow, Russian Federation

(540)

ГОРОДКИ

(591) Black and white

(511)

30 – Coffee; tea; rice; sugar; tapioca; artificial coffee; flour and preparations made from cereals; bread, pastries and confectionery; ice cream; honey; sugar, honey, treacle; yeast, baking-powder; salt; mustard; vinegar; sauces [condiments]; spices; edible ices.

(260) AM 2018 95853 A

(800) 725192

(151) 1999 11 30

(891) 2017 11 20

(731) SPAR International B.V.

Rokin 99-101, NL-1012 KM Amsterdam, Netherlands

(540)



(531) 05.01.01; 26.01.01; 26.01.03; 26.01.15; 26.04.02; 26.04.05; 26.04.24; 27.05.01; 27.05.24

(511)

35 – Advertising and business; sales promotion; demonstration of goods; professional business consul-

ting; business intermediation services, including support, for the sale of various goods; services provided by supermarkets and retailers, namely assorting (for others) of various goods (excluding their transport) enabling consumers to view and buy them at their convenience.

(260) AM 2018 95855 A

(800) 1381921

(151) 2017 10 20

(891) 2017 10 20

(731) EPO FASHION CO., LTD.

24, No.397 Xingang Road Middle, HaiZhu District, GuangZhou City 510310 Guangdong Province, China

(540)

little MO&Co.

(591) Black and white

(531) 24.17.09; 27.05.17

(511)

5 – Clothing; shoes; hats; children's clothing; layettes [clothing]; hosiery; bathing suits; waterproof clothing; masquerade costumes; girdles; gloves [clothing]; scarfs; wedding dresses.

(260) AM 2018 95897 A

(800) 1382402

(151) 2017 08 24

(891) 2017 08 24

(731) Zakrytoe aktsionerhoe obshchestvo

"KAPITAL RIGENT SECURITIES"

ul. Lyusinovskaya, 36, build. 2 RU-115093 Moscow, Russian Federation

(540)

CAH

(591) Blue

(531) 28.05; 29.01.04

(511)

6 – Common metals and their alloys; metal materials for building and construction; transportable buildings of metal; railway material of metal; non-electric cables and wires of common metal; buckles of common metal [hardware]; hardware of metal, small; works of art of common metal; metal pipes; safes; ores.

7 – Motors and engines [except for land vehicles]; machine coupling and transmission components [except for land vehicles]; agricultural implements, other than hand-operated; incubators for eggs.

8 – Hand tools and implements [hand-operated]; cutlery; side arms; razors.

12 – Vehicles; apparatus for locomotion by land, air or water.

13 – Firearms; ammunition and projectiles; explosives; fireworks.

14 – Precious metals and their alloys; jewellery plated with precious metals; jewellery; bijouterie; precious stones; horological and chronometric instruments.

17 – Unprocessed and semi-processed rubber, gutta-percha, gum, asbestos, mica and substitutes for all these materials; plastics in extruded form for use in manufacture; packing, stopping and insulating materials.

29 – Meat, fish, poultry and game; meat extracts; preserved, frozen, dried and cooked fruits and vegetables; jellies, jams, compotes; eggs; milk and milk products; edible oils and fats.

30 – Tea; sugar; rice; tapioca; sago; honey; molasses syrup; yeast; salt; mustard; vinegar; condiments; spices; ice.

31 – Raw and unprocessed agricultural, horticultural, forestry products; raw and unprocessed grains and seeds; live animals; fresh fruits and vegetables; natural plants and flowers; foodstuffs for animals; malt.

32 – Beers; mineral and aerated waters and other non-alcoholic beverages; fruit beverages and fruit juices; syrups and other preparations for making beverages.

33 – Alcoholic beverages [except beers].

35 – Office functions.

36 – Insurance; financial affairs; monetary affairs; real estate affairs.

39 – Packaging and storage of goods.

40 – Treatment of materials.

42 – Scientific and technological services and research and design relating thereto; industrial analysis and research services.

45 – Legal services; security services for the physical protection of tangible property and individuals; personal and social services rendered by others to meet the needs of individuals.

(260) AM 2018 95907 A

(800) 1382764

(151) 2017 10 30

(891) 2017 10 30

(731) Joint Stock Company "EURASIAN FOODS CORPORATION"

Bayzakov Str., 69 050026 Almaty, Kazakhstan

(540)

SUNOLA

(591) Black and white

(531) 27.05.17

(511)

29 – Meat, fish, poultry and game; meat extracts; preserved, frozen, dried and cooked fruits and vegetables (including tomato purée); jellies, jams, compotes; eggs, milk and milk products; sunflower seeds, prepared, nuts, prepared, potato chips, fruit chips.

30 – Coffee, tea, cocoa and artificial coffee, sugar, rice, tapioca and sago; frozen confectionery; honey, yeast, baking-powder; salt, vinegar, sauces [condiments], including horseradish, sauces, ketchup [sauce]; spices; edible ices; popcorn; precooked products, included in this class, pelmeni [dumplings stuffed with meat], ravioli, vareniki [stuffed dumplings].

(260) AM 2018 95910 A

(800) 1382701

(151) 2017 09 18

(891) 2017 09 18

(731) Public Joint Stock Company "INTER RAO UES"

ul. Bol'shaja Pirogovskaja, dom 27, str. 2
RU-119435 Moskva, Russian Federation

(540)

INTER  RAOUES

(591) Blue, orange and white

(531) 01.03.16; 27.05.17; 29.01.13

(511)

7 – Vending machines; welding machines, electric; soldering apparatus, gas-operated; vulcanization apparatus; acetylene cleaning apparatus; high pressure washers; apparatus for drawing up beer under pressure; apparatus for aerating water; apparatus for aerating beverages; electrical apparatus for sealing plastics [packaging]; electric arc cutting apparatus; electric arc welding apparatus; electric welding apparatus; inking apparatus for printing machines; welding apparatus, electric; fittings for engine boilers; expansion tanks [parts of machines]; drums [parts of machines]; reels, mechanical, for flexible hoses; brake shoes, other than for vehicles; concrete mixers [machines]; bobbins for weaving looms; harrows; journal boxes [parts of machines]; bulldozers; hoppers [mechanical discharging]; mine borers; truck lifts; rolling mill cylinders; crank shafts; printing rollers for machines; transmission shafts, other than for land vehicles; valves [parts of machines]; fans for motors and engines; saw benches [parts of

machines]; winnowers; vibrators [machines] for industrial purposes; bearings [parts of machines]; water heaters [parts of machines]; bellows [parts of machines]; agitators; drilling rigs, floating or non-floating; lawnmowers [machines]; card clothing [parts of carding machines]; emergency power generators; alternators; dynamos; bicycle dynamos; current generators; generators of electricity; hydraulic controls for machines, motors and engines; exhausts for motors and engines; drilling heads [parts of machines]; drilling bits [parts of machines]; cylinder heads for engines; soldering blow pipes, gas-operated; gas-operated blow torches; raking machines; stalk separators [machines]; sieves [machines or parts of machines]; mud catchers and collectors [machines]; tarring machines; hydraulic engines and motors; aeronautical engines; aeroplane engines; engines for air cushion vehicles; compressed air engines; jet engines, other than for land vehicles; engines for boats; driving motors, other than for land vehicles; engines and motors, other than for land vehicles; propulsion mechanisms, other than for land vehicles; de-aerators for feedwater; disintegrators; tympan [parts of printing presses]; holding devices for machine tools; turf removing ploughs; pump diaphragms; chisels for machines; jacks [machines]; rack and pinion jacks; moving pavements [sidewalks]; electric hand drills; crushers, electric, for household purposes; flues for engine boilers; reapers and binders; millstones; rakes for raking machines; shredders [machines] for industrial use; injectors for engines; incubators for eggs; tools [parts of machines]; hand-held tools, other than hand-operated; air condensers; control cables for machines, engines or motors; calenders; rotary steam presses, portable, for fabrics; ditchers [ploughs]; carburettors; carriages for knitting machines; crankcases for motors and engines; road rollers; reels [parts of machines]; pressure valves [parts of machines]; clack valves [parts of machines]; pressure reducers [parts of machines]; can openers, electric; cowlings [parts of machines]; machine wheels; freewheels, other than for land vehicles; machine boiler scale collectors; lasts for shoes [parts of machines]; brake pads, other than for vehicles; piston segments; grease rings [parts of machines]; reapers and threshers; coalcutting machines; compressors [machines]; air pumps [garage installations]; compressors for refrigerators; conveyors [machines]; belt conveyors; converters for steelworks; steam condensers [parts of machines]; aerocondensers; diggers [machines]; rams [machines]; thermic lances [machines]; mechanized livestock feeders; boxes for matrices [printing]; gear boxes, other than for land vehicles; grease boxes [parts of machines]; housings [parts of machines]; harvesting machines; steam engine boilers; coffee grinders, other than hand-operated; taps [parts of machines, engines or motors]; cranes [lifting and hoisting apparatus]; roller bridges; drain cocks; spray guns for paint; cranks [parts

of machines]; potters' wheels; grindstones [parts of machines]; cultivators [machines]; soldering lamps; winches; ploughshares; belts for conveyors; igniting magnetos; handling machines, automatic [manipulators]; lubricators [parts of machines]; churns; matrices for use in printing; machine fly-wheels; hair clipping machines for animals; papermaking machines; blowing machines; knitting machines; galvanizing machines; bending machines; ironing machines; mineworking machines; net hauling machines [fishing]; electroplating machines; bottle sealing machines; sealing machines for industrial purposes; embossing machines; engraving machines; finishing machines; garbage [waste] disposals; blade sharpening [stropping] machines; earth moving machines; cord making machines; lace making machines; butter machines; cigarette machines for industrial purposes; sausage making machines; stereotype machines; hosiery looms; grinding machines; dyeing machines; bottle washing machines; dishwashers; bottle filling machines; racket stringing machines; leather-working machines; dairy machines; glass working machines; tobacco processing machines; corn husking machines; painting machines; oil refining machines; peeling machines; ore treating machines; plastic processing machines; printing machines for use on sheet metal; brewing machines; color-washing machines; road sweeping machines [self-propelled]; leather paring machines; bitumen making machines; machines for making pasta; sugar making machines; weeding machines; cinder sifters [machines]; pudding machines; notchers [machine tools]; bread cutting machines; blowing machines for the compression, exhaustion and transport of gases; road making machines; railroad constructing machines; machines for the textile industry; rail-laying machines; bottle capping machines; bottle stoppering machines; packaging machines; blowing machines for the compression, sucking and carrying of grain; trash compacting machines; die-stamping machines; stamping machines; darning machines; milking machines; drainage machines; wrapping machines; grain separators; bookbinding apparatus and machines for industrial purposes; machines and apparatus for cleaning, electric; machines and apparatus for carpet shampooing, electric; machines and apparatus for polishing, electric; sizing machines; punching machines; riveting machines; kitchen machines, electric; foundry machines; smoothing presses; fleshing machines; rinsing machines; flour mill machines; typesetting machines [printing]; hemming machines; grating machines for vegetables; braiding machines; wringing machines for laundry; cutting machines; steam engines; printing machines; rotary printing presses; compressed air machines; apparatus for dressing; spinning machines; filling machines; friezing machines; cutters [machines]; satinizing machines; agricultural machines; mixing machines; sorting machines for industry; stitching machines; washing

machines [laundry]; coin-operated washing machines; clippers [machines]; spinning frames; spin driers [not heated]; looms; kneading machines; typographic machines; type-setting machines [photocomposition]; beating machines; beaters, electric; packing machines; filtering machines; molding machines; carding machines; sewing machines; typecasting machines; electromechanical machines for chemical industry; labellers [machines]; mills [machines]; mills for household purposes, other than hand-operated; pepper mills, other than hand-operated; centrifugal mills; machine wheelwork; feeders [parts of machines]; forge bellows; mixers [machines]; blenders, electric, for household purposes; vacuum cleaner bags; threshing machines; pneumatic hammers; hammers [parts of machines]; tilt hammers; power hammers; reeling apparatus, mechanical; motorized cultivators; motors for boats; clutches, other than for land vehicles; meat choppers [machines]; superchargers; pneumatic controls for machines, motors and engines; guides for machines; vacuum cleaner attachments for disseminating perfumes and disinfectants; pumps [machines]; pumps [parts of machines, engines or motors]; aerating pumps for aquaria; vacuum pumps [machines]; compressed air pumps; pumps for heating installations; beer pumps; lubricating pumps; self-regulating fuel pumps; fuel dispensing pumps for service stations; centrifugal pumps; blades [parts of machines]; knives for mowing machines; chaff cutter blades; knives, electric; shears, electric; bearing brackets for machines; pulverisers [machines]; agricultural implements other than hand-operated; axles for machines; steam traps; chucks [parts of machines]; drill chucks [parts of machines]; exhaust manifold for engines; soldering irons, gas-operated; soldering irons, electric; superheaters; gears, other than for land vehicles; reduction gears, other than for land vehicles; drilling machines; saws [machines]; chain saws; guns [tools using explosives]; glue guns, electric; compressed air guns for the extrusion of mastics; carburetter feeders; feeding apparatus for engine boilers; loading ramps; ploughs; pneumatic transporters; hangers [parts of machines]; anti-friction bearings for machines; roller bearings; self-oiling bearings; bearings for transmission shafts; ball-bearings; elevators [lifts]; hoists; lifts, other than ski-lifts; pulleys; saw blades [parts of machines]; pistons [parts of machines or engines]; dashpot plungers [parts of machines]; pistons for engines; pistons for cylinders; catalytic converters; torque converters, other than for land vehicles; fuel conversion apparatus for internal combustion engines; presses [machines for industrial purposes]; wine presses; basket presses; fodder presses; printing presses; typographic presses; swaging machines; pedal drives for sewing machines; cleaning appliances utilizing steam; food processors, electric; springs [parts of machines]; spinning wheels; punches for punching machines; vacuum cleaners; tambours for

embroidery machines; radiators [cooling] for motors and engines; sewage pulverizers; air brushes for applying color; regulators [parts of machines]; pressure regulators [parts of machines]; speed governors for machines, engines and motors; knives [parts of machines]; cutting blow pipes, gas-operated; blade holders [parts of machines]; loom shafts; gears for weaving looms; belts for machines; elevator belts; fan belts for motors and engines; dynamo belts; belts for motors and engines; adhesive bands for pulleys; robots [machines]; kick starters for motorcycles; stuffing boxes [parts of machines]; paper feeders [printing]; whisks, electric, for household purposes; sparking plugs for internal combustion engines; glow plugs for Diesel engines; brake segments, other than for vehicles; tedding machines; separators; steam/oil separators; cream/milk separators; ball rings for bearings; sowers [machines]; snow ploughs; sheaf-binding machines; shaft couplings [machines]; fruit presses, electric, for household purposes; chaff cutters; suction cups for milking machines; stands for machines; machine tools; die-cutting and tapping machines; woodworking machines; sharpening machines; bicycle assembling machines; mortising machines; stone working machines; metalworking machines; threading machines; planing machines; lathes [machine tools]; milling machines; trueing machines; metal drawing machines; rolling mills; starters for motors and engines; stators [parts of machines]; glaziers' diamonds [parts of machines]; tables for machines; derricks; slide rests [parts of machines]; couplings, other than for land vehicles; heat exchangers [parts of machines]; transmissions for machines; boiler tubes [parts of machines]; wind turbines; hydraulic turbines; turbines, other than for land vehicles; turbocompressors; connecting rods for machines, motors and engines; joints [parts of engines]; central vacuum cleaning installations; suction machines for industrial purposes; vehicle washing installations; degreasers [machines]; dust exhausting installations for cleaning purposes; mineral water making machines; sifting installations; pneumatic tube conveyors; dust removing installations for cleaning purposes; condensing installations; lifting apparatus; air suction machines; dividing machines; igniting devices for internal combustion engines; electric door closers; washing apparatus; binding apparatus for hay; extractors for mines; electric door openers; hydraulic door openers and closers [parts of machines]; pneumatic door openers and closers [parts of machines]; curtain drawing devices, electrically operated; adhesive tape dispensers [machines]; anti-pollution devices for motors and engines; beverage preparation machines, electromechanical; food preparation machines, electromechanical; elevator operating apparatus; control mechanisms for machines, engines or motors; shoe polishers, electric; machines and apparatus for wax-polishing, electric; air cushion devices for moving loads; han-

dling apparatus for loading and unloading; elevating apparatus; aprons [parts of machines]; filter presses; filters [parts of machines or engines]; filters for cleaning cooling air, for engines; molds [parts of machines]; printing plates; journals [parts of machines]; centrifugal machines; elevator chains [parts of machines]; driving chains, other than for land vehicles; transmission chains, other than for land vehicles; cylinders for motors and engines; cylinders for machines; printing cylinders; shuttles [parts of machines]; universal joints [cardan joints]; pulleys [parts of machines]; vacuum cleaner hoses; brushes [parts of machines]; dynamo brushes; brushes, electrically operated [parts of machines]; carbon brushes [electricity]; ejectors; fuel economisers for motors and engines; excavators; shovels, mechanical; agricultural elevators; motors, electric, other than for land vehicles; electrodes for welding machines; electric hammers; parquet wax-polishers, electric; cartridges for filtering machines; escalators; automatic grapnels for marine purposes.

35 – Import-export agencies; commercial information agencies; cost price analysis; rental of advertising space; account auditing; employment agencies; computerized file management; accounting; efficiency experts; demonstration of goods; transcription; opinion polling; marketing studies; business information; business investigations; marketing research; personnel recruitment; business management and organization consultancy; personnel management consultancy; professional business consultancy; business management of performing artists; news clipping services; updating of advertising material; word processing; organization of exhibitions for commercial or advertising purposes; arranging newspaper subscriptions for others; organization of trade fairs for commercial or advertising purposes; shop window dressing; business appraisals; payroll preparation; data search in computer files for others; business management assistance; commercial or Industrial management assistance; economic forecasting; auctioneering; sales promotion for others; office machines and equipment rental; rental of advertising time on communication media; publicity material rental; rental of photocopying machines; publication of publicity texts; radio advertising; bill-posting; distribution of samples; dissemination of advertising matter; advertising; advertising by mail order; television advertising; document reproduction; secretarial services; compilation of information into computer databases; systemization of information into computer databases; business inquiries; procurement services for others [purchasing goods and services for other businesses]; tax preparation; drawing up of statements of accounts; copywriting; shorthand; psychological testing for the selection of personnel; business management of hotels; public relations; modelling for advertising or sales promotion; reloca-

tion services for businesses; telephone answering for unavailable subscribers; photocopying services.

36 – Credit bureaux; debt collection agencies, real estate agencies; customs brokerage; financial analysis; leasing of farms; hire-purchase financing; savings bank services; accommodation bureaux [apartments]; rent collection; issuing of travellers' checks [cheques]; issuance of credit cards; issue of tokens of value; capital investments; insurance information, financial information; clearing, financial; insurance consultancy; financial consultancy; stock exchange quotations; business liquidation services, financial; brokerage; financial management; exchanging money; home banking; debit card services; credit card services; factoring; organization of collections, antique appraisal; jewellery appraisal; stamp appraisal; numismatic appraisal; art appraisal; financial evaluation [insurance, banking, real estate]; electronic funds transfer; securities brokerage; housing agents; insurance brokerage; loans [financing]; instalment loans; pawnbrokerage; check [cheque] verification; charitable fund raising; renting of apartments; leasing of real estate; financial sponsorship; insurance underwriting; apartment house management; real estate management; banking; retirement payment services; fiduciary; mutual funds; financing services; safe deposit services; deposits of valuables; fiscal assessments.

37 – Maintenance and repair of motors and engines, including turbine engines.

38 – Information about telecommunication; message sending; computer aided transmission of messages and images; transmission of telegrams; communications by telegrams; communications by telephone; cellular telephone communication; satellite transmission; communications by fiber [fibre] optic networks; facsimile transmission; communications by computer terminals; paging services [radio, telephone or other means of electronic communication]; telegraph services; telephone services; teleconferencing services; providing user access to global computer networks; providing telecommunications connections to a global computer network; television broadcasting; radio broadcasting; cable television broadcasting; transmission of telegrams; electronic bulletin board services [telecommunications services]; telecommunications routing and junction services.

39 – Air transport; bus transport; car transport; transport reservation; towing; vehicle breakdown assistance [towing]; water distribution; newspaper delivery; message delivery; delivery of goods; launching of satellites for others; railway transport; transportation information; marine transport; passenger transport; freight [shipping of goods]; hauling; transport of travellers; armored-car transport; boat transport; river transport; refloating of ships; trans-

port brokerage; piloting; operating canal locks; vehicle rental; stevedoring; water supplying; escorting of travellers; underwater salvage; salvage of ships; taxi transport; tram transport; transport by pipeline; ambulance transport; pleasure boat transport; salvaging; transportation logistics; arranging of tours; freighting; freight forwarding.

41 – Educational services; practical training [demonstration]; correspondence courses; vocational guidance [education or training advice]; educational examination; arranging and conducting of workshops [training]; publication of books; organization of exhibitions for cultural or educational purposes; arranging and conducting of conferences; arranging and conducting of seminars; arranging and conducting of symposiums; publication of texts, other than publicity texts; providing on-line electronic publications, not downloadable; videotape film production; production of radio and television programmes; videotape editing; recording studio services; videotaping; photography.

42 – Technical research; chemical research; geological research; calibration [measuring]; quality control; styling [industrial design]; technical project studies; surveying; engineering; construction drafting; research in the field of environmental protection; computer programming; computer software design; maintenance of computer software; creating and maintaining web sites for others; urban planning; land surveying.

(260) AM 2018 95917 A

(800) 1382837

(151) 2017 10 18

(891) 2017 10 18

(731) AS 24

1 boulevard du Zenith, Parc Tertiaire
Ar Mor F-44800 Saint-Herblain, France

(540)



(591) Blue, Yellow, White

(531) 26.04.02; 26.04.17; 26.04.22; 26.04.24;
27.05.01; 27.05.24; 27.07.01; 27.07.24;
29.01.13

(511)

9 – Software for the processing of electronic payments; secure payment software on internet-type computer communication networks; credit and payment cards; magnetic identity cards; data processing equipment, mechanisms for coin-operated apparatus; electronic payment terminals, electronic wallets; apparatus used for securing, identifying and authenticating orders given by computers or any type of computer or telephone terminal; apparatus used for

securing bank operations and electronic data transfers; code generators.

35 – Subscription to a provider of access to a computer network for telecommunication or data transmission; business advice and business information services, commercial promotion of all kinds and on all media including via a computer communication network (such as the Internet or Intranet) and especially through the provision of temporary user codes; tracking, analysis and reporting of card holders' behavior relating to purchase; provision of information on the purchase of goods and services via computer networks.

36 – Banking business, financial services; electronic payment services; remote payment services; payment management services; bank, credit, debit, payment and other card or check services affording financial advantages; online banking operations; provision of payment facilities and financing whether via a telephone or a computer terminal; processing of payments for the purchase of goods and services via an electronic communication network.

38 – Secure transmission of data, particularly with access codes; downloading of data via access code; communication of data accessible by access code; computer transmission of information accessible via a code or a terminal.

(260) AM 2018 95918 A

(800) 1382859

(151) 2017 04 05

(891) 2017 04 05

(731) ESSITY HYGIENE AND HEALTH

AKTIEBOLAG

SE-405 03 Göteborg, Sweden

(540)



(591) Black and white

(531) 05.05.20; 05.05.21; 27.05.17

(511)

3 – Bleaching preparations; substances for laundry use; detergents; cleaning polishing, scouring and abrasive preparations; skin care products, namely washing creams, cleansing creams, moisturizers, skin lotions, barrier creams, zinc creams, hand-washing substances, soaps, cakes of soap; perfumery, essential oils; bath oils; shampoos and conditioners; hair gels; after-shave lotions; toothpaste; deodorants; disposable impregnated paper and cotton articles (toiletries) for cleaning, personal sanitary and cosmetic purposes; cotton wool; cotton sticks; cleaning and polishing paper containing cellulose or not.

5 – Disposable paper and cotton articles impregnated with pharmaceutical lotions for cleaning and sanitary

purposes; breast nursing pads; disposable diapers; diaper pants; disposable diapers, diaper pants and other absorbent articles; nappy liners, sanitary panty liners; tampons; sanitary napkins (towels) and other absorbent articles for sanitary purposes; ointments; diagnostic agents for pharmaceutical use; wound cleansing set composed of medical cleansers for wounds and wound dressings; plasters, dressings, wound dressings, medical strips, bandages for sanitary purposes (and/or medical purposes).

9 – Computer software in all forms containing information relating to all aspects of health care, personal care, incontinence care and geriatric care; computer software related to the measurement of patterns of urination; apparatus for the transmission of data; data storage devices; data processing equipment and accessories, communication equipment; sensors and detectors; software for analyzing business management and customer services for analyzing traffic and visitor data, consumption and stock levels; software for steering and optimizing operations, software for improvement of quality; software for providing information to customers and staff relating to traffic and visitor data, consumption and stock levels; software in form of apps; computer systems for automatic control of ventilating, air-purifying and air-freshening apparatus and installations, sanitary apparatus and installations, in particular toilets, urinals (sanitary fixtures), wash bowls, hand drying apparatus, towel dispensers, soap dispensers, toilet paper dispensers, aerosol containers; all mentioned except for software for data protection and software applications for data protection.

10 – Orthopedic support dressings and orthopedic bandages and hosiery; medical compression stockings, tights and socks, medical support stockings; casting tapes and bandages for orthopedic purposes; splints for surgical purposes; orthopedic articles; padding material for orthopedic purposes (included in this class).

16 – Paper; paper wipes containing cellulose or not, for wiping dry; paper products for household, hygienic, sanitary and cosmetic purposes, namely tissue paper, kitchen rolls, toilet paper, paper handkerchiefs, cellulose wipes, paper hand towels, paper napkins, paper serviettes, paper wash cloths, paper towels, paper tissues, babies bibs of paper, face towels of paper, facial tissues of paper; protective covers made of paper, namely bibs of paper, paper pads for changing nappies; printing products, namely colour prints, printed emblems, printed patterns, printed paper labels, graphic prints; printing paper, fine paper; writing paper, newsprint, paper for books, newspapers, catalogues, magazines and other printed matters; packagings made of paper or plastic; plastic material for packaging of soaps, degreasing agents, detergents; table linen of paper, absorbent paper.

20 – Non-metallic fixed stands (holders) and dispensers for products made of paper, namely towels, serviettes, kitchen rolls and toilet rolls; bins, bins for disposal of sanitary products.

21 – Household stands (holders), holders, containers and dispensers for paper, paper towels, liquid soap, air fresheners and other household, kitchen and toilet products; cleaning cloths; household and kitchen utensils and containers (not of precious metal or coated therewith).

24 – Woven fabrics and textile goods not included in other classes; bed and table linen, woven, non-woven; bed and table covers, under sheets.

35 – Business information services provided on-line from a computer database or the internet; distribution of samples; systematization of data in databases.

38 – Providing access to a compilation of information from computer databases matter in relation to health care, hygienic care and geriatric care; providing access to a global computer network for the transfer and dissemination of information.

41 – Education; education services relating to personal care, health care and geriatric care; arranging and conducting of educational seminars in relation to personal care, health care and geriatric care.

42 – Industrial analysis and research services in the field of the paper industry including area of paper and cotton products for household, hygienic, sanitary and cosmetic purposes; quality assurance consultancy; advice and analysis relating to improvement of quality in relation to analysis of traffic and visitor data, product consumption and stock levels.

44 – Healthcare; consulting services relating to health; individualised and group healthcare services provided through planning, organizing and monitoring, the aforementioned services also provided online or via the internet; hygienic and beauty care for human beings.

(260) AM 2018 95919 A

(800) 1382869

(151) 2017 02 22

(891) 2017 02 22

(731) EXPERIAN TECHNOLOGY LIMITED

The Sir John Peace Building, Experian
Way, NG2 Business Park, Nottingham
NG80 1ZZ, United Kingdom

(540)



(591) Dark blue; light blue; purple; shades of pink

(531) 26.04.01; 26.04.04; 27.05.01; 27.05.17;

29.01.13

(511)

9 – Commercial information agency software; communication installations; communications software; computer programs & software; credit bureau software; credit consultancy software; database management software; databases, data sets and software relating to account management (including credit accounts); databases, data sets and software relating to advertising; databases, data sets and software relating to bank accounts; databases, data sets and software relating to bank sort codes; databases, data sets and software relating to billing; databases, data sets and software relating to biometric data; databases, data sets and software relating to business research; databases, data sets and software relating to candidate verification; databases, data sets and software relating to companies and unincorporated businesses; databases, data sets and software relating to comparisons of items (whether goods or services) by price and/or other attributes; databases, data sets and software relating to competitors; databases, data sets and software relating to consumer lifestyle information; databases, data sets and software relating to consumer values; databases, data sets and software relating to creating, managing and printing maps; databases, data sets and software relating to credit application processing; databases, data sets and software relating to credit assessment and credit screening; databases, data sets and software relating to credit scorecards; databases, data sets and software relating to credit strategy management; databases, data sets and software relating to customer profiling; databases, data sets and software relating to customer relationship management; databases, data sets and software relating to customers and potential customers; databases, data sets and software relating to data processing and data cleansing; databases, data sets and software relating to data searching; databases, data sets and software relating to digital certificates; databases, data sets and software relating to financial asset management; databases, data sets and software relating to financial information; databases, data sets and software relating to fraud prevention and detection; databases, data sets and software relating to geodemographic analysis and profiling; databases, data sets and software relating to health information; databases, data sets and software relating to identity documents; databases, data sets and software relating to identity verification and authentication; databases, data sets and software relating to image recognition; databases, data sets and software relating to insurance claims; databases, data sets and software relating to insurance perils; databases, data sets and software relating to known aliases used by individuals; databases, data sets and software relating to known associations bet-

ween individuals; databases, data sets and software relating to loyalty schemes; databases, data sets and software relating to names of individuals and organisations; databases, data sets and software relating to passports; databases, data sets and software relating to pedestrian and vehicle traffic (including bicycles, cars, motorbikes, goods vehicles or aircraft); databases, data sets and software relating to petrol stations and their facilities; databases, data sets and software relating to postal codes and addresses; databases, data sets and software relating to property (whether real and/or intangible); databases, data sets and software relating to public record information; databases, data sets and software relating to retail site location; databases, data sets and software relating to risk management; databases, data sets and software relating to tenants or prospective tenants; databases, data sets and software relating to vehicles and vehicle parts; databases, data sets and software relating to voters and registers of voters; databases, data sets, software and apparatus relating to image capture and image processing; databases, data sets, software and apparatus relating to payment processing; non-volatile media (including CDs, DVDs, tapes and video cassettes and other devices) for recording data, sound, images, text or other information; publications in electronic form; software (including for mobile devices) relating to financial education.

35 – Billing services; business continuity services; business information services, business management; business research services; collection of data; commercial information agency services; company and non-corporate enterprise information services; comparisons of items (whether goods or services) by price and/or other attributes; competitor information services; compilation of information onto databases; computerised data verification; consumer lifestyle information services; consumer values information services; customer loyalty services; customer profiling services; customer relationship management services; customer targeting and marketing services; data analysis services; data cleansing services; data management services; data processing services; data retrieval services; data searching services; database management services; employee record and employee history verification services; geodemographic analysis and profiling services; rental of mailing lists; services to screen mailing lists to remove inappropriate content for compliance purposes; local market planning services; market analysis bureau services; market penetration information services; market research services; postcode analysis services for business purposes; provision of information about companies and unincorporated businesses; provision of information about postal codes and addresses; retail site location services; business risk management services; telephone call handling services; opinion polling; voters roll information services;

public record information services (terms considered too vague by the International Bureau – Rule 13 (2) (b) of the Common Regulations).

36 – Consumer credit history services; credit account management services; credit agency services; credit assessment services; credit bureau services; credit consultancy services; credit evaluation services; credit information services; credit rating services; credit risk assessment services; credit risk information services; credit scoring and credit scorecard services; credit screening services; credit strategy management services; debt collection services; financial asset location services; financial database services; financial sponsorship; fraudulent credit application detection services; insurance claims assessments; preparation of credit reports; previous credit application history services; property related valuation and categorisation services; provision of financial information; real estate evaluation services; vehicle finance information services; bank account information services; credit application processing services; credit assessment and credit screening services; financial asset management services; insurance perils services; insurance risk and claims information services; account management (including credit accounts) services; financial affordability assessment services; consultancy services regarding financial economics; economic research services (financial); financial feasibility study services; financial modelling services.

42 – Cartography services; maps stored or viewed in electronic form; computer analyst and programming services; computer database consultancy services; computer disaster recovery services (computer); computerised analysis of data; data security services; database design services; geodemographic coding services; industrial research services; information systems design services; maintenance and updating of computer software; recovery of computer data; rental of computer hardware and software; testing of databases, data, electronic apparatus and/or computer software; web pages creation services; disaster recovery services; computerised data storage services.

45 – Access control (for security) services; age verification services; biometric security services; electronic signature authentication and verification services; identity of individuals authentication and verification services; identity theft prevention and identity theft detection services; information security services; issuing digital identity certificates; passport authentication and verification services; providing background identification and verification of individuals check services; provision of information about criminals or suspected criminals; provision of information relating to vehicle verification, mileage and condition for fraud prevention and detection purposes; registration services for notification of loss; se-

curity consultancy services; services for providing information on aliases (assumed names) and third parties with whom they have an association; alias and association information services; candidate verification services; provision of information about names of individuals and/or organizations; vehicle (and vehicle parts) information services, namely identification of a vehicle's history, including details of ownership, vehicle identifiers (such as VIN numbers, engine numbers, parts numbers and other serial numbers); fraud prevention and detection services; licensing of intellectual property; forensic analysis services relating to databases, data, electronic apparatus and/or computer software; provision of domain names; public record information services; tenant identification verification services.

(260) AM 2018 95921 A

(800) 1382871

(151) 2017 03 21

(891) 2017 03 21

(731) LC WAİKİKİ MAĞAZACILIK
HİZMETLERİ TİCARET ANONİM
ŞİRKETİ

Evren Mahallesi, Gülbahar Caddesi, No:96
Bağcılar – İstanbul, Turkey

(540)

LCW HOME

(591) Black and white

(526) HOME

(511)

3 – Bleaching and cleaning preparations, detergents other than for use in manufacturing operations and for medical purposes, laundry bleach, fabric softeners for laundry use, stain removers, dishwasher detergent; perfumery; cosmetics (except medicated cosmetics); fragrances; deodorants for personal use and animals; soaps (except medicated soap); dental care preparations, dentifrices, denture polishes, tooth whitening preparations, mouth washes, not for medical purposes; abrasive preparations; emery cloth; sandpaper; pumice stone; abrasive pastes; polishing preparations for leather, vinyl, metal and wood, polishes and creams for leather, vinyl, metal and wood, wax for polishing.

4 – Industrial oils and greases; cutting fluids; dust absorbing, wetting and binding compositions; solid fuels, coal, firewood; liquid and gas fuels; petrol, diesel oil, liquified petroleum gas, natural gas, fuel oil and their non-chemical additives; candles; wicks; semi-finished wax; wax and paraffin for lighting purposes.

5 – Pharmaceutical and veterinary preparations for medical purposes; chemical preparations for medical and veterinary purposes, chemical reagents for pharmaceutical and veterinary purposes, radioactive sub-

stances for medical and veterinary purposes; medicated cosmetics; dietary supplements for pharmaceutical and veterinary purposes; dietary supplements for human consumption; dietary supplements for animals; nutritional supplements; medical preparations for slimming purposes; food for babies; herbs and herbal beverages adapted for medicinal purposes; dental preparations and articles, teeth filling material, dental impression material, dental adhesives and material for repairing teeth; sanitary preparations for medical use; hygienic pads; hygienic tampons; plasters; materials for dressings; diapers, including those made of paper and textiles; babies' diapers of paper; babies' diapers of textile, babies' napkins of paper, adult diapers of paper, adult diapers of textile, diapers for pets; preparations for destroying vermin; fungicides, herbicides; rodenticides; deodorants, other than for human beings or for animals; air deodorising preparations; disinfectants; antiseptics; detergents for medical purposes; medicated soap, disinfectant soap, antibacterial hand lotions.

16 – Paper and cardboard; paper and cardboard for packaging and wrapping purposes, cardboard boxes; paper towels; toilet paper; paper napkins; plastic materials for packaging and wrapping purposes; printing blocks and types; bookbinding material; printed publications; printed matter; books, magazines, newspapers, bill books, printed dispatch notes, printed vouchers, calendars; posters; photographs [printed]; paintings; stickers [stationery]; postage stamps; stationery, office stationery, instructional and teaching material [except furniture and apparatus]; writing and drawing implements; artists' materials; paper products for stationery purposes; adhesives for stationery purposes, pens, pencils, erasers, adhesive tapes for stationery purposes, cardboard cartons [artists' materials], writing paper, copying paper, paper rolls for cash registers, drawing materials, chalkboards, painting pencils, watercolors [paintings]; office requisites; paint rollers and paintbrushes for painting.

18 – Unworked or semi-worked leather and animal skins, imitations of leather, stout leather, leather used for linings; goods made of leather, imitations of leather or other materials, designed for carrying items, included in this class; bags, wallets, boxes and trunks made of leather or stout leather; keycases, trunks [luggage], suitcases; umbrellas; parasols; sun umbrellas; walking sticks; whips; harness; saddlery; stirrups; straps of leather (saddlery).

20 – Furniture, made of any kind of material; mattresses, pillows, air mattresses and cushions, not for medical purposes, water beds, not for medical purposes; mirrors; beehives, artificial honeycombs and sections of wood for honeycombs; bouncing chairs for babies, playpens for babies, cradles, infant walkers; display boards, frames for pictures and paintings, identification plates, identification tags, name-

plates, identification tags of wood or synthetic materials; packaging containers of wood or plastics, casks for use in transportation or storage, barrels, storage drums, tanks, boxes, storage containers, transportation containers, chests, loading pallets and closures for the aforementioned goods, of wood or plastics; small hardware goods of wood or synthetic materials included in this class, furniture fittings, of wood or synthetic materials; ornaments and decorative goods of wood, cork, reed, cane, wicker, horn, bone, ivory, whalebone, shell, amber, mother-of-pearl, meerschaum, beeswax, plastic or plaster, included in this class, namely figurines, holiday ornaments for walls and sculptures, all made of wood, cork, reed, cane, wicker, horn, bone, ivory, whalebone, shell, amber, mother-of-pearl, meerschaum, beeswax, plastic or plaster; baskets, fishing baskets; kennels, nesting boxes and beds for household pets; portable ladders and mobile boarding stairs of wood or synthetic materials; bamboo curtains, roller indoor blinds [for interiors], slatted indoor blinds, bead curtains for decoration, curtain hooks, curtain rings, curtain tie-backs, curtain rods; non-metal wheel chocks.

21 – Hand-operated non-electric cleaning instruments and appliances, brushes, other than paintbrushes, steel chips for cleaning, sponges for cleaning, steel wool for cleaning, cloths of textile for cleaning, gloves for dishwashing, non-electric polishing machines for household purposes, brooms for carpets, mops; toothbrushes, electric toothbrushes, dental floss, shaving brushes, hair brushes, combs; non-electric household or kitchen utensils, included in this class, [other than forks, knives, spoons], services [dishes], pots and pans, bottle openers, flower pots, drinking straws, non-electric cooking utensils; ironing boards and shaped covers therefor, drying racks for washing, clothes drying hangers; cages for household pets, indoor aquariums, vivariums and indoor terrariums for animals and plant cultivation; ornaments and decorative goods of glass, porcelain, earthenware or terra cotta, included in this class, namely statues, figurines and vases, all made of glass, porcelain, earthenware or terra cotta, cups, not of precious metal, vases of fired clay; mouse traps, insect traps, electric devices for attracting and killing flies and insects, fly catchers, fly swatters; perfume burners, perfume sprayers, perfume vaporizers, electric or non-electric make-up removing appliances, powder puffs, toilet cases; nozzles for sprinkler hose, nozzles for watering cans, watering devices, garden watering cans; unworked or semi-worked glass, except building glass, mosaics of glass and powdered glass for decoration, except for building, glass wool other than for insulation or textile use.

24 – Woven or non-woven textile fabrics; textile goods for household use, not included in other classes: curtains, bed covers, sheets (textile), pillowca-

ses, blankets, quilts, towels; flags, pennants, labels of textile; swaddling blankets.

25 – Clothing, including underwear and outerclot-
hing, other than special purpose protective clothing; socks, mufflers [clothing], shawls, bandanas, scarves, belts [clothing]; footwear, shoes, slippers, sandals; headgear, hats, caps with visors, berets, caps [headwear], skull caps.

27 – Carpets, rugs, mats; prayer rugs; linoleum, artificial turf, linoleum for covering floors; gymnasium mats; wallpaper, wall hangings not of textile.

35 – Advertising, marketing and public relations; organization of exhibitions and trade fairs for commercial or advertising purposes; design of advertising materials; office functions; secretarial services; arranging newspaper subscriptions for others; compilation of statistics; rental of office machines; systemization of information into computer databases; telephone answering for unavailable subscribers; business management, business administration and business consultancy; accounting; commercial consultancy services; personnel recruitment, personnel placement, employment agencies, import-export agencies; temporary personnel placement services; auctioneering; the bringing together, for the benefit of others, of a variety of goods, namely, bleaching and cleaning preparations, detergents other than for use in manufacturing operations and for medical purposes, laundry bleach, fabric softeners for laundry use, stain removers, dishwasher detergent, perfumery, cosmetics (except medicated cosmetics), fragrances, deodorants for personal use and animals, soaps (except medicated soap), dental care preparations, dentifrices, denture polishes, tooth whitening preparations, mouth washes, not for medical purposes, abrasive preparations, emery cloth, sandpaper, pumice stone, abrasive pastes, polishing preparations for leather, vinyl, metal and wood, polishes and creams for leather, vinyl, metal and wood, wax for polishing, industrial oils and greases, cutting fluids, dust absorbing, wetting and binding compositions, solid fuels, coal, firewood, liquid and gas fuels, petrol, diesel oil, liquified petroleum gas, natural gas, fuel oil and their non-chemical additives, candles, wicks, semi-finished wax, wax and paraffin for lighting purposes, pharmaceutical and veterinary preparations for medical purposes, chemical preparations for medical and veterinary purposes, chemical reagents for pharmaceutical and veterinary purposes, radioactive substances for medical and veterinary purposes, medicated cosmetics, dietary supplements for pharmaceutical and veterinary purposes, dietary supplements for human consumption, dietary supplements for animals, nutritional supplements, medical preparations for slimming purposes, food for babies, herbs and herbal beverages adapted for medicinal purposes, dental preparations and articles, teeth filling material, dental impression material, dental

adhesives and material for repairing teeth, sanitary preparations for medical use, hygienic pads, hygienic tampons, plasters, materials for dressings, diapers, including those made of paper and textiles, babies diapers of paper, babies diapers of textile, babies napkins of paper, adult diapers of paper, adult diapers of textile, diapers for pets, preparations for destroying vermin, fungicides, herbicides, rodenticides, deodorants, other than for human beings or for animals, air deodorising preparations, disinfectants, antiseptics, detergents for medical purposes, medicated soap, disinfectant soap, antibacterial hand lotions, paper and cardboard, paper and cardboard for packaging and wrapping purposes, cardboard boxes, paper towels, toilet paper, paper napkins, plastic materials for packaging and wrapping purposes, printing blocks and types, bookbinding material, printed publications, printed matter, books, magazines, newspapers, bill books, printed dispatch notes, printed vouchers, calendars, posters, photographs [printed], paintings, stickers [stationery], postage stamps, stationery, office stationery, instructional and teaching material [except furniture and apparatus], writing and drawing implements, artists' materials, paper products for stationery purposes, adhesives for stationery purposes, pens, pencils, erasers, adhesive tapes for stationery purposes, cardboard cartons [artists' materials], writing paper, copying paper, paper rolls for cash registers, drawing materials, chalkboards, painting pencils, watercolors [paintings], office requisites, paint rollers and paintbrushes for painting, chaplets (rosaries), unworked or semi-worked leather and animal skins, imitations of leather, stout leather, leather used for linings, goods made of leather, imitations of leather or other materials, designed for carrying items, bags, wallets, boxes and trunks made of leather or stout leather, keycases, trunks [luggage], suitcases, umbrellas, parasols, sun umbrellas, walking sticks, whips, harness, saddlery, stirrups, straps of leather (saddlery), furniture, made of any kind of material, mattresses, pillows, air mattresses and cushions, not for medical purposes, water beds, not for medical purposes, mirrors, beehives, artificial honeycombs and sections of wood for honeycombs, bouncing chairs for babies, playpens for babies, cradles, infant walkers, display boards, frames for pictures and paintings, identification plates, identification tags, nameplates, identification tags of wood or synthetic materials, packaging containers of wood or plastics, casks for use in transportation or storage, barrels, storage drums, tanks, boxes, storage containers, transportation containers, chests, loading pallets and closures for the aforementioned goods, of wood or plastics, small hardware goods of wood or synthetic materials, furniture fittings, of wood or synthetic materials, ornaments and decorative goods of wood, cork, reed, cane, wicker, horn, bone, ivory, whalebone, shell, amber, mother-of-pearl, meerschaum, beeswax, plastic or plaster,

namely figurines, holiday ornaments for walls and sculptures, all made of wood, cork, reed, cane, wicker, horn, bone, ivory, whalebone, shell, amber, mother-of-pearl, meerschaum, beeswax, plastic or plaster, baskets, fishing baskets, kennels, nesting boxes and beds for household pets, portable ladders and mobile boarding stairs of wood or synthetic materials, bamboo curtains, roller indoor blinds [for interiors], slatted indoor blinds, bead curtains for decoration, curtain hooks, curtain rings, curtain tie-backs, curtain rods, non-metal wheel chocks, hand-operated non-electric cleaning instruments and appliances, brushes, other than paintbrushes, steel chips for cleaning, sponges for cleaning, steel wool for cleaning, cloths of textile for cleaning, gloves for dishwashing, non-electric polishing machines for household purposes, brooms for carpets, mops, toothbrushes, electric toothbrushes, dental floss, shaving brushes, hair brushes, combs, non-electric household or kitchen utensils [other than forks, knives, spoons], services [dishes], pots and pans, bottle openers, flower pots, drinking straws, non-electric cooking utensils, ironing boards and shaped covers therefor, drying racks for washing, clothes drying hangers, cages for household pets, indoor aquariums, vivariums and indoor terrariums for animals and plant cultivation, ornaments and decorative goods of glass, porcelain, earthenware or clay, namely statues, figurines and vases, all made of glass, porcelain, earthenware or clay and cups, not of precious metal, mouse traps, insect traps, electric devices for attracting and killing flies and insects, fly catchers, fly swatters, perfume burners, perfume sprayers, perfume vaporizers, electric or non-electric make-up removing appliances, powder puffs, toilet cases, nozzles for sprinkler hose, nozzles for watering cans, watering devices, garden watering cans, unworked or semi-worked glass, except building glass, mosaics of glass and powdered glass for decoration, except for building, glass wool other than for insulation or textile use, woven or non-woven textile fabrics, textile goods for household use, curtains, bed covers, sheets (textile), pillowcases, blankets, quilts, towels, flags, pennants, labels of textile, swaddling blankets, clothing, including underwear and outer clothing, other than special purpose protective clothing, socks, mufflers [clothing], shawls, bandanas, scarves, belts [clothing], footwear, shoes, slippers, sandals, headgear, hats, caps with visors, berets, caps [headwear], skull caps, carpets, rugs, mats, prayer rugs, linoleum, artificial turf, linoleum for covering floors, gymnasium mats, wallpaper, wall hangings not of textile, enabling customers to conveniently view and purchase those goods, such services may be provided by retail stores, wholesale outlets, by means of electronic media or through mail order catalogues.

(260) AM 2018 95923 A

(800) 1382883

(151) 2017 06 27

(891) 2017 06 27

(731) MARKER DALBELLO VÖLKL

(INTERNATIONAL) GMBH

Ruessenstrasse 6, CH-6340 Baar, Switzerland

(540)

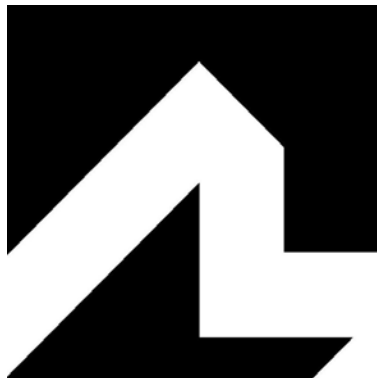

(591) Black and white

(531) 26.04.12; 26.04.24; 26.11.06; 26.11.13;
26.11.25

(511)

9 – Sports helmets; protective helmets for sports; spectacles for athletes; ski goggles.

18 – Bags, namely, handbags; luggage; tote bags; fanny packs; duffel bags; clutch bags; drawstring pouches; all-purpose sports bags; travel bags; ruck-sacks.

25 – Clothing, namely, shirts; sports suits; skirts; sweatshirts; t-shirts; shorts; socks; vests; jackets and pants; undergarments; headwear, namely, skiing caps, snowboarding caps, tennis caps; headbands and hats; ski gloves and snowboard gloves; ski boots; after-ski boots; snowboard boots and tennis shoes; bags for ski boots.

28 – Sports equipment and sporting goods, namely, skis and snowboards; ski poles; ski bindings and snowboard bindings; tennis racquets; squash racquets; racquetball racquets; badminton racquets; bags for skis, snowboards, tennis racquets, squash racquets, racquetball racquets, badminton racquets; climbing skins for use with touring skis; crampons for use with ski bindings; back protectors for sports people; shin, knee and elbow protectors, namely kneepads for sports, shin guards (sports articles), elbow pads for sports; grip tape and strings for racquets.

41 – Arranging and conducting sporting competitions; providing of sporting facilities for camps.

(260) AM 2018 95924 A

(800) 1382885

(151) 2017 08 08

(891) 2017 08 08

(731) I LAN FOODS INDUSTRIAL CO., LTD.

No.19-13, Xincheng North Rd., Su'ao

Township Yilan County, Taiwan, China

(540)



(591) Black and white

(531) 02.05.06; 02.09.01

(511)

29 – Meat; poultry, not live; game, not live; broth concentrates; meat extracts; fish fillets; fish, not live; shrimps, not live; clams [not live]; shellfish, not live; sea-cucumbers, not live; meat, tinned; crystallized fruits; vegetables, preserved; eggs; powdered eggs; milk products; milk beverages, milk predominating; edible fats; fruit salads; vegetable salads; pectin for culinary purposes; jellies for food; nuts, prepared; dried edible fungi; albumen for culinary purposes; milk of almonds [beverage]; dairy product substitutes.

30 – Coffee; vegetal preparations for use as coffee substitutes; cocoa; cocoa beverages with milk; tea; sugar; bread; candy; honey; golden syrup; pastries; rice; cereal preparations; groats for human food; husked oats; wheat flour; chips [cereal products]; pop corn; cereal-based snack food; rice-based snack food; soya flour; farinaceous foods; starch for food; sherbets [ices]; edible ices; ice cream; powders for making ice cream; ice, natural or artificial; ice for refreshment; cooking salt; soya sauce; vinegar; mustard; sauces [condiments]; chow-chow [condiment]; soya bean paste [condiment]; fruit coulis (sauces); yeast; flavourings, other than essential oils, for beverages; meat tenderizers, for household purposes; flowers or leaves for use as tea substitutes; noodles; macaroni.

32 – Beer; non-alcoholic beverages; whey beverages; preparations for making beverages; syrups for beverages; preparations for making mineral water.

(260) AM 2018 95925 A

(800) 1382892

(151) 2017 07 14

(891) 2017 07 14

(731) PCC Consumer Products Kosmet sp. z o.o.

ul. Sienkiewicza 4 PL-56-120 Brzeg Dolny,
Poland

(540)

(591) Blue, navy blue and light blue

(531) 27.05.01; 27.05.03; 29.01.04

(511)

3 – Laundry products and preparations, washing powders and liquids, rinsing liquids, laundry fabric softeners, laundry bleach, stain removers, starch for laundry use, stain removing and descaling preparations, detergents, detergents for household use, washing-up detergents, dishwashing liquids and preparations, drying agents for dishwashing machines, washing, cleaning, polishing, scouring and abrasive substances and preparations for household use, all-purpose cleaning preparations, window cleaning liquids and preparations, bleaching preparations for household use, destainers, de-greasing preparations for household purposes, preparations for unblocking drain pipes, cloths impregnated with a detergent for cleaning, impregnated cloths for polishing, fruit and vegetable wash, room perfumes in spray form, room scenting sprays, incense, potpourris, room fragranting preparations, scented sachets, air fragranting preparations, soaps.

5 – Disinfectants, sanitizers for household use, germicides, fungicides, substances and preparations for sanitary hygiene and for destroying vermin for household use, antibacterial and disinfectant soaps, air deodorising preparations, deodorants for textiles, deodorants for clothing, preparations for the neutralising of odours.

(260) AM 2018 95953 A

(800) 1383715

(151) 2017 04 05

(891) 2017 04 05

(731) Obshchestvo s ogranichennoj otvetstvennostyu "PARIKMAHERSKAYA № 1"
ul. Krasnodarskaya, 65/18, korp. 1,
RU-109469 Moscow, Russian Federation

(540)



(591) Black, dark purple, purple, pink and white

(531) 07.01.08; 26.11.08; 28.05; 29.01.13

(511)

44 – Hair implantation; manicuring; massage; hairdressing; medical assistance; beauty salon services; sanatorium services; tattooing; visagists' services; solarium services; physical therapy; plastic surgery; medical clinic services; chiropractic.

(260) AM 2018 95954 A

(800) 1383749

(151) 2017 11 07

(891) 2017 11 07

(731) "BELUGA MARKET", LLC

Proletarskaya street, 40A, Zvenigorog,
RU-143180 Moscow region, Russian
Federation

(540)

COPPER HORSE

(591) Black, white

(511)

33 – Aperitifs; arrack; brandy; wine; piquette; whiskey; vodka; anisette [liqueur]; kirsch; gin; digesters [liqueurs and spirits]; cocktails; anise [liqueur]; liqueurs; pre-mixed alcoholic beverages, other than beer-based; alcoholic beverages, except beer; alcoholic beverages containing fruit; spirits [beverages]; distilled beverages; mead (hydromel); peppermint liqueurs; bitters; nira (sugarcane-based alcoholic beverage); rum; sake; perry; cider; rice alcohol; alcoholic extracts; alcoholic fruit extracts; alcoholic essences.

(260) AM 2018 95963 A

(800) 1384050

(151) 2017 07 11

(891) 2017 07 11

(731) CA' DA MOSTO S.P.A.

Via Venezia, 146, I-30037 SCORZE' (VE),
Italy

(540)

SEVENTY

(591) Black, white

(531) 27.05.01

(511)

3 – Almond soap; soap; shaving soap; hair lotions; cleansing milk for toilet purposes; shampoos; soap for foot perspiration; deodorant soap; cakes of toilet soap; antiperspirant soap; bath salts, not for medical purposes; dry shampoo; shampoo; ointments for cosmetic use; conditioning balsam; hair conditioner; facial cleansing milk; bath lotion; cosmetic bath salts; non-medicated hand lotions; lacquer-removing preparations; creams for leather; leather preserving polishes; almond oil; badian essence; bergamot oil; es-

sential oils of cedarwood; essential oils of lemon; ethereal essences; essential oils; extracts of flowers [perfumes]; flower bases for perfumes; fumigation preparations [perfumes]; gaultheria oil; geraniol; heliotropine; jasmine oil; lavender oil; oils for perfumes and scents; rose oil; mint essence [essential oil]; mint for perfumery; musk [perfumery]; perfumery; terpenes [essential oils]; aromatics [essential oils]; cosmetic oils; perfumes for industrial purposes; scented soaps; oils for perfumes and scents; amber [perfume]; cosmetic preparations for baths; lipsticks; cotton sticks for cosmetic purposes; beauty masks; skin whitening creams; nail polish; make-up preparations; hair dyes; hair waving preparations; false eyelashes; cosmetic preparations for eyelashes; eau de Cologne; cosmetic kits; cosmetics; cotton wool for cosmetic purposes; cosmetic pencils; cosmetic creams; make-up removing preparations; lavender water; scented water; depilatory preparations; depilatory wax; make-up; petroleum jelly for cosmetic purposes; greases for cosmetic purposes; hydrogen peroxide for cosmetic purposes; toilettries; eyebrow cosmetics; neutralizers for permanent waving; perfumes; false nails; nail care preparations; cosmetic preparations for skin care; pomades for cosmetic purposes; make-up powder; shaving preparations; eyebrow pencils; cosmetic dyes; antiperspirants [toilettries]; almond milk for cosmetic purposes; sun-screen preparations; sun-tanning preparations [cosmetics]; beard dyes; cosmetic preparations for slimming purposes; deodorants for human beings; decorative transfers for cosmetic purposes; astringents for cosmetic purposes; bleaching preparations [decolorants] for cosmetic purposes; tissues impregnated with cosmetic lotions; after-shave lotions; hair spray; mascara; anti-wrinkle cream; eye shadow; hair colourants; hair tonic; hair dyeing preparations; dentifrices; preparations for cleaning dentures; breath freshening sprays; dental bleaching gels; scented wood; incense; sachets for perfuming linen; potpourris [fragrances]; cosmetics for animals; air fragrance preparations.

9 – Optical lenses; optical goods; eyeglass chains; eyeglass cases; spectacle glasses; eyeglass frames; pince-nez; eyeglasses; sunglasses.

14 – Precious metals, unwrought or semiwrought; alloys of precious metal; boxes of precious metal; jewelry cases [caskets]; bracelets [jewellery]; charms [jewellery]; trinkets [jewellery]; brooches [jewellery]; chains [jewellery]; necklaces [jewellery]; tie clips; diamonds; jewellery; ornamental pins; semi-precious stones; precious stones; statues of precious metal; paste jewellery [costume jewellery]; rings [jewellery]; earrings; cuff links; figurines [statuettes] of precious metal; tie pins; key rings [trinkets or fobs]; clocks; wristwatches; watch bands; watch chains; chronographs [watches]; chronometers; clock cases; watches; watch glasses; movements for clocks

and watches; alarm clocks; watch cases; stopwatches.

18 – Woman's bags, woman's handbags, woman's purses, all for formal wear.

25 – Overalls; shoulder wraps; camisoles; underclothing; dressing gowns; sweaters; shirts; short-sleeve shirts; clothing; furs [clothing]; tights; combinations [clothing]; corselets; suits; ready-made clothing; trousers; outerclothing; knitwear [clothing]; corsets [underclothing]; waistcoats; coats; jerseys [clothing]; skirts; sports jerseys; singlets; cuffs; pelisses; beach clothes; pyjamas; dresses; underpants; brassieres; overcoats; jackets [clothing]; bath-robos; parkas; petticoats; slips [undergarments]; clothing of imitations of leather; clothing of leather; tee-shirts; leggings [leg warmers]; wind jackets; down jackets; children's clothing; babies' pants [clothing]; layettes [clothing]; clothing for gymnastics; waterproof clothing; raincoats; dance clothing; footwear; bath slippers; boots; half-boots; gaiters; slippers; sandals; shoes; heels; berets; caps [headwear]; hats; headgear for wear; ear muffs [clothing]; headbands [clothing]; stockings; hosiery; socks; garters; leggings; ankle socks; gloves [clothing]; shawls; neckties; scarves; fur stoles; bandanas [neckerchiefs]; ascots; bow tie; belts [clothing]; girdles; leather belts [clothing]; chasubles; sashes for wear; wimples; maniples; shower caps; sleep masks; wedding dresses.

35 – Electronic commerce services, namely, providing information about products via telecommunication networks for advertising and sales purposes; presentation of goods on communication media, for retail purposes; business assistance relating to franchising; business advice relating to franchising; provision of business information relating to franchising; retail sale and wholesale services featuring almond soap, soap, shaving soap, hair lotions, cleansing milk for toilet purposes, shampoos, soap for foot perspiration, deodorant soap, cakes of toilet soap, antiperspirant soap, bath salts, not for medical purposes, dry shampoo, shampoo, ointments for cosmetic use, conditioning balsam, hair conditioner, facial cleansing milk, bath lotion, cosmetic bath salts, non-medicated hand lotions, lacquer-removing preparations, creams for leather, leather preserving polishes, almond oil, badian essence, bergamot oil, essential oils of cedarwood, essential oils of lemon, ethereal essences, essential oils, extracts of flowers [perfumes], flower bases for perfumes, fumigation preparations [perfumes], gaultheria oil, geraniol, heliotropine, jasmine oil, lavender oil, oils for perfumes and scents, rose oil, mint essence [essential oil], mint for perfumery, musk [perfumery], perfumery, terpenes [essential oils], aromatics [essential oils], cosmetic oils, perfumes for industrial purposes, scented soaps, oils for perfumes and scents, amber [perfume], cosmetic preparations for baths, lipsticks, cotton sticks for cosmetic purposes, beauty masks,

skin whitening creams, nail polish, make-up preparations, hair dyes, hair waving preparations, false eyelashes, cosmetic preparations for eyelashes, eau de Cologne, cosmetic kits, cosmetics, cotton wool for cosmetic purposes, cosmetic pencils, cosmetic creams, make-up removing preparations, lavender water, scented water, depilatory preparations, depilatory wax, make-up, petroleum jelly for cosmetic purposes, greases for cosmetic purposes, hydrogen peroxide for cosmetic purposes, toiletries, eyebrow cosmetics, neutralizers for permanent waving, perfumes, false nails, nail care preparations, cosmetic preparations for skin care, pomades for cosmetic purposes, make-up powder, shaving preparations, eyebrow pencils, cosmetic dyes, antiperspirants [toiletries], almond milk for cosmetic purposes, sunscreen preparations, sun-tanning preparations [cosmetics], beard dyes, cosmetic preparations for slimming purposes, deodorants for human beings, decorative transfers for cosmetic purposes, astringents for cosmetic purposes, bleaching preparations [decolorants] for cosmetic purposes, tissues impregnated with cosmetic lotions, after-shave lotions, hair spray, mascara, anti-wrinkle cream, eye shadow, hair colorants, hair tonic, hair dyeing preparations, dentifrices, preparations for cleaning dentures, breath freshening sprays, dental bleaching gels, scented wood, incense, sachets for perfuming linen, potpourris [fragrances], cosmetics for animals, air fragrance preparations, optical lenses, optical goods, eyeglass chains, eyeglass cases, spectacle glasses, eyeglass frames, pince-nez, eyeglasses, sunglasses, precious metals, unwrought or semiwrought, alloys of precious metal, boxes of precious metal, jewelry cases [caskets], bracelets [jewellery], charms [jewellery], trinkets [jewellery], brooches [jewellery], chains [jewellery], necklaces [jewellery], tie clips, diamonds, jewellery, ornamental pins, semi-precious stones, precious stones, statues of precious metal, paste jewellery [costume jewellery], rings [jewellery], earrings, cuff links, figurines [statuettes] of precious metal, tie pins, key rings [trinkets or fobs], clocks, wristwatches, watch bands, watch chains, chronographs [watches], chronometers, clock cases, watches, watch glasses, movements for clocks and watches, alarm clocks, watch cases, stopwatches, woman's bags, woman's handbags, woman's purses, all for formal wear, overalls, shoulder wraps, camisoles, underclothing, dressing gowns, sweaters, shirts, short-sleeve shirts, clothing, furs [clothing], tights, combinations [clothing], corselets, suits, ready-made clothing, trousers, outerclothing, knitwear [clothing], corsets [underclothing], waistcoats, coats, jerseys [clothing], skirts, sports jerseys, singlets, cuffs, pelisses, beach clothes, pyjamas, dresses, underpants, brassieres, overcoats, jackets [clothing], bath-robos, parkas, petticoats, slips [undergarments], clothing of imitations of leather, clothing of leather, tee-shirts, leggings [leg warmers], wind jackets,

down jackets, children's clothing, babies' pants [clothing], layettes [clothing], clothing for gymnastics, waterproof clothing, raincoats, dance clothing, footwear, bath slippers, boots, half-boots, gaiters, slippers, sandals, shoes, heels, berets, caps [headwear], hats, headgear for wear, ear muffs [clothing], headbands [clothing], stockings, hosiery, socks, garters, leggings, ankle socks, gloves [clothing], shawls, neckties, scarves, fur stoles, bandanas [neckerchiefs], ascots, bow tie, belts [clothing], girdles, leather belts [clothing], chasubles, sashes for wear, wimples, maniples, shower caps, sleep masks, wedding dresses.

(260) AM 2018 95966 A

(800) 1213251

(151) 2014 03 04

(891) 2017 05 22

(731) Name and address of the holder of the registration Obshchestvo s ogranichennoy otvetstvennostyu "SRP GRUPP" ul. Sovetskaya, 18, RU-630099 Novosibirsk, Russian Federation

(540)



(591) White, red, yellow and black. Background image in black, white letters, stylized flames with the transition from red to yellow

(531) 01.15.05; 26.04.13; 26.04.24; 27.05.24; 29.01.13

(511)

3 – Snack-bars; cafés; cafeterias; rental of chairs, tables, table linen, glassware; rental of tents; rental of transportable buildings; restaurants; self-service restaurants; canteens; bar services; food and drink catering.

(260) AM 2018 95968 A

(800) 1344883

(151) 2017 04 13

(891) 2017 12 15

(731) ara AG

Zur Schlenkhecke 4, 40764 Langenfeld, Germany

(540)

ara Fusion 4

(591) Black, white

(511)

25 – Clothing, in particular belts; footwear, in particular insoles; headgear.

(260) AM 2018 95971 A
 (800) 1365292
 (151) 2017 06 08
 (891) 2017 12 18
 (731) KRKA, tovarna zdravil, d.d. Novo mesto
 Šmarješka cesta 6, SI-8000 Novo mesto,
 Slovenia
 (540)

DEKENOR

(591) Black, white
 (511)
 5 – Pharmaceutical preparations.

(260) AM 2018 95979 A
 (800) 1382950
 (151) 2017 06 22
 (891) 2017 06 22
 (731) VIENNA INSURANCE GROUP AG Wiener
 Versicherung Gruppe
 Schottenring 30, A-1010 Wien, Austria
 (540)



(591) Red, white and grey
 (531) 26.04.04; 26.04.18; 26.04.24; 27.05.17;
 27.05.22; 27.05.24; 29.01.13
 (511)
 36 – Insurance; financial affairs; monetary affairs;
 real estate affairs.

(260) AM 2018 96010 A
 (800) 1383236
 (151) 2017 06 06
 (891) 2017 06 06
 (731) FUJIAN JINLU DAILY CHEMICALS,
 CO., LTD.
 Dongxi Industrial Zone, Honglai, Nan'an
 362300 Fujian, China
 (540)



(591) Black, white
 (531) 03.04.07; 03.04.22; 27.05.17; 27.05.22
 (511)
 5 – Mosquito-repellent incense; electric mosquito re-
 pellent incense; mosquito repellents aerosol; cock-

roach-repellent incense; liquid mosquito repellent
 incense; fly killing incense; preparations for destroy-
 ing mice; chemical preparations to treat mildew;
 toilet deodorizer.

(260) AM 2018 96011 A
 (800) 1383255
 (151) 2017 05 31
 (891) 2017 05 31
 (731) FONTI ALTA VALLE PO S.P.A.
 Via Roma, 61, PAESANA (Cuneo), Italy
 (540)



(591) Black, white
 (531) 26.01.18; 27.05.21; 27.07.01
 (511)
 32 – Non-alcoholic beverages; aerated mineral wa-
 ter; non-aerated mineral water; flavoured mineral
 water; vitamin enriched water [beverages]; energy
 and sports drinks; aerated non-alcoholic beverages;
 non-aerated non-alcoholic beverages; fruit-based
 beverages and juices; vegetable juices [beverages];
 syrups and other preparations for making beverages;
 essences for making beverages; sherbets [bevera-
 ges].

(260) AM 2018 96014 A
 (800) 1383396
 (151) 2017 06 05
 (891) 2017 06 05
 (731) RAPRO KİMYA TURİZM BİLİŞİM
 SANAYİ VE TİCARET ANONİM ŞİRKETİ
 Kemalpaşa Organize Sanayi Bölgesi Ankara
 Asfaltı 26.Km Kuyucak Yolu No:226
 Kemalpaşa İzmir, Turkey
 (540)



AUTOMOTIVE RUBBER PARTS

(591) Black, yellow
 (531) 26.04.02; 26.04.04; 26.04.22; 27.05.10;
 27.05.17; 29.01.12
 (526) AUTOMOTIVE RUBBER PARTS
 (511)
 7 – Engines and motors, other than for land vehicles,
 parts and fittings therefor, hydraulic and pneumatic
 controls for engines and motors, brakes other than
 for vehicles, brake linings for engines, crankshafts,
 transmission gears for machines, cylinders for engi-
 nes, pistons for engines, turbines, not for land ve-

hicles, filters for engines and motors, oil, air and fuel filters for land vehicle engines, exhausts for land vehicle engines, exhaust manifolds for land vehicle engines, engine cylinders for land vehicles, engine cylinder heads for land vehicles, pistons for land vehicle engines, carburetors for land vehicles, fuel conversion apparatus for land vehicle engines, injectors for land vehicle engines, fuel economisers for land vehicle engines, pumps for land vehicle engines, valves for land vehicle engines, starter motors for land vehicles, dynamos for land vehicle engines, sparking plugs for land vehicle engines; bearings, namely ball or roller bearings for machines.

12 – Motor land vehicles, motorcycles, mopeds; engines and motors for land vehicles; clutches for land vehicles; transmissions, transmission belts and transmission chains for land vehicles; gearing for land vehicles; brakes, brake discs and brake linings for land vehicles; vehicle chassis, automobile bonnets, vehicle suspension springs, shock absorbers for automobiles, gearboxes for land vehicles, steering wheels for vehicles, rims for vehicle wheels; vehicles for locomotion by water and their parts, other than their motors and engines.

17 – Raw or semi worked rubber and gum for use in the manufacture of goods made from these materials and not included in other classes; gutta-percha; asbestos; latex, mica and goods made from these materials; flexible pipes made from rubber and plastic; hoses made of plastic and rubber, including those used for vehicles; junctions for pipes of plastic and rubber; pipe jackets of plastic and rubber; hoses of textile material; junctions for pipes, not of metal; pipe jackets, not of metal; connecting hose for vehicle radiators; synthetic plastic as semi-finished products in form of foils, plates, rods, profiles, hoses, tubes, blocks; rubber hoses.

35 – Advertising, marketing and public relations; organization of exhibitions and trade fairs for commercial or advertising purposes; design of advertising materials; compiling indexes of information for commercial or advertising purposes; office functions; secretarial services; arranging newspaper subscriptions for others; compilation of statistics; rental of office machines; systemization of information into computer databases; telephone answering for unavailable subscribers; business management, business administration and business consultancy; accounting; commercial consultancy services; personnel recruitment, personnel placement, employment agencies, import-export agencies; temporary personnel placement services; the bringing together, for the benefit of others, of a variety of goods, namely, engines and motors, other than for land vehicles, parts and fittings therefor, hydraulic and pneumatic controls for engines and motors, brakes other than for vehicles, brake linings for engines, crankshafts, transmission gears for machines, cylinders for engi-

nes, pistons for engines, turbines, not for land vehicles, filters for engines and motors, oil, air and fuel filters for land vehicle engines, exhausts for land vehicle engines, exhaust manifolds for land vehicle engines, engine cylinders for land vehicles, engine cylinder heads for land vehicles, pistons for land vehicle engines, carburetors for land vehicles, fuel conversion apparatus for land vehicle engines, injectors for land vehicle engines, fuel economisers for land vehicle engines, pumps for land vehicle engines, valves for land vehicle engines, starter motors for land vehicles, dynamos for land vehicle engines, sparking plugs for land vehicle engines, bearings, namely ball or roller bearings for machines, motor land vehicles, motorcycles, mopeds, engines and motors for land vehicles, clutches for land vehicles, transmissions, transmission belts and transmission chains for land vehicles, gearing for land vehicles, brakes, brake discs and brake linings for land vehicles, vehicle chassis, automobile bonnets, vehicle suspension springs, shock absorbers for automobiles, gearboxes for land vehicles, steering wheels for vehicles, rims for vehicle wheels, vehicles for locomotion by water and their parts, other than their motors and engines, raw or semi worked rubber and gum for use in the manufacture of goods made from these materials, gutta-percha, asbestos, latex, mica and goods made from these materials, flexible pipes made from rubber and plastic, hoses made of plastic and rubber, including those used for vehicles, junctions for pipes of plastic and rubber, pipe jackets of plastic and rubber, hoses of textile material, junctions for pipes, not of metal, pipe jackets, not of metal, connecting hose for vehicle radiators, synthetic plastic as semi-finished products in form of foils, plates, rods, profiles, hoses, tubes, blocks, rubber hoses; enabling customers to conveniently view and purchase those goods, such services may be provided by retail stores, wholesale outlets, by means of electronic media or through mail order catalogues.

(260) AM 2018 96017 A

(800) 1383453

(151) 2017 10 17

(891) 2017 10 17

(731) SHURAVKO VLADIMIR

MIKHAYLOVICH

ul. Zvezdnaya, d.38, g. Zhukovka RU-242700
Bryanskaya obl., Russian Federation

(540)



(591) Yellow, black, blue, white.
 (531) 01.15.23; 14.07.06; 14.07.18; 14.07.19;
 26.04.01; 26.04.02; 26.04.10; 26.04.24;
 27.05.24; 28.05; 29.01.15

(526) TOOL COLLECTION

(511)

8 – Hand tools and implements (hand-operated).

35 – Demonstration of goods; opinion polling; market studies; business information; commercial information and advice for consumers [consumer advice shop]; business investigations; business research; marketing research; marketing; organization of exhibitions for commercial or advertising purposes; presentation of goods on communication media, for retail purposes; sales promotion for others; distribution of samples; administrative processing of purchase orders; procurement services for others [purchasing goods and services for other businesses]; business efficiency expert services.

(260) AM 2018 96018 A

(800) 1383462

(151) 2017 11 09

(891) 2017 11 09

(731) APPLE INC.

One Apple Park Way Cupertino CA 95014,
 USA

(540)

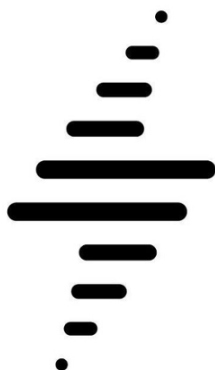

(591) Black, white

(531) 01.15.03; 26.01.01; 26.01.03; 26.01.24;
 26.11.03; 26.11.05; 26.11.08

(511)

9 – Charging devices for digital electronic devices; wireless charging devices for computers, digital electronic devices, mobile phones, media players, smartwatches, wearable computer, earphones, earphone cases, and computer peripherals; wireless chargers; wireless charging cases.

(260) AM 2018 96019 A

(800) 1383504

(151) 2017 10 23

(891) 2017 10 23

(731) JAPAN TOBACCO INC.

2-2-1 Toranomon, Minato-ku Tokyo, Japan

(540)



(591) Black, white

(531) 03.07.01; 03.07.16; 27.05.01

(511)

34 – Tobacco, raw or manufactured; smoking tobacco, pipe tobacco, rolling tobacco, chewing tobacco, snus; cigarettes, electronic cigarettes, cigars, cigarettos; snuff; smokers' articles included in this class; cigarette paper, cigarette tubes and matches.

(260) AM 2018 96020 A

(800) 1383526

(151) 2017 09 04

(891) 2017 09 04

(731) COMPAGNIE GÉNÉRALE DES
 ÉTABLISSEMENTS MICHELIN

12 cours Sablon, F-63000 Clermont-Ferrand,
 France

(540)



(591) Black, white

(531) 02.01.23; 04.05.04; 04.05.05; 26.11.08

(511)

1 – Unprocessed, natural and synthetic polymers; plasticizers for polymers; unprocessed polymer resins; compositions for repairing tires and inner tubes; rubber adhesives and fillers for repairing tires and inner tubes; antifreeze; chemical products in the form of granules and/or powders and composite materials made of ceramic, all these goods for additive manufacturing.

3 – Windshield-cleaning liquid; cleaning, polishing, degreasing and abrasive preparations; soaps; degreasers other than for use in manufacturing processes.

4 – Lubricants; lubricating oils; lubricants for pneumatic tires.

5 – Deodorants (deodorizing products); equipped first-aid kits.

6 – Unwrought and semi-wrought common metals and their alloys; non-electric cables and wires of metal; balls of steel; metal nails, studs and screws; metal air bottles for inflating tires; metal wheel moun-

ting bolts; common metals and their alloys in the form of powders and/or granules for additive manufacturing.

7 – Machines and machine tools; coupling mechanisms and belts for transmission, except for land vehicles; belts for conveyors; anti-vibration devices for machines, transmission components for machines, other than for land vehicles; stationary or mobile motors for machines; fuel cell electricity generators; high-pressure cleaners; apparatus for tire mounting and dismounting; jacks [machines] and cylinders [machines]; air pumps and their accessories; inflators (machines); connectors for inflating tires (parts of machines); vacuum cleaners; spray guns for paint; air compressors; machines for additive manufacturing (3D printers).

8 – Hand-operated hand tools and implements; cutlery, forks and spoons; side arms, other than fire-arms; scrappers for vehicle windows; shovels; chain rivet; screwdrivers; multi-function hand tools; jacks [hand tools] and cylinders [hand tools]; levers for tire mounting and dismounting; breast drills (tools).

9 – Tire deflation warning devices; tire electronic surveillance system for providing information on the operational parameters of vehicle tires; fuel cells; systems and fuel cell components for electric, fixed or mobile generators; chargers for electric batteries for vehicles; electric current rectifiers; electric converters and inverters, voltage regulators for vehicles; computer programs and software for querying databases; media for processing, storage of information and data for computers and peripheral apparatus for computers; software and applications for mobile devices; software, databases and computer hardware for vehicle, trailer and tire management; downloadable software and applications for mobile devices for navigation systems (GPS); social interactive software for the exchange of information between users relating to navigation, meteorology, transport, traffic, travel, restaurants, service stations, parking lots, resting places and vehicle maintenance and repair centers; devices for global positioning systems (GPS); software and applications for mobile devices especially for the on-line calculation of road itineraries, route planning to follow in all types of vehicles and on foot; downloadable software and applications for mobile devices especially for managing information relating to tourism, transport, traffic, travel, restaurants, service stations, car parks, rest areas and vehicle maintenance and repair centers; downloadable software and applications for mobile devices notably for enabling the provision of information and advice in the field of tourism, transport, travel, traffic, restaurants, service stations, car parks, rest areas and vehicle maintenance and repair centers; downloadable software and applications for mobile devices for on-line assistance systems in the prepara-

tion and planning of travel, travel itineraries and tours; application development software; computer databases in the field of road itineraries, transport and traffic, travel, tourism, restaurant services, service stations, car parks, rest areas and vehicle maintenance and repair centers; computer programs for accessing, browsing and searching databases on-line; website design, creation, publication and hosting software; database server centers in the field of information concerning traffic, transport, travel, tourism and restaurant services, service stations, car parks, rest areas and vehicle maintenance and repair centers; downloadable electronic publications provided on-line from databases in the field of road itineraries, transport and traffic, travel, tourism, restaurant services, service stations, car parks, rest areas and vehicle maintenance and repair of centers; books, magazines, periodicals, newsletters, newspapers, reviews and other downloadable electronic publications; jump start cables; pressure gauges; clothing for protection against fire; ear plugs for diving; safety gloves for protection against accidents or injury; vehicle breakdown warning triangles; protective helmets, reflectors for clothing, divers' masks, spectacles (optics) and sunglasses; diaries and personal digital assistants, cameras, video game programs; calculators, mouse pads, USB flash drives; computer mice; blood alcohol level measuring apparatus; printers.

10 – Ear plugs [ear protection].

11 – Apparatus and instruments for lighting; heated blankets for non-medical use, defrosters for vehicles, air deodorizing apparatus, isothermal cabinets or any other electric isothermal container, cooking apparatus; tanks and apparatus for pressurized water distribution; light bulbs for vehicles.

12 – Pneumatic tires for vehicle wheels; inner tubes for pneumatic tires; treads for retreading tires; tracks for track vehicles; suspensions, axles, springs, shock absorbers, filtering units, anti-vibration devices for vehicles, elastic crawler tracks for land vehicles; protection flaps for pneumatic tires; wheels, wheel carriers, anti-skid spikes and studs for tires; adhesive rubber parts and patches for repairing tubes or tires; air pumps and their accessories; tire valves; equipment for tire repair, tire repair kits, tire puncture repair equipment for pneumatic tires; rims; anti-skid chains for tires; mudguards; luggage carriers for vehicles; safety seats for children, for vehicles; seats for two-wheeled vehicles and tricycles; anti-theft devices for vehicles; bags for two-wheeled vehicles and tricycles; strollers for children; tire inflators; windshield wiper blades; bicycle carriers for automobiles; ski carriers for automobiles; covers for tires; covers for bicycles; hub caps for wheels; bicycle handlebar grips; plastic light bulb boxes for vehicles [included]; water bottle holders for bicycles.

14 – Works of art of precious metal; timepieces and chronometric instruments; jewelry articles; jewelry; key rings; cuff links; tie clips and tie pins; ornamental pins; badges of precious metal.

16 – Paper; cardboard; printed matter; newspapers; prospectuses; pamphlets; magazines and periodicals; books; albums; road and tourist maps; tourism and travel guides; bookbinding material; photographs; stationery; adhesive materials (stationery); paintbrushes; typewriters and office requisites (other than furniture); instructional and teaching material (other than apparatus); pens; writing instruments; cases for pens and pencils (not of precious metal or coated therewith); non-leather card cases for business cards and credit cards; cases for road and tourist maps and tourist guides; calendars; paperweight; note books, address books; diaries (planners); almanacs; posters; desk mats; notepads; plastic or paper bags for household purposes.

17 – Elastomeric polymers; semi-processed or unprocessed natural or synthetic rubber; plastics (semi-finished), rubber sheets, rubber pipes; rubber thread not for textile use; gutta-percha; raw or semi-processed elastic resins, balata and substitutes; sheets, plates and rods of plastic (semi-finished goods); materials for packing, stopping and insulating; flexible pipes not of metal.

18 – Beach umbrellas; umbrellas; traveling sets (leatherware), attaché cases, briefcases (leather goods), suitcases, traveling bags, handbags, backpacks, shopping bags, bags for campers, beach bags, rucksacks for mountaineers, garment bags for travel, business card cases, credit card cases.

20 – Goods not included in other classes made of wood, cork, reed, rush, wicker, horn, bone, ivory, shell, amber, wax, plaster, mother-of-pearl, meerschaum, substitutes for all these materials or of plastics; Furniture, mirrors, picture frames; decorative articles made of plastic (figurines); pillows, cushions, mattresses; plastic light bulb boxes for vehicles.

21 – Glassware for domestic use; porcelain and earthenware; tableware [dishes]; cutlery holders; brushes; bottle openers, bottle openers; portable household containers, water bottles for cyclists and other sportsmen, utensils and containers for household and kitchen use (not made of precious metal, or coated therewith and non-electric), non-electric portable coolers, tableware not made of precious metal, isothermal cases.

24 – Decorative textile goods (not included in other classes) namely flags and badges, textile badges and labels; textile table cloths and table napkins, travel blankets.

25 – Clothing, sports clothing, underwear, wind breakers, tracksuits, raincoats, tank tops, parkas, ponchos, anoraks, fleece coats, shirts, blouses, polo

shirts, t-shirts, sweatshirts, pullovers, vests, trousers, dresses, skirts, sarongs, shorts, Bermuda shorts, bathing suits, pajamas, costumes, bathing caps, jackets, blazers, jackets, blouses, aprons, belts (clothing), suspenders, gloves (clothing), gloves for cyclists, neckties, scarves, bandannas, shawls (clothing), headbands (clothing), ear muffs, hats, berets, beanies, caps, visors and other headgear, socks, ankle socks, work overalls; boots, half-boots, sandals, town shoes and sports shoes, slippers and other footwear; belts made of leather and imitation leather belts.

26 – Badges for wear, not of precious metal.

27 – Mats, floor mats and rubber mats for vehicles; doormats.

28 – Games, toys and sports articles (except clothing); playing cards; decorations for Christmas trees except candles and confectionery; snow globes; pool snookers; rackets; balls and shuttlecocks [games]; scale model vehicles.

34 – Non-electric lighters, ashtrays (not made of precious metal or coated therewith), matches.

35 – Advertising; advertising by mail order; commercial business management; commercial administration; office functions; dissemination of advertising material (leaflets, prospectuses, printed matter, samples); newspaper subscription services (for others); arranging subscriptions to telecommunication services for others; business management and organization consultancy; business organization and management consulting intended especially for automotive and tire professionals; management of computer files and databases; organization of exhibitions for commercial or advertising purposes; online advertising on a computer network; rental of advertising time on all communication media; publication of advertising texts; rental of advertising space; dissemination of advertisements; organization and conducting of trade promotional and advertising operations to build customer loyalty; organization and conducting of market surveys; data entry, processing, collection, compilation and systemization in computer databases comprised of information and data relating to the management of vehicles, tires, vehicle location and road itineraries; research and recovery services for computerized commercial information; providing information and advice on the selection of tires and driving methods and practices; commercial information and advice related to tire management, namely the choice, maintenance, repair, retreading, replacement and pressure monitoring of vehicle fleet tires; commercial information and advice related to vehicle location; organization and management of demonstrations of driving practices concerning motor vehicles in various conditions relating to driving, roads and tires for commercial purposes; retail and wholesale services of vehicle tires, inner tubes, valves for tires and vehicles parts; on-line retail and

wholesale services for vehicle tires, inner tubes, valves for tires and vehicles parts; advertising and commercial patronage and sponsoring; public relations services for foundations and other establishments dedicated to industrial research, training and education, social and humanitarian actions, health, culture, heritage conservation, protection of the environment, sports; consultancy and advice relating to management, strategy, organization and management of businesses and employees thereof; advice, information linked to employment development and professional and social integration; organization of exhibitions for commercial and advertising purposes; domestic assistance services to individuals namely for carrying out administrative procedures; advice regarding organizational project management for installation of additive manufacturing machines; retail services for items and/or spare parts in the nuclear field, aeronautics, railway, automotive, medical and dental fields produced by additive manufacturing.

36 – Insurance services; insurance compensation of the residual value in case of tire replacement, cost coverage for tire or vehicle expenses, hotel accommodation or transportation home in case of breakdown; capital investments; financial sponsorship and patronage; charitable fundraising; fund raising, collection and distribution of donations to associations, to non-profit organizations; financing of studies and projects in relation to the fields of education, social and humanitarian action, health, culture, heritage conservation, protection of the environment, sports; financial support for industrial research, training and education, social and humanitarian acts, health, culture, heritage conservation, protection of the environment, sports; assistance to facilitate the schooling of adults (financing).

37 – Installation, maintenance, inflating, repair, mounting, dismounting, retreading, regrooving and/or replacement of tires, inner tubes or wheels for vehicles and trailers; wheel balancing services; repair and maintenance of vehicles, spare parts, accessories for vehicles; cleaning and washing of vehicles, tires and/or vehicle wheel; road assistance services in case of breakdown caused by tires (repair); information and advisory services relating to the repair or maintenance of vehicles; services relating to the inspection of vehicles prior to maintenance and repair; organization of mounting, maintenance, repair and replacement of tires and vehicle parts; installation, maintenance, assembly, disassembly and repair of additive manufacturing machines.

38 – Provision of online forums; provision of access and rental of access to databases relating to road itineraries, transport and traffic, travel, tourism and gastronomy by electronic transmission; transmission of data relating to business and road itineraries; provision of information and/or computer data relating

to road itineraries, transport and traffic, travel, tourism and gastronomy.

39 – Assistance in the event of vehicle breakdown (towing); repatriation by all means, of individuals and/or vehicles in case of breakdown; storage of tires and/or vehicle wheels; vehicle location services; information services relating to the tracking of vehicles and trailers; transport; transport information; transportation logistics services; transport of goods; delivery of tires and/or vehicle wheels and/or vehicle parts and components; travel organization, and particularly by on-line transmission of road itineraries, which are accessible via global communication networks (the Internet); provision of data and/or geographical information, cartographic information, and of information relating to roads, navigation, traffic, road itineraries, transport, travel and points of interest by means of telecommunication networks and mobile devices; vehicle navigation and location services by computer via global positioning systems (GPS); consulting and information services in the field of transport by road, air, sea and railway; information and advice relating to tourism, road itineraries, transport and traffic, travel; transportation of equipment for humanitarian aid operations and solidarity actions.

40 – Waste recycling; information on waste treatment; manufacturing of materials including manufacturing of powders and/or granules for the manufacturing of additive; serial manufacturing of objects and/or spare parts produced by additive manufacturing; recycling of materials used for additive manufacturing; treatment of materials including the treatment of powders and/or granules for additive manufacturing of products made of metal and/or ceramic.

41 – Arranging and conducting of events in connection with teaching automobile driving and vehicle tires usage; organization and management of demonstrations of vehicle driving practices in various conditions relating to driving, roads and tires; organization of vehicle races; arranging and conducting of competitions in the field of vehicle tires; technical training services relating to the tire trade; training services in the field of repair and replacement of tires; training services in the use of machines for the mounting, dismounting, repair and inflating tires; training services relating to business franchise management; education; training; entertainment; sporting and cultural activities; information relating to entertainment or education; ticket agency and reservation services for events; publication of books; organization of competitions (education or entertainment); arranging and conducting of seminars, colloquiums, conferences or congresses; organization of exhibitions for cultural or educational purposes; publishing services (including electronic publishing) of newspapers, magazines, books, journals, pamphlets, guidebooks and maps; organization and conducting of

workshops and training courses; provision of downloadable and/or non-downloadable publications; assistance to facilitate adult schooling (training); training in the field of treatment of materials and in the field of additive manufacturing; training for the operation of machines for additive manufacturing.

42 – Technical information and advice related to tire management, namely the choice, maintenance, repair, retreading, replacement and pressure monitoring of vehicle fleet tires; expertise services in connection with the choice, condition, maintenance and/or repair of tires, spare parts and accessories for vehicles; technical information and advice related to vehicle and trailer tracking; testing and quality control of tires and inner tubes; design of business premises for the tire trade; development, design, maintenance, publishing and providing of software, mobile applications, databases and web sites; provision of search engines enabling the procurement of information via a communication network; evaluations and assessments in the fields of science and technology provided by engineers; scientific and technological research; research and development of new products for others; technical project studies; engineering department services, expertise, assistance in design and development for the construction of additive manufacturing machines, of objects and/or spare parts with a view to their production by means of additive manufacturing; software design, development and installation services; studies and research related to waste treatment.

43 – Information and consulting services in the field of tourism (restaurant services and accommodations), culinary and gastronomic matters, restaurants and hotels, foodstuffs and alcoholic and non-alcoholic beverages; hotel and restaurant reservation services; provision of information and/or data relating to culinary, gastronomic, restaurant and hotel matters.

44 – Domestic assistance to individuals namely assistance with daily care; domestic assistance to individuals namely medical assistance; medical aid services to people in need.

45 – Legal aid services for the creation of businesses; support and monitoring services for employment search and professional and social integration.

(260) AM 2018 96031 A

(800) 1384245

(151) 2017 10 17

(891) 2017 10 17

(731) GRINDEKS, AS

Krustpils iela 53 LV-1057 Rīga,
Latvia

(540)



(591) Orange, violet, pink, blue, silver, grey and white

(531) 02.09.19; 25.01.01; 29.01.15

(511)

3 – Cosmetics; cosmetic preparations for skin care.

5 – Pharmaceutical preparations; medicated toiletry preparations.

(260) AM 2018 96032 A

(800) 1384255

(151) 2017 11 11

(891) 2017 11 11

(731) AGILENT TECHNOLOGIES, INC.

5301 Stevens Creek Boulevard Santa Clara
CA 95051, USA

(540)

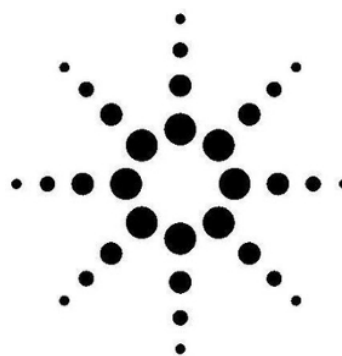

(591) Black and white

(531) 01.01.01; 01.01.10; 26.01.06; 26.01.24

(511)

44 – Medical services in the nature of medical analysis and diagnosis; genetic analysis and reporting services for medical purposes; nucleic acid sequencing and analysis services for medical purposes; genome sequencing and analysis services for medical purposes; DNA screening for medical purposes; providing information in the field of DNA sequencing and genomics for medical purposes; consultation in the field of medicine, health and pharmaceuticals;

medical testing for diagnostic purposes in the field of human cancer; DNA and polynucleic acid testing services for medical diagnostic services; conducting medical tests to diagnose diseases.

(260) AM 2018 96033 A
 (800) 1384261
 (151) 2017 11 08
 (891) 2017 11 08
 (731) SHANDONG HUASHENG RUBBER CO., LTD.
 Daozhuang Town, Guangrao County,
 Dongying City 257300 Shandong Province,
 China

(540)



(591) Black and white
 (531) 27.01.01; 27.01.12; 27.05.02
 (511)
 12 – Automobiles tires; tires for vehicle wheels.

(260) AM 2018 96034 A
 (800) 1384270
 (151) 2017 11 15
 (891) 2017 11 15
 (731) BEIERSDORF AG
 Unnastr. 48 20253 Hamburg, Germany

(540)



(591) Dark blue, white, silver, black and various shades of grey
 (531) 25.07.02; 26.01.03; 26.01.20; 26.04.24; 27.05.10; 27.05.24; 29.01.13
 (511)
 3 – Non-medicated soaps; perfumery, non-medicated cosmetics, cosmetic hair care preparations, deodorants and anti-perspirants for personal use, cosmetic skin care and skin cleansing preparations, cosmetic shaving preparations.

(260) AM 2018 96035 A
 (800) 1384362
 (151) 2017 07 12
 (891) 2017 07 12
 (731) ORIFLAME COSMETICS AG
 c/o Oriflame Global Management AG,
 Bleicheplatz 3 CH-8200 Schaffhausen,
 Switzerland

(540)

ORIFLAME FEET UP

(591) Black and white
 (511)
 3 – Skin moisturisers; body moisturisers; foot scrubs; foot deodorant spray; foot balms (non-medicated -); foot care preparations (non-medicated -).

(260) AM 2018 96036 A
 (800) 1384364
 (151) 2017 08 03
 (891) 2017 08 03
 (731) ORIFLAME COSMETICS AG
 c/o Oriflame Global Management AG,
 Bleicheplatz 3 CH-8200 Schaffhausen,
 Switzerland

(540)

ORIFLAME SUBLIME NATURE

(591) Black and white
 (511)
 3 – Non-medicated conditioning and care preparations for application to the hair, scalp, skin and nails; soaps; perfumes; perfumery; eau de cologne; toilet waters; essential and herbal oils; cosmetics; make-up preparations; lipsticks; nail varnishes; nail varnish removers; non-medicated toilet preparations; hair lotions; hair sprays and hair gels; preparations for use in the bath or shower; bath and shower oils, gels, creams and foams; face and body masks; face and body scrubs; facial washes; skin cleansers and hydrators; skin toners; skin moisturizers; blemish creams and blemish gels; deodorants; antiperspirants; preparations for use before shaving and after shaving; shaving soaps; shaving creams; shaving gels; after-shave preparations; pre-shave preparations; talcum powders; toiletries; dentifrices; toothpastes.

(260) AM 2018 96037 A
 (800) 1384367
 (151) 2017 08 23
 (891) 2017 08 23
 (731) ORIFLAME COSMETICS AG
 34, chemin des Colombettes, P.O. Box 18,
 CH-1211 Geneva, Switzerland

(540)

ORIFLAME VIP

(591) Black, white

(511)

3 – Non-medicated conditioning and care preparations for application to the hair, scalp, skin and nails; soaps; perfumes; perfumery; eau de cologne; toilet waters; essential and herbal oils; cosmetics; make-up preparations; lipsticks; nail varnishes; nail varnish removers; non-medicated toilet preparations; hair lotions; hair sprays and hair gels; preparations for use in the bath or shower; bath and shower oils, gels, creams and foams; face and body masks; face and body scrubs; facial washes; skin cleansers and hydrators; skin toners; skin moisturizers; blemish creams and blemish gels; deodorants; antiperspirants; preparations for use before shaving and after shaving; shaving soaps; shaving creams; shaving gels; after-shave preparations; pre-shave preparations; talcum powders; toiletries; dentifrices; toothpastes.

(260) AM 2018 96038 A

(800) 1384391

(151) 2017 06 14

(891) 2017 06 14

(731) ECOLEAN AB

Box 812, SE-251 08 Helsingborg, Sweden

(540)

ECOLEAN

(591) Black, white

(511)

29 – Meat extracts; soups; soup concentrates; preparations for making soups; preserved and cooked fruits and vegetables; jellies, jams, compotes; fruit juices for cooking; eggs; milk and milk products; milk beverages; beverages consisting principally of milk; milk based drinks and beverages, milk predominating; milk beverages containing fruit; beverages having a milk base; dairy-based beverages; milk shakes; organic milk; sour milk; kefir; buttermilk; sour red milk; skimmed milk; evaporated milk; condensed milk; flavoured milk; drinks flavoured with fruit, fruit pastes or fruit juices and having a milk base; milk-based beverages flavoured with coffee, chocolate or vanilla; fermented milk; milk substitutes; desserts made of milk products; dairy puddings; milk based desserts; dairy products and substitutes for dairy products; cream [dairy products]; cream, being dairy products; artificial cream (dairy product substitutes); non-dairy creamers; sour cream; sour cream substitutes; crème fraîche; yoghurt; flavored yoghurt; drinking yoghurt; yoghurt drinks; yoghurt beverages; yoghurt-based drinks; Turkish yoghurt, Greek yoghurt; beverages made from yoghurt, yoghurt based beverages and yoghurt desserts; lactic acid bacteria beverages; oat based and cereal based beverages for use as milk substitutes; edible oils and

fats; cooking fats; edible cooking oils; dairy products based on milk substitutes.

30 – Coffee, tea, cocoa and artificial coffee; ready-to-drink tea; ready-to-drink coffee; edible ices; mustard; vinegar, sauces (condiments); sauces; ready-made sauces; ice.

32 – Beers; mineral and aerated waters and other non-alcoholic beverages; waters; bottled water; bottled drinking water; carbonated water; carbonated mineral water; drinking water; drinking mineral water; drinking spring water; non-carbonated soft drinks; still water; soft drinks; fruit flavored soft drinks; non-carbonated soft drinks; energy drinks; energy drinks containing caffeine; sports drinks; nutritionally fortified beverages; beverages containing vitamins; fruit beverages and fruit juices; juices; fruit nectars; fruit nectars, non-alcoholic; fruit juice concentrates; smoothies; beverages mainly consisting of fruit juices; iced and frozen fruit beverages; syrups and other preparations for making beverages.

33 – Alcoholic beverages (except beers); wine.

(260) AM 2018 96039 A

(800) 1384406

(151) 2017 07 31

(891) 2017 07 31

(731) BARE ESCENTUALS BEAUTY, INC.

71 Stevenson Street, 22nd Floor San Francisco CA 94105, USA

(540)

BAREMINERALS

(591) Black, white

(511)

3 – Cosmetics; make-up kits comprised of powders for the face; make-up kits comprised of powders for the eyes; skincare products, namely, non-medicated skin care preparations, namely, skin moisturizer, skin cleansers, facial cleansers, beauty serums, beauty masks, skin lotions, facial cream, facial lotion, facial masks, facial scrubs, facial concealer, anti-aging creams and non-medicated exfoliant preparations for skin; non-medicated skin care preparations; powder for makeup; make-up powder; non-medicated skin creams; non-medicated lip care preparations; lip liner; lip gloss; eye make-up; concealers for eyes; eye liner; eye-shadow; eye make-up remover; cleaner for cosmetic brushes; skin bronzer; blush; foundation; make-up primer; mascara; lipstick; non-medicated lip plumping preparations.

21 – Cosmetic brushes; lip brush; make-up brushes.

(260) AM 2018 96040 A

(800) 1384453

(151) 2017 08 22

(891) 2017 08 22
 (731) ROCKWOOL INTERNATIONAL A/S
 Hovedgaden 584, DK-2640 Hedehusene,
 Denmark
 (540)



(591) The mark is in blue and white
 (531) 26.04.10; 26.05.04; 29.01.12
 (511)
 6 – Building materials of metal, namely, grids of metal; ceiling systems of metal for attaching ceiling panels.

17 – Insulating materials of mineral wool; packing, stopping and insulating materials; insulants in the form of strips, felt, mats, boards, slatted mats, shaped parts for insulation and scaling against heat, cold, fire, sound, vibrations, air, light and humidity/moisture/damp/vapour, including sound absorbing materials for acoustic regulation; acoustic and thermal insulation products and articles; insulation and vapour barrier products and articles; insulation in the form of floor, wall and roof coverings; ceiling panels of mineral wool fibres; mineral wool fibres in the form of matting for insulation; mineral wool/fibres [insulators]; processed mineral fibres for use in the manufacture of seals, sealants, fillers and gaskets; boards of extruded mineral wool, shells of mineral wool, blankets of mineral wool, mineral wool stucco and mineral wool felt, loose or semi-finished granulated mineral wool and loose or semi-finished mineral wool fibres for manufacture of reinforcing and/or filling materials for insulation; insulating mineral wool fibres for use in sealing and gasketing applications in the automotive and building industry; electrical insulating boards; friction materials; mineral wool boards for ventilated constructions, for facade cladding, roofs, soffits and fascias; insulating building materials of mineral wool; wall, floor and ceiling panels, all made of mineral wool and fibres.

19 – Building materials for road and track constructions and for fencing; processed mineral fibres for use in the manufacture of cements and plaster for building purposes; processed mineral fibres for use in the manufacture of asphalt sealants and of sealants for road construction and roofing.

(260) AM 2018 96043 A
 (800) 1384467
 (151) 2017 10 23
 (891) 2017 10 23
 (731) AL HILAL & AL NEGMA A IZAHABIA
 COMPANY. S.A.E
 23 Abdel Aziz Street, Abdeen, Cairo, Egypt
 (540)



(591) Red and golden yellow
 (531) 01.01.02; 01.01.10; 01.07.06; 26.04.01;
 26.04.05; 26.04.13; 29.01.13
 (511)
 21 – Plastic containers and articles for cleaning purposes.

(260) AM 2018 96045 A
 (800) 1384497
 (151) 2017 11 19
 (891) 2017 11 19
 (731) APPLE INC.
 One Apple Park Way, Cupertino CA 95014,
 USA
 (540)

PROMOTION

(591) Black, white
 (511)
 9 – Computer graphics software; computers; computer display screens; handheld mobile digital electronic devices used as a telephone, personal digital assistant, electronic personal organizer, and electronic notepad computer, and used to access the Internet, electronic mail, digital audio and video, and other digital data; computer display screen software.

(260) AM 2018 96090 A
 (800) 1385088
 (151) 2017 11 27
 (891) 2017 11 27
 (731) ALPEN PHARMA AG
 Casinoplatz 2, CH-3011 Bern, Switzerland
 (540)

COLLART

(591) Black, white

(511)
10 – Surgical, medical, dental and veterinary apparatus and instruments; artificial limbs, eyes and teeth; orthopedic articles; suture material; therapeutic and assistance devices designed for people with disabilities; massage apparatus; apparatus, devices and articles for child care; apparatus, devices and articles for sexual activities.

(260) AM 2018 96091 A
(800) 1385097
(151) 2017 07 06
(891) 2017 07 06
(731) "UCOM" Limited Liability Company
Teryan Str. 19, apt. 4, Yerevan, Armenia
(540)



(591) Green (pantone 375C) and white.
(531) 01.15.21; 24.17.04; 27.05.01; 27.05.17;
29.01.12
(511)
38 – Telecommunications; cable television broadcasting; communications by cellular phones; communications by computer terminals; communications by fiber optic networks; communications by telegrams; communications by telephone; computer aided transmission of messages and images; electronic bulletin board services [telecommunications services]; facsimile transmission; information about telecommunication; message sending; news agency services; paging services [radio, telephone or other means of electronic communication]; providing access to databases; providing Internet chatrooms; providing online forums; providing telecommunication channels for teleshopping services; providing telecommunication connections to a global computer network; providing user access to global computer networks; radio broadcasting; radio communications; rental of access time to global computer networks; rental of facsimile apparatus; rental of message sending apparatus; rental of modems; rental of telecommunication equipment; rental of telephones; satellite transmission; streaming of data; telecommunications routing and junction services; teleconferencing services; telegraph services; telephone services; television broadcasting; telex services; transmission of digital files; transmission of electronic mail; transmission of greeting cards online; transmission of telegrams; videoconferencing services; video-on-demand transmission; voice mail services; wireless broadcasting.

(260) AM 2018 96092 A
(800) 375704B
(151) 1971 01 15
(891) 2017 11 23
(731) BEIERSDORF AG
Unnastrasse 48, 20253 Hamburg, Germany
(540)

AQUAPHOR

(591) Black, white
(511)
3 – Perfumery products, cosmetics, essential oils, soap, washing and bleaching substances.
5 – pharmaceutical drugs and preparations, plasters, surgical dressings, disinfectants.

(260) AM 2018 96095 A
(800) 770374
(151) 2001 10 30
(891) 2018 01 02
(731) STICHTING BDO
Dr. Holtropaan 27, NL-5652 XR
EINDHOVEN, Netherlands
(540)

BDO

(591) Black, white
(511)
9 – Computer software; electronic publications.
16 – Printed matter; printed publications; newsletters; reports; forms; handbooks on the subject of computer software.
35 – Accountancy; forensic accountancy, including fraud investigation and research; internal and external auditing; book-keeping; tax research; tax preparation; consultancy and services rendered in the administrative and secretarial field; business investigations; business investigations and business consultancy relating to insolvent companies; formation of companies; providing commercial and commercial business information, whether or not on-line; cost price analysis and consultancy related thereto; providing temporary management to an organization (interim management); business management assistance and consultancy; market research, market studies and market analysis; business management and organization consultancy; business consultancy for the benefit of companies; consultancy in the field of marketing and business efficiency; consultancy relating to mergers, acquisitions, franchising, company sales and winding-up; consultancy in the field of risk management and business process management; personnel management, selection and recruitment; personnel management consultancy; outplacement of personnel; counselling in dismissal procedures.
36 – Fiscal assessments; consultancy relating to financial and fiscal matters; consultancy relating to cre-

dit and debtor control; actuarial services and consultancy related thereto; financial and fiscal research; consultancy in the field of investments and subsidies; consultancy in the field of (obtaining) financing and loans; consultancy in the field of company financing; real estate appraisal; real estate management; consultancy in the field of insurance and risk management; pension services; management of pension funds; debt collection services; investment trust services; providing (whether or not online) information in the field of insurance, financial matters and fiscal matters.

41 – Education, courses and training in the field of accountancy, book-keeping, financial and fiscal management, personnel and business management; arranging and conducting conferences, seminars, symposiums and workshops; editing and publishing in the field of accountancy, book-keeping, financial and fiscal management, personnel and business management.

42 – Consultancy on the subject of information technology, computer hardware and computer software; system analysis; computer programming and programming for data processing; legal services, legal consultancy, legal research; consultancy in the field of tax law; consultancy and services rendered by a notary public; arbitration services; dealing with complaints; consultancy regarding rules and legislation in the field of environment; quality control, quality research; scientific research; translation.

(260) AM 2018 96100 A

(800) 1098383

(151) 2011 05 16

(891) 2017 12 11

(731) MORFOSE KİŞİSEL BAKIM VE
KOZMETİK ÜRÜNLERİ SANAYİ
TİCARET ANONİM ŞİRKETİ
Ortaköy Merkez Mahallesi, Atalay Sokak,
No:5, Silivri, İstanbul, Turkey

(540)

morfose

(591) Black, white

(511)

3 – Detergents (other than those for industrial and medical purposes), laundry bleach, laundry starch, laundry blue, gelatinous soap, laundry softeners, anti-lime substances, granulated soap, glass cleaning substances, whitening and shining substances, perfumes, volatile oils (essential oils), cologne, lotions, deodorants, rose water, shaving lotions, anti-perspirant deodorants, nail polish, lipstick, mascara, creams, hair dyes, shampoos, hair care substances; eyebrow pencils (eye-liners), eye-brow colors in the form of powders, nail polish remover, shaving creams, shower gels, petroleum jelly, depilatory sub-

stances, henna for cosmetic purposes, slimming cosmetic products, filled cosmetic bags (cosmetic sets), tissues soaked with cosmetic substances; ear cleaning swabs; cotton for cosmetic purposes; wet wipes, soaps, soaps for personal use including soaps for medical and deodorant use, disinfectant soaps, anti-perspirant soaps, teeth care products, dentifrices, toothpastes, medical teeth cleaning substances, teeth cleaning powders, mouthwashes, cleaning substances for dentures, non-medical mouth washes, anti-tartar toothpastes, abrasive products, emery cloth, emery paper, emery powders and pastes, pumice stones, pastes, polishes, polishes for leatherwear, polishes for metal ware, polishes for wood articles, polishes for floors, natural products used in the manufacturing of cosmetic and perfumery products and soap.

(260) AM 2018 96109 A

(800) 1307914

(151) 2016 03 24

(891) 2017 11 30

(731) CATH KIDSTON LIMITED

2nd Floor, Frestonia, 125-135 Freston Road,
London W10 6TH, United Kingdom

(540)

CATH KIDSTON

(591) Black, white

(511)

8 – Hand tools and implements (hand-operated); cutlery; razors; manicure sets; scissors; tweezers; nail clippers; emery boards; nail files; side arms; knives, cutters (pizza, cake), hair straighteners (electric).

14 – Jewellery; horological and chronometric apparatus and instruments; watches; clocks; alarm clocks; earrings; necklaces; bracelets; bangles; badges of precious metal; pin badges; brooches; jewellery boxes; lanyards for keys; key rings, key fobs; beads for making jewellery; parts and fittings for the aforesaid goods.

20 – Furniture, mirrors, picture frames; inflatable furniture; inflatable seats; inflatable headrests; sleeping bags; furniture for camping; garden furniture; pet beds; stools; chairs; tables; sofas; pet cushions; pillows; cushions; seat pads; kneeling cushions; door stops, not of metal or rubber; neck pillows; clothes hangers; interior window blinds.

21 – Household and kitchen utensils and containers; laundry hampers; laundry baskets; waste baskets; domestic bread baskets; picnic baskets; glassware, porcelain and earthenware; china; household ceramics; cups; mugs; crockery; trays; mixing bowls; flour shakers; rolling pins; pie funnels; worktop savers; spatulas; kitchen containers in the form of storage tins, jars and boxes; plates; bowls; teapots; cake stands; salt/pepper shakers; jugs; egg cups; bento

boxes; coasters; dishes; toast racks; biscuit tins; bottles; flasks; sippy cups; picnic sets; piggy banks; money boxes; clothes pegs; tableware; ironing board covers; tea cosies; oven gloves; napkin rings; wash bags; make-up brushes; statuettes of porcelain, ceramic, earthenware or glass; brushes; combs; soap dispensers; cool bags; baking tins; baking utensils; baking dishes; chopsticks, whisks non electric, food mixers non-electric, bread bins, cutters (pastry, cookie, sandwich, food).

24 – Tea towels, towels, napkins, sheets, bed linen, pillowcases, duvet covers, quilts, cushion covers, fabrics, textiles and textile goods; table coverings; curtains; shower curtains; place mats; blankets; throws; bedding sets; handkerchiefs; muslin; face cloths.

26 – Lace and embroidery, ribbons and braid; buttons, hooks and eyes, pins and needles; artificial flowers; sewing baskets, sewing boxes, sewing kits; hair bobbles; needle cases; needle boxes; needle cushions; pin cushions; thimbles; badges; pin badges; hair accessories, hair slides, clips, bands, pins, ties; haberdashery; beads, not for making jewellery; patches for decoration of textile articles; buttons; lanyards being cords for wear; laces; shoe laces; cross stitch kits.

27 – Wallpaper; carpets, rugs and matting; wall hangings; bath mats; carpet tiles; tiles made of linoleum for fixing to existing floors; floor coverings; rugs.

(260) AM 2018 96110 A
(800) 1318548
(151) 2016 08 01
(891) 2017 12 18
(731) DEGESCH GMBH
Dr.-Werner-Freyberg-Strasse 11, 69514
Laudenbach, Germany
(540)

Magtoxin

(591) Black, white
(511)
5 – Preparations for pest control; pest extermination preparations and articles; vermin extermination preparations; vermin destroying preparations, pesticides; herbicides; fungicides; parasiticides; pest control preparations in storage protection.

(260) AM 2018 96111 A
(800) 1321420
(151) 2016 06 12
(891) 2017 11 27
(731) SHANGHAI HARDEN TOOLS CO., LTD.
Unit 2006, No.1 100 Lane, East Sport
Road, Shanghai, China

(540)

HARDEN

(591) Black, white
(531) 27.05.01; 27.05.17
(511)
8 – Abrading instruments; hand tools, hand operated; agricultural implements [hand-operated]; garden tools; livestock marking tools; harpoons; nail clippers [electric or non-electric]; spanners [hand tools]; nail drawers; pliers; bits; saws [hand tools]; axes; rams [hand tools]; screwdrivers; lifting jacks, hand-operated; ratchet [hand tools]; rivet gun [hand tools]; engraving tool; knife; side arms, other than firearms; cutlery (knives, forks and spoons).

(260) AM 2018 96114 A
(800) 1340485
(151) 2017 01 04
(891) 2017 11 28
(731) JOINT STOCK COMPANY "FARMAK"
63, st. Kyrylivska, Kyiv 04080, Ukraine
(540)

УРОПРЕС

(591) Black, white
(531) 28.05
(511)
5 – Pharmaceutical preparations; medicines for human purposes.

(260) AM 2018 96125 A
(800) 1384794
(151) 2016 09 12
(891) 2016 09 12
(731) "ROBAPHARM" EOOD
apartment office 34, Boulevard "Tzar Boris
III" N°168, District "Ovcha Kupel" BG-1618
Sofia, Bulgaria

(540)

RUMALON ПУМАЛОН

(591) Black, white
(511)
5 – Absorbent cotton; acaricides; acetates for pharmaceutical purposes; acids for pharmaceutical purposes; acne treatment preparations; aconitine; adhesive plasters; adhesive bands for medical purposes; adhesives for dentures; adjuvants for medical purposes; air purifying preparations; air deodorising preparations; albumin dietary supplements; albuminous foodstuffs for medical purposes; albuminous preparations for medical purposes; alcohol for pharmaceutical purposes; aldehydes for pharmaceutical purposes; algicides; alginate dietary supplements; alginates for pharmaceutical purposes; alkaline iodides for pharmaceutical purposes; alkaloids for medical pur-

poses; alloys of precious metals for dental purposes; aloe vera preparations for pharmaceutical purposes; aluminium acetate for pharmaceutical purposes; amino acids for medical purposes; amino acids for veterinary purposes; anaesthetics; analgesics; angostura bark for medical purposes; animal feed supplements for veterinary purposes; animal washes; anthelmintics; anti-rheumatism bracelets; anti-rheumatism rings; anti-uric preparations; antibiotics; anticytotoxic preparations; antioxidant pills; antiparasitic preparations; antiparasitic collars for animals; antiseptic cotton; antiseptics; appetite suppressants for medical purposes; appetite suppressant pills; aseptic cotton; asthmatic tea; babies' diapers [napkins]; babies' napkin-pants [diaper-pants]; bacterial poisons; bacterial preparations for medical and veterinary use; bacteriological preparations for medical and veterinary use; balms for medical purposes; balsamic preparations for medical purposes; bandages for dressings; barks for pharmaceutical purposes; bath preparations for medical purposes; bath salts for medical purposes; belts for sanitary napkins [towels]; bicarbonate of soda for pharmaceutical purposes; biocides; biological preparations for medical purposes; biological preparations for veterinary purposes; biological tissue cultures for medical purposes; biological tissue cultures for veterinary purposes; bismuth preparations for pharmaceutical purposes; bismuth subnitrate for pharmaceutical purposes; blood plasma; blood for medical purposes; bone cement for surgical and orthopaedic purposes; bouillons for bacteriological cultures; bracelets for medical purposes; breast-nursing pads; bromine for pharmaceutical purposes; bronchodilating preparations; bunion pads; by-products of the processing of cereals for dietetic or medical purposes; cachets for pharmaceutical purposes; cachou for pharmaceutical purposes; preparations for callouses; calomel; camphor oil for medical purposes; camphor for medical purposes; candy, medicated; candy for medical purposes; capsules for medicines; carbolineum [parasiticide]; casein dietary supplements; castor oil for medical purposes; cattle washes; caustic pencils; caustics for pharmaceutical purposes; cedar wood for use as an insect repellent; cellulose esters for pharmaceutical purposes; cellulose ethers for pharmaceutical purposes; cement for animal hooves; charcoal for pharmaceutical purposes; chemical conductors for electrocardiograph electrodes; chemical contraceptives; chemical preparations for the diagnosis of pregnancy; chemical preparations to treat mildew; chemical preparations to treat wheat blight [smut]; chemical preparations for treating phylloxera; chemical preparations for pharmaceutical purposes; chemical preparations for medical purposes; chemical preparations for veterinary purposes; chemical reagents for medical or veterinary purposes; chemico-pharmaceutical preparations; chewing gum for medical purposes; chilblain preparations; chinoline for

medical purposes; chloroform; cocaine; cod liver oil; collagen for medical purposes; collodion for pharmaceutical purposes; collyrium; compresses; condurango bark for medical purposes; solutions for contact lenses; contact lens cleaning preparations; cooling sprays for medical purposes; corn rings for the feet; corn remedies; cotton for medical purposes; cotton swabs for medical purposes; cream of tartar for pharmaceutical purposes; creosote for pharmaceutical purposes; croton bark; cultures of microorganisms for medical or veterinary use; curare; decoctions for pharmaceutical purposes; dental abrasives; dental amalgams; dental cements; dental impression materials; dental lacquer; dental mastics; dental amalgams of gold; deodorants, other than for human beings or for animals; deodorants for clothing and textiles; depuratives; preparations for destroying noxious animals; preparations for destroying dry rot fungus; preparations for destroying mice; detergents for medical purposes; diabetic bread adapted for medical use; diagnostic preparations for medical purposes; diagnostic biomarker reagents for medical purposes; diagnostic preparations for veterinary purposes; diapers for pets; diastase for medical purposes; dietary fibre; dietary supplements for animals; dietetic foods adapted for medical purposes; dietetic beverages adapted for medical purposes; dietetic substances adapted for medical use; digestives for pharmaceutical purposes; digitalin; dill oil for medical purposes; disinfectants for hygiene purposes; disinfectants for chemical toilets; disinfectants; dog washes; dog lotions; douching preparations for medical purposes; dressings, medical; drugs for medical purposes; elixirs [pharmaceutical preparations]; plant fibre for use as a dietary supplement; enzyme preparations for medical purposes; enzyme preparations for veterinary purposes; enzyme dietary supplements; enzymes for medical purposes; enzymes for veterinary purposes; ergot for pharmaceutical purposes; esters for pharmaceutical purposes; ethers for pharmaceutical purposes; eucalyptol for pharmaceutical purposes; eucalyptus for pharmaceutical purposes; extracts of hops for pharmaceutical purposes; eye-washes; eyepatches for medical purposes; preparations to facilitate teething; febrifuges; fennel for medical purposes; ferments for pharmaceutical purposes; first-aid boxes, filled; fish meal for pharmaceutical purposes; flour for pharmaceutical purposes; flowers of sulfur for pharmaceutical purposes; fly catching paper; fly glue; fly destroying preparations; food for babies; formic aldehyde for pharmaceutical purposes; frostbite salve for pharmaceutical purposes; fumigating sticks; fumigation preparations for medical purposes; fungicides; gallic acid for pharmaceutical purposes; gamboge for medical purposes; gases for medical purposes; gauze for dressings; gelatine for medical purposes; gentian for pharmaceutical purposes; germicides; glucose for medical purposes; glucose dietary supplements; glycerine for

medical purposes; glycerophosphates; greases for medical purposes; greases for veterinary purposes; guaiacol for pharmaceutical purposes; gum for medical purposes; gurjun [gurjon, gurjan] balsam for medical purposes; haematogen; haemoglobin; haemorrhoid preparations; haemostatic pencils; headache pencils; herbal teas for medicinal purposes; herbicides; hormones for medical purposes; hydrastine; hydrastinine; hydrated chloral for pharmaceutical purposes; hydrogen peroxide for medical purposes; infant formula; insect repellents; insect repellent incense; insecticides; iodides for pharmaceutical purposes; iodine for pharmaceutical purposes; iodoform; Irish moss for medical purposes; isotopes for medical purposes; jalap; jujube, medicated; lacteal flour for babies; larvae exterminating preparations; laxatives; lead water; lecithin for medical purposes; lecithin dietary supplements; leeches for medical purposes; lime-based pharmaceutical preparations; liniments; linseed for pharmaceutical purposes; linseed meal for pharmaceutical purposes; linseed dietary supplements; linseed oil dietary supplements; lint for medical purposes; liquorice for pharmaceutical purposes; lotions for pharmaceutical purposes; lotions for veterinary purposes; lupulin for pharmaceutical purposes; magnesia for pharmaceutical purposes; malt for pharmaceutical purposes; malted milk beverages for medical purposes; mangrove bark for pharmaceutical purposes; meal for pharmaceutical purposes; medical preparations for slimming purposes; medicated animal feed; medicinal alcohol; medicinal mud; medicinal infusions; medicinal tea; medicinal oils; medicinal herbs; medicinal roots; medicinal drinks; medicinal hair growth preparations; medicine cases, portable, filled; medicines for alleviating constipation; medicines for dental purposes; medicines for human purposes; medicines for veterinary purposes; melissa water for pharmaceutical purposes; menstruation bandages; menstruation knickers; menthol; mercurial ointments; preparations of microorganisms for medical or veterinary use; milk ferments for pharmaceutical purposes; lactose for pharmaceutical purposes; milk of almonds for pharmaceutical purposes; milking grease; mineral waters for medical purposes; mineral water salts; mineral food supplements; mint for pharmaceutical purposes; moleskin for medical purposes; mothproofing preparations; mothproofing paper; moulding wax for dentists; mouthwashes for medical purposes; mud for baths; mustard oil for medical purposes; mustard for pharmaceutical purposes; mustard plasters; myrobalan bark for pharmaceutical purposes; napkins for incontinents; narcotics; nervines; nutritional supplements; nutritive substances for microorganisms; oil of turpentine for pharmaceutical purposes; ointments for pharmaceutical purposes; opiates; opium; opodeldoc; opotherapy preparations; oxygen baths; oxygen for medical purposes; pants, absorbent, for incontinents; panty liners [sanitary]; paper

for mustard plasters; parasiticides; pastilles for pharmaceutical purposes; pearl powder for medical purposes; pectin for pharmaceutical purposes; pepsins for pharmaceutical purposes; peptones for pharmaceutical purposes; pesticides; petroleum jelly for medical purposes; pharmaceutical preparations; pharmaceutical preparations for treating sunburn; pharmaceutical preparations for skin care; pharmaceutical preparations for treating dandruff; pharmaceuticals; phenol for pharmaceutical purposes; phosphates for pharmaceutical purposes; plant extracts for pharmaceutical purposes; poisons; pollen dietary supplements; pomades for medical purposes; porcelain for dental prostheses; potassium salts for medical purposes; poultices; powder of cantharides; powdered milk for babies; propolis for pharmaceutical purposes; propolis dietary supplements; protein dietary supplements; protein supplements for animals; purgatives; pyrethrum powder, quassia for medical purposes; quebracho for medical purposes; quinine for medical purposes; quinquina for medical purposes; radioactive substances for medical purposes; radiological contrast substances for medical purposes; radium for medical purposes; rat poison; reagent paper for medical or veterinary purposes; preparations for reducing sexual activity; remedies for foot perspiration; remedies for perspiration; repellents for dogs; rhubarb roots for pharmaceutical purposes; royal jelly for pharmaceutical purposes; royal jelly dietary supplements; rubber for dental purposes; salts for mineral water baths; salts for medical purposes; sanitary panties; sanitary tampons; sanitary towels; sarsaparilla for medical purposes; scapulars for surgical purposes; sea water for medicinal bathing; sedatives; semen for artificial insemination; serotherapeutic medicines; serums; personal sexual lubricants; siccatives [drying agents] for medical purposes; slimming tea for medical purposes; slimming pills; slug exterminating preparations; smelling salts; smoking herbs for medical purposes; sodium salts for medical purposes; soil-sterilising preparations; solvents for removing-adhesive plasters; soporifics; starch for dietetic or pharmaceutical purposes; stem cells for medical purposes; stem cells for veterinary purposes; sterilising preparations; steroids; stick liquorice for pharmaceutical purposes; strychnine; styptic preparations; sugar for medical purposes; sulfonamides [medicines]; sulphur sticks [disinfectants]; sunburn ointments; suppositories; surgical dressings; surgical implants comprised of living tissues; surgical glues; syrups for pharmaceutical purposes; tanning pills; tartar for pharmaceutical purposes; teeth filling material; therapeutic preparations for the bath; thermal water; thymol for pharmaceutical purposes; tincture of iodine; tinctures for medical purposes; tissues impregnated with pharmaceutical lotions; tobacco extracts [insecticides]; tobacco-free cigarettes for medical purposes; tonics [medicines]; preparations of trace elements

for human and animal use; transplants [living tissues]; preparations for the treatment of burns; turpentine for pharmaceutical purposes; vaccines; vaginal washes; vermifuges; vermin destroying preparations; vesicants; veterinary preparations; vine disease treating chemicals; vitamin preparations; vulnery sponges; wadding for medical purposes; wart pencils; wheat germ dietary supplements; yeast for pharmaceutical purposes; yeast dietary supplements.

(260) AM 2018 96127 A
 (800) 1384882
 (151) 2017 09 18
 (891) 2017 09 18
 (731) Private Joint Stock Company
 "ALEF-VINAL"
 1 Sobinova street Dnipro 49083, Ukraine
 (540)

MARLIN

(591) Black, white
 (531) 27.05.02
 (526)
 (511)
 33 – Rice alcohol; alcoholic beverages, except beer; alcoholic essences; alcoholic extracts; anise [liqueur]; anisette [liqueur]; aperitifs; arak [arrack]; alcoholic beverages containing fruit; distilled beverages; bitters; brandy; cider; cocktails; curacao; digesters [liqueurs and spirits]; distilled beverages; fruit extracts, alcoholic; gin; hydromel [mead]; kirsch; liqueurs; mead [hydromel]; peppermint liqueurs; perry; piquette; rice alcohol; rum; sake; spirits [beverages]; vodka; whisky; wine.

(260) AM 2018 96128 A
 (800) 1384903
 (151) 2017 09 14
 (891) 2017 09 14
 (731) TILLOTTS PHARMA AG
 Baslerstrasse 15 CH-4310 Rheinfelden,
 Switzerland
 (540)

UCAPSA

(591) Black, white
 (511)
 5 – Pharmaceutical and veterinary products, particularly for diagnosis, prevention and/or treatment of gastrointestinal conditions and disorders, as well as for treatment of inflammation.

(260) AM 2018 96131 A
 (800) 1385040
 (151) 2017 11 07

(891) 2017 11 07
 (731) RICHTER GEDEON NYRT.
 Gyömrői út 19-21, H-1103 Budapest, Hungary
 (540)

LIMAROSA

(591) Black, white
 (511)
 5 – Pharmaceutical preparations.

(260) AM 2018 96132 A
 (800) 1385041
 (151) 2017 11 07
 (891) 2017 11 07
 (731) RICHTER GEDEON NYRT.
 Gyömrői út 19-21, H-1103 Budapest, Hungary
 (540)

AUMA

(591) Black, white
 (511)
 5 – Pharmaceutical preparations.

(260) AM 2018 96133 A
 (800) 1385042
 (151) 2017 11 14
 (891) 2017 11 14
 (731) RICHTER GEDEON NYRT.
 Gyömrői út 19-21, H-1103 Budapest, Hungary
 (540)

ГЕНТРЭК

(591) Black, white
 (511)
 5 – Pharmaceutical preparations.

(260) AM 2018 96136 A
 (800) 1385046
 (151) 2017 11 07
 (891) 2017 11 07
 (731) RICHTER GEDEON NYRT.
 Gyömrői út 19-21, H-1103 Budapest, Hungary
 (540)

LASTULIN

(591) Black, white
 (511)
 5 – Pharmaceutical preparations.

(260) AM 2018 96137 A
 (800) 1385047
 (151) 2017 11 07
 (891) 2017 11 07
 (731) RICHTER GEDEON NYRT.
 Gyömrői út 19-21, H-1103 Budapest,
 Hungary

(540)

LIAMIL

(591) Black, white

(511)

5 – Pharmaceutical preparations.

(260) AM 2018 96138 A

(800) 1385048

(151) 2017 11 08

(891) 2017 11 08

(731) RICHTER GEDEON NYRT.

Gyömrői út 19-21 H-1103 Budapest, Hungary

(540)

LYSERC

(591) Black, white

(511)

5 – Pharmaceutical preparations.

(260) AM 2018 96142 A

(800) 1385051

(151) 2017 11 14

(891) 2017 11 14

(731) RICHTER GEDEON NYRT.

Gyömrői út 19-21, H-1103 Budapest, Hungary

(540)

ЛАСТУЛИН

(591) Black, white

(511)

5 – Pharmaceutical preparations.

(260) AM 2018 96143 A

(800) 1385052

(151) 2017 11 14

(891) 2017 11 14

(731) RICHTER GEDEON NYRT.

Gyömrői út 19-21, H-1103 Budapest, Hungary

(540)

ЛИАМИЛ

(591) Black, white

(511)

5 – Pharmaceutical preparations.

(260) AM 2018 96145 A

(800) 1385053

(151) 2017 11 14

(891) 2017 11 14

(731) RICHTER GEDEON NYRT.

Gyömrői út 19-21, H-1103 Budapest,
Hungary

(540)

ГЛОБУНТАК

(591) Black, white

(511)

5 – Pharmaceutical preparations.

(260) AM 2018 96196 A

(800) 1385225

(151) 2017 01 18

(891) 2017 01 18

(731) IVOCLAR VIVADENT AG

Bendererstrasse 2, FL-9494 Schaan, Liechtenstein

(540)

Virtual

(591) Black, white

(511)

5 – Materials for use in dentistry; materials and auxiliary materials for the manufacture of dental impressions, models, crowns, bridges, inlays, prostheses, artificial teeth; dental filling materials.

10 – Apparatus, devices, tools, and instruments for dental use, in this class.

(260) AM 2018 96197 A

(800) 1385233

(151) 2017 11 21

(891) 2017 11 21

(731) TENNECO AUTOMOTIVE OPERATING
COMPANY INC.

500 North Field Drive, Lake Forest IL 60045, USA

(540)

OESpectrum

(591) Black, white

(511)

12 – Vehicle parts, namely, shock absorbers, struts, and shock absorber and strut assemblies.

(260) AM 2018 96198 A

(800) 1385342

(151) 2017 11 27

(891) 2017 11 27

(731) CHINA TOBACCO JIANGSU
INDUSTRIAL CO., LTD.No.406-3 Zhongshan North Road, Nanjing
210011 Jiangsu, China

(540)



(591) Black, white
(531) 05.05.02; 05.05.20; 26.13.25
(511)

34 – Cigarette paper; lighters for smokers; matches; ashtrays for smokers; tobacco; electronic cigarettes; cigars; cigarettes containing tobacco substitutes, not for medical purposes; cigarettes; cigarette cases; cigarette filters.

(260) AM 2018 96214 A
(800) 1385781
(151) 2017 10 05
(891) 2017 10 05
(731) ADP GAUSELMANN GMBH
Mercur-Allee 1-15, 32339 Espelkamp,
Germany

(540)

Queen of Mars

(591) Black, white
(511)

9 – Computer and video games software; games software in particular for use on any computer platform, including electronic entertainment and games consoles; computer game programs; video games (software); computer games provided through a global computer network or supplied by means of multimedia electronic broadcast or through telecommunications or electronic transmission or via the internet; computer games, leisure and recreational software, video games and computer software, all being provided in the form of storage media; programs for operating electric and electronic apparatus for games, amusement and/or entertainment purposes; computer software for computer games on the internet; online games (software), in particular for online betting games, online prize games, online gambling games, online games of skill and online casino games; computer software in the form of an app for mobile devices and computers; software in particular for casino and/or amusement arcade games, for gaming machines and/or slot machines each one with or without prize payouts; gaming software that generates or displays wager outcomes of gaming machines; operational computer games software; computer software for managing of games (game collection); video game cartridges.

(260) AM 2018 96223 A
(800) 1385501
(151) 2017 11 08
(891) 2017 11 08
(731) SHANXI KANGTEER FINE CHEMICAL
CO., LTD.
No.7 Huakang South Road, Hengci Chemical
Industrial Park Zone, Wanrong County,
Yuncheng City, Shanxi Province, China

(540)



(591) Black, white
(531) 27.05.01; 27.05.11; 28.03
(511)

1 – Masonry preservatives, except paints and oils; brickwork preservatives, except paints and oils; agglutinants for concrete; concrete preservatives, except paints and oils; anti-incrustants; cement-waterproofing chemicals, except paints; cement preservatives, except paints and oils; damp-proofing chemicals, except paints, for masonry; concrete-aeration chemicals; preservatives for tiles, except paints and oils.

(260) AM 2018 96224 A
(800) 1385504
(151) 2017 11 17
(891) 2017 11 17
(731) APPLE INC.
One Apple Park Way, Cupertino CA 95014,
USA

(540)

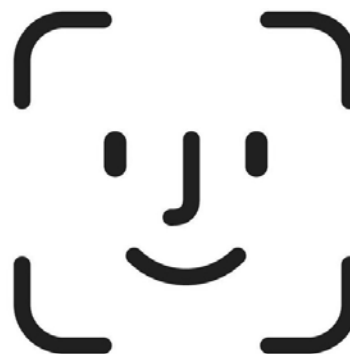

(591) Black, white
(531) 04.05.03
(511)

9 – Computer hardware and software for secure biometric authentication, and password management and protection for use on computers, handheld mobile digital electronic devices and mobile telephones.

(260) AM 2018 96230 A
(800) 1385555
(151) 2017 11 03
(891) 2017 11 03
(731) KARELIA TOBACCO COMPANY INC
Athinon Street, GR-241 00 Kalamata,
Greece

(540)



(591) Red, white, black
 (531) 10.01.05; 10.01.10; 10.01.25; 24.01.10;
 25.07.15; 27.05.01; 27.05.24; 29.01.14
 (511)
 34 – Tobacco, cigars, cigarettes, electronic cigarette
 ttes, cigarillos, smokers' articles, ashtrays, cigarette
 cases, cigarette lighters, cigarette papers, matches, li-
 quid solutions for use in electronic cigarettes.

(260) AM 2018 96232 A
 (800) 1385570
 (151) 2017 09 30
 (891) 2017 09 30
 (731) YUAN LIN
 chez M.Wong, 24 ave du Gros Peuplier,
 F-93600 Aulnay sous Bois, France

(540)



(591) Black, white
 (531) 26.04.22; 27.05.01; 27.05.10
 (511)
 25 – Clothing, footwear, headgear; shirts; clothing of
 leather or imitation of leather; belts (clothing); furs
 (clothing); gloves (clothing); scarves; neckties; hosi-
 ery; socks; bedroom slippers; beach, ski or sports
 footwear; underwear.

(260) AM 2018 96246 A
 (800) 1385646
 (151) 2017 11 08
 (891) 2017 11 08
 (731) RICHTER GEDEON NYRT.
 Gyömrői út 19-21, H-1103 Budapest,
 Hungary

(540)

RINOLTON

(591) Black, white
 (511)
 5 – Pharmaceutical preparations.

(260) AM 2018 96248 A
 (800) 1385648
 (151) 2017 11 07
 (891) 2017 11 07
 (731) RICHTER GEDEON NYRT.
 Gyömrői út 19-21, H-1103 Budapest, Hungary
 (540)

ODEXAN

(591) Black, white
 (511)
 5 – Pharmaceutical preparations for gynecological
 purposes.

(260) AM 2018 96250 A
 (800) 1385650
 (151) 2017 11 08
 (891) 2017 11 08
 (731) RICHTER GEDEON NYRT.
 Gyömrői út 19-21, H-1103 Budapest, Hungary
 (540)

SINELLA

(591) Black, white
 (511)
 5 – Pharmaceutical preparations.

(260) AM 2018 96251 A
 (800) 1385651
 (151) 2017 11 08
 (891) 2017 11 08
 (731) RICHTER GEDEON NYRT.
 Gyömrői út 19-21, H-1103 Budapest, Hungary
 (540)

HEURISTIN

(591) Black, white
 (511)
 5 – Pharmaceutical preparations.

(260) AM 2018 96254 A
 (800) 1385652
 (151) 2017 11 07
 (891) 2017 11 07
 (731) RICHTER GEDEON NYRT.
 Gyömrői út 19-21, H-1103 Budapest, Hungary
 (540)

LARISSIMA

(591) Black, white
(511)
5 – Pharmaceutical preparations.

(260) AM 2018 96256 A
(800) 1385653
(151) 2017 11 08
(891) 2017 11 08
(731) RICHTER GEDEON NYRT.
Gyömrői út 19-21, H-1103 Budapest, Hungary
(540)

RINOREX

(591) Black, white
(511)
5 – Pharmaceutical preparations.

(260) AM 2018 96263 A
(800) 1385660
(151) 2017 11 07
(891) 2017 11 07
(731) Richter Gedeon Nyrt.
Gyömrői út 19-21, H-1103 Budapest,
Hungary
(540)

DEMIRON

(591) Black, white
(511)
5 – Pharmaceutical preparations.

(260) AM 2018 96264 A
(800) 1385794
(151) 2017 09 29
(891) 2017 09 29
(731) ASTELLAS PHARMA INC.
5-1, Nihonbashi-Honcho 2-chome, Chuo-ku,
103-8411 Tokyo, Japan
(540)

NUPAVLI

(591) Black, white
(531) 27.05.01; 27.05.17
(511)
5 – Pharmaceutical preparations and substances.

(260) AM 2018 96265 A
(800) 1385803
(151) 2017 07 28
(891) 2017 07 28
(731) SOUTH BEACH BEVERAGE COMPANY,
INC.
700 Anderson Hill Road, Purchase NY 10577,
USA

(540)



(591) Black, white
(531) 26.04.01; 26.04.24; 27.05.17; 27.05.24;
27.05.25

(511)
32 – Aperitifs, non-alcoholic; aerated water; mineral water [beverages]; waters [beverages]; table waters; cocktails, non-alcoholic; lemonades; non-alcoholic beverages; isotonic beverages; non-alcoholic honey-based beverages; whey beverages; non-alcoholic fruit juice beverages; fruit nectars, non-alcoholic; syrups for beverages; smoothies; vegetable juices [beverages]; fruit juices; preparations for making aerated water; preparations for making mineral water; preparations for making beverages; non-alcoholic fruit extracts.

(260) AM 2018 96266 A
(800) 1385824
(151) 2017 11 07
(891) 2017 11 07
(731) RICHTER GEDEON NYRT.
Gyömrői út 19-21, H-1103 Budapest, Hungary
(540)

DINARA

(591) Black, white
(511)
5 – Pharmaceutical preparations.

(260) AM 2018 96270 A
(800) 1385887
(151) 2017 08 02
(891) 2017 08 02
(731) IDEMIA FRANCE
420 rue d'Estienne d'Orves, F-92700
Colombes, France
(540)

IDEMIA

(531) 27.05.17
(511)
9 – Electronic apparatus for checking the authenticity of cards, badges, passports, visas, namely electronic systems attesting to the authorization of entry

into a territory and secure documents bearing a seal which afford entry into a territory, drivers' licenses, biometric identity cards or identification documents, electronic detectors for banknotes or access passes; apparatus and instruments for authenticating banknotes, access passes and payment documents; chips [integrated circuits]; computer chips; computer chips; semiconductor chips; electronic chips for manufacturing integrated circuits; semi-conductors; semiconductor wafers; electronic semi-conductors; magnetic or electronic cards and badges, contact or contact-free, intended for use as payment, credit, debit, remote payment or loyalty cards and electronic wallets, including those with dynamic codes for securing all transactions online; cards, badges, passports, visas, namely electronic systems attesting to the authorization of entry into a territory, drivers' licenses, identity cards or electronic or biometric identification documents, all fitted with optical-effect security to combat unauthorized reproduction, forgery and counterfeiting; magnetic or electronic cards and badges intended for use as cards and badges for access, transport, single or multiple access to services and/or transport networks, subscription to transport services; electronic or magnetic cards for use as health cards, cards for access to pay television channels, games, and/or multimedia, or data banks, and, databases; biometric apparatus, instruments, terminals, readers and scanners for fingerprints, palm prints, features of the iris, veins, voices, facial features or other biometric features; integrated circuit cards; chip cards; integrated circuit cards (smart cards); memory cards; programmable cards; remote programmable cards; transmitter-receiver cards and badges; radio frequency cards and badges; infrared cards and badges; cards for access to telecommunications and/or computer networks; encoded cards; pre-recorded data cards, computer programs, and software; telecommunication cards; control cards for communication; magnetic or chip-based cards with units of credit; mobile telephone cards; electronic cards for secure access, to computer and/or telecommunications networks; electronic cards used for accessing services and/or performing operations and transactions on telecommunications and/or computer networks; computer programs; software; biometric identification and control systems; computers and computer software for biometric systems for the identification and authentication of persons; software for biometric systems for the identification and authentication of persons; software for detecting persons; software for interpreting finger or palm prints, features of the iris, veins, voice, facial features or other biometric features; computer programs and software for use in connection with cards; computer programs and software recorded on cards or to be recorded on cards and/or telecommunications apparatus; software for providing access to electronic mail services; messaging software; software for

providing access to electronic communication networks; software for providing access to the Internet and/or Internet sites; software for telecommunications, software for navigation (browsing); software for operations and, transactions by cards, namely, chip-based cards; integrated circuits; electronic chips; electronic signature support software, encryption software; encryption keys; electronic apparatus for checking the authenticity of cards; computer programs and software for storage, retrieval and secure transmission of information or data; computer programs and software for identifying and authenticating persons and/or electronic signatures for accessing networks, payment, operations and transactions, including online e-commerce; traceability software for the management and securing of documents and/or printed matter; computer servers, in particular for the downloading, distribution and management of applications on cards, including chip cards; computer programs and software for communication between chip-based cards and chip card readers and/or computer terminals; computer programs and software for transmitting, displaying and storing identification and/or operations and transactions data or information, particularly online; computer software for processing electronic payments and transferring funds to and from others; authentication software for controlling access to computers and computer networks and controlling communication between computers and computer networks; software, and, databases for the issue and/or management of cards, namely, chip-based cards, and, for the verification of the management of such cards; apparatus for the storage, conversion, processing and transmission of data, information and signals; scientific, photographic, cinematographic, optical, measuring, signaling and checking apparatus and instruments; electronic and/or computer apparatus, instruments and equipment for securing premises, including anti-theft warning apparatus, alarms; apparatus and instruments for the identification, access control using biometric data; electric locks; traffic control apparatus; apparatus for measuring speed; infrared cameras; apparatus for playing films; radar apparatus; software for capturing and processing data provided via the aforesaid apparatus and instruments; magnetic card encoders, readers; data encoders; data decoders; computers and computer peripherals for use in connection with cards and/or telecommunications apparatus; microcomputers; portable computers; hand-held computers; apparatus for controlling secure access to computer and/or telecommunications networks.

35 – Business management and company administration including personnel management; services provided by consultants and business management advice, provision of advice relating to company management and business operations; compilation and analysis of data and information relating to business

management; assistance and consultancy in the field of the business management of companies; assistance with the management of commercial activities or functions for an industrial or commercial company; business management and consultancy services; services provided by consultants regarding human resources; human resources management; advertising; advertising by mail order; radio advertising; television advertising; commercial business management; commercial administration; commercial information and advice for consumers in the field of identity, security and in the field of banking; dissemination of advertising material (leaflets, prospectuses, printed matter, samples); distribution of advertising material (leaflets, prospectuses, printed matter, samples); arranging newspaper subscriptions for others; arranging of telecommunication service subscriptions for others; updating and maintenance of data in computer databases; data search in computer files for others; web site traffic optimization; organization of exhibitions, trade fairs for commercial or advertising purposes; online advertising on a computer network; advertising mail; updating of advertising material; rental of advertising time on all communication media; publication of advertising texts; rental of advertising space; dissemination of advertisements; public relations; opinion polling; company audits (commercial analyses); commercial intermediation services; promotion of the goods of others, namely, provision of information about discounts, coupons, price reductions, vouchers and special offers for the goods of others; promotion of the goods and services of others by providing hyperlinks to the websites of others; promotion of the goods and services of others by providing websites with links to the online retail websites of others; services provided by business consultants in the field of online payments; management and monitoring of credit cards, immediate debit cards, prepaid cards, electronic checks, payment cards and other forms of payment transactions via electronic communication networks for business purposes; business information management, namely, business analysis e-reports regarding payment processing, authentication, tracking and invoicing; business management, namely, payment optimization for companies.

36 – Banking, financial and monetary affairs; insurance services; consultancy and information relating to financial, monetary and banking matters; consultancy and information relating to insurance underwriting; financial services, namely the electronic transfer of funds; clearing and reconciling of financial transactions; providing a wide range of payment and financial services, namely credit card services, issuance of credit cards, payment cards and credit lines, processing and transmission of bills and payments thereof, bill payment services with guaranteed provision of payment, and brokerage of money market funds, all via global communication networks;

processing of transactions carried out by credit card and immediate debit card; reimbursement of funds for disputed items in the field of purchasing via electronic payment; provision of purchase protection for goods and services purchased by others via global computer and wireless networks; processing of credit card transactions; credit services, namely, provision of revolving credit account services; bill payment services; provision of mobile electronic payment services for others; credit card and payment processing services; processing of payments through electronic foreign exchange operations; payment processing services, namely providing transaction processing services in virtual currency for others, deposits of valuables, deposits in safe boxes; issuing of travelers' checks, holiday vouchers and payment orders in general; financing of loans for security and surveillance systems.

38 – Telecommunications; telephone services; telephone exchange services; communications by telephone; computer telephony services; electronic messaging services; telephone voice messaging services; information on telecommunications; communications by computer terminals or by fiber-optic networks; communications by radio or telephone; cellular telephone communication services; transmission of data via telephone lines; providing telecommunications connections for hotlines and call centers; broadcasting of multimedia content via the Internet; streaming of audio, visual and audiovisual content via a global computer network; audio video and multimedia broadcasting via the internet and other communications networks; dissemination of data; provision of user access to global computer networks; provision of access to a Web portal and messaging; provision of on-line forums; provision of access to chat lines, chat rooms and forums on the Internet, including the mobile Internet; provision of access to electronic information, communication and transaction platforms on the Internet; transfer of all types of messages to Internet addresses [Web messaging]; provision of access to databases; electronic bulletin board services (telecommunication services); connection by telecommunications to a global computer network; news or information agencies; rental of telecommunication apparatus; radio or television programs (broadcasts); teleconferencing or videoconferencing services; rental of access time to global computer networks; transmission of information, data or software via telephone line, telecommunications and/or computer networks, cable, satellite, radio relay; downloading of data or software on cards and badges, including payment cards, remote payment, electronic cash, intended for securing transactions by code, particularly online; information concerning services.

40 – Printing; printing of documents or printed matter to combat unauthorized reproduction, falsifica-

tion and counterfeiting; photocomposition; photo-engraving; information and advice relating to printing; engraving; information and advice relating to engraving; services for etching a sequence of identifiable numbers onto automobile windows with a view to identification in case of theft.

42 – Computer engineering; technical consultancy relating to computers and/or telecommunications; design, development, maintenance and updating of software and databases; design and development of computers; development (design), installation, maintenance, updating or rental of software; computer programming; computer and software consultancy; programming for microprocessor cards and badges; lending and rental of computers, computer peripheral devices, computer programs and software; design, development, maintenance and updating of software for managing, securing and transferring cash; design, development of systems for the identification, authentication of the person; technical assistance, technical advice for the implementation of systems of identification and the authentication of persons; design, development and updating of programs and computer software for interpreting fingerprints, palm prints, features of the iris, veins, the voice, facial features or other biometric features in the field of access control and the authentication of persons; design, development and updating of cards and badges, including payment cards, remote payment, electronic cash, intended for securing all transactions by code, particularly online; design and development of currency, payment documents, access passes, identification documents, cards, badges, banners and labels; design, development and updating of cards and card readers; information and advice relating to design and development of currency, payment documents, access passes, identification documents, cards, badges, banners and labels; lending and leasing of cards and badges, including payment cards, remote payment, electronic cash intended for securing all transactions by code, particularly online; loan and rental of cards and keys for access to telecommunication systems and networks and computer systems and networks; the aforesaid services available for consultation or made available by means of data transmission or on telecommunication or computer networks; design and development of data acquisition systems in connection with documents or printed matter to combat unauthorized reproduction, falsification and counterfeiting; design, development of ink, watermarks, paper, and software products, electronic chips for authentication, customization, protection against unauthorized reproduction, forgery, counterfeiting of documents, printed matter; design and development of processes for protection against unauthorized reproduction, falsification, counterfeiting, processes for authentication, customization of documents by inking, watermarking, guilloche ornamentation, marking; hosting, development

and design of networks and servers for the processing and management of a customer's computer system; provision of temporary use of non-downloadable online software for processing electronic payments; provision of temporary use of non-downloadable online authentication software for controlling access to computers and computer networks as well as for controlling communication between computers and computer networks; computer programming and development; development of computer software, especially for processing data collected using traffic control apparatus; checks and certification of the quality of traffic control apparatus and computer software relating to traffic control; theoretical research and analysis of situations and information relating to traffic; advice relating to innovative technology and the improvement of traffic safety; reports, studies, analyses, evaluations, estimates, diagnostics, recommendations, consultancy and research in scientific and technological fields provided by engineers; technical project studies; research in the field of semi-conductor processing technology; creation of databases; certification, testing, analysis and evaluation of products and services of others with the aim of issuing certification; research and development of new products for others; services of a graphics studio; expert reports and studies relating to telecommunications; expert reports, studies, consultancy and technical advice relating to computer technology and/or management systems and/or securing the transfer of funds; electronic security consultancy; expert reports, studies, technical consulting and advice, in the field of electronic card management systems; design, development and customization of documents and printed matter, money, payment orders, documents for access, for identification, cards, badges, banderoles and labels; design and development of anti-intrusion, anti-sabotage, anti-destruction and anti-theft systems for premises or industrial facilities.

45 – Security services for the protection of property and individuals (excluding the transport thereof); night guard services; security agent services for the protection of property and individuals; providing information, advice and consultancy services relating to security services for the protection of property and individuals; security inspection services for others; authentication of personal identification information [identity verification services]; inspection of luggage for security purposes or in the field of transport, trade, regulated or unauthorized goods; information and consultancy relating to security for protection in the field of the transport of funds or valuables, luggage inspection; personal body guarding; surveillance and security for premises and industrial facilities; installation of anti-intrusion, anti-sabotage, anti-destruction and anti-theft systems for premises or industrial facilities; surveillance of anti-intrusion, anti-sabotage, anti-destruction and anti-theft and security

alarms; verification services for alarms and intervention subsequent to the triggering thereof; fingerprinting and fingerprint registration; assignment of identification numbers to affix to valuables to facilitate their recovery following loss or theft [security services]; locating stolen goods; stolen vehicle tracking; tracking services with a view to the recovery of encoded products; fraud detection services in the field of credit cards used for on-line shopping.

(260) AM 2018 96282 A
(800) 1093996
(151) 2011 07 11
(891) 2017 11 23
(731) BEIERSDORF AG
Unnastr. 48, 20253 Hamburg, Germany
(540)

DermaCapillaire

(591) Black, white
(511)
3 – Preparations for body and beauty care.

5 – Medicated preparations for body and beauty care; dermatological preparations for body and beauty care.

(260) AM 2018 96290 A
(800) 1278849
(151) 2015 10 15
(891) 2017 12 15
(731) NUTRISUN GMBH & CO. KG
Bosteler Feld 6 21218 Seevetal, Germany
(540)

Huxol

(591) Black, white
(511)
1 – Artificial sweeteners.
30 – Natural sweeteners.

(260) AM 2018 96314 A
(800) 1386798
(151) 2017 12 05
(891) 2017 12 05
(731) DR. THEISS NATURWAREN GMBH
Michelinstr. 10 66424 Homburg,
Germany
(540)

Redupetin

(591) Black, white
(511)
3 – Bleaching preparations and other substances for laundry use; cleaning, polishing, scouring and abrasive preparations; soaps; perfumery, essential oils, cosmetics, including non-medical skin cleaning and

care preparations, and hair care preparations; eyelashes (false -); lotions for hair; dentifrices.

5 – Pharmaceutical and veterinary preparations; medicines for human or veterinary purposes; sanitary preparations for medical purposes; dietetic foodstuffs and substances adapted for medical use; nutritional supplements; vitamin preparations, including beauty capsules.

(260) AM 2018 96315 A
(800) 1386803
(151) 2017 11 14
(891) 2017 11 14
(731) RICHTER GEDEON NYRT.
Gyömrői út 19-21, H-1103 Budapest, Hungary
(540)

РИНОРЕКС

(591) Black, white
(511)
5 – Pharmaceutical preparations.

(260) AM 2018 96316 A
(800) 1386804
(151) 2017 11 14
(891) 2017 11 14
(731) RICHTER GEDEON NYRT.
Gyömrői út 19-21, H-1103 Budapest, Hungary
(540)

ОПЛАНДА

(591) Black, white
(511)
5 – Pharmaceutical preparations.

(260) AM 2018 96342 A
(800) 1386094
(151) 2017 11 22
(891) 2017 11 22
(731) WINTCHAUTO OTOMOTIV PLASTIK
SANAYI TICARET LIMITED SİRKETİ
Alaaddinbey Mahallesi 624. Sok No:26/D2
Nilüfer/Bursa, Turkey
(540)



(591) WTW logotype on white ground;
WTW Colours blue and grey
(531) 26.11.11; 27.05.17; 27.05.23; 29.01.12

(511)

17 – Flexible pipes made from rubber and plastic; hoses made of plastic and rubber, including those used for vehicles; junctions for pipes of plastic and rubber; pipe jackets of plastic and rubber; hoses of textile material; junctions for pipes, not of metal; pipe jackets, not of metal; connecting hose for vehicle radiators.

(260) AM 2018 96344 A

(800) 1386128

(151) 2017 11 14

(891) 2017 11 14

(731) RICHTER GEDEON NYRT.

Gyömrői út 19-21, H-1103 Budapest, Hungary

(540)

ИННИКА

(591) Black, white

(511)

5 – Pharmaceutical preparations.

(260) AM 2018 96346 A

(800) 1386130

(151) 2017 11 14

(891) 2017 11 14

(731) RICHTER GEDEON NYRT.

Gyömrői út 19-21, H-1103 Budapest, Hungary

(540)

ФИБОТТА

(591) Black, white

(511)

5 – Pharmaceutical preparations.

(260) AM 2018 96347 A

(800) 1386131

(151) 2017 11 14

(891) 2017 11 14

(731) RICHTER GEDEON NYRT.

Gyömrői út 19-21, H-1103 Budapest, Hungary

(540)

ЛИНДАЛГИН

(591) Black, white

(511)

5 – Pharmaceutical preparations.

(260) AM 2018 96355 A

(800) 1386292

(151) 2017 12 11

(891) 2017 12 11

(731) HENKEL AG & CO. KGAA

Henkelstr. 67, 40589 Düsseldorf, Germany

(540)

NATURE BOX

(591) Black, white

(511)

3 – Non-medicated soaps; perfumery, essential oils, non-medicated cosmetics, non-medicated hair lotions; non-medicated dentifrices.

(260) AM 2018 96357 A

(800) 1386314

(151) 2017 12 14

(891) 2017 12 14

(731) ALPEN PHARMA AG

Casinoplatz 2, CH-3011 Bern, Switzerland

(540)

APICOLD

(591) Black, white

(511)

10 – Surgical, medical, dental and veterinary apparatus and instruments; artificial limbs, eyes and teeth; orthopedic articles; suture material; therapeutic and assistance devices designed for people with disabilities; massage apparatus; apparatus, devices and articles for child care; apparatus, devices and articles for sexual activities.

(260) AM 2018 96358 A

(800) 1386871

(151) 2016 06 02

(891) 2016 06 02

(731) SHANDONG HONGSHENG RUBBER CO., LTD.

Dongzhangzhuang Village, Dawang Town, Guangrao County, Dongying City, 257300 Shandong Province, China

(540)



(591) Black, white

(531) 25.05.01; 26.04.02; 26.04.05; 26.04.09; 26.04.22; 26.04.24; 27.05.17; 27.05.24

(511)

12 – Inner tubes for pneumatic tires; tires for vehicle wheels; vehicle tires; treads for vehicles [tractor type]; casings for pneumatic tires; treads for retreading tires; pneumatic tires; tires, solid, for vehicle wheels; vehicle wheel tires; automobile tires.

(260) AM 2018 96359 A

(800) 1386350

(151) 2017 12 01

(891) 2017 12 01

(731) FROSTKRONE TIEFKÜHLKOST GMBH

Konrad-Adenauer-Str.28, 33397 Rietberg,
Germany
(540)

frostkrone

(591) Black, white
(511)

29 – Meat; fish; poultry, not live; game; preserved, frozen, dried and cooked fruits and vegetables; milk; milk products; snack foods based on vegetables; meat-based appetisers.

30 – Rice; edible ices; savoury snacks; cheese-based snacks; fruit fritters.

(260) AM 2018 96361 A
(800) 1386921
(151) 2017 11 17
(891) 2017 11 17
(731) TISSOT SA

Chemin des Tourelles 17, CH-2400 Le Locle,
Switzerland

(540)

TISSOT, STYLE IS AUTOMATIC

(591) Black, white
(511)

14 – Precious metals and their alloys and goods made of these materials or coated therewith included in this class, namely figurines, trophies; jewelry, namely rings, earrings, cuff links, bracelets, charms, brooches, chains, necklaces, tie pins, tie clips, jewelry caskets (cases), cases; precious stones, semi-precious stones; timepieces and chronometric instruments namely chronometers, chronographs, clocks, watches, wristwatches, wall clocks, alarm clocks as well as parts and accessories for the aforesaid goods namely hands, anchors, pendulums, barrels, watch cases, watch straps, watch dials, clockworks, watch chains, movements for timepieces, watch springs, watch glasses, presentation cases for timepieces, cases for timepieces.

(260) AM 2018 96365 A
(800) 1386401
(151) 2017 11 07
(891) 2017 11 07
(731) RICHTER GEDEON NYRT.
Gyömrői út 19-21, H-1103 Budapest, Hungary

(540)

ENDARTEN

(591) Black, white
(511)

5 – Pharmaceutical preparations.

(260) AM 2018 96366 A
(800) 1386402
(151) 2017 11 07
(891) 2017 11 07
(731) RICHTER GEDEON NYRT.
34, chemin des Colombettes, P.O. Box 18,
CH-1211 Geneva, Hungary

(540)

CENBRATIN

(591) Black, white
(511)

5 – Pharmaceutical preparations.

(260) AM 2018 96395 A
(800) 1386506
(151) 2017 09 29
(891) 2017 09 29
(731) ASTELLAS PHARMA INC.
5-1, Nihonbashi-Honcho 2-chome, Chuo-ku
103-8411 Tokyo, Japan

(540)

НАРВУО

(591) Black, white
(531) 27.05.17

(511)

5 – Pharmaceutical preparations and substances.

(260) AM 2018 96399 A
(800) 1386542
(151) 2017 11 14
(891) 2017 11 14
(731) RICHTER GEDEON NYRT.
Gyömrői út 19-21, H-1103 Budapest, Hungary

(540)

ФОРИНДА

(591) Black, white
(511)

5 – Pharmaceutical preparations.

(260) AM 2018 96415 A
(800) 1268454
(151) 2013 07 11
(891) 2017 09 28
(731) TRADING POINT OF FINANCIAL
INSTRUMENTS LTD
12, Richard & Verengaria Street, Araouzos
Castle Court, 3rd Floor, CY-3042 Limassol,
Cyprus

(540)

XM

(591) Black, white

(511)

36 – Insurance; financial affairs; monetary affairs; real estate affairs; commodity trading and exchanges services; integration futures exchange services; international stock exchange price quotation; international financial exchange and monetary services; foreign currency exchange and advice; financial clearing house services; providing access to financial markets, stock markets, currency markets and commodities markets; financial brokerage services; financial and commodity trading services; providing trading services relating to financial instruments; financial services, namely, investment fund transfer and transaction services; financial trading services; executing trades and transactions on financial and commodities markets; holding money and funds for others; trustee services; providing loans; escrow services; currency exchange services; payment services; credit card services; debit card services; charge card services; prepaid card services; electronic credit and debit transactions; electronic funds transfer, provision of cards with computer chips and electronic cash services; cash disbursement; cash replacement; electronic cash transactions; cheque verification, cheque cashing; electronic funds transfers; stock exchange services; deposit access and automated teller machine services; payment processing services; transaction authentication and verification services; cash based foreign exchange services; advice, assistance, information, analysis and consultation services in the fields of finance, financial trading, commodities trading, banking, insurance, money, commodities trading, currency trading, stocks and shares; providing financial information on bonds, warrant bonds, commercial sales, and exchange and investment trusts; investment services; money lending services; fund raising services; loan services; mortgage services; information, advice and assistance relating to all the aforesaid; including (but not limited to) any of the aforesaid services provided online, and/or provided for use with and/or by way of the Internet, the world wide web and/or via communications, telephone, mobile telephone and/or wireless communication networks or devices.

41 – Education; providing of training; entertainment; providing education, entertainment and music; providing education and training in the fields of finance and financial trading; sporting and cultural activities; Internet, online, television, radio, musical entertainment and education services; presentation of radio, television and Internet programmes; entertainment services by providing non-downloadable playback of audio, visual and audio-visual recordings and content including via global communications networks; providing non-downloadable music, audio, visual and audio-visual recordings and content; organising and operating games and competitions; betting, gambling, gaming and lottery services; organising and operating educational and entertainment shows, ta-

lent shows and fashion shows; conducting auditions; arranging contests; publishing; music publishing; music mixing; production of music, films and of recordings and of audio, visual and audio-visual content; direction of music, films and of performances; organising and operating award schemes and ceremonies including in the fields of education, music and entertainment; organising and conducting parties, festivals, ceremonies, entertainment events and educational events; performances and live performances; music services; music group services; musical, radio, dramatic and television entertainment; disc jockey services; photography services and photographic syndication services; photographic reporting; news and current events reporting and syndication; educational and entertainment events ticket reservation services; advice, information and assistance relating to all the aforesaid, including (but not limited to) any of the aforesaid services provided online, and/or provided for use with and/or by way of the Internet, the world wide web and/or via communications, telephone, mobile telephone and/or wireless communication networks or devices.

(260) AM 2018 96416 A

(800) 1291576

(151) 2015 09 21

(891) 2017 06 19

(731) Otkrytoe Aktsionernoe Obshchestvo

"Bi-end-Bi (B&B)"

Street Ryazanovskaya, 1, Podolsk City

RU-142111 The Moscow Region, Russian

Federation

(540)

Пчелка

(591) Black, white

(511)

30 – Yeast, baking-powder; salt, mustard; vinegar, sauces [condiments]; spices.

(260) AM 2018 96418 A

(800) 1324332

(151) 2016 07 20

(891) 2017 11 27

(731) SOPHARMA AD

Iliensko shose str. 16, BG-1220 SOFIA,

Bulgaria

(540)

DEXPANTHEN SOPHARMA

(591) Black, white

(511)

3 – Perfumery, essential oils, cosmetics, hair lotions.

(260) AM 2018 96420 A

(800) 1365501

(151) 2017 03 27

(891) 2016 12 08

(731) STANISLAV OLEGOVYCH ZUBRYTSKYI

Vul. Pushkinska, 39, kv. 24, Odesa 65125,

Ukraine

(540)



(591) Black, white

(531) 26.01.22; 27.05.15

(511)

25 – Albs; ankle boots; aprons (clothing); ascots; babies' pants (underwear); bandanas (neckerchiefs); bath robes; bath sandals; bath slippers; bathing caps; bathing drawers; bathing suits; beach shoes; belts (clothing); berets; bibs, not of paper; boas (necklets); bodices (lingerie); underwear; boots; boot uppers; boots for sports; boxer shorts; brassieres; breeches for wear; camisoles; caps (headwear); cap peaks; chasubles; clothing; clothing for gymnastics; clothing of imitations of leather; clothing of leather; collars (clothing); combinations (clothing); coats; corselets; corsets (underclothing); cuffs (clothing); cuffs; cyclists' clothing; detachable collars; dress shields; dresses; dressing gowns; ear muffs (clothing); esparto shoes or sandals; fishing vests; fittings of metal for footwear; football boots; footmuffs, not electrically heated; footwear; footwear uppers; furs (clothing); fur stoles; gabardines (clothing); galoshes; gaiter straps; gaiters; garters; girdles; gloves (clothing); gymnastic shoes; half-boots; hat frames (skeletons); hats; headbands (clothing); headgear for wear; heelpieces for footwear; heelpieces for stockings; heels; hoods (clothing); hosiery; inner soles; jackets (clothing); jerseys (clothing); jumpers (pull-overs); knickers; knitwear (clothing); lace boots; layettes (clothing); leggings (leg warmers); leggings (trousers); liveries; maniples; mantillas; masquerade costumes; mitres (hats); mittens; money-belts (clothing); motorists' clothing; muffs (clothing); neck scarves; (mufflers); neckties; non-slipping devices for footwear; outer clothing; overcoats; panties; paper clothing; paper hats (clothing); parkas; pelerines; pelisses; petticoats; pinafore dresses; pocket squares; pockets for clothing; ponchos; pyjamas; ready-made clothing; ready-made linings (parts of clothing); sandals; saris; sarongs; sashes for wear; scarves; shawls; shirts; shirt fronts; shirt yokes; shoes; short-sleeve shirts, shower caps; singlets; ski boots; ski gloves; skirts; skull caps; sleep masks; slippers; socks; sock

suspenders; soles for footwear; sports shoes; sports jerseys; stockings; stocking suspenders; studs for football boots; stuff jackets; suits; suspenders; sweat-at-absorbent socks; sweat-absorbent stockings; sweat-at-absorbent underwear; sweaters; tee-shirts; tights; tips for footwear; togas; top hats; trousers; turbans; underclothing; underpants; uniforms; valenki (felted boots); veils (clothing); vests; visors (headwear); waterproof clothing; welts for footwear; wet suits for water-skiing; wimples; wooden shoes.

35 – Accounting; administration of consumer loyalty programs; administration of frequent flyer programs; administrative processing of purchase orders; advertising; advertising agency services; advertising by mail order; advisory services for business management; appointment reminder services (office functions); appointment scheduling services (office functions); arranging newspaper subscriptions for others; arranging subscriptions to telecommunication services for others; auctioneering; bill-posting; business administration; business appraisals; business auditing; business efficiency expert services; business information; business inquiries; business investigations; business management; business management and organization consultancy; business management assistance; business management consultancy; business management for freelance service providers; business management of hotels; business management of performing artists; business management of reimbursement programmes for others; business management of sports people; business organization consultancy; business project management services for construction projects; business research; commercial administration of the licensing of the goods and services of others; commercial information agency services; commercial information and advice for consumers (consumer advice shop); commercial intermediation services; commercial or industrial management assistance; compilation of information into computer databases; compilation of statistics; computerized file management; cost price analysis; data search in computer files for others; demonstration of goods; design of advertising materials; direct mail advertising; dissemination of advertising matter; distribution of samples; document reproduction; drawing up of statements of accounts; economic forecasting; employment agency services; import-export agency services; invoicing; layout services for advertising purposes; market studies; marketing; marketing research; modelling for advertising or sales promotion; negotiation and conclusion of commercial transactions for third parties; news clipping services; office functions; office machines and equipment rental; on-line advertising on a computer network; opinion polling; organization of exhibitions for commercial or advertising purposes; organization of fashion shows for promotional purposes; organization of trade fairs for commercial or advertising purposes; outdoor advertising; outsour-

ced administrative management for companies; outsourcing services (business assistance); pay per click advertising; payroll preparation; personnel management consultancy; personnel recruitment; photocopying services; presentation of goods on communication media, for retail purposes; price comparison services; procurement services for others (purchasing goods and services for other businesses); production of advertising films; professional business consultancy; providing business information via a web site; provision of an on-line marketplace for buyers and sellers of goods and services; provision of commercial and business contact information; psychological testing for the selection of personnel; public relations; publication of publicity texts; publicity material rental; radio advertising; relocation services for businesses; rental of advertising space; rental of advertising time on communication media; rental of billboards (advertising boards); rental of photocopying machines; rental of sales stands; rental of vending machines; retail or wholesale services for pharmaceutical, veterinary and sanitary preparations and medical supplies; sales promotion for others; scriptwriting for advertising purposes; search engine optimization for sales promotion; secretarial services; shop window dressing; shorthand; sponsorship search; systemization of information into computer databases; tax filing services; tax preparation; telemarketing services; telephone answering for unavailable subscribers; television advertising; transcription of communications (office functions); typing; updating and maintenance of data in computer databases; updating of advertising material; web indexing for commercial or advertising purposes; web site traffic optimization; word processing; writing of curriculum vitae for others; writing of publicity texts; writing of resumes for others.

(260) AM 2018 96421 A
 (800) 1387982
 (151) 2017 11 14
 (891) 2017 11 14
 (731) RICHTER GEDEON NYRT.
 Gyömrői út 19-21, H-1103 Budapest, Hungary
 (540)

ДИНАРА

(591) Black, white
 (511)
 5 – Pharmaceutical preparations.

(260) AM 2018 96423 A
 (800) 1387983
 (151) 2017 11 14
 (891) 2017 11 14
 (731) RICHTER GEDEON NYRT.
 Gyömrői út 19-21, H-1103 Budapest,
 Hungary

(540)

ФИБРОДЕКС

(591) Black, white
 (511)
 5 – Pharmaceutical preparations.

(260) AM 2018 96425 A
 (800) 1387985
 (151) 2017 11 14
 (891) 2017 11 14
 (731) RICHTER GEDEON NYRT.
 Gyömrői út 19-21, H-1103 Budapest, Hungary
 (540)

ЭНДАРТЕН

(591) Black, white
 (511)
 5 – Pharmaceutical preparations.

(260) AM 2018 96466 A
 (800) 1387628
 (151) 2017 11 07
 (891) 2017 11 07
 (731) RICHTER GEDEON NYRT.
 Gyömrői út 19-21, H-1103 Budapest, Hungary
 (540)

LIPILLA

(591) Black, white
 (511)
 5 – Pharmaceutical preparations.

(260) AM 2018 96467 A
 (800) 1387629
 (151) 2017 11 14
 (891) 2017 11 14
 (731) RICHTER GEDEON NYRT.
 Gyömrői út 19-21, H-1103 Budapest,
 Hungary
 (540)

ДЕМИРОН

(591) Black, white
 (511)
 5 – Pharmaceutical preparations.

(260) AM 2018 96468 A
 (800) 1387637
 (151) 2017 11 20
 (891) 2017 11 20
 (731) LONSMAX LIMITED
 101 ROOM, BUILDING C10, BLOCK C,
 FUHAI INDUSTRY PARK, FUHAI AVE-
 NUE, FUYONG, BAO'AN, SHENZHEN
 GUANGDONG, China

(540)

LONSMAX

(591) Black, white

(511)

9 – Computers; computer hardware; cellular phones; cases and covers for mobile telephones; headphones; cameras [photography]; materials for electricity mains [wires, cables]; batteries, electric; chargers for electric batteries; mobile electric power supply units (rechargeable batteries).

(260) AM 2018 96469 A

(800) 1387640

(151) 2017 12 06

(891) 2017 12 06

(731) HYUNDAI MOTOR COMPANY

12, Heolleung-ro, Seocho-gu Seoul 06797,
Republic of Korea

(540)

ELECCITY

(591) Black, white

(511)

12 – Electrically powered buses; motor buses; automobiles, electrically powered motor vehicles.

(260) AM 2018 96470 A

(800) 1387665

(151) 2017 09 29

(891) 2017 09 29

(731) Encavis AG

Große Elbstraße 59 22767 Hamburg,
Germany

(540)

ENCAVIS

(591) Black, white

(511)

4 – Electrical power; Electrical energy, including electrical energy from solar power and wind power; Additives in connection with aforesaid goods, included in this class.

36 – Finance services; Monetary affairs; Financial consultancy in the energy sector; Consultancy concerning financing of energy projects; Brokerage of financial investments in energy companies.

(260) AM 2018 96471 A

(800) 1388365

(151) 2017 11 27

(891) 2017 11 27

(731) ZHOUSHAN SHENYING AUTOMOBILE

ACCESSORY FACTORY

Fengshou Zhan, Daidong Town, Daishan
County, Zhejiang, China

(540)

RENKEN

(591) Black, white

(511)

7 – Oil filters; air cleaners; diesel fuel filters; mufflers for automobiles engines; inlet exhaust pipes for mufflers for automobile engines; engine exhaust pipes; fan belts for motors and engines; igniting magnets for engines; alternators; dynamos.

(260) AM 2018 96527 A

(800) 1387978

(151) 2017 11 14

(891) 2017 11 14

(731) Richter Gedeon Nyrt.

Gyömrői út 19-21, H-1103 Budapest, Hungary

(540)

АУМА

(591) Black, white

(511)

5 – Pharmaceutical preparations.

(260) AM 2018 96528 A

(800) 1387979

(151) 2017 11 14

(891) 2017 11 14

(731) Richter Gedeon Nyrt.

Gyömrői út 19-21, H-1103 Budapest, Hungary

(540)

АЛМИОН

(591) Black, white

(511)

5 – Pharmaceutical preparations.

(260) AM 2018 96529 A

(800) 1387980

(151) 2017 11 14

(891) 2017 11 14

(731) Richter Gedeon Nyrt.

Gyömrői út 19-21, H-1103 Budapest, Hungary

(540)

АРЛИНТА

(591) Black, white

(511)

5 – Pharmaceutical preparations.

(260) AM 2018 96541 A

(800) 1388529

(151) 2017 09 05

(891) 2017 09 05

(731) Limited liability company "Trading
Distributor "MERA"

Str. 2 Institutskaya, 6, build. 2, room 12
RU-109428 Moscow, Russian Federation

(540)

DR. ALKASTONE

(591) Black, white

(531) 27.05.17

(511)

35 – Demonstration of goods; commercial information and advice for consumers [consumer advice shop]; presentation of goods on communication media, for retail purposes; sales promotion for others; procurement services for others [purchasing goods and services for other businesses]; retail or wholesale services provided by shops; retail or wholesale services for goods, including retail or wholesale services provided via teleshopping or Internet sites.

(260) AM 2018 96584 A

(800) 1389309

(151) 2017 07 19

(891) 2017 07 19

(731) EVGENY ROBERTOVICH SERKIN

ul. Demjana Bednogo, d. 14 korp. 1, kv. 47

RU-195274 Saint-Petersburg, Russian

Federation

(540)

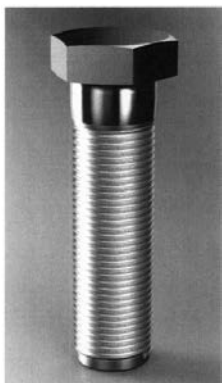

(591) Black, white

(531) 14.03.01; 14.03.03

(554) Three-dimensional

(511)

21 – Plastic bottles; glass bottles.

32 – Aperitifs, non-alcoholic; aerated water; mineral water [beverages]; waters [beverages]; kvass [non-alcoholic beverage]; cocktails, non-alcoholic; beer-based cocktails; lemonades; non-alcoholic beverages; isotonic beverages; non-alcoholic honey-based beverages; soya-based beverages, other than milk substitutes; aloe vera drinks, non-alcoholic; whey beverages; non-alcoholic fruit juice beverages; fruit nectars, non-alcoholic; orgeat; beer; sarsaparilla [non-alcoholic beverage]; syrups for lemonade; syrups for beverages; smoothies; vegetable juices [beverages]; fruit juices.

33 – Aperitifs; arrack [arak]; baijiu [Chinese distilled alcoholic beverage]; brandy; wine; whisky; vodka; anisette [liqueur]; kirsch; gin; digesters [liqueurs and spirits]; cocktails; curacao; anise [liqueur]; liqueurs; alcoholic beverages, except beer; pre-mixed alcoholic beverages, other than beer-based; alcoholic beverages containing fruit; distilled beverages; spirits [beverages]; mead [hydromel]; peppermint liqueurs; bitters; rum; sake; perry; cider; rice alcohol; alcoholic essences.

(260) AM 2018 96585 A

(800) 1389363

(151) 2017 09 13

(891) 2017 09 13

(731) PEPSICO, INC.

(a North Carolina corporation)

700 Anderson Hill Road Purchase NY 10577,

USA

(540)



(591) White, black, red, brown, light brown and yellow

(531) 08.01.03; 08.05.03; 27.05.17; 29.01.13

(511)

30 – Cereal bars; cereal-based snack food; crackers; petit-beurre biscuits; oat-based food; rusks.

(260) AM 2018 96586 A

(800) 1389376

(151) 2017 10 13

(891) 2017 10 13

(731) METER S.p.A.

Via Leonardo Da Vinci, 5 I-10070

ROBASSOMERO (TO), Italy

(540)



(591) Black, white

(531) 15.07.11; 25.07.15; 26.11.06; 26.11.08; 27.05.24

(511)
7 – Rolling bearings.

(260) AM 2018 96587 A
(800) 1389388
(151) 2017 11 08
(891) 2017 11 08
(731) Obshchestvo s ogranichennoi
otvetstvennost'yu "SBB"
ul. Kommunisticheskaya, 40, of. 1102
RU-630007 Novosibirsk, Russian Federation

(540)



(591) Black, white
(531) 26.04.07; 26.04.22; 27.05.17
(511)
43 – Bar services; café services; cafeteria services;
food and drink catering; food sculpting; rental of
meeting rooms; restaurant services; self-service res-
taurant services; snack-bar services.

(260) AM 2018 96589 A
(800) 1389424
(151) 2017 12 22
(891) 2017 12 22
(731) DAVID AND LILY PENN, INC.
10201 Wayzata Boulevard, Suite 250
Minnetonka MN 55305, USA

(540)

MINE PRO

(591) Black, white
(511)
12 – Tires.

(260) AM 2018 96590 A
(800) 1389449
(151) 2018 01 02
(891) 2018 01 02
(731) DR. THEISS NATURWAREN GMBH
Michelinstr. 10 66424 Homburg, Germany

(540)

Repecalm

(591) Black, white
(511)
3 – Bleaching preparations and other substances for
laundry use; cleaning, polishing, scouring and abra-
sive preparations; soaps; perfumery, essential oils,
cosmetics, including non-medical skin cleaning and
care preparations, and hair care preparations; eye-
lashes (false -); lotions for hair; dentifrices.

5 – Pharmaceutical and veterinary preparations; me-
dicines for human or veterinary purposes; sanitary
preparations for medical purposes; dietetic foods-
tuffs and substances adapted for medical use; nu-
tritional supplements; vitamin preparations, including
beauty capsules.

(260) AM 2018 96591 A
(800) 1389479
(151) 2016 12 30
(891) 2016 12 30
(731) JUVENTUS FOOTBALL CLUB S.p.A.
Via Druento, 175 I-10151 Torino, Italy

(740)



(591) Black, white
(531) 27.05.21
(511)
9 – Apparatus and instruments for recording, trans-
mission and reproduction of sound or images; video
and/or sound recordings; audio and/or video CDs;
audio and/or video tapes and cassettes; DVD; optical
discs containing sound recordings and/or video; au-
dio and video clips made for the purposes of
teaching, training and information; PC games;
downloadable application software for smartphones
and tablets; electronic publications; electronic down-
loadable publications; downloadable publications
and multimedia content in digital format; eyewear;
glasses; sun glasses; spectacle frames; protective
glasses; eyeglass cases; safety clothing for protection
against accident or injury; protective work gloves;
head protection; protective glasses; helmets; cases
for telephones; cases for smartphones; tablet cases;
cell phone straps; smartphone straps; tablet straps;
shoulder straps for smartphones; acoustic headpho-
nes; headsets for mobile phones; headphones for
smartphones and tablets.

16 – Stationery; writing and drawing instruments;
office requisites (except furniture); printed photos;
adhesives (glues) for stationery or household purpo-
ses; artists' materials; artists' brushes; instructional
and teaching material (except apparatus); printed
publications; books; newspapers; magazines; perio-
dicals; bookmarks; greeting cards; notebooks; diari-
es; agendas; writing or drawing books; sketch books;
posters; calendars; figurines; paper towels.

25 – Casualwear; formalwear; sportswear; clothing, for the practice of sports, namely, shirts, team and competition jerseys and team and competition uniforms, polo shirts, tracksuits, warm-up suits, shorts, pants, socks, tights; underwear, namely, underpants, long underpants, tank tops, long and short sleeve undershirts; belts; ties; swimwear; bathrobes; footwear; boots; slippers; slippers; sports footwear; headgear.

28 – Games; toys; gymnastic and sporting articles; balls and balloons for sports; soccer balls; guards for sports including elbow guards, knee pads, shin guards; goalkeeper gloves; soccer ball goal nets; soccer goals; Christmas tree decorations.

41 – Sporting and cultural activities; education and educational services; training courses; organisation of training courses, refresher courses, events, symposiums, colloquiums, exhibitions, workshops or other activities and events for educational, training, cultural, recreational or sporting purposes; arranging and conducting of events for cultural, educational, entertainment, training, sports and recreational purposes; organisation and conducting of sporting events and tournaments, shows, concerts, festivals, awards; organisation of awards ceremonies and ceremonies for awarding sporting and academic titles; hire of equipment for sports; provision of courses of instruction relating to sport; entertainment, namely providing multimedia content, information, libraries and podcasts via the internet and/or other communications networks; publication of video, audio and digital multimedia content; publishing services and online digital publishing services.

(260) AM 2018 96592 A

(800) 1389488

(151) 2017 06 30

(891) 2017 06 30

(731) PIRELLI TYRE S.P.A.

Viale Piero e Alberto Pirelli, 25 I-20126
Milan, Italy

(540)

SMARTNET

(591) Black, white

(511)

1 – Chemicals and polymers used in the manufacture of tyres, inner tubes, and rubber containing products and the repair thereof; chemical additives, chemical reagents, chemical intermediates and chemical compounds used in the manufacture of tyres, inner tubes, and rubber containing products and the repair thereof; adhesives used in connection with tyres, inner tubes, and rubber containing products industry and the repair thereof; unprocessed plastics; emulsifying, dispersing, solubilising and wetting agents; chemical additives for rubber processing; chemical additives

for rubber vulcanising; latex rubber additives; chemical intensifiers for rubber; chemical products for use as plasticizers in rubbers; chemical products for use in the processing of natural rubber; chemical substances for use in the production of synthetic rubber; chemicals for use in the rubber industry; chemicals for use in the treatment of materials made of rubber; compounds for compounding rubber and latex; dehydrating agents for the treatment of rubber materials; fillers for rubber; polyisoprene rubber; preservatives for rubber; rubber adhesives (other than for household or stationery use); rubber antioxidants and antiozonants; rubber based adhesives (other than for household or stationery use); rubber compounds for industrial use.

12 – Tires, solid, for vehicle wheels; pneumatic, semi pneumatic and/or solid tyres; vehicle wheels; wheel rims; inner tubes and mousse for vehicle tyres.

17 – Rubber; gum; goods made from, partly from or including these materials not included in other classes; rubber material for recapping tyres; plastics in extruded form for use in manufacture; packing stopping and insulating materials; flexible pipes not of metal; rubber solutions.

(260) AM 2018 96593 A

(800) 1389496

(151) 2017 08 01

(891) 2017 08 01

(731) Obshchestvo s ogranichennoy

otvetstvennostyu "LABORATORIYA
TESTIROVANIY"

Leningradskoe sh., 46/1, RU-125212 Moskva,
Russian Federation

(540)



(591) Black and red.

(531) 24.17.25; 27.05.08; 27.05.11; 29.01.12

(511)

35 – Arranging subscriptions to telecommunication services for others; import-export agency services; commercial information agency services; advertising agency services; cost price analysis; rental of advertising space; employment agency services; computerized file management; demonstration of goods; transcription of communications; opinion polling;

market studies; business information; commercial information and advice for consumers; business investigations; marketing research; personnel recruitment; business management and organization consultancy; business organization consultancy; business management consultancy; professional business consultancy; layout services for advertising purposes; business management of performing artists; updating of advertising material; word processing; secretarial services; shorthand; organization of exhibitions for commercial or advertising purposes; organization of trade fairs for commercial or advertising purposes; business appraisals; data search in computer files for others; sponsorship search; business management assistance; commercial or industrial management assistance; presentation of goods on communication media, for retail purposes; economic forecasting; auctioneering; sales promotion for others; publication of publicity texts; typing; radio advertising; bill-posting; distribution of samples; dissemination of advertising matter; writing of publicity texts; advertising; on-line advertising on a computer network; advertising by mail order; television advertising; document reproduction; compilation of statistics; compilation of information into computer databases; business inquiries; systemization of information into computer databases; administrative processing of purchase orders; public relations; procurement services for others [purchasing goods and services for other businesses]; business efficiency expert services.

41 – Academies [education]; publication of books; education information; recreation information; entertainment information; club services [entertainment or education]; layout services, other than for advertising purposes; videotape editing; production of radio and television programmes; game services provided on-line from a computer network; providing on-line electronic publications, not downloadable; correspondence courses; practical training [demonstration]; organization of exhibitions for cultural or educational purposes; arranging and conducting of colloquiums; arranging and conducting of congresses; arranging and conducting of conferences; arranging and conducting of workshops [training]; arranging and conducting of seminars; arranging and conducting of symposiums; organization of competitions [education or entertainment]; vocational guidance [education or training advice]; educational examination; electronic desktop publishing; on-line publication of electronic books and journals; publication of texts, other than publicity texts; writing of texts; teaching; translation.

42 – Computer system analysis; recovery of computer data; graphic arts design; computer virus protection services; conducting technical project studies; engineering; installation of computer software; research and development of new products for others;

technical research; consultancy in the design and development of computer hardware; computer software consultancy; architectural consultancy; updating of computer software; maintenance of computer software; conversion of data or documents from physical to electronic media; providing search engines for the internet; conversion of computer programs and data, other than physical conversion; computer system design; rental of web servers; computer rental; rental of computer software; hosting computer sites [web sites]; duplication of computer programs; construction drafting; computer software design; creating and maintaining web sites for others; computer programming; surveying.

(260) AM 2018 96607 A
 (800) 769193
 (151) 2001 09 24
 (891) 2017 12 21
 (731) BELGOMILK, coöperatieve vennootschap met beperkte aansprakelijkheid
 Fabriekstraat 141, B-9120 Kallo, Belgium
 (540)

INCOLAC

(591) Black, white
 (511)
 29 – Milk and dairy products; powdered milk; whey (lactoserum) and milk beverages, mainly of milk.

(260) AM 2018 96615 A
 (800) 1388692
 (151) 2017 08 15
 (891) 2017 08 15
 (731) "VEYSAIOGLU- YAYCILI GARDASHLARY" Limited Liability Company
 Keshle settlement, Ikindzi enine str., ap. 2
 AZ-1031 Baku, Azerbaijan
 (540)



(591) White, black, orange, yellow, green, brown and red
 (531) 05.07.06; 25.01.05; 26.04.06; 26.04.24; 27.05.10; 27.05.17; 27.05.24; 29.01.15
 (511)
 30 – Confectionery, candies, chocolate.
 35 – Sales of goods indicated in class 30.

39 – Transporting and storage of goods indicated in class 30.

(260) AM 2018 96616 A

(800) 1301165

(151) 2016 02 11

(891) 2018 01 05

(731) VALERIIA VADYMYVNA BORODINA

vul. Urytskoho, bud. 25, kv. 17 m. Kyiv

03035, Ukraine

(540)

G.Bar

(591) Black, white

(531) 27.05.17; 27.05.17; 27.05.23

(511)

44 – Beauty salons; midwife services; nursing homes; veterinary assistance; wreath making; plant nurseries; pet grooming; animal grooming; public baths for hygiene purposes; lawn care; weed killing; hair implantation; flower arranging; health counseling; landscape gardening; landscape design; hospitals; massage; medical assistance; health care; medical advice for individuals with disabilities; nursing, medical; health centers; convalescent homes; hairdressing salons; plastic surgery; horticulture; aerial and surface spreading of fertilizers and other agricultural chemicals; alternative medicine services; blood bank services; visagists' services; aromatherapy services; health spa services; medical clinic services; opticians' services; services of a psychologist; sauna services; solarium services; telemedicine services; aquaculture services; speech therapy services; in vitro fertilization services; manicuring; artificial insemination services; medical equipment rental; rental of sanitation facilities; farming equipment rental; rehabilitation for substance abuse patients; animal breeding; tree surgery; gardening; tree planting for carbon offsetting purposes; beauty salons; sanatoriums; dentistry; tattooing; therapy services; Turkish baths; pharmacy advice; pharmacists' services to make up prescriptions; physical therapy; chiropractics; hospices.

(260) AM 2018 96623 A

(800) 1388753

(151) 2017 11 08

(891) 2017 11 08

(731) MUNDIPHARMA AG

St. Alban-Rheinweg 74, CH-4020 Basel,

Switzerland

(540)

MUNDICARE

(591) Black, white

(511)

3 – Soaps; perfumery products; essential oils; cosmetics; hair treatments and preparations; hair lotions; toiletry products; sunscreen preparations, including sprays, lotions, creams, gels, oils for sun protection, sun balms and creams for lip care; cosmetic skin-tanning preparations; after-sun products (cosmetics); cosmetic preparations for skin care, including moisturizing treatments, protective creams, tonics for skin care, exfoliants, artificial sun-tanning preparations, degreasing products for use on the skin; cosmetic preparations, including cosmetics for the scalp, hair, skin and nails; wipes and tissues impregnated with cosmetic preparations.

5 – Pharmaceutical preparations and substances; veterinary preparations; hygienic products for medical use; dietetic substances and substances adapted for medical or veterinary use; food supplements for humans and animals; food supplements, plasters, materials for dressings; disinfectants; antiseptics; pharmaceutical preparations and substances, including chemical and acid preparations for pharmaceutical use; creams for pharmaceutical use; gels for dermatological use; oils for medical use; cream for the skin, gels, oils, lotions and ointments for pharmaceutical use; ointments for medical use; homeopathic pharmaceutical preparations; pharmaceutical preparations based on plant extracts; medicinal plant extracts; nail care preparations for medical use; medicated hair care preparations; pharmaceutical preparations for skin care; pharmaceutical sun protection and sun care products; antiseptic and antibacterial products; wipes for medical use; medical dressings; wipes, dressings, cloths and materials serving as dressings for wounds, including those impregnated with pharmaceutical preparations; cleaning wipes impregnated with disinfectants, for hygiene use; wound dressings.

(260) AM 2018 96624 A

(800) 1388784

(151) 2017 09 01

(891) 2017 09 01

(731) MEDIAPPOINT LTD

103 Sham Peng Tong Plaza, Victoria, Mahe,

Seychelles, Seychelles

(540)

Boro-da

(591) Black, white

(531) 27.05.01

(511)

32 – Aperitifs, non-alcoholic; aerated water; mineral water [beverages]; kvass [non-alcoholic beverage]; cocktails, non-alcoholic; lemonades; non-alcoholic beverages; isotonic beverages; non-alcoholic honey-

based beverages; non-alcoholic fruit juice beverages; beer; smoothies; vegetable juices [beverages]; fruit juices; preparations for making beverages; non-alcoholic fruit extracts; extracts of hops for making beer.

33 – Alcoholic beverages, except beer, including aperitifs, wine, vodka, cocktails, liqueurs; pre-mixed alcoholic beverages, other than beer-based; digesters [liqueurs and spirits]; mead [hydromel]; bitters; cider; perry.

(260) AM 2018 96625 A

(800) 1388790

(151) 2017 09 13

(891) 2017 09 13

(731) Joint-Stock Company "Fabrika
"RUSSKIY SHOKOLAD"

ul. Vereyskaya, d. 29, str. 143 RU-121357
Moscow, Russian Federation

(540)

Felicita Soufletto

(591) Black, white

(531) 27.05.17

(511)

30 – Coffee flavorings; high-protein cereal bars; sponge cakes; buns; bread rolls; waffles; malt biscuits; cake frosting [icing]; rice-based snack food; cereal-based snack food; fruit jellies [confectionery]; confectionery for decorating Christmas trees; cakes; pastries; peanut confectionery; almond confectionery; frozen yogurt [confectionery ices]; cocoa; caramels [candy]; sweetmeats [candy]; liquorice [confectionery]; peppermint sweets; coffee; unroasted coffee; crackers; macarons [pastry]; marzipan; ice cream; dessert mousses [confectionery]; chocolate mousses; muesli; mint for confectionery; cocoa-based beverages; coffee-based beverages containing milk; coffee-based beverages; chocolate beverages with milk; tea-based beverages; chocolate-based beverages; stick liquorice [confectionery]; pastilles [confectionery]; cookies; petit-beurre biscuits; pies; fondants [confectionery]; popcorn; petits fours [cakes]; pralines; gingerbread; cake powder; fruit coulis [sauces]; chewing gum; confectionery; nougat; chocolate paste; sherbets [ices]; rusks; breadcrumbs; sandwiches; tabbouleh; tacos; tarts; almond paste; tortillas; halvah; bread; unleavened bread; chips [cereal products]; corn flakes; oat flakes; chicory [coffee substitute]; tea; iced tea; cheeseburgers [sandwiches]; chocolate.

(260) AM 2018 96638 A

(800) 1389130

(151) 2017 11 29

(891) 2017 11 29

(731) M. Eric CANTONA

Rua Vale do pereiro 17, 2°esq P-1250-270

Lisboa, Portugal

(540)

NOSTRA

(591) Black, white

(531) 27.05.01

(511)

3 – Soaps; perfumery, essential oils, cosmetics, hair lotions; dentifrices; depilatories; make-up removing products; lipstick; beauty masks; shaving products; cosmetic skin-tanning preparations; cosmetic preparations for baths; bath salts not for medical use; shoe polish; polish for footwear; cosmetic kits; deodorants for personal use (perfumery); deodorant soaps; oils for cosmetic use; oils for toilet purposes; cleansing milk for toilet purposes; tissues impregnated with cosmetic lotions; shampoos; soaps for foot perspiration; antiperspirants (toiletries); incense.

(260) AM 2018 96639 A

(800) 1389176

(151) 2017 12 11

(891) 2017 12 11

(731) BIONORICA SE

Kerschensteinerstrasse 11-15, 92318
Neumarkt, Germany

(540)



(591) Black, white

(531) 05.03.14; 19.11.07

(511)

5 – Pharmaceutical products; medicines; medicinal preparations; veterinary preparations; dietary supplements for human beings; dietary supplements for animals.

16 – Paper; cardboard; printed matter; photographs.

(260) AM 2018 96653 A

(800) 1390196

(151) 2017 10 31

(891) 2017 10 31

(731) Aktsionernoe Obschestvo "NIZHE-
GORODSKY KHIMIKO-FARMAT-
SEVTICHESKY ZAVOD"

Salganskaya St., 7 RU-603950 Nizhny
Novgorod, Russian Federation

(540)

ТромбоМар

(591) Black and white

(511)

5 – Albuminous foodstuffs for medical purposes; albuminous preparations for medical purposes; biological preparations for medical purposes; cachets for pharmaceutical purposes; capsules for medicines; chemical preparations for medical purposes; chemical preparations for pharmaceutical purposes; chemico-pharmaceutical preparations; dietetic foods adapted for medical purposes; dietetic substances adapted for medical use; drugs for medical purposes; food for babies; liniments; medicines for human purposes; mineral food supplements; nutritional supplements; ointments for pharmaceutical purposes; pharmaceutical preparations; preparations of trace elements for human and animal use; vitamin preparations; suppositories.

(260) AM 2018 96655 A

(800) 1390241

(151) 2017 08 25

(891) 2017 08 25

(731) LENZING AG

Werkstr. 2 A-4860 Lenzing, Austria

(540)

Tencel

(591) Black and white

(511)

16 – Crepe paper; filtering materials of paper; filter paper; paper filters for coffee makers; printed packaging materials of paper; containers of paper for packaging purposes; bags made of paper for packaging; decorative paper bows for wrapping; decorative wrapping paper; humidity control sheets of paper or plastic for foodstuff packaging; sheets of reclaimed cellulose for wrapping; paper gift tags; gift wrap paper; cardboard packaging; plastic film for packaging; paper impregnated with oil for wrapping purposes; cartons of cardboard for packaging; plastic materials for packaging; paper for wrapping and packaging; paper sacks; bags made of paper for packaging; bows for decorating packaging; bags made of paper for packaging; bags and articles for packaging, wrapping and storage of paper, cardboard or plastics; industrial packaging containers of paper; containers of card for packaging; packaging containers of regenerated cellulose; bags [envelopes, pouches] of paper or plastics, for packaging; films for wrapping foodstuffs; packing cardboard; cartons of cardboard for packaging; fiberboard boxes; plastic materials for packaging (not included in other classes); wrapping materials made of paper; packaging materials made of cardboard; packaging materials made of recycled paper; packaging material made of

starches; packaging materials; wrapping paper; cartons of cardboard for packaging; cartons of cardboard for packaging; bags made of paper for packaging; viscose sheets for wrapping; paper identification tags; writing tablets; notebooks; labels of paper; pencil boxes; cases for stationery; ball pens; small blackboards; adhesive packaging tapes; printed matter; stickers [stationery]; stickers [decalcomanias]; printed advertising boards of paper; printed advertising boards of cardboard; pamphlets; flags of paper; printed brochures; printed calendars; printed promotional material; adhesive wall decorations of paper; annuals [printed publications]; calendars; paper banners; posters; postcards; prospectuses; christmas cards; promotional publications; promotional publications; signboards of paper or cardboard; advertisement boards of card; advertisement boards of card; book covers; crepe paper for domestic use; paper for use in the manufacture of wallpaper; tissue paper for use as material of stencil paper (ganpishi); paper for use in the manufacture of tea bags; tissues of paper for removing make-up; coarse tissue [for toiletry use]; filters (paper coffee -); paper wipes; facial tissues of paper; absorbent sheets of paper or plastic for foodstuff packaging; paper tissues; tissue paper; hygienic paper; paper tissues for cosmetic use; cellulose wipes; periodicals; legal pads; disposable absorbent underpads for pets (terms considered too vague by the International Bureau – rule 13 (2) (b) of the Common Regulations); disposable absorbent training pads for pets.

20 – Beds, bedding, mattresses, pillows and cushions; bedding for cots [other than bed linen]; bedding for cots [other than bed linen]; replacement seat covers [fitted] for furniture; textile covers [shaped] for furniture; inflatable pillows; bath pillows; bedding, except linen; children's beds made of cloth in the form of a bag; futon mattresses [other than childbirth mattresses]; head supporting pillows; maternity pillows; mattress toppers; mattresses; mattresses; mattresses [other than child birth mattresses]; nap mats [cushions or mattresses]; neck-supporting pillows; nursing pillows; pet cushions; pillows; scented pillows; sleeping mats for camping [mattresses]; soft furnishings [cushions]; stuffed pillows; support pillows for use in baby car safety seats; support pillows for use in baby seating; animal housing and beds; beds for pets; pet houses; advertising display boards; advertisement display boards of plastic [non-luminous].

27 – Carpets, rugs and mats; bath mats; textile bath mats; bath mats; vehicles mats and carpets; rugs (floor -); door mats; runners [mats]; oriental non-woven rugs (mosen); carpet tile backing; carpet backing; carpeting; carpet tiles; primary carpet backing; textile bath mats; carpets [textile]; wallpaper; wall paper of vinyl; wall coverings of paper; carpets.

35 – Advertising, marketing and promotional services; bill-posting; banner advertising; merchandising; public relations services; online advertisements (terms considered too vague by the International Bureau – rule 13 (2) (b) of the Common Regulations); telemarketing services; sales promotion for others; advertising; display services for merchandise; preparation and presentation of audio visual displays for advertising purposes; organisation and conducting of product presentations; presentation of goods and services; sales demonstration [for others]; demonstration of goods and services by electronic means, also for the benefit of the so-called teleshopping and homeshopping services; demonstration of goods for promotional purposes; arranging of demonstrations for advertising purposes; demonstration of goods; trade fairs and exhibitions (terms considered too vague by the International Bureau – rule 13 (2) (b) of the Common Regulations); arranging of exhibitions for business purposes; arranging of exhibitions for advertising purposes; exhibitions (conducting -) for business purposes; exhibitions (conducting -) for business purposes; exhibitions (conducting -) for advertising purposes; organisation of exhibitions and trade fairs for business and promotional purposes; shows (conducting business -); fashion show exhibitions for commercial purposes; arranging of displays for commercial purposes; organisation of events for commercial and advertising purposes; organization of events, exhibitions, fairs and shows for commercial, promotional and advertising purposes; arranging of demonstrations for advertising purposes; planning and conducting of trade fairs, exhibitions and presentations for economic or advertising purposes; arranging of exhibitions for advertising purposes; rental of advertising space on-line; rental of advertising space; distribution of advertising, marketing and promotional material; distribution of promotional matter; distribution of advertisements and commercial announcements; dissemination of advertising matter; distribution of advertising material; dissemination of advertising and promotional materials; dissemination of advertising, marketing and publicity materials; dissemination of advertisements; dissemination of advertising for others; dissemination of advertising for others via the internet; distribution and dissemination of advertising materials [leaflets, prospectuses, printed material, samples]; handbill distribution; handbill distribution; handbill distribution; distribution of samples for publicity purposes; distribution of prospectuses and samples; handbill distribution; distribution of products for advertising purposes; sample distribution; distribution of advertising announcements; distribution and dissemination of advertising materials [leaflets, prospectuses, printed material, samples]; handbill distribution; handbill distribution; distribution of promotional matter; arranging the distribution of advertising literature in response to telephone enquiries;

arranging of presentations for business purposes; office functions; business management; supply chain management services; business administration; marketing studies.

(260) AM 2018 96660 A

(800) 1390358

(151) 2017 09 15

(891) 2017 09 15

(731) DENISOVA DARINA BORISOVNA

1-st Dubrovskaya, 1, build.1, flat 44

RU-109044 Moscow, Russian Federation

(540)

OLIMPBET

(591) Black and white

(511)

41 – Gambling services; providing recreation facilities; organization of lotteries; providing amusement arcade services; entertainment services; providing casino facilities [gambling]; providing on-line entertainment in the nature of game tournaments, fantasy sports leagues and game shows; organization of games and competitions; arranging of games and competitions via the Internet; organization and provision of games and competitions via the Internet; entertainment club services.

(260) AM 2018 96661 A

(800) 1390359

(151) 2017 09 15

(891) 2017 09 15

(731) DENISOVA DARINA BORISOVNA

1-st Dubrovskaya, 1, build.1, flat 44

RU-109044 Moscow, Russian Federation

(540)

BETOLIMP

(591) Black and white

(511)

41 – Gambling services; recreation information; entertainment information; nightclub services [entertainment]; game services provided on-line from a computer network; providing recreation facilities; organization of lotteries; providing amusement arcade services; games equipment rental; entertainment services; providing casino facilities [gambling]; club services [entertainment or education].

(260) AM 2018 96665 A

(800) 1390392

(151) 2017 12 04

(891) 2017 12 04

(731) MUMUSOKR CO., LTD

Room601, 47, Sejong-daero 23-gil, Jongno-gu

Seoul 03182, Republic of Korea

(540)

MUMUSO[®].KR

(591) Black and white

(531) 26.01.18; 27.05.01; 27.05.17

(511)

3 – Skin cleansers; perfumes; cosmetic sun milk lotions; cosmetics; air fragrancing preparations; bases for flower perfumes; cotton sticks for cosmetic purposes; soap powder; soaps for household use; cleaning preparations for household purposes; cakes of soap for body washing; cleaning preparations; shampoos; hand cleaners; hair rinses; dentifrices; cosmetics for animals; essential oils; liquid detergents.

9 – Optical mirrors; stands for photographic apparatus; surveying instruments; surveying apparatus and instruments; sunglasses; cases for eyeglasses and sunglasses; time recording apparatus; battery chargers; wires, electric; ear phones; loudspeakers; mouse [computer peripheral]; mouse pads; calculating machines; eyeglasses frame.

16 – Copy paper; cardboard; paper tissues; note books; stationery; self-adhesive tapes for stationery purposes; files [office requisites]; sketch books; stamping inks; ink; drawing rulers; drawing materials; plastic films used as packaging for keeping fresh food; pictures; printed publications.

18 – Leather and imitation leather bags; backpacks; shopping bags; sling bags for carrying infants; purses; card cases [notecases]; handbags; umbrellas; canes; leather leads; leather and imitations of leather.

21 – Soap boxes; cosmetic utensils; toothbrushes; dusting apparatus, non-electric; clothes-pins; drying racks for laundry; scrubbing brushes; garbage cans; services [dishes]; toothpicks; isothermic bags; insulating flasks; thermos water bottles; thermos bottle; boxes for dispensing paper towels; china ornaments; containers for household or kitchen use.

25 – Footwear; ready-made clothing; underwear; drawers (clothing); mufflers; winter gloves; socks; gloves [clothing]; hats; belts [clothing]; clothing.

28 – Costume masks; apparatus for games; golfballs; rods for fishing; fishing lines; badminton equipment; skis; toys for pets; baseball gloves; games and playthings; toys (playthings); physical exercise apparatus; dolls and dolls' clothing; dice; gymnastic and sporting articles; hangers for Christmas tree ornaments; puzzles.

35 – Demonstration of furniture; advice in the field of business management and marketing; planing and conducting of trade fairs, exhibitions and presentations for economic or advertising purposes; advertising in the field of tourism and travel; business information and accounting advisory services; secretarial and clerical services; demonstration of goods;

market studies; promotion of sports competitions and events; online comprehensive shopping mall retail; advertising and commercial information services via the internet; provision of advertising space in periodicals, newspapers and magazines; affiliate marketing; retail convenience stores; accounting.

(260) AM 2018 96666 A

(800) 1390458

(151) 2017 11 30

(891) 2017 11 30

(731) M. Eric CANTONA

Rua Vale do pereiro 17, 2^oesq P-1250-270
Lisboa, Portugal;

Mme. Rachida BRAKNI

Rua Vale do pereiro 17, 2^oesq P-1250-270
Lisboa, Portugal

(540)

ESPÉRANTO

(591) Black and white

(511)

25 – Footwear with the exception of orthopedic footwear; sports, ski or beach footwear; soles for footwear; non-slipping devices for footwear; bedroom slippers; boots; headgear; hosiery; headbands; clothing; clothing of leather or imitation of leather; sports clothing; underwear; sashes for wear; stoles; furs (clothing); gloves (clothing); scarves; neckties; socks; muffs (clothing); belts (clothing); coats; mittens; cyclists' trousers; pelisses; pullovers, clothing for cyclists, parkas; bathing trunks and suits.

(260) AM 2018 96667 A

(800) 1390471

(151) 2017 12 20

(891) 2017 12 20

(731) BIOFARMA

50 rue Carnot F-92284 Suresnes Cedex,
France

(540)

BIZOLIPREL

(591) Black and white

(511)

5 – Pharmaceutical products, medical preparations, veterinary preparations; sanitary products for medical purposes; dietetic food and substances for medical or veterinary use, food for babies; food supplements for humans and animals; plasters, materials for dressings; material for dental fillings and dental impressions; disinfectants; products for destroying vermin; fungicides, herbicides.

(260) AM 2018 96668 A
 (800) 1390167
 (151) 2017 07 21
 (891) 2017 07 21
 (731) APPLE INC.

One Apple Park Way Cupertino CA 95014,
 USA

(540)

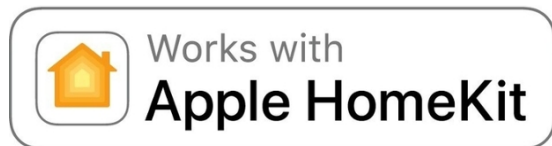

(591) Orange, Black, and Gray
 (531) 07.01.09; 26.04.04; 26.04.07; 26.04.16;
 26.04.22; 29.01.13

(511)
 7 – Window shades and window blind openers, electric.

9 – Computers; computer hardware; wireless communication devices for the transmission of voice, data, images, audio, video, and multimedia content; computer peripheral devices; cameras; digital audio and video recorders; radio transmitters and receivers; electrical and electronic connectors, couplers, and adapters; remote controls used for controlling computers, alarm, security and surveillance devices and systems, smoke and carbon monoxide detectors and monitors, energy management devices and systems, lighting, electrical and electronic switches and outlets, and doors, windows, drapes, curtains, window shades, shutters, blinds and garage doors; alarms, alarm sensors, and alarm monitoring systems; electronic video surveillance products, namely, electronic components of security systems; smoke and carbon monoxide detectors; thermostats, monitors, sensors, and controls for air conditioning, heating, and ventilation devices and systems; electric and electronic door locks and latches; remote controls for opening and closing garage doors; lighting controls; electrical outlets; electrical and electronic switches.

11 – Light bulbs, lighting fixtures, and lamps; electric space heaters, air conditioners, and electric fans.

42 – Computer programming; design and development of computer software; computer software development consulting services; support and consultation services for developing computer systems and applications; providing information in the field of computer software development online.

(260) AM 2018 96689 A
 (800) 1274453
 (151) 2015 02 18
 (891) 2017 10 17
 (731) UVENCO HOLDING LIMITED

Arch. Makariou & Kalogreon, 4, Nicolai des

Sea View City, 9th floor, Flat/Office 903-904,
 Block A-B, CY-6016 LARNACA, Cyprus

(540)



(591) White, green and light green
 (531) 26.04.04; 26.04.07; 26.04.18; 26.04.24;
 27.05.21; 27.05.24; 29.01.12

(526) ®

(511)
 7 – Automatic vending machines; door closers, electric; door openers, electric; elevator operating apparatus; coin-operated, token-operated, coupon-operated, card-operated, note-operated vending machines.

9 – Scientific, nautical, surveying, photographic, cinematographic, optical, weighing, measuring, signalling, checking (supervision), life-saving and teaching apparatus and instruments; apparatus and instruments for conducting, switching, transforming, accumulating, regulating or controlling electricity; apparatus for recording, transmitting and reproducing sound or images; magnetic recording media; sound recording discs; mechanisms for coin-operated apparatus; cash registers, calculating machines, data processing equipment and computers; fire extinguishers; computer peripheral devices and their parts; computer software, recorded; video game cartridges; computer software for encryption; encoded key cards; digital signs; computer communication software for use by banks to exchange bank cards information via their interbank computer systems; calculating machines; data processing equipment; optical data media; electronic publications, downloadable; electronic notice boards; microprocessors; monitors [computer hardware]; printers for use with computers; scanners [data processing equipment]; computer software designed for interoperability of bank cards and smart cards with terminals and reading devices for cards; readers [data processing equipment] for magnetically encoded cards and other data carries, including computer chips; bank cards, credit cards, debit cards and payment cards and magnetically encoded charge cards; integrated circuit cards [smart cards]; identity cards, magnetic; card readers for magnetically encoded cards; card readers for integrated circuit cards [smart cards]; data management computing devices; ticket dispensers; automated teller machines [ATM]; computer terminals; point-of-sale [POS] terminals; coin counting and sorting machines; coin-operated musical automata

[juke boxes]; camcorders; video cassettes; video telephones; video screens; plugs, sockets and other contacts [electric connections]; answering machines; accumulators, electric; accumulators, electric, for vehicles; antennas; high-frequency apparatus; testing apparatus not for medical purposes; remote control apparatus; monitoring apparatus, electric; sound recording apparatus; apparatus to check franking; sound transmitting apparatus; electric apparatus for commutation; intercommunication apparatus; blueprint apparatus; stereoscopic apparatus; telegraphs [apparatus]; telephone apparatus; telephone transmitters; facsimile machines; phototelegraphy apparatus; barometers; anode batteries; galvanic batteries; batteries for pocketlamps; batteries for lighting; solar batteries; batteries, electric; binoculars; electronic tags for goods; computer memories; magnetic tape units for computers; hygrometers; hydrometers; pepholes [magnifying lenses] for doors; loudspeakers; detectors; smoke detectors; false coin detectors; floppy disks; dictating machines; disks, magnetic; optical discs; circular slide rules; disk drives for computers; juke boxes for computers; buzzers; buzzers, electric; measures; simulators for the steering and control of vehicles; inverters [electricity]; measuring instruments; mathematical instruments; levelling instruments; surveying instruments; azimuth instruments; interfaces for computers; coaxial cables; fibre optic cables; cables, electric; pocket calculators; cinematographic cameras; electronic pens [visual display units]; computer keyboards; electronic agendas; mouse pads; commutators; compact discs [audio-video]; compact discs [read-only memory]; DVDs; notebook computers; carrying cases adapted for computers; sleeves for laptops; cabinets for loudspeakers; accumulator boxes; terminal blocks; ATM cases; parts and accessories for terminals, point-of-sale [POS] terminals, automated teller machines [ATM], vending machines and computers included in this class; mouse [data processing equipment]; voting machines; money counting and sorting machines; material testing instruments and machines; megaphones; metal detectors for industrial or military purposes; coin-operated mechanisms for television sets; microphones; modems; microscopes; animated cartoons; headphones; sound recording carriers; magnetic data media; punched card machines for offices; limiters [electricity]; signalling panels, luminous or mechanical; radio pagers; electronic pocket translators; transmitters [telecommunication]; transmitters of electronic signals; switches, electric; wafers for integrated circuits; plates for batteries; compact disc players; cassette players; sound recording strips; diagnostic apparatus, not for medical purposes; distance measuring apparatus; speed checking apparatus for vehicles; time recording apparatus; distance recording apparatus; measuring apparatus; measuring devices, electric; observation instruments; navigation apparatus for vehicles [on-board compu-

ters]; satellite navigational apparatus; regulating apparatus, electric; precision measuring apparatus; instruments containing eyepieces; audio- and video-receivers; magnetic wires; telegraph wires; telephone wires; wires, electric; computer game programs; computer programs [downloadable software]; record players; central processing units [processors]; distribution consoles [electricity]; control panels [electricity]; radios; signals, luminous or mechanical; connections, electric; audiovisual teaching apparatus; personal stereos; integrated circuits; printed circuits; counters; parking meters; kilometer recorders for vehicles; revolution counters; abacuses; television apparatus; telescopes; teleprinters; teleprompters; portable telephones; totalizers; transistors [electronic]; battery chargers; transformers [electricity]; telephone receivers; quantity indicators; amplifiers; electric installations for the remote control of industrial operations; steering apparatus, automatic, for vehicles; video recorders; sound reproduction apparatus; invoicing machines; tape recorders; time clocks [time recording devices]; optical character readers; chargers for electric batteries; acoustic [sound] alarms; editing appliances for cinematographic films; couplers [data processing equipment]; computer peripheral devices; anti-theft warning apparatus; adding machines; readers [data processing equipment]; photocopiers [photographic, electrostatic, thermic]; bar code readers; cameras [photography]; glazing apparatus for photographic prints; shutters [photography]; photovoltaic cells; chips [integrated circuits]; projection screens; screens [photography]; galvanic cells.

28 – Apparatus for games adapted for use with an external display screen or monitor; amusement apparatus adapted for use with an external display screen or monitor; coin-operated, token-operated, coupon-operated, card-operated, note-operated gambling machines.

35 – Advertising; business management; business administration; office functions; import-export agencies; commercial information agencies; cost price analysis; rental of advertising space; computerized file management; business efficiency expert services; demonstration of goods; transcription; opinion polling; marketing studies, including studies of market of gaming machines, coin-operated machines, automated teller machines [ATM] and payment terminals, services of electronic and other payments, services in the field of entertainment, casinos and gaming halls; business information; compilation of statistics; business research; marketing research; personnel recruitment; business management and organization consultancy, including management and consultancy in the field of manufacturing of gaming machines, coin-operated machines, automated teller machines [ATM] and payment terminals; personnel management consultancy; professional business con-

sultancy, including professional business consultancy in the field of manufacturing of gaming machines, coin-operated machines, automated teller machines [ATM] and payment terminals; professional business consultancy in the field of services of electronic and other payments, and in the field of entertainment, casinos and gaming halls services; business management of performing artists; word processing; secretarial services; organization of exhibitions for commercial or advertising purposes; business appraisals; organization of trade fairs for commercial or advertising purposes; data search in computer files for others; business management assistance; commercial or industrial management assistance, including assistance in the field of manufacturing of gaming machines, coin-operated machines, automated teller machines [ATM] and payment terminals, their parts and accessories; economic forecasting; auctioneering; sales promotion for others; office machines and equipment rental; rental of vending machines; rental of coin-operated vending machines; rental of photocopying machines; publication of publicity texts; distribution of samples; dissemination of advertising matter; on-line advertising on a computer network; compilation of information into computer databases; business inquiries; systemization of information into computer databases; psychological testing for the selection of personnel; business management of hotels; public relations; procurement services for others [purchasing goods and services for other businesses] including purchasing of gaming machines, coin-operated machines, automated teller machines [ATM] and payment terminals, their parts and accessories; business management, including management in the field of manufacturing of gaming machines, coin-operated machines, automated teller machines [ATM] and payment terminals, their parts and accessories, in the field of entertainment, gambling, services of casinos and gaming halls; business administration, including administration in the field of manufacturing of gaming machines, coin-operated machines, automated teller machines [ATM] and payment terminals, their parts and accessories, in the field of entertainment, gambling, services of casinos and gaming halls; business research in the field of entertainment and gambling.

36 – Insurance; financial affairs; monetary affairs; real estate affairs; brokerage; financial services; brokerage in the field of financial services; financial management; banking; bill payment services; services in the field of financial exchanges; financial investment; preparation of financial reports; services in the field of electronic funds transfer and electronic currency transactions; electronic payment services; financial services provided via telephone and internet and via other electronic communication facilities; financial services relating to charge cards, bank cards, credit cards, debit cards, payment cards, cheque verification and cheque cashing services and

payment processing services; processing of electronic cash transactions; services in the field of identification and confirmation of payment transactions; issuance of travellers' checks and vouchers; electronic banking services; online banking services; home bank settlements; financial information; automated teller machine [ATM] banking services; financial clearing; bill payment services provided through a web site; credit bureaux; financial analysis; hire-purchase financing; savings banks; issuance of credit cards; issue of tokens of value; capital investments; insurance consultancy; financial consultancy; stock exchange quotations; exchanging money; debit card services; credit card services; Internet banking; factoring; financial evaluation [insurance, banking, real estate]; electronic funds transfer; bail-bonding; securities brokerage; real estate brokerage; insurance brokerage; loans [financing]; lending against security; check verification; financial sponsorship; mortgage banking; instalment loans; mutual funds; rental of automated teller machines [ATM] and payment terminals; management and consultancy in the field of services of electronic and other payments.

(260) AM 2018 96690 A

(800) 1369122

(151) 2017 06 08

(891) 2018 01 15

(731) SOCIÉTÉ DES PRODUITS NESTLÉ S.A.
CH-1800 Vevey, Switzerland

(540)



(591) Black, white

(531) 02.01.01; 02.01.23; 02.03.01; 02.03.23;
02.05.01; 27.05.01; 27.05.17

(511)

5 – Dietetic substances and foodstuffs for medical and clinical use; food and food substances for babies; foodstuffs and food substances for medical use for children and patients; foodstuffs and food substances for medical use for nursing mothers; nutritional and dietetic supplements for medical use; vitamin preparations, mineral-based preparations; dietary fibers.

29 – Milk, cream, butter, cheese and dairy products; milk substitutes; milk beverages, milk predominating; powdered milk; evaporated milk; sweetened condensed milk; milk-based desserts and cream-based desserts; milk-based beverages containing cereals and/or chocolate; yogurts and yogurt beverages; yogurt-based beverages and products; non-dairy

yogurts; soy-based yogurts and yogurt beverages; yogurts and yogurt beverages from plant-based ingredients; yogurts and yogurt beverages made from nuts; soy milk (milk substitute); plant-based milk; nut-based milk; foodstuffs and beverages made with soy; shakes and smoothies made from fruit, vegetables, milk products and/or grains (where milk content is high); dairy-based beverages containing oats, cereals, fruit juices and/or fruit-flavored juices; protein preparations for human consumption; protein powder; coffee and/or tea whiteners (cream substitutes); food products and beverages enriched with nutritional and/or dietetic elements (with milk predominating); preparations for making dairy-based beverages.

30 – Coffee, coffee extracts, flavored coffee, coffee-based beverages and preparations; iced coffee; artificial coffee, artificial coffee extracts; preparations and beverages based on artificial coffee; chicory (coffee substitute); tea, tea extracts, preparations and beverages made with tea; iced tea; malt extract for food; malt for food, malt-based preparations for human consumption; cocoa and cocoa-based beverages and preparations; chocolate, chocolate products, chocolate-based beverages and preparations; cereal-based beverages included in this class; sugar; confectionery, sugar confectionery; bakery products, pastry; biscuits, cakes, cookies, wafers, caramels, desserts (included in this class), puddings; candy; chewing gum not for medical use; natural sweeteners; bakery products; flours; bread; yeast; powdered mixture for cakes; desserts (included in this class); edible ices, water ices, sherbets, frozen confectionery, frozen cakes, ice cream, frozen desserts, frozen yogurts, powders and binding agents (included in this class) for making edible ices and/or water ices and/or sherbets and/or frozen confectionery and/or frozen cakes and/or ice cream and/or frozen desserts and/or frozen yogurts; honey and honey substitutes; cereals, breakfast cereals, muesli and muesli preparations, corn flakes, cereal bars, ready-to-eat cereals; cereal preparations; cereal-based snacks; beverages and preparations made from cereals (included in this class); rice, pasta, noodles; food products based on rice, flour, oat meal or cereals, also in the form of cooked dishes; hot cereals; oats; oatmeal; porridge; granola; cereal-based beverages and food products enriched with nutritional and/or dietetic elements included in this class; pizzas; sandwiches; ready-to-bake cake paste and food paste preparations; desserts made from ingredients which are plant-based, and/or nut-based and/or soy-based.

32 – Fruit-flavored beverages and fruit-based beverages, fruit juices and vegetable juices, nectars, lemonades, soda water and other non-alcoholic beverages; beverages based on milk ferments; malt-based beverages; isotonic beverages; dietetic and/or nutri-

tionally fortified beverages included in this class; non-alcoholic beverages made from plant-based ingredients; smoothies; smoothies made from fruit, vegetables, milk products and/or seeds; plant-based beverages; beverages made from nuts; vegetable protein beverages.

(260) AM 2018 96716 A
 (800) 1389915
 (151) 2017 12 22
 (891) 2017 12 22
 (731) JANSSEN PHARMACEUTICA NV
 Turnhoutseweg 30,B-2340 Beerse,
 Belgium

(540)

ZONDUTRIZ

(591) Black, white

(511)

5 – Human pharmaceutical preparations for the prevention and treatment of viral diseases, auto-immune and inflammatory diseases, cardiovascular diseases, central nervous system diseases, pain, dermatologic diseases, gastro-intestinal diseases, infectious-related diseases, metabolic diseases, oncologic diseases, ophthalmic diseases and respiratory diseases; vaccines.

(260) AM 2018 96717 A
 (800) 1389916
 (151) 2017 12 22
 (891) 2017 12 22
 (731) JANSSEN PHARMACEUTICA NV
 Turnhoutseweg 30, B-2340 Beerse,
 Belgium

(540)

TALPAQTO

(591) Black, white

(511)

5 – Human pharmaceutical preparations for the prevention and treatment of viral diseases, auto-immune and inflammatory diseases, cardiovascular diseases, central nervous system diseases, pain, dermatologic diseases, gastro-intestinal diseases, infectious-related diseases, metabolic diseases, oncologic diseases, ophthalmic diseases and respiratory diseases; vaccines.

(260) AM 2018 96718 A
 (800) 1389930
 (151) 2017 12 07
 (891) 2017 12 07
 (731) PHILIP MORRIS PRODUCTS S.A.
 Quai Jeanrenaud 3, CH-2000 Neuchâtel,
 Switzerland

(540)



(591) Black, white

(531) 13.01.10; 24.09.12; 25.01.01; 25.07.25;
27.05.04

(511)

34 – Tobacco, raw or manufactured; tobacco products; cigars, cigarettes, cigarillos, tobacco for roll-your-own cigarettes, pipe tobacco, chewing tobacco, snuff tobacco, kretek; snus; tobacco substitutes (not for medical purposes); electronic cigarettes; tobacco products for the purpose of being heated; electronic devices and their parts for the purpose of heating cigarettes or tobacco in order to release nicotine-containing aerosol for inhalation; liquid nicotine solutions for use in electronic cigarettes; smokers' articles, cigarette paper, cigarette tubes, cigarette filters, tobacco tins, cigarette cases, ashtrays, pipes, pocket apparatus for rolling cigarettes, lighters, matches.

(260) AM 2018 96724 A

(800) 1389948

(151) 2017 10 10

(891) 2017 10 10

(731) TERRA FOOD MANAGEMENT
COMPANY LIMITEDEsperidon, 12, 4th floor CY-1087 Nicosia,
Cyprus

(540)

Premialle

(591) Black, white

(531) 27.05.17

(511)

29 – Milk and milk products; albumin milk; peanut butter; peanut milk; peanut milk for culinary purposes; albumen for culinary purposes; white of eggs; cream [dairy products]; oat milk; milk substitutes; whipped cream; condensed milk; yoghurt; kephir [milk beverage]; curd; coconut oil for food; coconut butter; coconut milk; coconut milk for culinary purposes; coconut fat; milk shakes; kumys [kumyss] [milk beverage]; margarine; butter; cocoa butter for

food; buttercream; almond milk; almond milk for culinary purposes; milk; powdered milk; milk beverages, milk predominating; milk products; peanut milk-based beverages; coconut milk-based beverages; almond milk-based beverages; prostokvasha [soured milk]; rice milk; rice milk for culinary purposes; ryazhenka [fermented baked milk]; cheese; whey; rennet; smetana [sour cream]; soya milk; milk ferments for culinary purposes.

(260) AM 2018 96725 A

(800) 1390020

(151) 2017 06 02

(891) 2017 06 02

(731) ENTER DİJİTAL MEDYA İLETİŞİM
REKLAM VE PAZARLAMA LİMİTED
ŞİRKETİFulya Ortaklar Cad., Özbal Sk. No:12/A-B,
Şişli İstanbul, Turkey

(540)

ventoso

(591) Black, white

(531) 27.05.08; 27.05.11

(511)

8 – Forks, spoons, knives and non-electric cutters, slicers, peelers for kitchen use, including those made of precious metals; side arms and blades (weapons); tools and apparatus included in this class for personal beauty care use; tools and apparatus included in this class for shaving, epilation, manicure and pedicure, electric hand implements for straightening and curling hair, scissors; hand-operated [non-electric] hand tools included in this class for the repair of machines, apparatus and vehicles and for use in construction, agriculture, horticultural and forestry, none of them being power tools; electric or non-electric irons; steam irons.

11 – Lighting installations; lights for vehicles and interior-exterior spaces; heating installations using solid, liquid or gas fuels or electricity; installations for air-conditioning and ventilating; cooling installations and freezers; electric and gas-powered devices, installations and apparatus for cooking, drying and boiling; electric laundry driers; hair driers; hand drying apparatus; sanitary installations; water softening apparatus; water purification apparatus; water purification installations; waste water purification installations; electric bed warmers and electric blankets, not for medical use; electric pillow warmers; electric or non-electric footwarmers; hot water bottles; filters for aquariums and aquarium filtration apparatus; industrial type installations for cooking, drying and cooling purposes; pasteurizers and sterilizers.

(260) AM 2018 96727 A

(800) 1390022

(151) 2017 08 03

(891) 2017 08 03

(731) Limited liability company "OMEGA SKY"

Dostoevsky str., 100, Republic of

Bashkortostan RU-450077 Ufa,

Russian Federation

(540)

Cipria

(591) Black, white

(531) 27.05.17

(511)

35 – Administration of consumer loyalty programs; administration of frequent flyer programs; administrative processing of purchase orders; advertising agencies; publicity agencies; advertising by mail order; advertising; publicity; advisory services for business management; appointment reminder services [office functions]; appointment scheduling services [office functions]; arranging newspaper subscriptions for others; arranging subscriptions to telecommunication services for others; auctioneering; bill-posting; outdoor advertising; book-keeping; accounting; business appraisals; business auditing; business efficiency expert services; business information; business inquiries; business intermediary services relating to the matching of potential private investors with entrepreneurs needing funding; business investigations; business management and organization consultancy; business management assistance; business management consultancy; business management for freelance service providers; business management of hotels; business management of performing artists; business management of reimbursement programs for others; business management of reimbursement programmes for others; business management of sports people; business organization consultancy; business project management services for construction projects; business research; commercial administration of the licensing of the goods and services of others; commercial information agency services; commercial information and advice for consumers [consumer advice shop]; commercial intermediation services; commercial or industrial management assistance; compilation of information into computer databases; compilation of statistics; compiling indexes of information for commercial or advertising purposes; computerized file management; consultancy regarding advertising communications strategy; consultancy regarding public relations communications strategy; cost price analysis; data search in computer files for others; demonstration of goods; design of advertising materials; direct mail advertising; dissemination of advertising matter; distribution of samples; document reprodu-

ction; drawing up of statements of accounts; economic forecasting; employment agency services; import-export agency services; invoicing; layout services for advertising purposes; marketing; marketing research; market studies; modelling for advertising or sales promotion; negotiation and conclusion of commercial transactions for third parties; negotiation of business contracts for others; news clipping services; office machines and equipment rental*; on-line advertising on a computer network; opinion polling; organization of exhibitions for commercial or advertising purposes; organization of fashion shows for promotional purposes; organization of trade fairs for commercial or advertising purposes; outsourced administrative management for companies; outsourcing services [business assistance]; pay per click advertising; payroll preparation; personnel management consultancy; personnel recruitment; photocopying services; presentation of goods on communication media, for retail purposes; price comparison services; procurement services for others [purchasing goods and services for other businesses]; production of advertising films; production of teleshopping programmes; production of teleshopping programs; professional business consultancy; providing business information via a web site; provision of an on-line marketplace for buyers and sellers of goods and services; provision of commercial and business contact information; psychological testing for the selection of personnel; publication of publicity texts; publicity material rental; public relations; radio advertising; registration of written communications and data; relocation services for businesses; rental of advertising space; rental of advertising time on communication media; rental of billboards [advertising boards]; rental of photocopying machines; rental of sales stands; rental of vending machines; retail or wholesale services for pharmaceutical, veterinary and sanitary preparations and medical supplies; sales promotion for others; scriptwriting for advertising purposes; search engine optimization for sales promotion; search engine optimisation for sales promotion; secretarial services; shop window dressing; shorthand; sponsorship search; systemization of information into computer databases; tax filing services; tax preparation; telemarketing services; telephone answering for unavailable subscribers; television advertising; transcription of communications [office functions]; typing; updating and maintenance of data in computer databases; updating and maintenance of information in registries; updating of advertising material; web indexing for commercial or advertising purposes; web site traffic optimization; web site traffic optimisation; word processing; writing of publicity texts; writing of résumés for others; writing of curriculum vitae for others.

(260) AM 2018 96728 A

(800) 1390027

(151) 2017 10 27

(891) 2017 10 27

(731) Limited Liability Company

"DIAMED-Farma"

Sovetskaya street, 31, Pervomayskiy

community, Korolev city RU-141069

Moscow region, Russian Federation

(540)

MYKOCAT

(591) Black, white

(531) 28.05

(511)

5 – Pharmaceuticals, medical and veterinary preparations; sanitary preparations for medical purposes; dietetic food and substances adapted for medical or veterinary use, food for babies; dietary supplements for humans and animals; plasters, materials for dressings; material for dental fillings and dental impressions; preparations for destroying noxious animals; aconitine; alkaloids for medical purposes; alginates for pharmaceutical purposes; algicides; aldehydes for pharmaceutical purposes; dental amalgams of gold; dental amalgams; amino acids for veterinary purposes; amino acids for medical purposes; analgesics; anaesthetics; antibiotics; antiseptics; medicine cases, portable, filled; first-aid boxes, filled; aluminium acetate for pharmaceutical purposes; acetates for pharmaceutical purposes; germicides; balms for medical purposes; bandages for dressings; diagnostic biomarker reagents for medical purposes; biocides; bromine for pharmaceutical purposes; paper for mustard plasters; fly catching paper; reagent paper for veterinary purposes; reagent paper for medical purposes; mothproofing paper; petroleum jelly for medical purposes; vaccines; oxygen baths; antiseptic cotton; aseptic cotton; absorbent cotton; wadding for medical purposes; cotton for medical purposes; dietetic substances adapted for medical use; radiological contrast substances for medical purposes; nutritive substances for microorganisms; radioactive substances for medical purposes; melissa water for pharmaceutical purposes; sea water for medicinal bathing; mineral waters for medical purposes; thermal water; dietary fiber; molding wax for dentists; gases for medical purposes; guaiacol for pharmaceutical purposes; sexual stimulant gels; hematogen; hemoglobin; hydrastine; hydrastinine; glycerine for medical purposes; glycerophosphates; glucose for medical purposes; gentian for pharmaceutical purposes; hormones for medical purposes; mustard for pharmaceutical purposes; mustard plasters; mud for baths; medicinal mud; gamboge for medical purposes; gurjun [gurjon, gurjan] balsam for medical purposes; air deodorising preparations; deodorants, other than for human beings or for animals; deodorants for clothing and textiles; diastase for medical pur-

poses; digitalin; dietary supplements; mineral food supplements; nutritional supplements; albumin dietary supplements; dietary supplements for animals; yeast dietary supplements; alginate dietary supplements; glucose dietary supplements; casein dietary supplements; lecithin dietary supplements; linseed oil dietary supplements; propolis dietary supplements; protein dietary supplements; protein supplements for animals; royal jelly dietary supplements; pollen dietary supplements; wheat germ dietary supplements; linseed dietary supplements; enzyme dietary supplements; yeast for pharmaceutical purposes; gelatine for medical purposes; cod liver oil; isotopes for medical purposes; immunostimulants; insecticides; iodine for pharmaceutical purposes; iodides for pharmaceutical purposes; alkaline iodides for pharmaceutical purposes; iodoform; calomel [fungicide]; tartar for pharmaceutical purposes; camphor for medical purposes; capsules for medicines; cachets for pharmaceutical purposes; hemostatic pencils; wart pencils; caustic pencils; carbolineum [parasiticide]; caustics for pharmaceutical purposes; cachou for pharmaceutical purposes; quassia for medical purposes; quebracho for medical purposes; oxygen for medical purposes; gallic acid for pharmaceutical purposes; acids for pharmaceutical purposes; adhesives for dentures; surgical glues; stem cells for veterinary purposes; stem cells for medical purposes; cocaine; collagen for medical purposes; collodion for pharmaceutical purposes; corn rings for the feet; candy, medicated; angostura bark for medical purposes; barks for pharmaceutical purposes; cedar wood for use as an insect repellent; condurango bark for medical purposes; croton bark; mangrove bark for pharmaceutical purposes; myrobalan bark for pharmaceutical purposes; quinquina for medical purposes; medicated animal feed; medicinal roots; rhubarb roots for pharmaceutical purposes; lint for medical purposes; starch for dietetic or pharmaceutical purposes; creosote for pharmaceutical purposes; blood for medical purposes; cultures of microorganisms for medical or veterinary use; curare; dental lacquer; liquorice for pharmaceutical purposes; lactose for pharmaceutical purposes; candy for medical purposes; adhesive plasters; medicines for alleviating constipation; lecithin for medical purposes; lotions for veterinary purposes; medicated hair lotions; lotions for pharmaceutical purposes; medicated after-shave lotions; personal sexual lubricants; lupulin for pharmaceutical purposes; magnesia for pharmaceutical purposes; liniments; ointments for pharmaceutical purposes; sunburn ointments; mercurial ointments; frostbite salve for pharmaceutical purposes; gauze for dressings; medicinal oils; mustard oil for medical purposes; camphor oil for medical purposes; castor oil for medical purposes; oil of turpentine for pharmaceutical purposes; dill oil for medical purposes; dental mastics; dental abrasives; dental impression materials; teeth filling

material; dressings, medical; surgical dressings; drugs for medical purposes; medicines for veterinary purposes; serotherapeutic medicines; medicines for human purposes; medicines for dental purposes; menthol; medicinal drinks; moleskin for medical purposes; almond milk for pharmaceutical purposes; powdered milk for babies; royal jelly for pharmaceutical purposes; milk ferments for pharmaceutical purposes; Irish moss for medical purposes; flour for pharmaceutical purposes; linseed meal for pharmaceutical purposes; fish meal for pharmaceutical purposes; fly glue; antibacterial soap; disinfectant soap; medicated soap; freeze-dried meat adapted for medical purposes; mint for pharmaceutical purposes; dietetic beverages adapted for medical purposes; malted milk beverages for medical purposes; narcotics; medicinal infusions; tincture of iodine; eucalyptol for pharmaceutical purposes; tinctures for medical purposes; opium; opodeldoc; decoctions for pharmaceutical purposes; antiparasitic collars for animals; stick liquorice for pharmaceutical purposes; sulfur sticks [disinfectants]; medicated dentifrices; pectin for pharmaceutical purposes; pepsins for pharmaceutical purposes; peptones for pharmaceutical purposes; hydrogen peroxide for medical purposes; pesticides; food for babies; leeches for medical purposes; blood plasma; eyepatches for medical purposes; poultices; compresses; scapulars for surgical purposes; babies' diapers [napkins]; diapers for pets; diapers for incontinents; bunion pads; breast-nursing pads; pomades for medical purposes; powder of cantharides; pyrethrum powder; belts for sanitary napkins [towels]; anti-uric preparations; bacterial preparations for medical and veterinary use; bacteriological preparations for medical and veterinary use; balsamic preparations for medical purposes; albuminous preparations for medical purposes; biological preparations for veterinary purposes; biological preparations for medical purposes; veterinary preparations; bismuth preparations for pharmaceutical purposes; vitamin preparations; diagnostic preparations for medical purposes; bath preparations for medical purposes; therapeutic preparations for the bath; hemorrhoid preparations; preparations for callouses; lice treatment preparations [pediculicides]; acne treatment preparations; preparations to facilitate teething; preparations for the treatment of burns; fumigation preparations for medical purposes; ophotherapy preparations; air purifying preparations; bronchodilating preparations; preparations for reducing sexual activity; sterilising preparations; soil-sterilising preparations; corn remedies; pharmaceutical preparations for treating dandruff; herbicides; preparations for destroying dry rot fungus; larvae exterminating preparations; fly destroying preparations; preparations for destroying mice; slug exterminating preparations; vermin destroying preparations; pharmaceutical preparations for skin care; contact lens cleaning preparations; preparations of microorganisms for medi-

cal or veterinary use; lime-based pharmaceutical preparations; medicated eye-washes; medicinal hair growth preparations; nutraceutical preparations for therapeutic or medical purposes; opiates; anticryptogamic preparations; aloe vera preparations for pharmaceutical purposes; preparations of trace elements for human and animal use; sulfonamides [medicines]; pharmaceutical preparations; pharmaceutical preparations for treating sunburn; enzyme preparations for veterinary purposes; enzyme preparations for medical purposes; phytotherapy preparations for medical purposes; chemico-pharmaceutical preparations; chemical preparations for veterinary purposes; chemical preparations for the diagnosis of pregnancy; chemical preparations for medical purposes; chemical preparations to treat wheat blight [smut]; vine disease treating chemicals; chemical preparations to treat mildew; chemical preparations for treating phylloxera; chemical preparations for pharmaceutical purposes; chilblain preparations; mothproofing preparations; collyrium; lead water; chemical conductors for electrocardiograph electrodes; albuminous foodstuffs for medical purposes; dietetic foods adapted for medical purposes; by-products of the processing of cereals for dietetic or medical purposes; homogenized food adapted for medical purposes; freeze-dried food adapted for medical purposes; pharmaceuticals; sanitary towels; sanitary pads; panty liners [sanitary]; propolis for pharmaceutical purposes; pearl powder for medical purposes; radium for medical purposes; hydrated chloral for pharmaceutical purposes; solvents for removing adhesive plasters; plasters; vaginal washes for medical purposes; solutions for contact lenses; chemical reagents for medical or veterinary purposes; gum for medical purposes; rubber for dental purposes; chewing gum for medical purposes; insect repellents; insect repellent incense; repellents for dogs; tissues impregnated with pharmaceutical lotions; sarsaparilla for medical purposes; sugar for medical purposes; asthmatic tea; fumigating sticks; linseed for pharmaceutical purposes; tobacco-free cigarettes for medical purposes; siccatives [drying agents] for medical purposes; syrups for pharmaceutical purposes; turpentine for pharmaceutical purposes; greases for veterinary purposes; greases for medical purposes; lacteal flour for babies; infant formula; soporifics; bicarbonate of soda for pharmaceutical purposes; bath salts for medical purposes; salts for mineral water baths; salts for medical purposes; potassium salts for medical purposes; sodium salts for medical purposes; smelling salts; mineral water salts; malt for pharmaceutical purposes; semen for artificial insemination; alcohol for pharmaceutical purposes; medicinal alcohol; alloys of precious metals for dental purposes; ergot for pharmaceutical purposes; cooling sprays for medical purposes; antibacterial handwashes; adjuvants for medical purposes; astringents for medical purposes; vermifuges;

disinfectants for hygiene purposes; disinfectants for chemical toilets; douching preparations for medical purposes; appetite suppressants for medical purposes; medical preparations for slimming purposes; parasiticides; mouthwashes for medical purposes; febrifuges; depuratives; animal washes [insecticides]; detergents for medical purposes; cattle washes [insecticides]; dog washes [insecticides]; insecticidal veterinary washes; vesicants; purgatives; remedies for perspiration; remedies for foot perspiration; chemical contraceptives; antiparasitic preparations; laxatives; tonics [medicines]; medicated toiletry preparations; digestives for pharmaceutical purposes; nervines; media for bacteriological cultures; steroids; strychnine; serums; tanning pills; appetite suppressant pills; slimming pills; antioxidant pills; sanitary tampons; vulnerary sponges; thymol for pharmaceutical purposes; biological tissue cultures for veterinary purposes; biological tissue cultures for medical purposes; smoking herbs for medical purposes; medicinal herbs; surgical implants comprised of living tissues; pants, absorbent, for incontinents; sanitary panties; babies' napkin-pants [diaper-pants]; charcoal for pharmaceutical purposes; porcelain for dental prostheses; phenol for pharmaceutical purposes; enzymes for veterinary purposes; enzymes for medical purposes; ferments for pharmaceutical purposes; formic aldehyde for pharmaceutical purposes; phosphates for pharmaceutical purposes; fungicides; quinine for medical purposes; chinoline for medical purposes; diabetic bread adapted for medical use; chloroform; flowers of sulfur for pharmaceutical purposes; cement for animal hooves; bone cement for surgical and orthopaedic purposes; dental cements; medicinal tea; herbal teas for medicinal purposes; insecticidal animal shampoo; medicated shampoos; medicated shampoos for pets; pediculicidal shampoos; medicated dry shampoos; pre-filled syringes for medical purposes; eucalyptus for pharmaceutical purposes; herbal extracts for medical purposes; plant extracts for pharmaceutical purposes; tobacco extracts [insecticides]; extracts of hops for pharmaceutical purposes; elixirs [pharmaceutical preparations]; ethers for pharmaceutical purposes; esters for pharmaceutical purposes; cellulose esters for pharmaceutical purposes; cellulose ethers for pharmaceutical purposes; rat poison; poisons; bacterial poisons; jalap; fungicides, herbicides; acaricides; bismuth subnitrate for pharmaceutical purposes; disinfectants; cream of tartar for pharmaceutical purposes; adhesive tapes for medical purposes; cotton sticks for medical purposes; pastilles for pharmaceutical purposes; diagnostic preparations for veterinary purposes; suppositories; milking grease; sedatives; jujube, medicated; transplants [living tissues]; fennel for medical purposes.

10 – Surgical, medical, dental and veterinary apparatus and instruments; artificial limbs, eyes and teeth; suture materials; therapeutic and assistive devices

adapted for the disabled; massage apparatus; apparatus, devices and articles for nursing infants; blood testing apparatus; anaesthetic apparatus; galvanic therapeutic appliances; apparatus for artificial respiration; apparatus for the treatment of deafness; physical exercise apparatus for medical purposes; body rehabilitation apparatus for medical purposes; dental apparatus and instruments; surgical apparatus and instruments; resuscitation apparatus; dental apparatus, electric; physiotherapy apparatus; bed vibrators; hot air therapeutic apparatus; diagnostic apparatus for medical purposes; traction apparatus for medical purposes; radiotherapy apparatus; microdermabrasion apparatus; fumigation apparatus for medical purposes; apparatus for the regeneration of stem cells for medical purposes; apparatus for DNA and RNA exams for medical purposes; apparatus and installations for the production of X-rays, for medical purposes; radiological apparatus for medical purposes; X-ray apparatus for medical purposes; hearing aids; nasal aspirators; trusses; maternity belts; bandages, elastic; cupping glasses; dental burs; bracelets for medical purposes; anti-rheumatism bracelets; feeding bottles; vaporizers for medical purposes; hot air vibrators for medical purposes; vibromassage apparatus; gastroscopes; hemocytometers; lice combs; surgical sponges; defibrillators; dialyzers; containers especially made for medical waste; clips, surgical; mirrors for dentists; mirrors for surgeons; probes for medical purposes; urethral probes; artificial teeth; acupuncture needles; suture needles; needles for medical purposes; orthopedic articles; surgical implants comprised of artificial materials; inhalers; injectors for medical purposes; incubators for medical purposes; incubators for babies; obstetric apparatus; obstetric apparatus for cattle; electric acupuncture instruments; surgical cutlery; insufflators; endoscopy cameras for medical purposes; cannulae; droppers for medical purposes; dropper bottles for medical purposes; heart pacemakers; heart rate monitoring apparatus; catheters; catgut; draw-sheets for sick beds; enema apparatus for medical purposes; artificial skin for surgical purposes; menstrual cups; teething rings; anti-rheumatism rings; compressors [surgical]; thermo-electric compresses [surgery]; abdominal corsets; corsets for medical purposes; crutches; dentists' armchairs; armchairs for medical or dental purposes; beds specially made for medical purposes; feeding bottle valves; love dolls [sex dolls]; lasers for medical purposes; lamps for medical purposes; quartz lamps for medical purposes; ultraviolet ray lamps for medical purposes; lancets; lenses [intraocular prostheses] for surgical implantation; spoons for administering medicine; masks for use by medical personnel; respiratory masks for artificial respiration; anaesthetic masks; childbirth mattresses; air mattresses for medical purposes; hydrostatic [water] beds for medical purposes; furniture especially made for medical pur-

poses; water bags for medical purposes; douche bags; breast pumps; body fat monitors; body composition monitors; urinals [vessels]; teeth protectors for dental purposes; temperature indicator labels for medical purposes; knee bandages, orthopaedic; tips for crutches; finger guards for medical purposes; medical guidewires; pumps for medical purposes; thread, surgical; knives for surgical purposes; scissors for surgery; ambulance stretchers; stretchers, wheeled; boots for medical purposes; orthopaedic footwear; clothing especially for operating rooms; compression garments; blankets, electric, for medical purposes; supports for flat feet; ophthalmometers; ophthalmoscopes; slings [supporting bandages]; gloves for massage; gloves for medical purposes; pessaries; saws for surgical purposes; ear picks; spittoons for medical purposes; plaster bandages for orthopaedic purposes; supportive bandages; suspensory bandages; abdominal pads; cushions for medical purposes; pads [pouches] for preventing pressure sores on patient bodies; air pillows for medical purposes; soporific pillows for insomnia; heating cushions [pads], electric, for medical purposes; abdominal belts; galvanic belts for medical purposes; hypogastric belts; belts for medical purposes; orthopaedic belts; umbilical belts; belts, electric, for medical purposes; condoms; aerosol dispensers for medical purposes; sphygmomanometers; pulse meters; esthetic massage apparatus; veterinary apparatus and instruments; medical apparatus and instruments; urological apparatus and instruments; orthodontic appliances; nursing appliances; brushes for cleaning body cavities; invalids' hoists; appliances for washing body cavities; corn knives; incontinence sheets; sterile sheets, surgical; surgical drapes; hair prostheses; artificial eyes; artificial breasts; dentures; artificial limbs; artificial jaws; ice bags for medical purposes; toe separators for orthopaedic purposes; orthodontic rubber bands; X-ray photographs for medical purposes; respirators for artificial respiration; strait jackets; sex toys; scalpels; tongue scrapers; babies' pacifiers [teats]; feeding bottle teats; receptacles for applying medicines; spirometers [medical apparatus]; vaginal syringes; implantable subcutaneous drug delivery devices; hearing protectors; contraceptives, non-chemical; orthopaedic soles; stents; stethoscopes; operating tables; commode chairs; basins for medical purposes; bed pans; instrument cases for use by doctors; arch supports for footwear; ear plugs [ear protection devices]; thermometers for medical purposes; tomographs for medical purposes; trocars; drainage tubes for medical purposes; X-ray tubes for medical purposes; radium tubes for medical purposes; balling guns; protection devices against X-rays, for medical purposes; apparatus for acne treatment; filters for ultraviolet rays, for medical purposes; walking frames for disabled persons; cases fitted for medical instruments; elastic stockings for surgical purposes; stockings for vari-

ces; splints, surgical; tongue depressors for medical purposes; syringes for injections; syringes for medical purposes; hypodermic syringes; uterine syringes; urethral syringes; pins for artificial teeth; forceps; castrating pincers; radiology screens for medical purposes; electrodes for medical use; electrocardiographs; brain pacemakers; sexual activity apparatus, devices and articles; analysers for bacterial identification for medical purposes; testing apparatus for medical purposes; air cushions for medical purposes; biodegradable bone fixation implants; surgical bougies; ear trumpets; thermal packs for first aid purposes; quad canes for medical purposes.

44 – Medical services; veterinary services; hygienic and beauty care for human beings or animals; Turkish bath services; hospital services; reforestation services; landscape design; nursing home services; wreath making; hair implantation; medical advice for individuals with disabilities; pharmacy advice; manicuring; chiropractic; massage; horticulture; artificial insemination services; palliative care; hairdressing; body piercing; midwife services; veterinary assistance; medical assistance; tree planting for carbon offsetting purposes; preparation of prescriptions by pharmacists; medical equipment rental; rental of sanitation facilities; farming equipment rental; aerial and surface spreading of fertilizers and other agricultural chemicals; animal breeding; gardening; landscape gardening; beauty salon services; sanatorium services; blood bank services; health care; health counselling; flower arranging; tattooing; weed killing; health spa services; human tissue bank services; aquaculture services; visagists' services; convalescent home services; rest home services; medical clinic services; alternative medicine services; opticians' services; plant nursery services; pest control services for agriculture, aquaculture, horticulture and forestry; services of a psychologist; sauna services; solarium services; telemedicine services; therapy services; nursing, medical; lawn care; animal grooming; pet grooming; physical therapy; plastic surgery; tree surgery; hospice services; agriculture, horticulture and forestry services; public bath services for hygiene purposes; depilatory waxing; rehabilitation for substance abuse patients; health center services; aromatherapy services; speech therapy; orthodontic services; dentistry services; vermin exterminating for agriculture, aquaculture, horticulture and forestry; in vitro fertilization services.

(260) AM 2018 96729 A

(800) 1390028

(151) 2017 10 27

(891) 2017 10 27

(731) Obshchestvo s ogranichennoy

otvetstvennostyu "ARGO"

ul. Lenina, dom 34, of. 63 RU-197136

Saint Petersburg, Russian Federation

(540)

FANBATTLE

(591) Black, white

(531) 27.05.01

(511)

41 – Arranging and conducting of competitions [education or entertainment]; arranging and conducting of games; arranging of competitions via the Internet; arranging of games and competitions via the Internet; conducting of competitions on the Internet; educational and training services relating to games; electronic games services provided by means of a global communication network; electronic games services provided by means of the Internet; electronic games services provided by means of the Internet or other communication network; entertainment information; entertainment services; gambling services; game services provided on-line from a computer network; game services provided via communication networks; gaming; information relating to computer gaming entertainment provided on-line from a computer database or a global communication network; on-line game services; organization and presentation of shows, competitions, games, concerts and entertainment events; organization and provision of games and competitions via the Internet; organization of competitions [education or entertainment]; organization of competitions and award ceremonies; organization of competitions for education or entertainment; organization of educational, entertainment, cultural and sporting competitions; organization of games and competitions; organization of lotteries and other gambling activities; organization of sports competitions; organization of sports events and competitions; organizing and conducting sports competitions; providing on-line information in the field of computer games entertainment; providing recreation facilities.

INTERNATIONAL TRADEMARKS PROTECTED IN GEORGIA

(260) AM 2018 92001 A
(800) 1341216
(151) 2016 10 21
(181) 2026 10 21
(891) 2016 10 21
(511) 30

(260) AM 2018 92041 A
(800) 1341290
(151) 2017 01 24
(181) 2027 01 24
(891) 2017 01 24
(511) 03, 25, 28

(260) AM 2018 92086 A
(800) 1064658
(151) 2010 08 06
(181) 2020 08 06
(891) 2017 02 20
(511) 09

(260) AM 2018 92216 A
(800) 1343294
(151) 2016 12 12
(181) 2026 12 12
(891) 2016 12 12
(511) 34

(260) AM 2018 92285 A
(800) 1091420
(151) 2011 08 23
(181) 2021 08 23
(891) 2017 03 27
(511) 05

(260) AM 2018 92651 A
(800) 1348100
(151) 2017 04 28
(181) 2027 04 28
(891) 2017 04 28
(511) 05

(260) AM 2018 92922 A
(800) 1349957
(151) 2016 10 19
(181) 2026 10 19

(891) 2016 10 19
(511) 10, 25, 35

(260) AM 2018 93258 A
(800) 1353842
(151) 2017 05 18
(181) 2027 05 18
(891) 2017 05 18
(511) 09, 41

(260) AM 2018 93732 A
(800) 1359884
(151) 2017 06 01
(181) 2027 06 01
(891) 2017 06 01
(511) 11

(260) AM 2018 93742 A
(800) 1359212
(151) 2017 06 14
(181) 2027 06 14
(891) 2027 06 14
(511) 05

(260) AM 2018 93743 A
(800) 1359227
(151) 2016 12 02
(181) 2026 12 02
(891) 2016 12 02
(511) 09, 12, 37

(260) AM 2018 93763 A
(800) 1360047
(151) 2017 06 12
(181) 2027 06 12
(891) 2017 06 12
(511) 29, 30

(260) AM 2018 93789 A
(800) 1359453
(151) 2017 01 17
(181) 2017 08 10
(891) 2017 01 17
(511) 16, 45

(260) AM 2018 93802 A
(800) 1359740
(151) 2017 03 03
(181) 2027 03 03
(891) 2017 03 03
(511) 35

(260) AM 2018 93882 A
(800) 1360343
(151) 2017 07 11
(181) 2027 07 11
(891) 2017 07 11
(511) 33

(260) AM 2018 93886 A
(800) 1360511
(151) 2017 01 27
(181) 2027 01 27
(891) 2017 01 27
(511) 09, 16, 28, 35, 36, 38, 41, 42, 45

(260) AM 2018 93887 A
(800) 1360521
(151) 2017 05 11
(181) 2027 05 11
(891) 2017 05 11
(511) 11, 20, 21

(260) AM 2018 93890 A
(800) 1360533
(151) 2017 05 18
(181) 2027 05 18
(891) 2017 05 18
(511) 03

(260) AM 2018 93892 A
(800) 1360605
(151) 2017 12 09
(181) 2027 12 09
(891) 2016 12 09
(511) 03, 09, 14, 18, 24, 25, 26, 28, 32, 35

(260) AM 2018 93894 A
(800) 1360619
(151) 2017 06 07
(181) 2027 06 07
(891) 2017 06 07
(511) 14

(260) AM 2018 93896 A
(800) 1360679
(151) 2017 05 19
(181) 2027 05 19

(891) 2017 05 19
(511) 03, 21

(260) AM 2018 93897 A
(800) 1360732
(151) 2017 06 26
(181) 2017 06 26
(891) 2017 06 26
(511) 07, 11, 37

(260) AM 2018 93997 A
(800) 1362202
(151) 2017 03 16
(181) 2027 03 16
(891) 2017 03 16
(511) 08, 20, 21, 27

(260) AM 2018 93999 A
(800) 1362273
(151) 2017 05 22
(181) 2027 05 22
(891) 2017 05 22
(511) 29, 30

(260) AM 2018 94038 A
(800) 1324695
(151) 2016 09 01
(181) 2026 09 01
(891) 2017 06 09
(511) 41, 42

(260) AM 2018 94039 A
(800) 1347215
(151) 2017 01 19
(181) 2027 01 19
(891) 2017 06 19
(511) 09

(260) AM 2018 94096 A
(800) 1363623
(151) 2017 07 04
(181) 2027 07 04
(891) 2017 07 04
(511) 34

(260) AM 2018 94097 A
(800) 426208
(151) 1976 11 12
(181) 2026 11 12
(891) 2017 07 19
(511) 05

(260) AM 2018 94098 A
(800) 1363630
(151) 2017 07 03
(181) 2027 07 03
(891) 2017 07 03
(511) 35

(260) AM 2018 94099 A
(800) 1363642
(151) 2017 05 18
(181) 2027 05 18
(891) 2017 05 18
(511) 09

(260) AM 2018 94100 A
(800) 1363665
(151) 2017 05 18
(181) 2027 05 18
(891) 2017 05 18
(511) 20, 24

(260) AM 2018 94101 A
(800) 1363704
(151) 2017 03 01
(181) 2027 03 01
(891) 2017 03 01
(511) 07, 09, 11, 35

(260) AM 2018 94102 A
(800) 492773
(151) 1985 03 28
(181) 2025 03 28
(891) 2017 08 04
(511) 20

(260) AM 2018 94104 A
(800) 1363714
(151) 2017 03 21
(181) 2027 03 21
(891) 2017 03 21
(511) 11

(260) AM 2018 94105 A
(800) 1210697
(151) 2013 12 23
(181) 2023 12 23
(891) 2017 07 24
(511) 03, 04, 05

(260) AM 2018 94106 A
(800) 1222539
(151) 2014 02 20
(181) 2024 02 20

(891) 2017 07 12
(511) 16, 28

(260) AM 2018 94107 A
(800) 1363733
(151) 2017 04 24
(181) 2027 04 24
(891) 2017 04 24
(511) 29

(260) AM 2018 94108 A
(800) 1222540
(151) 2017 02 20
(181) 2024 02 20
(891) 2017 07 12
(511) 16, 28

(260) AM 2018 94110 A
(800) 1242844
(151) 2014 12 11
(181) 2024 12 11
(891) 2017 03 21
(511) 03, 05

(260) AM 2018 94111 A
(800) 1363755
(151) 2017 06 12
(181) 2027 06 12
(891) 2017 06 12
(511) 09, 10, 44

(260) AM 2018 94112 A
(800) 1363758
(151) 2017 06 09
(181) 2027 06 09
(891) 2017 06 09
(511) 07

(260) AM 2018 94116 A
(800) 1322356
(151) 2016 06 27
(181) 2026 06 27
(891) 2017 07 31
(511) 03

(260) AM 2018 94124 A
(800) 1363997
(151) 2017 03 13
(181) 2027 03 13
(891) 2017 03 13
(511) 09, 11

(260) AM 2018 94130 A
(800) 1364082
(151) 2017 03 15
(181) 2027 03 15
(891) 2017 03 15
(511) 28

(260) AM 2018 94131 A
(800) 1363149
(151) 2017 04 07
(181) 2027 04 07
(891) 2017 04 07
(511) 09, 28, 41

(260) AM 2018 94132 A
(800) 1364183
(151) 2017 02 24
(181) 2027 02 24
(891) 2017 02 24
(511) 08, 15, 41

(260) AM 2018 94133 A
(800) 1363155
(151) 2017 02 02
(181) 2027 02 02
(891) 2017 02 02
(511) 12

(260) AM 2018 94134 A
(800) 1364240
(151) 2017 02 16
(181) 2027 02 16
(891) 2017 02 16
(511) 29, 30

(260) AM 2018 94135 A
(800) 1363210
(151) 2017 06 06
(181) 2027 06 06
(891) 2017 06 06
(511) 03

(260) AM 2018 94136 A
(800) 1363243
(151) 2017 06 12
(181) 2027 06 12
(891) 2017 06 12
(511) 34

(260) AM 2018 94137 A
(800) 1364247
(151) 2017 02 17
(181) 2027 02 17

(891) 2017 02 17
(511) 15, 20, 28

(260) AM 2018 94139 A
(800) 1363313
(151) 2017 06 08
(181) 2027 06 08
(891) 2017 06 08
(511) 39, 41, 43

(260) AM 2018 94140 A
(800) 1364249
(151) 2017 02 07
(181) 2027 02 07
(891) 2017 02 07
(511) 03, 05

(260) AM 2018 94141 A
(800) 1363323
(151) 2017 06 01
(181) 2027 06 01
(891) 2017 06 01
(511) 43

(260) AM 2018 94142 A
(800) 1364267
(151) 2016 10 03
(181) 2026 10 03
(891) 2016 10 03
(511) 09, 11

(260) AM 2018 94143 A
(800) 1363324
(151) 2017 06 08
(181) 2027 06 08
(891) 2017 06 08
(511) 39

(260) AM 2018 94144 A
(800) 1363341
(151) 2017 03 21
(181) 2027 03 21
(891) 2017 03 21
(511) 06

(260) AM 2018 94145 A
(800) 1363363
(151) 2017 05 16
(181) 2027 05 16
(891) 2017 05 16
(511) 30, 32

(260) AM 2018 94146 A
(800) 1363382
(151) 2016 12 16
(181) 2026 12 16
(891) 2016 12 16
(511) 03, 09, 14, 18, 35

(260) AM 2018 94147 A
(800) 1363448
(151) 2017 02 27
(181) 2027 02 27
(891) 2017 02 27
(511) 09, 11

(260) AM 2018 94148 A
(800) 1363470
(151) 2017 07 03
(181) 2027 07 03
(891) 2017 07 03
(511) 35

(260) AM 2018 94149 A
(800) 1363479
(151) 2017 07 19
(181) 2027 07 19
(891) 2017 07 19
(511) 03, 05

(260) AM 2018 94151 A
(800) 1363504
(151) 2016 12 23
(181) 2026 12 23
(891) 2016 12 23
(511) 05, 31, 35

(260) AM 2018 94152 A
(800) 1363516
(151) 2017 05 30
(181) 2027 05 30
(891) 2017 05 30
(511) 41

(260) AM 2018 94153 A
(800) 1363524
(151) 2017 06 19
(181) 2027 06 19
(891) 2017 06 19
(511) 09

(260) AM 2018 94154 A
(800) 1363551
(151) 2017 06 07
(181) 2027 06 07

(891) 2017 06 07
(511) 33

(260) AM 2018 94155 A
(800) 1363552
(151) 2017 06 22
(181) 2027 06 22
(891) 2017 06 22
(511) 05, 32, 35

(260) AM 2018 94156 A
(800) 1363564
(151) 2017 07 14
(181) 2027 07 14
(891) 2017 07 14
(511) 09

(260) AM 2018 94157 A
(800) 1363584
(151) 2017 03 29
(181) 2027 03 29
(891) 2017 03 29
(511) 34

(260) AM 2018 94158 A
(800) 1363603
(151) 2017 06 23
(181) 2027 06 23
(891) 2017 06 23
(511) 03, 05

(260) AM 2018 94159 A
(800) 1363618
(151) 2017 07 03
(181) 2027 07 03
(891) 2017 07 03
(511) 05

(260) AM 2018 94160 A
(800) 1363619
(151) 2017 06 14
(181) 2027 06 14
(891) 2017 06 14
(511) 05

(260) AM 2018 94161 A
(800) 1363622
(151) 2017 05 30
(181) 2027 05 30
(891) 2017 05 30
(511) 05, 30

(260) AM 2018 94198 A
(800) 1365348
(151) 2017 07 25
(181) 2027 07 25
(891) 2017 07 25
(511) 09

(260) AM 2018 94199 A
(800) 1365393
(151) 2017 06 15
(181) 2027 06 15
(891) 2017 06 15
(511) 09, 39, 42

(260) AM 2018 94200 A
(800) 1365410
(151) 2017 02 23
(181) 2027 02 23
(891) 2017 02 23
(511) 09, 25, 28, 38, 41

(260) AM 2018 94203 A
(800) 577361A
(151) 1991 11 11
(181) 2021 11 11
(891) 2017 08 29
(511) 32

(260) AM 2018 94206 A
(800) 675875
(151) 1997 05 15
(181) 2027 05 15
(891) 2017 05 16
(511) 14

(260) AM 2018 94207 A
(800) 988542
(151) 2008 07 25
(181) 2028 07 25
(891) 2017 04 11
(511) 21, 30, 35, 37, 38, 39, 41, 43, 45

(260) AM 2018 94208 A
(800) 1004532
(151) 2009 01 16
(181) 2019 01 16
(891) 2017 04 11
(511) 35, 39, 41, 43

(260) AM 2018 94210 A
(800) 1224736
(151) 2014 07 23
(181) 2024 07 23

(891) 2017 04 12
(511) 33

(260) AM 2018 94212 A
(800) 1260509
(151) 2015 03 19
(181) 2025 03 19
(891) 2017 07 28
(511) 03

(260) AM 2018 94214 A
(800) 1323709
(151) 2015 12 03
(181) 2025 12 03
(891) 2017 07 24
(511) 07

(260) AM 2018 94228 A
(800) 1365207
(151) 2017 03 07
(181) 2027 03 07
(891) 2017 03 07
(511) 03

(260) AM 2018 94233 A
(800) 1364754
(151) 2017 07 22
(181) 2027 07 22
(891) 2017 07 22
(511) 18

(260) AM 2018 94234 A
(800) 1364820
(151) 2017 06 08
(181) 2027 06 08
(891) 2017 06 08
(511) 01, 05, 31, 44

(260) AM 2018 94236 A
(800) 1364887
(151) 2017 04 07
(181) 2027 04 07
(891) 2017 04 07
(511) 09, 28, 41

(260) AM 2018 94237 A
(800) 1365267
(151) 2017 06 01
(181) 2027 06 01
(891) 2017 06 01
(511) 09, 28

(260) AM 2018 94238 A
(800) 1364888
(151) 2017 04 07
(181) 2027 04 07
(891) 2017 04 07
(511) 09, 28, 35, 37, 41, 42

(260) AM 2018 94239 A
(800) 1364993
(151) 2017 06 27
(181) 2027 06 27
(891) 2017 06 27
(511) 10

(260) AM 2018 94243 A
(800) 1364914
(151) 2017 04 07
(181) 2027 04 07
(891) 2017 04 07
(511) 09, 28, 35, 37, 41, 42

(260) AM 2018 94244 A
(800) 1364926
(151) 2016 06 29
(181) 2026 06 29
(891) 2016 06 29
(511) 29

(260) AM 2018 94245 A
(800) 1364928
(151) 2017 01 25
(181) 2027 01 25
(891) 2017 01 25
(511) 30

(260) AM 2018 94248 A
(800) 1364931
(151) 2017 04 07
(181) 2027 04 07
(891) 2017 04 07
(511) 09, 28, 41

(260) AM 2018 94249 A
(800) 1365286
(151) 2017 05 12
(181) 2027 05 12
(891) 2017 05 12
(511) 36

(260) AM 2018 94250 A
(800) 1365046
(151) 2017 01 13
(181) 2027 01 13

(891) 2017 01 13
(511) 29, 30, 32, 35, 43

(260) AM 2018 94251 A
(800) 1365052
(151) 2017 02 02
(181) 2027 02 02
(891) 2017 02 02
(511) 09, 36

(260) AM 2018 94252 A
(800) 1365294
(151) 2017 06 08
(181) 2027 06 08
(891) 2017 06 08
(511) 05

(260) AM 2018 94272 A
(800) 680389
(151) 1997 08 21
(181) 2027 08 21
(891) 2017 08 22
(511) 07, 12

(260) AM 2018 94274 A
(800) 1365503
(151) 2017 04 07
(181) 2027 04 07
(891) 2017 04 07
(511) 09, 28, 41

(260) AM 2018 94275 A
(800) 1365551
(151) 2017 02 21
(181) 2027 02 21
(891) 2017 02 21
(511) 30, 35, 43

(260) AM 2018 94276 A
(800) 1365538
(151) 2017 02 23
(181) 2027 02 23
(891) 2017 02 23
(511) 09, 25, 28

(260) AM 2018 94277 A
(800) 1051843
(151) 2010 08 02
(181) 2020 08 02
(891) 2017 10 01
(511) 05

(260) AM 2018 94279 A
(800) 1365573
(151) 2016 12 30
(181) 2026 12 30
(891) 2016 12 30
(511) 07, 12

(260) AM 2018 94280 A
(800) 1070321
(151) 2011 02 09
(181) 2021 02 09
(891) 2017 09 07
(511) 05

(260) AM 2018 94281 A
(800) 1159316
(151) 2013 04 16
(181) 2023 04 16
(891) 2017 07 12
(511) 12

(260) AM 2018 94282 A
(800) 1160473
(151) 2013 04 30
(181) 2023 04 30
(891) 2017 07 12
(511) 12

(260) AM 2018 94285 A
(800) 1365624
(151) 2017 07 12
(181) 2027 07 12
(891) 2017 07 12
(511) 12

(260) AM 2018 94286 A
(800) 1365625
(151) 2017 07 12
(181) 2017 07 12
(891) 2017 07 12
(511) 12

(260) AM 2018 94287 A
(800) 1365626
(151) 2017 07 12
(181) 2027 07 12
(891) 2017 07 12
(511) 12

(260) AM 2018 94288 A
(800) 1365673
(151) 2017 07 25
(181) 2027 07 25

(891) 2017 07 25
(511) 09

(260) AM 2018 94290 A
(800) 1365694
(151) 2017 07 12
(181) 2027 07 12
(891) 2017 07 12
(511) 12

(260) AM 2018 94291 A
(800) 1365736
(151) 2017 02 21
(181) 2027 09 21
(891) 2017 02 21
(511) 05, 30

(260) AM 2018 94292 A
(800) 1365735
(151) 2017 02 01
(181) 2027 02 01
(891) 2017 02 01
(511) 18

(260) AM 2018 94293 A
(800) 1365744
(151) 2017 03 14
(181) 2027 03 14
(891) 2017 03 14
(511) 43

(260) AM 2018 94295 A
(800) 1365751
(151) 2017 03 22
(181) 2027 03 22
(891) 2017 03 22
(511) 30

(260) AM 2018 94307 A
(800) 321778
(151) 1966 09 26
(181) 2026 09 26
(891) 2017 07 18
(511) 03, 05, 21

(260) AM 2018 94308 A
(800) 506510
(151) 1986 10 09
(181) 2026 10 09
(891) 2017 09 07
(511) 05

(260) AM 2018 94354 A
(800) 1367150
(151) 2017 07 12
(181) 2027 07 12
(891) 2017 07 12
(511) 33

(260) AM 2018 94355 A
(800) 1367213
(151) 2017 05 04
(181) 2027 05 04
(891) 2017 05 04
(511) 05

(260) AM 2018 94357 A
(800) 1367218
(151) 2017 06 28
(181) 2027 06 28
(891) 2017 06 28
(511) 05

(260) AM 2018 94365 A
(800) 1367220
(151) 2017 07 04
(181) 2027 07 04
(891) 2017 07 04
(511) 30

(260) AM 2018 94368 A
(800) 1367251
(151) 2017 07 21
(181) 2027 07 21
(891) 2017 07 21
(511) 30

(260) AM 2018 94369 A
(800) 1367252
(151) 2017 07 21
(181) 2027 07 21
(891) 2017 07 21
(511) 30

(260) AM 2018 94370 A
(800) 1367253
(151) 2017 07 21
(181) 2027 07 21
(891) 2017 07 21
(511) 30

(260) AM 2018 94373 A
(800) 1366566
(151) 2017 07 28
(181) 2027 07 28

(891) 2017 07 28
(511) 11

(260) AM 2018 94374 A
(800) 1366605
(151) 2017 05 23
(181) 2027 05 23
(891) 2017 05 23
(511) 29

(260) AM 2018 94375 A
(800) 1366615
(151) 2017 07 22
(181) 2017 07 22
(891) 2017 07 22
(511) 12

(260) AM 2018 94376 A
(800) 1366651
(151) 2017 08 04
(181) 2027 08 04
(891) 2017 08 04
(511) 03, 05

(260) AM 2018 94377 A
(800) 1366036
(151) 2017 01 25
(181) 2027 01 25
(891) 2017 01 25
(511) 07, 09, 11, 16, 35, 36, 41, 42

(260) AM 2018 94381 A
(800) 1366128
(151) 2016 11 08
(181) 2026 11 08
(891) 2016 11 08
(511) 35, 36, 39

(260) AM 2018 94382 A
(800) 1366140
(151) 2017 01 26
(181) 2027 01 26
(891) 2017 01 26
(511) 03, 05, 09, 10, 16, 20, 21, 24, 35, 38, 41, 42, 44

(260) AM 2018 94387 A
(800) 1366233
(151) 2017 04 13
(181) 2027 04 13
(891) 2017 04 13
(511) 09

(260) AM 2018 94390 A
(800) 1366319
(151) 2017 04 28
(181) 2027 04 28
(891) 2017 04 28
(511) 16

(260) AM 2018 94391 A
(800) 1366338
(151) 2017 06 15
(181) 2027 06 15
(891) 2017 06 15
(511) 09, 39, 42

(260) AM 2018 94392 A
(800) 1366341
(151) 2017 06 28
(181) 2027 06 28
(891) 2017 06 28
(511) 09

(260) AM 2018 94393 A
(800) 1367265
(151) 2017 08 04
(181) 2027 08 04
(891) 2017 08 04
(511) 30

(260) AM 2018 94395 A
(800) 1366372
(151) 2017 06 30
(181) 2027 06 30
(891) 2017 06 30
(511) 05

(260) AM 2018 94397 A
(800) 1366412
(151) 2017 02 15
(181) 2027 02 15
(891) 2017 02 15
(511) 43, 44

(260) AM 2018 94404 A
(800) 1366424
(151) 2017 06 29
(181) 2027 06 29
(891) 2017 06 29
(511) 29, 30

(260) AM 2018 94405 A
(800) 1366447
(151) 2017 03 07
(181) 2027 03 07

(891) 2017 03 07
(511) 01

(260) AM 2018 94406 A
(800) 1366662
(151) 2017 07 14
(181) 2027 07 14
(891) 2017 07 14
(511) 14

(260) AM 2018 94407 A
(800) 1366479
(151) 2017 03 20
(181) 2027 03 20
(891) 2017 03 20
(511) 10

(260) AM 2018 94408 A
(800) 1366480
(151) 2017 03 20
(181) 2027 03 20
(891) 2017 03 20
(511) 05

(260) AM 2018 94409 A
(800) 1366685
(151) 2017 08 07
(181) 2027 08 07
(891) 2017 08 07
(511) 05

(260) AM 2018 94410 A
(800) 1366521
(151) 2017 06 29
(181) 2027 06 29
(891) 2017 06 29
(511) 29, 30

(260) AM 2018 94411 A
(800) 1366556
(151) 2017 08 10
(181) 2027 08 10
(891) 2017 08 10
(511) 01, 02, 03, 04

(260) AM 2018 94412 A
(800) 1367268
(151) 2017 08 29
(181) 2027 08 29
(891) 2017 08 29
(511) 03

(260) AM 2018 94413 A
(800) 1367274
(151) 2017 07 17
(181) 2027 07 17
(891) 2017 07 17
(511) 30

(260) AM 2018 94414 A
(800) 1366702
(151) 2017 04 28
(181) 2027 04 28
(891) 2017 04 28
(511) 33

(260) AM 2018 94415 A
(800) 1366727
(151) 2017 05 19
(181) 2027 05 19
(891) 2017 05 19
(511) 05

(260) AM 2018 94417 A
(800) 1367342
(151) 2017 04 04
(181) 2027 04 04
(891) 2017 04 04
(511) 29, 30, 32, 35, 41, 43

(260) AM 2018 94418 A
(800) 1366792
(151) 2017 05 24
(181) 2027 05 24
(891) 2017 05 24
(511) 03, 05, 10

(260) AM 2018 94420 A
(800) 1366798
(151) 2017 08 21
(181) 2027 08 21
(891) 2017 08 21
(511) 05

(260) AM 2018 94421 A
(800) 1366801
(151) 2017 01 13
(181) 2027 01 13
(891) 2017 01 13
(511) 29, 30, 32, 35, 43

(260) AM 2018 94423 A
(800) 1367346
(151) 2017 04 25
(181) 2027 04 25

(891) 2017 04 25
(511) 06, 07, 09, 11, 12, 17

(260) AM 2018 94424 A
(800) 1366815
(151) 2017 04 24
(181) 2027 04 24
(891) 2017 04 24
(511) 33

(260) AM 2018 94426 A
(800) 1367436
(151) 2017 07 21
(181) 2027 07 21
(891) 2017 07 21
(511) 30

(260) AM 2018 94427 A
(800) 1366832
(151) 2017 08 08
(181) 2027 08 08
(891) 2017 08 08
(511) 09, 35, 37, 42

(260) AM 2018 94428 A
(800) 778012
(151) 2001 12 03
(181) 2021 12 03
(891) 2017 09 11
(511) 03, 07, 09, 11

(260) AM 2018 94430 A
(800) 882808
(151) 2005 12 15
(181) 2025 12 15
(891) 2017 09 11
(511) 03, 07, 09, 11

(260) AM 2018 94431 A
(800) 917907
(151) 2007 03 13
(181) 2027 03 13
(891) 2017 03 14
(511) 29, 31, 35

(260) AM 2018 94434 A
(800) 925307
(151) 2007 04 04
(181) 2027 04 04
(891) 2017 08 29
(511) 30

(260) AM 2018 94444 A
(800) 1366876
(151) 2017 07 24
(181) 2027 07 24
(891) 2017 07 24
(511) 10

(260) AM 2018 94445 A
(800) 1366916
(151) 2017 08 01
(181) 2027 09 28
(891) 2017 08 01
(511) 36

(260) AM 2018 94446 A
(800) 1366952
(151) 2017 08 09
(181) 2027 08 09
(891) 2017 08 09
(511) 41

(260) AM 2018 94448 A
(800) 1366995
(151) 2017 02 09
(181) 2027 02 09
(891) 2017 02 09
(511) 09, 29, 30, 41

(260) AM 2018 94449 A
(800) 1367059
(151) 2017 06 29
(181) 2027 06 29
(891) 2017 06 29
(511) 29, 30, 35

(260) AM 2018 94450 A
(800) 1367135
(151) 2017 06 30
(181) 2027 06 30
(891) 2017 06 30
(511) 06, 12, 35, 37, 39

(260) AM 2018 94501 A
(800) 1367604
(151) 2017 07 26
(181) 2027 07 26
(891) 2017 07 26
(511) 03

(260) AM 2018 94502 A
(800) 1367650
(151) 2017 06 19
(181) 2017 06 19

(891) 2017 06 19
(511) 14

(260) AM 2018 94507 A
(800) 1367743
(151) 2017 06 27
(181) 2027 06 27
(891) 2017 06 27
(511) 30

(260) AM 2018 94508 A
(800) 1367794
(151) 2017 03 23
(181) 2027 03 23
(891) 2017 03 23
(511) 16, 28

(260) AM 2018 94509 A
(800) 1367843
(151) 2017 07 18
(181) 2027 07 18
(891) 2017 07 18
(511) 35, 43

(260) AM 2018 94510 A
(800) 1368058
(151) 2017 07 28
(181) 2027 07 28
(891) 2017 07 28
(511) 01, 09

(260) AM 2018 94516 A
(800) 1367900
(151) 2017 08 01
(181) 2027 08 01
(891) 2017 08 01
(511) 36

(260) AM 2018 94517 A
(800) 1367904
(151) 2017 08 03
(181) 2027 08 03
(891) 2017 08 03
(511) 03

(260) AM 2018 94518 A
(800) 1367906
(151) 2017 08 21
(181) 2027 08 21
(891) 2017 08 21
(511) 05

(260) AM 2018 94520 A
(800) 1367930
(151) 2017 05 23
(181) 2027 05 23
(891) 2017 05 23
(511) 03, 05

(260) AM 2018 94522 A
(800) 1368175
(151) 2017 04 11
(181) 2027 04 11
(891) 2017 04 11
(511) 30

(260) AM 2018 94668 A
(800) 1368734
(151) 2017 07 06
(181) 2027 07 06
(891) 2017 07 06
(511) 09

(260) AM 2018 94669 A
(800) 1368833
(151) 2017 06 07
(181) 2027 06 07
(891) 2017 06 07
(511) 09, 28

(260) AM 2018 94670 A
(800) 1368845
(151) 2017 06 14
(181) 2027 06 14
(891) 2017 06 14
(511) 07, 11

(260) AM 2018 94672 A
(800) 1368846
(151) 2017 06 14
(181) 2027 06 14
(891) 2017 06 14
(511) 07, 11

(260) AM 2018 94673 A
(800) 1368848
(151) 2017 06 14
(181) 2027 06 14
(891) 2017 06 14
(511) 07, 11

(260) AM 2018 94675 A
(800) 1368849
(151) 2017 06 14
(181) 2027 06 14

(891) 2017 06 14
(511) 11

(260) AM 2018 94676 A
(800) 1368850
(151) 2017 06 14
(181) 2027 06 14
(891) 2017 06 14
(511) 11

(260) AM 2018 94678 A
(800) 1368909
(151) 2017 07 28
(181) 2027 07 28
(891) 2017 07 28
(511) 09

(260) AM 2018 94683 A
(800) 1369000
(151) 2017 07 27
(181) 2027 07 27
(891) 2017 07 27
(511) 04, 06, 07, 09, 35, 36, 37, 39, 42

(260) AM 2018 94685 A
(800) 1369001
(151) 2017 07 27
(181) 2027 07 27
(891) 2017 07 27
(511) 06, 07, 09, 35, 36, 37, 39, 40, 42, 45

(260) AM 2018 94747 A
(800) 1371375
(151) 2017 07 10
(181) 2027 07 10
(891) 2017 07 10
(511) 12

(260) AM 2018 94762 A
(800) 1370730
(151) 2017 01 24
(181) 2027 01 24
(891) 2017 01 24
(511) 03, 18, 28, 35, 38, 41

(260) AM 2018 94768 A
(800) 1370864
(151) 2017 09 13
(181) 2027 09 13
(891) 2017 09 13
(511) 05, 29, 30

(260) AM 2018 94837 A
(800) 476538
(151) 1983 03 25
(181) 2023 03 25
(891) 2017 09 01
(511) 19

(260) AM 2018 94851 A
(800) 1342027
(151) 2016 12 15
(181) 2026 12 15
(891) 2017 04 24
(511) 09, 28, 41

(260) AM 2018 94853 A
(800) 1347222
(151) 2017 01 30
(181) 2027 01 30
(891) 2017 08 25
(511) 09

(260) AM 2018 94854 A
(800) 1371897
(151) 2017 09 20
(181) 2027 09 20
(891) 2017 10 12
(511) 05

(260) AM 2018 94859 A
(800) 1371460
(151) 2017 05 20
(181) 2027 05 20
(891) 2017 05 20
(511) 03

(260) AM 2018 94860 A
(800) 1371465
(151) 2017 08 04
(181) 2027 08 04
(891) 2017 08 04
(511) 30

(260) AM 2018 94861 A
(800) 1371481
(151) 2017 02 24
(181) 2027 02 24
(891) 2017 02 24
(511) 25

(260) AM 2018 94862 A
(800) 1371527
(151) 2017 04 07
(181) 2027 04 07

(891) 2017 04 07
(511) 09, 11, 14, 16, 20, 25, 35, 37, 40

(260) AM 2018 94863 A
(800) 1371528
(151) 2017 04 07
(181) 2027 04 07
(891) 2017 04 07
(511) 09

(260) AM 2018 94864 A
(800) 1371533
(151) 2017 03 14
(181) 2027 03 14
(891) 2017 03 14
(511) 03, 05, 35

(260) AM 2018 94866 A
(800) 1371542
(151) 2017 05 10
(181) 2027 05 10
(891) 2017 05 10
(511) 09, 35, 36, 38, 42

(260) AM 2018 94867 A
(800) 1371543
(151) 2017 05 10
(181) 2027 05 10
(891) 2017 12 10
(511) 09, 35, 36, 38, 42

(260) AM 2018 94868 A
(800) 1371545
(151) 2017 06 01
(181) 2027 06 01
(891) 2017 06 01
(511) 42

(260) AM 2018 94870 A
(800) 1371554
(151) 2017 06 14
(181) 2027 06 14
(891) 2017 06 14
(511) 07, 11

(260) AM 2018 94903 A
(800) 1371978
(151) 2017 07 13
(181) 2027 07 13
(891) 2017 07 13
(511) 30

(260) AM 2018 94907 A
(800) 1372043
(151) 2017 07 13
(181) 2027 07 13
(891) 2017 07 13
(511) 30

(260) AM 2018 94934 A
(800) 1373365
(151) 2017 11 07
(181) 2027 11 07
(891) 2017 11 07
(511) 36

(260) AM 2018 94935 A
(800) 1373372
(151) 2017 09 08
(181) 2027 09 08
(891) 2017 09 08
(511) 10, 21, 34

(260) AM 2018 94938 A
(800) 1373387
(151) 2017 09 12
(181) 2027 09 12
(891) 2017 09 12
(511) 10, 41, 44

(260) AM 2018 94939 A
(800) 1373388
(151) 2017 09 12
(181) 2027 09 12
(891) 2017 09 12
(511) 10, 41, 44

(260) AM 2018 94941 A
(800) 1372453
(151) 2017 08 17
(181) 2027 08 17
(891) 2017 08 17
(511) 05

(260) AM 2018 95015 A
(800) 1374284
(151) 2017 04 27
(181) 2027 04 27
(891) 2017 04 27
(511) 35, 39

(260) AM 2018 95022 A
(800) 1374478
(151) 2017 08 12
(181) 2027 08 12

(891) 2017 08 12
(511) 18, 25

(260) AM 2018 95044 A
(800) 1374627
(151) 2017 09 15
(181) 2027 09 15
(891) 2017 09 15
(511) 09

(260) AM 2018 95046 A
(800) 1374694
(151) 2017 09 21
(181) 2027 09 21
(891) 2017 09 21
(511) 09

(260) AM 2018 95062 A
(800) 1344642
(151) 2016 09 28
(181) 2026 09 28
(891) 2017 06 01
(511) 03, 08, 11, 14, 16, 21, 35, 44

(260) AM 2018 95243 A
(800) 1374983
(151) 2017 04 14
(181) 2027 04 14
(891) 2017 04 14
(511) 05

(260) AM 2018 95244 A
(800) 1374993
(151) 2017 06 19
(181) 2027 06 19
(891) 2017 06 19
(511) 01, 03

(260) AM 2018 95246 A
(800) 1375038
(151) 2017 09 01
(181) 2027 09 01
(891) 2017 09 01
(511) 25

(260) AM 2018 95247 A
(800) 1375075
(151) 2017 07 12
(181) 2027 07 12
(891) 2017 07 12
(511) 09, 14, 16, 18, 25, 34

(260) AM 2018 95248 A
(800) 1375109
(151) 2017 01 19
(181) 2027 01 19
(891) 2017 01 19
(511) 05

(260) AM 2018 95250 A
(800) 1375151
(151) 2016 10 20
(181) 2016 10 20
(891) 2016 10 20
(511) 32

(260) AM 2018 95266 A
(800) 1375838
(151) 2016 08 10
(181) 2025 08 10
(891) 2016 08 10
(511) 03, 09, 16, 25, 28, 35, 41

(260) AM 2018 95267 A
(800) 1375841
(151) 2016 10 20
(181) 2026 10 20
(891) 2016 10 20
(511) 29, 30

(260) AM 2018 95273 A
(800) 1376060
(151) 2017 09 13
(181) 2027 09 13
(891) 2017 09 13
(511) 19

(260) AM 2018 95275 A
(800) 1376114
(151) 2017 05 03
(181) 2027 05 03
(891) 2017 05 03
(511) 03, 05

(260) AM 2018 95398 A
(800) 1297823
(151) 2016 02 08
(181) 2026 02 08
(891) 2017 09 08
(511) 43

(260) AM 2018 95416 A
(800) 1377190
(151) 2017 09 18

(181) 2027 09 18
(891) 2017 09 18
(511) 25

(260) AM 2018 95441 A
(800) 1377547
(151) 2017 06 02
(181) 2027 06 02
(891) 2017 06 02
(511) 09, 38, 41, 42

(260) AM 2018 95459 A
(800) 1377603
(151) 2017 07 14
(181) 2027 07 14
(891) 2017 07 14
(511) 09, 25, 28, 38, 41

APPELLATION OF ORIGIN (AO) AND GEOGRAPHICAL INDICATION OF GOODS (GI)

In accordance to the Article 8(4) of the Legislation of Georgia on Appellations of Origins (AOs) and Geographical Indications (GIs) of Goods the LEPL National Intellectual Property Center of Georgia SAKPATENTI publishes application materials submitted NNLE (Non-entrepreneurial Non-commercial Legal Entity) – Bolnisi wine.

If within 3 months from application materials publication no additional information concerning these materials is submitted to SAKPATENTI, the information concerning registration of the appellation of origin shall be entered in the State Register of GIs and AOs and published in the Official Bulletin of Industrial Property of SAKPATENTI.

If additional information is submitted to SAKPATENTI within 3 months from application materials publication, it shall be sent to the Ministry of Environment Protection and Agriculture of Georgia, for examination.

BOLNISI AO WINE PRODUCTION SPECIFICATION

APPLICATION № 1533/06

DATE OF APPLICATION: 2018/07/19

AO: "BOLNISI"

NAME OF GOOD FOR WHICH REGISTRATION IS REQUIRED: Wine

NAME OF APPLICANT AND ADDRESS: NNLE – Bolnisi wine
44, David Aghmashenebeli Str., Bolnisi, Georgia

1. NAME: "BOLNISI"

2. ADDITIONAL SIGNS

3. TYPE, COLOR AND MAIN REQUIREMENTS

"BOLNISI" – is a dry wine that can be white, amber, red and rose.

"BOLNISI" **WHITE** should meet the following requirements:

- Color – light amber;
- Aroma and taste – perfect, delicate, soft, harmonic, joyful, exquisite, has grade aroma characteristic to this geographical place, with flower tones; and aging gets sharp bouquet with fruit tones.
- Actual volume alcohol content – no less than 11%;
- Received extract mass concentration – no less than 16 g/l;
- Sugar – no more than 4 g/l;
- Titrated acidity – no less than 4 g/l;
- Other characteristics shall correspond to the requirements established by the Legislation of Georgia.

"BOLNISI" **RED** shall meet the following requirements:

- Color – dark red;
- Aroma and taste – perfect, full, masculine, extracted, velvet, harmonic, has grade aroma characteristic to this geographical place; and aging gets sharp bouquet with fruit tones.

- Actual volume alcohol content – no less than 11%;
- Received extract mass concentration – no less than 22 g/l;
- Sugar – no more than 4 g/l;
- Titrated acidity – no less than 4 g/l;
- Other characteristics shall correspond to the requirements established by the Legislation of Georgia.

"BOLNISI" ROSE shall meet the following requirements:

- Color – pink;
- Aroma and taste – perfect, delicate, soft, harmonic, joyful, exquisite, has grade aroma characteristic to this geographical place, with flower tones.
- Actual volume alcohol content – no less than 11%;
- Received extract mass concentration – no less than 16 g/l;
- Sugar – no more than 4 g/l;
- Titrated acidity – no less than 4 g/l;
- Other characteristics shall correspond to the requirements established by the Legislation of Georgia.

"BOLNISI" AMBER shall meet the following requirement:

- Color – from dark amber to color of black tea;
- Aroma and taste – complex, has grade aroma with sharp fruit tones; has body, energetical, extracted, velvet, with well developed bouquet; typical with its acidity.
- Actual volume alcohol content – no less than 12%;
- Received extract mass concentration – no less than 22 g/l;
- Sugar – no more than 4 g/l;
- Titrated acidity – no less than 4 g/l;
- Other characteristics shall correspond to the requirements established by the Legislation of Georgia.

4. GEOGRAPHICAL AREA AND ZONES OF PRODUCTION:

The micro-zone Bolnisi situates in the South part of Kvemo Kartli, Municipality of Bolnisi, on 570 m above sea level, in the bassins of rivers Mashavera and Khrami; it covers large area situated between the North latitude 40° 10՝ – 41° 45՝ and the East longitude 43° 28՝ – 44° 45՝; from the East side it is bordered with Kvemo Kartli flat (Marneuli), from the West – with Janakheti volcanic plateau (Dmanisi), from the North – with Khrami Valley (Tetritskaro), and from the South Loki Ridge (mountainy area of Armenia).

Microzone Bolnisi comprises City Bolnisi and villages: Ratevani, Khatisopeli, Rachisubani, Savaneti, Talaveri, Kvemo Arkevani, Samtredo, Chapala, Zvareti, Bolnisi village, Kveshi, Mushevani, Akaurta, Disveli, Kvemo Bolnisi, Samtsevrissi, Nakhiduri, Tsurtavi, Parizi, small town Tamarisi, Vanati, Kianeti, and Mamkhuti.

5. VINE VARIETES:

"BOLNISI" white and amber shall be produced only with the grapes: Rkatsiteli, Chinuri and Goruli Mtsvane (green), cultivated in the microzone Bolnisi.

"BOLNISI" red shall be produced only with the grapes: Saperavi, Tavkveri, Shavkapito, and Asuretuli Shavi (black), cultivated in the microzone Bolnisi.

"BOLNISI" rose shall be produced only with grapes processing of colored vine varieties, cultivated for winemaking in the microzone Bolnisi; with white must fermentation on red grapes squash; or mixing of white and red wines.

For the production of **"BOLNISI"** wines other vine varieties except listed above are not permitted.

6. VINEYARD CULTIVATION, SHAPE OF PRUNING AND CARE:

- Vineyards for "BOLNISI" winemaking shall be situated on 500-800 m above sea level;
- Density between the rows in the vineyards – 1.8 -2.5 m;
- Density between the vines in the row – 1-1.5 m;
- Height of stem – 0.5-0.8 cm;
- Shape of pruning – one-sided or Georgian two-sided, one-sided or two-sided cordon, and free.

Vine cultivation, shape and pruning, pests and diseases control, and soil treatment, fertilization, and other operations, shall be provided according to agro-technical activities selected by wine-maker.

7. GRAPE RIPENESS, VINTAGE, TRANSPORTATION

- "BOLNISI" is produced only with ripe grapes. Sugar content for white, red and amber shall be no less than 20% and for rose – no less than 19%, at the vintage;
- Grapes transportation is permitted only with wooden or plastic boxes, with bodyworks made of stainless steel or painted with especial colour;
- Usage of polyethylene packages and/or bags is not allowed;
- The grapes shall be protected from dirtying at the transportation.

8. VINTAGE- AND WINE HARVESTS:

Vintage harvest on 1 ha vineyard shall be no more than 10 tonnes;

Wine harvest shall be no more than:

- 650 liter – from 1 tonne grapes;
- 6500 liter – from 1 ha vineyard.

9. GRAPE PROCESSING, WINEMAKING AND BOTTLING:

Grapes for producing wine "BOLNISI" shall be only from the vineyards cultivated in micro-zone Bolnisi.

Grapes processing and winemaking shall be provided exclusively inside of borders of micro-zone Bolnisi, but bottling is permitted outside of said micro-zone, in whole territory of Georgia.

Only sober and ripe grapes shall be used for "BOLNISI" production, and damage ration shall not be more than 5%.

"BOLNISI" is produced by full alcoholic fermentation of must or squash. During the "BOLNISI" winemaking operations, materials and substances permitted to be used are only ones established by Legislation of Georgia.

10. LINK BETWEEN EXCLUSIVE QUALITY, REPUTATION AND GEOGRAPHICAL AREA: CLIMATE

The region is characterized with moderately cold winter and hot summer. Slopes (Ketuchi, Sansara and Loki) situated on the West and the South from valley, prevent warm and humid air mass spread from West to South. What about Trialeti slope it borders the territory from the North and the Northwest.

Kvemo Kartli, particularly territory of Bolnisi surrounded with mountains from three sides, and it is under influence of atmospherical processes of Georgia, but because of local conditions the processes are changing and creating local special climate.

In accordance with region meteorological statistical data of many years, annual average temperature is 12°C. The average temperature from beginning of February is above zero and in March it reaches up to 5.9°C, in following months it increases and reaches its maximum in July. The warmest months are July and August; accordingly, average monthly temperature is 23.6–23.3°C. The coldest month is January and it is characterized with below zero degrees (-0.3°C). The frosts are unstable. First frosts

are observed from 12th November and is finished by 4th April. Frosty period lasts for 120–144 days, and not frosty days are 210–221, during a year.

A table

Meteorological station	Air temperature	Months											
		I	II	III	IV	V	VI	VII	VIII	IX	X	XI	XII
Bolnisi	Absolute minimum	-24	-21	-15	-5	-1	5	7	7	-1	-6	-8	-20
	Absolute maximum	19	22	28	32	33	36	38	39	36	37	32	24

Sediment annual amount in the territory of Bolnisi is 700 mm. During winter the sediment type is a snow, which is usually unsteady.

Snowing may start from December and continue till first half of March. Based on previous years data, average height of snow cover is 6 cm.

Absolute minimum temperature in the region is quite low and caused with arctic masses flow from the East and the West (see the table).

Absolute maximum temperature is quite high in summer (36-39°C).

Sediment amount reaches its maximum in May and June (80-86 mm), and minimum in December and January (20-25 mm). Sediment amount is small (152-166 mm) in cold period, and it is 28-29% of annual sum, that can not provide enough humidity reserve of the soil; but in the spring, sediment sum is more (183-196 mm), that has positive influence on grape quality.

SOIL – quite complex relief, soil creating variety of rocks, climate conditions, flora and human activity create soil diversity of Kvemo Kartli South part.

Based on the researchers and existed data the Bolnisi soil map is created with 1:50000 scale; wherein, accordingly physico-geographical conditions and genesical data the mountain-glade, grey, woody brown, black, chestnut (grey-brown) and glade alluvial soils deviding in varieties and categories in accordance with soil-making process, thikness, mechanical content, grade of erosion, etc.

Quite diversity of mezzo and micro relief shapes are appropriate on middle mountain, foothills and flat relief type background, that plays significant role as on soil creation process as on soil usage at agriculture.

Glade brown and alluvial soils 1212 ha area is appropriated on I and II terraces of the river Mashavera Valley.

Glade brown soils are spreaded on the territory of village Ratevani, on right bank of the river Mashavera.

Glade alluvial soils are spreaded on the banks of the river Mashavera and Bolnisi waters, on the conditions of the flat and a little inclined relief.

Said soils are prospect and providing desirable solid stock for viticulture development. It is possible to treat 2000 ha area to plant vineyards in the micro-zone.

Subregional territory includes 8 188 ha area, that proceeds Kvemo Kartli flat. The soils are spread on both banks of the river Mashavera, mainly on flat and light sloped areas in the villages: Nakhiduri, Chapala, Savaneti, Kvemo Archevani, talavera and city Bolnisi territory.

Soil resources and actions provided with appropriate agro-rules are a foundation for the best quality grape production.

Pursuant to executed researches, soil specifications represented in the micro-zone are one of main factor for wine "BOLNISI" production.

HUMAN FACTOR – scientifically justified and known from historical materials, that Georgia is one of first country, where human embodied "cultural" - "domestic" vine from wild one, in Neolithic era; Georgia and Bolnisi along with other regions have a history of continual link to wine culture of 8000 years old, what is proved by archeological (clay qvevri-s (wine jar), gold and silver bowls) and ethnographic materials, writings, terminologies and songs.

In ancient economy of Georgia the viticulture-winemaking sphere had special place at Goergian nation's lifestyle and their well-being. It had significant place in foreign trade, as Georgian wine was exported product from ancient times. It was mentioned by academician Ivane Javakhishvili in V volume of his works, about viticulture history and traditions of Georgia and Bolnisi, among it.

Ancient viticulture and winemaking culture high professional level is shown in ornamental artistic works, culture monuments, ethnographic and literary sources, folk stories and costumes of Bolnisi region.

At archeological excavations are discovered the grape seeds in Bolnisi on Arukhlo ruins, belonging to VI millennium B.C. and cellars of IV-III millennium B.C. are discovered in Bolnisi, nearby territories and Borjomi region, as well as wine storage clay jar – qvevri-s, having double layered walls for wine thermal treatment, among them, that is one of unique worldwide event.

Iv. Javakhishvili in his twelve volume work often mentions winemaking in Bolnisi region and gives wide information about wine name, Appellation of Origin, and characteristics, particularly:

- from typical fragment of IX-X centuries monastery situated nearby Bolnisi is seen that at monastery farm wine made of "babilo" (grape alley) was kept separately in "babilo tchuri" (wine jar). Same fragment indicates that back to times of Queen Tamar the grapes – white, green and dark-red were picked and pressed separately in Bolnisi; in accordance with Giorgi Mtatsmindeli, wines produced in Bolnisi were divided in 3 categories: "light-", "moderate-" and "the best wine" – "nobel wine".
- in XIII-XIV centuries, due to Mongolian, Persian and Ottoman systematic invasions and wars, population of Bolnisi has been exterminated or migrated. In accordance of Armenian historical sources, there were spread Saperavi and green grapes during that period.
- from the beginning of XVII century, in 1619-1620 the Orbeliani's nobel family recorded amount of vineries and yield. Based on figures; it is seen that in 1619, they made 778 "sapanne" wine (1 packet-boat is 6 "puti"- 96 liter), and in 1620 – 808 "sapanne", from the vineries of the villages: Mukhrana, Balakhauri, Shua Bolnisi, Tsughrughasheni, Kvemo Bolnisi, Chapala, Potskhveriani, Disveli and Zvareti.
- at 1818, arrived in Bolnisi Schwab colonists from German Empire helped viticulture-winemaking next development. They had not traditional knowledge of winemaking, but were diligent and hardworking, learned well from local population, and cultivated Muscate, Malera and Isabella varieties by help of Viceroy - Count Vorontsov. They also cultivated Rkatsiteli, Saperavi, Aligote, Gurula, etc. high quality vine varieties, as mentioned German colonist Ernst Allmendinger at his book "Katharinenfeld, ein deutsches Dorf im Kaukasus", 1818-1941. He has mentioned in the book, that in Katherine Feld (nowadays – Bolnisi) viticulture was so developed, that population (814 families) couldn't take yield and treat so great amount of grapes, and they created winemakers cooperation "Union" and at 1908, built winery with its unique wine cellars, basements and infrastructure, where they produced wine, brandy and vodka, and solded in Tbilisi in their own six

wine shops. Besides Tbilisi they transported wine in various sides of Georgia, cities of Empire of Russia, and their wine "Caucasian Red" was annually sent to Emperor of Russia.

After I World War, winemaking was increased at "Union", accordingly – financial incomes and their industry became one of the greatest between Georgian winemaking.

In the 1920s, Bolnisi vinery produced 32-35 000 tons of grapes and bottled millions bottles of wine, for which the vessels were made by glass in the enterprise of Baron Von Kuechenbach. At the time in Katharinenfeld and nearby villages 20-22 tons of grapes per ha were harvested, since the distance between rows were 1 m, and in 100m row 90-95 vine were planted.

Especially significant to mention German vinemakers role in revive of aborigin variety – Asuretuli, with which was produced dry red wine.

In the 1950-70-s, viticulture played significant role for Bolnisi economy, renovated German vinemakers vineyards, was created Soviet vineyards, in Bolnisi and the villages nearby: Ratevani, Kveshi, Nakhiduri, Mamkhuti, Tsurtavi, Savaneti, Chapala, Kvemo Bolnisi, wherein were produced 14-17 000 tons of grapes; and produced therefrom wine material, portwein, wine alcohol, and grape juice were sent to various regions of Soviet Union.

Nowadays in Bolnisi, well functioning winery built by Germans, producing high quality wine alcohol selling in EU countries.

Viticulture cooperative "Union" and winery Heads were: Emmanuel Almendiger (1908–1918), Ernst Almendiger (1918–1930), Rudolph Huttenlocher (1900–1941), Petre Sokhadze (1941–1944), Ivane Kakhidze (1944–1950), Pavle Orjonikidze (1950–1952), Archil Kobiashvili (1952–1954), Dimitri Javelidze (1954–1964), Nariman Dolidze (1964–1972), Jimsher Kurashvili (1972–1975), Bidzina Javelidze (1975–2015), and from 2015 – Gia Loladze.

Geographical location of micro-zone Bolnisi, climate with moderately cold winter and hot summer, moderate amount of atmospheric sediments, soils diversity, Rkatsiteli, Chinuri, Goruli Mtsvane, Saperavi, Tavkveri, Shavkapito, and Asuretuli Shavi – vine varieties, especial characteristics of the micro-zone, and local tradition of viticulture and winemaking provides organoleptic characteristic specifying only for the wine "BOLNISI".

11. LABELING SPECIAL RULES:

Name "BOLNISI" and sign – PDO (Protected Designation of Origin) on the label, package, in the documents accompanying wine, and advertising materials, as well, used in foreign languages, looks like that:

With Latin font – "**Bolnisi**" or "**Bolnisi Wine**"

Protected Designation of Origin and/or PDO

Cyrillic font – "**Болниси**" or "**Болнисское Вино**"

Защищённое наименование места происхождения

12. ACCOUNTING AND NOTIFICATION

"BOLNISI" production and storage technological processes accounting and notification is provided in accordance to the rules established by the Legislation of Georgia.

13. MAIN CONTROLLABLE POINTS:

At the PDO wine "BOLNISI" production process control the producer shall satisfy requirements established by LEPL Wine National Agency, and shall have compliance with following parameters:

Main Controllable Points	Evaluation Methods
Vineyard location	Cadaster map, control on the place
Area	Vineyard accounting magazine, cadaster
Vine variety	Vineyard accounting journal, control on the place
Cultivation methods	Journal of registration of Agrotechnical Measures, treating journal, control on the place
Vintage and transportation	Vintage journal
Grape heritage on ha	Vintage journal
Grape heritage in whole	Vintage journal
Grape processing place, processing and winemaking	Grape receiving journal, grape processing journal, product turnover calculation journal, laboratory analysis journals, notifications, control on the place
Wine bottling, packe and storage conditions	Bottling journal, journal for ready product motion in the storage, laboratory analysis journals
Wine physical-chemical characteristics at winemaking, before and after bottling	Laboratory analysis journals
Wine organoleptic characteristics	Degustation submission protocols
Traceability	Technological and Laboratory Records

14. CONTROL BODY OF WINEMAKING:

Control for winemaking specification protection and legal usage of PDO is provided by LEPL Wine National Agency, corresponding to the rules established by the Legislation of Georgia.

Microzone Bolnisi



OFFICIAL NOTIFICATIONS

INVENTIONS

RENEWAL OF PATENTS

(21) AP 2009 11256

(11) P 2011 5286 B

(73) Devi Vasadze

(54) **NOTIFICATION SYSTEM OF AIR-RAID PRECAUTIONS**

DATE OF PATENT CANCELLATION: 2018 05 15

DATE OF PATENT RENEWAL: 2018 11 12

(21) AP 2010 12025

(11) P 2013 5749 B

(73) LLC "BASALT FIBERS"

(54) **COMPOSITION FOR SHOTCRETE PREPARATION**

DATE OF PATENT CANCELLATION: 2015 12 -06

DATE OF PATENT RENEWAL: 2018 11 12

CANCELLATION OF PATENTS

(21) AP 2012 12873

(11) P 2017 6727 B

(73) Leri Datashvili

(54) **OPENING COSMIC REFLECTOR**

DATE OF PATENT CANCELLATION: 2018 10 19

PATENT RESTORATION IS AVAILABLE: 2019 10 19

(21) AP 2012 13478

(11) P 2016 6434 B

(73) MERCK SHARP & DOHME CORP.

(54) **FUSED BICYCLIC OXAZOLIDINONE CETP INHIBITOR**

DATE OF PATENT CANCELLATION: 2018 10 25

PATENT RESTORATION IS AVAILABLE: 2019 10 25

(21) AP 2013 13785

(11) P 2017 6621 B

(73) H. Lundbeck A/S

(54) **BENZAMIDES**

DATE OF PATENT CANCELLATION: 2018 10 11

PATENT RESTORATION IS AVAILABLE: 2019 10 11

(21) AP 2015 13969
(11) P 2017 6791 B
(73) Merab Kiknavelidze
(54) **DEVICE FOR PISCATION**
DATE OF PATENT CANCELLATION: 2018 10 21
PATENT RESTORATION IS AVAILABLE: 2019 10 21

(21) AP 2003 7158
(11) P 2004 3374 B
(73) LTD "KAMELIN"
(54) **MEDICINAL MEANS ON THE BASE OF HONEY, THEIR USE AND METHOD FOR PRODUCTION THEREOF**
DATE OF PATENT CANCELLATION: 2018 10 17
PATENT RESTORATION IS AVAILABLE: 2019 10 17

(21) AP 2001 8198
(11) P 2007 4029 B
(73) "OTSUKA PHARMACEUTICAL" CO., LTD
(54) **FLASHMELT ORAL DOSAGE FORMULATION**
DATE OF PATENT CANCELLATION: 2018 10 09
PATENT RESTORATION IS AVAILABLE: 2019 10 09

(21) AP 2004 9401
(11) P 2009 4800 B
(73) Interdigital Technology Corporation
(54) **METHOD FOR REPORTING WLAN CAPABILITIES OF A DUAL MODE GPRS/WLAN OR UMTS/WLAN WTRU**
DATE OF PATENT CANCELLATION: 2018 10 14
PATENT RESTORATION IS AVAILABLE: 2019 10 14

CHANGES IN NAMES AND/OR ADDRESSES OF OWNERS

(21) AP 2009 12045
(11) P 2015 6220 B
(54) **COMPOSITION TREATING OCULAR HYPERTENSION AND GLAUCOMA, AND USAGE THEREOF**

New name and/or address:	AGC Inc. (JP) 5-1, Marunouti, 1-Tome, Tiioda-ku, 1008405, Tokio (JP); SANTEN PHARMACEUTICAL CO., LTD 9-19, Shimoshinjo 3-chome, Higashiyodogawa-ku, Osaka, 533-8651 (JP)
Former name and/or address:	Asahi glas ko., ltd 5-1, Marunouti, 1-Tome, Tiioda-ku, 1008405, Tokio (JP); SANTEN PHARMACEUTICAL CO., LTD 9-19, Shimoshinjo 3-chome, Higashiyodogawa-ku, Osaka, 533-8651
Date of entry to the registry:	2018 10 24

(21) AP 2010 12393

(11) P 2014 6211 B

(54) FUNGICIDAL PYRAZOLES

New name and/or address: PMC Corporation (US)
2929 Walnut String, Philadelphia, Pennsylvania, 19104 (US);
Former name and/or address: E.I. Du Pont De Nemours and Company
1007 Market Street, Wilmington, De 19898, USA
Date of entry to the registry: 2018 10 24

(21) AP 2011 13039

(11) P 2015 6262 B

(54) FUNGICIDAL PYRAZOLES AND THEIR MIXTURES

New name and/or address: PMC Corporation (US)
2929 Walnut String, Philadelphia, Pennsylvania, 19104 (US)
Former name and/or address: E.I. Du Pont De Nemours and Company
1007 Market Street, Wilmington, De 19898, USA
Date of entry to the registry: 2018 10 24

(21) AP 2001 5846

(11) P 2004 3289 B

(54) SUSTAINED RELEASE RANOLAZINE FORMULATION

New name and/or address: Roche Palo Alto LLC (US)
1 DNA Wai Mele Stop 24, South San Francisco, CA 94080 (US)
Former name and/or address: Roche Palo Alto LLC
3431 Hillview Avenue, Palo Alto, CA 94304, USA
Date of entry to the registry: 2018 10 19

(21) AP 2001 5846

(11) P 2004 3289 B

(54) SUSTAINED RELEASE RANOLAZINE FORMULATION

New name and/or address: Giled Science Inc. (US)
333 Lexside Drive, Foster City, CA 94404 (US)
Former name and/or address: Roche Palo Alto LLC (US)
1 DNA Wai Mele Stop 24, South San Francisco, CA 94080 (US)
Date of entry to the registry: 2018 10 19

(21) AP 1999 5847

(11) P 2005 3420 B

(54) SUSTAINED RELEASE RANOLANOLAZINE FORMULATION

New name and/or address: Giled Science Inc. (US)
333 Lexside Drive, Foster City, CA 94404 (US)
Former name and/or address: Roche Palo Alto LLC (US)
1 DNA Wai Mele Stop 24, South San Francisco, CA 94080 (US)
Date of entry to the registry: 2018 10 22

(21) AP 1999 5847

(11) P 2005 3420 B

(54) SUSTAINED RELEASE RANOLANOLAZINE FORMULATION

New name and/or address: Roche Palo Alto LLC (US)
1 DNA Wai Mele Stop 24, South San Francisco, CA 94080 (US)

Former name and/or address: Roche Palo Alto LLC (US)
3431 Hilview Avenue, Palo Alto, CA 94304, USA

Date of entry to the registry: 2018 10 22

(21) AP 2000 6308

(11) P 2006 3885 B

(54) INDAZOLE COMPOUNDS AND PHARMACEUTICAL COMPOSITIONS FOR INHIBITING PROTEIN KINASES, AND METHODS FOR THEIR USE

New name and/or address: AGOURON PHARMACEUTICALS LLC (US)
10646 Science Center Drive, San Diego, CA 92121 (US)

Former name and/or address: AGOURON PHARMACEUTICALS INC
10350 North Torrey Pines Road, La Jolla, CA 92037-1020, USA

Date of entry to the registry: 2018 10 24

(21) AP 2003 7209

(11) P 2004 3370 B

(54) BLEND FOR PRODUCTION OF SILICON MANGANESE

New name and/or address: "Georgian manganese" LLC (GE)
Sakarkhnos q. 9, 2000, Zestaponi (GE)

Former name and/or address: "Georgian manganese" LLC (GE)
Sakarkhnos q. 9, 2000, Zestaponi, Georgia (GE)

Date of entry to the registry: 2018 10 22

(21) AP 2005 8583

(11) P 2006 3841 B

(54) METHOD FOR PRODUCTION OF SILICON MANGANESE

New name and/or address: Ketevan Tsereteli (GE)
Varketilis Mas. Zemo plato, II mkr., korp. 21, b. 62, 0182, Tbilisi (GE);
Boris Gachechiladze (GE)
Chkheidzis q. 122, 2000, Zestaponi (GE);
Shukri Grigalashvili (GE)
Iashvilis q. 16, 5500, Chiatura (GE);
Davit Gvelesiani (GE)
D. Aghmasheneblis q 17, 2000, Zestaponi (GE);
Vladimer Akhobadze (GE)
Bibilashvilis q. 7/5, 2000, Zestaponi (GE);
Nugzar Tsereteli (GE)
Varketilis Mas. Zemo plato, II mkr., korp. 21, b. 62, 0182, Tbilisi (GE)

Former name and/or address: Ketevan Tsereteli (GE)
Varketilis Mas. Zemo plato, II mkr., korp. 21, b. 62, 0182, Tbilisi (GE);
Boris Gachechiladze (GE)
Chkheidzis q. 122, 2000, Zestaponi (GE);
Shukri Grigalashvili (GE)
Iashvilis q. 16, 5500, Chiatura (GE);
Davit Gvelesiani (GE)
D. Aghmasheneblis q 17, 2000, Zestaponi (GE);
Hamlet Vasadze (GE)

D. Uznadzis q. 114, 2000, Zestaponi (GE);
Vladimer Akhobadze (GE)
Bibilashvilis q. 7/5, 2000, Zestaponi (GE);
Nugzar Tsereteli (GE)
Varketilis Mas. Zemo plato, II mkr., korp. 21, b. 62, 0182, Tbilisi (GE)

Date of entry to the registry: 2018 10 22

UTILITY MODELS

CANCELLATION OF PATENTS

(21) AU 2014 13582

(11) U 2015 1868 Y

(73) Vakhtang Aslanikashvili

(54) **TURBINE**

DATE OF PATENT CANCELLATION:2018 09 25

PATENT RESTORATION IS AVAILABLE: 2019 09 25

(21) AU 2014 13606

(11) U 2017 1921 Y

(73) Gocha Pipia

(54) **ADVERTISING MATERIAL FOR DISTILLED ALCOHOLIC BEVERAGES**

DATE OF PATENT CANCELLATION:2018 10 22

PATENT RESTORATION IS AVAILABLE: 2019 10 22

DESIGNS

RENEWAL OF REGISTRATION

(11) D 2014 576 S

(73) Tamta Bilonashvili

Varketilis Mas., IV mkr., III kvart., korp. 1, b. 58, 0152, Tbilisi, Georgia (GE)

(54) **SUNFLOWER, GROUND NUT AND OTHER PRODUCTS STORAGE PACK**

(28) 1

(24) 2013 10 09

(18) 2023 10 09

(58) 2018 10 23

CANCELLATION OF REGISTRATION

(11) D 1999 75 S

(73) BP OIL INTERNATIONAL LIMITED (GB)

Britanic House, 1 Finsber Sircuse, London, EC2M 7BA, England, United Kingdom (GB)

(54) **DISHES WITH A CAP**

(18) 2018 03 13

(58) 2018 10 22

CHANGES IN NAMES AND/OR ADDRESSES OF OWNERS

(11) D 2004 194 S

New name and/or address: State Enterprise "Artemisil" (UA)
Chkalovi Street, House 1a, 84545, Bakhmutis District, Soledari, Donetsk District, Ukraine (UA)

Former name and/or address: State Enterprise "Artemisil" (UA)
Chkalovi Street, House 1a, 84545, Soledari, Donetsk District, Ukraine (UA)

(58) 2018 10 26

TRADEMARKS

RENEWAL OF REGISTRATIONS

(111) M 1998 10390 R2

(156) 20 08 1998

(186) 20 08 2028

(732) CHURCH & DWIGHT CO., INC.

(a Delaware corporation)

500 Charles Ewing Boulevard, Ewing,
New Jersey, 08628, USA

(111) M 1998 10396 R2

(156) 20 08 1998

(186) 20 08 2028

(732) CHURCH & DWIGHT CO., INC.

(a Delaware corporation)

500 Charles Ewing Boulevard, Ewing,
New Jersey, 08628, USA

(111) M 1998 10790 R2

(156) 15 09 1998

(186) 15 09 2028

(732) SOCIETE DU FIGARO S.A.S.

14 Boulevard Haussmann, 75009, Paris,
France

(111) M 1998 9062 R2

(156) 29 04 1998

(186) 29 04 2028

(732) SYNGENTA LIMITED

Syngenta Jealott's Hill International Research
Centre, Bracknell, Berkshire RG42 6EY,
United Kingdom

(111) M 1998 11087 R2

(156) 11 11 1998

(186) 11 11 2028

(732) TETRA LAVAL HOLDINGS &

FINANCE S.A.

Avenue General-Guisan 70, CH-1009 Pully,
Switzerland

(111) M 1998 11088 R2

(156) 11 11 1998

(186) 11 11 2028

(732) TETRA LAVAL HOLDINGS & FINANCE

S.A.

Avenue General-Guisan 70, CH-1009 Pully,
Switzerland

(111) M 1998 10735 R2

(156) 11 09 1998

(186) 11 09 2028

(732) PETRONAS LUBRICANTS ITALY S.p.A.

Via Santena 1, Villastellone (Torino), Italy

(111) M 1998 11044 R2

(156) 29 10 1998

(186) 29 10 2028

(732) WORLDWIDE FRANCHISE SYSTEMS, INC.

One StarPoint, Stamford, CT 06902, USA

(111) M 1998 11050 R2

(156) 30 10 1998

(186) 30 10 2028

(732) AVEDA CORPORATION

(a Delaware corporation)

4000 Pheasant Ridge Road, Blaine, Minnesota
55449, USA

(111) M 1998 11025 R2

(156) 28 10 1998

(186) 28 10 2028

(732) SIG COMBIBLOC GMBH

Rurstrasse 58, 52441 Linnich, Germany

(111) M 1998 11073 R2

(156) 09 11 1998

(186) 09 11 2028

(732) STADLBAUER MARKETING+VERTRIEB

GMBH

Rennbahnallee 1, 5412 Puch/Salzburg, Austria

(111) M 1998 11302 R2

(156) 16 12 1998

(186) 16 12 2028

(732) AMERICAN HEART ASSOCIATION, INC.

7272 Greenville Avenue, Dallas
TX 75231-4596, USA

(111) M 1998 11243 R2

(156) 09 12 1998

(186) 09 12 2028

(732) WYETH LLC

235 East 42nd Street, New York, NY 10017,
USA

(111) M 1998 11305 R2 (156) 16 12 1998 (186) 16 12 2028 (732) INVISTA Technologies S.a.r.l. Flurhofstrabse 160, 9000 9000 St. Gallen, Switzerland	235 East 42nd Street, New York, NY 10017, USA
(111) M 1998 11261 R2 (156) 11 12 1998 (186) 11 12 2028 (732) WYETH LLC 235 East 42nd Street, New York, NY 10017, USA	(111) M 1999 12738 R2 (156) 23 09 1999 (186) 23 09 2029 (732) WYETH HOLDINGS LLC 235 East 42nd Street, New York, NY 10017, USA
(111) M 1998 11314 R2 (156) 16 12 1998 (186) 16 12 2028 (732) GODIVA BELGIUM B.V.B.A./S.P.R.L. Wapenstilstandstraat 5 (rue de L'Armistice 5) B-1080 Brussels, Belgium	(111) M 1998 10668 R2 (156) 10 09 1998 (186) 10 09 2028 (732) WRANGLER APPAREL CORP. 3411 Silverside Road, Wilmington, DE 19810, USA
(111) M 1998 11357 R2 (156) 22 12 1998 (186) 22 12 2028 (732) BAXTER HEALTHCARE S.A. Hertistrasse 2, 8304 Wallisellen, Switzerland	(111) M 1998 8970P R2 (156) 24 04 1998 (186) 24 04 2028 (732) SKODA AUTO A.S. Tr. Vaclava Klementa 869,CZ-293 60 Mlada Boleslava, Czech Republic
(111) M 1999 11390 R2 (156) 26 01 1999 (186) 26 01 2029 (732) WM.WRIGLEY JR.COMPANY 1132 West Blackhawk Street, Chicago, Illinois 60642, USA	(111) M 1998 8968P R2 (156) 24 04 1998 (186) 24 04 2028 (732) SKODA AUTO A.S. Tr. Vaclava Klementa 869,CZ-293 60 Mlada Boleslava, Czech Republic
(111) M 1999 11931 R2 (156) 30 04 1999 (186) 30 04 2029 (732) STARBUCKS CORPORATION 2401 Utah Avenue South, Seattle, Washington 98134, USA	(111) M 2006 16938 R1 (156) 26 10 2006 (186) 26 10 2026 (732) LTD "GORGASALI" Leselidzis q., 44, 0105, Tbilisi, Georgia
(111) M 1999 11938 R2 (156) 30 04 1999 (186) 30 04 2029 (732) MARY KAY INC. 16251 Dallas Parkway, Addison, Texas 75001, USA	(111) M 1998 9556 R2 (156) 03 06 1998 (186) 03 06 2028 (732) NOVARTIS AG 4002 Basel, Switzerland
(111) M 1999 12737 R2 (156) 23 09 1999 (186) 23 09 2029 (732) WYETH HOLDINGS LLC	(111) M 1998 9554 R2 (156) 03 06 1998 (186) 03 06 2028 (732) NOVARTIS AG 4002 Basel, Switzerland
(111) M 1999 12737 R2 (156) 23 09 1999 (186) 23 09 2029 (732) WYETH HOLDINGS LLC	(111) M 2007 18138 R1 (156) 27 12 2007 (186) 27 12 2027

(732) ZURAB RAMAZASHVILI
Jorjiashvilis q.40, telavi, 2200, Georgia

(111) M 1998 8726 R2
(156) 25 03 1998
(186) 25 03 2028

(732) ILLVA SARONNO S.p.A.
(in short I.S. S.p.A.)
Via Archimede 243 - 21047 Saronno (VA),
Italy

(111) M 2008 18619 R1
(156) 31 07 2008
(186) 31 07 2028

(732) LTD "G-M-P"
Ponitchala 65, 0165, Tbilisi, Georgia

(111) M 2008 18461 R1
(156) 16 05 2008
(186) 16 05 2028

(732) YILDIZ HOLDING A.Ş.
Kisikli mahallesi Çeşme Çikmazi, Sokak.
No:6/1, Uskudar, Istanbul, Turkey

(111) M 2008 18462 R1
(156) 16 05 2008
(186) 16 05 2028

(732) YILDIZ HOLDING A.Ş.
Kisikli mahallesi Çeşme Çikmazi, Sokak.
No:6/1, Uskudar, Istanbul, Turkey

(111) M 2008 18464 R1
(156) 16 05 2008
(186) 16 05 2028

(732) YILDIZ HOLDING A.Ş.
Kisikli mahallesi Çeşme Çikmazi, Sokak.
No:6/1, Uskudar, Istanbul, Turkey

(111) M 2008 18465 R1
(156) 16 05 2008
(186) 16 05 2028

(732) YILDIZ HOLDING A.Ş.
Kisikli mahallesi Çeşme Çikmazi, Sokak.
No:6/1, Uskudar, Istanbul, Turkey

(111) M 2008 18529 R1
(156) 16 06 2008
(186) 16 06 2028

(732) HEXAL AKTIENGESELLSCHAFT
Industriestrasse 25, 83607 Holzkirchen,
Germany

(111) M 2008 18340 R1
(156) 27 03 2008
(186) 27 03 2028

(732) JSC "BADAGONI"
Sop. Zemo Khodasheni, 0910, Akhmetis
aioni, Georgia

(111) M 2008 18542 R1
(156) 16 06 2008
(186) 16 06 2028

(732) ROVALL S.p.A.
Strada del Lavoro 73, Franzione Gualdicciolo
– ACQUAVIVA, San Marino

(111) M 2008 18408 R1
(156) 29 04 2008
(186) 29 04 2028

(732) SSIP TBILISIS SAKHELMTSIFO
SAMEDICINO UNIVERSITETI
Vazha-Pshavelas gamz. 33, 0177, Tbilisi,
Georgia

(111) M 2008 18726 R1
(156) 26 09 2008
(186) 26 09 2028

(732) GSH TRADEMARKS LIMITED
Afroditis, 25, 2nd floor, office 204, Nicosia,
Cyprus

(111) M 2008 18974 R1
(156) 15 12 2008
(186) 15 12 2028

(732) JSC "TELAVI WINE CELLAR"
Sop. Kurdghelauri, 2200, Telavi, Georgia

(111) M 2008 18771 R1
(156) 16 10 2008
(186) 16 10 2028

(732) JSC "TELAVIS GVINIS MARANI"
sof. Kurdgelauri, 2200, Telavi, Georgia

(111) M 2008 18684 R1
(156) 17 09 2008
(186) 17 09 2028

(732) L' OREAL
14 Rue Royale, 75008 Paris, France

(111) M 2008 18892 R1
(156) 17 11 2008
(186) 17 11 2028

(732) PARK HOSPITALITY WORLDWIDE LLC
a Delaware Limited Liability Company

Carlson Parkway, P.O. Box 59159,
Minneapolis, MN 55459, USA

(732) LTD "NIU HOSPITALS"
Dzveli Tbilisis Raioni, D. Aghmasheneblis
Gamz. N148/III, Georgia

(111) M 2008 18840 R1

(156) 03 11 2008

(186) 03 11 2028

(732) Aqcionernoe Obschestvo "SINERGIA
KAPITAL" (AO "Sinergia Kapital")
Ul. pobedi, d.26, 143090 krasnoznamenski,
moskovskaia obl., Russian Federation

(111) M 2008 18946 R1

(156) 28 11 2008

(186) 28 11 2028

(732) LTD "LUDI BATUMURI"
Tbel Abuseridzis q.24, 6000, Batumi, Georgia

(111) M 2008 18749 R1

(156) 26 09 2008

(186) 26 09 2028

(732) LTD "G-M-P"
Ponitchala 65, 0165, Tbilisi, Georgia

(111) M 2008 19003 R1

(156) 15 12 2008

(186) 15 12 2028

(732) ORION CORPORATION
30-10, Munbae-Dong, Yongsan-Ku, Seoul,
Republic of Korea

(111) M 2008 18750 R1

(156) 26 09 2008

(186) 26 09 2028

(732) LTD "G-M-P"
Ponitchala 65, 0165, Tbilisi, Georgia

(111) M 2008 19004 R1

(156) 15 12 2008

(186) 15 12 2028

(732) ORION CORPORATION
30-10, Munbae-Dong, Yongsan-Ku, Seoul,
Republic of Korea

(111) M 2008 18751 R1

(156) 26 09 2008

(186) 26 09 2028

(732) LTD "G-M-P"
Ponitchala 65, 0165, Tbilisi, Georgia

(111) M 2008 19005 R1

(156) 15 12 2008

(186) 15 12 2028

(732) ORION CORPORATION
30-10, Munbae-Dong, Yongsan-Ku, Seoul,
Republic of Korea

(111) M 2008 18752 R1

(156) 26 09 2008

(186) 26 09 2028

(732) LTD "G-M-P"
Ponitchala 65, 0165, Tbilisi, Georgia

(111) M 2008 19006 R1

(156) 15 12 2008

(186) 15 12 2028

(732) ORION CORPORATION
30-10, Munbae-Dong, Yongsan-Ku, Seoul,
Republic of Korea

(111) M 2008 18753 R1

(156) 26 09 2008

(186) 26 09 2028

(732) LTD "G-M-P"
Ponitchala 65, 0165, Tbilisi, Georgia

(111) M 2008 19007 R1

(156) 15 12 2008

(186) 15 12 2028

(732) ORION CORPORATION
30-10, Munbae-Dong, Yongsan-Ku, Seoul,
Republic of Korea

(111) M 2008 18800 R1

(156) 16 10 2008

(186) 16 10 2028

(732) Nemiroff Intellectual Property
Establishment
Haus Rechsteiner, P.O. Box 634/Stadtle 31,
LI-9490 Vaduz, Liechtenstein

(111) M 2008 19008 R1

(156) 15 12 2008

(186) 15 12 2028

(732) ORION CORPORATION
30-10, Munbae-Dong, Yongsan-Ku, Seoul,
Republic of Korea

(111) M 2008 18939 R1

(156) 28 11 2008

(186) 28 11 2028

(111) M 2008 19009 R1 (156) 15 12 2008 (186) 15 12 2028 (732) ORION CORPORATION 30-10, Munbae-Dong, Yongsan-Ku, Seoul, Republic of Korea	Hattenbergstrasse 10, 55122 Mainz, Germany
(111) M 2008 19010 R1 (156) 15 12 2008 (186) 15 12 2028 (732) ORION CORPORATION 30-10, Munbae-Dong, Yongsan-Ku, Seoul, Republic of Korea	(111) M 1999 11790 R2 (156) 24 03 1999 (186) 24 03 2029 (732) REEBOK INTERNATIONAL LIMITED 4th Flor, 11-12 Pall Mall, London SW1Y 5LU, United Kingdom
(111) M 2008 19011 R1 (156) 15 12 2008 (186) 15 12 2028 (732) ORION CORPORATION 30-10, Munbae-Dong, Yongsan-Ku, Seoul, Republic of Korea	(111) M 1998 10773 R2 (156) 15 09 1998 (186) 15 09 2028 (732) SCHOTT AG Hattenbergstrasse 10, 55122 Mainz, Germany
(111) M 2009 19129 R1 (156) 16 03 2009 (186) 16 03 2029 (732) TECHKING TIRES LIMITED Room 1908, Building 2, Tianbao International Business Center N61, Haier Road, Qingdao, China	(111) M 1998 10257 R2 (156) 17 08 1998 (186) 17 08 2028 (732) CHANEL SARL Burgstrasse 26, CH-8750 GLARUS, Switzerland
(111) M 1998 8954 R2 (156) 23 04 1998 (186) 23 04 2028 (732) INDESIT COMPANY LUXEMBOURG S.A. 11-13 Boulevard de la Foire, Luxembourg, L-1528, Luxembourg	(111) M 1998 9737 R2 (156) 15 06 1998 (186) 15 06 2028 (732) SANDVIK INTELLECTUAL PROPERTY AB SE-81181 Sandviken, Sweden
(111) M 1998 10768 R2 (156) 15 09 1998 (186) 15 09 2028 (732) SCHOTT AG Hattenbergstrasse 10, 55122 Mainz, Germany	(111) M 1998 8932 R2 (156) 17 04 1998 (186) 17 04 2028 (732) WINCOR NIXDORF INTERNATIONAL GMBH Heinz-Nixdorf-Ring 1, D-33106 Paderborn, Germany
(111) M 1998 10769 R2 (156) 15 09 1998 (186) 15 09 2028 (732) SCHOTT AG Hattenbergstrasse 10, 55122 Mainz, Germany	(111) M 1998 9481 R2 (156) 29 05 1998 (186) 29 05 2028 (732) FMC CORPORATION a Delaware Corporation 1735 Market Street, Philadelphia, Pennsylvania 19103, USA
(111) M 1998 10771 R2 (156) 15 09 1998 (186) 15 09 2028 (732) SCHOTT AG	(111) M 1998 9741 R2 (156) 15 06 1998 (186) 15 06 2028 (732) TRUSTED MEDIA BRANDS, INC. 44 South Broadway, White Plains, New-York 10601, USA

(111) M 1998 9742 R2
(156) 15 06 1998
(186) 15 06 2028
(732) TRUSTED MEDIA BRANDS, INC.
44 South Broadway, White Plains,
New York 10601, USA

(111) M 1998 9256 R2
(156) 07 05 1998
(186) 07 05 2028
(732) WURZBURG HOLDING S.A.
134 Boulevard de la Petrusse, L-2330
Luxembourg, Luxembourg

(111) M 1998 10272 R2
(156) 19 08 1998
(186) 19 08 2028
(732) CRODA INTERNATIONAL PLC
Cowick Hall, Snaith, Goole, East Yorkshire,
DN14 9AA, United Kingdom

(111) M 1998 10273 R2
(156) 19 08 1998
(186) 19 08 2028
(732) CRODA INTERNATIONAL PLC
Cowick Hall, Snaith, Goole, East Yorkshire,
DN14 9AA, United Kingdom

(111) M 1998 10274 R2
(156) 19 08 1998
(186) 19 08 2028
(732) CRODA INTERNATIONAL PLC
Cowick Hall, Snaith, Goole, East Yorkshire,
DN14 9AA, United Kingdom

(111) M 1998 8722 R2
(156) 25 03 1998
(186) 25 03 2028
(732) FEDERAL EXPRESS CORPORATION
3620 Haks Kros Roudi, Bilding B, 3 Flori,
Memfisi, Tenesi, USA

(111) M 1998 8631 R2
(156) 11 03 1998
(186) 11 03 2028
(732) CANDY S.P.A.
Via Privata Eden Fumagalli, 20861 Brugherio
(Monza e Brianza), Italy

(111) M 1998 10306 R2
(156) 19 08 1998
(186) 19 08 2028

(732) INTERPARFUMS S.A.
4 Rond Point des Champs-Élysées, 75008
Paris, France

(111) M 1998 11198 R2
(156) 02 12 1998
(186) 02 12 2028
(732) INTERPARFUMS S.A.
4 Rond Point des Champs Elysee, 75008
Paris, France

(111) M 1998 11199 R2
(156) 02 12 1998
(186) 02 12 2028
(732) INTERPARFUMS S.A.
4 Rond Point des Champs Elysee, 75008
Paris, France

(111) M 1998 11201 R2
(156) 02 12 1998
(186) 02 12 2028
(732) INTERPARFUMS S.A.
4 Rond Point des Champs Elysee,
75008 Paris, France

(111) M 1999 12139 R2
(156) 12 05 1999
(186) 12 05 2029
(732) REMA TIP TOP AG
Gruber Strasse 65, 85586 Poing, Germany

(111) M 1998 8968P2 R2
(156) 24 04 1998
(186) 24 04 2028
(732) SKODA AUTO A.S.
Tr. Vaclava Klementa 869, 293 60 Mlada
Boleslava, Czech Republic

(111) M 1998 8970P1 R2
(156) 24 04 1998
(186) 24 04 2028
(732) SKODA AUTO A.S.
Tr. Vaclava Klementa 869, 293 60 Mlada
Boleslava, Czech Republic

(111) M 1998 10034 R2
(156) 09 07 1998
(186) 09 07 2028
(732) RHODIA OPERATIONS
25 rue de Clichy - 75009 PARIS, France

(111) M 1998 10014 R2
(156) 09 07 1998
(186) 09 07 2028
(732) FEDERAL EXPRESS CORPORATION
3620 Hacks Cross Road, Building B, 3rd
Floor, Memphis, Tennessee, USA

(111) M 1998 10281 R2
(156) 19 08 1998
(186) 19 08 2028
(732) SPEEDO HOLDINGS B.V.
Claude Debussylaan 24, 1082 MD
Amsterdam, Netherlands

(111) M 1998 10282 R2
(156) 19 08 1998
(186) 19 08 2028
(732) SPEEDO HOLDINGS B.V.
Claude Debussylaan 24, 1082 MD
Amsterdam, Netherlands

(111) M 1998 10283 R2
(156) 19 08 1998
(186) 19 08 2028
(732) SPEEDO HOLDINGS B.V.
Claude Debussylaan 24, 1082 MD
Amsterdam, Netherlands

(111) M 1998 9305 R2
(156) 13 05 1998
(186) 13 05 2028
(732) MAIDENFORM LLC
1000 Hanes Mill Road, Winston-Salem
NC 27105, USA

(111) M 1998 8461 R2
(156) 26 02 1998
(186) 26 02 2028
(732) BELLE ETOILE
8 rue Lincoln, 75008 PARIS, France

(111) M 1998 10188 R2
(156) 05 08 1998
(186) 05 08 2028
(732) KONINKLIJKE PHILIPS ELECTRONICS
N.V.
1, Groenewoudseweg, Eindhoven,
Netherlands

(111) M 1998 10189 R2
(156) 05 08 1998
(186) 05 08 2028

(732) KONINKLIJKE PHILIPS ELECTRONICS
N.V.
1, Groenewoudseweg, Eindhoven,
Netherlands

(111) M 1998 10190 R2
(156) 05 08 1998
(186) 05 08 2028
(732) KONINKLIJKE PHILIPS ELECTRONICS
N.V.
1, Groenewoudseweg, Eindhoven,
Netherlands

(111) M 1998 10191 R2
(156) 05 08 1998
(186) 05 08 2028
(732) MÄURER & WIRTZ GmbH & Co. KG
Zweifaller Strasse 120,52224 Stolberg,
Germany

(111) M 1998 10192 R2
(156) 05 08 1998
(186) 05 08 2028
(732) MÄURER & WIRTZ GmbH & Co. KG
Zweifaller Strasse 120,52224 Stolberg,
Germany

(111) M 1998 10194 R2
(156) 05 08 1998
(186) 05 08 2028
(732) BIOTHERM S.A.M.
"Le Neptune", 11 Avenue Albert II, MC
98000, Monaco

(111) M 1998 9755 R2
(156) 15 06 1998
(186) 15 06 2028
(732) PACO RABANNE
17, rue Francois 1er, 75008 Paris, France

(111) M 1998 9360 R2
(156) 19 05 1998
(186) 19 05 2028
(732) KONINKLEIKE DOIUVE EGBERTS B.V.
Oosterdoksstraat 80, 1011 DK Amsterdam,
Netherlands

(111) M 1998 10367 R2
(156) 19 08 1998
(186) 19 08 2028
(732) HYUNDAI MOTOR COMPANY
231, Yangjae-Dong, Seocho-Gu, Seoul,

137-938, Republic of Korea

(111) M 1998 8492 R2
 (156) 02 03 1998
 (186) 02 03 2028
 (732) EPGPrints B.V.
 Raamstraat 3, 5831 AT Boxmeer,
 Netherlands

(111) M 1998 8494 R2
 (156) 02 03 1998
 (186) 02 03 2028
 (732) EPGPrints B.V.
 Raamstraat 3, 5831 AT Boxmeer,
 Netherlands

(111) M 1998 8610 R2
 (156) 10 03 1998
 (186) 10 03 2028
 (732) JAWAUNION S.R.O.
 Brodce 46, 257 41 Tunec-nad-sazavou,
 Czech Republic

(111) M 1998 10775 R2
 (156) 15 09 1998
 (186) 15 09 2028
 (732) ILLINOIS TOOL WORKS INC.
 a Delaware corporation
 155 Harlem Avenue, Glenview, Illinois
 60025, USA

(111) M 1998 8533 R2
 (156) 04 03 1998
 (186) 04 03 2028
 (732) MASTERCARD INTERNATIONAL
 INCORPORATED
 2000 Purchase Street, Purchase, New York
 10577-2509, USA

(111) M 1998 10048 R2
 (156) 09 07 1998
 (186) 09 07 2028
 (732) NEC CORPORATION
 7-1, Shiba 5-chome, Minato-ku, Tokyo,
 Japan

(111) M 1998 9641 R2
 (156) 09 06 1998
 (186) 09 06 2028
 (732) COMPAGNIE CHAMPENOISE PH-CH.
 PIPER HEIDSIECK-ANCIENNE MAISON
 HEIDSIECK FONDEE EN 1785

12 Allée du Vignoble, 51100 Reims, France

(111) M 1998 9122 R2
 (156) 30 04 1998
 (186) 30 04 2028
 (732) CARRIER CORPORATION
 One Carrier Place, Farmington, Connecticut
 06034-4015, USA

(111) M 1998 9648 R2
 (156) 09 06 1998
 (186) 09 06 2028
 (732) MLV MARKENZEICHEN-UND LIZEN-
 ZVERWALTUNGS GMBH
 Rosslerstrasse 94, 64293 Darmstadt,
 Germany

(111) M 1998 9266 R2
 (156) 07 05 1998
 (186) 07 05 2028
 (732) WARNER COMMUNICATIONS LLC
 One Time Warner Center, New York, New
 York 10019, USA

(111) M 1998 9671 R2
 (156) 09 06 1998
 (186) 09 06 2028
 (732) BEAM GLOBAL UK LIMITED
 Prewetts Mill, Worthing Road, Horcham,
 West Suisse RH12 1 ST, United Kingdom

(111) M 1998 11235 R2
 (156) 09 12 1998
 (186) 09 12 2028
 (732) INTERPARFUMS S.A.
 4 Rond Point des Champs Elysee, 75008
 Paris, France

(111) M 1998 9563 R2
 (156) 04 06 1998
 (186) 04 06 2028
 (732) JENOPTIK INDUSTRIAL METROLOGY
 FRANCE SA
 14400 Saint-MartIn-des-Entrees, France

(111) M 1998 9409 R2
 (156) 25 05 1998
 (186) 25 05 2028
 (732) XEROX CORPORATION
 201 Merritt 7, Norwalk, Connecticut
 06851-1056, USA

(111) M 1998 9268 R2
(156) 07 05 1998
(186) 07 05 2028
(732) XEROX CORPORATION
201 Merritt 7, Norwalk, Connecticut
06851-1056, USA

(111) M 1998 10445 R2
(156) 20 08 1998
(186) 20 08 2028
(732) INTERNATIONAL FOODSTUFFS CO.
Al-Wahda Street, Industrial Area N1, P.O.
BOX 4115, Sharjah, United Arab Emirates
(511) 30

COMPLETE TRANSFER OF RIGHTS

(111) M 1998 11025 R
(732) SIG COMBIBLOC GMBH
Rurstrasse 58, 52441 Linnich, Germany
(770) SIG COMBIBLOC VERMOGENSVER-
WALTUNGS-GMBH
Rurstrasse 58, D-52441 Linnich, Germany
(580) 2018 09 28

(111) M 2012 22920 R
(732) LTD "Georgian Abrasive Company"
G. Brtskinvales q. 25/ L. Asatianis q. 69-71,
Batumi, Georgia
(770) GRIGOL DIDIA
Tbetis q. 9, b. 22, 6000, Batumi, Georgia
(580) 2018 10 04

CHANGES IN NAMES AND/OR ADDRESSES OF OWNERS

(111) M 1998 10390 R
(732) CHURCH & DWIGHT CO., INC.
(a Delaware corporation)
500 Charles Ewing Boulevard, Ewing,
New Jersey, 08628, USA
(770) CHURCH & DWIGHT CO., INC.
(a Delaware corporation)
500 Charles Ewing Boulevard, Ewing,
New Jersey, 08628, USA
(580) 2018 09 12

(111) M 1998 10396 R
(732) CHURCH & DWIGHT CO., INC.
(a Delaware corporation)
500 Charles Ewing Boulevard, Ewing,
New Jersey, 08628, USA
(770) CHURCH & DWIGHT CO., INC.
(a Delaware corporation)
500 Charles Ewing Boulevard, Ewing,
New Jersey, 08628, USA
(580) 2018 09 12

(111) M 1998 10790 R
(732) SOCIETE DU FIGARO S.A.S.
37 rue du Louvre, 75002 Paris, France
(770) SOCIETE DU FIGARO S.A.
37 rue du Louvre, 75002 Paris, France
(580) 2018 10 16

(111) M 1998 9062 R
(732) SYNGENTA LIMITED
Syngenta Jealott's Hill International Research
Centre, Bracknell, Berkshire RG42 6EY,
United Kingdom
(770) SYNGENTA LIMITED
Syngenta European Regional Centre,
Priestley Road, Surrey Research Park,
Guildford, Surrey GU2 7YH, United
Kingdom
(580) 2018 03 27

(111) M 1998 9975 R
(732) KRAFT FUDS DANMARK
INTELLECTUAL PROPERTY APS
Ringager 2 A, 2.tv. 2605 Brøndby, Denmark
(770) KRAFT FUDS DANMARK
INTELLECTUAL PROPERTY APS
Roskildevej 161, DK-2620 Albertslund,
Denmark
(580) 2018 10 16

(111) M 1999 11942 R
(732) ADVANCE MAGAZINE PUBLISHERS
INC.
One World Trade Center, New York,
NY 10007, USA
(770) ADVANCE MAGAZINE PUBLISHERS
INC.
Four Times Square, New York, New York
10036, USA
(580) 2018 10 15

(111) M 1998 11025 R
(732) SIG COMBIBLOK GMBH
Rurstrasse 58, D-52441 Linnich, Germany
(770) PKL VERPACKUNGSSYSTEME GMBH
Rurstrasse 58, D-52441 Linnich, Germany
(580) 2018 09 28

(111) M 1998 11243 R
(732) WYETH LLC
235 East 42nd Street, New York, NY 10017,
USA
(770) WYETH LLC
Five Giralda Farms, Madison, New Jersey,
07940, USA
(580) 2018 10 03

(111) M 1998 11261 R
(732) WYETH LLC
235 East 42nd Street, New York, NY 10017,
USA
(770) WYETH LLC
Five Giralda Farms, Madison, New Jersey,
07940, USA
(580) 2018 10 03

(111) M 1999 11390 R
(732) WM.WRIGLEY JR.COMPANY
1132 West Blackhawk Street, Chicago,
Illinois 60642, USA
(770) WM.WRIGLEY JR.COMPANY
410 North Michigan Avenue, Chicago,
Illinois 60611, USA
(580) 2018 10 17

(111) M 1999 12737 R
(732) WYETH HOLDINGS LLC
235 East 42nd Street, New York, NY 10017,
USA
(770) WYETH HOLDINGS LLC

Five Giralda Farms, Madison, New Jersey
07940-0874, USA
(580) 2018 10 03

1, Infinite Loop, Cupertino, California 95014
USA
(580) 2018 10 25

(111) M 1999 12738 R
(732) WYETH HOLDINGS LLC
235 East 42nd Street, New York, NY 10017,
USA
(770) WYETH HOLDINGS LLC
Five Giralda Farms, Madison, New Jersey
07940-0874, USA
(580) 2018 10 03

(111) M 1998 10775 R
(732) ILLINOIS TOOL WORKS INC.
a Delaware corporation
155 Harlem Avenue, Glenview, Illinois
60025, USA
(770) ILLINOIS TOOL WORKS INC.
a Delaware corporation
3600 West Lake Avenue, Glenview, Illinois
60026, USA
(580) 2018 10 26

(111) M 2016 26646 R
(732) APPLE INC.
One Apple Park Way, Cupertino, California
95014, USA
(770) APPLE INC.
1 Infinite Loop, Cupertino, California 95014
USA
(580) 2018 10 25

(111) M 1997 7433 R
(732) EFL INK.
One Apple Park Way, Cupertino, California
95014, USA
(770) APPLE INC.
1 Infinite loop, Cupertino, California 95014,
USA
(580) 2018 10 25

(111) M 1998 10191 R
(732) MÄURER & WIRTZ GmbH & Co. KG
Zweifaller Strasse 120,52224 Stolberg,
Germany
(770) MAURER+WIRTZ GMBH & CO., KG.
Zweifaller Strasse 120,52224 Stolberg,
Germany
(580) 2018 10 16

(111) M 1998 10192 R
(732) MÄURER & WIRTZ GmbH & Co. KG
Zweifaller Strasse 120,52224 Stolberg,
Germany
(770) MAURER+WIRTZ GMBH & CO. KG
Zweifaller Strasse 120,52224 Stolberg,
Germany
(580) 2018 10 16

(111) M 2016 27998 R
(732) APPLE INC.
One Apple Park Way, Cupertino, California
95014, USA
(770) APPLE INC.

CHANGE OF THE LIST OF GOODS AND/OR SERVICES
OF TRADEMARKS

(111) M 1998 8966 R
(732) SIGMA LUTIN A.S.
783 50 Lutinen, Czech Republic
(511) 6, 7, 9, 11, 12, 21

(111) M 1998 8967 R
(732) SIGMA LUTIN A.S.
783 50 Lutinen, Czech Republic
(511) 6, 7, 9, 11

(111) M 1998 10565 R
(732) TAKASAGO KORYO KOGYO
KABUSHIKI KAISHA
(also trading as Takasago International
Corporation)
(511) 1, 3, 30

(111) M 1998 10566 R
(732) TAKASAGO KORYO KOGYO
KABUSHIKI KAISHA
(also trading as Takasago International
Corporation)
5-37-1, Kamata, Ota-ku, Tokyo, Japan
(511) 1, 3, 30

CLASSIFICATION INDEXES

INVENTIONS

CONCORDANCE TABLE OF INTERNATIONAL CLASSIFICATION INDEX AND PUBLICATION NUMBERS

INTERNATIONAL CLASSIFICATION INDEXES (51)	NUMBER OF PUBLISHED APPLICATION (10)
A 61 K 31/44; C 07 D 455/02; A 01 N 43/90	AP 2018 14124 A
61 K 31/416; A 61 K 31/4174; A 61 K 45/06; A 61 P 31/10	AP 2018 14557 A
A 61 K 35/10	AP 2018 14212 A
B 26 B 21/24	AP 2018 14619 A
C 07 D 471/04; C 07 D 473/34; C 07 D 473/38; C 07 D 487/04; A 61 K 31/4162; A 61 K 31/52;	AP 2018 14179 A
C 07 D 487/04; A 61 K 31/5025; A 61 K 9/00; A 61 P 11/00; A 61 P 25/00; A 61 P 27/02	AP 2018 14410 A
E 02 B 5/02; E 02 B 3/16	AP 2018 14433 A

CONCORDANCE TABLE OF PUBLICATION NUMBERS AND INTERNATIONAL CLASSIFICATION INDEX

NUMBER OF PUBLISHED APPLICATION (10)	INTERNATIONAL CLASSIFICATION INDEXES (51)
AP 2018 14124 A	A 61 K 31/44; C 07 D 455/02; A 01 N 43/90
AP 2018 14179 A	C 07 D 471/04; C 07 D 473/34; C 07 D 473/38; C 07 D 487/04; A 61 K 31/4162; A 61 K 31/52;
AP 2018 14212 A	A 61 K 35/10
AP 2018 14410 A	C 07 D 487/04; A 61 K 31/5025; A 61 K 9/00; A 61 P 11/00; A 61 P 25/00; A 61 P 27/02
AP 2018 14433 A	E 02 B 5/02; E 02 B 3/16
AP 2018 14557 A	61 K 31/416; A 61 K 31/4174; A 61 K 45/06; A 61 P 31/10
AP 2018 14619 A	B 26 B 21/24

**CONCORDANCE TABLE OF INTERNATIONAL CLASSIFICATION INDEX,
PATENT NUMBERS AND PUBLICATION NUMBERS**

INTERNATIONAL CLASSIFICATION INDEX (51)	NUMBER OF PATENT (11)	NUMBER OF PUBLISHED APPLICATION (10)
A 61 G 5/04	P 2018 6919 B	AP 2018 14258 A
A 61 K 31/444; A 61 K 9/08; A 61 K 47/04; A 61 K 47/12; A 61 K 47/18; A 61 K 47/34; A 61 P 27/02; A 61 P 27/06	P 2018 6916 B	AP 2018 14216 A
A 61 K 31/444; A 61 P 27/02; A 61 P 27/06	P 2018 6917 B	AP 2018 14239 A
A 61 N 2/00; A 61 N 2/02	P 2018 6918 B	AP 2018 14256 A
B 66 B 9/00	P 2018 6926 B	AP 2018 14428 A
C 03 C 25/10, 25/24, 25/50; F 16 D 69/02	P 2018 6924 B	AP 2018 14373 A
C 07 D 401/14; A 61 K 31/454; A 61 P 29/02; A 61 P 37/08	P 2018 6927 B	AP 2018 14455 A
C 07 D 403/12; A 61 K 31/506; A 61 P 25/00	P 2018 6920 B	AP 2018 14286 A
C 07 D 409/14; C 07 D 453/02; A 61 K 31/439; A 61 P 11/00	P 2018 6922 B	AP 2018 14338 A
C 07 D 417/12; A 61 K 31/506; A 61 P 35/00	P 2018 6923 B	AP 2018 14361 A
C 07 D 471/04; C 07 D 487/04; A 61 K 31/4162; A 61 P 35/00;	P 2018 6921 B	AP 2018 14322 A
C 10 J 3/12	P 2018 6915 B	AP 2018 14569 A
G 01 N 23/222; G 01 V 5/00	P 2018 6925 B	AP 2018 14394 A

**CONCORDANCE TABLE OF PATENT NUMBERS,
PUBLICATION NUMBERS AND INTERNATIONAL CLASSIFICATION INDEX**

NUMBER OF PATENT (11)	NUMBER OF PUBLISHED APPLICATION (10)	INTERNATIONAL CLASSIFICATION INDEX (51)
P 2018 6915 B	AP 2018 14569 A	C 10 J 3/12
P 2018 6916 B	AP 2018 14216 A	A 61 K 31/444; A 61 K 9/08; A 61 K 47/04; A 61 K 47/12; A 61 K 47/18; A 61 K 47/34; A 61 P 27/02; A 61 P 27/06
P 2018 6917 B	AP 2018 14239 A	A 61 K 31/444; A 61 P 27/02; A 61 P 27/06
P 2018 6918 B	AP 2018 14256 A	A 61 N 2/00; A 61 N 2/02
P 2018 6919 B	AP 2018 14258 A	A 61 G 5/04
P 2018 6920 B	AP 2018 14286 A	C 07 D 403/12; A 61 K 31/506; A 61 P 25/00
P 2018 6921 B	AP 2018 14322 A	C 07 D 471/04; C 07 D 487/04; A 61 K 31/4162; A 61 P 35/00;
P 2018 6922 B	AP 2018 14338 A	C 07 D 409/14; C 07 D 453/02; A 61 K 31/439; A 61 P 11/00
P 2018 6923 B	AP 2018 14361 A	C 07 D 417/12; A 61 K 31/506; A 61 P 35/00
P 2018 6924 B	AP 2018 14373 A	C 03 C 25/10, 25/24, 25/50; F 16 D 69/02
P 2018 6925 B	AP 2018 14394 A	G 01 N 23/222; G 01 V 5/00
P 2018 6926 B	AP 2018 14428 A	B 66 B 9/00
P 2018 6927 B	AP 2018 14455 A	C 07 D 401/14; A 61 K 31/454; A 61 P 29/02; A 61 P 37/08

**CONCORDANCE TABLE OF APPLICATION NUMBERS, PUBLICATION NUMBERS
AND PATENTS**

NUMBER OF APPLICATION (21)	NUMBER OF PUBLISHED APPLICATION (10)	NUMBER OF PATENT (11)
AP 2015 14216	AP 2018 14216 A	P 2018 6916 B
AP 2015 14239	AP 2018 14239 A	P 2018 6917 B
AP 2016 14256	AP 2018 14256 A	P 2018 6918 B
AP 2016 14258	AP 2018 14258 A	P 2018 6919 B
AP 2015 14286	AP 2018 14286 A	P 2018 6920 B
AP 2015 14322	AP 2018 14322 A	P 2018 6921 B
AP 2015 14338	AP 2018 14338 A	P 2018 6922 B
AP 2015 14361	AP 2018 14361 A	P 2018 6923 B
AP 2016 14373	AP 2018 14373 A	P 2018 6924 B
AP 2015 14394	AP 2018 14394 A	P 2018 6925 B
AP 2017 14428	AP 2018 14428 A	P 2018 6926 B
AP 2015 14455	AP 2018 14455 A	P 2018 6927 B
AP 2017 14569	AP 2018 14569 A	P 2018 6915 B

UTILITY MODEL

**CONCORDANCE TABLE OF INTERNATIONAL CLASSIFICATION INDEX
AND PUBLICATION NUMBERS**

INTERNATIONAL CLASSIFICATION INDEXES (51)	NUMBER OF PUBLISHED APPLICATION (10)
F 24 D 19/00; F 24 H 9/00	AU 2018 14602 U

**CONCORDANCE TABLE OF PUBLICATION NUMBERS
AND INTERNATIONAL CLASSIFICATION INDEX**

NUMBER OF PUBLISHED APPLICATION (10)	INTERNATIONAL CLASSIFICATION INDEXES (51)
AU 2018 14602 U	F 24 D 19/00; F 24 H 9/00

**CONCORDANCE TABLE OF INTERNATIONAL CLASSIFICATION INDEX,
PATENT NUMBERS AND PUBLICATION NUMBERS**

INTERNATIONAL CLASSIFICATION INDEX (51)	NUMBER OF PATENT (11)	NUMBER OF PUBLISHED APPLICATION (10)
A 47 K 10/38	U 2018 1992 Y	AU 2018 14170 U
A 61 K 35/50, 47/46	U 2018 1991 Y	AU 2018 14053 U
A 61 K 35/76	U 2018 1990 Y	AU 2018 14570 U
C 09 D 5/18, 1/00	U 2018 1993 Y	AU 2018 14285 U

**CONCORDANCE TABLE OF PATENT NUMBERS,
PUBLICATION NUMBERS AND INTERNATIONAL CLASSIFICATION INDEX**

NUMBER OF PATENT (11)	NUMBER OF PUBLISHED APPLICATION (10)	INTERNATIONAL CLASSIFICATION INDEX (51)
U 2018 1990 Y	AU 2018 14570 U	A 61 K 35/76
U 2018 1991 Y	AU 2018 14053 U	A 61 K 35/50, 47/46
U 2018 1992 Y	AU 2018 14170 U	A 47 K 10/38
U 2018 1993 Y	AU 2018 14285 U	C 09 D 5/18, 1/00

**CONCORDANCE TABLE OF APPLICATION NUMBERS, PUBLICATION NUMBERS
AND PATENTS**

NUMBER OF APPLICATION (21)	NUMBER OF PUBLISHED APPLICATION (10)	NUMBER OF PATENT (11)
AU 2016 14053	AU 2018 14053 U	U 2018 1991 Y
AU 2014 14170	AU 2018 14170 U	U 2018 1992 Y
AU 2016 14285	AU 2018 14285 U	U 2018 1993 Y
AU 2017 14570	AU 2018 14570 U	U 2018 1990 Y

DESIGNS

**CONCORDANCE TABLE OF INTERNATIONAL CLASSIFICATION INDEX,
PATENT NUMBERS AND PUBLICATION NUMBERS**

INTERNATIONAL CLASSIFICATION INDEX (51)	NUMBER OF PATENT (11)	NUMBER OF PUBLISHED APPLICATION (10)
02-03	D 2018 783 S	AD 2018 1019 S
09-02	D 2018 780 S	AD 2018 1002 S
11-01	D 2018 782 S	AD 2018 1018 S
13-03	D 2018 781 S	AD 2018 1014 S
21-01	D 2018 779 S	AD 2018 1030 S

**CONCORDANCE TABLE OF PATENT NUMBERS,
PUBLICATION NUMBERS AND INTERNATIONAL CLASSIFICATION INDEX**

NUMBER OF PATENT (11)	NUMBER OF PUBLISHED APPLICATION (10)	INTERNATIONAL CLASSIFICATION INDEX (51)
D 2018 779 S	AD 2018 1030 S	21-01
D 2018 780 S	AD 2018 1002 S	09-02
D 2018 781 S	AD 2018 1014 S	13-03
D 2018 782 S	AD 2018 1018 S	11-01
D 2018 783 S	AD 2018 1019 S	02-03

CONCORDANCE TABLE OF APPLICATION NUMBERS, PUBLICATION NUMBERS
AND PATENTS

NUMBER OF APPLICATION (21)	NUMBER OF PUBLISHED APPLICATION (10)	NUMBER OF PATENT (11)
AD 2017 1002	AD 2018 1002 S	D 2018 780 S
AD 2018 1014	AD 2018 1014 S	D 2018 781 S
AD 2018 1018	AD 2018 1018 S	D 2018 782 S
AD 2018 1019	AD 2018 1019 S	D 2018 783 S
AD 2018 1030	AD 2018 1030 S	D 2018 779 S

TRADEMARKS

CONCORDANCE TABLE OF REGISTRATION NUMBERS, APPLICATION NUMBERS,
PUBLICATION NUMBERS AND BULLETIN NUMBERS

NUMBER OF REGISTRATION (111)	NUMBER OF APPLICATIONS (210)	NUMBER OF PUBLISHED APPLICATIONS (260)	NUMBER OF BULLETIN
M 2018 30333 R	AM 92481	AM 2018 92481 A	12(496)2018
M 2018 30334 R	AM 92586	AM 2018 92586 A	12(496)2018
M 2018 30335 R	AM 93054	AM 2018 93054 A	7(491) 2018
M 2018 30336 R	AM 93531	AM 2018 93531 A	10(494)2018
M 2018 30337 R	AM 93556	AM 2018 93556 A	7(491)2018
M 2018 30338 R	AM 93834	AM 2018 93834 A	12(496)2018
M 2018 30339 R	AM 93835	AM 2018 93835 A	12(496)2018
M 2018 30340 R	AM 93836	AM 2018 93836 A	12(496)2018
M 2018 30341 R	AM 94547	AM 2018 94547 A	12(496)2018
M 2018 30342 R	AM 94577	AM 2018 94577 A	12(496)2018
M 2018 30343 R	AM 94926	AM 2018 94926 A	13(497)2018
M 2018 30344 R	AM 95066	AM 2018 95066 A	13(497)2018
M 2018 30345 R	AM 95346	AM 2018 95346 A	13(497)2018
M 2018 30346 R	AM 95347	AM 2018 95347 A	13(497)2018
M 2018 30347 R	AM 95348	AM 2018 95348 A	13(497)2018
M 2018 30348 R	AM 95349	AM 2018 95349 A	13(497)2018
M 2018 30349 R	AM 95350	AM 2018 95350 A	13(497)2018
M 2018 30350 R	AM 95352	AM 2018 95352 A	13(497)2018
M 2018 30351 R	AM 95554	AM 2018 95554 A	13(497)2018
M 2018 30352 R	AM 90882	AM 2018 90882 A	11(495)2018
M 2018 30353 R	AM 92050	AM 2018 92050 A	7(491)2018
M 2018 30354 R	AM 99646	-	21(505)2018
M 2018 30355 R	AM 99647	-	21(505)2018
M 2018 30356 R	AM 99648	-	21(505)2018
M 2018 30357 R	AM 97998	-	21(505)2018
M 2018 30358 R	AM 99866	-	21(505)2018
M 2018 30359 R	AM 99781	-	21(505)2018
M 2018 30360 R	AM 99782	-	21(505)2018
M 2018 30361 R	AM 99790	-	21(505)2018
M 2018 30362 R	AM 99791	-	21(505)2018
M 2018 30363 R	AM 99793	-	21(505)2018
M 2018 30364 R	AM 99794	-	21(505)2018
M 2018 30365 R	AM 99796	-	21(505)2018
M 2018 30366 R	AM 99797	-	21(505)2018
M 2018 30367 R	AM 99873	-	21(505)2018
M 2018 30368 R	AM 99874	-	21(505)2018
M 2018 30369 R	AM 99875	-	21(505)2018
M 2018 30370 R	AM 99877	-	21(505)2018
M 2018 30371 R	AM 99878	-	21(505)2018
M 2018 30372 R	AM 99879	-	21(505)2018
M 2018 30373 R	AM 99880	-	21(505)2018
M 2018 30374 R	AM 99881	-	21(505)2018
M 2018 30375 R	AM 99882	-	21(505)2018
M 2018 30376 R	AM 99889	-	21(505)2018
M 2018 30377 R	AM 100045	-	21(505)2018
M 2018 30378 R	AM 100007	-	21(505)2018
M 2018 30379 R	AM 99867	-	21(505)2018
M 2018 30380 R	AM 99435	-	21(505)2018
M 2018 30381 R	AM 99436	-	21(505)2018

CONCORDANCE TABLE OF PUBLICATION NUMBERS
AND APPLICATION NUMBERS

NUMBER OF PUBLISHED APPLICATION (260)	NUMBER OF APPLICATION (210)	1	2
1	2		
AM 2018 87187 A*	AM 87187	AM 2018 96841 A	AM 96841
AM 2018 87189 A*	AM 87189	AM 2018 96863 A	AM 96863
AM 2018 92380 A	AM 92380	AM 2018 96867 A	AM 96867
AM 2018 92452 A*	AM 92452	AM 2018 96868 A	AM 96868
AM 2018 92994 A	AM 92994	AM 2018 96886 A	AM 96886
AM 2018 93532 A	AM 93532	AM 2018 96887 A	AM 96887
AM 2018 93707 A	AM 93707	AM 2018 96888 A	AM 96888
AM 2018 94716 A	AM 94716	AM 2018 96905 A	AM 96905
AM 2018 94928 A	AM 94928	AM 2018 96916 A	AM 96916
AM 2018 95172 A	AM 95172	AM 2018 96919 A	AM 96919
AM 2018 95173 A	AM 95173	AM 2018 96971 A	AM 96971
AM 2018 95360 A	AM 95360	AM 2018 96974 A	AM 96974
AM 2018 95408 A	AM 95408	AM 2018 96975 A	AM 96975
AM 2018 96167 A	AM 96167	AM 2018 96976 A	AM 96976
AM 2018 96168 A	AM 96168	AM 2018 97001 A	AM 97001
AM 2018 96679 A	AM 96679	AM 2018 97003 A	AM 97003
AM 2018 96709 A	AM 96709	AM 2018 97005 A	AM 97005
AM 2018 96710 A	AM 96710	AM 2018 97013 A	AM 97013
AM 2018 96732 A	AM 96732	AM 2018 97020 A	AM 97020
AM 2018 96733 A	AM 96733	AM 2018 97023 A	AM 97023
AM 2018 96734 A	AM 96734	AM 2018 97024 A	AM 97024
AM 2018 96763 A	AM 96763	AM 2018 97063 A	AM 97063
AM 2018 96764 A	AM 96764	AM 2018 97070 A	AM 97070
AM 2018 96766 A	AM 96766	AM 2018 97074 A	AM 97074
AM 2018 96767 A	AM 96767	AM 2018 97164 A	AM 97164
AM 2018 96770 A	AM 96770	AM 2018 97165 A	AM 97165
AM 2018 96810 A	AM 96810	AM 2018 97193 A	AM 97193
AM 2018 96811 A	AM 96811	AM 2018 97195 A	AM 97195
AM 2018 96817 A	AM 96817	AM 2018 97197 A	AM 97197
		AM 2018 97216 A	AM 97216
		AM 2018 97226 A	AM 97226
		AM 2018 97233 A	AM 97233
		AM 2018 97369 A	AM 97369
		AM 2018 97371 A	AM 97371

CONCORDANCE TABLE OF INDEX OF GOODS AND/OR SERVICES
AND APPLICATION NUMBERS

INDEX OF GOODS AND/OR SERVICES (511)	NUMBER OF PUBLISHED APPLICATIONS (26)	1	2
1	2	9	AM 2018 95360 A
1	AM 2018 96167 A	9	AM 2018 96167 A
1	AM 2018 96168 A	9	AM 2018 96168 A
1	AM 2018 96841 A	9	AM 2018 96811 A
1	AM 2018 97003 A	9	AM 2018 96976 A
2	AM 2018 96167 A	9	AM 2018 97003 A
2	AM 2018 96168 A	10	AM 2018 96167 A
2	AM 2018 97003 A	10	AM 2018 96168 A
3	AM 2018 96167 A	10	AM 2018 97003 A
3	AM 2018 96168 A	11	AM 2018 96167 A
3	AM 2018 96710 A	11	AM 2018 96168 A
3	AM 2018 96733 A	11	AM 2018 96889 A
3	AM 2018 96817 A	11	AM 2018 97369 A
3	AM 2018 96976 A	12	AM 2018 96167 A
3	AM 2018 97003 A	12	AM 2018 96168 A
4	AM 2018 96167 A	12	AM 2018 97003 A
4	AM 2018 96168 A	13	AM 2018 96167 A
4	AM 2018 97003 A	13	AM 2018 96168 A
5	AM 2018 87187 A*	13	AM 2018 97003 A
5	AM 2018 87189 A*	14	AM 2018 96167 A
5	AM 2018 92380 A	14	AM 2018 96168 A
5	AM 2018 92994 A	14	AM 2018 96679 A
5	AM 2018 96167 A	14	AM 2018 96976 A
5	AM 2018 96168 A	14	AM 2018 97003 A
5	AM 2018 96709 A	15	AM 2018 96167 A
5	AM 2018 96732 A	15	AM 2018 96168 A
5	AM 2018 96734 A	15	AM 2018 97003 A
5	AM 2018 96886 A	16	AM 2018 96167 A
5	AM 2018 96887 A	16	AM 2018 96168 A
5	AM 2018 96888 A	16	AM 2018 96976 A
5	AM 2018 96916 A	16	AM 2018 97003 A
5	AM 2018 97003 A	17	AM 2018 96167 A
5	AM 2018 97013 A	17	AM 2018 96168 A
5	AM 2018 97020 A	17	AM 2018 97003 A
5	AM 2018 97023 A	18	AM 2018 96167 A
5	AM 2018 97063 A	18	AM 2018 96168 A
5	AM 2018 97070 A	18	AM 2018 96679 A
5	AM 2018 97074 A	18	AM 2018 96976 A
5	AM 2018 97193 A	18	AM 2018 97003 A
5	AM 2018 97233 A	19	AM 2018 96167 A
6	AM 2018 96167 A	19	AM 2018 96168 A
6	AM 2018 96168 A	19	AM 2018 97003 A
6	AM 2018 97003 A	20	AM 2018 96167 A
7	AM 2018 96167 A	20	AM 2018 96168 A
7	AM 2018 96168 A	20	AM 2018 96976 A
7	AM 2018 97003 A	21	AM 2018 97003 A
8	AM 2018 96167 A	21	AM 2018 96167 A
8	AM 2018 96168 A	21	AM 2018 96168 A
8	AM 2018 97003 A	21	AM 2018 96976 A
		21	AM 2018 97003 A
		22	AM 2018 96167 A
		22	AM 2018 96168 A
		22	AM 2018 97003 A

1	2
23	AM 2018 96167 A
23	AM 2018 96168 A
23	AM 2018 97003 A
24	AM 2018 96167 A
24	AM 2018 96168 A
24	AM 2018 97003 A
24	AM 2018 97164 A
25	AM 2018 96167 A
25	AM 2018 96168 A
25	AM 2018 96679 A
25	AM 2018 96810 A
25	AM 2018 96976 A
25	AM 2018 97003 A
25	AM 2018 97165 A
26	AM 2018 96167 A
26	AM 2018 96168 A
26	AM 2018 97003 A
26	AM 2018 97164 A
26	AM 2018 97165 A
27	AM 2018 96167 A
27	AM 2018 96168 A
27	AM 2018 97003 A
28	AM 2018 96167 A
28	AM 2018 96168 A
28	AM 2018 96976 A
28	AM 2018 97003 A
29	AM 2018 93532 A
29	AM 2018 96167 A
29	AM 2018 96168 A
29	AM 2018 97003 A
29	AM 2018 97197 A
30	AM 2018 92452 A*
30	AM 2018 93532 A
30	AM 2018 96167 A
30	AM 2018 96168 A
30	AM 2018 96974 A
30	AM 2018 96975 A
30	AM 2018 96976 A
30	AM 2018 97003 A
31	AM 2018 96167 A
31	AM 2018 97003 A
32	AM 2018 93532 A
32	AM 2018 96167 A
32	AM 2018 96168 A
32	AM 2018 96763 A
32	AM 2018 96767 A
32	AM 2018 96976 A
32	AM 2018 97003 A
32	AM 2018 97216 A
33	AM 2018 95172 A
33	AM 2018 95173 A
33	AM 2018 97003 A
33	AM 2018 97195 A
34	AM 2018 96167 A
34	AM 2018 96168 A
34	AM 2018 96868 A

1	2
34	AM 2018 96905 A
34	AM 2018 96919 A
34	AM 2018 96971 A
34	AM 2018 97003 A
35	AM 2018 93532 A
35	AM 2018 94928 A
35	AM 2018 96167 A
35	AM 2018 96168 A
35	AM 2018 96710 A
35	AM 2018 96817 A
35	AM 2018 97003 A
35	AM 2018 97005 A
35	AM 2018 97165 A
35	AM 2018 97371 A
36	AM 2018 96167 A
36	AM 2018 96168 A
36	AM 2018 96766 A
36	AM 2018 96770 A
36	AM 2018 96867 A
36	AM 2018 97001 A
36	AM 2018 97003 A
36	AM 2018 97024 A
37	AM 2018 96167 A
37	AM 2018 96168 A
37	AM 2018 97001 A
37	AM 2018 97003 A
37	AM 2018 97369 A
38	AM 2018 96167 A
38	AM 2018 96168 A
38	AM 2018 97003 A
39	AM 2018 96167 A
39	AM 2018 96168 A
39	AM 2018 97001 A
39	AM 2018 97003 A
39	AM 2018 97164 A
40	AM 2018 96167 A
40	AM 2018 96168 A
40	AM 2018 97003 A
40	AM 2018 97164 A
41	AM 2018 94716 A
41	AM 2018 94928 A
41	AM 2018 95360 A
41	AM 2018 95408 A
41	AM 2018 96167 A
41	AM 2018 96168 A
41	AM 2018 96976 A
41	AM 2018 97003 A
42	AM 2018 96167 A
42	AM 2018 96168 A
42	AM 2018 96764 A
42	AM 2018 96766 A
42	AM 2018 96770 A
42	AM 2018 96976 A
42	AM 2018 97003 A
42	AM 2018 97369 A
43	AM 2018 93532 A

1	2
43	AM 2018 93707 A
43	AM 2018 96167 A
43	AM 2018 96168 A
43	AM 2018 96863 A
43	AM 2018 96976 A
43	AM 2018 97001 A
43	AM 2018 97003 A
43	AM 2018 97024 A
44	AM 2018 96167 A

1	2
44	AM 2018 96168 A
44	AM 2018 97003 A
44	AM 2018 97226 A
45	AM 2018 94716 A
45	AM 2018 95408 A
45	AM 2018 96167 A
45	AM 2018 96168 A
45	AM 2018 97003 A

CONCORDANCE TABLE OF INDEX OF GOODS AND/OR SERVICES
AND NUMBERS OF TRADEMARKS REGISTERED ACCORDING
TO THE ACCELERATED PROCEDURE

INDEX OF GOODS AND/OR SERVICES (511)	NUMBER OF REGISTERED ACCORDING TO THE ACCELERATED PROCEDURE (111)
1	2
4	M 2018 30355 R
5	M 2018 30358 R
9	M 2018 30357 R
9	M 2018 30367 R
9	M 2018 30368 R
9	M 2018 30369 R
9	M 2018 30370 R
9	M 2018 30371 R
9	M 2018 30372 R
9	M 2018 30373 R
9	M 2018 30374 R
9	M 2018 30375 R
12	M 2018 30355 R
12	M 2018 30356 R
16	M 2018 30367 R
16	M 2018 30368 R
16	M 2018 30369 R
16	M 2018 30370 R
16	M 2018 30371 R
16	M 2018 30372 R
16	M 2018 30373 R
16	M 2018 30374 R
16	M 2018 30375 R
18	M 2018 30367 R
18	M 2018 30368 R
18	M 2018 30369 R
18	M 2018 30370 R
18	M 2018 30371 R
18	M 2018 30372 R
18	M 2018 30373 R
18	M 2018 30374 R
18	M 2018 30375 R
25	M 2018 30367 R
25	M 2018 30368 R

1	2
25	M 2018 30369 R
25	M 2018 30370 R
25	M 2018 30371 R
25	M 2018 30372 R
25	M 2018 30373 R
25	M 2018 30374 R
25	M 2018 30375 R
30	M 2018 30379 R
33	M 2018 30361 R
33	M 2018 30362 R
33	M 2018 30363 R
33	M 2018 30364 R
33	M 2018 30365 R
33	M 2018 30366 R
35	M 2018 30361 R
35	M 2018 30362 R
35	M 2018 30363 R
35	M 2018 30364 R
35	M 2018 30365 R
35	M 2018 30366 R
35	M 2018 30367 R
35	M 2018 30368 R
35	M 2018 30369 R
35	M 2018 30370 R
35	M 2018 30371 R
35	M 2018 30372 R
35	M 2018 30373 R
35	M 2018 30374 R
35	M 2018 30375 R
36	M 2018 30359 R
36	M 2018 30360 R
36	M 2018 30361 R
36	M 2018 30362 R
36	M 2018 30363 R
36	M 2018 30364 R
36	M 2018 30365 R
36	M 2018 30366 R
36	M 2018 30367 R
36	M 2018 30368 R

1	2	1	2
36	M 2018 30369 R	41	M 2018 30368 R
36	M 2018 30370 R	41	M 2018 30369 R
36	M 2018 30371 R	41	M 2018 30370 R
36	M 2018 30372 R	41	M 2018 30371 R
36	M 2018 30373 R	41	M 2018 30372 R
36	M 2018 30374 R	41	M 2018 30373 R
36	M 2018 30375 R	41	M 2018 30374 R
36	M 2018 30376 R	41	M 2018 30375 R
37	M 2018 30354 R	41	M 2018 30380 R
37	M 2018 30359 R	41	M 2018 30381 R
37	M 2018 30360 R	42	M 2018 30357 R
37	M 2018 30361 R	42	M 2018 30367 R
37	M 2018 30362 R	42	M 2018 30368 R
37	M 2018 30363 R	42	M 2018 30369 R
37	M 2018 30364 R	42	M 2018 30370 R
37	M 2018 30365 R	42	M 2018 30371 R
37	M 2018 30366 R	42	M 2018 30372 R
37	M 2018 30367 R	42	M 2018 30373 R
37	M 2018 30368 R	42	M 2018 30374 R
37	M 2018 30369 R	42	M 2018 30375 R
37	M 2018 30370 R	43	M 2018 30361 R
37	M 2018 30371 R	43	M 2018 30362 R
37	M 2018 30372 R	43	M 2018 30363 R
37	M 2018 30373 R	43	M 2018 30364 R
37	M 2018 30374 R	43	M 2018 30365 R
37	M 2018 30375 R	43	M 2018 30366 R
38	M 2018 30367 R	43	M 2018 30377 R
38	M 2018 30368 R	43	M 2018 30380 R
38	M 2018 30369 R	43	M 2018 30381 R
38	M 2018 30370 R	44	M 2018 30367 R
38	M 2018 30371 R	44	M 2018 30368 R
38	M 2018 30372 R	44	M 2018 30369 R
38	M 2018 30373 R	44	M 2018 30370 R
38	M 2018 30374 R	44	M 2018 30371 R
38	M 2018 30375 R	44	M 2018 30372 R
39	M 2018 30380 R	44	M 2018 30373 R
39	M 2018 30381 R	44	M 2018 30374 R
41	M 2018 30357 R	44	M 2018 30375 R
41	M 2018 30367 R	44	M 2018 30378 R

OFFICIAL BULLETIN OF THE INDUSTRIAL PROPERTY

**INVENTIONS
UTILITY MODELS
DESIGNS
TRADEMARKS**

APPELLATIONS OF ORIGIN AND GEOGRAPHICAL INDICATIONS OF GOODS

21(505)

EDITOR-IN-CHIEF: N. Bebrishvili

EDITOR-TRANSLATOR: E. Gabunia

PROOFREADER: A. Shikhashvili

COMPUTER LAYOUT: M. Ordenidze
K. Svanidze

www.sakpatenti.gov.ge
E-mail: info@sakpatenti.org.ge