

Official Bulletin of the Industrial Property

Inventions

Utility Models

Designs

Trademarks

Appellation of Origin of Goods



საქართველოს ინტელექტუალური
საკუთრების ეროვნული ცენტრი

საქპატენტი

SAKPATENTI

NATIONAL INTELLECTUAL PROPERTY
CENTER OF GEORGIA

www.sakpatenti.gov.ge

Date of Publication – 2023 11 10

21(624)

INID CODES FOR IDENTIFICATION OF BIBLIOGRAPHIC DATA

INVENTIONS, UTILITY MODELS

- (10) Number of publication of examined application/
Application publication number***
- (11) Patent number/ Patent number***
Registered utility model number***
- (21) Application number
- (22) Date of filing of the application
- (23) Date of exhibition priority
- (24) Date from which patent may have effect
- (31) Number of priority application
- (32) Date of filing of priority application
- (33) Code of the country or regional organization allotting application number
- (43) Date of publication of application, number of bulletin***
- (44) Date of publication of examined application, on which no grant has taken place and number of bulletin
- (45) Date of publication of patent/ Date of publication of patent***
Date of publication of registered utility model***
- (51) International Patent Classification Index
- (54) Title of the invention/title of the utility model
- (57) Abstract
- (60) Number of examined patent document granted by foreign patent office, date from which patent has effect and country code
- (62) Number and filing date of the earlier application in case of a divisional application
- (71) Name and address of applicant (country code)
- (72) Name of inventor (country code)
- (73) Name and address of patent owner/patent owner***/ registered utility model owner*** (country code)
- (74) Name of representative or patent attorney
- (85) Date of commencement of the national phase of international application (PCT)
- (86) Number and date of filing of international application (PCT)
- (87) Number and date of publication of international application (PCT)
- (94) Calculated date of expiry of the SPC or the duration of the SPC

DESIGNS

- (10) Number of publication for application
- (11) Number of patent and kind of document or number of registration
- (15) Date of registration/Date of patent renewal
- (18) Expected expiration date of patent or registration
- (21) Serial number of application
- (22) Date of filing of the application
- (23) Date of exhibition or the date of the earlier filing and the number of application, if any
- (24) Date from which patent may have effect
- (28) Number of designs included in the application
- (30) Data relating to priority (number of application, date of filing of application, two-letter code identifying the authority with whom the priority application was made)
- (31) Number of priority application
- (32) Date of filing of priority application
- (33) Code of the country or regional organization allotting priority application number
- (34) Two-letter code according to WIPO St.3 identifying the authority with which the priority application was made
- (44) Date of publication of design and number of bulletin (the first publication)
- (45) Date of publication of design registered by WIPO and number of bulletin
- (51) International Classification for designs (class and subclass of the Locarno Classification)
- (54) Title of the invention
- (55) Reproduction of the design
- (57) Description of characteristic features of the design including indication of colors
- (58) Date of recording of any kind of amendment in the Register
- (62) Number of the earlier application, registration and document number and if available the date of filing an application in case of divided application
- (71) Name, surname and address of applicant (country code)
- (72) Name, surname of creator (country code)
- (73) Name, surname and address of patent owner (country code)
- (74) Name, surname of representative or patent attorney
- (81) Contracting states concerned
II designated contracting states according to the 1960 Act
III designated contracting states according to the 1999 Act
- (85) Owner's permanent address
- (86) Owner's nationality
- (87) Owner's residence
- (88) State in which the owner has a real and effective industrial or commercial establishment

TRADEMARKS

- (111) – Number of registration
- (151) – Date of registration
- (156) – Date of the renewal
- (181) – Expected expiration date of registration
- (186) – Renewal expiration date of registration
- (141) – Date of cancel of duration of the mark
- (210) – Serial number of application
- (220) – Date of filing of the application
- (230) – Data concerning exhibition
- (260) – Number of application, for which favorable decision of examination about registration has been taken (publication number)
- (310) – Number of the first application
- (320) – Date of filing of the first application
- (330) – Code, identifying national or regional Office where the first application was made
- (511) – International Classification of Goods and Services for the purposes of registration of trade marks and/or list of goods and/or services classified according thereto
- (526) – Disclaimer
- (531) – Description of figurative elements of Trade Marks according to the International Classification of the Figurative Elements of Marks
- (540) – Reproduction of Trade Mark
- (550) – Nature and kind of Trade Mark
- (551) – Indication to the effect that the mark is a collective mark, a certification mark or a guarantee mark
- (554) – Three-dimensional mark
- (580) – Date of recording of any kind changes in respect of applications or registrations
- (591) – Information concerning colors claimed
- (731) – Name and address of the applicant
- (732) – Name and address of the holder of the registration
- (740) – Name and address of the representative
- (750) – Addreses for correspondence
- (770) – Name and address of the previous applicant or holder in case of change in ownership
- (771) – Previous name and address of the applicant or holder in case of change in ownership
- (791) – Name and address of the licensee
- (793) – Indication of conditions and/or restrictions under the license (Type of license, number of license agreement, data of license, data of validity of license)
- (800) – Certain data relating to the international registration of Trade Marks under the Protocol Relating to Madrid Agreement (International registration number
- (852) – Partial cancellation of the list of goods and services
- (891) – Date of subsequent designation

CODES FOR PUBLICATION IN BULLETIN

- (21) AP 0000 000000 – number of application for invention
- (10) AP 0000 0000 A – number of publication of application for invention
- (11) P 0000 0000 B – number of patent for invention/ patent number***
- (21) API 0000 000000 – number of application for imported patent
- (11) PI 0000 0000 A – number of imported patent
- (21) AU 0000 000000 – number of application for utility model
- (10) AU 0000 000 U – number of publication of application for utility model
- (11) U 0000 000 Y – number of patent for utility model/ registered utility model number***
- (21) AD 0000 000000 – serial number of application for design
- (10) AD 0000 000 S – number of published application for design (first publication)
- (11) D 0000 000 S – registered design

INTERNATIONAL PATENT CLASSIFICATION FOR INVENTIONS AND UTILITY MODELS

- SECTION A – HUMAN NECESSITIES
- SECTION B – PERFORMING OPERATIONS; TRANSPORTING
- SECTION C – CHEMISTRY; METALLURGY
- SECTION D – TEXTILES; PAPER
- SECTION E – FIXED CONSTRUCTIONS
- SECTION F – MECHANICAL ENGINEERING; LIGHTING; HEATING; WEAPONS; BLASTING
- SECTION G – PHYSICS
- SECTION H – ELECTRICITY

* Number of application published after the decision of Appellation Chamber of SAKPATENTI

** Number of application published after Court decision

*** Materials published according to the amendments of May 16, 2023 (No. 2883-XI0b-X03) to the Patent Law of Georgia

- M – Trade Mark
- (210) AM 0000 000000 – Serial number of application;
- (260) AAM 0000 00000 A – Publication number of application;
- (111) M 0000 00000 R – Number of registration;
- (111) MMM0000 00000 Rn – Number of renewals, in which n=1,2,3;
- (111) M 0000 00000 R(P) – Number of registration under partial assignment of rights

Official Bulletin of the Industrial Property

Inventions

Utility Models

Designs

Trademarks

Appellation of Origin of Goods

CONTENT

PUBLISHED TITLES OF PROTECTION	3
INVENTIONS	
▪ APPLICATIONS APPROVED FOR GRANTING PATENT	4
▪ PATENTED INVENTIONS	6
▪ APPLICATIONS***	7
UTILITY MODELS	
▪ PATENTED UTILITY MODEL	9
DESIGNS	
▪ APPLICATION APPROVED FOR REGISTRATION	10
▪ DESIGN REGISTERED ACCORDING TO THE ACCELERATED PROCEDURE	14
▪ DESIGNS, WHICH HAVE BEEN REGISTERED WITH THE INTERNATIONAL BUREAU CLAIMING PRIORITY ON THE TERRITORY OF GEORGIA	19
TRADEMARKS	
▪ APPLICATIONS FILED UNDER THE NATIONAL PROCEDURE APPROVED FOR REGISTRATION	38
▪ REGISTERED TRADEMARKS	45
▪ TRADEMARKS REGISTERED ACCORDING TO THE ACCELERATED PROCEDURE	49
▪ INTERNATIONAL TRADEMARKS FOR WHICH A DECISION ON GRANTING PROTECTION IS TAKEN	52
▪ INTERNATIONAL TRADEMARKS PROTECTED IN GEORGIA	123
APPELLATION OF ORIGIN OF GOODS	
APPELLATION OF ORIGIN OF GOODS FILED IN GEORGIA FOR EXAMINATION UNDER LISBON AGREEMENT, ON THE BASIS OF THE INTERNATIONAL REGISTRATION.....	141
OFFICIAL NOTIFICATION	
INVENTIONS	
▪ RESTORATION OF PATENTS	142
▪ LAPSE OF PATENTS WITH THE RIGHT TO RESTORE	142
▪ EXPIRATION OF PATENTS RESTORATION TERM	144
▪ EXPIRATION OF PATENT	144
▪ TRANSFER OF RIGHT	145
UTILITY MODELS	
▪ RESTORATION OF PATENT	145
▪ LAPSE OF PATENTS WITH THE RIGHT TO RESTORE	145
▪ EXPIRATION OF PATENTS RESTORATION TERM	146
DESIGNS	
▪ EXTENSION OF TERM OF DESIGN REGISTRATION	146
▪ CANCELLATION OF DESIGN REGISTRATION	146
▪ CANCELLATION OF INTERNATIONAL DESIGNS REGISTRATION	147
TRADEMARKS	
▪ EXTENSION OF TERM OF TRADEMARKS REGISTRATION	153
▪ COMPLETE TRANSFER OF RIGHTS	155
▪ CHANGES OF NAME AND/OR ADDRESS OF TRADEMARKS OWNERS	157
▪ CANCELLATION OF TRADEMARKS REGISTRATION	159
CLASSIFICATION INDEXES	
INVENTIONS	161
UTILITY MODELS	163
DESIGNS	163
TRADEMARKS	165

PUBLISHED TITLES OF PROTECTION

INVENTIONS

- **APPLICATIONS APPROVED FOR GRANTING PATENT:**
15827; 16018; 15577; 15809
- **PATENTED INVENTIONS:**
7564-7566
- **APPLICATIONS:*****
16334; 16345; 16357

UTILITY MODELS

- PATENTED UTILITY MODEL:**
2158

DESIGNS

- **APPLICATION APPROVED FOR REGISTRATION:**
1319
- **DESIGN REGISTERED ACCORDING TO THE ACCELERATED PROCEDURE:**
982
- **DESIGNS, WHICH HAVE BEEN REGISTERED WITH THE INTERNATIONAL BUREAU CLAIMING PRIORITY ON THE TERRITORY OF GEORGIA:**
230711; 226980; 230681; 227036; 230758; 230872-230874; 230928; 227186; 227356; 227483

TRADEMARKS

- **APPLICATIONS FILED UNDER THE NATIONAL PROCEDURE APPROVED FOR REGISTRATION:**
119370; 121538; 121733; 121901, 121902; 121909; 121917; 121936; 122008; 122016; 122023; 122025; 122041; 122135; 122197, 122198; 122205; 122212; 122224; 122282; 122295; 122386; 122389; 122404-122406; 122412; 122420, 122421; 122423; 122425-122428; 122500; 122567; 122574, 122575; 122649
- **REGISTERED TRADEMARKS:**
37425-37441; 37447-37468; 37471-37478
- **TRADEMARKS REGISTERED ACCORDING TO THE ACCELERATED PROCEDURE:**
37442-37446; 37469, 37470; 37479-37485
- **INTERNATIONAL TRADEMARKS FOR WHICH A DECISION ON GRANTING PROTECTIONS IS TAKEN:**
117887*; 119053; 119311*; 119393; 119668; 119922; 120211; 120265; 121003-121005; 121076, 121077; 121079; 121099; 121168-121172; 121264-121269; 121288, 121289; 121373-121375; 121377, 121378; 121380; 121382; 121384; 121393; 121456-121458; 121460; 121462; 121540, 121541; 121543-121546; 121557-121562; 121564; 121572, 121573; 121575, 121576; 121590; 121593; 121597-121599; 121601; 121622-121624; 121673; 121684, 121685; 121688; 121690-121693; 121695; 121701; 121705-121709; 121777-121780; 121786; 121798; 121800, 121801; 121827-121836; 121879; 121886, 121887; 121953; 121961, 121962; 121981; 121996; 122190-122195; 122243; 122245; 122255; 122259
- **INTERNATIONAL TRADEMARKS PROTECTED IN GEORGIA:**
118359; 118796; 118908; 119661; 119708, 119709; 119711-119717; 119720; 119731-119737; 119744; 119746; 119748; 119754; 119820-119825; 119828-119833; 119849-119853; 119864-119866; 119868; 119870; 119872, 119873; 119877-119879; 119918-119921; 119923-119926; 119936; 119941-119944; 119946-119948; 119950-119955; 119957-119959; 119961-119971; 119977-119982; 120053; 120056-120060; 120062-120069; 120071-120080; 120092-120099; 120101-120103; 120107-120113; 120115, 120116; 120118-120125; 120185-120187; 120196; 120198; 120200-120203; 120206-120210; 120212-120215; 120217-120221; 120266, 120267; 120273-120275; 120277; 120279-120281; 120285, 120286; 120288, 120289; 120291-120294; 120310, 120311; 120313-120317; 120323, 120324; 120326-120334; 120373-120377; 120389-120391; 120398-120400; 120402; 120419-120421; 120423, 120424; 120426-120428; 120430, 120431; 120538; 120551-120557; 120639-120645; 120684, 120685; 120687; 120695; 120879

APPELLATION OF ORIGIN OF GOODS

3538

INVENTIONS

APPLICATIONS APPROVED FOR GRANTING PATENT

The decision can be appealed at the Chamber of Appeal of Sakpatenti within 3 months from the publication or at the Mtskheta District Court Administrative Cases Board (Address: №17, Samkhedro St., Mtskheta), within 1 month following the publication.

PART A

A 61

- (10) AP 2023 15827 A (51) Int. Cl. (2006)
A 61 K 31/506
A 61 K 31/41
A 61 K 31/497
A 61 K 31/4402
A 61 K 31/4192
A 61 P 35/00
C 07 D 413/06
- (21) AP 2020 15827 (22) 2020 06 16
(31) 62/863.199; 62/953.223; 63/025.278
(32) 2019 06 18; 2019 12 24; 2020 05 15
(33) US; US; US
(71) CTXT PTY LTD (AU)
305 Grattan Street Parkville, Melbourne, 3000,
Australia (AU);
Pfizer INC. (US)
66, Hudson Blvd. East, New York, N.Y.
10001-2192, USA (US)
- (72) SUTTON, Scott Channing (US);
CAMERINO, Michelle Ang (AU);
BRODSKY, Oleg (US);
GREASLEY, Samantha Elizabeth (US);
HOFFMAN, Robert Louis (US);
STUPPLE, Paul Anthony (AU);
KUNG, Pei-Pei (US);
BOZIKIS, Ylva Elisabet Bergman (AU);
KUMPF, Robert Arnold (US);
RICHARDSON, Paul Francis (US)
- (74) Tamar Kotchlamazashvili
(85) 2021 12 17
(86) PCT/IB2020/055589, 2020 06 16
(54) BENZISOXAZOLE SULFONAMIDE
DERIVATIVES
(57) Compound of formula (I),

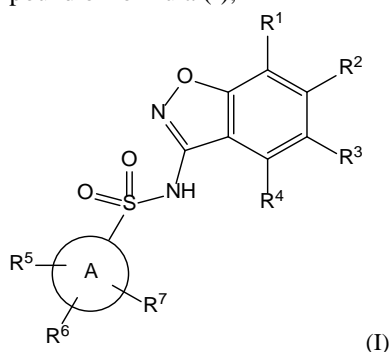

pharmaceutical compositions on the basis thereof, and their usage in the treatment of abnormal cell growth in patients.

Claims: 3 independents

23 dependents

Fig.: 1

- (10) AP 2023 16018 A (51) Int. Cl. (2006)
A 61 K 39/00
- (21) AP 2022 16018 (22) 2022 08 03
(71) G. Eliava Institute of Bacteriophages,
Microbiology and Virology (GE)
Levan Gotua St. 3, 0160, Tbilisi, Georgia (GE);
Shota Rustaveli National Science Foundation
of Georgia (GE)
Merab Aleksidze St., II Lane 2, 0193, Tbilisi,
Georgia (GE)
- (72) Sergo Rigvava (GE);
Lia Gubeladze (GE);
Merab Natidze (GE);
Natia Karumidze (GE);
Leila Kvachadze (GE);
Dali Gogiashvili (GE);
Darejan Bolkvadze (GE);
Lali Kavtaradze (GE)
- (74) Shalva Gvaramadze
(54) METHOD FOR ANTISTAPHYLOCOCCAL
POLYCLONAL IMMUNOGLOBULIN
PREPARATION
(57) Present invention relates to a method for
antistaphylococcal polyclonal immunoglobulin prepa-
ration, and provides producer animal, in particular, a
goat, immunization with the following immunogens:
Staphylococcus aureus thermoinactivated bacteria,
staphylococcal anatoxin, PV-leukocidin, and bacterial
hyaluronidase, and then: hyperimmunization,
immunoglobulin separation from blood serum and
clearance therewith special kit.
Claims: 2 independents

PART B**B 61**

- (10) AP 2023 15577 A (51) Int. Cl. (2006)
B 61 H 1/00
F 61 D 65/04
- (21) AP 2019 15577 (22) 2019 05 30
(31) 2018131073
(32) 2018 08 28
(33) RU
- (71) Public Joint Stock Company "Ural Plant of Auto-
Textile Products" (RU)
Plekhanova St. 64, Asbest, Sverdlovsk Rgn.,
624273, Russian Federation (RU)
- (72) KUZMINYIKH, Andrey Germanovich (RU);
ROMANENKO, Vitaliy Valerievich (RU)
- (74) Larisa Amirkhanyan
(85) 2021 03 01
(86) PCT/RU2019/000388, 2019 05 30
(54) BRAKE SHOE FOR A RAIL VEHICLE
(57) Two recesses (4) are provided on a part of the
flat lateral surface corresponding to a part of shoe
which is not worn down during use. Each recess is
provided with smooth semi-conical surface (5) and
flat surface (6), that are disposed at a non-right angle
relative to the flat lateral surface of shoe (3) in both
parts thereof.

Claims: 1 independent

Fig.: 2

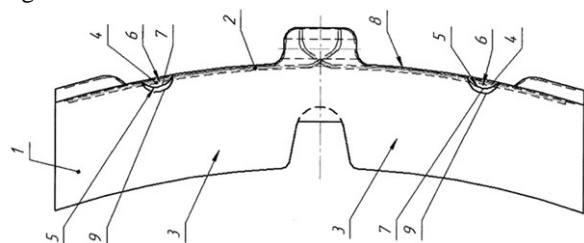

Fig. 1

PART C**C 22**

- (10) AP 2023 15809 A (51) Int. Cl. (2006)
C 22 B 9/16
C 22 B 9/10
C 22 B 11/02
- (21) AP 2019 15809 (22) 2019 08 20
(31) 16/397,441; 16/507,158
(32) 2019 04 29; 2019 07 10
(33) US; US
- (71) Techemet, LP (US)
6025 Genoa Red Bluff Rd. Pasadena, TX 77507,
USA (US)
- (72) ALBRECHT, Edward W. (US);
MCCULLOUGH, Steven D. (US)
- (74) Shalva Gvaramadze
(85) 2021 11 26
(86) PCT/US2019/047304, 2019 08 20
(54) PGM CONVERTING PROCESS AND
JACKETED ROTARY CONVERTER
(57) Present invention relates to PGM converting
process and jacketed rotary converter. The process
can include low- or no-flux converting; partial pre-
oxidation of PGM collector alloy; using a refractory
protectant in the converter; magnetic separation of
slag; recycling part of the slag to the converter;
smelting catalyst material in a primary furnace to
produce the collector alloy; and/or smelting the
converter slag in a secondary furnace with slag from
the primary furnace. The converter can include an
inclined converter pot mounted for rotation; a
refractory lining; an opening in a top of the pot to
introduce converter feed; a lance for injecting oxygen-
containing gas into the alloy pool; a heat transfer
jacket adjacent the refractory lining; and a coolant
system to circulate a heat transfer medium through the
jacket to remove heat from the alloy pool in thermal
communication with the refractory lining.

Claims: 10 independents

166 dependents

Fig.: 14

Table: 13

PATENTED INVENTIONS
PART A**A 61**

- (11) P 2023 7566 B (51) Int. Cl. (2006)
A 61 K 31/473
A 61 K 38/20
A 61 P 35/00
C 07 D 219/06
- (10) AP 2023 15959 A (44) 13(616)/2023
(21) AP 2020 15959
(22) 2020 10 22
(24) 2020 10 22
(31) 2019134800
(32) 2019 10 29
(33) RU
(86) PCT/RU2020/050289, 2020 10 22
(73) Scientific Technological Pharmaceutical Firm
"Polysan" (OOO NTFF "Polysan") (RU)
Salova Street 72, Bldg. 2, Liter A, Saint-
Petersburg RU-192102, Russian
Federation (RU)
(72) KOVALENKO, Alexey Leonidovich (RU);
PETROV, Andrey Yurievich (RU)
(74) Tamar Kotchlamazashvili
(54) NOVEL CHEMICAL COMPOUND L-LYSINE
9-OXOACRIDINYL-10-ACETATE o

-
- (11) P 2023 7565 B (51) Int. Cl. (2006)
A 61 P 35/00
C 07 K 16/28
- (10) AP 2023 15366 A (44) 14(617)/2023
(21) AP 2018 15366
(22) 2018 11 15
(24) 2018 11 15
(31) 62/587,604
(32) 2017 11 17
(33) US
(86) PCT/US2018/061165, 2018 11 15
(73) Merck Sharp & Dohme LLC (US)
126 E Lincoln Av., P.O. Box 2000, Rahway,
NJ 07065, USA (US)
(72) MEEHL, Michael, A. (US);
BRANDISH, Philip, E. (US);
FAYADAT-DILMAN, Laurence (US);
JUAN, Veronica (US);
MIECZKOWSKI, Carl (US);
SINGH, Latika (US)
(74) Shalva Gvaramadze
(54) ANTIBODIES SPECIFIC FOR IMMUNOGLO-
BULIN-LIKE TRANSCRIPT 3 (ILT3) AND
USES THEREOF
-

PART B**B 01**

- (11) P 2023 7564 B (51) Int. Cl. (2006)
B 01 J 19/00
- (10) AP 2023 16061 A (44) 13(616)/2023
(21) AP 2022 16061
(22) 2022 10 20
(24) 2022 10 20
(73) Daviti Gelenidze (GE)
Rustavi Highway 28, ap. 57, 0165, Tbilisi,
Georgia (GE);
Gela Gelashvili (GE)
Paliashvili St. 78, ap. 138, 0162, Tbilisi,
Georgia (GE);
LEPL "Shota Rustaveli National Science
Foundation of Georgia" (GE)
Aleksidze II Lane 2, Tbilisi, Georgia (GE);
LEPL "Ivane Javakhishvili Tbilisi State
University" (GE)
Ilia Chavchavadze Av. 1, TSU 1st bld., 0179,
Tbilisi, Georgia (GE)
(72) Daviti Gelenidze (GE);
Gela Gelashvili (GE)
(54) METHOD FOR EVAPORATION OF
CONDUCTIVE MATERIALS TO
OBTAIN NANOSCALE PARTICLES

APPLICATIONS***

PART A

A 61

- (10) AP 2023 16334 A (51) A 61 K 39/09
A 61 K 39/385
A 61 K 39/39
A 61 P 37/04
A 61 P 11/00
A 61 P 31/04
- (43) 2023 11 10 №21
(21) AP 2022 16334
(22) 2022 02 02
(31) 63/145,651
(32) 2021 02 04
(33) US
(71) Merck Sharp & Dohme LLC (US)
126 East Lincoln Aven., Rahway, NJ 07065,
USA (US)
(72) SMITH, William, J. (US);
AHL, Patrick, L. (US);
SOUKUP, Randal, J. (US);
SKINNER, Julie, M. (US)
(74) Giorgi Kartvelishvili
(85) 2023 08 26
(86) PCT/US2022/014812, 2022 02 02
(54) NANOEMULSION ADJUVANT COMPO-
SITION FOR PNEUMOCOCCAL CONJUGATE
VACCINES
(57)

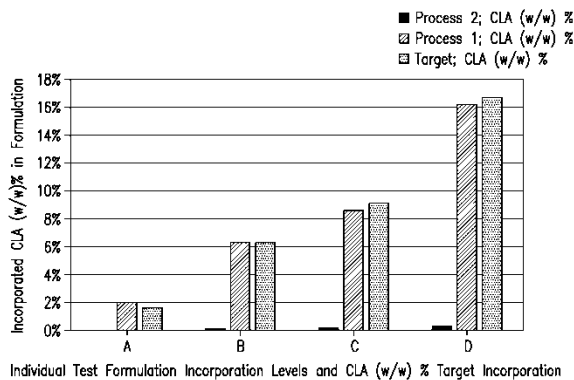

Fig. 4

Present invention relates generally to the prevention of pneumococcal disease. More specifically, the invention relates to a composition comprising pneumococcal conjugates and a stable nanoemulsion (SNE).

PART C

C 02

- (10) AP 2023 16345 A (51) C 02 F 1/46
C 02 F 1/461
C 02 F 1/467
C 02 F 1/469
C 02 F 103/08
C 02 F 9/00
C 02 F 1/44
C 02 F 1/68
- (43) 2023 11 10 №21
(21) AP 2022 16345
(22) 2022 02 09
(31) 102021000002963
(32) 2021 02 10
(33) IT
(71) Genio SRL (IT)
Vicolo San Giovanni sul Muro 9, Milano (MI),
20121, Italy (IT)
(72) CAVALLI, Stefano (IT);
TREVISAN, Marco (IT)
(74) Tamar Kotchlamazashvili
(85) 2023 09 07
(86) PCT/IB2022/051149, 2022 02 09
(54) DESALINATION DEVICE AND PROCESS
FOR RECOVERY AND VALORISATION
OF CHLORIDES IN DILUTE SOLUTIONS

(57) The invention relates to a device and a process for the desalination of NaCl solutions employing a three-chamber electrochemical cell separated by relative ion exchange membranes, namely a succession of a cathode chamber (16; 116), a cation exchange membrane (28; 128), a central chamber (12; 112) for the saline solution, an anion exchange membrane (26; 126) and an anode chamber (14; 114). The oxidation of OH⁻ and the reduction of H₃O⁺ under the formation of OH⁻ and H₂ causes the passage of Na⁺ and Cl⁻ ions from the central chamber to the other chambers, thereby reducing the salt concentration. The feeding of the cathode chamber can be managed in a circuit with the insertion of a carbonation reactor (50) to reduce the concentration of NaOH and eliminate CO₂ from the air. Under certain conditions, the chlorides entering the anode chamber undergo oxidation and the chlorine formed therein reacts with water to produce HCl and HClO.

Fig.: 2

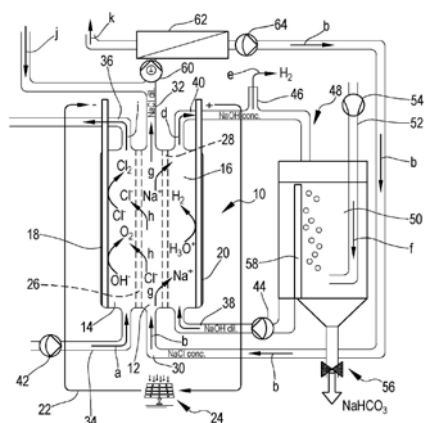

Fig. 1

C 07

(10) AP 2023 16357 A (51) C 07 D 487/04

(43) 2023 11 10 №21

(21) AP 2022 16357

(22) 2022 02 28

(31) P2100077

(32) 2021 02 26

(33) HU

(71) Egis Gyógyszergyár ZRT (HU)

Keresztúri út 30-38, 1106 Budapest,

Hungary (HU)

(72) PORCS-MAKKAY, Márta (HU);

BERTHA, Ferenc (HU);

MOLNÁR, Enikő (HU);

NÉMETH, Gábor (HU);

HORVÁTH, Simon (HU);

SZEDELÉDI, Ildikó (HU);

BALL, Beatrix (HU);

TELLÉR, Mónika (HU);

KÁTAINÉ FADGYAS, Katalin (HU);

(74) Larisa Amirkhanyan

(85) 2023 09 20

(86) PCT/HU2022/050019, 2022 02 28

(54) PROCESS FOR OBTAINING AVAPRITINIB
AND ITS INTERMEDIATES

(57) Present invention relates to process for obtaining Avapritinib of the formula (I) and its intermediates. Avapritinib, is used for treatment of gastrointestinal stromal tumors (GIST) and for tumors of stomach and intestines.

DESIGNS

APPLICATION APPROVED FOR REGISTRATION

The decision can be appealed at the Chamber of Appeal of Sakpatenti within 3 months from the publication or at the Mtskheta District Court Administrative Cases Board (Address: №17, Samkhedro str., Mtskheta), within 1 month following the publication.

(10) AD 2023 1319 S (51) 11-01

(21) AD 2023 1319 (22) 2023 07 01

(28) 14

(71) Donara Berdzenishvili (GE)

Vill. Kvemo Erketi, 4900, Chokhatauri, Georgia (GE)

(72) Donara Berdzenishvili (GE)

(74) Donara Berdzenishvili (GE)

(54) 12.-14. BRACELET; 1. SET OF EARRINGS AND PENDANT; 2.-11. EARRING

(55)



1.1



1.2



1.3



1.4

1.5



2.1



2.2



2.3



2.4



3.1



3.2



3.3



3.4





11.1



11.2



12.1



12.2

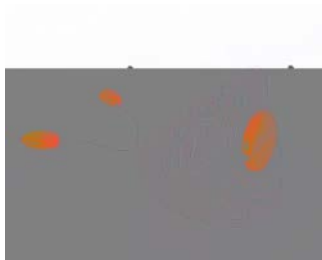

12.3

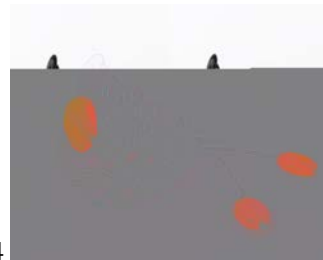

12.4



13.1



13.2



13.3



13.4



13.5



14.1



14.2



14.3



14.4



14.5

DESIGN REGISTERED ACCORDING TO THE ACCELERATED PROCEDURE

The decision can be appealed at the Chamber of Appeal of Sakpatenti within 3 months from the publication.

- (11) D 2023 982 S (51) 09-01; 09-03
- (21) AD 2023 1338 (22) 2023 10 10
- (24) 2023 10 10
- (28) 8
- (18) 2028 10 10
- (73) Giorgi Gomelauri (GE)
G. Chanturia St. 14, 0900, Akhmeta, Georgia (GE)
- (72) Giorgi Gomelauri (GE)
- (54) 1.-5. HONEY PACKAGE; 6. 6. VODKA PACKAGE; 7; 7. VODKA BOTTLE PACKAGE;
8. GOZINAKI PACKAGE
- (55)



1.1



1.2



1.3



1.4



2.1



2.2



2.3



2.4



2.5



3.1



3.2



3.3



3.4



4.1



4.2



4.3



4.4



5.1



5.2



5.3



5.4



5.5



5.6



6.1

6.2

6.3

6.4

6.5



7.1

7.2

7.3

7.4

7.5

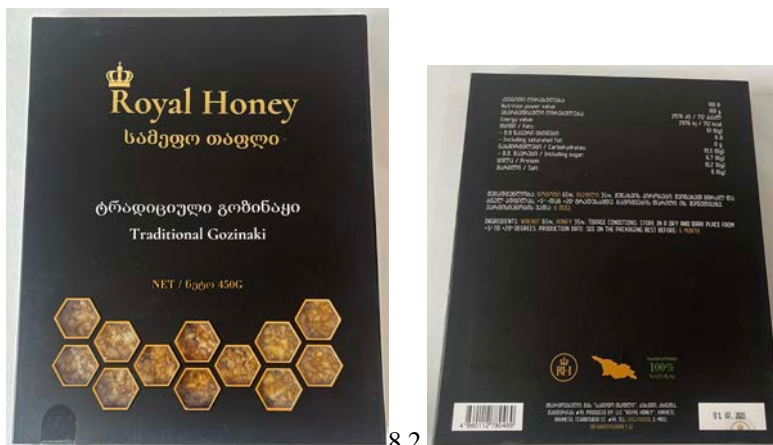

8.1

8.2



8.3



8.4

DESIGNS, WHICH HAVE BEEN REGISTERED WITH THE INTERNATIONAL BUREAU CLAIMING PRIORITY ON THE TERRITORY OF GEORGIA

The decision can be appealed at the Chamber of Appeal of Sakpatenti within 3 months from the publication or at the Mtskheta District Court Administrative Cases Board (Address: №17, Samkhedro St., Mtskheta), within 1 month following the publication.

- (11) DM/230 711 (51) 09-01
(15) 2023 04 19 (44) 33/2023 (2023 08 18)
(22) 2023 04 19
(28) 3
(73) GÜROK TURİZM VE MADENCİLİK ANONİM ŞİRKETİ
İnköy Mahallesi, Eskişehir Karayolu Bulvarı No:96 KÜTAHYA (TR)
(85) TR
(86) TR
(87) TR
(88) TR
(89) TR
(81) III. UA, GE, MK, US, BA, RS, CH, MD, ME, AZ, AL
(72) ESİN GÜRAL ARGAT
İnköy Mahallesi, Eskişehir Karayolu Bulvarı No:96, KÜTAHYA (TR)
(74) DESTEK PATENT ANONİM ŞİRKETİ
Odunluk Mahallesi, Akademi Caddesi, Zeno İş Merkezi, D Blok Kat: 4, 16110 BURSA, Nilüfer (TR)
(46) 2023 08 18
(54) 1.-3. BOTTLE
(55)



(11) DM/226 980

(51) 10-02

(15) 2023 02 17

(44) 33/2023 (2023 08 18)

(22) 2023 02 17

(28) 1

(73) Compagnie des Montres Longines, Francillon S.A. (Longines Watch Co. Francillon Ltd.)
Les Longines 8, 2610 St-Imier (CH)

(85) CH

(86) CH

(87) CH

(88) CH

(89) CH

(81) III. KG, LI, GE, MK, OM, CA, BA, NO, RU, EM, AM, MD, TN, GB, TR, MN, CH, KR, AL, UA, MA, SG,
MC, BZ, ME, AZ

(72) Gaïane DEMUR

c/o Compagnie des Montres Longines, Francillon S.A. Les Longines 8, 2610, St-Imier (CH)

(74) The Swatch Group AG (The Swatch Group SA) (The Swatch Group Ltd.)

Faubourg du Lac 6, 2501 Biel/Bienne (CH)

(46) 2023 08 18

(54) 1. WATCH

(55)



1.1



1.2



1.3



1.4



1.5

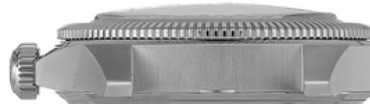

1.6



1.7



1.8

- (11) DM/230 681 (51) 10-02
 (15) 2023 07 25 (44) 33/2023 (2023 08 18)
 (22) 2023 07 25
 (28) 1
 (30) No1: 23.03.2023; 2023-00182; CH
 (73) ROLEX SA
 rue François-Dussaud 3-5-7, 1211 Genève 26 (CH)
 (85) CH
 (86) CH
 (87) CH
 (88) CH
 (89) CH
 (81) III. OM, GE, CA, RS, NO, RW, MU, EM, AM, BW, TJ, MD, VN, TN, SR, MN, JP, KR, UA, OA, MA,
 ME, AZ, SM, WS, KG, LI, MK, BA, EG, RU, JM, IS, BY, GB, KH, TR, GH, ST, IL, KP, MX, AL, BN, NA,
 SG, MC, BZ, TM
 (72) Giovanni SICILIANO
 9, Chemin Docteur-Adolphe Pasteur, 1209, Genève (CH)
 (74) BUGNION S.A.
 10, route de Florissant Case postale 375, 1211 Genève 12 (CH)
 (46) 2023 08 18
 (54) 1. WATCH
 (55)



- (11) DM/227 036
- (15) 2023 02 17
- (22) 2023 02 17
- (28) 3
- (73) HARRY WINSTON SA
Chemin Du Tourbillon 8, 1228 Plan-les-Ouates (CH)
- (85) CH
- (86) CH
- (87) CH
- (88) CH
- (89) CH
- (81) III. KG, LI, OM, CA, MK, TR, GE, BA, NO, MN, CH, EM, AL, AM, UA, SG, MA, MC, MD, BZ, ME, AZ, TN, GB
- (72) 1 Rie YATSUGI-KANG
C/o Harry Winston Inc., 718 Fifth Avenue, 10019, New York (US);
2-3 Delphine ABDOURAHIM
C/o Harry Winston Inc., 718 Fifth Avenue, 10019, New York (US)
- (74) The Swatch Group AG (The Swatch Group SA) (The Swatch Group Ltd.)
Faubourg Du Lac 6, 2501 Biel/Bienne (CH)
- (46) 2023 08 18
- (54) 1. FINGER RING, 2. PAIR OF EARRINGS, 3. NECKLACE WITH PENDANT
- (55)



1.1



1.2



1.3



1.4



1.5



1.6



1.7



1.8



2.1



2.2





2.3



2.4



2.5



2.6



2.7



2.8



3.1



3.2



3.3



3.4



3.5



3.6



3.7



3.8

- (11) DM/230 758 (51) 25-03
 (15) 2023 05 25 (44) 33/2023 (2023 08 18)
 (22) 2023 05 25
 (28) 1
 (73) MAGAIA Energie
 11 Rue Du Stade Marcel Cuaz, 78910 Orgerus, Yvelines (FR)
 (85) FR
 (86) FR
 (87) FR
 (88) FR
 (89) FR
 (81) IL, NE, GA, SN, ML, CI, BJ III. CA, US, GE, GH, EG, CH, EM, NA, GB
 (72) Magali VIELMON
 11 Rue du Stade Marcel Cuaz, 78910, Orgerus, Yvelines (FR)
 (46) 2023 08 18
 (54) 1. STRUCTURE FOR ENERGY RENEWAL
 (55)

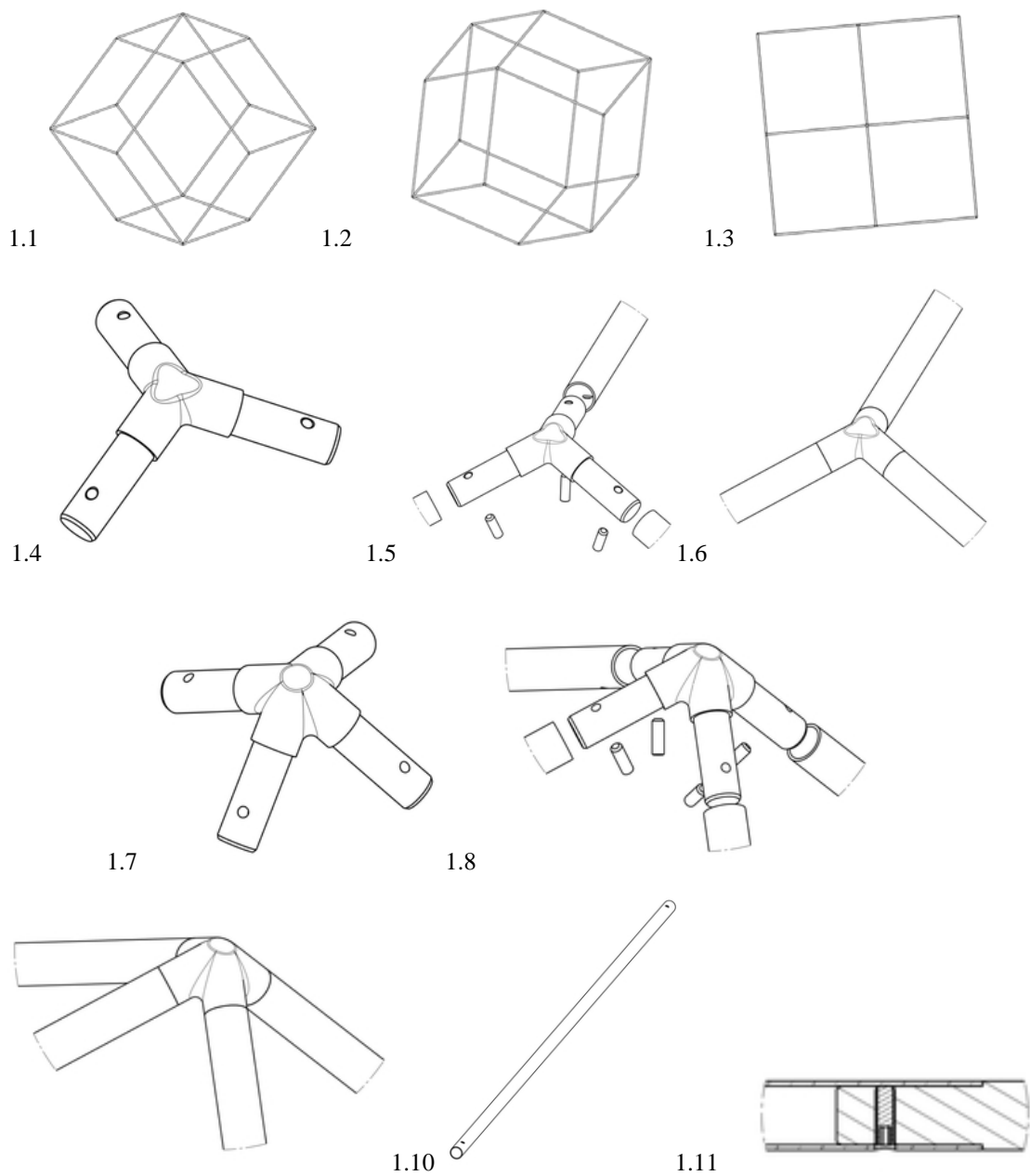

- (11) DM/230 872 (51) 06-01
(15) 2023 07 31 (44) 34/2023 (2023 08 25)
(22) 2023 07 31
(28) 1
(73) Tribù N.V.
Oude Heidestraat 72, 3740 BILZEN (BE)
(85) –
(86) –
(87) –
(88) BX
(89) BX
(81) III. OM, CA, GE, RS, NO, RW, SY, EM, MU, AM, BW, TJ, MD, VN, TN, SR, MN, JP, KR, CN, UA, OA, MA, ME, AZ, SM, WS, KG, LI, US, MK, BA, EG, RU, JM, IS, BY, GB, KH, TR, GH, ST, IL, CH, KP, MX, AL, BN, NA, SG, MC, BZ, TM
(72) Christophe DELCOURT
C/O Tribù N.V. Oude Heidestraat 72, 3740, BILZEN (BE)
(74) AWA Benelux SA
Tour & Taxis - Royal Depot Box: 216 Havenlaan 86c Avenue Du Port Brussels, 1000 Brussels (BE)
(46) 2023 08 25
(54) 1. LOUNGE CHAIR
(55)



1.1



1.2



1.3



1.4

1.5



1.6



1.7



1.8



1.9



(11) DM/230 873

(51) 06-01

(15) 2026 07 31

(44) 34/2023 (2023 08 25)

(22) 2023 07 31

(28) 1

(73) Tribù N.V.

Oude Heidestraat 72, 3740 BILZEN (BE)

(85) –

(86) –

(87) –

(88) BX

(89) BX

(81) III. GE, CA, OM, RS, NO, RW, SY, EM, MU, AM, BW, TJ, MD, VN, TN, SR, MN, JP, KR, CN, UA, OA, MA, ME, AZ, SM, KG, WS, LI, US, MK, BA, EG, RU, JM, IS, BY, GB, KH, TR, GH, ST, IL, KP, CH, AL, MX, BN, NA, SG, MC, BZ, TM

(72) Christophe DELCOURT

C/O Tribù N.V. Oude Heidestraat 72, 3740, BILZEN (BE)

(74) AWA Benelux SA

Tour & Taxis - Royal Depot Box: 216 Havenlaan 86c Avenue Du Port, 1000 Brussels (BE)

(46) 2023 08 25

(54) 1. ARMCHAIR

(55)



1.1



1.2



1.3



1.4



1.5



1.6



1.7



1.8



1.9

- (11) DM/230 874 (51) 06-01
(15) 2023 07 31 (44) 34/2023 (2023 08 25)
(22) 2023 07 31
(28) 1
(73) Tribù N.V.
Oude Heidestraat 72, 3740 BILZEN (BE)
(85) –
(86) –
(87) –
(88) BX
(89) BX
(81) III. OM, GE, CA, RS, NO, RW, SY, MU, EM, AM, BW, TJ, MD, VN, TN, SR, MN, JP, KR, CN, UA, OA,
MA, ME, AZ, SM, KG, WS, LI, US, MK, BA, EG, JM, RU, IS, BY, GB, KH, TR, GH, ST, IL, CH, KP, MX,
AL, BN, NA, SG, MC, BZ, TM
(72) Christophe DELCOURT
C/O Tribù N.V. Oude Heidestraat 72, 3740, BILZEN (BE)
(74) AWA Benelux SA
Tour & Taxis - Royal Depot Box: 216 Havenlaan 86c Avenue Du Port Brussels, 1000 Brussels (BE)
(46) 2023 08 25
(54) 1. BENCH SEAT
(55)



1.1



1.2





1.6



1.7

1.8



1.9

- (11) DM/230 928 (51) 07-99
(15) 2023 03 22 (44) 34/2023 (2023 08 25)
(22) 2023 03 22
(28) 1
(73) Fedor Vladimirovich Poletaev
EZHK Edem, kvartal 3, d.2, kv. 18, RU-143441 d. Gavrilkovo, Krasnogorskiy r-n, Moskovskaya obl. (RU)
(85) RU
(86) RU
(87) RU
(88) RU
(89) RU
(81) III. KG, TR, US, GE, CA, RU, EM, CN, AM, TJ, BY, MD, TM, AZ, GB
(72) Fedor Vladimirovich Poletaev
EZHK Edem, kvartal 3, d.2, kv. 18, RU-143441, d. Gavrilkovo, Krasnogorskiy r-n, Moskovskaya obl. (RU)
(74) INTELLECT/ Tatiana Aleksandrovna Vagenleitner
a/ya 798, RU-620000 Ekaterinburg (RU)
(46) 2023 08 25
(54) 1. FOOD WRAP FILM DISPENSER
(55)

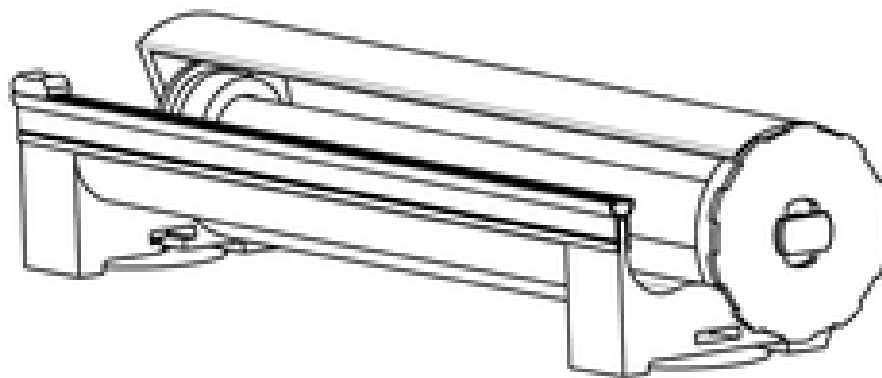

1.1



1.2

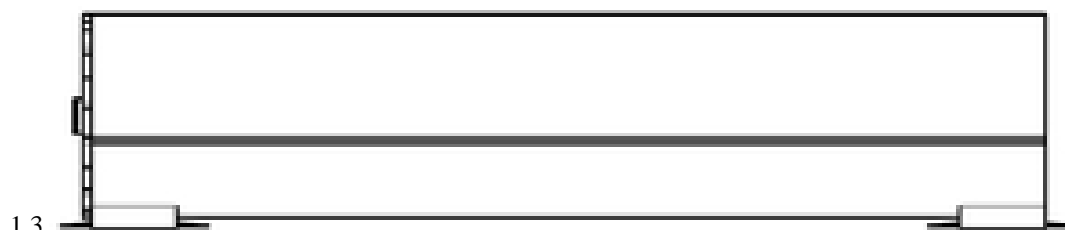

1.3

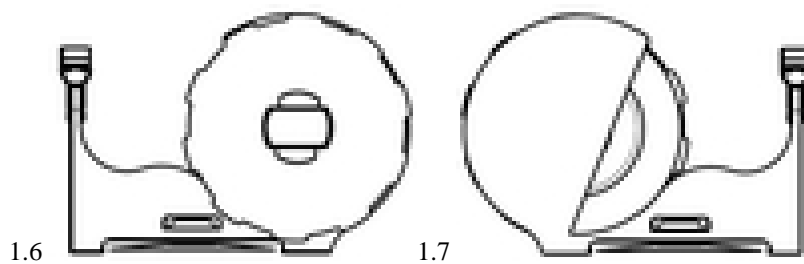
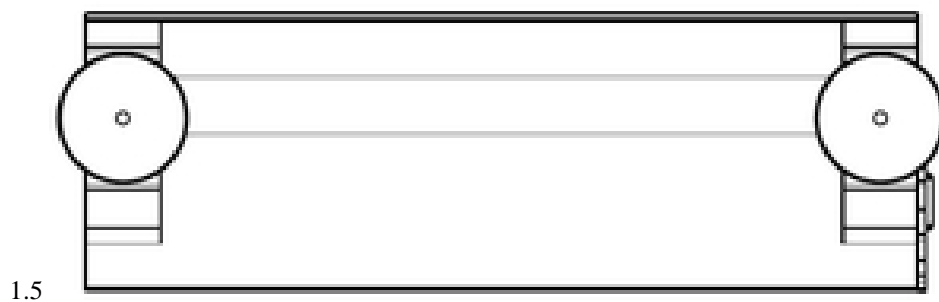
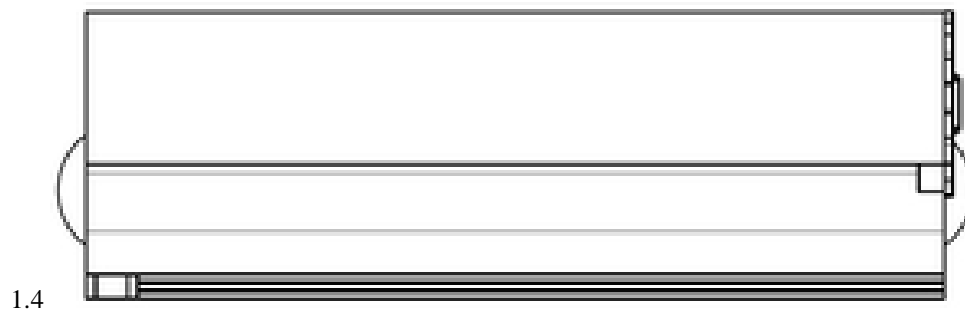

- (11) DM/227 186 (51) 10-02
 (15) 2023 02 21 (44) 34/2023 (2023 08 25)
 (22) 2023 02 21
 (28) 1
 (73) OMEGA SA (OMEGA AG) (OMEGA LTD.)
 Jakob-Stämpfli-Strasse 96, 2502 BIEL/BIENNE (CH)
 (85) CH
 (86) CH
 (87) CH
 (88) CH
 (89) CH
 (81) III. KG, LI, TR, MK, OM, GE, BA, MN, NO, CH, EM, AL, UA, AM, MA, SG, MC, MD, BZ, ME, AZ,
 TN, GB
 (72) Gregory Kissling
 C/o OMEGA SA (OMEGA AG) (OMEGA LTD.), Jakob-Stämpfli-Strasse 96, 2502, Biel/Bienne (CH)
 (74) The Swatch Group AG (The Swatch Group SA) (The Swatch Group Ltd.)
 6, Faubourg Du Lac, 2501 BIEL/BIENNE (CH)
 (46) 2023 08 25
 (54) 1. WATCH
 (55)



1.1

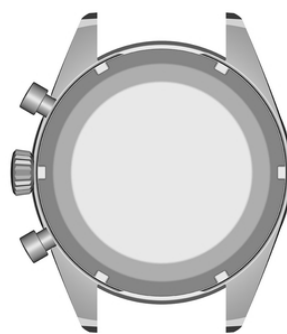

1.2



1.3



1.4



1.5



1.6



1.7



1.8

(11) DM/227 356
 (15) 2023 02 28
 (22) 2023 02 28
 (28) 1

(51) 10-07
 (44) 35/2023 (2023 09 01)

(73) HARRY WINSTON SA
 Chemin Du Tourbillon 8, 1228 Plan-les-Ouates (CH)

(85) CH
 (86) CH
 (87) CH
 (88) CH
 (89) CH

(81) III. KG, LI, GE, CA, OM, MK, BA, NO, RU, EM, AM, MD, TN, GB, TR, MN, CH, AL, UA, MA, SG, MC, BZ, ME, AZ

(72) Mathilde PETIT
 C/o Harry Winston SA, Chemin Du Tourbillon 8, 1228, Plan-les-Ouates (CH)

(74) The Swatch Group AG (The Swatch Group SA) (The Swatch Group Ltd.)
 Faubourg Du Lac 6, 2501 Biel/Bienne (CH)

(46) 2023 09 01
 (54) 1. WATCH DIAL
 (55)

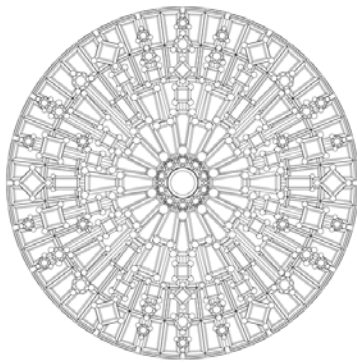

1.1

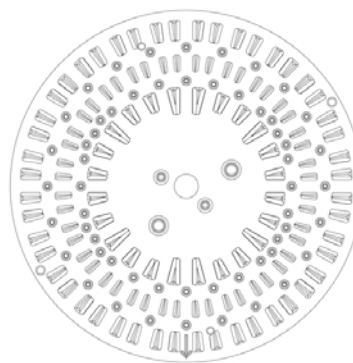

1.2

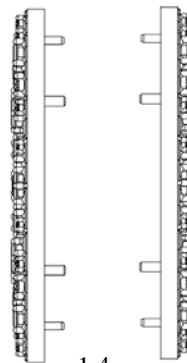

1.3

1.4

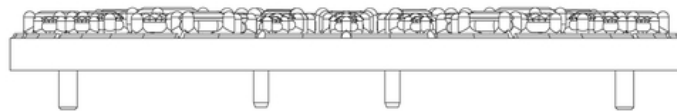

1.5

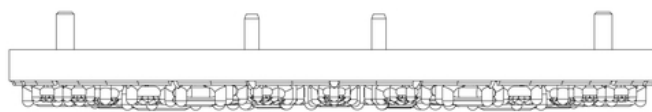

1.6

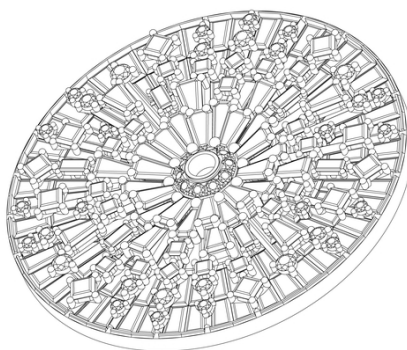

1.7

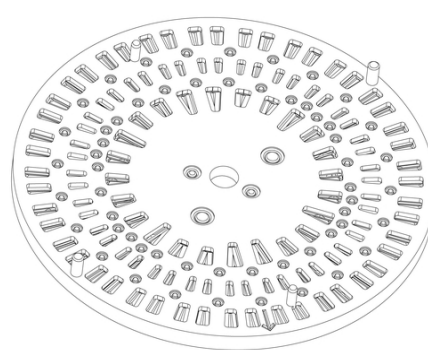

1.8

- (11) DM/227 483 (51) 10-02
 (15) 2023 03 08 (44) 36/2023 (2023 09 08)
 (22) 2023 03 08
 (28) 1
 (73) Compagnie Des Montres Longines, Francillon S.A. (Longines Watch Co. Francillon Ltd.)
 Les Longines 8, 2610 St-Imier (CH)
 (85) CH
 (86) CH
 (87) CH
 (88) CH
 (89) CH
 (81) III. KG, LI, CA, OM, MK, GE, BA, NO, RU, EM, AM, MD, TN, GB, TR, MN, CH, KR, AL, UA, MA, SG,
 MC, BZ, ME, AZ
 (72) Gaiiane DEMUR
 C/o Compagnie Des Montres Longines, Francillon S.A. Les Longines 8, 2610, St-Imier (CH)
 (74) The Swatch Group AG (The Swatch Group SA) (The Swatch Group Ltd.)
 Faubourg Du Lac 6, 2501 Biel/Bienne (CH)
 (46) 2023 09 08
 (54) 1. WATCH
 (55)



1.1



1.2



1.3

1.4



1.5



1.6



1.7



1.8

TRADEMARKS

APPLICATIONS FILED UNDER THE NATIONAL PROCEDURE APPROVED FOR REGISTRATION

The decision can be appealed at the Chamber of Appeal of Sakpatenti within 3 months from the publication or at the Mtskheta District Court Administrative Cases Board (Address: №17, Samkhedro St., Mtskheta), within 1 month following the publication.

(260) AM 2023 119370 A

(210) AM 119370

(220) 2022 09 14

(731) Natela Sheklashvili

P. Iashvili Dead End 3, Sachkhere, Georgia

(740) Vakhtang Torotadze

(540)



(591) FFFFFFF white, 000000 black, FFF12C yellow, C92229 red, 3FA865 green

(531) 03.03.01; 03.03.17; 24.01.09; 24.01.15; 29.01.15

(511) 32

(260) AM 2023 121538 A

(210) AM 121538

(220) 2023 02 09

(731) LTD "Odella"

Irakli Abashidze St. 31, 0179, Tbilisi, Georgia

(540)



(591) Lilac, green, silver, white

(531) 01.01.02; 01.01.10; 01.01.12; 01.15.07; 24.17.03; 24.17.25; 27.05.01; 27.05.09; 27.05.10; 29.01.13

(511) 14, 24, 25

(260) AM 2023 121733 A

(210) AM 121733

(220) 2023 02 20

(731) Enriko Beridze

G. Tsitsishvili St. 18, Tbilisi, Georgia

(740) Salome Jeladze

(540)



(591) Black-white

(531) 03.01.14; 05.01.16; 24.15.03; 24.15.13; 28.19

(526) ზესოფელი

(511) 33, 35

(260) AM 2023 121901 A

(210) AM 121901

(220) 2023 03 06

(731) LTD "GM Pharmaceuticals"

Rustavi Highway 52, 0114, Tbilisi, Georgia

(740) Nugzar Ksovreli

(540)



(591) EF9736 light brown, 00AFF0 sky-blue, white

(531) 01.15.15; 26.11.08; 27.05.01; 27.05.11; 29.01.13

(511) 5

(260) AM 2023 121902 A

(210) AM 121902

(220) 2023 03 06

(731) LTD "GM Pharmaceuticals"

Rustavi Highway 52, 0114, Tbilisi, Georgia

(740) Nugzar Ksovreli

(540)



(591) EFC501 yellow, EF9736 light brown, white

(531) 01.15.15; 26.11.08; 27.05.01; 27.05.11; 29.01.13

(511) 5

(260) AM 2023 121909 A
 (210) AM 121909
 (220) 2023 03 06
 (731) Cytec Technology Corp
 504 Carnegie Center, Princeton, NJ, 08540,
 USA
 (740) Tamar Kotchlamazashvili
 (540)

AEROFLOAT

(591) Black-white
 (511) 1

(260) AM 2023 121917 A
 (210) AM 121917
 (220) 2023 03 06
 (731) Spray Moret, LLC
 1411 Broadway, 8 fl., New York,
 NY 10018, USA
 (740) Tamaz Shilakadze
 (540)

SPRAYGROUND

(591) Black-white
 (511) 35

(260) AM 2023 121936 A
 (210) AM 121936
 (220) 2023 03 09
 (731) Zakrytoe Aktsionernoe Obshchestvo
 "PharmFirma "Sotex"
 Selskoe poselenie Berezhnyakovskoe,
 pos. Belikovo, d. 11, Sergievo-Posadskiy
 Munitsipalny Rayon, 141345, Moskovskaya
 Oblast, Russian Federation
 (740) Giorgi Taktakishvili
 (540)

КАЛЬЦЕМАРА

(591) Black-white
 (511) 5

(260) AM 2023 122008 A
 (210) AM 122008
 (220) 2023 03 10

(731) LTD "PARK Gida"
 Vill. Khutsubani, 5th Ubani, St. 46a, 6200,
 Kobuleti, Georgia
 (740) Dato Jaiani
 (540)

7 night drink

(591) Black-white
 (511) 16, 32, 35

(260) AM 2023 122016 A
 (210) AM 122016
 (220) 2023 03 10
 (731) LLC "Ranko"
 Tsikhisdziri St. 15, Isani District, Tbilisi,
 Georgia
 (740) Giorgi Kartvelishvili
 (540)



(591) Orange, blue
 (531) 27.05.01; 29.01.12
 (511) 36

(260) AM 2023 122023 A
 (210) AM 122023
 (220) 2023 03 14
 (731) The News Hub Limited
 Office at 10th Floor, Building 7 Chiswick Park,
 566 Chiswick High Road, London, W4 5YG,
 United Kingdom
 (540)



(591) Blue, black
 (531) 27.05.01; 27.05.09; 27.05.10; 28.01; 29.01.12
 (511) 38, 41

(260) AM 2023 122025 A
 (210) AM 122025
 (220) 2023 03 15
 (731) LTD "Kakhetian Traditional Winemaking"
 Sulkhan Tsintsadze St. 12, 0160, Tbilisi,
 Georgia
 (540)



(591) Black-white
 (531) 11.03.02; 28.19
 (511) 33

(260) AM 2023 122041 A
 (210) AM 122041
 (220) 2023 03 16
 (731) LLC "Music Room"
 Bogdan Khmelnitskiy St. 151, ap. 69, 0136,
 Tbilisi, Georgia

(540)

sonate

(591) Black-white
 (531) 27.05.04
 (511) 15

(260) AM 2023 122135 A

(210) AM 122135

(220) 2023 03 23

(731) Yiwu OK Electric Appliance Co., Ltd.
 Shop N17476, Market 2, Iu Interneishenal
 Treid Siti, Futian Strit, Iu Siti, People's
 Republic of China

(740) Giorgi Kartvelishvili

(540)

LumaBella

(591) Black-white
 (531) 27.05.01; 27.05.08; 27.05.09
 (511) 7, 8, 11

(260) AM 2023 122197 A

(210) AM 122197

(220) 2023 03 24

(731) LTD "Ad Media"

Kukuri Gogiasvili st., Lane I, 0131, Tbilisi,
 Georgia

(540)

ALUCOSUN®

(591) Green, blue, white
 (531) 26.13.25; 27.05.01; 29.01.13
 (511) 6

(260) AM 2023 122198 A

(210) AM 122198

(220) 2023 03 24

(731) Harry Winston SA

Chemin du Tourbillon 8, 1228 Plan-les-Ouates,
 Switzerland

(740) Shalva Gvaramadze

(540)

**HARRY WINSTON**

JEWELS THAT TELL TIME

(591) Black-white
 (531) 26.05.01; 26.05.02; 26.05.18; 27.05.10
 (511) 14

(260) AM 2023 122205 A

(210) AM 122205

(220) 2023 03 27

(731) JSC "Telavi Wine Cellar"

Village Kurdghelauri, 2200, Telavi Region,
 Georgia

(740) Giorgi Taktakishvili

(540)

VELURI

(591) Black-white

(511) 33

(260) AM 2023 122212 A

(210) AM 122212

(220) 2023 03 27

(731) LTD "Abella"

Friedrich Graf von der Schulenburg St. 5,
 Tbilisi, Georgia

(540)



(591) F71111 red, FCF9F9 white, 0C0505 black

(531) 02.01.23; 02.03.23; 02.05.23; 26.01.14;
 26.04.02; 26.04.05; 26.04.14; 26.04.22;
 26.04.24; 27.05.01; 27.05.24; 28.19; 29.01.13

(511) 43

(260) AM 2023 122224 A

(210) AM 122224

(220) 2023 03 30

(731) LTD "Batono"

Gotua St. 8, 0160, Tbilisi, Georgia

(540)



(591) Red, black, white, brown and light brown

(531) 02.09.14; 11.03.02; 27.05.01; 28.05; 28.19;
 29.01.13

(511) 33

(260) AM 2023 122282 A

(210) AM 122282

(220) 2023 04 03

(731) Mamuka Gobejishvili

Selim Khimshiashvili St. 6 (Former Aliluev St.),
 0101, Tbilisi, Georgia

(540)

გურმანისტი
Gurmanisti

(591) Black-white

(511) 29, 30, 43

(260) AM 2023 122295 A

(210) AM 122295

(220) 2023 04 05

(731) Teimuraz Kanchaveli

Ramishvili st. 31a, Tbilisi, Georgia

(540)

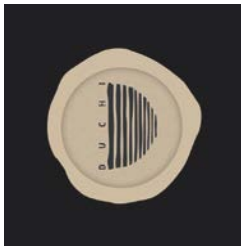

(591) Black, brown, ivory

(531) 24.03.01; 24.03.07; 24.03.17; 24.03.18;

24.03.19; 26.04.02; 26.04.05; 26.04.12;

26.04.16; 29.01.12

(511) 14, 35

(260) AM 2023 122386 A

(210) AM 122386

(220) 2023 04 07

(731) JSC "Panex"

Tbilisi-Red Bridge Highway 17th km., 3700,
Rustavi, Georgia

(540)

(591) Sky-blue, white, blue

(531) 07.01.24; 26.04.09; 27.05.01; 28.19; 29.01.04

(511) 6

(260) AM 2023 122389 A

(210) AM 122389

(220) 2023 04 07

(731) LLC "Giguashvili Law Office"

Tskneti Highway 22, floor 1, ap. 37b, 0179,
Tbilisi, Georgia

(540)



(591) 264658 blue, BB9C5F golden, white

(531) 27.05.01; 27.05.09; 27.05.10; 27.05.11;

27.05.21; 28.19; 29.01.12

(511) 45

(260) AM 2023 122404 A

(210) AM 122404

(220) 2023 04 10

(731) LTD "Madison Lab"

Vazha-Pshavela Av. 83/11, Tbilisi, Georgia

(540)



(591) E5E5E5 light grey, 032F3C dark sky-blue

(531) 24.13.01; 26.01.01; 26.15.01; 26.15.15; 28.19

(511) 44

(260) AM 2023 122405 A

(210) AM 122405

(220) 2023 04 10

(731) LTD "Stellar Group Georgia"

Gldani, V m/r, bld. 4, ap. 18, 0107, Gldani
District, Tbilisi, Georgia

(540)

(591) 56A540 green, 0F0101 black, F40C10 red,
white

(531) 03.09.01; 03.09.10; 26.11.09; 29.01.14

(511) 43

(260) AM 2023 122406 A

(210) AM 122406

(220) 2023 04 10

(731) LLC "Smile"

Stepane Zubalashvili St. 37, 6010, Batumi,
Georgia

(540)

(591) FFFFFFF white, E31E24 red, 1C1B17
black, sky-blue, blue

(531) 03.07.06; 26.01.02; 26.01.04; 26.01.15;
26.01.21; 29.01.13
(511) 30

(260) AM 2023 122412 A
(210) AM 122412
(220) 2023 04 11
(731) LTD "Park Gida"
Vill. Khutsubani, 5th Ubani, St. 46a, 6200,
Kobuleti, Georgia
(740) Dato Jaiani
(540)

48 Hours

(591) Black-white
(511) 5

(260) AM 2023 122420 A
(210) AM 122420
(220) 2023 04 13
(731) LTD "Rich Group"
Vill. Mughanlo, Marneuli Region, Georgia
(540)

Oxazar ოქსაზარი

(591) Black-white
(511) 35
35 – რეკლამა; ბიზნესის მართვა; ბიზნესის ად-
მინისტრირება; საოფისე მომსახურება.

(260) AM 2023 122421 A
(210) AM 122421
(220) 2023 04 13
(731) LTD "Rich Group"
Vill. Mughanlo, Marneuli Region, Georgia
(540)

AZADENT აზადენტი

(591) Black-white
(511) 35

(260) AM 2023 122423 A
(210) AM 122423
(220) 2023 04 13
(731) Guga Petriashvili
Gldani, bld. 21, ap. 88, Tbilisi, Georgia
(540)



(591) Green, red, light brown (straw), brown, light
lilac
(531) 07.01.09; 27.05.01; 29.01.13
(511) 30, 35

(260) AM 2023 122425 A
(210) AM 122425
(220) 2023 04 13
(731) IDS Borjomi Beverages Co.N.V.
Pareraweg №45, Curaçao
(740) Giorgi Jokharidze
(540)



(591) Silver, green, red, white, orange, light
orange, blue
(531) 03.04.07; 05.07.11; 25.01.25; 27.05.01;
29.01.15
(511) 32, 35

(260) AM 2023 122426 A
(210) AM 122426
(220) 2023 04 13
(731) IDS Borjomi Beverages Co.N.V.
Pareraweg №45, Curaçao
(740) Giorgi Jokharidze
(540)



(591) White, red, green, light green, yellow, silver,
blue
(531) 03.04.07; 05.07.12; 25.01.19; 27.05.01;
29.01.15
(511) 32, 35

(260) AM 2023 122427 A
(210) AM 122427
(220) 2023 04 13
(731) IDS Borjomi Beverages Co.N.V.
Pareraweg №45, Curaçao
(740) Giorgi Jokharidze

(540)



(591) Gold, green, white, red, light yellow, silver, blue

(531) 03.04.07; 05.07.15; 25.01.19; 25.01.25; 27.05.01; 29.01.15

(511) 32, 35

(260) AM 2023 122428 A

(210) AM 122428

(220) 2023 04 13

(731) IDS Borjomi Beverages Co.N.V.
Pareraweg №45, Curaçao

(740) Giorgi Jokharidze

(540)



(591) Green, tarhun green, red, white, light green, silver, blue

(531) 03.04.07; 05.11.11; 25.01.19; 25.01.25; 27.05.01; 29.01.15

(511) 32, 35

(260) AM 2023 122500 A

(210) AM 122500

(220) 2023 04 19

(731) LLC "American University of Athens"
Vazha-Pshavela Av. 20, ap. 70, 0165,
Saburtalo District, Tbilisi, Georgia

(540)

Harrison Institute Of Technology**HIT**

(591) 070707 black-white

(531) 27.05.01

(511) 41

(260) AM 2023 122567 A

(210) AM 122567

(220) 2023 04 21

(731) LLC "Studio Bicycle"

Gldani, VI m/r, bld. 20, ap. 81, 0107, Tbilisi
Georgia

(740) Lia Shikhiashvili;

Ioane Iarajuli;

Zurab Bezhashvili

(540)



(591) Brown, sky-blue, orange, yellow, red, white

(531) 03.02.09; 03.02.15; 07.01.09; 07.01.24; 28.19; 29.01.15

(511) 41, 43

(260) AM 2023 122574 A

(210) AM 122574

(220) 2023 04 25

(731) Shenzhen Uwell Technology Co., Ltd.
-5, 7/F, Bldg. G, Huafeng Intel. Robot
Industrial Park, Hangcheng, Av., Xixiang St,
Baoan Dist., Shenzhen, 518000, People's
Republic of China

(740) Giorgi Kartvelishvili

(540)

CALIBURN

(591) Black-white

(531) 27.05.01

(511) 34

(260) AM 2023 122575 A

(210) AM 122575

(220) 2023 04 25

(731) Shenzhen Uwell Technology Co., Ltd.
-5, 7/F, Bldg. G, Huafeng Intel. Robot
Industrial Park, Hangcheng, Av., Xixiang St,
Baoan Dist., Shenzhen, 518000, People's
Republic of China

(740) Giorgi Kartvelishvili

(540)



(591) Black-white

(531) 26.03.23; 27.01.01; 27.01.25

(511) 34

(260) AM 2023 122649 A
(210) AM 122649
(220) 2023 04 28
(731) Société des Produits Nestlé S.A.
1800 Vevey, Switzerland
(740) Tamaz Shilakadze
(540)



(591) Black, white, dark and light purple
(531) 01.15.21; 01.15.24; 01.15.25; 26.01.18;
26.01.24; 26.13.25; 27.05.01; 27.05.24;
29.01.13
(511) 5

REGISTERED TRADEMARKS

(111) M 2023 37425 R
 (151) 2023 10 18
 (181) 2033 10 18
 (260) AM 2022 120597 A
 (220) 2022 12 02

(732) LTD "Green Lab"
 D. Arakishvili St. 7, ap. 9, Vake District,
 Tbilisi, Georgia

(111) M 2023 37426 R
 (151) 2023 10 18
 (181) 2033 10 18
 (260) AM 2022 120233 A
 (220) 2022 11 07

(732) LLC "Rich Group"
 Vill. Mughanlo, Marneuli Region, Georgia

(111) M 2023 37427 R
 (151) 2023 10 18
 (181) 2033 10 18
 (260) AM 2022 119282 A
 (220) 2022 09 06

(732) Barceló Corporación Empresarial S.A.
 Calle José Rover Motta 27, 07006 Palma de
 Mallorca (Illes Balears), Spain

(111) M 2023 37428 R
 (151) 2023 10 18
 (181) 2033 10 18
 (260) AM 2022 120129 A
 (220) 2022 10 28

(732) JSC "Gefa"
 Akaki Beliashvili St. 142, 0159, Tbilisi,
 Georgia

(111) M 2023 37429 R
 (151) 2023 10 18
 (181) 2033 10 18
 (260) AM 2022 119190 A
 (220) 2022 08 29

(732) Otar Chekurishvili
 Tskneti Highway 23, ap. 37, 0179, Tbilisi,
 Georgia

(111) M 2023 37430 R
 (151) 2023 10 18
 (181) 2033 10 18
 (260) AM 2022 118766 A
 (220) 2022 07 29

(732) Bait Al-Shatira Fast Food Restaurants Company
 4005 Al Uyaynah road, Dhahrat Laban district,
 Riyadh 12562-7277, Saudi Arabia

(111) M 2023 37431 R
 (151) 2023 10 18
 (181) 2033 10 18
 (260) AM 2022 117272 A
 (220) 2022 03 28

(732) Philip Morris Brands Sàrl
 Quai Jeanrenaud 3, 2000 Neuchâtel, Switzerland

(111) M 2023 37432 R
 (151) 2023 10 18
 (181) 2033 10 18
 (260) AM 2022 120234 A
 (220) 2022 11 07

(732) LLC "Rich Group"
 Vill. Mughanlo, Marneuli Region, Georgia

(111) M 2023 37433 R
 (151) 2023 10 18
 (181) 2033 10 18
 (260) AM 2022 120502 A
 (220) 2022 11 25

(732) JSC "Nizhegorodskiy Khimiko-Pharmatsev-
 ticheskiy Zavod"
 Salganskaya St. 7, Nizhniy Novgorod, 603105,
 Russian Federation

(111) M 2023 37434 R
 (151) 2023 10 18
 (181) 2033 10 18
 (260) AM 2022 120052 A
 (220) 2022 10 27

(732) Shanxi Xinghuacun Fenjiu Distillery Co., Ltd.
 Xinghuacun Village, Fenyang City, Shanxi
 Province, People's Republic of China

(111) M 2023 37435 R
 (151) 2023 10 18
 (181) 2033 10 18
 (260) AM 2022 120024 A
 (220) 2022 10 25

(732) Shenzhen TCL New Technology CO., LTD.
 9/F, Building D4, International E City, 1001
 Zhongshan Park Road, Xili Street, Nanshan
 District, Shenzhen, 518000, Guangdong,
 People's Republic of China

(111) M 2023 37436 R
(151) 2023 10 18
(181) 2033 10 18
(260) AM 2022 120506 A
(220) 2022 11 28
(732) LLC "Aversi Pharma"
Davit Aghmashenebeli Av. 148, 0112, Tbilisi,
Georgia

(111) M 2023 37437 R
(151) 2023 10 18
(181) 2033 10 18
(260) AM 2022 119278 A
(220) 2022 09 05
(732) Otar Chekurishvili
Tskneti Highway 23, ap. 37, 0179, Tbilisi,
Georgia

(111) M 2023 37438 R
(151) 2023 10 18
(181) 2033 10 18
(260) AM 2022 120519 A
(220) 2022 11 29
(732) Iliia Skanadze
Gela Kakiashvili St. 30, Khashuri, Georgia

(111) M 2023 37439 R
(151) 2023 10 18
(181) 2033 10 18
(260) AM 2022 120444 A
(220) 2022 11 22
(732) Ferrari S.P.A.
Via Emilia Est 1163, Modena, Italy

(111) M 2023 37440 R
(151) 2023 10 18
(181) 2033 10 18
(260) AM 2022 120445 A
(220) 2022 11 22
(732) Ferrari S.P.A.
Via Emilia Est 1163, Modena, Italy

(111) M 2023 37441 R
(151) 2023 10 18
(181) 2033 10 18
(260) AM 2022 119343 A
(220) 2022 09 09
(732) Slazengers Limited
Unit A, Brook Park East, Shirebrook
NG20 8RY, United Kingdom

(111) M 2023 37447 R
(151) 2023 10 23
(181) 2033 10 23
(260) AM 2022 118839 A
(220) 2022 08 01
(732) MEDI Plus TEC Medizinisch-Technische
Handelsgesellschaft MBH
Baerler Str. 100, Moers, 47441, Germany

(111) M 2023 37448 R
(151) 2023 10 23
(181) 2033 10 23
(260) AM 2022 120351 A
(220) 2022 11 16
(732) Partner Center sp. z o.o.
(Partner Center Limited Liability Company)
ul. Piotrkowska 89, 90-423, Lodz, Poland

(111) M 2023 37449 R
(151) 2023 10 23
(181) 2033 10 23
(260) AM 2022 120022 A
(220) 2022 10 24
(732) BMJ Industries FZ-LLC
Al-Hamra Industrial Zone-FZ, Ras Al Khaimah,
United Arab Emirates

(111) M 2023 37450 R
(151) 2023 10 23
(181) 2033 10 23
(260) AM 2022 119897 A
(220) 2022 10 20
(732) Philip Morris Products S.A.
Quai Jeanrenaud 3, 2000 Neuchâtel, Switzerland

(111) M 2023 37451 R
(151) 2023 10 23
(181) 2033 10 23
(260) AM 2022 119619 A
(220) 2022 09 30
(732) LLC "Pirveli Meghvineoba"
At the corner of Zovreti and Mgaloblishvili
Streets, Saburtalo District, Tbilisi, Georgia

(111) M 2023 37452 R
(151) 2023 10 23
(181) 2033 10 23
(260) AM 2022 120737 A
(220) 2022 12 15
(732) Zurab Topuridze
Nutsubidze Slope, III m/r, II qu., bld. 3, ap. 1,
Tbilisi, Georgia

<p>(111) M 2023 37453 R (151) 2023 10 23 (181) 2033 10 23 (260) AM 2022 120724 A (220) 2022 12 13 (732) Cegos SA 19 rue René Jacques, ISSY-LES-Moulineaux, 92130, France</p>	<p>(111) M 2023 37459 R (151) 2023 10 23 (181) 2033 10 23 (260) AM 2022 120535 A (220) 2022 12 02 (732) Philip Morris Products S.A. Quai Jeanrenaud 3, 2000 Neuchâtel, Switzerland</p>
<p>(111) M 2023 37454 R (151) 2023 10 23 (181) 2033 10 23 (260) AM 2022 119819 A (220) 2022 10 13 (732) Shenzhen GreenSound High-Tech Co., LTD 2nd/3rd Flor Bilding Si, 2nd/3rd Flor Bilding Di, 13rd Tonfuiu Indaustrial Park, Hepin Qomiuniti, Fuhai Strit Bao'an Distriqt, Shenjen Siti 518000, People's Republic of China</p>	<p>(111) M 2023 37460 R (151) 2023 10 23 (181) 2033 10 23 (260) AM 2022 119810 A (220) 2022 10 13 (732) LTD "Agrochemicals Georgia" Dighomi, VI qu., bld. 9, ap. 50, Didube- Chughureti District, Tbilisi, Georgia</p>
<p>(111) M 2023 37455 R (151) 2023 10 23 (181) 2033 10 23 (260) AM 2022 120532 A (220) 2022 12 01 (732) Philip Morris Products S.A. Quai Jeanrenaud 3, 2000 Neuchâtel, Switzerland</p>	<p>(111) M 2023 37461 R (151) 2023 10 23 (181) 2033 10 23 (260) AM 2022 120176 A (220) 2022 11 03 (732) BGV S.R.O. Hniezdne 471, SK-06501 Hniezdne, Slovakia</p>
<p>(111) M 2023 37456 R (151) 2023 10 23 (181) 2033 10 23 (260) AM 2022 120533 A (220) 2022 12 02 (732) Philip Morris Products S.A. Quai Jeanrenaud 3, 2000 Neuchâtel, Switzerland</p>	<p>(111) M 2023 37462 R (151) 2023 10 23 (181) 2033 10 23 (260) AM 2022 120021 A (220) 2022 10 24 (732) Farm Fresh L.L.C. P.O. Box 7011, GMG Building, Umm Hurair Rd, Oud Metha, Bur Dubai, Dubai, United Arab Emirates</p>
<p>(111) M 2023 37457 R (151) 2023 10 23 (181) 2033 10 23 (260) AM 2022 120168 A (220) 2022 11 03 (732) LTD "Kakhetian Traditional Winemaking" S. Tsintsadze St. 12, 0160, Tbilisi, Georgia</p>	<p>(111) M 2023 37463 R (151) 2023 10 23 (181) 2033 10 23 (260) AM 2022 120177 A (220) 2022 11 04 (732) BGV S.R.O. Hniezdne 471, SK-06501 Hniezdne, Slovakia</p>
<p>(111) M 2023 37458 R (151) 2023 10 23 (181) 2033 10 23 (260) AM 2022 120534 A (220) 2022 12 02 (732) Philip Morris Products S.A. Quai Jeanrenaud 3, 2000 Neuchâtel, Switzerland</p>	<p>(111) M 2023 37464 R (151) 2023 10 23 (181) 2033 10 23 (260) AM 2022 120175 A (220) 2022 11 03 (732) BGV S.R.O. Hniezdne 471, SK-06501 Hniezdne, Slovakia</p>

(111) M 2023 37465 R
(151) 2023 10 23
(181) 2033 10 23
(260) AM 2022 119895 A
(220) 2022 10 19
(732) Philip Morris Products S.A.
Quai Jeanrenaud 3, 2000 Neuchâtel, Switzerland

(111) M 2023 37466 R
(151) 2023 10 23
(181) 2033 10 23
(260) AM 2022 119896 A
(220) 2022 10 19
(732) Philip Morris Products S.A.
Quai Jeanrenaud 3, 2000 Neuchâtel, Switzerland

(111) M 2023 37467 R
(151) 2023 10 23
(181) 2033 10 23
(260) AM 2022 119898 A
(220) 2022 10 20
(732) Philip Morris Products S.A.
Quai Jeanrenaud 3, 2000 Neuchâtel, Switzerland

(111) M 2023 37468 R
(151) 2023 10 23
(181) 2033 10 23
(260) AM 2022 120341 A
(220) 2022 11 14
(732) Philip Morris Products S.A.
Quai Jeanrenaud 3, 2000 Neuchâtel, Switzerland

(111) M 2023 37471 R
(151) 2023 10 23
(181) 2033 10 23
(260) AM 2022 120368 A
(220) 2022 11 17
(732) Philip Morris Products S.A.
Quai Jeanrenaud 3, 2000 Neuchâtel, Switzerland

(111) M 2023 37472 R
(151) 2023 10 23
(181) 2033 10 23
(260) AM 2022 120342 A
(220) 2022 11 14
(732) Philip Morris Products S.A.
Quai Jeanrenaud 3, 2000 Neuchâtel, Switzerland

(111) M 2023 37473 R
(151) 2023 10 23
(181) 2033 10 23
(260) AM 2022 120167 A
(220) 2022 11 03

(732) LTD "Kakhetian Traditional Winemaking"
S. Tsintsadze St. 12, 0160, Tbilisi, Georgia

(111) M 2023 37474 R
(151) 2023 10 23
(181) 2033 10 23
(260) AM 2022 120002 A
(220) 2022 10 21
(732) LTD "Kakhetian Traditional Winemaking"
S. Tsintsadze St. 12, 0160, Tbilisi, Georgia

(111) M 2023 37475 R
(151) 2023 10 23
(181) 2033 10 23
(260) AM 2022 119995 A
(220) 2022 10 21
(732) LTD "Kakhetian Traditional Winemaking"
S. Tsintsadze St. 12, 0160, Tbilisi, Georgia

(111) M 2023 37476 R
(151) 2023 10 23
(181) 2033 10 23
(260) AM 2022 120001 A
(220) 2022 10 21
(732) LTD "Kakhetian Traditional Winemaking"
S. Tsintsadze St. 12, 0160, Tbilisi, Georgia

(111) M 2023 37477 R
(151) 2023 10 23
(181) 2033 10 23
(260) AM 2022 119996 A
(220) 2022 10 21
(732) LTD "Kakhetian Traditional Winemaking"
S. Tsintsadze St. 12, 0160, Tbilisi, Georgia

(111) M 2023 37478 R
(151) 2023 10 23
(181) 2033 10 23
(260) AM 2022 120166 A
(220) 2022 11 03
(732) LTD "Kakhetian Traditional Winemaking"
S. Tsintsadze St. 12, 0160, Tbilisi, Georgia

TRADEMARKS REGISTERED ACCORDING TO THE ACCELERATED PROCEDURE

The decision can be appealed at the Chamber of Appeal of Sakpatenti within 3 months from the publication.

(111) M 2023 37442 R

(151) 2023 10 19

(181) 2033 10 19

(210) AM 125059

(220) 2023 10 11

(732) Cooperative "SSK"

Vil. Garalovka, 4th Street 57, Ninotsminda,
Georgia

(540)



(591) Yellow, brown, red, white, sky-blue, green,
black, blue

(531) 06.19.07; 06.19.09; 06.19.16; 07.01.08;
07.01.09; 07.01.11; 08.03.08; 25.01.09;
25.01.10; 25.01.25; 27.05.01; 29.01.15

(511) 29

(111) M 2023 37443 R

(151) 2023 10 19

(181) 2033 10 19

(210) AM 125064

(220) 2023 10 11

(732) LLC "Nice Day Company"

Gldani, III m/r, bld. 80, Gldani District, Tbilisi,
Georgia

(540)



(591) White, red

(531) 26.04.05; 26.04.22; 26.04.24; 27.05.01;
27.05.24; 29.01.12

(511) 30

(111) M 2023 37444 R

(151) 2023 10 19

(181) 2033 10 19

(210) AM 124807

(220) 2023 09 25

(732) Hair Company S.r.l.

Via Siracusa, 8, Frazione Bolladello, Cairate
(VA), 21050, Italy

(740) Shalva Gvaranadze

(540)

HAIR COMPANY

(591) Black-white

(531) 26.01.19; 26.01.24; 27.05.01

(511) 3

(111) M 2023 37445 R

(151) 2023 10 19

(181) 2033 10 19

(210) AM 124965

(220) 2023 10 04

(732) LTD "Tamiro"

Al. Kazbegi Av. 24g, Ent. 8, floor 16, ap. 297,
0160, Tbilisi, Georgia

(540)

TAMIRO
Watch & Jewellery

(591) Black-white

(531) 27.05.01; 27.05.10; 27.05.22

(511) 14, 35

(111) M 2023 37446 R

(151) 2023 10 20

(181) 2033 10 20

(210) AM 124817

(220) 2023 09 26

(732) Roland Priborsky

Kojori, Tskaro St. 1 a, Mtatsminda-
Krtsanisi District, Tbilisi, Georgia

(540)

IRON GPT

(591) Black-white

(531) 01.15.21; 15.09.12; 26.13.25; 27.05.01
(511) 38

(111) M 2023 37469 R
(151) 2023 10 23
(181) 2033 10 23
(210) AM 125165
(220) 2023 10 17
(732) LLC "Georgian Wine and Spirits Company"
Achinebuli, 2200, Telavi, Georgia
(540)

Kitsi & Kitsmatsuri

(591) Black-white
(511) 33

(111) M 2023 37470 R
(151) 2023 10 23
(181) 2033 10 23
(210) AM 125141
(220) 2023 10 13
(732) Aquaprole Inc.
88 Scott Street, M5E 0A9, Toronto, Canada
(740) Shalva Giorgadze
(540)



(591) White, green, blue, black
(531) 01.05.01; 01.05.05; 01.05.10; 01.15.14;
01.15.15; 27.05.01; 29.01.14
(511) 29, 35

(111) M 2023 37479 R
(151) 2023 10 26
(181) 2033 10 26
(210) AM 125058
(220) 2023 10 11
(732) Cooperative Shir-Ant
Vill. Jigrasheni, Ninotsminda, Georgia
(540)



(591) Black, blue, sky-blue, yellow, green, white,
brown
(531) 06.19.11; 06.19.13; 08.03.08; 27.05.01;
27.05.09; 27.05.10; 28.19; 29.01.15
(511) 29

(111) M 2023 37480 R
(151) 2023 10 26
(181) 2033 10 26
(210) AM 125135
(220) 2023 10 13
(732) Nobel Ilac Sanayii ve Ticaret Anonim
Sirketi - Representative in Georgia
Freedom Square 4, 0105, Tbilisi, Georgia
(740) Tinatin Tskhvediani
(540)

Praxobel პრახობელი

(591) Black-white
(511) 5

(111) M 2023 37481 R
(151) 2023 10 26
(181) 2033 10 26
(210) AM 125179
(220) 2023 10 18
(732) LTD "Nova"
R. Agladze St. 45, 0119, Tbilisi, Georgia
(540)



(591) Dark grey, orange, white, light grey
(531) 26.04.17; 27.05.21; 29.01.12
(511) 17

(111) M 2023 37482 R
(151) 2023 10 26
(181) 2033 10 26
(210) AM 125174
(220) 2023 10 18
(732) Kenover Marketing Corp.
72 New Hook Road, Bayonne, New Jersey,
07002, USA
(740) Irakli Gvilia
(540)

GEFEN

(591) Black-white
(511) 32

(111) M 2023 37483 R
(151) 2023 10 27
(181) 2033 10 27
(210) AM 125265
(220) 2023 10 24
(732) Marcel Atashyan
Khvedeliani St. 49, Tbilisi, Georgia

(540)



(591) Black, golden

(531) 03.01.08; 24.01.09; 25.01.25; 26.04.02;
26.04.16; 26.04.22; 26.04.24; 27.05.01;
27.05.24; 29.01.12

(511) 18, 25

(111) M 2023 37484 R

(151) 2023 10 30

(181) 2033 10 30

(210) AM 125261

(220) 2023 10 23

(732) Sergiy Billi

V. Dolidze St. 27/3, Tbilisi, Georgia

(540)



(591) Green, orange, cream

(531) 01.03.01; 01.07.01; 26.01.19; 27.05.01;
27.05.10; 27.05.24; 29.01.13

(511) 41

(111) M 2023 37485 R

(151) 2023 11 02

(181) 2033 11 02

(210) AM 124947

(220) 2023 10 02

(732) JSC "Viani"

Akaki Beliashvili St. 142, 0159, Tbilisi,
Georgia

(540)

საქართველოს კლინიკები

(591) Black-white

(526) საქართველო

(511) 44

INTERNATIONAL TRADEMARKS FOR WHICH A DECISION ON GRANTING PROTECTIONS IS TAKEN

The decision can be appealed at the Chamber of Appeal of Sakpatenti within 3 months from the publication or at the Mtskheta District Court Administrative Cases Board (Address: №17, Samkhedro St., Mtskheta), within 1 month following the publication.

(260) AM 2023 117887 A*

(800) 1516597

(151) 2020 01 09

(891) 2022 04 27

(731) Gulf Air B.S.C. (c)

P.O. Box 138, Manama, Bahrain

(540)

GULF AIR A CLASS OF OUR OWN

(591) Black, white

(511)

39 – Transport (except transport associated with fuel and lubricants); packaging and storage of goods (except packaging and storage of fuel and lubricants); air transport of goods (except air transport of fuel and lubricants); air cargo transport (except air transport of fuel and lubricants); loading of air freight and cargo (except loading of fuel and lubricants); arranging for the storage and transportation of goods (except arranging for the storage and transportation of fuel and lubricants); the mentioned services are not associated with storage, transportation and delivery of fuel and lubricants.

(260) AM 2023 119053 A

(800) 1678738

(151) 2021 12 29

(891) 2021 12 29

(731) DAIKIN ISITMA VE SOĞUTMA

SİSTEMLERİ SANAYİ VE TİCARET ANONİM ŞİRKETİ

Gülsuyu Mahallesi Fevzi Çakmak Caddesi, Burçak Sokak No:20/A, Maltepe, İstanbul, Türkiye

(540)



(591) Red

(531) 27.05.01; 29.01.01

(511)

11 – Lighting installations; lights for vehicles and interior-exterior spaces; heating installations using solid, liquid or gas fuels or electricity; central heating boilers; boilers for heating installations; radiators [heating]; heat exchangers, not parts of machines; stoves; kitchen stoves; solar thermal collectors [heating]; steam, gas and fog generators; steam boilers, other than

parts of machines; acetylene generators; oxygen generators; nitrogen generators; installations for airconditioning and ventilating; cooling installations and freezers; electric and gas-powered devices, installations and apparatus for cooking, drying and boiling: cookers; electric cooking pots; electric water heaters; barbecues; electric laundry driers; hair driers; hand drying apparatus; sanitary installations; taps [faucets]; shower installations; toilets [water-closets]; shower and bathing cubicles; bath tubs; toilet seats; sinks; wash-hand basins [parts of sanitary installations]; washers for water taps; water softening apparatus; water purification apparatus; water purification installations; waste water purification installations; electric pillow warmers; electric or non-electric footwarmers; hot water bottles; electrically heated socks; filters for aquariums and aquarium filtration apparatus; pasteurizers and sterilizers.

(260) AM 2023 119311 A*

(800) 1681493

(151) 2022 08 01

(891) 2022 08 01

(731) The William Carter Company

3438 Peachtree Road NE, Suite 1800, Atlanta GA 30326, USA

(540)

CARTER'S

(591) Black, white

(511)

35 – Retail store and on-line retail store services featuring clothing, footwear, headwear, bedding, handbags, furniture, toys, and related accessory products for infants and children.

(260) AM 2023 119393 A

(800) 1682680

(151) 2022 07 12

(891) 2022 07 12

(731) COTTON CLUB INVESTMENT LLC

1'st Lipovy per., vl. 4, d. Soboliha, g. Balashiha, RU-143985 Moscow obl., Russian Federation

(540)



(591) Light blue, blue, dark blue and white
(531) 02.09.01; 25.03.03; 26.13.25; 27.05.01;
27.05.24; 29.01.12

(511)

3 – Bleaching preparations [decolorants] for household purposes; laundry bleach; colour-brightening chemicals for household purposes [laundry].

5 – Wadding for medical purposes; babies' diapers; swim diapers, reusable, for babies; swim diapers, disposable, for babies; diaper changing mats, disposable, for babies; breast-nursing pads; sanitary towels; panty liners [sanitary]; sanitary panties; babies' diaper-pants.

(260) AM 2023 119668 A

(800) 1054145

(151) 2010 01 15

(891) 2022 08 24

(731) BETEK BOYA VE KİMYA SANAYİ
ANONİM ŞİRKETİ

Gebze Organize Sanayi Bölgesi, Tembelova
Alanı 3200 Sok. No:3206, Gebze, Kocaeli,
Türkiye

(540)

Fayfiks

(591) Black, white

(531) 27.05.01

(511)

17 – Natural rubber, gutta-percha, rubber, rock wool (asbestos), mica or semi-finished synthetic materials and goods made from these materials and not included in other classes in the form of powder, plate, rod and foil; semi-finished synthetic materials and substances included in this class for energy insulation and absorption purposes; flexible pipes, hoses (including those used in vehicles) made of rubber, plastic or natural rubber, pipe sheaths and sleeves, hoses made of textile, fire hoses, non-metallic pipe sheaths and sleeves, radiator hoses for vehicles; materials and substances for sound, heat and electricity insulation: insulators, glass wools, foams, insulation plates; insulation plates made of mica, insulating materials, fabrics and coatings; paper, cardboard and bases with asbestos for insulation; insulation paints, varnishes and oils, adhesive bands other than stationary and not for medical or household purposes, insulating strips and bands not for stationary, household or medical use; insulating strips and bands for doors and windows of buildings and vehicles, asbestos covering, asbestos containing fibers and plates, asbestos containing felts and fabrics, stuffing of rubber or plastic and buffers of rubber, chemical compositions for repairing the holes and cracks; grout, silicone pastes, non-metallic heat insulation plates, insulation panels, insulation plates for use under roofing tiles in the roofs; fillers for expansion joints.

(260) AM 2023 119922 A

(800) 1690157

(151) 2022 08 18

(891) 2022 08 18

(731) NURDOĞUŞ GİYİM SANAYİ VE TİCARET
LİMİTED ŞİRKETİ

ÇAĞLAYAN PARK SOKAK 15,
KAĞITHANE, İSTANBUL, Türkiye

(540)



EXPLOSION

(591) Black, white

(531) 27.05.14; 27.05.22

(511)

18 – Leather and imitations of leather, animal skins and hides, luggage and carrying bags.

(260) AM 2023 120211 A

(800) 1693882

(151) 2022 05 19

(891) 2022 05 19

(731) LEGO Juris A/S

Koldingvej 2, DK-7190 Billund, Denmark

(540)

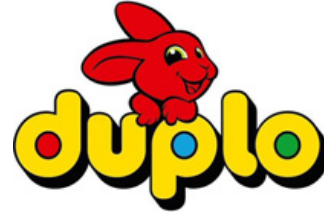

(591) Red, yellow, blue, green

(531) 03.05.01; 03.05.24; 03.05.25; 27.05.01;
27.05.03; 27.05.08; 27.05.17; 29.01.15

(511)

9 – Scientific, nautical, surveying, photographic, cinematographic, optical, weighing, measuring, signalling, checking (supervision), life-saving and teaching apparatus and instruments; apparatus and instruments for conducting, switching, transforming, accumulating, regulating or controlling electricity; apparatus for recording, transmission or reproduction of sound or images; magnetic data carriers, recording discs; mechanisms for coin-operated apparatus; cash registers, calculating machines, data processing equipment and computers; software; fire-extinguishing apparatus; magnets; electrical apparatus and instruments (including wireless) for use in communications; video tapes, magnetic tapes contained in cassettes and gramophone records; recorded computer programs and software; computer software for use in computer aided design; computer software for use in manipulating drawings and graphics files; computer software used to create two and three dimensional curves, surfaces and solids; computer programs (downloadable

software); computers and computer hardware (included in this class), namely keyboards, terminals, monitors, disc stations, interfaces, interface cables, discs and floppy disks, computer programmes (software); photographic, film and optical apparatus and instruments; apparatus and instruments for education; recorded sound and image carriers, especially films, gramophone records, sound tapes, sound cassettes, compact discs, video records, video tapes; transparencies (photography); motion picture films (recorded); animated films, including animated cinematographic films prepared for exhibitions; electronic publications (including downloadable electronic publications); electronic downloadable publications; animated cartoons; digital audio devices, including portable digital audio devices; electronic apparatus and devices for use with digital audio players; computer game programs; computer game software; software providing multi-user access to an online virtual environment; interactive multimedia multi-user computer games; USB sticks; educational computer programs used for teaching mathematics, science and technology and/or use in the computer-assisted design of toy models and structures; glasses, including sun glasses; educational resources for teachers and educators, namely downloadable computer software for design and construction of construction toys; downloadable images for use as computer wallpaper and screensavers; downloadable computer games; educational resources for teachers and educators, namely downloadable computer software for uploading images of design and construction of construction toys; reflective articles for wear, for the prevention of accidents; computer accessories, namely, computer cables, interface boxes used to connect model robots, model vehicles or other motorized building set constructions to a computer, through which the computer operator controls them, and slot cards used to adapt a computer therefor; radios, CD players, MP3 players, digital cameras.

16 – Paper, cardboard; printed matter; books, magazines, newsletters, printed manuals and user guides; stickers, trading cards, books for collecting stickers and trading cards; pamphlets, postcards, greeting cards, posters, calendars, book binding material; photographs; stationery, writing paper, envelopes, writing and drawing pads, notebooks, pens and pencils, pen and pencil cases, pencil sharpeners, erasers; adhesives for stationery or household purposes; artists' materials; paint brushes; typewriters and office requisites (except furniture); instructional and teaching material (except apparatus); plastic materials for packaging (not included in other classes); printers' type; printing blocks; printed building instructions; wrapping paper and gift tags.

21 – Household or kitchen utensils and containers (not of precious metal or coated therewith); combs and sponges; brushes (except paint brushes); brush-making materials; articles for cleaning purposes; ste-

elwool; unworked or semi-worked glass (except glass used in building); lunch boxes; ice cube molds; piggy banks.

25 – Clothing; footwear; headgear.

28 – Games and playthings; gymnastic and sporting articles not included in other classes; decorations for Christmas trees; handheld electronic video games (for use with television receivers only); video game apparatus and electronic game equipment.

41 – Education; providing of training; entertainment; sporting and cultural activities; providing online fan-club services [education] for users of construction toys via the Internet; providing online fan-club services [entertainment] for users of construction toys via the Internet; educational and entertainment services, including providing online educational and entertainment services, namely interactive games, activities, stories, comic books, information in the fields of education and entertainment, on-line computer games, video, audio and images, all featuring toys, cartoons, construction toys or robotic toys; educational and entertainment services, including the provision of articles and demonstrations for parents and educators, all available via the Internet; entertainment services, including conducting parties; providing online games; online game services; providing online multi-user computer games; electronic games services, including provision of computer games online or by means of a global computer; providing a computer game that may be accessed by users on a global network and/or the Internet network; providing interactive multi-user computer games via the Internet and electronic communication networks; entertainment services; education services; organising competitions for entertainment purposes, competitions for educational purposes; organisation of competitions for recreational purposes; camps for educational purposes; camps for entertainment purposes; camps for recreational purposes.

(260) AM 2023 120265 A

(800) 1694110

(151) 2022 06 20

(891) 2022 06 20

(731) MUSTANG – Bekleidungswerke GmbH + Co. KG

Karl-Kurz-Straße 44/1, 74523 Schwäbisch Hall, Germany

(540)

MUSTANG

(591) Black, white

(531) 27.05.01

(511)

3 – Soap; perfumery; ethereal oils; cosmetics; hair lotions; dentifrices; deodorising preparations for per-

sonal use (perfumery); room sprays as fragrance sprays.

14 – Goods in precious metals and/or their alloys and coated therewith, namely works of art, ornaments, key rings [split rings with trinket or decorative fob], jewellery charms and decorative articles [trinkets or jewellery] for personal use; jewellery; paste jewellery, clocks, wrist watches, pocket watches.

18 – Goods made from leather and imitation leather, namely bags and other containers not adapted to the objects to be accommodated, as well as small leather goods, namely purses, pocket wallets, key bags, labels of leather, cases (for storing keys), luggage tags, cosmetic purses, toiletry bags; handbags; reusable shopping bags; sport bags; sport packs; briefcases; school knapsacks; rucksacks; suitcases and small suitcases; travelling bags; umbrellas and parasols.

24 – Textiles; fabrics; curtains; textile fabrics for the production of roller blinds; household linen; table linen; bed linen; bed covers; table covers; handkerchiefs of textile; fabric of imitation animal skins; non-woven fabrics; towels; face towels of textile.

25 – Clothing, in particular trousers, denim jeans, shirts and blouses, skirts and dresses, shorts, t-shirts, tops, sweaters, sweat shirts, parkas, coats, jackets [clothing], scarves, pyjamas, nighties, dressing gowns, bathrobes, foundation garments and undergarments, corsets [underclothing], socks, stockings; sportswear; workwear; clothing for children; clothing of leather; belts; suspenders [braces]; headgear; footwear; shoes; sports shoes.

35 – Advertising; marketing and public relations; promotional services; business management; business administration; office functions; bringing together, for the benefit of others, of a variety of goods, namely of clothing and accessories, footwear, headwear, handbags and leather goods, perfumery and cosmetics, sporting goods, jewellery and watches and other fashion and lifestyle goods, excluding the transport thereof, to enable customers to conveniently view and purchase these items in retail stores, through catalogues and electronic media; presentation of goods for sales purposes, enabling customers to compare and purchase those goods; procurement services for others [purchasing goods and services for other businesses]; management services for retailing, mail order and/or online businesses; information and advice regarding retail stores; import and export agency services; franchise management in connection with the operation or management of commercial enterprises.

(260) AM 2023 121003 A

(800) 1704827

(151) 2022 11 04

(891) 2022 11 04

(731) Richter Gedeon Nyrt.

Gyömrői út 19-21., H-1103 Budapest, Hungary

(540)

BOZITEDIN

(591) Black, white

(511)

5 – Pharmaceutical preparations.

(260) AM 2023 121004 A

(800) 1704941

(151) 2022 05 25

(891) 2022 05 25

(731) AUTOMOBILI LAMBORGHINI SPA

Via Modena 12, I-40019 Sant'Agata Bolognese
(BO), Italy

(540)

REVUELTO

(591) Black, white

(511)

12 – Cars; electric cars; spray prevention flaps for vehicles; automobile tires [tires]; automobile hoods; steering wheels for vehicles; anti-theft devices for vehicles; bumpers for automobiles; horns for motor cars; automobile bodies; car seats; automobile engines; motor racing cars; automobile chassis; shock absorbers for automobiles; upholstery for automobiles; electric motors for motor cars; self-driving cars; wheel rims [for automobiles]; automobiles and structural parts therefor; racing seats for automobiles; interior trim parts of automobiles; automatic gearboxes for motor cars; gear shifts for automobiles; powerboats; cycle cars; electric vehicles; bicycles; hybrid cars; brakes for motor cars; disc brake pads for land vehicles; spoilers for vehicles; spoilers for water vehicles; spoilers for land vehicles; air flow spoilers for vehicles; spoilers for air vehicles; hydraulic brake pressure regulators for vehicles; aerodynamic attachments for vehicle bodies; self-balancing boards; civilian drones; camera drones; delivery drones; push scooters [vehicles]; motorized and non-motorized scooters for personal transportation; folding bikes; electric bicycles; sports bicycles; bicycles; racing bicycles; children's bicycles; bicycle frames; mountain bikes; engines for bicycles; motorcycles; folding electric bicycles; electrically operated wheelchairs; wheelchairs; yachts; motor yachts; scooters; scooters [vehicles]; water scooters; self balancing electric scooters; electric one wheel scooters; motorised scooters for the disabled and those with mobility difficulties; boats; jet boats; pneumatic boats; inflatable boats; ships; motor-bikes.

28 – Toy cars; scale model vehicles; racing car games; toy pedal cars; toy vehicle tracks; kits of parts [sold complete] for making toy model cars; scale model cars [toys]; radio controlled toy model cars; sports equipment; sports games; arcade games machines; electronic games; electronic hand-held game units; racing car games; hand-held electronic games; electronic games for the teaching of children; toys, games,

and playthings; jigsaw puzzles; drones [toys]; scooters [toys]; toy bicycles; toy boats; toy scooters.

(260) AM 2023 121005 A

(800) 1704988

(151) 2022 09 15

(891) 2022 09 15

(731) Clinical Services Corporate Operations, Inc.

271 Waverly Oaks Rd. Suite 208, Waltham

MA 02452, USA

(540)



(591) The color(s) Dark blue, orange and gold is/are claimed as a feature of the mark

(531) 27.05.01; 27.05.09; 29.01.13

(511)

9 – Downloadable computer application software for use in connection with the collection, tracking, retrieval, validation, summarization, statistical analysis and presentation of data used in the areas of medical research and product regulatory approval, environmental health, health care, and in relation to the design, research, development, and testing of new medical products and devices; downloadable computer application software for providing telehealth, telemedicine, remote care and virtual health care services to patients; downloadable computer application software for use in connection with collection, tracking, retrieval, validation, summarization, statistical analysis and presentation of remotely gathered patient-generated health data for use in clinical studies.

35 – Providing statistical information and analysis resulting from clinical trials in the fields of pharmaceuticals, biotechnology, medical devices and diagnostics; providing data processing, project management and cost management services for preclinical and clinical trials in the fields of pharmaceuticals, biotechnology, medical devices and diagnostics; designing laboratory research, namely, managing and monitoring preclinical and clinical trials; data management, namely, abstraction and collection of medical data from clinical tests for business purposes; market research and business marketing consulting services in the pharmaceutical, biotechnology, medical device, and diagnostics industries.

38 – Providing access to online database for controlling and managing electronic health records and patient health and medical information, for communications between patients and their health care providers, and for medical practice management.

41 – Training and development in the field of conducting clinical trials, namely, conducting tutorials, seminars and workshops in the field of clinical trials; training in the field of computer software support, name-

ly, conducting tutorials, seminars and workshops in the field of software support.

42 – Scientific research for others conducted using databases for collection of patient-generated health data; cloud computing featuring software that allows users to collect, review, analyze and report on clinical research; technical support services, namely, installation and remote administration of software, and troubleshooting of software problems and hosted software applications, all for use in connection with medical research and product regulatory approval, environmental health, health care, and in relation to the design, research, development, and testing of new medical products and devices; cloud computing featuring software for providing telehealth, telemedicine, remote care and virtual health care services to patients; cloud computing featuring software that allows users to collect, track, retrieve, validate, summarize, statistically analyze and present data used in the areas of medical research and product regulatory approval, environmental health, health care, and in relation to the design, research, development, and testing of new medical products and devices; cloud computing featuring software to aggregate, integrate, transfer and manage data generated from home health and remote monitoring devices and applications and health-related smartphone applications; cloud computing featuring software that provides integrated workflows, analytics, visualizations, and reporting features to deliver, process, analyze, elevate, and display patient-generated health data; cloud computing featuring software that integrates remotely collected health data into databases, systems, platforms, applications, and software that inform clinical research, remote monitoring, and care management; providing a web-based portal for study sponsors and contract research organizations (CROs) to build programs, enroll members, automate actions, and visualize/analyze data in connection with clinical studies; technical consulting services, namely, evaluating the safety of pharmaceutical, medical, cosmetic and consumer devices and products in clinical development or in commercial production.

45 – Development of regulatory compliance strategies in the field of medical research, namely, regulatory compliance in drug, biologic, cosmetic and medical device development.

(260) AM 2023 121076 A

(800) 1705997

(151) 2022 07 05

(891) 2022 07 05

(731) Tovarishchestvo s ogranichennoy otvetstvennostyu «Torgovaya kompaniya "PLYUS" ulitsa Kabdolova, 16, korpus 1, ofis 301, Auezovskiy rayon, 050062 gorod Almaty, Kazakhstan

(540)



(591) Blue, white and red

(531) 07.01.08; 07.01.09; 07.01.24; 27.05.09;
27.05.17; 29.01.12

(526) Euro, Mebel

(511)

16 – Paper and cardboard; printed matter; bookbinding material; photographs [printed]; stationery; adhesive bands for stationery or household purposes; artists' materials; paintbrushes; typewriters and office requisites [except furniture]; instructional and teaching materials; plastic film for wrapping; printing type; printing blocks; fountain pens; posters; banners of paper; forms, printed; announcement cards [stationery]; note books; pads [stationery]; loose-leaf binders; pamphlets; booklets; newsletters; signboards of paper or cardboard; bookmarks; printed publications; calendars; pencils; pictures; cards; index cards [stationery]; catalogues; envelopes [stationery]; boxes of paper or cardboard; printed coupons; flyers; bags [envelopes, pouches] of paper or plastics, for packaging; greeting cards; conical paper bags; folders for papers/jackets for papers; desk mats; writing cases [sets]; office requisites, except furniture; printed matter; marking pens [stationery]; writing or drawing books; stationery; flags of paper; photographs [printed]; address stamps; stamps [seals]; shields [paper seals]; prints [engravings]; labels of paper or cardboard.

20 – Furniture; mirrors [looking glasses]; picture frames; artificial horns, bone, ivory, whalebones or mother-of-pearl, unworked or semi-worked; shells; meerscham; yellow amber; picture frame brackets; sideboards; bolsters; work benches; vice benches [furniture]; valet stands; coatstands; display stands; showcases [furniture]; signboards of wood or plastics; covers for clothing [wardrobe]; doors for furniture; divans; flower-stands [furniture]; hand-held mirrors [toilet mirrors]; bamboo, unworked or semi-worked; rattan; wickerwork; works of art of wood, wax, plaster or plastic; cabinet work; settees; index cabinets [furniture]; bed casters, not of metal; furniture casters, not of metal; bassinets; chests of drawers; console tables; containers, not of metal [storage, transport]; lecterns; armchairs; deck chairs; hospital beds; bedsteads of wood; beds; cots for babies; edgings of plastic for furniture; brackets, not of metal, for furniture; table tops; clothes hooks, not of metal; playpens for babies; mattresses; furniture of metal; inflatable furniture; office furniture; school furniture; legs for furniture; feet for furniture; bed bases; furniture partitions of wood; freestanding partitions [furniture]; head-rests [furniture]; trestles [furniture]; magazine racks; book rests [furniture]; flower pot supports; reusable baby changing mats; pillows; cushions; air cushions, not for medical purposes; air pillows, not for medical purposes; racks [furniture]; library shelves; shelves

for file cabinets; furniture shelves; shelves for storage; wood ribbon; towel stands [furniture]; hat stands; inflatable publicity objects; counters [tables]; bedding, except linen; picture frames; door handles, not of metal; knobs, not of metal; writing desks; seats of metal; benches [furniture]; sofas; statues of wood, wax, plaster or plastic; figurines of wood, wax, plaster or plastic; silvered glass [mirrors]; shelving units; trolleys for computers [furniture]; dressing tables; washstands [furniture]; typing desks; drafting tables; massage tables; tables of metal; wall-mounted baby changing platforms; saw benches [furniture]; desks; tea trolleys; dinner wagons [furniture]; tables; chairs [seats]; high chairs for babies; placards of wood or plastics; stools; footstools; crates; trolleys [furniture]; decorations of plastic for foodstuffs; door fasteners, not of metal; door fittings, not of metal; bed fittings, not of metal; furniture fittings, not of metal; hinges, not of metal; screens [furniture]; filing cabinets; medicine cabinets; plate racks [furniture]; meat safes; bookcases; wardrobes; cupboards; woven timber blinds [furniture]; indoor window blinds [shades] [furniture]/indoor window shades [furniture]; screens for fireplaces [furniture]; labels of plastic; lockers [furniture]; chests for toys; tool chests, not of metal, empty; boxes of wood or plastic; bottle racks.

35 – Advertising; business management services; business administration services; office functions; import-export agency services; commercial information agency services; advertising agency services; cost price analysis; rental of advertising space; business auditing; employment agency services; computerized file management; book-keeping; invoicing; demonstration of goods; transcription of communications [office functions]; opinion polling; market studies; business information; commercial information and advice for consumers [consumer advice shop]; business investigations; business research; marketing research; personnel recruitment; business management and organization consultancy; business organization consultancy; consultancy regarding public relations communications strategy; business management consultancy; personnel management consultancy; professional business consultancy; consultancy regarding advertising communications strategy; layout services for advertising purposes; marketing; scriptwriting for advertising purposes; news clipping services; updating and maintenance of information in registries; updating and maintenance of data in computer databases; updating of advertising material; word processing; organization of exhibitions for commercial or advertising purposes; organization of trade fairs for commercial or advertising purposes; shop window dressing; development of advertising concepts; business appraisals; payroll preparation; sponsorship search; business management assistance; commercial or industrial management assistance; commercial intermediation services; providing business information via a website; providing commercial and business contact information; provisi-

on of an online marketplace for buyers and sellers of goods and services; web indexing for commercial or advertising purposes; presentation of goods on communication media, for retail purposes; economic forecasting; sales promotion for others; production of teleshopping programmes; production of advertising films; rental of advertising time on communication media; publicity material rental; rental of billboards [advertising boards]; rental of sales stands; publication of publicity texts; radio advertising; bill-posting / outdoor advertising; distribution of samples; dissemination of advertising matter; direct mail advertising; registration of written communications and data; editing of publicity texts; online advertising on a computer network; television advertising; document reproduction; compilation of statistics; compilation of information into computer databases; business inquiries; systemization of information into computer databases; advisory services for business management; negotiation of business contracts for others; negotiation and conclusion of commercial transactions for third parties; compiling indexes of information for commercial or advertising purposes; tax preparation; drawing up of statements of accounts; telemarketing services; psychological testing for the selection of personnel; outsourced administrative management for companies; business management for freelance service providers; business project management services for construction projects; commercial administration of the licensing of the goods and services of others; business management of reimbursement programmes for others; administration of consumer loyalty programs; administrative processing of purchase orders; public relations; appointment reminder services [office functions]; website traffic optimization; administrative services for the relocation of businesses; tax filing services; search engine optimization for sales promotion; appointment scheduling services [office functions]; price comparison services; pay per click advertising; secretarial services; procurement services for others [purchasing goods and services for other businesses]; outsourcing services [business assistance]; business efficiency expert services.

37 – Construction; repair; installation services; repair information; riveting; varnishing; re-tinning; upholstery; rustproofing; sanding; paper hanging; painting or repair of signs; painting services; carpentry services; upholstery repair; furniture restoration; warehouse construction and repair; kitchen equipment installation; office machines and equipment installation, maintenance and repair; furniture maintenance; leather care, cleaning and repair.

39 – Transport; packaging and storage of goods; organization of tours; parking place rental; rental of warehouses; transport reservation; delivery of goods; traffic information; transportation information; storage information; transportation logistics; hauling; transporting furniture; ferry-boat transport; car tran-

sport; railway transport; transport brokerage; freight brokerage [forwarding (Am.)]; providing driving directions for travel purposes; stevedoring; unloading cargo; wrapping of goods; chauffeur services; courier services [messages or merchandise]; transport; freight [shipping of goods]; freighting; physical storage of electronically stored data or documents; storage of goods; storage; freight forwarding.

(260) AM 2023 121077 A

(800) 1706041

(151) 2022 05 23

(891) 2022 05 23

(731) EMBECTA CORP.

200 BULFINCH DRIVE, ANDOVER MA
01810, USA

(540)

EMBECTA

(591) Black, white

(511)

9 – Downloadable software for medical information, patient care and medicine management; downloadable software in the nature of a mobile application for obtaining, controlling and managing patient medical information or wearable medical devices; downloadable software in the nature of a mobile application for the collection, editing, organizing, modifying, transmission, storage and sharing of patient care instruction and medical information; and downloadable and recorded computer software, mobile applications and programming interface software and hardware for acquiring, transmitting and storing medical and physiological data.

10 – Medical devices and apparatus for patient care and delivery of medicine; medical ports, lancets, needles and syringes; kits for diabetic patients comprised primarily of syringes or pen needles, lancets, glucose tablets, and disinfectant prep pad; clipper used for destruction of medical needles; scale magnifier and needle guide for insulin syringes; pen needles used to deliver medications to manage diabetes; a subcutaneous set or a feature of subcutaneous infusion sets for use by diabetes patients in connection with insulin pumps; infusion and insulin pumps and accessories, medical sensors, meters and devices for measuring and monitoring blood and urine properties, and accessories therefor.

16 – Educational materials.

41 – Medical training and education services in the diabetes field; educational instruction on medical injection technique; online newsletter relating to diabetes healthcare; educational services, namely, providing training in the field of diabetes and diabetes care provided by means of a call center and distribution of printed and electronic materials in connection therewith.

42 – Providing software for patient information, patient care and medicine management; providing temporary use of non-downloadable cloud-based software for controlling and managing patient medical information; providing temporary use of non-downloadable cloud-based software for the collection, editing, organizing, modifying, transmission, storage and sharing of patient care instruction and medical information; software as a service (saas) and application service provider featuring application programming interface software for acquiring, storing, communicating and sharing medical and physiological data, and consulting services related thereto; providing a web site for medical professionals and patients featuring medical information and data from devices used for medical monitoring purposes that feed information to the website that is processed, exchanged and accessed in real-time by users.

44 – Interactive medical monitoring, reporting and alert services for monitoring and managing diabetes.

(260) AM 2023 121079 A

(800) 1706057

(151) 2022 07 14

(891) 2022 07 14

(731) Blockchain Game Partners, Inc.

680 S Cache Street, Suite 100, Jackson WY
83001, USA

(540)

GALA

(591) Black, white

(511)

9 – Downloadable computer software for managing electronic payment transactions using distributed ledger technology (DLT); downloadable computer software for managing and validating cryptocurrency transactions using blockchain-based smart contracts; downloadable software for streaming, delivering, distributing, transmitting, sharing, storing, collecting, retrieving, organizing, creating, publishing, arranging, and editing audio, video, audiovisual and multimedia content; downloadable virtual goods, namely, downloadable art, image, photograph, graphic, text, music, audio, video, and audiovisual files for use in online virtual worlds and metaverse; downloadable software featuring virtual currency, namely, computer programs featuring currency for use in online virtual worlds and metaverse; downloadable audio files featuring music, books, spoken text, and audio performances; downloadable audio files featuring music, books, spoken text, and audio performances authenticated by non-fungible tokens (NFTs); downloadable audio recordings featuring music, books, spoken text, and audio performances; downloadable video recordings featuring music, film, movies, shows, plays, and performances; downloadable computer software for processing video and digital sounds and audio files;

downloadable software for streaming multimedia entertainment content; downloadable software for engaging in social networking and interacting with online communities; downloadable software for creating, managing, and interacting with an online community; downloadable software for creating, managing and accessing groups within virtual communities; downloadable software that enables individuals, groups, companies, and brands to create and maintain an online presence for marketing and sales purposes; downloadable software for organizing events, searching for events, calendaring and managing events, none of the foregoing to include special occasion gala events.

35 – Provision of an online marketplace for buyers and sellers of downloadable digital art, images, sound, audio, video, audiovisual and game files authenticated by non-fungible tokens (NFTs); promotional advertising of products and services of third parties through sponsoring arrangements and license agreements relating to art, images, sound, audio, video, audiovisual and game files; online retail store services for downloadable art, images, sound, audio, video, audiovisual and game files; online wholesale store services for downloadable art, images, sound, audio, video, audiovisual and game files; providing consumer information, user reviews, and personalized recommendations being user reviews of software, games, audio, video, and events, excluding special occasion gala events, in the field of entertainment for commercial purposes.

36 – Collecting fees and monies and making payments to intellectual property owners, entertainers, creators, promoters, influencers and the owners and hosts of non-fungible tokens (NFTs); intellectual property valuation services; fee calculation services being a type of financial calculation service.

38 – Streaming of audio, video, and audiovisual materials via the internet; streaming of audio, video, and audiovisual materials being data via mobile networks and computer networks; electronic transmission of digital media content for others via the internet, mobile networks being a type of global computer network and local computer networks; communications services, namely, transmitting streamed sound, audio, video, and audiovisual recordings via the Internet, mobile networks and computer networks; online distribution of data, sound, images, photos, graphics, audio, video and audiovisual content and media in the nature of transmitting and streaming of audio, visual and audiovisual material via a global computer network; providing access to online chat rooms for social networking; providing access to online chat rooms for transmission of data and messages among computer users.

41 – Providing entertainment data, audio, video, and audiovisual content via an online virtual environment for users; digital multimedia publishing of software, games, audio, video, audiovisual content, and electro-

nic publications; interactive online entertainment services provided via metaverse; providing entertainment information, online reviews and personalized recommendations in the form of online reviews of software, games, audio, video, and events, excluding special occasion gala events, in the field of entertainment for entertainment purposes; entertainment, namely, providing non-downloadable playback of audio being music, books, spoken text, and audio performances, video featuring music, film, shows, features, and performances, and multimedia content being music, books, spoken text, film, movies, shows, plays, and performances via global communications networks; provision of non-downloadable video, audio and audiovisual programs being music, books, spoken text, film, movies, shows, plays, and performances via an online video-on-demand service; digital entertainment content in the nature of music, books, spoken text, film, movies, shows, plays, and performances provided online from a computer database; entertainment services, namely, providing information and commentary in the fields of games and entertainment all via a global computer network; entertainment services, namely, providing online contest, sweepstakes, quizzes being a type of competition and incentive award programs designed to reward program participants who play multiplayer online games or participate in metaverses; entertainment services, namely, providing entertainment information relating to rankings and statistics of users relating to performance via a website; online non-downloadable audio files being audio recordings featuring music, books, spoken text, and audio performances.

42 – Providing online non-downloadable computer software for managing electronic payment transactions using distributed ledger technology (DLT); providing online non-downloadable computer software for managing and validating cryptocurrency transactions using blockchain-based smart contracts; providing online non-downloadable software for streaming, delivering, distributing, transmitting, sharing, storing, collecting, retrieving, organizing, creating, publishing, arranging, and editing audio, video, audiovisual and multimedia content; electronic computerized data storage; hosting online metaverses featuring data, sound, images, photos, graphics, audio, video and audiovisual content for others; providing online non-downloadable software featuring technology that enables users to upload, download and share information, data, sound, images, photos, graphics, audio and video content and organize and conduct online meetings, gatherings, and interactive discussions; providing online non-downloadable software for streaming data, sound, images, photos, graphics, audio and video content; providing online non-downloadable software featuring virtual goods for use in online virtual worlds and metaverse; providing online non-downloadable software featuring virtual currency, namely, computer programs featuring currency for use in online virtual

worlds and metaverse; providing online non-downloadable audio files; providing online non-downloadable software for use in playing audio files authenticated by non-fungible tokens (NFTs); providing online non-downloadable software for processing video and digital sounds and audio files; providing online non-downloadable software for streaming multimedia entertainment content; providing online non-downloadable software for engaging in social networking and interacting with online communities; providing online non-downloadable software for creating, managing, and interacting with an online community; providing online non-downloadable software for creating, managing and accessing groups within virtual communities; providing online non-downloadable software that enables individuals, groups, companies, and brands to create and maintain an online presence for marketing and sales purposes; providing online non-downloadable software for organizing events, searching for events, calendaring and managing events, excluding special occasion gala events; providing virtual locations being virtual private network computer servers to others for social networking; providing temporary use of online non-downloadable software through which people locate information about people, events, and competitions in the entertainment field, excluding special occasion gala events.

45 – Online social networking services; online social networking services accessible by means of downloadable mobile applications; intellectual property services, namely, intellectual property consultancy.

(260) AM 2023 121099 A

(800) 1706482

(151) 2022 08 22

(891) 2022 08 22

(731) Malakhova Natal'ya Anatol'yevna
ul. Dekabristov, 41, kv. 249, RU-630126
Novosibirsk, Russian Federation

(540)

NATALYA SHIK

(591) Black, white

(511)

2 – Annotto [dyestuff]; auramine; Canada balsam; white lead; paper for dyeing Easter eggs; dyes; binding preparations for paints; glazes [paints, lacquers]; orange lead; primers; gamboge for painting; gum-lac; titanium dioxide [pigment]; repositionable paint patches; indigo [colorant]; gum resins; colophony; caramel [food colorant]; carbonyl [wood preservative]; cochineal carmine; ink cartridges, filled, for printers and photocopiers; edible ink cartridges, filled, for printers; copal; colorants; alizarine dyes; aniline dyes; colorants for the restoration of furniture in the form of markers; ink for leather; colorants for liqueurs; colorants for beverages; shoe dyes; colorants for beer; colorants for butter; dyewood; malt colo-

rants; food dyes; paints; watercolour paints for use in art; aluminium paints; asbestos paints; bactericidal paints; ceramic paints; marking ink for animals; distempers; oil paints for use in art; anti-urine paints; anti-fouling paints; fireproof paints; printing ink; conductive paints; enamels for painting; creosote for wood preservation; turmeric [colorant]; black japan; lacquers; bitumen varnish; bronzing lacquers; wood floor finishes; copal varnish; anti-corrosive bands; anti-rust oils; oils for the preservation of wood; mastic [natural resin]; lime wash; wood stains; cobalt oxide [colorant]; zinc oxide [pigment]; silver paste; printers' pastes [ink]; pigments; coatings [paints]; coatings for roofing felt [paints]; wood coatings [paints]; anti-graffiti coatings [paints]; undercoating for vehicle chassis; varnishes; aluminium powder for painting; bronze powder for painting; silvering powders; anti-corrosive preparations; protective preparations for metals; mordants; wood mordants; stains for leather; thinners for paints; thinners for lacquers; whitewash; soot [colorant]; carbon black [pigment]; lamp black [pigment]; sandarac; thickeners for paints; sienna earth; siccatives [drying agents] for paints; anti-rust greases; natural resins, raw; malt caramel [food colorant]; badigeon; anti-tarnishing preparations for metals; anti-rust preparations; wood preservatives; sumac for varnishes; red lead; turpentine [thinner for paints]; toner for printers and photocopiers; fixatives [varnishes]; fixatives for watercolours; yellowwood [colorant]; engraving ink; ink for printers and photocopiers; tattooing ink; edible inks; conductive inks; saffron [colorant]; dyewood extracts; enamels [varnishes]; silver emulsions [pigments]; metal foil for use in painting, decorating, printing and art.

3 – Abrasives; amber [perfume]; descaling preparations for household purposes; antistatic preparations for household purposes; aromatics [essential oils]; air fragrancing preparations; cake flavourings [essential oils]; flavourings for beverages [essential oils]; food flavourings [essential oils]; breath freshening sprays; canned pressurized air for cleaning and dusting purposes; balms, other than for medical purposes; basma [cosmetic dye]; lip glosses; nail glitter; body glitter; polishing stones; abrasive paper; emery paper; polishing paper; petroleum jelly for cosmetic purposes; shoe polish; cobblers' wax; cotton wool for cosmetic purposes; cotton wool impregnated with make-up removing preparations; sachets for perfuming linen; drying agents for dishwashing machines; adhesives for cosmetic purposes; scented water; Javelle water; lavender water; micellar water; toilet water; wax for parquet floors; floor wax; non-slipping wax for floors; depilatory wax; moustache wax; shoe wax; tailors' wax; creams for leather; polish for furniture and flooring; shoemakers' wax; polishing wax; massage gels, other than for medical purposes; heliotropine; dental bleaching gels; geraniol; starch glaze for laundry purposes; make-up; deodorants for pets; depilatory preparations; air fragrance reed diffusers; scented

wood; perfumes; non-slipping liquids for floors; windscreen cleaning liquids; greases for cosmetic purposes; volcanic ash for cleaning; perfumery; decorative transfers for cosmetic purposes; ionone [perfumery]; shaving stones [astringents]; smoothing stones; eyebrow pencils; cosmetic pencils; silicon carbide [abrasive]; carbides of metal [abrasives]; alum stones [astringents]; tripoli stone for polishing; adhesives for affixing false eyelashes; adhesives for affixing false hair; hair conditioners; quillaia bark for washing; corundum [abrasive]; beard dyes; colorants for toilet purposes; cosmetic dyes; body paint for cosmetic purposes; starch for laundry purposes; shoe cream; polishing creams; cosmetic creams; skin whitening creams; essential oil-based creams for aromatherapy use; polishing rouge; incense; hair spray; nail varnish; liquid latex body paint for cosmetic purposes; hair lotions; lotions for cosmetic purposes; after-shave lotions; beauty masks; sheet masks for cosmetic purposes; disposable steam-heated masks, not for medical purposes; oils for perfumes and scents; oils for cosmetic purposes; oils for toilet purposes; essential oils; essential oils for aromatherapy use; essential oils of cedarwood; essential oils of lemon; essential oils of citron; oils for cleaning purposes; bergamot oil; gaultheria oil; jasmine oil; lavender oil; almond oil; rose oil; oil of turpentine for degreasing; whiting; cleaning chalk; almond milk for cosmetic purposes; cleansing milk for toilet purposes; musk [perfumery]; soap; deodorant soap; shaving soap; soap for brightening textile; cakes of toilet soap; antiperspirant soap; soap for foot perspiration; almond soap; mint for perfumery; cosmetic kits; emery; gel eye patches for cosmetic purposes; nail art stickers; double eyelid tapes; false nails; eau de Cologne; joss sticks; pastes for razor strops; toothpaste; pumice stone; lipstick cases; hydrogen peroxide for cosmetic purposes; dressings for nail reconstruction; breath freshening strips; teeth whitening strips; sandcloth; glass cloth [abrasive cloth]; lipsticks; pomades for cosmetic purposes; shaving preparations; cosmetic preparations for baths; bath preparations, not for medical purposes; hair straightening preparations; hair waving preparations; laundry soaking preparations; grinding preparations; smoothing preparations [starching]; colour-removing preparations; leather bleaching preparations; polishing preparations; denture polishes; mouthwashes, not for medical purposes; preparations to make the leaves of plants shiny; eye-washes, not for medical purposes; fabric softeners for laundry use; dry-cleaning preparations; paint stripping preparations; lacquer-removing preparations; make-up removing preparations; floor wax removers [scouring preparations]; varnish-removing preparations; rust removing preparations; nail care preparations; cleaning preparations; preparations for cleaning dentures; wallpaper cleaning preparations; preparations for unblocking drain pipes; chemical cleaning preparations for household purposes; collagen preparations for cosmetic purposes; bleaching

preparations [decolorants] for household purposes; aloe vera preparations for cosmetic purposes; sunscreen preparations; colour-brightening chemicals for household purposes [laundry]; breath freshening preparations for personal hygiene; shining preparations [polish]; make-up powder; diamantine [abrasive]; stain removers; wax melts [fragrancing preparations]; nail varnish removers; vaginal washes for personal sanitary or deodorant purposes; scouring solutions; false eyelashes; antistatic dryer sheets; baby wipes impregnated with cleaning preparations; colour run prevention laundry sheets; tissues impregnated with cosmetic lotions; tissues impregnated with make-up removing preparations; safrol; massage candles for cosmetic purposes; laundry blueing; turpentine for degreasing; potpourris [fragrances]; bleaching soda; washing soda, for cleaning; bath salts, not for medical purposes; bleaching salts; fumigation preparations [perfumes]; leather preservatives [polishes]; ammonia [volatile alkali] [detergent]; cooling sprays for cosmetic purposes; astringents for cosmetic purposes; eyebrow cosmetics; make-up preparations; sun-tanning preparations [cosmetics]; hair dyes; neutralizers for permanent waving; laundry glaze; cosmetic preparations for eyelashes; laundry preparations; cosmetic preparations for skin care; dentifrices; cosmetics; cosmetics for children; cosmetics for animals; mascara; cleansers for intimate personal hygiene purposes, non medicated; douching preparations for personal sanitary or deodorant purposes [toiletries]; detergents, other than for use in manufacturing operations and for medical purposes; degreasers, other than for use in manufacturing processes; bleaching preparations [decolorants] for cosmetic purposes; laundry bleach; toiletry preparations; antiperspirants [toiletries]; phytocosmetic preparations; detergent tablets for coffee machines; talcum powder, for toilet use; cotton swabs for cosmetic purposes; terpenes [essential oils]; emery cloth; toners for cosmetic purposes; cloths impregnated with a detergent for cleaning; henna [cosmetic dye]; bath tea for cosmetic purposes; shampoos; shampoos for animals [non-medicated grooming preparations]; shampoos for pets [non-medicated grooming preparations]; dry shampoos; sandpaper; cosmetic stamps, filled; soda lye; herbal extracts for cosmetic purposes; extracts of flowers [perfumes]; ethereal essences; badian essence; mint essence [essential oil]; deodorants for human beings or for animals; cosmetic preparations for slimming purposes.

16 – Fountain pens; aquarelles; albums; almanacs; document laminators for office use; mimeograph apparatus and machines; atlases; banknotes; souvenir banknotes; banners of paper; paper bows, other than haberdashery or hair decorations; name badges [office requisites]; table linen of paper; tickets; baggage claim check tags of paper; forms, printed; announcement cards [stationery]; glitter for stationery purposes; note books; pads [stationery]; drawing pads; wristbands for the retention of writing instruments; pamphlets; book-

lets; paper; paper sheets [stationery]; waxed paper; baking paper; paper for medical examination tables; origami folding paper; plantable seed paper [stationery]; paper for recording machines; paper for radiograms; papers for painting and calligraphy; electrocardiograph paper; drawer liners of paper, perfumed or not; wood pulp paper; carbon paper; copying paper [stationery]; parchment paper; writing paper; rice paper; luminous paper; toilet paper; wrapping paper; filter paper; wash; blotters; newsletters; rollers for typewriters; house painters' rollers; composing sticks; adhesives [glues] for stationery or household purposes; modelling wax, not for dental purposes; signboards of paper or cardboard; sewing patterns; bunting of paper; newspapers; electrotypes; hectographs; modelling clay; polymer modelling clay; terrestrial globes; drawing sets; engravings; slate pencils; pencil leads; document holders [stationery]; pencil holders; chalk holders; holders for cheque books; holders for stamps [seals]; page holders; name badge holders [office requisites]; diagrams; table runners of paper; engraving plates; writing slates; blackboards; magnetic boards being office requisites; galley racks [printing]; drawing boards; advertisement boards of paper or cardboard; duplicators; punches [office requisites]; cream containers of paper; correcting fluids [office requisites]; magazines [periodicals]; money clips; clips for name badge holders [office requisites]; tags for index cards; pen clips; bookmarks; etching needles; tracing needles for drawing purposes; periodicals; printed publications; paper shredders for office use; graphic representations; credit card imprinters, non-electric; paper creasers [office requisites]; graining combs; drawing instruments; calendars; tracing paper; tracing cloth; tracing patterns; gums [adhesives] for stationery or household purposes; lithographic stones; ink stones [ink reservoirs]; pencils; pencil lead holders; charcoal pencils; pictures; transfers [decalcomanias]; paintings [pictures], framed or unframed; colouring pictures; cardboard; wood pulp board [stationery]; hat boxes of cardboard; cards; index cards [stationery]; geographical maps; paper tapes and cards for the recordal of computer programmes; trading cards, other than for games; perforated cards for Jacquard looms; catalogues; spools for inking ribbons; flower-pot covers of paper; paintbrushes; painters' brushes; writing brushes; typewriter keys; glue for stationery or household purposes; isinglass for stationery or household purposes; gluten [glue] for stationery or household purposes; starch paste [adhesive] for stationery or household purposes; printing blocks; books; colouring books; manifolds [stationery]; comic books; drawing pins; mats of paper for beer glasses; cigar bands; envelopes [stationery]; boxes of paper or cardboard; cases for stamps [seals]; paint boxes for use in schools; printed coupons; stencils [stationery]; French curves; paper ribbons, other than haberdashery or hair decorations; gummed tape [stationery]; typewriter ribbons; barcode ribbons; adhesive tapes for

stationery or household purposes; correcting tapes [office requisites]; inking ribbons; self-adhesive tapes for stationery or household purposes; square rulers for drawing; drawing rulers; flyers; absorbent sheets of paper or plastic for foodstuff packaging; humidity control sheets of paper or plastic for foodstuff packaging; viscose sheets for wrapping; sheets of reclaimed cellulose for wrapping; plastic bubble packs for wrapping or packaging; steel letters; type [numerals and letters]; lithographs; letter trays; paint trays; architects' models; postage stamps; plastics for modelling; graphic prints; modelling materials; teaching materials [except apparatus]; sealing compounds for stationery purposes; padding materials of paper or cardboard; bookbinding material; packing [cushioning, stuffing] materials of paper or cardboard; packaging material made of starches; filtering materials of paper; addressing machines; pencil sharpening machines, electric or non-electric; bookbinding apparatus and machines [office equipment]; typewriters, electric or non-electric; franking machines for office use; chalk for lithography; writing chalk; tailors' chalk; marking chalk; spray chalk; bags [envelopes, pouches] of paper or plastics, for packaging; garbage bags of paper or of plastics; plastic bags for pet waste disposal; painters' easels; hand-rests for painters; printing sets, portable [office requisites]; bibs of paper; bibs, sleeved, of paper; floor decals; stickers [stationery]; fingerstalls for office use; writing cases [stationery]; cords for bookbinding; paper knives [letter openers]; printed sheet music; numbering apparatus; bottle envelopes of paper or cardboard; sealing wafers; covers [stationery]; passport holders; protective covers for books; plastic cling film, extensible, for palletization; embroidery designs [patterns]; handwriting specimens for copying; oleographs; musical greeting cards; greeting cards; postcards; etchings; conical paper bags; paper bags for use in the sterilization of medical instruments; bags for microwave cooking; palettes for painters; ink sticks; pantographs [drawing instruments]; loose-leaf binders; files [office requisites]; folders for papers; papier mâché; pastels [crayons]; modelling paste; pen cases; mezuzah parchments; pen wipers; office perforators; pens [office requisites]; nibs of gold; nibs; steel pens; drawing pens; song books; seals [stamps]; sealing stamps; posters; clipboards; address plates for addressing machines; handkerchiefs of paper; plastic film for wrapping; transparencies [stationery]; trays for sorting and counting money; coasters of paper; bookends; stamp stands; stands for pens and pencils; photograph stands; obliterating stamps; inking pads; stamp pads; binding strips [bookbinding]; face towels of paper; towels of paper; inking sheets for document reproducing machines; inking sheets for duplicators; cloth for bookbinding; gummed cloth for stationery purposes; printers' blankets, not of textile; portraits; paperweights; writing cases [sets]; inkstands; office requisites, except furniture; writing materials; writing

instruments; drawing materials; school supplies [stationery]; adhesive tape dispensers [office requisites]; hand labelling appliances; printed matter; lithographic works of art; prospectuses; printed timetables; ledgers [books]; printers' galleys; indexes; paper cutters [office requisites]; rubber erasers; elastic bands for offices; T-squares for drawing; graphic reproductions; retractable reels for name badge holders [office requisites]; penholders; marking pens [stationery]; tissues of paper for removing make-up; paper wipes for cleaning; dental tray covers of paper; place mats of paper; tablemats of paper; tablecloths of paper; paper clasps; document files [stationery]; scrapers [erasers] for offices; paper-clips; clips for offices; erasing products; biological samples for use in microscopy [teaching materials]; histological sections for teaching purposes; steatite [tailor's chalk]; writing board erasers; composing frames [printing]; carrier bags of paper or plastic; sealing wax; arithmetical tables; placards of paper or cardboard; writing or drawing books; fabrics for bookbinding; stationery; pencil sharpeners, electric or non-electric; stencil plates; stencils for decorating food and beverages; cardboard tubes; Indian inks; moisteners [office requisites]; moisteners for gummed surfaces [office requisites]; squares for drawing; chart pointers, non-electronic; bottle wrappers of paper or cardboard; envelope sealing machines for offices; sealing machines for offices; vignetting apparatus; apparatus for mounting photographs; stapling presses [office requisites]; manuals [handbooks]; figurines of papier mâché; paper coffee filters; flags of paper; flip charts; silver paper; moulds for modelling clays [artists' materials]; photo-engravings; photographs [printed]; mezuzah cases; stencil cases; canvas for painting; chromolithographs [chromos]; animation cels; compasses for drawing; numbers [type]; artists' watercolour saucers; ink; correcting ink [heliography]; inkwells; blueprints; stencils; erasing shields; balls for ball-point pens; desktop cabinets for stationery [office requisites]; printing type; address stamps; stamps [seals]; shields [paper seals]; prints [engravings]; labels of paper or cardboard; desk mats.

18 – Mountaineering sticks; luggage tags; sew-on tags of leather for clothing; adhesive tags of leather for bags; pocket wallets; saddlecloths for horses; business card cases; reins; reins for guiding children; sling bags for carrying infants; harness fittings; credit card cases [wallets]; parts of rubber for stirrups; chamois leather, other than for cleaning purposes; umbrellas; parasols; saddlery; frames for umbrellas or parasols; frames for bags [structural parts of bags]; card cases [notecases]; cases of leather or leatherboard; valves of leather; whips; vegan leather; imitation leather; leather, unworked or semi-worked; leatherboard; casings, of leather, for springs; umbrella rings; hat boxes of leather; boxes of leather or leatherboard; boxes of vulcanized fibre; purses; chain mesh purses; fastenings for saddles; butts [parts of hides]; saddle trees; bags [envelopes, pouches] of leather, for packaging; moleskin

[imitation of leather]; travelling sets [leatherware]; knee-pads for horses; muzzles; halters; vanity cases, not fitted; furniture coverings of leather; clothing for pets; covers for animals; suitcase packing organizers; trimmings of leather for furniture; collars for animals; hiking sticks; conference folders; music cases; slings for carrying infants; goldbeaters' skin; cat o' nine tails; leather leashes; pads for horse saddles; horseshoes; girths of leather; leathercloth; horse blankets; garment bags for travel; shoulder belts [straps] of leather; briefcases; traces [harness]; fur; randsels [Japanese school satchels]; haversacks; leather straps; straps for soldiers' equipment; harness straps; straps for skates; straps of leather [saddlery]; chin straps, of leather; stirrup leathers; umbrella handles; walking stick handles; suitcase handles; rucksacks; backpacks for carrying infants; travelling bags; riding saddles; net bags for shopping; umbrella or parasol ribs; stirrups; bags; bags for climbers; tool bags, empty; toilet bags, not fitted; handbags; beach bags; saddlebags; bags for sports; bags for campers; reusable shopping bags; wheeled shopping bags; school bags; pouch baby carriers; travelling trunks; trunks [luggage]; nose bags [feed bags]; bridoons; walking sticks; umbrella sticks; walking stick seats; tefillin [phylacteries]; bits for animals [harness]; bridles [harness]; harness for animals; key cases; horse collars; suitcases; motorized suitcases; suitcases with wheels; valises; attaché cases; covers for horse saddles; umbrella covers; kid; curried skins; animal skins; cattle skins; leather cord; blinkers [harness]; labels of leather; game bags [hunting accessories].

21 – Autoclaves, non-electric, for cooking; indoor aquaria; wine aerators; buckets; automatic opening and closing trash cans; cookie jars; candle jars [holders]; china ornaments; dishes; vegetable dishes; saucers; boxes for sweets; bottles; demijohns; vases; epergnes; fruit bowls; inflatable bath tubs for babies; bird baths; baby baths, portable; plungers for clearing blocked drains; waffle irons, non-electric; diaper disposal pails; ice buckets; mop wringer buckets; buckets made of woven fabrics; whisks, non-electric, for household purposes; cooking skewers of metal; towel rails and rings; clothing stretchers; barbecue forks; serving forks; hair for brushes; horsehair for brush-making; funnels; pie funnels; candle warmers, electric and non-electric; carpet beaters [hand instruments]; signboards of porcelain or glass; candle extinguishers; heads for electric toothbrushes; flower pots; chamber pots; glue-pots; cruets; decanters; large-toothed combs for the hair; combs for animals; tea cosies; abrasive sponges for scrubbing the skin; bath sponges; make-up sponges; sponges for household purposes; sponge holders; stands for portable baby baths; toothpick holders; soap holders; table napkin holders; holders for flowers and plants [flower arranging]; tea bag rests; shaving brush stands; toilet paper holders; toilet paper dispensers; soap dispensers; plug-in diffusers for mosquito repellents; aromatic oil diffusers,

other than reed diffusers, electric and non-electric; ironing boards; cutting boards for the kitchen; bread boards; washing boards; crushers for kitchen use, non-electric; strainers for household purposes; smoke absorbers for household purposes; containers for household or kitchen use; kitchen containers; glass jars [carboys]; heat-insulated containers; heat-insulated containers for beverages; thermally insulated containers for food; glass flasks [containers]; closures for pot lids; chamois leather for cleaning; toothpicks; ceramics for household purposes; majolica; works of art of porcelain, ceramic, earthenware, terra-cotta or glass; kitchen grinders, non-electric; cleaning instruments, hand-operated; cabarets [trays]; stew-pans; couscous cooking pots, non-electric; cooking pots, non-electric; flower-pot covers, not of paper; shaving brushes; make-up brushes; birdcages; cages for collecting insects; baking mats; ladles for serving wine; polishing leather; hot pots, not electrically heated; glass bulbs [receptacles]; shoe trees; napkin rings; poultry rings; rings for birds; disposable aluminium foil containers for household purposes; coin banks; piggy banks; bread baskets for household purposes; baskets for household purposes; waste paper baskets; feeding troughs; pet feeding bowls, automatic; mangers for animals; lunch boxes; insect collectors' boxes; tea caddies; washtubs; earthenware saucepans; mess-tins; cauldrons; coffee percolators, non-electric; coffeeepots, non-electric; coffee grinders, hand-operated; mugs; beer mugs; tankards; rat traps; pot lids; aquarium hoods; butter-dish covers; dish covers; cheese-dish covers; reusable silicone food covers; button-hooks; reusable ice cubes; jugs; perfume burners; watering cans; fly traps; insect traps; ice cream scoops; mixing spoons [kitchen utensils]; basting spoons [cooking utensils]; serving spoons; pie servers; cosmetic spatulas; spatulas for kitchen use; valet trays [receptacles for small objects] for household purposes; litter boxes for pets; butter dishes; material for brush-making; polishing materials for making shiny, except preparations, paper and stone; tablemats, not of paper or textile; noodle machines, hand-operated; lint removers, electric or non-electric; pasta makers, hand-operated; polishing apparatus and machines, for household purposes, non-electric; pepper mills, hand-operated; mills for household purposes, hand-operated; feather-dusters; brooms; isothermic bags; decorating bags for confectioners; cooking mesh bags, other than for microwaves; bowls [basins]; pet feeding bowls; soup bowls; mosaics of glass, not for building; dishcloths; saucepan scourers of metal; soap boxes; mouse traps; meat grinders, non-electric; cooking pot sets; nozzles for watering cans; pouring spouts; wine pourers; cake decorating tips and tubes; nozzles for watering hose; fitted picnic baskets, including dishes; toilet cases; floss for dental purposes; fibreglass thread, other than for textile use; cookie [biscuit] cutters; pastry cutters; sprinklers; syringes for watering flowers and plants; egg yolk separators; cotton waste for

cleaning; wool waste for cleaning; cleaning tow; cold packs for chilling food and beverages; chopsticks; cocktail stirrers; food steamers, non-electric; pepper pots; abrasive mitts for scrubbing the skin; oven mitts; animal grooming gloves; gloves for household purposes; car washing mitts; polishing gloves; gardening gloves; pestles for kitchen use; droppers for household purposes; wine-tasting pipettes; droppers for cosmetic purposes; plates for diffusing aromatic oil; plates to prevent milk boiling over; dripping pans; trays for household purposes; trays of paper, for household purposes; lazy susans; heaters for feeding bottles, non-electric; candelabra [candlesticks]; trivets [table utensils]; coasters, not of paper or textile; grill supports; menu card holders; knife rests for the table; mats, not of paper or textile, for beer glasses; flat-iron stands; egg cups; abrasive pads for kitchen purposes; scouring pads; drinking troughs; serving ladles; powdered glass for decoration; pottery; pots; vessels for making ices and ice cream, non electric; painted glassware; tableware, other than knives, forks and spoons; porcelain ware; earthenware; crystal [glassware]; cosmetic utensils; trouser presses; tortilla presses, non-electric [kitchen utensils]; tube squeezers for household purposes; deodorizing apparatus for personal use; cruet sets for oil and vinegar; make-up removing appliances; spice sets; apparatus for wax-polishing, non-electric; bottle openers, electric and non-electric; glove stretchers; boot jacks; crumb trays; tie presses; potholders; clothes-pegs; glass stoppers; roaster pans; perfume vaporizers; powder puffs; dusting apparatus, non-electric; foam toe separators for use in pedicures; combs; electric combs; grills [cooking utensils]; sifters [household utensils]; drinking horns; shoe horns; candle drip rings; broom handles; salad bowls; place mats, not of paper or textile; beverage urns, non-electric; sugar bowls; beaters, non-electric; egg separators, non-electric, for household purposes; services [dishes]; coffee services [tableware]; liqueur sets; tea services [tableware]; sieves [household utensils]; cinder sifters [household utensils]; tea strainers; siphon bottles for carbonated water; rolling pins, domestic; frying pans; squeegees [cleaning instruments]; steel wool for cleaning; currycombs; smart medicine bottles, sold empty; blenders, non-electric, for household purposes; scoops for household purposes; straws for drinking; salt cellars; drinking vessels; refrigerating bottles; bulb basters; cups of paper or plastic; glasses [receptacles]; drinking glasses; statues of porcelain, ceramic, earthenware, terracotta or glass; figurines of porcelain, ceramic, earthenware, terra-cotta or glass; glass for vehicle windows [semi-finished product]; fused silica [semi-worked product], other than for building; plate glass [raw material]; opal glass; glass, unworked or semi-worked, except building glass; opaline glass; glass incorporating fine electrical conductors; enamelled glass, not for building; glass wool, other than for insulation; vitreous silica fibres, other than for textile use; fibreg-

lass, other than for insulation or textile use; mortars for kitchen use; portable cool boxes, non-electric; soup tureens; drying racks for laundry; rotary washing lines; tajines, non-electric; basins [receptacles]; table plates; paper plates; disposable table plates; graters for kitchen use; insulating flasks; indoor terrariums [plant cultivation]; indoor terrariums [vivariums]; roller tubes for peeling garlic; cloth for washing floors; polishing cloths; cloths for cleaning; dusting cloths [rags]; furniture dusters; wax-polishing appliances, non-electric, for shoes; water apparatus for cleaning teeth and gums; electric devices for attracting and killing insects; watering devices; ultrasonic pest repellents; utensils for household purposes; kitchen utensils; cooking utensils, non-electric; figurines of porcelain, ceramic, earthenware, terra-cotta or glass for cakes; coffee filters, non-electric; flasks; water flossers; hip flasks; drinking bottles for sports; boot trees; moulds [kitchen utensils]; egg poachers; cake moulds; baking cases of paper; baking cases of silicone; ice cube moulds; cookery moulds; deep fryers, non-electric; comb cases; bread bins; fly swatters; teapots; kettles, non-electric; cups; garlic presses [kitchen utensils]; ironing board covers, shaped; tea infusers; decorative glass spheres; mops; mop wringers; cocktail shakers; cosmetic stamps, sold empty; corkscrews, electric and non-electric; animal bristles [brushware]; pig bristles for brush-making; brushes; sound wave vibration hairbrushes; dishwashing brushes; ski wax brushes; brushes for cleaning tanks and containers; lamp-glass brushes; horse brushes; scrubbing brushes; toothbrushes; toothbrushes, electric; basting brushes; carpet sweepers; shoe brushes; tar-brushes, long handled; toilet brushes; electric brushes, except parts of machines; eyebrow brushes; nail brushes; eyelash brushes; barbecue tongs; nutcrackers; ice tongs; salad tongs; sugar tongs; decanter tags; nest eggs, artificial; boxes for dispensing paper towels; dustbins; window-boxes; boxes of glass; powder compacts, empty.

35 – Retail and wholesale services; arranging subscriptions to telecommunication services for others; import-export agency services; commercial information agency services; advertising agency services; cost price analysis; rental of cash registers; rental of office equipment in co-working facilities; rental of advertising space; business auditing; financial auditing; business intermediary services relating to the matching of potential private investors with entrepreneurs needing funding; employment agency services; computerized file management; book-keeping; invoicing; demonstration of goods; transcription of communications [office functions]; opinion polling; market studies; business investigations; business research; marketing research; personnel recruitment; business management and organization consultancy; business organization consultancy; business management consultancy; personnel management consultancy; professional business consultancy; consultancy regarding advertising communication strategies; consultancy regarding pub-

lic relations communication strategies; layout services for advertising purposes; marketing; marketing in the framework of software publishing; influencer marketing; targeted marketing; business management of performing artists; business management of sports people; writing of curriculum vitae for others; writing of publicity texts; scriptwriting for advertising purposes; news clipping services; updating and maintenance of information in registries; updating and maintenance of data in computer databases; updating of advertising material; word processing; online retail services for downloadable and pre-recorded music and movies; online retail services for downloadable ring tones; online retail services for downloadable digital music; organization of exhibitions for commercial or advertising purposes; arranging newspaper subscriptions for others; arranging subscriptions to electronic toll collection [ETC] services for others; organization of fashion shows for promotional purposes; organization of trade fairs; shop window dressing; business appraisals; preparation of business profitability studies; payroll preparation; data search in computer files for others; sponsorship search; administrative assistance in responding to calls for tenders; business management assistance; commercial or industrial management assistance; commercial intermediation services; providing business information; providing business information via a website; providing commercial and business contact information; providing telephone directory information; providing commercial information and advice for consumers in the choice of products and services; provision of an online marketplace for buyers and sellers of goods and services; providing user reviews for commercial or advertising purposes; web indexing for commercial or advertising purposes; providing user rankings for commercial or advertising purposes; media relations services; auctioneering; economic forecasting; sales promotion for others; promotion of goods and services through sponsorship of sports events; promotion of goods through influencers; production of teleshopping programmes; production of advertising films; office machines and equipment rental; rental of advertising time on communication media; publicity material rental; rental of billboards [advertising boards]; rental of vending machines; rental of sales stands; rental of photocopying machines; consumer profiling for commercial or marketing purposes; publication of publicity texts; radio advertising; development of advertising concepts; bill-posting; distribution of samples; dissemination of advertising matter; direct mail advertising; registration of written communications and data; advertising; online advertising on a computer network; outdoor advertising; advertising by mail order; television advertising; compilation of statistics; compilation of information into computer databases; business inquiries; systemization of information into computer databases; administrative services for medical referrals; corporate communications services;

negotiation of business contracts for others; negotiation and conclusion of commercial transactions for third parties; compiling indexes of information for commercial or advertising purposes; tax preparation; drawing up of statements of accounts; telemarketing services; psychological testing for the selection of personnel; interim business management; outsourced administrative management for companies; business management of hotels; business management for freelance service providers; business project management services for construction projects; commercial administration of the licensing of the goods and services of others; business management of reimbursement programmes for others; computerized management of medical records and files; administration of consumer loyalty programs; administration of frequent flyer programs; administrative processing of purchase orders; administrative services for the relocation of businesses; public relations; commercial lobbying services; competitive intelligence services; business consulting services for digital transformation; advisory services for business management; lead generation services; modelling for advertising or sales promotion; typing; online ordering services in the field of restaurant take-out and delivery; market intelligence services; appointment reminder services [office functions]; data processing services [office functions]; website traffic optimization; wholesale services for pharmaceutical, veterinary and sanitary preparations and medical supplies; appointment scheduling services [office functions]; tax filing services; search engine optimization for sales promotion; retail services for works of art provided by art galleries; retail services for pharmaceutical, veterinary and sanitary preparations and medical supplies; retail services relating to bakery products; gift registry services; price comparison services; business intermediary services relating to the matching of various professionals with clients; reception services for visitors [office functions]; pay per click advertising; advertising services to create brand identity for others; secretarial services; procurement services for others [purchasing goods and services for other businesses]; shorthand; outsourcing services [business assistance]; telephone answering for unavailable subscribers; telephone switchboard services; photocopying services; business efficiency expert services; presentation of goods on communication media, for retail purposes.

41 – Academies [education]; rental of indoor aquaria; rental of artwork; rental of movie props; rental of sports grounds; rental of tennis courts; mobile library services; lending library services; booking of seats for shows; videotaping; physical education; production of music; discotheque services; animal training; dubbing; publication of books; research in the field of education; escape room [entertainment]; film distribution; movie studio services; health club services [health and fitness training]; nightclub services [entertainment]; layout services, other than for advertising

purposes; microfilming; videotape editing; production of radio and television programmes; screenplay writing; music education; religious education; aikido instruction; gymnastic instruction; judo instruction; correspondence courses; practical training [demonstration]; training services provided via simulators; organization of balls; organization of exhibitions for cultural and educational purposes; providing recreation facilities; arranging and conducting of colloquiums; arranging and conducting of congresses; arranging and conducting of conferences; arranging and conducting of concerts; arranging and conducting of workshops [training]; arranging and conducting of in-person educational forums; arranging and conducting of seminars; arranging and conducting of symposiums; arranging and conducting of sports events; organization of competitions [education or entertainment]; arranging of beauty contests; organization of cosplay entertainment events; organization of lotteries; organization of fashion shows for entertainment purposes; organization of entertainment events; organization of electronic sports competitions; organization of shows [impresario services]; organization of sports competitions; vocational guidance [education or training advice]; amusement park services; sign language interpretation; language interpretation; transfer of business knowledge and know-how [training]; know-how transfer [training]; television entertainment; vocational retraining; directing of shows; providing online videos, not downloadable; providing information in the field of education; providing information relating to recreational activities; providing information in the field of entertainment; providing museum facilities; providing online music, not downloadable; providing television programmes, not downloadable, via video-on-demand services; providing films, not downloadable, via video-on-demand services; providing user reviews for entertainment or cultural purposes; providing golf facilities; providing user rankings for entertainment or cultural purposes; providing sports facilities; providing amusement arcade services; cinema presentations; providing online electronic publications, not downloadable; presentation of circus performances; presentation of variety shows; presentation of live performances; theatre productions; presenting museum exhibitions; conducting of entertainment events; conducting guided climbing tours; conducting fitness classes; educational examination; production of podcasts; film production, other than advertising films; rental of audio equipment; rental of video cameras; rental of video cassette recorders; rental of videotapes; rental of show scenery; rental of sound recordings; toy rental; rental of cinematographic apparatus; rental of motion pictures; games equipment rental; rental of stadium facilities; rental of lighting apparatus for theatrical sets or television studios; rental of radio and television sets; rental of skin diving equipment; rental of sports equipment, except vehicles; rental of stage scenery; rental of training simula-

tors; rental of electronic book readers; electronic desktop publishing; online publication of electronic books and journals; publication of texts, other than publicity texts; radio entertainment; entertainment services; writing of texts; sado instruction [tea ceremony instruction]; zoological garden services; educational certification services, namely, providing training and educational examination; news reporters services; film directing, other than advertising films; party planning [entertainment]; music composition services; captioning; subtitling; tutoring; entertainer services; holiday camp services [entertainment]; gambling services; e-sports services; video editing services for events; video imaging services by drone; conducting guided tours; disc jockey services; sound engineering services for events; game services provided online from a computer network; games library services; personal trainer services [fitness training]; providing casino facilities [gambling]; calligraphy services; karaoke services; songwriting; cultural, educational or entertainment services provided by art galleries; multimedia library services; modelling for artists; teaching; educational services provided by special needs assistants; educational services provided by schools; orchestra services; translation; scriptwriting, other than for advertising purposes; physical fitness assessment services for training purposes; face painting; ticket agency services [entertainment]; educational examination for users to qualify to pilot drones; coaching [training]; lighting technician services for events; sport camp services; recording studio services; photographic imaging services by drone; nursery schools; photography; photographic reporting; timing of sports events; boarding school education; production of shows.

44 – Rental of bottles and containers containing gas for medical purposes; rental of hydrogen water generators for baths; rental of animals for gardening purposes; rental of gardening implements; rental of beehives; dietary and nutritional advice; art therapy; landscape architecture; public bath services for hygiene purposes; Turkish bath services; hospital services; reforestation services; cultivation of plants; depilatory waxing; diagnosis of visual processing disorders; landscape design; health centre services; nursing home services; acupuncture; wreath making; hair implantation; medical advice for individuals with disabilities; consultancy in the field of viticulture; pharmacy advice; medical treatment using cultured cells; animal-assisted therapy; manicuring; massage; remote monitoring of medical data for medical diagnosis and treatment; music therapy; pruning of trees; horticulture; artificial insemination services; hairdressing; transplanting of trees; body piercing; midwife services; veterinary assistance; dentistry services; medical assistance; palliative care; tree planting for carbon offsetting purposes; providing community gardening facilities; providing service animals to individuals with disabilities; preparation of prescriptions by pharma-

cists; medical equipment rental; rental of hair styling apparatus; rental of sanitary installations; farming equipment rental; aerial and surface spreading of fertilizers and other agricultural chemicals; animal breeding; rehabilitation for substance abuse patients; gardening; landscape gardening; beauty salon services; medical screening; blood bank services; health care; health counselling; rental of surgical robots; flower arranging; tattooing; cupping therapy; chiropractic; speech therapy; dance therapy; vermin exterminating for agriculture, aquaculture, horticulture and forestry; weed killing; wildlife management; health spa services; human tissue bank services; cultured cell bank services for medical transplantation; barber shop services; aquaculture services; aromatherapy services; viticulture services; convalescent home services; beautician services; medical clinic services; medical analysis services for diagnostic and treatment purposes provided by medical laboratories; home-visit nursing care; alternative medicine services; opticians' services; orthodontic services; plant nursery services; pest control services for agriculture, aquaculture, horticulture and forestry; Attention Deficit Hyperactivity Disorder screening services; learning disability screening services; Attention Deficit Disorder screening services; hair dyeing services; in vitro fertilization services; health assessment services; postnatal care services; vaccination services; services of a psychologist; regenerative medicine services; sanatorium services; sauna services; solarium services; telemedicine services; therapy services; aesthetician services; nursing, medical; lawn care; animal grooming; pet grooming; physiotherapy; tree surgery; plastic surgery; hospice services; occupational therapy.

(260) AM 2023 121168 A

(800) 1707155

(151) 2022 10 25

(891) 2022 10 25

(731) LOUIS DREYFUS TRADEMARKS B.V.
WTC AMSTERDAM, H-25 Zuidplein 208,
NL-1077 XV Amsterdam, Netherlands

(540)

LDC.
Louis Dreyfus Company

(591) Black, white

(531) 24.17.02; 27.05.09; 27.05.10; 27.05.17

(511)

5 – Pharmaceuticals and medical preparations; sanitary preparations for medical purposes; dietetic food and substances adapted for medical use, food for babies; dietary supplements for human beings; disinfectants; herbal supplements, vitamins and dietary supplements for human consumption; soy extracts and isoflavones for use as dietary and nutritional supplements, and as ingredients for dietary and nutritional

supplements; dietetic beverages adapted for medical purposes; probiotic supplements; prebiotic supplements; probiotic preparations for medical use to help maintain a natural balance of flora in the digestive system; nutritional supplements; health food supplements for persons with special dietary requirements; powdered nutritional supplement drink mix; nutritional drink mix for use as a meal replacement; nutritional supplement meal replacement bars for boosting energy; nutritional supplement energy bars; preparations for supplementing the body with essential vitamins and microelements; infant formula; food and beverages for babies and infants; powdered milk for babies and infants; dietary supplements for infants; medicinal tea; biotechnological preparations for medical, pharmaceutical purposes; whey protein supplements; protein supplements; bacterial preparations for medical use; anti-microbial preparations, probiotic bacterial formulations and supplements (for medical use); naturopathic and homeopathic preparations and substances [alternative medicines]; dietetic nutrients for medical use and nutriment for babies; coconut oil for medical purposes; glycerine for medical purposes; glycerine for medical use; lecithin dietary supplements; lecithin for medical purposes; antioxidants [dietary supplements]; vitamins, minerals and antioxidants being nutritional and dietary supplements; protein supplements for human beings; pesticides; insecticides, fungicides, herbicides, nematicides, rodenticides, insect growth regulators; preparations for activating the biological resistance of plants and seeds against insects, bacteria, fungal diseases, parasites and weeds; preparations and substances for use in improving water quality and preventing virus and bacteria growth in aquaculture and water systems [pharmaceutical]; antibiotic preparations and products relating to the prevention of the growth of algae in water; veterinary preparations; biotechnological preparations for veterinary purposes; bacterial preparations for veterinary use; cultures of microorganisms for veterinary use; worm repellents for farm animals and poultry, anti-insect spray and disinfectants in powder form; dietetic food and substances adapted for veterinary use; dietary supplements for animal beings; animal feed additives for use as nutritional supplements; medicated animal feed; non-medicated animal dietary supplements; protein supplements for animals.

9 – Downloadable mobile apps; computer software for blockchain technology and cryptocurrency; apparatus and instruments for recording, transmitting, reproducing or processing sound, images or data; recorded and downloadable media, computer software, blank digital or analogue recording and storage media; computer software and hardware for use in the field of trading, agricultural, horticultural and forestry companies; computer software and hardware for electronic trading of currency; downloadable mobile application in the field of trading, agricultural, horticultural and forestry companies; downloadable software in

the field of trading agricultural, horticultural and forestry companies; computer software in the field of animal health; downloadable computer software applications in the field of animal health; downloadable applications in the field of animal health; scientific, research, navigation, surveying, photographic, cinematographic, audio-visual, optical, weighing, measuring, signalling, detecting, testing, inspecting, life-saving and teaching apparatus and instruments; apparatus and instruments for conducting, switching, transforming, accumulating, regulating or controlling the distribution or use of electricity; apparatus and instruments for monitoring and measuring energy; control apparatus and control instruments for energy management; energy regulators; photovoltaic apparatus and installations for the production of electricity; photovoltaic cells and modules; apparatus and software for testing and analysing petroleum and chemical products.

44 – Medical services; hygienic and beauty care for human beings; health care services; health assessment and consultancy services; naturopathy and homeopathy [alternative medicines] services; advice related to animal nutrition; advice relating to the breeding of animals; agriculture, aquaculture, viticulture, arboriculture, horticulture and forestry services; animal husbandry; farming (animals); agricultural consultancy; cultivation advisory services relating to agriculture; providing information and offering consulting and advisory services, all in the fields of agriculture, aquaculture, horticulture, forestry, viticulture, arboriculture, market-gardening, fruit growing, seed planting, growing and protection of seeds; consultancy services relating to farming equipment; agriculture services relating to environmental conservation; services and advice relating to seed planting, the growing of plants and crop protection; consultancy in the field of agricultural food; aerial and surface spreading of fertilizers and other agricultural chemicals; providing information relating to the use of fertilizers; information services relating to the use of chemicals used in agriculture; insecticide spraying for agriculture; advisory and consultancy services relating to the use of non-chemical treatments for sustainable agriculture and horticulture; consultancy relating to tree planting; tree planting; animal feed rationing services; counselling, advice and information related to the formulation of personalized diets for animals.

(260) AM 2023 121169 A
 (800) 1707194
 (151) 2022 11 15
 (891) 2022 11 15
 (731) KMG International N.V.
 Strawinskylaan 807, Tower A-8, NL-1077
 XX Amsterdam, Netherlands

(540)



Pregatit pentru cariera

Ready for your career

(591) Red, black, orange, white and yellow
 (531) 01.03.01; 01.03.16; 05.05.04; 05.05.20;
 26.01.04; 26.01.06; 27.05.10; 29.01.13
 (511)

35 – Advertising; business management; business administration; office functions; retail services in relation to fuels; office function; rental of advertising space; commercial information and advice for consumers [consumer advice shop]; commercial information and commercial advice for consumers [consumer advice shop]; presentation of goods on communication media, for retail purposes; price comparison services; exhibitions (organization of-) for commercial or advertising purposes; public relations; administrative loyalty card services; administration of consumer loyalty programs; administration of loyalty rewards programs; loyalty, incentive and bonus program services; organisation, operation and supervision of loyalty schemes; customer loyalty services for commercial, promotional and /or advertising purposes; sales promotion; commercial business promotion services; drafting business administrative guidelines and administrative management of (savings and discount) schemes aimed at promoting customer loyalty; sales promotion using or based on price and reward schemes; business administration of savings and other funds; accounting services being administrative services consisting of converting (converting) valuations of points into monetary quantities or purchase, exchange and discount rights.

(260) AM 2023 121170 A
 (800) 1707198
 (151) 2022 11 15
 (891) 2022 11 15
 (731) Richter Gedeon Nyrt.
 Gyömrői út 19-21, H-1103 Budapest, Hungary

(540)

ЭННЕРОВАН

(591) Black, white
 (531) 28.05
 (511)
 5 – Pharmaceutical preparations.

(260) AM 2023 121171 A
 (800) 1707199
 (151) 2022 11 15
 (891) 2022 11 15
 (731) Richter Gedeon Nyrt.
 Gyömrői út 19-21, H-1103 Budapest, Hungary

(540)

ДАВОЛЕН

(591) Black, white

(531) 28.05

(511)

5 – Pharmaceutical preparations.

(260) AM 2023 121172 A

(800) 1707200

(151) 2022 11 15

(891) 2022 11 15

(731) Richter Gedeon Nyrt.

Gyömrői út 19-21., H-1103 Budapest, Hungary

(540)

БОЗИТЕДИН

(591) Black, white

(531) 28.05

(511)

5 – Pharmaceutical preparations.

(260) AM 2023 121264 A

(800) 1708087

(151) 2022 11 15

(891) 2022 11 15

(731) Richter Gedeon Nyrt.

Gyömrői út 19-21, H-1103 Budapest, Hungary

(540)

СИРУВИН

(591) Black, white

(531) 28.05

(511)

5 – Pharmaceutical preparations.

(260) AM 2023 121265 A

(800) 1708089

(151) 2022 11 15

(891) 2022 11 15

(731) RICHTER GEDEON NYRT.

Gyömrői út 19-21, H-1103 Budapest, Hungary

(540)

ТАНДАРУМ

(591) Black, white

(531) 28.05

(511)

5 – Pharmaceutical preparations.

(260) AM 2023 121266 A

(800) 1708090

(151) 2022 11 15

(891) 2022 11 15

(731) Richter Gedeon Nyrt.

Gyömrői út 19-21, H-1103 Budapest, Hungary

(540)

СТЕРВАЛТ

(591) Black, white

(531) 28.05

(511)

5 – Pharmaceutical preparations.

(260) AM 2023 121267 A

(800) 1708099

(151) 2022 10 31

(891) 2022 10 31

(731) Geehy Semiconductor Company Limited

68710 (Centralized office), Rm.105, No.6,

Baohua Rd., Hengqin New Dist., Zhuhai,

519000 Guangdong, China

(540)

Geehy

(591) Black, white

(531) 27.05.01

(511)

9 – Microcontrollers; microchips; multiprocessor chips; high definition graphic chipsets; electronic chips for the manufacture of integrated circuits; semiconductor devices; chips (integrated circuits); semiconductor devices; computer programs, downloadable; graphics processor units (GPUs).

(260) AM 2023 121268 A

(800) 1708119

(151) 2022 12 20

(891) 2022 12 20

(731) Apple Inc.

One Apple Park Way, Cupertino CA 95014, USA

(540)

CLOUDKIT

(591) Black, white

(511)

9 – Computer software used in developing other software applications; application development software; database management software.

(260) AM 2023 121269 A

(800) 1708179

(151) 2022 06 06

(891) 2022 06 06

(731) Palantir Technologies Inc.

1555 Blake Street, Suite 250, Denver

CO 80202, USA

(540)

PALANTIR

(591) Black, white

(511)

9 – Software for edge computing; edge artificial intelligence software; software for data processing, data storage, data capture, data collection, data validation, data security, data warehousing, data management, and data mining; software for artificial intelligence, machine learning, deep learning, natural language generation, statistical learning, supervised learning, unsupervised learning, data mining, predictive analytics, business intelligence, and computer vision; software, namely, knowledge-based artificial intelligence platforms, data analytics platforms, and automation platforms for use in the fields of artificial intelligence, machine learning, deep learning, statistical learning, supervised learning, un-supervised learning, data mining, predictive analytics and business intelligence; simulation, modeling and data processing software for use in data visualization, data analysis, data mining, data interpretation, predictive analytics, accessing and editing large-scale data, interactive visual computing, and design of information graphics; software for information and data integration, analysis, management, collaboration, algorithmic and human-driven exploration, viewing, modeling, exporting, visualization, organization, modification, book marking, transmission, storage, exchange, sharing, querying, auditing, collection, editing, hosting, security, and tracking of data and information; software for analysis, management, collaboration, algorithmic and human-driven exploration, viewing, modeling, exporting, visualization, organization, modification, book marking, transmission, storage, exchange, sharing, querying, auditing, collection, editing, hosting, security, and tracking of geospatial, map and location data and information; software for use in scientific and technological research and analysis in the field of national security; software for use in scientific and technological research and development in the field of national security; software for use in technology consultation and research in the field of national security; software for use in advance product research in the field of national security; software for use in engineering and design in the field of national security; software development tools in the field of national security; all of the aforementioned goods designed for and marketed to governmental, business, or other institutional users (but not to individual consumers) and not distributed through retail channels.

35 – Business data analysis; business consulting services concerning use of data and information by financial institutions, health institutions, non-profit organizations, legal institutions, commercial entities, and government agencies; advisory services relating to information and data processing; all the aforementioned services designed for and marketed to governmental, business, or other institutional users (but not to individual consumers) and not distributed through retail channels.

42 – Providing non-downloadable software for edge computing; providing non-downloadable edge artificial intelligence software; providing non-downloadable software for data processing, data storage, data capture, data collection, data validation, data security, data warehousing, data management, and data mining; providing non-downloadable software for artificial intelligence, machine learning, deep learning, natural language generation, statistical learning, supervised learning, un-supervised learning, data mining, predictive analytics, business intelligence, and computer vision; providing non-downloadable software, namely, knowledge-based artificial intelligence platforms, data analytics platforms, and automation platforms for use in the fields of artificial intelligence, machine learning, deep learning, statistical learning, supervised learning, un-supervised learning, data mining, predictive analytics and business intelligence; providing non-downloadable simulation, modeling and data processing software for use in data visualization, data analysis, data mining, data interpretation, predictive analytics, accessing and editing large-scale data, interactive visual computing, and design of information graphics; providing non-downloadable software for information and data integration, analysis, management, collaboration, algorithmic and human-driven exploration, viewing, modeling, exporting, visualization, organization, modification, book marking, transmission, storage, exchange, sharing, querying, auditing, collection, editing, hosting, security, and tracking of data and information; providing non-downloadable software for analysis, management, collaboration, algorithmic and human-driven exploration, viewing, modeling, exporting, visualization, organization, modification, book marking, transmission, storage, exchange, sharing, querying, auditing, collection, editing, hosting, security, and tracking of geospatial, map and location data and information; software as a service (SaaS) featuring software for data processing, data storage, data capture, data collection, data validation, data security, data warehousing, data management, and data mining; software as a service (SaaS) featuring software for artificial intelligence, machine learning, deep learning, natural language generation, statistical learning, supervised learning, un-supervised learning, data mining, predictive analytics, business intelligence, and computer vision; software as a service (SaaS) featuring knowledge-based artificial intelligence platforms, data analytics platforms, and automation platforms for use in the fields of artificial intelligence, machine learning, deep learning, statistical learning, supervised learning, un-supervised learning, data mining, predictive analytics and business intelligence; software as a service (SaaS) featuring simulation, modeling and data processing software for use in data visualization, data analysis, data mining, data interpretation, predictive analytics, accessing and editing large-scale data, interactive visual computing, and design of information graphics; software as a service (SaaS) featuring

software for information and data integration, analysis, management, collaboration, algorithmic and human-driven exploration, viewing, modeling, exporting, visualization, organization, modification, book marking, transmission, storage, exchange, sharing, querying, auditing, collection, editing, hosting, security, and tracking of data and information; software as a service (SaaS) featuring software for analysis, management, collaboration, algorithmic and human-driven exploration, viewing, modeling, exporting, visualization, organization, modification, book marking, transmission, storage, exchange, sharing, querying, auditing, collection, editing, hosting, security, and tracking of geospatial, map and location data and information; advanced product research in the field of artificial intelligence; scientific and technological research and analysis in the field of national security; scientific and technological research and development in the field of national security; technology consultation and research in the field of national security; advance product research in the field of national security; engineering and design in the field of national security; software design and development in the field of national security; providing non-downloadable software for use in scientific and technological research and analysis in the field of national security; providing non-downloadable software for use in scientific and technological research and development in the field of national security; providing non-downloadable software for use in technology consultation and research in the field of national security; providing non-downloadable software for use in advance product research in the field of national security; providing non-downloadable software for use in engineering and design in the field of national security; providing non-downloadable software development tools in the field of national security; all the aforementioned services designed for and marketed to governmental, business, or other institutional users (but not to individual consumers) and not distributed through retail channels.

(260) AM 2023 121288 A

(800) 1365412

(151) 2017 02 15

(891) 2022 12 30

(731) KALESERAMİK ÇANAKKALE
KALEBODUR SERAMİK SANAYİ ANONİM
ŞİRKETİ

Büyükdere Caddesi Kaleseramik Binası, Levent
Beşiktaş, İstanbul, Türkiye

(540)

Kalebodur

(591) Black, white

(531) 07.01.01; 07.01.06; 07.15.01

(511)

19 – floor tiles of natural stone; mosaic floor tiles; mosaic art tiles made of marble; mosaic wall tiles;

natural stone tiles; paving tiles; terra cotta floor tiles; wall tiles, not of metal, for building; wall tiles of glass; wall tiles of natural stone; cladding, not of metal, for building; wall claddings, not of metal, for building; swimming pools, not of metal; swimming pools [structures], not of metal; terra cotta [building material]; vinyl tile flooring; wall linings, not of metal, for building; asphalt, bitumen, cement, lime, plaster, concrete, marble blocks for construction, included in this class; doors and windows of wood and synthetic materials; traffic signs not of metal, non-luminous and non-mechanical, for roads; monuments and statuettes of stone, concrete and marble; building glass; prefabricated swimming pools not of metal [structures]; aquarium sand; building materials [non-metallic]; non-metallic rigid pipes for building; asphalt, pitch and bitumen; non-metallic transportable buildings; monuments, not of metal.

(260) AM 2023 121289 A

(800) 1378532

(151) 2017 02 15

(891) 2022 12 30

(731) KALESERAMİK ÇANAKKALE
KALEBODUR SERAMİK SANAYİ ANONİM
ŞİRKETİ

Levent Mah. Prof. Ahmet Kemal Aru Sok, Kale
Holding No:4/1, Beşiktaş/İstanbul, Türkiye

(540)

Kale

(591) Black, white

(531) 07.01.01; 07.01.06; 07.15.01

(511)

11 – Air conditioning apparatus for household purposes; air conditioning installations for industrial purposes; air deodorising apparatus; air dryers; air filters for household purposes; air purifying apparatus and machines; anti-splash tap nozzles; automatic hand dryers; automatic faucets; bath fittings; bath lights; ceiling light fixtures; chandeliers; cooling appliances and installations; cooling installations and machines; dehumidifiers for household purposes; deodorising apparatus, not for personal use; desk lamps; drip irrigation emitters [irrigation fittings]; drip irrigation systems; drying apparatus and installations; electric lamps; electric lighting fixtures; electric showers; facial sauna apparatus; faucet aerators; faucet filters; faucet handles; faucet sprayers; fitted liners for baths and showers; floor lamps; fluorescent lamps; hair dryers; halogen lamps; halogen light bulbs; hand drying apparatus for washrooms; hand-held shower heads; hand-held showers; heating apparatus; hot air bath fittings; hot air apparatus; humidifiers; hydromassage bath apparatus; indoor lighting fixtures; lamp bulbs; lamp glasses; lamp globes; lamp mantles; lamp reflectors; lamps; lamps for outdoor use; lamp shades;

lampshade holders; lanterns for lighting; light bulbs; light diffusers; light-emitting diode [LED] landscape lights; light-emitting diode [LED] light bulbs; light-emitting diode [LED] lighting fixtures; light-emitting diode [LED] lighting installations; light-emitting diode [LED] lights; light-emitting diodes [LED] lighting apparatus; lighting apparatus; mixer showers; mixer taps for water pipes; mixing valves for faucets; pipes [parts of sanitary installations]; power showers; sanitary apparatus and installations; sauna bath installations; sauna heaters; sauna rocks; sauna stoves; sconce lighting fixtures; shampoo basins; shower bath installations; shower baths; shower control valves; shower cubicles [enclosures (Am.)]; shower doors; shower fittings; shower heads; shower head sprayers; shower hoses; shower installations; shower mixing valves; shower panels; shower platforms; shower roses; showers; shower screens; shower sprayers [plumbing fittings]; shower trays; single-lever faucets for sinks; spa baths [vessels]; spotlights; spray heads for showers; table lamps; taps [cocks, spigots] [faucets (Am.)] for pipes; taps for wash-hand basins; toilet bowls; toilet bowls and seats sold as a unit; toilet bowls with integrated bidet water jets; toilets, portable; toilet tank balls; toilet tanks; towel steamers; Turkish bath cabinets, portable; wall light fixtures; wall lights; wall-mounted spouts for baths; wall-mounted spouts for bidets; wall-mounted spouts for sinks; wall-mounted spouts for wash-hand basins; washers for water taps; water conduits installations; water control valves for faucets; water distribution installations; water filtering apparatus; water heaters; water jets; water jets for use in bath tubs; whirlpool-jet apparatus; heated towel rails; electric towel warmers; lighting installations; lights for vehicles and interior-exterior spaces; heating installations using solid, liquid or gas fuels or electricity, central heating boilers, boilers for heating installations, radiators [heating], heat exchangers, not parts of machines, stoves, kitchen stoves, solar thermal collectors [heating]; steam, gas and fog generators, steam boilers, other than parts of machines, acetylene generators, oxygen generators, nitrogen generators; installations for air-conditioning and ventilating; cooling installations and freezers; electric and gas-powered devices, installations and apparatus for cooking, drying and boiling; cookers, electric cooking pots, electric water heaters, barbecues, electric laundry' driers; hair driers; hand drying apparatus; sanitary installations, taps [faucets], shower installations, toilets [water-closets], shower and bathing cubicles, bath tubs, toilet seats, sinks, wash-hand basins [parts of sanitary installations]; water softening apparatus; water purification apparatus; water purification installations; waste water purification installations; electric bed warmers and electric blankets, not for medical use; electric pillow warmers; electric or non-electric footwarmers; hot water bottles; filters for aquariums and aquarium filtration apparatus; industrial type installations for cooking, drying and cooling

purposes; pasteurizers and sterilizers; apparatus for lighting, heating, steam generating, cooking, refrigerating, drying, ventilating, water supply and sanitary purposes.

19 – Floor tiles of natural stone; mosaic floor tiles; mosaic art tiles made of marble; mosaic wall tiles; natural stone tiles; paving tiles; terra cotta floor tiles; wall tiles, not of metal, for building; wall tiles of natural stone; cladding, not of metal, for building; wall claddings, not of metal, for building; buildings, not of metal; swimming pools, not of metal; swimming pools [structures], not of metal; poles not of metal for power lines, traffic signs not of metal, non-luminous and non-mechanical, for roads; monuments and statues of stone, concrete and marble; prefabricated swimming pools not of metal [structures]; aquarium sand; asphalt, pitch and bitumen; non-metallic transportable buildings; monuments, not of metal; none of the aforementioned goods being related to doors, doors and windows hardware as well as locking, access control and security systems, solutions, device.

(260) AM 2023 121373 A

(800) 1709232

(151) 2022 11 10

(891) 2022 11 10

(731) OCP S.A.

2 Rue Al Abtal – Hay Erraha, 20200

Casablanca, Morocco

(540)



(591) Green and yellow

(531) 01.01.01; 01.01.02; 01.01.10; 05.13.01;
05.13.11; 28.01; 29.01.12

(511)

1 – Chemical products for use in industry, science, photography, as well as in agriculture, horticulture and forestry; unprocessed artificial resins, unprocessed plastics; fire extinguishing and fire prevention compositions; tempering and soldering preparations; materials for tanning leather and animal skins; adhesives for use in industry; putties and other paste fillers; compost, manures, fertilizers; biological preparations for use in industry and science.

6 – Common metals and their alloys; ores; building materials of metal; transportable buildings of metal; non-electric cables and wires of metal; small items of metal hardware; containers of metal for storage or transport; safes.

37 – Construction services; installation and repair services; mining extraction; oil and gas drilling.

41 – Education; training; entertainment; sporting and cultural activities.

42 – Scientific and technological services as well as research and design services relating thereto; industrial analysis, industrial research and industrial design services; quality control and authentication services; design and development of computers and software.

(260) AM 2023 121374 A

(800) 1709236

(151) 2022 10 27

(891) 2022 10 27

(731) Stiftung Ethereum (Foundation Ethereum)

Zeughausgasse 7a, CH-6300 Zug, Switzerland

(540)



(591) Black, white

(531) 03.11.01; 03.11.24; 03.11.25; 26.15.25

(511)

41 – Publication of journals online, namely, blogs featuring information and commentary in the fields of blockchain technology and software development.

42 – Providing information in the field of software development and information with respect to computer technology and programming, including in the field of blockchain technology, by means of a website.

(260) AM 2023 121375 A

(800) 1709301

(151) 2022 12 02

(891) 2022 12 02

(731) COTTON CLUB INVESTMENT LLC

1'st Lipovy per., vl. 4, d. Soboliha, g. Balashiha,
RU-143985 Moscow obl., Russian Federation

(540)



(591) White, blue and yellow

(531) 01.01.04; 01.01.09; 01.15.11; 28.05; 29.01.13

(511)

3 – Antistatic preparations for household purposes; balms, other than for medical purposes; lip glosses; nail glitter; body glitter; cotton wool for cosmetic purposes; cotton wool impregnated with make-up removing preparations; sachets for perfuming linen; drying agents for dishwashing machines; scented water; micellar water; deodorants for human beings or for animals; non-slipping liquids for floors; windscreen cleaning liquids; hair conditioners; quillaia bark for washing; body paint for cosmetic purposes; cosmetic creams; skin whitening creams; essential oil-based creams for aromatherapy use; hair spray; nail varnish; hair lotions; lotions for cosmetic purposes; beauty masks; sheet masks for cosmetic purposes; oils for cosmetic purposes; oils for cleaning purposes; cleaning chalk; soap; deodorant soap; soap for brightening textile; cakes of toilet soap; toothpaste; cosmetic preparations for baths; bath preparations, not for medical purposes; laundry soaking preparations; mouthwashes, not for medical purposes; fabric softeners for laundry use; dry-cleaning preparations; paint stripping preparations; lacquer-removing preparations; make-up removing preparations; rust removing preparations; nail care preparations; cleaning preparations; chemical cleaning preparations for household purposes; bleaching preparations [decolorants] for household purposes; aloe vera preparations for cosmetic purposes; sunscreen preparations; colour-brightening chemicals for household purposes [laundry]; breath freshening preparations for personal hygiene; stain removers; scouring solutions; antistatic dryer sheets; baby wipes impregnated with cleaning preparations; colour run prevention laundry sheets; tissues impregnated with cosmetic lotions; tissues impregnated with make-up removing preparations; bleaching soda; washing soda, for cleaning; bath salts, not for medical purposes; bleaching salts; cooling sprays for cosmetic purposes; sun-tanning preparations [cosmetics]; laundry glaze; laundry preparations; cosmetic preparations for skin care; dentifrices; cosmetics; cosmetics for children; cosmetics for animals; cleansers for intimate personal hygiene purposes, non medicated; douching preparations for personal sanitary or deodorant purposes [toiletries]; detergents, other than for use in manufacturing operations and for medical purposes; laundry bleach; phytocosmetic preparations; cotton swabs for cosmetic purposes; toners for cosmetic purposes; cloths impregnated with a detergent for cleaning; herbal extracts for cosmetic purposes.

5 – Antibacterial soap; disinfectant soap; medicated soap; cotton swabs for medical purposes; babies' diapers; diapers for pets; swim diapers, disposable, for babies; diapers for incontinence; disposable absorbent pads for lining pet crates; diaper changing mats, disposable, for babies; disposable house training pads for pets; breast-nursing pads; pomades for medical purposes; sanitary towels; panty liners [sanitary]; tissues impregnated with pharmaceutical lotions; antibacterial

handwashes; disinfectants; disinfectants for hygiene purposes; sanitary tampons; pants, absorbent, for incontinence; sanitary panties; babies' diaper-pants; medicated shampoos.

(260) AM 2023 121377 A
 (800) 1709358
 (151) 2022 10 26
 (891) 2022 10 26
 (731) Amouage SAOC
 P.O. Box 307, 111 Oman, Oman
 (540)

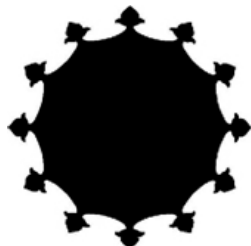

(591) Black, white
 (531) 26.13.25
 (511)
 3 – Soap; perfumery; perfumes; essential oils; air fragrance preparations; cosmetics; cleansers for intimate personal hygiene purposes, non medicated; depilatory preparation; make-up removing preparations; nail varnish removers; nail polish; shampoos; hair conditioner; hair dyes; hair spray; hair straightening preparations; hair waving preparations; lotions for cosmetic purposes; balms, other than for medical purposes; bath preparations, not for medical purposes; deodorants for human beings or animal; make-up powder; hair lotions; cosmetic creams.

(260) AM 2023 121378 A
 (800) 1709363
 (151) 2022 09 01
 (891) 2022 09 01
 (731) NIPPON PAINT HOLDINGS SG PTE. LTD
 16 RAFFLES QUAY, #17-03 HONG LEONG
 BUILDING, SINGAPORE 048581, Singapore
 (540)



(591) Blue, black, red, white
 (531) 26.04.04; 26.04.07; 26.04.18; 26.04.24;
 27.05.01; 27.05.02; 27.05.17; 29.01.14
 (511)
 35 – Advertising; business management; business administration; office functions; administration of the business affairs of franchises; organising of business competitions; organising of trade competitions; arran-

ging exhibitions for advertising purposes; arranging exhibitions for business purposes; arranging exhibitions for commercial purposes; arranging exhibitions for trade purposes; conducting exhibitions for advertising purposes; conducting exhibitions for business purposes; conducting exhibitions for commercial purposes; conducting exhibitions for trade purposes; event management services [organisation of exhibitions or trade fairs for commercial or advertising purposes]; arranging business shows; business auditing; business consultancy; online retail services; online retail store services; online wholesale services; online wholesale store services; presentation of goods on communication media, for retail purposes; retail services; retail store services; retail services for goods [by any means]; sales promotion services; online advertising on a computer network; presentation of goods on communication media, for retail purposes; television advertising; production of teleshopping programs; shop window dressing; production of advertising films; recruitment advertising; outdoor advertising; press advertising services; provision of an online marketplace for buyers and sellers of goods and services; import-export agency services; promotion of goods through influencers; influencer marketing; marketing.

(260) AM 2023 121380 A
 (800) 1709447
 (151) 2022 07 26
 (891) 2022 07 26
 (731) Euro Games Technology Ltd.
 4, "Maritsa" Str., "Vranya-Lozen-Triugulnika",
 BG-1151 Sofia, Bulgaria
 (540)

HIT FLAME

(591) Black, white
 (511)
 9 – Software; games software; computer gaming software; computer software packages; computer operating system software; computer software for the administration of on-line games and gaming; computer software, recorded; software drivers; virtual reality software; entertainment software for computer games; computer programs for network management; hardware and software for gambling, gambling machines, gambling games on the Internet and via telecommunication network; operating computer software for main frame computers; monitors (computer hardware); computer hardware; apparatus for recording images; monitors (computer programs); computer game programs; computer programs for recorded games; apparatus for recording, transmission or reproduction of sound or images; computer hardware for communication services; electronic components for gambling machines; computer application software featuring games and gaming; computer hardware for games and gaming.

28 – Games; chips for gambling; mah-jong; arcade games; gambling machines operating with coins, notes and cards; electropneumatic and electrical gambling machines (slot machines), electronic games; parlor games; gaming chips; gaming tables; slot machines [gaming machines]; LCD game machines; slot machines and gaming devices; coin-operated amusement machines; roulette chips; poker chips; chips and dice [gaming equipment]; equipment for casinos; roulette tables; gaming roulette wheels; casino games; automats and gambling machines; coin-operated machines and/or electronic coin-operated machines with or without the possibility of gain; boxes for coin-operated machines, slot machines and gaming machines; electronic or electrotechnical gaming devices, automats and machines, coin-operated machines; housings for coin-operated machines, gaming equipment, gaming machines, machines for gambling; gaming machines for gambling.

41 – Casino management services; operation of gaming establishments, gaming halls, internet casinos, online gambling sites; services related to gambling; gaming services for entertainment purposes; casino, gaming and gambling services; gambling; training in the development of software systems; provision of gaming equipment for gambling halls; providing casino equipment [gambling]; gaming machine entertainment services; providing casino facilities [gambling]; providing halls with gaming machines; amusement arcade services; games equipment rental; rental of gaming machines; providing amusement arcade services; rental of gaming machines with images of fruits; editing or recording of sounds and images; sound recording and video entertainment services; hire of sound reproducing apparatus; provision of gaming equipment for casinos; providing of casino facilities; online gambling services.

(260) AM 2023 121382 A

(800) 1709450

(151) 2022 07 26

(891) 2022 07 26

(731) Euro Games Technology Ltd.

4, "Maritsa" Str., "Vranya-Lozen-Triugulnika",
BG-1151 Sofia, Bulgaria

(540)

HOT WIN

(591) Black, white

(511)

9 – Software; games software; computer gaming software; computer software packages; computer operating system software; computer software for the administration of on-line games and gaming; computer software, recorded; software drivers; virtual reality software; entertainment software for computer games; computer programs for network management; hardware and software for gambling, gambling machines,

gambling games on the Internet and via telecommunication network; operating computer software for main frame computers; monitors (computer hardware); computer hardware; apparatus for recording images; monitors (computer programs); computer game programs; computer programs for recorded games; apparatus for recording, transmission or reproduction of sound or images; computer hardware for communication services; electronic components for gambling machines; computer application software featuring games and gaming; computer hardware for games and gaming.

28 – Games; chips for gambling; mah-jong; arcade games; gambling machines operating with coins, notes and cards; electropneumatic and electrical gambling machines (slot machines), electronic games; parlor games; gaming chips; gaming tables; slot machines [gaming machines]; LCD game machines; slot machines and gaming devices; coin-operated amusement machines; roulette chips; poker chips; chips and dice [gaming equipment]; equipment for casinos; roulette tables; gaming roulette wheels; casino games; automats and gambling machines; coin-operated machines and/or electronic coin-operated machines with or without the possibility of gain; boxes for coin-operated machines, slot machines and gaming machines; electronic or electrotechnical gaming devices, automats and machines, coin-operated machines; housings for coin-operated machines, gaming equipment, gaming machines, machines for gambling; gaming machines for gambling.

41 – Casino management services; operation of gaming establishments, gaming halls, internet casinos, online gambling sites; services related to gambling; gaming services for entertainment purposes; casino, gaming and gambling services; gambling; training in the development of software systems; provision of gaming equipment for gambling halls; providing casino equipment [gambling]; gaming machine entertainment services; providing casino facilities [gambling]; providing halls with gaming machines; amusement arcade services; games equipment rental; rental of gaming machines; providing amusement arcade services; rental of gaming machines with images of fruits; editing or recording of sounds and images; sound recording and video entertainment services; hire of sound reproducing apparatus; provision of gaming equipment for casinos; providing of casino facilities; online gambling services.

(260) AM 2023 121384 A

(800) 1709453

(151) 2022 07 26

(891) 2022 07 26

(731) Euro Games Technology Ltd.

4, "Maritsa" Str., "Vranya-Lozen-Triugulnika",
BG-1151 Sofia, Bulgaria

(540)

Flamy Dice

(591) Black, white

(511)

9 – Software; games software; computer gaming software; computer software packages; computer operating system software; computer software for the administration of on-line games and gaming; computer software, recorded; software drivers; virtual reality software; entertainment software for computer games; computer programs for network management; hardware and software for gambling, gambling machines, gambling games on the Internet and via telecommunication network; operating computer software for main frame computers; monitors (computer hardware); computer hardware; apparatus for recording images; monitors (computer programs); computer game programs; computer programs for recorded games; apparatus for recording, transmission or reproduction of sound or images; computer hardware for communication services; electronic components for gambling machines; computer application software featuring games and gaming; computer hardware for games and gaming.

28 – Games; chips for gambling; mah-jong; arcade games; gambling machines operating with coins, notes and cards; electropneumatic and electrical gambling machines (slot machines), electronic games; parlor games; gaming chips; gaming tables; slot machines [gaming machines]; LCD game machines; slot machines and gaming devices; coin-operated amusement machines; roulette chips; poker chips; chips and dice [gaming equipment]; equipment for casinos; roulette tables; gaming roulette wheels; casino games; automats and gambling machines; coin-operated machines and/or electronic coin-operated machines with or without the possibility of gain; boxes for coin-operated machines, slot machines and gaming machines; electronic or electrotechnical gaming devices, automats and machines, coin-operated machines; housings for coin-operated machines, gaming equipment, gaming machines, machines for gambling; gaming machines for gambling.

41 – Casino management services; operation of gaming establishments, gaming halls, internet casinos, online gambling sites; services related to gambling; gaming services for entertainment purposes; casino, gaming and gambling services; gambling; training in the development of software systems; provision of gaming equipment for gambling halls; providing casino equipment [gambling]; gaming machine entertainment services; providing casino facilities [gambling]; providing halls with gaming machines; amusement arcade services; games equipment rental; rental of gaming machines; providing amusement arcade services; rental of gaming machines with images of fruits; editing or recording of sounds and images; sound recording and video entertainment services; hire of sound rep-

roducing apparatus; provision of gaming equipment for casinos; providing of casino facilities; online gambling services.

(260) AM 2023 121393 A

(800) 1709709

(151) 2022 11 03

(891) 2022 11 03

(731) ŠKODA AUTO a.s.

Tř. Václava Klementa 869, Mladá Boleslav II,
CZ-293 01 Mladá Boleslav, Czech Republic

(540)



(591) Black, white

(531) 03.07.17; 03.07.24; 24.15.01; 24.15.05;
26.01.03

(511)

9 – Recorded content; mobile apps; downloadable computer software for use as an electronic wallet; downloadable computer software for blockchain technology; interactive software; electronic publications, downloadable; downloadable image files; virtual and augmented reality software; virtual assistant software; safety, security, protection and signalling devices; locks, electric; burglar alarms; vehicle breakdown warning lamps; vehicle breakdown warning triangles; driver assistance systems for motor vehicles; measuring, detecting, monitoring and controlling devices; speed indicators; revolution counters; controllers and regulators; tachographs; apparatus and instruments for controlling electricity; apparatus and instruments for accumulating electricity; apparatus and instruments for switching electricity; apparatus and instruments for transforming electricity; apparatus and instruments for regulating electricity; apparatus and instruments for conducting electricity; apparatus, instruments and cables for electricity; photovoltaic apparatus for generating electricity; batteries, electric; accumulators, electric; chargers for electric batteries; electric-car charger; electric car charging piles; apparatus and instruments for accumulating and storing electricity; fuel cells; light-emitting diodes [led]; aerials; scientific research and laboratory apparatus, educational apparatus and simulators; navigation, guidance, tracking, targeting and map making devices; on-board computers; electronic displays; computer programs for use in the autonomous navigation of vehicles; computer programs for use in autonomous control of vehicles; telematic apparatus; telephone apparatus; electronic control systems; electronic control instruments; information technology and audio-visual, multimedia and

photographic devices; data processing equipment and accessories (electrical and mechanical); sound and picture recording apparatus; sound reproduction apparatus; loudspeakers; radios; data storage devices and media; personal digital assistants [pdas]; voice command devices; downloadable virtual goods, namely automobiles, clothes, bags, toys to be used online and in online virtual world; lasers, not for medical purposes; spectacles; magnets; integrated circuit cards [smart cards]; banking cards [encoded or magnetic]; electronic id cards; multifunction cards for financial services; hands-free kits for telephones.

12 – Vehicles and conveyances; parts and fittings for land vehicles; cars; autonomous vehicles; lorries; motorcycles; bicycles; carts; caravans; engines for land vehicles; motors, electric, for land vehicles.

35 – Retail services in relation to vehicles; wholesale services in relation to vehicles; sales administration; administrative processing and organising of mail order services; administrative processing of purchase orders; administrative processing of warranty claims; advisory services relating to commercial transactions; computerised stock ordering; providing information via the internet relating to the sale of automobiles; business assistance, management and administrative services; advertising, marketing and promotional services; retail services relating to automobile accessories; retail services relating to automobile parts; provision of an online marketplace for buyers and sellers of goods and services; wholesale services relating to automobile accessories; wholesale services relating to automobile parts; retail services in relation to virtual goods, namely automobiles, clothes, bags and toys.

36 – Valuation services; financial, monetary and banking services; insurance underwriting; issuance of prepaid cards and tokens of value; fundraising and financial sponsorship; financial consultancy; electronic transfer of crypto assets; financial services in relation to digital currencies; financial transactions via blockchain.

37 – Maintenance, servicing and repair of vehicles; garage services for vehicle repair; assembly [installation] of accessories for vehicles; fitting of replacement vehicle parts; vehicle cleaning; providing information relating to the repair of land vehicles; provision of information relating to the maintenance of vehicles; charging of batteries and power storage devices, and rental of equipment therefore; rental of battery chargers.

38 – Telecommunication services; interactive communication services; geolocation services [telecommunications services]; information, consultancy and advisory services relating to telecommunications; transmission of data, messages and information; provision of access to content, websites and portals; transmission of podcasts; podcast broadcasting; broadcasting of audiovisual and multimedia content via the inter-

net; video telephone services; provision and rental of telecommunications facilities and equipment; computer communication and internet access; communications by telephone; communications services; communication services for the delivery of emergency messages; network conferencing services; providing electronic telecommunication connections; telematic communication services; transmission and receiving by radio.

39 – Packaging and storage of goods; rental services related to vehicles, transportation, and storage; transport; vehicle parking and storage; transport information, advice and reservation services; car sharing services; rental of means of transportation.

(260) AM 2023 121456 A

(800) 1710187

(151) 2022 10 18

(891) 2022 10 18

(731) BTL Industries

Tzar Kaloyan str 8, BG-1000 Sofia, Bulgaria

(540)

HIFES

(591) Black, white

(511)

10 – Medical apparatus and instruments; aesthetic apparatus and instruments for aesthetic therapy, namely apparatus and instruments generating electrical, magnetic, electromagnetic, mechanical or thermal therapeutic energy; aesthetic apparatus and instruments for aesthetic therapy, namely apparatus and instruments for body shaping, fat removal, girth reduction, skin tightening, cellulite reduction, skin rejuvenation, wrinkle reduction, scar reduction, stretch mark reduction, increasing muscle mass, increasing amount of muscle fibres, increasing muscle tone; aesthetic massage apparatus, in particular apparatus for lymphatic drainage and increasing the circulation of bodily fluids; aesthetic massage apparatus; devices for facial aesthetic treatment using electrical, magnetic, electromagnetic, mechanical or thermal therapeutic energy; therapeutic facial masks; physical therapy apparatus, in particular apparatus for treating pain and preventing muscle cramps; gynaecological and urological apparatus and instruments; dental equipment; body rehabilitation apparatus for medical purposes; physical therapy equipment; physiotherapy and rehabilitation equipment; beds specially made for medical purposes; contraceptives, non-chemical; artificial limbs; orthopedic articles; suture materials.

(260) AM 2023 121457 A

(800) 1710199

(151) 2022 12 13

(891) 2022 12 13

(731) Duolingo, Inc.

5900 Penn Ave., Pittsburgh PA 15206, USA

(540)

DUOLINGO

(591) Black, white

(511)

9 – Downloadable software for mobile phones for learning foreign languages.

41 – Language instruction; providing online classes for learning foreign languages; publication of online journals, namely, blogs in the field of language instruction; translation services for others.

42 – Software as a service (SaaS) services featuring software for learning foreign languages; providing non-downloadable software for learning foreign languages via a website.

(260) AM 2023 121458 A

(800) 1710231

(151) 2022 07 13

(891) 2022 07 13

(731) CRISTEL

Parc d'Activité du Moulin, F-25490

Feschés-le-Chatel, France

(540)

LET'S COOK UP A BETTER WORLD

(591) Black, white

(511)

8 – Cutlery, kitchen knives and cutting utensils for kitchen use; table knives; hand-operated vegetable peelers; vegetable choppers; meat choppers; kitchen slicers; household tools; hand-operated vegetable graters; carving knives; knife cases.

21 – Tableware, kitchen utensils and containers for household or kitchen use; autoclaves (term considered too vague in the opinion of the International Bureau – Rule 13 (2) (b) of the Regulations); non-electric kitchen mixers; pouring spouts for culinary use; cooking pot sets; metal lunch boxes; tea caddies; mixing bowls; bottles; non-electric kettles; perfume burner (term considered too vague in the opinion of the International Bureau – Rule 13 (2) (b) of the Regulations); stew-pans; coffee machines; non-electric candelabras; lazy susans [kitchenware]; ceramics for kitchen use; casseroles; cups; pot and pan lids; non-electric couscous pans; mixing spoons [kitchen utensils]; steam cooking apparatus [cookware]; trivets [table utensils]; non-electric devices for making pasta for domestic use; paper towel dispensers; spice racks; skimmers [non-electric kitchen utensils]; vacuum flasks for household use; whisks [kitchen utensils]; non-electric deep fryers; vegetable dishes; grills [cooking utensils]; infusers [tea filters] not of precious metal; coffee machines, non-electric; cake molds; mugs; salt and pepper mills; molds [kitchen utensils]; spice mills (term considered too vague in the opinion of the Inter-

national Bureau – Rule 13 (2) (b) of the Regulations); cooking pots and pans [non-electric]; strainers [kitchen utensils]; kitchen brushes; non-electric percolators for brewing coffee; candle jars [holders]; chopping boards; trays for household use; roasting dishes; dishes; earthenware saucepans; non-electric cooking pans; spice pots; pottery; non-electric fruit presses for household use; vegetable presses (term considered too vague in the opinion of the International Bureau – Rule 13 (2) (b) of the Regulations); graters [non-electric utensils for household purposes]; all-purpose portable household containers; salad bowls; gravy boats; skillets; coffee services; condiment sets; spatulas; cups; teapots; woks.

35 – Retail services concerning instruments for cooking food; retail services concerning metal hardware; retail services concerning kitchen utensils; retail services concerning tableware; retail sale services relating to cleaning products; retail services concerning cutlery; wholesale services concerning instruments for cooking food; wholesale services concerning kitchen utensils; wholesale services concerning cutlery; wholesale services concerning metal hardware; wholesale services concerning tableware; wholesale services concerning food preparation implements; providing consumers with product information via the Internet; import-export agency services; telemarketing services; administrative processing of purchase orders; administrative processing and organizing of mail order services; computerized online ordering services; loyalty, incentive and bonus program services; product presentation and demonstration services; public relations services; organization of promotional events for charitable fundraising; organization and conducting of promotional events; arranging and placing of advertisements; business promotion [advertising]; market prospecting; advertising and marketing; product launch services; developing creative marketing plans; services in the field of corporate identity; event marketing services; advertising services for promoting public awareness of environmental issues; advertising services aimed at promoting public awareness in the field of social well-being; advertising services in the field of the tourist industry; advertising, promotional and public relations services; business support and management services and administrative services; commercial administration of the licensing of third-party goods and services; business project management; business process management (term considered too vague in the opinion of the International Bureau – Rule 13 (2) (b) of the Regulations); commercial management services; assistance for organizing company matters; customer relations management; business administration services for the processing of sales made on the Internet.

41 – Organization of conferences, exhibitions and competitions; consultancy with respect to organizing culinary competitions (term considered too vague in

the opinion of the International Bureau – Rule 13 (2) (b) of the Regulations); organization of award ceremonies; organization of demonstrations for cultural purposes; organization of quizzes; arranging, coordination and organization of workshops; consulting services in the field of culinary competitions; museum services; theme park services; production of talent competitions; production of training videos; television, radio and film production; presentation of live entertainment events; wine tastings [entertainment services] [term considered too vague in the opinion of the International Bureau – Rule 13 [2] [b] of the Regulations]; conducting of guided tours; organization of local cultural events; organization of festivals; organizing and conducting of exhibitions for cultural or educational purposes; library services; tutoring; professional skills validation (term considered too vague in the opinion of the International Bureau – Rule 13 (2) (b) of the Regulations); publication of documents; multimedia publication of journals; blog writing services; coaching [training]; conducting of online nutrition courses; conducting courses on diet via the Internet; training related to food presentation; organization of courses relating to nutrition; business mentoring services; educational services relating to Japanese cuisine; educational services concerning tea ceremony; transmission of know-how [training]; preparation, coordination and organization of seminars.

(260) AM 2023 121460 A

(800) 1710357

(151) 2022 12 09

(891) 2022 12 09

(731) Individual entrepreneur Morgunov Leonid Grigor'evich
ul. Dostoevskogo, d. 8, kv. 47, g. Novosibirsk,
RU-630091 Novosibirskaya oblast', Russian
Federation

(540)

Greenway 
G L O B A L

(591) Black and green

(531) 26.03.01; 27.05.10; 29.01.12

(511)

35 – Import-export agency services; computerized file management; demonstration of goods; online wholesale and retail store services; arranging commercial transactions, for others, via on-line shops; business management and organization consultancy; business organization consultancy; business management consultancy; professional business consultancy; consultancy regarding advertising communication strategies; consultancy regarding public relations communication strategies; marketing; marketing in the framework of software publishing; targeted marketing; business management services; commercial management; business project management services; personnel manage-

ment; updating and maintenance of information in registries; updating and maintenance of data in computer databases; organization of exhibitions for commercial or advertising purposes; organization of trade fairs for commercial or advertising purposes; data search in computer files for others; business management assistance; commercial or industrial management assistance; commercial intermediation services; providing business information via a website; provision of an online marketplace for buyers and sellers of goods and services; auctioneering; wholesale services featuring a wide variety of consumer goods; wholesale services for pharmaceutical, veterinary and sanitary preparations and medical supplies; retail services featuring a wide variety of consumer goods; retail services for pharmaceutical, veterinary and sanitary preparations and medical supplies; sales promotion for others; promotion of goods and services through sponsorship of sports events; registration of written communications and data; compilation and systemization of information on the Internet; compilation of information into computer databases; systemization of information into computer databases; advisory services for business management; negotiation of business contracts for others; negotiation and conclusion of commercial transactions for third parties; telemarketing services; interim business management; outsourced administrative management for companies; commercial administration of the licensing of the goods and services of others; business management of reimbursement programmes for others; administration of consumer loyalty programs; administration of frequent flyer programs; administration of sales and promotional incentive schemes; administrative processing of purchase orders; advertising; commercial lobbying services; wholesale or retail store services; website traffic optimization; organization of exhibitions and events for commercial or advertising purposes; search engine optimization for sales promotion; business intermediary services; retail services provided by means of mail order catalogs; retail services provided by television stores or via a web sites; procurement services for others [purchasing goods and services for other businesses]; outsourcing services [business assistance].

(260) AM 2023 121462 A

(800) 1710436

(151) 2022 10 04

(891) 2022 10 04

(731) ALTONA COSMETICS TECHNOLOGY
SANAYİ VE TİCARET ANONİM ŞİRKETİ
KARAMEHMET MAH/SEMT AVRUPA,
SERBEST BÖLGESİ 13. SK. 8 1, ERGENE,
TEKİRDAĞ, Türkiye

(540)

Poesia

(591) Black, white

(511)

3 – Non-medicated cosmetics and toiletry preparations; non-medicated dentifrices; perfumery, essential oils; soaps; hair lotions; bleaching preparations and other substances for laundry use; cleaning, polishing, scouring and abrasive preparations.

(260) AM 2023 121540 A

(800) 1711348

(151) 2022 12 07

(891) 2022 12 07

(731) HALK HİJYENİK ÜRÜNLER DETERJAN SANAYİ VE TİCARET ANONİM ŞİRKETİ ACIDEREOSB MAH. BAKLALI CAD. 19, Sarıçam, Adana, Türkiye

(540)



(591) Blue, green

(531) 24.13.01; 27.05.01; 27.05.08; 27.05.09; 29.01.12

(511)

5 – Pharmaceutical and veterinary preparations for medical purposes; chemical preparations for medical and veterinary purposes, chemical reagents for pharmaceutical and veterinary purposes; medicated cosmetics; dietary supplements for pharmaceutical and veterinary purposes; dietary supplements; nutritional supplements; medical preparations for slimming purposes; food for babies; herbs and herbal beverages adapted for medicinal purposes; dental preparations and articles: teeth filling material, dental impression material, dental adhesives and material for repairing teeth; sanitary preparations for medical use; hygienic pads; hygienic tampons; plasters; materials for dressings; diapers made of paper and textiles for babies, adults and pets; preparations for destroying vermin; herbicides, fungicides, preparations for destroying rodents; deodorants, other than for human beings or for animals; air purifying preparations; air deodorising preparations; disinfectants; antiseptics; detergents for medical purposes; medicated soaps; disinfectant soaps; antibacterial hand lotions.

(260) AM 2023 121541 A

(800) 1711350

(151) 2022 12 07

(891) 2022 12 07

(731) HALK HİJYENİK ÜRÜNLER DETERJAN SANAYİ VE TİCARET ANONİM ŞİRKETİ ACIDEREOSB MAH. BAKLALI CAD. 19, Sarıçam, Adana, Türkiye

(540)



(591) Black, white

(531) 27.05.01

(511)

5 – Pharmaceutical and veterinary preparations for medical purposes; chemical preparations for medical and veterinary purposes, chemical reagents for pharmaceutical and veterinary purposes; medicated cosmetics; dietary supplements for pharmaceutical and veterinary purposes; dietary supplements; nutritional supplements; medical preparations for slimming purposes; food for babies; herbs and herbal beverages adapted for medicinal purposes; dental preparations and articles: teeth filling material, dental impression material, dental adhesives and material for repairing teeth; sanitary preparations for medical use; hygienic pads; hygienic tampons; plasters; materials for dressings; diapers made of paper and textiles for babies, adults and pets; preparations for destroying vermin; herbicides, fungicides, preparations for destroying rodents; deodorants, other than for human beings or for animals; air purifying preparations; air deodorising preparations; disinfectants; antiseptics; detergents for medical purposes; medicated soaps; disinfectant soaps; antibacterial hand lotions.

(260) AM 2023 121543 A

(800) 1711387

(151) 2023 01 05

(891) 2023 01 05

(731) SAMSUNG ELECTRONICS CO., LTD. 129, Samsung-ro, Yeongtong-gu, Suwon-si, Gyeonggi-do, Republic of Korea

(540)



(591) Black, white

(511)

9 – Computer monitors; video monitors; television monitors; wearable video display monitors; LCD monitors; LED monitors; tablet monitors; digital signage monitors; touchscreen monitors.

(260) AM 2023 121544 A

(800) 1711429

(151) 2022 10 05

(891) 2022 10 05

(731) Euro Games Technology Ltd.

4, "Maritsa" Str., "Vranya-Lozen-Triugulnika", BG-1151 Sofia, Bulgaria

(540)



(591) Green, dark green, light green, gold, black, white, orange and yellow

(531) 01.15.07; 01.15.09; 05.03.06; 05.03.13; 29.01.14

(511)

9 – Operating computer software for main frame computers; monitors (computer hardware); computer hardware; apparatus for recording images; monitors (computer programs); computer game programs; recorded computer game programs; apparatus for recording, transmission or reproduction of sound or images; communications servers (computer hardware); electronic components for gambling machines; computer application software featuring games and gaming; computer software for the administration of on-line games and gaming; computer hardware for games and gaming; hardware and software for gambling, gambling machines, gambling games on the Internet and via telecommunication network; computer systems; computer operating system software; computer terminals; interactive terminals; multimedia terminals; electronic terminals for generating lottery tickets; interactive touch screen terminals; computer touchscreens; electronic display panels; liquid crystal display screens; digital signage display panels; multimedia software; multimedia apparatus and instruments; interactive multimedia software for playing games; computer screens; LCD large-screen displays; liquid crystal displays [LCDs] for home theatres; media streaming software; computer application software for streaming audio-visual media content via the Internet; software; computer gaming software; computer software packages; computer operating system software; computer software, recorded; software drivers; virtual reality software; games software; entertainment software for computer games; computer programs for network management; electronic lottery tickets; computer software platforms; operating systems; interactive computer systems; operating system programs; computer game software for use with on-line interactive games; interactive casino games provided through a computer or mobile platform; software for slot machines, betting software, software for video slot games, for casino games, for gambling and bingo games, provided online or through computer networks and that can be played on any type of computer device, including arcade games, personal computers, portable devices and mobile phones.

28 – Gaming machines for gambling; chips for gambling; mah-jong; arcade games; gambling machines operating with coins, notes and cards; games; electronic games; parlor games; gaming chips; gaming tables; slot machines [gaming machines]; LCD game machines; slot machines and gaming devices; coin-operated amusement machines; roulette chips; poker chips; chips and dice [gaming equipment]; gaming equipment for casinos; roulette tables; gaming roulette wheels; casino games; gambling machines and amusement machines, automatic and coin-operated; coin-

operated amusement machines and/or electronic coin-operated amusement machines with or without the possibility of gain; boxes for coin-operated amusement machines, slot machines and gaming machines; electronic or electrotechnical amusement machines and apparatus, gaming machines, coin-operated entertainment machines; housings for coin-operated amusement machines, gaming equipment, gaming machines, machines for gambling; electropneumatic and electrical gambling machines (slot machines); lottery games; electronic targets for games and sports.

41 – Gambling services; gaming services for entertainment purposes; casino, gaming and gambling services; training in the development of software systems; provision of gaming equipment for gambling halls; providing casino equipment [gambling]; gaming machine entertainment services; providing casino facilities [gambling]; gaming hall services; games equipment rental; rental of gaming machines; providing amusement arcade services; rental of gaming machines with images of fruits; editing or recording of sounds and images; sound recording and video entertainment services; hire of sound reproducing apparatus; provision of gaming equipment for casinos; providing of gambling facilities; online gambling services; casino services; provision of gaming facilities and gaming hall facilities, Internet casinos and online gambling services; lottery services; organization of lotteries; provision of games by means of a computer based system; online interactive entertainment; on-line casino services; online game services through mobile devices; providing online entertainment in the nature of game tournaments; providing on-line information in the field of computer gaming entertainment; sports betting services; online sports betting services; providing online games and games of chance; entertainment services related to gambling.

(260) AM 2023 121545 A

(800) 1711487

(151) 2022 11 30

(891) 2022 11 30

(731) Société des Produits Nestlé S.A.

CH-1800 Vevey, Switzerland

(540)



(591) White, black, brown, red, orange, dark brown and light brown

(531) 01.15.15; 01.15.25; 08.01.19; 26.13.01;

27.05.01; 27.05.02; 27.05.08; 27.05.17;

27.05.24; 29.01.12

(511)

30 – Cocoa and cocoa-based beverages and preparations; chocolate, chocolate products, chocolate-based

beverages and preparations; cereal-based beverages and preparations included in this class; sugar; biscuits and cookies; confectionery; sugar confectionery; cookies; cakes; wafers; caramels; puddings; candy; chewing gum not for medical use; bakery products; bread; powdered mixture for cakes; pastry; edible ices, water ices, sherbets, frozen confectionery products, frozen cakes, ice cream, frozen desserts, frozen yogurts; cereals, breakfast cereals, cereal bars, muesli, corn flakes, cereal bars, ready-to-eat cereals; cereal preparations; cereal-based snacks.

(260) AM 2023 121546 A

(800) 1711493

(151) 2022 11 25

(891) 2022 11 25

(731) Philip Morris Brands Sàrl

Quai Jeanrenaud 3, CH-2000 Neuchâtel,
Switzerland

(540)



(591) Black, white

(531) 03.01.02; 24.01.15; 24.03.08; 24.09.01;
24.09.03; 25.01.06; 27.01.12

(511)

34 – Tobacco, raw or manufactured; tobacco products; cigars, cigarettes, cigarillos, tobacco for roll-your-own cigarettes, pipe tobacco, chewing tobacco, snuff tobacco, kretek; snus; tobacco substitutes (not for medical purposes); electronic cigarettes; tobacco products for the purpose of being heated; electronic devices and their parts for the purpose of heating cigarettes or tobacco in order to release nicotine-containing aerosol for inhalation; liquid nicotine solutions for use in electronic cigarettes; smokers' articles, cigarette paper, cigarette tubes, cigarette filters, tobacco tins, cigarette cases, ashtrays, pipes, pocket apparatus for rolling cigarettes, lighters, matches.

(260) AM 2023 121557 A

(800) 1711767

(151) 2023 01 09

(891) 2023 01 09

(731) International Fruit Genetics, LLC

8224 Espresso Drive, Suite 200, Bakersfield
CA 93312, USA

(540)

CHEERY CHANT

(591) Black, white

(511)

31 – Fresh fruits and fresh vegetables; live plants, namely, live cherry trees; live plants and live propagating material, namely, live cuttings, live plant tissue, and live plant clones, all for growing live plants.

(260) AM 2023 121558 A

(800) 1711768

(151) 2023 01 09

(891) 2023 01 09

(731) International Fruit Genetics, LLC

8224 Espresso Drive, Suite 200, Bakersfield
CA 93312, USA

(540)

CHEERY PROSE

(591) Black, white

(511)

31 – Fresh fruits and fresh vegetables; live plants, namely, live cherry trees; live plants and live propagating material, namely, live cuttings, live plant tissue, and live plant clones, all for growing live plants.

(260) AM 2023 121559 A

(800) 1711772

(151) 2022 10 24

(891) 2022 10 24

(731) GANZHOU ACHTECK TOOL

TECHNOLOGY CO., LTD

Gongye Third Road, Ganzhou Economic
Development Area, Jiangxi Province, China

(540)



(591) Black, white

(531) 26.13.25

(511)

6 – Common metals, unwrought or semi-wrought; tungsten; alloys of common metal; powdery metal; tungsten powder; metal bolts; metal screws; hardware of metal, small; common metal statues; common metal art works; metal ores; tungsten ores.

7 – Cutting tools (machine parts); drills (machine parts); inserts (machine parts); chucks (machine parts); fixtures of machine; drill chucks (machine parts); turning tools (machine parts); hole making machine tools; milling tools being machine tools; threading tools [machines]; gear cutting tools being machine tools; broaching tools [machines]; band saws; machine tool holders.

(260) AM 2023 121560 A
 (800) 1711779
 (151) 2023 01 09
 (891) 2023 01 09
 (731) International Fruit Genetics, LLC
 8224 Espresso Drive, Suite 200, Bakersfield
 CA 93312, USA

(540)

CHEERY NEBULA

(591) Black, white
 (511)
 31 – Fresh fruits and fresh vegetables; live plants, namely, live cherry trees; live plants and live propagating material, namely, live cuttings, live plant tissue, and live plant clones, all for growing live plants.

(260) AM 2023 121561 A
 (800) 1711787
 (151) 2022 11 23
 (891) 2022 11 23
 (731) VIENNA INSURANCE GROUP AG Wiener
 Versicherung, Gruppe
 Schottenring 30, A-1010 Wien, Austria

(540)



(591) Black, red
 (531) 01.05.02; 05.05.20; 24.01.13; 24.13.24;
 24.13.25; 26.11.01; 26.11.08; 27.05.01;
 29.01.13
 (511)
 9 – Software; computer software packages; downloadable software.
 36 – Insurance; financial affairs; monetary affairs; real estate affairs.
 42 – Software development, programming and implementation; software creation; software engineering; providing software on a global computer network; computer software consultancy.

(260) AM 2023 121562 A
 (800) 1711874
 (151) 2022 08 10
 (891) 2022 08 10
 (731) "ROBO SCHOOL" Limited Liability Company
 Bratislava Street, Apt. 11, Yakkasaray district,
 Tashkent City, Uzbekistan

(540)



(591) Black, white
 (531) 04.05.04; 27.05.01; 27.05.17
 (511)
 41 – Academics [education]; providing information in the field of education; arranging and conducting of seminars; educational examination; online publication of electronic books and journals; publication of texts, other than publicity texts; teaching; cultural, educational or entertainment services provided by art galleries; educational services provided by special needs assistants; educational services provided by schools; coaching [training]; education; providing of training; training center.

(260) AM 2023 121564 A
 (800) 1711922
 (151) 2022 11 17
 (891) 2022 11 17
 (731) Meteofor L.L.C-FZ
 Business Center 1, M Floor, The Meydan Hotel,
 Nad Al Sheba, Dubai, United Arab Emirates

(540)



(591) Black, white
 (531) 01.15.03; 26.01.01; 26.01.24; 27.05.01
 (511)
 35 – Publicity material rental; publication of publicity texts; advertising and publicity services; computerized file management services; rental of advertising space; systemization of information into computer databases; online advertising on a computer network; data search in computer files for others; rental of advertising time on communication media.
 42 – Meteorological information; research in the field of environmental protection; scientific research; weather forecasting; scientific and technological services; providing geographical information; providing online geographic maps, not downloadable; environmental monitoring services.

(260) AM 2023 121572 A
 (800) 1712008
 (151) 2022 09 15
 (891) 2022 09 15
 (731) Clinical Services Corporate Operations, Inc.
 271 Waverly Oaks Rd. Suite 208, Waltham
 MA 02452, USA

(540)

ALLUCENT CLINICAL RESEARCH

(591) Black, white
 (511)
 35 – Data management, namely, abstraction and collection of medical data from clinical tests for busi-

ness purposes; market research and business marketing consulting services in the pharmaceutical, biotechnology, medical device, and diagnostics industries.

42 – Programming of software for managing and collecting patient-generated health data for scientific research purposes; cloud computing featuring software that allows users to collect, review, analyze and report on clinical research; technical support services, namely, installation and remote administration of software, and troubleshooting of software problems and hosted software applications, all for use in connection with medical research and product regulatory approval, environmental health, health care, and in relation to the design, research, development, and testing of new medical products and devices; cloud computing featuring software for providing telehealth, telemedicine, remote care and virtual health care services to patients; cloud computing featuring software that allows users to collect, track, retrieve, validate, summarize, statistically analyze and present data used in the areas of medical research and product regulatory approval, environmental health, health care, and in relation to the design, research, development, and testing of new medical products and devices; cloud computing featuring software to aggregate, integrate, transfer and manage data generated from home health and remote monitoring devices and applications and health-related smart-phone applications; cloud computing featuring software that provides integrated workflows, analytics, visualizations, and reporting features to deliver, process, analyze, elevate, and display patient-generated health data; cloud computing featuring software that integrates remotely collected health data into databases, systems, platforms, applications, and software that inform clinical research, remote monitoring, and care management; hosting of web-based portal for study sponsors and contract research organizations (CROS) to build programs, enroll members, automate actions, and visualize/analyze data in connection with clinical studies; technical consulting services, namely, evaluating the safety of pharmaceutical, medical, cosmetic and consumer devices and products in clinical development or in commercial production; consulting services for others in the field of design, planning, and implementation project management of clinical trials; analysis of statistical data relating to clinical trials for pharmaceuticals, biotechnology, medical devices and diagnostics for scientific research.

45 – Development of regulatory compliance strategies in the field of medical research, namely, regulatory compliance in drug, biologic, cosmetic and medical device development.

(260) AM 2023 121573 A

(800) 1712009

(151) 2022 09 15

(891) 2022 09 15

(731) Clinical Services Corporate Operations, Inc.
271 Waverly Oaks Rd. Suite 208, Waltham
MA 02452, USA

(540)

ALLUCENT CLINICAL RESEARCH ORGANIZATION

(591) Black, white

(511)

35 – Data management, namely, abstraction and collection of medical data from clinical tests for business purposes; market research and business marketing consulting services in the pharmaceutical, biotechnology, medical device, and diagnostics industries.

42 – Programming of software for managing and collecting patient-generated health data for scientific research purposes; cloud computing featuring software that allows users to collect, review, analyze and report on clinical research; technical support services, namely, installation and remote administration of software, and troubleshooting of software problems and hosted software applications, all for use in connection with medical research and product regulatory approval, environmental health, health care, and in relation to the design, research, development, and testing of new medical products and devices; cloud computing featuring software for providing telehealth, telemedicine, remote care and virtual health care services to patients; cloud computing featuring software that allows users to collect, track, retrieve, validate, summarize, statistically analyze and present data used in the areas of medical research and product regulatory approval, environmental health, health care, and in relation to the design, research, development, and testing of new medical products and devices; cloud computing featuring software to aggregate, integrate, transfer and manage data generated from home health and remote monitoring devices and applications and health-related smart-phone applications; cloud computing featuring software that provides integrated workflows, analytics, visualizations, and reporting features to deliver, process, analyze, elevate, and display patient-generated health data; cloud computing featuring software that integrates remotely collected health data into databases, systems, platforms, applications, and software that inform clinical research, remote monitoring, and care management; hosting of web-based portal for study sponsors and contract research organizations (CROS) to build programs, enroll members, automate actions, and visualize/analyze data in connection with clinical studies; technical consulting services, namely, evaluating the safety of pharmaceutical, medical, cosmetic and consumer devices and products in clinical development or in commercial production; consulting services for others in the field of design, planning, and implementation project management of clinical trials; analysis of statistical data relating to clinical trials for pharmaceuticals, biotechnology, medical devices and diagnostics for scientific research.

duction; consulting services for others in the field of design, planning, and implementation project management of clinical trials; analysis of statistical data relating to clinical trials for pharmaceuticals, biotechnology, medical devices and diagnostics for scientific research.

45 – Development of regulatory compliance strategies in the field of medical research, namely, regulatory compliance in drug, biologic, cosmetic and medical device development.

(260) AM 2023 121575 A

(800) 1712217

(151) 2022 11 25

(891) 2022 11 25

(731) Zhejiang Pixfra Technology Co., Ltd.
Rm 201, Building A, Integrated Circuit
Design Industrial Park, No. 858, Jianshe 2nd
Road, Economic and Technological Development Zone, Xiaoshan District, China

(540)

Pixfra

(591) Black, white

(531) 27.05.01

(511)

9 – Computer software, recorded; computer hardware; thermal imaging cameras; computer programs, downloadable; computer peripheral devices; network communication devices; camcorders; cameras; electric and electronic video surveillance installations; optical apparatus and instruments; infrared thermometers, not for medical purposes; telescopes; anti-intrusion alarms; facial recognition apparatus.

42 – Technological research; research and development of new products for others; quality testing; information technology consultation; industrial design; software as a service [SaaS]; interior design; design and development of computer hardware and computer software; computer programming; computer system design.

(260) AM 2023 121576 A

(800) 1712219

(151) 2022 12 12

(891) 2022 12 12

(731) H.I.S. Co., Ltd.

4-1-1 Toranomon, Minato-ku, Tokyo 105-6905,
Japan

(540)

HIS

(591) Black, white

(531) 27.05.01; 27.05.23

(511)

39 – Conducting of travel tours; escorting of travel tours; agencies or liaison services for travel contract (excluding those for lodging); travel information services relating to tour conducting (excluding those for lodging) via the internet or portable terminals; consulting services for travel; agencies or liaison services for issuing passenger tickets; temporary safekeeping of personal belongings; agencies or liaison services for providing parking space; agencies or liaison services for rental of cars; agencies or liaison services for rental of suitcases; agencies for arrangement of travel visas and travel documents; car transport; railway transport; marine transport; air transport.

41 – Educational and instruction services relating to arts, crafts, sports or general knowledge; services of reference libraries for literature and documentary records; planning or arranging of movies, shows, plays or musical performances; movie showing, movie film production, or movie film distribution; production of radio or television programs; providing sports facilities and liaison services therefor; providing amusement facilities and liaison services therefor; booking of seats for shows and liaison services therefor; rental of sports equipment; rental of records or sound recorded magnetic tapes or discs, and agencies or liaison services for rental of records or sound recorded magnetic tapes or discs; rental of image-recorded magnetic tapes or discs, and agencies or liaison services for rental of image-recorded magnetic tapes or discs; book rental; photography; language interpretation; translation; organization or arrangement of entertainment events relating to travel; publication of books and electronic publications.

43 – Accommodation bureaux (brokering reservations for hotels, boarding houses, and other forms of temporary accommodations); information services relating to accommodation; information services relating to accommodation via the internet or portable terminals; agencies or liaison services for homestay accommodation; agencies or liaison services for animal accommodation; providing event facilities and agencies or liaison services for providing event facilities; providing convention facilities and agencies or liaison services for providing convention facilities; providing temporary accommodation; providing food and beverages; agencies or liaison services for providing reservation for providing foods and beverages.

(260) AM 2023 121590 A

(800) 1712452

(151) 2022 11 25

(891) 2022 11 25

(731) Wenzhou Morning Electronics Co., Ltd.
Yangzhai Industry District, Liushi town,
Yueqing, Wenzhou, Zhejiang, China

(540)

MOES

(591) Black, white

(531) 27.05.01

(511)

9 – Pedometers; counters; chronographs [time recording apparatus]; digital bathroom scales; body fat scales for household use; microphones; sound recording apparatus; horns for loudspeakers; headphones; video baby monitors; virtual reality headsets; security surveillance robots; wearable video display monitors; set-top boxes; detectors; barometers; anti-theft warning apparatus; fire alarms; electric door bells; distance recording apparatus; usb cables; electric cables for the transmission of sounds and images; data synchronization cables; usb cables for cellphones; connectors [electricity]; switches, electric; electric plugs; cell switches [electricity]; time switches, automatic; light regulators [dimmers], electric; sensors; thermostats; climate control digital thermostats; electric sockets; remote control apparatus; electrical adapters; converters for electric plugs; home remote controls; alarms; bells [warning devices]; smoke detectors; peepholes [magnifying lenses] for doors; digital door locks; alarms for the detection of inflammable gases; usb chargers; wireless chargers; battery charging equipment; charging appliances for rechargeable equipment; battery chargers.

(260) AM 2023 121593 A

(800) 1712474

(151) 2022 12 02

(891) 2022 12 02

(731) Perfect Gem Global Hong Kong Limited
Level 96, International Commerce Centre,
1 Austin Road, West Kowloon, Hong Kong,
China

(540)

WAR HORSE

(591) Black, white

(531) 27.05.01; 27.05.17

(511)

32 – Isotonic energy drinks; waters [beverages]; mineral water [beverages]; condensed juice for making sports drinks; vegetable drink; whey beverages; alcohol-free beverages for energy supplementation; protein-enriched sports beverages; carbonated beverages, non-alcoholic; energy drinks.

(260) AM 2023 121597 A

(800) 1712609

(151) 2022 10 26

(891) 2022 10 26

(731) ÖNTAR TARIM ALETLERİ SANAYİ VE
TİCARET LİMİTED ŞİRKETİ

Büyükkayacıkosb Mahallesi, 405 Nolu Sokak,
28 Selçuklu, Konya, Türkiye

(540)



(591) Green and grey

(531) 04.05.01; 04.05.21; 05.07.02; 27.05.01;
29.01.12

(511)

7 – Machines, machine tools and industrial robots for processing and shaping wood, metals, glass, plastics and minerals; construction machines and robotic mechanisms (machines) for use in construction; lifting, loading and transmission machines and robotic mechanisms (machines) for lifting, loading and transmission purposes; machines and robotic mechanisms (machines) for use in agriculture and animal breeding, machines and robotic mechanisms (machines) for processing cereals, fruits, vegetables and food; engines and motors, other than for land vehicles, parts and fittings therefor; parts of land vehicle motors and engines, included in this class; bearings (parts of machines), roller or ball bearings; machines for mounting and detaching tires; alternators, current generators, electric generators, current generators operated with solar energy; painting machines, automatic spray guns for paint, electric, hydraulic and pneumatic punching machines and guns, electric adhesive tape dispensers (machines), electric guns for compressed gas or liquid spraying machines, electric hand drills, electric hand saws, electric jigsaw machines, spiral machines, compressed air machines, compressors (machines), vehicle washing installations, robotic mechanisms (machines) with the abovementioned functions; electric and gas-operated welding apparatus, electric arc welding apparatus, electric soldering apparatus, electric arc cutting apparatus, electrodes for welding machines, industrial robots with the abovementioned functions; printing machines; packaging machines, filling, plugging and sealing machines, labellers (machines), sorting machines, industrial robots (machines) with the abovementioned functions, electric packing machines for plugging and sealing of plastics; machines for textile processing, sewing machines, industrial robots (machines) with the abovementioned functions; fuel dispensing pumps for service stations, self-regulating

fuel pumps; electric kitchen machines for chopping, grinding, crushing, mixing and mincing foodstuff, washing machines, laundry washing machines, dishwashers, spin driers (not heated), electric cleaning machines for cleaning floors, carpets or floorings, vacuum cleaners and parts thereof; automatic vending machines; galvanizing and electroplating machines; electric door openers and closers; joints (parts of engines).

(260) AM 2023 121598 A

(800) 1712662

(151) 2022 11 27

(891) 2022 11 27

(731) CEYLANOĞLU TEKSTİL İNŞAAT SANAYİ VE TİCARET LİMİTED ŞİRKETİ
SURURİ MAH. ÇEŞNİCİ SK., DOĞAN
YILDIZ İÇ GİYİM 1 101, FATİH, İstanbul,
Türkiye

(540)



(591) Black, white

(531) 26.01.03; 26.01.18; 27.05.01

(511)

25 – Clothing, including underwear and outer clothing, other than special purpose protective clothing, namely, tops, bottoms, underwear, coats, hats, gloves; socks, mufflers as neck scarves, shawls, bandanas, scarves, belts for clothing; footwear, shoes, slippers, sandals; headwear, caps with visors, berets, caps being headwear, skull caps.

(260) AM 2023 121599 A

(800) 1712666

(151) 2022 12 08

(891) 2022 12 08

(731) KIBRIS TURK TUTUN ENDUSTRISI LTD.
STI.
BAHÇEKAPI MAHALLESİ ATATÜRK
ORMAN, ÇİFTLİĞİ KÜMEEVLERİ NO 4,
ETİMESGUT, ANKARA, Türkiye

(540)



(591) Blue and grey

(531) 26.01.03; 26.01.18; 27.05.01; 27.05.03;
29.01.12

(511)

34 – Tobacco, chewing tobacco, cigarettes, cigars; smokers' articles including those made of precious metals: pipes, mouthpieces for cigars and cigarettes, ashtrays, tobacco boxes, pocket apparatus for rolling cigarettes, cigarette paper, tobacco pipes, firestones, lighters for smokers; electronic cigarettes and their cartridges; matches.

(260) AM 2023 121601 A

(800) 1712687

(151) 2023 01 03

(891) 2023 01 03

(731) JingAo Solar Co., Ltd

Jinglong Street, Ningjin County, Xingtai City,
Hebei Province, China

(540)



(591) Blue, white

(531) 27.05.01; 27.05.09; 29.01.04

(511)

9 – Optical products, namely optical glass; semi-conductors; integrated circuits; quartz crystal as semi-conductors; polycrystalline silicon as semi-conductors; single crystal silicon as semi-conductors; galvanic cells; solar batteries; photovoltaic cells.

(260) AM 2023 121622 A

(800) 1663358

(151) 2022 04 13

(891) 2023 01 20

(731) "DAICHI" Limited Liability Company

Staropetrovskiy pr-d, 11, korp. 1, 3 floor, of. 20,
RU-125130 Moscow, Russian Federation

(540)



(591) Light-blue, dark-blue and black

(531) 26.03.01; 26.03.23; 26.03.24; 27.05.01;

27.05.09; 27.05.10; 29.01.12

(511)

11 – Air-conditioning apparatus; air-conditioning installations.

(260) AM 2023 121623 A

(800) 1664800

(151) 2022 02 02

(891) 2022 12 28

(731) CEVDET TANRIKULU

Keresteciler Sit. Fatih Cad., Karadal Sok. No 20
Merter, Güngören, Türkiye

(540)

2Y

(591) Black, white

(531) 27.05.21; 27.07.21

(511)

25 – Clothing, including underwear and outer clothing, other than special purpose protective clothing; socks; footwear; headgear.

35 – The bringing together, for the benefit of others, of a variety of goods, enabling customers to conveniently view and purchase those goods, such services may be provided by retail stores, wholesale outlets, by means of electronic media or through mail order catalogues.

(260) AM 2023 121624 A

(800) 1666731

(151) 2022 04 13

(891) 2023 01 20

(731) DAICHI Limited Liability Company

Staropetrovskiy pr-d, 11, korp. 1, 3 floor, of. 20,

RU-125130 Moscow, Russian Federation

(540)

Aurum

(591) Black, white

(511)

7 – Connecting rods for engines; fruit presses, electric, for household purposes; spin dryers [not heated]; blades [parts of machines]; washing machines; grinding machines for industrial purposes; mechanized livestock feeders; door closers, electric; machines, machine tools, power-operated tools; machine coupling and transmission components, except for land vehicles; vending machines; 3D printers; welding machines, electric; soldering apparatus, gas-operated; vulcanization apparatus; acetylene cleaning apparatus; high pressure washers; apparatus for drawing up beer under pressure; apparatus for aerating water; apparatus for aerating beverages; electrical apparatus for sealing plastics [packaging]; electric arc cutting apparatus; electric arc welding apparatus; electrical welding apparatus; inking apparatus for printing machines; fittings for engine boilers; expansion tanks [parts of machines]; drums [parts of machines]; reels, mechanical, for flexible hoses; brake shoes, other than for vehicles; concrete mixers [machines]; reels [parts of machines]; bobbins for weaving looms; harrows; journal boxes [parts of machines]; bulldozers; hoppers [mechanical discharging]; mine borers; railway wagon lifts; rolling mill cylinders; crank shafts; printing rollers for machines; camshafts for vehicle engines; transmission shafts, other than for land vehicles; valves [parts of machines]; fans for motors and engines; saw benches [parts of machines]; winnowers; vibrators [machines] for industrial use; bearings [parts of

machines]; bellows [parts of machines]; agitators; exhausts for motors and engines; drilling rigs, floating or non-floating; lawnmowers [machines]; card clothing [parts of carding machines]; nail extractors, electric; emergency power generators; alternators; dynamos; bicycle dynamos; current generators; electricity generators; hydraulic controls for machines, motors and engines; mufflers for motors and engines; drilling heads [parts of machines]; drilling bits [parts of machines]; cylinder heads for engines; soldering blow pipes, gas-operated; gas-operated blow torches; raking machines; stalk separators [machines]; sieves [machines or parts of machines]; mud catchers and collectors [machines]; tarring machines; rubber tracks being parts of crawlers on mining machines; rubber tracks being parts of crawlers on snow plows; rubber tracks being parts of crawlers on loading-unloading machines and apparatus; rubber tracks being parts of crawlers on agricultural machines; rubber tracks being parts of crawlers on construction machines; hydraulic engines and motors; aeronautical engines; aircraft engines; engines for air cushion vehicles; compressed air engines; jet engines, other than for land vehicles; engines for boats; driving motors, other than for land vehicles; motors, other than for land vehicles; propulsion mechanisms, other than for land vehicles; disintegrators; tympan [parts of printing presses]; holding devices for machine tools; turf removing plows; pump diaphragms; door closers, hydraulic; door closers, pneumatic; chisels for machines; jacks [machines]; rack and pinion jacks; moving walkways; electric hand drills; crushers for kitchen use, electric; flues for engine boilers; reapers; reapers and binders; millstones; rakes for raking machines; shredders [machines] for industrial use; kitchen grinders, electric; injectors for engines; incubators for eggs; ski edge sharpening tools, electric; hand-held tools, other than hand-operated; agricultural implements, other than hand-operated; air condensers; control cables for machines, engines or motors; capstans; calenders; rotary steam presses, portable, for fabrics; ditchers [ploughs]; carburettors; sliders for knitting machines; crankcases for machines, motors and engines; steamrollers; pressure valves [parts of machines]; clack valves [parts of machines]; pressure reducers [parts of machines]; cowlings [parts of machines]; machine wheels; freewheels, other than for land vehicles; scale collectors for machine boilers; lasts for shoes [parts of machines]; brake pads, other than for vehicles; piston segments; grease rings [parts of machines]; reapers and threshers; coal-cutting machines; compressors [machines]; air pumps [garage installations]; compressors for refrigerators; conveyors [machines]; belt conveyors; converters for steelworks; steam condensers [parts of machines]; aerocondensers; diggers [machines]; rams [machines]; thermic lances [machines]; boxes for matrices [printing]; gear boxes, other than for land vehicles; grease boxes [parts of machines]; housings [parts of machines]; harvesting machines; steam engine

boilers; coffee grinders, other than hand-operated; taps [parts of machines, engines or motors]; cranes [lifting and hoisting apparatus]; roller bridges; mobile cranes; water separators; spray guns for paint; cranks [parts of machines]; potters' wheels; grindstones [parts of machines]; cultivators [machines]; soldering lamps; winches; plowshares; belts for conveyors; lubricators [parts of machines]; igniting magnetos; handling machines, automatic [manipulators]; churns; matrices for use in printing; machine fly-wheels; shearing machines for animals; paper mill machines; blowing machines; knitting machines; galvanizing machines; bending machines; ironing machines; mine-working machines; blowing machines for the compression, exhaustion and transport of gases; blowing machines for the compression, sucking and carrying of grain; net hauling machines [fishing]; electroplating machines; bottle sealing machines; sealing machines for industrial purposes; embossing machines; engraving machines; finishing machines; crushing machines; waste disposal units; blade sharpening [stropping] machines; earth moving machines; cord making machines; lace making machines; butter machines; cigarette machines for industrial purposes; sausage making machines; stereotype machines; hosiery looms; dyeing machines; bottle washing machines; dishwashers; bottle filling machines; racket stringing machines; leather-working machines; dairy machines; glass-working machines; tobacco processing machines; grain husking machines; painting machines; oil refining machines; peeling machines; machines for processing plastics; ore treating machines; printing machines for use on sheet metal; brewing machines; whitewashing machines; road sweeping machines, self-propelled; leather paring machines; bitumen making machines; papermaking machines; pasta making machines, electric; machines for the production of sugar; weeding machines; sifting machines; cinder sifters [machines]; puddling machines; notchers [machine tools]; bread cutting machines; road making machines; railroad constructing machines; machines for the textile industry; rammers [machines]; rail-laying machines; bottle capping machines; bottle stoppering machines; waste compacting machines; die-stamping machines; stamping machines; darning machines; milking machines; drainage machines; wrapping machines; grain separators; bookbinding apparatus and machines for industrial purposes; machines and apparatus for cleaning, electric; machines and apparatus for carpet shampooing, electric; machines and apparatus for polishing [electric]; size adjustment cutting machines for industrial purposes; punching machines; riveting machines; kitchen machines, electric; foundry machines; smoothing presses; fleshing machines [printing]; hemming machines; grating machines for vegetables; braiding machines; wringing machines for laundry; cutting machines; steam engines; printing machines; rotary printing presses; industrial inkjet

printing machines; compressed air machines; tilling machines for agricultural purposes; trimming machines; spinning machines; filling machines; friezing machines; cutters [machines]; satinizing machines; agricultural machines; mixing machines; sorting machines for industry; stitching machines; washing machines [laundry]; coin-operated washing machines; clippers [machines]; spinning frames; looms; kneading machines; typographic machines; type-setting machines [photocomposition]; beating machines; beaters, electric; packaging machines; filtering machines; molding machines; carding machines; sewing machines; typecasting machines; electromechanical machines for chemical industry; labellers [machines]; mills [machines]; mills for household purposes, other than hand-operated; pepper mills, other than hand-operated; centrifugal mills; machine wheelwork; feeders [parts of machines]; forge blowers; mixers [machines]; blenders, electric, for household purposes; vacuum cleaner bags; threshing machines; pneumatic hammers; hammers [parts of machines]; tilt hammers; power hammers; reeling apparatus, mechanical; motorized cultivators; motors for boats; clutches, other than for land vehicles; meat choppers, electric; superchargers; brake linings, other than for vehicles; guides for machines; suction nozzles for vacuum cleaners; vacuum cleaner attachments for disseminating perfumes and disinfectants; pumps [machines]; pumps [parts of machines, engines or motors]; aerating pumps for aquaria; vacuum pumps [machines]; compressed air pumps; pumps for heating installations; beer pumps; pumps for counter-current swimming; lubricating pumps; self-regulating fuel pumps; fuel dispensing pumps for service stations; centrifugal pumps; hydrogen dispensing pumps for service stations; tin openers, electric; knives for mowing machines; chaff cutter blades; knives, electric; shears, electric; scissors, electric; vegetable spiralizers, electric; bearing brackets for machines; pulverisers [machines]; axles for machines; steam traps; chucks [parts of machines]; drill chucks [parts of machines]; exhaust manifold for engines; soldering irons, gas-operated; soldering irons, electric; superheaters; gears, other than for land vehicles; reduction gears, other than for land vehicles; drilling machines; saws [machines]; chain saws; guns [tools using explosive cartridges]; glue guns, electric; compressed air guns for the extrusion of mastics; carburetter feeders; feeding apparatus for engine boilers; loading ramps; plows; pneumatic transporters; pneumatic controls for machines, motors and engines; hangers [parts of machines]; anti-friction bearings for machines; roller bearings; self-oiling bearings; bearings for transmission shafts; ball-bearings; elevators [lifts]; hoists; lifts, other than ski-lifts; pulleys; saw blades [parts of machines]; pistons [parts of machines or engines]; shock absorber plungers [parts of machines]; pistons for engines; pistons for cylinders; catalytic converters; torque converters, other than for land vehicles; fuel conversion apparatus for

internal combustion engines; presses [machines for industrial purposes]; wine presses; fodder presses; printing presses; typographic presses; swaging machines; pedal drives for sewing machines; cleaning appliances utilizing steam; food processors, electric; springs [parts of machines]; spinning wheels; punches for punching machines; vacuum cleaners; radiators [cooling] for motors and engines; sewage pulverizers; air brushes for applying colour; regulators [parts of machines]; pressure regulators [parts of machines]; speed governors for machines, engines and motors; knives being parts of machines; cutting blow pipes, gas-operated; blade holders [parts of machines]; loom shafts; gears for weaving looms; belts for machines; elevator belts; fan belts for motors and engines; dynamo belts; belts for motors and engines; adhesive bands for pulleys; industrial robots; 3D printing pens; kick starters for motorcycles; joysticks being parts of machines, other than for game machines; stuffing boxes [parts of machines]; paper feeders [printing]; whisks, electric, for household purposes; sparking plugs for internal combustion engines; glow plugs for diesel engines; brake segments, other than for vehicles; tedding machines; steam/oil separators; cream/milk separators; ball rings for bearings; sowers [machines]; pigs for cleaning pipes; snow plows; sheaf-binding machines; shaft couplings [machines]; juice extractors, electric; straw [chaff] cutters; suction cups for milking machines; stands for machines; die-cutting and tapping machines; woodworking machines; sharpening machines; bicycle assembling machines; mortising machines; stone-working machines; metalworking machines; threading machines; planing machines; lathes [machine tools]; milling machines; grinding machines; metal drawing machines; rolling mills; starters for motors and engines; stators [parts of machines]; glaziers' diamonds [parts of machines]; tables for machines; derricks; slide rests [parts of machines]; couplings, other than for land vehicles; heat exchangers [parts of machines]; transmissions for machines; transmission mechanisms, other than for land vehicles; boiler tubes [parts of machines]; wind turbines; hydraulic turbines; turbines, other than for land vehicles; turbocompressors; joints [parts of engines]; central vacuum cleaning installations; suction machines for industrial purposes; machines for the mineralization of drinking water; washing installations for vehicles; degreasers [machines]; dust exhausting installations for cleaning purposes; sifting installations; pneumatic tube conveyors; dust removing installations for cleaning purposes; condensing installations; pneumatic waste oil drainers; lifting apparatus; air suction machines; dividing machines; igniting devices for internal combustion engines; window closers, pneumatic; washing apparatus; binding apparatus for hay; haulage apparatus [mining]; door openers, hydraulic; door openers, pneumatic; door openers, electric; curtain drawing devices, electrically operated; adhesive tape dispensers [machines]; anti-pollu-

tion devices for motors and engines; beverage preparation machines, electromechanical; food preparation machines, electromechanical; elevator operating apparatus; control mechanisms for machines, engines or motors; shoe polishers, electric; machines and apparatus for wax-polishing, electric; air cushion devices for moving loads; handling apparatus for loading and unloading; elevating apparatus; aprons [parts of machines]; filter presses; filters for cleaning cooling air, for engines; filters being parts of machines or engines; molds [parts of machines]; printing plates; journals [parts of machines]; centrifugal machines; elevator chains [parts of machines]; drive chains, other than for land vehicles; transmission chains, other than for land vehicles; cylinders for motors and engines; cylinders for machines; printing cylinders; pneumatic jacks; shuttles [parts of machines]; universal joints [cardan joints]; steam mops; pulleys [parts of machines]; vacuum cleaner hoses; screwdrivers, electric; brushes [parts of machines]; dynamo brushes; brushes for vacuum cleaners; brushes, electrically operated [parts of machines]; carbon brushes [electricity]; ejectors; robotic exoskeleton suits, other than for medical purposes; fuel economisers for motors and engines; excavators; shovels, mechanical; agricultural elevators; motors, electric, other than for land vehicles; electrodes for welding machines; electric hammers; parquet wax-polishers, electric; cartridges for filtering machines; moving staircases [escalators]; automatic grapnels for marine purposes; water heaters being parts of machines; de-aerators for feedwater; cutting tools being parts of machines; engine mounts, other than for land vehicles; tambours for embroidery machines; window closers, hydraulic; window closers, electric; window openers, hydraulic; window openers, pneumatic; window openers, electric.

11 – Wicks adapted for oil stoves; thermo-pots, electric; disinfectant apparatus for dispensing solutions into water-pipes for sanitary installations; lampshades; steam accumulators; heat accumulators; defrosters for vehicles; disinfectant apparatus for medical purposes; distillation apparatus; desiccating apparatus; hydromassage bath apparatus; disinfectant apparatus; air deodorizing apparatus; tanning beds; ionization apparatus for the treatment of air or water; coffee roasters; beverage cooling apparatus; hand drying apparatus for washrooms; fruit roasters; water purifying apparatus and machines; refrigerating apparatus and machines; drying apparatus and installations; freezers; heating and cooling apparatus for dispensing hot and cold beverages; drying apparatus; coolers for furnaces; expansion tanks for central heating installations; flushing tanks; refining towers for distillation; bidets; boilers, other than parts of machines; spa baths [vessels]; bath tubs for sitz baths; bath tubs; waffle irons, electric; fans [air-conditioning]; fans [parts of air-conditioning installations]; electric fans for personal use; roasting spits; refrigerating display cabinets; heated display cabinets; water heaters; water flushing ins-

tallations; air reheaters; extractor hoods for kitchens; gas condensers, other than parts of machines; acetylene generators; microbubble generators for baths; hydrants; acetylene burners; gas burners; burners for lamps; germicidal burners; incandescent burners; oxyhydrogen burners; laboratory burners; oil burners; alcohol burners; burners; footwarmers, electric or non-electric; bed warmers; USB-powered hand warmers; pocket warmers; warming pans; hot water bottles; roasting apparatus; food dehydrators, electric; lampshade holders; stills; showers; refrigerating containers; gas lighters; friction lighters for igniting gas; chimney blowers; coils [parts of distilling, heating or cooling installations]; furnace ash boxes; evaporators; electric appliances for making yogurt; shower cubicles; heating apparatus; cool boxes, electric; refrigerating chambers; fireplaces, domestic; chimney flues; structural framework for ovens; air valves for steam heating installations; level controlling valves in tanks; thermostatic valves [parts of heating installations]; electrically heated carpets; light bulbs; light bulbs, electric; solar thermal collectors [heating]; distillation columns; furnace grates; ventilation hoods for laboratories; ventilation hoods; lamp globes; air conditioners for vehicles; air-conditioning apparatus; gas boilers; laundry room boilers; heating boilers; coffee machines, electric; taps for pipes and pipelines; taps; mixer taps for water pipes; forges, portable; lava rocks for use in barbecue grills; couscous cookers, electric; lights, electric, for christmas trees; acetylene flares; safety lamps; gas lamps; curling lamps; nail lamps; curing lamps, not for medical purposes; germicidal lamps for purifying air; light bulbs for directional signals for vehicles; arc lamps; laboratory lamps; oil lamps; ultraviolet ray lamps, not for medical purposes; miners' lamps; electric lamps; chandeliers; barbecues; watering machines for agricultural purposes; ice-cream making machines; pounded rice cake making machines, electric, for household purposes; multicookers; footmuffs, electrically heated; heaters for baths; heaters for heating irons; immersion heaters; brackets for gas burners; anti-splash tap nozzles; heat pumps; filaments for electric lamps; magnesium filaments for lighting; heating filaments, electric; luminous house numbers; socks, electrically heated; heating apparatus for defrosting vehicle windows; bath fittings; loading apparatus for furnaces; kiln furniture [supports]; refrigerating appliances and installations; directional lights for bicycles; electrically heated clothing; blankets, electric, not for medical purposes; fabric steamers; lamp reflectors; vehicle reflectors; hearths; electric cooktops; food steamers, electric; steam boilers, other than parts of machines; pasteurisers; lamp mantles; sockets for electric lights; coffee percolators, electric; stoves [heating apparatus]; bakers' ovens; hot air ovens; kitchen ranges [ovens]; microwave ovens [cooking apparatus]; microwave ovens for industrial purposes; incinerators; kilns; solar furnaces; dental ovens; furnaces, other

than for laboratory use; urinals being sanitary fixtures; feeding apparatus for heating boilers; heating plates; cooking stoves; hot plates; wine cellars, electric; heaters, electric, for feeding bottles; aquarium heaters; USB-powered cup heaters; aquarium lights; heating cushions, electric, not for medical purposes; clean chambers [sanitary installations]; tortilla presses, electric; water intake apparatus; apparatus for dehydrating food waste; fumigation apparatus; oil-scrubbing apparatus; glue-heating appliances; drying apparatus for fodder and forage; water filtering apparatus; air purifying apparatus and machines; ice machines and apparatus; cooling appliances and installations; cooking apparatus and installations; lighting apparatus and installations; sanitary apparatus and installations; cooking rings; lighting apparatus for vehicles; light-emitting diodes [LED] lighting apparatus; heating apparatus for solid, liquid or gaseous fuels; heating apparatus, electric; hot air apparatus; safety accessories for water or gas apparatus and pipes; regulating and safety accessories for gas apparatus; regulating accessories for water or gas apparatus and pipes; regulating and safety accessories for water apparatus; regulating and safety accessories for gas pipes; roasting jacks; plate warmers; anti-glare devices for vehicles [lamp fittings]; rotisseries; radiator caps; diving lights; searchlights; washers for water taps; heat guns; radiators [heating]; central heating radiators; radiators, electric; sinks; drip irrigation emitters [irrigation fittings]; light diffusers; nuclear reactors; heat regenerators; pressure water tanks; roasters; ceiling lights; lamps; toilet seats; hydroponic growing systems; lighting installations for air vehicles; gas scrubbers [parts of gas installations]; lamp glasses; water sterilizers; air sterilizers; sterilizers; air dryers; laundry dryers, electric; hair dryers; malt roasters; tobacco roasters; tajines, electric; heat exchangers, other than parts of machines; bread toasters; discharge tubes, electric, for lighting; lamp chimneys; luminous tubes for lighting; pipes [parts of sanitary installations]; flues for heating boilers; boiler pipes [tubes] for heating installations; toilets [water-closets]; toilets, portable; humidifiers for central heating radiators; wash-hand basins [parts of sanitary installations]; toilet bowls; water conduits installations; air-conditioning installations; desalination plants; installations for processing nuclear fuel and nuclear moderating material; watering installations, automatic; cooling installations for water; cooling installations for liquids; milk cooling installations; cooling installations for tobacco; water purification installations; purification installations for sewage; steam generating installations; water distribution installations; air filtering installations; swimming pool chlorinating apparatus; ventilation [air-conditioning] installations for vehicles; ventilation [air-conditioning] installations and apparatus; water softening apparatus and installations; cooling installations and machines; heaters for vehicles; heating installations [water]; hea-

ting installations; polymerisation installations; water supply installations; flare stacks for use in the oil industry; ash conveyor installations, automatic; whirlpool-jet apparatus; air cooling apparatus; apparatus and installations for lighting, heating, cooling, steam generating, cooking, drying, ventilating, water supply and sanitary purposes; aquarium filtration apparatus; cooking utensils, electric; flaming torches; headlights for automobiles; vehicle headlights; filters for air conditioning; filters for drinking water; lights for automobiles; bicycle lights; motorcycle lights; lights for vehicles; electric torches; head torches; lanterns for lighting; candle lanterns; street lamps; Chinese lanterns; ornamental fountains; chocolate fountains, electric; fountains; air fryers; deep fryers, electric; fittings, shaped, for furnaces; oven fittings made of fireclay; bread-making machines; refrigerators, cooling apparatus and freezers for medical storage purposes; refrigerators; chromatography apparatus for industrial purposes; kettles, electric; dampers [heating]; book sterilization apparatus; refrigerating cabinets; carbon for arc lamps; heating elements; fairy lights for festive decoration; bread baking machines; deodorizing apparatus, not for personal use; standard lamps; autoclaves, electric, for cooking; bath installations.

(260) AM 2023 121673 A

(800) 1712929

(151) 2022 11 25

(891) 2022 11 25

(731) Zhejiang Meishuo Electric Technology Co., Ltd.

No. 158 Wei 12th Road, Yueqing Economic Development Zone, Yueqing City, 325600 Zhejiang Province, China

(540)



(591) Black, white

(531) 26.01.03; 26.01.24; 26.04.05; 26.04.10; 26.04.12; 26.04.18; 26.04.24; 26.07.25; 26.11.02; 26.11.13

(511)

9 – Relays, electric; wires, electric; switches, electric; circuit breakers; electromagnetic coils; control panels [electricity]; sensor; electric wire harnesses for automobiles.

(260) AM 2023 121684 A

(800) 1713309

(151) 2022 10 03

(891) 2022 10 03

(731) DIPTYQUE S.A.S.

34 boulevard Saint Germain, F-75005 Paris, France

(540)



(591) Black, white

(531) 01.15.11; 11.03.11; 24.03.08

(511)

3 – Non-medicated toilet preparations; cosmetic preparations and substances for the conditioning, care, fragancing and healthy appearance of the skin, hands, body, face, eyes, hair, scalp, teeth and nails; soaps, personal cleansing preparations, shower gels, bath gels and bath preparations; skin cleansers; skin moisturizers; skin toners; facial scrubs; body scrubs; exfoliating scrubs and creams for cosmetics purposes; body creams and lotions; lip balm; perfumery, eau de parfum, colognes and toilet waters; deodorant preparations for personal use, anti-perspirants; cosmetics, colour cosmetics, eye cream, eye contour beauty masks, nail cosmetics, lip cosmetics; make-up removers; impregnated tissues with cosmetic lotions; shampoos, hair conditioners, hair lotions; perfumes; dentifrices; sun-tanning preparations, sun-screening preparations; shaving preparations, after shave creams (non-medicated) and preshave lotions and oils; depilatory preparations; essential oils, oils for toilet purposes; pomanders; potpourris, fragrance sachets; room fragrance, room perfume sprays, scented room sprays, room perfume in the form of spray, aromatics (essential oils); incense; aromatic plant extracts.

4 – Lamp oils; candles; scented candles; wicks; wax for making candles.

35 – Retail services in the field of preparations and substances for the conditioning, care and appearance of the skin, body, face, eyes, hair, scalp, teeth and nails, perfumery products, soaps, personal cleansing preparations, shower gels, bath gels, bath preparations, perfumery, eau de parfum, toilet waters, deodorant preparations for personal use, anti perspirants, cosmetics, colour cosmetics, eye cosmetics, nail cosmetics, lip cosmetics, make up removers, cosmetic impregnated tissues; retail services in the field of shampoos, hair conditioners, preparations for the hair, hair lotions; retail services in the field of dentifrices; retail services in the field of sun tanning preparations, sun-screening preparations, shaving preparations, after shave and pre shave lotions and oils, depilatory preparations; retail services in the field of essential oils, oils for toilet purposes; retail services in the field of pomanders, potpourris, perfumed drawer liners,

fragranced sachets for drawers, incense, aromatic plant extracts; retail services in the field of illuminants, lamp oils, candles, scented candles, candle making kits and wicks; retail services in the field of eyewear and sunglasses; retail services in the field of leather goods and accessories, namely, leather boxes, leather coasters, leather pouches, leather cases and leather bags; business advice and business management assistance services; business advisory services relating to the establishment and operation of franchises; retail services in the field of household or kitchen utensils and containers, cookware and tableware, glassware, porcelain and earthenware; retail services in the field of paper and cardboard, printed matter, photographs, stationery, notebooks, gift cards, calendars and wrapping paper, retail services in the field of textiles and textile goods; retail services in the field of clothing, footwear, headgear.

(260) AM 2023 121685 A

(800) 1713381

(151) 2022 06 10

(891) 2022 06 10

(731) MATARACI BMB ULUSLARARASI,
NAKLIYE İNŞAAT VE LOJİSTİK,
HİZMETLERİ İÇ VE DIŞ, TİCARET
LİMİTED ŞİRKETİ
EMİNETTİN MAH/SEMT, MENDERES BLV.
170 -172A, Merkez, Rize, Türkiye

(540)



(591) Black, white

(531) 26.11.01; 26.11.08; 27.05.11; 27.05.24

(511)

24 – Woven or non-woven textile fabrics; textile goods for household use, not included in other classes; curtains (term considered too vague by the International Bureau – Rule 13 (2) (b) of the Regulations), bed covers, sheets (textile), pillowcases, blankets, quilts, towels; flags, pennants, labels of textile; swaddling blankets; sleeping bags for camping.

35 – The bringing together, for the benefit of others, of a variety of goods, namely, woven or non-woven textile fabrics, textile goods for household use: curtains, bed covers, sheets (textile), pillowcases, blankets, quilts, towels, flags, pennants, labels of textile, swaddling blankets, sleeping bags for camping, enabling customers to conveniently view and purchase those goods, such services may be provided by retail stores, wholesale outlets, by means of electronic media or through mail order catalogues.

(260) AM 2023 121688 A

(800) 1713512

(151) 2022 12 14

(891) 2022 12 14

(731) YASİN TEKSTİL İŞLETMELERİ SANAYİ
VE DIŞ TİCARET ANONİM ŞİRKETİ
Sururi Mh. Bezciler Sk., 12 101 Fatih,
İSTANBUL, Türkiye

(540)

Arnetta

(591) Black, white

(531) 27.05.01

(511)

25 – Clothing, namely, trousers, jackets, overcoats, coats, skirts, suits, jerseys, waistcoats, shirts, T-shirts, sweatshirts, dresses, bermuda shorts, shorts, pajamas, sleepwears, lingerie, night-robos, sportswear, tracksuits, T-shirts, capri pants, capri suits, pullovers, jeans, tracksuits, rainwear, beachwear, bathing suits, swimming suits, clothing for sports (for exclusive use for sports), clothing for babies, namely, shirts, pants, coats, dresses, underclothing, namely, boxer shorts, brassieres, briefs, pants, socks, footwear, namely shoes excluding orthopedic shoes, sandals, waterproof boots, walking boots, booties, sporting shoes, slippers, shoe parts namely heelpieces, insoles for footwear, footwear uppers, headgear, namely caps, skull caps, sports caps, hats, berets, gloves (clothing), stockings, belts (clothing), camisoles, sarongs, scarves, neck scarves, shawls, collars, neckties, ties, suspender belts.

(260) AM 2023 121690 A

(800) 1713556

(151) 2022 12 07

(891) 2022 12 07

(731) SENSI VIGNE & VINI S.R.L.
VIA CERBAIA 107, FRAZ. CERBAIA,
I-51035 LAMPORECCHIO (PT), Italy

(540)



(591) Black, gold

(531) 19.07.01; 27.05.01; 29.01.02

(554) Three Dimensional

(511)
33 – Wine; sparkling wines; rose wines; sparkling white wines; sparkling red wines; dessert wines; wine-based aperitifs.

(260) AM 2023 121691 A
(800) 1713641
(151) 2022 10 24
(891) 2022 10 24
(731) CAPGEMINI CONSULTING
145-151 quai du Président Roosevelt, F-92130
Issy-les-Moulineaux, France
(540)



(591) Black, white
(531) 01.05.01; 01.05.01; 01.05.05; 01.05.15;
01.17.02; 01.17.03; 01.17.05; 27.05.01;
27.05.08; 27.05.09; 27.05.10

(511)
3 – Cosmetics; perfumes; eaux de toilette; eau de cologne; make-up; hair preparations and treatments; essential oils.

35 – Providing consumer information relating to cosmetic products.

41 – Publication of research and information reports relating to cosmetic products.

42 – Analysis and evaluation of cosmetic products with regard to their environmental and social impact; providing searchable technical information online on cosmetic products, with regard to their environmental and social impact.

(260) AM 2023 121692 A
(800) 1713723
(151) 2022 09 05
(891) 2022 09 05
(731) Egis Gyógyszergyár Zrt.
Keresztúri út 30-38., H-1106 Budapest,
Hungary
(540)

SUBODEX

(591) Black, white
(511)
5 – Pharmaceutical preparations for human use; dietic substances adapted for medical use; vitamin compositions, mineral food supplements, dietary supplements; all of these for oncological use, with the exce-

ption of pharmaceutical preparations for ophthalmology and otolaryngology.

(260) AM 2023 121693 A
(800) 1713773
(151) 2023 01 19
(891) 2023 01 19
(731) Jelly Belly Candy Company
One Jelly Belly Lane, Fairfield CA 94533, USA
(540)

JELLY BELLY

(591) Black, white
(511)
28 – Dolls and accessories therefor.

(260) AM 2023 121695 A
(800) 1713798
(151) 2022 07 26
(891) 2022 07 26
(731) Euro Games Technology Ltd.
4, "Maritsa" Str., "Vranya-Lozen-Triugulnika",
BG-1151 Sofia, Bulgaria
(540)

Flame Wings

(591) Black, white
(511)
9 – Software; games software; computer gaming software; computer software packages; computer operating system software; computer software for the administration of on-line games and gaming; computer software, recorded; software drivers; virtual reality software; entertainment software for computer games; computer programs for network management; hardware and software for gambling, gambling machines, gambling games on the Internet and via telecommunication network; operating computer software for main frame computers; monitors (computer hardware); computer hardware; apparatus for recording images; monitors (computer programs); computer game programs; computer programs for recorded games; apparatus for recording, transmission or reproduction of sound or images; computer hardware for communications services; electronic components for gambling machines; computer application software featuring games and gaming; computer hardware for games and gaming.

28 – Games; chips for gambling; mah-jong; arcade games; gambling machines operating with coins, notes and cards; electropneumatic and electrical gambling machines (slot machines), electronic games; parlor games; gaming chips; gaming tables; slot machines [gaming machines]; LCD game machines; slot machines and gaming devices; coin-operated amusement machines; roulette chips; poker chips; chips and dice [gaming equipment]; gambling equipment for casinos; roulette tables; gaming roulette wheels; casino

games; automats and gambling machines; coin-operated machines and/or electronic coin-operated machines with or without the possibility of gain; boxes for coin-operated machines, slot machines and gaming machines; electronic or electrotechnical gaming devices, automats and machines, coin-operated machines; housings for coin-operated machines, gaming equipment, gaming machines, machines for gambling; gaming machines for gambling.

41 – Casino management services in the nature of organizing gambling activities in casinos; operation of gaming establishments, gaming halls, Internet casinos, online gambling sites; services related to gambling; gaming services for entertainment purposes; casino, gaming and gambling services; gambling; training in the development of software systems; provision of gaming equipment for gambling halls; providing casino equipment [gambling]; gaming machine entertainment services; providing casino facilities [gambling]; providing halls with gaming machines; amusement arcade services; games equipment rental; rental of gaming machines; providing amusement arcade services; rental of gaming machines with images of fruits; editing or recording of sounds and images; sound recording and video entertainment services; hire of sound reproducing apparatus; provision of gaming equipment for casinos; providing of casino facilities; online gambling services.

(260) AM 2023 121701 A

(800) 1713853

(151) 2022 09 23

(891) 2022 09 23

(731) UNAL PEYNIRCILIK ITHALAT IHRACAT TICARET LIMITED SIRKETI
Kocatepe Mah. Gumruk Iskelesi Cad. A Blok,
Mega Center 89 562, Bayrampasa, Istanbul,
Türkiye

(540)



(591) Red, black, white, dark yellow and light yellow

(531) 01.03.02; 03.04.13; 24.01.09; 24.09.21;

26.03.05; 26.03.15; 27.05.24; 29.01.14

(511)

29 – Milk and milk products, namely, cheese, yoghurt, drink made of yoghurt and water [ayran], clotted cream, cream, whipped cream, powdered milk, kefir, fruit flavoured yoghurts; butter.

(260) AM 2023 121705 A

(800) 1714091

(151) 2022 10 21

(891) 2022 10 21

(731) LLC DISPO TRADE-FZCO

Dubai Silicon Oasis, DDP, Building A1,
Dubai, United Arab Emirates

(540)

INFLAVE

(591) Black, white

(511)

34 – Flavourings, other than essential oils, for tobacco; flavourings, other than essential oils, for use in electronic cigarettes; gas containers for cigar lighters; absorbent paper for tobacco pipes; cigarette paper; lighters for smokers; hookahs; tobacco pouches; books of cigarette papers; humidors; matchboxes; cigar cutters; cigar holders; cigarette holders; mouthpieces for cigarette holders; tips of yellow amber for cigar and cigarette holders; ashtrays for smokers; spittoons for tobacco users; pipe racks for tobacco pipes; pipe cleaners for tobacco pipes; liquid solutions for use in electronic cigarettes; electronic cigarettes; cigarettes; cigarettes containing tobacco substitutes, not for medical purposes; cigarillos; cigars; tobacco jars; match holders; matches; oral vaporizers for smokers; tobacco; chewing tobacco; snuff; snuff boxes; herbs for smoking; tobacco pipes; pocket machines for rolling cigarettes; cigarette filters; wicks adapted for cigarette lighters; cigarette tips; cigar cases; cigarette cases.

(260) AM 2023 121706 A

(800) 563004

(151) 1990 11 09

(891) 2023 01 12

(731) Anheuser-Busch InBev S.A.

Grand-Place 1, B-1000 Brussels, Belgium

(540)

STELLA ARTOIS

(591) Black, white

(531) 27.05.01

(511)

32 – Beers; mineral and sparkling water and other non-alcoholic beverages; fruit drinks and fruit juices; syrups and other preparations for making beverages.

(260) AM 2023 121707 A

(800) 1226152

(151) 2014 08 07

(891) 2023 02 01

(731) BIMBA & LOLA, S.L.

Parque Tecnológico y Logístico de Vigo -,
Nave D13, E-36315 Vigo (Pontevedra),
Spain

(540)

BIMBA Y LOLA

(591) Black, white

(531) 27.05.01; 27.05.17

(511)

9 – Scientific, nautical, surveying, photographic, cinematographic, optical, weighing, measuring, signalling, checking (supervision), life-saving and teaching apparatus and instruments; apparatus and instruments for conducting, switching, transforming, accumulating, regulating or controlling electricity; apparatus for recording, transmission or reproduction of sound or images; magnetic recording media, sound recording disks; compact disks, DVDs and other digital recording media; mechanisms for coin-operated apparatus; cash registers, calculating machines, data processing equipment, computers; software; extinguishers; abacuses; protection devices for personal use against accidents; particle accelerators; acid hydrometers; azimuth instruments; connections for electric lines; acoustic couplers; couplers [data processing equipment]; actinometers; electric accumulators; cleaning devices for sound recording disks; aerometers; electronic agendas; surveying instruments; electro-dynamic apparatus for the remote control of railway points; needles for record players; air analysis apparatus; stills for laboratory experiments; alarms; anti-theft alarms; fire alarms; sound alarms; alcoholmeters; fuse wire; mouse pads; alidades; food analysis apparatus; loudspeakers; altimeters; asbestos clothing for protection against fire; ammeters; enlarging apparatus [photography]; amplifiers; testing apparatus not for medical use; anemometers; calibrating rings; anodes; antennas; surveyors' levels; anticathodes; cathodic anti-corrosion devices; anti-interference devices [electricity]; antiglare glasses; electric theft prevention installations; GPS (global positioning system) apparatus; data processing apparatus; x-ray apparatus not for medical use; x-ray producing apparatus and installations not for medical use; apertometers [optics]; downloadable image files; downloadable music files; distribution boxes [electricity]; safety restraints, other than for vehicle seats and sports equipment; asbestos gloves for protection against accidents; apparatus and instruments for astronomy; audiovisual teaching apparatus; headphones; telephone receivers; fire engines; life-saving apparatus and equipment; scales; precision balances; lighting ballasts; luminous beacons; luminous or mechanical road signs; life-saving rafts; laboratory trays; fire boats; barometers; weighbridges; fire beaters; acid hydrometers for batteries; anode batteries; batteries for lighting; electric batteries for vehicles; plates for batteries; betatrons; binoculars; electric coils; holders for electric coils; electromagnetic coils; speaking tubes; special bags for portable computers; fire engines; flashlights [photography]; wire connectors [electricity]; terminals [electricity]; push buttons for bells; reference buoys; signalling buoys; tone arms

for record players; identification threads for electric wires; directional compasses; marine compasses; spirit levels; coaxial cables; starter cables for motors and engines; fiber-optic cables; electric cables; surveying chains; eyeglass chains; cabinets for loudspeakers; accumulator boxes; branch boxes [electricity]; switchboxes [electricity]; junction boxes [electricity]; petri dishes; containers for microscope slides; cash registers; automated teller machines [ATM]; electrically heated socks; calculators; pocket calculators; boiler control instruments; gauges; calipers; shoes for protection against accidents, irradiation and fire; cinematographic cameras; decompression chambers; cameras [photography]; jukeboxes for computers; signal bells; protective masks for workers; solderers' helmets; battery chargers; chargers for electric batteries; spools [photography]; video game cartridges; riding helmets; protective helmets; protective helmets for sports; video cassettes; telescopes; cathodes; galvanic cells; photovoltaic cells; laboratory centrifuges; electric locks; bullet-proof vests; life jackets; chips [integrated circuits]; dNA chips; cyclotrons; editing devices for cinematographic films; magnetic tapes; demagnetizing apparatus for magnetic tapes; sound recording strips; head cleaning tapes; life belts; printed circuits; integrated circuits; gradient indicators; insulated copper wire; magnetic encoders; bar code readers; electric collectors; comparators; compasses [measuring instruments]; laptop computers; condensers [capacitors]; optical condensers; ducts [electricity]; materials for electricity mains [wires, cables]; electric conductors; acoustic conduits; electricity conduits; connectors [electricity]; electric apparatus for commutation; commutators (switches); converters; traffic cones; distribution consoles [electricity]; electric contacts; counters; answering machines; electric control apparatus; speed-checking apparatus for vehicles; apparatus to check franking; remote control apparatus; electric installations for the remote control of industrial operations; electro-dynamic apparatus for the remote control of signals; cupels [laboratory]; eyeglass cords; straps for mobile telephones; logs [measuring instruments]; cosmographic instruments; dressmakers' measures; circuit closers; galena crystals [detectors]; chromatography apparatus for laboratory use; chronographs [time recording apparatus]; darkrooms [photography]; washing trays [photography]; measuring spoons; thread counters; kilometer recorders for vehicles; revolution counters; apparatus for measuring the thickness of leather; densimeters; densitometers; distillation apparatus for scientific use; detectors; counterfeit [false] coin detectors; smoke detectors; metal detectors for industrial or military use; diaphragms [acoustics]; diaphragms [photography]; diaphragms for scientific apparatus; diagnostic apparatus, not for medical use; transparencies; centering apparatus for photographic transparencies; animated cartoons; dictaphones; diffraction apparatus [microscopy]; dynamometers; money counting and sorting machines; light-

emitting diodes [LED]; sound recording disks; compact disks [audio-video]; calculating disks; magnetic disks; optical disks; optical compact disks; reflecting disks for wear, for the prevention of traffic accidents; shutter releases [photography]; floppy disks; distance measuring devices; ticket dispensers; circuit breakers; dosage dispensers; marine depth finders; electrolyzers; transmitters of electronic signals; transmitting sets [telecommunication]; electric couplings; electric igniting apparatus for igniting at a distance; plugs, sockets and other contacts [electric connections]; material testing instruments and machines; epidiascopes; balancing devices; ergometers; diving suits; fire escapes; sounding leads; scanners [data processing equipment]; school apparatus; drainers for use in photography; spherometers; spectrograph apparatus; mirrors for inspecting work; mirrors [optics]; apparatus for measuring the thickness of skins; drying racks [photography]; stereoscopic apparatus; stereoscopes; stroboscopes; cases fitted with dissecting instruments [microscopy]; cases especially made for photographic apparatus and instruments; spectacle cases; containers for contact lenses; pince-nez cases; electronic tags for goods; temperature indicator labels not for medical use; exposure meters [light meters]; extinguishers; invoicing machines; facsimile machines; apparatus for fermentation [laboratory apparatus]; optical fibers [light conducting filaments]; mechanisms for counter-operated apparatus; filters for ultraviolet rays for photography; filters [photography]; filters for respiratory masks; apparatus and instruments for physics; flash-bulbs [photography]; blueprint apparatus; photocopiers; glazing apparatus for photographic prints; drying apparatus for photographic prints; photometers; high-frequency apparatus; frequency meters; identification sheaths for electric wires; sheaths for electric cables; cases for laptops; fuses; goggles for sports; sunglasses; spectacles [optics]; jigs [measuring instruments]; galvanometers; gas testing instruments; gasometers [measuring instruments]; surveying apparatus and instruments; meteorological balloons; sound recording apparatus; sound recording media; video recorders; marking gauges [joinery]; gloves for divers; gloves for protection against accidents; gloves for protection against X-rays for industrial use; heliographic apparatus; hydrometers; hygrometers; electric wires; magnetic wires; telephone wires; telegraph wires; holograms; furnaces for laboratory use; magnets; decorative magnets; computer printers; incubators for bacteria culture; automatic indicators of low pressure in vehicle tires; quantity indicators; gasoline gauges; electric loss indicators; temperature indicators; speed indicators; water level indicators; armatures [electricity]; inductors [electricity]; intercommunication apparatus; interfaces for computers; carriers for dark plates [photography]; electric switches; inverters [electricity]; ionization apparatus not for the treatment of air or water; leveling staffs [surveying instruments]; hands free kits for telephones; lactodensimeters; optical

lamps; darkroom lamps [photography]; fire hose nozzles; electronic pens [visual display units]; lasers, not for medical use; cassette players; compact disc players; dVD players; readers [data processing equipment]; optical character readers; correcting lenses [optics]; contact lenses; instruments containing eyepieces; optical lenses; lenses for spectacles; lens hoods; neon signs; luminous signs; mechanical signs; limiters [electricity]; signal lanterns; magic lanterns; safety tarpaulins; blinkers [signaling lights]; magnifying glasses [optics]; tape recorders; wind socks for indicating wind direction; fire hoses; junction sleeves for electric cables; crash test dummies; resuscitation mannequins [teaching apparatus]; pressure gauges; fire blankets; hemline markers; frames for photographic transparencies; digital photograph frames; divers' masks; protective masks; respiratory masks, other than for artificial respiration; mathematical instruments; measuring apparatus; electric measuring apparatus; measuring instruments; precision measuring apparatus; measures; speed-measuring apparatus [photography]; megaphones; computer memory devices; uSB flash drives; mercury levels; meteorological instruments; metronomes; rules [measuring instruments]; microphones; microprocessors; microscopes; microtomes; sighting telescopes for firearms; peepholes [magnifying lenses] for doors; furniture especially made for laboratories; modems; monitors [computer hardware]; monitors [computer programs]; spectacle frames; eyeglass frames; breathing apparatus for underwater swimming; nautical apparatus and instruments; naval signaling apparatus; navigation apparatus for vehicles [on-board computers]; satellite navigational apparatus; navigational instruments; leveling instruments; levels [instruments for determining the horizontal]; verniers; lenses for astrophotography; objectives [lenses] [optics]; boards for integrated circuits; observation instruments; shutters [photography]; octants; eyepieces; punched card machines for offices; ohmmeters; wavemeters; optical goods; optical apparatus and instruments; computers; notebook computers (laptops); oscillographs; egg-candlers; oxygen transvasing apparatus; ozonizers; horns for loudspeakers; micrometer gauges; luminous or mechanical signaling panels; asbestos screens for firemen; projection screens; video screens; fluorescent screens; screens [photography]; radiology screens for industrial use; spark-guards; lightning conductors [rods]; parking meters; film-cutting apparatus; exposed cinematographic films; exposed X-ray films; exposed films; computer peripheral devices; periscopes; letter scales; weighing apparatus and instruments; weighing machines; lactometers; weights; slide calipers; stands for photographic apparatus; electric batteries; galvanic batteries; solar batteries; autopilots; nose clips for divers and swimmers; pipettes; pyrometers; plane tables [surveying instruments]; planimeters; plumb lines; plumb bobs; plotters; pedometers; polarimeters; masts for wireless aerials; pressure measuring apparatus;

mechanisms for coin-operated apparatus; prisms [optics]; test tubes; processors [central processing units]; recorded computer operating programs; recorded computer programs; computer programs [downloadable software]; voltage surge protectors; teeth protectors; projection apparatus; slide projectors; apparatus for changing record player needles; downloadable electronic publications; magnetic encoded identification bracelets; light-emitting electronic pointers; pince-nez; chemistry apparatus and instruments; radar apparatus; radios; vehicle radios; radio pagers; x-ray photographs, other than for medical use; radiological apparatus for industrial use; radiotelephony sets; walkie-talkies; radiotelegraphy sets; electrified rails for mounting spot lights; mice [data processing equipment]; x-ray apparatus not for medical use; protection devices against X-rays, not for medical purposes; choking coils [impedance]; audio and video-receivers; measuring glassware; current rectifiers; nets for protection against accidents; life nets; cell switches [electricity]; refractometers; refractors; distance recording apparatus; pressure indicators; time recording apparatus; slide-rules; carpenters' rules; rulers [measuring instruments]; stage lighting regulators; speed regulators for record players; voltage regulators for vehicles; grids for batteries; electric relays; egg timers [sandglasses]; time clocks [time recording devices]; rheostats; wrist rests for use with computers; sound reproduction apparatus; personal stereos; portable media players; electric resistors; breathing apparatus, except for artificial respiration; respirators for filtering air; retorts; sprinkler systems for fire protection; musical jukeboxes; knee-pads for workers; balances [steelyards]; clothing especially made for laboratories; clothing for protection against fire; screw-tapping gauges; saccharometers; salinometers; life buoys; satellites for scientific use; railway traffic safety apparatus; traffic-light apparatus [signaling devices]; semi-conductors; non-explosive fog signals; luminous or mechanical signals; sextants; whistle alarms; signaling whistles; dog whistles; simulators for the steering and control of vehicles; sirens; computer game software; software [recorded programs]; sonars; sounding lines; probes for scientific use; sounding apparatus and machines; sound transmitting apparatus; sound locating instruments; magnetic data media; optical data media; retorts' stands; sulphitometers; adding machines; switchboards; control panels [electricity]; distribution boards [electricity]; electronic notice boards; tachometers; covers for electric outlets; ear plugs for divers; pressure indicator plugs for valves; printed circuit boards; smart cards [integrated circuit cards]; encoded magnetic cards; magnetic identity cards; taximeters; computer keyboards; teleprompters; telephone apparatus; telephone transmitters; mobile telephones; phototelegraphy apparatus; telegraphs [apparatus]; range finders; telerupters; teleprinters; television apparatus; coin-operated mechanisms for television sets; automatic time switches; theodolites; thermometers not for

medical use; heat-regulating apparatus; thermostats; thermostats for vehicles; bells [warning devices]; electric alarm bells; electric door bells; record players; downloadable ringtones for mobile telephones; micrometer screws for optical instruments; totalizers; electronic pocket translators; clothing for protection against accidents, irradiation and fire; protective suits for aviators; suits for protection against fire; screens for photoengraving; transformers [electricity]; step-up transformers; transistors [electronic]; transmitters [telecommunication]; transponders; protractors [measuring instruments]; vehicle breakdown warning triangles; triodes; tripods for cameras; amplifying tubes; capillary tubes; electric discharge tubes other than for lighting; pitot tubes; x-ray tubes not for medical use; vacuum tubes [radio]; thermionic tubes; magnetic tape units for computers; disk drives for computers; urinometers; vacuum gauges; electrified fences; solenoid valves [electromagnetic switches]; electric light regulators [dimmers]; rods for water diviners; variometers; accumulator jars; camcorders; videotapes; video telephones; glass covered with an electrical conductor; optical glass; electric monitoring apparatus; viscosimeters; anti-dazzle shades; photographic viewfinders; voltmeters; voting machines; buzzers.

14 – Precious metals and their alloys, as well as goods made of these materials or coated therewith not included in other classes; jewelry articles, jewelry, precious stones; timepieces and chronometric instruments; ornaments [jewelry]; ornaments of jet; footwear ornaments of precious metal; hat ornaments of precious metal; agates; clock hands; alloys of precious metal; pins [jewelry]; ornamental pins; amulets [jewelry]; anchors [clock and watch making]; rings [jewelry]; earrings; works of art of precious metal; unwrought or semi-wrought jet; brooches [jewelry]; busts of precious metal; chains [jewelry]; watch chains; boxes of precious metal; clock cases; necklaces [jewelry]; watch glasses; chronographs [watches]; chronometric instruments; chronometers; stopwatches; chronoscopes; beads for making jewelry; alarm clocks; diamonds; charms [jewelry]; dials [clock and watch making]; spinel [precious stones]; statues of precious metal; statuettes of precious metal; costume jewelry; cases for clock and watchmaking; cases for watches [presentation]; copper tokens; tie pins; cuff links; threads of precious metal [jewelry]; badges of precious metal; iridium; jewelry of yellow amber; cloisonné jewelry; jewelry articles; jewelry cases [caskets]; ingots of precious metals; key rings [trinkets or fobs]; clockworks; ivory [jewelry articles]; movements for clocks and watches; medals; medallions [jewelry]; unwrought or semi-wrought precious metals; coins; watch springs; olivine [gems]; unwrought or beaten gold; gold thread [jewelry]; osmium; palladium; pendulums [clock and watch making]; pearls [jewelry]; pearls made of ambroid [pressed amber]; precious stones; semi-precious stones; unwrought or beaten silver; spun silver [silver wire]; silver thread;

platinum [metal]; bracelets [jewelry]; watch straps; watches; atomic clocks; watch cases; wall clocks; wristwatches; sundials; electric clocks and watches; master clocks; rhodium; ruthenium; tie clips; barrels [clock and watch making].

18 – Leather and imitation leather, goods made of these materials not included in other classes; animal skins; trunks and suitcases; umbrellas and parasols; walking sticks; whips, harness and saddlery; leather trimmings for furniture; umbrella rings; blinkers [harness]; handbag frames; frames for umbrellas or parasols; harness for animals; saddle trees; suitcase handles; bandoliers; chin straps of leather; walking sticks; walking stick seats; mountaineering sticks; umbrella sticks; traveling trunks; trunks [luggage]; pocket wallets; bags; bags for campers; empty tool bags of leather; bags for sports; bags for climbers; beach bags; net bags for shopping; wheeled shopping bags; travel bags; shopping bags; envelopes, of leather, for packing; handbags; muzzles; bridles [harness]; bridoons; kid; boxes of leather or leather board; boxes of vulcanized fiber; pouch baby carriers; school satchels; leather board; bands of leather; fastenings for saddles; coverings of skins [furs]; collars for animals; horse collars; leather laces; straps for soldiers' equipment; harness straps; straps of leather [saddlery]; leather leads; stirrup leathers; straps for skates; imitation leather; unworked or semi-worked leather; butts [parts of hides]; walking stick handles; stirrups; parts of rubber for stirrups; cases of leather or leather board; traveling sets [leatherware]; vanity cases; key cases; bits for animals [harness]; slings for carrying infants; casings, of leather, for springs; umbrella covers; covers for horse-saddles; whips; chamois leather other than for cleaning purposes; saddlery; harness fittings; horseshoes; leather thread; cat o' nine tails; haversacks; suitcases; hand luggage (suitcases); attaché cases; horse blankets; backpacks; sling bags for carrying infants; moleskin [imitation of leather]; purses; chain mesh purses; nose bags [feed bags]; game bags [hunting accessories]; umbrellas; parasols; curried skins; animal skins; cattle skins; furs [animal skins]; document portfolios; music cases; garment bags for travel; umbrella handles; furniture coverings of leather; reins; kneepads for horses; halters; clothing for pets; riding saddles; hat boxes of leather; pads for horse saddles; card cases [notecases]; leather straps; traces [harness]; gold beaters' skin; gut for making sausages; valves of leather; umbrella or parasol ribs.

25 – Clothing, footwear, headgear; coats; layettes [clothing]; bath robes; esparto for shoes or sandals; non-slipping devices for footwear; sleep masks; hat frames [skeletons]; motorists' clothing; bibs not of paper; swimsuits; bandanas [neckerchiefs]; bands; headbands [clothing]; bath slippers; bath sandals; overalls; dressing gowns; boas [necklets]; teddies [undergarments]; berets; footmuffs, not electrically heated; pockets for clothing; lace boots; boots; ski boots; football

boots; half-boots; breeches for wear; babies' pants [clothing]; socks; leggings [leg warmers]; footwear; footwear for sports; beach shoes; underpants; shirts; short-sleeve shirts; sports jerseys; tee-shirts; bodices [lingerie]; boot uppers; shirt yokes; hoods [clothing]; chasubles; vests; shawls; galoshes; jackets; fishing vests; stuff jackets; waterproof clothing; cyclists' clothing; money belts [clothing]; belts [clothing]; caps; slippers [undergarments]; ready-made clothing; combinations [clothing]; heelpieces for footwear; neckties; corselets; corsets [underclothing]; camisoles; collars [clothing]; detachable collars; aprons [clothing]; sports shoes; masquerade costumes; petticoats; fur stoles; girdles; skirts; skorts; ready-made linings [parts of clothing]; scarves; top coats; gabardines [clothing]; gymnastic shoes; bathing caps; shower caps; ski gloves; gloves [clothing]; metal fittings for footwear; jerseys [clothing]; leggings [trousers]; body linen [garments]; liveries; sock suspenders; garters; stocking suspenders; muffs [clothing]; maniples; mantillas; stockings; sweat-absorbent stockings; hosiery articles; mittens; miters [hats]; ear muffs [clothing]; footwear uppers; trousers; tights; pocket squares; ascots; parkas; bootees; shirt fronts; pelerines; pelisses; jumper dresses; furs [clothing]; pajamas; inner soles; beach clothes; spats; ponchos; knitwear [clothing]; collar protectors for clothing; pullovers; cuffs; tips for footwear; heelpieces for stockings; clothing of leather; clothing of imitation leather; clothing for gymnastics; paper clothing; outerclothing; sweat-absorbent underclothing [underwear]; sandals; saris; sarongs; bathing drawers; underpants; dress shields; skull caps; hats; top hats; paper hats [clothing]; brassieres; soles for footwear; sweaters; heels; studs for football boots; suspenders; head coverings [headgear]; wimples; togas; trouser straps; suits; wet suits for water-skiing; turbans; uniforms; veils [clothing]; dresses; clothing (garments); welts for footwear; cap peaks; cap peaks; shoes; wooden shoes.

35 – Advertising; business management; business administration; office functions; procurement services for others [purchasing goods and services for other businesses]; updating of advertising material; import-export agencies; commercial information agencies; advertising agencies; rental of vending machines; rental of advertising space; rental of photocopying machines; office machines and equipment rental; advertising material rental; rental of advertising time on communication media; cost price analysis; advisory services for business management; business management assistance; business auditing; data search in computer files for others; marketing research; sponsorship search; business research; assistance in the management of commercial industrial companies; price comparison services; compilation of information into computer databases; layout services for advertising purposes; news clipping services; business management consultancy; personnel management consultancy; business organization consultancy; business

management and organization consultancy; professional business consultancy; accounting; telephone answering for unavailable subscribers; publicity columns preparation; tax preparation; shop window dressing; demonstration of goods; dissemination of advertisements; distribution of samples; relocation services for businesses; drawing up of statements of accounts; marketing studies; outsourcing services [business assistance]; invoicing; organization of trade fairs for commercial or advertising purposes; business management of hotels; commercial administration of the licensing of the goods and services of others; computerized file management; business management of performing artists; business inquiries; business information; commercial information and advice for consumers [consumer advice shop]; business investigations; marketing; typing services; modeling for advertising or sales promotion; payroll preparation; employment agencies; organization of fashion shows for promotional purposes; organization of exhibitions for commercial or advertising purposes; arranging newspaper subscriptions for others; psychological testing for the selection of personnel; presentation of goods on communication media for retail purposes; economic forecasting; production of advertising films; sales promotion for others; publication of advertising texts; advertising; on-line advertising on a computer network; bill-posting; direct mail advertising; advertising by mail order; radio advertising; television advertising; compilation of statistics; writing of advertising texts; public relations; document reproduction; secretarial services; personnel recruitment; business efficiency expert services; photocopying services; business management of sports people; telemarketing services; systematization of information into computer databases; opinion polling; arranging subscriptions to telecommunication services for others; shorthand services; administrative processing of purchase orders; transcription of communications; word processing; business appraisals; retail sale or wholesale of pharmaceutical, veterinary and sanitary preparations, as well as of medical supplies; auctioneering; retail sale and wholesale in stores, via global computer networks, via catalogs, by mail order, by telephone, via radio and television, and via other electronic media of bleaching preparations and other substances for laundry use, preparations for cleaning, polishing, degreasing and scouring, soaps, perfumery products, essential oils, cosmetics, hair lotions, dentifrices, abrasives, almond oil, gaultheria oil, jasmine oil, lavender oil, rose oil, oil of turpentine [degreasing product], oils for cleaning purposes, oils for perfumes and scents, oils for toiletry purposes, essential oils of cedarwood, essential oils of citron, essential oils of lemon, ethereal oils, oils for cosmetic use, cosmetic preparations for slimming, adhesives for affixing false eyelashes, adhesives for affixing false hair, adhesives for cosmetic use, breath freshening sprays, shaving products, grinding products, drying agents for dish-

washing machines, eau de cologne, lavender water, eau de toilette, scented water, canned pressurized air for cleaning and dusting purposes, volatile alkali [ammonia] [detergent], smoothing products [starching], starch for laundry purposes, starch glaze for laundry purposes, musk [perfumery], amber [perfumery], bluing for laundry, antistatic preparations for household use, antiperspirants [toiletries], aromatics [essential oils], flavorings for cakes [essential oils], flavorings for beverages [essential oils], air fragrancing products, astringents for cosmetic use, chemical products for household use for laundry brightening, balms other than for medical use, cosmetic preparations for baths, varnish-removing products, shoe black [shoe polish], whiting, leather bleaching products, sachets for perfuming linen, products to make the leaves of plants shiny, shining products [polish], lip glosses, sun-tanning preparations [cosmetics], refurbishing preparations, hair waving preparations, silicon carbide [abrasive], carbides of metal [abrasives], eyebrow cosmetics, volcanic ash for cleaning, non-slipting wax for floors, laundry wax, tailors' wax, shoemakers' wax, depilatory wax, shoe wax, mustache wax, parquet floor wax, polishing wax, waxes for leather, shampoos, dry shampoos, shampoos for pets, preservatives for leather [polishes], corundum [abrasive], quillaia bark for washing, cosmetics, cosmetics for animals, skin whitening creams, cosmetic creams, boot polish, polishing creams, cosmetic products for skin care, floor wax removers [scouring preparations], scouring solutions, bleaches for cosmetic use, dentifrices, depilatories, degreasers other than for use in manufacturing processes, scale removing preparations for household use, make-up removing preparations, deodorants for pets, deodorants [perfumery products], detergents other than for use in manufacturing operations and for medical use, diamantine [abrasive], douching preparations for personal sanitary or deodorant purposes [toiletries], polish for furniture and flooring, mouthwashes not for medical use, badian essence, bergamot oil, mint essence [essential oil], ethereal essences, emery, extracts of flowers [perfumery products], bases for flower perfumes, fumigation products [perfumes], dental bleaching gels, massage gels other than for medical use, geraniol, laundry glaze, greases for cosmetic use, cotton wool for cosmetic use, heliotropine, henna [dyes for cosmetic use], swabs for cosmetic use, incense, ionone [perfumery], shaving soap, almond soap, soaps, antiperspirant soaps, soap for foot perspiration, disinfectant soaps, deodorant soaps, medicated soaps, soap for brightening textile, petroleum jelly for cosmetic use, nail polish, hair sprays, lacquer-removing products, breath freshening strips, eyebrow pencils, cosmetic pencils, almond milk for cosmetic use, cleansing milk for toilet purposes, javelle water, soda lye, windshield cleaning liquids, preparations for cleaning dentures, dry-cleaning products, cleaning products, non-slipting liquids for floors, hair lotions, after-shave loti-

ons, lotions for cosmetic use, scented wood, make-up, make-up products, mascara, beauty masks, mint for perfumery, decorative patterns for cosmetic use, cosmetic kits, neutralizers for permanent waving, cloths impregnated with a detergent for cleaning, emery paper, sandpaper, polishing paper, wallpaper cleaning products, abrasive paper, pastes for razor strops, bars of soap, nail art stickers, perfumery products, perfumes, hydrogen peroxide for cosmetic use, cosmetic preparations for eyelashes, false eyelashes, cobblers' wax, pumice stone, shaving stones [astringents], alum stones [astringents], polishing stones, smoothing stones, lipsticks, paint-stripping products, make-up powder, pomades for cosmetic use, potpourris [fragrances], laundry preparations, sunscreen preparations, aloe vera preparations for cosmetic use, preparations for unblocking drain pipes, bleaching products for laundry use, rust removing products, denture polishes, polishing preparations, stain removers, laundry soaking products, jewelers' rouge, safrol, bleaching salts, bath salts other than for medical use, washing soda for cleaning, bleaching soda, fabric softeners for laundry use, talcum powder, for toilet use, sandcloth, emery cloth, glass cloth, terpenes [essential oils], cosmetic dyes, dyes for toilet purposes, hair dyes, beard dyes, products for removing dyes, cleaning chalk, tissues impregnated with cosmetic lotions, toiletry products, turpentine [degreasing product], tripoli stone for polishing, false nails, nail care products, joss sticks, scientific, nautical, surveying, photographic, cinematographic, optical, weighing, measuring, signaling, checking [supervision], life-saving and teaching apparatus and instruments, apparatus and instruments for conducting, switching, transforming, accumulating, regulating or controlling electricity, apparatus for recording, transmission or reproduction of sound or images, magnetic recording media, sound recording disks, compact disks, DVDs and other digital recording media, mechanisms for coin-operated apparatus, cash registers, calculating machines, data processing equipment, computers, software, extinguishers, abacuses, accidents [personal protection devices for use against accidents], particle accelerators, acid hydrometers, azimuth instruments, connections for electric lines, acoustic couplers, couplers [data processing equipment], actinometers, electric accumulators, devices for cleaning recording discs, aerometers, electronic agendas, surveying [instruments therefor], railway points [electro-dynamic apparatus for the remote control thereof], needles for record players, air [apparatus to analyze air], stills for laboratory experiments, alarms [instruments therefor], anti-theft alarms, fire alarms, sound alarms, alcoholmeters, metal alloys [wires made thereof] [fuses], mouse pads, alidades, food [apparatus for analyzing food], loudspeakers, altimeters, asbestos [fireproof clothing made of asbestos], ammeters, enlarging apparatus [photography], amplifiers, analysis [apparatus therefor], not for medical purposes, anemometers, calibrating rings, ano-

des, antennas, surveyors' levels, anticathodes, anti-rust [cathodic devices for protection thereof], anti-interference [devices] [electricity], anti-glare [eyeglasses], theft prevention installations [electric-], GPS [global positioning system] apparatus, data processing apparatus, x-ray apparatus not for medical use, x-ray producing apparatus and installations not for medical use, apertometers [optics], downloadable image files, downloadable music files, distribution boxes [electricity], safety restraints, other than for vehicle seats and sports equipment, asbestos [gloves made thereof], for protection from accidents, astronomy [apparatus and instruments therefor], audiovisual [teaching apparatus], headphones, telephone receivers, fire engines, rescue [apparatus and devices therefor], scales, precision balances, lighting ballasts, luminous beacons, luminous or mechanical road signs, life-saving rafts, laboratory trays, fire boats, barometers, weighbridges [weighing apparatus], fire beaters, batteries [acidimeters for-], anode batteries, batteries for lighting, electric batteries for vehicles, batteries [plates for], betatrons, binoculars, electric coils, electric coils [carriers therefor], electromagnetic coils, speaking tubes, special bags for portable computers, fire engines, flash bulbs, wire connectors [electricity], terminals [electricity], push buttons for bells, reference buoys, signalling buoys, tone arms for record players, identification threads for electric wires, directional compasses, marine compasses, spirit levels, coaxial cables, starter cables for motors and engines, fiber-optic cables, electric cables, surveying chains, eyeglass chains, cabinets for loudspeakers, accumulator boxes, branch boxes [electricity], switchboxes [electricity], junction boxes [electricity], petri dishes, containers for microscope slides, cash registers, automated teller machines, electrically heated socks, calculators, pocket calculators, boilers [instruments for controlling boilers], gauges, calipers, footwear for protection against accidents, irradiation and fire, cinematographic cameras, decompression chambers, cameras [photography], jukeboxes [computer peripherals], signal bells, protective masks for workers, solderers' helmets, battery chargers, chargers for electric batteries, spools [photography], video game cartridges, riding helmets, protective helmets, protective helmets for sports, video cassettes, telescopes, cathodes, galvanic cells, photovoltaic cells, laboratory centrifuges, electric locks, bullet-proof vests, life jackets, chips [integrated circuits], DNA chips, cyclotrons, cinematographic film [devices for editing such film], magnetic tapes, magnetic tapes [demagnetizing apparatus therefor], sound recording strips, head cleaning tapes, life belts, printed circuits, integrated circuits, gradient indicators, insulated copper [wires thereof], magnetic encoders, bar codes, [readers thereof], electric collectors, comparators, compasses [measuring instruments], laptop computers, electrical capacitors, optical condensers, electrical ducts, electrical ducts [material therefor] [wires, cables, electric conductors, acoustic conduits,

electricity conduits, connectors [electricity], switching [electrical apparatus therefor], switches, converters, traffic cones, distribution consoles [electricity], electric contacts, counters, answering machines, control [electrical apparatus therefor], speed control for vehicles [apparatus therefor], control of franking [apparatus therefor], remote control [apparatus therefor], remote control of industrial operations [electrical installations therefor], remote control of signals [electrodynamic apparatus therefor], cupels [laboratory], eyeglass cords, straps for mobile telephones, runners, cosmography [instruments therefor], dressmaking [tape measures therefor], circuit closers, galena crystals [detectors], chromatography [apparatus therefor] for laboratories, chronographs [time recording apparatus], darkrooms [photography], washing trays [photography], measuring spoons, thread counters, kilometer recorders for vehicles, revolution counters, leather [apparatus for measuring the thickness thereof], densimeters, densitometers, distillation [apparatus therefor] for scientific purposes, detectors, counterfeit [false] coin detectors, smoke detectors, metal detectors for industrial or military use, diaphragms [acoustics], diaphragms [photography], diaphragms for scientific apparatus, diagnosis [apparatus therefor], not for medical purposes, transparencies, slides [apparatus for framing thereof], animated cartoons, dictaphones, diffraction [apparatus therefor] [microscopy], dynamometers, money [machines for counting and sorting thereof], light-emitting diodes [LED], sound recording disks, compact disks [audio-video], calculating disks, magnetic disks, optical disks, optical compact disks, reflecting disks for wear, for the prevention of traffic accidents, shutter releases [photography], floppy disks, distance measuring devices, ticket [ticket] dispensers, circuit breakers, dosage dispensers, marine depth finders, electrolyzers, transmitters of electronic signals, transmitting sets [telecommunication], electric couplings, remote ignition [electrical devices therefor], electrical sockets, testing of materials [instruments and machines therefor], epidiascopes, balancing [devices therefor], ergometers, diving suits, fire escapes, sounding leads, scanners [data processing equipment], school apparatus, drainers for use in photography, spherometers, spectrograph apparatus, mirrors for inspecting work, mirrors [optics], thickness of skins [apparatus for measuring the thickness of skins], drying racks [photography], stereoscopic apparatus, stereoscopes, stroboscopes, cases fitted with dissecting instruments [microscopy], cases especially made for photographic apparatus and instruments, spectacle cases, containers for contact lenses, pince-nez cases, electronic tags for goods, temperature indicator labels not for medical use, exposure meters, extinguishers, billing [machines], facsimile [apparatus therefor], fermentation [apparatus therefor] [laboratory apparatus], optical fibers [light conducting filaments], cards [mechanisms for apparatus operated thereby], filters for ultraviolet rays for photography, filters [photography],

filters for respiratory masks, physics [apparatus and instruments therefor], flash-bulbs [photography], blueprints [apparatus therefor], photocopiers, apparatus for glazing photographic prints, apparatus for drying photographic prints, photometers, high-frequency apparatus, frequency meters, identification sheaths for electric wires, sheaths for electric cables, cases for laptops, fuses, goggles for sports, sunglasses, spectacles [optics], jigs [measuring instruments], galvanometers, gases [apparatus for analyzing gases], gasometers [measuring instruments], surveying [apparatus and instruments], meteorological balloons, sound recording [apparatus therefor], sound recordings [media therefor], video recorders, marking gauges, gloves for divers, gloves for protection against accidents, gloves for protection against X-rays for industrial use, heliographic [apparatus], hydrometers, hygrometers, electric wires, magnetic wires, telephone wires, telegraph wires, holograms, furnaces for laboratory use, magnets, decorative magnets, computer printers, incubators for bacteria culture, automatic indicators of low pressure in vehicle tires, quantity indicators, gasoline gauges, electric loss indicators, temperature indicators, speed indicators, water level indicators, armatures [electricity], inductors [electricity], intercommunication [apparatus therefor], interfaces [computers], carriers for dark plates [photography], electric switches, inverters [electricity], ionization [apparatus therefor] not for the treatment of air or water, leveling staffs [surveying instruments], hands free kits for telephones, lactodensimeters, optical lamps, darkroom lamps [photography], fire hose nozzles, electronic pens for visual display units, lasers, not for medical use, cassette players, compact disc players, dVD players, readers [data processing equipment], optical character readers, correcting lenses [optics], contact lenses, eyepieces [instruments containing eyepieces], optical lenses, lenses for spectacles, supplementary lenses [optical], neon signs, luminous signs, mechanical signs, limiters [electricity], signal lanterns, magic lanterns, safety tarpaulins, blinkers [signaling lights], magnifying glasses [optics], tape recorders, wind socks for indicating wind direction, fire hoses, junction sleeves for electric cables, crash test dummies, resuscitation mannequins [teaching apparatus], pressure gauges, fire blankets, hemline markers, frames for photographic transparencies, digital photograph frames, divers' masks, protective masks, respiratory masks, other than for artificial respiration, mathematical [instruments], measuring [apparatus therefor], measuring [electrical apparatus therefor], measuring [instruments therefor], precision measuring [apparatus therefor], measures, measuring speed [apparatus therefor] [photography], megaphones, computer memory devices, uSB flash drives, mercury [levels thereof], meteorological [instruments], metronomes, rules [measuring instruments], microphones, microprocessors, microscopes, microtomes, sighting telescopes for firearms, peepholes [magnifying lenses] for doors, furni-

ture especially made for laboratories, modems, monitors [computer hardware], monitors [computer programs], spectacle frames, eyeglass frames, underwater swimming [breathing apparatus therefor], nautical [apparatus and instruments], naval [signaling apparatus], navigation [apparatus] for vehicles [on-board computers], navigation [apparatus] via satellite, navigation [instruments therefor], leveling [instruments therefor], levels [instruments for determining the horizontal], verniers, lenses for astrophotography, objectives [lenses] [optics], boards for integrated circuits, observation [instruments thereof], shutters [photography], octants, eyepieces, offices [punched card machines therefor], ohmmeters, wavemeters, optical [articles], optical [apparatus and instruments], computers, notebook computers [laptops], oscillographs, egg-candlers, oxygen [apparatus for transfilling oxygen], ozonizers, horns for loudspeakers, micrometer gauges, luminous or mechanical signaling panels, asbestos screens for firemen, projection screens, video screens, fluorescent screens, screens [photography], radiology screens for industrial use, spark-guards, lightning rods, parking meters, film [apparatus for cutting-], exposed cinematographic films, exposed X-ray films, exposed films, computer peripheral devices, periscopes, letter scales, weighing [apparatus and instruments therefor], weighing [machines therefor], lactometers, weights, slide calipers, stands for photographic apparatus, electric batteries, galvanic batteries, solar batteries, autopilots, nose clips for divers and swimmers, pipettes, pyrometers, plane tables [surveying instruments], planimeters, plumb lines, plumb bobs, plotters, pedometers, polarimeters, masts for wireless aeries, pressure [meters], prepayment [mechanisms for apparatus therefor], prisms [optics], test tubes, processors [central processing units], recorded computer operating programs, recorded computer programs, computer programs [downloadable software], voltage surge protectors, teeth protectors, projection [apparatus therefor], slide projectors, styluses for record players [devices for changing-], downloadable electronic publications, magnetic encoded identification bracelets, light-emitting electronic pointers, pince-nez, chemistry [apparatus and instruments for], radar apparatus, radio [apparatus therefor], radio [apparatus therefor] for vehicles, paging [apparatus therefor], x-ray photographs, other than for medical use, radiology [apparatus] for industrial purposes, walkie-talkies [apparatus], walkie-talkies, radiotelegraph [apparatus-], electrified rails for mounting spot lights, mice [data processing equipment], x-ray photographs, other than for medical use, radiology [apparatus] for industrial purposes, walkie-talkies [apparatus], walkie-talkies, radiotelegraph [apparatus-], electrified rails for mounting spot lights, mice [data processing equipment], x-rays [apparatus therefor], not for medical purposes, x-rays [protection devices against -], not for medical purposes, choking coils [impedance coils], receivers [audio and video], measuring glass-

ware, current rectifiers, nets for protection against accidents, life nets, cell switches [electricity], refractometers, refractors, distance-recording apparatus, pressure indicators, recording time [apparatus therefor], slide-rules, carpenters' rulers [sliding rulers], rulers [measuring instruments], stage lighting regulators, speed regulators for record players, voltage regulators for vehicles, grids for batteries, electric relays, egg timers, time clocks, rheostats, wrist rests for use with computers, reproduction of sound [apparatus therefor], personal stereos, portable multimedia players, electric resistors, breathing [apparatus therefor], not for artificial respiration, respirators for filtering air, retorts, sprinkler systems for fire protection, musical jukeboxes, knee-pads for workers, balances [steelyards], clothing especially made for laboratories, clothing for protection against fire, screw-tapping gauges, saccharometers, salinometers, life buoys, satellites for scientific use, safety [apparatus] for railway traffic, traffic-light apparatus [signaling devices], semi-conductors, non-explosive fog signals, luminous or mechanical signals, sextants, whistle alarms, signaling whistles, dog whistles, simulators for the steering and control of vehicles, sirens, computer game software, software [recorded programs], sonars, sounding lines, probes for scientific use, drilling [apparatus and machines therefor], sound [apparatus for transmission thereof], sound locating instruments, magnetic data media, optical data media, retorts' stands, sulphitometers, adding [machines therefor], switchboards, control panels [electricity], distribution boards [electricity], electronic notice boards, tachometers, covers for electric outlets, ear plugs for divers, pressure indicator plugs for valves, printed circuit boards, smart cards, encoded magnetic cards, magnetic identity cards, taximeters, computer keyboards, teleprompters, telephone [apparatus], telephone [transmitters], mobile telephones, picture transmission [apparatus therefor], telegraphs [apparatus], range finders, telerupters, teleprinters, television apparatus, televisions [prepayment mechanisms therefor], automatic time switches, theodolites, thermometers not for medical use, heat regulating [apparatus-], thermostats, thermostats for vehicles, bells [warning devices], electric alarm bells, electric door bells, record players, downloadable ringtones for mobile telephones, micrometer screws for optical instruments, totalizers, electronic pocket translators, clothing for protection against accidents, irradiation and fire, protective suits for aviators, suits for protection against fire, screens for photoengraving, electrical transformers, step-up transformers, transistors [electronic], transmitters [telecommunication], transponders, protractors [measuring instruments], vehicle breakdown warning triangles, triodes, tripods for cameras, amplifying tubes, capillary tubes, electric discharge tubes other than for lighting, pitot tubes, x-ray tubes not for medical use, vacuum tubes [radio], thermionic tubes, magnetic tape units [computers], disk drives [hardware], urinometers, vacuum gauges, elec-

trified fences, solenoid valves [electromagnetic switches], electric light regulators, rods for water diviners, variometers, accumulator jars, camcorders, videotapes, video telephones, glass covered with an electrical conductor, optical glass, monitoring [electrical apparatus therefor], viscosimeters, anti-dazzle shades, photographic viewfinders, voltmeters, voting [machines therefor], buzzers, precious metals and their alloys, and goods made of these materials or coated therewith, jewelry articles, jewelry, precious stones, timepieces and chronometric instruments, ornaments [jewelry], ornaments of jet, footwear ornaments of precious metal, hat ornaments of precious metal, agates, clock hands, alloys of precious metal, pins [jewelry], ornamental pins, amulets [jewelry], anchors [clock and watch making], rings [jewelry], earrings, art [works thereof] of precious metal, unwrought or semi-wrought jet, brooches [jewelry], busts of precious metal, chains [jewelry], watch chains, boxes of precious metal, clock cases, necklaces [jewelry], watch glasses, chronographs [watches], chronometric [instruments], chronometers, stopwatches, chronoscopes, beads for making jewelry, alarm clocks, diamonds, charms [jewelry], dials [clock and watch making], spinel [precious stones], statues of precious metal, statuettes of precious metal, costume jewelry, cases for clock and watchmaking, cases for watches [presentation], copper tokens, tie pins, cuff links, threads of precious metal [jewelry], badges of precious metal, iridium, jewelry of yellow amber, cloisonné jewelry, jewelry [articles thereof], jewelry caskets, ingots of precious metals, key rings, clockworks, ivory [decorations thereof] [jewelry], movements for clocks and watches, medals, medallions [jewelry], unwrought or semi-wrought precious metals, coins, watch springs, olivine, unwrought or beaten gold, gold [thread of] [jewelry], osmium, palladium, pendulums [clock and watch making], pearls [jewelry], pearls made of pressed amber, precious stones, semi-precious stones, unwrought or beaten silver, spun silver, silver [wires thereof], platinum [metal], bracelets [jewelry], watch straps, watches, atomic clocks, watches [casings therefor], wall clocks, wristwatches, sundials, electric clocks and watches, master clocks, rhodium, ruthenium, tie clips, clock barrels, leather and imitation leather and products made of these materials, animal skins, trunks and suitcases, umbrellas and parasols, walking sticks, whips, harness and saddlery, leather trimmings for furniture, umbrella rings, blinkers [harness], handbag frames, frames for umbrellas or parasols, harness for animals, saddle trees, suitcase handles, bandoliers, chin straps of leather, walking sticks, walking stick seats, mountaineering sticks, umbrella sticks, traveling trunks, trunks [luggage], pocket wallets, bags, bags for campers, empty tool bags of leather, bags for sports, bags for climbers, beach bags, net bags for shopping, wheeled shopping bags, travel bags, shopping bags, envelopes, of leather, for packaging, handbags, muzzles, bridles for horses, brid-

ons, kid, boxes of leather or leather board, boxes of vulcanized fiber, pouch baby carriers, school satchels, leather board, bands of leather, fastenings for saddles, coverings of skins [furs], collars for animals, horse collars, leather laces, straps for soldiers' equipment, harness straps, straps of leather [saddlery], leather leads, stirrup leathers, straps for skates, imitation leather, unworked or semi-worked leather, butts, walking stick handles, stirrups, parts of rubber for stirrups, cases of leather or leather board, traveling sets [leatherware], vanity cases, not fitted, key cases, bits for animals [harness], slings for carrying infants, casings, of leather, for springs, umbrella covers, covers for horse-saddles, whips, chamois leather other than for cleaning purposes, saddlery articles, harness fittings, horseshoes, leather thread, cat o' nine tails, haversacks, suitcases, hand luggage [suitcases], attaché cases, horse blankets, backpacks, sling bags for carrying infants, moleskin [imitation of leather], purses, chain mesh purses, feed bags, game bags, umbrellas, parasols, curried skins, animal skins, cattle skins, furs [animal skins], document portfolios, music cases, garment bags for travel, umbrella handles, furniture coverings of leather, reins, knee-pads for horses, halters, clothing for pets, riding saddles, hat boxes of leather, pads for horse saddles, card cases [notecases], leather straps, traces [harness], gold beaters' skin, gut for making sausages, valves of leather, umbrella or parasol ribs, furniture, mirrors, picture frames, goods made of wood, cork, cane, reed, rattan, horn, bone, ivory, whalebone, tortoiseshell, amber, mother-of-pearl, meerscham, substitutes for all these materials or plastics, household and cooking utensils and containers, combs and sponges, brushes, brush-making materials, cleaning material, steel wool, unworked or semi-worked glass [except building glass], glassware, porcelain and earthenware, fabrics and textile goods, bed linen, table linen, clothing, footwear, headgear, coats, layettes [clothing], bath robes, esparto for shoes or sandals, non-slipping devices for footwear, sleep masks, hat frames, clothing for motorists, bibs not of paper, swimsuits, bandanas [neckerchiefs], bands, headbands [clothing], bath slippers, bath sandals, overalls, dressing gowns, boas [necklets], teddies [undergarments], berets, footmuffs, not electrically heated, pockets for clothing, lace boots, boots, ski boots, football boots, half-boots, breeches for wear, babies' pants, socks, leggings, footwear, footwear for sports, beach shoes, underpants, shirts, short-sleeve shirts, sports jerseys, tee-shirts, bodices, boot uppers, shirt yokes, hoods, chasubles, vests, shawls, galoshes, jackets, fishing vests, stuff jackets, waterproof clothing, clothing for cyclists, money belts [clothing], belts [clothing], caps, slips [undergarments], ready-made clothing, combinations, heelpieces for footwear, neckties, corselets, corsets [underclothing], camisoles, collars, detachable collars, aprons [clothing], sneakers, disguise costumes, petticoats, fur stoles, girdles, skirts, skorts, ready-made linings [parts of clothing], scarves, top coats,

gabardines [clothing], footwear for gymnastics, bathing caps, shower caps, ski gloves, gloves [clothing], metal fittings for footwear, jerseys [clothing], leggings [trousers], underwear, liveries, sock suspenders, garters, stocking suspenders, muffs [clothing], maniples, mantillas, stockings, sweat-absorbent stockings, hosiery, mittens, miters [hats], ear muffs [clothing], footwear uppers, trousers, tights, handkerchiefs [clothing], ascots, parkas, bootees, shirt fronts, pelerines, pelisses, jumper dresses, furs [clothing], pajamas, inner soles, beach clothes, spats, ponchos, knitwear, collar protectors, pullovers, wristbands [clothing], tips for footwear, heelpieces for stockings, clothing of leather, clothing of imitations of leather, clothing for gymnastics, paper clothing, outerclothing, sweat-absorbent underclothing, sandals, saris, sarongs, bathing drawers, underpants, dress shields, skull caps, hats, top hats, paper hats [clothing], brassieres, soles for footwear, sweaters, heels, studs for football boots, suspenders, head coverings [headgear], wimples [clothing], togas, trouser straps, suits, wet suits for water-skiing, turbans, uniforms, veils, dresses, clothing [garments], welts for footwear, cap peaks, cap peaks, shoes, wooden shoes, lace and embroidery, ribbons and cords, buttons, hooks and eyelets, pins and needles, artificial flowers, carpets, door mats, mats, linoleum and other floor coverings, wall hangings, not of textile, games and toys, articles for gymnastics and sports, decorations for Christmas trees, meat, fish, poultry and game, meat extracts, fruit and vegetables, canned vegetables, frozen dried and cooked, jellies, jams, compotes, eggs, milk and dairy products, edible oils and fats, coffee, tea, cocoa and artificial coffee, rice, tapioca and sago, flour and preparations made from cereals, bread, pastry and confectionery products, edible ices, sugar, honey, golden syrup, yeast, baking powder, salt, mustard, vinegar, sauces [condiments], spices, ice, beer, mineral and aerated waters and other non-alcoholic beverages, fruit beverages and fruit juices, syrups and other preparations for making beverages.

(260) AM 2023 121708 A

(800) 1316011

(151) 2016 06 22

(891) 2023 01 30

(731) Suvorov Ihor Viktorovych

vul. Yuriia Kondratiuka, 28 B, m. Kremenchuk,
Poltavska oblast, 39603, Ukraine

(540)

SweeTale

(591) Black, white

(511)

30 – Peanut confectionery; cereal bars; pastries; bread rolls; buns; waffles; nut confectionery; chocolate-coated nuts; rice-based snack food; cereal-based snack food; cereal preparations; marshmallow (confectione-

ry); caramels (candy); confectionery; sugar confectionery; confectionery for decorating Christmas trees; liquorice (confectionery); candy; marzipan; macarons (pastry); almond confectionery; dessert mousses (confectionery); chocolate mousses; peppermint sweets; cookies; quiches; fondants (confectionery); pralines; candy decorations for cakes; chocolate decorations for cakes; gingerbread; puddings; rice cakes; eastern sweets (confectionery); cakes; petits fours (cakes); tarts; fruit jellies (confectionery); halvah; sweetmeats (candy); chocolate; chocolate sweets.

(260) AM 2023 121709 A

(800) 1320353

(151) 2016 07 18

(891) 2023 02 01

(731) BIMBA & LOLA, S.L.

Parque Tecnológico y Logístico de Vigo -,

Nave D13; E-36315 Vigo (Pontevedra), Spain

(540)

BIMBA Y LOLA

(591) Black, white

(531) 27.05.17

(511)

3 – Bleaching preparations and other substances for laundry use; cleaning, polishing, scouring and abrasive preparations; soaps; perfumery, essential oils, cosmetics, hair lotions; dentifrices; abraders; almond oil; gaultheria oil; jasmine oil; lavender oil; rose oil; oil of turpentine for degreasing; oils for cleaning purposes; oils for perfumes and scents; oils for toilet purposes; cedarwood (essential oils of -); lemon [essential oils of -]; lemon [essential oils of -]; essential oils; oils for cosmetic purposes; cosmetic preparations for slimming purposes; eyelashes (adhesives for affixing false -); adhesives for affixing false hair; adhesives for cosmetic purposes; breath freshening sprays; shaving preparations; abraders; drying agents for dishwashing machines; eau de cologne; lavender water; eau de cologne; perfume water; canned pressurized air for cleaning and dusting purposes; ammonia [volatile alkali] [detergent]; smoothing preparations [starching]; starch for laundry purposes; starch glaze for laundry purposes; musk [perfumery]; amber [perfume]; laundry blue; antistatic preparations for household purposes; antiperspirants [toiletries]; aromatics [essential oils]; cake flavorings [essential oils]; flavorings for beverages [essential oils]; air fragrancing preparations; astringents for cosmetic purposes; color-brightening chemicals for household purposes [laundry]; non-medicated lotions; baths (cosmetic preparations for -); lacquer-removing preparations; shoe polish; whitening; leather bleaching preparations; sachets for perfuming linen; plants (preparations to make shiny the leaves of -); shining preparations [polish]; lip gloss; sun-tanning preparations [cosmetics]; fur-bishing preparations; hair waving preparations; silicon carbide [abrasive]; carbides of metal [abrasives]; eye-

brow cosmetics; volcanic ash for cleaning; non-slip wax for floors; laundry wax; tailors' wax; shoemakers' wax; wax (depilatory -); shoe wax; moustache wax; parquet floor wax; parquet floor wax; creams for leather; shampoo; dry shampoos; shampoos for pets; preservatives for leather [polishes]; corundum [abrasive]; quillaia bark for washing; cosmetics; cosmetics for animals; skin whitening creams; creams (cosmetic -); boot cream; polishing creams; skincare cosmetics; floor wax removers [scouring preparations]; scouring solutions; bleaching preparations [decolorants] for cosmetic purposes; dentifrices; depilatories; degreasers other than for use in manufacturing processes; scale removing preparations for household purposes; make-up removing preparations; deodorants for pets; deodorants for human beings or for animals; detergents other than for use in manufacturing operations and for medical purposes; diamantine [abrasive]; douching preparations for personal sanitary or deodorant purposes [toiletries]; polish for furniture and flooring; dental rinses, non medicated; badian essence; bergamot oil; mint essence [essential oil]; ethereal essences; emery; extracts of flowers [perfumes]; flower perfumes (bases for -); fumigation preparations [perfumes]; dental bleaching gels; massage gels other than for medical purposes; geraniol; laundry glaze; greases for cosmetic purposes; cotton wool for cosmetic purposes; heliotropine; henna [cosmetic dye]; cotton sticks for cosmetic purposes; incense; ionone [perfumery]; shaving soap; almond soap; soaps; antiperspirant soap; soap for foot perspiration; disinfectant soap; deodorant soap; medicated soap; soap for brightening textile; petroleum jelly for cosmetic purposes; nail polish; hair spray; lacquer-removing preparations; breath freshening strips; eyebrow pencils; eyebrow pencils; almond milk for cosmetic purposes; cleansing milk for toilet purposes; javelle water; soda lye; wind-screen cleaning fluids; dentures (preparations for cleaning -); dry-cleaning preparations; polishing preparations; non-slip liquids for floors; hair lotions; aftershave; lotions for cosmetic purposes; scented wood; make-up; make-up preparations; mascara; cosmetic masks; mint for perfumery; transfers (decorative -) for cosmetic purposes; cosmetic kits; neutralizers for permanent waving; cloths impregnated with a detergent for cleaning; emery paper; emery paper; polishing paper; wallpaper cleaning preparations; emery paper; pastes for razor strops; soap; nail art stickers; perfumery; perfumery; hydrogen peroxide for cosmetic purposes; cosmetics for eye-lashes; eye-lashes (false -); shoemakers' wax; pumice stone; alum stones [astringents]; alum stones [astringents]; polishing stones; polishing stones; lipstick; color-removing preparations; face powder; pomades for cosmetic purposes; pot-pourri; laundry preparations; sun tan lotion; aloe vera preparations for cosmetic purposes; unblocking drain pipes (preparations for -); laundry bleach; rust removers; denture polishes; polishing preparations; destainers; laundry soaking preparations; jewe-

llers' rouge; safrol; bleaching salts; bath salts, not for medical purposes; washing soda, for cleaning; bleaching soda; fabric softeners for laundry use; talcum powder, for toilet use; emery cloth; emery cloth; glass cloth; terpenes [essential oils]; dyes (cosmetic -); colorants for toilet purposes; hair dyes; beard dyes; color-removing preparations; cleaning chalk; tissues impregnated with cosmetic lotions; toiletries; turpentine, for degreasing; tripoli stone for polishing; false nails; nail care preparations; joss sticks.

(260) AM 2023 121777 A
 (800) 1714210
 (151) 2022 10 28
 (891) 2022 10 28
 (731) AZER MAYA ISTEHSAL
 11th Daghlig 3105th Block, Narimanov
 District, AZ-1108 Baku City, Azerbaijan
 (540)



(591) Red, green and blue
 (531) 05.03.13; 05.03.15; 05.05; 05.05.20;
 05.05.21; 27.05; 27.05.01; 27.05.01; 27.07.01;
 29.01; 29.01.13; 29.01.14
 (511)
 30 – Yeast.

(260) AM 2023 121778 A
 (800) 1714211
 (151) 2022 12 06
 (891) 2022 12 06
 (731) PLASTIKA KRITIS S.A.
 P Street, Industrial Zone; GR-714 08 Iraklion,
 Greece
 (540)

(591) Black, white
 (531) 27.05.01
 (511)
 17 – Plastic films for agricultural use.

(260) AM 2023 121779 A
 (800) 1714228
 (151) 2023 01 04
 (891) 2023 01 04
 (731) VIENNA INSURANCE GROUP AG Wiener
 Versicherung Gruppe
 Schottenring 30, A-1010 Wien, Austria

(540)

VIG Re
VIENNA INSURANCE GROUP

(591) Black, red

(531) 26.11.01; 26.11.08; 27.05.01; 27.05.09;
27.05.10; 27.05.11; 29.01.12

(511)

36 – Insurance; financial affairs; monetary affairs;
real estate affairs.

(260) AM 2023 121780 A

(800) 1714281

(151) 2022 12 02

(891) 2022 12 02

(731) HABİP ULUS

YENİŞEHİR MAH. REYHAN CAD. AYTEPE
SİTESİ NO:4/8, KURTKÖY PENDİK,
İSTANBUL, Türkiye

(540)

KOTA

(591) Black, white

(531) 27.05.17

(511)

25 – Clothing, including underwear and outer clothing,
other than special purpose protective clothing, socks,
mufflers, clothing, shawls, bandanas, scarves, belts,
clothing; footwear, shoes, slippers, sandals; headgear,
hats, caps with visors, berets, caps, headwear, skull
caps.

(260) AM 2023 121786 A

(800) 1714699

(151) 2022 11 08

(891) 2022 11 08

(731) Euro Games Technology Ltd.

4, "Maritsa" Str., "Vranya-Lozen-Triugulnika",
BG-1151 Sofia, Bulgaria

(540)

Burning Hot Wins

(591) Black, white

(511)

9 – Operating computer software for main frame com-
puters; monitors (computer hardware); computer har-
dware; apparatus for recording images; monitors
(computer programs); computer game programs; com-
puter programs for recorded games; apparatus for re-
cording, transmission or reproduction of sound or
images; communications servers [computer hardwa-
re]; electronic components for gambling machines;
computer application software featuring games and
gaming; computer software for the administration of
on-line games and gaming; computer hardware for
games and gaming; computer hardware and software
for gambling, gambling machines, gambling games on
the Internet and via telecommunication network; com-puter systems; computer operating system software;
computer terminals; interactive terminals; multimedia
terminals; electronic terminals for generating lottery
tickets; interactive touch screen terminals; computer
touchscreens; electronic display panels; liquid crystal
display screens; digital signage display panels; multi-
media software; multimedia apparatus and instru-
ments; interactive multimedia software for playing
games; computer screens; LCD large-screen displays;
liquid crystal displays [LCDs] for home theatres; me-
dia streaming software; computer application software
for streaming audio-visual media content via the
internet; software; computer gaming software; com-
puter software packages; computer operating system
software; computer software, recorded; software dri-
vers; virtual reality software; games software; enter-
tainment software for computer games; computer pro-
grams for network management; electronic lottery
tickets; computer software platforms; operating syst-
ems; interactive computer systems; operating system
programs; computer game software for use with on-
line interactive games; games software for use with
video game consoles.28 – Gaming machines for gambling; chips for gam-
bling; mah-jong; arcade games; gambling machines
operating with coins, notes and cards; games; electro-
nic games; parlor games; gaming chips; gaming
tables; slot machines [gaming machines]; LCD game
machines; slot machines and gaming devices; coin-
operated amusement machines; roulette chips; poker
chips; chips and dice [gaming equipment]; gaming
equipment for casinos; roulette tables; gaming roulette
wheels; casino games; gambling machines and amuse-
ment machines, automatic and coin-operated; coin-
operated amusement machines and/or electronic coin-
operated amusement machines with or without the
possibility of gain; boxes for coin-operated amuse-
ment machines, slot machines and gaming machines;
electronic or electrotechnical amusement machines
and apparatus, gaming machines, coin-operated enter-
tainment machines; housings for coin-operated amu-
sement machines, gaming equipment, gaming machi-
nes, machines for gambling; electropneumatic and
electrical gambling machines (slot machines); lottery
games; electronic targets for games and sports; video
game consoles.41 – Gambling; entertainment services related to gam-
bling; gaming services for entertainment purposes;
casino, gaming and gambling services; training in the
development of software systems; provision of gam-
ing equipment for gambling halls; providing casino
equipment [gambling]; gaming machine entertainment
services; providing casino facilities [gambling]; gam-
ing hall services; amusement arcade services; games
equipment rental; rental of gaming machines; provi-
ding amusement arcade services; rental of gaming
machines with images of fruits; editing or recording
of sounds and images; sound recording and video

entertainment services; hire of sound reproducing apparatus; provision of gaming equipment for casinos; providing of casino facilities; online gambling services; casino management services; provision of gaming facilities, gaming hall facilities, Internet casinos and online gambling services; lottery services; organization of lotteries; provision of games by means of a computer based system; online interactive entertainment; on-line casino services; online game services through mobile devices; providing online entertainment in the nature of game tournaments; providing on-line information in the field of computer gaming entertainment; sports betting services; online sports betting services; providing on-line computer games and games of chance; rental of video game consoles.

(260) AM 2023 121798 A

(800) 1715103

(151) 2022 12 19

(891) 2022 12 19

(731) SHANDONG HUASHENG RUBBER CO., LTD.

Daozhuang Town, Guangrao County, Dongying City, 257300 Shandong Province, China

(540)



(591) Black, white

(531) 03.01.04; 03.01.24; 03.01.25; 03.01.26

(511)

12 – Tubeless tires for bicycles; inner tubes for pneumatic tires; pneumatic tires; airplane tires; treads for retreading tires; solid tires for vehicle wheels; automobile tires; tires for vehicle wheels; bicycle tires; casings for pneumatic tires.

(260) AM 2023 121800 A

(800) 1715123

(151) 2022 11 22

(891) 2022 11 22

(731) GUANGDONG MANCANDO INFORMATION TECHNOLOGY CO., LTD.

Floor 22 (Whole Floor), Vanke Sanyuanli Center, No. 31, Airport Road, Baiyun District, Guangzhou City, 510080 Guangdong Province, China

(540)

BAOBO

(591) Black, white

(531) 27.05.01; 27.05.17

(511)

12 – Traction pads for vehicle tires; inflatable inner tubes for wheels; inner tubes (automobile tires); tire repair patches; anti-skid spikes for vehicle tires; repair outfits for inner tubes; tires for vehicle wheels; casings for pneumatic tires; treads for retreading tires; tire mousse inserts.

(260) AM 2023 121801 A

(800) 1715163

(151) 2022 11 29

(891) 2022 11 29

(731) SHANGHAI NAR INDUSTRIAL CO., LTD.

No. 26, Xinhua Road, Xinchang Town, Pudong New District, 201214 Shanghai, China

(540)

NAR

(591) Black, white

(531) 25.03.01; 27.05.01; 27.05.09; 27.05.24

(511)

17 – Plastic film, other than for wrapping; anti-dazzle films for windows [tinted films]; asbestos cloth; adhesive tapes, other than stationery and not for medical or household purposes; plastic fibers, other than for textile use; viscose sheets, other than for wrapping.

(260) AM 2023 121827 A

(800) 1715674

(151) 2022 11 22

(891) 2022 11 22

(731) Aktsionernoe Obshchestvo "Nizhegorodsky

khimiko-farmatsevtichesky zavod"
Salganskaya St., 7, Nizhny Novgorod,
RU-603105 Nizhegorodskaya obl.,
Russian Federation

(540)

REPRODOZ

(591) Black, white

(511)

5 – Pharmaceuticals, medical and veterinary preparations; sanitary preparations for medical purposes; dietetic food and substances adapted for medical or veterinary use, food for babies; dietary supplements for human beings and animals; nutritional supplements; plasters, materials for dressings; material for dental fillings and dental impressions; disinfectants; preparations for destroying noxious animals; fungicides, herbicides; acaricides; aconitine; alkaloids for medical purposes; alginates for pharmaceutical purposes; algicides; aldehydes for pharmaceutical purposes; dental amalgams of gold; dental amalgams; amino acids for veterinary purposes; amino acids for medical purposes; analgesics; anaesthetics; antibiotics; antiseptics;

medicine cases, portable, filled; first-aid boxes, filled; aluminium acetate for pharmaceutical purposes; acetates for pharmaceutical purposes; germicides; oxygen cylinders, filled, for medical purposes; balms for medical purposes; bandages for dressings; diagnostic biomarker reagents for medical purposes; biocides; bracelets impregnated with insect repellent; bromine for pharmaceutical purposes; paper for mustard plasters; fly catching paper; reagent paper for veterinary purposes; reagent paper for medical purposes; moth-proofing paper; petroleum jelly for medical purposes; vaccines; oxygen baths; antiseptic cotton; aseptic cotton; absorbent cotton; wadding for medical purposes; cotton for medical purposes; dietetic substances adapted for medical use; radiological contrast substances for medical purposes; nutritive substances for microorganisms; radioactive substances for medical purposes; bismuth subnitrate for pharmaceutical purposes; melissa water for pharmaceutical purposes; seawater for medicinal bathing; mineral waters for medical purposes; thermal water; dietary fibre; moulding wax for dentists; gases for medical purposes; guaiacol for pharmaceutical purposes; massage gels for medical purposes; sexual stimulant gels; haematogen; haemoglobin; hydrastine; hydrastinine; glycerine for medical purposes; glycerophosphates; glucose for medical purposes; gentian for pharmaceutical purposes; hormones for medical purposes; mustard for pharmaceutical purposes; mustard plasters; mud for baths; medicinal mud; contraceptive sponges; gamboge for medical purposes; gurgun balsam for medical purposes; deodorizers for litter trays; air deodorizing preparations; deodorants, other than for human beings or for animals; deodorants for clothing and textiles; diastase for medical purposes; digitalin; vitamin supplement patches; mineral dietary supplements; dietary supplements; albumin dietary supplements; yeast dietary supplements; alginate dietary supplements; glucose dietary supplements; casein dietary supplements; lecithin dietary supplements; linseed oil dietary supplements; propolis dietary supplements; protein dietary supplements; protein supplements for animals; royal jelly dietary supplements; pollen dietary supplements; wheat germ dietary supplements; linseed dietary supplements; acai powder dietary supplements; dietary supplements with a cosmetic effect; enzyme dietary supplements; yeast for pharmaceutical purposes; gelatine for medical purposes; cod liver oil; isotopes for medical purposes; immunostimulants; insecticides; iodine for pharmaceutical purposes; iodides for pharmaceutical purposes; alkaline iodides for pharmaceutical purposes; iodoform; calomel [fungicide]; cream of tartar for pharmaceutical purposes; tartar for pharmaceutical purposes; camphor for medical purposes; capsules for medicines; cachets for pharmaceutical purposes; capsules made of dendrimer-based polymers, for pharmaceuticals; haemostatic pencils; wart pencils; caustic pencils; carbolineum [parasiticide]; caustics for pharmaceutical purposes; cachou for pharma-

ceutical purposes; quassia for medical purposes; quibracho for medical purposes; oxygen for medical purposes; gallic acid for pharmaceutical purposes; acids for pharmaceutical purposes; adhesives for dentures; surgical glues; stem cells for veterinary purposes; stem cells for medical purposes; cocaine for medical purposes; collagen for medical purposes; colloidion for pharmaceutical purposes; corn rings for the feet; cannabis for medical purposes; medicated sweets; angostura bark for medical purposes; barks for pharmaceutical purposes; cedar wood for use as an insect repellent; condurango bark for medical purposes; croton bark; mangrove bark for pharmaceutical purposes; myrobalan bark for pharmaceutical purposes; quinquina for medical purposes; medicated animal feed; medicinal roots; rhubarb roots for pharmaceutical purposes; lint for medical purposes; starch for dietetic or pharmaceutical purposes; creosote for pharmaceutical purposes; blood for medical purposes; biological tissue cultures for veterinary purposes; biological tissue cultures for medical purposes; cultures of microorganisms for medical or veterinary use; curare; dental lacquer; liquorice for pharmaceutical purposes; milk sugar for pharmaceutical purposes; adhesive plasters; medicines for alleviating constipation; adhesive tapes for medical purposes; lecithin for medical purposes; lotions for veterinary purposes; medicated hair lotions; lotions for pharmaceutical purposes; medicated after-shave lotions; personal sexual lubricants; lupulin for pharmaceutical purposes; magnesia for pharmaceutical purposes; liniments; ointments for pharmaceutical purposes; sunburn ointments; mercurial ointments; frostbite salve for pharmaceutical purposes; gauze for dressings; medicinal oils; mustard oil for medical purposes; camphor oil for medical purposes; castor oil for medical purposes; oil of turpentine for pharmaceutical purposes; dill oil for medical purposes; dental mastics; dental abrasives; dressings, medical; surgical dressings; drugs for medical purposes; medicines for veterinary purposes; serotherapeutic medicines; medicines for human purposes; medicines for dental purposes; menthol; medicinal drinks; moleskin for medical purposes; almond milk for pharmaceutical purposes; powdered milk for babies; royal jelly for pharmaceutical purposes; milk ferments for pharmaceutical purposes; Irish moss for medical purposes; flour for pharmaceutical purposes; linseed meal for pharmaceutical purposes; fish meal for pharmaceutical purposes; fly glue; antibacterial soap; disinfectant soap; medicated soap; freeze-dried meat adapted for medical purposes; mint for pharmaceutical purposes; dietetic beverages adapted for medical purposes; malted milk beverages for medical purposes; injectable dermal fillers; bone void fillers comprised of living tissues; narcotics; medicinal infusions; tincture of iodine; eucalyptol for pharmaceutical purposes; tinctures for medical purposes; opium; opodeldoc; decoctions for pharmaceutical purposes; antiparasitic collars for animals; cotton swabs for me-

dical purposes; cotton wool swabs for medical purposes; stick liquorice for pharmaceutical purposes; sulfur sticks [disinfectants]; pastilles for pharmaceutical purposes; medicated toothpaste; pectin for pharmaceutical purposes; pepsins for pharmaceutical purposes; peptones for pharmaceutical purposes; hydrogen peroxide for medical purposes; pesticides; leeches for medical purposes; blood plasma; nicotine patches for use as aids to stop smoking; eyepatches for medical purposes; poultices; compresses; scapulars for surgical purposes; babies' diapers; diapers for pets; swim diapers, reusable, for babies; swim diapers, disposable, for babies; diapers for incontinence; diaper changing mats, disposable, for babies; bunion pads; breast-nursing pads; pomades for medical purposes; powder of cantharides; pyrethrum powder; anti-uric preparations; bacterial preparations for medical and veterinary use; bacteriological preparations for medical and veterinary use; balsamic preparations for medical purposes; albuminous preparations for medical purposes; biological preparations for veterinary purposes; biological preparations for medical purposes; bismuth preparations for pharmaceutical purposes; vitamin preparations; diagnostic preparations for veterinary purposes; diagnostic preparations for medical purposes; douching preparations for medical purposes; bath preparations for medical purposes; therapeutic preparations for the bath; haemorrhoid preparations; preparations for callouses; lice treatment preparations [pediculicides]; acne treatment preparations; preparations to facilitate teething; preparations for the treatment of burns; fumigation preparations for medical purposes; ootherapy preparations; air purifying preparations; bronchodilating preparations; preparations for reducing sexual activity; sterilizing preparations; soil-sterilizing preparations; corn remedies; pharmaceutical preparations for treating dandruff; vermin destroying preparations; herbicides; preparations for destroying dry rot fungus; larvae exterminating preparations; fly destroying preparations; preparations for destroying mice; slug exterminating preparations; pharmaceutical preparations for skin care; contact lens cleaning preparations; preparations of microorganisms for medical or veterinary use; lime-based pharmaceutical preparations; styptic preparations; medicated eye-washes; medicinal hair growth preparations; nutraceutical preparations for therapeutic or medical purposes; opiates; anticryptogamic preparations; aloe vera preparations for pharmaceutical purposes; preparations of trace elements for human and animal use; sulfonamides [medicines]; pharmaceutical preparations for treating sunburn; enzyme preparations for veterinary purposes; enzyme preparations for medical purposes; phytotherapy preparations for medical purposes; chemico-pharmaceutical preparations; chemical preparations for veterinary purposes; chemical preparations for the diagnosis of pregnancy; chemical preparations for medical purposes; chemical preparations for treating diseases affecting cereal plants;

chemical preparations for treating wheat blight; chemical preparations for treating diseases affecting vine plants; chemical preparations for treating mildew; chemical preparations for treating phyloxera; chemical preparations for pharmaceutical purposes; chilblain preparations; mothproofing preparations; collyrium; lead water; chemical conductors for electrocardiograph electrodes; albuminous foodstuffs for medical purposes; dietetic foods adapted for medical purposes; by-products of the processing of cereals for dietetic or medical purposes; homogenized food adapted for medical purposes; freeze-dried food adapted for medical purposes; pharmaceuticals; sanitary towels; panty liners [sanitary]; propolis for pharmaceutical purposes; pearl powder for medical purposes; radium for medical purposes; hydrated chloral for pharmaceutical purposes; solvents for removing adhesive plasters; vaginal washes for medical purposes; solutions for contact lenses; chemical reagents for medical or veterinary purposes; gum for medical purposes; rubber for dental purposes; chewing gum for medical purposes; nicotine gum for use as an aid to stop smoking; insect repellents; insect repellent incense; repellents for dogs; tissues impregnated with pharmaceutical lotions; sarsaparilla for medical purposes; sugar for medical purposes; crystallized rock sugar for medical purposes; asthmatic tea; fumigating sticks; massage candles for therapeutic purposes; linseed for pharmaceutical purposes; tobacco-free cigarettes for medical purposes; siccatives [drying agents] for medical purposes; syrups for pharmaceutical purposes; turpentine for pharmaceutical purposes; milking grease; greases for veterinary purposes; greases for medical purposes; lacteal flour for babies; infant formula; soporifics; bicarbonate of soda for pharmaceutical purposes; bath salts for medical purposes; salts for mineral water baths; salts for medical purposes; potassium salts for medical purposes; sodium salts for medical purposes; smelling salts; mineral water salts; malt for pharmaceutical purposes; semen for artificial insemination; alcohol for pharmaceutical purposes; medicinal alcohol; alloys of precious metals for dental purposes; ergot for pharmaceutical purposes; cooling sprays for medical purposes; antibacterial handwashes; adjuvants for medical purposes; astringents for medical purposes; vermifuges; disinfectants for hygiene purposes; disinfectants for chemical toilets; appetite suppressants for medical purposes; medical preparations for slimming purposes; parasiticides; mouthwashes for medical purposes; medicated dentifrices; febrifuges; depuratives; animal washes [insecticides]; detergents for medical purposes; cattle washes [insecticides]; dog washes [insecticides]; insecticidal veterinary washes; vesicants; purgatives; remedies for perspiration; remedies for foot perspiration; chemical contraceptives; antiparasitic preparations; sedatives; laxatives; tonics [medicines]; medicated toiletry preparations; digestives for pharmaceutical purposes; nervines; bouillons for bacteriological cultures; ste-

roids; headache relief sticks; strychnine; suppositories; serums; tanning pills; appetite suppressant pills; slimming pills; jujube, medicated; antioxidant pills; sanitary tampons; vulnerary sponges; thymol for pharmaceutical purposes; smoking herbs for medical purposes; medicinal herbs; transplants [living tissues]; surgical implants comprised of living tissues; pants, absorbent, for incontinence; sanitary panties; babies' diaper-pants; charcoal for pharmaceutical purposes; fennel for medical purposes; porcelain for dental prostheses; phenol for pharmaceutical purposes; enzymes for veterinary purposes; enzymes for medical purposes; ferments for pharmaceutical purposes; formic aldehyde for pharmaceutical purposes; phosphates for pharmaceutical purposes; quinine for medical purposes; chinoline for medical purposes; diabetic bread adapted for medical use; chloroform; flowers of sulfur for pharmaceutical purposes; cement for animal hooves; bone cement for surgical and orthopaedic purposes; dental cements; medicinal tea; herbal teas for medicinal purposes; insecticidal animal shampoos; medicated shampoos; medicated shampoos for pets; pediculicidal shampoos; medicated dry shampoos; pre-filled syringes for medical purposes; eucalyptus for pharmaceutical purposes; herbal extracts for medical purposes; plant extracts for pharmaceutical purposes; tobacco extracts [insecticides]; extracts of hops for pharmaceutical purposes; elixirs [pharmaceutical preparations]; ethers for pharmaceutical purposes; esters for pharmaceutical purposes; cellulose esters for pharmaceutical purposes; cellulose ethers for pharmaceutical purposes; rat poison; poisons; bacterial poisons; jalap; angioprotectors; antiplatelet agents; anticoagulants; anti-inflammatory preparations; anti-thrombotic agents; decongestants; pharmaceutical preparations for the treatment of nervous system diseases; pharmaceutical preparations for the treatment of articular-ligamentous disorders; pharmaceutical preparations for the treatment of musculoskeletal disorders; pharmaceutical preparations for the treatment of various diseases; pharmaceutical preparations for treating injuries; pharmaceuticals for the treatment of thrombophlebitis; anti-itch pharmaceutical preparations; venotonic pharmaceuticals; pharmaceutical preparations for the treatment of venous system diseases; pharmaceutical preparations for the treatment of lymphatic system diseases; pharmaceutical preparations for the treatment of rheumatic lesion; pharmaceutical preparations for treatment and prevention of vaginal infections; pharmaceutical preparations for normalization of vaginal flora; preparations for normalization of vaginal pH; pharmaceutical preparations for treatment of bacterial infections; preparations for relief of menopause symptoms; fertility enhancement preparations.

(260) AM 2023 121828 A

(800) 1715700

(151) 2022 12 16

(891) 2022 12 16

(731) Philip Morris Products S.A.

Quai Jeanrenaud 3, CH-2000 Neuchâtel,
Switzerland

(540)



(591) Black, white

(531) 01.15.15; 27.05.24

(511)

34 – Wired vaporizers for electronic cigarettes and electronic smoking devices; tobacco, raw or manufactured; tobacco products, including cigars, cigarettes, cigarillos, tobacco for roll-your-own cigarettes, pipe tobacco, chewing tobacco, snuff tobacco, kretek; snus; tobacco substitutes (not for medical purposes); smokers' articles, namely cigarette paper and tubes, cigarette filters, tobacco tins, cigarette cases and ashtrays, pipes, pocket apparatus for rolling cigarettes, lighters; matches; tobacco sticks, tobacco products for the purpose of being heated, electronic devices and their parts for the purpose of heating cigarettes or tobacco in order to release nicotine-containing aerosols for inhalation; liquid nicotine solutions for use in electronic cigarettes; electronic smoking devices; electronic cigarettes; electronic cigarettes as substitutes for traditional cigarettes; electronic devices for the inhalation of nicotine-containing aerosols; oral vaporizing devices for smokers, tobacco products and tobacco substitutes; smokers' articles for electronic cigarettes; parts and fittings for the aforesaid products included in this class; devices for extinguishing heated cigarettes and cigars as well as heated tobacco sticks; electronic rechargeable cigarette cases.

(260) AM 2023 121829 A

(800) 1715701

(151) 2022 12 19

(891) 2022 12 19

(731) Philip Morris Products S.A.

Quai Jeanrenaud 3, CH-2000 Neuchâtel,
Switzerland

(540)



(591) Black, white
 (531) 26.01.05; 27.05.24
 (511)

34 – Wired vaporizers for electronic cigarettes and electronic smoking devices; tobacco, raw or manufactured; tobacco products, including cigars, cigarettes, cigarillos, tobacco for roll-your-own cigarettes, pipe tobacco, chewing tobacco, snuff tobacco, kretek; snus; tobacco substitutes (not for medical purposes); smokers' articles, namely cigarette paper and tubes, cigarette filters, tobacco tins, cigarette cases and ashtrays, pipes, pocket apparatus for rolling cigarettes, lighters; matches; tobacco sticks, tobacco products for the purpose of being heated, electronic devices and their parts for the purpose of heating cigarettes or tobacco in order to release nicotine-containing aerosols for inhalation; liquid nicotine solutions for use in electronic cigarettes; electronic smoking devices; electronic cigarettes; electronic cigarettes as substitutes for traditional cigarettes; electronic devices for the inhalation of nicotine-containing aerosols; oral vaporizing devices for smokers, tobacco products and tobacco substitutes; smokers' articles for electronic cigarettes; parts and fittings for the aforesaid products included in this class; devices for extinguishing heated cigarettes and cigars as well as heated tobacco sticks; electronic rechargeable cigarette cases.

(260) AM 2023 121830 A
 (800) 1715702
 (151) 2022 12 16
 (891) 2022 12 16
 (731) Philip Morris Products S.A.
 Quai Jeanrenaud 3, CH-2000 Neuchâtel,
 Switzerland
 (540)



(591) Black, white
 (531) 01.15.15; 27.05.24

(511)
 34 – Wired vaporizers for electronic cigarettes and electronic smoking devices; tobacco, raw or manufactured; tobacco products, including cigars, cigarettes, cigarillos, tobacco for roll-your-own cigarettes, pipe tobacco, chewing tobacco, snuff tobacco, kretek; snus; tobacco substitutes (not for medical purposes); smokers' articles, namely cigarette paper and tubes, cigarette filters, tobacco tins, cigarette cases and ashtrays, pipes, pocket apparatus for rolling cigarettes, lighters; matches; tobacco sticks, tobacco products for the purpose of being heated, electronic devices and

their parts for the purpose of heating cigarettes or tobacco in order to release nicotine-containing aerosols for inhalation; liquid nicotine solutions for use in electronic cigarettes; electronic smoking devices; electronic cigarettes; electronic cigarettes as substitutes for traditional cigarettes; electronic devices for the inhalation of nicotine-containing aerosols; oral vaporizing devices for smokers, tobacco products and tobacco substitutes; smokers' articles for electronic cigarettes; parts and fittings for the aforesaid products included in this class; devices for extinguishing heated cigarettes and cigars as well as heated tobacco sticks; electronic rechargeable cigarette cases.

(260) AM 2023 121831 A
 (800) 790321
 (151) 2002 09 05
 (891) 2022 11 17
 (731) Kleyn Group B.V.
 Industrieweg 2, NL-4214 KZ VUREN,
 Netherlands
 (540)

KLEYN

(591) Black, white
 (511)
 35 – Business intermediary services in the purchase and sale of vehicles, in particular trucks.

(260) AM 2023 121832 A
 (800) 883762
 (151) 2006 03 23
 (891) 2023 02 08
 (731) Ferrara Candy Company
 404 W. Harrison Street, Chicago IL 60607,
 USA
 (540)

RED HOTS

(591) Black, white
 (511)
 30 – Candy.

(260) AM 2023 121833 A
 (800) 884473
 (151) 2006 03 16
 (891) 2023 02 08
 (731) Ferrara Candy Company
 404 W. Harrison Street, Chicago IL 60607,
 USA
 (540)

LEMONHEAD

(591) Black, white

(511)
30 – Candy namely, lemon drops.

(260) AM 2023 121834 A
(800) 894001
(151) 2006 03 15
(891) 2023 02 07
(731) Obchtchestvo s ogranichennoi
otvetstvennostiu "AQUILEJA"
vlad. 9/14, ul. Frunze, g. Stupino, RU-142800
Moskovskaia oblast, Russian Federation

(540)
ЧИСТИН

(591) Black, white
(511)
3 – Cleaning preparations.

(260) AM 2023 121835 A
(800) 1105866
(151) 2011 12 21
(891) 2023 02 08
(731) Ferrara Candy Company
404 W. Harrison Street, Chicago IL 60607,
USA

(540)
LAFFY TAFFY

(591) Black, white
(511)
30 – Coffee, coffee-based preparations and beverages;
iced coffee; tea, preparations and beverages made
with tea; iced tea; malt-based preparations for human
consumption; cocoa and cocoa-based preparations and
beverages; chocolate, chocolate goods, chocolate-
based preparations and beverages; confectionery,
sugar confectionery, candy; sugar; chewing gum not
for medical use; baked goods, bread, pastries; biscuits,
cakes, cookies, wafers, caramels; ice cream, water
ices, sherbets, iced confectionery, frozen cakes, ice
desserts, frozen yoghurts; breakfast cereals, muesli,
corn flakes, cereal bars, ready-to-eat cereals; cereal
preparations; pizzas; sandwiches; pastry preparations
and ready-to-bake cake doughs.

(260) AM 2023 121836 A
(800) 1106838
(151) 2011 12 30
(891) 2023 02 08
(731) Ferrara Candy Company
404 W. Harrison Street, Chicago IL 60607,
USA

(540)
NERDS

(591) Black, white

(511)
30 – Coffee, coffee-based preparations and beverages;
iced coffee; tea, tea-based preparations and beverages;
iced tea; malt-based preparations for human consump-
tion; cocoa and cocoa-based preparations and beve-
rages; chocolate, chocolate products, chocolate-based
preparations and beverages; confectionery, sweet-
meats, candy; sugar; chewing gum, not for medical
purposes; bakery goods, bread, pastries; biscuits, ca-
kes, cookies, wafers, caramels; ice cream, water-based
ices, sherbets, iced confectionery, ice-cream cakes, ice
desserts, frozen yogurts; breakfast cereals, muesli,
corn flakes, cereal bars, ready-to-eat cereals; cereal
preparations; pizzas; sandwiches; oven-ready prepara-
tions of farinaceous paste and cake pastry.

(260) AM 2023 121879 A
(800) 1716233
(151) 2022 09 13
(891) 2022 09 13
(731) Nub Technologies Ltd
2nd Floor, Crown House, 37 High Street,
East Grinstead, West Sussex RH19 3AF,
United Kingdom

(540)
NUB

(591) Black, white
(511)
1 – Industrial chemicals, including for the cosmetolo-
gical industry, the human, dietetic and animal food
industry, the pharmaceutical industry; concentrated
soy protein used in the manufacture of food products
and dietary supplements; starch substances (natural
and/or modified), starch for the food industry; starch
for use in the manufacture of beverages; starch for use
in the manufacture of food supplements; starch for the
feed industry; starch for use in the manufacture of pet
food; starch for the cosmetic industry; starch for use
in the manufacture of cosmetic products and deri-
vatives for industrial use; flours, pectins, dextrose,
dextrins, proteins, cellulosic materials, glucose, glu-
cose syrups for industrial purposes, maltodextrins,
sugars and derivatives, polyols and derivatives, or-
ganic acids, their salts, and derivatives, dextrins, cyc-
lodextrins, proteins, cellulose substances, gluten, mal-
todextrins, polyols and derivatives, hydrogenated
saccharides, hydrogenated glucose syrups, glucose
polymers, artificial sweeteners, organic acids, their
salts and derivatives, enzymes.

29 – Processed legumes; preserved, prepared and
cooked legumes; milk and milk beverages and pro-
ducts including cheese, butter, yoghurt, buttercream;
vegetable-based cream; cream [dairy products]; plant-
based cream; artificial cream [dairy products sub-
stitutes]; cheese specialties; vegetable-based spreads;
whipped cream; vegetable fat spreads; creamers for
beverages; milk substitutes; dairy products; dairy sub-

stitutes; fruit spreads; jams; jellies; compotes; fruit-based meal replacement bars; fruit-based snack foods; fruit-based snack bars; crystallized fruits; fruit paste; milk predominating-based beverages contain fruit juice; plant-based dessert; vegetable-based desserts; pulse-based dessert; vegetable-based snack food; plant-based snack food; pulse-based snack food; vegetable-based food bars; plant-based food bars; pulse-based food bars; pulse-based beverages; vegetable spreads; plant spreads; plant-based spreads; pulse spreads; pulse-based spread; vegetable-based meal replacement bars; plant-based meal replacement bars; pulse-based meal replacement bars; prepared meals consisting primarily of vegetables; prepared meals consisting primarily of plants; prepared meals consisting primarily of pulses; frozen meals consisting primarily of vegetables; frozen meals consisting primarily of plants; frozen meals consisting primarily of pulse; meat substitute; vegetable-based meat substitute; plant-based meat substitute; pulse-based meat substitute; prepared vegetables; prepared plants for food; prepared pulse; prepared plants not included in other classes; processed vegetables; processed plants for food; processed pulse; processed plants not included in other classes; soups; preparations for making soups; charcuterie; processed meat; processed meat product; processed poultry; processed poultry products; processed fish; processed fish products; processed sea food; processed sea food products; processed egg; processed egg products; spreads consisting mainly of eggs; nuggets; prepared fish; prepared meat; prepared poultry; prepared egg; prepared meals consisting primarily of meat; prepared meals consisting primarily of poultry; prepared meals consisting primarily of fish; prepared meals consisting primarily of seafood; frozen prepared meal consisting primarily of meat; frozen prepared meal consisting primarily of poultry; frozen prepared meal consisting primarily of fish; frozen prepared meal consisting primarily of seafood; food made of processed plants; food made of prepared plants; prepared meals containing [principally] eggs; frozen prepared meals containing [principally] eggs; eggs.

(260) AM 2023 121886 A

(800) 1716641

(151) 2023 01 13

(891) 2023 01 13

(731) TERRAVITA Spółka z o.o.

ul.Szarych Szeregów 48, PL-60-462 Poznań,
Poland

(540)

cocoacara

(591) Black, white

(511)

30 – Chocolate, sweets, candies, pralines, confectionery, chocolate-based spreads, chocolate spreads

containing nuts, chocolate mousses, confectionery for decorating christmas trees.

(260) AM 2023 121887 A

(800) 1716646

(151) 2023 01 17

(891) 2023 01 17

(731) Limited Liability Company "SLADKIJ ORESHEK"

d. Melechkino, stroenie 123, g. Solnechnogorsk,
RU-141554 Moskovskaya oblast, Russian
Federation

(540)

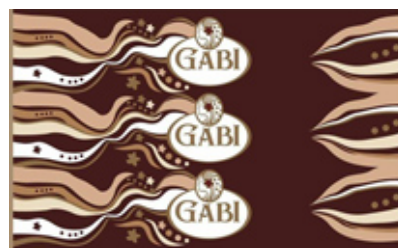

(591) Dark brown, brown, light brown, beige and white

(531) 02.03.01; 26.01.02; 26.11.03; 26.11.13;
27.05.01; 29.01.13

(511)

30 – Vanilla flavourings for culinary purposes; flavourings, other than essential oils, for cakes; flavourings, other than essential oils, for beverages; coffee flavourings; food flavourings, other than essential oils; star aniseed; baozi; cereal bars; high-protein cereal bars; pancakes; savoury pancakes; noodle-based prepared meals; buns; bulgur; bread rolls; pains au chocolat; edible paper wafers; edible rice paper; edible paper; burritos; vanillin [vanilla substitute]; waffles; vermicelli; natural sweeteners; sausage binding materials; binding agents for ice cream; orange blossom water for culinary purposes; seawater for cooking; seaweed [condiment]; malt biscuits; cloves [spice]; mirror icing [mirror glaze]; cake frosting [icing]; glucose for culinary purposes; mustard; croûtons; buckwheat, processed; gluten additives for culinary purposes; yeast; thickening agents for cooking foodstuffs; leaven; rice-based snack food; cereal-based snack food; cocoa substitutes; coffee substitutes; vegetal preparations for use as coffee substitutes; dressings for salad; fruit jellies [confectionery]; candy decorations for cakes; confectionery in the form of mousses; confectionery for decorating Christmas trees; cakes; Danish pastries; pastries; peanut confectionery; almond confectionery; confectionery; fruit confectionery; pasta; ground ginger; frozen yogurt [confectionery ices]; cocoa; cream of tartar for culinary purposes; capers; coffee capsules, filled; caramels [sweets]; curry [spice]; ketchup [sauce]; quinoa, processed; quiches; gluten prepared as foodstuff; flour-based dumplings; sweets; liquorice [confectionery]; peppermint sweets; mints for breath freshening; liqueur

chocolates; dulce de leche; cinnamon [spice]; coffee; unroasted coffee; starch for food; crackers; rice crackers; custard; crème brûlée; croissants; hominy grits; semolina; oatmeal; crushed barley; groats for human food; ice cubes; corn, milled; corn, roasted; meat pies; fruit coulis [sauces]; turmeric; couscous; laksa; noodles; soba noodles; udon noodles; ice for refreshment; ice, natural or artificial; edible ices; ice pops; potato-based flatbreads; rice cakes; mayonnaise; macaroni; maltose; hominy; piccalilli; marinades; marzipan; honey; miso; royal jelly; ice cream; bean meal; buckwheat flour; tapioca flour; potato flour; corn flour; nut flours; flour; wheat flour; soya flour; barley meal; chocolate mousses; muesli; mint for confectionery; cocoa beverages with milk; coffee beverages with milk; coffee-based beverages; cocoa-based beverages; chamomile-based beverages; tea-based beverages; tea beverages with milk; chocolate beverages with milk; chocolate-based beverages; infusions, not medicinal; nougat; gnocchi; crushed oats; husked oats; kimchi pancakes; onigiri; nutmegs [spice]; chocolate-coated nuts; stick liquorice [confectionery]; ginger paste [seasoning]; lozenges [confectionery]; molasses for food; pâtés en croûte; pelmeni; pepper; allspice; peppers [seasonings]; pesto; biscuits; coconut macarons; petit-beurre biscuits; bibimbap [rice mixed with vegetables and beef]; pies; noodle-based prepared meals for toddlers; pizzas; meat gravies; spelt, processed; fondants [confectionery]; popcorn; powders for making ice cream; baking powder; mustard meal; pralines; aromatic preparations for food; condiments; meat tenderizers for culinary purposes; cereal preparations; oat-based food; propolis; profiteroles; gingerbread; spices; petits fours; rice pudding; puddings; cake powder; ravioli; ramen; chewing gum; chewing gum for breath freshening; relish [condiment]; rice; prepared rice rolled in seaweed; instant rice; wheat germ for human consumption; spring rolls; sago; sugar; crystallized rock sugar; palm sugar; sesame seeds [seasonings]; linseed for culinary purposes [seasoning]; processed seeds for use as a seasoning; processed squash seeds [seasonings]; aniseed; agave syrup [natural sweetener]; golden syrup; savoury pancake mixes; batter mixes; baking soda [bicarbonate of soda for cooking purposes]; crystallized lemon juice [seasoning]; malt for human consumption; salt for preserving foodstuffs; cooking salt; celery salt; sorbets [ices]; ham glaze; cranberry sauce [condiment]; soya sauce; tomato sauce; apple sauce [condiment]; sauces [condiments]; pasta sauce; spaghetti; seasonings; chocolate-based spreads; chocolate spreads containing nuts; preparations for stiffening whipped cream; shaved ice with sweetened red beans; rusks; breadcrumbs; sushi; sandwiches; tabbouleh; tacos; tamarind [condiment]; tapioca; tarts; dough; pastry dough; almond paste; rice pulp for culinary purposes; cake batter; tortillas; garden herbs, preserved [seasonings]; chocolate decorations for cakes; vinegar; beer vinegar; ferments for dough; halvah; harissa [condi-

ment]; bread; gluten-free bread; unleavened bread; chips [cereal products]; corn flakes; oat flakes; hot dog sandwiches; jiaozi; chicory [coffee substitute]; herbal teas; tea; kelp tea; iced tea; chutneys [condiments]; minced garlic [condiment]; cheeseburgers [sandwiches]; chocolate-covered potato chips; chowchow [condiment]; saffron [seasoning]; chocolate; malt extract for food; essences for foodstuffs, except etheric essences and essential oils; husked barley.

(260) AM 2023 121953 A

(800) 1717464

(151) 2022 11 16

(891) 2022 11 16

(731) HUGO BOSS Trade Mark Management GmbH
& Co. KG

Dieselstraße 12, 72555 Metzingen, Germany

(540)

HUGO RED

(591) Black, white

(511)

9 – Spectacles and parts therefor; spectacle cases; cell phone cases; laptop cases; smartwatches and software; mobile apps; wearable activity trackers; electronic pens; ear phones; alarm bells; films, downloadable image files; electronic magazines; downloadable music files; podcasts; usb web keys; communications headsets; microphones for communication devices; mobile data receivers; digital optical transmission apparatus; cd storage wallets; digital notepads; electronic memories; labels with integrated rfid chips; labels carrying magnetically recorded or encoded information; labels with machine-readable codes; cases for music storage devices; memory sticks; headsets for virtual reality games; electronic book reader covers; smart speakers; mp4 players; headphones; wireless headphones; in-ear headphones; headphones for smart phones; cases for headphones; noise cancelling headphones; wireless headsets for smartphones; telephone headsets; headphone- microphone combinations; loudspeakers; cabinets for loudspeakers; wireless speakers; portable speaker docks; downloadable virtual goods, namely, computer programs featuring clothing, footwear, headwear and clocks and watches, jewelry, eyewear, fashion accessories, cosmetics and perfumery, bags, handbags, purses, card wallets, backpacks, household articles, namely household containers, household textiles, household linen, household utensils and household fragrances, shoe polishing sets, wine openers and wine decanters, stationery, candles, luggage, toys, sport bags, art for use online and in online virtual worlds; gaming software.

14 – Precious metals and their alloys and goods of precious metals or coated therewith (included in this class), namely amulets (jewellery), ornaments (jewellery), charms for key rings, pins (jewellery), bracelets (jewellery), brooches (jewellery), cabochons, dia-

monds, precious stones, ivory (jewellery), jewellery findings, ornaments of jet, semi-precious stones, necklaces (jewellery), chains (jewellery), tie clips, tie pins, works of art of precious metal, beads for making jewellery, cuff links, lockets (jewellery), earrings, pearls (jewellery), platinum (metal), rings (jewellery), jewellery charms, ornamental pins, jewellery rolls, hat jewellery, clasps for jewellery, jewels, medaillons, stick pins, cloisonné jewellery; jewellery; clocks and watches; jewellery boxes and watch boxes; alarm clocks; cuff links.

18 – Leather and imitations of leather, and goods made of these materials (included in this class), namely brief bags, wallets, casings, of leather, for stationery, purses, card wallets [leatherware], garment bags for travel, vanity cases, not fitted, credit card cases [wallets], toiletry bags, cosmetic bags sold empty, straps (leather-), traveling sets, key bags, bags [envelopes, pouches] of leather, for packaging; trunks and travelling bags; bags; umbrellas and parasols; luggage, bags, wallets and other carriers, namely suitcases, rucksacks, backpacks; clothing for pets; collars for animals; dog collars; dog shoes; dog leashes; dog leads; dog parkas; dog clothing; dog apparel; dog coats; dog bellybands; raincoats for dogs; horse shoes; horse covers; horse blankets; horse cloths; horse collars; horse saddles; harness for horses; blinkers for horses; headbands for horses; rain sheets for horses; golf umbrellas; animal skins; hides; walking sticks; whips; harness and saddlery; attaché cases; feed bags; sport bags; leather shoulder belts; beach bags; card cases [notecases]; chain mesh purses; handbag frames; frames for umbrellas or parasols; handbags; suitcase handles; walking cane handles; haversacks; music cases; muzzles; purses; shopping bags; straps for skates; slings for carrying infants; umbrella rings; umbrella sticks; vanity cases, not fitted; walking stick seats; wheeled shopping bags; combination walking sticks and umbrellas; bags for umbrellas; covers for parasols; umbrella covers; beach umbrellas [beach parasols]; metal parts of umbrellas; suitcases; wheeled luggage; toiletry bags; travelling sets [leatherware]; tie cases for travel; cases of imitation leather; key cases made of leather; key cases; cosmetic purses; shaving bags sold empty; driving licence cases; tool pouches, sold empty; carry-on bags; travel luggage; boston bags; casual bags; bucket bags; shoulder bags; cross-body bags; children's shoulder bags; fashion handbags; drawstring bags; wheeled bags; flight bags; bags (game -) [hunting accessories]; bags for campers; hiking bags; work bags; wrist mounted carryall bags; saddlebags; evening handbags; travel baggage; travelling bags made of imitation leather; travel bags made of plastic materials; garment bags for travel made of leather; shoe bags for travel; garment carriers; canvas bags; diplomatic bags; leather bags and wallets; flexible bags for garments; waterproof bags; felt bags; briefcases [leather goods]; artificial fur bags; knitted bags, not of precious metals; bags for

sports clothing; wash bags for carrying toiletries; towelling bags; shoe bags; tool bags sold empty; small bags for men; hipsacks; purses made of precious metal; leather purses; handbags made of leather; handbags made of imitation leather; pouches [sold empty] for holding make-up, keys and other personal items; hat boxes for travel; hat boxes of leather; straps for luggage; straps for coin purses; business card holders in the form of wallets; coin holders; travel cases; luggage covers; bumbags; clutches [purses]; card wallets [leatherware]; nappy wallets; all-purpose athletic bags; kit bags; bags for climbers; travelling bags; purse frames; wheeled suitcases; valises; hand luggage; hiking rucksacks; sports packs; harness fittings; studs of leather; straps made of imitation leather; laces (leather-); leather, unworked or semi-worked; leather for harnesses; leather for shoes; imitation leather; moleskin [imitation of leather]; curried skins; polyurethane leather; fur; faux fur; semi-worked fur; leather cloth; articles of clothing for horses; saddle trees; saddlery; animal harnesses; reins; fastenings for saddles; saddle blankets; covers for animals; hunting crops; jockey sticks; spats and knee bandages for horses; leggings for animals; covers and wraps for animals; saddlecloths for horses.

25 – Clothing for men, women and children; stockings; headgear; underwear; nightwear; swimwear; bathrobes; belts; shawls; accessories, namely headscarves, neck scarves, shawls, dress handkerchiefs; ties; gloves; shoes; belts of leather.

35 – Business management, sales consultancy; wholesale and retail services in relation to clothing, footwear, headgear and clocks and watches, eyewear, jewelry, fashion accessories, cosmetics and perfumery, goods of leather, namely trunks and bags, purses, card wallets [leather ware], garment bags for travel, vanity cases, not fitted, toiletry bags, straps (leather), backpacks, key bags, satchels, gym bags, bags [envelopes, pouches] of leather, for packaging, umbrellas and parasols; wholesale and retail services in relation to bed linen, home textiles, household articles, namely household containers, household textiles, household linen, household utensils and household fragrances, shoe polishing sets, wine openers and wine decanters, stationery, luggage, sporting articles; marketing services; market research and market analysis; advertising; sales promotion; rental of advertising space; distribution of goods and advertising material for advertising purposes, including via electronic media and via the internet; presentation of goods, in particular shop and shop window dressing; organization of exhibitions for commercial or advertising purposes; promotion of business relationships by providing of commercial and business contacts; commercial information and advice for consumers [consumer advice shop]; business consultancy and administration; business organization consulting; professional business consulting; business consultancy relating to fashion;

organization of fashion shows for commercial, industrial and advertising purposes; management of retail stores, online wholesale and retail services and online ordering services, mail ordering services and computerized online- ordering services in relation to clothing, footwear, headgear and clocks and watches, eyewear, jewelry, fashion accessories, cosmetics and perfumery; management of retail stores, online wholesale and retail services and online ordering services, mail ordering services and computerized online- ordering services in relation to goods of leather, namely trunks and bags, purses, card wallets [leather ware], garment bags for travel, vanity cases, not fitted, toiletry bags, straps (leather), backpacks, key bags, satchels, gym bags, bags [envelopes, pouches] of leather, for packaging, umbrellas and parasols; management of retail stores, online wholesale and retail services and online ordering services, mail ordering services and computerized online- ordering services in relation to bed linen, home textiles, household articles, namely household containers, household textiles, household linen, household utensils and household fragrances, shoe polishing sets, wine openers and wine decanters, stationery, luggage, sporting articles.

(260) AM 2023 121961 A

(800) 1717633

(151) 2022 05 06

(891) 2022 05 06

(731) "Evromis" Obshchestvo s ogranichennoy Otvetstvennostyu
proyezd Metallurgov (L`vovskij Mkr.), dom
6V, gorod Podolsk, RU-142155 Moskovskaya
oblast, Russian Federation

(540)



(591) Red and white

(531) 26.04.07; 26.04.22; 27.05.01; 27.05.24;
29.01.12

(511)

11 – Refrigerating apparatus and machines; extractor hoods for kitchens; grills [cooking appliances]; lighters; taps; mixer faucets for water pipes; anti-splash tap nozzles; bath fittings; electric cooktops; kitchen ranges [ovens]; microwave ovens [cooking apparatus]; cookers; water filtering apparatus; cooking apparatus and installations; sanitary apparatus and installations; sinks; wash-hand basins [parts of sanitary installations]; cooking utensils, electric; filters for drinking water.

35 – Marketing; organization of exhibitions for commercial or advertising purposes; organization of trade fairs for commercial or advertising purposes; development of advertising concepts; presentation of goods on communication media, for retail purposes; sales promotion for others; publication of publicity texts;

distribution of samples; direct mail advertising; advertising; online advertising on a computer network; television advertising; procurement services for others [purchasing goods and services for other businesses].

(260) AM 2023 121962 A

(800) 1717645

(151) 2023 01 26

(891) 2023 01 26

(731) TOYOTA JIDOSHA KABUSHIKI KAISHA

(also trading as TOYOTA MOTOR
CORPORATION)

1, Toyota-cho, Toyota-shi, Aichi-ken 471-8571,
Japan

(540)

BZ1C

(591) Black, white

(511)

12 – Driving motors for land vehicles; engine mounts for land vehicles; engines for land vehicles; jet engines for land vehicles; motors for land vehicles; propulsion mechanisms for land vehicles; turbines for land vehicles; drive chains for land vehicles; connecting rods for land vehicles, other than parts of motors and engines; gear boxes for land vehicles; gearing for land vehicles; hydraulic circuits for automobiles; reduction gears for land vehicles; torque converters for land vehicles; transmission chains for land vehicles; transmission shafts for land vehicles; transmissions for land vehicles; power transmission belts for land vehicles; brake discs for land vehicles; brake linings for land vehicles; brake pads for automobiles; brake segments for land vehicles; brake shoes for land vehicles; brakes for land vehicles; brake systems for land vehicles; AC motors for land vehicles, not including their parts; DC motors for land vehicles not including their parts; motors, electric, for land vehicles; automobiles and structural parts thereof; buses; structural parts for buses; trucks; structural parts for trucks; dune buggies [vehicles]; vans [vehicles]; sports utility vehicles; coaches; electrically powered motor vehicles; electric cars; hybrid cars; electric tri-cycles; ambulances; racing cars; amphibious vehicles; snowmobiles; armored vehicles; fork lift trucks; camping cars; tractors; trailers; trolley buses; hearses; fuel cell cars; automobile bodies; automobile bonnets; automobile bumpers; automobile chassis; automobile dashboards; automobile doors; automobile door handles; automobile hoods; automobile horns; automobile seats; automobile seat covers; automobile sunroofs; automobile tires; automobile wheels; spokes for automobile wheels; inner tubes for automobile tires; automobile wheel rims; rearview mirrors for automobiles; automobile windows; automobile windscreens; automobile windshields; automobile convertible tops; safety belts for automobile seats; safety harnesses for automobile racing; safety harnesses for automobile seats; security harness for automobile seats; steering

wheels for automobiles; steering wheel covers for automobiles; air bags for automobiles, buses and trucks; seat belt pre-tensioners for automobiles; brake pedals for land vehicles; direction signals for automobiles; leather upholstery for automobile seats; leather upholstery for automobiles; cigar lighters for automobiles; shaped automobile covers; mudguards for automobiles; luggage carriers for automobiles; spare wheel holders for automobiles; automobile roof racks; headlight wipers; windscreen wipers; windscreen wiper blades; motor vehicle brake control systems for applying emergency braking at low vehicle speeds; electronic brake control apparatus for automobiles; two-wheeled motor vehicles; structural parts for two-wheeled motor vehicles; bicycles; structural parts for bicycles; motorcycles; structural parts for motorcycles.

(260) AM 2023 121981 A

(800) 1717964

(151) 2022 10 26

(891) 2022 10 26

(731) ÖNTAR TARIM ALETLERİ SANAYİ VE
TİCARET LİMİTED ŞİRKETİ
Büyükkayacıosb Mahallesi, 405 Nolu Sokak,
28 Selçuklu, Konya, Türkiye

(540)



(591) Blue and green.

(531) 05.03.14; 27.05.01; 27.05.08; 27.05.22;
29.01.12

(511)

7 – Machines, machine tools and industrial robots for processing and shaping wood, metals, glass, plastics and minerals; construction machines and robotic mechanisms (machines) for use in construction; lifting, loading and transmission machines and robotic mechanisms (machines) for lifting, loading and transmission purposes; machines and robotic mechanisms (machines) for use in agriculture and animal breeding, machines and robotic mechanisms (machines) for processing cereals, fruits, vegetables and food; engines and motors, other than for land vehicles, parts and fittings therefor; parts of land vehicle motors and engines, included in this class; bearings (parts of machines), roller or ball bearings; machines for mounting and detaching tires; alternators, current generators, electric generators, current generators operated with solar energy; painting machines, automatic spray guns for paint, electric, hydraulic and pneumatic punching machines and guns, electric adhesive tape dispensers (machines), electric guns for compressed gas or liquid spraying machines, electric hand drills, electric hand saws, electric jigsaw machines, spiral machines, compressed air machines, compressors (machines), vehicle washing installations, robotic mechanisms (machines)

with the abovementioned functions; electric and gas-operated welding apparatus, electric arc welding apparatus, electric soldering apparatus, electric arc cutting apparatus, electrodes for welding machines, industrial robots with the abovementioned functions; printing machines; packaging machines, filling, plugging and sealing machines, labellers (machines), sorting machines, industrial robots (machines) with the abovementioned functions, electric packing machines for plugging and sealing of plastics; machines for textile processing, sewing machines, industrial robots (machines) with the abovementioned functions; centrifugal pumps, lubricating pumps, pneumatic pumps, fuel dispensing pumps for service stations, self-regulating fuel pumps; electric kitchen machines for chopping, grinding, crushing, mixing and mincing foodstuff, washing machines, laundry washing machines, dishwashers, spin driers (not heated), electric cleaning machines for cleaning floors, carpets or floorings, vacuum cleaners and parts thereof; automatic vending machines; galvanizing and electroplating machines; electric door openers and closers; joints (parts of engines).

(260) AM 2023 121996 A

(800) 1540697

(151) 2020 05 26

(891) 2023 02 15

(731) ZHEJIANG GEELY HOLDING GROUP CO.,
LTD.

1760 Jiangling Road, Binjiang District,
Hangzhou, Zhejiang, China

(540)

MONJARO

(591) Black, white

(531) 27.05.01

(511)

12 – Electric vehicles; vehicles for locomotion by land, air, water or rail; gear boxes for land vehicles; propulsion mechanisms for land vehicles; motorcycles; automobiles; automobile chassis; tyres for vehicle wheels; brakes for vehicles; vehicle seats.

(260) AM 2023 122190 A

(800) 1593341

(151) 2020 11 26

(891) 2023 03 01

(731) Swarovski Aktiengesellschaft
Dröschstrasse 15, FL-9495 Triesen,
Liechtenstein

(540)



(591) Black, white
 (531) 03.07.06; 03.07.24; 26.05.01; 26.05.15
 (511)

3 – Non-medicated cosmetics and toiletry preparations; non-medicated dentifrices; perfumery, essential oils; bleaching preparations and other substances for laundry use; cleaning, polishing, scouring and abrasive preparations; fragrances; aromatic oils; soaps; bath gels and bath salts; make-up preparations; skin care preparations; hair care preparations; nail care preparations; temporary tattoo transfers, sprays and stencils; decorative transfers and skin jewels for cosmetic purposes; nail polish and paint; nail glitter; nail art stickers; lipstick holders and cases; compacts for cosmetics and make-up.

(260) AM 2023 122191 A
 (800) 1661071
 (151) 2022 04 02
 (891) 2023 02 07

(731) BELLES MARKS LTD
 Artemidos 3-5, ARTEMIDOS TOWER,
 1st floor, Flat/Office 101, CY-6020 Larnaca,
 Cyprus

(540)

ANTARKTYS

(591) Black, white
 (511)
 33 – Alcoholic beverages (except beer).

(260) AM 2023 122192 A
 (800) 1663885
 (151) 2022 05 10
 (891) 2023 03 06

(731) Balthazar Whisky Distillers Pty. Ltd.
 Level 7, 330 Collins Street, Melbourne VIC
 3000, Australia

(540)

Balthazar

(591) Black, white
 (511)
 33 – Whiskey.

(260) AM 2023 122193 A
 (800) 1667230
 (151) 2022 03 19
 (891) 2022 12 16

(731) Obshchestvo s ogranichennoy otvetstvennostyu
 "ZARYAD!"
 Bolshoi bulvar, 42, building 1, floor 4, room
 1575, workplace 5, territory of the innovation
 center "Skolkovo", Moscow, RU-121205,
 Russian Federation

(540)



(591) White and blue
 (531) 26.04.05; 26.04.22; 26.04.24; 28.05; 29.01.12
 (511)

7 – Vending machines; coin-operated vending machines; electric vending machines for telephone and smartphone batteries.

37 – Telephone and smartphone batteries charging services; recharging of batteries; recharging of batteries and accumulators; repair or maintenance of vending machines; computer and telephone battery recharge services; installation, maintenance and repair of batteries and accumulators; rental of telephone and smartphone battery chargers.

38 – Rental of telephones and smartphones; rental of telephone and smartphone accessories.

(260) AM 2023 122194 A
 (800) 1675282
 (151) 2022 03 09
 (891) 2023 01 30

(731) SHANGHAI JIDU AUTOMOBILE CO., LTD.
 Building 2, No. 1688 Yecheng Road, Jiading
 District, Shanghai, China

(540)

极度

(591) Black, white
 (531) 28.03
 (511)

12 – Repair outfits for inner tubes; brakes for vehicles; tyres for vehicle wheels; remote control vehicles, other than toys; vehicles for locomotion by land, air, water or rail; sleighs [vehicles]; pushchairs; driverless cars [autonomous cars]; robotic cars; civilian drones; cars; bicycles; pumps for bicycle tyres; boats.

(260) AM 2023 122195 A
 (800) 1709566
 (151) 2022 11 30
 (891) 2023 02 07

(731) FIDIA FARMACEUTICI S.p.A.
 Via Ponte della Fabbrica, 3/A, I-35031
 ABANO TERME (PD), Italy

(540)

HYAL-SYSTEM

(591) Black, white

(511)

3 – Non-medicated cosmetics and toiletry preparations; non-medicated dentifrices; perfumery, essential oils; beauty care preparations; beauty care cosmetics.

5 – Pharmaceutical preparations; medical and veterinary preparations; sanitary preparations for medical purposes; dietetic food and substances adapted for medical or veterinary use; dietary supplements for human beings and animals; plasters, materials for dressings; disinfectants; injectable dermal fillers; pre-filled syringes for medical purposes; medicinal preparations and substances.

(260) AM 2023 122243 A

(800) 1721184

(151) 2021 12 03

(891) 2021 12 03

(731) NETAŞ MADENCİLİK NAKLIYE İNŞAAT

SAN. VE TİC. LTD. ŞTİ.

BOLAMAN MH. YENİ PAZAR MEVKİİ,

ILICA YOLU ÜZERİ, No:93 – 90 FATSA,

ORDU, Türkiye

(540)



(591) Black and red

(531) 02.09.01; 27.05.07; 27.05.10; 29.01.12

(511)

31 – Agricultural and horticultural products not included in other classes, seeds; forestry products not included in other classes; live animals; fertilized eggs for hatching; plants; dried plants for decoration; fresh garden herbs; dried garden herbs decoration (term considered linguistically incorrect by the International Bureau – Rule 13 (2) (b) of the Regulations); animal foodstuffs; malt not for human consumption; underlays for pets (term considered too vague by the International Bureau – Rule 13 (2) (b) of the Regulations); cat litters.

(260) AM 2023 122245 A

(800) 1721213

(151) 2023 02 13

(891) 2023 02 13

(731) Alpen Pharma AG

Finkenhubelweg 16, CH-3012 Bern,

Switzerland

(540)

COMPLEX G

(591) Black, white

(511)

5 – Food supplements for human consumption.

(260) AM 2023 122255 A

(800) 1721913

(151) 2023 02 01

(891) 2023 02 01

(731) STADA Arzneimittel AG

Stadastraße 2 – 18, 61118 Bad Vilbel, Germany

(540)

Coldrex Колдрекс День Ночь

(591) Black, white

(531) 28.05

(511)

5 – Pharmaceutical, veterinary and sanitary preparations; pharmaceutical preparations for cold, flu, cough and sore throat treatment; analgesics; dietetic substances for medical use, food for babies; plasters, materials for dressings; material for stopping teeth, dental wax; disinfectants, preparations for destroying vermin; fungicides, herbicides.

(260) AM 2023 122259 A

(800) 1722144

(151) 2023 02 09

(891) 2023 02 09

(731) SPARTA Holdings, LLC

14-34 110th Street, Suite 303-Room 100,

College Point NY 11356, USA

(540)



(591) Black, white

(531) 02.09.01; 03.09.01; 03.09.24

(511)

35 – Online retail store services for consumer goods of others relating to: clothing, jewelry, candles, scented candles, fragranced candles, nightlights, Christmas tree candles, candles (Christmas tree -), fridge magnets, magnets, coasters of paper, bookmarks, leather bookmarks, decals, wall decals, throw pillows, wall decorations of wood, wall decorations of wax, picture frames, tumblers, tumblers for use as drinking, glasses, shot glasses, wine glasses, glasses, bottles, glass bottles, bottles (refrigerating -), water bottles, drinking bottles, reusable bottles, biobased bottles, biodegradable bottles, decorative sand bottles, ceramic mugs, mugs made of ceramic materials, mugs, glass mugs, coffee mugs, porcelain mugs, cups and mugs, mugs of porcelain, mugs made of porcelain, drinking mugs made of porcelain, bowls, soup bowls, candle holders, wall decorations of porcelain, coffee cups, coasters (tableware), porcelain coasters, leather coasters, coasters, not of paper and other than table linen, coasters other than of paper or of table linen, coasters, not of paper or textile, woollen blankets, silk blankets, bed blankets, blankets (bed -), cot blankets,

woolen blankets, sofa blankets, swaddling blankets, baby blankets, cotton blankets, children's blankets, silk bed blankets, wall decorations of textile, textile coasters, cloth coasters, coasters, coasters of textile, drink coasters of table linen, wallpaper in the nature of room size decorative adhesive wall coverings, decorative wall hangings, not of textile, candle holders for Christmas trees, souvenir collector spoons, posters, stickers, decals, wall decals, postcards, postcards and picture postcards, picture postcards, pencils, pens, journals, photo albums, photograph albums, photographic albums, mini photo albums, photo albums and collectors' albums, souvenir plates, plates, cake plates, imitation leather key chains, metal key chains, paper plates, decorative plates, dishes, plates; retail services in relation to car accessories, stationery; retail services relating to home textiles; retail services relating to kitchen knives; retail services in relation to kitchen appliances; retail services connected with stationery; retail services in relation to stationery supplies, religious artifacts.

INTERNATIONAL TRADEMARKS PROTECTED IN GEORGIA

(260) AM 2023 118359 A
(800) 1364703
(151) 2017 04 06
(181) 2027 04 06
(891) 2022 05 16
(511) 06, 09

(260) AM 2023 118796 A
(800) 1674940
(151) 2022 06 02
(181) 2032 06 02
(891) 2022 06 02
(511) 05

(260) AM 2023 118908 A
(800) 826827
(151) 2004 03 30
(181) 2024 03 30
(891) 2022 06 02
(511) 05

(260) AM 2023 119661 A
(800) 1687107
(151) 2022 08 22
(181) 2032 08 22
(891) 2022 08 22
(511) 42

(260) AM 2023 119708 A
(800) 1687235
(151) 2022 05 11
(181) 2032 05 11
(891) 2022 05 11
(511) 05

(260) AM 2023 119709 A
(800) 1687240
(151) 2022 08 31
(181) 2032 08 31
(891) 2022 08 31
(511) 09, 11, 42

(260) AM 2023 119711 A
(800) 1687251
(151) 2022 05 11
(181) 2032 05 11
(891) 2022 05 11
(511) 05

(260) AM 2023 119712 A
(800) 1687252
(151) 2022 05 11
(181) 2032 05 11
(891) 2022 05 11
(511) 05

(260) AM 2023 119713 A
(800) 1687254
(151) 2022 05 11
(181) 2032 05 11
(891) 2022 05 11
(511) 05

(260) AM 2023 119714 A
(800) 1687255
(151) 2022 06 02
(181) 2032 06 02
(891) 2022 06 02
(511) 09, 28, 41

(260) AM 2023 119715 A
(800) 1687256
(151) 2022 06 02
(181) 2032 06 02
(891) 2022 06 02
(511) 09, 28, 41

(260) AM 2023 119716 A
(800) 1687257
(151) 2022 06 08
(181) 2032 06 08
(891) 2022 06 08
(511) 09, 28, 41

(260) AM 2023 119717 A
(800) 1687258
(151) 2022 06 08
(181) 2032 06 08
(891) 2022 06 08
(511) 09, 28, 41

(260) AM 2023 119720 A
(800) 1687410
(151) 2022 06 08
(181) 2032 06 08
(891) 2022 06 08
(511) 09, 28, 41

(260) AM 2023 119731 A
(800) 1687761
(151) 2022 07 07
(181) 2032 07 07
(891) 2022 07 07
(511) 33

(260) AM 2023 119744 A
(800) 1688108
(151) 2022 09 16
(181) 2032 09 16
(891) 2022 09 16
(511) 33

(260) AM 2023 119732 A
(800) 1687764
(151) 2022 08 05
(181) 2032 08 05
(891) 2022 08 05
(511) 05

(260) AM 2023 119746 A
(800) 1688233
(151) 2022 03 15
(181) 2032 03 15
(891) 2022 03 15
(511) 09

(260) AM 2023 119733 A
(800) 1687813
(151) 2022 07 08
(181) 2032 07 08
(891) 2022 07 08
(511) 32, 33

(260) AM 2023 119748 A
(800) 1688325
(151) 2022 07 14
(181) 2032 07 14
(891) 2022 07 14
(511) 31

(260) AM 2023 119734 A
(800) 1687864
(151) 2022 02 23
(181) 2032 02 23
(891) 2022 02 23
(511) 01, 02, 03, 04, 07, 08, 09, 11, 12, 17, 24, 37, 40

(260) AM 2023 119754 A
(800) 1515577
(151) 2020 01 16
(181) 2030 01 16
(891) 2022 09 15
(511) 42

(260) AM 2023 119735 A
(800) 1687892
(151) 2022 05 19
(181) 2032 05 19
(891) 2022 05 19
(511) 09, 28, 41

(260) AM 2023 119820 A
(800) 1688443
(151) 2022 05 19
(181) 2032 05 19
(891) 2022 05 19
(511) 09, 28, 41

(260) AM 2023 119736 A
(800) 1687893
(151) 2022 05 19
(181) 2032 05 19
(891) 2022 05 19
(511) 09, 28, 41

(260) AM 2023 119821 A
(800) 1688452
(151) 2022 08 31
(181) 2032 08 31
(891) 2022 08 31
(511) 30

(260) AM 2023 119737 A
(800) 1687907
(151) 2021 11 18
(181) 2031 11 18
(891) 2021 11 18
(511) 35, 36, 42

(260) AM 2023 119822 A
(800) 1688453
(151) 2022 08 31
(181) 2032 08 31
(891) 2022 08 31
(511) 30

(260) AM 2023 119823 A
(800) 1688514
(151) 2022 08 12
(181) 2032 08 12
(891) 2022 08 12
(511) 05

(260) AM 2023 119832 A
(800) 1688985
(151) 2022 08 08
(181) 2032 08 08
(891) 2022 08 08
(511) 19, 20

(260) AM 2023 119824 A
(800) 1688591
(151) 2022 07 12
(181) 2032 07 12
(891) 2022 07 12
(511) 17, 19, 24

(260) AM 2023 119833 A
(800) 1688987
(151) 2022 07 08
(181) 2032 07 08
(891) 2022 07 08
(511) 32, 33

(260) AM 2023 119825 A
(800) 1688611
(151) 2022 08 12
(181) 2032 08 12
(891) 2022 08 12
(511) 12

(260) AM 2023 119849 A
(800) 1689474
(151) 2022 08 10
(181) 2032 08 10
(891) 2022 08 10
(511) 03, 05, 10, 16, 32, 35

(260) AM 2023 119828 A
(800) 1688828
(151) 2022 07 04
(181) 2032 07 04
(891) 2022 07 04
(511) 01, 03, 04, 07, 09, 10, 11, 12

(260) AM 2023 119850 A
(800) 1689506
(151) 2022 08 01
(181) 2032 08 01
(891) 2022 08 01
(511) 01

(260) AM 2023 119829 A
(800) 1688873
(151) 2022 09 09
(181) 2032 09 09
(891) 2022 09 09
(511) 09

(260) AM 2023 119851 A
(800) 1689514
(151) 2022 08 12
(181) 2032 08 12
(891) 2022 08 12
(511) 05, 10

(260) AM 2023 119830 A
(800) 1688885
(151) 2022 04 04
(181) 2032 04 04
(891) 2022 04 04
(511) 03, 04, 09, 12, 14, 16, 18, 25, 26, 28, 29, 30, 32,
35, 36, 38, 39, 41, 43

(260) AM 2023 119852 A
(800) 1689542
(151) 2022 02 23
(181) 2032 02 23
(891) 2022 02 23
(511) 25, 35

(260) AM 2023 119831 A
(800) 1688896
(151) 2022 07 14
(181) 2032 07 14
(891) 2022 07 14
(511) 05

(260) AM 2023 119853 A
(800) 1689555
(151) 2022 08 16
(181) 2032 08 16
(891) 2022 08 16
(511) 42

(260) AM 2023 119864 A
(800) 1689796
(151) 2022 04 04
(181) 2032 04 04
(891) 2022 04 04
(511) 03

(260) AM 2023 119877 A
(800) 1456541
(151) 2018 10 18
(181) 2028 10 18
(891) 2022 09 15
(511) 07, 11

(260) AM 2023 119865 A
(800) 1689830
(151) 2022 04 18
(181) 2032 04 18
(891) 2022 04 18
(511) 01, 02, 04, 05, 17, 35, 36, 42

(260) AM 2023 119878 A
(800) 1458072
(151) 2018 10 18
(181) 2028 10 18
(891) 2022 09 15
(511) 07, 11

(260) AM 2023 119866 A
(800) 1689831
(151) 2022 05 04
(181) 2032 05 04
(891) 2022 05 04
(511) 07, 09, 37

(260) AM 2023 119879 A
(800) 1666849
(151) 2022 03 25
(181) 2032 03 25
(891) 2022 09 21
(511) 09, 35, 39, 43

(260) AM 2023 119868 A
(800) 1689871
(151) 2022 07 14
(181) 2032 07 14
(891) 2022 07 14
(511) 09

(260) AM 2023 119918 A
(800) 1690018
(151) 2022 05 19
(181) 2032 05 19
(891) 2022 05 19
(511) 09, 28, 41

(260) AM 2023 119870 A
(800) 1689895
(151) 2022 08 19
(181) 2032 08 19
(891) 2022 08 19
(511) 03

(260) AM 2023 119919 A
(800) 1690036
(151) 2022 03 02
(181) 2032 03 02
(891) 2022 03 02
(511) 25

(260) AM 2023 119872 A
(800) 1689936
(151) 2022 09 12
(181) 2032 09 12
(891) 2022 09 12
(511) 29

(260) AM 2023 119920 A
(800) 1690101
(151) 2022 08 03
(181) 2032 08 03
(891) 2022 08 03
(511) 03

(260) AM 2023 119873 A
(800) 1689953
(151) 2022 08 25
(181) 2032 08 25
(891) 2022 08 25
(511) 12

(260) AM 2023 119921 A
(800) 1690114
(151) 2022 08 31
(181) 2032 08 31
(891) 2022 08 31
(511) 02, 17, 19, 24, 27, 37, 42

(260) AM 2023 119923 A
(800) 1690245
(151) 2022 04 16
(181) 2032 04 16
(891) 2022 04 16
(511) 16, 28

(260) AM 2023 119924 A
(800) 1690256
(151) 2022 09 22
(181) 2032 09 22
(891) 2022 09 22
(511) 09

(260) AM 2023 119925 A
(800) 1690257
(151) 2022 09 22
(181) 2032 09 22
(891) 2022 09 22
(511) 09

(260) AM 2023 119926 A
(800) 1690307
(151) 2022 08 08
(181) 2032 08 08
(891) 2022 08 08
(511) 03, 05

(260) AM 2023 119936 A
(800) 1690586
(151) 2022 03 28
(181) 2032 03 28
(891) 2022 03 28
(511) 17, 35

(260) AM 2023 119941 A
(800) 1690665
(151) 2022 09 16
(181) 2032 09 16
(891) 2022 09 16
(511) 09, 41, 44

(260) AM 2023 119942 A
(800) 1690756
(151) 2022 06 03
(181) 2032 06 03
(891) 2022 06 03
(511) 03, 16, 18, 25, 35

(260) AM 2023 119943 A
(800) 1690757
(151) 2022 06 03
(181) 2032 06 03
(891) 2022 06 03
(511) 03, 16, 18, 25, 35

(260) AM 2023 119944 A
(800) 1690758
(151) 2022 06 03
(181) 2032 06 03
(891) 2022 06 03
(511) 03, 16, 18, 25, 35

(260) AM 2023 119946 A
(800) 1690795
(151) 2022 04 07
(181) 2032 04 07
(891) 2022 04 07
(511) 05, 06, 07, 08, 09, 10, 11, 12, 13, 14, 15, 16, 17,
18, 19, 20, 21, 22, 23, 24, 25, 26, 27, 28, 29, 30,
31, 32, 33, 34, 35, 36, 37, 38, 39, 40, 41, 42, 43,
44, 45

(260) AM 2023 119947 A
(800) 1690832
(151) 2022 06 20
(181) 2032 06 20
(891) 2022 06 20
(511) 09, 16, 35, 39, 41, 42

(260) AM 2023 119948 A
(800) 1690846
(151) 2022 09 14
(181) 2032 09 14
(891) 2022 09 14
(511) 09

(260) AM 2023 119950 A
(800) 1690861
(151) 2022 02 03
(181) 2032 02 03
(891) 2022 02 03
(511) 07, 09, 11, 35

(260) AM 2023 119951 A
(800) 1690936
(151) 2022 03 15
(181) 2032 03 15
(891) 2022 03 15
(511) 09, 14, 16, 18, 24, 25, 27, 28, 32, 33, 35, 36, 38,
41, 42, 43, 45

(260) AM 2023 119952 A
 (800) 1690939
 (151) 2022 03 15
 (181) 2032 03 15
 (891) 2022 03 15
 (511) 09, 14, 16, 18, 24, 25, 27, 28, 32, 33, 35, 36, 38,
 41, 42, 43, 45

(260) AM 2023 119953 A
 (800) 1690941
 (151) 2022 03 15
 (181) 2032 03 15
 (891) 2022 03 15
 (511) 09, 14, 16, 18, 24, 25, 27, 28, 32, 33, 35, 36, 38,
 41, 42, 43, 45

(260) AM 2023 119954 A
 (800) 1690942
 (151) 2022 03 15
 (181) 2032 03 15
 (891) 2022 03 15
 (511) 09, 14, 16, 18, 24, 25, 27, 28, 32, 33, 35, 36, 38,
 41, 42, 43, 45

(260) AM 2023 119955 A
 (800) 1690943
 (151) 2022 03 15
 (181) 2032 03 15
 (891) 2022 03 15
 (511) 09, 14, 16, 18, 24, 25, 27, 28, 32, 33, 35, 36, 38,
 41, 42, 43, 45

(260) AM 2023 119957 A
 (800) 1691121
 (151) 2022 08 17
 (181) 2032 08 17
 (891) 2022 08 17
 (511) 11

(260) AM 2023 119958 A
 (800) 1691126
 (151) 2022 08 17
 (181) 2032 08 17
 (891) 2022 08 17
 (511) 11

(260) AM 2023 119959 A
 (800) 1691227
 (151) 2022 05 19
 (181) 2032 05 19
 (891) 2022 05 19
 (511) 09, 28, 41

(260) AM 2023 119961 A
 (800) 1691230
 (151) 2022 08 03
 (181) 2032 08 03
 (891) 2022 08 03
 (511) 03

(260) AM 2023 119962 A
 (800) 1691237
 (151) 2022 09 12
 (181) 2032 09 12
 (891) 2022 09 12
 (511) 39

(260) AM 2023 119963 A
 (800) 1691320
 (151) 2022 09 19
 (181) 2032 09 19
 (891) 2022 09 19
 (511) 10

(260) AM 2023 119964 A
 (800) 1691321
 (151) 2022 09 19
 (181) 2032 09 19
 (891) 2022 09 19
 (511) 25

(260) AM 2023 119965 A
 (800) 1691322
 (151) 2022 09 19
 (181) 2032 09 19
 (891) 2022 09 19
 (511) 36

(260) AM 2023 119966 A
 (800) 1691323
 (151) 2022 09 19
 (181) 2032 09 19
 (891) 2022 09 19
 (511) 37

(260) AM 2023 119967 A
 (800) 1691357
 (151) 2022 02 01
 (181) 2032 02 01
 (891) 2022 02 01
 (511) 18, 25, 35

(260) AM 2023 119968 A
(800) 1691429
(151) 2022 07 25
(181) 2032 07 25
(891) 2022 07 25
(511) 10

(260) AM 2023 119980 A
(800) 1631282
(151) 2021 10 11
(181) 2031 10 11
(891) 2022 09 27
(511) 09, 35, 36, 39, 42

(260) AM 2023 119969 A
(800) 1691488
(151) 2022 08 23
(181) 2032 08 23
(891) 2022 08 23
(511) 05

(260) AM 2023 119981 A
(800) 1650889
(151) 2022 02 03
(181) 2032 02 03
(891) 2022 10 05
(511) 32

(260) AM 2023 119970 A
(800) 1691489
(151) 2022 08 23
(181) 2032 08 23
(891) 2022 08 23
(511) 05

(260) AM 2023 119982 A
(800) 1669612
(151) 2022 03 10
(181) 2032 03 10
(891) 2022 09 21
(511) 25

(260) AM 2023 119971 A
(800) 1691491
(151) 2022 03 23
(181) 2032 03 23
(891) 2022 03 23
(511) 35, 42

(260) AM 2023 120053 A
(800) 1691547
(151) 2022 09 07
(181) 2032 09 07
(891) 2022 09 07
(511) 34

(260) AM 2023 119977 A
(800) 1456385
(151) 2019 02 13
(181) 2029 02 13
(891) 2022 09 28
(511) 01

(260) AM 2023 120056 A
(800) 1691619
(151) 2022 07 14
(181) 2032 07 14
(891) 2022 07 14
(511) 29

(260) AM 2023 119978 A
(800) 1591148
(151) 2021 03 05
(181) 2031 03 05
(891) 2022 09 16
(511) 09

(260) AM 2023 120057 A
(800) 1691635
(151) 2022 09 16
(181) 2032 09 16
(891) 2022 09 16
(511) 29, 30

(260) AM 2023 119979 A
(800) 1622441
(151) 2021 05 06
(181) 2031 05 06
(891) 2022 09 27
(511) 25

(260) AM 2023 120058 A
(800) 1691727
(151) 2022 09 22
(181) 2032 09 22
(891) 2022 09 22
(511) 25

(260) AM 2023 120059 A
(800) 1691744
(151) 2022 08 04
(181) 2032 08 04
(891) 2022 08 04
(511) 03, 05

(260) AM 2023 120067 A
(800) 1691807
(151) 2022 08 30
(181) 2032 08 30
(891) 2022 08 30
(511) 03

(260) AM 2023 120060 A
(800) 1691745
(151) 2022 07 25
(181) 2032 07 25
(891) 2022 07 25
(511) 44

(260) AM 2023 120068 A
(800) 1691831
(151) 2022 08 16
(181) 2032 08 16
(891) 2022 08 16
(511) 12

(260) AM 2023 120062 A
(800) 1691770
(151) 2022 09 22
(181) 2032 09 22
(891) 2022 09 22
(511) 25

(260) AM 2023 120069 A
(800) 1691854
(151) 2021 12 27
(181) 2031 12 27
(891) 2021 12 27
(511) 35, 39

(260) AM 2023 120063 A
(800) 1691772
(151) 2022 09 22
(181) 2032 09 22
(891) 2022 09 22
(511) 25

(260) AM 2023 120071 A
(800) 1691893
(151) 2022 08 22
(181) 2032 08 22
(891) 2022 08 22
(511) 03, 04

(260) AM 2023 120064 A
(800) 1691773
(151) 2022 09 22
(181) 2032 09 22
(891) 2022 09 22
(511) 25

(260) AM 2023 120072 A
(800) 1691949
(151) 2022 06 06
(181) 2032 06 06
(891) 2022 06 06
(511) 35, 37

(260) AM 2023 120065 A
(800) 1691789
(151) 2022 03 25
(181) 2032 03 25
(891) 2022 03 25
(511) 05, 32

(260) AM 2023 120073 A
(800) 1691967
(151) 2022 06 30
(181) 2032 06 30
(891) 2022 06 30
(511) 03

(260) AM 2023 120066 A
(800) 1691802
(151) 2022 08 23
(181) 2032 08 23
(891) 2022 08 23
(511) 11

(260) AM 2023 120074 A
(800) 1691974
(151) 2022 08 10
(181) 2032 08 10
(891) 2022 08 10
(511) 05

(260) AM 2023 120075 A
(800) 1692015
(151) 2022 06 16
(181) 2032 06 16
(891) 2022 06 16
(511) 09, 28, 41

(260) AM 2023 120093 A
(800) 1692375
(151) 2022 08 09
(181) 2032 08 09
(891) 2022 08 09
(511) 30

(260) AM 2023 120076 A
(800) 1692042
(151) 2022 10 05
(181) 2032 10 05
(891) 2022 10 05
(511) 09, 20

(260) AM 2023 120094 A
(800) 1692380
(151) 2022 09 23
(181) 2032 09 23
(891) 2022 09 23
(511) 29

(260) AM 2023 120077 A
(800) 1692064
(151) 2022 05 02
(181) 2032 05 02
(891) 2022 05 02
(511) 07, 12

(260) AM 2023 120095 A
(800) 1692381
(151) 2022 09 23
(181) 2032 09 23
(891) 2022 09 23
(511) 29

(260) AM 2023 120078 A
(800) 1692067
(151) 2022 05 02
(181) 2032 05 02
(891) 2022 05 02
(511) 07, 12

(260) AM 2023 120096 A
(800) 1692418
(151) 2022 06 27
(181) 2032 06 27
(891) 2022 06 27
(511) 07, 08

(260) AM 2023 120079 A
(800) 1692084
(151) 2022 08 30
(181) 2032 08 30
(891) 2022 08 30
(511) 10, 12, 18, 20, 24, 25, 28

(260) AM 2023 120097 A
(800) 1692459
(151) 2022 05 05
(181) 2032 05 05
(891) 2022 05 05
(511) 33

(260) AM 2023 120080 A
(800) 1692097
(151) 2022 08 19
(181) 2032 08 19
(891) 2022 08 19
(511) 29, 30

(260) AM 2023 120098 A
(800) 1692481
(151) 2022 10 10
(181) 2032 10 10
(891) 2022 10 10
(511) 33

(260) AM 2023 120092 A
(800) 1692371
(151) 2022 08 23
(181) 2032 08 23
(891) 2022 08 23
(511) 36

(260) AM 2023 120099 A
(800) 1692494
(151) 2022 06 16
(181) 2032 06 16
(891) 2022 06 16
(511) 09, 28, 41

(260) AM 2023 120101 A
(800) 1692498
(151) 2022 09 19
(181) 2032 09 19
(891) 2022 09 19
(511) 03, 35

(260) AM 2023 120111 A
(800) 962865
(151) 2008 01 31
(181) 2028 01 31
(891) 2022 10 05
(511) 32

(260) AM 2023 120102 A
(800) 1692514
(151) 2022 08 10
(181) 2032 08 10
(891) 2022 08 10
(511) 25

(260) AM 2023 120112 A
(800) 1238684
(151) 2015 01 26
(181) 2025 01 26
(891) 2022 10 05
(511) 32

(260) AM 2023 120103 A
(800) 1692529
(151) 2022 08 08
(181) 2032 08 08
(891) 2022 08 08
(511) 07

(260) AM 2023 120113 A
(800) 1266201
(151) 2015 06 08
(181) 2025 06 08
(891) 2022 10 05
(511) 32

(260) AM 2023 120107 A
(800) 1692617
(151) 2022 10 05
(181) 2032 10 05
(891) 2022 10 05
(511) 09, 20

(260) AM 2023 120115 A
(800) 1328446
(151) 2016 05 10
(181) 2026 05 10
(891) 2022 08 24
(511) 30

(260) AM 2023 120108 A
(800) 1692640
(151) 2022 09 23
(181) 2032 09 23
(891) 2022 09 23
(511) 29

(260) AM 2023 120116 A
(800) 1339784
(151) 2017 01 24
(181) 2027 01 24
(891) 2022 09 21
(511) 30

(260) AM 2023 120109 A
(800) 431873
(151) 1977 08 10
(181) 2027 08 10
(891) 2022 07 21
(511) 03

(260) AM 2023 120118 A
(800) 1383006
(151) 2017 11 03
(181) 2027 11 03
(891) 2022 10 13
(511) 05

(260) AM 2023 120110 A
(800) 906109
(151) 2006 10 24
(181) 2026 10 24
(891) 2022 10 05
(511) 32

(260) AM 2023 120119 A
(800) 1388273
(151) 2017 06 21
(181) 2027 06 21
(891) 2022 10 05
(511) 14

(260) AM 2023 120120 A
(800) 1499709
(151) 2019 08 05
(181) 2029 08 05
(891) 2022 09 05
(511) 09, 35, 41, 42

(260) AM 2023 120186 A
(800) 1693157
(151) 2022 07 14
(181) 2032 07 14
(891) 2022 07 14
(511) 05, 10, 24, 25

(260) AM 2023 120121 A
(800) 1516309
(151) 2020 01 17
(181) 2030 01 17
(891) 2022 10 13
(511) 05

(260) AM 2023 120187 A
(800) 1693179
(151) 2022 10 05
(181) 2032 10 05
(891) 2022 10 05
(511) 05, 30

(260) AM 2023 120122 A
(800) 1581926
(151) 2020 10 08
(181) 2030 10 08
(891) 2022 07 04
(511) 01

(260) AM 2023 120196 A
(800) 1693271
(151) 2022 01 16
(181) 2032 01 16
(891) 2022 01 16
(511) 03, 35

(260) AM 2023 120123 A
(800) 1583746
(151) 2020 12 23
(181) 2030 12 23
(891) 2022 09 21
(511) 04, 08, 09, 11, 21, 24, 27, 34

(260) AM 2023 120198 A
(800) 1693299
(151) 2022 09 08
(181) 2032 09 08
(891) 2022 09 08
(511) 03

(260) AM 2023 120124 A
(800) 1636206
(151) 2021 11 16
(181) 2031 11 16
(891) 2022 06 28
(511) 18, 25

(260) AM 2023 120200 A
(800) 1693383
(151) 2022 03 22
(181) 2032 03 22
(891) 2022 03 22
(511) 01, 05, 09, 20, 21, 31, 44

(260) AM 2023 120125 A
(800) 1650848
(151) 2021 12 01
(181) 2031 12 01
(891) 2022 09 23
(511) 09

(260) AM 2023 120201 A
(800) 1693445
(151) 2022 07 11
(181) 2032 07 11
(891) 2022 07 11
(511) 09, 28, 41

(260) AM 2023 120185 A
(800) 1693111
(151) 2022 06 02
(181) 2032 06 02
(891) 2022 06 02
(511) 03, 05, 16

(260) AM 2023 120202 A
(800) 1693516
(151) 2022 09 15
(181) 2032 09 15
(891) 2022 09 15
(511) 09, 12, 28, 38

(260) AM 2023 120203 A
(800) 1693585
(151) 2022 07 28
(181) 2032 07 28
(891) 2022 07 28
(511) 01, 02, 04, 05, 17, 35, 36, 42

(260) AM 2023 120213 A
(800) 1693929
(151) 2022 06 20
(181) 2032 06 20
(891) 2022 06 20
(511) 03, 09, 14, 16, 18, 25, 34, 35

(260) AM 2023 120206 A
(800) 1693695
(151) 2022 08 29
(181) 2032 08 29
(891) 2022 08 29
(511) 03

(260) AM 2023 120214 A
(800) 1693953
(151) 2022 09 19
(181) 2032 09 19
(891) 2022 09 19
(511) 35

(260) AM 2023 120207 A
(800) 1693760
(151) 2022 08 17
(181) 2032 08 17
(891) 2022 08 17
(511) 32, 33

(260) AM 2023 120215 A
(800) 1693959
(151) 2022 04 03
(181) 2032 04 03
(891) 2022 04 03
(511) 25

(260) AM 2023 120208 A
(800) 1693812
(151) 2022 08 19
(181) 2032 08 19
(891) 2022 08 19
(511) 30

(260) AM 2023 120217 A
(800) 1694047
(151) 2022 08 25
(181) 2032 08 25
(891) 2022 08 25
(511) 41, 42

(260) AM 2023 120209 A
(800) 1693855
(151) 2022 06 07
(181) 2032 06 07
(891) 2022 06 07
(511) 05, 10, 42

(260) AM 2023 120218 A
(800) 1694053
(151) 2022 04 04
(181) 2032 04 04
(891) 2022 04 04
(511) 05

(260) AM 2023 120210 A
(800) 1693856
(151) 2022 06 07
(181) 2032 06 07
(891) 2022 06 07
(511) 05, 10, 42

(260) AM 2023 120219 A
(800) 857432
(151) 2005 04 15
(181) 2025 04 15
(891) 2022 10 18
(511) 03, 08, 21

(260) AM 2023 120212 A
(800) 1693889
(151) 2022 07 21
(181) 2032 07 21
(891) 2022 07 21
(511) 06, 19, 20, 35, 40

(260) AM 2023 120220 A
(800) 1147674
(151) 2012 10 08
(181) 2032 10 08
(891) 2022 10 09
(511) 06, 35

(260) AM 2023 120221 A
(800) 1389366
(151) 2017 10 31
(181) 2027 10 31
(891) 2022 09 30
(511) 05

(260) AM 2023 120279 A
(800) 1694469
(151) 2022 10 05
(181) 2032 10 05
(891) 2022 10 05
(511) 09, 16, 18, 21, 25, 35

(260) AM 2023 120266 A
(800) 1694125
(151) 2022 08 12
(181) 2032 08 12
(891) 2022 08 12
(511) 09

(260) AM 2023 120280 A
(800) 1694473
(151) 2022 10 10
(181) 2032 10 10
(891) 2022 10 10
(511) 45

(260) AM 2023 120267 A
(800) 1694127
(151) 2022 07 01
(181) 2032 07 01
(891) 2022 07 01
(511) 01, 02, 09, 35

(260) AM 2023 120281 A
(800) 1694523
(151) 2022 10 07
(181) 2032 10 07
(891) 2022 10 07
(511) 12

(260) AM 2023 120273 A
(800) 1694235
(151) 2022 06 20
(181) 2032 06 20
(891) 2022 06 20
(511) 09, 16, 35, 38, 39, 43

(260) AM 2023 120285 A
(800) 1694638
(151) 2022 06 14
(181) 2032 06 14
(891) 2022 06 14
(511) 03, 05

(260) AM 2023 120274 A
(800) 1694236
(151) 2022 06 20
(181) 2032 06 20
(891) 2022 06 20
(511) 09, 16, 35, 38, 39, 43

(260) AM 2023 120286 A
(800) 1694643
(151) 2022 10 12
(181) 2032 10 12
(891) 2022 10 12
(511) 06, 09, 35, 37, 42

(260) AM 2023 120275 A
(800) 1694302
(151) 2022 09 05
(181) 2032 09 05
(891) 2022 09 05
(511) 01

(260) AM 2023 120288 A
(800) 1694683
(151) 2022 04 28
(181) 2032 04 28
(891) 2022 04 28
(511) 02, 04, 05, 07, 12, 15, 34, 40, 44

(260) AM 2023 120277 A
(800) 1694363
(151) 2022 07 11
(181) 2032 07 11
(891) 2022 07 11
(511) 09, 28, 41

(260) AM 2023 120289 A
(800) 1694732
(151) 2022 10 04
(181) 2032 10 04
(891) 2022 10 04
(511) 09

(260) AM 2023 120291 A
(800) 1694832
(151) 2022 09 29
(181) 2032 09 29
(891) 2022 09 29
(511) 30

(260) AM 2023 120314 A
(800) 1695402
(151) 2022 08 02
(181) 2032 08 02
(891) 2022 08 02
(511) 06, 37

(260) AM 2023 120292 A
(800) 1694929
(151) 2022 05 16
(181) 2032 05 16
(891) 2022 05 16
(511) 36

(260) AM 2023 120315 A
(800) 1695408
(151) 2022 08 19
(181) 2032 08 19
(891) 2022 08 19
(511) 09, 10, 42, 44

(260) AM 2023 120293 A
(800) 1694992
(151) 2022 07 25
(181) 2032 07 25
(891) 2022 07 25
(511) 35, 41

(260) AM 2023 120316 A
(800) 1695445
(151) 2022 08 25
(181) 2032 08 25
(891) 2022 08 25
(511) 12, 35, 37

(260) AM 2023 120294 A
(800) 1695000
(151) 2022 09 29
(181) 2032 09 29
(891) 2022 09 29
(511) 01, 05

(260) AM 2023 120317 A
(800) 1695466
(151) 2022 08 04
(181) 2032 08 04
(891) 2022 08 04
(511) 20

(260) AM 2023 120310 A
(800) 1695294
(151) 2022 07 08
(181) 2032 07 08
(891) 2022 07 08
(511) 41

(260) AM 2023 120323 A
(800) 1695526
(151) 2022 09 07
(181) 2032 09 07
(891) 2022 09 07
(511) 05

(260) AM 2023 120311 A
(800) 1695295
(151) 2022 06 28
(181) 2032 06 28
(891) 2022 06 28
(511) 30

(260) AM 2023 120324 A
(800) 1695593
(151) 2022 08 11
(181) 2032 08 11
(891) 2022 08 11
(511) 03, 05

(260) AM 2023 120313 A
(800) 1695336
(151) 2021 08 11
(181) 2031 08 11
(891) 2021 08 11
(511) 08, 21

(260) AM 2023 120326 A
(800) 1373528
(151) 2017 08 15
(181) 2027 08 15
(891) 2022 09 30
(511) 05

(260) AM 2023 120327 A
(800) 1414350
(151) 2018 04 18
(181) 2028 04 18
(891) 2022 10 25
(511) 33

(260) AM 2023 120334 A
(800) 1614008
(151) 2021 07 30
(181) 2031 07 30
(891) 2022 10 20
(511) 36, 42

(260) AM 2023 120328 A
(800) 1431024
(151) 2018 05 03
(181) 2028 05 03
(891) 2022 10 18
(511) 03, 05, 10, 44

(260) AM 2023 120373 A
(800) 1695615
(151) 2022 09 03
(181) 2032 09 03
(891) 2022 09 03
(511) 43

(260) AM 2023 120329 A
(800) 1465968
(151) 2019 03 04
(181) 2029 03 04
(891) 2022 10 24
(511) 05

(260) AM 2023 120374 A
(800) 1695628
(151) 2022 10 14
(181) 2032 10 14
(891) 2022 10 14
(511) 42

(260) AM 2023 120330 A
(800) 1512179
(151) 2019 07 19
(181) 2029 07 19
(891) 2022 09 21
(511) 30

(260) AM 2023 120375 A
(800) 1695642
(151) 2022 08 08
(181) 2032 08 08
(891) 2022 08 08
(511) 07, 08, 19

(260) AM 2023 120331 A
(800) 1583961
(151) 2020 11 13
(181) 2030 11 13
(891) 2022 10 24
(511) 34

(260) AM 2023 120376 A
(800) 1695658
(151) 2022 06 09
(181) 2032 06 09
(891) 2022 06 09
(511) 11

(260) AM 2023 120332 A
(800) 1605086
(151) 2020 12 09
(181) 2030 12 09
(891) 2022 10 12
(511) 11, 35

(260) AM 2023 120377 A
(800) 1695663
(151) 2022 06 20
(181) 2032 06 20
(891) 2022 06 20
(511) 09, 28, 41

(260) AM 2023 120333 A
(800) 1613357
(151) 2021 07 19
(181) 2031 07 19
(891) 2022 10 10
(511) 34

(260) AM 2023 120389 A
(800) 1696057
(151) 2022 06 13
(181) 2032 06 13
(891) 2022 06 13
(511) 03

(260) AM 2023 120390 A
(800) 1696091
(151) 2021 10 28
(181) 2031 10 28
(891) 2021 10 28
(511) 07, 08, 09, 11, 21

(260) AM 2023 120420 A
(800) 1697031
(151) 2022 09 29
(181) 2032 09 29
(891) 2022 09 29
(511) 29, 30

(260) AM 2023 120391 A
(800) 1696103
(151) 2022 03 28
(181) 2032 03 28
(891) 2022 03 28
(511) 35

(260) AM 2023 120421 A
(800) 1018130
(151) 2009 08 12
(181) 2029 08 12
(891) 2022 10 31
(511) 03, 05

(260) AM 2023 120398 A
(800) 1696206
(151) 2022 07 11
(181) 2032 07 11
(891) 2022 07 11
(511) 09, 28, 41

(260) AM 2023 120423 A
(800) 1151886
(151) 2013 02 19
(181) 2023 02 19
(891) 2022 10 27
(511) 30

(260) AM 2023 120399 A
(800) 1696219
(151) 2022 10 04
(181) 2032 10 04
(891) 2022 10 04
(511) 03, 05, 16

(260) AM 2023 120424 A
(800) 1223763
(151) 2014 06 09
(181) 2024 06 09
(891) 2022 10 17
(511) 02

(260) AM 2023 120400 A
(800) 1696225
(151) 2022 09 13
(181) 2032 09 13
(891) 2022 09 13
(511) 05

(260) AM 2023 120426 A
(800) 1282764
(151) 2015 09 09
(181) 2025 09 09
(891) 2022 10 20
(511) 18, 25, 35

(260) AM 2023 120402 A
(800) 1696241
(151) 2022 09 01
(181) 2032 09 01
(891) 2022 09 01
(511) 33

(260) AM 2023 120427 A
(800) 1425697
(151) 2018 06 22
(181) 2028 06 22
(891) 2022 10 31
(511) 12

(260) AM 2023 120419 A
(800) 1697028
(151) 2022 09 23
(181) 2032 09 23
(891) 2022 09 23
(511) 30

(260) AM 2023 120428 A
(800) 1431951
(151) 2018 05 31
(181) 2028 05 31
(891) 2022 11 02
(511) 06, 07, 12

(260) AM 2023 120430 A
(800) 1620978
(151) 2021 06 15
(181) 2031 06 15
(891) 2022 10 20
(511) 05

(260) AM 2023 120555 A
(800) 1698582
(151) 2022 10 11
(181) 2032 10 11
(891) 2022 09 05
(511) 03

(260) AM 2023 120431 A
(800) 1663279
(151) 2022 05 03
(181) 2032 05 03
(891) 2022 11 03
(511) 05

(260) AM 2023 120556 A
(800) 1698598
(151) 2022 05 04
(181) 2032 05 04
(891) 2022 05 04
(511) 29

(260) AM 2023 120538 A
(800) 1698017
(151) 2022 09 20
(181) 2032 09 20
(891) 2022 09 20
(511) 05, 10, 17, 19, 20, 21, 22, 24, 25, 35, 39, 41, 42

(260) AM 2023 120557 A
(800) 1698626
(151) 2022 09 02
(181) 2032 09 02
(891) 2022 09 02
(511) 09

(260) AM 2023 120551 A
(800) 1698453
(151) 2022 10 21
(181) 2032 10 21
(891) 2022 10 21
(511) 09

(260) AM 2023 120639 A
(800) 1699718
(151) 2022 10 18
(181) 2032 10 18
(891) 2022 10 18
(511) 25

(260) AM 2023 120552 A
(800) 1698479
(151) 2022 10 28
(181) 2032 10 28
(891) 2022 10 28
(511) 09

(260) AM 2023 120640 A
(800) 1699724
(151) 2022 07 25
(181) 2032 07 25
(891) 2022 07 25
(511) 09, 28, 41

(260) AM 2023 120553 A
(800) 1698480
(151) 2022 10 28
(181) 2032 10 28
(891) 2022 10 28
(511) 35

(260) AM 2023 120641 A
(800) 1699756
(151) 2022 09 30
(181) 2032 09 30
(891) 2022 09 30
(511) 03

(260) AM 2023 120554 A
(800) 1698513
(151) 2022 09 19
(181) 2032 09 19
(891) 2022 09 19
(511) 09, 35, 36, 37, 39, 42

(260) AM 2023 120642 A
(800) 1699777
(151) 2022 09 23
(181) 2032 09 23
(891) 2022 09 23
(511) 34

(260) AM 2023 120643 A
(800) 1699783
(151) 2022 09 21
(181) 2032 09 21
(891) 2022 09 21
(511) 03, 06, 09, 20, 21, 27, 35, 36, 39

(260) AM 2023 120879 A
(800) 1702769
(151) 2022 08 22
(181) 2032 08 22
(891) 2022 08 22
(511) 03

(260) AM 2023 120644 A
(800) 1699816
(151) 2022 09 20
(181) 2032 09 20
(891) 2022 09 20
(511) 09

(260) AM 2023 120645 A
(800) 1699878
(151) 2022 07 29
(181) 2032 07 29
(891) 2022 07 29
(511) 09, 28, 41

(260) AM 2023 120684 A
(800) 1700673
(151) 2022 08 18
(181) 2032 08 18
(891) 2022 08 18
(511) 09, 35, 39, 43

(260) AM 2023 120685 A
(800) 1700690
(151) 2022 07 13
(181) 2032 07 13
(891) 2022 07 13
(511) 29, 30, 32

(260) AM 2023 120687 A
(800) 1700761
(151) 2022 07 28
(181) 2032 07 28
(891) 2022 07 28
(511) 01, 02, 03, 04, 06, 08, 09, 10, 11, 13, 14, 15, 16,
17, 18, 19, 20, 21, 22, 23, 24, 25, 26, 27, 28, 29,
30, 31, 32, 33, 34, 35, 36, 37, 38, 39, 40, 41, 42,
43, 44, 45

(260) AM 2023 120695 A
(800) 1654180
(151) 2022 03 01
(181) 2032 03 01
(891) 2022 11 17
(511) 05

APPELLATION OF ORIGIN OF GOODS

APPELLATION OF ORIGIN OF GOODS FILED IN GEORGIA FOR EXAMINATION UNDER LISBON AGREEMENT, ON THE BASIS OF THE INTERNATIONAL REGISTRATION

The decision can be appealed at the Chamber of Appeal of Sakpatenti within 3 months from the publication or at the Mtskheta District Court Administrative Cases Board (Address: №17, Samkhedro St., Mtskheta), within 1 month following the publication.

(210) 3538

(800) 1140

(151) 2023 06 02

(731) Kurdistan Province Handwoven Carpet Corporation

Bijar Region, Iran;

Kurdistan Province Rural Handwoven Carpet Cooperative Companies Union

Bijar Region, Iran;

Kurdistan Province Urban Handwoven Carpet Cooperative Companies Union

Bijar Region, Iran;

Sanandaj County Handwoven Carpet Union

Bijar Region, Iran

(540) Bijar Handmade Carpet

فرش دستبافت بیجار

(511)

27 – Handmade Carpet.

OFFICIAL NOTIFICATIONS

INVENTIONS RESTORATION OF PATENTS

(21) AP 2014 13602
(11) P 2015 6404 B
(73) Merab Lekveishvili
(54) DRUG FOR TREATMENT OF CONDITIONS RELATED TO OXIDATIVE STRESS
DATE OF PATENT LAPSE: 2023 10 20
DATE OF PATENT RESTORATION: 2023 11 10

(21) AP 2020 15454
(11) P 2022 7400 B
(73) Gocha Kurdadze
(54) METHOD FOR RECOVERY OF MANGANESE AND OBTAINING SIMN METAL PHASE
DATE OF PATENT LAPSE: 2023 09 21
DATE OF PATENT RESTORATION: 2023 11 10

(21) AP 2020 15886
(11) P 2023 7512 B
(73) Denis Valentinovich Tyaglin
(54) ENERGY GENERATOR
DATE OF PATENT LAPSE: 2023 08 13
DATE OF PATENT RESTORATION: 2023 11 10

LAPSE OF PATENTS WITH THE RIGHT TO RESTORE

(21) AP 2010 12718
(11) P 2014 6047 B
(73) Vlado MOULIS
(54) CULTIVATION OF HAZEL TREE WITH THE CROWN HAVING THE FORM OF VERTICAL SPINDLE
ON THE SUPPORT
DATE OF PATENT LAPSE: 2023 10 22
PATENT RESTORATION TERM: 2024 10 22

(21) AP 2012 12871
(11) P 2014 6083 B
(73) General Electric Company
(54) OPTIMIZED BORON POWDER FOR NEURON DETECTION APPLICATIONS
DATE OF PATENT LAPSE: 2023 10 15
PATENT RESTORATION TERM: 2024 10 15

(21) AP 2011 13092
(11) P 2015 6303 B
(73) Reforcetech LTD.
(54) REINFORCEMENT BAR AND METHOD FOR MANUFACTURING SAME
DATE OF PATENT LAPSE: 2023 10 21
PATENT RESTORATION TERM: 2024 10 21

(21) AP 2013 13269
(11) P 2015 6411 B
(73) Gizo Tsanava
(54) METHOD FOR WALL CONSTRUCTION WITH DRY WALLING
DATE OF PATENT LAPSE: 2023 10 24
PATENT RESTORATION TERM: 2024 10 24

(21) AP 2014 13602
(11) P 2015 6404 B
(73) Merab Lekveishvili
(54) DRUG FOR TREATMENT OF CONDITIONS RELATED TO OXIDATIVE STRESS
DATE OF PATENT LAPSE: 2023 10 20
PATENT RESTORATION TERM: 2025 10 20

(21) AP 2013 13833
(11) P 2018 6891 B
(73) Omeros Corporation
(54) STABLE PRESERVATIVE-FREE MYDRIATIC AND ANTI-INFLAMMATORY SOLUTIONS FOR INJECTION
DATE OF PATENT LAPSE: 2023 10 23
PATENT RESTORATION TERM: 2024 10 23

(21) AP 2017 14618
(11) P 2020 7066 B
(73) Giorgi Oniashvili;
Garegin Zakharov;
Giorgi Tavadze;
Alex Berner;
Zurab Aslamazashvili
(54) METHOD FOR PRODUCTION OF GRADIENT MATERIAL RESISTANT TO DYNAMIC LOAD OF HIGH INTENSITY WITH METHOD OF SELF-PROPAGATING HIGH-TEMPERATURE SYNTHESIS IN TI-B-N-C-ME AND TI-CR-C-ME SYSTEMS
DATE OF PATENT LAPSE: 2023 10 27
PATENT RESTORATION TERM: 2024 10 27

(21) AP 2017 15051
(11) P 2022 7414 B
(73) Tokyo Rope MFG.Co., LTD.
(54) HIGH-STRENGTH WIRE MESH AND ROCK FALL PREVENTION NET
DATE OF PATENT LAPSE: 2023 10 16
PATENT RESTORATION TERM: 2024 10 16

(21) AP 2018 15340
(11) P 2022 7344 B
(73) Theravance Biopharma R&D IP LLC
(54) PYRIMIDINE COMPOUND AS JAK KINASE INHIBITOR
DATE OF PATENT LAPSE: 2023 10 26
PATENT RESTORATION TERM: 2024 10 26

EXPIRATION OF PATENTS RESTORATION TERM

(21) AP 2012 12880
(11) P 2014 6048 B
(73) Sopio Burjanadze
(54) CAVITATION-ELECTROLYSIS DEVICE FOR HYDROGEN GENERATION
DATE OF PATENT LAPSE: 2022 10 26
DATE OF EXPIRATION OF PATENT RESTORATION TERM: 2023 10 26

(21) AP 2015 14514
(11) P 2020 7081 B
(73) Ioulia Tseti
(54) PROCESS FOR PRODUCING IRON (III) CASEIN N-ACETYL-ASPARTYLATED COMPLEXES AND USE
THEREOF IN PHARMACEUTICAL COMPOSITIONS
DATE OF PATENT LAPSE: 2022 10 22
DATE OF EXPIRATION OF PATENT RESTORATION TERM: 2023 10 22

(21) AP 2017 15096
(11) P 2021 7248 B
(73) The General Hospital Corporation;
Bayer Aktiengesellschaft;
President and Fellows of Harvard College;
Bayer Pharma Aktiengesellschaft;
The Broad Institute Inc.
(54) 2,4,5-TRISUBSTITUTED 1,2,4-TRIAZOLONES USEFUL AS INHIBITORS OF DHODH
DATE OF PATENT LAPSE: 2022 10 25
DATE OF EXPIRATION OF PATENT RESTORATION TERM: 2023 10 25

(21) AP 2020 15474
(11) P 2022 7337 B
(73) Simon Bitsadze;
Rususdan Bitsadze
(54) MAGNETIC HYDRAULIC PUSHER HAVING MEMBRANE
DATE OF PATENT LAPSE: 2022 10 20
DATE OF EXPIRATION OF PATENT RESTORATION TERM: 2023 10 20

EXPIRATION OF PATENT

(21) AP 2003 7158
(11) P 2004 3374 B
(73) LTD "Kamelin"
(54) MEDICINAL MEANS ON THE BASE OF HONEY, THEIR USE AND METHOD FOR PRODUCTION
THEREOF
DATE OF EXPIRATION OF PATENT: 2023 10 17

TRANSFER OF RIGHT

(21) AP 2013 13630

(11) P 2017 6644 B

(54) INSECTICIDAL WATER-IN-OIL (W/O) FORMULATION

NAME AND ADDRESS OF NEW PATENT OWNER: Discovery Purchaser Corporation (US)

1209 Orange Street, Wilmington, Country of

New Castle, 19801, Delaware, USA (US)

NAME AND ADDRESS OF FORMER PATENT OWNER: Bayer Cropscience AG (DE)

Alfred-Nobel-Str. 50, 40789 Monheim,

Germany (DE)

DATE OF REGISTRATION: 2023 10 19

UTILITY MODELS RESTORATION OF PATENT

(21) AU 2021 15629

(11) U 2022 2132 Y

(73) Nikoloz Kozanashvili

(54) FOOD FIXTURE

DATE OF PATENT LAPSE: 2023 05 13

DATE OF PATENT RESTORATION: 2023 11 10

LAPSE OF PATENTS WITH THE RIGHT TO RESTORE

(21) AU 2015 13963

(11) U 2017 1919 Y

(73) LEPL "TSSU Iovel Kutateladze Institute of Pharmacochemistry";

LEPL "TSMU Tbilisi State Medical University"

(54) GEL FOR ELECTROTHERAPY

DATE OF PATENT LAPSE: 2023 10 16

PATENT RESTORATION TERM: 2024 10 16

(21) AU 2020 15477

(11) U 2022 2108 Y

(73) Mamuka Verulava

(54) METHOD FOR HOUSEFLY WORM GROWTH

DATE OF PATENT LAPSE: 2023 10 27

PATENT RESTORATION TERM: 2024 10 27

EXPIRATION OF PATENTS RESTORATION TERM

(21) AU 2019 15197
(11) U 2020 2046 Y
(73) Akaki Tsereteli State University;
Temur Ghvinianidze;
LEPL "Shota Rustaveli National Science Foundation of Georgia"
(54) ANTIOXIDANT SPECIAL DESSERT WINE
DATE OF PATENT LAPSE: 2022 10 16
DATE OF EXPIRATION OF PATENT RESTORATION TERM: 2023 10 16

(21) AU 2019 15204
(11) U 2020 2057 Y
(73) Avtandil Bitsadze
(54) GREENHOUSE FOR COLD REGIONS
DATE OF PATENT LAPSE: 2022 10 25
DATE OF EXPIRATION OF PATENT RESTORATION TERM: 2023 10 25

DESIGNS

EXTENSION OF TERM OF DESIGN REGISTRATION

(11) D 2013 558 S
(73) LTD "Aisi" (GE)
Egnate Evdoshvili St. 37, 1500, Gurjaani, Georgia (GE)
(54) GRAPHICAL COMBINATION, GRAPHICAL SYMBOL
(28) 2
(24) 2013 04 05
(18) 2028 04 05
(58) 2023 10 27

CANCELLATION OF DESIGN REGISTRATION

(11) D 2019 796 S
(73) Tamta Jikia (GE)
First Festival St. 49, 6600, Sukhumi, Georgia (GE)
(54) CERAMIC BOTTLES FOR WINE
(18) 2023 04 16
(58) 2023 10 30

EXTENSION OF TERM OF INTERNATIONAL DESIGN REGISTRATION

(11) DM/102 706
(73) TISSOT SA (Tissot AG) (Tissot Ltd)
Chemin des Tourelles 17 Le Locle, CH-2400 (CH)
(15) 2018 09 06
(24) 2018 09 06
(18) 2028 09 06
(28) 6
(28') 6
(54) 1.-4. DIALS, 5.-6. WATCH STRAP PARTS

(11) DM/103 391
(73) OMEGA SA (OMEGA AG) (OMEGA LTD.)
Jakob-Stämpfli-Strasse 96 Biel/Bienne, CH-2502 (CH)
(15) 2018 10 16
(24) 2018 10 16
(18) 2028 10 16
(28) 2
(28') 2

(54) 1. WATCH, 2. WATCH BRACELET

(11) DM/103 583
(73) NORWEGIAN DEFENCE MATERIAL AGENCY
Grev Wedels Plass 1, N-0151, Oslo (NO)
(15) 2018 08 17
(24) 2018 08 17
(18) 2028 08 17
(28) 3
(28') 3
(54) 1.-3. ORNAMENTATION

(11) DM/64276
(73) MOVADO WATCH COMPANY S.A.
Bettlachstrasse 8 2540 Grenchen (CH)
(15) 2003 09 03
(24) 2003 09 03
(18) 2028 09 03
(28) 2
(28') 2
(54) WATCH CASES

(11) DM/64297
(73) MOVADO WATCH COMPANY S.A.
Bettlachstrasse 8 2540 Grenchen (CH)
(15) 2003 09 03
(24) 2003 09 03
(18) 2028 09 03
(28) 1
(28') 1
(54) WATCH BRACELET

(11) DM/64396
(73) SWATCH AG (SWATCH SA) SWATCH (LTD.)
94, Rue Jakob Stämpfli, CH-2502 BIENNE (CH)
(15) 2003 10 08
(24) 2003 10 08
(18) 2028 10 08
(28) 1
(28') 1
(54) WATCH CASE

(11) DM/64405
(73) SWATCH AG (SWATCH SA) (SWATCH LTD.)
94, Rue Jakob Stämpfli, CH-2502 BIENNE (CH)
(15) 2003 10 08
(24) 2003 10 08
(18) 2028 10 08
(28) 2
(28') 2
(54) CASES FOR WATCHES

(11) DM/64460
(73) SWATCH AG (SWATCH SA) (SWATCH LTD.)
94, Rue Jakob Stämpfli, CH-2502 BIENNE (CH)
(15) 2003 10 15
(24) 2003 10 15
(18) 2028 10 15
(28) 1
(28') 1
(54) WATCH BRACELET

(11) DM/64478
(73) SWATCH AG (SWATCH SA) (SWATCH LTD.)
94, Rue Jakob Stämpfli, CH-2502 BIENNE (CH)
(15) 2003 10 22
(24) 2003 10 22
(18) 2028 10 22
(28) 4
(28') 1
(54) WRISTWATCHES

(11) DM/64479
(73) SWATCH AG (SWATCH SA) (SWATCH LTD.)
94, Rue Jakob Stämpfli, CH-2502 BIENNE (CH)
(15) 2003 10 22
(24) 2003 10 22
(18) 2028 10 22
(28) 3
(28') 1
(54) WRISTWATCHES

(11) DM/64569
(73) ROLEX PROMOTIONS S.A.
5, Rue François-Dussaud, CH-1211 Genève 24 (CH)
(15) 2003 10 23

(24) 2003 10 23
(18) 2028 10 23
(28) 1
(28') 1
(54) DIVOT REPAIR TOOL

(11) DM/64570
(73) ROLEX SA
Rue François-Dussaud 3-5-7, CH-1211 Genève 24 (CH)
(15) 2003 10 23
(24) 2003 10 23
(18) 2028 10 23
(28) 5
(28') 5
(54) WATCH BRACELETS

(11) DM/65054
(73) BEAUTE PRESTIGE INTERNATIONAL
56 A Rue Du Faubourg Saint-Honoré, F-75008 Paris (FR)
(15) 2003 09 29
(24) 2003 09 29
(18) 2028 09 29
(28) 1
(28') 1
(54) BOTTLE

(11) DM/65890
(73) COMPAGNIE GERVAIS DANONE
126-130, Rue Jules Guesde F-92300 Levallois-Perret (FR)
(15) 2003 11 13
(24) 2003 11 13
(18) 2028 11 13
(28) 1
(28') 1
(54) JAR FOR FOOD PRODUCTS

(11) DM/70759
(73) OMEGA SA (OMEGA AG) (OMEGA LTD.)
Jakob-Stämpfli-Strasse 96, CH-2502 Biel/Bienne (CH)
(15) 2008 10 03
(24) 2008 10 03
(18) 2028 10 03
(28) 1
(28') 1
(54) WRISTWATCH

(11) DM/81809
(73) SWATCH AG (SWATCH SA) (SWATCH LTD.)
Jakob-Stämpfli-Strasse 94, CH-2502 Biel/Bienne (CH)
(15) 2013 09 18
(24) 2013 09 18
(18) 2028 09 18
(28) 2
(28') 2

(54) Watch presentation cases

(11) DM/81887

(73) SWATCH AG (SWATCH SA) (SWATCH LTD.)

Jakob-Stämpfli-Strasse 94, CH-2502 Biel/Bienne (CH)

(15) 2013 10 04

(24) 2013 10 04

(18) 2028 10 04

(28) 2

(28') 2

(54) WRISTWATCHES

(11) DM/81925

(73) ROLEX SA

3-5-7 rue François-Dussaud, CH-1211 Genève 26 (CH)

(15) 2013 10 08

(24) 2013 10 08

(18) 2028 10 08

(28) 3

(28') 3

(54) WATCH DIALS

(11) DM/82008

(73) SWATCH AG (SWATCH SA) (SWATCH LTD.)

Jakob-Stämpfli-Strasse 94, CH-2502 Biel/Bienne (CH)

(15) 2013 10 21

(24) 2013 10 21

(18) 2033 10 21

(28) 7

(28') 1

(54) 1.-5. WRISTWATCHES, 6.-7. WATCH HANDS

(11) DM/82068

(73) HARRY WINSTON SA

Chemin du Tourbillon 8, CH-1228 Plan-les-Ouates (CH)

(15) 2013 10 29

(24) 2013 10 29

(18) 2028 10 29

(28) 8

(28') 8

(54) BRACELET, EARRINGS, FINGER RINGS

(11) DM/82076

(73) HARRY WINSTON SA

Chemin du Tourbillon 8, CH-1228 Plan-les-Ouates (CH)

(15) 2013 10 31

(24) 2013 10 31

(18) 2028 10 31

(28) 2

(28') 2

(54) BRACELET, EARRINGS

(11) DM/82082
(73) ETA SA MANUFACTURE HORLOGÈRE SUISSE
Schild-Rust-Strasse 17, CH-2540 Grenchen (CH)
(15) 2013 10 08
(24) 2013 10 08
(18) 2028 10 08
(28) 10
(28') 1
(54) WRISTWATCHES

(11) DM/82083
(73) SWATCH AG (SWATCH SA) (SWATCH LTD.)
Jakob-Stämpfli-Strasse 94, CH-2502 Biel/Bienne (CH)
(15) 2013 10 21
(24) 2013 10 21
(18) 2028 10 21
(28) 1
(28') 1
(54) 1. WRISTWATCH

(11) DM/82244
(73) SWATCH AG (SWATCH SA) (SWATCH LTD.)
Jakob-Stämpfli-Strasse 94, CH-2502 Biel/Bienne (CH)
(15) 2013 10 21
(24) 2013 10 21
(18) 2028 10 21
(28) 2
(28') 2
(54) WRISTWATCHES

(11) DM/82569
(73) SOREMARTEC S.A.
Findel Business Center, Complexe B, Rue de Trèves, L-2632 Findel (LU)
(15) 2013 10 11
(24) 2013 10 11
*(18) 2028 10 11
(28) 3
(28') 3
(54) 1.-3. DISPLAY UNITS

(11) DM/82755
(73) ECZACIBAŞI TÜKETİM ÜRÜNLERİ SANAYİ VE TİCARET ANONİM ŞİRKETİ
KAVACIK OFİS RÜZGARLI BAHÇE MAH. KAVAK SK. NO.20 BEYKOZ, İSTANBUL (TR)
(15) 2013 12 09
(24) 2013 12 09
(18) 2028 12 09
(28) 4
(28') 4
(54) 1.-4. PAPER DISPENSERS

(11) DM/83239

(73) GEORG NEUMANN GMBH

Ollenhauerstrasse 98, 13403 Berlin (DE)

(15) 2013 10 08

(24) 2013 10 08

(18) 2028 10 08

(28) 10

(28') 10

(54) 1. PART OF MICROPHONE, 2. MICROPHONE, 3.-10. PARTS OF MICROPHONE

TRADEMARKS**EXTENSION OF TERM OF TRADEMARKS REGISTRATION**

(111) M 2003 15276 R2

(151) 2003 10 15

(186) 2033 10 15

(732) Diageo Brands B.V.

Molenwerf 10-12, 1014 BG Amsterdam,
Netherlands

(111) M 2013 24215 R1

(151) 2013 11 04

(186) 2033 11 04

(732) Vlaktor Trading Limited

Zinonos Kitieos, 8, Kato Lakatamia,
P.C. 2322 Nicosia, Cyprus

(111) M 2003 15335 R2

(151) 2003 11 14

(186) 2033 11 14

(732) Husqvarna Aktiebolag

SE-561, 82 Huskvarna, Sweden

(111) M 2013 24216 R1

(151) 2013 11 04

(186) 2033 11 04

(732) Vlaktor Trading Limited

Zinonos Kitieos, 8, Kato Lakatamia,
P.C. 2322 Nicosia, Cyprus

(111) M 2003 15334 R2

(151) 2003 11 14

(186) 2033 11 14

(732) Kimberly-Clark Worldwide Inc.

Neenah, Wi 54956, USA

(111) M 2013 23949 R1

(151) 2013 08 14

(186) 2033 08 14

(732) LLC "Aversi-Pharma"

Davit Aghmashenebeli Av. 148, 0112,
Tbilisi Georgia

(111) M 2004 15401 R2

(151) 2004 01 15

(186) 2034 01 15

(732) Reckitt & Colman (Overseas) Health Limited

103-105 Bath Road, Slough, Berkshire,
SL1 3UH, United Kingdom

(111) M 2013 24058 R1

(151) 2013 09 17

(186) 2033 09 17

(732) LLC "Aversi-Pharma"

Davit Aghmashenebeli Av. 148, 0112,
Tbilisi Georgia

(111) M 2004 15550 R2

(151) 2004 06 15

(186) 2034 06 15

(732) Corporacion Habanos S.A.

Avenida Tercera entre 78 y 80, Centro de
Negocios Miramar, Edificio Habana, 3er.
Piso, Playa, La Habana, Cuba

(111) M 2013 24162 R1

(151) 2013 10 17

(186) 2033 10 17

(732) Hewlett-Packard Development Company L.P.

10300 Energy Drive, Spring, Texas 77389, USA

(111) M 2013 24148 R1

(151) 2013 10 17

(186) 2033 10 17

(732) LLC "Aversi-Pharma"

Davit Aghmashenebeli Av. 148, 0112,
Tbilisi Georgia

(111) M 2013 24288 R1

(151) 2013 11 18

(186) 2033 11 18

(732) LLC "Aversi-Pharma"

Davit Aghmashenebeli Av. 148, 0112,
Tbilisi Georgia

(111) M 2013 24214 R1

(151) 2013 11 04

(186) 2033 11 04

(732) Vlaktor Trading Limited

Zinonos Kitieos, 8, Kato Lakatamia,
P.C. 2322 Nicosia, Cyprus

(111) M 2013 24008 R1

(151) 2013 09 02

(186) 2033 09 02

(732) Noucor Health S.A.

Avinguda Camí Reial, 51-57, Palau-Solità
i Plegamans, Barcelona, Spain

(111) M 2013 24399 R1
(151) 2013 12 30
(186) 2033 12 30
(732) JNTL Consumer Health I (Switzerland)
GmbH
Gubelstrasse 34, CH-6300 Zug, Switzerland

(111) M 2013 24304 R1
(151) 2013 11 18
(186) 2033 11 18
(732) SUmimoto Chemical Company, Limited
2-7-1, Nihonbashi, Chuo-ku, Tokyo 103-6020,
Japan

(111) M 2013 24401 R1
(151) 2013 12 30
(186) 2033 12 30
(732) NPAO Svetogorsk PPM
ul. Zavodskaya, dom 17, 188991, Svetogorsk,
Russian Federation

(111) M 2013 24402 R1
(151) 2013 12 30
(186) 2033 12 30
(732) NPAO Svetogorsk PPM
ul. Zavodskaya, dom 17, 188991, Svetogorsk,
Russian Federation

(111) M 2013 24403 R1
(151) 2013 12 30
(186) 2033 12 30
(732) NPAO Svetogorsk PPM
ul. Zavodskaya, dom 17, 188991, Svetogorsk,
Russian Federation

(111) M 2013 24369 R1
(151) 2013 12 13
(186) 2033 12 13
(732) NPAO Svetogorsk PPM
ul. Zavodskaya, dom 17, 188991, Svetogorsk,
Russian Federation

(111) M 2013 24321 R1
(151) 2013 11 29
(186) 2033 11 29
(732) Macmillan Publishers International Limited
Brunel Road, Houndmills, Basingstoke,
Hampshire, RG21 6XS, United Kingdom

(111) M 2013 24322 R1
(151) 2013 11 29
(186) 2033 11 29
(732) Macmillan Publishers International Limited
Brunel Road, Houndmills, Basingstoke,
Hampshire, RG21 6XS, United Kingdom

(111) M 2013 24247 R1
(151) 2013 11 11
(186) 2033 11 11
(732) Ersel Isitma Enerji Sistemleri Ve Büro
Gereçleri Sanayi ve Ticaret Limited Şirketi
Organize Sanayi Bölgesi 20. Cad. N:66
Melikgazi Kayseri, Türkiye

COMPLETE TRANSFER OF RIGHTS

(111) M 2021 33781 R
(732) Grazyna Sworowska
Zabrodzie 4/1, 52-327 Wroclaw, Poland
(770) Teliani Valley Polska S.A.
Kobierzycka 9A/14, 52-315 Wroclaw,
Poland
(580) 2023 10 17

(111) M 2022 35962 R
(732) Giorgi Mariamidze
Shalva Nutsubidze St. 127, ap. 27, Tbilisi,
Georgia
(770) LTD "Skilvili"
Akhmeta St. 1, 0103, Isani District, Tbilisi,
Georgia
(580) 2023 10 17

(111) M 1997 7922 R
(732) T-Mobile Innovations LLC
12920 SE 38th St., Bellevue, WA 98006, USA
(770) Sprint Communications Company L.P.
6450 Sprint Parkway, City of Overland Park,
State of Kansas 66251, USA
(580) 2023 10 26

(111) M 2023 37235 R
(732) Giorgi Mariamidze
Shalva Nutsubidze St. 127, ap. 27, Tbilisi,
Georgia
(770) LTD "Skilvili"
Akhmeta St. 1, 0103, Isani District, Tbilisi,
Georgia
(580) 2023 10 17

(111) M 1996 2566 R
(732) OVS S.P.A.
Via Terraglio 17, 30174 Venezia (VE), Italy
(770) Stefanel S.P.A.
85, Via Postumia, I-31 047 Ponte Di Piave,
Italy
(580) 2023 10 10

(111) M 1996 2567 R
(732) OVS S.P.A.
Via Terraglio 17, 30174 Venezia (VE), Italy
(770) Stefanel S.P.A.
85, Via Postumia, I-31 047 Ponte Di Piave,
Italy
(580) 2023 10 10

(111) M 1996 2561 R
(732) OVS S.P.A.
Via Terraglio 17, 30174 Venezia (VE), Italy
(770) Stefanel S.P.A.
85, Via Postumia, I-31 047 Ponte Di Piave,
Italy
(580) 2023 10 10

(111) M 2008 18773 R
(732) Jadran-Galenski Laboratorij d.d.
Svilno 20, 51000 Rijeka, Croatia
(770) JSC "Gefa"
Akaki Beliashvili St. 142, 0159, Tbilisi
Georgia
(580) 2023 09 21

(111) M 2008 18774 R
(732) Jadran-Galenski Laboratorij d.d.
Svilno 20, 51000 Rijeka, Croatia
(770) JSC "Gefa"
Akaki Beliashvili St. 142, 0159, Tbilisi
Georgia
(580) 2023 09 21

(111) M 1997 5789 R
(732) TE Connectivity Solutions GmbH
(TE Connectivity Solutions Sarl)
(TE Connectivity Solutions LLC)
Muhlenstrasse 26, 8200 Schaffhausen,
Switzerland
(770) TE Connectivity Services GmbH
Muhlenstrasse 26, 8200 Schaffhausen,
Switzerland
(580) 2023 09 18

(111) M 1996 3590 R
(732) ABG-Rockport LLC
(a Delaware limited liability company
1411 Broadway, New York, New York 10018,
USA
(770) The Rockport Company, LLC
1220 Washington Street, Newton,
Massachusetts 02465, USA
(580) 2023 10 20

(111) M 2015 26515 R
(732) LLC "Tourism of Georgia Development
Fund"
Ilia Chavchavadze Av. 37M, 3rd floor, Vake
District, Tbilisi, Georgia

(770) LLC "Hotel Management Company"
Ilia Chavchavadze Av. 39A, 0168, Tbilisi,
Georgia
(580) 2023 10 03

(111) M 1998 9648 R
(732) IsarCare Holding GmbH
Augustenstr. 68 a, 80333 München,
Germany
(770) MLV Markenzeichen-und Lizenzverwaltungs
GmbH
Rosslerstrasse 94, 64293 Darmstadt, Germany
(580) 2023 10 16

(111) M 2018 30623 R
(732) Al Furat FZE
Jafza One Jebel Ali Free Zone, P.O. Box
449804, Dubai, United Arab Emirates
(770) Al Furat LTD
Craigmuir Chamber, PO Box 71, Road Town,
Tortola VG1110, Virgin Islands (British)
(580) 2023 10 26

(111) M 1998 9563 R
(732) Movomatic SA
Rue du Tombet 29, 2034 Peseux,
Switzerland
(770) Jenoptik Industrial Metrology france Sa
14400 Saint-MartIn-des-Entrees, France
(580) 2023 10 10

CHANGES OF NAME AND/OR ADDRESS OF TRADEMARKS OWNERS

(111) M 1996 2757 R
 (732) Bristol-Myers Squibb Company
 a Delaware Corporation
 Route 206 & Province Line Road, Princeton,
 New Jersey 08543, USA
 (770) Bristol-Myers Squibb Company
 a Delaware Corporation
 430 East 29th Street, 14th Floor, New York,
 New York 10016, USA
 (580) 2023 09 28

(111) M 1996 2758 R
 (732) Bristol-Myers Squibb Company
 a Delaware Corporation
 Route 206 & Province Line Road, Princeton,
 New Jersey 08543, USA
 (770) Bristol-Myers Squibb Company
 a Delaware Corporation
 430 East 29th Street, 14th Floor, New York,
 New York 10016, USA
 (580) 2023 09 28

(111) M 2003 15277 R
 (732) Kantar Media UK Limited
 222 Gray's Inn Road, London, WC1X 8HB,
 United Kingdom
 (770) Kantar Media UK Limited
 Ealing Gateway, 26-30 Uxbridge Road, Ealing,
 London, W5 2AU, United Kingdom
 (580) 2023 10 16

(111) M 2004 15550 R
 (732) Corporacion Habanos S.A.
 Avenida Tercera entre 78 y 80, Centro de
 Negocios Miramar, Edificio Habana, 3er.
 Piso, Playa, La Habana, Cuba
 (770) Corporacion Habanos S.A.
 Carretera Vieja de Guanabacoa y Linea
 del Ferrocarril Final, Guanabacoa, La Habana,
 Cuba
 (580) 2023 09 18

(111) M 1996 3921 R
 (732) Pernod Ricard India Private Limited
 Atelier, No. 10, Level 1, Worldmark 2,
 Aerocity, New Delhi -110037, India
 (770) Pernod Ricard India Private Limited
 5th Floor, D-3, District Centre, Saket,
 New Delhi 110017, India
 (580) 2023 10 20

(111) M 2005 16079 R
 (732) Bristol-Myers Squibb Company
 Route 206 & Province Line Road, Princeton,
 New Jersey 08543, USA
 (770) Bristol-Myers Squibb Company
 430 East 29th Street, 14th Floor, New York,
 New York 10016, USA
 (580) 2023 09 28

(111) M 2007 17425 R
 (732) HD Hyundai Infracore Co., LTD.
 477, Bundangsuseo-ro, Bundang-gu,
 Seongnam-si, Gyeonggi-do, Republic of Korea
 (770) HD Hyundai Infracore Co., LTD.
 75, Yulgok-Ro, Jongno-Gu, Seoul,
 Republic of Korea
 (580) 2023 10 19

(111) M 2011 22074 R
 (732) Bristol-Myers Squibb Company,
 a Delaware Corporation
 Route 206 & Province Line Road,
 Princeton, New Jersey 08543, USA
 (770) Bristol-Myers Squibb Company
 a Delaware Corporation
 430 East 29th Street, 14th Floor, New York,
 New York 10016, USA
 (580) 2023 09 28

(111) M 1998 8621 R
 (732) The Yokohama Rubber CO., LTD
 2-1, Oiwake, Hiratsuka-shi, Kanagawa
 254-8601, Japan
 (770) The Yokohama Rubber CO., LTD
 36-11, Shimbashi 5-chome, Minato-ku,
 Tokyo, Japan
 (580) 2023 10 24

(111) M 2013 24304 R
 (732) Sumitomo Chemical company, Limited
 2-7-1, Nihonbashi, Chuo-ku, Tokyo
 103-6020, Japan
 (770) sumitomo Chemical CO., LTD
 27-1, Shinkawa 2-chome, Chuo-ku, Tokyo
 104-8260, Japan
 (580) 2023 10 10

(111) M 2013 24401 R
(732) NPAO Svetogorsk PPM
Zavodskaya St., Dom. 17, 188991,
Svetogorsk, Russian Federation
(770) NPAO Sylvamo Corporation Rus
Zavodskaya St., Dom. 17, 188991,
Svetogorsk, Russian Federation
(580) 2023 10 13

(111) M 2013 24402 R
(732) NPAO Svetogorsk PPM
Zavodskaya St., Dom. 17, 188991,
Svetogorsk, Russian Federation
(770) NPAO Sylvamo Corporation Rus
Zavodskaya St., Dom. 17, 188991,
Svetogorsk, Russian Federation
(580) 2023 10 13

(111) M 2013 24403 R
(732) NPAO Svetogorsk PPM
Zavodskaya St., Dom. 17, 188991,
Svetogorsk, Russian Federation
(770) NPAO Sylvamo Corporation Rus
Zavodskaya St., Dom. 17, 188991,
Svetogorsk, Russian Federation
(580) 2023 10 13

(111) M 2013 24369 R
(732) NPAO Svetogorsk PPM
Zavodskaya St., Dom. 17, 188991,
Svetogorsk, Russian Federation
(770) NPAO Sylvamo Corporation Rus
Zavodskaya St., Dom. 17, 188991,
Svetogorsk, Russian Federation
(580) 2023 10 13

(111) M 1999 12170 R
(732) The Yokohama Rubber CO., LTD
2-1, Oiwake, Hiratsuka-shi, Kanagawa
254-8601, Japan
(770) The Yokohama Rubber CO., LTD
36-11, Shimbashi 5-chome, Minato-ku,
Tokyo, Japan
(580) 2023 10 24

(111) M 2015 25629 R
(732) The Yokohama Rubber CO., LTD
2-1, Oiwake, Hiratsuka-shi, Kanagawa
254-8601, Japan
(770) The Yokohama Rubber CO., LTD
36-11, 5-chome Shimbashi, Minato-ku,
Tokyo, Japan
(580) 2023 10 24

(111) M 1996 3590 R
(732) The Rockport Company LLC
1220 Washington Street, Newton,
Massachusetts 02465, USA
(770) The Rockport Company LLC
1895 J. W. Foster Boulevard, Canton,
Massachusetts 02021, USA
(580) 2023 10 20

(111) M 1996 4099 R
(732) Bristol-Myers Squibb Company
(a Delaware Corporation)
Route 206 & Province Line Road,
Princeton, New Jersey 08543, USA
(770) Bristol-Myers Squibb Company
(a Delaware Corporation)
430 East 29th Street, 14th Floor, New York,
New York 10016, USA
(580) 2023 09 28

(111) M 1996 4100 R
(732) Bristol-Myers Squibb Company
(a Delaware Corporation)
Route 206 & Province Line Road,
Princeton, New Jersey 08543, USA
(770) Bristol-Myers Squibb Company
(a Delaware Corporation)
430 East 29th Street, 14th Floor, New York,
New York 10016, USA
(580) 2023 09 28

CANCELLATION OF TRADEMARKS REGISTRATION

(111) M 2003 15073 R
(151) 2003 04 16
(732) Public Joint Stock Company
"Zvenigorodskiy Cheese Processing Plant"
Karl Marx St. 35A, 20200 Zvenigorodka,
Ukraine
(141) 2023 10 30

(111) M 2003 15080 R
(151) 2003 04 16
(732) Nissan Jidosha Kabushiki Kaisha
(also trading as Nissan Motor Co., LTD.)
No.2 Takaracho, Kanagawa-ku, Yokohama-
shi, Kanagawa-ken, Japan
(141) 2023 10 30

(111) M 2013 23606 R
(151) 2013 04 26
(732) JSC "Exhibition Center"
Akaki Tsereteli Av. 118, 0119, Tbilisi, Georgia
(141) 2023 10 30

(111) M 2013 23610 R
(151) 2013 04 26
(732) LTD "Marco Georgia"
Railway St. 10, 0101, Tbilisi, Georgia
(141) 2023 11 03

(111) M 2013 23612 R
(151) 2013 04 26
(732) LTD "Georgian Pfeiffer Production"
Mevele St. Lane 2, 0120, Tbilisi, Georgia
(141) 2023 10 30

(111) M 2013 23613 R
(151) 2013 04 26
(732) Thai Energy Storage Technology
Public Company Limited
387 Moo 4, Sukhumvit Road, Phraek Sa
Sub-district, Mueang Samut Prakan District,
Samut Prakan Province, Thailand
(141) 2023 11 03

(111) M 2013 23614 R
(151) 2013 04 26
(732) General Motors LLC
300 Renaissance Center, City of Detroit,
State of Michigan 48265-3000, USA
(141) 2023 11 03

(111) M 2013 23616 R
(151) 2013 04 26
(732) Celltrion Inc.
13-6, Songdo-dong, Yeonsu-gu,
Incheon, Republic of Korea
(141) 2023 10 30

(111) M 2013 23617 R
(151) 2013 04 26
(732) Celltrion Inc.
13-6, Songdo-dong, Yeonsu-gu,
Incheon, Republic of Korea
(141) 2023 11 03

(111) M 2013 23621 R
(151) 2013 04 26
(732) JSC "Lomisi"
Vill. Natakhtari, 3308, Mtskheta, Georgia
(141) 2023 10 30

(111) M 2013 23622 R
(151) 2013 04 26
(732) JSC "Lomisi"
Vill. Natakhtari, 3308, Mtskheta, Georgia
(141) 2023 10 30

(111) M 2013 23624 R
(151) 2013 04 26
(732) DP Everages Limited
PO box 309GT, Uglan House, Souch Church
Street, George Town, Grand Cayman, Cayman
Islands
(141) 2023 11 03

(111) M 2013 23691 R
(151) 2013 05 17
(732) Irakli Manelidze
Avto Varazi 64, ap. 9, Tbilisi, Georgia
(141) 2023 10 30

(111) M 2013 23630 R
(151) 2013 04 26
(732) WM. Wrigley JR. Company
410 North Michigan Avenue, Chicago,
Illinois 60611, USA
(141) 2023 10 30

(111) M 2013 23631 R
 (151) 2013 04 26
 (732) Cinsay Inc.
 a Nevada Corporation
 13355 Noel Road, Suite 400, Dallas,
 Texas 75240, USA
 (141) 2023 11 03

(111) M 2013 23632 R
 (151) 2013 04 26
 (732) JSC "Lomisi"
 Vill. Natakhtari, 3308, Mtskheta, Georgia
 (141) 2023 11 03

(111) M 2013 23633 R
 (151) 2013 04 26
 (732) JSC "Lomisi"
 Vill. Natakhtari, 3308, Mtskheta, Georgia
 (141) 2023 11 03

(111) M 2013 23634 R
 (151) 2013 04 26
 (732) JSC "Lomisi"
 Vill. Natakhtari, 3308, Mtskheta, Georgia
 (141) 2023 10 30

(111) M 2013 23635 R
 (151) 2013 04 26
 (732) Merck Sharp & Dohme Corp.
 One Merck Drive, Whitehouse Station,
 New Jersey 08889, USA
 (141) 2023 10 30

(111) M 2013 23644 R
 (151) 2013 04 26
 (732) Torquay Enterprises Limited
 439 East Tamaki Road East Tamaki
 Auckland, New Zealand
 (141) 2023 11 03

(111) M 2013 23647 R
 (151) 2013 04 26
 (732) Tab Gıda Sanayi ve Ticaret Anonim Şirketi
 Emirhan Cad. AtaKule №109 Dikilitaş
 Beşiktaş İstanbul, Türkiye
 (141) 2023 11 03

(111) M 2013 23648 R
 (151) 2013 04 26
 (732) Tab Gıda Sanayi ve Ticaret Anonim Şirketi
 Emirhan Cad. AtaKule №109 Dikilitaş
 Beşiktaş İstanbul, Türkiye

(141) 2023 11 03

(111) M 2013 23649 R
 (151) 2013 04 26
 (732) JSC "Lomisi"
 Vill. Natakhtari, 3308, Mtskheta, Georgia
 (141) 2023 11 03

(111) M 2013 23650 R
 (151) 2013 04 26
 (732) JSC "Lomisi"
 Vill. Natakhtari, 3308, Mtskheta, Georgia
 (141) 2023 10 30

(111) M 2013 23651 R
 (151) 2013 04 26
 (732) JSC "Lomisi"
 Vill. Natakhtari, 3308, Mtskheta, Georgia
 (141) 2023 10 30

(111) M 2014 24815 R
 (151) 2014 05 30
 (732) National Manufacturing Company S.A.
 Avenida Justo Arosemena y Calle 32,
 Casa №26, Corregimiento de Calidonia,
 Republic of Panama
 (141) 2023 10 30

(111) M 2013 23600 R
 (151) 2013 04 16
 (732) Manana Goglichidze
 Zakaria Paliashvili St. 15, 0179, Tbilisi,
 Georgia
 (141) 2023 10 23

(111) M 2013 23603 R
 (151) 2013 04 23
 (732) Samt LTD
 Suite 11801, 2nd Floor, 145-147 St. John
 Street, London EC1V 4PY, England, United
 Kingdom
 (141) 2023 10 30

(111) M 2013 23605 R
 (151) 2013 04 25
 (732) LTD "Geonet Expo"
 Kutaisi St. 51, 6000, Batumi, Georgia
 (141) 2023 11 01

CLASSIFICATION INDEXES

INVENTIONS

CONCORDANCE TABLE OF INTERNATIONAL CLASSIFICATION INDEX AND PUBLICATION NUMBERS

INTERNATIONAL CLASSIFICATION INDEXES (51)	NUMBER OF PUBLISHED APPLICATION (10)
A 61 K 31/506; A 61 K 31/41; A 61 K 31/497; A 61 K 31/4402; A 61 K 31/4192; A 61 P 35/00; C 07 D 413/06	AP 2023 15827 A
A 61 K 39/00	AP 2023 16018 A
B 61 H 1/00; F 61 D 65/04	AP 2023 15577 A
C 22 B 9/16; C 22 B 9/10; C 22 B 11/02	AP 2023 15809 A

CONCORDANCE TABLE OF PUBLICATION NUMBERS AND INTERNATIONAL CLASSIFICATION INDEX

NUMBER OF PUBLISHED APPLICATION (10)	INTERNATIONAL CLASSIFICATION INDEXES (51)
AP 2023 15577 A	B 61 H 1/00; F 61 D 65/04
AP 2023 15809 A	C 22 B 9/16; C 22 B 9/10; C 22 B 11/02
AP 2023 15827 A	A 61 K 31/506; A 61 K 31/41; A 61 K 31/497; A 61 K 31/4402; A 61 K 31/4192; A 61 P 35/00; C 07 D 413/06
AP 2023 16018 A	A 61 K 39/00

CONCORDANCE TABLE OF INTERNATIONAL CLASSIFICATION INDEX, PATENT NUMBERS AND PUBLICATION NUMBERS

INTERNATIONAL CLASSIFICATION INDEX (51)	NUMBER OF PATENT (11)	NUMBER OF PUBLISHED APPLICATION (10)
A 61 K 31/473; A 61 K 38/20; A 61 P 35/00; C 07 D 219/06	P 2023 7566 B	AP 2023 15959 A
A 61 P 35/00; C 07 K 16/28	P 2023 7565 B	AP 2023 15366 A
B 01 J 19/00	P 2023 7564 B	AP 2023 16061 A

CONCORDANCE TABLE OF PATENT NUMBERS, PUBLICATION NUMBERS AND INTERNATIONAL CLASSIFICATION INDEX

NUMBER OF PATENT (11)	NUMBER OF PUBLISHED APPLICATION (10)	INTERNATIONAL CLASSIFICATION INDEX (51)
P 2023 7564 B	AP 2023 16061 A	B 01 J 19/00
P 2023 7565 B	AP 2023 15366 A	A 61 P 35/00; C 07 K 16/28
P 2023 7566 B	AP 2023 15959 A	A 61 K 31/473; A 61 K 38/20; A 61 P 35/00; C 07 D 219/06

**CONCORDANCE TABLE OF APPLICATION NUMBERS,
PUBLICATION NUMBERS AND PATENTS**

NUMBER OF APPLICATION (21)	NUMBER OF PUBLISHED APPLICATION (10)	NUMBER OF PATENT (11)
AP 2018 15366	AP 2023 15366 A	P 2023 7565 B
AP 2020 15959	AP 2023 15959 A	P 2023 7566 B
AP 2022 16061	AP 2023 16061 A	P 2023 7564 B

APPLICATION***

**CONCORDANCE TABLE OF INTERNATIONAL CLASSIFICATION INDEX
AND PUBLICATION NUMBERS**

INTERNATIONAL CLASSIFICATION INDEXES (51)	NUMBER OF PUBLISHED APPLICATION (10)
A 61 K 39/09; A 61 K 39/385; A 61 K 39/39; A 61 P 37/04; A 61 P 11/00; A 61 P 31/04	AP 2023 16334 A
C 02 F 1/46; C 02 F 1/461; C 02 F 1/467; C 02 F 1/469; C 02 F 103/08; C 02 F 9/00; C 02 F 1/44; C 02 F 1/68	AP 2023 16345 A
C 07 D 487/04	AP 2023 16357 A

**CONCORDANCE TABLE OF PUBLICATION NUMBERS
AND INTERNATIONAL CLASSIFICATION INDEX**

NUMBER OF PUBLISHED APPLICATION (10)	INTERNATIONAL CLASSIFICATION INDEXES (51)
AP 2023 16334 A	A 61 K 39/09; A 61 K 39/385; A 61 K 39/39; A 61 P 37/04; A 61 P 11/00; A 61 P 31/04
AP 2023 16345 A	C 02 F 1/46; C 02 F 1/461; C 02 F 1/467; C 02 F 1/469; C 02 F 103/08; C 02 F 9/00; C 02 F 1/44; C 02 F 1/68
AP 2023 16357 A	C 07 D 487/04

UTILITY MODELS**CONCORDANCE TABLE OF INTERNATIONAL CLASSIFICATION INDEX,
PATENT NUMBERS AND PUBLICATION NUMBERS**

INTERNATIONAL CLASSIFICATION INDEX (51)	NUMBER OF PATENT (11)	NUMBER OF PUBLISHED APPLICATION (10)
A 23 K 1/16	U 2023 2158 Y	AU 2023 15890 U

**CONCORDANCE TABLE OF PATENT NUMBERS,
PUBLICATION NUMBERS AND INTERNATIONAL CLASSIFICATION INDEX**

NUMBER OF PATENT (11)	NUMBER OF PUBLISHED APPLICATION (10)	INTERNATIONAL CLASSIFICATION INDEX (51)
U 2023 2158 Y	AU 2023 15890 U	A 23 K 1/16

**CONCORDANCE TABLE OF APPLICATION NUMBERS,
PUBLICATION NUMBERS AND PATENTS**

NUMBER OF APPLICATION (21)	NUMBER OF PUBLISHED APPLICATION (10)	NUMBER OF PATENT (11)
AU 2022 15890	AU 2023 15890 U	U 2023 2158 Y

DESIGNS**CONCORDANCE TABLE OF INTERNATIONAL CLASSIFICATION INDEX
AND PUBLICATION NUMBERS**

INTERNATIONAL CLASSIFICATION INDEXES (51)	NUMBER OF PUBLISHED APPLICATION (10)
11-01	AD 2023 1319 S

**CONCORDANCE TABLE OF PUBLICATION NUMBERS
AND INTERNATIONAL CLASSIFICATION INDEX**

NUMBER OF PUBLISHED APPLICATION (10)	INTERNATIONAL CLASSIFICATION INDEXES (51)
AD 2023 1319 S	11-01

DESIGNS REGISTERED ACCORDING TO THE ACCELERATED PROCEDURE

CONCORDANCE TABLE OF INTERNATIONAL CLASSIFICATION INDEX AND PUBLICATION NUMBERS

INTERNATIONAL CLASSIFICATION INDEXES (51)	NUMBER OF REGISTRATION (11)
09-01; 09-03	D 2023 982 S

CONCORDANCE TABLE OF PUBLICATION NUMBERS AND INTERNATIONAL CLASSIFICATION INDEX

NUMBER OF REGISTRATION (11)	INTERNATIONAL CLASSIFICATION INDEXES (51)
D 2023 982 S	09-01; 09-03

CONCORDANCE TABLE OF APPLICATION NUMBERS, PUBLICATION NUMBERS AND PATENTS

NUMBER OF APPLICATION (21)	NUMBER OF REGISTRATION (11)
AD 2023 1338	D 2023 982 S

TRADEMARKS

CONCORDANCE TABLE OF REGISTRATION NUMBERS, APPLICATION NUMBERS, PUBLICATION NUMBERS AND BULLETIN NUMBERS

NUMBER OF REGISTRATION (111)	NUMBER OF APPLICATIONS (210)	NUMBER OF PUBLISHED APPLICATIONS (260)	NUMBER OF BULLETIN
1	2	3	4
M 2023 37425 R	AM 120597	AM 2023 120597 A	12(615)2023
M 2023 37426 R	AM 120233	AM 2023 120233 A	12(615)2023
M 2023 37427 R	AM 119282	AM 2023 119282 A	8(611)2023
M 2023 37428 R	AM 120129	AM 2023 120129 A	12(615)2023
M 2023 37429 R	AM 119190	AM 2023 119190 A	7(610)2023
M 2023 37430 R	AM 118766	AM 2023 118766 A	10(613)2023
M 2023 37431 R	AM 117272	AM 2022 117272 A	24(603) 2022
M 2023 37432 R	AM 120234	AM 2023 120234 A	12(615)2023
M 2023 37433 R	AM 120502	AM 2023 120502 A	11(614)2023
M 2023 37434 R	AM 120052	AM 2023 120052 A	11(614)2023
M 2023 37435 R	AM 120024	AM 2023 120024 A	12(615)2023
M 2023 37436 R	AM 120506	AM 2023 120506 A	12(615)2023
M 2023 37437 R	AM 119278	AM 2023 119278 A	7(610)2023
M 2023 37438 R	AM 120519	AM 2023 120519 A	12(615)2023
M 2023 37439 R	AM 120444	AM 2023 120444 A	12(615)2023
M 2023 37440 R	AM 120445	AM 2023 120445 A	12(615)2023
M 2023 37441 R	AM 119343	AM 2023 119343 A	7(610)2023
M 2023 3742 R	AM 125059	-	21(624)2023
M 2023 3743 R	AM 125064	-	21(624)2023
M 2023 3744 R	AM 124807	-	21(624)2023
M 2023 3745 R	AM 124965	-	21(624)2023
M 2023 37446 R	AM 124817	-	21(624)2023
M 2023 37447 R	AM 118839	AM 2023 118839 A	9(612)2023
M 2023 37448 R	AM 120351	AM 2023 120351 A	12(615)2023
M 2023 37449 R	AM 120022	AM 2023 120022 A	12(615)2023
M 2023 37450 R	AM 119897	AM 2023 119897 A	10(613)2023
M 2023 37451 R	AM 119619	AM 2023 119619 A	10(613)2023
M 2023 37452 R	AM 120737	AM 2023 120737 A	13(616)2023
M 2023 37453 R	AM 120724	AM 2023 120724 A	13(616)2023
M 2023 37454 R	AM 119819	AM 2023 119819 A	9(612)2023
M 2023 37455 R	AM 120532	AM 2023 120532 A	12(615)2023
M 2023 37456 R	AM 120533	AM 2023 120533 A	12(615)2023
M 2023 37457 R	AM 120168	AM 2023 120168 A	10(613)2023
M 2023 37458 R	AM 120534	AM 2023 120534 A	12(615)2023
M 2023 37459 R	AM 120535	AM 2023 120535 A	12(615)2023
M 2023 37460 R	AM 119810	AM 2023 119810 A	9(612)2023
M 2023 37461 R	AM 120176	AM 2023 120176 A	11(614)2023
M 2023 37462 R	AM 120021	AM 2023 120021 A	12(615)2023
M 2023 37463 R	AM 120177	AM 2023 120177 A	11(614)2023
M 2023 37464 R	AM 120175	AM 2023 120175 A	11(614)2023
M 2023 37465 R	AM 119895	AM 2023 119895 A	10(613)2023
M 2023 37466 R	AM 119896	AM 2023 119896 A	10(613)2023
M 2023 37467 R	AM 119898	AM 2023 119898 A	10(613)2023
M 2023 37468 R	AM 120341	AM 2023 120341 A	11(614)2023
M 2023 37469 R	AM 125165	-	21(624)2023
M 2023 37470 R	AM 125141	-	21(624)2023

CONCORDANCE TABLE OF INDEX OF GOODS AND/OR SERVICES
AND APPLICATION NUMBERS

INDEX OF GOODS AND/OR SERVICES (511)	NUMBER OF PUBLISHED APPLICATIONS (260)	1	2
1	2		
1	AM 2023 121909 A	32	AM 2023 122427 A
5	AM 2023 121901 A	32	AM 2023 122428 A
5	AM 2023 121902 A	33	AM 2023 121733 A
5	AM 2023 121936 A	33	AM 2023 122025 A
5	AM 2023 122412 A	33	AM 2023 122205 A
5	AM 2023 122649 A	33	AM 2023 122224 A
6	AM 2023 122197 A	34	AM 2023 122574 A
6	AM 2023 122386 A	34	AM 2023 122575 A
7	AM 2023 122135 A	35	AM 2023 121733 A
8	AM 2023 122135 A	35	AM 2023 121917 A
11	AM 2023 122135 A	35	AM 2023 122008 A
14	AM 2023 121538 A	35	AM 2023 122295 A
14	AM 2023 122198 A	35	AM 2023 122420 A
14	AM 2023 122295 A	35	AM 2023 122421 A
15	AM 2023 122041 A	35	AM 2023 122423 A
16	AM 2023 122008 A	35	AM 2023 122425 A
24	AM 2023 121538 A	35	AM 2023 122426 A
25	AM 2023 121538 A	35	AM 2023 122427 A
29	AM 2023 122282 A	35	AM 2023 122428 A
30	AM 2023 122282 A	36	AM 2023 122016 A
30	AM 2023 122406 A	38	AM 2023 122023 A
30	AM 2023 122423 A	41	AM 2023 122023 A
32	AM 2023 119370 A	41	AM 2023 122500 A
32	AM 2023 122008 A	41	AM 2023 122567 A
32	AM 2023 122425 A	43	AM 2023 122212 A
32	AM 2023 122426 A	43	AM 2023 122282 A
		43	AM 2023 122405 A
		43	AM 2023 122567 A
		44	AM 2023 122404 A
		45	AM 2023 122389 A

CONCORDANCE TABLE OF INDEX OF GOODS AND/OR SERVICES
AND NUMBERS OF TRADEMARKS REGISTERED ACCORDING
TO THE ACCELERATED PROCEDURE

INDEX OF GOODS AND/OR SERVICES (511)	NUMBERS OF REGISTERED ACCORDING TO THE ACCELERATED PROCEDURE (111)
3	M 2023 37444 R
5	M 2023 37480 R
14	M 2023 37445 R
17	M 2023 37481 R
18	M 2023 37483 R
25	M 2023 37483 R
29	M 2023 37442 R
29	M 2023 37470 R
29	M 2023 37479 R
30	M 2023 37443 R
32	M 2023 37482 R
33	M 2023 37469 R
35	M 2023 37445 R
35	M 2023 37470 R
38	M 2023 37446 R
41	M 2023 37484 R
44	M 2023 37485 R

OFFICIAL BULLETIN OF THE INDUSTRIAL PROPERTY

INVENTIONS

UTILITY MODELS

DESIGNS

TRADEMARKS

APPELLATION OF ORIGIN OF GOODS

21(624)

EDITOR-IN-CHIEF: N. Bebrishvili

EDITOR-TRANSLATOR: E. Gabunia

PROOFREADER: A. Shikhashvili

COMPUTER LAYOUT: M. Ordenidze
K. Svanidze

ISSN 2720-8486

info@sakpatenti.gov.ge
www.sakpatenti.gov.ge