

# Official Bulletin of the Industrial Property

Inventions

Utility Models

Designs

Trademarks



საქართველოს ინტელექტუალური  
საკუთრების ეროვნული ცენტრი

**საქპატენტი**

**SAKPATENTI**

NATIONAL INTELLECTUAL PROPERTY  
CENTER OF GEORGIA

[www.sakpatenti.gov.ge](http://www.sakpatenti.gov.ge)

Date of Publication – 2023 01 25

**2(605)**

# INID CODES FOR IDENTIFICATION OF BIBLIOGRAPHIC DATA

## INVENTIONS, UTILITY MODELS

- (10) Number of publication for application, which has been examined
- (11) Number of patent and kind of document
- (21) Serial number of application
- (22) Date of filing of the application
- (23) Date of exhibition or the date of the earlier filing and the number of application, if any
- (24) Date from which patent may have effect
- (31) Number of priority application
- (32) Date of filing of priority application
- (33) Code of the country or regional organization allotting priority application number
- (44) Date of publication of application not granted, but examined and number of bulletin
- (45) Date of publication of registered document
- (51) International Patent Classification Index

- (54) Title of the invention
- (57) Abstract
- (60) Number of examined patent document granted by foreign patent office, date from which patent has effect and country code
- (62) Number of the earlier application and in case of divided application, date of filing an application
- (71) Name, surname and address of applicant (country code)
- (72) Name, surname of inventor (country code)
- (73) Name, surname and address of patent owner (country code)
- (74) Name, surname of representative or patent attorney
- (85) Date of commencement of the national phase of International Application
- (86) Number and date of filing of international application
- (87) Number and date of publication of international application
- (94) Calculated date of expiry of the SPC or the duration of the SPC

## DESIGNS

- (10) Number of publication for application
- (11) Number of patent and kind of document or number of registration
- (15) Date of registration/Date of patent renewal
- (18) Expected expiration date of patent or registration
- (21) Serial number of application
- (22) Date of filing of the application
- (23) Date of exhibition or the date of the earlier filing and the number of application, if any
- (24) Date from which patent may have effect
- (28) Number of designs included in the application
- (30) Data relating to priority (number of application, date of filing of application, two-letter code identifying the authority with whom the priority application was made)
- (31) Number of priority application
- (32) Date of filing of priority application
- (33) Code of the country or regional organization allotting priority application number
- (34) Two-letter code according to WIPO St.3 identifying the authority with which the priority application was made
- (44) Date of publication of design and number of bulletin (the first publication)
- (45) Date of publication of design registered by WIPO and number of bulletin

- (51) International Classification for designs (class and subclass of the Locarno Classification)
- (54) Title of the invention
- (55) Reproduction of the design
- (57) Description of characteristic features of the design including indication of colors
- (58) Date of recording of any kind of amendment in the Register
- (62) Number of the earlier application, registration and document number and if available the date of filing an application in case of divided application
- (71) Name, surname and address of applicant (country code)
- (72) Name, surname of creator (country code)
- (73) Name, surname and address of patent owner (country code)
- (74) Name, surname of representative or patent attorney
- (81) Contracting states concerned
  - II designated contracting states according to the 1960 Act
  - III designated contracting states according to the 1999 Act
- (85) Owner's permanent address
- (86) Owner's nationality
- (87) Owner's residence
- (88) State in which the owner has a real and effective industrial or commercial establishment

## TRADEMARKS

- (111) - Number of registration
- (151) - Date of registration
- (156) - Date of the renewal
- (181) - Expected expiration date of registration
- (186) - Renewal expiration date of registration
- (141) - Date of cancel of duration of the mark
- (210) - Serial number of application
- (220) - Date of filing of the application
- (230) - Data concerning exhibition
- (260) - Number of application, for which favorable decision of examination about registration has been taken (publication number)
- (310) - Number of the first application
- (320) - Date of filing of the first application
- (330) - Code, identifying national or regional Office where the first application was made
- (511) - International Classification of Goods and Services for the purposes of registration of trade marks and/or list of goods and/or services classified according thereto
- (526) - Disclaimer
- (531) - Description of figurative elements of Trade Marks according to the International Classification of the Figurative Elements of Marks

- (540) - Reproduction of Trade Mark
- (550) - Nature and kind of Trade Mark
- (551) - Indication to the effect that the mark is a collective mark, a certification mark or a guarantee mark
- (554) - Three-dimensional mark
- (580) - Date of recording of any kind changes in respect of applications or registrations
- (591) - Information concerning colors claimed
- (731) - Name and address of the applicant
- (732) - Name and address of the holder of the registration
- (740) - Name and address of the representative
- (750) - Addreses for correspondence
- (770) - Name and address of the previous applicant or holder in case of change in ownership
- (771) - Previous name and address of the applicant or holder in case of change in ownership
- (791) - Name and address of the licensee
- (793) - Indication of conditions and/or restrictions under the license (Type of license, number of license agreement, data of license, data of validity of license)
- (800) - Certain data relating to the international registration of Trade Marks under the Protocol Relating to Madrid Agreement (International registration number
- (852) - Partial cancellation of the list of goods and services
- (891) - Date of subsequent designation

## CODES FOR PUBLICATION IN BULLETIN

- (21) AP 0000 000000 - serial number of application for invention
- (10) AP 0000 0000 A - number of published application for invention (first publication)
- (11) P 0000 0000 B - number of patent for invention (second publication)
- (21) API 0000 000000 - number of application for imported patent
- (11) PI 0000 0000 A - number of imported patent (first publication)
- (21) AU 0000 000000 - serial number of application for utility model
- (10) AU 0000 000 U - number of published application for utility model (first publication)
- (11) U 0000 000 Y - number of patent for utility model (second publication)
- (21) AD 0000 000000 - serial number of application for design
- (10) AD 0000 000 S - number of published application for design (first publication)
- (11) D 0000 000 S - registered design

## INTERNATIONAL PATENT CLASSIFICATION FOR INVENTIONS AND UTILITY MODELS

- SECTION A - HUMAN NECESSITIES
- SECTION B - PERFORMING OPERATIONS; TRANSPORTING
- SECTION C - CHEMISTRY; METALLURGY
- SECTION D - TEXTILES; PAPER
- SECTION E - FIXED CONSTRUCTIONS
- SECTION F - MECHANICAL ENGINEERING; LIGHTING; HEATING; WEAPONS; BLASTING
- SECTION G - PHYSICS
- SECTION H - ELECTRICITY

- 
- M - Trade Mark
  - (210) AM 0000 000000 - Serial number of application;
  - (260) AAM 0000 00000 A - Publication number of application;
  - (111) M 0000 00000 R - Number of registration;
  - (111) MMM0000 00000 Rn - Number of renewals, in which n=1,2,3;
  - (111) M 0000 00000 R(P) - Number of registration under partial assignment of rights
-

# Official Bulletin of the Industrial Property

Inventions

Utility Models

Designs

Trademarks

# CONTENT

<b>PUBLISHED TITLES OF PROTECTION</b> .....	3
<b>INVENTIONS</b>	
▪ APPLICATIONS APPROVED FOR GRANTING PATENT .....	4
▪ PATENTED INVENTIONS .....	6
<b>UTILITY MODELS</b>	
▪ APPLICATIONS APPROVED FOR GRANTING PATENT .....	9
▪ PATENTED UTILITY MODELS .....	11
<b>DESIGNS</b>	
▪ DESIGN REGISTERED ACCORDING TO THE ACCELERATED PROCEDURE .....	12
▪ DESIGNS, WHICH HAVE BEEN REGISTERED WITH THE INTERNATIONAL BUREAU CLAIMING PRIORITY ON THE TERRITORY OF GEORGIA .....	16
<b>TRADEMARKS</b>	
▪ APPLICATIONS FILED UNDER THE NATIONAL PROCEDURE APPROVED FOR REGISTRATION .....	21
▪ REGISTERED TRADEMARKS .....	32
▪ TRADEMARKS REGISTERED ACCORDING TO THE ACCELERATED PROCEDURE .....	36
▪ INTERNATIONAL TRADEMARKS FOR WHICH A DECISION ON GRANTING PROTECTION IS TAKEN .....	40
▪ INTERNATIONAL TRADEMARKS PROTECTED IN GEORGIA .....	87
<b>OFFICIAL NOTIFICATIONS</b>	
<b>INVENTIONS</b>	
▪ RESTORATION OF PATENT .....	95
▪ ABOLITION OF PATENTS WITH THE RIGHT TO RESTORE .....	95
▪ DATE OF PATENTS RESTORATION EXPIRATION .....	97
▪ EXPIRATION OF TERMS OF PATENT .....	97
<b>UTILITY MODELS</b>	
▪ RESTORATION OF PATENT .....	98
▪ ABOLITION OF PATENTS WITH THE RIGHT TO RESTORE .....	98
▪ DATE OF PATENTS RESTORATION EXPIRATION .....	99
▪ TRANSFER OF RIGHT .....	99
<b>DESIGNS</b>	
▪ EXTENSION OF TERMS OF DESIGNS REGISTRATION .....	100
▪ CANCELLATION OF DESIGNS REGISTRATION .....	100
<b>TRADEMARKS</b>	
▪ EXTENSION OF TERMS OF TRADEMARKS REGISTRATION .....	101
▪ COMPLETE TRANSFER OF RIGHTS .....	104
▪ CHANGES OF NAMES AND/OR ADDRESSES OF TRADEMARKS OWNERS .....	105
▪ CANCELLATION OF TRADEMARKS REGISTRATION .....	107
▪ REGISTRATION OF LICENSE AGREEMENTS .....	112
▪ INTERNATIONAL LICENSE AGREEMENTS .....	113
<b>CLASSIFICATION INDEXES</b>	
INVENTIONS .....	114
UTILITY MODELS .....	115
DESIGN .....	117
TRADEMARKS .....	118

## **PUBLISHED TITLES OF PROTECTION**

### **INVENTIONS**

- **APPLICATIONS APPROVED FOR GRANTING PATENT:**  
15794; 15500; 15635
- **PATENTED INVENTIONS:**  
7459-7466

### **UTILITY MODELS**

- **APPLICATIONS APPROVED FOR GRANTING PATENT:**  
15907; 15787
- **PATENTED UTILITY MODELS:**  
2142, 2143

### **DESIGNS**

- **DESIGN REGISTERED ACCORDING TO THE ACCELERATED PROCEDURE:**  
955
- **DESIGNS, WHICH HAVE BEEN REGISTERED WITH THE INTERNATIONAL BUREAU CLAIMING PRIORITY ON THE TERRITORY OF GEORGIA:**  
221298; 224951; 221341

### **TRADEMARKS**

- **APPLICATIONS FILED UNDER THE NATIONAL PROCEDURE APPROVED FOR REGISTRATION:**  
116620\*, 117840; 118141; 118222; 118226, 118227; 118229; 118231; 118235; 118241; 118244; 118247; 118288- 118296; 118298, 118299; 118301; 118303; 118305-118311; 118377; 118379-118383; 118388; 118392; 118404- 118406; 118408, 118409; 118412-118415; 118470; 118476, 118477; 118479; 118532-118535; 118537; 118539; 118548; 118550; 118565; 118634-118638; 118644-118646
- **REGISTERED TRADEMARKS:**  
36303, 36304; 36310-36321; 36325-36330; 36332-36348
- **TRADEMARKS REGISTERED ACCORDING TO THE ACCELERATED PROCEDURE:**  
36297-36302; 36305-36309; 36322-36324; 36331; 36349-36355
- **INTERNATIONAL TRADEMARKS FOR WHICH A DECISION ON GRANTING PROTECTIONS IS TAKEN:**  
114425\*, 114507; 115262; 116060; 116694; 116806; 117204; 117212; 117358; 117365, 117366, 117369; 117373; 117396; 117463; 117465; 117471; 117490; 117511; 117515; 117562; 117572-117579; 117581; 117588; 117592; 117638-117647; 117680-117683; 117690, 117691; 117766; 118183
- **INTERNATIONAL TRADEMARKS PROTECTED IN GEORGIA:**  
110103; 113564; 115487; 115548; 115616; 115733; 115781-115790; 115820-115823; 115826-115830; 115834; 115904-115909; 115911-115914; 115916-115923; 115948; 115950, 115951; 115954, 115955; 115957-115967; 116002-116012; 116014-116017; 116027; 116029; 116031-116035; 116047-116051; 116053; 116055, 116056; 116065; 116080-116086; 116097; 116112; 116258; 116491; 116678; 116686

---

# INVENTIONS

## APPLICATIONS APPROVED FOR GRANTING PATENT

The decision can be appealed at the Chamber of Appeal of Sakpatenti within 3 months from the publication or at the Mtskheta District Court Administrative Cases Board (Address: №17, Samkhedro St., Mtskheta), within 1 month following the publication.

### PART A

#### A 61

- (10) AP 2023 15794 A (51) Int. Cl. (2006)  
A 61 K 31/4025  
A 61 K 31/4015  
A 61 P 31/14  
C 07 D 401/12  
C 07 D 403/14  
C 07 D 497/04  
C 07 D 403/12  
C 07 D 207/267
- (21) AP 2021 15794 (22) 2021 08 06  
(31) 63/073,982; 63/143,435; 63/170,158; 63/194,241  
(32) 2020 09 03; 2021 01 29; 2021 04 02; 2021 05 28  
(33) US; US; US; US  
(71) PFIZER INC. (US)  
235 East 42<sup>nd</sup> Street, New York, NY 10017,  
USA (US)
- (72) PETTERSSON, Martin Youngjin (US);  
YANG, Qingyi (US);  
VERHOEST, Patrick Robert (US);  
TUTTLE, Jamison Bryce (US);  
OWEN, Dafydd Rhys (US);  
REESE, Matthew Richard (US);  
WEI, Liuqing (US);  
SAMMONS, Matthew Forrest (US);  
YANG, Xiaojing (US)
- (74) Tamar Kochlamazashvili  
(85) 2021 11 10  
(86) PCT/IB2021/057281, 2021 08 06  
(54) NITRILE-CONTAINING ANTIVIRAL  
COMPOUNDS  
(57) Present invention relates to compound: (1R, 2S,  
5S)-N-[(1S)-1-cyano-2-[(3S)-2-oxo-3-pyrrolidinyl]  
ethyl]-6,6-dimethyl-3-[3-methyl-N-(trifluoroacetyl)-L-  
valyl]-3-azabicyclo [3.1.0] hexane-2-carboxamide, and  
their solid forms, compositions thereof, and usage  
thereat the treatment of coronaviruses COVID-19  
infection.  
Claims: 4 independents  
22 dependents  
Fig.: 15
- 

- (10) AP 2023 15500 A (51) Int. Cl. (2006)  
A 61 K 35/74  
A 61 P 5/00  
A 61 P 1/00  
C 12 P 17/165  
C 12 P 19/40  
C 12 R 1/225

- (21) AP 2019 15500 (22) 2019 07 24  
(31) 1812079.0; 1905470.9  
(32) 2018 07 24; 2019 04 17  
(33) GB; GB  
(71) BIOGAIA AB (SE)  
PO Box 3242, Kungsbrolan 3A, 10364,  
Stockholm, Sweden (SE)
- (72) ROOS, Stefan (SE);  
MÖLLSTAM, Bo (SE)
- (74) Shalva Gvaramadze  
(85) 2020 11 26  
(86) PCT/EP2019/069984, 2019 07 24  
(54) SELECTION AND USE OF MELATONIN  
SUPPORTING BACTERIA TO REDUCE  
INFANTILE COLIC  
(57) Novel lactic acid bacterial strains – Lactobacil-  
lus reuteri, capable to produce or induce the produ-  
ction of melatonin, are disclosed. Therapeutic uses  
of such strains including the treatment or preventi-  
on of diseases associated with melatonin deficien-  
cy, for example infantile colic.  
Claims: 7 independents  
7 dependents  
Fig.: 5
-

**PART C****C 12**

(10) AP 2023 15635 A (51) Int. Cl. (2006)  
C 12 N 5/04

(21) AP 2021 15635 (22) 2021 05 17

(71) Irakli Partsvania (GE)

Egnate Ninoshvili St. 3, 6000, Batumi,  
Georgia (GE)

(72) Irakli Partsvania (GE)

(54) METHOD FOR MICROCLONAL PROPAGA-  
TION OF FRUIT TREES AND BERRY  
CROPS

(57) An invention relates to a method for microclonal propagation of fruit trees and berry crops, providing plant material cultivation in tissue culture, and the tincture of Schizandra (*Schisandra chinensis*) is added in nourishing area thereof.

Claims: 1 independent

---

## PATENTED INVENTIONS

### PARTA

#### A 01

- (11) P 2023 7464 B (51) Int. Cl. (2006)  
A 01 G 9/12
- (10) AP 2022 15922 A (44) 18(597)/2022
- (21) AP 2022 15922
- (22) 2022 04 04
- (24) 2022 04 04
- (73) Tornike Mzhavanadze (GE)  
Iliko Kurkhuli St. 4, Tbilisi, Georgia (GE)
- (72) Tornike Mzhavanadze (GE)
- (54) TRANSFORMABLE GREENHOUSE SYSTEM

- (11) P 2023 7461 B (51) Int. Cl. (2006)  
A 01 N 43/78  
C 07 D 277/56
- (10) AP 2022 15670 A (44) 15(594)/2022
- (21) AP 2019 15670
- (22) 2019 11 28
- (24) 2019 11 28
- (31) 18209586.9
- (32) 2018 11 30
- (33) EP
- (86) PCT/EP2019/082978, 2019 11 28
- (73) Syngenta Crop Protection AG (CH)  
Rosentalstrasse 67, Basel 4058,  
Switzerland (CH)
- (72) BURNS, David (GB);  
MONACO, Mattia, Riccardo (CH);  
RENDINE, Stefano (CH);  
LAMBERTH, Clemens (CH);  
BLUM, Mathias (CH)
- (74) Tamar Kochlamazashvili
- (54) MICROBIOCIDAL 2-ACYLAMINO-  
THIAZOLE-4-CARBOXAMIDE  
DERIVATIVES

#### A 23

- (11) P 2023 7463 B (51) Int. Cl. (2006)  
A 23 K 10/18
- (10) AP 2022 15714 A (44) 18(597)/2022
- (21) AP 2021 15714
- (22) 2021 08 06
- (24) 2021 08 06
- (73) Vladimer Elisashvili (GE)  
Didi Dighomi, III m/r, bld. 29, ap. 34a, Tbilisi,  
Georgia (GE);

- Tamar Khardziani (GE)  
Dighomi Array, I qu., bld. 6, ap. 58, Tbilisi,  
Georgia (GE);  
Amrosi Chkuaseli (GE)  
Ketevan Tsamebuli Ave. 76b, ap. 8, Tbilisi,  
Georgia (GE)
- (72) Vladimer Elisashvili (GE);  
Tamar Khardziani (GE);  
Amrosi Chkuaseli (GE)
- (54) METHOD FOR SPORE-FORMING PROBIO-  
TICS PRODUCTION AND THEIR USAGE IN  
POULTRY FARMING

#### A 61

- (11) P 2023 7459 B (51) Int. Cl. (2006)  
A 61 K 31/54  
A 61 P 25/18  
C 07 D 285/16  
C 07 D 471/04  
C 07 D 417/12  
C 07 D 417/04
- (10) AP 2022 15558 A (44) 14(593)/2022
- (21) AP 2019 15558
- (22) 2019 07 12
- (24) 2019 07 12
- (31) P1800249
- (32) 2018 07 13
- (33) HU
- (86) PCT/IB2019/055949, 2019 07 12
- (73) Richter Gedeon Nyrt. (HU)  
Gyömrői út. 19-21, H-1103 Budapest,  
Hungary (HU)
- (72) LEDNECZKI, István (HU);  
ÉLES, János (HU);  
TAPOLCSÁNYI, Pál (HU);  
JABLONKAI, Erszébet (HU);  
GÁBOR, Eszter (HU);  
VISEGRÁDI, András (HU);  
NÉMETHY, Zsolt (HU);  
LÉVAY, György István (HU);  
PETRO, József Levente (HU);  
SELÉNYI, György (HU)
- (74) Liliana Darakhvelidze
- (54) THIADIAZINE DERIVATIVES

- (11) P 2023 7460 B (51) Int. Cl. (2006)  
A 61 K 31/437  
A 61 P 35/00  
C 07 D 471/04
- (10) AP 2022 15446 A (44) 16(595)/2022
- (21) AP 2019 15446
- (22) 2019 07 22



- (24) 2019 07 22  
 (31) 201810867252.2  
 (32) 2018 07 31  
 (33) CN  
 (86) PCT/CN2019/097028, 2019 07 22  
 (73) Ascentage Pharma (Suzhou) Co., LTD. (CN)  
 Unit 701, Bldg. B7, 218 Xinghu Street, Suzhou  
 Industrial Park, Suzhou Jiangsu  
 215000, Public Republic of China (CN)  
 (72) YANG, Dajun (CN);  
 ZHAI, Yifan (CN);  
 WANG, Guangfeng (CN)  
 (74) Tamaz Shilakadze  
 (54) SYNERGISTIC ANTITUMOR EFFECT OF  
 BCL-2 INHIBITOR COMBINED WITH RI-  
 TUXIMAB AND/OR BENDAMUSTINE OR  
 BCL-2 INHIBITOR COMBINED WITH  
 CHOP

---

(11) P 2023 7466 B (51) Int. Cl. (2006)  
 A 61 K 39/395  
 A 61 P 27/02  
 A 61 P 7/00  
 C 07 K 16/40

(10) AP 2022 14913 A (44) 18(597)/ 2022

(21) AP 2017 14913

(22) 2017 03 31

(24) 2017 03 31

(31) 62/315,857

(32) 2016 03 31

(33) US

(86) PCT/US2017/025411, 2017 03 31

(73) Univercity Of Leicester (GB)

Univercity Rd., Leicester, Lestershere LE1 7RF,  
 UK (GB);

Omeros Corporation (US)

201 Elliott Ave W, Seattle, WA 98119,  
 USA (US)

(72) TJOELKER, Larry (US);

SCHWABLE, Hans-Wilhelm (GB);

DADLER, Thomas (US);

DEMOPOLUS, Gregory A. (US)

(74) Tamar Kochlamazashvili

(54) METHODS OF INHIBITING ANGIOGE-  
 NESIS IN PATIENT

## PART B

### B 03

- (11) P 2023 7465 B (51) Int. Cl. (2006)  
 B 03 B 9/06  
 C 04 B 28/14  
 C 04 B 18/16  
 E 04 C 2/02  
 (10) AP 2022 15265 A (44) 15(594)/2022  
 (21) AP 2017 15265  
 (22) 2017 06 29  
 (24) 2017 06 29  
 (86) PCT/EP2017/000772, 2017 06 29  
 (73) Knauf Gips KG (DE)  
 Am Bahnhof 7, Iphofen 97346, Germany (DE)  
 (72) HALBACH, Martin (DE);  
 LIU, Tong (CN)  
 (74) Tamar Kochlamazashvili  
 (54) METHOD OF PRODUCING GYPSUM  
 SLURRY FOR FORMING GYPSUM  
 PRODUCTS AND METHOD OF  
 MANUFACTURING GYPSUM PRODUCT

### B 61

- (11) P 2023 7462 B (51) Int. Cl. (2006)  
 B 61 B 7/00  
 (10) AP 2022 15565 A (44) 16(595)/2022  
 (21) AP 2021 15565  
 (22) 2021 02 19  
 (24) 2021 02 19  
 (73) Ramaz Tkemaladze (GE)  
 Vill. Etseri, 5510, Chiatura, Georgia (GE);  
 Malkhaz Tsutskiridze (GE)  
 Ikalto St. 3, 0171, Tbilisi, Georgia (GE);  
 Nugzar Tsintsadze (GE)  
 Gldani, I m/r., bld. 13, app. 2, 0167, Tbilisi,  
 Georgia (GE);  
 Zaur Chitidze (GE)  
 Tarkhnishvili St. 16, 0179, Tbilisi,  
 Georgia (GE);  
 Vakhtang Abaishvili (GE)  
 Shartava St. 6, app. 53, 0160, Tbilisi,  
 Georgia (GE);  
 Tinatin Gogishvili (GE)  
 Gldani Gorge, bld. 3, app. 111, 0107, Tbilisi,  
 Georgia (GE);  
 Malkhaz Akhvlediani (GE)  
 Gldani, II m/r., bld. 45, app. 95, 0167, Tbilisi,  
 Georgia (GE);  
 Irakli Grdzlishvili (GE)  
 Vazha-Pshavela St. 4a, app. 6, 3700, Rustavi,  
 Georgia (GE);  
 Nikoloz Gelashvili (GE)  
 Dighomi Array, III qu., bld. 1a, app. 74, 0159,  
 Tbilisi, Georgia (GE);

- Igor Gelashvili (GE)  
Rustavi Highway 28a, app. 1, 0165, Tbilisi,  
Georgia (GE);  
Davit Mosulishvili (GE)  
Megobroba Av., bld. 41, app. 64, 3700, Rustavi,  
Georgia (GE);  
Zaur Balamtsarashvili (GE)  
S. Tsintsadze St. 7, 0160, Tbilisi, Georgia (GE)
- (72) Ramaz Tkemaladze (GE);  
Malkhaz Tsutskiridze (GE);  
Nugzar Tsintsadze (GE);  
Zaur Chitidze (GE);  
Vakhtang Abaishvili (GE);  
Tinatin Gogishvili (GE);  
Malkhaz Akhvlediani (GE);  
Irakli Grdzelishvili (GE);  
Nikoloz Gelashvili (GE);  
Igor Gelashvili (GE);  
Davit Mosulishvili (GE);  
Zaur Balamtsarashvili (GE)
- (54) SHORT DISTANCE MOBILE AERIAL  
ROPEWAY LOG PULLER MACHINE
-

# UTILITY MODELS

## APPLICATIONS APPROVED FOR GRANTING PATENT

The decision can be appealed at the Chamber of Appeal of Sakpatenti within 3 months from the publication or at the Mtskheta District Court Administrative Cases Board (Address: №17, Samkhedro St., Mtskheta), within 1 month following the publication.

### PART A

#### A 61

(10) AU 2023 15907 U (51) Int. Cl. (2006)

A 61 M 5/14

(21) AU 2022 15907 (22) 2022 03 16

(71) Zurab Chkhaidze (GE)

Marie Brosset St. 2, 0108, Tbilisi,

Georgia (GE);

Nodar Khodeli (GE)

Budapest St. 40, Tbilisi, Georgia (GE);

Otar Shengelia (GE)

Davit Garejeli St. 49, Tbilisi, Georgia (GE);

Davit Songhulashvili (GE)

Teodore Tironi St. 10, VIII. Dighomi, Tbilisi,

Georgia (GE);

LEPL Shota Rustaveli National Science

Foundation of Georgia (GE)

M. Aleksidze St. 2, Turn II, 0193, Tbilisi,

Georgia (GE)

(72) Zurab Chkhaidze (GE);

Nodar Khodeli (GE);

Otar Shengelia (GE);

Davit Songhulashvili (GE)

(54) DEVICE FOR CREATING PULSATING  
BLOOD FLOW

(57) A device includes couple of tanks 1 and 2, inlet 7 and 8, and outlet 5 and 6 blood-conducts having electric external lockers 11, 12, 13 and 14 for connecting thereto a body disposed thereon; at that, said tanks are connected together by means of water-conducts 9 and 10, and water reverse roller pump 19, and soft-wall bag for blood 3 and 4, having inlet and outlet blood-conducts with lockers, are hermetically mounted into each tank. The device has control panel equipped with relevant software for outer lockers open-lock with convenient frequency and duration, and automatic adjustment of roller pump reverse operation by switching of external locks in contradictory positions.

Claims: 1 independent

Fig.: 2

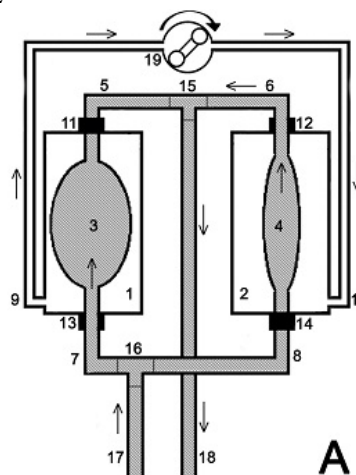

Fig. 1

### PART C

#### C 04

(10) AU 2023 15787 U (51) Int. Cl. (2006)

C 04 B 38/00

C 04 B 38/02

(21) AU 2021 15787 (22) 2021 11 05

(71) Elena Shapakidze (GE)

Ilia Chavchavadze Ave. 35a, ap. 7, 0179,

Tbilisi, Georgia (GE);

Lamara Gabunia (GE)

Toradze Dead End 5, 0108, Tbilisi,

Georgia (GE);

Izolda Kamushadze (GE)

Nutsubidze Plateau IV m/r, bld. 28, ap. 21,

0183, Tbilisi, Georgia (GE);

Ioseb Gejadze (GE)

Ilia Chavchavadze Ave., I Lane, bld. 6, ap. 7,

0179, Tbilisi, Georgia (GE);

Tamar Petriashvili (GE)

Vill. Zemo Nikozi, 1417, Gori, Georgia (GE);

Ivane Javakhishvili Tbilisi State University (GE)

Ilia Chavchavadze Ave. 1, 0179, Tbilisi,

Georgia (GE);

LEPL "Shota Rustaveli National Science

Foundation of Georgia" (GE)

M. Aleksidze St. 2, Turn II, 0193, Tbilisi,  
Georgia (GE)

- (72) Elena Shapakidze (GE);  
Lamara Gabunia (GE);  
Izolda Kamushadze (GE);  
Ioseb Gejadze (GE);  
Tamar Petriashvili (GE)

(54) MIXTURE OF RAW MATERIALS FOR  
OBTAINING POROUS HEAT-INSULATION  
MATERIAL

(57) A mixture of raw materials for obtaining porous heat-insulating material contains a shale. Furthermore, it contains manganese-containing production waste (slag or dust or sludge), boron processing waste ( $H_3BO_3$ ) and sulfate-alcohol mud, as additional corrective additive, with certain ratio of componentry (mass%).

Claims: 1 independent

Table: 2

---

---

## PATENTED UTILITY MODELS

### PART A

#### A 21

- (11) U 2023 2143 Y (51) Int. Cl. (2006)  
A 21 C 1/00  
A 21 D 10/04
- (10) AU 2022 15768 U (44) 15(594)/2022  
(21) AU 2021 15768  
(22) 2021 10 23  
(24) 2021 10 23
- (73) Ramini Ghvaladze (GE)  
Varketili 3, IV m/r, bld. 414, app. 165, Tbilisi,  
Georgia (GE)
- (72) Ramini Ghvaladze (GE)
- (54) DEVICE FOR KNEADING DOUGH  
WITHOUT YEAST
- 

### PART F

#### F 03

- (11) U 2023 2142 Y (51) Int. Cl. (2006)  
F 03 B 13/00
- (10) AU 2022 15880 U (44) 17(596)/2022  
(21) AU 2022 15880  
(22) 2022 02 17  
(24) 2022 02 17
- (73) Ana Rokhvadze (GE)  
Kazbegi Av. 10a, app. 66, 0177, Tbilisi,  
Georgia (GE)
- (72) Ana Rokhvadze (GE)
- (54) HYDROPOWER PLANT
-

---

# DESIGNS

## DESIGN REGISTERED ACCORDING TO THE ACCELERATED PROCEDURE

The decision can be appealed at the Chamber of Appeal of Sakpatenti within 3 months from the publication.

- (11) D 2023 955 S           (51) 02-04  
(21) AD 2022 1282       (22) 2022 11 16  
(24) 2022 11 16  
(28) 7  
(18) 2027 11 16  
(73) Gvantsa Macharashvili (GE)  
Ilia Chavchavadze Ave. 49e, 0179, Tbilisi, Georgia (GE);  
Nino Macharashvili (GE)  
Ilia Chavchavadze Ave. 49e, 0179, Tbilisi, Georgia (GE)  
(72) Gvantsa Macharashvili (GE);  
Nino Macharashvili (GE)  
(54) SHUES  
(55)



1.1



1.2



1.3



1.4



1.5



1.6



1.7



1.8



2.1



2.2



2.3



3.1



3.2



3.3



3.4



4.1



4.2



4.3



4.4



5.1



5.2





6.1



6.2



6.3



7.1



7.2



7.3

**DESIGNS, WHICH HAVE BEEN REGISTERED WITH THE INTERNATIONAL BUREAU CLAIMING PRIORITY ON THE TERRITORY OF GEORGIA**

The decision can be appealed at the Chamber of Appeal of Sakpatenti within 3 months from the publication or at the Mtskheta District Court Administrative Cases Board (Address: №17, Samkhedro St., Mtskheta), within 1 month following the publication.

- (11) DM/221 298
- (15) 2022 05 23
- (22) 2022 05 23
- (28) 1
- (73) HARRY WINSTON SA  
Chemin du Tourbillon 8, 1228 Plan-les-Ouates (CH)
- (85) CH
- (86) CH
- (87) CH
- (88) CH
- (89) CH
- (81) II. MA III. AL, AM, AZ, BA, BZ, CA, CH, EM, GB, GE, KG, LI, MC, MD, ME, MK, MN, NO, OM, RU, SG, TN, TR, UA
- (72) Carole PIERRE  
c/o Harry Winston SA Chemin du Tourbillon 8, 1228, Plan-les-Ouates (CH)
- (74) The Swatch Group AG (The Swatch Group SA) (The Swatch Group Ltd.)  
Faubourg du Lac 6, 2501 Biel/Bienne (CH)
- (46) 2022 11 25
- (54) 1. WATCH
- (55)



1.1

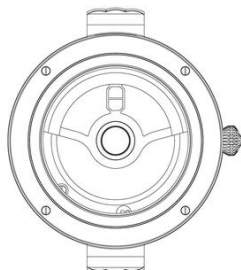

1.2

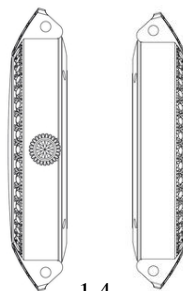

1.3

1.4

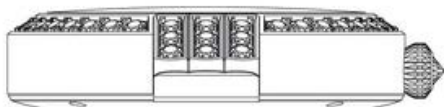

1.5

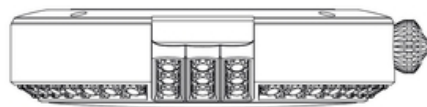

1.6



1.7

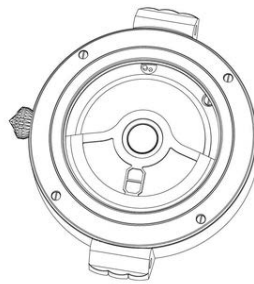

1.8

- (11) DM/224 951 (51) 28-03  
(15) 2022 11 03 (44) 48/2022 (2022 12 02)  
(22) 2022 11 03  
(28) 1  
(30) No1: 04.05.2022; 009015142; EM  
(73) INDUSTRIAS BETER S.A.  
C/ Aribau, 200, 7. Planta, 08036 BARCELONA (ES)  
(85) –  
(86) ES  
(87) –  
(88) –  
(89) EM  
(81) III. EG, GE, MX, NO, RU, UA  
(72) MARIA LUISA MESTRE MASSA  
C/ Aribau, 200, 7. Planta, 08036, BARCELONA (ES)  
(74) DURAN-CORRETJER, S.L.P.  
C/ Còrsega, 329 (P° de Gracia / Diagonal), 08037 BARCELONA (ES)  
(46) 2022 12 02  
(54) 1. COSMETIC MIRROR  
(55)

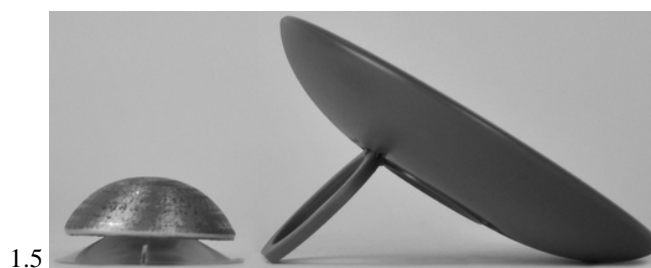
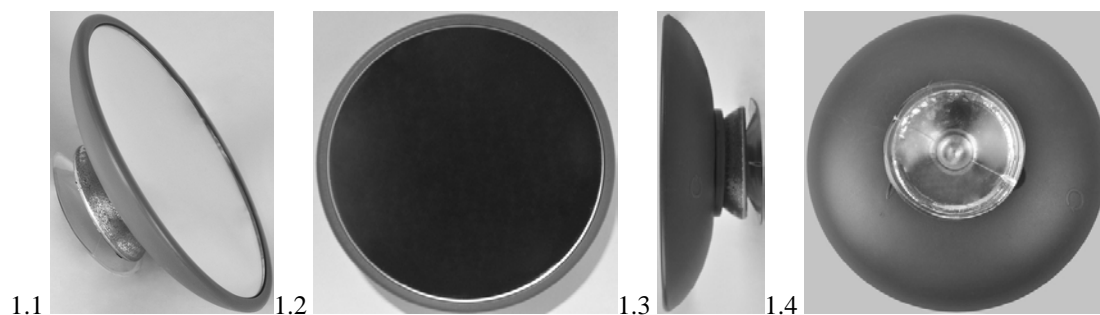

- (11) DM/221 341
- (15) 2022 06 10
- (22) 2022 06 10
- (28) 3
- (73) HARRY WINSTON SA  
Chemin Du Tourbillon 8, 1228 Plan-les-Ouates (CH)
- (85) CH
- (86) CH
- (87) CH
- (88) CH
- (89) CH
- (81) II. MA III. AL, AM, AZ, BA, BZ, CA, CH, EM, GB, GE, KG, LI, MC, MD, ME, MK, MN, NO, OM, SG, TN, TR, UA
- (72) 1 Christina YANG  
C/o Harry Winston Inc., 718 Fifth Avenue, 10019, New York (US);  
2 Rie YATSUGI-KANG  
C/o Harry Winston Inc., 718 Fifth Avenue, 10019, New York (US);  
3 Delphine ABDOURAHIM  
C/o Harry Winston Inc., 718 Fifth Avenue, 10019, New York (US)
- (74) The Swatch Group AG (The Swatch Group SA) (The Swatch Group Ltd.)  
Faubourg Du Lac 6, 2501 Biel/Bienne (CH)
- (46) 2022 12 16
- (54) 1. FINGER RING, 2. NECKLACE, 3. NECKLACE
- (55)



1.1



1.2



1.3



1.4



1.5



1.6



1.7



1.8



2.1



2.2



2.3



2.4



2.5



2.6



2.7



2.8



2.9



3.1



3.2



3.3



3.4



3.5



3.6



3.7



3.8

---

# TRADEMARKS

## APPLICATIONS FILED UNDER THE NATIONAL PROCEDURE APPROVED FOR REGISTRATION

The decision can be appealed at the Chamber of Appeal of Sakpatenti within 3 months from the publication or at the Mtskheta District Court Administrative Cases Board (Address: №17, Samkhedro St., Mtskheta), within 1 month following the publication.

(260) AM 2023 116620 A\*  
(210) AM 116620  
(220) 2022 02 11  
(731) LLC "Georgian Legend"  
I. Abashidze Str. 70, Entrance 3, ap. 118,  
0162, Tbilisi, Georgia  
(740) Giorgi Taktakishvili  
(540)

### ЛЕГЕНДА ГРУЗИИ

(591) Black-white  
(511) 33

---

(260) AM 2023 117840 A  
(210) AM 117840  
(220) 2022 05 19  
(731) Mikheil Berishvili  
Shota Modebadze Str. 66, 3700, Rustavi,  
Georgia  
(540)



(591) Light grey, golden, black  
(531) 05.07.02; 05.11.15; 25.01.19; 25.03.05;  
29.01.13  
(526) რუსთავი RUSTAVI  
(511) 32

---

(260) AM 2023 118141 A  
(210) AM 118141  
(220) 2022 06 13  
(731) LTD "Zebra Group"  
Bakhtrioni Str. 28, 0194, Tbilisi, Georgia

(540)



(591) White, orange  
(531) 03.03.03; 26.04.02; 26.04.04; 26.04.08;  
26.04.15; 26.04.22; 26.04.24; 29.01.12  
(511) 16

---

(260) AM 2023 118222 A  
(210) AM 118222  
(220) 2022 06 20  
(731) Brass Monkey Holding Limited  
The Gold and Diamond Park, Office  
102&103, Building 6, P.O. Box 450676, Jebel  
Ali Free Zone, Dubai, United Arab Emirates  
(540)



(591) Black-white  
(531) 02.01.01; 02.01.23; 04.02.20; 09.01.10;  
16.03.13; 25.01.05; 27.05.01; 27.05.03;  
27.05.09; 27.05.10; 27.05.24  
(511) 25, 35, 41, 43

---

(260) AM 2023 118226 A  
 (210) AM 118226  
 (220) 2022 06 20  
 (731) LLC "TR Georgia Project 2"  
 Chitadze Str. 3a/Niaghvari Str. 4, ap. 11,  
 Mtatsminda District, Tbilisi, Georgia  
 (540)

**Iori Valley**  
**იორი ველი**

(591) Black-white  
 (511) 29, 30, 31, 43

(260) AM 2023 118227 A  
 (210) AM 118227  
 (220) 2022 06 20  
 (731) LLC "TR Georgia Project 2"  
 Chitadze Str. 3a/Niaghvari Str. 4, ap. 11,  
 Mtatsminda District, Tbilisi, Georgia  
 (540)

**იორის ხეობა**

(591) Black-white  
 (511) 29, 30, 31, 43

(260) AM 2023 118229 A  
 (210) AM 118229  
 (220) 2022 06 21  
 (731) FMC Agro Singapore Pte Ltd.  
 10 Marina Boulevard, N40 – 01, Marina Bay  
 Financial Centre, Singapore, 018983,  
 Singapore;  
 FMC Corporation  
 2929 Walnut Street Philadelphia,  
 Pennsylvania, 19104, USA  
 (740) Tamaz Shilakadze  
 (540)

**CORAGEN**

(591) Black-white  
 (511) 5

(260) AM 2023 118231 A  
 (210) AM 118231  
 (220) 2022 06 21  
 (731) Davit Gigauri  
 Vill. Kvemo Sobisi, Gori Region, Georgia  
 (540)

**მიწდა**

(591) Black-white  
 (511) 29, 30, 32, 33, 35, 43

(260) AM 2023 118235 A  
 (210) AM 118235  
 (220) 2022 06 21  
 (731) Vistros INTL-F.Z.E  
 Makateb Business Centers, Office No.26,  
 Al Shorafa Complex, Sh Khalifa Bin Zayed  
 Road, P.O. Box 380, Ajman, United Arab  
 Emirates  
 (540)

**3 Tekel**  
**000**

(591) Black-white  
 (531) 27.05.01; 27.05.12; 27.07.01; 27.07.11;  
 27.07.12  
 (511) 34

(260) AM 2023 118241 A  
 (210) AM 118241  
 (220) 2022 06 22  
 (731) Ani Burduli  
 Zaza Panaskertel-Tsitsishvili Str., bld. 18,  
 0194, Tbilisi, Georgia  
 (540)



(591) F2E5B2 yellow, E46CA9 pink  
 (531) 08.01.18; 08.01.24; 26.01.16; 26.01.20; 28.19;  
 29.01.13  
 (511) 30, 35

(260) AM 2023 118244 A  
 (210) AM 118244  
 (220) 2022 06 23  
 (731) LTD "IBEL Academy"  
 Borjomi Str. 12, 3300, Mtskheta, Georgia  
 (540)



(591) 60B347 green, 7E4394 lilac, white  
 (531) 09.07.22; 24.15.13; 27.05.01; 27.05.09;  
 27.05.10; 29.01.12  
 (511) 16, 41



(260) AM 2023 118247 A  
 (210) AM 118247  
 (220) 2022 06 23  
 (731) Companhia Minuano De Alimentos  
 Av. Senador Alberto Pasqualine, No.1535,  
 Lajeado 95913-162, Brazil  
 (740) Giorgi Taktakishvili  
 (540)

**MINUANO ROYAL**

(591) Black-white  
 (511) 29

(260) AM 2023 118288 A  
 (210) AM 118288  
 (220) 2022 06 24  
 (731) Hasan Syulyun  
 Guryanov Str., 4, Bld. 2, ap. 229, 109548,  
 Moskow, Russian Federation  
 (740) Giorgi Taktakishvili  
 (540)



(591) Yellow, blue  
 (531) 09.03.02; 09.03.13; 26.04.02; 26.04.22;  
 26.04.24; 27.05.01; 27.05.24; 29.01.12  
 (511) 16, 25, 35

(260) AM 2023 118289 A  
 (210) AM 118289  
 (220) 2022 06 24  
 (731) Hasan Syulyun  
 Guryanov Str., 4, Bld. 2, ap. 229, 109548,  
 Moskow, Russian Federation  
 (740) Giorgi Taktakishvili  
 (540)



(591) Yellow, blue  
 (531) 09.03.02; 09.03.13; 26.04.22; 26.04.24;  
 27.05.01; 27.05.04; 27.05.24; 29.01.12  
 (511) 16, 25, 35

(260) AM 2023 118290 A  
 (210) AM 118290  
 (220) 2022 06 24  
 (731) Hasan Syulyun  
 Guryanov Str., 4, Bld. 2, ap. 229, 109548,  
 Moskow, Russian Federation  
 (740) Giorgi Taktakishvili  
 (540)

**Megahand**

(591) Black-white  
 (511) 16, 25, 35

(260) AM 2023 118291 A  
 (210) AM 118291  
 (220) 2022 06 24  
 (731) Hasan Syulyun  
 Guryanov Str., 4, Bld. 2, ap. 229, 109548,  
 Moskow, Russian Federation  
 (740) Giorgi Taktakishvili  
 (540)

**Мегахенд**

(591) Black-white  
 (511) 16, 25, 35

(260) AM 2023 118292 A  
 (210) AM 118292  
 (220) 2022 06 24  
 (731) Hasan Syulyun  
 Guryanov Str., 4, Bld. 2, ap. 229, 109548,  
 Moskow, Russian Federation  
 (740) Giorgi Taktakishvili  
 (540)



(591) Yellow, blue  
 (531) 09.03.02; 09.03.13; 26.04.01; 26.04.04;  
 29.01.12  
 (511) 16, 25, 35

(260) AM 2023 118293 A  
 (210) AM 118293  
 (220) 2022 06 24  
 (731) LLC "Palavani"  
 Shindisi Highway 19, Gori, Georgia  
 (740) Giorgi Taktakishvili  
 (540)

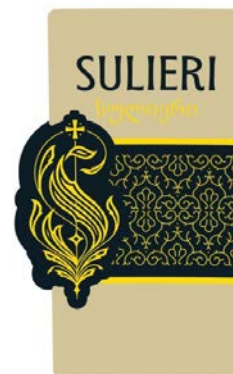

(591) Yellow, straw-color, black

(531) 24.13.01; 25.01.05; 25.01.19; 25.01.25;  
29.01.13  
(511) 3

(260) AM 2023 118294 A  
(210) AM 118294  
(220) 2022 06 24  
(731) LLC "Amaline Group"  
Dighomi, IV qu., bld. 25, ap. 48, 0159, Didube  
District, Tbilisi, Georgia  
(740) Giorgi Meipariani  
(540)



(591) Green, black, white  
(531) 05.03.15; 27.05.01; 27.05.09; 27.05.10;  
29.01.13  
(511) 32

(260) AM 2023 118295 A  
(210) AM 118295  
(220) 2022 06 24  
(731) LLC "Amaline Group"  
Dighomi, IV qu., bld. 25, ap. 48, 0159, Didube  
District, Tbilisi, Georgia  
(740) Giorgi Meipariani  
(540)



(591) White, black, grey  
(531) 26.11.09; 26.13.01; 27.05.01; 27.05.09;  
27.05.10  
(511) 32

(260) AM 2023 118296 A  
(210) AM 118296  
(220) 2022 06 24  
(731) LTD "Gemovani"  
Krtsanisi Str. 22-24, ap. 44, Tbilisi, Georgia  
(540)

საკურნელა

(591) Black-white  
(511) 30, 33

(260) AM 2023 118298 A  
(210) AM 118298  
(220) 2022 06 25  
(731) JSC "Kotekhi-Gurjaani Winery"  
K. Koroghlishvili Str. 38, 1500, Gurjaani,  
Georgia  
(740) Dimitri Dzamukashvili  
(540)

Glenmerisi - გლენმერისი

(591) Black-white  
(511) 33

(260) AM 2023 118299 A  
(210) AM 118299  
(220) 2022 06 28  
(731) Mikheil Songhulashvili  
Village Dighomi, Davit Aghmashenebeli  
Dead End 2, ap. 5, 0159, Tbilisi, Georgia  
(740) Dimitri Dzamukashvili  
(540)

მუსაიფი  
Musaifi

(591) Black-white  
(511) 33

(260) AM 2023 118301 A  
(210) AM 118301  
(220) 2022 06 28  
(731) Shenzhen GreenSound High-Tech Co., LTD  
2nd/3rd Flor Bilding Si, 2nd/3rd Flor Bilding  
Di, 13rd Tonfuiu Industrial Park, Hepin  
Qomiuniti, Fuhai Strit Bao'an Distriqt,  
Shenjen Siti 518000, People's Republic of  
China  
(740) Nino Bakhtadze  
(540)

VAPORLAX

(591) Black-white  
(531) 27.05.01; 27.05.22  
(511) 34

(260) AM 2023 118303 A  
(210) AM 118303  
(220) 2022 06 29  
(731) Levan Nekreselashvili  
Vill. Gombori, Sagarejo, Georgia

(540)

საარი  
SAARI

(591) Black-white  
(511) 33

(260) AM 2023 118305 A  
(210) AM 118305  
(220) 2022 06 29  
(731) JSC "Teliani Valley"  
Tbilisi Highway 3, 2200, Telavi,  
Georgia

(540)



(591) FFFFFFF white, A00C0C carmelian,  
50BA1B green, 428702 light green  
(531) 02.01.15; 02.01.18; 06.19.07; 19.01.03;  
19.01.25; 28.19; 29.01.14  
(511) 33

(260) AM 2023 118306 A  
(210) AM 118306  
(220) 2022 06 29  
(731) JSC "Teliani Valley"  
Tbilisi Highway 3, 2200, Telavi, Georgia  
(540)

თელი  
Teli  
Тели

(591) Black-white  
(511) 33

(260) AM 2023 118307 A  
(210) AM 118307  
(220) 2022 06 29  
(731) JSC "Teliani Valley"  
Tbilisi Highway 3, 2200, Telavi,  
Georgia

(540)



LE CAUCASE

(591) Black-white  
(531) 02.01.20; 02.01.21; 03.03.01; 09.07.01;  
09.07.25; 18.01.01; 18.01.03; 27.05.01  
(511) 33

(260) AM 2023 118308 A  
(210) AM 118308  
(220) 2022 06 30  
(731) KT & G Corporation  
71, Beotkkot-gil, Daedeok-gu, Daejeon,  
Republic of Korea  
(740) Giorgi Taktakishvili  
(540)

ფიტი

(591) Black-white  
(511) 34

(260) AM 2023 118309 A  
(210) AM 118309  
(220) 2022 06 30  
(731) KT & G Corporation  
71, Beotkkot-gil, Daedeok-gu, Daejeon,  
Republic of Korea  
(740) Giorgi Taktakishvili  
(540)

ფიტ რეგულარ დიფი

(591) Black-white  
(511) 34

(260) AM 2023 118310 A  
(210) AM 118310  
(220) 2022 06 30  
(731) KT & G Corporation  
71, Beotkkot-gil, Daedeok-gu, Daejeon,  
Republic of Korea  
(740) Giorgi Taktakishvili  
(540)

ფიტ რეგულარ სქაი

(591) Black-white  
(511) 34

(260) AM 2023 118311 A  
(210) AM 118311  
(220) 2022 06 30  
(731) KT & G Corporation  
71, Beotkkot-gil, Daedeok-gu, Daejeon,  
Republic of Korea  
(740) Giorgi Taktakishvili  
(540)

## ფიჭ ვიოლა

(591) Black-white  
(511) 34

---

(260) AM 2023 118377 A  
(210) AM 118377  
(220) 2022 07 01  
(731) Meta Platforms, Inc.  
1601 Willow Road, Menlo Park, California  
94025, USA  
(740) Shalva Gvaramadze  
(540)

## REELS

(591) Black-white  
(511) 9, 38, 41, 45

---

(260) AM 2023 118379 A  
(210) AM 118379  
(220) 2022 07 03  
(731) KT & G Corporation  
71, Beotkkot-gil, Daedeok-gu, Daejeon,  
Republic of Korea  
(740) Pavle Meipariani  
(540)

## BLOOMING

(591) Black-white  
(511) 34

---

(260) AM 2023 118380 A  
(210) AM 118380  
(220) 2022 07 03  
(731) KT & G Corporation  
71, Beotkkot-gil, Daedeok-gu, Daejeon,  
Republic of Korea  
(740) Pavle Meipariani  
(540)

## CONCORD

(591) Black-white  
(511) 34

---

(260) AM 2023 118381 A  
(210) AM 118381  
(220) 2022 07 03  
(731) KT & G Corporation

71, Beotkkot-gil, Daedeok-gu, Daejeon,  
Republic of Korea  
(740) Pavle Meipariani  
(540)

## INDIGO

(591) Black-white  
(511) 34

---

(260) AM 2023 118382 A  
(210) AM 118382  
(220) 2022 07 03  
(731) KT & G Corporation  
71, Beotkkot-gil, Daedeok-gu, Daejeon,  
Republic of Korea  
(740) Pavle Meipariani  
(540)

## LANDUS

(591) Black-white  
(511) 34

---

(260) AM 2023 118383 A  
(210) AM 118383  
(220) 2022 07 04  
(731) KT & G Corporation  
71, Beotkkot-gil, Daedeok-gu, Daejeon,  
Republic of Korea  
(740) Pavle Meipariani  
(540)

## ESSE CHANGE

(591) Black-white  
(511) 34

---

(260) AM 2023 118388 A  
(210) AM 118388  
(220) 2022 07 04  
(731) Gela Peradze  
S. Tsintsadze Str. 34, ap. 2, 0160, Tbilisi,  
Georgia  
(540)

## SAVANELO

## სავანელო

(591) Black-white  
(511) 33

---

(260) AM 2023 118392 A  
(210) AM 118392  
(220) 2022 07 05  
(731) Weiguang Hong  
No. 602, West ladder, Building 38, Longyuan  
New Village, Liusha North Street, Puning,

Guangdong, 515300, People's Republic of  
China

(740) Giorgi Kartvelishvili  
(540)



(591) Black-white  
(531) 26.04.04; 26.04.22; 26.04.24; 27.05.01;  
27.05.24  
(511) 16

(260) AM 2023 118404 A  
(210) AM 118404  
(220) 2022 07 06  
(731) LTD "Tfilisis Marani"  
Paliashvili Str. 33, ap. 6, 0179, Tbilisi, Georgia  
(540)



(591) 000000 Black, white  
(531) 20.07.01; 20.07.02; 24.01.15; 25.01.15;  
25.01.17; 25.01.19; 25.01.25  
(511) 32, 33

(260) AM 2023 118405 A  
(210) AM 118405  
(220) 2022 07 06  
(731) LTD "Tfilisis Marani"  
Paliashvili Str. 33, ap. 6, 0179, Tbilisi, Georgia  
(540)



**GEMRIELI**

(591) 000000 Black, white  
(531) 24.01.15; 25.01.19; 26.05.01; 26.13.25;  
27.05.01; 27.05.21  
(511) 32, 33

(260) AM 2023 118406 A  
(210) AM 118406  
(220) 2022 07 06  
(731) Tequila Cuervo, S.A. DE C.V.  
Avenida Periferico Sur No. 8500,  
Tlaquepaque, Jalisco, C.P. 45609, Mexico

(740) Liliana Darakhvelidze  
(540)

**JOSE CUERVO PLATINO  
RESERVA DE LA FAMILIA**

(591) Black-white  
(511) 33

(260) AM 2023 118408 A  
(210) AM 118408  
(220) 2022 07 06  
(310) 37079  
(320) 2022 01 27  
(330) AD  
(731) Philip Morris Products S.A.  
Quai Jeanrenaud 3, 2000 Neuchâtel,  
Switzerland  
(740) Pavle Meipariani  
(540)



(591) Black, white, grey  
(531) 10.01.18; 26.02.07; 26.04.02; 26.04.04;  
26.04.13; 26.04.16; 26.04.18; 26.04.22;  
26.04.24; 27.05.21; 27.05.24  
(511) 34

(260) AM 2023 118409 A  
(210) AM 118409  
(220) 2022 07 06  
(310) 37010  
(320) 2022 01 26  
(330) AD  
(731) Philip Morris Products S.A.  
Quai Jeanrenaud 3, 2000 Neuchâtel,  
Switzerland  
(740) Pavle Meipariani  
(540)

**VEEBA**

(591) Black-white  
(531) 27.05.01; 27.05.17  
(511) 34

(260) AM 2023 118412 A  
 (210) AM 118412  
 (220) 2022 07 07  
 (731) LLC "M2 Group"  
 Aleksandre Kazbegi Ave. 15, 0179, Tbilisi,  
 Georgia

(540)



(591) White, black, grey, orange  
 (531) 24.17.07; 26.04.01; 26.04.07; 26.04.18;  
 26.11.09; 27.05.21; 29.01.13  
 (511) 36, 37

(260) AM 2023 118413 A  
 (210) AM 118413  
 (220) 2022 07 07  
 (731) LLC "M2 Group"  
 Aleksandre Kazbegi Ave. 15, 0179, Tbilisi,  
 Georgia

(540)

**m<sup>2</sup> – ყველაფერი აუცილებელი**

(591) Black-white  
 (531) 24.17.07; 28.19  
 (511) 36, 37

(260) AM 2023 118414 A  
 (210) AM 118414  
 (220) 2022 07 07  
 (731) LLC "HPM"  
 Kipshidze Str., Lane 15, floor 3, Tbilisi,  
 Georgia

(540)



(591) Orange, white  
 (531) 27.05.01; 27.05.22; 28.19; 29.01.12  
 (511) 36, 37, 43

(260) AM 2023 118415 A  
 (210) AM 118415  
 (220) 2022 07 08  
 (731) LLC "Premiera.TM"  
 Trikotazhi Str. 3/ V. Ninua Str. 3/ Trikotazhi  
 Str. 3, Gldani-Nadzaladevi District, Tbilisi,  
 Georgia

(540)

**wilner**

(591) Black-white  
 (511) 25

(260) AM 2023 118470 A  
 (210) AM 118470  
 (220) 2022 07 08  
 (731) Maksim Korzhov  
 Sovetskaya Str. 7/104, Khartsyzk, Ukraine

(540)



(591) Black, white, yellow  
 (531) 26.03.01; 26.03.24; 27.05.08; 29.01.12  
 (511) 9

(260) AM 2023 118476 A  
 (210) AM 118476  
 (220) 2022 07 08  
 (731) LTD "Bolero & Company"  
 Kuchishvili Str. 12-14-16, 0179, Tbilisi,  
 Georgia

(540)

**ბაბიკო  
 ДЗАМИКО  
 DZAMIKO**

(591) Black-white  
 (511) 33

(260) AM 2023 118477 A  
 (210) AM 118477  
 (220) 2022 07 08  
 (731) LTD "Be Yo"  
 St. Ketevan Dedopali Ave. 41/ Samasi  
 Aragveli Str. 6, Entrance 1, floor 2, Tbilisi,  
 Georgia

(540)



(591) White, turquoise  
 (511) 43

(260) AM 2023 118479 A  
 (210) AM 118479  
 (220) 2022 07 08  
 (731) LLC "Business Laboratory"  
 Adam Mickiewicz Str. 29b, floor 1, Saburtalo  
 District, Tbilisi, Georgia  
 (540)



(591) Black, green, light green, blue  
 (531) 01.13.15; 24.17.02; 27.05.01; 27.05.10;  
 29.01.14  
 (511) 35

(260) AM 2023 118532 A  
 (210) AM 118532  
 (220) 2022 07 11  
 (731) LLC "Aversi-Pharma"  
 David Aghmashenebli Ave. 148, 0112, Tbilisi,  
 Georgia  
 (540)

ვილტამეტი  
**Viltamet**  
**Вилтамет**

(591) Black-white  
 (511) 5

(260) AM 2023 118533 A  
 (210) AM 118533  
 (220) 2022 07 11  
 (731) LLC "Aversi-Pharma"  
 David Aghmashenebli Ave. 148, 0112, Tbilisi,  
 Georgia  
 (540)

გლორმეტი  
**Глормет**  
**Glormet**

(591) Black-white  
 (511) 5

(260) AM 2023 118534 A  
 (210) AM 118534  
 (220) 2022 07 11  
 (731) LLC "Tegeta Motors"  
 Davit Aghmashenebeli Alley 129, 0131,  
 Tbilisi, Georgia  
 (740) Giorgi Kartvelishvili  
 (540)

**TEGETA**  
 HOLDING

(591) Yellow, grey, white  
 (531) 26.11.01; 26.11.05; 26.11.08; 27.05.01;  
 27.05.11; 27.05.17; 29.01.12  
 (511) 1, 4, 7, 9, 12, 35, 37, 40

(260) AM 2023 118535 A  
 (210) AM 118535  
 (220) 2022 07 11  
 (731) LLC "Tegeta Motors"  
 Davit Aghmashenebeli Alley 129, 0131,  
 Tbilisi, Georgia  
 (740) Giorgi Kartvelishvili  
 (540)

**თეგეტა**  
 ჰოლდინგი

(591) Grey, yellow, white  
 (531) 26.11.01; 26.11.05; 26.11.08; 28.19; 29.01.12  
 (511) 1, 4, 7, 9, 12, 35, 37, 40

(260) AM 2023 118537 A  
 (210) AM 118537  
 (220) 2022 07 12  
 (731) LTD "Aragvi Spirit Chonkadze"  
 Vill. Aragvispiri, Dusheti Region, Georgia  
 (740) Shalva Gvaramadze  
 (540)



(591) Blue, white, straw-color  
 (531) 01.03.15; 06.01.01; 06.01.04; 06.03.11;  
 19.11.09; 26.01.03; 26.01.16; 26.01.21;  
 27.05.24; 29.01.13  
 (511) 33

(260) AM 2023 118539 A  
 (210) AM 118539  
 (220) 2022 07 12  
 (731) LLC "Palavani"  
 Shindisi Highway 19, Gori, Georgia  
 (740) Giorgi Taktakishvili  
 (540)



(591) Yellow, red, black  
 (531) 05.03.04; 25.01.19; 26.04.02; 26.04.07;  
 26.04.22; 26.04.24; 27.05.01; 27.05.10;  
 29.01.13  
 (511) 33

(260) AM 2023 118548 A  
 (210) AM 118548  
 (220) 2022 07 13  
 (731) Davit Potskhveria  
 Viktor Dolidze Str. 60, Tbilisi, Georgia  
 (740) Tamar Kharazishvili  
 (540)

ძვობს  
**Mkisa**  
**Мкиса**

(591) Black-white  
 (511) 1, 5, 29, 30, 31, 32, 44

(260) AM 2023 118550 A  
 (210) AM 118550  
 (220) 2022 07 13  
 (731) Davit Potskhveria  
 Viktor Dolidze Str. 60, Tbilisi, Georgia  
 (740) Tamar Kharazishvili  
 (540)



(591) Dark green, light green, white, orange, pink,  
 crimson, peach pink  
 (531) 02.01.23; 02.03.23; 04.05.01; 04.05.02;  
 04.05.04; 05.03.14; 29.01.13  
 (511) 1, 5, 29, 30, 31, 32, 44

(260) AM 2023 118565 A  
 (210) AM 118565  
 (220) 2022 07 14  
 (731) Jaba Jakeli  
 K. Gamsakhurdia Str. 38, Batumi,  
 Georgia  
 (540)



(591) Black-white  
 (531) 26.04.07; 26.04.22; 26.04.24; 27.05.02;  
 27.05.24; 28.19  
 (511) 43

(260) AM 2023 118634 A  
 (210) AM 118634  
 (220) 2022 07 17  
 (731) KT & G Corporation  
 71, Beotkkot-gil, Daedeok-gu, Daejeon,  
 Republic of Korea  
 (740) Pavle Meipariani  
 (540)

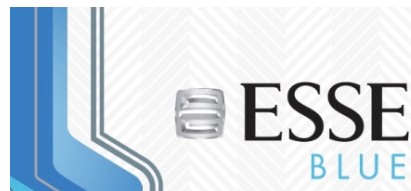

(591) Blue, sky-blue, silver, black, grey  
 (531) 25.07.01; 25.07.08; 25.07.15; 25.07.20;  
 25.07.21; 26.04.07; 26.04.18; 26.11.09;  
 26.11.11; 29.01.13  
 (511) 34

(260) AM 2023 118635 A  
 (210) AM 118635  
 (220) 2022 07 17  
 (731) KT & G Corporation  
 71, Beotkkot-gil, Daedeok-gu, Daejeon,  
 Republic of Korea  
 (740) Pavle Meipariani  
 (540)





(591) Silver, black, grey, white  
 (531) 25.07.15; 25.07.20; 25.07.21; 26.04.18;  
 26.11.07; 26.11.11; 27.05.01; 27.05.10;  
 27.05.21  
 (511) 34

(260) AM 2023 118636 A  
 (210) AM 118636  
 (220) 2022 07 17  
 (731) KT & G Corporation  
 71, Beotkkot-gil, Daedeok-gu, Daejeon,  
 Republic of Korea  
 (740) Pavle Meipariani  
 (540)



(591) Blue, sky-blue, silver, white  
 (531) 01.15.09; 01.15.21; 26.04.18; 26.15.01;  
 27.05.01; 27.05.09; 27.05.10; 27.05.24;  
 29.01.12  
 (511) 34

(260) AM 2023 118637 A  
 (210) AM 118637  
 (220) 2022 07 17  
 (731) KT & G Corporation  
 71, Beotkkot-gil, Daedeok-gu, Daejeon,  
 Republic of Korea  
 (740) Pavle Meipariani  
 (540)



(591) Golden, black  
 (531) 25.05.02; 26.04.07; 26.04.18; 26.04.22;  
 26.04.24; 26.11.02; 26.11.06; 26.11.08;  
 27.05.01; 27.05.09; 27.05.10; 27.05.24;  
 29.01.13  
 (511) 34

(260) AM 2023 118638 A  
 (210) AM 118638  
 (220) 2022 07 17  
 (731) KT & G Corporation  
 71, Beotkkot-gil, Daedeok-gu, Daejeon,  
 Republic of Korea  
 (740) Pavle Meipariani

(540)



(591) Golden, brown, silver  
 (531) 25.05.02; 26.04.07; 26.04.18; 26.04.22;  
 26.04.24; 29.01.13  
 (511) 34

(260) AM 2023 118644 A  
 (210) AM 118644  
 (220) 2022 07 19  
 (731) LTD "G M P Pharmaceuticals"  
 Rustavi Highway 52, 0114, Tbilisi, Georgia  
 (740) Nugzar Ksovreli  
 (540)

ვენლექსი  
 Венлекс  
 Venlex

(591) Black-white  
 (511) 5

(260) AM 2023 118645 A  
 (210) AM 118645  
 (220) 2022 07 19  
 (731) LTD "G M P Pharmaceuticals"  
 Rustavi Highway 52, 0114, Tbilisi, Georgia  
 (740) Nugzar Ksovreli  
 (540)

ფლებოსმინი  
 Флебосмин  
 Flebosmin

(591) Black-white  
 (511) 5

(260) AM 2023 118646 A  
 (210) AM 118646  
 (220) 2022 07 19  
 (731) Enriko Beridze  
 G. Tsitsishvili Str. 18, Tbilisi, Georgia  
 (740) Salome Jeladze  
 (540)

BEROA  
 ბეროა

(591) Black-white  
 (511) 33

---

**REGISTERED TRADEMARKS**

(111) M 2023 36303 R  
(151) 2023 01 04  
(181) 2033 01 04  
(260) AM 2022 116072 A  
(220) 2022 01 05

(732) Ramada International Inc.  
22 Sylvan Way, Parsippany, New Jersey,  
07054, USA

---

(111) M 2023 36304 R  
(151) 2023 01 04  
(181) 2033 01 04  
(260) AM 2022 116149 A  
(220) 2022 01 10

(732) LTD "Kambisene"  
Old Anaga, X Brigade, Signaghi Region,  
Georgia

---

(111) M 2023 36310 R  
(151) 2023 01 04  
(181) 2033 01 04  
(260) AM 2022 116657 A  
(220) 2022 02 16

(732) Davit Barnabishvili  
Varketili 3, IIIa m/r, bld. 337, ap. 181,  
Tbilisi, Georgia

---

(111) M 2023 36311 R  
(151) 2023 01 09  
(181) 2033 01 09  
(260) AM 2021 115338 A  
(220) 2021 11 10

(732) LTD "UV Print"  
Kukuri Gogiashvili Str., I Lane 2, 0131, Tbilisi,  
Georgia

---

(111) M 2023 36312 R  
(151) 2023 01 09  
(181) 2033 01 09  
(260) AM 2021 115435 A  
(220) 2021 11 18

(732) General Motors LLC  
300 Renaissance Center, City of Detroit, State  
of Michigan 48265-3000, USA

---

(111) M 2023 36313 R  
(151) 2023 01 09  
(181) 2033 01 09  
(260) AM 2021 115436 A  
(220) 2021 11 18

(732) General Motors LLC  
300 Renaissance Center, City of Detroit, State  
of Michigan 48265-3000, USA

---

(111) M 2023 36314 R  
(151) 2023 01 09  
(181) 2033 01 09  
(260) AM 2021 115437 A  
(220) 2021 11 18

(732) General Motors LLC  
300 Renaissance Center, City of Detroit, State  
of Michigan 48265-3000, USA

---

(111) M 2023 36315 R  
(151) 2023 01 09  
(181) 2033 01 09  
(260) AM 2021 115519 A  
(220) 2021 11 24

(732) General Motors LLC  
300 Renaissance Center, City of Detroit, State  
of Michigan 48265-3000, USA

---

(111) M 2023 36316 R  
(151) 2023 01 09  
(181) 2033 01 09  
(260) AM 2021 115520 A  
(220) 2021 11 24

(732) General Motors LLC  
300 Renaissance Center, City of Detroit, State  
of Michigan 48265-3000, USA

---

(111) M 2023 36317 R  
(151) 2023 01 09  
(181) 2033 01 09  
(260) AM 2021 115521 A  
(220) 2021 11 24

(732) General Motors LLC  
300 Renaissance Center, City of Detroit, State  
of Michigan 48265-3000, USA

---

(111) M 2023 36318 R  
(151) 2023 01 09  
(181) 2033 01 09  
(260) AM 2021 115507 A  
(220) 2021 11 22

(732) KT & G Corporation  
71, Beotkkot-gil, Daedeok-gu, Daejeon,  
Republic of Korea

---

(111) M 2023 36319 R  
(151) 2023 01 09  
(181) 2033 01 09  
(260) AM 2022 116076 A  
(220) 2022 01 06  
(732) Wyndham Hotels and Resorts LLC  
22 Sylvan Way, Parsippany, New Jersey,  
07054, USA

---

(111) M 2023 36320 R  
(151) 2023 01 11  
(181) 2033 01 11  
(260) AM 2022 116073 A  
(220) 2022 01 06  
(732) Wyndham Hotels and Resorts LLC  
22 Sylvan Way, Parsippany, New Jersey,  
07054, USA

---

(111) M 2023 36321 R  
(151) 2023 01 11  
(181) 2033 01 11  
(260) AM 2021 115881 A  
(220) 2021 12 22  
(732) Carrefour  
93 Avenue de Paris, 91300 MASSY, France

---

(111) M 2023 36325 R  
(151) 2023 01 13  
(181) 2033 01 13  
(260) AM 2021 115434 A  
(220) 2021 11 17  
(732) BMJ Industries FZ-LLC  
Al-Hamra Industrial Zone-FZ, Ras Al  
Khaimah, United Arab Emirates

---

(111) M 2023 36326 R  
(151) 2023 01 13  
(181) 2033 01 13  
(260) AM 2021 115325 A  
(220) 2021 11 08  
(732) LTD "Royal Dent"  
Kipshidze Str. 2, 0162, Tbilisi, Georgia

---

(111) M 2023 36327 R  
(151) 2023 01 13  
(181) 2033 01 13  
(260) AM 2021 115752 A  
(220) 2021 12 14  
(732) Davit Kiria  
Baratashvili Str. 9, Vill. Ingiri, Zugdidi,  
Georgia

---

(111) M 2023 36328 R  
(151) 2023 01 13  
(181) 2033 01 13  
(260) AM 2022 116528 A  
(220) 2022 02 08  
(732) LTD "Formula"  
Adam Mitskevich Str. 29, Tbilisi, Georgia

---

(111) M 2023 36329 R  
(151) 2023 01 13  
(181) 2033 01 13  
(260) AM 2022 116542 A  
(220) 2022 02 09  
(732) LTD "Automoby"  
M. and A. Balanchivadze's Str. 51, ap. 51,  
0171, Tbilisi, Georgia

---

(111) M 2023 36330 R  
(151) 2023 01 13  
(181) 2033 01 13  
(260) AM 2022 116239 A  
(220) 2022 01 18  
(732) Rasim Bairamov  
Liakhvi Str. 47, Tbilisi, Georgia

---

(111) M 2023 36332 R  
(151) 2023 01 16  
(181) 2033 01 16  
(260) AM 2022 116744 A  
(220) 2022 02 21  
(732) LTD "Rich Group"  
Vill. Mughanlo, Marneuli Region, Georgia

---

(111) M 2023 36333 R  
(151) 2023 01 16  
(181) 2033 01 16  
(260) AM 2022 116325 A  
(220) 2022 01 26  
(732) Obshestvo s Ogranichennoy Otvestven-  
nostiu "Tviordiy Znak"  
Ul. Professor Kachalova, dom 3, Litera O,  
Etazh 4, 192019, Sankt-Peterburg, Russian  
Federation

---

(111) M 2023 36334 R  
(151) 2023 01 16  
(181) 2033 01 16  
(260) AM 2022 116745 A  
(220) 2022 02 21  
(732) LTD "Rich Group"  
Vill. Mughanlo, Marneuli Region, Georgia

---

(111) M 2023 36335 R  
(151) 2023 01 16  
(181) 2033 01 16  
(260) AM 2022 116741 A  
(220) 2022 02 21  
(732) LTD "Rich Group"  
Vill. Mughanlo, Marneuli Region, Georgia

---

(111) M 2023 36336 R  
(151) 2023 01 16  
(181) 2033 01 16  
(260) AM 2022 116746 A  
(220) 2022 02 21  
(732) LTD "Rich Group"  
Vill. Mughanlo, Marneuli Region, Georgia

---

(111) M 2023 36337 R  
(151) 2023 01 16  
(181) 2033 01 16  
(260) AM 2022 116743 A  
(220) 2022 02 21  
(732) LTD "Rich Group"  
Vill. Mughanlo, Marneuli Region, Georgia

---

(111) M 2023 36338 R  
(151) 2023 01 16  
(181) 2033 01 16  
(260) AM 2021 115673 A  
(220) 2021 12 04  
(732) LTD "პროვაიდერ.ჯი Provider.GE"  
I. Noneshvili Str. 60, ap. 27, 6000, Batumi,  
Georgia

---

(111) M 2023 36339 R  
(151) 2023 01 16  
(181) 2033 01 16  
(260) AM 2022 116431 A  
(220) 2022 02 03  
(732) LTD "Eurotrade"  
Cherkezishvili Str. 2, Vake-Saburtalo District,  
Tbilisi, Georgia

---

(111) M 2023 36340 R  
(151) 2023 01 16  
(181) 2033 01 16  
(260) AM 2022 116425 A  
(220) 2022 02 02  
(732) LTD "Impexpharm"  
Giorgi Saakadze II exit 17, 0160, Tbilisi,  
Georgia

---

(111) M 2023 36341 R  
(151) 2023 01 16  
(181) 2033 01 16  
(260) AM 2021 115099 A  
(220) 2021 10 22  
(732) LTD "3G – Georgian Global Group "  
Mukhiani, I mcr., bld. 13, ap. 25, Tbilisi,  
Georgia

---

(111) M 2023 36342 R  
(151) 2023 01 16  
(181) 2033 01 16  
(260) AM 2022 116633 A  
(220) 2022 02 14  
(732) LTD "Tao 2052"  
Leselidze Str. 25, 0105, Old Tbilisi District,  
Tbilisi, Georgia

---

(111) M 2023 36343 R  
(151) 2023 01 16  
(181) 2033 01 16  
(260) AM 2022 116544 A  
(220) 2022 02 09  
(732) Hyatt International Corporation  
150 North Riverside Plaza, 14th Floor,  
Chicago, IL 60606, USA

---

(111) M 2023 36344 R  
(151) 2023 01 16  
(181) 2033 01 16  
(260) AM 2022 116543 A  
(220) 2022 02 09  
(732) Hyatt International Corporation  
150 North Riverside Plaza, 14th Floor,  
Chicago, IL 60606, USA

---

(111) M 2023 36345 R  
(151) 2023 01 16  
(181) 2033 01 16  
(260) AM 2022 116391 A  
(220) 2022 01 28  
(732) Lesaffre Et Compagnie  
41, rue Etienne Marcel, 75001 Paris, France

---

(111) M 2023 36346 R  
(151) 2023 01 16  
(181) 2033 01 16  
(260) AM 2022 116413 A  
(220) 2022 02 01  
(732) Alkaloid AD Skopje  
Blvd. Aleksandar Makedonski 12, Skopje,  
1000, The Republic of North Macedonia

---

(111) M 2023 36347 R  
(151) 2023 01 16  
(181) 2033 01 16  
(260) AM 2022 116322 A  
(220) 2022 01 25  
(732) Kimberly-Clark Worldwide Inc.  
Neenah, WI 54956, USA

---

(111) M 2023 36348 R  
(151) 2023 01 16  
(181) 2033 01 16  
(260) AM 2022 116517 A  
(220) 2022 02 04  
(732) LTD "Cor"  
Vakhushti Bagrationi Str. 3a, ap. 26, 0154,  
Tbilisi, Georgia

---

**TRADEMARKS REGISTERED ACCORDING TO THE  
ACCELERATED PROCEDURE**

The decision can be appealed at the Chamber of Appeal of Sakpatenti within 3 months from the publication.

(111) M 2023 36297 R  
(151) 2023 01 04  
(181) 2033 01 04  
(210) AM 120818  
(220) 2022 12 19  
(732) LLC "Europe Plus"  
Besiki Str. 1, ap. 9, 5400, Tskaltubo, Georgia  
(740) Davit Dzamukashvili  
(540)

**ანტიგუსინი**

(591) 000000 black, FFFFFFF white  
(511) 5

(111) M 2023 36298 R  
(151) 2023 01 04  
(181) 2033 01 04  
(210) AM 120602  
(220) 2022 12 02  
(732) Giorgi Chkonია  
26 Maisi Str. 17, ap. 7-8-9, 6010, Batumi,  
Georgia  
(540)



**შალე კვირიკე**  
**CHALET KVIRIKE**

(591) Black, brown, green  
(531) 05.01.01; 06.01.01; 06.01.02; 06.01.04;  
07.01.09; 26.11.08; 29.01.13  
(526) კვირიკე KVIRIKE  
(511) 43

(111) M 2023 36299 R  
(151) 2023 01 04  
(181) 2033 01 04  
(210) AM 120600  
(220) 2022 12 02  
(732) Giorgi Chkonია  
26 Maisi Str. 17, ap. 7-8-9, 6010, Batumi,  
Georgia

(540)



**კვირიკე**  
CHATEAU  
**KVIRIKE**

(591) Black, brown  
(531) 25.01.25; 27.05.01; 27.05.21; 28.19; 29.01.13  
(526) კვირიკე KVIRIKE  
(511) 43

(111) M 2023 36300 R  
(151) 2023 01 04  
(181) 2033 01 04  
(210) AM 120812  
(220) 2022 12 16  
(732) WHR Europe Inc.  
22 Sylvan Way, Parsippany, New Jersey  
07054, USA  
(740) Tamaz Shilakadze  
(540)

**VIENNA HOUSE**

(591) Black-white  
(511) 43

(111) M 2023 36301 R  
(151) 2023 01 04  
(181) 2033 01 04  
(210) AM 120813  
(220) 2022 12 16  
(732) WHR Europe Inc.  
22 Sylvan Way, Parsippany, New Jersey  
07054, USA  
(740) Tamaz Shilakadze  
(540)

**VIENNA HOUSE**

(591) Red  
(531) 27.01.12; 29.01.01  
(511) 43

(111) M 2023 36302 R  
 (151) 2023 01 04  
 (181) 2033 01 04  
 (210) AM 120446  
 (220) 2022 11 22  
 (732) LTD "Lindin +"  
 Parmen Loria Str. 8, ap. 23, Batumi, Georgia  
 (450)



(591) DFE529 yellow, F9F9F4 white, 111010 black, EAE391 straw-color, DDB511 golden, 775E49 brown  
 (531) 02.09.01; 26.11.05; 26.11.07; 26.11.09; 26.11.14; 27.05.01; 29.01.13  
 (511) 43

(111) M 2023 36305 R  
 (151) 2023 01 04  
 (181) 2033 01 04  
 (210) AM 120712  
 (220) 2022 12 12  
 (732) Kakhaber Okriashvili  
 Iakob Tsurtaveli Str. 65, 1700, Dmanisi, Georgia  
 (740) Nugzar Ksovreli  
 (540)

## Baumbepg

(591) Black-white  
 (511) 5

(111) M 2023 36306 R  
 (151) 2023 01 04  
 (181) 2033 01 04  
 (210) AM 120728  
 (220) 2022 12 15  
 (732) LTD "Qvevris Taoba"  
 Zazishvilis Str. 1, Tbilisi, Georgia  
 (540)



(591) Black-white  
 (531) 19.09.02; 27.05.01  
 (511) 33, 43

(111) M 2023 36307 R  
 (151) 2023 01 04  
 (181) 2033 01 04  
 (210) AM 120722  
 (220) 2022 12 13  
 (732) LTD "Bekauri Family Vineyards"  
 Iosebidge Str. 72, ap. 27, 1800, Saburtalo District, Tbilisi, Georgia  
 (740) Zurab Bezhashvili;  
 Ioane Iarajuli;  
 Lia Shikhiashvili  
 (540)



## BORBALO

(591) Black-white  
 (531) 26.01.01; 26.01.18; 26.01.24; 27.05.01; 27.05.21; 27.05.24  
 (526) BORBALO  
 (511) 33

(111) M 2023 36308 R  
 (151) 2023 01 04  
 (181) 2033 01 04  
 (210) AM 120609  
 (220) 2022 12 03  
 (732) Philip Morris Products S.A.  
 Quai Jeanrenaud 3, 2000 Neuchâtel, Switzerland  
 (740) Pavle Meipariani  
 (540)

## HEETS SATIN WAVE

(591) Black-white  
 (511) 34

(111) M 2023 36309 R  
 (151) 2023 01 04  
 (181) 2033 01 04  
 (210) AM 120708  
 (220) 2022 12 12  
 (732) LTD "Wine Kakheti"  
 Sadguri Str. 2, Telavi, Georgia  
 (540)

## PILIGRANI

(591) 000000 Black-white  
 (511) 33

(111) M 2023 36322 R  
 (151) 2023 01 12  
 (181) 2033 01 12  
 (210) AM 120716  
 (220) 2022 12 12  
 (732) Kakhaber Okriashvili  
 Iakob Tsurtaveli Str. 65, 1700, Dmanisi,  
 Georgia  
 (740) Nugzar Ksovreli  
 (540)

**Novabaum**

(591) Black-white  
 (511) 5

(111) M 2023 36323 R  
 (151) 2023 01 13  
 (181) 2033 01 13  
 (210) AM 120345  
 (220) 2022 11 15  
 (732) LTD "Kava Batumuri"  
 Mujirishvili Str. 12, Tbilisi, Georgia  
 (540)



(591) White, blue, brown, orange  
 (531) 07.01.01; 07.01.08; 22.05.10; 22.05.15;  
 25.07.06; 25.07.07; 25.07.08; 26.01.21;  
 26.04.06; 26.04.10; 27.01.06; 28.19; 29.01.14  
 (526) საქართველო  
 (511) 30

(111) M 2023 36324 R  
 (151) 2023 01 13  
 (181) 2033 01 13  
 (210) AM 120501  
 (220) 2022 11 25  
 (732) Federal Treasury Enterprise  
 "Sojuzplodoimport" (FKP "Sojuzplodoimport")  
 Orlikov Lane, bldg. 1/11, Moscow, 107139,  
 Russian Federation  
 (740) Giorgi Taktakishvili  
 (540)



(591) White, red, golden, grey, brown, black  
 (531) 07.01.08; 25.05.02; 25.05.25; 27.05.01;  
 27.05.02; 27.05.03; 27.05.19; 29.01.15  
 (511) 32

(111) M 2023 36331 R  
 (151) 2023 01 16  
 (181) 2033 01 16  
 (210) AM 120941  
 (220) 2022 12 26  
 (732) Davit Nadiradze  
 Iakob Gogebashvili Str. 36, Marneuli, Georgia  
 (540)



(591) Blue, white, orange, yellow  
 (531) 01.15.05; 04.03.05; 27.05.01; 27.05.24;  
 29.01.14  
 (511) 32

(111) M 2023 36349 R  
 (151) 2023 01 18  
 (181) 2033 01 18  
 (210) AM 121049  
 (220) 2023 01 04  
 (732) LTD "Vaka"  
 Ek. Jughashvili Str. 73, 1400, Gori, Georgia  
 (540)

**უმალი**  
**Umali**

(591) Black-white  
 (511) 29, 33, 35

(111) M 2023 36350 R  
 (151) 2023 01 18  
 (181) 2033 01 18  
 (210) AM 120826  
 (220) 2022 12 20  
 (732) LTD "Amalthea Group"  
 Vazha-Pshavela Ave. 6, ap. 29, Tbilisi,  
 Georgia  
 (540)

**ამალთეა**

(591) 2BC7D8 Black-white  
 (511) 29



(111) M 2023 36351 R  
 (151) 2023 01 18  
 (181) 2033 01 18  
 (210) AM 120951  
 (220) 2022 12 28  
 (732) LTD "West Invest"  
 Grigol Lortkipanidze Str. 13a, 0137, Tbilisi,  
 Georgia  
 (540)



(591) F6D123 yellow, F7EB2B light yellow,  
 F4D21C dark yellow, 4B76BA sky-blue,  
 436CAE blue, 404480 dark blue  
 (531) 05.03.13; 28.05; 29.01.12  
 (511) 29

(111) M 2023 36352 R  
 (151) 2023 01 18  
 (181) 2033 01 18  
 (210) AM 121124  
 (220) 2023 01 09  
 (732) Kakhaber Okriashvili  
 Iakob Tsurtaveli Str. 65, 1700, Dmanisi,  
 Georgia  
 (740) Nugzar Ksovreli  
 (540)

## Vivabaum

(591) Black-white  
 (511) 5

(111) M 2023 36353 R  
 (151) 2023 01 18  
 (181) 2033 01 18  
 (210) AM 121116  
 (220) 2023 01 06  
 (732) Kakhaber Okriashvili  
 Iakob Tsurtaveli Str. 65, 1700, Dmanisi,  
 Georgia  
 (740) Nugzar Ksovreli  
 (540)

## Greenbaum

(591) Black-white  
 (511) 5

(111) M 2023 36354 R  
 (151) 2023 01 18  
 (181) 2033 01 18  
 (210) AM 121118  
 (220) 2023 01 06  
 (732) Kakhaber Okriashvili  
 Iakob Tsurtaveli Str. 65, 1700, Dmanisi,  
 Georgia  
 (740) Nugzar Ksovreli  
 (540)

## Baumleben

(591) Black-white  
 (511) 5

(111) M 2023 36355 R  
 (151) 2023 01 18  
 (181) 2033 01 18  
 (210) AM 121119  
 (220) 2023 01 06  
 (732) Kakhaber Okriashvili  
 Iakob Tsurtaveli Str. 65, 1700, Dmanisi,  
 Georgia  
 (740) Nugzar Ksovreli  
 (540)

## Goldbaum

(591) Black-white  
 (511) 5

## INTERNATIONAL TRADEMARKS FOR WHICH A DECISION ON GRANTING PROTECTIONS IS TAKEN

The decision can be appealed at the Chamber of Appeal of Sakpatenti within 3 months from the publication or at the Mtskheta District Court Administrative Cases Board (Address: №17, Samkhedro St., Mtskheta), within 1 month following the publication.

(260) AM 2022 114425 A\*

(800) 1608972

(151) 2021 06 01

(891) 2021 06 01

(731) SUBSIDIARY COMPANY

"CONFECTIONERY CORPORATION

"ROSHEN"

prospect Nauky, bud. 1, korpus 1, m. Kyiv  
03039, Ukraine

(540)

# Yummi Gummi Roshen

(591) Black, white

(531) 27.05.01

(511)

30 – Caramels [sweets]; liquorice [confectionery]; peppermint sweets; stick liquorice [confectionery]; pastilles [confectionery]; candy decorations for cakes; sorbets [ices]; fruit jellies [confectionery]; sweets.

(260) AM 2022 114507 A

(800) 1611172

(151) 2021 01 27

(891) 2021 01 27

(731) Blaser Group GmbH

Ziegelstadel 1, 88316 Isny, Germany

(540)

# Blaser

(591) Black, white

(511)

8 – Hunting knives; pocket knives; instruments and tools for skinning animals; cutlery and plastic cutlery, namely knives, forks, spoons; kitchen knives.

18 – Luggage, bags, wallets and carrying bags; leather and imitations of leather, and goods made of these materials, namely trunks and traveling bags, handbags, briefcases, tote bags, bum bags, travel accessories, hunting bags, pack sacks, backpacks; umbrellas; parasols; walking sticks; mountaineering sticks; saddlery, whips and clothing for animals.

25 – Clothing, namely hunting, hiking, walking, sports and leisure wear, in particular shorts, shirts, T-shirts, underwear, socks, trousers, jackets, coats, capes, pullovers, vests and combinations; footwear; headwear, namely, caps and hats.

28 – Toy weapons, model and replica weapons, decorative weapons, paintball guns (toys), airsoft guns (toys), air pistols (toys), air guns (toys), ammunition and projectiles for the aforesaid weapons (toys); model and replica weapons for virtual shooting, model and replica weapons for use with electronic targets and/or electronic displays (toys); games apparatus, suitable for use with model and replica weapons for virtual shooting.

(260) AM 2022 115262 A

(800) 1623959

(151) 2021 05 05

(891) 2021 05 05

(731) BONDUELLE CENTRAL EUROPE KFT

Ceglédi út 25, Nagykörös, Hungary

(540)



(591) Black, white

(531) 26.04.19; 26.11.12; 27.05.10

(511)

35 – Market campaigns; copywriting for advertising and promotional purposes; collection and systematisation of information into computer databases; dissemination of advertising matter online; publication of publicity materials and texts; preparation of publicity texts; advertising, including on-line advertising on a computer network; writing of publicity texts; publicity and advertisement services; opinion polling; providing commercial information to consumers; commercial information and advice for consumers in the choice of products and services; advertisement and publicity services by television, radio, mail; dissemination of advertising, marketing and publicity materials; television advertising; production and distribution of radio and television commercials.

41 – Educational services related to recipes; organizing gastronomy events and exhibitions; organizing gastronomic or culinary related competitions; organizing culinary competitions; books editing and publishing services, including the field of gastronomy; providing on-line publications; organizing online training courses relating to nutrition; publication of ma-

gazines; publishing of magazines in electronic format on the Internet; publication of texts, other than publicity texts; conducting of competitions on the Internet; writing of texts, other than for advertising purposes; provision of instruction relating to nutrition; on-line publishing services; providing recreational information; providing information in the educational field; entertainment service; entertainment services, in the field of gastronomy; providing education and training services in the field of gastronomy; providing online electronic publications, not downloadable; providing information in the field of entertainment, gastronomy and gastronomy education, also transmitted online.

(260) AM 2022 116060 A

(800) 1305868

(151) 2016 03 31

(891) 2021 11 05

(731) SUBSIDIARY COMPANY  
CONFECTIONERY CORPORATION  
"ROSHEN"  
1 Nauky Avenue, building 1, Kyiv 03039,  
Ukraine

(540)



(591) Black, white

(531) 19.03.24; 26.04.01; 26.04.02; 26.04.04;  
26.04.18; 26.11.03; 26.11.12; 26.11.13;  
26.11.25; 27.05.01; 27.05.03; 27.05.09;  
27.05.10

(511)

30 – Confectionery; caramels [candy]; sweetmeats.

(260) AM 2022 116694 A

(800) 1644738

(151) 2021 08 13

(891) 2021 08 13

(731) Limited liability company  
"EXPERTTECHNO"  
Botanichna str., 1/6, Boryspil city, Boryspil  
district, Kyiv region 08301, Ukraine

(540)

VEGAS

(591) Black, white

(531) 27.05.01

(511)

7 – Motors, other than for land vehicles; couplings and transmissions; agricultural implements, other than handoperated; incubators for eggs; vending machines;

3D printers; aerocondensers; apparatus for aerating water; apparatus for aerating beverages; apparatus for machining; apparatus for drawing up beer under pressure; flour mill machines; vacuum pumps [machines]; screwdrivers, electric; wringing machines for laundry; centrifugal mills; centrifugal pumps; whisks; automatic [manipulators]; butter machines; sausage making machines; pasta making machines; machines for the mineralization of drinking water; machines for the production of sugar; food preparation machines; electromechanical; beverage preparation machines, electromechanical, corn and grain husking machines; peeling machines; dairy machines; hemming machines; crushing machines; grinding machines; machines and apparatus for carpet shampooing, electric; machines and apparatus for cleaning, electric; high pressure washers; washing apparatus; agitators; mills [machines]; pepper mills, other than hand-operated; mills for household purposes, other than hand-operated; meat choppers [machines]; vacuum cleaner attachments for disseminating perfumes and disinfectants; pumps [machines]; aerating pumps for aquaria; beer pumps; pumps for counter-current swimming; shears, electric; scissors, electric; knives, electric; tin openers, electric; vegetable spiralizers, electric; dust removing installations for cleaning purposes; dust exhausting installations for cleaning purposes; welding apparatus, gasoperated; soldering apparatus, electric; saws [machines]; vacuum cleaners; air suction machines; blowing machines; blowing machines for the compression, sucking and carrying of grain; fans for the compression, sucking and carrying of grain; air condensers; air pumps [garage installations]; crushers for kitchen use, electric; dishwashers; washing machines [laundry]; coin-operated washing machines; ironing machines; smoothing presses; fruit presses, electric, for household purposes; shoe polishers, electric; parquet wax-polishers, electric; cleaning appliances utilizing steam; curtain drawing devices, electrically operated; hand-held tools, other than hand-operated; water separators; juice extractors, electric; grating machines for vegetables; kneading machines; vacuum cleaner bags; filtering machines; bread cutting machines; sewing machines; brushes for vacuum cleaners.

8 – Abrading instruments [hand instruments]; emergency hammers; glaziers' diamonds [parts of hand tools]; apparatus for destroying plant parasites, hand-operated; laser hair removal apparatus, other than for medical purposes; bayonets; razors, electric or non-electric; borers; pickhammers; levers; fulling tools [hand tools]; table forks; carving forks; screwdrivers, non-electric; agricultural forks [hand tools]; tap wrenches; spanners [hand tools]; harpoons; harpoons for fishing; tattoo needles; scythe stones; sharpening stones; sharpening wheels [hand tools]; edge tools [hand tools]; pincers; hoop cutters [hand tools]; goffering irons; rakes [hand tools]; sand trap rakes; engraving needles; cutter bars [hand tools]; handles for hand-operated hand tools; punch pliers [hand tools]; chi-

sels; sculptors' chisels; mortise chisels; lifting jacks, hand-operated; extension pieces for braces for screw taps; hand drills, hand-operated; fish tapes [hand tools]; spades [hand tools]; clamps for carpenters or coopers; side arms, other than firearms; rabbeting planes; bits [hand tools]; implements for decanting liquids [hand tools]; hand implements for hair curling; grafting tools [hand tools]; agricultural implements, hand-operated; priming irons [hand tools]; gouges [hand tools]; oyster openers; sharpening instruments; ski edge sharpening tools, hand-operated; fingernail polishers, electric or non-electric; stropping instruments; ear-piercing apparatus; livestock marking tools; braiders [hand tools]; hand tools, hand-operated; instruments and tools for skinning animals; stamping-out tools [hand tools]; moulding irons; stone hammers; ditchers [hand tools]; embossers [hand tools]; punch rings [knuckle dusters]; trowels; centre punches [hand tools]; truncheons; daggers; picks [hand tools]; pickaxes; mallets [hand instruments]; annular screw plates; scythe rings; scythe handles; riveters [hand tools]; riveting hammers [hand tools]; blades [weapons]; pliers; dies [hand tools]; breast drills; fireplace bellows [hand tools]; instruments for punching tickets; caulking irons; diggers [hand tools]; lasts [shoemakers' hand tools]; rams [hand tools]; scythes; hainault scythes; squares [hand tools]; fire irons; emery grinding wheels; sledgehammers; nail clippers, electric or non-electric; blades [hand tools]; razor blades; blades for planes; shear blades; blade sharpening instruments; vices; bench vices [hand implements]; foundry ladles [hand tools]; jig-saws; spoons; crow bars; shovels [hand tools]; spatulas for use by artists; ice picks; manicure sets; manicure sets, electric; palette knives; machetes; beard clippers; lawn clippers [hand instruments]; hair clippers for animals [hand instruments]; hair clippers for personal use, electric and non-electric; swords; taps [hand tools]; hammers [hand tools]; bushhammers; masons' hammers; mattocks; knife steels; pedicure sets; needle files; emery files; emery boards; files [tools]; air pumps, hand-operated; hand pumps; metal wire stretchers [hand tools]; metal band stretchers [hand tools]; shaving cases; cattle shearers; shears; wick trimmers [scissors]; shearers [hand instruments]; pruning shears; border shears; scissors; farriers' knives; scaling knives; pizza cutters, non-electric; mincing knives [hand tools]; paring knives; box cutters; ceramic knives; tin openers, non-electric; hunting knives; cleavers; budding knives, pruning knives; bill-hooks; penknives; knives; carving knives; cutlery; nail drawers [hand tools]; vegetable choppers; vegetable spiralizers, hand-operated; vegetable slicers, hand-operated; vegetable peelers, hand-operated; stirring sticks for mixing paint; reamer sockets; perforating tools [hand tools]; saws [hand tools]; bow saws; nail files; nail files, electric; hair-removing tweezers; tweezers; guns [hand tools]; guns, hand-operated, for the extrusion of mastics; non-electric caulking guns; sword scabbards; fruit pickers [hand tools];

paring irons [hand tools]; thistle extractors [hand tools]; weeding forks [hand tools]; polishing irons [glazing tools]; saw blades [parts of hand tools]; tool belts [holders]; flat irons; irons [non-electric hand tools]; irons [non-electric hand tools]; depilation appliances, electric and non-electric; meat claws; fruit corers; money scoops; wine bottle foil cutters, hand-operated; fruit segmenters; hair braiders, electric; apparatus for tattooing; punches [hand tools]; numbering punches; nail punches; pin punches; insecticide vaporizers [hand tools]; frames for handsaws; rasps [hand tools]; razor strops; razor strops; tube cutting instruments; tube cutting instruments; bits [parts of hand tools]; graving tools [hand tools]; cutters; syringes for spraying insecticides; reamers; expanders [hand tools]; planes; plane irons; knife handles; fullers [hand tools]; garden tools, hand-operated; hoes [hand tools]; augers [hand tools]; hollowing bits [parts of hand tools]; carpenters' augers; gimlets [hand tools]; drill holders [hand tools]; pruning scissors; tree pruners; sickles; cheese slicers, non-electric; choppers [knives]; scrapers [hand tools]; scrapers for skis; trowels [gardening]; axes; holing axes; hatchets; sterile body piercing instruments; silver plate [knives, forks and spoons]; table knives, forks and spoons for babies; table knives, forks and spoons of plastic; table cutlery [knives, forks and spoons]; wire strippers [hand tools]; drawing knives; mortars for pounding [hand tools]; mitre boxes [hand tools]; branding irons; adzes [tools]; pestles for pounding [hand tools]; sharpening steels; grindstones [hand tools]; rammers [hand tools]; earth rammers [hand tools]; whetstone holders; saw holders; ratchets [hand tools]; tube cutters [hand tools]; razor cases; hobby knives [scalpels]; nail extractors, hand-operated; ladles [hand tools]; hackles [hand tools]; scraping tools [hand tools]; sabres; milling cutters [hand tools]; kitchen mandolines; marline spikes; awls; spatulas [hand tools]; cuticle tweezers; curling tongs; nail nippers; eyelash curlers; egg slicers, non-electric.

9 – Scientific, nautical, surveying, optical, weighing, measuring, signalling, control (testing), life-saving, teaching apparatus and instruments; fire extinguishing apparatus; 3D spectacles; ticket dispensers; cash registers; automated teller machines [ATM]; batteries for electronic cigarettes; accumulators, electric; accumulators, electric, for vehicles; aerials; igniting apparatus, electric, for igniting at a distance; audiovisual teaching apparatus; audio interfaces; barometers; batteries, electric; balances [steelyards]; binoculars; biochips; lightning conductors; scales; baby scales; scales with body mass analysers; bathroom scales; electric plugs; electric sockets; measuring apparatus; measuring devices, electric; peepholes [magnifying lenses] for doors; virtual reality headsets; diagnostic apparatus, not for medical purposes; DNA chips; adding machines; dosimeters; dosage dispensers; electric door bells; electronic key fobs being remote control apparatus; electronic publications, downloadable; electro-

nic interactive whiteboards; electronic collars to train animals; electronic pens [visual display units]; electronic notice boards; electronic access control systems for interlocking doors; electronic tags for goods; locks, electric; battery chargers; chargers for electric accumulators; chargers for electronic cigarettes; goggles for sports; protective helmets; infrared detectors; ionization apparatus not for the treatment of air or water; pocket calculators; rearview cameras for vehicles; encoded key cards; cinematographic cameras; directional compasses; contact lenses; containers for contact lenses; laptop computers; optical lanterns; counters; magnetic encoders; selfie lenses; spectacles; sunglasses; spectacle frames; optical lenses; selfie sticks [hand-held monopods]; parking meters; personal digital assistants [PDAs]; time recording apparatus; theft prevention installations, electric; anti-theft warning apparatus; cell phone straps; light-emitting electronic pointers; reflective articles for wear, for the prevention of accidents; reflective safety vests; signals, luminous or mechanical; smartglasses; bags adapted for laptops; time clocks [time recording devices]; temperature indicators; temperature indicator labels, not for medical purposes; thermometers, not for medical purposes; thermostats; pressure measuring apparatus; transformers [electricity]; wearable activity trackers; photovoltaic cells; photocopiers [photographic, electrostatic, thermic]; spectacle cases; cases for smartphones; digital weather stations; digital signs; digital photo frames; saccharometers; magic lanterns; frequency meters; sleeves for laptops; covers for personal digital assistants [PDAs]; covers for tablet computers; covers for smartphones.

11 – Installations for lighting, heating, generating installations, cooking, cooling, drying; lampshades; autoclaves, electric; for cooking; aquarium lights; aquarium heaters; aquarium filtration apparatus; anti-glare devices for vehicles [lamp fittings], defrosters for vehicles; hot air apparatus; air deodorizing apparatus; ionization apparatus for the treatment of air or water; beverage cooling apparatus; air cooling apparatus; tanning apparatus [sun beds]; coffee roasters; hand drying apparatus for washrooms; water filtering apparatus; steam facial apparatus [saunas]; heating and cooling apparatus for dispensing hot and cold beverages; air purifying apparatus and machines; water softening apparatus and installations; lighting apparatus; hydro-massage bath apparatus; barbecues; bidets; laundry room boilers; bath tubs; spa baths [vessels]; electric cooktops; waffle irons; electric; bicycle lights; fans [air-conditioning]; fans [parts of air-conditioning installations]; electric fans for personal use; ventilation [air-conditioning] installations for vehicles; ventilation [air-conditioning] installations and apparatus; kilns; evaporators; extractor hoods for kitchens; ventilation hoods; fabric steamers; pressure water tanks; water heaters; water heaters; water purification installations; water purifying apparatus and machines; gas boilers; gas burners; gas lamps; discharge tubes, elec-

tric; for lighting; microbubble generators for baths; fairy lights for festive decoration; rotisseries; hot water bottles; warming pans; footwarmers; electric or non-electric; bed warmers; disinfectant apparatus; disinfectant apparatus for medical purposes; deodorizing apparatus; not for personal use; ornamental fountains; chimney flues; disinfectant dispensers for toilets; stills\*; distillation apparatus\*; arc lamps; showers; shower cubicles; electric appliances for making yogurt; electric lamps; electrically heated carpets; roasting apparatus; immersion heaters.

21 – Abrasive pads for kitchen purposes; autoclaves, non-electric, for cooking; wine aerators; indoor aquaria; cookie jars; decanter tags; saucers; demijohns; vases; fruit bowls; epergnes; inflatable bath tubs for babies; bird baths; baby baths, portable; plungers for clearing blocked drains; waffle irons, non-electric; carpet beaters [hand instruments]; signboards of porcelain or glass; cookie [biscuit] cutters; ceramics for household purposes; toothpaste tube squeezers; diaper disposal pails; ice buckets; coolers [ice pails]; buckets; mop wringer buckets; buckets made of woven fabrics; cotton waste for cleaning; wool waste for cleaning; whisks, non-electric, for household purposes; towel rails and rings; boxes for dispensing paper towels; containers for household or kitchen use; tea caddies; disposable aluminium foil containers for household purposes; thermally insulated containers for food; lunch boxes; water apparatus for cleaning teeth and gums; horsehair for brush-making; hair for brushes; furniture dusters; dusting cloths [rags]; cloth for washing floors; polishing cloths; dishcloths; cloths for cleaning; candle extinguishers; buttonhooks; jugs; feeding troughs; heads for electric toothbrushes; pots; flower pots; large-toothed combs for the hair; combs for animals; electric combs; combs; make-up sponges; abrasive sponges for scrubbing the skin; sponges for household purposes; toilet sponges; dripping pans; broom handles; smoke absorbers for household purposes; soap dispensers; toilet paper dispensers; cutting boards for the kitchen; bread boards; washing boards; ironing boards; china ornaments; kitchen grinders, non-electric; plug-in diffusers for mosquito repellents; beverage urns, non-electric; chamois leather for cleaning; closures for pot lids; beaters, non-electric; blenders, non-electric, for household purposes; pasta makers, hand-operated; cleaning instruments, hand-operated; toothpicks; coffeepots, non-electric; coffee percolators, non-electric; coffee services [tableware]; coffee grinders, hand-operated; cauldrons; mess-tins; candelabra [candlesticks]; stew-pans; earthenware saucepans; rolling pins, domestic; flower-pot covers, not of paper; reusable silicone food covers; baking mats; napkin rings; rings for birds; poultry rings; polishing leather; glue-pots; cages for household pets; birdcages; cleaning tow; candy boxes; cosmetic utensils; cosmetic spatulas; nappy disposal bins; waste paper baskets; refuse bins; bread baskets for household purposes; fitted picnic baskets, including dishes; baskets for

household purposes; droppers for household purposes; crystal [glassware]; reusable ice cubes; decorative glass spheres; bulb basters; tea balls; mugs; beer mugs; tankards; cooking utensils, non-electric; cooking pots; couscous cooking pots, non-electric; cookery moulds; kitchen utensils; kitchen containers; oven mitts; funnels; ice cream scoops; mixing spoons [kitchen utensils]; basting spoons [cooking utensils]; spatulas for kitchen use; pie servers; crumb trays; litter boxes for pets; majolica; butter dishes; material for brush-making; opal glass; opal glass; lint removers, electric or non-electric; soap holders; bowls [basins]; pet feeding bowls; pet feeding bowls, automatic; mouse traps; brooms; confectioners' decorating bags [pastry bags]; cooking mesh bags, other than for microwaves; pepper mills, hand-operated; mills for household purposes, hand-operated; mosaics of glass, not for building; saucepan scourers of metal; steel wool for cleaning; fly swatters; fly traps; liqueur sets; spice sets; cooking pot sets; cruet sets for oil and vinegar; heaters for feeding bottles, non-electric; cake decorating tips and tubes; pot lids; butter-dish covers; dish covers; cheese-dish covers; aquarium hoods; drinking troughs; wine pourers; nozzles for watering cans; nozzles for watering hose; tablemats, not of paper or textile; utensils for household purposes; toilet cases; floss for dental purposes; chamber pots; pouring spouts; washtubs; opaline glass; portable cool boxes, non-electric; cold packs for chilling food and beverages; isothermic bags; chopsticks; cocktail stirrers; food steamers, non-electric; insect traps; rat traps; basting brushes; make-up brushes; pepper pots; dusting apparatus, non-electric; candle warmers, electric and non-electric; nest eggs, artificial; cabarets [trays]; trays for household purposes; trays of paper, for household purposes; lazy susans; trivets [table utensils]; holders for flowers and plants [flower arranging]; coasters, not of paper or textile; knife rests for the table; stands for portable baby baths; shaving brush stands; flat-iron stands; grill supports; tea bag rests; egg cups; place mats, not of paper or textile; wine-tasting pipettes; feather-dusters; plates for diffusing aromatic oil; plates to prevent milk boiling over; cruets; glass bulbs [receptacles]; bottles; drinking bottles for sports; busts of porcelain, ceramic, earthenware, terra-cotta or glass; crushers for kitchen use, non-electric; scouring pads; watering cans; watering devices; polishing apparatus and machines, for household purposes, non-electric; polishing materials for making shiny, except preparations, paper and stone; polishing gloves; shaving brushes; dishes; earthenware; vegetable dishes; porcelain ware; refrigerating bottles; drinking vessels; vessels of metal for making ices and iced drinks; fruit presses, non-electric, for household purposes; trouser presses; tie presses; make-up removing appliances; syringes for watering flowers and plants; mop wringers; bottle openers, electric and non-electric; egg yolk separators; boot jacks; egg poachers; clothing stretchers; glove stretchers; drying racks for laundry;

rotary washing lines; wax-polishing appliances, non-electric, for shoes; apparatus for wax-polishing, non-electric; electric devices for attracting and killing insects; potholders; clothes-pegs; glass stoppers; cinder sifters [household utensils]; powder puffs; sifters [household utensils]; grills [cooking utensils]; shoe horns; pastry cutters; drinking horns; sprinklers; foam toe separators for use in pedicures; candle drip rings; shoe trees; boot trees; fused silica [semi-worked product], other than for building; gloves for household purposes; kitchen mitts; car washing mitts; abrasive mitts for scrubbing the skin; animal grooming gloves; gardening gloves; salad bowls; piggy banks; candlesticks; candle jars [holders]; egg separators, non-electric, for household purposes; services [dishes]; serving ladles; sieves [household utensils]; siphon bottles for carbonated water; wine-tasting siphons; salt cellars; coin banks; glass for vehicle windows [semi-finished product]; enamelled glass, not for building; glass incorporating fine electrical conductors; plate glass [raw material]; glass, unworked or semi-worked, except building glass; glass wool, other than for insulation; vitreous silica fibres, other than for textile use; fiberglass, other than for insulation or textile use; fiberglass thread, other than for textile use; painted glassware; powdered glass for decoration; powdered glass for decoration; glasses [receptacles]; drinking glasses; frying pans; griddles [cooking utensils]; pressure cookers, non-electric; squeegees [cleaning instruments]; currycombs; garbage cans; scoops for household purposes; straws for drinking; statues of porcelain, ceramic, earthenware, terra-cotta or glass; tableware, other than knives, forks and spoons; mortars for kitchen use; portable coolers, non-electric; tajines, non-electric; basins [receptacles]; disposable table plates; paper plates; table plates; works of art of porcelain, ceramic, earthenware, terra-cotta or glass; indoor terrariums [vivariums]; indoor terrariums [plant cultivation]; heat-insulated containers; heat-insulated containers for beverages; insulating flasks; hot pots, not electrically heated; graters for kitchen use; pestles for kitchen use; sponge holders; toothpick holders; dishes for soap; toilet paper holders; menu card holders; table napkin holders; roller tubes for peeling garlic; toilet utensils; tea cosies; trash cans; figurines of porcelain, ceramic, earthenware, terra-cotta or glass; coffee filters, non-electric; flasks; hip flasks; moulds [kitchen utensils]; cake moulds; deep fryers, non-electric; comb cases; bread bins; pails; strainers for household purposes; boxes for sweets; sugar bowls; garlic presses [kitchen utensils]; teapots; kettles, non-electric; tea services [tableware]; tea infusers; tea strainers; cups; cups of paper or plastic; ladles for serving wine; ironing board covers, shaped; cooking skewers of metal; cocktail shakers, corkscrews, electric and non-electric; pig bristles for brush-making; animal bristles [brushware]; ice tongs; nutcrackers; salad tongs; sugar tongs; shoe brushes; carpet sweepers; horse brushes; lamp-glass brushes; tar-brushes,

long handled; dishwashing brushes; ski wax brushes; toilet brushes; brushes for cleaning tanks and containers; electric brushes, except parts of machines; scrubbing brushes; toothbrushes; toothbrushes, electric; brushes; eyebrow brushes; eyelash brushes; nail brushes; mangers for animals; window-boxes; dustbins.

35 – Administrative processing of purchase orders; administration of consumer loyalty programs; cost price analysis; business auditing; auctioneering; outsourced administrative management for companies; accounting; negotiation of business contracts for others; market studies; opinion polling; business inquiries; business management assistance; commercial or industrial management assistance; advisory services for business management; business research; economic forecasting; providing business information via a website; compilation of information into computer databases; compilation of statistics; providing business information; business management of reimbursement programmes for others; providing commercial information and advice for consumers in the choice of products and services; commercial administration of the licensing of the goods and services of others; computerized file management; personnel management consultancy; business management consultancy; business organization consultancy; marketing; marketing research; providing commercial and business contact information; provision of an online marketplace for buyers and sellers of goods and services; updating and maintenance of data in computer databases; updating and maintenance of information in registries; business appraisals; personnel recruitment; business management and organization consultancy; business intermediary services relating to the matching of potential private investors with entrepreneurs needing funding; commercial information agency services; employment agency services; business efficiency expert services; outsourcing services [business assistance]; business project management services for construction projects; commercial intermediation services; administrative services for the relocation of businesses; import-export agency services; business investigations; systemization of information into computer databases; negotiation and conclusion of commercial transactions for third parties; professional business consultancy.

(260) AM 2022 116806 A

(800) 1646887

(151) 2021 06 11

(891) 2021 06 11

(731) KAÇAR TEKSTİL TURİZM YATIRIM  
İNŞAAT SANAYİ VE TİCARET  
İŞLETMELERİ ANONİM ŞİRKETİ  
Org. San. Böl. Kırmızı Cd., No:15 Nilüfer,  
Bursa, Türkiye

(540)

**alissafabrics**

(591) Red and black

(531) 27.05.01; 29.01.12

(511)

24 – Woven or non-woven textile fabrics; textile goods for household use, not included in other classes: curtains, bed covers, sheets (textile), pillowcases, blankets, quilts, towels; flags, pennants, labels of textile; swaddling blankets; sleeping bags for camping.

(260) AM 2022 117204 A

(800) 1651233

(151) 2021 09 17

(891) 2021 09 17

(731) INTERNATIONAL CONTAINER  
TERMINAL, SERVICES, INC. (ICTSI)  
ICTSI Administration Building, Manila  
International Container Terminal, MICT South  
Access Road City of Manila, Metro Manila,  
Philippines

(540)



(591) Orange

(531) 15.01.19; 26.04.02; 26.04.07; 26.04.16;  
26.07.18; 29.01.13

(526) INTERNATIONAL, CONTAINER,  
TERMINAL, SERVICES, INC.

(511)

9 – Management, operation and development of terminals which will involve the handling of containers, bulk liquid and dry cargoes, refrigerated warehousing facilities, warehousing complex, container storage and/or storing of cargo of all kinds, the transportation of freight and other cargo to and from port terminals in the country intended for delivery from abroad and/or shipment abroad.

(260) AM 2022 117212 A

(800) 1651573

(151) 2021 12 24

(891) 2021 12 24

(731) LG Corp.

128, Yeoui-daero, Yeongdeungpo-gu, Seoul  
07336, Republic of Korea

(540)



(591) Black, white

(531) 24.17.02; 26.01.01; 26.01.03; 26.01.18;  
26.01.24; 27.05.09; 27.05.22; 27.05.24

(511)

9 – Battery charge devices; electronic power supplies; electricity distribution/control apparatus and instruments; apparatus and instruments for conducting electricity; conductors, electric; apparatus and instruments for accumulating and storing electricity; lithium secondary battery pack; separator for secondary batteries; anodes for secondary batteries; cathodes for secondary batteries; lithium secondary batteries; modules for lithium secondary batteries; lithium batteries; batteries; cooling pads especially adapted for decreasing the heat generation of batteries; battery separators; battery packs; battery cell; cell for lithium secondary batteries; battery cell electrodes; batteries for vehicles; secondary cells; batteries, electric; magnets for industrial purposes; anodes; cathodes; cathodic protection apparatus; cathodic anti-corrosion apparatus; fuel cell electrodes; printed circuit boards.

17 – Electrical insulating materials; electric insulators; electrical insulating compound materials; insulating materials; polymer films for use in manufacture; semi-processed thermoplastic polymer resins for use in manufacture; synthetic resins, semi-processed; semi-processed plastics; insulating refractory materials; foils of metal for insulating; polymer film used for manufacturing electronic circuits; self-adhesive plastic sheets for use in manufacturing; electrical insulators made of rubber; multilayer films for use in sealing and insulating; seals materials and insulating materials; insulators for electric mains; polyurethane sheets; plastic film, other than for wrapping; plastic sheet materials for use in manufacture; semi-worked plastic film; vinyl sheet; semi-finished plastic sheets; semi-worked vinyl sheets; adhesive-coated plastic sheets for use in manufacture; laminated plastic material in the form of boards for use in manufacture; electrical insulating rubber products; insulating foam for use in building and construction; building insulation materials; non-conducting materials for retaining heat for building; padding materials of rubber or plastic; heat insulation film; rubber, raw or semi-worked; scratch protection films for use in manufacture; non-conducting materials; tinted, laminated and reflective plastic films for interior decorating; synthetic rubber; ethylene vinyl acetate rubber; thermoplastic elastomer resins in pellet form for use in manufacture; rigid polyvinyl chloride films for use in manufacture; thermal insulating materials; metalized films for use in sealing and insulating; polyvinyl chloride films for use in manufacture; films for sun protection; tinted plastic films for use on windows; ultraviolet-proof films for vehicles; transparent acrylic sheets for use in manufacture.

(260) AM 2022 117358 A

(800) 1653707

(151) 2021 12 14

(891) 2021 12 14

(731) Yiwu Sumy Technology Co., LTD

702-1, International Business Center,  
399 Yin Hai Road, Futian Street, Yiwu City,  
Zhejiang Province, China

(540)



**CREEPER**

(591) Black, white

(531) 26.02.01; 26.02.03; 26.02.18; 26.02.24;  
27.05.01; 27.05.08; 27.05.09

(511)

8 – Manual hand tools; gardening tools (manual); razor; manicure sets; pliers; hand pumps; tableware (knives, forks and spoons); hand-operated agricultural implements; hand tools for curling hair; knife; dagger.

12 – Electric vehicle; wheelbarrow; bicycle; scooter (vehicle); cable car; baby carriage; bicycle tyres; air vehicles; bicycle pump; water vehicles; automobile.

(260) AM 2022 117365 A

(800) 1357160

(151) 2017 02 06

(891) 2022 02 09

(731) Jaguar Land Rover Limited

Abbey Road, Whitley, Coventry CV3 4LF,  
United Kingdom

(540)

**DEFENDER**

(591) Black, white

(511)

9 – Computer hardware; on-board computers for vehicles; computers for autonomous-driving; on board electronic systems for providing driving and parking assistance; cruise control systems for vehicles; vehicle speed control apparatus; computer software; automotive computer software and hardware; computer software for use in relation to vehicles; telemetry devices for motor vehicle and engine applications; downloadable mobile applications; global positioning system (GPS); navigational systems, comprising electronic transmitters, receivers, circuitry, microprocessors, cellular telephone and computer software all for use in navigation and all integrated into a motor vehicle; downloadable electronic maps; electric control panels; electronic control apparatus, instruments and displays; sensors; integrated electronic safety systems for land vehicles; safety and driving assistant systems; lasers for use in relation to vehicles; cameras for vehicles; onboard cameras; action cameras; parking sensors and rear-view cameras for vehicles; automotive measuring instruments; electronic apparatus for collecting measurements and receiving data; wireless transmission



and receiving equipment; interactive multimedia software; electric connections; anti-theft warning devices; alarm sensors; gauges; instrument panels and clusters; odometers; speedometers; tachometers; temperature sensors; voltmeters; ammeters; testing apparatus; proximity meters; electric circuit breakers; commutators; electric condensers; electric connections; electric cables; electric fuses; electric fuse boxes; electric control apparatus and instruments for motor vehicles and engines; electrical sensors; fire extinguishing apparatus; gauges; lenses for lamps; printed electrical circuits; electric relays; electric switches; electric wiring harnesses; testing apparatus; apparatus for recording, transmission or reproduction of sound and images; mechanical remote controls for motors; remote control starters for vehicles; emergency warning lights; emergency notification system; wireless controllers to remotely monitor and control the function and status of other electrical, electronic, signaling systems and mechanical devices for use in connection with vehicles and engines for vehicles; computer software, mobile applications and wireless transmission and receiving equipment for use in connection with autonomous and hands-free driving, automobile safety features and warning or alarm functions, accident prevention and traffic alerts; communications apparatus to transmit and receive communications via vehicles; charging stations for charging electric vehicles; apparatus and cables for use in charging electric vehicles; batteries for vehicles; electric accumulators, voltage regulators, aerials, electric batteries and mountings; computer hardware and software for tracking driver behaviour; sensors, computers and wireless transceivers to provide connectivity within the vehicle, between vehicles, with cell phones, and with data centers, computer hardware, software and electrical apparatus to provide tactile, audible and visual interfaces to interact with occupants of the vehicle; wireless transmission and receiving equipment for use in connection with remote computers for use in automobiles for tracking, monitoring and diagnosing maintenance for vehicles and for providing information to drivers; computer application software for use by drivers and passengers of vehicles for accessing, viewing, and interacting with and downloading information and entertainment content; downloadable software and on-board computer software that provides users with remote and in-vehicle access to motor vehicle functions and functions relating to driver safety, convenience, communication, entertainment, and navigation; diagnostic apparatus consisting of sensors for use in testing vehicle function and in diagnosing vehicle electrical and mechanical problems; software and software applications to allow users to track and locate stolen vehicles, charge electronics, and store and synchronize collected personalized user and vehicle information; electronic interface modules sold as an integral part of a vehicle; display panels for vehicles; electronic interface modules for wired and wireless inter-

face of mobile phones and electronic media players with an automotive electrical system; integrated electronic automated systems for vehicles; audio, audiovisual or telecommunications equipment; radio apparatus; in-car entertainment systems; sound reproducing equipment; televisions; radios; CD players; loud speakers; personal digital assistants; tablet computers; multimedia devices; mp3 or mp4 apparatus and equipment; mobile hard drives; universal serial bus drives; telephones; mobile telephones; mobile phone and tablet computer headsets and accessories, none being cases for mobile phones or tablet computers; straps for telephone handsets; screen savers for phones and tablets; car telephone installations; computer games, computer games software; recording media; storage boxes for recording media; highway emergency warning equipment; thermometers; compasses; calculators; electronic instructional and teaching apparatus and instruments; electrical and scientific apparatus for use in the repair and servicing of vehicles; magnets; tape measures; eyewear, glasses, sunglasses, driving glasses, skiing goggles; cases for eyeglasses, sunglasses or skiing goggles; driver helmets; racing driver protective clothing; apparatus, gloves and clothing, all for use in protection against accident or injury; parts and fittings for any of the aforesaid goods.

(260) AM 2022 117366 A

(800) 1520829

(151) 2019 09 11

(891) 2021 12 07

(731) SAMSUN SEGMAN VE GÖMLEK SANAYİ  
TİCARET LİMİTED ŞİRKETİ  
Şabanoğlu O.S.B. Mahallesi, Kızırmak  
Caddesi, No:3, Merkez Köyü / Merkez  
Bucağı Tekkeköy -, Samsun, Türkiye

(540)



(591) Black.

(531) 26.11.03; 26.11.09

(511)

7 – Machines, machine tools and industrial robots for processing and shaping wood, metals, glass, plastics and minerals, 3D printers; construction machines and robotic mechanisms (machines) for use in construction, bulldozers, diggers (machines), excavators, road construction and road paving machines, drilling machines, rock drilling machines, road sweeping machines; lifting, loading and transmission machines and robotic mechanisms (machines) for lifting, loading and transmission purposes; elevators, escalators and

cranes; machines and robotic mechanisms (machines) for use in agriculture and animal breeding, machines and robotic mechanisms (machines) for processing cereals, fruits, vegetables and food; beverage preparation machines, electromechanical; beverage processing machines; engines and motors, other than for land vehicles, parts and fittings therefor, hydraulic and pneumatic controls for engines and motors, brakes other than for vehicles, brake linings for engines, crankshafts, transmission gears for machines, cylinders for engines, pistons for engines, turbines, not for land vehicles, filters for engines and motors, oil, air and fuel filters for land vehicle engines, exhausts for land vehicle engines, exhaust manifolds for land vehicle engines, engine cylinders for land vehicles, engine cylinder heads for land vehicles, pistons for land vehicle engines, carburetors for land vehicles, fuel conversion apparatus for land vehicle engines, injectors for land vehicle engines, fuel economisers for land vehicle engines, pumps for land vehicle engines, valves for land vehicle engines, starters for motors and engines, dynamos for land vehicle engines, sparking plugs for land vehicle engines; bearings (parts of machines), roller or ball bearings; machines for mounting and detaching tires; alternators, current generators, electric generators, current generators operated with solar energy; painting machines, automatic spray guns for paint, electric, hydraulic and pneumatic punching machines and guns, electric adhesive tape dispensers (machines), electric guns for compressed gas or liquid spraying machines, electric hand drills, electric hand saws, electric jigsaw machines, spiral binding machines for industrial purposes, compressed air machines, compressors (machines), vehicle washing installations, robotic mechanisms (machines) with the abovementioned functions; electric and gas-operated welding apparatus, electric arc welding apparatus, electric soldering apparatus, electric arc cutting apparatus, electrodes for welding machines, industrial robots (machines) with the abovementioned functions; printing machines; packaging machines, filling, plugging and sealing machines, labellers (machines), sorting machines, industrial robots (machines) with the abovementioned functions, electrical apparatus for sealing plastics [packaging]; machines for textile processing, sewing machines, industrial robots (machines) with the abovementioned functions; pumps [machines], self-regulating fuel pumps; electric kitchen machines for chopping, grinding, crushing, mixing and mincing foodstuff, washing machines, laundry washing machines, dishwashers, spin driers (not heated), electric cleaning machines for cleaning floors, carpets or floorings, vacuum cleaners and parts thereof; automatic vending machines; galvanizing and electroplating machines; electric door openers and closers; joints (parts of engines), piston rings; piston rings being engine parts; marine engines and parts and fittings therefor; generators for land vehicles; air compressors for vehicles;

compressors as parts of machines, motors and engines.

12 – Motor land vehicles, motorcycles, mopeds; engines and motors for land vehicles; clutches for land vehicles; transmissions, transmission belts and transmission chains for land vehicles; gearing for land vehicles; brakes, brake discs and brake linings for land vehicles; vehicle chassis, automobile bonnets, vehicle suspension springs, shock absorbers for automobiles, gearboxes for land vehicles, steering wheels for vehicles, rims for vehicle wheels; bicycles and their bodies; handlebars and mudguards for bicycles; vehicle bodies; tipping bodies for trucks; trailers for tractors; frigorific bodies for land vehicles; trailer hitches for vehicles; vehicle seats; head-rests for vehicle seats; safety seats for children, for vehicles; seat covers for vehicles; vehicle covers (shaped); sun-blinds adapted for vehicles; direction signals and arms for direction signals for vehicles; windscreen wipers and wiper arms for vehicles; inner and outer tires for vehicle wheels; tubeless tires; tire-fixing sets comprised of tire patches and tire valves for vehicles; windows for vehicles, safety windows for vehicles, rearview mirrors and wing mirrors for vehicles; anti-skid chains for vehicles; luggage carriers for vehicles; bicycle and ski carriers for cars; saddles for bicycles or motorcycles; air pumps for vehicles, for inflating tires; anti-theft alarms for vehicles, horns for vehicles; safety belts for vehicle seats, air bags (safety devices for automobiles); baby carriages, wheelchairs, pushchairs; wheelbarrows; shopping carts; single or multi-wheeled wheelbarrows; shopping trolleys; grocery carts; handling carts; rail vehicles; locomotives; trains; trams; waggons; cable cars; chairlifts; vehicles for locomotion by water and their parts, other than their motors and engines; vehicles for locomotion by air and their parts, other than their motors and engines; brakes for vehicles.

(260) AM 2022 117369 A

(800) 1653834

(151) 2022 01 17

(891) 2022 01 17

(731) Public Joint Stock Company "Vimpel-Communications"  
8 Marta, 10, bld. 14, RU-127083 Moscow,  
Russian Federation

(540)



(591) Yellow and black

(531) 25.07.20; 26.15.01; 29.01.12

(511)

9 – 3D glasses; DVD players; ticket dispensers; juke boxes, musical; fire engines; answering machines; electrical adapters; batteries for electronic cigarettes; accumulators, electric; batteries, electric, for vehicles; accelerometers; actinometers; alidades; altimeters; ear pads for earphones; ammeters; nanoparticle size analysers; anemometers; anodes; aerials; anticathodes; apertometers [optics]; high-frequency apparatus; testing apparatus not for medical purposes; remote control apparatus; electro-dynamic apparatus for the remote control of railway points; electro-dynamic apparatus for the remote control of signals; monitoring apparatus, other than for medical purposes; sound recording apparatus; global positioning system [GPS] apparatus; distillation apparatus for scientific purposes; diffraction apparatus [microscopy]; air analysis apparatus; apparatus to check franking; sound transmitting apparatus; apparatus for fermentation [laboratory apparatus]; breathing apparatus for underwater swimming; breathing apparatus, except for artificial respiration; apparatus and installations for the production of x-rays, not for medical purposes; cash registers; electric apparatus for commutation; magnetic resonance imaging [MRI] apparatus, not for medical purposes; intercommunication apparatus; stills for laboratory experiments; projection apparatus; fire extinguishing apparatus; radiological apparatus for industrial purposes; X-ray apparatus not for medical purposes; blueprint apparatus; blinkers [signalling lights]; stereoscopic apparatus; telephone apparatus; facsimile machines; phototelegraphy apparatus; electric apparatus for remote ignition; acid hydrometers; salinometers; acidimeters for batteries; aerometers; beacons, luminous; battery jars; automated teller machines [atm]; barometers; anode batteries; galvanic batteries; solar batteries; solar panels for the production of electricity; batteries, electric; balances [steelyards]; betatrons; binoculars; biochips; electronic tags for goods; lens hoods; magnetic tape units for computers; computer memory devices; fire hose nozzles; encoded identification bracelets, magnetic; connected bracelets [measuring instruments]; safety tarpaulins; electronic key fobs being remote control apparatus; bullet-proof clothing; signalling buoys; life buoys; marking buoys; directional compasses; vacuum gauges; electrolyzers for laboratory use; variometers; verniers; scales; baby scales; bathroom scales; letter scales; weighbridges; precision balances; scales with body mass analysers; rods [surveying instruments]; camcorders; video baby monitors; video cassettes; video projectors; video telephones; video screens; viewfinders, photographic; electric plugs; micrometer screws for optical instruments; viscosimeters; circuit closers; wavemeters; voltmeters; mechanical signs; signs, luminous; switchboxes [electricity]; current rectifiers; gas testing instruments; gasometers [measuring instruments]; galvanometers; hands free kits for phones; heliographic apparatus; hygrometers; hydrometers; weights; peep-

holes [magnifying lenses] for doors; hairdressing training heads [teaching apparatus]; holograms; plotters; loudspeakers; sounding leads; plumb bobs; telemeters; parking sensors for vehicles; piezoelectric sensors; densimeters; densitometers; detectors; smoke detectors; infrared detectors; false coin detectors; joysticks for use with computers, other than for video games; slides [photography]; slide projectors; diaphragms [photography]; dictating machines; dynamometers; light-emitting diodes [LED]; quantum dot light-emitting diodes [QLED]; organic light-emitting diodes [OLED]; floppy disks; phonograph records; disks, magnetic; optical discs; disk drives for computers; juke boxes for computers; wearable video display monitors; electronic numeric displays; DNA chips; electronic interactive whiteboards; electronic notice boards; electric wire harnesses for automobiles; bullet-proof waistcoats; life jackets; reflective safety vests; identification threads for electric wires; nose clips for divers and swimmers; padlocks, electronic; locks, electric; bells [warning devices]; alarm bells, electric; electric door bells; signal bells; acoustic conduits; mirrors for inspecting work; road signs, luminous or mechanical; downloadable emoticons for mobile phones; probes for scientific purposes; buzzers; needles for surveying compasses; styli for record players; eyewear; reflective articles for wear, for the prevention of accidents; measures; pressure measuring apparatus; simulators for the steering and control of vehicles; inverters [electricity]; pressure indicators; automatic indicators of low pressure in vehicle tyres; temperature indicators; incubators for bacteria culture; measuring instruments; cosmographic instruments; mathematical instruments; levelling instruments; instruments containing eyepieces; surveying instruments; azimuth instruments; interfaces for computers; audio interfaces; ionization apparatus not for the treatment of air or water; satellite finder meters; spark-guards; coaxial cables; fibre [fiber (am.)] optic cables; cables, electric; calipers; slide calipers; screw-tapping gauges; calorimeters; calculating machines; pocket calculators; decompression chambers; rearview cameras for vehicles; cinematographic cameras; thermal imaging cameras; mouth guards for sports; life-saving capsules for natural disasters; electronic pens [visual display units]; holders for electric coils; biometric identity cards; identity cards, magnetic; video game cartridges; toner cartridges, unfilled, for printers and photocopiers; ink cartridges, unfilled, for printers and photocopiers; memory cards for video game machines; encoded magnetic cards; riding helmets; protective helmets; carriers for dark plates [photography]; cathodes; spools [photography]; choking coils [impedance]; coils, electric; electromagnetic coils; cinematographic film, exposed; computer keyboards; solenoid valves [electromagnetic switches]; wire connectors [electricity]; thin client computers; downloadable cryptographic keys for receiving and spending cryptocurrency; encoded key cards; electronic book readers; electronic agen-

das; push buttons for bells; mouse pads; magnetic encoders; visors for helmets; collectors, electric; calibrating rings; smart rings; ring sizers; protective suits for aviators; commutators; compact discs [audio-video]; compact discs [read-only memory]; comparators; marine compasses; computers; laptop computers; tablet computers; notebook computers; wearable computers; capacitors; contacts, electric; wind socks for indicating wind direction; traffic cones; branch boxes [electricity]; distribution boxes [electricity]; junction boxes [electricity]; battery boxes; cabinets for loudspeakers; diving suits; downloadable e-wallets; galena crystals [detectors]; calculating disks; covers for electric outlets; logs [measuring instruments]; lasers, not for medical purposes; lactodensimeters; lactometers; vacuum tubes [radio]; darkroom lamps [photography]; thermionic tubes; amplifying tubes; flashlights [photography]; head cleaning tapes [recording]; magnetic tapes; videotapes; surveying chains; fire escapes; rulers [measuring instruments]; square rulers for measuring; slide-rules; circular slide rules; contact lenses; correcting lenses [optics]; optical lenses; optical condensers; sounding lines; electricity conduits; measuring spoons; magnifying glasses [optics]; waling glasses; magnets; decorative magnets; crash test dummies; resuscitation mannequins [teaching apparatus]; mouse [computer peripheral]; manometers; security tokens [encryption devices]; divers' masks; solderers' helmets; protective masks; respiratory masks, other than for artificial respiration; materials for electricity mains [wires, cables]; voting machines; money counting and sorting machines; material testing instruments and machines; furniture especially made for laboratories; megaphones; portable media players; diaphragms [acoustics]; diaphragms for scientific apparatus; metal detectors for industrial or military purposes; digital weather stations; metronomes; rules [measuring instruments]; carpenters' rules; dressmakers' measures; mechanisms for coin-operated apparatus; mechanisms for counter-operated apparatus; coin-operated mechanisms for television sets; shutter releases [photography]; micrometers; microprocessors; microscopes; microtomes; microphones; audio mixers; modems; lightning arresters; monitors [computer hardware]; monitors [computer programs]; selfie sticks [hand-held monopods]; terminals [electricity]; junction sleeves for electric cables; teeth protectors; temperature indicator labels, not for medical purposes; knee-pads for workers; ear pads for headphones; headphones; earpieces for remote communication; surveyors' levels; sound recording carriers; magnetic data media; optical data media; electronic sheet music, downloadable; computer game software, recorded; computer software, recorded; sheaths for electric cables; identification sheaths for electric wires; weighing machines; computer hardware; punched card machines for offices; life saving equipment; shoes for protection against accidents, irradiation and fire; objectives [lenses] [optics]; lenses for astrophotography; selfie lenses; egg-

candlers; fire extinguishers; rescue laser signalling flares; electrified fences; limiters [electricity]; clothing for protection against accidents, irradiation and fire; clothing for protection against fire; asbestos clothing for protection against fire; clothing especially made for laboratories; survival blankets; ozonisers [ozonators]; octants; eyepieces; ohmmeters; wrist rests for use with computers; spectacle frames; oscillographs; plumb lines; mirrors [optics]; spectacles [optics]; sunglasses; goggles for sports; electronic collars to train animals; finger sizers; signalling panels, luminous or mechanical; biometric passports; wah-wah pedals; radio pagers; pince-nez; electronic pocket translators; transmitters [telecommunication]; telephone transmitters; transmitters of electronic signals; switches, electric; periscopes; data gloves; gloves for divers; gloves for protection against accidents; gloves for protection against X-rays for industrial purposes; asbestos gloves for protection against accidents; ovens for laboratory use; droppers for measuring, other than for medical or household purposes; laboratory pipettes; pyrometers; planimeters; plane tables [surveying instruments]; plates for batteries; computer software platforms, recorded or downloadable; wafers for integrated circuits; printed circuit boards; compact disc players; cassette players; protective films adapted for computer screens; protective films adapted for smartphones; sound recording strips; X-ray films, exposed; films, exposed; life-saving rafts; animal signalling rattles for directing livestock; laboratory trays; digital signs; stands adapted for laptops; semi-conductors; polarimeters; personal digital assistants [pdas]; fire pumps; graduated glassware; weight belts for divers; life belts; fuses; circuit breakers; converters, electric; telerupters; food analysis apparatus; diagnostic apparatus, not for medical purposes; distance recording apparatus; distance measuring apparatus; speed measuring apparatus [photography]; appliances for measuring the thickness of leather; apparatus for measuring the thickness of skins; speed checking apparatus for vehicles; teaching apparatus; time recording apparatus; apparatus and instruments for astronomy; surveying apparatus and instruments; weighing apparatus and instruments; nautical apparatus and instruments; navigational instruments; optical apparatus and instruments; apparatus and instruments for physics; chemistry apparatus and instruments; measuring apparatus; measuring devices, electric; boiler control instruments; meteorological instruments; naval signalling apparatus; observation instruments; navigation apparatus for vehicles [on-board computers]; satellite navigational apparatus; regulating apparatus, electric; telecommunication apparatus in the form of jewellery; precision measuring apparatus; audio- and video-receivers; prisms [optics]; computer software applications, downloadable; ticket printers; printers for use with computers; hemline markers; retorts' stands; apparatus for changing record player needles; photographic racks; cleaning apparatus for phonograph re-

cords; fire beaters; sighting telescopes for firearms; telescopic sights for artillery; test tubes; pressure indicator plugs for valves; magnetic wires; telegraph wires; telephone wires; wires, electric; conductors, electric; copper wire, insulated; fuse wire; computer programs, recorded; computer game software, downloadable; computer programs, downloadable; computer operating programs, recorded; computer screen saver software, recorded or downloadable; record players; central processing units [processors]; rods for water diviners; electronic publications, downloadable; distribution consoles [electricity]; control panels [electricity]; radar apparatus; baby monitors; masts for wireless aerials; transmitting sets [telecommunication]; radios; vehicle radios; sprinkler systems for fire protection; frames for photographic transparencies; screens for photoengraving; flowmeters; walkie-talkies; voltage surge protectors; voltage regulators for vehicles; stage lighting regulators; light dimmers [regulators], electric; speed regulators for record players; reducers [electricity]; washing trays [photography]; marking gauges [joinery]; t-squares for measuring; time switches, automatic; relays, electric; safety restraints, other than for vehicle seats and sports equipment; body harnesses for support when lifting loads; x-ray photographs, other than for medical purposes; rheostats; respirators for filtering air; retorts; refractometers; refractors; grids for batteries; security surveillance robots; laboratory robots; teaching robots; telepresence robots; humanoid robots with artificial intelligence for use in scientific research; electric sockets; height measuring instruments; speaking tubes; horns for loudspeakers; subwoofers; saccharometers; light conducting filaments [optical fibers [fibres]]; traffic-light apparatus [signalling devices]; dog whistles; signalling whistles; sports whistles; sextants; inductors [electricity]; life nets; nets for protection against accidents; fire alarms; signals, luminous or mechanical; rescue flares, non-explosive and non-pyrotechnic; sirens; electronic access control systems for interlocking doors; scanners [data processing equipment]; hand-held electronic dictionaries; integrated circuit cards [smart cards]; smartglasses; smartphones; smartwatches; connections for electric lines; couplings, electric; sonars; sound locating instruments; lighting ballasts; resistances, electric; spectrograph apparatus; spectroscopes; speed indicators; alcoholmeters; satellites for scientific purposes; protection devices for personal use against accidents; audiovisual teaching apparatus; charging stations for electric vehicles; radiotelegraphy sets; radiotelephony sets; spectacle lenses; anti-glare glasses; optical glass; personal stereos; stereoscopes; stands for photographic apparatus; stroboscopes; fire boats; sulphitometers; bags adapted for laptops; drying racks [photography]; spherometers; integrated circuits; printed circuits; meters; parking meters; milage recorders for vehicles; revolution counters; abacuses; hourglasses; taximeters; ear plugs for divers; tachometers; television apparatus; tele-

graphs [apparatus]; telescopes; teleprompters; teleprinters; mobile telephones; cordless telephones; theodolites; credit card terminals; interactive touch screen terminals; thermo-hygrometers; thermometers, not for medical purposes; thermostats; thermostats for vehicles; climate control digital thermostats; cupels [laboratory]; tone arms for record players; totalizers; transistors [electronic]; transponders; protractors [measuring instruments]; transformers [electricity]; step-up transformers; trackballs [computer peripherals]; resuscitation training simulators; vehicle breakdown warning triangles; triodes; starter cables for motors; electric discharge tubes, other than for lighting; capillary tubes; neon signs; pitot tubes; x-ray tubes not for medical purposes; telephone receivers; headgear being protective helmets; squares for measuring; gauges; quantity indicators; petrol gauges; water level indicators; electric loss indicators; light-emitting electronic pointers; clinometers; levels [instruments for determining the horizontal]; mercury levels; spirit levels; urinometers; amplifiers; particle accelerators; electric installations for the remote control of industrial operations; steering apparatus, automatic, for vehicles; balancing apparatus; video recorders; sound reproduction apparatus; invoicing machines; tape recorders; protection devices against X-rays, not for medical purposes; railway traffic safety appliances; data processing apparatus; oxygen transvasing apparatus; theft prevention installations, electric; devices for the projection of virtual keyboards; film cutting apparatus; drying apparatus for photographic prints; optical character readers; centering apparatus for photographic transparencies; dosimeters; battery chargers; chargers for electric batteries; chargers for electronic cigarettes; sound alarms; sounding apparatus and machines; apparatus for editing cinematographic film; cathodic anti-corrosion apparatus; couplers [data processing equipment]; wearable activity trackers; anti-theft warning apparatus; computer peripheral devices; anti-interference devices [electricity]; demagnetizing apparatus for magnetic tapes; acoustic couplers; alarms; fog signals, non-explosive; whistle alarms; adding machines; readers [data processing equipment]; heat regulating apparatus; photocopiers [photographic, electrostatic, thermic]; electric and electronic effects units for musical instruments; bar code readers; downloadable ring tones for mobile phones; downloadable image files; downloadable music files; animated cartoons; filters for respiratory masks; filters for ultraviolet rays, for photography; filters for use in photography; USB flash drives; magic lanterns; optical lamps; signal lanterns; cameras [photography]; glazing apparatus for photographic prints; shutters [photography]; darkrooms [photography]; photometers; flash-bulbs [photography]; digital photo frames; enlarging apparatus [photography]; photovoltaic cells; containers for contact lenses; spectacle cases; containers for microscope slides; cases for smartphones; cases especially made for photographic apparatus and instruments; chroma-

tography apparatus for laboratory use; chronographs [time recording apparatus]; laboratory centrifuges; spectacle chains; cyclotrons; compasses for measuring; frequency meters; time clocks [time recording devices]; petri dishes; sleeves for laptops; covers for personal digital assistants [pdas]; covers for tablet computers; covers for smartphones; fire blankets; chips [integrated circuits]; jigs [measuring instruments]; pedometers; meteorological balloons; electrified rails for mounting spot lights; asbestos screens for firemen; fire hose; virtual reality headsets; protective helmets for sports; head guards for sports; lifeboats; snorkels; cell phone straps; spectacle cords; tripods for cameras; switchboards; distribution boards [electricity]; equalizers [audio apparatus]; screens [photography]; workmen's protective face-shields; projection screens; radiology screens for industrial purposes; fluorescent screens; exposure meters [light meters]; ducts [electricity]; galvanic cells; downloadable graphics for mobile phones; epidiascopes; ergometers; armatures [electricity]; black boxes [data recorders].

16 – Fountain pens; watercolors [paintings]; albums; almanacs; document laminators for office use; mimeograph apparatus and machines; atlases; posters; banknotes; banners of paper; paper bows, other than haberdashery or hair decorations; name badges [office requisites]; table linen of paper; tickets; baggage claim check tags of paper; forms, printed; announcement cards [stationery]; glitter for stationery purposes; note books; pads [stationery]; drawing pads; wristbands for the retention of writing instruments; pamphlets; booklets; paper; paper sheets [stationery]; waxed paper; paper for medical examination tables; paper for recording machines; paper for radiograms; papers for painting and calligraphy; electrocardiograph paper; drawer liners of paper, perfumed or not; wood pulp paper; copy paper; copying paper [stationery]; parchment paper; writing paper; rice paper; luminous paper; toilet paper; packing paper; filter paper; japanese paper; blotters; newsletters; rollers for typewriters; house painters' rollers; composing sticks; modelling wax, not for dental purposes; signboards of paper or cardboard; patterns for dressmaking; bunting of paper; newspapers; electrotypes; hectographs; modelling clay; polymer modelling clay; terrestrial globes; drawing sets; engravings; slate pencils; pencil leads; document holders [stationery]; pencil holders; chalk holders; holders for checkbooks [cheque books]; holders for stamps [seals]; page holders; name badge holders [office requisites]; diagrams; table runners of paper; engraving plates; writing slates; blackboards; galley racks [printing]; drawing boards; advertisement boards of paper or cardboard; duplicators; punches [office requisites]; cream containers of paper; magazines [periodicals]; money clips; clips for name badge holders [office requisites]; tags for index cards; pen clips; bookmarkers; etching needles; tracing needles for drawing purposes; periodicals; printed publicati-

ons; paper shredders for office use; graphic representations; credit card imprinters, non-electric; paper creasers [office requisites]; graining combs; drawing instruments; calendars; tracing paper; tracing cloth; tracing patterns; gums [adhesives] for stationery or household purposes; lithographic stones; ink stones [ink reservoirs]; pencils; pencil lead holders; charcoal pencils; pictures; decalcomanias; paintings [pictures], framed or unframed; cardboard; wood pulp board [stationery]; hat boxes of cardboard; charts; index cards [stationery]; geographical maps; paper tapes and cards for the recordal of computer programmes; trading cards other than for games; perforated cards for jacquard looms; catalogues; spools for inking ribbons; flower-pot covers of paper; paintbrushes; painters' brushes; writing brushes; typewriter keys; glue for stationery or household purposes; isinglass for stationery or household purposes; gluten [glue] for stationery or household purposes; starch paste [adhesive] for stationery or household purposes; printing blocks; books; colouring books; manifolds [stationery]; comic books; thumbtacks; cigar bands; envelopes [stationery]; boxes of paper or cardboard; cases for stamps [seals]; paint boxes [articles for use in school]; correcting fluids [office requisites]; printed coupons; stencils [stationery]; french curves; paper ribbons, other than haberdashery or hair decorations; gummed tape [stationery]; typewriter ribbons; barcode ribbons; adhesive bands for stationery or household purposes; correcting tapes [office requisites]; inking ribbons; self-adhesive tapes for stationery or household purposes; square rulers for drawing; drawing rulers; flyers; absorbent sheets of paper or plastic for foodstuff packaging; humidity control sheets of paper or plastic for foodstuff packaging; viscose sheets for wrapping; sheets of reclaimed cellulose for wrapping; plastic bubble packs for wrapping or packaging; steel letters; letters [type]; lithographs; letter trays; paint trays; architects' models; postage stamps; plastics for modelling; graphic prints; modelling materials; teaching materials [except apparatus]; sealing compounds for stationery purposes; adhesives [glues] for stationery or household purposes; padding materials of paper or cardboard; bookbinding material; packing [cushioning, stuffing] materials of paper or cardboard; packaging materials made of starches; filtering materials [paper]; table place setting mats of paper; addressing machines; pencil sharpening machines, electric or non-electric; bookbinding apparatus and machines [office equipment]; typewriters, electric or non-electric; postage meters for office use; chalk for lithography; writing chalk; tailors' chalk; marking chalk; spray chalk; bags [envelopes, pouches] of paper or plastics, for packaging; garbage bags of paper or of plastics; plastic bags for pet waste disposal; painters' easels; hand-rests for painters; printing sets, portable [office requisites]; bibs of paper; bibs, sleeved, of paper; stickers [stationery]; fingerstalls for office use; writing cases [stationery]; bookbinding cords; paper knives [letter

openers]; printed sheet music; numbering apparatus; bottle envelopes of paper or cardboard; sealing wafers; covers [stationery]; passport holders; protective covers for books; plastic cling film, extensible, for palletization; embroidery designs [patterns]; handwriting specimens for copying; oleographs; musical greeting cards; greeting cards; postcards; etchings; conical paper bags; paper bags for use in the sterilization of medical instruments; bags for microwave cooking; palettes for painters; ink sticks; pantographs [drawing instruments]; loose-leaf binders; file folders [office requisites]; document covers [stationery]; papier mâché; pastels [crayons]; modelling paste; pen cases; pen wipers; office perforators; pens [office requisites]; nibs of gold; nibs; steel pens; drawing pens; song books; seals [stamps]; sealing stamps; clipboards; address plates for addressing machines; handkerchiefs of paper; plastic film for wrapping; transparencies [stationery]; desk mats; trays for sorting and counting money; coasters of paper; bookends; stamp stands; mats for beer glasses; stands for pens and pencils; photograph stands; obliterating stamps; inking pads; stamp pads; binding strips [bookbinding]; facial tissues of paper; towels of paper; inking sheets for document reproducing machines; inking sheets for duplicators; bookbinding cloth; gummed cloth for stationery purposes; printers' blankets, not of textile; portraits; paperweights; writing cases [sets]; inkstands; office requisites, except furniture; writing materials; writing instruments; drawing materials; school supplies [stationery]; adhesive tape dispensers [office requisites]; hand labelling appliances; printed matter; lithographic works of art; prospectuses; printed timetables; ledgers [books]; printers' galleys; indexes; paper cutters [office requisites]; rubber erasers; elastic bands for offices; drawing T-squares; graphic reproductions; retractable reels for name badge holders [office requisites]; pen holders; marking pens [stationery]; tissues of paper for removing make-up; paper wipes for cleaning; dental tray covers of paper; place mats of paper; tablemats of paper; tablecloths of paper; paper clasps; document files [stationery]; scrapers [erasers] for offices; paper-clips; clips for offices; erasing products; biological samples for use in microscopy [teaching materials]; histological sections for teaching purposes; figurines of papier mâché; steatite [tailor's chalk]; writing board erasers; composing frames [printing]; sealing wax; calculating tables; placards of paper or cardboard; writing or drawing books; fabrics for bookbinding; stationery; pencil sharpeners, electric or non-electric; stencil plates; stencils for decorating food and beverages; cardboard tubes; indian inks; moisteners [office requisites]; moisteners for gummed surfaces [office requisites]; drawing squares; chart pointers, non-electronic; bottle wrappers of paper or cardboard; envelope sealing machines, for offices; sealing machines for offices; vignetting apparatus; apparatus for mounting photographs; stapling presses [office requisites]; handbooks [manuals]; papier

mâché figurines; paper coffee filters; flags of paper; silver paper; molds for modelling clays [artists' materials]; photo-engravings; photographs [printed]; stencil cases; canvas for painting; chromolithographs [chromos]; animation cels; compasses for drawing; numbers [type]; artists' watercolour saucers; ink; correcting ink [heliography]; inkwells; plans; stencils; erasing shields; balls for ball-point pens; desktop cabinets for stationery [office requisites]; printing type; address stamps; stamps [seals]; shields [paper seals]; prints [engravings]; labels of paper or cardboard.

18 – Alpenstocks; slings for carrying infants; luggage tags; pocket wallets; saddlecloths for horses; business card cases; reins; reins for guiding children; sling bags for carrying infants; harness fittings; credit card cases [wallets]; parts of rubber for stirrups; chamois leather, other than for cleaning purposes; umbrellas; parasols; saddlery; frames for umbrellas or parasols; handbag frames; card cases [notecases]; cases, of leather or leatherboard; valves of leather; whips; imitation leather; leather, unworked or semi-worked; leatherboard; casings, of leather, for springs; umbrella rings; hat boxes of leather; boxes of leather or leather board; boxes of vulcanised fibre; purses; chain mesh purses; fastenings for saddles; butts [parts of hides]; saddle trees; pouches, of leather, for packaging; moleskin [imitation of leather]; travelling sets [leatherware]; knee-pads for horses; muzzles; halters; vanity cases, not fitted; furniture coverings of leather; clothing for pets; covers for animals; leather trimmings for furniture; collars for animals; hiking sticks; conference folders; music cases; goldbeaters' skin; cat o' nine tails; leather leads; pads for horse saddles; horseshoes; girths of leather; leathercloth; horse blankets; garment bags for travel; bandoliers; briefcases; traces [harness]; fur; randsels [japanese school satchels]; haversacks; leather straps; straps for soldiers' equipment; harness straps; straps for skates; straps of leather [saddlery]; chin straps, of leather; stirrup leathers; umbrella handles; walking cane handles; suitcase handles; grips for holding shopping bags; backpacks; backpacks for carrying infants; travelling bags; riding saddles; net bags for shopping; umbrella or parasol ribs; stirrups; bags; bags for climbers; tool bags, empty; handbags; beach bags; saddlebags; compression cubes adapted for luggage; bags for sports; bags for campers; wheeled shopping bags; school bags; pouch baby carriers; travelling trunks; nose bags [feed bags]; bridoons; canes; umbrella sticks; walking stick seats; tefillin [phylacteries]; bits for animals [harness]; bridles [harness]; harness for animals; key cases; horse collars; suitcases; motorized suitcases; suitcases with wheels; attaché cases; covers for horse-saddles; umbrella covers; kid; curried skins; pelts; cattle skins; leather laces; blinders [harness]; labels of leather; game bags [hunting accessories].

25 – Wimples; bandanas [neckerchiefs]; underwear; sweat-absorbent underwear; berets; smocks; boas [ne-

cklets]; teddies [undergarments]; pants; ankle boots; ski boots; boots for sports; breeches for wear; trousers; football boots; brassieres; adhesive bras; valenki [felted boots]; mittens; shoulder wraps; detachable collars; shirt yokes; veils [clothing]; gabardines [clothing]; galoshes; neckties; ascots; chaps; spats; gaiters [leg warmers]; boot uppers; corselets; jerseys [clothing]; vests; singlets; hosiery; heels; heelpieces for footwear; hoods [clothing]; hat frames [skeletons]; pockets for clothing; scarves; caps being headwear; kimonos; cap peaks; visors being headwear; tights; slippers [undergarments]; combinations [clothing]; wet suits for water-skiing; bodices [lingerie]; corsets [underclothing]; suits; swimsuits; masquerade costumes; beach clothes; headscarves; leotards; jackets [clothing]; stuff jackets [clothing]; fishing vests; leggings [trousers]; liveries; camisoles; sports singlets; cuffs; short-sleeve shirts; mantillas; coats; sleep masks; furs [clothing]; miters [hats]; muffs [clothing]; footmuffs, not electrically heated; bibs, not of paper; bibs, sleeved, not of paper; fur stoles; hairdressing capes; heel protectors for shoes; ear muffs [clothing]; socks; sweat-absorbent socks; footwear; gymnastic shoes; beach shoes; sports shoes; clothing; paper clothing; outerclothing; embroidered clothing; ready-made clothing; motorists' clothing; cyclists' clothing; clothing for gymnastics; clothing of imitations of leather; latex clothing; clothing of leather; waterproof clothing; clothing incorporating LEDs; uniforms; clothing containing slimming substances; fittings of metal for footwear; maniples; topcoats; knickers; parkas; pelerines; gloves [clothing]; fingerless gloves; ski gloves; pyjamas; bathing trunks; shirt fronts; scarfs; pocket squares; dresses; headbands [clothing]; garters; sock suspenders; stocking suspenders; ready-made linings [parts of clothing]; dress shields; soles for footwear; suspenders; half-boots; lace boots; ponchos; girdles; belts [clothing]; sashes for wear; money belts [clothing]; layettes [clothing]; non-slipping devices for footwear; sweaters; heelpieces for stockings; welts for footwear; chasubles; shirts; wooden shoes; sandals; bath sandals; boots; jumper dresses; saris; sarongs; footwear uppers; inner soles; albs; bath slippers; togas; knitwear [clothing]; underpants; shoes; slippers; skull caps; turbans; headgear for wear; aprons [clothing]; judo uniforms; karate uniforms; tee-shirts; rash guards; dressing gowns; bath robes; top hats; tips for footwear; stockings; sweat-absorbent stockings; shawls; paper hats [clothing]; shower caps; bathing caps; neck tube scarves; studs for football boots; hats; babies' pants [underwear]; gaiter straps; pelisses; esparto shoes or sandals; skirts; petticoats; skorts.

35 – Arranging subscriptions to telecommunication services for others; import-export agency services; commercial information agency services; publicity agencies; cost price analysis; rental of office equipment in co-working facilities; rental of advertising space; business auditing; financial auditing; business intermediary services relating to the matching of potential

private investors with entrepreneurs needing funding; employment agency services; computerized file management; accounting; invoicing; demonstration of goods; transcription; opinion polling; marketing studies; business investigations; business research; marketing research; personnel recruitment; business management and organization consultancy; business organization consultancy; business management consultancy; personnel management consultancy; professional business consultancy; consultancy regarding advertising communication strategies; consultancy regarding public relations communication strategies; layout services for advertising purposes; marketing; marketing in the framework of software publishing; targeted marketing; business management of performing artists; business management of sports people; writing of curriculum vitae for others; scriptwriting for advertising purposes; news clipping services; updating and maintenance of information in registries; updating and maintenance of data in computer databases; updating of advertising material; word processing; online retail services for downloadable and pre-recorded music and movies; online retail services for downloadable ring tones; online retail services for downloadable digital music; organization of exhibitions for commercial or advertising purposes; arranging newspaper subscriptions for others; organization of fashion shows for promotional purposes; organization of trade fairs; shop window dressing; business appraisals; payroll preparation; data search in computer files for others; sponsorship search; administrative assistance in responding to calls for tenders; business management assistance; commercial or industrial management assistance; commercial intermediation services; providing business information; providing business information via a website; providing commercial and business contact information; providing commercial information and advice for consumers in the choice of products and services; provision of an online marketplace for buyers and sellers of goods and services; providing user reviews for commercial or advertising purposes; web indexing for commercial or advertising purposes; providing user rankings for commercial or advertising purposes; presentation of goods on communication media, for retail purposes; media relations services; economic forecasting; auctioneering; wholesale services for pharmaceutical, veterinary and sanitary preparations and medical supplies; retail services for works of art provided by art galleries; retail services for pharmaceutical, veterinary and sanitary preparations and medical supplies; sales promotion for others; promotion of goods and services through sponsorship of sports events; production of advertising films; office machines and equipment rental; rental of advertising time on communication media; publicity material rental; rental of billboards [advertising boards]; rental of vending machines; rental of sales stands; rental of photocopying machines; consumer



profiling for commercial or marketing purposes; publication of publicity texts; radio advertising; development of advertising concepts; bill-posting; distribution of samples; dissemination of advertising matter; direct mail advertising; registration of written communications and data; writing of publicity texts; publicity; on-line advertising on a computer network; advertising by mail order; television advertising; compilation of statistics; compilation of information into computer databases; business inquiries; systemization of information into computer databases; administrative services for medical referrals; advisory services for business management; corporate communications services; negotiation of business contracts for others; negotiation and conclusion of commercial transactions for third parties; compiling indexes of information for commercial or advertising purposes; tax preparation; drawing up of statements of accounts; telemarketing services; psychological testing for the selection of personnel; interim business management; outsourced administrative management for companies; business management of hotels; business management for freelance service providers; business project management services for construction projects; commercial administration of the licensing of the goods and services of others; business management of reimbursement programmes for others; administration of consumer loyalty programs; administration of frequent flyer programs; administrative processing of purchase orders; pay per click advertising; administrative services for the relocation of businesses; public relations; commercial lobbying services; competitive intelligence services; modelling for advertising or sales promotion; typing; market intelligence services; appointment reminder services [office functions]; website traffic optimization; appointment scheduling services [office functions]; tax filing services; search engine optimization for sales promotion; retail services relating to bakery products; gift registry services; price comparison services; secretarial services; procurement services for others [purchasing goods and services for other businesses]; shorthand; outsourcing services [business assistance]; telephone answering for unavailable subscribers; telephone switchboard services; photocopying services; business efficiency expert services.

36 – Credit bureau services; debt collection agency services; financial analysis; renting of flats; rental of offices for co-working; rental of real estate; rental of offices [real estate]; rental of farms; hire-purchase financing; savings bank services; accommodation bureau services [apartments]; rent collection; issuing of travellers' checks [cheques]; issuance of credit cards; issue of tokens of value; fund investments; financial research; clearing, financial; insurance consultancy; financial consultancy; debt advisory services; stock exchange quotations; crowdfunding; lending against security; business liquidation services, financial; brokerage; financial management; exchanging money; home banking; debit card services; credit card servi-

ces; financial exchange of virtual currency; real estate affairs; factoring; organization of monetary collections; arranging finance for construction projects; antique appraisal; jewelry appraisal; financial valuation of standing timber; stamp appraisal; real estate appraisal; numismatic appraisal; art appraisal; financial evaluation of development costs relating to the oil, gas and mining industries; financial valuation of intellectual property assets; financial evaluation of wool; financial evaluation [insurance, banking, real estate]; financial appraisals in responding to calls for tenders; repair costs evaluation [financial appraisal]; electronic funds transfer; surety services; securities brokerage; real estate brokerage; brokerage of carbon credits; insurance brokerage; providing insurance information; providing rebates at participating establishments of others through use of a membership card; loans [financing]; pawnbrokerage; providing financial information; providing financial information via a website; check [cheque] verification; investment of funds; charitable fund raising; stocks and bonds brokerage; financial sponsorship; mortgage banking; instalment loans; insurance underwriting; life insurance underwriting; health insurance underwriting; accident insurance underwriting; marine insurance underwriting; fire insurance underwriting; apartment house management; real estate management; financial management of reimbursement payments for others; real estate agency services; actuarial services; banking; stock brokerage services; e-wallet payment services; retirement payment services; bail-bonding; preparation of quotes for cost estimation purposes; electronic transfer of virtual currencies; fiduciary; provident fund services; financial customs brokerage services; mutual funds; financing services; safe deposit services; deposits of valuables; fiscal valuations.

37 – Asphaltting; drilling of deep oil or gas-wells; drilling of wells; rebuilding engines that have been worn or partially destroyed; rebuilding machines that have been worn or partially destroyed; renovation of clothing; retreading of tires; vulcanization of tires [repair]; building sealing; linen ironing; pressing of clothing; disinfecting; mining extraction; vehicle battery charging; charging of electric vehicles; knife sharpening; building insulating; bricklaying; riveting; construction consultation; varnishing; re-tinning; installation of utilities in construction sites; scaffolding; road paving; window cleaning; vehicle wash; building construction supervision; tuning of musical instruments; upholstering; rustproofing; anti-rust treatment for vehicles; sanding; pumicing; strong-room maintenance and repair; vehicle maintenance; wallpapering; painting or repair of signs; cleaning of buildings [exterior surface]; vehicle polishing; vehicle breakdown repair services; providing information relating to repairs; providing construction information; rental of bulldozers; rental of drainage pumps; rental of dish drying machines; rental of road sweeping machines; rental of cleaning machines; rental of cranes [construction equi-

ipment]; rental of dishwashing machines; rental of laundry washing machines; rental of construction equipment; rental of excavators; laying of cable; plumbing; masonry; roofing services; painting, interior and exterior; carpentry services; underwater repair; plastering; quarrying services; repair of security locks; umbrella repair; parasol repair; motor vehicle maintenance and repair; burner maintenance and repair; film projector repair and maintenance; airplane maintenance and repair; safe maintenance and repair; clock and watch repair; repair of power lines; pump repair; upholstery repair; shoe repair; clothing repair; photographic apparatus repair; furniture restoration; restoration of musical instruments; restoration of works of art; vehicle greasing; demolition of buildings; warehouse construction and repair; vehicle service stations [refuelling and maintenance]; sterilization of medical instruments; washing; washing of linen; building construction; pier breakwater building; pipeline construction and maintenance; underwater construction; harbour construction; factory construction; building of fair stalls and shops; shipbuilding; cleaning of buildings [interior]; snow removal; street cleaning; vermin exterminating, other than for agriculture, aquaculture, horticulture and forestry; housekeeping services [cleaning services]; tyre balancing; pest control services, other than for agriculture, aquaculture, horticulture and forestry; hydraulic fracturing services; refilling of toner cartridges; refilling of ink cartridges; cell phone battery charging services; artificial snow-making services; laundering; services of electricians; installation of doors and windows; irrigation devices installation and repair; lift installation and repair; installation and repair of flood protection equipment; heating equipment installation and repair; burglar alarm installation and repair; furnace installation and repair; telephone installation and repair; air conditioning apparatus installation and repair; fire alarm installation and repair; freezing equipment installation and repair; electric appliance installation and repair; kitchen equipment installation; installation, maintenance and repair of computer hardware; machinery installation, maintenance and repair; office machines and equipment installation, maintenance and repair; interference suppression in electrical apparatus; swimming-pool maintenance; furniture maintenance; chimney sweeping; boiler cleaning and repair; cleaning of clothing; dry cleaning; vehicle cleaning; diaper cleaning; leather care, cleaning and repair; fur care, cleaning and repair.

38 – News agency services; wireless broadcasting; television broadcasting; cable television broadcasting; electronic bulletin board services [telecommunications services]; providing user access to global computer networks; providing access to databases; providing internet chatrooms; providing telecommunications connections to a global computer network; providing telecommunication channels for teleshopping services; video-on-demand transmission; transmission of

podcasts; transmission of greeting cards online; message sending; computer aided transmission of messages and images; transmission of telegrams; transmission of digital files; providing information in the field of telecommunications; providing online forums; videoconferencing services; rental of message sending apparatus; rental of access time to global computer networks; rental of modems; rental of telecommunication equipment; rental of smartphones; rental of telephones; rental of facsimile apparatus; radio broadcasting; radio communications; transmission of electronic mail; communications by fiber [fibre] optic networks; cellular telephone communication; communications by computer terminals; satellite transmission; communications by telegrams; communications by telephone; facsimile transmission; paging services [radio, telephone or other means of electronic communication]; teleconferencing services; telex services; voice mail services; telecommunications routing and junction services; streaming of data; telegraph services; telephone services.

41 – Modelling for artists; academies [education]; rental of indoor aquaria; rental of artwork; rental of sports grounds; rental of tennis courts; mobile library services; lending libraries; booking of seats for shows; videotaping; physical education; production of music; discotheque services; animal training; dubbing; publication of books; film distribution; movie studio services; health club services [health and fitness training]; nightclub services [entertainment]; layout services, other than for advertising purposes; microfilming; videotape editing; production of radio and television programmes; screenplay writing; religious education; aikido instruction; gymnastic instruction; judo instruction; correspondence courses; practical training [demonstration]; training services provided via simulators; organization of balls; organization of exhibitions for cultural or educational purposes; providing recreation facilities; arranging and conducting of colloquiums; arranging and conducting of congresses; arranging and conducting of conferences; arranging and conducting of concerts; arranging and conducting of workshops [training]; arranging and conducting of in-person educational forums; arranging and conducting of seminars; arranging and conducting of symposiums; organization of competitions [education or entertainment]; arranging of beauty contests; organization of cosplay entertainment events; organization of lotteries; organization of fashion shows for entertainment purposes; organization of shows [impresario services]; organization of sports competitions; vocational guidance [education or training advice]; amusement park services; sign language interpretation; language interpretation; know-how transfer [training]; television entertainment; vocational retraining; providing online videos, not downloadable; providing information in the field of education; providing information relating to recreational activities; providing information in the field of entertainment; providing online music, not

downloadable; providing television programmes, not downloadable, via video-on-demand services; providing films, not downloadable, via video-on-demand services; providing user reviews for entertainment or cultural purposes; providing golf facilities; providing user rankings for entertainment or cultural purposes; providing sports facilities; providing amusement arcade services; cinema presentations; providing online electronic publications, not downloadable; presentation of circus performances; presentation of variety shows; presentation of live performances; theatre productions; conducting guided climbing tours; conducting fitness classes; educational examination; film production, other than advertising films; rental of audio equipment; rental of camcorders; rental of video cassette recorders; rental of videotapes; rental of show scenery; rental of sound recordings; toy rental; rental of cinematographic apparatus; rental of motion pictures; games equipment rental; rental of stadium facilities; rental of lighting apparatus for theatrical sets or television studios; rental of radio and television sets; rental of skin diving equipment; rental of sports equipment, except vehicles; rental of stage scenery; rental of training simulators; electronic desktop publishing; publication of electronic books and journals on-line; publication of texts, other than publicity texts; radio entertainment; entertainment services; writing of texts; sado instruction [tea ceremony instruction]; zoological garden services; news reporters services; film directing, other than advertising films; party planning [entertainment]; music composition services; subtitling; tutoring; entertainment services provided by performing artists; holiday camp services [entertainment]; gambling services; video editing services for events; conducting guided tours; disc jockey services; sound engineering services for events; game services provided online from a computer network; personal trainer services [fitness training]; providing casino facilities [gambling]; calligraphy services; karaoke services; club services [entertainment or education]; songwriting; cultural, educational or entertainment services provided by art galleries; providing museum facilities [presentation, exhibitions]; teaching; educational services provided by special needs assistants; educational services provided by schools; orchestra services; translation; scriptwriting, other than for advertising purposes; physical fitness assessment services for training purposes; face painting; ticket agency services [entertainment]; educational examination for users to qualify to pilot drones; coaching [training]; lighting technician services for events; sport camp services; recording studio services; nursery schools; photography; photographic reporting; timing of sports events; boarding school education; production of shows.

42 – Water analysis; computer system analysis; handwriting analysis [graphology]; chemical analysis; rental of meters for the recording of energy consumption; energy auditing; recovery of computer data; business card design; graphic design of promotional materials;

interior design; industrial design; graphic arts design; computer virus protection services; oil-field surveys; geological surveys; engineering; installation of computer software; weather forecasting; clinical trials; material testing; textile testing; bacteriological research; biological research; geological research; research in the field of environmental protection; cosmetic research; mechanical research; research in the field of welding; research in the field of building construction; research in the field of telecommunications technology; research in the field of physics; chemical research; research and development of new products for others; medical research; scientific and technological research relating to patent mapping; scientific and technological research in the field of natural disasters; scientific research; analysis for oil-field exploitation; underwater exploration; technological research; calibration [measuring]; web site design consultancy; computer security consultancy; information technology [IT] consulting services; computer technology consultancy; consultancy in the design and development of computer hardware; architectural consultation; internet security consultancy; computer software consultancy; data security consultancy; technological consultancy; oil-well testing; quality control; vehicle roadworthiness testing; land surveying; dress designing; updating of computer software; monitoring of computer systems to detect breakdowns; monitoring of computer systems for detecting unauthorized access or data breach; monitoring of computer systems by remote access; electronic monitoring of credit card activity to detect fraud via the internet; electronic monitoring of personally identifying information to detect identity theft via the internet; software as a service [SaaS]; maintenance of computer software; authenticating works of art; design of interior decor; quality evaluation of standing timber; quality evaluation of wool; digitization of documents [scanning]; conversion of data or documents from physical to electronic media; urban planning; providing information relating to computer technology and programming via a website; providing scientific information, advice and consultancy relating to carbon offsetting; providing search engines for the internet; platform as a service [PaaS]; conversion of computer programs and data, other than physical conversion; conducting technical project studies; computer system design; rental of web servers; computer rental; rental of computer software; unlocking of mobile phones; geological prospecting; oil prospecting; hosting computer sites [web sites]; development of computer platforms; construction drafting; computer software design; software development in the framework of software publishing; cloud seeding; server hosting; consultancy in the field of energy-saving; creating and designing website-based indexes of information for others [information technology services]; creating and maintaining web sites for others; computer programming; technical writing; copying of computer programs; cloud computing; architectural

services; information technology services provided on an outsourcing basis; chemistry services; packaging design; off-site data backup; telecommunications technology consultancy; scientific laboratory services; user authentication services using single sign-on technology for online software applications; user authentication services using technology for e-commerce transactions; styling [industrial design]; cartography services; exploration services in the field of the oil, gas and mining industries; data encryption services; electronic data storage; oilfield surveys; surveying.

(260) AM 2022 117373 A

(800) 1653864

(151) 2021 12 24

(891) 2021 12 24

(731) LG Corp.

128, Yeoui-daero, Yeongdeungpo-gu, Seoul,  
Republic of Korea

(540)



(591) Black, white

(531) 24.17.02; 26.01.01; 26.01.03; 26.01.18;

26.01.24; 27.05.09; 27.05.22; 27.05.24

(511)

9 – Electronic power supplies; electricity distribution/control apparatus and instruments; apparatus and instruments for conducting electricity; conductors, electric; apparatus and instruments for accumulating and storing electricity; lithium secondary battery pack; separator for secondary batteries; anodes for secondary batteries; cathodes for secondary batteries; lithium secondary batteries; modules for lithium secondary batteries; lithium batteries; cooling pads especially adapted for decreasing the heat generation of batteries; battery separators; battery packs; battery cell; cell for lithium secondary batteries; battery cell electrodes; batteries for vehicles; batteries, electric; magnets for industrial purposes; anodes; cathodes; cathodic protection apparatus; cathodic anti-corrosion apparatus; fuel cell electrodes; printed circuit boards; battery charge devices; batteries; secondary cells.

17 – Electrical insulating materials; electric insulators; electrical insulating compound materials; insulating materials; polymer films for use in manufacture; semi-processed thermoplastic polymer resins for use in manufacture; synthetic resins, semi-processed; semi-processed plastics; insulating refractory materials; foils of metal for insulating; polymer film used for manufacturing electronic circuits; self-adhesive plastic sheets for use in manufacturing; electrical insulators made of rubber; multilayer films for use in sealing and insulating; seals materials and insulating materials; insulators for electric mains; polyurethane sheets; plastic film, other than for wrapping; plastic sheet

materials for use in manufacture; semi-worked plastic film; vinyl sheet; semi-finished plastic sheets; semi-worked vinyl sheets; adhesive-coated plastic sheets for use in manufacture; laminated plastic material in the form of boards for use in manufacture; electrical insulating rubber products; insulating foam for use in building and construction; building insulation materials; non-conducting materials for retaining heat for building; padding materials of rubber or plastic; heat insulation film; rubber, raw or semi-worked; scratch protection films for use in manufacture; non-conducting materials; tinted, laminated and reflective plastic films for interior decorating; synthetic rubber; ethylene vinyl acetate rubber; thermoplastic elastomer resins in pellet form for use in manufacture; rigid polyvinyl chloride films for use in manufacture; thermal insulating materials; metalized films for use in sealing and insulating; polyvinyl chloride films for use in manufacture; films for sun protection; tinted plastic films for use on windows; ultraviolet-proof films for vehicles; transparent acrylic sheets for use in manufacture.

(260) AM 2022 117396 A

(800) 1654722

(151) 2021 10 04

(891) 2021 10 04

(731) "BEVERLee Club" Limited Liability

Partnership (KZ)

Samal-2 microdistrict, 33A, Medeu district,  
050000 Almaty, Kazakhstan

(540)



(591) Black, white and red

(531) 26.04.05; 26.04.18; 26.04.24; 27.05.01;

27.05.09; 27.05.10; 27.05.22; 27.05.24;

29.01.13

(511)

3 – Deodorants for human beings or for animals; creams for leather / waxes for leather; scented wood; dentifrices; polishing preparations; washing soda, for cleaning; shoe wax; abrasives; amber [perfume]; descaling preparations for household purposes; antistatic preparations for household purposes; aromatics [essential oils]; air fragrancing preparations; cake flavourings [essential oils]; flavourings for beverages [essential oils]; food flavourings [essential oils]; breath freshening sprays; canned pressurized air for cleaning and dusting purposes; balms, other than for medical purposes; lip glosses; polishing stones; abrasive paper; emery paper; polishing paper; petroleum jelly for cosmetic purposes; shoe polish; cobblers' wax; cotton wool for cosmetic purposes; sachets for perfuming linen; drying agents for dishwashing machines; adhesives for cosmetic purposes; scented water; javelle water; lavender water; toilet water; wax for parquet floors; floor wax; non-slipping wax for floors; depilatory

wax; moustache wax; tailors' wax; polish for furniture and flooring; shoemakers' wax; polishing wax; massage gels, other than for medical purposes; heliotropine; dental bleaching gels; geraniol; make-up; deodorants for pets; depilatory preparations; air fragrance reed diffusers; perfumes; non-slipping liquids for floors; windscreen cleaning liquids; greases for cosmetic purposes; volcanic ash for cleaning; perfumery; decorative transfers for cosmetic purposes; ionone [perfumery]; shaving stones [astringents]; smoothing stones; eyebrow pencils; cosmetic pencils; silicon carbide [abrasive]; carbides of metal [abrasives]; alum stones [astringents]; tripoli stone for polishing; adhesives for affixing false eyelashes; adhesives for affixing false hair; hair conditioners; quillaia bark for washing; corundum [abrasive]; beard dyes; colorants for toilet purposes; cosmetic dyes; starch for laundry purposes; laundry glaze; shoe cream; polishing creams; cosmetic creams; skin whitening creams; polishing rouge; incense; hair spray; nail varnish; hair lotions; lotions for cosmetic purposes; after-shave lotions; beauty masks; oils for perfumes and scents; oils for cosmetic purposes; oils for toilet purposes; essential oils; essential oils of cedarwood; essential oils of lemon; essential oils of citron; oils for cleaning purposes; bergamot oil; gaultheria oil; jasmine oil; lavender oil; almond oil; rose oil; oil of turpentine for degreasing; whitening; cleaning chalk; almond milk for cosmetic purposes; cleansing milk for toilet purposes; musk [perfumery]; deodorant soap; shaving soap; soap for brightening textile; cakes of toilet soap; antiperspirant soap; soap for foot perspiration; soap; almond soap; mint for perfumery; cosmetic kits; emery; nail art stickers; false nails; eau de cologne; bases for flower perfumes; joss sticks; pastes for razor strops; pumice stone; lipstick cases; hydrogen peroxide for cosmetic purposes; breath freshening strips; teeth whitening strips; sandcloth; glass cloth [abrasive cloth]; lipsticks; pomades for cosmetic purposes; shaving preparations; cosmetic preparations for baths; bath preparations, not for medical purposes; hair straightening preparations; hair waving preparations; laundry soaking preparations; grinding preparations; smoothing preparations [starching]; colour-removing preparations; leather bleaching preparations; polishing preparations; denture polishes; mouthwashes, not for medical purposes; cosmetic preparations for slimming purposes; starch glaze for laundry purposes; eye-washes, not for medical purposes; fabric softeners for laundry use; laundry bleach; dry-cleaning preparations; paint stripping preparations; lacquer-removing preparations; make-up removing preparations; floor wax removers [scouring preparations]; varnish-removing preparations; rust removing preparations; nail care preparations; cleaning preparations; preparations for cleaning dentures; wall-paper cleaning preparations; preparations for unblocking drain pipes; chemical cleaning preparations for household purposes; collagen preparations for cosmetic purposes; bleaching preparations [decolorants] for

household purposes; laundry preparations; aloe vera preparations for cosmetic purposes; sunscreen preparations; colour-brightening chemicals for household purposes [laundry]; breath freshening preparations for personal hygiene; shining preparations [polish]; make-up powder; diamantine [abrasive]; stain removers; nail varnish removers; vaginal washes for personal sanitary or deodorant purposes; scouring solutions; false eyelashes; tissues impregnated with cosmetic lotions; tissues impregnated with make-up removing preparations; saffrol; massage candles for cosmetic purposes; laundry blueing; turpentine for degreasing; potpourris [fragrances]; bleaching soda; bath salts, not for medical purposes; bleaching salts; fumigation preparations [perfumes]; leather preservatives [polishes]; ammonia [volatile alkali] [detergent]; astringents for cosmetic purposes; eyebrow cosmetics; make-up preparations; sun-tanning preparations [cosmetics]; hair dyes; neutralizers for permanent waving; preparations to make the leaves of plants shiny; cosmetic preparations for eyelashes; cosmetic preparations for skin care; cosmetics; cosmetics for children; cosmetics for animals; mascara; cleansers for intimate personal hygiene purposes, non medicated; douching preparations for personal sanitary or deodorant purposes [toiletries]; detergents, other than for use in manufacturing operations and for medical purposes; degreasers, other than for use in manufacturing processes; bleaching preparations [decolorants] for cosmetic purposes; antiperspirants [toiletries]; toiletry preparations; phytocosmetic preparations; talcum powder, for toilet use; cotton swabs for cosmetic purposes; terpenes [essential oils]; emery cloth; cloths impregnated with a detergent for cleaning; henna [cosmetic dye]; shampoos for animals [non-medicated grooming preparations]; shampoos for pets [non-medicated grooming preparations]; dry shampoos; shampoos; sandpaper; soda lye; herbal extracts for cosmetic purposes; extracts of flowers [perfumes]; ethereal essences; badian essence; mint essence [essential oil]; baby wipes impregnated with cleaning preparations; basma [cosmetic dye]; gel eye patches for cosmetic purposes; nail glitter.

35 – Arranging subscriptions to telecommunication services for others; import-export agency services; commercial information agency services; advertising agency services; cost price analysis; rental of advertising space; business auditing; financial auditing; business intermediary services relating to the matching of potential private investors with entrepreneurs needing funding; employment agency services; computerized file management; book-keeping; invoicing; demonstration of goods; transcription of communications [office functions]; opinion polling; market studies, business investigations; business research; marketing research; personnel recruitment; business management and organization consultancy; business organization consultancy; business management consultancy; personnel management consultancy; professional business consultancy; consultancy regarding advertising

communication strategies; layout services for advertising purposes; marketing; targeted marketing; business management of performing artists; business management of sports people; writing of curriculum vitae for others; scriptwriting for advertising purposes; news clipping services; updating and maintenance of information in registries; updating and maintenance of data in computer databases; updating of advertising material; word processing; online retail services for downloadable and pre-recorded music and movies; online retail services for downloadable ring tones; online retail services for downloadable digital music; organization of exhibitions for commercial or advertising purposes; arranging newspaper subscriptions for others; organization of fashion shows for promotional purposes; organization of trade fairs for commercial or advertising purposes; shop window dressing; business appraisals; payroll preparation; data search in computer files for others; sponsorship search; administrative assistance in responding to calls for tenders; business management assistance; commercial or industrial management assistance; commercial intermediation services; providing business information via a website; providing commercial and business contact information; provision of an online marketplace for buyers and sellers of goods and services; web indexing for commercial or advertising purposes; economic forecasting; auctioneering; retail services for works of art provided by art galleries, sales promotion for others; promotion of goods and services through sponsorship of sports events; production of teleshopping programmes; production of advertising films; office machines and equipment rental; rental of advertising time on communication media, publicity material rental; rental of billboards [advertising boards]; rental of vending machines; rental of photocopying machines; publication of publicity texts; radio advertising; bill-posting; distribution of samples, dissemination of advertising matter; direct mail advertising; registration of written communications and data; writing of publicity texts; advertising; online advertising on a computer network, advertising by mail order; television advertising; document reproduction; compilation of statistics; compilation of information into computer databases; business inquiries; systemization of information into computer databases; advisory services for business management; negotiation of business contracts for others; negotiation and conclusion of commercial transactions for third parties; compiling indexes of information for commercial or advertising purposes; tax preparation; drawing up of statements of accounts; telemarketing services; psychological testing for the selection of personnel; interim business management; business management of hotels; business management for freelance service providers; business project management services for construction projects; commercial administration of the licensing of the goods and services of others; business management of reimbursement programmes for others; admini-

stration of consumer loyalty programs; administration of frequent flyer programs; administrative processing of purchase orders; public relations; competitive intelligence services; modelling for advertising or sales promotion; typing; market intelligence services; appointment reminder services [office functions]; website traffic optimization; tax filing services; search engine optimization for sales promotion; appointment scheduling services [office functions]; gift registry services; price comparison services; secretarial services; procurement services for others [purchasing goods and services for other businesses]; shorthand; outsourcing services [business assistance]; telephone answering for unavailable subscribers; photocopying services; business efficiency expert services; media relations services; corporate communications services; rental of office equipment in co-working facilities; commercial lobbying services; business information; commercial information and advice for consumers in the choice of products and services; consultancy regarding public relations communication strategies; marketing in the framework of software publishing; graphic design of promotional materials; presentation of goods on communication media, for retail purposes; rental of sales stands; wholesale services for pharmaceutical, veterinary and sanitary preparations and medical supplies; retail services for pharmaceutical, veterinary and sanitary preparations and medical supplies; outsourced administrative management for companies; administrative services for the relocation of businesses; pay per click advertising.

---

(260) AM 2022 117463 A

(800) 1655327

(151) 2021 10 21

(891) 2021 10 21

(731) thyssenkrupp AG

ThyssenKrupp Allee 1, 45143 Essen, Germany

(540)

## **coworking<sup>2</sup>**

(591) Black, white

(511)

35 – Rental of office equipment in shared working facilities; marketing research and analysis; business management of logistics for others; administrative order processing; inventory management; business data analysis; business process auditing; business risk analysis; optimization studies.

36 – Brokerage; rental of office space; rental of offices for shared working; provision of temporary office.

39 – Transport; inspection of goods for transportation; rental of warehouse space; hiring of storage sites; rental of storage units; transportation of goods; warehousing; packaging of goods; analysis of loading and packing processes; inspection of goods for transportation.

42 – Testing, authentication and quality control; inspection of goods for quality control.

43 – Providing conference rooms; provision of conference, exhibition and meeting facilities; provision of event facilities and meeting facilities.

(260) AM 2022 117465 A

(800) 1655370

(151) 2022 02 26

(891) 2022 02 26

(731) NFS MEDIA, LLC

40900 WOODWARD AVENUE, SUITE  
111, BLOOMFIELD HILLS MI 48304, USA

(540)

## DIANA AND ROMA

(591) Black, white

(511)

3 – Cosmetics for children; cosmetics; cosmetic preparations; make-up; cosmetic oils; pre-moistened cosmetic tissues; cotton buds for cosmetic purposes; pencils for cosmetic purposes; cosmetic pads; cosmetic balls; cosmetics in general, including perfumes; pomades for cosmetic purposes; cosmetics and makeup; nail cosmetics; cosmetic soaps; cosmetic nail preparations; cleaning preparations; make-up removing preparations; make-up preparations; essential oils for household use; non-medicated skin and hair care preparations.

(260) AM 2022 117471 A

(800) 1655530

(151) 2022 03 15

(891) 2022 03 15

(731) GAS Familia, s.r.o.

Prešovská 8, SK-064 01 Stará Ľubovňa,  
Slovakia

(540)



(591) Silver, red and transparent

(531) 19.07.01; 29.01.13

(554) მოცულობითი

(511)

33 – Vodka.

(260) AM 2022 117490 A

(800) 1655908

(151) 2021 10 13

(891) 2021 10 13

(731) Hazet-Werk Hermann Zerver GmbH & Co. KG  
Güldenwerther Bahnhofstrasse 25-29,  
42857 Remscheid, Germany

(540)

## Hazet

(591) Black, white

(511)

6 – Empty tool boxes; goods of metal, namely, empty tool and material boxes; goods of metal, namely, tool chests of metal, empty; tool chests of metal, empty; metal tool boxes; boxes for stacking purposes [metal], tool storage containers of metal [empty], storage containers of metal, containers of metal for transport; spring cotter pins; goods of metal, namely, snap ring fasteners of metal; goods of metal, namely, connecting pins of metal; oil cans made of metal; oil filter chains of metal; oil drainage containers of metal; clamping angles of metal, multi-tooth adapters [small hardware of metal]; goods of metal, namely, coupling mandrels; goods of metal, namely, brass mandrels; props of metal; reels of metal [non-mechanical] for storing cables; structures and transportable buildings of metal, mobile partitions [structures] made of metal; ramps of metal; metal ramps for use with vehicles; ferrules of metal for handles, air hose reels of metal [non-mechanical], ferrules of metal; cable drums (non-mechanical -) of metal; metal stepladders and ladders; locks of metal, locking elements of metal, striking plates of metal for locks; forcing screws; goods of metal, namely, cable drums of metal for electrical cables.

7 – Compressed air operated hand tools, hand-held tools, other than hand-operated, power operated tools, power-operated ratchet wrenches, power-driven wrenches, mechanical tools, motor driven tools, air-powered tools, electric jacks, hydraulic jacks, pneumatic jacks, hydraulic tools; controlled volume pumps, compressed air machines, compressed air machines, air spray guns, fluid pumps, lifting gear for handling loads, pneumatic grease guns, grease guns operated by compressed air.

8 – Hand tools and implements [hand-operated]; screw wrenches, open-end and ring spanners, articulated wrenches, lug wrenches, nut wrenches, spark wrenches, spark plug sockets being hand tools, ratchet spanners, torque wrenches, torque screwdriver, oil filter wrenches, strap wrenches, cartridge wrenches, screwdriver, screw and bolt extractors, hand-operated scrapers, centre punches [hand tools], hand drills, hand-operated, crow bars, pliers, tin snips, hand-operated sheet metal moulding tools, files [tools], metal cutting saws; cable release tools, tyre levers, nut splitters, hand tools for lifting, hand-operated gear pullers for motor vehicle parts, hand-operated valve spring

tensioning apparatus, hand-operated piston ring compressors, hand-operated tools for pipe working, hand-operated spring tensioning apparatus; knives, blades [hand tools]; hand-operated coupling centring tools, hand-operated valve adjustment tools; holders for hand tools; stripping knives, strippers [hand operated tools], panel beating hammers, working knives, crow bars, hack saws, tweezers, jointing trowels, milling cutters [hand tools], handles for hand-operated hand tools, pincers [hand tools], pearl catchers [hand-operated tools], needle work scissors, hammers [hand tools]; lifting jacks, hand-operated, hand pumps, hand saws, levers, halligan bars, socket wrenches [hand operated tools], wire strippers [hand tools], cable tie tools, wedges [hand-operated tools], ratchet handles [hand-operated tools], nippers [hand tools], knee kickers [hand tools], scraping tools [hand tools], air pumps, hand-operated; chisels [hand tools], shears, riveters [hand tools], tyre removers [hand operated tools], braiders [hand tools], hoop cutters [hand tools]; pipe wrenches, tube cutters [hand tools], tube cutting instruments, pipe bending apparatus [hand-operated tool]; monkey wrenches [hand-operated tools], rotary drills [hand-operated tools], rotary metal cutting tools [hand-operated tools], rotary dies [hand-operated tools], spanners [hand tools], screwdriver bits for hand operated screwdrivers, spanners [hand tools], screwdrivers, non-electric, clamps for carpenters or coopers, vices; hex keys, hex tools, countersinking tools for hand operated tools, putty knives; expanders [hand tools]; chucks for hand-operated tools; tighteners [hand-operated tools]; ratchets [hand tools]; tensioners [hand-operated tools]; nut drivers [hand tools], socket sets [hand-operated tools], tool belts [holders], tool holders, tool aprons, tool bags [filled], tool pouches for attachment to tool belts, monkey wrenches [hand-operated tools], extension bars for hand tools, extensions for hand tools, cramps in the nature of vices for use in holding workpieces; axes, axes; sets of socket spanners; holders for hand tools, not of metal.

9 – Gloves for protection against accident or injury; stands adapted for laptops, cabinets adapted to hold electrical apparatus, goggles, protective visors, goggles; safety glasses for protecting the eyes; gloves for protection against accidents.

11 – Heating, ventilating, and air conditioning and purification equipment (ambient); burners; heating apparatus; induction heaters; air and water filters for industrial use; lighting and lighting reflectors; luminaires; luminaires; electric lamps; lamps; electric torches, lighting apparatus and installations, lighting apparatus, lamps, inspection lamps, handheld spotlights, heating plates, heating rings, coils for heating, heating rods, induction heaters.

12 – Empty tool and material trolleys, made of metal; hand-operated tool and material trolleys, hand propelled trolleys, dollies [hand trucks], forklift trucks,

dollies [trolleys], mechanics' creepers, car creepers for use in inspecting the underneath of cars, tool trolleys, roll containers [trolleys]; electrically powered tool and material trolleys, motorised tool and material trolleys; electric drives for tool and material trolleys; fitted vehicle covers, fitted automotive seat covers; steering wheel covers, shaped steering wheel covers for automobiles.

20 – Tool cabinets (non-metallic), empty tool and material boxes (not of metal); workbenches and tables; adjustable feet for workbenches and tables, not of metal; storage drawer units for small metal parts (not of metal); wall mounted hose supports (non-metallic -); storage modules [furniture]; wall-mounted tool racks; cupboard units; work benches, work surfaces, work surfaces, worktables, work stools, industrial work tables; storage bins, not of metal; containers, not of metal, for storage; plastic racks for tools; tool storage containers (non-metallic -) [empty]; metal shelving; metal cabinets [furniture]; racks being furniture of metal; pedestal cabinets; reels, not of metal, non-mechanical, for flexible hoses; hose hangers not of metal; lockers; tool boxes (non-metallic -) [empty]; cases (non-metallic -) for tools; tool chests (non-metallic -) [empty]; wall-mounted non-metal tool racks; metal tool cabinets; tool cabinets (non-metallic -) [empty], tool chests [furniture]; tool chests [furniture]; furniture casters, not of metal; cable drums (non-mechanical -) of non-metallic materials; adjustable feet for workbenches and tables, of metal; forcing screws, not of metal; cable drums, not of metal, for electrical cables; drawer cabinets of metal for small metal parts.

(260) AM 2022 117511 A

(800) 804938

(151) 2003 04 25

(891) 2022 03 09

(731) Roche Diagnostics GmbH

Sandhofer Str. 116, 68305 Mannheim, Germany

(540)

## TaqMan

(591) Black, white

(511)

1 – Chemical, biochemical and biological products and reagents for use in industry and science as well as in agriculture, horticulture and forestry.

5 – Chemical, biochemical and biological products and reagents for medical and veterinary use.

9 – Scientific instruments and apparatus; laboratory instruments for use in research, science, industry, agriculture, horticulture and forestry; dispensers for taking up, treatment, dosage and distribution of receptacles, capillary tubes, cartridges, control solutions, pipettes, buffers and reagents; disposable articles for laboratory instruments, in particular receptacles, capillary tubes, cartridges, pipettes and containers; com-



puter software and computer hardware; computer programmes; computer programmes for use with instruments for medical and veterinary use; electronic publications.

10 – Medical and veterinary apparatus for diagnostic purposes.

(260) AM 2022 117515 A

(800) 1006519

(151) 2009 01 29

(891) 2022 03 09

(731) TORAY KABUSHIKI KAISHA (TORAY INDUSTRIES, INC.)

1-1, Nihonbashi-Muromachi 2-chome,  
Chuo-ku, Tokyo 103-8666, Japan

(540)

**TORAY**

**Innovation by Chemistry**

(591) Blue and black

(531) 27.05.01; 27.05.10; 29.01.12

(511)

1 – Chemicals; adhesives (not for stationery or household purposes); plant growth regulating preparations; fertilizers; ceramic glazings; higher fatty acids; nonferrous metals; non-metallic minerals; photographic supplies; chemical test paper; artificial sweeteners; flour and starch for industrial purposes; unprocessed plastics (plastics in primary form); pulp; wallpaper removing preparations.

2 – Canada balsam; copal; sandarac; shellac; pine oil; dammar; mordants; mastic; pine gum; wood preservatives; dyestuffs; pigments; paints; printing inks; colors (for drawing pictures); anti-rust greases; nonferrous metals in foil or powder form for painters, decorators, printers and artists; precious metals in foil or powder form for painters, decorators, printers and artists.

3 – Anti-static preparations for household purposes; de-greasing preparations for household purposes; rust removing preparations; stain removing benzine; fabric softeners for laundry use; laundry bleach; adhesives for affixing false hair; adhesives for affixing false eyelashes; laundry starch; seaweed gelatine for laundry use (funori); paint stripping preparations; shoe and boot cream; shoe black (shoe polish); polishing preparations; soaps and detergents; dentifrices; cosmetics and toiletries; perfumery, fragrances and incenses (other than perfumes used as cosmetics or toiletries); abrasive paper (sandpaper); abrasive cloth; abrasive sand; artificial pumice stone; polishing paper; polishing cloth; false nails; false eyelashes.

4 – Solid lubricants; grease for shoes and boots; leather preserving oil and grease; fuels; mineral oils and greases for industrial purposes (not for fuel); non-mineral oils and greases for industrial purposes (not for

fuel); waxes (raw material); lamp wicks; candles.

5 – Pharmaceutical, veterinary and sanitary preparations; oiled paper for medical purposes; sanitary masks; pharmaceutical wafer; gauze for dressings; empty capsules for pharmaceuticals; eye patches for medical purposes; ear bandages; menstruation bandages; menstruation tampons; sanitary napkins; sanitary panties; absorbent cotton; adhesive plasters; bandages for dressings; collodion for pharmaceutical purposes; breast-nursing pads; dental materials; bracelets for medical purposes; incontinence diapers; fly catching paper; mothproofing paper; lactose (milk sugar); lacteal flour (for babies); semen for artificial insemination.

6 – Irons and steels; nonferrous metals and their alloys; ores of metal; metal materials for building or construction; prefabricated building assembly kits of metal; loading and unloading pallets of metal; turntables for load handling; traversers for load handling; artificial fish reefs of metal; poultry cages of metal; paint spraying booths of metal; metal moulds for forming cement products; metal pulleys, springs and valves (not including machine elements); metal junctions for pipes; metal flanges; keys (mechanical element); cotter pins; railway points; road signs of metal (not luminous nor mechanical); beacons of metal (non-luminous); reservoirs of metal; anchors; mooring bitts of metal; mooring bollards of metal; containers of metal for transport; anvils; swage blocks; metal hardware; wire ropes; wire nets and gauzes; industrial packaging containers of metal; metal nameplates and door nameplates; chains for dogs; metal stepladders and ladders; letter boxes of metal; hat-hanging hooks of metal; money boxes of metal; water tanks of metal for household purposes; tool boxes of metal (empty); towel dispensers of metal; metal joinery fittings; safes; door mats of metal; upright signboards of metal; transportable greenhouses of metal for household use; metal tombs and metal tomb plaques; buckles of metal; ferrules of metal for canes and walking-sticks; crampons (climbing irons); carabiners; rock pitons; diving platforms of metal; spurs; sculptures of metal.

7 – Metalworking machines and tools; mining machines and apparatus; construction machines and apparatus; loading-unloading machines and apparatus; fishing machines and instruments; chemical processing machines and apparatus; textile machines and apparatus; food or beverage processing machines and apparatus; lumbering, woodworking, or veneer or plywood making machines and apparatus; pulp making, paper-making or paper-working machines and apparatus; printing or bookbinding machines and apparatus; sewing machines; agricultural machines, agricultural implements other than hand-operated; shoe making machines; leather tanning machines; tobacco processing machines; glassware manufacturing machines and apparatus; painting machines and apparatus; packaging or wrapping machines and apparatus; power-operated potters' wheels; plastic processing machines

and apparatus; semiconductor manufacturing machines and systems; machines and apparatus for manufacturing rubber goods; stone working machines and apparatus; non-electric prime movers (not for land vehicles); pneumatic or hydraulic machines and instruments; adhesive tape dispensing machines; automatic stamping machines; dishwashers; electric wax-polishing machines; washing machines; vacuum cleaners; electric food blenders (for household purposes); repairing fixing machines and apparatus; mechanical parking systems; vehicle washing installations; power sprayers for disinfecting, insecticides and deodorants (not for agricultural purposes); machine elements (not for land vehicles); lawnmowers; curtain drawing devices electrically operated; waste compacting machines and apparatus; waste crushing machines; starters for motors and engines; AC motors and DC motors (not including those for land vehicles but including "parts" for any AC motors and DC motors); AC generators (alternators); DC generators; dynamo brushes.

8 – Tweezers; braiders (hand-held ones only); hoes (hand-held); digging forks (spading forks); lawn rakes (hand-held ones only); lasts for shoe-making (hand-held ones only); electric razors and electric hair clippers; bladed or pointed hand tools; hand tools; egg slicers (non-electric); non-electric planes for flaking dried bonito blocks (katsuo-bushi planes); sugar tongs; can openers (non-electric); nutcrackers (not of precious metal); spoons; cheese slicers (non-electric); pizza cutters (non-electric); forks (cutlery); flat irons (non-electric); eedle-threaders; dressmakers' chalk sharpeners; pot stands; fire pans for carrying live charcoal (juno); fireplace bellows (hand-tools); Japanese charcoal extinguishers (hikeshi-tsubo); fire tongs; bludgeons; insecticide sprayers (hand-held ones only); shaving cases; pedicure sets; eyelash curlers; manicure sets; diving knives; diving knife holders; mountaineering pickels (ice axes); palette knives.

9 – Ear plugs; processed glass (not for building); electric arc welding machines; electric metal cutting machines (by arc, gas or plasma); electric welding apparatus; ozonisers (ozonators); electrolyzers (electrolytic cells); egg-candlers; cash registers; coin counting or sorting machines; electric sign boards for displaying target figures, current outputs or the like; photo-copying machines; manually operated computing apparatus; drawing or drafting instruments and apparatus; time and date stamping machines; time clocks (time recording devices); punched card office machines; voting machines; billing machines; postage stamp checking apparatus; vending machines; gasoline station equipment; coin-operated gates for car parking facilities; life saving apparatus and equipment; fire extinguishers; fire hydrants; fire hose nozzles; sprinkler systems for fire protection; fire alarms; gas alarms; anti-theft warning apparatus; protective helmets; railway signal apparatus, luminous or mechanical; vehicle breakdown warning triangles; luminous or mecha-

nical road signs; diving machines and apparatus (not for sports); arcade games adapted for use with an external display screen or monitor; electric door openers; simulators for the steering and control of vehicles; sports training simulators; laboratory apparatus and instruments; photographic instruments and apparatus; cinematographic instruments and apparatus; optical apparatus and instruments; measuring or testing machines and instruments; power distribution or control machines and apparatus; rotary converters; phase modifiers; batteries and cells; electric or magnetic meters and testers; electric wires and cables; electric flat irons; electric hair-curlers; electric buzzers; telecommunication devices and apparatus; electronic machines, apparatus and their parts; magnetic cores; resistance wires; electrodes; fire boats; rockets; fire engines; cigar lighters for automobiles; gloves for protection against accidents; dust masks; gas masks; welding masks; fireproof garments; spectacles (eyeglasses and goggles); consumer games adopted for use with an external display screen or monitor; electronic circuits and CD-ROMs recorded with programs for hand-held games with liquid crystal displays; weight belts (for scuba diving); wetsuits (for scuba diving); inflatable swimming floats; protective helmets for sports; air tanks (for scuba diving); swimming flutter boards; regulators (for scuba diving); phonograph records; metronomes; electronic circuits and CD-ROMs recorded with automatic performance programs for electronic musical instruments; slide-rules; exposed cinematographic films; exposed slide films; slide film mounts; recorded video discs and video tapes; electronic publications; blueprinting apparatus.

10 – Pacifiers for babies; ice bag pillows (for medical purposes); triangular bandages; supportive bandages; surgical catguts; feeding cups (for medical purposes); dropping pipettes (for medical purposes); teats; medical ice bags; medical ice bag holders; baby bottles; vacuum bottles for nursing; cotton swabs for medical use; finger guards (for medical purposes); contraceptives, non-chemical; artificial tympanic membranes; prosthetic or filling materials (not for dental use); es-  
thetic massage apparatus for industrial purposes; medical machines and apparatus; electric massage apparatus for household use; gloves for medical purposes; urinals (for medical purposes); bed pans; ear picks.

11 – Set units of toilet bowl and seat; set units of bathroom; drying apparatus (for chemical processing); recuperators (for chemical processing); steamers (for chemical processing); evaporators (for chemical processing); distillers (for chemical processing); heat exchangers (for chemical processing); milk sterilizers; industrial furnaces; nuclear reactors (atomic piles); forage drying apparatus; industrial boilers; air-conditioning apparatus (for industrial purposes); freezing machines and apparatus; laundry dryers (electric, for industrial purposes); machines and apparatus for use in beauty salons and barbers' shops (not including "hair-

dressing chairs"); cooking equipment for industrial purposes; industrial dish drying apparatus and installations; dish disinfectant apparatus for industrial purposes; tap water faucets; level controlling valves for tanks; pipe line cocks; waste water treatment tanks (for industrial purposes); septic tanks (for industrial purposes); garbage incinerators; solar water heaters; water purifying apparatus; electric lamps and other lighting apparatus; household electrothermic appliances; washers for water taps; gas water heaters (for household use); non-electric cooking heaters (for household purposes); kitchen worktops; kitchen sinks; ice chests (for household purposes, non-portable); ice-cooling refrigerators (for household purposes); household tap-water filters; bathtubs and the like; standing paper lanterns (andon); portable paper lanterns (chochin); gas lamps; oil lamps; lamp chimneys; warming pans (non-electric); pocket warmers (non-electric); stick fuel for Japanese pocket warmers (kairo-bai); hot water bottles (for warming one's feet in bed); toilet stool units with a washing water squirter; disinfectant dispensers for toilets; toilet bowls; seatings for use with Japanese style toilet bowls; waste water treatment tanks for household purposes; septic tanks for household purposes; heating or cooling packs filled with chemical substances ready to react when required; non-electric heating apparatus for household purposes.

12 – Ropeways for cargo or freight handling; unloading tippers (for tilting railway freight cars); pusher cars for mining; puller cars for mining; traction engine; non-electric prime movers for land vehicles (not including their parts); machine elements for land vehicles; parachutes; anti-theft alarms for vehicles; wheelchairs; AC motors or DC motors for land vehicles (not including their parts); vessels and their parts and fittings; aircraft and their parts and fittings; railway rolling stock and their parts and fittings; automobiles and their parts and fittings; two-wheeled motor vehicles, bicycles and their parts and fittings; baby carriages (prams); rickshaws; sleighs and sleds (vehicles); wheelbarrows; carts; horse drawn carriages; bicycle trailers (riyakah); adhesive rubber patches for repairing tubes or tires.

13 – Firearms; ammunition for firearms; gunpowder; explosives powders; pyrotechnic products and their peripherals; tanks (weapons).

14 – Precious metals; keyrings (trinkets or fobs); jewel cases of precious metal; trophies (prize cups); commemorative shields; personal ornaments; unwrought and semi-wrought precious stones and their imitations; shoe ornaments of precious metal; clocks and watches.

15 – Tuning apparatus for musical instruments; musical instruments; musical performance auxiliaries; tuning forks.

16 – Pastes and other adhesives for stationery or household purposes; sealing wax; printers' reglets (inter-line leads); printing types; addressing machines; ink ribbons; automatic stamp affixing machines; electric staplers for offices; envelope sealing machines for offices; stamp obliterating machines; drawing instruments; typewriters; checkwriters; mimeographs; relief duplicators; paper shredders (for office use); franking machines (stamping machines); rotary duplicators; marking templates; electric pencil sharpeners; decorators' paintbrushes; babies' diapers of paper; industrial packaging containers of paper; food wrapping plastic film for household use; garbage bags of paper (for household use); garbage bags of plastics (for household use); paper patterns; tailors' chalk; banners of paper; flags of paper; hygienic hand towels of paper; towels of paper; table napkins of paper; hand towels of paper; handkerchiefs of paper; baggage tags; printed lottery tickets (other than toys); table cloths of paper; paper and cardboard; stationery and study materials; printed matter; paintings and calligraphic works; photographs; photograph stands.

17 – Mica (raw or partly processed); valves of rubber or vulcanized fiber (not including machine elements); gaskets; junctions for pipes (not of metal); packings; fire hoses; asbestos fire curtains; floating anti-pollution barriers; electrical insulating materials; washers of rubber or vulcanized fiber; chemical fiber (not for textile use); carbon fibers (fibres), other than for textile use; asbestos; rock wool; slag wool; rubber thread and covered rubber yarn (not for textile use); chemical fiber yarn and thread (not for textile use); asbestos yarn; asbestos fabrics; asbestos felt; insulating gloves; rubber cords and laces; asbestos cords and strings; asbestos nets; industrial packaging containers of rubber; rubber stoppers; rubber lids and caps (for industrial packaging containers); plastic sheeting for agricultural purposes; condenser paper; asbestos paper; vulcanized fiber; plastic semi-worked products (for use as material); rubber (raw or semi-worked); soundproofing materials of rock wool (not for building purposes); asbestos boards; asbestos powder.

18 – Handbag frames; purse frames; industrial packaging containers of leather; clothing for domestic pets; bags and the like; pouches and the like; vanity cases (not fitted); umbrellas and their parts; walking sticks; canes; metal parts of canes and walking-sticks; handles of canes and walking-sticks; saddlery; leather and fur (unworked or semi-worked); stirrups of metal; purses and wallets of precious metal; horseshoes (not of metal).

19 – Tar and pitch; non-metallic minerals for building or construction; ceramic building materials, bricks and refractory products; linoleum building materials; plastic building materials; synthetic building materials; asphalt, and asphalt building or construction materials; rubber building or construction materials; plaster (for building purposes); lime building or con-

struction materials; building or construction materials of plaster; rockfall prevention nets of textile; prefabricated building kits (not of metal); vegetation seed-carrier sheets for prevention of earth collapse or landslide; plastic security windows allowing communication; demarcating tapes; cement and its products; building timber; building stone; building glass; artificial fish reefs (not of metal); hen-houses and poultry cages (not of metal); paint spraying booths (not of metal); moulds for forming cement products (not of metal); water-pipe valves (not of metal or plastics); road signs (not of metal, non-luminous, and not mechanical); beacons (not of metal, non-luminous); storage tanks (not of metal or plastics); mooring bits and bollards (not of metal); letter boxes of masonry; joinery fittings (not of metal); stone lanterns; transportable greenhouses (not of metal) for household use; gravestones and tomb plaques (not of metal); diving platforms (not of metal); stone sculptures; concrete sculptures; marble sculptures; nonmetallic mineral materials (unworked or partly worked).

20 – Meerschaum (raw or partly worked material); yellow amber; loading pallets (not of metal); beehives (hive boxes or honeycombs); hairdresser's chairs; barbers' chairs; valves of plastic (not including machine elements); storage tanks (not of metal or masonry); containers for transport, not of metal; curtain fittings; metal-substitute plastic fasteners; nails, wedges, nuts, screws, tacks, bolts, rivets and casters (not of metal); washers (not of metal, not of rubber or vulcanized fiber); locks (non-electric, not of metal); cushions (furniture); Japanese floor cushions (zabuton); pillows; mattresses; straw plaits (braids); industrial packaging containers of wood, bamboo or plastics; drinking straws; trays (not of metal); embroidery frames and hoops; nameplates and door nameplates (not of metal); flagpoles; hand-held flat fans; hand-held folding fans; stakes for plants or trees; beds for household pets; dog kennels; nesting boxes for small birds; step ladders and ladders (not of metal); letter boxes (not of metal or masonry); hat hooks (not of metal); shopping baskets; water tanks for household purposes (not of metal or masonry); hanging boards (Japanese style pegboards using positional hooks); tool boxes (not of metal); towel dispensers (not of metal); furniture; indoor window blinds (shade) (furniture); blinds of reed, rattan or bamboo (sudare); bead curtains for decoration; oriental single panel standing partition (tsuitate); oriental folding partition screens (byoubu); benches; advertising balloons; upright signboards of wood or plastics; artificial model food samples; man-made garden ponds (structures); ritual equipment; cradles; infant walkers; mannequins; costume display stands; sleeping bags (for camping); picture frames; plaster sculptures; plastic sculptures; wooden sculptures; Japanese food wrapping sheets of wood as materials (kyogi); ferns (unworked or partly worked material); bamboo (unworked or partly worked material); bamboo skins (unworked or partly worked material); vi-

nes; rattan (unworked or partly worked material); tree barks; reeds (raw or partly worked material); rushes (raw or partly worked material); onigaya hay (raw or partly worked material); sedges (unworked or partly worked material); vegetable aggregate for plaster (susa); straw of wheat, barley or oats; rice straw; tusks (raw or partly worked material); whalebones; shells and crusts; artificial horns; ivory (unworked or partly worked material); animal horns; animal teeth; tortoiseshells (unworked or partly worked material); animal bone (unworked or partly worked material); coral (unworked or partly worked).

21 – Dental floss (floss for dental purposes); unworked or semi-worked glass (not for building); mangers for animals (troughs for livestock); poultry rings; cooking skewers; tub brushes; metal brushes; brushes for pipes; industrial brushes; ship-scrubbing brushes; gloves for household purposes; industrial packaging containers of glass or porcelain; cooking pots and pans (non-electric); coffee-pots (non-electric, not of precious metal); Japanese cast iron kettles, non-electric (tetsubin); kettles (non-electric); tableware (not of precious metal); portable coldboxes (non-electric); rice chests; food preserving jars of glass; drinking flasks (for travellers); vacuum bottles (insulated flasks); ice pails; whisks (non-electric); cooking strainers; pepper pots, sugar bowls and salt shakers (not of precious metal); egg cups (not of precious metal); napkin holders and napkin rings (not of precious metal); trays (not of precious metal); toothpick holders (not of precious metal); colanders; shakers; Japanese style cooked rice scoops (shamoji); hand-operated coffee grinders and pepper mills; cooking funnels; Japanese style wooden pestles (surikogi); Japanese style earthenware mortars (suribachi); Japanese style personal dining trays or stands (zen); bottle openers; cooking graters; tart scoops; pan-mats; chopsticks; chopstick cases; ladles and dippers; cooking sieves and sifters; chopping boards for kitchen use; rolling pins (for cooking purposes); grills (cooking utensils); toothpicks; lemon squeezers (citrus juicers); waffle irons (non-electric); cleaning tools and washing utensils; ironing boards; tailors' sprayers; ironing boards (kotedai); marking boards for use with an impress blades (hera-dai); stirrers for hot bathtub water (yukakibo); bathroom stools; bathroom pails; candle extinguishers and candlesticks (not of precious metal); cinder sifters for household purposes; coal scuttles; fly swatters; mouse traps; flower pots; hydroponic apparatus for domestic horticultural purposes; watering cans; feeding vessels for pets; brushes for pets; chewing goods for pet dogs; bird cages; bird baths; clothes brushes; chamber pots; toilet paper holders; piggy banks (not of metal); lucky charms (omamori); sacred lots (omikuji); boxes of metal for dispensing paper towels; boot jacks; soap dispensers; flower vases and bowls (not of precious metal); wind chimes; upright signboards of glass or ceramics; perfume burners; cosmetic and toilet utensils; shoe brushes; shoe horns; shoe shine

cloths; handy shoe shiners; shoe-trees (stretchers); portable cooking kits for outdoor use; pig bristles (hog bristles for brushes); tableware of precious metal; nutcrackers, pepper pots, sugar bowls, salt shakers, egg cups, napkin holders, napkin rings, trays and toothpick holders of precious metal; candle extinguishers and candlesticks of precious metal; flower vases and bowls of precious metal; powder compacts of precious metal; indoor aquaria and their fittings.

22 – Tarpaulins (for ships); sails; raw textile fibers; carbon fibers (fibres) for textile use; cotton waddings for clothes; hammocks; futon bags; cotton batting for futon; knitted cords and braids; Japanese style braids (sanada-himo); starched braids; twist braids; cordage; netting (not of metal or asbestos); industrial packaging containers of textile; industrial packaging containers of straw; elastic bands for binding; window awnings; tarpaulins (not for ships); tents (not for camping); sunshades; Japanese reed screens (yoshizu); wax ends; mountaineering ropes; tents for mountaineering or camping; sawdust; kapok; wood shavings; wood wool (wooden excelsior); rice hulls; wax waste; cattle hair (not for textile use, not for brushes); human hair (not for textile use, not for brushes); raccoon dog hair (not for textile use, not for brushes); pig bristles (not for brushes); horsehair (not for textile use, not for brushes); feathers and downs.

23 – Threads and yarns (for textile use).

24 – Woven fabrics; knitted fabrics; felt and non-woven textile fabrics; oilcloth; gummed waterproof cloth; vinyl coated cloth; rubberized cloth; leather cloth; filtering materials of textile; personal articles of woven textile (not for wear); mosquito nets; bedsheets; futon and quilts; futon and quilts cases (linen); futon ticks (unstuffed/wtow); pillowcases (pillow slips); blankets; table napkins of textile; dish cloths; shower curtains; banners and flags (not of paper); toilet seat covers of textile; seat covers of textile; wall hangings of textile; curtains; table cloths (not of paper); draperies (thick drop curtains); shrouds (sheets for wrapping corpses); shrouds for dressing a corpse for funeral (kyokatabira kimono); Japanese cloth screens with black-and-white stripes (kuroshiro-maku); Japanese cloth screens with red-and-white stripes (kohaku-maku); billiard cloth (baize); labels of cloth.

25 – Clothing; garters; sock suspenders; suspenders (braces); waistbands; belts for clothing; footwear (other than boots for sports); masquerade costumes; clothes for sports; boots for sports.

26 – Shuttles for making fishing nets; hosiery loom needles; needles; eyelets for clothing; tapes (semi-finished); ribbons; knitted raschel lace fabrics; embroidery lace fabrics; tufts and tassels (semi-finished); braids; knitting sticks; sewing boxes; dressmakers' impressing blades; sewing thimbles; pin and needle cushions; needle cases (not of precious metal); armbands; insignias for wear (not of precious metal); bad-

ges for wear (not of precious metal); buckles for clothing (clothing buckles); brooches for clothing; special sash clips for obi (obi-dome); bonnet pins (not of precious metal); ornamental stickers for front jackets; brassards; hair ornaments; buttons and the like; artificial flowers; false beards; false moustaches; hair curlers (non-electric); shoe ornaments (not of precious metal); shoe eyelets; shoe laces; metal fasteners for shoes and boots; boxes of precious metal for needles.

27 – Bath mats for wash places; tatami mats and the like; artificial turf; floor coverings; wall hangings (not of textile); gymnastic mats; wallpaper.

28 – Wax for skis; amusement machines and apparatus for use in amusement parks (other than arcade video game machines); toys for domestic pets; toys; dolls; go games; Japanese playing cards (utagaruta); Japanese chess (shogi games); dice; Japanese dice games (sugoroku); dice cups; diamond games; chess games; checkers (checker sets); conjuring apparatus; dominoes; playing cards; Japanese playing cards (hanafuda); mah-jong; game machines and apparatus; billiard equipment; sports equipment; fishing tackle; insect collecting implements; slot machines.

29 – Edible oils and fats; milk products; meat for human consumption (fresh, chilled or frozen); eggs; fresh, chilled or frozen edible aquatic animals (not live); frozen vegetables; frozen fruits; processed meat products; processed seafood; processed vegetables and fruits; fried tofu pieces (abura-age); freeze-dried tofu pieces (kohri-dofu); jelly made from devils' tongue root (konnyaku); soya milk (milk substitute); tofu; fermented soybeans (natto); processed eggs; curry, stew and soup mixes; dried flakes of laver for sprinkling on rice in hot water (ochazuke-nori); seasoned powder for sprinkling on rice (furi-kake); side-dish made of fermented soybean (name-mono); raw pulses; protein for human consumption.

30 – Binding agents for ice cream; meat tenderizers for household purposes; preparations for stiffening whipped cream; aromatic preparations for food (not from essential oils); tea; coffee and cocoa; ice; confectionery, bread and buns; seasonings (other than spices); spices; ice cream mixes; sherbet mixes; unroasted coffee (unprocessed); cereal preparations; almond paste; Chinese stuffed dumplings (gyoza, cooked); sandwiches; Chinese steamed dumplings (shumai, cooked); sushi; fried balls of batter mix with small pieces of octopus (takoyaki); steamed buns stuffed with minced meat (niku-manjuh); hamburgers (sandwiches); pizzas; box lunches (prepared); hot dogs (sandwiches); meat pies; ravioli; yeast powder; fermenting malted rice (koji); yeast; baking powder; instant confectionery mixes; by-product of rice for food (sake lees); husked rice; husked oats; husked barley; flour for food; gluten for food.

31 – Wreaths of natural flowers; fishing baits; hops (unprocessed); edible aquatic animals (live); edible

seaweeds; vegetables (fresh); sugar crops (sugar cane, sugar beet); fruits (fresh); copra; malt (not for food); foxtail millet (unprocessed); proso millet (unprocessed); sesame (unprocessed); buckwheat (unprocessed); corn (unprocessed grain); Japanese barnyard millet (unprocessed); wheat, barley and oats (unprocessed); unprocessed rice; sorghum (unprocessed); protein for animal consumption; animal foodstuffs; seeds and bulbs; trees; grasses; turf (natural); dried flowers; seedlings; saplings; flowers (natural); pasture grass; potted dwarfed trees (bonsai); live mammals and fish (not for food); birds and insects (live); silkworm eggs; cocoons for silkworm breeding; eggs for hatching; urushi tree seeds; rough cork; palm tree leaves (unworked).

32 – Beer; carbonated drinks (refreshing beverages); non-alcoholic fruit juice beverages; extracts of hops for making beer; whey beverages; vegetable juices (beverages).

33 – Japanese liquors (in general); western liquors (in general); alcoholic beverages of fruit; Chinese liquors (in general); flavored tonic liquors.

34 – Cigarette paper; tobacco; smokers' articles (not of precious metal); matches; smokers' articles of precious metal.

35 – Advertising and publicity services; issuance of trading stamps; business management analysis or business consultancy; marketing research; providing information on commodity sales; business management of hotels; employment agencies; auctioneering; import-export agencies; arranging newspaper subscriptions; shorthand services; transcription; document reproduction; office functions, namely filing, in particular documents or magnetic tape; operation of computers, typewriters, telex machines and other similar office machines; reception for visitors in buildings; publicity material rental; rental of typewriters and copying machines; providing employment information; rental of vending machines.

36 – Acceptance of deposits (including substitute bond issuance) and acceptance of fixed interval installment deposits; loans (financing) and discount of bills; domestic exchange settlement; liability guarantee and acceptance of bills; securities lending; acquisition and transfer of monetary claims; safekeeping of valuables including securities and precious metals (safe deposit services); money exchange (exchanging money); trusteeship of financial futures contracts; trusteeship of money, securities, monetary claims, personal property, land, rights on land fixtures, surface rights or lease on land; agencies for bond subscriptions; foreign exchange transactions; letter-of-credit related services; brokerage for hire-purchase; issue of tokens of value; agencies for collecting gas or electric power utility payments; buying and selling of securities, trading of securities index futures, trading of securities options and trading of overseas market securi-

ties futures; agencies or brokerage for trading of securities, securities index futures, securities options, and overseas market securities futures; agencies or brokerage for entrusting agents with on-commission trading in domestic markets of securities, securities index futures and securities options; agencies or brokerage for entrusting agents with on-commission trading in overseas markets of securities, and securities index futures; securities underwriting; securities offering; transaction of securities subscription or offering; providing stock market information; agencies for commodity futures trading; life insurance brokerage; life insurance underwriting; agencies for non-life insurance; claim adjustment for non-life insurance; non-life insurance underwriting; insurance premium rate computing; management of buildings; agencies or brokerage for renting of buildings; leasing or renting of buildings; purchase and sale of buildings; agencies or brokerage for purchase and sale of buildings; real estate appraisal; land management; agencies or brokerage for leasing or renting of land; leasing of land; purchase and sale of land; agencies or brokerage for purchase or sales of land; providing information on buildings or land (real estate affairs); antique appraisal; art appraisal; precious stone appraisal; used automobiles appraisal; company credit investigation; charitable fund raising; rental of paper money and coin counting or processing machines; rental of cash dispensers or automated-teller machines.

37 – Construction; construction consultancy; operation, check or maintenance of building; shipbuilding; repair or maintenance of vessels; aircraft maintenance or repair; repair of bicycles; repair or maintenance of automobiles; repair or maintenance of railway rolling stock; repair or maintenance of two-wheeled motor vehicles; repair or maintenance of cinematographic machines and apparatus; repair or maintenance of optical machines and instruments; repair or maintenance of photographic machines and apparatus; repair or maintenance of loading-unloading machines and apparatus; repair or maintenance of fire alarms; repair or maintenance of office machines and apparatus; repair or maintenance of air-conditioning apparatus (for industrial purposes); burner maintenance or repair; repair or maintenance of boilers; pump repair or maintenance; repair or maintenance of freezing machines and apparatus; repair or maintenance of electronic machines and apparatus; repair or maintenance of telecommunication machines and apparatus; repair or maintenance of construction machines and apparatus; repair or maintenance of consumer electric appliances; repair or maintenance of electric lighting apparatus; repair or maintenance of power distribution or control machines and apparatus; repair or maintenance of power generators; repair or maintenance of electric motors; repair or maintenance of laboratory apparatus and instruments; repair or maintenance of measuring and testing machines and instruments; repair or maintenance of medical machines and apparatus; re-

pair or maintenance of firearms; repair or maintenance of printing or bookbinding machines and apparatus; repair or maintenance of chemical processing machines and apparatus; repair or maintenance of glassware manufacturing machines and apparatus; repair or maintenance of fishing machines and instruments; repair or maintenance of metalworking machines and tools; repair or maintenance of shoe making machines and instruments; repair or maintenance of industrial furnaces; repair or maintenance of mining machines and apparatus; repair or maintenance of rubber-goods manufacturing machines and apparatus; repair or maintenance of integrated circuits manufacturing machines and systems; repair or maintenance of semiconductor manufacturing machines and systems; repair or maintenance of machines and apparatus for processing foods or beverages; repair or maintenance of machines and apparatus for lumbering, woodworking, or veneer or plywood making; repair or maintenance of textile machines and apparatus; repair or maintenance of tobacco processing; repair or maintenance of painting machines and apparatus; repair or maintenance of agricultural machines and implements; repair or maintenance of machines and apparatus for pulp-making, papermaking or paper-working; repair or maintenance of plastic processing machines and apparatus; repair or maintenance of packing or wrapping machines and apparatus; repair or maintenance of sewing machines; repair or maintenance of storage tanks; repair or maintenance of gasoline station equipment; repair or maintenance of mechanical parking systems; repair or maintenance of bicycle parking apparatus; repair or maintenance of industrial dish washing machines; repair or maintenance of cooking apparatus for industrial purposes; repair or maintenance of industrial washing machines; repair or maintenance of vehicle washing installation; repair or maintenance of vending machines; repair or maintenance of power-driven floor cleaning machines; repair or maintenance of amusement machines and apparatus; repair or maintenance of machines and apparatus for use in beauty salons or barbers' shops; repair or maintenance of water pollution control equipment; repair or maintenance of water purifying apparatus; repair or maintenance of waste compacting machines and apparatus; repair or maintenance of waste crushing machines and apparatus; repair or maintenance of diving machines and apparatus; repair or maintenance of nuclear power plants; repair or maintenance of chemical plants; furniture restoration; umbrella repair; repair or maintenance of musical instruments; safe maintenance or repair; shoe repair; clock and watch repair or maintenance; sharpening of scissors and kitchen knives; setup or repair of locks; repair or maintenance of gas water heaters; repair or maintenance of non-electric cooking heaters; repair or maintenance of cooking pots and pans; repair or maintenance of signboards; repair of bags or pouches; repair of personal ornaments; repair of toys or dolls; repair of sports equip-

ment; repair of billiard equipment; repair of game machines and apparatus; repair or maintenance of bathtubs and the like; repair of toilet stool units with a washing water squirts; repair of fishing tackle; repair of spectacles; fur care and repair; laundering; pressing of clothing; clothing repair (mending clothing); fluffing of cotton batting for futon; repair of tatami mats; chimney sweeping; cleaning of building exterior surfaces; window cleaning; carpet and rug cleaning; floor polishing; septic tank cleaning; bathtub and bath boiler cleaning; street cleaning; storage tank cleaning; disinfecting of telephone hand-sets; vermin exterminating (other than for agriculture, forestry or horticulture); sterilization of medical machines and apparatus; rental of construction machines and apparatus; rental of floor cleaning machines; rental of mops; rental of car-washing apparatus; rental of electric washing machines; rental of laundry dryers; rental of spin dryers for clothes; rental of mining machines and apparatus.

38 – Telecommunication (other than broadcasting); broadcasting; news agencies; rental of telecommunication equipment including telephones and facsimile apparatus.

39 – Railway transport; car transport; providing road and traffic information; vehicle-driving services; marine transport; air transport; packaging of goods; freight brokerage; cargo unloading; removal services; brokerage for rental, selling, purchasing or chartering of vessels; refloating of ships; ship piloting; tour conducting; tour conducting or escorting; travel agencies or liaison services (excluding those for lodging); warehousing services; temporary safekeeping of personal belongings; gas supplying (distribution); electricity distribution; water supplying (distribution); heat supplying (distribution); rental of warehouse space; parking services; providing toll roads; providing vessel mooring facilities; airport services; management of parking places; rental of loading-unloading machines and apparatus; car rental; rental of vessels; rental of wheelchairs; rental of bicycles; rental of aircraft; rental of mechanical parking systems; rental of packing or wrapping machines and apparatus; rental of safes; rental of refrigerator-freezers for household purposes; rental of freezers for household purposes; rental of freezing machines and apparatus, rental of gasoline station equipment (not for repair and maintenance of automobiles).

40 – Removal of radiation rays; treatment or processing of cloth, clothing or fur (including drying); tailoring or dressmaking; embroidery (embroidering); metalwork; processing of rubber; processing of plastics; ceramic processing; wood-working; paper treating and working; stone-working; taxidermy; processing of bamboo, tree barks, rattan, vines or other mineral vegetable materials (other than processing of ingredients); food processing; processing of artificial limbs or artificial teeth (including processing of medical

materials); processing of cinematographic films; photographic enlarging; photographic printing; photographic film development; bookbinding; water treating; recycling of waste; nuclear fuel reprocessing; engraving of sealing stamps; photogravure; rental of textile machines and apparatus; rental of machines and apparatus for film development, photograph printing, photograph enlargement or photograph finishing; rental of metaltreating machines and tools; rental of bookbinding machines; rental of machines and apparatus for processing foods or beverages; rental of machines and apparatus for lumbering, woodworking, or veneering or plywood making; rental of machines and apparatus for pulp-making, papermaking or paperworking; rental of water purifying apparatus; rental of waste compacting machines and apparatus; rental of waste crushing machines and apparatus; rental of chemical processing machines and apparatus; rental of glassware manufacturing machines and apparatus; rental of shoe making machines; rental of tobacco processing machines; providing material treatment information; printing; collection, sorting and disposal of waste and trash; rental of knitting machines; rental of sewing machines; rental of printing machines and apparatus; rental of space cooling apparatus (for household purposes); rental of air-conditioning apparatus.

41 – Operating lotteries; educational and instruction services relating to arts, crafts, sports or general knowledge; providing information on donation of human corpses for medical research; arranging of donation of human corpses for medical research; arranging, conducting and organization of seminars; animal training; plant exhibitions; animal exhibitions; providing of electronic publications; services of reference libraries for literature and documentary records; art exhibitions; gardens for public admission; caves for public admission; publication of books; planning or arrangement of showing movies, shows, plays or musical performances; movie showing, movie film production, or movie film distribution; presentation of live show performances; direction or presentation of plays; presentation of musical performance; production of radio or television programs; production of video tape film in the fields of education, culture, entertainment or sports (not for movies, radio or television programs and not for advertising and publicity); direction of radio or television programs' making; operation of video equipment or audio equipment for production of radio or television programs; organization, management or arrangement of sports competitions; organization, management or arrangement of entertainment (excluding movies, shows, plays, musical performances, sports, horse races, bicycle races, boat races and autoraces); organization, management or arrangement of horse races; organization, management or arrangement of bicycle races; organization, management or arrangement of boat races; organization, management or arrangement of autoraces; providing audio or video studio services; providing sports facilities;

providing amusement facilities; providing facilities for movies, shows, plays, music or educational training; booking of seats for shows; rental of cinematographic machines and apparatus; rental of cinefilms; rental of musical instruments; rental of sports equipment; rental of television sets; rental of radio sets; book rental; rental of records or sound-recorded magnetic tapes; rental of image-recorded magnetic tapes; rental of film negatives; rental of film positives; rental of toys; rental of amusement machines and apparatus; rental of game machines and apparatus; rental of paintings and calligraphic works; photography; language interpretation; translation; rental of cameras; rental of optical machines and instruments.

42 – Providing meteorological information; architectural design; surveying; geological surveys or research; designing of machines, apparatus, instruments (including their parts) or systems composed of such machines, apparatus and instruments; designing; computer software design, computer programming, or maintenance of computer software; technical advice relating to performance, operation of computers, automobiles and other machines that require high levels of personal knowledge, skill or experience of the operators to meet the required accuracy in operating them; testing, inspection or research of pharmaceuticals, cosmetics or foodstuff; research on building construction or city planning; testing or research on prevention of pollution; testing or research on electricity; testing or research on civil engineering; testing, inspection or research on agriculture, livestock breeding or fisheries; testing or research on machines, apparatus and instruments; agencies or brokerage for copyright licensing; rental of measuring apparatus; rental of computers; providing computer programs; rental of laboratory apparatus and instruments; rental of drawing instruments.

43 – Providing temporary accommodation; accommodation bureaux (brokering reservations for hotels, boarding houses or the like); providing foods and beverages; boarding for animals; preschooler and infant care at daycare centers; caring of elderlies; providing conference rooms; providing facilities for exhibitions; rental of futon and quilts; rental of cooking equipment for industrial purposes; rental of industrial dish drying machines; rental of dish washing machines for industrial purposes; rental of non-electric cooking heaters; rental of kitchen worktops; rental of sinks; rental of curtains; rental of furniture; rental of wall hangings; rental of floor coverings; rental of towels.

44 – Beauty salons, hairdressing salons; providing bath houses; garden or flower bed care; garden tree planting; fertilizer spreading; weed killing; vermin exterminating (for agriculture, horticulture or forestry); massage and therapeutic shiatsu massage; chiropractics; moxibustion; treatment for dislocated joints, sprain, bone fractures or the like (judo-seifuku); acupuncture; medical services; providing medical infor-



mation; physical examination; dentistry; preparation and dispensing of medications; dietary and nutritional guidance; animal breeding; veterinary services; rental of potted plants; farming equipment rental; rental of medical machines and apparatus; rental of fishing machines and instruments; rental of machines and apparatus for use in beauty salons or barbers' shops; rental of lawnmowers.

45 – Fashion information; providing information on newspaper articles; marriage partner introduction or dating services, providing facilities for wedding ceremonies (including post-ceremony receptions); funeral service undertaking; providing grave spaces or charnel houses; security guarding for facilities; personal body guarding; investigation or surveillance on background profiles; fortune-telling; personal affairs consultancy; housework services; rental of clothing; rental of altars; rental of fire alarms; rental of fire extinguishers; rental of household electrothermic appliances not included in other classes; rental of prime movers; rental of pneumatic or hydraulic machines and instruments; rental of personal ornaments for wearing; agencies for social insurance.

(260) AM 2022 117562 A

(800) 1656636

(151) 2022 02 28

(891) 2022 02 28

(731) Amusnet Interactive Ltd

Garitage Park, Building No. 4, Floor 2,  
2 Donka Ushlinova Str., BG-1766 Sofia,  
Bulgaria

(540)

## BurningKeno

(591) Black, white

(511)

9 – Computer software for the administration of on-line games and gaming; computer application software featuring games and gaming; betting software; gaming software that generates or displays wager outcomes of gaming machines.

28 – Gaming machines for gambling; slot machines [gaming machines].

41 – Providing of casino and gaming facilities; betting services.

(260) AM 2022 117572 A

(800) 1656781

(151) 2021 10 15

(891) 2021 10 15

(731) United Biscuits (UK) Limited

Building 3, Chiswick Park, 566 Chiswick High  
Road, Chiswick, London W4 5YA, United  
Kingdom

(540)

## McVITIE'S BLISS

(591) Black, white

(511)

30 – Bread, biscuits, chocolate covered biscuits, cakes, pastries and shortbread; chocolate, chocolates and confectionery; preparations made from potato/corn flour and from cereals; snack foods (terms too vague in the opinion of the International Bureau – Rule 13 (2) (b) of the Regulations).

(260) AM 2022 117573 A

(800) 1656800

(151) 2022 02 08

(891) 2022 02 08

(731) Fox's Biscuits Limited

Fieldfisher LLP, Riverbank House, 2 Swan  
Lane, London EC4R 3TT, United Kingdom

(540)



(591) Black, white

(531) 27.05.02

(511)

30 – Biscuits; biscuit confectionery; bakery goods but excluding croutons; preparations for making bakery goods; dough, batter and mixes; chocolate; chocolate confectionery; confectionery excluding medicated and non-medicated sugar confectionery; wafers, cakes; ice creams and edible ices; sorbets; ice cream products; puddings; savoury biscuits; crackers; cereal bars and energy bars; snack bars containing a mixture of grains, nuts and dried fruit.

(260) AM 2022 117574 A

(800) 1656883

(151) 2021 10 06

(891) 2021 10 06

(731) "INTERNATIONAL MASIS TABAK" LLC

Hrant Vardanyan str. 10, 0802 Masis,  
Ararat Region, Armenia

(540)



(591) White, silver, light and dark blue and grey  
 (531) 19.03.24; 25.01.01; 26.04.09; 26.04.18;  
 26.04.24; 27.05.09; 27.05.11; 27.05.24;  
 29.01.14

(511)  
 34 – Tobacco, smokers' articles, matches; gas containers for lighters; absorbent paper for tobacco pipes, cigarette papers; cigarette lighters; tobacco pouches (bags); books of cigarette papers; humidors; match boxes, firestones; cigar cutters; tobacco pipes, pipe racks for tobacco pipes, tips of yellow amber for cigar and cigarette holders; ashtrays; spittoons for tobacco; tobacco pipe holders; pipe cleaners for tobacco pipes, cigarettes; cigarillos; cigars; tobacco jars, match boxes, not from precious metals; chewing tobacco; snuff; tobacco cases; tobacco pipes, pocket machines for rolling cigarettes, cigarette filters; cigar cases, cigarette cases for tobacco.

(260) AM 2022 117575 A

(800) 1656890

(151) 2021 12 29

(891) 2021 12 29

(731) Armacell Enterprise GmbH & Co. KG  
 Zeppelinstraße 1, 12529 Schönefeld OT  
 Waltersdorf, Germany

(540)

## ArmaFix

(591) Black, white

(511)

6 – Metal materials for building and construction; pipes and tubes of metal; metal pipe supports; insulated pipe supports of metal.

17 – Unprocessed and semi-processed rubber, gutta-percha, gum, asbestos, mica and substitutes for all these materials; plastics and resins in extruded form for use in manufacture; packing, stopping and insulating materials; flexible pipes, tubes and hoses, not of metal; insulating materials for technical equipment and technical installations; fitted pipe insulating sleeves; insulated pipe supports, not of metal.

20 – Pipe fasteners, pipe fastening collars, clips and clamps, non-metallic; hinges, not of metal, for fixing pipes; pipe supports, not of metal, namely, pipe saddles, pipe clamps and pipe clips.

(260) AM 2022 117576 A

(800) 1656927

(151) 2022 03 22

(891) 2022 03 22

(731) LTD "VALENTA-INTELLEKT"  
 ul. Ryabinovaya, d. 26, str. 10, k. 6-26,  
 RU-121471 Moscow, Russian Federation

(540)

## ЛИФЕСПАН

(591) Black, white

(531) 28.05

(511)

5 – Pharmaceutical preparations; veterinary preparations; sanitary preparations for medical purposes; dietetic foods adapted for medical purposes; dietetic foods adapted for veterinary purposes; dietetic substances adapted for medical use; dietary supplements for human beings and animals; dressings, medical; petroleum jelly for medical purposes; aseptic cotton; antiseptic cotton; absorbent cotton; wadding for medical purposes; liniments; sunburn ointments; diapers for incontinence; biological preparations for veterinary purposes; biological preparations for medical purposes; chemical preparations for veterinary purposes; sanitary towels; panty liners [sanitary]; chemical reagents for veterinary purposes; sanitary tampons.

(260) AM 2022 117577 A

(800) 1657024

(151) 2022 01 19

(891) 2022 01 19

(731) Janssen Pharmaceutica NV  
 Turnhoutseweg 30, B-2340 Beerse, Belgium

(540)

## TEKIMFI

(591) Black, white

(511)

5 – Pharmaceutical preparations for human purposes.

(260) AM 2022 117578 A

(800) 1657042

(151) 2022 03 07

(891) 2022 03 07

(731) Amusnet Interactive Ltd.  
 Garitage Park, Building No. 4, Floor 2,  
 2 Donka Ushlinova Str., BG-1766 Sofia,  
 Bulgaria

(540)

## MEGAWINS

(591) Yellow and golden

(531) 27.05.03; 27.05.17; 29.01.13

(511)

9 – Computer software for the administration of on-line games and gaming; computer application software featuring games and gaming; betting software; gaming software that generates or displays wager outcomes of gaming machines.

28 – Slot machines [gaming machines]; gaming machines for gambling.

41 – Providing of casino and gaming facilities; betting services.

(260) AM 2022 117579 A

(800) 1657043

(151) 2022 03 07

(891) 2022 03 07

(731) Amusnet Interactive Ltd.

Garitage Park, Building No. 4, Floor 2,  
2 Donka Ushlina Str., BG-1766 Sofia,  
Bulgaria

(540)



(591) Blue, black, yellow and golden

(531) 01.15.07; 27.05.01; 27.05.03; 27.05.04;  
27.05.09; 27.05.24; 29.01.14

(511)

9 – Computer software for the administration of on-line games and gaming; computer application software featuring games and gaming; betting software; gaming software that generates or displays wager outcomes of gaming machines.

28 – Slot machines [gaming machines]; gaming machines for gambling.

41 – Providing of casino and gaming facilities; betting services.

(260) AM 2022 117581 A

(800) 1657126

(151) 2022 03 07

(891) 2022 03 07

(731) Amusnet Interactive Ltd.

Garitage Park, Building No. 4, Floor 2,  
2 Donka Ushlina Str., BG-1766 Sofia,  
Bulgaria

(540)



(591) Green, red and yellow

(531) 05.03.13; 27.05.02; 27.05.03; 27.05.17;  
29.01.13

(511)

9 – Computer software for the administration of on-line games and gaming; computer application software featuring games and gaming; betting software; gaming software that generates or displays wager outcomes of gaming machines.

28 – Slot machines [gaming machines]; gaming machines for gambling.

41 – Providing of casino and gaming facilities; betting services.

(260) AM 2022 117588 A

(800) 1657386

(151) 2021 11 26

(891) 2021 11 26

(731) Tronios Group International B.V.

Bedrijvenpark Twente N 18, NL-7602 KR  
Almelo, Netherlands

(540)



(591) Orange and grey

(531) 27.05.22; 29.01.13

(511)

9 – Professional and consumer audio/video goods, including sound amplifiers, amplifiers, transmitters and audio-receivers and video-receivers, audio and video apparatus and instruments, CD/DVD/MP3/MP4 players and recorders, sound processors, equalisers, audio mixers, loudspeakers, mobile sound systems, 100V amplifiers and loudspeakers, (wireless) microphones, headphones, stands for loudspeakers and microphones and other audio, video, audio/visual devices and lighting control apparatus, computer peripheral devices for audio and video purposes, measuring apparatus for audio and video goods, accessories included in this class for the aforesaid goods, including cables and plugs and electrical cables for musical instruments.

15 – Musical instruments; electric and acoustic guitars, electronic keyboards [musical instruments], electronic drum sets, music stands, and accessories for the aforesaid goods included in this class.

(260) AM 2022 117592 A

(800) 1657439

(151) 2021 12 17

(891) 2021 12 17

(731) Holland & Barrett International Limited

Samuel Ryder House, Barling Way, Eliot Park,  
Nuneaton, Warwickshire CV10 7RH, United  
Kingdom

(540)



(591) Black, white  
(531) 02.09.01; 26.13.25  
(511)

3 – Soaps; perfumery; essential oils; cosmetics; toiletries; non-medicated toilet preparations; personal care products; cosmetic preparations for slimming purposes; aromatherapy products; hair lotions; shampoos; hair conditioners; anti-perspirants and deodorants for personal use; bath preparations; body care products; body lotions, oils and washes; dental and dental hygiene products (term considered too vague by the International Bureau – rule 13 (2) (b) of the Regulations); dentifrices; fragrance oils; incense; lip balms; massage oils.

5 – Pharmaceutical and medicinal preparations and substances; dietetic substances, foodstuffs and beverages; diabetic foodstuffs; herbal preparations for medicinal purposes; herbal supplements; herbal extracts; herbal beverages (term considered too vague by the International Bureau – rule 13 (2) (b) of the Regulations); vitamins; vitamin preparations; minerals, mineral preparations (term considered too vague by the International Bureau – rule 13 (2) (b) of the Regulations); vitamin and mineral food supplements; food supplements; detox preparations and substances; diuretic preparations and substances; herbal medicinal products, preparations and substances; homeopathic preparations and substances; nutraceutical preparations and substances; nutritional and dietary supplements; nutraceutical foodstuffs and beverages; vitamin drinks and beverages; medicated confectionery; medicated preparations for making beverages; preparations for promoting weight loss; protein supplements; dietary supplements; foods for babies and infants; gluten free drinks (term considered too vague by the International Bureau – rule 13 (2) (b) of the Regulations); lactose-free foodstuffs (term considered too vague by the International Bureau – rule 13 (2) (b) of the Regulations); gluten-free foodstuffs (term considered too vague by the International Bureau – rule 13 (2) (b) of the Regulations); lactose-free drinks (term considered too vague by the International Bureau – rule 13 (2) (b) of the Regulations); lactose-free foodstuffs (term considered too vague by the International Bureau – rule 13 (2) (b) of the Regulations); sports nutrition products (term considered too vague by the International Bureau – rule 13 (2) (b) of the Regulations); tonics (medicine); nutritional drink mix for use as a meal replacement (term considered too vague by the International Bureau – rule 13 (2) (b) of the Regulations); meal replacement powders.

35 – Demonstration of goods; direct mail advertising; distribution of samples; retail services connected with the sale of cosmetics, toiletries, dental products, diabetic foodstuffs, dietary supplements and dietetic preparations, herbal supplements and preparations, vitamins and vitamin preparations, essential oils and fragrances, food and drinks, health foods, supplements,

household cleaning products, magazines and periodicals, minerals, nutraceuticals, nutritional supplements, perfumery, personal care products, pharmaceuticals, printed matter, shopping and carrier bags, sports nutrition products, therapeutic products.

(260) AM 2022 117638 A  
(800) 1658348  
(151) 2022 03 16  
(891) 2022 03 16  
(731) Joint-Stock Company "AVTOVAZ"  
Yuzhnoe shosse, 36, RU-445024 Togliatti,  
Samarskaya oblast, Russian Federation  
(540)



(591) Orange, gray and white  
(531) 26.04.22; 26.04.24; 27.05.10; 29.01.13  
(511)  
9 – Multimedia systems for automobiles.

(260) AM 2022 117639 A  
(800) 1658479  
(151) 2021 12 16  
(891) 2021 12 16  
(731) Euro Games Technology Ltd.  
4, "Maritsa" Str., "Vranya-Lozen-Triugulnika",  
BG-1151 Sofia, Bulgaria  
(540)



(591) Red, orange, yellow, brown, white and black  
(531) 24.17.18; 27.03.15; 27.05.02; 27.05.03;  
27.05.04; 29.01.15  
(511)

9 – Software; computer gaming software; computer software packages; computer operating system software; computer software, recorded; software drivers; virtual reality software; games software; entertainment software for computer games; computer programs for network management; operating computer software for main frame computers; monitors (computer hardware); computer hardware; apparatus for recording images; monitors (computer programs); computer game programs; computer programs for recorded games; apparatus for recording, transmission or reproduction of sound or images; communications

servers [computer hardware]; electronic components for gambling machines; computer application software featuring games and gaming; computer software for the administration of on-line games and gaming; computer hardware for games and gaming; hardware and software for gambling, gambling machines, gambling games on the Internet and via telecommunication network.

28 – Gaming machines for gambling; chips for gambling; mah-jong; arcade games; gambling machines operating with coins, notes and cards; games; electronic games; parlor games; gaming chips; gaming tables; slot machines [gaming machines]; LCD game machines; slot machines and gaming devices; coin-operated amusement machines; roulette chips; poker chips; chips and dice [gaming equipment]; gaming equipment for casinos; roulette tables; gaming roulette wheels; casino games; gambling machines and amusement machines, automatic and coin-operated; coin-operated amusement machines and/or electronic coin-operated amusement machines with or without the possibility of gain; boxes for coin-operated machines, slot machines and gaming machines; electronic or electrotechnical amusement machines and apparatus, gaming machines, coin-operated entertainment machines; housings for coin-operated machines, gaming equipment, gaming machines, machines for gambling; electropneumatic and electrical gambling machines (slot machines).

41 – Gambling; entertainment services related to gambling; gaming services for entertainment purposes; casino, gaming and gambling services; training in the development of software systems; provision of gaming equipment for gambling halls; providing casino equipment [gambling]; gaming machine entertainment services; providing casino facilities [gambling]; gaming hall services; amusement arcade services; games equipment rental; rental of gaming machines; providing amusement arcade services; rental of gaming machines with images of fruits; editing or recording of sounds and images; sound recording and video entertainment services; hire of sound reproducing apparatus; provision of gaming equipment for casinos; providing of casino facilities; online gambling services; casino, gaming and gambling services; provision of gaming facilities, gaming hall facilities, Internet casinos and online gambling services.

(260) AM 2022 117640 A

(800) 1658491

(151) 2022 02 08

(891) 2022 02 08

(731) Paedi Protect AG

Zu den Sandbeeten 5, 35043 Marburg,  
Germany

(540)

**PAEDIPROTECT**

(591) Black, white

(511)

3 – Sun creams for babies; baby foam baths; baby foam shampoo; baby care products, non-medicated; baby oils; baby lotions; baby creams (non-medicated); baby shampoo; sun protecting creams (cosmetics); sun care preparations (cosmetics); sunscreen preparations; sunscreen sticks; waterproof sunscreens; cosmetic sun blocking lipsticks; sun care preparations for cosmetic purposes; sunscreen lotions for cosmetic purposes; sun protectors for lips (cosmetics); sun blocking preparations (cosmetic products for skin tanning); sun care lotions; sunscreen; sunscreen creams; cosmetic sun-protecting preparations.

(260) AM 2022 117641 A

(800) 1658565

(151) 2022 02 03

(891) 2022 02 03

(731) WSCAD GmbH

Dieselstr. 4, 85232 Bergkirchen, Germany

(540)

**ELECTRIX**

(591) Black, white

(531) 27.05.01; 27.05.09; 27.05.10

(511)

9 – CDs, DVDs and other digital recording media, namely compact discs (ROM, memory, sound, image), USB sticks; computer software, namely computer programs / software (recorded, downloadable), software applications for computers (downloadable), computer-aided design software (CAD); software for computer-aided production (CAM); software for computer-aided technical engineering (CAE).

42 – Design and development of computer software, namely updating of computer software, conversion of computer programs and data, software as a service, rental of computer software / web servers, maintenance of computer software.

(260) AM 2022 117642 A

(800) 1658595

(151) 2022 03 04

(891) 2022 03 04

(731) KARAVELA, SIA

Atlantijas iela 15, LV-1015 Riga, Latvia

(540)



(591) Green, dark green and light green  
 (531) 03.09.01; 03.09.24; 05.09.19; 27.05.01;  
 27.05.08; 27.05.17; 29.01.11

(511)  
 29 – Processed legumes; preserved pulses; snack foods based on legumes.

(260) AM 2022 117643 A

(800) 1658810

(151) 2022 01 25

(891) 2022 01 25

(731) SICPA HOLDING SA

Avenue de Florissant 41, CH-1008 Prilly,  
 Switzerland

(540)

## SICPA HORIZON

(591) Black, white

(511)

9 – Computer software for detecting counterfeits and verifying the authenticity of goods, documents, product packaging, digitally produced images and labels; computer software for organizing and presenting data relating to branded goods, product packaging, product labels, verifying the control chain, identifying and using markers.

35 – Commercial risk assessment services, namely, risk analysis with respect to product supply chains, namely, distribution and supply chains of raw materials and finished products, to combat counterfeiting, misappropriation and alteration of goods; business management consultancy; commercial analysis of revenue lost due to counterfeiting, misappropriation and alteration of goods; data automation and collection services, namely, using proprietary software to assess, analyze and collect data; private investigation services, namely, compiling proof of control chains for the purpose of fighting counterfeiting, misappropriation and alteration of goods.

38 – Providing access to online databases in the field of the authentication and inventory management of goods, such as goods in the pharmaceutical, health, alcohol, consumer goods, industrial, agrochemical, luxury goods and tobacco sectors; transmitting data and information via the Internet concerning the monitoring and inventory management of goods, such as goods in the pharmaceutical, health, alcohol, consumer goods, industrial, agrochemical, luxury goods and tobacco sectors.

42 – Quality control services for certification purposes relating to the authentication of goods in the pharmaceutical, health, alcohol, consumer goods, industrial, agrochemical, luxury goods and tobacco sectors; designing, implementing and managing control chain and authentication programs and excise debt collection services.

45 – Private investigations and related advice linked to counterfeiting, misappropriation of goods, brand degradation and liability claims; legal advisory services, namely, legal advisory services in the fields of authentication and tracking of goods and documents, and brand control and protection, against counterfeiting, alteration and misappropriation of goods and for ensuring the integrity of authentic goods and documents.

(260) AM 2022 117644 A

(800) 1658828

(151) 2022 01 26

(891) 2022 01 26

(731) Trina Solar Co., Ltd

No. 2 Trina Road, Trina PV Park, Xinbei  
 District, Changzhou, 213031 Jiangsu, China

(540)

# OxPV

(591) Black, white

(531) 27.05.01

(511)

1 – Silicon; industrial silicon; silicon for solar batteries; calcium silicate; calcium; titanium dioxide for industrial purposes; titanium oxides; organometallic compounds; industrial chemicals; battery electrolytes; acidulated water for recharging batteries; salts for galvanic cells.

9 – Polycrystalline silicon wafers, chips, solar cells; monocrystalline silicon wafers, chips, solar cells; silicon wafers; inverters [electricity]; alternating current switches [electricity]; junction boxes [electricity]; photocells; accumulators, electric; batteries, electric; solar batteries; photovoltaic cells; crystalline silicon solar cells; lithium ion batteries; fuel cells; solar panels for the production of electricity; solar cell modules.

(260) AM 2022 117645 A

(800) 1658880

(151) 2021 12 16

(891) 2021 12 16

(731) Euro Games Technology Ltd.

4, "Maritsa" Str., "Vranya-Lozen-Triugulnika",  
 BG-1151 Sofia, Bulgaria

(540)

## Gods & Kings Jackpot

(591) Black, white

(511)

9 – Software; computer gaming software; computer software packages; computer operating system software; computer software, recorded; software drivers; virtual reality software; games software; entertainment software for computer games; computer pro-

grams for network management; operating computer software for main frame computers; monitors (computer hardware); computer hardware; apparatus for recording images; monitors (computer programs); computer game programs; computer programs for recorded games; apparatus for recording, transmission or reproduction of sound or images; communications servers [computer hardware]; electronic components for gambling machines; computer application software featuring games and gaming; computer software for the administration of on-line games and gaming; computer hardware for games and gaming; hardware and software for gambling, gambling machines, gambling games on the Internet and via telecommunication network.

28 – Gaming machines for gambling; chips for gambling; mah-jong; arcade games; gambling machines operating with coins, notes and cards; games; electronic games; parlor games; gaming chips; gaming tables; slot machines [gaming machines]; LCD game machines; slot machines and gaming devices; coin-operated amusement machines; roulette chips; poker chips; chips and dice [gaming equipment]; gaming equipment for casinos; roulette tables; gaming roulette wheels; casino games; gambling machines and amusement machines, automatic and coin-operated; coin-operated amusement machines and/or electronic coin-operated amusement machines with or without the possibility of gain; boxes for coin-operated machines, slot machines and gaming machines; electronic or electrotechnical amusement machines and apparatus, gaming machines, coin-operated entertainment machines; housings for coin-operated machines, gaming equipment, gaming machines, machines for gambling; electropneumatic and electrical gambling machines (slot machines).

41 – Gambling; entertainment services related to gambling; gaming services for entertainment purposes; casino, gaming and gambling services; training in the development of software systems; provision of gaming equipment for gambling halls; providing casino equipment [gambling]; gaming machine entertainment services; providing casino facilities [gambling]; gaming hall services; amusement arcade services; games equipment rental; rental of gaming machines; providing amusement arcade services; rental of gaming machines with images of fruits; editing or recording of sounds and images; sound recording and video entertainment services; hire of sound reproducing apparatus; provision of gaming equipment for casinos; providing of casino facilities; online gambling services; casino, gaming and gambling services; provision of gaming facilities, gaming hall facilities, Internet casinos and online gambling services.

(260) AM 2022 117646 A  
(800) 1112338  
(151) 2012 01 20  
(891) 2022 04 11  
(731) ZF Friedrichshafen AG  
Löwentaler Str. 20, 88046 Friedrichshafen,  
Germany

(540)  
LIFEGUARD  
(591) Black, white  
(511)  
4 – Industrial oils and greases; lubricants.

(260) AM 2022 117647 A  
(800) 1599908  
(151) 2021 05 12  
(891) 2022 04 13  
(731) ZHEJIANG GEELY HOLDING GROUP CO.,  
LTD.  
1760 Jiangling Road, Binjiang District,  
Hangzhou, Zhejiang, China

(540)



(591) Black, white  
(531) 24.15.01; 26.03.23; 26.13.25  
(511)

12 – Electric vehicles; vehicles for locomotion by land, air, water or rail; anti-theft devices for automobiles; motorcycles; cars; automobile chassis; two-wheeled trolleys; tyres for vehicle wheels; brakes for vehicles; safety belts for vehicle seats.

37 – Providing information relating to repairs; construction; machinery installation, maintenance and repair; interference suppression in electrical apparatus; fuelling of vehicles; motor vehicle maintenance and repair; vehicle maintenance; retreading of tyres; repair of rubber tires; installation and maintenance of entertainment or sports apparatus.

(260) AM 2022 117680 A  
(800) 1659202  
(151) 2022 01 24  
(891) 2022 01 24  
(731) Amgen Inc.  
One Amgen Center Drive, Trademark  
Operations MS 28-5-A, Thousand Oaks CA  
91320-1799, USA

(540)



(591) Black, white

(531) 26.03.01; 26.11.21; 27.05.01

(511)

5 – Pharmaceutical preparations for the treatment of respiratory diseases and disorders, pulmonary diseases and disorders, cardiovascular diseases and disorders, inflammation, inflammatory diseases and disorders, autoimmune diseases and disorders, cancer, oncological diseases and disorders, hematological diseases and disorders, tumorous diseases, neurological diseases and disorders and metabolic diseases and disorders.

(260) AM 2022 117681 A

(800) 1659209

(151) 2021 10 01

(891) 2021 10 01

(731) TEQBALL HOLDING S.A.R.L.

44, avenue John F. Kennedy, L-1855  
Luxembourg, Luxembourg

(540)

## TEQBALL

(591) Black, white

(511)

45 – Consultancy relating to copyright management; consultancy relating to industrial property; consultancy relating to industrial property rights; consultancy relating to intellectual property management; consultancy relating to the licensing of intellectual property; consultancy relating to the licensing of computer software; consultancy relating to the registration of domain names; copyright licensing agency services; domain name registration services, namely, conducting domain name searches for the purpose of providing legal advice on domain name registration; film, television and video licensing [legal services]; intellectual property consultancy services for inventors; intellectual property consultancy; intellectual property consultancy services for non-profit organizations; intellectual property consultancy services for universities and research institutions; Internet-based dating and social introduction services; Internet-based dating, match-making and personal introduction services; Internet-based matchmaking services; Internet-based personal introduction services; Internet-based social introduction services; Internet-based social networking, introduction, and dating services; Internet-based social networking services; legal services in the nature of trademark monitoring; legal services relating to the exploitation of broadcasting rights; legal services relating to the exploitation of copyright for printed matter; legal services relating to the exploitation of film copy-

right; legal services relating to the exploitation of intellectual property rights; legal services relating to the exploitation of patents; legal services relating to the management, control and granting of license rights; legal services relating to the negotiation and drafting of contracts relating to intellectual property rights; licensing of advertising slogans and cartoon characters [legal services]; licensing of computer programs [legal services]; licensing of computer software and industrial property rights [legal services]; licensing of computer software [legal services]; licensing of databases [legal services]; licensing of franchise concepts [legal services]; licensing of industrial property rights and copyright [legal services]; licensing of printed matter [legal services]; licensing of radio and television programs [legal services]; licensing of registered designs [legal services]; licensing of research and development [legal services]; licensing of rights relating to films [legal services]; licensing of rights relating to television productions [legal services]; licensing of rights relating to television, video and radio programs, productions and formats [legal services]; licensing of rights relating to the use of photographs [legal services]; licensing of rights relating to video productions [legal services]; licensing of rights to films, television and video productions [legal services]; licensing of technology [legal services]; licensing of trademarks [legal services]; licensing services; licensing services relating to the manufacture of goods [legal services]; lobbying services, other than for commercial purposes; management of industrial property rights and copyright; management of industrial property rights and copyright for others; monitoring intellectual property rights for legal advisory purposes; organization of political meetings; organization of religious meetings; professional legal consultations relating to franchising; providing clothing to underprivileged persons for charitable purposes; providing clothing to needy persons [charitable services]; providing clothing to needy children for charitable purposes; providing information via interactive on-line web sites in the field of dating and to facilitate introduction of individuals and development of relationships and friendships; providing shoes to needy children for charitable purposes; providing shoes to needy persons [charitable services]; providing shoes to underprivileged persons for charitable purposes; trademark monitoring [legal services]; trademark agent services.

(260) AM 2022 117682 A

(800) 1659211

(151) 2022 01 14

(891) 2022 01 14

(731) Honor Device Co., Ltd.

Suite 3401, Unit A, Building 6, Shum Yip  
Sky Park, No. 8089, Hongli West Road,  
Xiangmihu Street, Futian District, Shenzhen,  
518040 Guangdong, China



(540)

**HONOR AI Space**

(591) Black, white

(531) 27.05.01

(511)

9 – All-in-one personal computer TVs; personal digital assistants [PDAs]; interactive touch screen terminals; laptop computers; downloadable software applications for mobile phones; computer software applications, downloadable; computer programs, downloadable; LCD large-screen displays; computer software platforms, recorded or downloadable; computer programs, recorded; tablet computers; stands adapted for tablet computers; hand-held electronic dictionaries; smart rings (data processing apparatus); smartwatches; smartglasses; liquid crystal display screens; wearable computers; notebook computers; video printers; digital color printers; flexible flat panel displays for computers; integrated circuit cards [smart cards]; holders for mobile phones; selfie sticks for use with smartphones; smartphones; protective films adapted for smartphones; cases for smartphones; wearable activity trackers; network communication devices; network routers; wrist mounted smartphones; telecommunication apparatus in the form of jewellery; portable media players; headphones; virtual reality headsets; security surveillance robots; cabinets for loudspeakers; camcorders; digital photo frames; set-top boxes; liquid crystal display [LCD] televisions; television apparatus; wearable video display monitors; earphones; car video recorders; video monitors; car televisions; microphones; cameras [photography]; selfie lenses; USB cables; USB cables for cell phones; materials for electricity mains [wires, cables]; electronic chips; video screens; touch screens; integrated circuits; humanoid robots with artificial intelligence for use in scientific research.

(260) AM 2022 117683 A

(800) 1659228

(151) 2021 12 15

(891) 2021 12 15

(731) Euro Games Technology Ltd.

4, "Maritsa" Str., "Vranya-Lozen-Triugulnika",  
BG-1151 Sofia, Bulgaria

(540)



(591) Red, green, yellow, black, brown, orange and pink

(531) 27.05.01; 27.05.03; 27.05.09; 27.05.10;  
27.07.01; 27.07.03; 27.07.11; 29.01.15

(511)

9 – Software; computer gaming software; computer software packages; computer operating system soft-

ware; computer software, recorded; software drivers; virtual reality software; games software; entertainment software for computer games; computer programs for network management; operating computer software for main frame computers; monitors (computer hardware); computer hardware; apparatus for recording images; monitors (computer programs); computer game programs; computer programs for recorded games; apparatus for recording, transmission or reproduction of sound or images; communications servers [computer hardware]; electronic components for gambling machines; computer application software featuring games and gaming; computer software for the administration of on-line games and gaming; computer hardware for games and gaming; hardware and software for gambling, gambling machines, gambling games on the internet and via telecommunication network.

28 – Gaming machines for gambling; chips for gambling; mah-jong; arcade games; gambling machines operating with coins, notes and cards; games; electronic games; parlor games; gaming chips; gaming tables; slot machines [gaming machines]; LCD game machines; slot machines and gaming devices; coin-operated amusement machines; roulette chips; poker chips; chips and dice [gaming equipment]; gaming equipment for casinos; roulette tables; gaming roulette wheels; casino games; gambling machines and amusement machines, automatic and coin-operated; coin-operated amusement machines and/or electronic coin-operated amusement machines with or without the possibility of gain; boxes for coin-operated machines, slot machines and gaming machines; electronic or electrotechnical amusement machines and apparatus, gaming machines, coin-operated entertainment machines; housings for coin-operated machines, gaming equipment, gaming machines, machines for gambling; electropneumatic and electrical gambling machines (slot machines).

41 – Gambling; entertainment services related to gambling; gaming services for entertainment purposes; casino, gaming and gambling services; training in the development of software systems; provision of gaming equipment for gambling halls; providing casino equipment [gambling]; gaming machine entertainment services; providing casino facilities [gambling]; gaming hall services; amusement arcade services; games equipment rental; rental of gaming machines; providing amusement arcade services; rental of gaming machines with images of fruits; editing or recording of sounds and images; sound recording and video entertainment services; hire of sound reproducing apparatus; provision of gaming equipment for casinos; providing of casino facilities; online gambling services; casino, gaming and gambling services; provision of gaming facilities, gaming hall facilities, Internet casinos and online gambling services.

(260) AM 2022 117690 A  
 (800) 1659478  
 (151) 2022 03 15  
 (891) 2022 03 15  
 (731) PEPCO Poland Sp. z o.o.  
 Strzeszyńska 73A, PL-60-479 Poznań,  
 Poland

(540)

## BOABU

(591) Black, white  
 (511)  
 28 – Bubble making wand and solution sets; soap bubbles [toys]; soap bubble dispenser toys; toy swords, pistols, fans for blowing bubbles.

(260) AM 2022 117691 A  
 (800) 1659503  
 (151) 2021 10 01  
 (891) 2021 10 01  
 (731) TEQBALL HOLDING S.A.R.L.  
 44, avenue John F. Kennedy, L-1855  
 Luxembourg, Luxembourg

(540)

## TEQ

(591) Black, white  
 (511)  
 25 – Ankle pants; ankle socks; arm warmers [clothing]; articles of clothing for human beings; athletic footwear for runners; athletic footwear for soccer; athletic pants; athletic shirts; athletic shoes; athletic shorts; athletic skirts; athletic tights; athletic tops and bottoms for runners; athletic tops and bottoms for yoga; athletic uniforms; bags specially adapted for football shoes; baseball caps; beach hats; beanies; belts for clothing; belts made from imitation leather; belts made of cloth; belts made of cloth [clothing]; belts made of fabric; belts made of leather; belts made of textile; bomber jackets; boots for gymnastics; camp shirts; canvas shoes; caps being headwear; clothing, footwear and headwear for human beings; clothing, footwear, headgear; clothing for children; clothing for boys; clothing for girls; clothing for gymnastics; clothing for men; clothing for men, women and children; clothing for sports; clothing for women; clothing of imitations of leather; clothing of leather or imitations of leather; coats for men; coats for women; coats made of cotton; collared shirts; crop leggings; crop tops; dresses; dresses for children; dresses for girls; dresses for women; dress pants; dress shoes; dress shirts; flat shoes; footwear for adults; footwear for children; footwear for men; footwear for men and women; footwear for women; hooded sweatshirts; hooded pullovers; hooded tops; hoods [clothing]; leather belts [clothing]; leisure footwear; leisure shoes; leisure wear; linen clothing; men's socks; pocket squares; printed T-shirts; raincoats; rain ponchos; replica soccer shorts; replica soccer socks; replica soccer shirts, shorts and

socks; replica soccer shirts; running shoes; running suits; shell jackets; shirts for women; shirts for wear with suits; shirts for men; shirts for children; shirts for adults; shirts [business wear]; shirts; shoes; shoes for men; shoes for children; shoes for women; shoes for adults; shorts; shorts for men; shorts for children; shorts for adults; short sets [clothing]; shorts for women; skull caps; soccer shirts; soccer shoe bags; soccer shorts; soccer socks; socks; sport coats; sports bras; sports caps; sport shirts; sports jackets; sports jerseys; sports shirts; sports shoes; sports socks; sports vests; strapless bras; stretch pants; sweaters; sweaters for adults; sweaters for children; sweaters for men; sweaters for women; sweatpants; sweatpants for adults; sweatpants for children; sweatpants for men; sweatpants for women; sweatshirts; sweat shorts; sweatsocks; tennis clothing; tennis dresses; tennis shirts; tennis shoes; tennis shorts; tennis skirts; tennis socks; tennis suits; tennis sweatbands; tennis sweaters; tennis tops; textile belts [clothing]; thermal clothing; tops [clothing]; tops for adults; tops for children; tops for men; tops for women; toques; track jackets; track shoes; tracksuits; tracksuit tops; training shoes; T-shirts with designer logos; T-shirts with logos; underpants; underwear; volleyball jerseys; volleyball shoes; warm-up jackets; warm-up pants; warm-up tops; waterproof clothing; waterproof jackets; waterproof pants [trousers]; weatherproof jackets; weatherproof clothing; windproof clothing; wind-resistant jackets; women's underwear; women's socks.

28 – Amusement and game apparatus adapted for use with an external display screen or monitor; amusement apparatus adapted for use with an external display screen or monitor; amusement apparatus for use in arcades; amusement apparatus for use with a television screen; amusement game machines; amusement machines, automatic and coin-operated; apparatus for consumer games adapted for use with an external display screen or monitor; apparatus for electronic games adapted for use with an external display screen or monitor; apparatus for electronic games other than those adapted for use with an external display screen or monitor; apparatus for games; apparatus for games other than those adapted for use with an external display screen or monitor; arcade game machines; arcade video game machines; bags adapted for use with sporting equipment; bags specially adapted for sports equipment; balls for games; balls for playing paddleball; balls for playing platform tennis; balls for racket sports; balls for sports; computerized video game tables for gaming purposes; computerized video table games for gaming purposes; controllers for game consoles; dreidels; educational toys; electronic and electromechanical gaming tables with video output; electronic educational game machines for children; electronic games apparatus; electronic games consoles adapted for use with an external display screen or monitor; electronic hand-held game units; electronic targets; electronic targets for games and sports; electro-

nic toys; equipment for playing outdoor games; exercise equipment; exercise equipment, other than for medical rehabilitative purposes; exercise equipment, other than for physical therapy purposes; foosball tables; game apparatus adapted for use with an external display screen or monitor; game consoles; game machines and apparatus; games; games and playthings; games apparatus adapted for use with television receivers; games, toys and playthings; hand-held apparatus for electronic games; hand-held electronic games; hand-held electronic games adapted for use with television receivers only; hand-held electronic game units adapted for use with an external display screen or monitor; hand-held electronic video games; hand-held game consoles; hand-held games with liquid crystal displays; hand-held joystick units for playing video games; hand-held units for playing electronic games; hand-held units for playing electronic games for use with an external display screen or monitor; hand-held units for playing electronic games, other than those adapted for use with an external display screen or monitor; hand-held units for playing video games; hand-held units for playing video games, other than those adapted for use with an external display screen or monitor; hand-held video game apparatus; hand-held video game consoles; interactive remote control units for video games; machines and apparatus for physical exercise; machines for physical exercises; motion controllers for computer and video games; nets for soccer goals; outdoor play equipment; outdoor toys; paddles for playing paddleball; paddles for playing platform tennis; physical exercise apparatus, other than for medical purposes; platform tennis nets; pocket-sized apparatus for playing video games; portable games and toys incorporating telecommunication functions; portable games incorporating telecommunication functions; portable games with liquid crystal displays; portable toys incorporating telecommunication functions; soccer balls; soccer goals; sporting articles; sports equipment; stand-alone video game machines; tables for table football; table football tables; table tennis rackets; table tennis nets; table tennis balls; tables for table tennis; target games; toys incorporating telecommunication functions; video game apparatus; video game consoles; video game consoles for use with an external display screen or monitor; video game machines; video game machines for use with an external display screen or monitor; video game machines for use with televisions; video games apparatus adapted for use with an external display screen or monitor; video output game machines for use with an external display screen or monitor; video output game machines for use with televisions; volleyball; gaming headsets specially adapted for use in playing video games.

41 – Adult education; adult training; advanced training; advisory services relating to training; amusement arcade services; amusement center services; animation production services; arranging and conducting

of athletic competitions; arranging and conducting of business conferences; arranging and conducting of classes; arranging and conducting of competitions [education or entertainment]; arranging and conducting of conferences; arranging and conducting of colloquiums, conferences, congresses, seminars, symposiums and training workshops; arranging and conducting of colloquiums, conferences and congresses; arranging and conducting of colloquiums; arranging and conducting of conferences and exhibitions for cultural or educational purposes; arranging and conducting of conferences and seminars; arranging and conducting of conferences, congresses and symposiums; arranging and conducting of conferences, congresses, concerts, symposiums, seminars, training courses, classes and lectures; arranging and conducting of conferences, congresses, seminars and training workshops; arranging and conducting of conferences, congresses, seminars, symposiums, training courses, classes and lectures; arranging and conducting of conferences, congresses, symposiums and seminars; arranging and conducting of conferences, conventions and exhibitions for cultural or educational purposes; arranging and conducting of conferences, conventions, educational exhibitions, classes, lectures, seminars and training workshops; arranging and conducting of conferences, seminars and symposiums; arranging and conducting of congresses; arranging and conducting of conventions; arranging and conducting of cultural activities; arranging and conducting of cultural events; arranging and conducting of educational conferences; arranging and conducting of educational courses; arranging and conducting of educational events; arranging and conducting of educational seminars; arranging and conducting of entertainment activities; arranging and conducting of entertainment events; arranging and conducting of entertainment, sporting and cultural activities; arranging and conducting of exhibitions for entertainment purposes; arranging and conducting of fitness classes; arranging and conducting of games; arranging and conducting of in-person educational forums; arranging and conducting of lectures; arranging and conducting of live entertainment events; arranging and conducting of meetings in the field of education; arranging and conducting of meetings in the field of entertainment; arranging and conducting of seminars; arranging and conducting of seminars and training workshops; arranging and conducting of seminars, conferences and exhibitions for cultural or educational purposes; arranging and conducting of seminars, conferences, training courses and further training; arranging and conducting of seminars, congresses, conferences and symposiums; arranging and conducting of seminars, workshops [education], congresses, colloquia, distance learning courses and exhibitions for cultural purposes; arranging and conducting of soccer training programs; arranging and conducting of sporting and cultural events; arranging

and conducting of sporting events; arranging and conducting of sports competitions; arranging and conducting of sports events; arranging and conducting of symposiums; arranging and conducting of training courses; arranging and conducting of training seminars; arranging and conducting of tutorials; arranging and conducting of workshops and seminars; arranging and conducting of workshops [training]; arranging and conducting of workshops, tutorials, seminars and conferences; arranging and conducting of youth soccer training programs; arranging and conducting online workshops in the field of health; arranging and conducting online workshops in the field of wellness; arranging and conducting workshops in weight control; arranging award ceremonies and gala evenings for entertainment purposes; arranging award ceremonies for major corporations and individuals who have made significant charitable contributions; arranging, conducting and organization of colloquiums; arranging, conducting and organization of conferences; arranging, conducting and organization of conferences, congresses, colloquiums, workshops [training], seminars and symposiums; arranging, conducting and organization of congresses; arranging, conducting and organization of seminars; arranging, conducting and organization of symposiums; arranging, conducting and organization of training workshops; arranging gala evenings for entertainment purposes; arranging of classes; arranging of colloquiums; arranging of competitions for education or entertainment; arranging of competitions via the Internet; arranging of conferences; arranging of congresses; arranging of contests; arranging of conventions; arranging of cultural and sporting events; arranging of cultural events; arranging of educational conferences; arranging of educational courses; arranging of educational events; arranging of educational seminars; arranging of entertainment events; arranging of entertainment shows; arranging of exhibitions, congresses, seminars and conferences for cultural and entertainment purposes; arranging of exhibitions for cultural or educational purposes; arranging of exhibitions for training purposes; arranging of exhibitions, seminars and conferences; arranging of film events, live musical events, and cultural and sporting events; arranging of film events, musical events, cultural and sporting events and live entertainment events; arranging of games and competitions via the Internet; arranging of in-person educational forums; arranging of live entertainment events; arranging of seminars; arranging of seminars and conferences; arranging of soccer games; arranging of sports competitions; arranging of sports competitions to needy children for charitable purposes; arranging of sports competitions to underprivileged persons for charitable purposes; arranging of sports training to needy children for charitable purposes; arranging of sports training to underprivileged persons for charitable purposes; arranging of symposiums; arranging

of symposiums and training workshops; arranging of training courses; arranging of training courses in teaching institutes; arranging of training seminars; arranging of workshops and seminars; arranging professional workshop and training courses; audio and video editing services; audio and video recording services; audio entertainment services; audio, film, video and television recording services; betting services; body awareness instruction; business education; business training; business training consultancy; club services [entertainment or education]; club services in the nature of entertainment; coaching [education and training]; coaching in the field of sports; coaching [training]; computer-based training; computer-based training courses; computer education training services; conducting entertainment events, cultural events, live sports events, educational events, and entertainment and cultural activities; conducting exercise classes; conducting fitness classes; conducting of business conferences; conducting of classes; conducting of colloquiums; conducting of competitions on the Internet; conducting of conferences; conducting of congresses; conducting of conventions; conducting of cultural activities; conducting of cultural events; conducting of distance learning courses; conducting of educational conferences; conducting of educational courses; conducting of educational events; conducting of educational seminars; conducting of entertainment activities; conducting of entertainment events; conducting of exhibitions in the field of entertainment; conducting of instructional, educational and training courses for young people and adults; conducting of live entertainment events; conducting of seminars; conducting of soccer games; conducting of sports competitions; conducting of sports events; conducting of symposiums; conducting of training courses; conducting of training courses in the field of technology and innovation; conducting of training seminars; conducting of training workshops; conducting of workshops and seminars; conducting physical fitness conditioning classes; consultancy and information services relating to arranging, conducting and organization of colloquiums; consultancy and information services relating to arranging, conducting and organization of conferences; consultancy and information services relating to arranging, conducting and organization of congresses; consultancy and information services relating to arranging, conducting and organization of seminars; consultancy and information services relating to arranging, conducting and organization of symposiums; consultancy and information services relating to arranging, conducting and organization of training workshops; consultancy relating to arranging and conducting of colloquiums; consultancy relating to arranging and conducting of conferences; consultancy relating to arranging and conducting of congresses; consultancy relating to arranging and conducting of seminars; consultancy relating to arranging and conducting of symposiums; consultancy relating to arranging and

conducting of training workshops; consultancy relating to education and training; consultancy relating to physical fitness training; consultancy relating to training and further training; consultancy relating to training, further training and education; consultancy services in the field of entertainment; consultancy services in the field of entertainment provided via the Internet; consultancy services relating to training; continuous training services; cultural activities; digital imaging services [editing of images]; digital imaging services [photography]; digital photography; digital video, audio and multimedia entertainment publishing services; distance learning services provided on-line; editing of photographs; editing of printed matter and texts; editing of video recordings; editing of texts; educational and entertainment services provided by an association to its members; educational and instruction services; educational and instruction services relating to arts, crafts, sports or general knowledge; educational and instruction services relating to sport; educational and teaching services; educational and training services relating to games; educational and training services relating to sport; educational consultancy; educational examination; educational services in the nature of coaching; education and entertainment services; education and training in the field of business management; education and training in the field of electronic data processing; education and training services; education information; education in the field of business management; education, teaching and training; education, training and entertainment services; education, training and instructional services in relation to manufacturing and production; electronic games services provided by means of a global communication network; electronic games services provided by means of the Internet; electronic games services provided by means of the Internet or other communication network; entertainer services; entertainment and sporting activities; entertainment by Internet protocol television; entertainment by means of wireless television broadcasts; entertainment information; entertainment in the nature of animated and live action television series; entertainment in the nature of fantasy soccer leagues; entertainment in the nature of fantasy sports leagues; entertainment in the nature of live performances; entertainment in the nature of ongoing television programs; entertainment in the nature of soccer games; entertainment in the nature of sports competitions; entertainment in the nature of sports games; entertainment in the nature of sports tournaments; entertainment in the nature of tennis tournaments; entertainment services; entertainment services in the nature of an ongoing reality-based television programs; entertainment services in the nature of ongoing television programs in the field of sport; entertainment services in the nature of television news shows; entertainment services provided via a global communication network; exercise club services; fan club services in the nature of entertainment; film pro-

duction services; film editing; fitness and exercise club services; fitness club services; game services provided by means of communications by computer terminals or cellular phone; game services provided online from a computer network; game services provided on-line from a computer network for entertainment and further education purposes; game services provided on-line from a computer network or mobile phone network; game services provided via communication networks; game services provided via computer networks and global communication networks; gaming; handicapping for sports events; health and fitness club services; health and fitness training; health and recreational club services; health club services [health and fitness training]; health clubs for physical exercise; health education; information relating to computer gaming entertainment provided on-line from a computer database or a global communication network; information relating to education and entertainment; information relating to education and entertainment provided on-line from a computer database or the Internet; information relating to education or entertainment, provided on-line from a computer database or the Internet or by means of television or radio programs; information relating to education or entertainment provided on-line or via television, broadband and wireless communications; instruction and training services; interactive entertainment services; leisure and recreation services; live entertainment services; officiating at sports contests; on-line entertainment services; on-line game services; organisation of conferences, exhibitions and competitions; organising events being the provision of entertainment, sporting and cultural activities for charitable purposes; organization and arranging of seminars, conferences, training courses and further training; organization and conducting of colloquiums, conferences or congresses; organization and conducting of cultural and recreational activities; organization and presentation of live performances; organization and presentation of shows; organization and presentation of shows, competitions, games, concerts and entertainment events; organization and provision of games and competitions via the Internet; organization of community sports and cultural events; organization of competitions and award ceremonies; organization of competitions [education or entertainment]; organization of competitions for education or entertainment; organization of competitions or other sporting and cultural events for charitable purposes; organization of congresses and conferences for cultural and educational purposes; organization of educational and entertainment events for professionals and executives; organization of educational, entertainment, cultural and sporting competitions; organization of educational, entertainment, sporting and cultural events; organization of educational events; organization of educational shows; organization of electronic game competitions; organization of entertainment events; organization of entertainment

shows; organization of exhibitions, conventions and conferences for cultural or educational purposes; organization of exhibitions for cultural or educational purposes; organization of exhibitions for educational purposes; organization of games; organization of games and competitions; organization of live shows; organization of seminars; organization of shows; organization of soccer competitions; organization of soccer games; organization of sporting and cultural activities; organization of sporting and cultural events; organization of sporting events; organization of sporting events for charitable purposes; organization of sports activities for summer camps; organization of sports competitions; organization of sports events and competitions; organization of sports events in the field of soccer; organization of sports tournaments; organization of tennis tournaments; organization of training; organization of training courses; organization of youth training schemes; organization, production and presentation of events for educational, cultural or entertainment purposes; organization, presentation and production of shows and live performances; organizing and arranging exhibitions for entertainment purposes; organizing and conducting athletic competitions and games; organizing and conducting athletic competitions and games in the field of soccer; organizing and conducting athletic events; organizing and conducting college athletic events; organizing and conducting college sport competitions; organizing and conducting of sporting and cultural events; organizing and conducting sports competitions; organizing of sports tournaments to needy children for charitable purposes; organizing of sports tournaments to underprivileged persons for charitable purposes; party planning [entertainment]; party planning [entertainment] for celebration events; party planning [entertainment] for corporate events; party planning [entertainment] for promotion events in relation to charity fundraisings; party planning [entertainment] for promotion events in relation to non-profit organizations; party planning [entertainment] for promotion events in relation to product launches; party planning [entertainment] for social events; personal coaching [training]; personal fitness training; personal trainer services [fitness training]; photographic reporting; physical education; physical fitness instruction; physical fitness training; physical health education; planning and conducting of parties [entertainment]; post-production editing services in the field of videos and films; practical training [demonstration]; presentation of live entertainment events; presentation of live entertainment performances; presentation of live performances; presentation of live show performances; production and distribution of television programs; production and rental of educational and instructional materials; production of audio and video recordings; production of educational and instructional materials; production of educational materials; production of instructional materials; production of live entertainment; production of live en-

tertainment events; production of radio and television programs for the Internet and other media; production of radio and television programmes; production of shows; production of sound and video recordings; production of sound, music and video recordings; production of television, mobile phone television and radio programs; production of television, mobile television and radio programs; production of television programs; production of television programs for broadcast on cellular phones; production of television programs for broadcast on mobile devices; production of video podcasts; production of video recordings; providing athletic camp services [entertainment or education] to underprivileged persons for charitable purposes; providing athletics camp services [entertainment or education] to needy children for charitable purposes; providing courses of instruction; providing cultural activities to needy children for charitable purposes; providing cultural activities to underprivileged persons for charitable purposes; providing educational courses; providing educational courses, lectures, seminars and youth training schemes; providing educational demonstrations; providing educational entertainment services for children in after-school centers; providing educational information; providing educational materials to needy children for charitable purposes; providing educational materials to underprivileged persons for charitable purposes; providing education in the field of computers rendered through video conferencing; providing entertainment; providing football camp services [entertainment or education] to needy children for charitable purposes; providing football camp services [entertainment or education] to underprivileged persons for charitable purposes; providing holiday camp services [entertainment or education] to needy children for charitable purposes; providing holiday camp services [entertainment or education] to underprivileged persons for charitable purposes; providing information about sporting activities; providing information about exercise and fitness from a web site; providing information about education, training, entertainment, sporting and cultural activities; providing information about sporting and cultural activities; providing information in the field of education; providing information in the field of entertainment; providing information in the field of recreational activities; providing information on-line relating to computer games and computer enhancements for games; providing information relating to physical education via an on-line web site; providing information relating to physical exercises via an on-line web site; providing information relating to physical training via an on-line web site; providing information relating to sporting events; providing information relating to sports; providing information relating to sports and sporting events; providing information relating to training; providing instruction in the field of physical exercise; providing educational manuals and teaching materials in the field of well-

ness; providing of continuous training courses; providing of entertainment activities to needy children for charitable purposes; providing of entertainment activities to underprivileged persons for charitable purposes; providing of entertainment events to needy children for charitable purposes; providing of entertainment events to underprivileged persons for charitable purposes; providing of training; providing of training and education; providing of training and further training; providing of training via a global computer network; providing on-line computer games; providing on-line courses of instruction; providing online educational classes via a live video chat; providing on-line entertainment in the nature of fantasy sports leagues; providing on-line entertainment in the nature of game tournaments; providing on-line entertainment in the nature of game tournaments, fantasy sports leagues and game shows; providing on-line information about education, training, entertainment, sporting and cultural activities; providing on-line information in the field of computer games entertainment; providing on-line information in the field of education; providing on-line information in the field of training; providing on-line information in the field of entertainment; providing on-line information relating to entertainment or education; providing on-line instructional videos, not downloadable; providing on-line training; providing on-line training seminars; providing on-line tutorials; providing online video games [entertainment services]; providing online videos, not downloadable; providing recreational camp services [entertainment or education] to needy children for charitable purposes; providing recreational camp services [entertainment or education] to underprivileged persons for charitable purposes; providing recreation facilities; providing recreation facilities and services; providing soccer camp services [entertainment or education] to needy children for charitable purposes; providing soccer camp services [entertainment or education] to underprivileged persons for charitable purposes; providing sporting activities to needy children for charitable purposes; providing sporting activities to underprivileged persons for charitable purposes; providing sports camp services [entertainment or education] to needy children for charitable purposes; providing sports camp services [entertainment or education] to underprivileged persons for charitable purposes; providing sports facilities; providing sports facilities to needy children for charitable purposes; providing sports facilities to underprivileged persons for charitable purposes; providing sports goods to underprivileged children in the nature of sports activities [charitable services]; providing sports goods to underprivileged children in the nature of sports activities, for charitable purposes; providing sports information from a web site; providing sports training facilities; providing tennis camp services [entertainment or education] to needy children for charitable purposes; providing tennis camp services [entertainment or education]

to underprivileged persons for charitable purposes; providing tennis court facilities; providing tennis facilities; providing toys to underprivileged children in the nature of educational events, for charitable purposes; providing toys to underprivileged children in the nature of educational events [charitable services]; providing volleyball camp services [entertainment or education] to needy children for charitable purposes; providing volleyball camp services [entertainment or education] to underprivileged persons for charitable purposes; providing workshops in weight control; provision of non-downloadable games on the Internet; provision of training courses; provision of training programs; publication of educational and training guides; publication of educational materials; publication of manuals; publication of multimedia material online; publication of technical regulations; publication of training manuals; recreational services; recreation information; rental of sports equipment, except vehicles; rental of sports facilities; rental of sports grounds; rental of tennis equipment; rental of video games; soccer camp services; soccer instruction; sport camp services; sporting activities; sporting and cultural activities; sports club services; sports coaching; sports instruction; sports officiating; sports refereeing; sports refereeing and officiating; sports training; teacher training services; teaching; teaching and training services in the fields of business, industry and information technology; training and further training for personnel, team and organizational development; training services in the nature of coaching; video editing services; video editing services for events; videography services; video mastering services; video recording services; virtual reality game services provided online from a computer network.

(260) AM 2022 117766 A

(800) 1660586

(151) 2021 12 17

(891) 2021 12 17

(731) Firsov Oleksandr Oleksiiovych

st. O. Myshuhy, 3A, apt. 7, Lviv 79034,  
Ukraine;

Zadko Oleksandr Oleksandrovych  
st. O. Myshuhy, 3A, apt. 7, Lviv 79034,  
Ukraine

(540)



(591) Red, black, white and gray

(531) 02.01.11; 09.07.19; 26.04.14; 26.04.18;  
27.05.10; 29.01.14

(526) KebabChef men's food

(511)

43 – Services for providing food and drink; bar services; café services; cafeteria services; canteen services; decorating of food; food and drink catering; food sculpting; information and advice in relation to the preparation of meals; personal chef services; rental of chairs, tables, table linen, glassware; rental of cooking apparatus; rental of drinking water dispensers; rental of meeting rooms; restaurant services; self-service restaurant services; snack-bar services.

---

(260) AM 2022 118183 A

(800) 1666281

(151) 2022 02 03

(891) 2022 02 03

(731) Bretz Wohnträume GmbH

Alexander-Bretz-Str. 2, 55457 Gensingen,  
Germany

(540)

## **Bretz**

(591) Black, white

(511)

20 – Furniture and non-metallic furniture fittings being individual pieces and integrated units, in particular upholstered furniture such as seats and reclining furniture, and parts and fittings therefor; mirrors, picture frames; cushions for upholstered furniture; bedsteads; mattresses; fittings, namely furniture, bed and door fittings (non-metallic).

27 – Carpets, rugs, mats and matting, linoleum and other materials for covering existing floors.

35 – Retail trade services; retail services provided by department stores.

---



---

**INTERNATIONAL TRADEMARKS PROTECTED IN GEORGIA**

(260) AM 2022 110103 A  
(800) 967714  
(151) 2008 05 09  
(181) 2028 05 09  
(891) 2020 09 22  
(511) 05, 29, 30, 32

---

(260) AM 2022 113564 A  
(800) 1597374  
(151) 2020 10 26  
(181) 2030 10 26  
(891) 2020 10 26  
(511) 01, 04, 06, 07, 09, 11, 12, 20

---

(260) AM 2022 115487 A  
(800) 1627489  
(151) 2021 09 03  
(181) 2031 09 03  
(891) 2021 09 03  
(511) 42, 44

---

(260) AM 2022 115548 A  
(800) 1627834  
(151) 2021 05 26  
(181) 2031 05 26  
(891) 2021 05 26  
(511) 18, 21, 25, 35

---

(260) AM 2022 115616 A  
(800) 1629149  
(151) 2021 04 13  
(181) 2031 04 13  
(891) 2021 04 13  
(511) 01, 02, 03, 04, 05, 07, 08, 09, 11, 14, 15, 16, 18,  
20, 21, 24, 26, 27, 28, 31, 35, 36

---

(260) AM 2023 115733 A  
(800) 1632238  
(151) 2021 09 14  
(181) 2031 09 14  
(891) 2021 09 14  
(511) 09, 35, 37

---

(260) AM 2023 115781 A  
(800) 1632930  
(151) 2021 09 21  
(181) 2031 09 21

(891) 2021 09 21  
(511) 03, 05

---

(260) AM 2023 115782 A  
(800) 1632931  
(151) 2021 09 21  
(181) 2031 09 21  
(891) 2021 09 21  
(511) 03, 05

---

(260) AM 2023 115783 A  
(800) 1632982  
(151) 2021 11 11  
(181) 2031 11 11  
(891) 2021 11 11  
(511) 03

---

(260) AM 2023 115784 A  
(800) 1632986  
(151) 2021 10 28  
(181) 2031 10 28  
(891) 2021 10 28  
(511) 20

---

(260) AM 2023 115785 A  
(800) 1633000  
(151) 2021 06 08  
(181) 2031 06 08  
(891) 2021 06 08  
(511) 30

---

(260) AM 2023 115786 A  
(800) 1633009  
(151) 2021 06 22  
(181) 2031 06 22  
(891) 2021 06 22  
(511) 01, 03, 05

---

(260) AM 2023 115787 A  
(800) 1633029  
(151) 2021 07 01  
(181) 2031 07 01  
(891) 2021 07 01  
(511) 30

---

(260) AM 2023 115788 A  
(800) 1633153  
(151) 2021 11 08  
(181) 2031 11 08  
(891) 2021 11 08  
(511) 09

---

(260) AM 2023 115826 A  
(800) 1301788  
(151) 2016 02 26  
(181) 2026 02 26  
(891) 2021 11 30  
(511) 11, 37

---

(260) AM 2023 115789 A  
(800) 1633183  
(151) 2021 09 14  
(181) 2031 09 14  
(891) 2021 09 14  
(511) 39

---

(260) AM 2023 115827 A  
(800) 1305115  
(151) 2016 05 02  
(181) 2026 05 02  
(891) 2021 11 12  
(511) 18

---

(260) AM 2023 115790 A  
(800) 1633204  
(151) 2021 11 17  
(181) 2031 11 17  
(891) 2021 11 17  
(511) 19

---

(260) AM 2023 115828 A  
(800) 1365845  
(151) 2017 05 09  
(181) 2027 05 09  
(891) 2021 11 12  
(511) 28

---

(260) AM 2022 115820 A  
(800) 1179730  
(151) 2013 06 03  
(181) 2023 06 03  
(891) 2021 11 11  
(511) 12, 35

---

(260) AM 2023 115829 A  
(800) 1414745  
(151) 2018 04 16  
(181) 2028 04 16  
(891) 2021 11 26  
(511) 09, 15

---

(260) AM 2023 115821 A  
(800) 1202942  
(151) 2014 01 14  
(181) 2024 01 14  
(891) 2021 11 26  
(511) 11

---

(260) AM 2023 115830 A  
(800) 1445075  
(151) 2018 10 30  
(181) 2028 10 30  
(891) 2021 12 02  
(511) 31

---

(260) AM 2023 115822 A  
(800) 1211342  
(151) 2014 01 14  
(181) 2024 01 14  
(891) 2021 11 26  
(511) 11

---

(260) AM 2023 115834 A  
(800) 1524794  
(151) 2020 02 21  
(181) 2030 02 21  
(891) 2021 11 11  
(511) 12, 28

---

(260) AM 2023 115823 A  
(800) 1217941  
(151) 2014 03 31  
(181) 2024 03 31  
(891) 2021 11 26  
(511) 09, 15

---

(260) AM 2023 115904 A  
(800) 1634014  
(151) 2021 08 19  
(181) 2031 08 19  
(891) 2021 08 19  
(511) 03, 05

---

(260) AM 2023 115905 A  
(800) 1634019  
(151) 2021 08 19  
(181) 2031 08 19  
(891) 2021 08 19  
(511) 03, 05

---

(260) AM 2023 115906 A  
(800) 1634020  
(151) 2021 08 19  
(181) 2031 08 19  
(891) 2021 08 19  
(511) 03, 05

---

(260) AM 2023 115907 A  
(800) 1634022  
(151) 2021 08 12  
(181) 2031 08 12  
(891) 2021 08 12  
(511) 03, 05

---

(260) AM 2023 115908 A  
(800) 1634047  
(151) 2021 11 03  
(181) 2031 11 03  
(891) 2021 11 03  
(511) 05

---

(260) AM 2023 115909 A  
(800) 1634058  
(151) 2021 11 09  
(181) 2031 11 09  
(891) 2021 11 09  
(511) 03

---

(260) AM 2023 115911 A  
(800) 1634080  
(151) 2021 10 19  
(181) 2031 10 19  
(891) 2021 10 19  
(511) 12, 37

---

(260) AM 2023 115912 A  
(800) 1634099  
(151) 2021 08 03  
(181) 2031 08 03  
(891) 2021 08 03  
(511) 32, 33

---

(260) AM 2023 115913 A  
(800) 1634141  
(151) 2021 11 04  
(181) 2031 11 04  
(891) 2021 11 04  
(511) 30

---

(260) AM 2023 115914 A  
(800) 1634170  
(151) 2021 10 19  
(181) 2031 10 19  
(891) 2021 10 19  
(511) 12, 37

---

(260) AM 2023 115916 A  
(800) 1634308  
(151) 2021 08 17  
(181) 2031 08 17  
(891) 2021 08 17  
(511) 16, 25, 28, 35, 41

---

(260) AM 2023 115917 A  
(800) 1634344  
(151) 2021 08 20  
(181) 2031 08 20  
(891) 2021 08 20  
(511) 06, 07, 08, 09, 11, 16, 17, 19, 22, 35

---

(260) AM 2023 115918 A  
(800) 1634440  
(151) 2021 10 25  
(181) 2031 10 25  
(891) 2021 10 25  
(511) 05, 10

---

(260) AM 2023 115919 A  
(800) 1634446  
(151) 2021 10 29  
(181) 2031 10 29  
(891) 2021 10 29  
(511) 05, 10

---

(260) AM 2023 115920 A  
(800) 1634447  
(151) 2021 10 29  
(181) 2031 10 29  
(891) 2021 10 29  
(511) 05, 10

---

(260) AM 2023 115921 A  
(800) 1634467  
(151) 2021 11 10  
(181) 2031 11 10  
(891) 2021 11 10  
(511) 03

---

(260) AM 2023 115955 A  
(800) 1635203  
(151) 2021 10 15  
(181) 2031 10 19  
(891) 2021 10 15  
(511) 20

---

(260) AM 2023 115922 A  
(800) 1634508  
(151) 2021 11 01  
(181) 2031 11 01  
(891) 2021 11 01  
(511) 36

---

(260) AM 2023 115957 A  
(800) 1635267  
(151) 2021 07 20  
(181) 2031 07 20  
(891) 2021 07 20  
(511) 07, 09, 12, 37, 42

---

(260) AM 2023 115923 A  
(800) 1634546  
(151) 2021 10 18  
(181) 2031 10 18  
(891) 2021 10 18  
(511) 18, 25

---

(260) AM 2023 115958 A  
(800) 1635375  
(151) 2021 11 02  
(181) 2031 11 02  
(891) 2021 11 02  
(511) 29

---

(260) AM 2023 115948 A  
(800) 1635142  
(151) 2021 11 19  
(181) 2031 11 19  
(891) 2021 11 19  
(511) 03

---

(260) AM 2023 115959 A  
(800) 1635376  
(151) 2021 11 12  
(181) 2031 11 12  
(891) 2021 11 12  
(511) 29, 30, 39, 43

---

(260) AM 2023 115950 A  
(800) 1635155  
(151) 2021 10 14  
(181) 2031 10 14  
(891) 2021 10 14  
(511) 45

---

(260) AM 2023 115960 A  
(800) 1635411  
(151) 2021 10 28  
(181) 2031 10 28  
(891) 2021 10 28  
(511) 09

---

(260) AM 2023 115951 A  
(800) 1635163  
(151) 2021 11 03  
(181) 2031 11 03  
(891) 2021 11 03  
(511) 05, 09, 10, 25, 29, 35, 38, 42

---

(260) AM 2023 115961 A  
(800) 942461  
(151) 2007 10 01  
(181) 2027 10 01  
(891) 2021 12 07  
(511) 03, 21

---

(260) AM 2023 115954 A  
(800) 1635192  
(151) 2021 09 10  
(181) 2031 09 10  
(891) 2021 09 10  
(511) 28

---

(260) AM 2023 115962 A  
(800) 1193817  
(151) 2013 12 09  
(181) 2023 12 09  
(891) 2021 11 09  
(511) 09

---

(260) AM 2023 115963 A  
(800) 1207465  
(151) 2014 03 21  
(181) 2024 03 21  
(891) 2021 10 27  
(511) 05

---

(260) AM 2023 116004 A  
(800) 1635516  
(151) 2021 10 15  
(181) 2031 10 15  
(891) 2021 10 15  
(511) 09, 35, 38, 42

---

(260) AM 2023 115964 A  
(800) 1452177  
(151) 2018 10 15  
(181) 2028 10 15  
(891) 2021 12 07  
(511) 18, 24, 25, 27

---

(260) AM 2023 116005 A  
(800) 1635517  
(151) 2021 10 15  
(181) 2031 10 15  
(891) 2021 10 15  
(511) 09, 11, 35

---

(260) AM 2023 115965 A  
(800) 1459590  
(151) 2018 08 31  
(181) 2028 08 31  
(891) 2021 11 07  
(511) 03, 05, 16

---

(260) AM 2023 116006 A  
(800) 1635581  
(151) 2021 10 15  
(181) 2031 10 15  
(891) 2021 10 15  
(511) 07, 09, 11

---

(260) AM 2023 115966 A  
(800) 1548833  
(151) 2020 06 12  
(181) 2030 06 12  
(891) 2021 12 02  
(511) 07, 12

---

(260) AM 2023 116007 A  
(800) 1635598  
(151) 2021 11 03  
(181) 2031 11 03  
(891) 2021 11 03  
(511) 18, 25

---

(260) AM 2023 115967 A  
(800) 1571167  
(151) 2020 08 20  
(181) 2030 08 20  
(891) 2021 10 05  
(511) 06, 11, 20, 21, 24, 26

---

(260) AM 2023 116008 A  
(800) 1635618  
(151) 2021 09 24  
(181) 2031 09 24  
(891) 2021 09 24  
(511) 35

---

(260) AM 2023 116002 A  
(800) 1635462  
(151) 2021 07 07  
(181) 2031 07 07  
(891) 2021 07 07  
(511) 03, 04, 16

---

(260) AM 2023 116009 A  
(800) 1635635  
(151) 2021 10 26  
(181) 2031 10 26  
(891) 2021 10 26  
(511) 05

---

(260) AM 2023 116003 A  
(800) 1635512  
(151) 2021 10 15  
(181) 2031 10 15  
(891) 2021 10 15  
(511) 09, 35, 38, 42

---

(260) AM 2023 116010 A  
(800) 1635636  
(151) 2021 11 30  
(181) 2031 11 30  
(891) 2021 11 30  
(511) 12

---

(260) AM 2023 116011 A  
(800) 1635638  
(151) 2021 10 19  
(181) 2031 10 19  
(891) 2021 10 19  
(511) 07

---

(260) AM 2023 116029 A  
(800) 1636230  
(151) 2021 10 25  
(181) 2031 10 25  
(891) 2021 10 25  
(511) 03

---

(260) AM 2023 116012 A  
(800) 1635647  
(151) 2021 11 18  
(181) 2031 11 18  
(891) 2021 11 18  
(511) 12

---

(260) AM 2023 116031 A  
(800) 1636259  
(151) 2021 10 18  
(181) 2031 10 18  
(891) 2021 10 18  
(511) 05

---

(260) AM 2023 116014 A  
(800) 1635655  
(151) 2021 10 27  
(181) 2031 10 27  
(891) 2021 10 27  
(511) 34

---

(260) AM 2023 116032 A  
(800) 1636275  
(151) 2021 11 01  
(181) 2031 11 01  
(891) 2021 11 01  
(511) 42

---

(260) AM 2023 116015 A  
(800) 1635656  
(151) 2021 10 27  
(181) 2031 10 27  
(891) 2021 10 27  
(511) 34

---

(260) AM 2023 116033 A  
(800) 1636342  
(151) 2021 08 23  
(181) 2031 08 23  
(891) 2021 08 23  
(511) 05

---

(260) AM 2023 116016 A  
(800) 1635657  
(151) 2021 10 27  
(181) 2031 10 27  
(891) 2021 10 27  
(511) 34

---

(260) AM 2023 116034 A  
(800) 1636343  
(151) 2021 08 23  
(181) 2031 08 23  
(891) 2021 08 23  
(511) 05

---

(260) AM 2023 116017 A  
(800) 1635658  
(151) 2021 10 27  
(181) 2031 10 27  
(891) 2021 10 27  
(511) 34

---

(260) AM 2023 116035 A  
(800) 1636345  
(151) 2021 10 08  
(181) 2031 10 08  
(891) 2021 10 08  
(511) 03, 35, 41, 44

---

(260) AM 2023 116027 A  
(800) 1636124  
(151) 2021 11 09  
(181) 2031 11 09  
(891) 2021 11 09  
(511) 07

---

(260) AM 2023 116047 A  
(800) 1636657  
(151) 2021 09 22  
(181) 2031 09 22  
(891) 2021 09 22  
(511) 14, 35

---

---

(260) AM 2023 116048 A  
(800) 1636727  
(151) 2021 07 26  
(181) 2031 07 26  
(891) 2021 07 26  
(511) 35, 38, 39, 41, 43, 45

---

---

(260) AM 2023 116065 A  
(800) 1559752  
(151) 2019 11 13  
(181) 2029 11 13  
(891) 2021 03 01  
(511) 03, 05, 35

---

---

(260) AM 2023 116049 A  
(800) 1636729  
(151) 2021 10 01  
(181) 2031 10 01  
(891) 2021 10 01  
(511) 03, 44

---

---

(260) AM 2023 116080 A  
(800) 1636940  
(151) 2021 07 29  
(181) 2031 07 29  
(891) 2021 07 29  
(511) 11, 35, 39

---

---

(260) AM 2023 116050 A  
(800) 1636742  
(151) 2021 11 23  
(181) 2031 11 23  
(891) 2021 11 23  
(511) 25

---

---

(260) AM 2023 116081 A  
(800) 1636947  
(151) 2021 09 06  
(181) 2031 09 06  
(891) 2021 09 06  
(511) 05

---

---

(260) AM 2023 116051 A  
(800) 1636746  
(151) 2021 11 29  
(181) 2031 11 29  
(891) 2021 11 29  
(511) 16, 26, 40

---

---

(260) AM 2023 116082 A  
(800) 1636948  
(151) 2021 09 06  
(181) 2031 09 06  
(891) 2021 09 06  
(511) 05

---

---

(260) AM 2023 116053 A  
(800) 1636752  
(151) 2021 05 17  
(181) 2031 05 17  
(891) 2021 05 17  
(511) 41

---

---

(260) AM 2023 116083 A  
(800) 1636949  
(151) 2021 09 06  
(181) 2031 09 06  
(891) 2021 09 06  
(511) 05

---

---

(260) AM 2023 116055 A  
(800) 1636780  
(151) 2021 10 26  
(181) 2031 10 26  
(891) 2021 10 26  
(511) 18

---

---

(260) AM 2023 116084 A  
(800) 1636950  
(151) 2021 09 06  
(181) 2031 09 06  
(891) 2021 09 06  
(511) 05

---

---

(260) AM 2023 116056 A  
(800) 836380  
(151) 2004 10 08  
(181) 2024 10 08  
(891) 2021 12 01  
(511) 34

---

---

(260) AM 2023 116085 A  
(800) 1636967  
(151) 2021 10 11  
(181) 2031 10 11  
(891) 2021 10 11  
(511) 29, 30, 32

---

(260) AM 2023 116086 A  
(800) 1636977  
(151) 2021 11 29  
(181) 2031 11 29  
(891) 2021 11 29  
(511) 25

---

(260) AM 2022 116097 A  
(800) 1637246  
(151) 2021 07 07  
(181) 2031 07 07  
(891) 2021 07 07  
(511) 09, 14, 18

---

(260) AM 2023 116112 A  
(800) 1637866  
(151) 2021 11 12  
(181) 2031 11 12  
(891) 2021 11 12  
(511) 03, 05, 21, 25, 44

---

(260) AM 2022 116258 A  
(800) 1639439  
(151) 2021 10 12  
(181) 2031 10 12  
(891) 2021 10 12  
(511) 03, 08, 16

---

(260) AM 2023 116491 A  
(800) 1642185  
(151) 2021 08 12  
(181) 2031 08 12  
(891) 2021 08 12  
(511) 28, 41

---

(260) AM 2023 116678 A  
(800) 1644462  
(151) 2021 11 19  
(181) 2031 11 19  
(891) 2021 11 19  
(511) 07

---

(260) AM 2023 116686 A  
(800) 1644560  
(151) 2021 12 01  
(181) 2031 12 01  
(891) 2021 12 01  
(511) 03

---



---

**OFFICIAL NOTIFICATIONS  
INVENTIONS  
RESTORATION OF PATENT**

(21) AP 2018 14915  
(11) P 2020 7140 B  
(73) Shota Gorjeladze;  
Irakli Gorjeladze  
(54) ROPEWAY  
DATE OF PATENT CANCELLATION: 2022 11 02  
DATE OF PATENT RESTORATION: 2023 01 25

---

**ABOLITION OF PATENTS WITH THE RIGHT TO RESTORE**

(21) AP 2011 12509  
(11) P 2013 5875 B  
(73) LTD "ABC Pharmacy"  
(54) METHOD OF MEDICINE PREPARATION AND APPLICATION THEREAT ADOLESCENT'S GROWTH  
STIMULATION  
DATE OF PATENT CANCELLATION: 2022 12 21  
LIMITED DATE OF PATENT RESTORATION: 2023 12 21

---

(21) AP 2012 12942  
(11) P 2014 6058 B  
(73) Besik Surguladze  
(54) PREPARATION FOR SECONDARY DISSEMINATION DIAGNOSTICATION AND TREATMENT AT  
MALIGNANT TUMOR  
DATE OF PATENT CANCELLATION: 2022 12 25  
LIMITED DATE OF PATENT RESTORATION: 2023 12 25

---

(21) AP 2012 13529  
(11) P 2016 6496 B  
(73) Alios Biopharma Inc.  
(54) SUBSTITUTED NUCLEOSIDES, NUCLEOTIDES AND ANALOGS THEREOF  
DATE OF PATENT CANCELLATION: 2022 12 20  
LIMITED DATE OF PATENT RESTORATION: 2023 12 20

---

(21) AP 2014 14220  
(11) P 2018 6871 B  
(73) Oncotartis Inc.  
(54) BENZAMIDE AND NICOTINAMIDE COMPOUNDS AND METHODS OF USING SAME  
DATE OF PATENT CANCELLATION: 2022 12 23  
LIMITED DATE OF PATENT RESTORATION: 2023 12 23

---

(21) AP 2015 14558  
(11) P 2019 7013 B  
(73) Mega Industri Kontrol Sistemleri Tic. LTD STI.  
(54) AN ELECTRONIC SYSTEM FOR PRODUCT IDENTIFICATION AND FILLING MANAGEMENT  
DATE OF PATENT CANCELLATION: 2022 12 31  
LIMITED DATE OF PATENT RESTORATION: 2023 12 31

---

(21) AP 2017 15119  
(11) P 2020 7136 B  
(73) Medid Innovation Development LTD  
(54) ANTISEPTIC COMPOSITION COMPRISING POLYVINYLPYRROLIDONE AND UNITHIOL AND USE  
OF THE COMPOSITION  
DATE OF PATENT CANCELLATION: 2022 12 14  
LIMITED DATE OF PATENT RESTORATION: 2023 12 14

---

(21) AP 2019 15240  
(11) P 2021 7323 B  
(73) LLC "AQUIX"  
(54) METHOD OF PREPARING OF BEVERAGE  
DATE OF PATENT CANCELLATION: 2022 12 19  
LIMITED DATE OF PATENT RESTORATION: 2024 12 19

---

(21) AP 2004 9503  
(11) P 2011 5291 B  
(73) Geox S. P. A.  
(54) WATERPROOF VAPOR-PERMEABLE MULTILAYER ARTICLE  
DATE OF PATENT CANCELLATION: 2022 12 27  
LIMITED DATE OF PATENT RESTORATION: 2023 12 27

---

(21) AP 2004 9504  
(11) P 2012 5461 B  
(73) Geox S. P. A.  
(54) BREATHABLE WATERPROOF SOLE FOR SHOES  
DATE OF PATENT CANCELLATION: 2022 12 27  
LIMITED DATE OF PATENT RESTORATION: 2023 12 27

---

(21) AP 2006 9773  
(11) P 2009 4603 B  
(73) Les Laboratoires Servier  
(54) NEW ASSOCIATION OF A SINUS CURRENT if INHIBITOR AND A CALCIC INHIBITOR, AND  
PHARMACEUTICAL COMPOSITIONS CONTAINING THE SAME  
DATE OF PATENT CANCELLATION: 2022 12 20  
LIMITED DATE OF PATENT RESTORATION: 2023 12 20

---

(21) AP 2006 9774  
(11) P 2009 4604 B  
(73) Les Laboratoires Servier  
(54) NEW ASSOCIATION OF A SINUS NODE if CURRENT INHIBITOR AND AN ANGIOTENSIN-  
CONVERTING ENZYME INHIBITOR, AND A PHARMACEUTICAL COMPOSITION  
CONTAINING THE SAME  
DATE OF PATENT CANCELLATION: 2022 12 20  
LIMITED DATE OF PATENT RESTORATION: 2023 12 20

---

## DATE OF PATENTS RESTORATION EXPIRATION

(21) AP 2011 13176  
(11) P 2016 6448 B  
(73) Santen Pharmaceutical CO., LTD  
(54) OPHTHALMIC SOLUTION CONTAINING DIQUAFOSOL, METHOD FOR PRODUCING SAME, AND  
METHOD FOR PREVENTING FORMATION OF INSOLUBLE PRECIPITATE  
DATE OF PATENT CANCELLATION: 2021 12 27  
DATE OF PATENT RESTORATION EXPIRATION: 2022 12 27

---

(21) AP 2014 14179  
(11) P 2019 6954 B  
(73) Chiesi Farmaceutici S.P.A.  
(54) ISOCHROMENE DERIVATIVES AS PHOSPHOINOSITIDE 3-KINASES INHIBITORS  
DATE OF PATENT CANCELLATION: 2021 12 17  
DATE OF PATENT RESTORATION EXPIRATION: 2022 12 17

---

(21) AP 2015 14562  
(11) P 2019 7006 B  
(73) Rivopharm SA  
(54) PHARMACEUTICAL FORMULATION OF RACECADOTRIL  
DATE OF PATENT CANCELLATION: 2021 12 23  
DATE OF PATENT RESTORATION EXPIRATION: 2022 12 23

---

## EXPIRATION OF TERMS OF PATENT

(21) AP 2013 12956  
(11) P 2016 1909 B  
(73) Davit Zukakishvili  
(54) LOWER JAW DENTAL MODEL MEASURING SPOON  
DATE OF PATENT EXPIRATION: 2023 01 09

---

## UTILITY MODELS RESTORATION OF PATENT

(21) AU 2020 15519  
(11) U 2022 2126 Y  
(73) Archil Geguchadze;  
Anzori Kuparadze;  
Nata Sulakvelidze;  
LEPL "Shota Rustaveli National Science Foundation of Georgia"  
(54) CONIC WIND WHEEL  
DATE OF PATENT CANCELLATION: 2022 12 16  
DATE OF PATENT RESTORATION: 2023 01 25

---

## ABOLITION OF PATENTS WITH THE RIGHT TO RESTORE

(21) AU 2014 13669  
(11) U 2015 1878 Y  
(73) Raul Turmanidze;  
Giorgi Popkhadze  
(54) EQUIPMENT FOR VINE PLANTS PROTECTION  
DATE OF PATENT CANCELLATION: 2022 12 22  
LIMITED DATE OF PATENT RESTORATION: 2023 12 22

---

(21) AU 2017 14631  
(11) U 2019 1999 Y  
(73) Besiki Surguladze  
(54) DRUG FOR MALIGNANT TUMORS SECONDARY METASTASES TREATMENT  
DATE OF PATENT CANCELLATION: 2022 12 28  
LIMITED DATE OF PATENT RESTORATION: 2023 12 28

---

(21) AU 2017 14654  
(11) U 2018 1989 Y  
(73) Vladimer Saanishvili  
(54) DEVICE FOR HOLDING IN HAND THE DOUGH PRODUCT WITH FILLING-KHINKALI  
DATE OF PATENT CANCELLATION: 2022 12 20  
LIMITED DATE OF PATENT RESTORATION: 2023 12 20

---

## DATE OF PATENTS RESTORATION EXPIRATION

(21) AU 2016 14374

(11) U 2017 1951 Y

(73) Levan Aleksishvili

(54) TELECOMMUNICATION SYSTEM FOR FOOD AND CONSUMER COMMODITY PURCHASE AND DELIVERY TO PLACE

DATE OF PATENT CANCELLATION: 2021 12 30

DATE OF PATENT RESTORATION EXPIRATION: 2022 12 30

---

(21) AU 2019 15249

(11) U 2021 2095 Y

(73) Ibrahim Zhaksimbetov;

Oleg Tashkalov

(54) METHOD FOR SULFUR CEMENT PRODUCTION

DATE OF PATENT CANCELLATION: 2021 12 24

DATE OF PATENT RESTORATION EXPIRATION: 2022 12 24

---

## TRANSFER OF RIGHT

(21) AU 2020 15425

(11) U 2022 2109 Y

(54) COASTLINE ANTI-LANDSLIDE FAST CONSTRUCTING WALL

NAME AND ADDRESS OF NEW PATENT OWNER: Giorgi Zhorzholiani (GE)

Gablani Str. 9, 3200, Mestia, Georgia (GE)

NAME AND ADDRESS OF FORMER PATENT OWNER: Roland Zhorzholiani

Vill. Kochara, 0121, Ochamchire Region, Georgia

DATE OF REGISTRATION: 2023 01 09

---

## DESIGNS

### EXTENSION OF TERMS OF DESIGNS REGISTRATION

(11) D 2018 779 S

(73) Nikolai Gennadovich Spesivcev (RU)

Ul. Alpiyskaya, Dom 70, 354000, Sochi, Krasnodar Territory, Russian Federation (RU)

Vadim Evgenievich Pravednikov (RU)

Ul. Vorovskogo, Dom 4, ap. 23, 354000, Sochi, Krasnodar Territory, Russian Federation (RU)

Irakli Tchafandze (GE)

J. Rapava Str. 37, 2100, Zugdidi, Georgia (GE)

(54) 1.-3. DICE

(28) 3

(24) 2018 03 16

(18) 2028 03 16

(58) 2023 01 10

---

(11) D 2013 555 S

(73) Molson Coors Brewing Company (UK) Limited (GB)

High Street, Burton Upon Trent, Staffordshire, DE14 1JZ , United Kingdom (GB)

(54) BOTTLE

(28) 1

(24) 2013 03 19

(18) 2028 03 19

(58) 2023 01 13

---

### CANCELLATION OF DESIGNS REGISTRATION

(11) D 2017 717 S

(73) LTD "Iwinehouse" (GE)

Elene Akhvlediani Uphill 4, 0103, Tbilisi, Georgia (GE)

(54) WINE BOTTLE LABEL

(18) 2022 06 23

(58) 2023 01 11

---

(11) D 2017 719 S

(73) LTD "Pushkin" (GE)

Botchorms Str. 3, 0144, Tbilisi, Georgia (GE)

(54) GRAPHIC SYMBOL

(18) 2022 06 28

(58) 2023 01 16

---

## TRADEMARKS

### EXTENSION OF TERMS OF TRADEMARKS REGISTRATION

(111) M 2003 14880 R2

(151) 2003 01 14

(186) 2033 01 14

(732) Accenture Global Services Limited  
3 Grand Canal Plaza, Upper Grande Canal  
Street, Dublin 4, Ireland

(111) M 2003 14944 R2

(151) 2003 01 30

(186) 2033 01 30

(732) Nike Innovate C.V.  
One Bowerman Drive, Beaverton, Oregon  
97005-6453, USA

(111) M 2003 14868 R2

(151) 2003 01 14

(186) 2033 01 14

(732) Alberto-Culver International Inc.  
a corporation of Daleware  
700 Sylvan Avenue, Englewood Cliffs,  
NJ 07632, USA

(111) M 2003 14945 R2

(151) 2003 01 30

(186) 2033 01 30

(732) Nike Innovate C.V.  
One Bowerman Drive, Beaverton, Oregon  
97005-6453, USA

(111) M 2003 14932 R2

(151) 2003 01 30

(186) 2033 01 30

(732) Mitsubishi Corporation  
3-1, Marunouchi 2-chome, Chiyoda-ku,  
Tokyo, Japan

(111) M 2003 14901 R2

(151) 2003 01 14

(186) 2033 01 14

(732) Illva Saronno S.p.A.  
Via Archimede 243-21047 Saronno (VA),  
Italy

(111) M 2003 14933 R2

(151) 2003 01 30

(186) 2033 01 30

(732) Mitsubishi Corporation  
3-1, Marunouchi 2-chome, Chiyoda-ku,  
Tokyo, Japan

(111) M 2003 14902 R2

(151) 2003 01 14

(186) 2033 01 14

(732) Leo Pharma A/S  
Industriparken 55, 2750 Ballerup, Denmark

(111) M 2003 14918 R2

(151) 2003 01 30

(186) 2033 01 30

(732) The Gillette Company LLC  
One Gillette Park, Boston, Massachusetts  
02127, USA

(111) M 2003 15052 R2

(151) 2003 03 28

(186) 2033 03 28

(732) Pfizer Inc. a Delaware corporation  
235 East 42nd Street, New York,  
NY 10017, USA

(111) M 2003 14860 R2

(151) 2003 01 14

(186) 2033 01 14

(732) CTBAT International Co. Limited  
29th Floor Oxford House, Taikoo Place,  
979 King's Road, Island East,  
Hong Kong

(111) M 2003 15164 R2

(151) 2003 06 11

(186) 2033 06 11

(732) Nissan Jidosha Kabushiki Kaisha  
(also trading as Nissan Motor Co., LTD.)  
No.2 Takaracho, Kanagawa-ku, Yokohama-  
shi, Kanagawa-ken, Japan

(111) M 2003 15165 R2

(151) 2003 06 11

(186) 2033 06 11

(732) Nissan Jidosha Kabushiki Kaisha  
(also trading as Nissan Motor Co., LTD.)

<p>No.2 Takaracho, Kanagawa-ku, Yokohama-shi, Kanagawa-ken, Japan</p> <hr/> <p>(111) M 2012 22518 R1 (151) 2012 04 25 (186) 2032 04 25 (732) LLC "Kakhetian Traditional Winery" Ksani Str. 12, 0141, Tbilisi, Georgia</p> <hr/> <p>(111) M 2012 22878 R1 (151) 2012 08 30 (186) 2032 08 30 (732) Williams-Sonoma Inc. 3250 Van Ness Avenue, San-Francisco, California 94109, USA</p> <hr/> <p>(111) M 2012 22879 R1 (151) 2012 08 30 (186) 2032 08 30 (732) Williams-Sonoma Inc. 3250 Van Ness Avenue, San-Francisco, California 94109, USA</p> <hr/> <p>(111) M 2012 22880 R1 (151) 2012 08 30 (186) 2032 08 30 (732) Williams-Sonoma Inc. 3250 Van Ness Avenue, San-Francisco, California 94109, USA</p> <hr/> <p>(111) M 2012 22881 R1 (151) 2012 08 30 (186) 2032 08 30 (732) Williams-Sonoma Inc. 3250 Van Ness Avenue, San-Francisco, California 94109, USA</p> <hr/> <p>(111) M 2012 22882 R1 (151) 2012 08 30 (186) 2032 08 30 (732) Williams-Sonoma Inc. 3250 Van Ness Avenue, San-Francisco, California 94109, USA</p> <hr/> <p>(111) M 2012 22732 R1 (151) 2012 07 02 (186) 2032 07 02 (732) Basf Agro B.V., Arnhem (NL), Zweigniederlassung Freienbach Huobstrasse 3, 8808 Pfeffikon SZ, Switzerland</p> <hr/>	<p>(111) M 2012 22889 R1 (151) 2012 08 30 (186) 2032 08 30 (732) American Express Marketing &amp; Development Corp. Limited 200 Vesey Street., New York, New York 10285, USA</p> <hr/> <p>(111) M 2012 22890 R1 (151) 2012 08 30 (186) 2032 08 30 (732) American Express Marketing &amp; Development Corp. Limited 200 Vesey Street., New York, New York 10285, USA</p> <hr/> <p>(111) M 2012 22891 R1 (151) 2012 08 30 (186) 2032 08 30 (732) American Express Marketing &amp; Development Corp. Limited 200 Vesey Street., New York, New York 10285, USA</p> <hr/> <p>(111) M 2012 22965 R1 (151) 2012 09 24 (186) 2032 09 24 (732) Basf Agro B.V., Arnhem (NL), Zweigniederlassung Freienbach Huobstrasse 3, 8808 Pfaffikon SZ, Switzerland</p> <hr/> <p>(111) M 2012 23113 R1 (151) 2012 11 29 (186) 2032 11 29 (732) Asphalt Research Technology Inc. 13611 S. Dixie Hwy, Suite 430, Miami, FL 33176, USA</p> <hr/> <p>(111) M 2013 23376 R1 (151) 2013 02 27 (186) 2033 02 27 (732) Hershey Chocolate &amp; Confectionary LLC a Delaware corporation ("HCC") 1209 Orange Street, Wilmington 198, Delaware; 19 East Chocolate Avenue, Hershey, PA 17033, USA</p> <hr/> <p>(111) M 2013 23302 R1 (151) 2013 01 25 (186) 2033 01 25 (732) General Motors LLC</p> <hr/>
--	---



---

300 Renaissance Center, City of Detroit,  
State of Michigan 48265-3000, USA

---

(111) M 2013 23448 R1  
(151) 2013 03 13  
(186) 2033 03 13  
(732) Castrol Limited  
Technology Centre, Whitchurch Hill,  
Pangbourne, Reading RG8 7QR, United  
Kingdom

---

(111) M 2013 23452 R1  
(151) 2013 03 13  
(186) 2033 03 13  
(732) Bridgestone Corporation  
1-1, Kyobashi 3-Chome, Chuo-ku,  
Tokyo, Japan

---

(111) M 2013 23454 R1  
(151) 2013 03 13  
(186) 2033 03 13  
(732) Knorr Naehrmittel Sktiengesellschaft  
Bahnhofstrasse 19, 8240 Thayngen,  
Switzerland

---

(111) M 2013 23455 R1  
(151) 2013 03 13  
(186) 2033 03 13  
(732) Unilever IP Holdings B.V.  
Weena 455, 3013 AL Rotterdam, Netherlands

---

(111) M 2013 23456 R1  
(151) 2013 03 13  
(186) 2033 03 13  
(732) Unilever IP Holdings B.V.  
Weena 455, 3013 AL Rotterdam, Netherlands

---

(111) M 2013 23457 R1  
(151) 2013 03 13  
(186) 2033 03 13  
(732) Nissan Jidosha Kabushiki Kaisha  
(also trading as Nissan Motor Co., LTD.)  
No.2 Takaracho, Kanagawa-ku, Yokohama-  
shi, Kanagawa-ken, Japan

---

(111) M 2013 23517 R1  
(151) 2013 03 27  
(186) 2033 03 27  
(732) Bridgestone Corporation  
1-1, Kyobashi 3-Chome, Chuo-ku, Tokyo,  
Japan

---

(111) M 2013 23893 R1  
(151) 2013 08 14  
(186) 2033 08 14  
(732) Stiefel Laboratories Inc.  
Corporation Service Company,  
251 Little Falls Drive, Wilmington, Delaware  
19808, USA

---

(111) M 2013 23894 R1  
(151) 2013 08 14  
(186) 2033 08 14  
(732) Stiefel Laboratories Inc.  
Corporation Service Company,  
251 Little Falls Drive, Wilmington, Delaware  
19808, USA

---

(111) M 2013 24258 R1  
(151) 2013 11 18  
(186) 2033 11 18  
(732) Corteva Agriscience LLC  
9330 Zionsville Road, Indianapolis,  
Indiana 46268, USA

---

(111) M 2013 24079 R1  
(151) 2013 09 30  
(186) 2033 09 30  
(732) Corteva Agriscience LLC  
9330 Zionsville Road, Indianapolis,  
Indiana 46268, USA

---

(111) M 2013 23921 R1  
(151) 2013 08 14  
(186) 2033 08 14  
(732) ViiV Healthcare UK Limited  
980 Great West Road, Brentford, Middlesex  
TW8 9GS, United Kingdom

---

(111) M 2013 24204 R1  
(151) 2013 11 04  
(186) 2033 11 04  
(732) Corteva Agriscience LLC  
9330 Zionsville Road, Indianapolis,  
Indiana 46268, USA

---

(111) M 2013 24205 R1  
(151) 2013 11 04  
(186) 2033 11 04  
(732) Corteva Agriscience LLC  
9330 Zionsville Road, Indianapolis,  
Indiana 46268, USA

---

(111) M 2013 24289 R1  
(151) 2013 11 18  
(186) 2033 11 18  
(732) Corteva Agriscience LLC  
9330 Zionsville Road, Indianapolis,  
Indiana 46268, USA

---

## COMPLETE TRANSFER OF RIGHTS

(111) M 2019 31769 R  
(732) Pfizer Pfc us Holdings 4 LLC  
235 East 42nd Street, New York,  
N.Y. 10017, USA  
(770) Pharmacia & Upjohn Company LLC  
7000 Portej Roud, Kalamazoo,  
MI 49001, USA  
(580) 2022 11 10

---

(111) M 2021 33759 R  
(732) LLC "Bekauri Family Vineyards"  
Iosebidge Str. 72, ap. 27, 0160, Saburtalo  
District, Tbilisi, Georgia  
(770) Tamaz Bekauri  
Oniashvili Str. 89, ap. 2, 0160, Tbilisi,  
Georgia  
(580) 2022 12 16

---

(111) M 1998 10452 R  
(732) Double Eagle Brands B.V.  
Hoofdstraat 14, 3114 GG Schiedam,  
Netherlands  
(770) Double Eagle Brands N.V.  
Kaya W.F.G. Mensing 32, Willemstad,  
Curacao, Netherlands Antilles  
(580) 2022 12 01

---

(111) M 1998 11029 R  
(732) Perrigo Pharma International DAC  
The Sharp Building, Hogan Place,  
Dublin 2, D02 TY74, Ireland  
(770) GlaxoSmithKline Consumer Healthcare  
(UK) IP Limited  
980 Great West Road, Brentford, Middlesex  
TW8 9GS, United Kingdom  
(580) 2022 11 17

---

(111) M 2012 22566 R  
(732) Perrigo Pharma International DAC  
The Sharp Building, Hogan Place,  
Dublin 2, D02 TY74, Ireland

(770) GlaxoSmithKline Consumer Healthcare  
(UK) IP Limited  
980 Great West Road, Brentford, Middlesex  
TW8 9GS, United Kingdom  
(580) 2022 11 17

---

(111) M 2013 23394 R  
(732) Sun Pharmaceutical Industries Limited  
[Sun Pharmaceutical Industries LTD]  
Spark, Tandalja, Vadodara – 390 020, Gujarat;  
Sun House, 201 B/1, Western Express  
Highway, Goregaon (E), Mumbai - 400 063,  
India  
(770) Ranbaxy Laboratories Limited  
Plot N 90, Sector-32, Gurgaon-122001,  
Haryana, India  
(580) 2022 11 21

---

(111) M 2013 23399 R  
(732) Sun Pharmaceutical Industries Limited  
[Sun Pharmaceutical Industries LTD]  
Spark, Tandalja, Vadodara – 390 020, Gujarat;  
Sun House, 201 B/1, Western Express  
Highway, Goregaon (E), Mumbai - 400 063,  
India  
(770) Ranbaxy Laboratories Limited  
Plot N 90, Sector-32, Gurgaon-122001,  
Haryana, India  
(580) 2022 11 21

---

(111) M 1996 3927 R  
(732) ZF Services UK Limited  
Abbeyfield Road, Lenton, Nottingham  
NG7 2SX, United Kingdom  
(770) Lucas Industries Limited  
Stratford Road, Solihull, West Midlands  
B90 4 AX, United Kingdom  
(580) 2022 11 24

---

## CHANGES OF NAMES AND/OR ADDRESSES OF TRADEMARKS OWNERS

(111) M 2021 33939 R  
 (732) Netflix Inc.  
 121 Albright Way, Los Gatos, CA 95032, USA  
 (770) Netflix Inc.  
 100 Winchester Circle, Los Gatos, California  
 95032, USA  
 (580) 2022 12 12

---

(111) M 2021 33940 R  
 (732) Netflix Inc.  
 121 Albright Way, Los Gatos, CA 95032, USA  
 (770) Netflix Inc.  
 100 Winchester Circle, Los Gatos, California  
 95032, USA  
 (580) 2022 12 12

---

(111) M 2012 22369 R  
 (732) Netflix Inc.  
 121 Albright Way, Los Gatos, CA 95032,  
 USA  
 (770) Netflix Inc., a corporation of Delaware  
 100 Winchester Circle, Los-Gatos, California  
 95032, USA  
 (580) 2022 12 12

---

(111) M 2013 23439 R  
 (732) Samsung Electronics Co., LTD  
 129, Samsung-ro, Yeongtong-gu, Suwon-si,  
 Gyeonggi-do, Republic of Korea  
 (770) Samsung Electronics Co., LTD  
 416, Maetan-dong, Yeongtong-gu, Suwon-si,  
 Gyeonggi-do, Republic of Korea  
 (580) 2022 12 12

---

(111) M 2013 23646 R  
 (732) Limited Liability Company "VMPAUTO"  
 Ul. Promishlennaya, Dom 40, Liter A,  
 Office 301, Sankt-Peterburg, 198099, Russian  
 Federation  
 (770) Limited Liability Company "VMPAUTO"  
 Ul. Promishlennaya, Dom 40, Liter A,  
 Office 301, Sankt-Peterburg, 198099, Russian  
 Federation  
 (580) 2022 12 16

---

(111) M 2014 24420 R  
 (732) Emilio Pucci International S.R.L.  
 Via Fieno 3 Cap 20123, Milano, Italy  
 (770) Emilio Pucci International B.V

Oude Utrechtseweg 22-24, 3743 KN Baarn,  
 Netherlands  
 (580) 2022 12 05

---

(111) M 2014 24421 R  
 (732) Emilio Pucci International S.R.L.  
 Via Fieno 3 Cap 20123, Milano, Italy  
 (770) Emilio Pucci International B.V  
 Oude Utrechtseweg 22-24, 3743 KN Baarn,  
 Netherlands  
 (580) 2022 12 05

---

(111) M 2014 24422 R  
 (732) Emilio Pucci International S.R.L.  
 Via Fieno 3 Cap 20123, Milano, Italy  
 (770) Emilio Pucci International B.V  
 Oude Utrechtseweg 22-24, 3743 KN Baarn,  
 Netherlands  
 (580) 2022 12 05

---

(111) M 2013 24401 R  
 (732) Npao Sylvamo Corporation Rus  
 ul. Zavodskaya, dom 17, 188991,  
 Svetogorsk, Russian Federation  
 (770) Zakritoe Aktsionernoe Obshchestvo  
 "International Peiper"  
 ul. Zavodskaya, dom 17, 188991,  
 Svetogorsk, Russian Federation  
 (580) 2022 12 06

---

(111) M 2013 24402 R  
 (732) Npao Sylvamo Corporation Rus  
 ul. Zavodskaya, dom 17, 188991,  
 Svetogorsk, Russian Federation  
 (770) Zakritoe Aktsionernoe Obshchestvo  
 "International Peiper"  
 ul. Zavodskaya, dom 17, 188991,  
 Svetogorsk, Russian Federation  
 (580) 2022 12 06

---

(111) M 2013 24403 R  
 (732) Npao Sylvamo Corporation Rus  
 ul. Zavodskaya, dom 17, 188991,  
 Svetogorsk, Russian Federation  
 (770) Zakritoe Aktsionernoe Obshchestvo  
 "International Peiper"  
 ul. Zavodskaya, dom 17, 188991,  
 Svetogorsk, Russian Federation  
 (580) 2022 12 06

---

(111) M 2013 24369 R

(732) Npao Sylvamo Corporation Rus  
ul. Zavodskaya, dom 17, 188991,  
Svetogorsk, Russian Federation

(770) Zakritoe Aktsionernoje Obshchestvo  
"International Peiper"

ul. Zavodskaya, dom 17, 188991,  
Svetogorsk, Russian Federation

(580) 2022 12 06

---

(111) M 2017 28232 R

(732) Netflix Inc.  
121 Albright Way, Los Gatos, CA 95032,  
USA

(770) Netflix Inc.  
a corporation of Delaware  
100 Winchester Circle, Los Gatos, California  
95032, USA

(580) 2022 12 12

---

(111) M 2018 30357 R

(732) Wolt Enterprises Oy  
Arkadiankatu 6, 00100 Helsinki, Finland

(770) Wolt Enterprises Oy  
Köydenpunojankatu 2a D, 00180 Helsinki,  
Finland

(580) 2022 12 05

---

## CANCELLATION OF TRADEMARKS REGISTRATION

---

(111) M 2002 14531 R

(151) 2002 06 13

(732) SmithKline Beecham (Cork) Limited  
Karabini, Karigalini, Kaunti-korki, Ireland

(141) 2023 01 11

---

(111) M 2002 14533 R

(151) 2002 06 13

(732) Unilever N.V.  
Weena 455, NL-3013 AL Rotterdam,  
Netherlands

(141) 2023 01 11

---

(111) M 2002 14464 R

(151) 2002 05 24

(732) "Actavis" EAD  
ul. Athanas Dukov 29, Sofia, Raion Lozenets,  
Bulgaria;  
Balkanfarma Dupnitsa AD  
Samokovsko Highway; 3, Dupnitsa 2600,  
Bulgaria

(141) 2023 01 11

---

(111) M 2002 14455 R

(151) 2002 05 24

(732) Mastercard International Incorporated  
2000 Purchase Street, Purchase,  
New York 10577-2509, USA

(141) 2023 01 11

---

(111) M 2002 14528 R

(151) 2002 06 13

(732) LTD "Poseidon"  
Kakheti Highway 14, 3800, Sagarejo, Georgia

(141) 2023 01 11

---

(111) M 2002 14461 R

(151) 2002 05 24

(732) Syngenta Limited  
Syngenta European Regional Centre, Priestley  
Road, Surrey Research Park, Guildford, Surrey  
GU2 7YH, United Kingdom

(141) 2023 01 11

---

(111) M 2002 14541 R

(151) 2002 06 27

(732) JSC Bank "Republic"  
Gr. Abashidze Str. 2, 0179, Tbilisi, Georgia

(141) 2023 01 11

---

(111) M 2002 14497 R

(151) 2002 06 13

(732) Dunhill Tobacco of London Limited  
Globe House, 4 Temple Place, London  
WC2R 2PG, United Kingdom

(141) 2023 01 11

---

(111) M 2002 14477 R

(151) 2002 05 24

(732) The Coca-Cola Company  
Uan Koka-kola Plaza, Atlanta, Georgia 30313,  
USA

(141) 2023 01 11

---

(111) M 2002 14506 R

(151) 2002 06 13

(732) LTD "Nikala"  
Beijing (Pekini) St. 12, 0171, Tbilisi, Georgia

(141) 2023 01 11

---

(111) M 2002 14512 R

(151) 2002 06 13

(732) OOO Pivovarennaya Kompaniya "Baltika"  
6-Verkhniy Pereulok 3, 194292 Sankt-  
Petersburg, Russian Federation

(141) 2023 01 11

---

(111) M 2012 22684 R

(151) 2012 07 02

(732) LTD "Abipharm"  
Gudiashvili Str. 9, 0105, Tbilisi, Georgia

(141) 2023 01 11

---

(111) M 2012 22685 R

(151) 2012 07 02

(732) Obshchestvo s Ogranichennoy Otvetstvennostiu  
"Bridgetown Invest"  
ul. Altufevskoe Shosse, 2a, 127273, Moscow,  
Russian Federation

(141) 2023 01 11

---

(111) M 2012 22657 R

(151) 2012 06 07

(732) Harrington Development Inc.  
Elvira Mendez Street, Vallarino bldg.,  
3rd Floor, Panama, Republic of Panama

(141) 2023 01 11

---

(111) M 2012 22658 R  
 (151) 2012 06 07  
 (732) Shalva Mgaloblishvili  
 Sanzona, bld. 19b, ap. 13, 0141, Tbilisi,  
 Georgia  
 (141) 2023 01 11

(111) M 2012 22687 R  
 (151) 2012 07 02  
 (732) LLC "Tribune and Tribunal"  
 Vazha-Pshavela Ave. 47, I qu., bld. 20,  
 ap. 33, 0177, Tbilisi, Georgia  
 (141) 2023 01 11

(111) M 2012 22688 R  
 (151) 2012 07 02  
 (732) LLC "Tribune and Tribunal"  
 Vazha-Pshavela Ave. 47, I qu., bld. 20,  
 ap. 33, 0177, Tbilisi, Georgia  
 (141) 2023 01 11

(111) M 2012 22689 R  
 (151) 2012 07 02  
 (732) Harrington Development Inc.  
 Elvira Mendez Street, Vallarino bldg.,  
 3rd Floor, Panama, Republic of Panama  
 (141) 2023 01 11

(111) M 2012 22690 R  
 (151) 2012 07 02  
 (732) Harrington Development Inc.  
 Elvira Mendez Street, Vallarino bldg.,  
 3rd Floor, Panama, Republic of Panama  
 (141) 2023 01 11

(111) M 2012 22659 R  
 (151) 2012 06 07  
 (732) LTD "ZMP Company"  
 Al. Kazbegi Ave. 26, ap. 0177, Tbilisi, Georgia  
 (141) 2023 01 11

(111) M 2012 22691 R  
 (151) 2012 07 02  
 (732) Companhia Nitro Química Brasileira  
 Av. Dr. José Artur Nova, 951, São Miguel  
 Paulista, São Paulo, SP, Brazil  
 (141) 2023 01 11

(111) M 2012 22692 R  
 (151) 2012 07 02  
 (732) Companhia Nitro Química Brasileira  
 Av. Dr. José Artur Nova, 951, São Miguel  
 Paulista, São Paulo, SP, Brazil

(141) 2023 01 11

(111) M 2012 22693 R  
 (151) 2012 07 02  
 (732) JSC "G-P-C"  
 Kote Marjanishvili Str. 26, 0102, Tbilisi,  
 Georgia  
 (141) 2023 01 11

(111) M 2012 22663 R  
 (151) 2012 06 07  
 (732) Marfrig Alimentos S.A.  
 Av. Chedid Jafet, 222-Bloco A-5 Andar-  
 Ed. Millennium Vila Olimpia-04551-065-  
 Sao Paulo, Brazil  
 (141) 2023 01 11

(111) M 2012 22664 R  
 (151) 2012 06 07  
 (732) Marfrig Alimentos S.A.  
 Av. Chedid Jafet, 222-Bloco A-5 Andar-  
 Ed. Millennium Vila Olimpia-04551-065-  
 Sao Paulo, Brazil  
 (141) 2023 01 11

(111) M 2012 22665 R  
 (151) 2012 06 07  
 (732) Garage International Lux Sarl  
 1 Allée Scheffer, Suite 2.05.1, L-2520  
 Luxembourg, Luxembourg  
 (141) 2023 01 09

(111) M 2012 22666 R  
 (151) 2012 06 07  
 (732) Garage International Lux Sarl  
 1 Allée Scheffer, Suite 2.05.1, L-2520  
 Luxembourg, Luxembourg  
 (141) 2023 01 09

(111) M 2012 22695 R  
 (151) 2012 07 02  
 (732) JSC "Liberty Capital"  
 Ilia Chavchavadze Ave. 74, ap. 0162, Tbilisi,  
 Georgia  
 (141) 2023 01 11

(111) M 2012 22668 R  
 (151) 2012 06 07  
 (732) Harrington Development Inc.  
 Elvira Mendez Street, Valerino Bldg,  
 3rd Floor, Panama, Republic of Panama

---

(141) 2023 01 11

---

(111) M 2012 22696 R

(151) 2012 07 02

(732) JSC "G-P-C"

Kote Marjanishvili Str. 26, 0102, Tbilisi,  
Georgia

(141) 2023 01 11

---

(111) M 2012 22697 R

(151) 2012 07 02

(732) LLC "Unimed Group Corp"

Adam Mickiewicz Str. 29, ap. 61, 0194,  
Tbilisi, Georgia

(141) 2023 01 11

---

(111) M 2012 22698 R

(151) 2012 07 02

(732) LLC "Unimed Group Corp"

Adam Mickiewicz Str. 29, ap. 61, 0194,  
Tbilisi, Georgia

(141) 2023 01 11

---

(111) M 2012 22699 R

(151) 2012 07 02

(732) LLC "Unimed Group Corp"

Adam Mickiewicz Str. 29, ap. 61, 0194,  
Tbilisi, Georgia

(141) 2023 01 11

---

(111) M 2012 22700 R

(151) 2012 07 02

(732) LLC "Unimed Group Corp"

Adam Mickiewicz Str. 29, ap. 61, 0194,  
Tbilisi, Georgia

(141) 2023 01 11

---

(111) M 2012 22701 R

(151) 2012 07 02

(732) LLC "Unimed Group Corp"

Adam Mickiewicz Str. 29, ap. 61, 0194,  
Tbilisi, Georgia

(141) 2023 01 11

---

(111) M 2012 22703 R

(151) 2012 07 02

(732) JSC "Mobile Finance Service-Georgia"

Kote Marjanishvili Str. 5, 0102, Tbilisi,  
Georgia

(141) 2023 01 11

---

(111) M 2012 22704 R

(151) 2012 07 02

(732) Nippon Kayaku Kabushiki Kaisha

of 11-2, Fujimi 1-chome, Chiyoda-ku, Tokyo,  
Japan

(141) 2023 01 11

---

(111) M 2012 22706 R

(151) 2012 07 02

(732) Assan Gıda Sanayi ve Ticaret Anonim Şirketi

Nispetiye Caddesi, Akmerkez Alışveriş  
Merkezi, B Blok, Kat: 5, Etiler, Beşiktaş-  
Istanbul, Türkiye

(141) 2023 01 11

---

(111) M 2012 22707 R

(151) 2012 07 02

(732) Assan Gıda Sanayi ve Ticaret Anonim Şirketi

Nispetiye Caddesi, Akmerkez Alışveriş  
Merkezi, B Blok, Kat: 5, Etiler, Beşiktaş-  
Istanbul, Türkiye

(141) 2023 01 11

---

(111) M 2012 22708 R

(151) 2012 07 02

(732) Orly International, Inc.

7710 Haskell Avenue, Van Nuys, CA 91406,  
USA

(141) 2023 01 11

---

(111) M 2012 22709 R

(151) 2012 07 02

(732) Jemal Baghashvili

Kipshidze Str. 10, ap. 25, 0179, Tbilisi,  
Georgia

(141) 2023 01 11

---

(111) M 2012 22710 R

(151) 2012 07 02

(732) LTD "Simetra"

Ateni Str. 20, ap. 28, 0179, Tbilisi, Georgia

(141) 2023 01 11

---

(111) M 2012 22711 R

(151) 2012 07 02

(732) GlaxoSmithKline Trading Services Limited

Karabini, Karigalini, Kaunti-korki, Ireland

(141) 2023 01 11

(111) M 2012 22715 R  
 (151) 2012 07 02  
 (732) Playboy Enterprises  
 International, Inc  
 680 North Lake Shore Drive Chicago,  
 Illinois 60611, USA, USA  
 (141) 2023 01 11

Kyiv, Ukraine;  
 Natalia Viktorovna Vasilenko  
 Vul. Piterskaya 3, ap. 10, 03087, Kyev,  
 Ukraine  
 (141) 2023 01 11

(111) M 2012 22716 R  
 (151) 2012 07 02  
 (732) Mikheil Pukhashvili  
 Zestaponi Str. 19, ap. 33, 0180, Tbilisi,  
 Georgia  
 (141) 2023 01 11

(111) M 2012 22722 R  
 (151) 2012 07 02  
 (732) Elena Vladimirovna Visotskaya  
 Vul. Dovnar-Zapolskogo 2/20, ap. 6, 04116,  
 Kyiv, Ukraine;  
 Natalia Viktorovna Vasilenko  
 Vul. Piterskaya 3, ap. 10, 03087, Kyev,  
 Ukraine  
 (141) 2023 01 11

(111) M 2012 22717 R  
 (151) 2012 07 02  
 (732) Karen Vardanyan  
 Bayron St. 3, app. 36, Yerevan, Armenia  
 (141) 2023 01 11

(111) M 2012 22724 R  
 (151) 2012 07 02  
 (732) LTD "Green Country"  
 Ksani Str. 36, 0141, Tbilisi, Georgia  
 (141) 2023 01 11

(111) M 2012 22672 R  
 (151) 2012 06 07  
 (732) National Investments Co. LTD.  
 Usman Nosir Str. 45, Office 11, 100100  
 Tashkent, Uzbekistan  
 (141) 2023 01 11

(111) M 2012 22725 R  
 (151) 2012 07 02  
 (732) LTD "Ziller Georgia"  
 Zhiuli Shartava Str. 35-37, ap. 97, 0160,  
 Tbilisi, Georgia  
 (141) 2023 01 11

(111) M 2012 22718 R  
 (151) 2012 07 02  
 (732) Harrington Development Inc.  
 Arango-Orillac Bldg. East 54th street,  
 Panama, Republic of Panama  
 (141) 2023 01 11

(111) M 2012 22728 R  
 (151) 2012 07 02  
 (732) British American Tobacco (Brands) Limited  
 Globe House, 4 Temple Place, London  
 WC2R 2 PG, United Kingdom  
 (141) 2023 01 11

(111) M 2012 22719 R  
 (151) 2012 07 02  
 (732) Harrington Development Inc.  
 Arango-Orillac Bldg. East 54th street,  
 Panama, Republic of Panama  
 (141) 2023 01 11

(111) M 2012 22675 R  
 (151) 2012 06 07  
 (732) LEPL "National Center of Cinematography  
 of Georgia"  
 Z. Gamsakhurdia Beach 4, 0105, Tbilisi,  
 Georgia  
 (141) 2023 01 11

(111) M 2012 22720 R  
 (151) 2012 07 02  
 (732) Harrington Development Inc.  
 Arango-Orillac Bldg. East 54th street,  
 Panama, Republic of Panama  
 (141) 2023 01 11

(111) M 2012 22735 R  
 (151) 2012 07 02  
 (732) LTD "Balis"  
 Davit Aghmashenebeli Str. 115-d, 0700,  
 Akhalkalaki, Georgia  
 (141) 2023 01 11

(111) M 2012 22721 R  
 (151) 2012 07 02  
 (732) Elena Vladimirovna Visotskaya  
 Vul. Dovnar-Zapolskogo 2/20, ap. 6, 04116,



---

(111) M 2012 22736 R  
(151) 2012 07 02  
(732) Philip Morris Brands SàRL.  
Quai Jeanrenaud 3, 2000 Neuchâtel,  
Switzerland  
(141) 2023 01 11

---

(111) M 2012 22739 R  
(151) 2012 07 02  
(732) JSC "Tbilisi Tobacco"  
Nadareishvili Str. 5, 0120, Tbilisi, Georgia  
(141) 2023 01 11

---

(111) M 2012 22740 R  
(151) 2012 07 02  
(732) Novartis AG  
4002 Basel, Switzerland  
(141) 2023 01 11

---

(111) M 2012 22677 R  
(151) 2012 06 07  
(732) Laboratoire Hra-Pharma  
15, Rue Béranger, 75003 Paris, France  
(141) 2023 01 11

---

(111) M 2012 22748 R  
(151) 2012 07 05  
(732) LLC "Georgian Trade Group" LLC  
Gagarin Str, Lane 1, 0160, Tbilisi,  
Georgia  
(141) 2023 01 13

---

(111) M 2012 22653 R  
(151) 2012 05 29  
(732) LLC "Microfinance Organization – Geocapital"  
Zviad Gamsakhurdia Ave. I Lane 1 /  
Zviad Gamsakhurdia Ave. 192, 4600, Kutaisi,  
Georgia  
(141) 2023 01 11

---

(111) M 2012 22680 R  
(151) 2012 06 11  
(732) Bracini Limited  
Intershore Chambers, Road Town, Tortola,  
Virgin Islands (British)  
(141) 2023 01 11

---

(111) M 2012 22679 R  
(151) 2012 06 08  
(732) LLC "Millennium Works"  
Melikishvili Ave. 16, 0179, Tbilisi, Georgia  
(141) 2023 01 11

---

---

(111) M 2012 22678 R  
(151) 2012 06 08  
(732) JSC "Agricultural Investment Fund"  
Ak. Shanidze Str. 2/Melikishvili Ave. 16,  
0179, Tbilisi, Georgia  
(141) 2023 01 11

---

(111) M 2012 22752 R  
(151) 2012 07 05  
(732) LTD "GL Georgia"  
Vill. Akhalterjola, 2400, Terjola Region,  
Georgia  
(141) 2023 01 13

---

(111) M 2012 22745 R  
(151) 2012 07 03  
(732) Japan Tobacco Inc.  
2-2-1, Toranomom, Minato-ku, Tokyo, Japan  
(141) 2023 01 11

---

(111) M 2012 22746 R  
(151) 2012 07 03  
(732) Japan Tobacco Inc.  
2-2-1, Toranomom, Minato-ku, Tokyo, Japan  
(141) 2023 01 11

---

(111) M 2012 22682 R  
(151) 2012 06 25  
(732) LTD "Medgroup Georgia"  
Zemo Vedzisi Str. 1b, Tbilisi, Georgia  
(141) 2023 01 11

---

(111) M 2012 22747 R  
(151) 2012 07 03  
(732) LTD "Hetline International"  
Eristavi Str. 1, 0179, Gldani-Nadzaladevi  
District, Tbilisi, Georgia  
(141) 2023 01 11

---

(111) M 2012 22749 R  
(151) 2012 07 05  
(732) Nino Chiburdanidze  
Ilia Chavchavadze Ave. 27/29, ap. 12,  
Tbilisi, Georgia  
(141) 2023 01 13

---

(111) M 2012 22750 R  
(151) 2012 07 05  
(732) LLC "Standard Tobacco Incorporated"  
Abuseridze-Tbeli Str. 13, 0120, Tbilisi,  
Georgia  
(141) 2023 01 13

---

(111) M 2012 22751 R  
(151) 2012 07 05  
(732) LLC "Standard Tobacco Incorporated"  
Abuseridze-Tbeli Str. 13, 0120, Tbilisi,  
Georgia  
(141) 2023 01 13

---

## REGISTRATION OF LICENSE AGREEMENTS

(111) M 2002 14600 R  
(732) Sosha Nassibi  
Leonardo da Vinci Allee 18c, Frankfurt am Main 60486, Germany  
(791) LTD "Humana Georgia"  
Davit Gamrekeli Str.19, Office 28, Saburtalo District, Tbilisi, Georgia  
(793) Simple  
№1722  
From 14 12 2022 for the period of validity of the trademark  
Simple  
Class: 5

---

(111) M 2013 23554 R  
(732) Sosha Nassibi  
Leonardo da Vinci Allee 18c, Frankfurt am Main 60486, Germany  
(791) LTD "Humana Georgia"  
Davit Gamrekeli Str.19, Office 28, Saburtalo District, Tbilisi, Georgia  
(793) Simple  
№1721  
From 14 12 2022 for the period of validity of the trademark  
Class: 5

---

## INTERNATIONAL LICENSE AGREEMENTS

(800) 1094193  
(791) Obshestvo s Ogranichennoy Otvetstvennostju  
"Arkhbum Tissue Group"  
Kaluga Region, Borisov District, Vill.  
Dobrinno, 6th East Exit, building 8, 249020,  
Russian Federation  
(793) №1720  
Simple  
From 14 12 2022 for the period of validity of  
the trademark  
Class: 16

---

(800) 1243853  
(791) Obshestvo s Ogranichennoy Otvetstvennostju  
"Arkhbum Tissue Group"  
Kaluga Region, Borisov District, Vill.  
Dobrinno, 6th East Exit, building 8, 249020,  
Russian Federation  
(793) №1719  
Simple  
From 14 12 2022 for the period of validity of  
the trademark  
Class: 16

---

(800) 1425875  
(791) Obshestvo s Ogranichennoy Otvetstvennostju  
"Arkhbum Tissue Group"  
Kaluga Region, Borisov District, Vill.  
Dobrinno, 6th East Exit, building 8, 249020,  
Russian Federation  
(793) №1718  
Simple  
From 14 12 2022 for the period of validity of  
the trademark  
Class: 16

---

# CLASSIFICATION INDEXES

## INVENTIONS

### CONCORDANCE TABLE OF INTERNATIONAL CLASSIFICATION INDEX AND PUBLICATION NUMBERS

INTERNATIONAL CLASSIFICATION INDEXES (51)	NUMBER OF PUBLISHED APPLICATION (10)
A 61 K 31/4025; A 61 K 31/4015; A 61 P 31/14; C 07 D 401/12; C 07 D 403/14; C 07 D 497/04; C 07 D 403/12; C 07 D 207/267	AP 2023 15794 A
A 61 K 35/74; A 61 P 5/00; A 61 P 1/00; C 12 P 17/165; C 12 P 19/40; C 12 R 1/225	AP 2023 15500 A
C 12 N 5/04	AP 2023 15635 A

### CONCORDANCE TABLE OF PUBLICATION NUMBERS AND INTERNATIONAL CLASSIFICATION INDEX

NUMBER OF PUBLISHED APPLICATION (10)	INTERNATIONAL CLASSIFICATION INDEXES (51)
AP 2023 15500 A	A 61 K 35/74; A 61 P 5/00; A 61 P 1/00; C 12 P 17/165; C 12 P 19/40; C 12 R 1/225
AP 2023 15635 A	C 12 N 5/04
AP 2023 15794 A	A 61 K 31/4025; A 61 K 31/4015; A 61 P 31/14; C 07 D 401/12; C 07 D 403/14; C 07 D 497/04; C 07 D 403/12; C 07 D 207/267

### CONCORDANCE TABLE OF INTERNATIONAL CLASSIFICATION INDEX, PATENT NUMBERS AND PUBLICATION NUMBERS

INTERNATIONAL CLASSIFICATION INDEX (51)	NUMBER OF PATENT (11)	NUMBER OF PUBLISHED APPLICATION (10)
A 01 G 9/12	P 2023 7464 B	AP 2022 15922 A
A 01 N 43/78; C 07 D 277/56	P 2023 7461 B	AP 2022 15670 A
A 23 K 10/18	P 2023 7463 B	AP 2022 15714 A
A 61 K 31/54; A 61 P 25/18; C 07 D 285/16; C 07 D 471/04; C 07 D 417/12; C 07 D 417/04	P 2023 7459 B	AP 2022 15558 A
A 61 K 31/437; A 61 P 35/00; C 07 D 471/04	P 2023 7460 B	AP 2022 15446 A
A 61 K 39/395; A 61 P 27/02; A 61 P 7/00; C 07 K 16/40	P 2023 7466 B	AP 2022 14913 A
B 03 B 9/06; C 04 B 28/14; C 04 B 18/16; E 04 C 2/02	P 2023 7465 B	AP 2022 15265 A
B 61 B 7/00	P 2023 7462 B	AP 2022 15565 A

**CONCORDANCE TABLE OF PATENT NUMBERS,  
PUBLICATION NUMBERS AND INTERNATIONAL CLASSIFICATION INDEX**

NUMBER OF PATENT (11)	NUMBER OF PUBLISHED APPLICATION (10)	INTERNATIONAL CLASSIFICATION INDEX (51)
P 2023 7459 B	AP 2022 15558 A	A 61 K 31/54; A 61 P 25/18; C 07 D 285/16; C 07 D 471/04; C 07 D 417/12; C 07 D 417/04
P 2023 7460 B	AP 2022 15446 A	A 61 K 31/437; A 61 P 35/00; C 07 D 471/04
P 2023 7461 B	AP 2022 15670 A	A 01 N 43/78; C 07 D 277/56
P 2023 7462 B	AP 2022 15565 A	B 61 B 7/00
P 2023 7463 B	AP 2022 15714 A	A 23 K 10/18
P 2023 7464 B	AP 2022 15922 A	A 01 G 9/12
P 2023 7465 B	AP 2022 15265 A	B 03 B 9/06; C 04 B 28/14; C 04 B 18/16; E 04 C 2/02
P 2023 7466 B	AP 2022 14913 A	A 61 K 39/395; A 61 P 27/02; A 61 P 7/00; C 07 K 16/40

**CONCORDANCE TABLE OF APPLICATION NUMBERS,  
PUBLICATION NUMBERS AND PATENTS**

NUMBER OF APPLICATION (21)	NUMBER OF PUBLISHED APPLICATION (10)	NUMBER OF PATENT (11)
AP 2017 14913	AP 2022 14913 A	P 2023 7466 B
AP 2017 15265	AP 2022 15265 A	P 2023 7465 B
AP 2019 15446	AP 2022 15446 A	P 2023 7460 B
AP 2019 15558	AP 2022 15558 A	P 2023 7459 B
AP 2021 15565	AP 2022 15565 A	P 2023 7462 B
AP 2019 15670	AP 2022 15670 A	P 2023 7461 B
AP 2021 15714	AP 2022 15714 A	P 2023 7463 B
AP 2022 15922	AP 2022 15922 A	P 2023 7464 B

## UTILITY MODELS

**CONCORDANCE TABLE OF INTERNATIONAL CLASSIFICATION INDEX  
AND PUBLICATION NUMBERS**

INTERNATIONAL CLASSIFICATION INDEXES (51)	NUMBER OF PUBLISHED APPLICATION (10)
A 61 M 5/14	AU 2023 15907 U
C 04 B 38/00; C 04 B 38/02	AU 2023 15787 U

**CONCORDANCE TABLE OF PUBLICATION NUMBERS  
AND INTERNATIONAL CLASSIFICATION INDEX**

NUMBER OF PUBLISHED APPLICATION (10)	INTERNATIONAL CLASSIFICATION INDEXES (51)
AU 2023 15787 U	C 04 B 38/00; C 04 B 38/02
AU 2023 15907 U	A 61 M 5/14

CONCORDANCE TABLE OF INTERNATIONAL CLASSIFICATION INDEX,  
PATENT NUMBERS AND PUBLICATION NUMBERS

INTERNATIONAL CLASSIFICATION INDEX (51)	NUMBER OF PATENT (11)	NUMBER OF PUBLISHED APPLICATION (10)
A 21 C 1/00; A 21 D 10/04	U 2023 2143 Y	AU 2022 15768 U
F 03 B 13/00	U 2023 2142 Y	AU 2022 15880 U

CONCORDANCE TABLE OF PATENT NUMBERS,  
PUBLICATION NUMBERS AND INTERNATIONAL CLASSIFICATION INDEX

NUMBER OF PATENT (11)	NUMBER OF PUBLISHED APPLICATION (10)	INTERNATIONAL CLASSIFICATION INDEX (51)
U 2023 2142 Y	AU 2022 15880 U	F 03 B 13/00
U 2023 2143 Y	AU 2022 15768 U	A 21 C 1/00; A 21 D 10/04

CONCORDANCE TABLE OF APPLICATION NUMBERS,  
PUBLICATION NUMBERS AND PATENTS

NUMBER OF APPLICATION (21)	NUMBER OF PUBLISHED APPLICATION (10)	NUMBER OF PATENT (11)
AU 2021 15768	AU 2022 15768 U	U 2023 2143 Y
AU 2022 15880	AU 2022 15880 U	U 2023 2142 Y

**DESIGNS****DESIGNS REGISTERED ACCORDING TO THE ACCELERATED  
PROCEDURE****CONCORDANCE TABLE OF INTERNATIONAL CLASSIFICATION INDEX  
AND PUBLICATION NUMBERS**

INTERNATIONAL CLASSIFICATION INDEXES (51)	NUMBER OF REGISTRATION (11)
02-04	D 2023 955 S

**CONCORDANCE TABLE OF PUBLICATION NUMBERS  
AND INTERNATIONAL CLASSIFICATION INDEX**

NUMBER OF REGISTRATION (11)	INTERNATIONAL CLASSIFICATION INDEXES (51)
D 2023 955 S	02-04

**CONCORDANCE TABLE OF APPLICATION NUMBERS,  
PUBLICATION NUMBERS AND PATENTS**

NUMBER OF APPLICATION (21)	NUMBER OF REGISTRATION (11)
AD 2022 1282	D 2023 955 S

## TRADEMARKS

### CONCORDANCE TABLE OF REGISTRATION NUMBERS, APPLICATION NUMBERS, PUBLICATION NUMBERS AND BULLETIN NUMBERS

NUMBER OF REGISTRATION (111)	NUMBER OF APPLICATIONS (210)	NUMBER OF PUBLISHED APPLICATIONS (260)	NUMBER OF BULLETIN
1	2	3	4
M 2023 36297 R	AM 120818	–	2(605)2023
M 2023 36298 R	AM 120602	–	2(605)2023
M 2023 36299 R	AM 120600	–	2(605)2023
M 2023 36300 R	AM 120812	–	2(605)2023
M 2023 36301 R	AM 120813	–	2(605)2023
M 2023 36302 R	AM 120446	–	2(605)2023
M 2023 36303 R	AM 116072	AM 2022 116072 A	14(593) 2022
M 2023 36304 R	AM 116149	AM 2022 116149 A	14(593) 2022
M 2023 36305 R	AM 120712	–	2(605)2023
M 2023 36306 R	AM 120728	–	2(605)2023
M 2023 36307 R	AM 120722	–	2(605)2023
M 2023 36308 R	AM 120609	–	2(605)2023
M 2023 36309 R	AM 120708	–	2(605)2023
M 2023 36310 R	AM 116657	AM 2022 116657 A	17(596) 2022
M 2023 36311 R	AM 115338	AM 2022 115338 A	13(592) 2022
M 2023 36312 R	AM 115435	AM 2022 115435 A	11(590) 2022
M 2023 36313 R	AM 115436	AM 2022 115436 A	11(590) 2022
M 2023 36314 R	AM 115437	AM 2022 115437 A	11(590) 2022
M 2023 36315 R	AM 115519	AM 2022 115519 A	11(590) 2022
M 2023 36316 R	AM 115520	AM 2022 115520 A	11(590) 2022
M 2023 36317 R	AM 115521	AM 2022 115521 A	11(590) 2022
M 2023 36318 R	AM 115507	AM 2022 115507 A	11(590) 2022
M 2023 36319 R	AM 116076	AM 2022 116076 A	14(593) 2022
M 2023 36320 R	AM 116073	AM 2022 116073 A	14(593) 2022
M 2023 36321 R	AM 115881	AM 2022 115881 A	14(593) 2022
M 2023 36322 R	AM 120716	–	2(605)2023
M 2023 36323 R	AM 120345	–	2(605)2023
M 2023 36324 R	AM 120501	–	2(605)2023
M 2023 36325 R	AM 115434	AM 2022 115434 A	11(590) 2022
M 2023 36326 R	AM 115325	AM 2022 115325 A	12(591) 2022
M 2023 36327 R	AM 115752	AM 2022 115752 A	13(592) 2022
M 2023 36328 R	AM 116528	AM 2022 116528 A	16(595) 2022
M 2023 36329 R	AM 116542	AM 2022 116542 A	16(595) 2022
M 2023 36330 R	AM 116239	AM 2022 116239 A	17(596) 2022
M 2023 36331 R	AM 120941	–	2(605)2023
M 2023 36332 R	AM 116744	AM 2022 116744 A	17(596) 2022
M 2023 36333 R	AM 116325	AM 2022 116325 A	15(594) 2022
M 2023 36334 R	AM 116745	AM 2022 116745 A	17(596) 2022
M 2023 36335 R	AM 116741	AM 2022 116741 A	17(596) 2022
M 2023 36336 R	AM 116746	AM 2022 116746 A	17(596) 2022
M 2023 36337 R	AM 116743	AM 2022 116743 A	17(596) 2022
M 2023 36338 R	AM 115673	AM 2022 115673 A	13(592) 2022
M 2023 36339 R	AM 116431	AM 2022 116431 A	17(596) 2022
M 2023 36340 R	AM 116425	AM 2022 116425 A	17(596) 2022
M 2023 36341 R	AM 115099	AM 2022 115099 A	11(590) 2022
M 2023 36342 R	AM 116633	AM 2022 116633 A	17(596) 2022



1	2	3	4
M 2023 36343 R	AM 116544	AM 2022 116544 A	17(596) 2022
M 2023 36344 R	AM 116543	AM 2022 116543 A	17(596) 2022
M 2023 36345 R	AM 116391	AM 2022 116391 A	15(594) 2022
M 2023 36346 R	AM 116413	AM 2022 116413 A	16(595) 2022
M 2023 36347 R	AM 116322	AM 2022 116322 A	17(596) 2022
M 2023 36348 R	AM 116517	AM 2022 116517 A	17(596) 2022
M 2023 36349 R	AM 121049	–	2(605)2023
M 2023 36350 R	AM 120826	–	2(605)2023
M 2023 36351 R	AM 120951	–	2(605)2023
M 2023 36352 R	AM 121124	–	2(605)2023
M 2023 36353 R	AM 121116	–	2(605)2023
M 2023 36354 R	AM 121118	–	2(605)2023
M 2023 36355 R	AM 121119	–	2(605)2023

**CONCORDANCE TABLE OF PUBLICATION NUMBERS  
AND APPLICATION NUMBERS**

NUMBER OF PUBLISHED APPLICATION (260)	NUMBER OF APPLICATION (210)
1	2
AM 2023 116620 A*	AM 116620
AM 2023 117840 A	AM 117840
AM 2023 118141 A	AM 118141
AM 2023 118222 A	AM 118222
AM 2023 118226 A	AM 118226
AM 2023 118227 A	AM 118227
AM 2023 118229 A	AM 118229
AM 2023 118231 A	AM 118231
AM 2023 118235 A	AM 118235
AM 2023 118241 A	AM 118241
AM 2023 118244 A	AM 118244
AM 2023 118247 A	AM 118247
AM 2023 118288 A	AM 118288
AM 2023 118289 A	AM 118289
AM 2023 118290 A	AM 118290
AM 2023 118291 A	AM 118291
AM 2023 118292 A	AM 118292
AM 2023 118293 A	AM 118293
AM 2023 118294 A	AM 118294
AM 2023 118295 A	AM 118295
AM 2023 118296 A	AM 118296
AM 2023 118298 A	AM 118298
AM 2023 118299 A	AM 118299
AM 2023 118301 A	AM 118301
AM 2023 118303 A	AM 118303
AM 2023 118305 A	AM 118305
AM 2023 118306 A	AM 118306
AM 2023 118307 A	AM 118307
AM 2023 118308 A	AM 118308
AM 2023 118309 A	AM 118309
AM 2023 118310 A	AM 118310
AM 2023 118311 A	AM 118311

---

1	2
AM 2023 118377 A	AM 118377
AM 2023 118379 A	AM 118379
AM 2023 118380 A	AM 118380
AM 2023 118381 A	AM 118381
AM 2023 118382 A	AM 118382
AM 2023 118383 A	AM 118383
AM 2023 118388 A	AM 118388
AM 2023 118392 A	AM 118392
AM 2023 118404 A	AM 118404
AM 2023 118405 A	AM 118405
AM 2023 118406 A	AM 118406
AM 2023 118408 A	AM 118408
AM 2023 118409 A	AM 118409
AM 2023 118412 A	AM 118412
AM 2023 118413 A	AM 118413
AM 2023 118414 A	AM 118414
AM 2023 118415 A	AM 118415
AM 2023 118470 A	AM 118470
AM 2023 118476 A	AM 118476
AM 2023 118477 A	AM 118477
AM 2023 118479 A	AM 118479
AM 2023 118532 A	AM 118532
AM 2023 118533 A	AM 118533
AM 2023 118534 A	AM 118534
AM 2023 118535 A	AM 118535
AM 2023 118537 A	AM 118537
AM 2023 118539 A	AM 118539
AM 2023 118548 A	AM 118548
AM 2023 118550 A	AM 118550
AM 2023 118565 A	AM 118565
AM 2023 118634 A	AM 118634
AM 2023 118635 A	AM 118635
AM 2023 118636 A	AM 118636
AM 2023 118637 A	AM 118637
AM 2023 118638 A	AM 118638
AM 2023 118644 A	AM 118644
AM 2023 118645 A	AM 118645
AM 2023 118646 A	AM 118646

CONCORDANCE TABLE OF INDEX OF GOODS AND/OR SERVICES  
AND APPLICATION NUMBERS

INDEX OF GOODS AND/OR SERVICES (511)	NUMBER OF PUBLISHED APPLICATIONS (260)	1	2
1	2	30	AM 2023 118296 A
1	AM 2023 118534 A	30	AM 2023 118548 A
1	AM 2023 118535 A	30	AM 2023 118550 A
1	AM 2023 118548 A	31	AM 2023 118226 A
1	AM 2023 118550 A	31	AM 2023 118227 A
3	AM 2023 118293 A	31	AM 2023 118548 A
4	AM 2023 118534 A	31	AM 2023 118550 A
4	AM 2023 118535 A	32	AM 2023 117840 A
5	AM 2023 118229 A	32	AM 2023 118231 A
5	AM 2023 118532 A	32	AM 2023 118294 A
5	AM 2023 118533 A	32	AM 2023 118295 A
5	AM 2023 118548 A	32	AM 2023 118404 A
5	AM 2023 118550 A	32	AM 2023 118405 A
5	AM 2023 118644 A	32	AM 2023 118548 A
5	AM 2023 118645 A	32	AM 2023 118550 A
7	AM 2023 118534 A	33	AM 2023 116620 A*
7	AM 2023 118535 A	33	AM 2023 118231 A
9	AM 2023 118377 A	33	AM 2023 118293 A
9	AM 2023 118470 A	33	AM 2023 118296 A
9	AM 2023 118534 A	33	AM 2023 118298 A
9	AM 2023 118535 A	33	AM 2023 118299 A
12	AM 2023 118534 A	33	AM 2023 118303 A
12	AM 2023 118535 A	33	AM 2023 118305 A
16	AM 2023 118141 A	33	AM 2023 118306 A
16	AM 2023 118244 A	33	AM 2023 118307 A
16	AM 2023 118288 A	33	AM 2023 118388 A
16	AM 2023 118289 A	33	AM 2023 118404 A
16	AM 2023 118290 A	33	AM 2023 118405 A
16	AM 2023 118291 A	33	AM 2023 118406 A
16	AM 2023 118292 A	33	AM 2023 118476 A
16	AM 2023 118392 A	33	AM 2023 118537 A
25	AM 2023 118222 A	33	AM 2023 118539 A
25	AM 2023 118288 A	33	AM 2023 118646 A
25	AM 2023 118289 A	34	AM 2023 118235 A
25	AM 2023 118290 A	34	AM 2023 118301 A
25	AM 2023 118291 A	34	AM 2023 118308 A
25	AM 2023 118292 A	34	AM 2023 118309 A
25	AM 2023 118415 A	34	AM 2023 118310 A
29	AM 2023 118226 A	34	AM 2023 118311 A
29	AM 2023 118227 A	34	AM 2023 118379 A
29	AM 2023 118231 A	34	AM 2023 118380 A
29	AM 2023 118247 A	34	AM 2023 118381 A
29	AM 2023 118548 A	34	AM 2023 118382 A
29	AM 2023 118550 A	34	AM 2023 118383 A
30	AM 2023 118226 A	34	AM 2023 118408 A
30	AM 2023 118227 A	34	AM 2023 118409 A
30	AM 2023 118231 A	34	AM 2023 118634 A
30	AM 2023 118241 A	34	AM 2023 118635 A
		34	AM 2023 118636 A
		34	AM 2023 118637 A
		34	AM 2023 118638 A

1	2	1	2
35	AM 2023 118222 A	37	AM 2023 118534 A
35	AM 2023 118231 A	37	AM 2023 118535 A
35	AM 2023 118241 A	38	AM 2023 118377 A
35	AM 2023 118244 A	40	AM 2023 118534 A
35	AM 2023 118288 A	40	AM 2023 118535 A
35	AM 2023 118289 A	41	AM 2023 118222 A
35	AM 2023 118290 A	41	AM 2023 118244 A
35	AM 2023 118291 A	41	AM 2023 118377 A
35	AM 2023 118292 A	43	AM 2023 118222 A
35	AM 2023 118479 A	43	AM 2023 118226 A
35	AM 2023 118534 A	43	AM 2023 118227 A
35	AM 2023 118535 A	43	AM 2023 118231 A
36	AM 2023 118412 A	43	AM 2023 118414 A
36	AM 2023 118413 A	43	AM 2023 118477 A
36	AM 2023 118414 A	43	AM 2023 118565 A
37	AM 2023 118412 A	44	AM 2023 118548 A
37	AM 2023 118413 A	44	AM 2023 118550 A
37	AM 2023 118414 A	45	AM 2023 118377 A

**CONCORDANCE TABLE OF INDEX OF GOODS AND/OR SERVICES  
AND NUMBERS OF TRADEMARKS REGISTERED ACCORDING  
TO THE ACCELERATED PROCEDURE**

INDEX OF GOODS AND/OR SERVICES (511)	NUMBERS OF REGISTERED ACCORDING TO THE ACCELERATED PROCEDURE (111)
5	M 2023 36297 R
5	M 2023 36305 R
5	M 2023 36322 R
5	M 2023 36352 R
5	M 2023 36353 R
5	M 2023 36354 R
5	M 2023 36355 R
29	M 2023 36349 R
29	M 2023 36350 R
29	M 2023 36351 R
30	M 2023 36323 R
32	M 2023 36324 R
32	M 2023 36331 R
33	M 2023 36306 R
33	M 2023 36307 R
33	M 2023 36309 R
33	M 2023 36349 R
34	M 2023 36308 R
35	M 2023 36349 R
43	M 2023 36298 R
43	M 2023 36299 R
43	M 2023 36300 R
43	M 2023 36301 R
43	M 2023 36302 R
43	M 2023 36306 R

# OFFICIAL BULLETIN OF THE INDUSTRIAL PROPERTY

**INVENTIONS**  
**UTILITY MODELS**  
**DESIGNS**  
**TRADEMARKS**

**2(605)**

EDITOR-IN-CHIEF: N. Bebrishvili

EDITOR-TRANSLATOR: E. Gabunia

PROOFREADER: A. Shixashvili

COMPUTER LAYOUT: M. Ordenidze  
K. Svanidze

ISSN 2720-8486

[info@sakpatenti.gov.ge](mailto:info@sakpatenti.gov.ge)  
[www.sakpatenti.gov.ge](http://www.sakpatenti.gov.ge)