



Official Bulletin of the Industrial Property

Inventions
Utility Models
Designs
Trademarks



საქართველოს ინტელექტუალური
საკუთრების ეროვნული ცენტრი
საქპატენტი
SAKPATENTI
NATIONAL INTELLECTUAL PROPERTY
CENTER OF GEORGIA

Date of Publication – 2024 01 25

2(629)

INID CODES FOR IDENTIFICATION OF BIBLIOGRAPHIC DATA

INVENTIONS, UTILITY MODELS

- (10) Number of publication of examined application/
Application publication number***
- (11) Patent number/ Patent number***
Registered utility model number***
- (21) Application number
- (22) Date of filing of the application
- (23) Date of exhibition priority
- (24) Date from which patent may have effect
- (31) Number of priority application
- (32) Date of filing of priority application
- (33) Code of the country or regional organization allotting application number
- (43) Date of publication of application, number of bulletin***
- (44) Date of publication of examined application, on which no grant has taken place and number of bulletin
- (45) Date of publication of patent/ Date of publication of patent***
Date of publication of registered utility model***
- (51) International Patent Classification Index
- (54) Title of the invention/title of the utility model
- (57) Abstract
- (60) Number of examined patent document granted by foreign patent office, date from which patent has effect and country code
- (62) Number and filing date of the earlier application in case of a divisional application
- (71) Name and address of applicant (country code)
- (72) Name of inventor (country code)
- (73) Name and address of patent owner/patent owner***/ registered utility model owner*** (country code)
- (74) Name of representative or patent attorney
- (85) Date of commencement of the national phase of international application (PCT)
- (86) Number and date of filing of international application (PCT)
- (87) Number and date of publication of international application (PCT)
- (94) Calculated date of expiry of the SPC or the duration of the SPC

DESIGNS

- (10) Number of publication for application
- (11) Number of patent and kind of document or number of registration
- (15) Date of registration/Date of patent renewal
- (18) Expected expiration date of patent or registration
- (21) Serial number of application
- (22) Date of filing of the application
- (23) Date of exhibition or the date of the earlier filing and the number of application, if any
- (24) Date from which patent may have effect
- (28) Number of designs included in the application
- (30) Data relating to priority (number of application, date of filing of application, two-letter code identifying the authority with whom the priority application was made)
- (31) Number of priority application
- (32) Date of filing of priority application
- (33) Code of the country or regional organization allotting priority application number
- (34) Two-letter code according to WIPO St.3 identifying the authority with which the priority application was made
- (44) Date of publication of design and number of bulletin (the first publication)
- (45) Date of publication of design registered by WIPO and number of bulletin
- (51) International Classification for designs (class and subclass of the Locarno Classification)
- (54) Title of the invention
- (55) Reproduction of the design
- (57) Description of characteristic features of the design including indication of colors
- (58) Date of recording of any kind of amendment in the Register
- (62) Number of the earlier application, registration and document number and if available the date of filing an application in case of divided application
- (71) Name, surname and address of applicant (country code)
- (72) Name, surname of creator (country code)
- (73) Name, surname and address of patent owner (country code)
- (74) Name, surname of representative or patent attorney
- (81) Contracting states concerned
II designated contracting states according to the 1960 Act
III designated contracting states according to the 1999 Act
- (85) Owner's permanent address
- (86) Owner's nationality
- (87) Owner's residence
- (88) State in which the owner has a real and effective industrial or commercial establishment

TRADEMARKS

- (111) - Number of registration
- (151) - Date of registration
- (156) - Date of the renewal
- (181) - Expected expiration date of registration
- (186) - Renewal expiration date of registration
- (141) - Date of cancel of duration of the mark
- (210) - Serial number of application
- (220) - Date of filing of the application
- (230) - Data concerning exhibition
- (260) - Number of application, for which favorable decision of examination about registration has been taken (publication number)
- (310) - Number of the first application
- (320) - Date of filing of the first application
- (330) - Code, identifying national or regional Office where the first application was made
- (511) - International Classification of Goods and Services for the purposes of registration of trade marks and/or list of goods and/or services classified according thereto
- (526) - Disclaimer
- (531) - Description of figurative elements of Trade Marks according to the International Classification of the Figurative Elements of Marks
- (540) - Reproduction of Trade Mark
- (550) - Nature and kind of Trade Mark
- (551) - Indication to the effect that the mark is a collective mark, a certification mark or a guarantee mark
- (554) - Three-dimensional mark
- (580) - Date of recording of any kind changes in respect of applications or registrations
- (591) - Information concerning colors claimed
- (731) - Name and address of the applicant
- (732) - Name and address of the holder of the registration
- (740) - Name and address of the representative
- (750) - Addreses for correspondence
- (770) - Name and address of the previous applicant or holder in case of change in ownership
- (771) - Previous name and address of the applicant or holder in case of change in ownership
- (791) - Name and address of the licensee
- (793) - Indication of conditions and/or restrictions under the license (Type of license, number of license agreement, data of license, data of validity of license)
- (800) - Certain data relating to the international registration of Trade Marks under the Protocol Relating to Madrid Agreement (International registration number
- (852) - Partial cancellation of the list of goods and services
- (891) - Date of subsequent designation

CODES FOR PUBLICATION IN BULLETIN

- (21) AP 0000 000000 - number of application for invention
- (10) AP 0000 0000 A - number of publication of application for invention
- (11) P 0000 0000 B - number of patent for invention/ patent number***
- (21) API 0000 000000 - number of application for imported patent
- (11) PI 0000 0000 A - number of imported patent
- (21) AU 0000 000000 - number of application for utility model
- (10) AU 0000 000 U - number of publication of application for utility model
- (11) U 0000 000 Y - number of patent for utility model/ registered utility model number***
- (21) AD 0000 000000 - serial number of application for design
- (10) AD 0000 000 S - number of published application for design (first publication)
- (11) D 0000 000 S - registered design

INTERNATIONAL PATENT CLASSIFICATION FOR INVENTIONS AND UTILITY MODELS

- SECTION A - HUMAN NECESSITIES
- SECTION B - PERFORMING OPERATIONS; TRANSPORTING
- SECTION C - CHEMISTRY; METALLURGY
- SECTION D - TEXTILES; PAPER
- SECTION E - FIXED CONSTRUCTIONS
- SECTION F - MECHANICAL ENGINEERING; LIGHTING; HEATING; WEAPONS; BLASTING
- SECTION G - PHYSICS
- SECTION H - ELECTRICITY

* Number of application published after the decision of Appellation Chamber of SAKPATENTI

** Number of application published after Court decision

*** Materials published according to the amendments of May 16, 2023 (No. 2883-XI0b-X03) to the Patent Law of Georgia

- M - Trade Mark
- (210) AM 0000 000000 - Serial number of application;
- (260) AAM 0000 00000 A - Publication number of application;
- (111) M 0000 00000 R - Number of registration;
- (111) MMM0000 00000 Rn - Number of renewals, in which n=1,2,3;
- (111) M 0000 00000 R(P) - Number of registration under partial assignment of rights

Official Bulletin of the Industrial Property

Inventions

Utility Models

Designs

Trademarks

CONTENT

| | |
|---|-----|
| PUBLISHED TITLES OF PROTECTION | 2 |
| INVENTIONS | |
| ▪ APPLICATIONS APPROVED FOR GRANTING PATENT | 4 |
| ▪ PATENTED INVENTIONS | 7 |
| ▪ APPLICATIONS*** | 9 |
| UTILITY MODELS | |
| PATENTED UTILITY MODEL | 13 |
| DESIGNS | |
| ▪ REGISTERED DESIGNS | 14 |
| ▪ DESIGN REGISTERED ACCORDING TO THE ACCELERATED PROCEDURE | 15 |
| ▪ DESIGNS, WICH HAVE BEEN REGISTERED WITH THE INTERNATIONAL BUREAU CLAIMING PRIORITY ON THE TERRITORY OF GEORGIA | 17 |
| TRADEMARKS | |
| ▪ APPLICATION FILED UNDER THE NATIONAL PROCEDURE APPROVED FOR REGISTRATION | 44 |
| ▪ REGISTERED TRADEMARKS | 45 |
| ▪ TRADEMARKS REGISTERED ACCORDING TO THE ACCELERATED PROCEDURE | 48 |
| ▪ INTERNATIONAL TRADEMARKS FOR WHICH A DECISION ON GRANTING PROTECTION IS TAKEN | 51 |
| ▪ INTERNATIONAL TRADEMARKS PROTECTED IN GEORGIA | 81 |
| OFFICIAL NOTIFICATION | |
| INVENTIONS | |
| ▪ RESTORATION OF PATENTS | 88 |
| ▪ LAPSE OF PATENTS WITH THE RIGHT TO RESTORE | 89 |
| ▪ EXPIRATION OF PATENTS RESTORATION TERM | 90 |
| ▪ TRANSFER OF RIGHTS | 91 |
| ▪ CHANGE OF NAME AND/OR ADDRESS OF PATENTOWNER | 91 |
| UTILITY MODELS | |
| ▪ RESTORATION OF PATENT | 92 |
| ▪ LAPSE OF PATENTS WITH THE RIGHT TO RESTORE | 92 |
| ▪ EXPIRATION OF PATENT RESTORATION TERM | 92 |
| DESIGNS | |
| ▪ CANCELLATION OF DESIGN REGISTRATION | 93 |
| ▪ EXTENSION OF TERM OF INTERNATIONAL DESIGNS REGISTRATION | 93 |
| TRADEMARKS | |
| ▪ EXTENSION OF TERM OF TRADEMARKS REGISTRATION | 96 |
| ▪ COMPLETE TRANSFER OF RIGHTS | 100 |
| ▪ CHANGES OF NAME AND/OR ADDRESS OF TRADEMARKS OWNERS | 101 |
| ▪ CANCELLATION OF TRADEMARKS REGISTRATION | 108 |
| ▪ INTERNATIONAL LICENSE AGREEMENT | 112 |
| CLASSIFICATION INDEXES | |
| INVENTIONS | 115 |
| UTILITY MODEL | 117 |
| DESIGNS | 118 |
| TRADEMARKS | 120 |

PUBLISHED TITLES OF PROTECTION

INVENTIONS

- **APPLICATIONS APPROVED FOR GRANTING PATENT:**
15862; 16087; 15431; 15822; 16197
- **PATENTED INVENTIONS:**
7585-7589
- **APPLICATIONS:** ***
16424; 16373; 16398; 16397; 16376; 16375; 16380; 16390; 16403

UTILITY MODELS

- **PATENTED UTILITY MODEL:**
2160

DESIGNS

- **REGISTERED DESIGNS:**
988-990
- **DESIGN REGISTERED ACCORDING TO THE ACCELERATED PROCEDURE:**
991
- **DESIGNS, WHICH HAVE BEEN REGISTERED WITH THE INTERNATIONAL BUREAU CLAIMING PRIORITY ON THE TERRITORY OF GEORGIA:**
228035; 231752; 231783; 228243; 232180; 228442; 232482; 228141; 228281; 232512; 226989; 233057

TRADEMARKS

- **APPLICATION FILED UNDER THE NATIONAL PROCEDURE APPROVED FOR REGISTRATION:**
122207
- **REGISTERED TRADEMARKS:**
37762-37786; 37791, 37792
- **TRADEMARKS REGISTERED ACCORDING TO THE ACCELERATED PROCEDURE:**
37761; 37787-37790; 37793-37797
- **INTERNATIONAL TRADEMARKS FOR WHICH A DECISION ON GRANTING PROTECTIONS IS TAKEN:**
119319*; 119431; 119522*; 120061*; 120197*; 120199*; 121000; 122185; 122188; 122236, 122237; 122240-122242; 122329-122331; 122338-122340; 122369, 122370; 122379-122381; 122383; 122447, 122448; 122470; 122609; 122626-122628; 122630; 122710, 122711; 122760, 122761; 122770, 122771; 122816, 122817
- **INTERNATIONAL TRADEMARKS PROTECTED IN GEORGIA:**
119567; 120678; 120869; 120913; 120916; 120991-120999; 121001, 121002; 121008; 121024; 121027; 121074, 121075; 121086, 121087; 121089-121091; 121104, 121105; 121108, 121109; 121159; 121173-121178; 121181; 121186; 121190-121192; 121195-121198; 121200-121202; 121270-121275; 121282; 121284-121287; 121290; 121293; 121295, 121296; 121359, 121360; 121391, 121392; 121395-121401; 121443-121448; 121488-121490; 121547-121551; 121583, 121584; 121602-121604; 121698, 121799; 121804; 121806; 121842

INVENTIONS

APPLICATIONS APPROVED FOR GRANTING PATENT

The decision can be appealed at the Chamber of Appeal of Sakpatenti within 3 months from the publication or at the Mtskheta District Court Administrative Cases Board (Address: №17, Samkhedro St., Mtskheta), within 1 month following the publication.

PART A

A 61

- (10) AP 2024 15862 A (51) Int. Cl. (2006)
A 61 P 25/18
A 61 P 25/22
A 61 P 25/24
A 61 P 25/28
C 07 C 235/08
- (21) AP 2020 15862 (22) 2020 07 30
- (31) 201910734123.0; 19189750.3; 19191887.9
- (32) 2019 08 09; 2019 08 02; 2019 08 15
- (33) CN; EP; EP
- (71) H. Lundbeck A/S (DK)
Ottilavej 9, DK-2500 Valby, Denmark (DK)
- (72) SAMS, Anette, Graven (DK);
ROSSLÄNDER, Mario (DK);
LARSEN, Krestian (DK);
WANG, Xiaofang (CN);
DAS, Debasis (CN);
HONG, Jian (CN);
CHEN, Shu, Hui (US)
- (74) Tamaz Shilakadze
- (85) 2022 01 25
- (86) PCT/EP2020/071520, 2020 07 30
- (54) ALCOHOL DERIVATIVES AS KV7
POTASSIUM CHANNEL OPENERS
- (57) Present invention relates to compounds of formula I

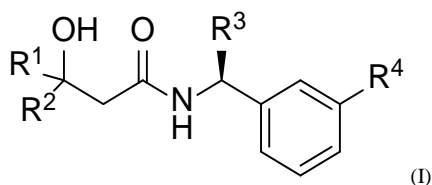

or pharmaceutically acceptable salts thereof, pharmaceutical compositions comprising them, and usage thereof the treatment of disorders responsive to the activation of Kv7 potassium channels.

Claims: 16 independents
5 dependents

PART E

E 02

- (10) AP 2024 16087 A (51) Int. Cl. (2006)
E 02 B 9/04
- (21) AP 2022 16087 (22) 2022 11 11
- (71) Nugzar Abzhandadze (GE)
Vill. Sareki, 4010, Sachkhere Municipality,
Georgia (GE)
- (72) Nugzar Abzhandadze (GE)
- (54) WATER INTAKE FILTER CONSTRUCTION FOR MICROHYDROPOWER PLANTS
- (57) A construction includes: a filter 4 placed inclined into concrete culvert 1; big size sediment control float barrier 2 directing sediment to river bed or spillway; a clarifier 3 of heavy sandbank having inclined bed; and discharge shield of remote control reverse mechanism. At that, the clarifier is connected to accumulation place 5 by means of filter disposed inclined relative to water stream, accumulation place is a roofing of certain section of construction culvert, and intended to accumulate weighted and floating sandbank. A shield 6 directing sediment is fixed in construction culvert, in accumulation area, in vertical plane, at an angle or parallel to current stream. At the event that water stream level is heightened, the shield is intended to direct sandbank into the spillway; furthermore, the construction includes stream limiting and block device 7, whereon stream block 7d and limiting 7b shields are placed. Stream limiting shield is remotely controlled by means of reversing mechanism, and block shield – by means of core solenoid; at that, the bed is deepened in front of charge pipe 9, creating, at the same time, water-collecting cell 8 intended to supply microhydropower plant by passing water stream throughout pressure pipeline, without creation of water funnel.

Claims: 1 independent

Fig.: 4

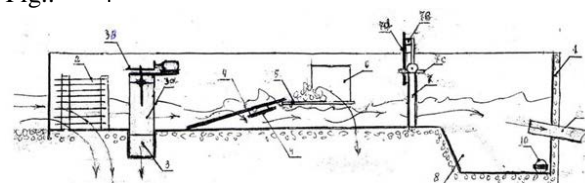

Fig. 1

E 04

- (10) AP 2024 15431 A (51) Int. Cl. (2006)
E 04 B 2/76
E 04 B 2/74
- (21) AP 2019 15431 (22) 2019 02 19
(31) 10 2018 002 951.5
(32) 2018 04 11
(33) DE
(71) Knauf Gips KG (DE)
Am Bahnhof 7, 97346 Iphoven, Germany (DE)
- (72) SCHAPER, Jens (DE);
VIEBAHN, Michael (DE)
- (74) Larisa Amirkhanyan
(85) 2020 09 02
(86) PCT/EP2019/000047, 2019 02 19
- (54) BRACKET AND ASSEMBLY KIT FOR CONNECTING BUILDING COMPONENTS FOR A DRYWALL CONSTRUCTION AND DRYWALL CONSTITUTED THEREWITH
- (57) A bracket includes a supporting metal plate (2) and side wall (3) installed perpendicular thereon. Side wall has sides bent several times in same direction so that in the cut it has the shape of semi-octagon from the octagon divided on parallel sides, and includes two cuts (4) started on opposite side of base plate and, at least, one elongated hole (5) slidable to fix the profile. The bracket is intended to connect building componentry in plasterboard construction, in particular, for fixing slidable, preferably, for fixing slidable on the side of ceiling, in plasterboard frame, uncoated, phenylated, preferably plasterboard fillets having multi-layered frame. Furthermore, invention relates to mounting kit and plasterboard construction with at least one such bracket and usage of such bracket in plasterboard construction.

Claims: 4 independents
13 dependents

Fig. 4

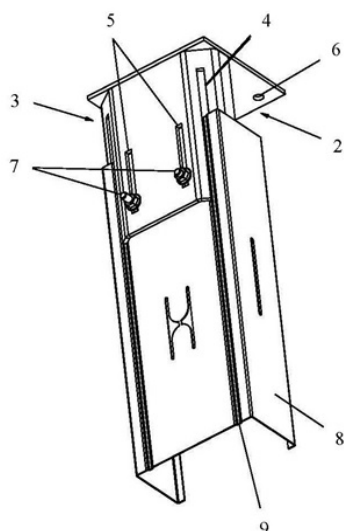

Fig. 3

PART F**F 03**

- (10) AP 2024 15822 A (51) Int. Cl. (2006)
F 03 B 13/16
- (21) AP 2021 15822 (22) 2021 12 09
(71) JSC "Zago Technology" (GE)
Besiki St. 4, Bysiness Center on Besiki St.,
Office 203, Tbilisi, 0108, Georgia (GE)
- (72) Vyacheslav Zagoruychenko (GE)
- (74) Levan Nikoladze
- (54) WAVE ENERGY DEVICE WITH ACCELERATING POLYSPASTON
- (57) A device includes floating component 1, mainly polystyrene 3, consisting of immobile unit, and mobile unit disposed above immobile one, and having a cable curved thereon, wherein each of units are formed with plurality of pulleys; at that, mobile unit is fixed onto floating component, and immobile one – on the frame 23. The device includes a load 6 disposed immobile on its bottom, and it is connected to said frame by means of main cables 7; furthermore, the device is equipped with additional load 5, additional polystyrene including immobile and mobile units executed as plurality of pulleys, and a cable curved thereon. Additional polystyrene immobile unit is disposed on the frame 23, and mobile one – on additional load 5, throughout perforation executed whereon said main cables are passed, and the units are movable reciprocally on vertical plane, along them. One common cable 8 is curved on main and additional polystyrenes, one free end whereof is connected to floating component; a generator having pulleys 15 is disposed on floating component, nearby another frame, and main and additional polystyrenes common cable is curved on the generator by passing throughout directing pulley 22.

Claims: 1 independent
4 dependents

Fig.: 4

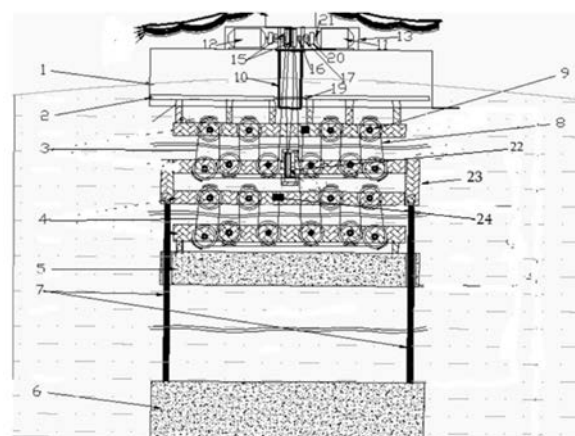

Fig. 1

PART G**G 04**

(10) AP 2024 16197 A (51) Int. Cl. (2006)
G 04 B 37/18

(21) AP 2023 16197 (22) 2023 04 19

(31) RU2023101642

(32) 2023 01 26

(33) RU

(71) Tengiz Amiranovich Sanikidze (RU)
Ostrovityanova St. 4, app. 282, 117513,
Moscow, Russian Federation (RU)

(72) Tengiz Amiranovich Sanikidze (RU)

(74) Shalva Gvaramadze

(54) WATCH

(57) A watch includes watch mechanism disposed into hermetic capsule, decorative case having a lid, and a means of capsule positioning relative to decorative case. Hermetic capsule is executed with cylindrical case and flat lid, wherein first transparent window for view is fixed, on case upper edge, and another one is fixed – on capsule lid. Watch mechanism positioning in capsule is accomplished by means of elastic setting ring, upper edge shape whereof is equal of capsule case inner surface shape. Capsule positioning in the case is accomplished by means of two symmetrical componentry having the rests on decorative case side wall. Additional fixation of case and capsule lid is accomplished by means of two set screws.

Claims: 1 independent
8 dependents

Fig.: 4

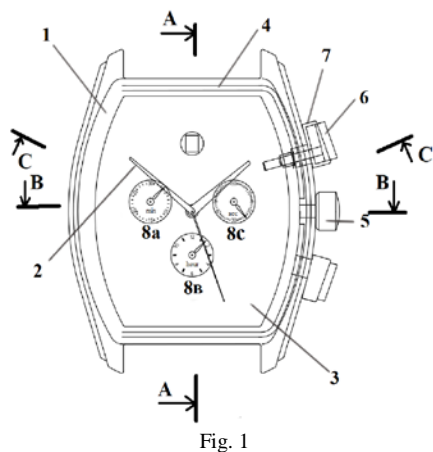

PATENTED INVENTIONS

PART A

A 01

- (11) P 2024 7586 B (51) Int. Cl. (2006)
A 01 G 9/029
A 01 G 31/06
- (10) AP 2023 15702 A (44) 18(621)/2023
(21) AP 2020 15702
(22) 2020 01 06
(24) 2020 01 06
(31) 19152899.1
(32) 2019 01 21
(33) EP
(86) PCT/EP2020/050137, 2020 01 06
(73) Wegrow Germany GMBH (DE)
Kehn 20, 47918 Tönisvorst, Germany (DE)
(72) DIESSENBACHER, Peter (DE)
(74) Shalva Gvaramadze
(54) PLANT PALLET

A 61

- (11) P 2024 7587 B (51) Int. Cl. (2006)
A 61 K 39/395
A 61 K 39/00
A 61 K 31/7105
A 61 K 48/00
A 61 K 45/00
A 61 P 7/00
- (10) AP 2023 15070 A (44) 17(620)/2023
(21) AP 2017 15070
(22) 2017 10 12
(24) 2017 10 12
(31) 62/407,979; 15/399,524; 15/470,647; 62/527,926
(32) 2016 10 13; 2017 01 05; 2017 03 27; 2017 06 30
(33) US; US; US; US
(86) PCT/US2017/056386, 2017 10 12
(73) University of Leicester (GB)
University Road of Leicester, Leicestershire,
LE1 7RH, UK (GB);
Omeros Corporation (US)
201 Elliott Avenue, West Seattle, WA 98119,
USA (US)
(72) DEMOPULOS, Gregory, A. (US);
SCHWAEBLE, Hans-Wilhelm (GB);
DUDLER, Tom (US);
BRUNSKILL, Nigel, John (GB)
(74) Tamar Kochlamazashvili
(54) METHODS FOR REDUCING PROTEINURIA
IN A HUMAN SUBJECT SUFFERING FROM
IMMUNOGLOBULIN A NEPHROPATHY

- (11) P 2024 7585 B (51) Int. Cl. (2006)
A 61 K 31/4164
A 61 P 3/10
A 61 P 11/06
A 61 P 17/06
A 61 P 19/02
C 07 D 491/048
- (10) AP 2023 16005 A (44) 15(618)/2023
(21) AP 2020 16005
(22) 2020 12 14
(24) 2020 12 14
(31) 19217856.4
(32) 2019 12 19
(33) EP
(86) PCT/EP2020/085905, 2020 12 14
(73) Bayer Aktiengesellschaft (DE)
Kaiser-Wilhelm-Allee 1, Leverkusen 51373,
Germany (DE)
(72) CERNECKA, Hana (DE);
SACHER, Frank (DE);
TER LAAK, Antonius (DE);
SIEBENEICHER, Holger (DE);
PANKNIN, Olaf (DE);
MIYATAKE ONDOZABAL, Hideki (DE);
ROTTMANN, Antje (DE);
PILARI, Sabine (DE);
NUBBEMEYER, Reinhard (DE);
NOWAK-REPPEL, Katrin (DE);
LANGER, Gernot (DE);
SCHMIDT, Nicole (DE)
(74) Tamar Kochlamazashvili
(54) FUROINDAZOLE DERIVATIVES

PART B

B 01

- (11) P 2024 7589 B (51) Int. Cl. (2006)
B 01 J 23/00
F 01 N 3/00
- (10) AP 2023 16037 A (44) 19(622)/2023
(21) AP 2022 16037
(22) 2022 09 06
(24) 2022 09 06
(73) LEPL "Rapiel Dvali Institute of Machine
Mechanics" (GE)
Mindeli St. 10, 0168, Tbilisi, Georgia (GE)
(72) Giorgi Tchilashvili (GE);
Tamaz Natriashvili (GE);
Revaz Kavtaradze (GE);
Lana Shamanauri (GE)

(54) METHOD FOR HYDROGEN ENGINE
EXHAUST GASES NITROGEN OXIDES
NEUTRALIZATION

PART H

H 04

- (11) P 2024 7588 B (51) Int. Cl. (2006)
H 04 R 9/06
(10) AP 2023 15894 A (44) 15(618)/2023
(21) AP 2022 15894
(22) 2022 03 04
(24) 2022 03 04
(73) Vasil Petriashvili (GE)
Nutsbidze Slope, III m/r, III qu., bld. 8, ap. 1,
0183, Tbilisi, Georgia (GE);
Vazha Ezugbaia (GE)
Gldani V m/r, bld. 18, ap. 87, 0107, Tbilisi,
Georgia (GE);
Irakli Petriashvili (GE)
Nutsbidze Slope, III m/r, III qu., bld. 8, ap. 1,
0183, Tbilisi, Georgia (GE);
(72) Vasil Petriashvili (GE);
Vazha Ezugbaia (GE);
Irakli Petriashvili (GE)
(74) Nikoloz Gogilidze
(54) ACOUSTO-ELECTRIC TRANSDUCER
-

APPLICATIONS***

PART A

A 23

- (10) AP 2024 16424 A (51) A 23 K 20/24
A 23 K 20/158
A 23 K 20/105
C 11 C 1/02
- (43) 2024 01 25 №2
(21) AP 2022 16424
(22) 2022 06 13
(31) 17/304,194
(32) 2021 06 16
(33) US
(71) Zinpro Corporation (US)
10400 Viking Drive, Suite 240, Eden Prairie,
Minnesota, 55344, USA (US)
(72) STARK, Peter A. (US);
WIBBELS, Jason Bernard (US)
(74) Nikoloz Gogilidze
(85) 2023 12 14
(86) PCT/US2022/033218, 2022 06 13
(54) NEAT REACTION PRODUCT OF CALCIUM
AND VOLATILE FATTY ACIDS AS NUTRI-
TIONAL SUPPLEMENT FOR LIVESTOCK
AND POULTRY
(57) A process and composition for animal feed
supplements without substantial foul odor problems
prepared by reacting neat, a calcium metal source
selected from the group consisting of calcium oxide
and calcium hydroxide with a low molecular weight
volatile fatty acid selected from the group consisting of
butyric acid, isobutyric acid, 2 methyl 5 butyric acid,
valeric acid and isovaleric acid. Under controlled
reaction conditions (neat) and a controlled weight ratio
of the two reactants a product that is substantially odor
free and useful as an animal feed supplement results.

A 61

- (10) AP 2024 16373 A (51) A 61 K 31/44
A 61 P 29/00
A 61 P 11/04
C 07 D 213/89
- (43) 2024 01 25 №2
(21) AP 2022 16373
(22) 2022 03 11
(31) 202110265997.3; 202210195905.3
(32) 2021 03 11; 2022 03 01
(33) CN; CN
(71) Jiangxi Jemincare Group Co. Ltd (CN)
№33333, Yaohu North Avenue Hight-Tech
Industries Development Zone Nanchang,
Jiangxi 330000, Public Republic of China (CN);

Shanghai Jemincare Pharmaceutical
Co. Ltd (CN)
1st Floor, Block 1 No. 1118 Halei Road Pilot
Free Trade Zone, Pudong New Area,
Shanghai 201 203, Public Republic of
China (CN)

- (72) WAN, Qingwei (CN);
CHENG, Hongming (CN);
ZHANG, Yong (CN);
CAO, Cheng (CN);
PENG, Jianbiao (CN)
(74) Giorgi Meipariani
(85) 2023 10 11
(86) PCT/CN2022/080430, 2022 03 11
(54) CRYSTAL FORM OF PYRIDINE NITROGEN
OXIDE COMPOUND AND USE THEREOF
(57) Specifically, the present invention relates to a
crystal form of a compound of formula (I)

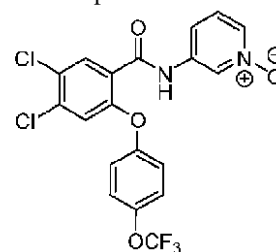

a crystal form of compound, pharmaceutical compo-
sition, and the use thereof.

- (10) AP 2024 16398 A (51) A 61 K 31/4168
A 61 P 1/16
A 61 P 3/10
A 61 P 3/06
A 61 P 3/04
A 61 P 9/00
A 61 P 9/04
A 61 P 9/10
A 61 P 9/12
A 61 P 35/00
A 61 P 3/00
A 61 P 43/00
- (43) 2024 01 25 №2
(21) AP 2022 16398
(22) 2022 05 19
(31) 63/191,321 ; 63/222,841 ; 63/307,515
(32) 2021 05 20; 2021 07 16; 2022 02 07
(33) US; US; US
(71) Rivus Pharmaceuticals, INC. (US)
706B Forest Street, Charlottesville, Virginia,
22903, USA (US)
(72) KHAN, Shaharyar (US);
JORKASKY, Diane (US)
(74) Nikoloz Gogilidze
(85) 2023 11 20
(86) PCT/US2022/029992, 2022 05 19

(54) METHODS OF TREATING MITOCHONDRIA-RELATED DISORDERS

(57)

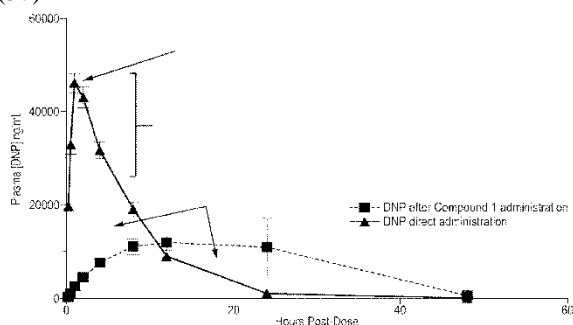

Fig. 1

Disclosed herein are methods of treatment comprising administering a therapeutically effective amount of 5-[(2,4-dinitrophenoxy) methyl]-1-methyl-2-nitro-1H-imidazole or a pharmaceutically acceptable salt thereof to a subject in need thereof. 5-[(2,4-Dinitrophenoxy) methyl]-1-methyl-2-nitro-1H-imidazole is useful in treating mitochondria-related disorders or conditions including obesity, diabetes, hypertension, cardiovascular disease, and liver diseases.

(10) AP 2024 16397 A (51) A 61 K 31/095
A 61 K 8/00
A 61 K 9/00
A 61 K 33/24
A 61 K 31/194
A 61 K 31/327
A 61 P 17/00

(43) 2024 01 25 №2
(21) AP 2022 16397
(22) 2022 04 30
(31) 63/182,196
(32) 2021 04 30
(33) US
(71) Noon Aesthetics M.R. LTD. (IL)
18 Ahavat Zion St., Tel Aviv, IL, 6215317,
Israel (IL)

(72) MINKIN, Masha (IL);
ROSMAN, Eran (IL)

(74) Tamar Kochlamazashvili

(85) 2023 11 20

(86) PCT/IB2022/054017, 2022 04 30

(54) TOPICAL FORMULATIONS COMPRISING
BENZOYL PEROXIDE AND AZELAIC
ACID, AND USE THEREOF

(57) Compositions comprising benzoyl peroxide, azelaic acid, a strontium salt, and methylsulfonylmethane (MSM) are provided, formulated as one or more dosage forms, wherein at least one dosage form comprises both benzoyl peroxide and azelaic acid. These compositions are formulated as cosmetic or medicinal products useful in treating skin diseases, disorders or conditions which may benefit from topical co-administration of BPO and azelaic acid. These skin

care products provide dermal shielding against neurogenic inflammation, stinging, itching, burning, redness, irritation, and/or other sensations and feelings associated with topical application of BPO and/or azelaic acid.

(10) AP 2024 16376 A (51) A 61 K 31/437
A 61 K 31/519
A 61 K 31/5365
A 61 P 11/00
A 61 P 13/12
A 61 P 27/02
A 61 P 1/16
A 61 P 7/04
A 61 P 9/10
C 07 D 519/00

(43) 2024 01 25 №2

(21) AP 2022 16376

(22) 2022 03 25

(31) 21165288.8; 21209682.0

(32) 2021 03 26; 2021 11 22

(33) EP; EP

(71) Chiesi Farmaceutici S.P.A. (IT)

Via Palermo, 26/A, 43122 Parma, Italy (IT)

(72) CARZANIGA, Laura (IT);

RIZZI, Andrea (IT);

IOTTI, Nicolò (IT);

RANCATI, Fabio (IT);

KARAWAJCZYK, Anna (IT);

WOLEK, Barbara Karolina (IT);

CLARK, David Edward (IT);

MULLINS, Toby Matthew Grover (IT);

KNIGHT, Keith Christopher (IT);

WHITTAKER, Ben Paul (IT);

LEVANTO, Stefano (IT)

(74) Shalva Gvaramadze

(85) 2023 10 19

(86) PCT/EP2022/057942, 2022 03 25

(54) TETRAHYDROTHIENO PYRIDINE DERIVATIVES AS DDRS INHIBITORS

(57) The present invention relates to compounds of general formula (I),

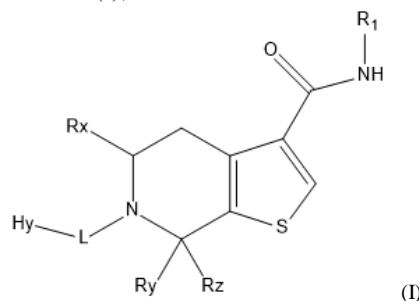

inhibiting Discoidin Domain Receptors (DDR inhibitors), methods of preparing such compounds, pharmaceutical compositions containing them and therapeutic use thereof. The compounds of the invention may be useful for instance in the treatment of many disorders associated with DDR mechanisms.

(10) AP 2024 16375 A (51) A 61 K 31/506
A 61 P 25/18
C 07 D 417/14

(43) 2024 01 25 №2

(21) AP 2022 16375

(22) 2022 03 15

(31) 63/162,333

(32) 2021 03 17

(33) US

(71) Merck Sharp & Dohme LLC (US)
126 East Lincoln Avenue, Rahway, NJ 07065,
USA (US)

(72) MITTAL, Sachin (US);
SKUDLAREK, Jason, W. (US);
RAHEEM, Izzat, T. (US)

(74) Shalva Gvaramadze

(85) 2023 10 12

(86) PCT/US2022/020297, 2022 03 15

(54) PRO DRUGS OF PDE10 COMPOUNDS

(57) The present invention is directed to pro drugs of 2-methyl-N-((5-methyl-1,3,4-thiadiazol-2-yl) methyl)-6-(((1S,2S)-2-(5-methylpyridin-2-yl)cyclopropyl)methoxy)pyrimidin-4-amine which are useful as therapeutic agents for the treatment of central nervous system disorders associated with phosphodiesterase 10 (PDE10). The present invention also relates to the use of such compounds for treating neurological and psychiatric disorders, such as schizophrenia, psychosis or Huntington's disease, and those associated with striatal hypofunction or basal ganglia dysfunction.

PART B

B 09

(10) AP 2024 16380 A (51) B 09 B 3/65
C 02 F 3/28
C 02 F 3/34

(43) 2024 01 25 №2

(21) AP 2022 16380

(22) 2022 11 10

(31) 63/264,410; 63/264,410; 63/264,410

(32) 2021 11 22; 2021 11 22; 2021 11 22

(33) US; US; US

(71) Carboniferous INC. (US)
200 San Jacinto St., Houston, TX 77004,
201 USA (US)

(72) MORRIS, Robert, Alden (US);
JACKSON, David, Taylor (US);
FELKER, Andrew, Jordan (US)

(74) Davit Dzamukashvili

(85) 2023 10 26

(86) PCT/US2022/049532, 2022 11 10

(54) CARBON SEQUESTRATION IN ANOXIC
ZONES

(57) A process and article for carbon sequestration including inducing a negative buoyancy in a carbon source with a non-buoyant material and submerging the carbon source into an aqueous anoxic environment. The negative buoyancy may be induced by bundling or baling the carbon source or by mixing it with a slurry.

PART C

C 07

(10) AP 2024 16390 A (51) C 07 D 401/04
C 07 D 401/12
C 07 D 231/14

(43) 2024 01 25 №2

(21) AP 2022 16390

(22) 2022 04 14

(31) 63/174,860

(32) 2021 04 14

(33) US

(71) Biocryst Pharmaceuticals, INC. (US)
4505 Emperor Blvd., Suite 200, Durham,
NC 2773, USA (US)

(72) KOTIAN, Pravin, L. (US);
BABU, Yarlagadda, S. (US);
ZHANG, Weihe (US);
LU, Peng-Cheng (US);
DANG, Zhao (US);
RAMAN, Krishnan (US)

(74) Nikoloz Gogilidze

(85) 2023 11 12

(86) PCT/US2022/024805, 2022 04 14

(54) BICYCLIC HETEROAROMATIC INHIBI-
TORS OF KLK5

(57) Disclosed are compounds of formulae (I) - (IV),

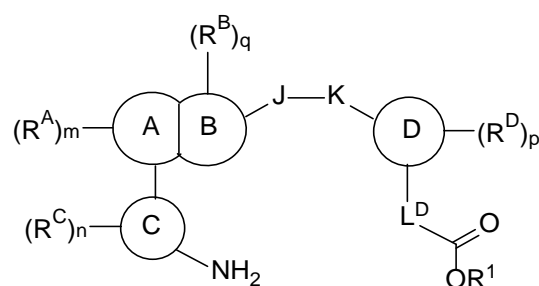
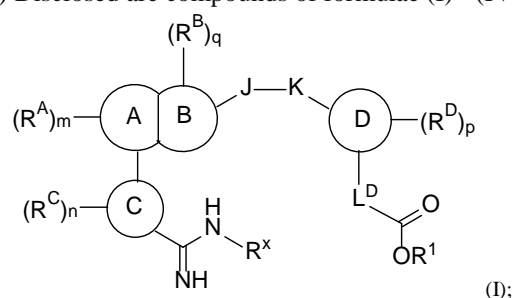

(II) and (III);

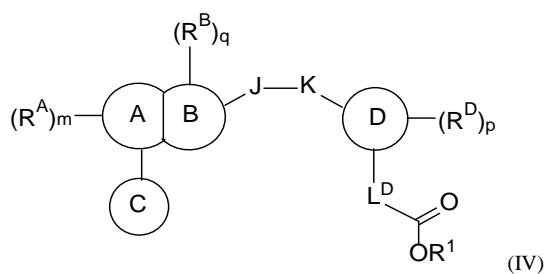

and pharmaceutically acceptable salts thereof, which are inhibitors of kallikrein-related peptidase 5 (KLK5). Also provided are pharmaceutical compositions comprising such a compound, and methods of using the compounds and compositions in the treatment or prevention of a disease or condition characterized by aberrant KLK5 activity, such as Netherton Syndrome.

PART F

F 28

- (10) AP 2024 16403 A (51) F 28 D 1/04
 F 28 D 21/00
 F 28 F 21/08
 F 28 F 9/26
- (43) 2024 01 25 №2
 (21) AP 2022 16403
 (22) 2022 05 02
 (31) 102021000011180
 (32) 2021 05 03
 (33) IT
 (71) Fondital S.P.A. a Socio Unico (IT)
 Via Cerreto, 40, Vobarno (BS), 25079, Italy (IT)
 (72) NIBOLI, Orlando (IT)
 (74) Tamar Kochlamazashvili
 (85) 2023 11 28
 (86) PCT/IB2022/054039, 2022 05 02
 (54) LIQUID CIRCULATION RADIATOR FOR
 INDOOR CLIMATE CONTROL AND
 MANUFACTURING METHOD
 THEREOF
 (57) A liquid circulation radiator (1) for indoor climate control comprises a monolithic body (2) made of die-cast aluminium comprising : a plurality of tubular elements (3) provided with respective inner chambers (4), in which an operating liquid circulates in use; a front heat exchange plate (5); and a plurality of heat exchange fins (6), substantially orthogonal to the plate (5); the tubular elements (3) and the respective chambers (4) extend along respective axes (A) substantially rectilinear and parallel to one another and the radiator comprises connection assemblies (20) connecting respective longitudinal ends (7) of pairs of adjacent tubular elements (3) to define a circuit (C) for the operating liquid circulating in the radiator (1).

UTILITY MODELS

PATENTED UTILITY MODEL

PART E

E 02

- (11) U 2024 2160 Y (51) Int. Cl. (2006)
E 02 B 3/04
- (10) AU 2023 16174 U (44) 18(621)/2023
- (21) AU 2023 16174
- (22) 2023 02 22
- (24) 2023 02 22
- (73) Archil Prangishvili (GE)
Pasteur St. 1a, ap. 2, 0102, Tbilisi,
Georgia (GE);
Zaur Tsikhelashvili (GE)
Dighomi Array, V qu., bld. 20, ap. 42, 0159,
Tbilisi, Georgia (GE);
Anzor Kupatadze (GE)
Dolidze St. 61, Tbilisi, Georgia (GE);
Beka Tchadashvili (GE)
Dolidze St. 61, Tbilisi, Georgia (GE);
Teona Chanadiri (GE)
Dolidze St. 61, Tbilisi, Georgia (GE);
Giorgi Berdzenashvili (GE)
Mezghvauri St. 57, Batumi, Georgia (GE);
Giorgi Jerenashvili (GE)
Gldani, IVm/r, bld. 110, ap. 94, Tbilisi,
Georgia (GE);
Ioseb Tsikhelashvili (GE)
Dighomi Array, V qu., bld. 20, ap. 42, 0159,
Tbilisi, Georgia (GE);
Shota Tsikhelashvili (GE)
Dighomi Array, V qu., bld. 20, ap. 42, 0159,
Tbilisi, Georgia (GE);
Zurab Gasitashvili (GE)
Didi Dighomi, Demetre Tavaddebuli St. 14, ap.
7, Tbilisi, Georgia (GE)
- (72) Archil Prangishvili (GE);
Zaur Tsikhelashvili (GE);
Anzor Kupatadze (GE);
Beka Tchadashvili (GE);
Teona Chanadiri (GE);
Giorgi Berdzenashvili (GE);
Giorgi Jerenashvili (GE);
Ioseb Tsikhelashvili (GE);
Shota Tsikhelashvili (GE);
Zurab Gasitashvili (GE)
- (54) BEACH PROTECTION ENGINEERING-
HYDROTECHNICAL CONSTRUCTION
-

DESIGNS

REGISTERED DESIGNS

(11) D 2024 989 S (51) 06-02
(10) AD 2023 1306 S (44) 2023 10 10 №19
(21) AD 2023 1306
(22) 2023 04 20
(24) 2023 04 20
(28) 1
(18) 2028 04 20
(731) Aleksandre Bolkvadze (GE)
Davit Aghmashenebeli Av. 129a, fl. 4, 0102,
Tbilisi, Georgia (GE)
(72) Ana Telia (GE)
(54) TABLE FOR MASSAGE

(11) D 2024 988 S (51) 11-01
(10) AD 2023 1302 S (44) 2023 10 10 №19
(21) AD 2023 1302
(22) 2023 03 28
(24) 2023 03 28
(28) 11
(18) 2028 03 28
(73) LTD "Eshvi" (GE)
Gergeti St. 3, 0105, Mtatsminda District,
Tbilisi, Georgia (GE)
(72) Natia Chkhartishvili (GE)
(54) 10-11. RING; 1.-8 EARRING; 9. NECKLACE

(11) D 2024 990 S (51) 11-01
(10) AD 2023 1303 S (44) 2023 09 11 №17
(21) AD 2023 1303
(22) 2023 04 07
(24) 2023 04 07
(28) 17
(18) 2028 04 07
(73) LTD "Zarapkhana" (GE)
Ljublyana St. 15, 0159, Tbilisi, Georgia (GE)
(72) Tea Tetradze (GE)
(54) 10. BRACELET; 11.-12. EARRING;
13. NECKLACE; 14.-16. EARRING;
17. RING; 1. NECKLACE; 2. RING;
3. EARRING; 4.-6. BRACELET
7. NECKLACE; 8.-9. EARRING

DESIGN REGISTERED ACCORDING TO THE ACCELERATED PROCEDURE

The decision can be appealed at the Chamber of Appeal of Sakpatenti within 3 months from the publication.

- (11) D 2024 991 S
- (21) AD 2023 1354
- (24) 2023 12 21
- (28) 1
- (18) 2028 12 21
- (73) Shota Tkhilishvili (GE)
Rustaveli St. 36, Mtskheta, Georgia (GE)
- (72) Shota Tkhilishvili (GE)
- (54) COAT
- (55)



1.1



1.2



1.3



1.4



1.5

**DESIGNS, WHICH HAVE BEEN REGISTERED WITH THE INTERNATIONAL
BUREAU CLAIMING PRIORITY ON THE TERRITORY OF GEORGIA**

The decision can be appealed at the Chamber of Appeal of Sakpatenti within 3 months from the publication or at the Mtskheta District Court Administrative Cases Board (Address: №17, Samkhedro St., Mtskheta), within 1 month following the publication.

- (11) DM/228 035 (51) 11-01
 (15) 2023 03 30 (44) 40/2023 (2023 10 06)
 (22) 2023 03 30
 (28) 1
 (73) Harry Winston SA
 Chemin Du Tourbillon 8, 1228 Plan-les-Ouates (CH)
 (85) CH
 (86) CH
 (87) CH
 (88) CH
 (89) CH
 (81) III. KG, LI, MK, CA, OM, GE, BA, NO, RU, EM, AM, MD, TN, GB, TR, MN, CH, AL, UA, MA, SG,
 MC, BZ, ME, AZ
 (72) Christina YANG
 C/o Harry Winston Inc. 718 Fifth Avenue, 10019, New York (US)
 (74) The Swatch Group AG (The Swatch Group SA) (The Swatch Group Ltd.)
 Faubourg Du Lac 6, 2501 Biel/Bienne (CH)
 (46) 2023 10 06
 (54) 1. FINGER RING
 (55)

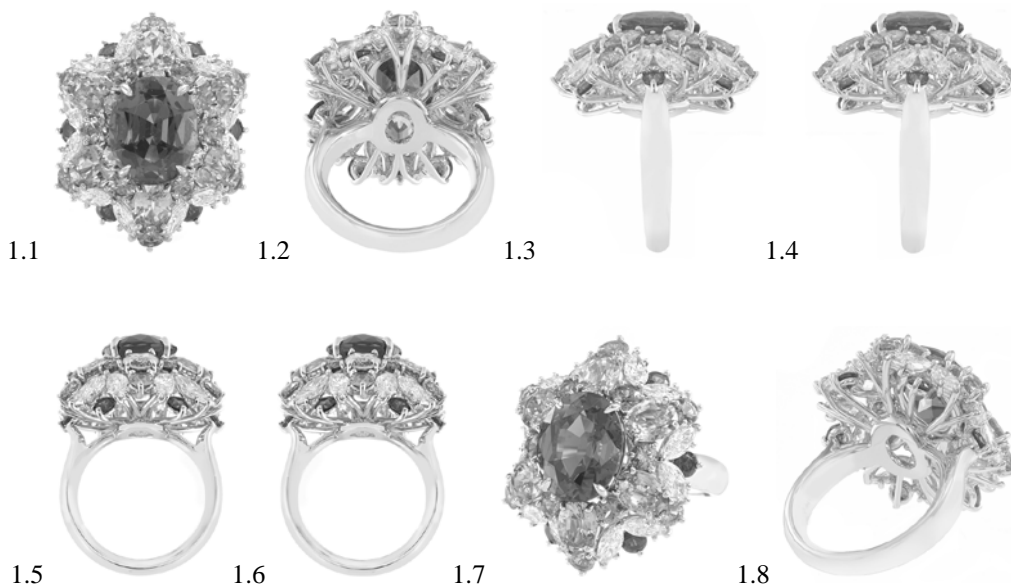

- (11) DM/231 752 (51) 14-02
(15) 2023 08 17 (44) 40/2023 (2023 10 06)
(22) 2023 08 17
(28) 3
(73) Token Finansal Teknolojiler Anonim Şirketi
Reşitpaşa Mahallesi Katar Caddesi Öğrenci Otomasyon SitesiNo:2/11/1 Sarıyer, 34467 İstanbul (TR)
(85) TR
(86) TR
(87) TR
(88) TR
(89) TR
(81) III. KG, GE, RS, EM, ME, AZ
(72) Bilgen Gülşen Deliormanlı
Reşitpaşa Mahallesi Katar Caddesi Öğrenci Otomasyon SitesiNo:2/11/1 Sarıyer, 34467, İstanbul (TR);
Serhan Kaya
Reşitpaşa Mahallesi Katar Caddesi Öğrenci Otomasyon Sitesi No:2/11/1 Sarıyer, 34467, İstanbul (TR);
Ali Şahinkaya
Göztepe Yolu Mah. Atatürk Cad. No:7 Kat:4 Anadolu Hisarı, 34815, İstanbul (TR);
Murat Armağan
Göztepe Yolu Mah. Atatürk Cad. No:7 Kat:4 Anadolu Hisarı, 34815, İstanbul (TR);
(74) Ankara Patent Bureau
Mustafa Kemal Mah., Dumlupınar Bulv. No 274/7 İç Kapı No 161 Çankaya Ankara (TR)
(46) 2023 10 06
(54) 1. POINT-OF-SALE TERMINAL (POS DEVICE), 2. INTERFACE UNIT FOR POINT-OF-SALE
TERMINAL, 3. POINT-OF-SALE TERMINAL (POS DEVICE) WITH INTERFACE UNIT
(55)



1.1

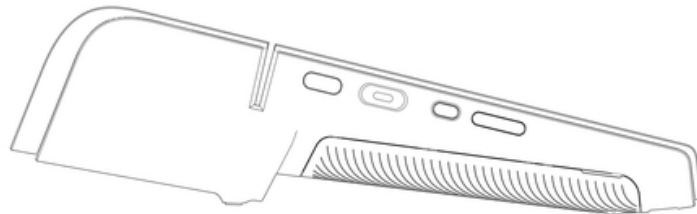

1.2

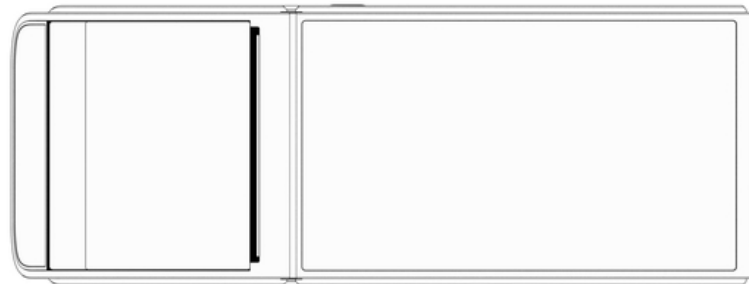

1.3

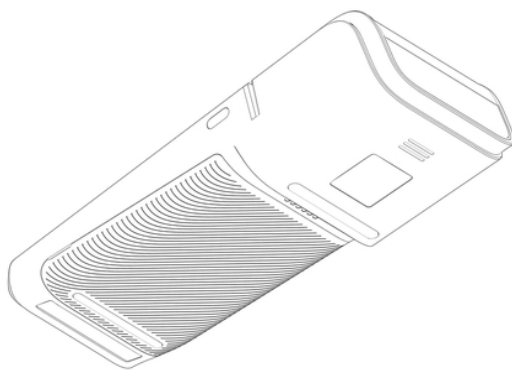

1.4



1.5



2.1

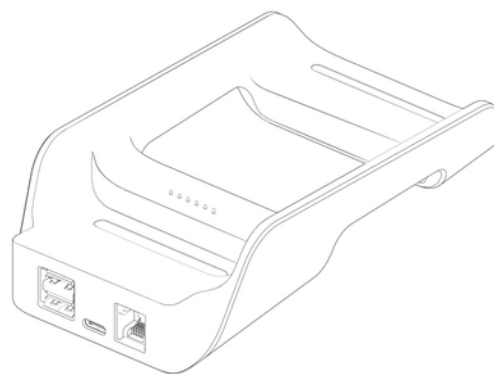

2.2

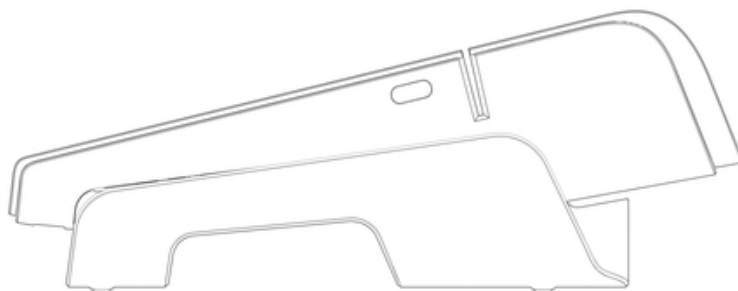

3.1

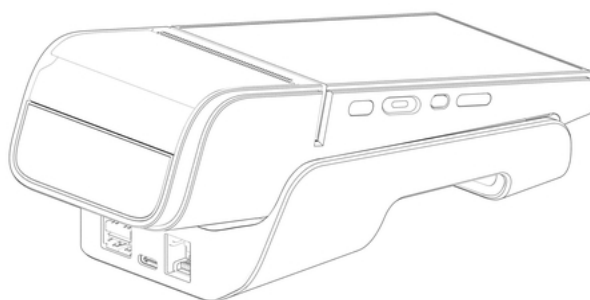

3.2

- (11) DM/231 783 (51) 27-07
- (15) 2023 09 20 (44) 40/2023 (2023 10 06)
- (22) 2023 09 20
- (28) 1
- (30) No1: 08.07.2023; 202330427208; CN
- (73) Dongguan Cloupor Atomization Technology Co., Ltd.
Room 201, Building 1, No.13 Fuma Road, Chigang, Humen Town Dongguan, Guangdong (CN)
- (85) –
- (86) CN
- (87) –
- (88) CN
- (89) CN
- (81) III. UA, GE, RU, EM
- (72) Wang LIN
Room201, Building 1, No.13 Fuma Road, Chigang, Humen Town, Dongguan (CN);
Bo LI
Room201, Building 1, No.13 Fuma Road, Chigang, Humen Town, Dongguan (CN);
Lin CHENG
Room201, Building 1, No.13 Fuma Road, Chigang, Humen Town, Dongguan (CN);
Xu ZHANG
Room201, Building 1, No.13 Fuma Road, Chigang, Humen Town, Dongguan (CN);
Lianhua ZHANG
Room201, Building 1, No.13 Fuma Road, Chigang, Humen Town, Dongguan (CN)
- (74) HUAXUE IP AGENCY CO., LTD
16th Floor, Tower A, R&F Yingtai Plaza, No.100 Huangpu Avenue West, Tianhe District Guangzhou, Guangdong (CN)
- (54) 1. ELECTRONIC CIGARETTE
- (55)

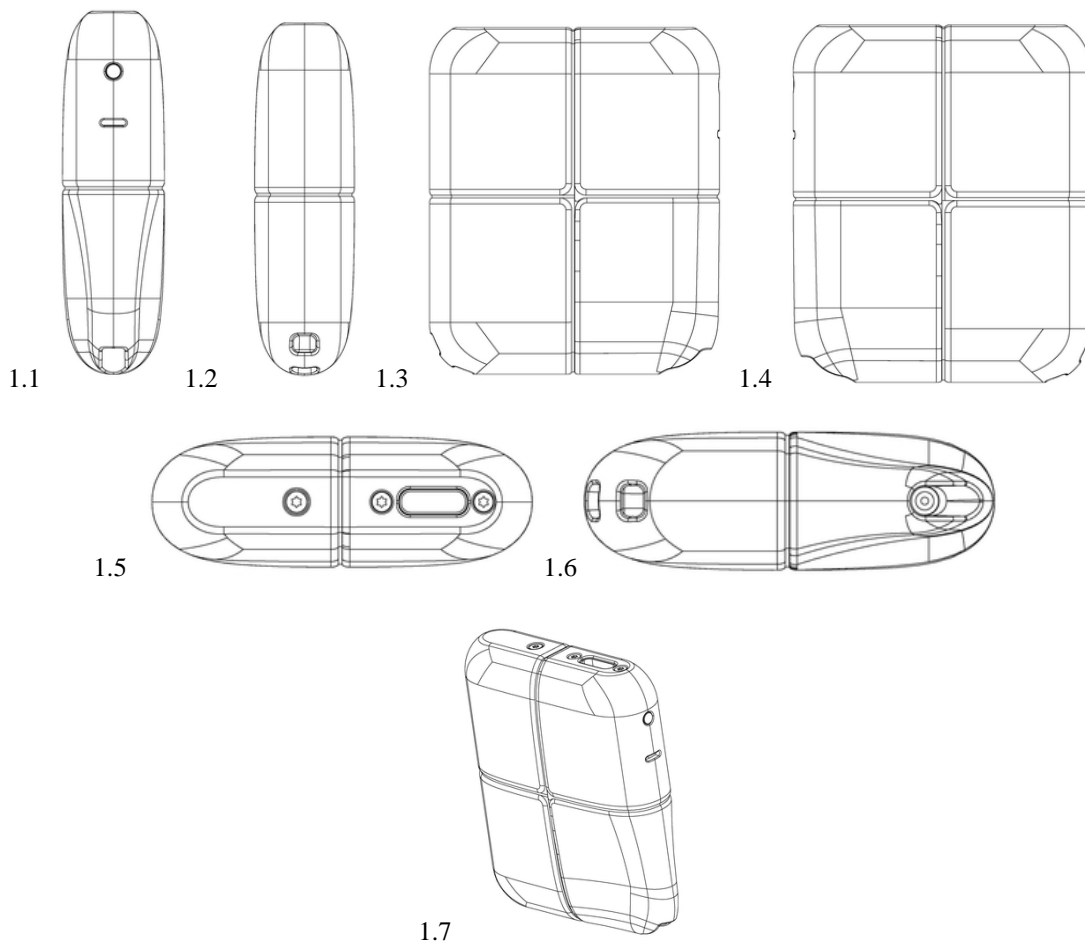

- (11) DM/228 243 (51) 10-02
 (15) 2023 04 11 (44) 41/2023 (2023 10 13)
 (22) 2023 04 11
 (28) 4
 (73) Rado Uhren AG (Rado Watch Co. LTD.) (Montres Rado SA)
 Bielstrasse 45, 2543 Lengnau (CH)
 (85) –
 (86) CH
 (87) CH
 (88) –
 (89) CH
 (81) III. UA, TR, OM, GE, BA, NO, SG, MA, CH, EM, TN, GB
 (72) 1-2: Marco SCARINZI
 Chemin du Cledar 1, 2501, Biel-Bienne, Bern (CH);
 3 Alfredo HÄBERLI
 C/o Design Development Seefeldstrasse 301a, 8008, Zürich (CH);
 3: Xavier Perrenoud
 c/o XJC Sàrl Nord 114, 2300, La Chaux-de-Fonds (CH);
 4: Christian VERDON
 c/o Rado Uhren AG (Rado Watch CO. LTD.) (Montres Rado SA) Bielstrasse 45, 2543, Lengnau (CH)
 (74) The Swatch Group AG
 Faubourg du Lac 6, 2501 Biel (CH)
 (46) 2023 10 13
 (54) 1.-3. WATCH, 4. WRIST WATCH
 (55)

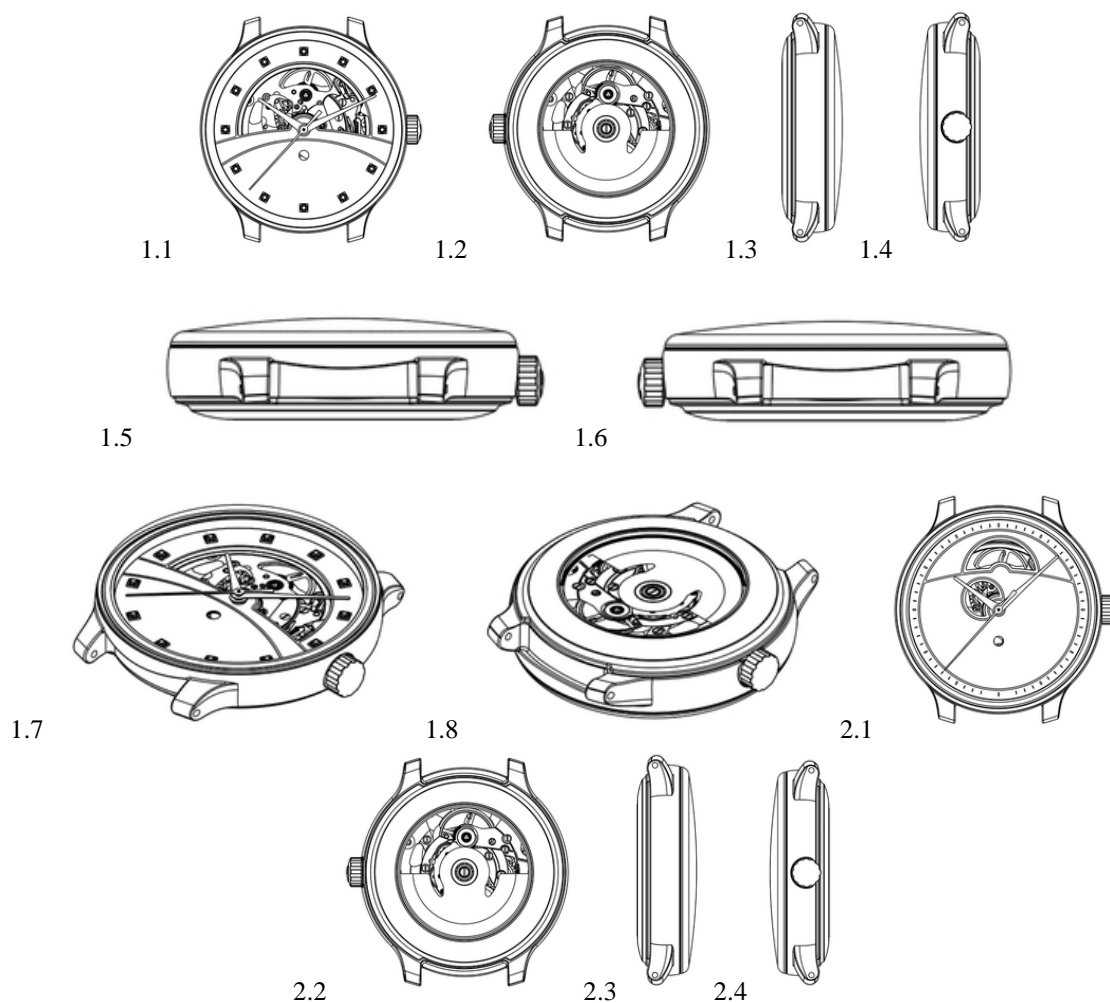

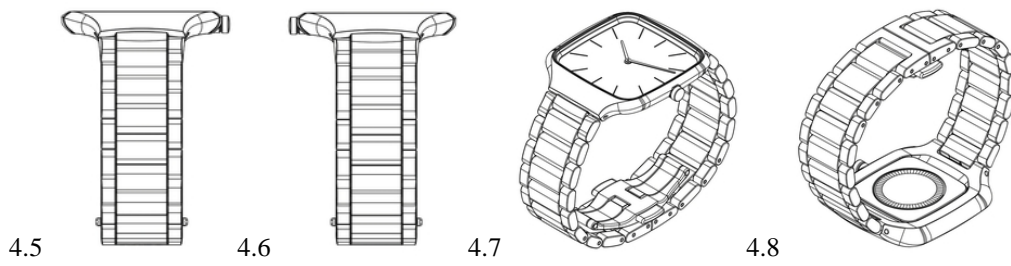
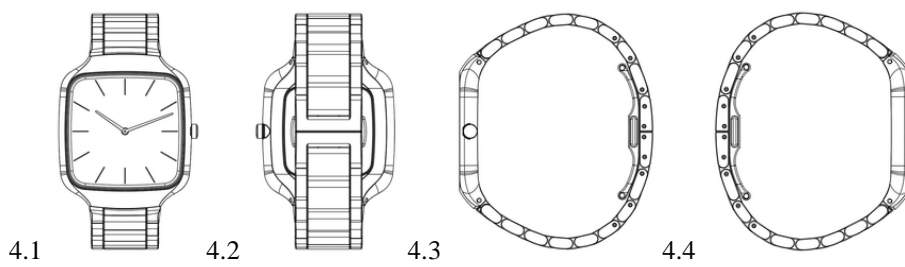
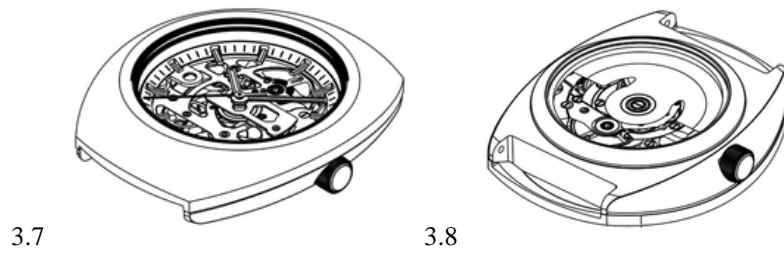
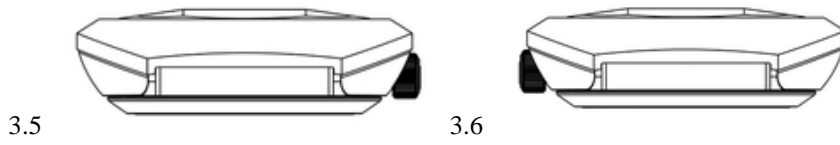
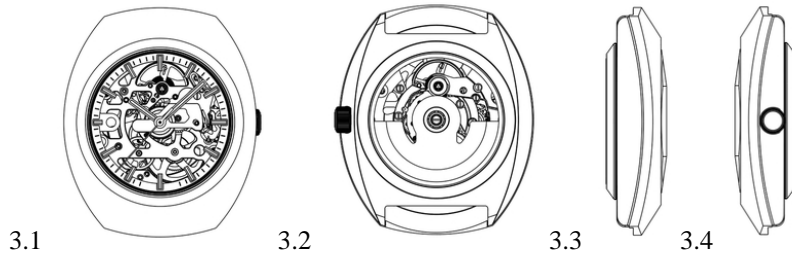
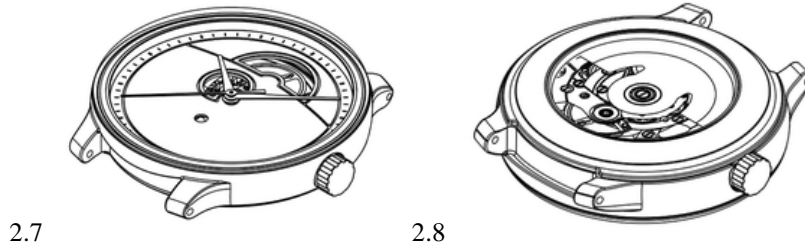
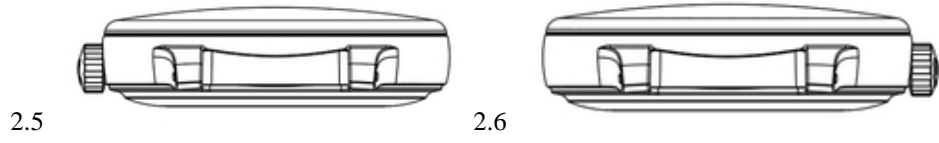

- (11) DM/232 180 (51) 26-06
 (15) 2023 09 08 (44) 42/2023 (2023 10 20)
 (22) 2023 09 08
 (28) 2
 (30) No1: 30.03.2023; 202330165486.4; CN; No2: 30.03.2023; 202330165482.6; CN
 (73) Zhejiang Leapmotor Technology Co., Ltd
 1st Floor, No.451 Wulianwang Street, Binjiang District, 310051 Hangzhou, Zhejiang (CN)
 (85) CN
 (86) CN
 (87) CN
 (88) CN
 (89) CN
 (81) III. CA, TR, GE, US, RS, NO, EG, IL, RU, CH, JP, KR, EM, IS, MX, MC, VN, AZ, TN, GB
 (72) Shuyue YU
 1st Floor, No.451 Wulianwang Street, Binjiang District, 310051, Hangzhou, Zhejiang (CN);
 Jianing WU
 1st Floor, No.451 Wulianwang Street, Binjiang District, 310051, Hangzhou, Zhejiang (CN);
 Xingchen LEI
 1st Floor, No.451 Wulianwang Street, Binjiang District, 310051, Hangzhou, Zhejiang (CN);
 Wentao LI
 1st Floor, No.451 Wulianwang Street, Binjiang District, 310051, Hangzhou, Zhejiang (CN);
 Yiqun WU
 1st Floor, No.451 Wulianwang Street, Binjiang District, 310051, Hangzhou, Zhejiang (CN)
 (74) China Wispro Intellectual Property LLP.
 Room A209, Zhongdi Building, China University Of Geosciences Base, No.8 Yuexing 3rd Road, High-Tech
 Industrial Estate, Nanshan District, 518000 Shenzhen, Guangdong (CN)
 (46) 2023 10 20
 (54) 1. HEADLIGHT FOR VEHICLES, 2. REAR LAMP CLUSTER FOR VEHICLES
 (55)

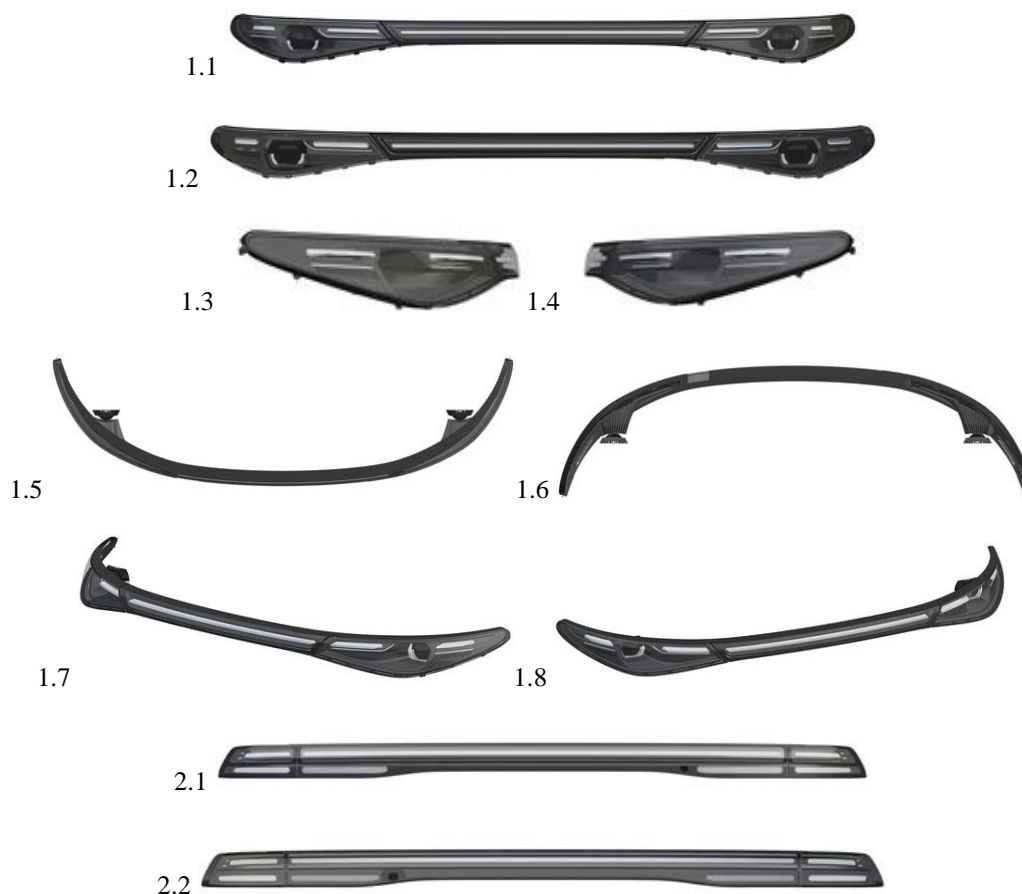



- (11) DM/228 442 (51) 11-01
 (15) 2023 04 21 (44) 43/2023 (2023 10 27)
 (22) 2023 04 21
 (28) 2
 (73) Harry Winston SA
 Chemin du Tourbillon 8, 1228 Plan-les-Ouates (CH)
 (85) CH
 (86) CH
 (87) CH
 (88) CH
 (89) CH
 (81) III. KG, LI, MK, OM, TR, CA, GE, BA, MN, NO, CH, EM, AL, AM, UA, MA, SG, MC, MD, ME, BZ, AZ,
 TN, GB
 (72) Rie YATSUGI-KANG
 c/o Harry Winston Inc. 718 Fifth Avenue, 10019, New York (US)
 (74) The Swatch Group AG (The Swatch Group SA) (The Swatch Group Ltd.)
 Faubourg du Lac 6, 2501 Biel/Bienne (CH)
 (46) 2023 10 27
 (54) 1. TIARA, 2. PAIR OF EARRING
 (55)

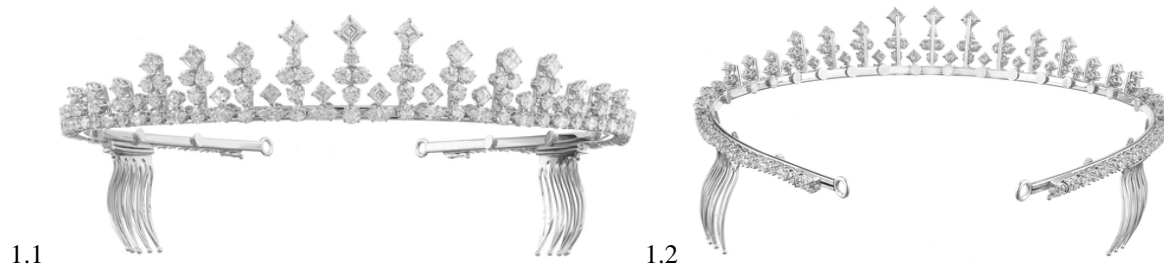

1.1

1.2



1.3



1.4



1.5

1.6

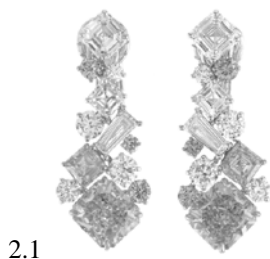
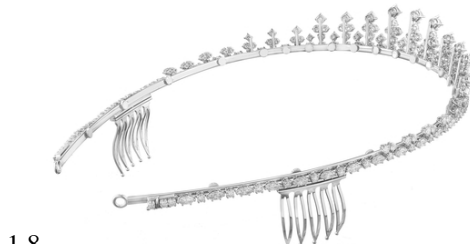
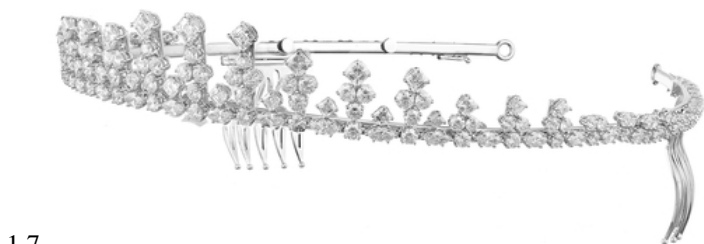

- (11) DM/232 482 (51) 25-03
(15) 2023 09 14 (44) 43/2023 (2023 10 27)
(22) 2023 09 14
(28) 1
(30) No1: 10.12.2023; 2023504355; RU
(73) Dmitriy Luchanskiy
Ul. Landyshevaya, D. 14, K. 3, Kv. 66 Moscow (RU)
(85) –
(86) RU
(87) –
(88) –
(89) RU
(81) III. AM, CA, GE, TR, BR, MN, DE, IL, TJ, AZ, CN
(72) Dmitriy Luchanskiy
Ul. Landyshevaya, D. 14, K. 3, Kv. 66 Moscow (RU)
(74) Alexandra Bolotova
A/ia 35, P/o 99, 630099 Novosibirsk (RU)
(46) 2023 10 27
(54) 1. HOUSE
(55)

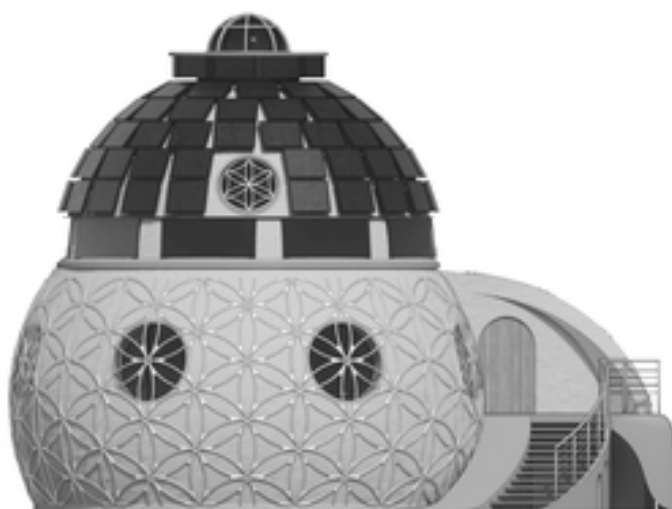

1.1

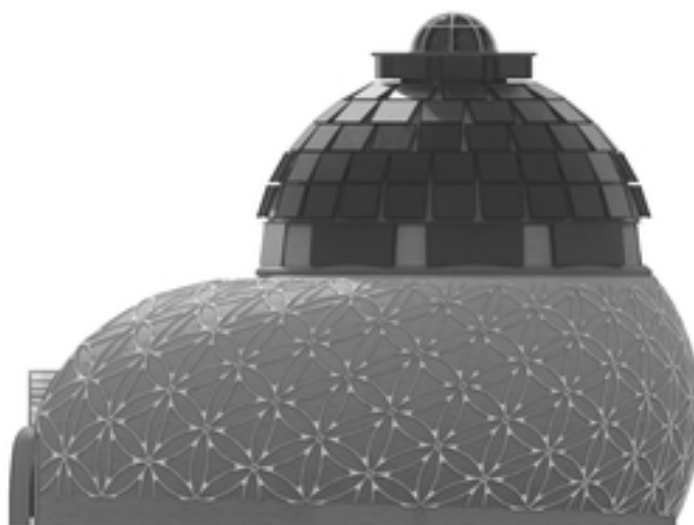

1.2



1.3

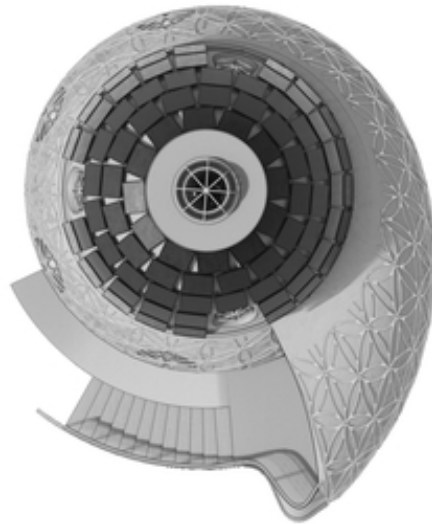

1.4

- (11) DM/228 141 (51) 10-02
 (15) 2023 03 31 (44) 44/2023 (2023 11 03)
 (22) 2023 03 31
 (28) 1
 (73) Compagnie des Montres Longines, Francillon S.A. (Longines Watch Co. Francillon Ltd.)
 Les Longines 8, 2610 St-Imier (CH)
 (85) CH
 (86) CH
 (87) CH
 (88) CH
 (89) CH
 (81) III. KG, LI, MK, CA, OM, GE, BA, NO, RU, EM, AM, MD, TN, GB, TR, MN, CH, KR, AL, UA, MA, SG,
 MC, BZ, ME, AZ
 (72) Antoine Guyomard
 c/o Compagnie des Montres Longines, Francillon S.A. Les Longines 8, 2610, St-Imier (CH)
 (74) The Swatch Group AG (The Swatch Group SA) (The Swatch Group Ltd.)
 Faubourg du Lac 6, 2501 Biel/Bienne (CH)
 (46) 2023 11 03
 (54) 1. WRISTWATCH
 (55)

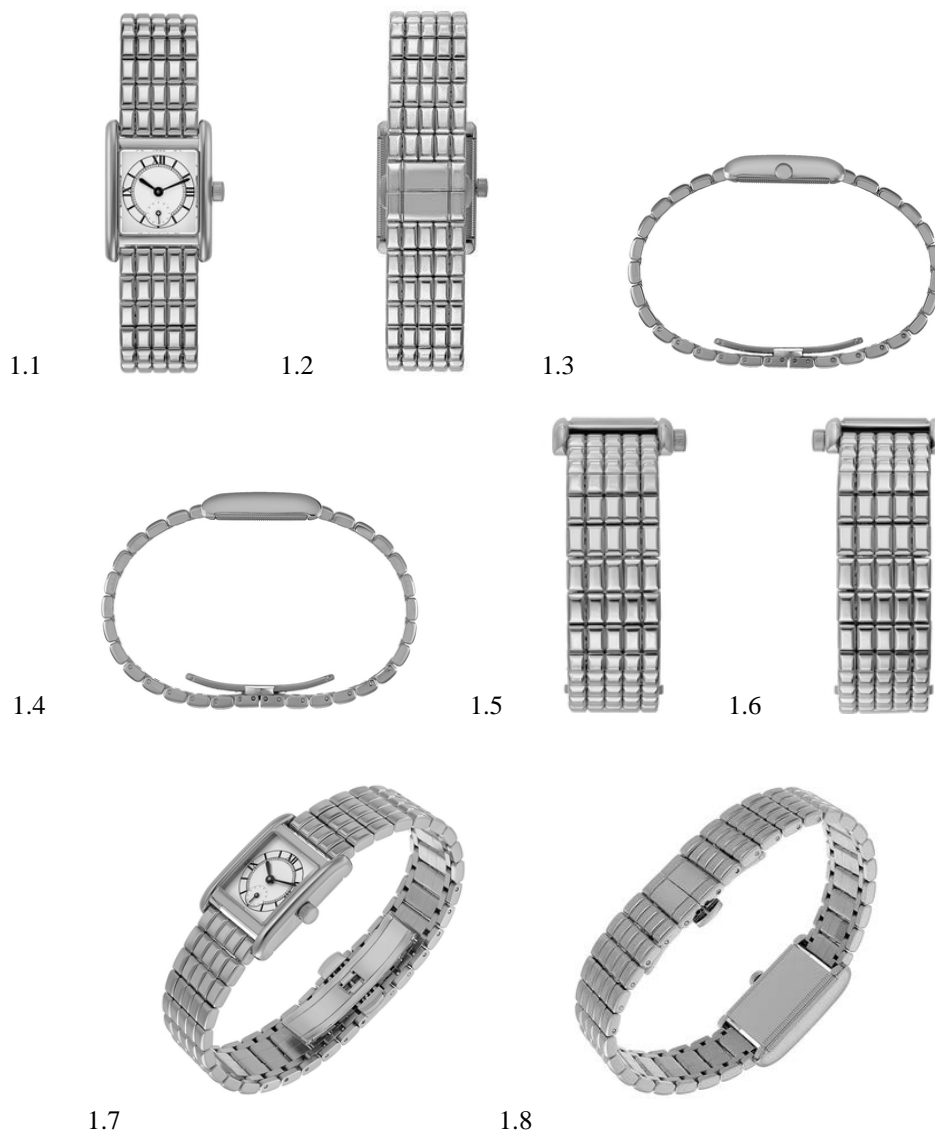

- (11) DM/228 281 (51) 10-07
- (15) 2023 03 28 (44) 44/2023 (2023 11 03)
- (22) 2023 03 28
- (28) 1
- (73) Compagnie des Montres Longines, Francillon S.A. (Longines Watch Co. Francillon Ltd.)
Les Longines 8, 2610 St-Imier (CH)
- (85) CH
- (86) CH
- (87) CH
- (88) CH
- (89) CH
- (81) III. KG, LI, GE, CA, OM, MK, BA, NO, RU, EM, AM, MD, TN, GB, TR, MN, CH, KR, AL, UA, SG,
MA, MC, BZ, ME, AZ
- (72) Antoine Laurent Guyomard
c/o Compagnie des Montres Longines, Francillon S.A., Les Longines 8, 2610, St-Imier (CH)
- (74) The Swatch Group AG (The Swatch Group SA) (The Swatch Group Ltd.)
Faubourg du Lac 6, 2501 Biel/Bienne (CH)
- (46) 2023 11 03
- (54) 1. WATCH CASE
- (55)

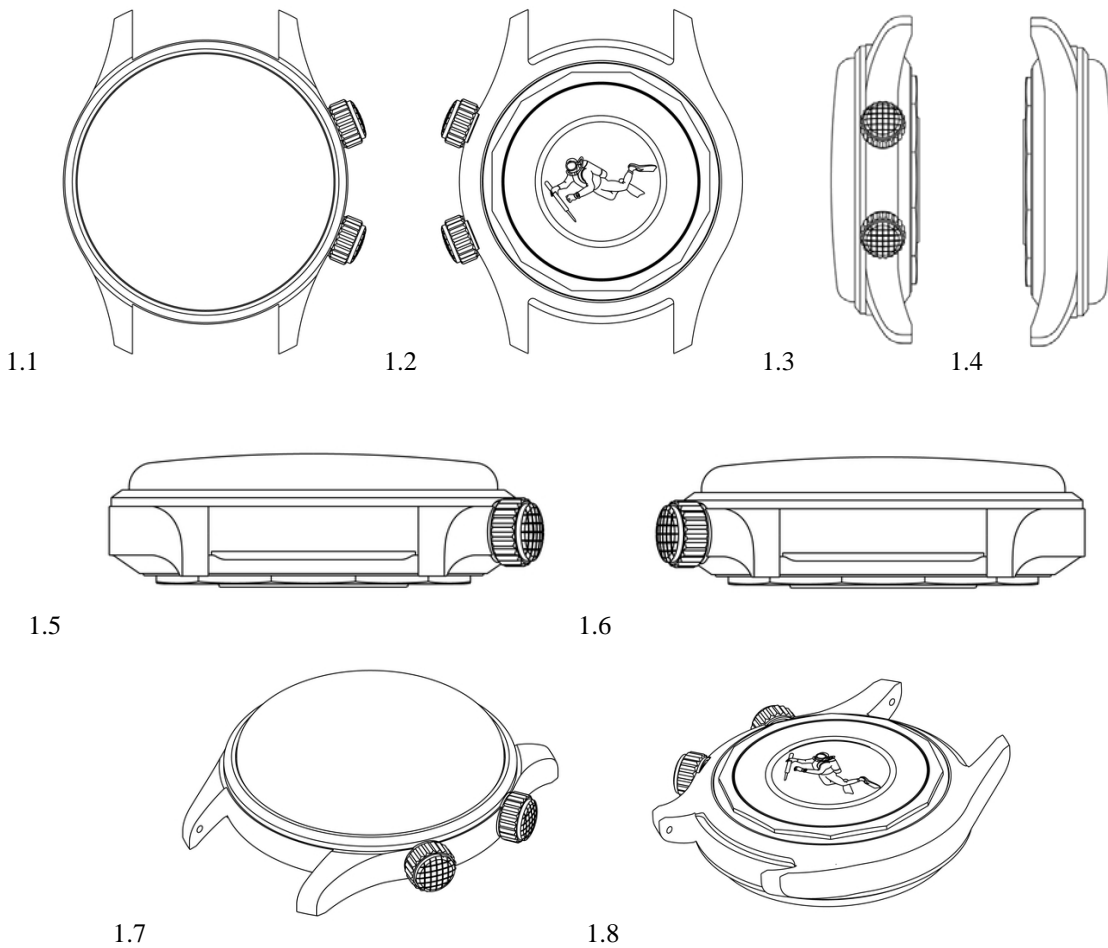

- (11) DM/232 512 (51) 12-08
 (15) 2023 09 08 (44) 43/2023 (2023 10 27)
 (22) 2023 09 08
 (28) 12
 (30) No1: 30.03.2023; 202330165498.7; CN; No2: 13.03.2023; 202330111603.9; CN; No3: 21.03.2023; 202330135549.1; CN; No4: 21.03.2023; 202330136556.3; CN; No5: 30.03.2023; 202330165484.5; CN; No6: 30.03.2023; 202330165489.8; CN; No7: 30.03.2023; 202330165490.0; CN; No8: 30.03.2023; 202330165483.0; CN; No9: 30.03.2023; 202330165497.2; CN; No10: 27.03.2023; 202330152763.8; CN; No11: 15.08.2023; 202330522141.X; CN; No12: 05.09.2023; 202330575383.5; CN
 (73) Zhejiang Leapmotor Technology Co., Ltd
 1st Floor, No.451 Wulianwang Street, Binjiang District, 310051 Hangzhou, Zhejiang (CN)
 (85) CN
 (86) CN
 (87) CN
 (88) CN
 (89) CN
 (81) III. US, CA, GE, TR, RS, NO, EG, IL, RU, CH, JP, KR, EM, IS, MX, MC, VN, AZ, TN, GB
 (72) 1: Wentao LI
 1st Floor, No.451 Wulianwang Street, Binjiang District, 310051, Hangzhou, Zhejiang (CN);
 1: Yiqun WU
 1st Floor, No.451 Wulianwang Street, Binjiang District, 310051, Hangzhou, Zhejiang (CN);
 1: Tiwei LU
 1st Floor, No.451 Wulianwang Street, Binjiang District, 310051, Hangzhou, Zhejiang, (CN);
 1: Xingchen LEI
 1st Floor, No.451 Wulianwang Street, Binjiang District, 310051, Hangzhou, Zhejiang, (CN);
 1: Jianing WU
 1st Floor, No.451 Wulianwang Street, Binjiang District, 310051, Hangzhou, Zhejiang (CN);
 10: Song ZHANG
 1st Floor, No.451 Wulianwang Street, Binjiang District, 310051, Hangzhou, Zhejiang (CN);
 10: Xingchen LEI
 1st Floor, No.451 Wulianwang Street, Binjiang District, 310051, Hangzhou, Zhejiang (CN);
 10-12: Jianing WU
 1st Floor, No.451 Wulianwang Street, Binjiang District, 310051, Hangzhou, Zhejiang (CN);
 10-12: Shuyue YU
 1st Floor, No.451 Wulianwang Street, Binjiang District, 310051, Hangzhou, Zhejiang (CN);
 11: Wei ZHOU
 1st Floor, No.451 Wulianwang Street, Binjiang District, 310051, Hangzhou, Zhejiang (CN);
 11: Boyi NI
 1st Floor, No.451 Wulianwang Street, Binjiang District, 310051, Hangzhou, Zhejiang (CN);
 12: Song ZHANG
 1st Floor, No.451 Wulianwang Street, Binjiang District, 310051, Hangzhou, Zhejiang (CN);
 12: Mingxiao ZHENG
 1st Floor, No.451 Wulianwang Street, Binjiang District, 310051, Hangzhou, Zhejiang (CN);
 2: Zifeng YU
 1st Floor, No.451 Wulianwang Street, Binjiang District, 310051, Hangzhou, Zhejiang (CN);
 2-4: Shuyue YU
 1st Floor, No.451 Wulianwang Street, Binjiang District, 310051, Hangzhou, Zhejiang (CN);
 2-4: Pengcheng ZHOU
 1st Floor, No.451 Wulianwang Street, Binjiang District, 310051, Hangzhou, Zhejiang (CN);
 2-4: Shaoming WANG
 1st Floor, No.451 Wulianwang Street, Binjiang District, 310051, Hangzhou, Zhejiang (CN);
 3-4: Weiwei GAO
 1st Floor, No.451 Wulianwang Street, Binjiang District, 310051, Hangzhou, Zhejiang (CN);
 3-4: Xingchen LEI
 1st Floor, No.451 Wulianwang Street, Binjiang District, 310051, Hangzhou, Zhejiang (CN);
 3-4: Doudou ZHANG
 1st Floor, No.451 Wulianwang Street, Binjiang District, 310051, Hangzhou, Zhejiang (CN);
 5: Wenyu YAN
 1st Floor, No.451 Wulianwang Street, Binjiang District, 310051, Hangzhou, Zhejiang (CN);

- 6-7: Tiwei LU
1st Floor, No.451 Wulianwang Street,Binjiang District, 310051, Hangzhou, Zhejiang (CN);
- 6-8: Wentao LI
1st Floor, No.451 Wulianwang Street,Binjiang District, 310051, Hangzhou, Zhejiang (CN);
- 6-8: Shuyue YU
1st Floor, No.451 Wulianwang Street,Binjiang District, 310051, Hangzhou, Zhejiang (CN);
- 6-8: Xingchen LEI
1st Floor, No.451 Wulianwang Street,Binjiang District, 310051, Hangzhou, Zhejiang (CN);
- 6-8: Jianing WU
1st Floor, No.451 Wulianwang Street,Binjiang District, 310051, Hangzhou, Zhejiang (CN);
- 8: Yiqun WU
1st Floor, No.451 Wulianwang Street,Binjiang District, 310051, Hangzhou, Zhejiang (CN);
- 9: Wenyu YAN
1st Floor, No.451 Wulianwang Street,Binjiang District, 310051, Hangzhou, Zhejiang (CN)
- (74) China Wispro Intellectual Property LLP.
Room A209, Zhongdi Building, China University Of Geosciences Base, No.8 Yuexing 3rd Road, High-Tech Industrial Estate, Nanshan District, 518000 Shenzhen, Guangdong (CN)
- (46) 2023 10 27
- (54) 10.-12. HUB OF VEHICLE WHEELS,1. AUTOMOBILE, 2. STEERING WHEEL, 3. CENTRAL CONSOLE FOR VEHICLES, 4. CONTROL AND INDICATOR PANEL FOR VEHICLES, 5. VEHICLE BONNET, 6.-8. BUMPER FOR VEHICLES, 9. VEHICLE WING
- (55)



1.1



1.2



1.3

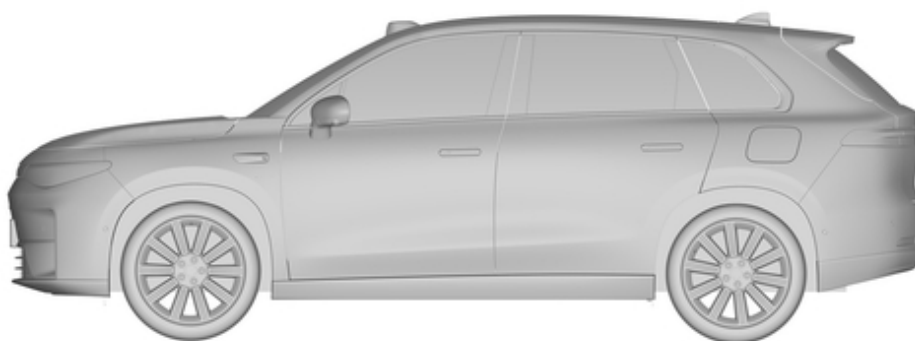

1.4

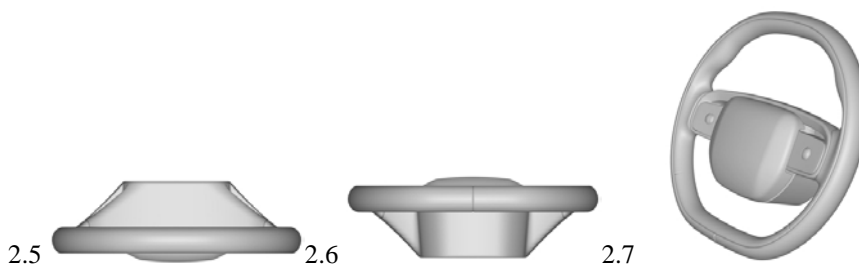
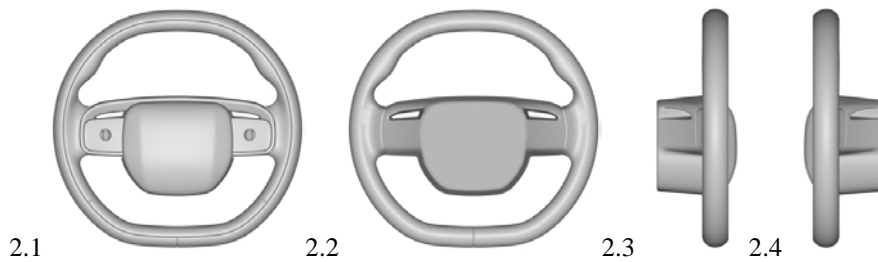
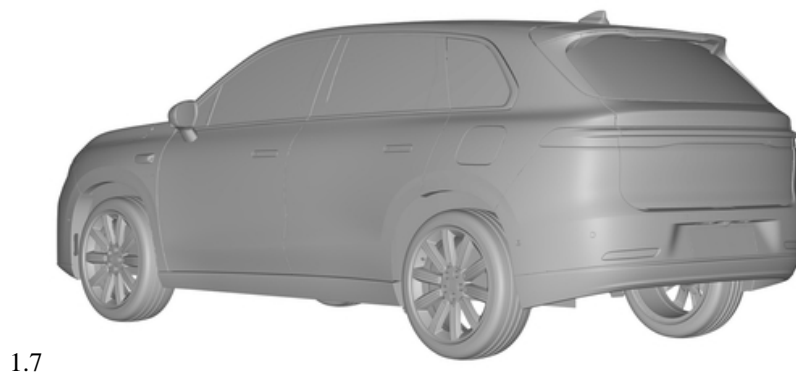
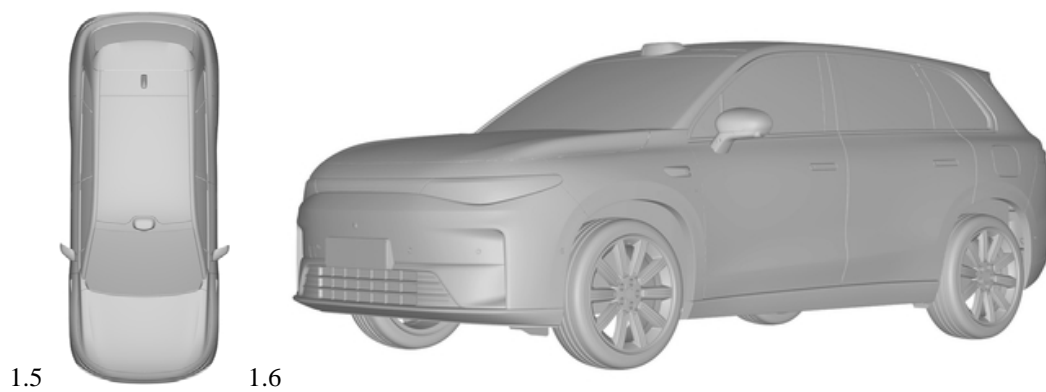

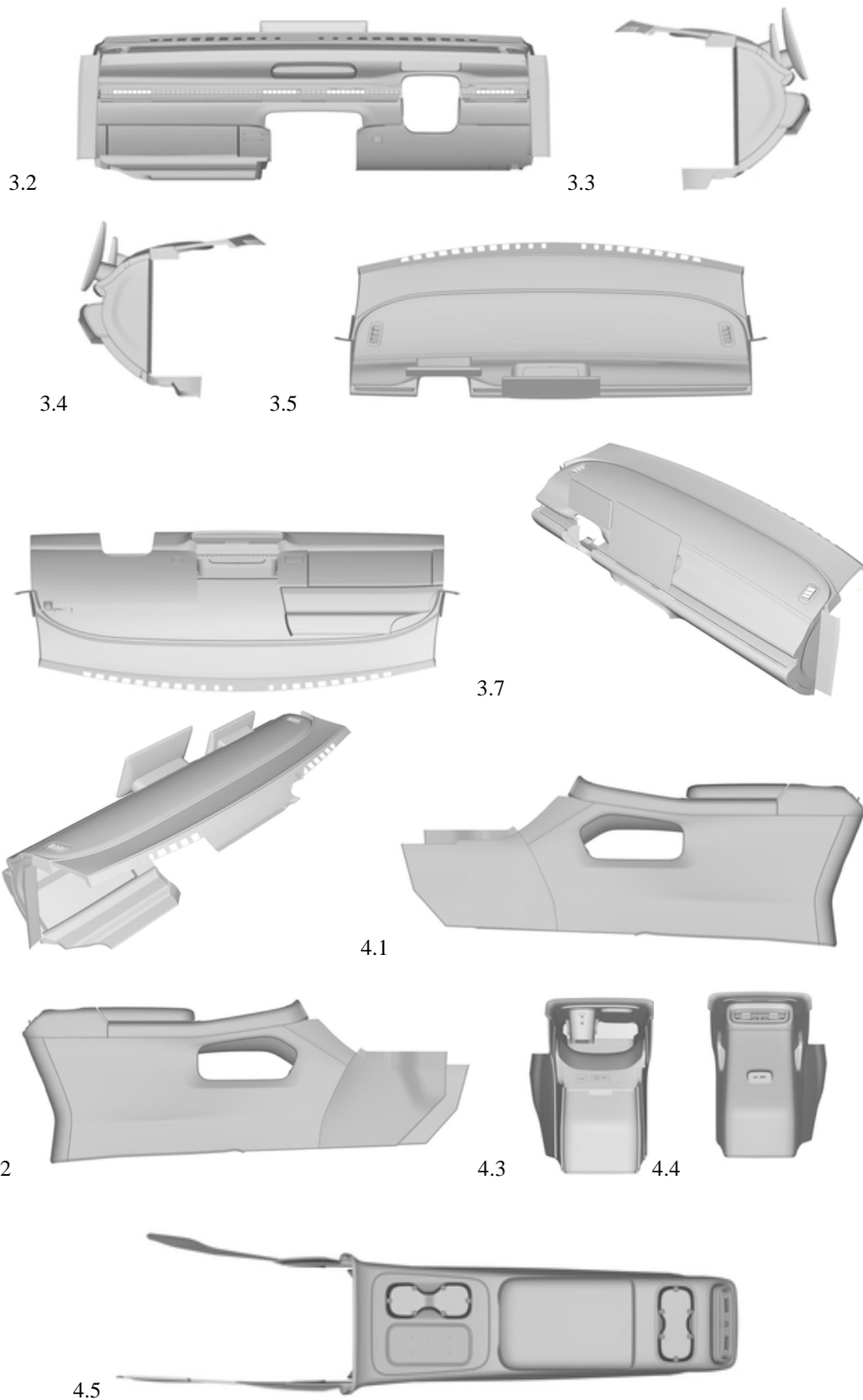

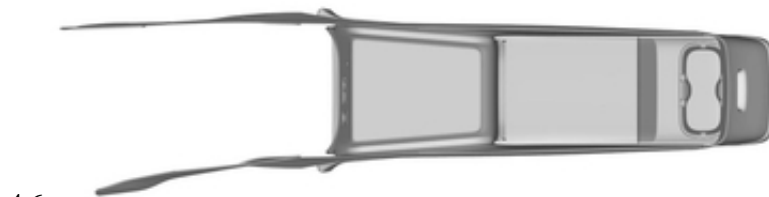

4.6

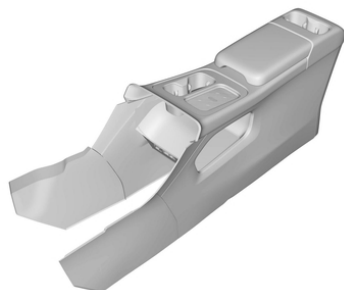

4.7

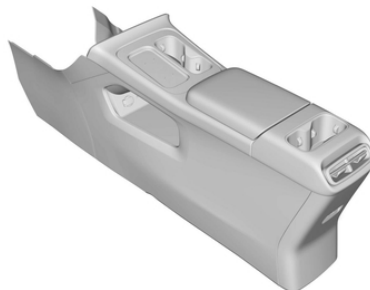

4.8



5.1



5.2



5.3



5.4



5.5



5.6



5.7



6.1



6.2

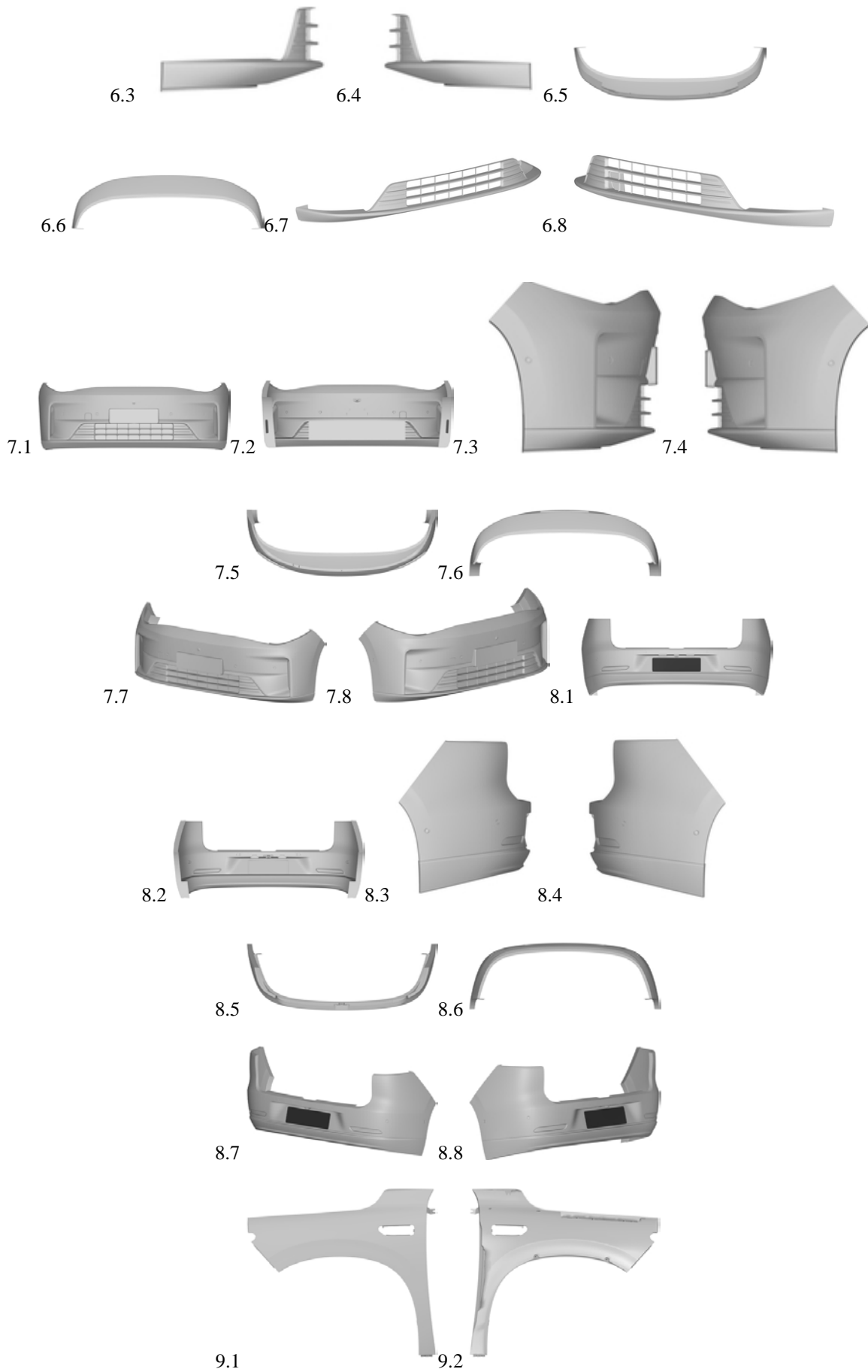

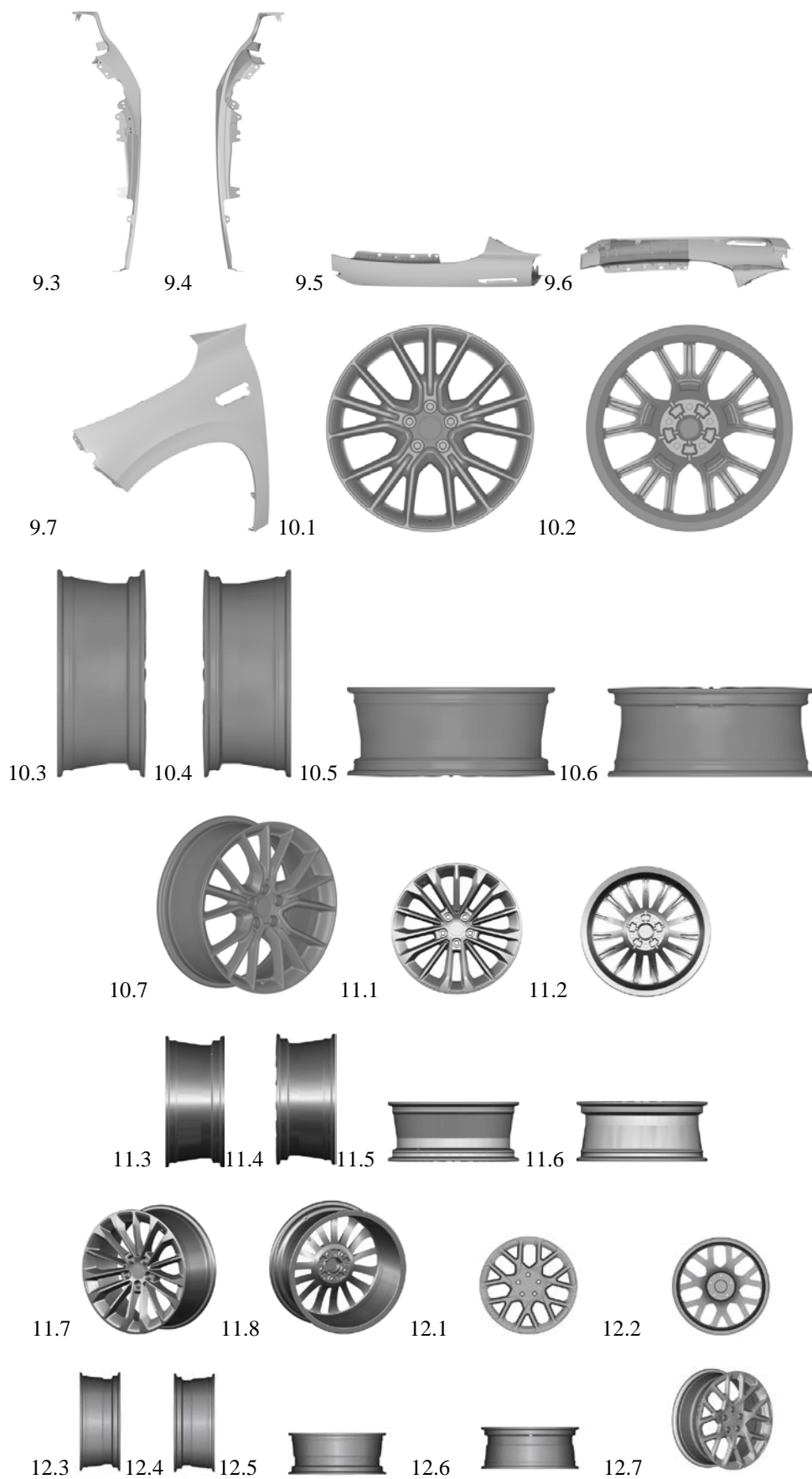

- (11) DM/226 989 (51) 12-08
(15) 2023 11 06 (44) 45/2023 (2023 11 10)
(22) 2023 11 06
(28) 1
(73) Limited Liability Company "Likino Bus Plant"
Ul. Kalinina, D. 1, Liter B, Office 1 (8 Floor), 142671 Likino-Dulyovo, Moskovskaya Oblast, Orekhovo-Zuevo Gorodskoi Okrug (RU)
(85) –
(86) RU, RU
(87) RU, RU
(88) RU, RU
(89) RU, RU
(81) III. GE, MD, TM
(72) Anatoly Vladimirovich SHASHKOV
Ul. Leskova, D. 62, Kv. 26, 603083, Nizhny Novgorod (RU);
Oleg Valerievich FILIMONOV
Prospekt Iliicha, D. 39/2, Kv. 57, 603101, Nizhny Novgorod (RU);
Viktor Vladimirovich MAKOVETSKY
Ul. Petrovskoe Sh., D. 1, Kv. 73, 143050, D. Malye Vyazemy, Moskovskaya Obl., Odintsovsky Region (RU)
Grigory Vladimirovich LOMONOV
Ul. Ivana Romanova, D. 11, Kv. 10, 603002, Nizhny Novgorod (RU);
Roman Viktorovich KAREV
Ul. Yanki Kupaly, D. 42, Kv. 141, 603142, Nizhny Novgorod (RU);
Aleksandr Nikolaevich SOROKIN
Ul. Robespiera, D. 81, K. 3, Kv. 124, 432001, Ulyanovsk (RU);
Aleksy Andreevich SERGEEV
Ul. Shalyapina, D. 19, Kv. 134, 603074, Nizhny Novgorod (RU);
Nikolay Evgenievich MOLEV
Ul. Admirala Makarova, D. 7, K. 1, Kv. 15, 603132, Nizhny Novgorod (RU);
Kirill Anatolievich KURYLEV
Ul. Radischeva, D. 130, K. 2, Kv. 143, 432027, Ulyanovsk (RU);
Sergey Aleksandrovich DANILOV
Ul. Melnikova, D. 16, Kv. 58, 603065, Nizhny Novgorod (RU)
(74) Limited Liability Company "United Engineering Center"
Prospekt Lenina, D. 88, 603004 Nizhny Novgorod (RU)
(46) 2023 11 10
(54) 1. BUS DRIVEN ELECTRICALLY
(55)



1.1



1.2

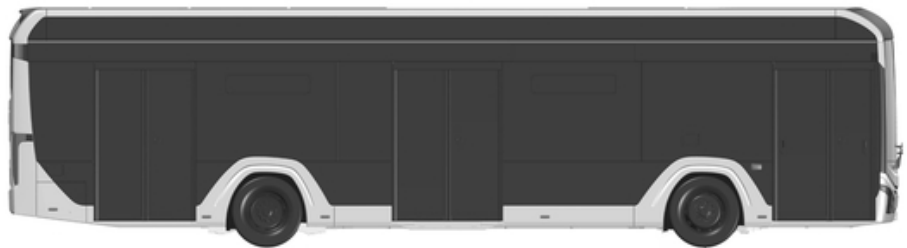

1.3



1.4



1.5

- (11) DM/233 057 (51) 02-04
(15) 2023 10 31 (44) 46/2023 (2023 11 17)
(22) 2023 10 31
(28) 3
(30) No1: 02.05.2023; 015020288-0001; EM; No2: 02.05.2023; 015020288-0003; EM;
No3: 02.05.2023; 015020288-0008; EM
(73) Autry International S.r.l.
Via Giovanni Duprè 1, 35134 Padova, PD (IT)
(85) –
(86) IT
(87) EM
(88) –
(89) EM
(81) III. RO, OM, CA, GE, NO, RS, EG, RU, IS, BY, MD, VN, TN, GB, KH, TR, IL, CH, JP, KR, LT, CN, MX,
AL, UA, BR, OA, SG, MA, MC, ME, SM
(72) Marco DORO
Riviera Martiri Della Libertà 3, 30031, Dolo, VE (IT)
(74) GALLO & PARTNERS SRL
Via Rezzonico, 6, 35131 Padova, PD (IT)
(46) 2023 11 17
(54) 1.-2. FOOTWEAR, 3. SOLE FOR FOOTWEAR
(55)



1.1



1.2



1.3



1.4



1.5



1.6



1.7



1.8



2.1



2.2



2.3



2.4

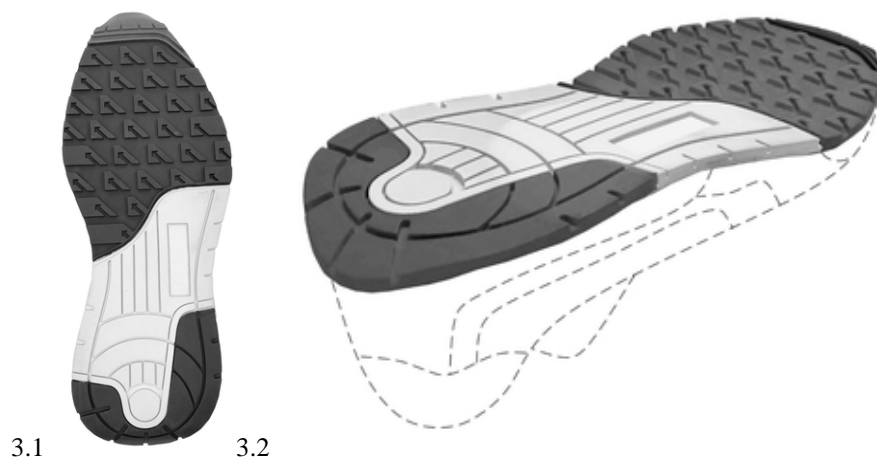
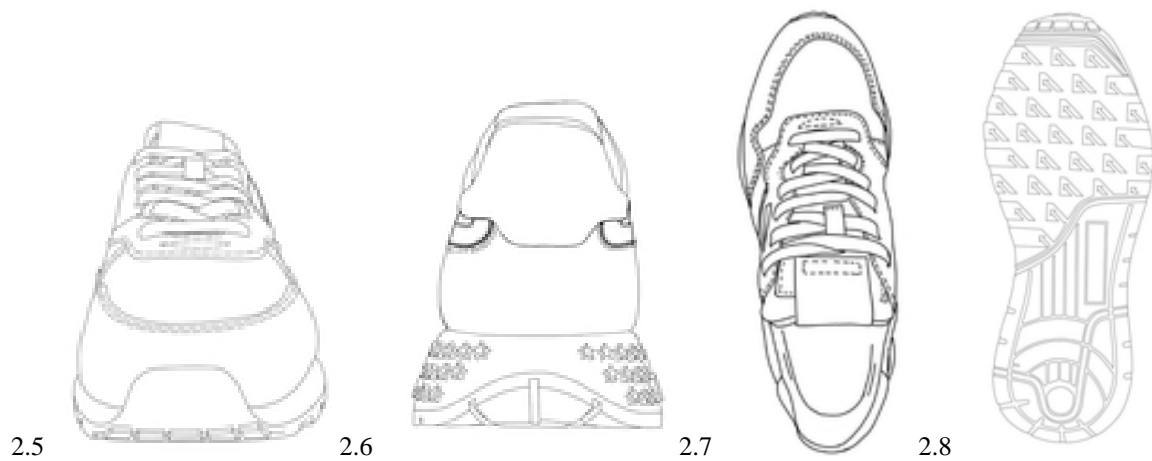



3.5

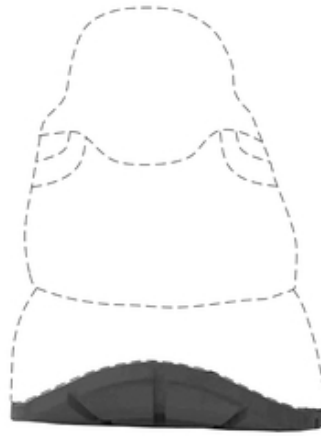

3.6

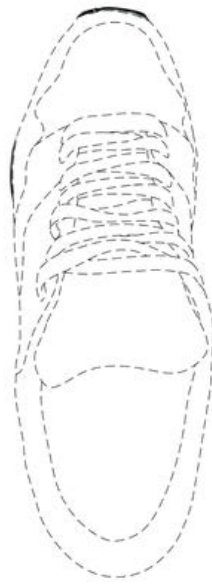

3.7

TRADEMARKS

APPLICATION FILED UNDER THE NATIONAL PROCEDURE APPROVED FOR REGISTRATION

The decision can be appealed at the Chamber of Appeal of Sakpatenti within 3 months from the publication or at the Mtskheta District Court Administrative Cases Board (Address: №17, Samkhedro St., Mtskheta), within 1 month following the publication.

(260) AM 2024 122207 A

(210) AM 122207

(220) 2023 03 27

(731) Zurab Akhalmosulishvili

Oragubi St., II Dead End 2a, Telavi, Georgia

(540)



(591) Black and golden

(531) 01.07.01; 01.07.06; 01.07.07; 02.03.05;
26.04.01; 26.04.05; 26.04.13; 26.04.14;
26.04.24; 29.01.12

(526) Khalde

(511) 32, 33, 43

REGISTERED TRADEMARKS

(111) M 2024 37762 R
 (151) 2024 01 10
 (181) 2034 01 10
 (260) AM 2023 121503 A
 (220) 2023 02 03
 (732) AL Muqarram Insulation Material Industry LLC
 Industrial Area 15, Sharjah, PO Box 24756,
 United Arab Emirates

(111) M 2024 37768 R
 (151) 2024 01 10
 (181) 2034 01 10
 (260) AM 2022 119353 A
 (220) 2022 09 12
 (732) Mzia Maskhulia
 Mshvidoba St. 117, Senaki, Georgia

(111) M 2024 37763 R
 (151) 2024 01 10
 (181) 2034 01 10
 (260) AM 2023 121502 A
 (220) 2023 02 03
 (732) Davit Shvelidze
 Nutsubidze Slope, II m/r. V qu., bld. 5, ap. 22,
 Tbilisi, Georgia

(111) M 2024 37769 R
 (151) 2024 01 10
 (181) 2034 01 10
 (260) AM 2023 121121 A
 (220) 2023 01 09
 (732) Retaj Hotels End Hospiteliti
 Dafna, Diplomatic District, P.O. Box: 25556,
 Doha, Qatar

(111) M 2024 37764 R
 (151) 2024 01 10
 (181) 2034 01 10
 (260) AM 2022 120824 A
 (220) 2022 12 19
 (732) LTD "Mezon 49"
 Iia Chavchavadze Av. 49e, Tbilisi, Georgia

(111) M 2024 37770 R
 (151) 2024 01 10
 (181) 2034 01 10
 (260) AM 2023 121217 A
 (220) 2023 01 16
 (732) Wenling Awt Machinery Co., Ltd.
 East Xincheng Avenue, Qiaowu Village, Zeguo
 Town, Wenling, Taizhou, Zhejiang Province,
 People's Republic of China

(111) M 2024 37765 R
 (151) 2024 01 10
 (181) 2034 01 10
 (260) AM 2023 121430 A
 (220) 2023 02 01
 (732) Levan Gvaramadze
 Aleksandre Kazbegi St. 2, ap. 12, 0160, Tbilisi,
 Georgia

(111) M 2024 37771 R
 (151) 2024 01 10
 (181) 2034 01 10
 (260) AM 2023 121120 A
 (220) 2023 01 09
 (732) Retaj Hotels End Hospiteliti
 Dafna, Diplomatic District, P.O. Box: 25556,
 Doha, Qatar

(111) M 2024 37766 R
 (151) 2024 01 10
 (181) 2034 01 10
 (260) AM 2022 119075 A
 (220) 2022 08 19
 (732) Mzia Maskhulia
 Mshvidoba St. 117, Senaki, Georgia

(111) M 2024 37772 R
 (151) 2024 01 10
 (181) 2034 01 10
 (260) AM 2022 120700 A
 (220) 2022 12 09
 (732) LTD "G T C Group"
 Ekvtime Kheladze St. 33, 0131, Tbilisi,
 Georgia

(111) M 2024 37767 R
 (151) 2024 01 10
 (181) 2034 01 10
 (260) AM 2022 120618 A
 (220) 2022 12 05
 (732) Philip Morris Products S.A.
 Quai Jeanrenaud 3, 2000 Neuchâtel,
 Switzerland

(111) M 2024 37773 R
 (151) 2024 01 10
 (181) 2034 01 10
 (260) AM 2023 121156 A
 (220) 2023 01 12
 (732) Alkaloid AD Skopje

| | |
|---|--|
| Blvd. Aleksandar Makedonski 12, 1000 Skopje, The Republic of North Macedonia | (111) M 2024 37779 R (151) 2024 01 10 (181) 2034 01 10 (260) AM 2022 119998 A (220) 2022 10 21 (732) LLC "Kakhetian Traditional Winery" Sulkhan Tsintsadze St. 12, floor 3, non-residential area 3-6, 0160, Tbilisi, Georgia |
| (111) M 2024 37774 R (151) 2024 01 10 (181) 2034 01 10 (260) AM 2023 121129 A (220) 2023 01 10 (732) Alikutty Thaikadappuram Hamza Koya Thaikadappuram Alkhail Gate 1-5(608), Alquoz Industrial Area №02, Dubai, 28005, United Arab Emirates | (111) M 2024 37780 R (151) 2024 01 10 (181) 2034 01 10 (260) AM 2023 121636 A (220) 2023 02 13 (732) Ucha Lursmanashvili Shio Aragvispireli St. 3, Khashuri, Georgia |
| (111) M 2024 37775 R (151) 2024 01 10 (181) 2034 01 10 (260) AM 2022 120815 A (220) 2022 12 16 (732) Bkairat General Trading (L.L.C) Office 2802, Westbury Officestower - Marasi Drive-Business Bay, Dubai, United Arab Emirates | (111) M 2024 37781 R (151) 2024 01 10 (181) 2034 01 10 (260) AM 2023 121310 A (220) 2023 01 20 (732) LTD "KTW Development" Sulkhan Tsintsadze St. 12, Space 3-6, 0160, Tbilisi, Georgia |
| (111) M 2024 37776 R (151) 2024 01 10 (181) 2034 01 10 (260) AM 2023 121127 A (220) 2023 01 10 (732) Riteil Konsultants Dmss LTD Unit No:2504, Mazaya Business Avenue BB1, Plot No: JLTE-PH2-BB1, Jumeirah Lakes Towers, Dubai, 416610, United Arab Emirates | (111) M 2024 37782 R (151) 2024 01 10 (181) 2034 01 10 (260) AM 2023 121351 A (220) 2023 01 26 (732) LTD "KTW Development" Sulkhan Tsintsadze St. 12, Space 3-6, 0160, Tbilisi, Georgia |
| (111) M 2024 37777 R (151) 2024 01 10 (181) 2034 01 10 (260) AM 2023 121241 A (220) 2023 01 18 (732) LTD "Kakhetian Traditional Winemaking" Sulkhan Tsintsadze St. 12, 0160, Tbilisi, Georgia | (111) M 2024 37783 R (151) 2024 01 10 (181) 2034 01 10 (260) AM 2023 121308 A (220) 2023 01 20 (732) LTD "KTW Development" Sulkhan Tsintsadze St. 12, Space 3-6, 0160, Tbilisi, Georgia |
| (111) M 2024 37778 R (151) 2024 01 10 (181) 2034 01 10 (260) AM 2022 120437 A (220) 2022 11 21 (732) LLC "Kakhetian Traditional Winery" Sulkhan Tsintsadze St. 12, floor 3, non-residential area 3-6, 0160, Tbilisi, Georgia | (111) M 2024 37784 R (151) 2024 01 10 (181) 2034 01 10 (260) AM 2023 121309 A (220) 2023 01 20 (732) LTD "KTW Development" Sulkhan Tsintsadze St. 12, Space 3-6, 0160, Tbilisi, Georgia |

(111) M 2024 37785 R
(151) 2024 01 10
(181) 2034 01 10
(260) AM 2022 120831 A
(220) 2022 12 20
(732) LTD "T-I-D Foods"
Gldani, Patara Vake, Tbilisi, Georgia

(111) M 2024 37786 R
(151) 2024 01 10
(181) 2034 01 10
(260) AM 2022 120830 A
(220) 2022 12 20
(732) LTD "T-I-D Foods"
Gldani, Patara Vake, Tbilisi, Georgia

(111) M 2024 37791 R
(151) 2024 01 18
(181) 2034 01 18
(260) AM 2022 120617 A
(220) 2022 12 05
(732) LTD "Wewin"
Ilia Chavchavadze Av. 51, bld. 2, ap. 62, 0165,
Tbilisi, Georgia

(111) M 2024 37792 R
(151) 2024 01 18
(181) 2034 01 18
(260) AM 2022 120935 A
(220) 2022 12 23
(732) Imiracle (HK) Limited
19H Maxgrand Plaza No.3 Tai Yau St San Po
Kong Kln, Hong Kong

TRADEMARKS REGISTERED ACCORDING TO THE ACCELERATED PROCEDURE

The decision can be appealed at the Chamber of Appeal of Sakpatenti within 3 months from the publication.

(111) M 2024 37761 R
(151) 2024 01 09
(181) 2034 01 09
(210) AM 126163
(220) 2023 12 22
(732) Nobel Ilac Sanayii Ve Ticaret Anonim
Sirketi Representation in Georgia
4 Freedom Square, 0105, Tbilisi, Georgia
(740) Tinatin Tskhvediani
(540)

Ticabel
ტიკაბელი

(591) Black-white
(511) 5

(111) M 2024 37787 R
(151) 2024 01 15
(181) 2034 01 15
(210) AM 126185
(220) 2023 12 27
(732) LLC "GCFUND – Georgian Tourism
Development Fund "
Ilia Chavchavadze Ave 37m, fl. 3,
Tbilisi, Georgia
(740) Giorgi Taktakishvili
(540)

პარაგრაფ აპარტამენტები
Paragraph Apartments

(591) Black-white
(511) 35, 36, 39, 43, 44, 45

(111) M 2024 37788 R
(151) 2024 01 15
(181) 2034 01 15
(210) AM 126114
(220) 2023 12 21
(732) JSC "Teliani Valley"
Tbilisi Highway 43, 2201, Telavi, Georgia
(540)



(591) 020000 black, FCFCFC white, D15840
brown, 07BC0D green
(531) 02.01.01; 05.03.19; 05.07.10; 11.03.02;
19.01.01; 19.01.06; 19.09.02; 27.05.01;
29.01.13
(511) 33

(111) M 2024 37789 R
(151) 2024 01 15
(181) 2034 01 15
(210) AM 126166
(220) 2023 12 23
(732) Hamid Shariati
Kipshidze St. 3b. 0159, Tbilisi, Georgia
(740) Hamid Shariati
(540)



(591) 2C3ACC blue, 47A1EF sky-blue, white
(531) 27.05.02
(511) 29

(111) M 2024 37790 R
(151) 2024 01 15
(181) 2034 01 15
(210) AM 126112
(220) 2023 12 21
(732) JSC "Teliani Valley"
Tbilisi Highway 43, 2201, Telavi, Georgia
(540)



(591) FCFCFC white, 0A0A0A black, 0E7CF2
sky-blue D8381C terracotta
(531) 19.09.02; 27.05.01; 29.01.14
(511) 33

(111) M 2024 37793 R
(151) 2024 01 18
(181) 2034 01 18
(210) AM 126381
(220) 2024 01 10

(732) LTD "E N Tobacco"
 Gldani, VII m/r, bld. 16, ap. 131, Tbilisi,
 Georgia
 (740) Giorgi Taktakishvili
 (540)



(591) Sky-blue, silver, blue
 (531) 02.01.01; 10.01.25; 19.03.03; 19.03.25;
 27.05.01; 27.05.24; 29.01.12
 (511) 34

(111) M 2024 37794 R
 (151) 2024 01 18
 (181) 2034 01 18
 (210) AM 126382
 (220) 2024 01 10
 (732) LTD "E N Tobacco"
 Gldani, VII m/r, bld. 16, ap. 131, Tbilisi,
 Georgia
 (740) Giorgi Taktakishvili
 (540)

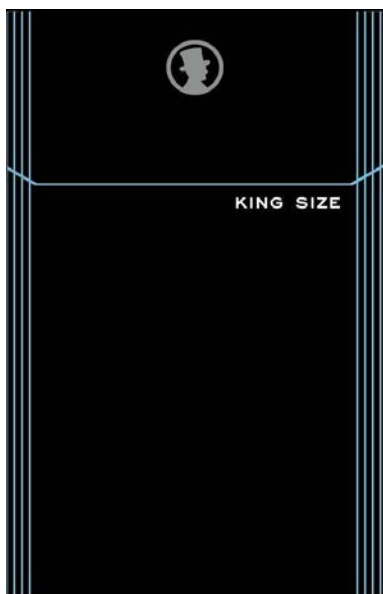

(591) White, sky-blue, silver, black
 (531) 02.01.01; 10.01.25; 19.03.03; 19.03.25;
 27.05.01; 27.05.24; 29.01.14
 (511) 34

(111) M 2024 37795 R
 (151) 2024 01 18
 (181) 2034 01 18
 (210) AM 126383
 (220) 2024 01 10
 (732) LTD "E N Tobacco"
 Gldani, VII m/r, bld. 16, ap. 131, Tbilisi,
 Georgia
 (740) Giorgi Taktakishvili
 (540)

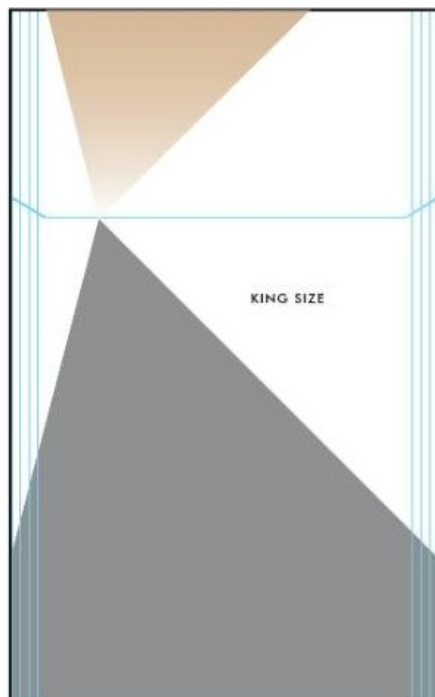

(591) Grey, beige, sky-blue, black, white
 (531) 10.01.25; 19.03.03; 19.03.25; 26.03.01;
 26.03.23; 26.05.01; 26.05.24; 27.05.01;
 29.01.15
 (511) 34

(111) M 2024 37796 R
 (151) 2024 01 18
 (181) 2034 01 18
 (210) AM 126384
 (220) 2024 01 10
 (732) LTD "E N Tobacco"
 Gldani, VII m/r, bld. 16, ap. 131, Tbilisi,
 Georgia
 (740) Giorgi Taktakishvili

(540)

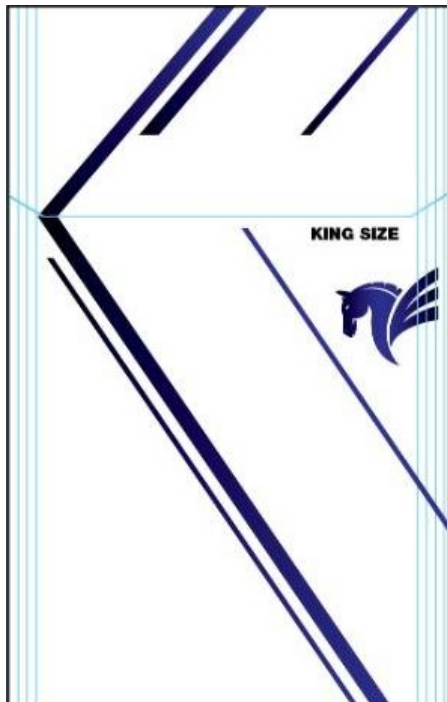

(591) Sky-blue, black, blue, white
(531) 03.03.01; 04.03.05; 10.01.25; 19.03.03;
19.03.25; 26.11.09; 29.01.13
(511) 34

(111) M 2024 37797 R
(151) 2024 01 18
(181) 2034 01 18
(210) AM 126385
(220) 2024 01 10
(732) LTD "E N Tobacco"
Gldani, VII m/r, bld. 16, ap. 131, Tbilisi,
Georgia
(740) Giorgi Taktakishvili
(540)



(591) White, blue
(531) 04.03.05; 29.01.12
(511) 34

INTERNATIONAL TRADEMARKS FOR WHICH A DECISION ON GRANTING PROTECTIONS IS TAKEN

The decision can be appealed at the Chamber of Appeal of Sakpatenti within 3 months from the publication or at the Mtskheta District Court Administrative Cases Board (Address: №17, Samkhedro St., Mtskheta), within 1 month following the publication.

(260) AM 2024 119319 A*

(800) 1681770

(151) 2022 04 07

(891) 2022 04 07

(731) NIO CO., LTD.

SUITE 115, 569 ANCHI ROAD, ANTING

TOWN, JIADING DISTRICT, 201805

SHANGHAI, China

(540)

NOMI

(591) Black, white

(511)

9 – Humanoid robots with artificial intelligence for use in scientific research; electronic-transaction terminal for toll system; holograms; apparatus to check stamping mail; ticket dispensers; signal lanterns; vehicle radios; driving recorders; rearview cameras for vehicles; cameras [photography]; cables, electric; semiconductor devices; optical fibres [light conducting filaments]; chips [integrated circuits]; remote control apparatus; lightning conductors; heat regulating apparatus; electrolysis apparatus for laboratory use; fire extinguishers; radiological apparatus for industrial purposes; protection devices for personal use against accidents; alarms; animated cartoons; portable remote controls for car arresters; artificial intelligence software for vehicles, recorded; downloadable mobile applications related with in-vehicle artificial intelligence; face recognition devices used in connection with in-vehicle artificial intelligence; navigational instruments for vehicles; portable media players for vehicles; video screens for vehicles; sensors for vehicles.

(260) AM 2023 119431 A

(800) 1683701

(151) 2022 05 23

(891) 2022 05 23

(731) GAS Familia, s. r. o. Stará Ľubovňa

Prešovská 8, SK-064 01 Stará Ľubovňa,

Slovakia

(540)



(591) Yellow, black and red

(531) 24.03.07; 24.03.18; 24.03.19; 25.01.15;
27.05.01; 27.05.02; 27.05.09; 29.01.14

(511)

33 – Slivovica (plum spirit).

(260) AM 2024 119522 A*

(800) 1684438

(151) 2022 08 22

(891) 2022 08 22

(731) Claris International Inc.

One Apple Park Way, Cupertino CA 95014,
USA

(540)

CLARIS PRO

(591) Black, white

(511)

9 – Downloadable computer software platforms for application development, application deployment, application management, and database management; recorded computer software platforms for application development, application deployment, application management, and database management; downloadable computer software for application development; recorded computer software for application development; downloadable and recorded software development tools; downloadable and recorded computer software platforms for storing, managing, and sharing of electronic data and information.

(260) AM 2024 120061 A*

(800) 1691758

(151) 2022 09 26

(891) 2022 09 26

(731) Claris International Inc.

One Apple Park Way, Cupertino CA 95014,
USA

(540)

CLARIS GO

(591) Black, white

(511)

9 – Downloadable computer software platforms for application development, application deployment, application management, and database management; downloadable computer software for application development; downloadable software development tools; downloadable computer software platforms for

storing, managing, and sharing of electronic data and information.

(260) AM 2024 120197 A*

(800) 1693294

(151) 2022 09 26

(891) 2022 09 26

(731) Claris International Inc.

One Apple Park Way, Cupertino CA 95014,
USA

(540)

CLARIS SERVER

(591) Black, white

(511)

9 – Downloadable and recorded computer software for storing, managing, and sharing electronic data and information; downloadable and recorded computer software for database management; downloadable and recorded computer software for software application hosting, access, sharing, and management.

(260) AM 2024 120199 A*

(800) 1693305

(151) 2022 09 26

(891) 2022 09 26

(731) Claris International Inc.

One Apple Park Way, Cupertino CA 95014,
USA

(540)

CLARIS WEBDIRECT

(591) Black, white

(511)

9 – Downloadable computer software, namely, computer software for hosting, managing, and configuring databases; downloadable computer software for managing and providing access to databases via local or global computer networks; downloadable computer software for automating database functions; downloadable database management software; downloadable database synchronization software; downloadable computer programs for accessing, browsing and searching online databases.

(260) AM 2024 121000 A

(800) 1704812

(151) 2022 07 14

(891) 2022 07 14

(731) Euro Games Technology Ltd.

4, "Maritsa" Str., "Vranya-Lozen-Triugulnika",
BG-1151 Sofia, Bulgaria

(540)



(591) Red and black

(531) 26.03.23; 27.05.01; 27.05.09; 29.01.12

(511)

9 – Operating computer software for main frame computers; monitors [computer hardware]; computer hardware; apparatus for recording images; monitors [computer programs]; games software; computer programs for recorded games; apparatus for recording, transmission or reproduction of sound or images; communications servers [computer hardware]; electronic components for gambling machines; computer application software featuring games and gaming; computer software for the administration of on-line games and gaming; computer hardware for games and gaming; hardware and software for gambling, gambling machines, gambling games on the Internet and via telecommunication network; computer operating system software; computer terminals; interactive terminals; multimedia terminals; electronic terminals for generating lottery tickets; interactive touch screen terminals; computer touchscreens; electronic display panels; liquid crystal display screens; digital signage display panels; multimedia software; multimedia apparatus and instruments; interactive multimedia software for playing games; computer screens; LCD large-screen displays; liquid crystal displays [LCDs] for home theatres; media streaming software; computer application software for streaming audio-visual media content via the internet; software; computer gaming software; computer software packages; computer operating system software; computer software, recorded; software drivers; virtual reality software; games software; entertainment software for computer games; computer programs for network management; electronic lottery tickets; computer software platforms; operating systems; interactive computer systems; operating system programs; computer game software for use with on-line interactive games.

28 – Gaming machines for gambling; chips for gambling; mah-jong; arcade games; gambling machines operating with coins, notes and cards; games; electronic games; parlor games; gaming chips; gaming tables; slot machines [gaming machines]; LCD game machines; slot machines and gaming devices; coin-operated amusement machines; roulette chips; poker chips; chips and dice [gaming equipment]; gaming equipment for casinos; roulette tables; gaming roulette wheels; casino games; automats and gambling machines; coin-operated amusement machines and/or electronic coin-operated amusement machines with or without the possibility of gain; boxes for coin-operated amusement machines, slot machines and gaming machines; electronic or electrotechnical amusement machines and apparatus, gaming machines, coin-operated entertainment machines; housings for coin-operated amusement machines, gaming equipment, gaming machines, machines for gambling; electropneumatic and electrical gambling machines (slot machines); lottery games; electronic targets for games and sports.

37 – Plant construction; machinery installation, maintenance and repair; providing information relating to the installation of machinery; installation of computers; installation of audiovisual equipment; installation of hardware for computer systems; installation of computer hardware; computer hardware (Installation, maintenance and repair of -); consultancy relating to the installation, maintenance and repair of computer hardware; upgrading of computer hardware; repair of game machines and apparatus; installation, maintenance and repair of computer network and information technology equipment.

38 – Telecommunication services; computer communication and Internet access; broadcasting services; automatic transfer of digital data using telecommunications channels; audiovisual communication services; video communication services; video transmission via digital networks; remote transmission of audio signals by means of telecommunications; remote transmission of data by means of telecommunications; delivery of messages by electronic media; electronic communications services; communication services for the electronic transmission of data; electronic transmission and retransmission of sounds, images, documents, messages and data; message sending, receiving and forwarding; interactive communication services; interactive telecommunications services; interactive transmission of video over digital networks; cable transmission of sounds, images, signals and data; communication by electronic means; communications via multinational telecommunication networks; communications services; communications services for the exchange of data in electronic form; communication services provided electronically; advisory services relating to communications equipment; mobile media services in the nature of electronic transmission of entertainment media content; network transmission of sounds, images, signals and data; virtual chatrooms established via text messaging; providing electronic telecommunication connections; transmission of data, messages and information; transmission of sound and vision via satellite or interactive multimedia networks; computer-aided transmission of sound; transmission of sound via interactive multimedia networks; transmission of sound or visual recordings over networks; transmission of vision via interactive multimedia networks; transmission of information through video communication systems; transmission of information in the audiovisual field; provision of communications facilities for the interchange of digital data; telecommunications services between computer networks; telecommunications services relating to electronic commerce; telecommunication of information (including web pages); electronic transmission of information (Services for the -); secured data, sound and image transmission services; inter-active video text services; video uploading services; photo uploading services; delivery of messages by audiovisual media; telematic data transmission and file transfer; digital trans-

mission services for audio and video data; rental of telecommunication devices and equipment enabling connection to networks; rental of telecommunication equipment; provision of access to content, websites and portals; provision of access to data or documents stored electronically in central files for remote consultation; provision of access to electronic sites; providing access to multimedia content online; providing access to platforms on the Internet; providing access to gambling and gaming websites on the Internet; providing access to websites on the Internet or any other communications network; providing user access to portals on the Internet; providing user access to platforms on the Internet; provision of telecommunication access to video and audio content provided via an online video-on-demand service; provision of telecommunication access to video content provided via the Internet; electrical data transmission over a global remote data processing network, including the Internet; video-on-demand transmission services; sending and receiving of electronic messages; message sending via a website; computerised communication services; communications by computer terminals; computer intercommunication; communication by computer; on-line communication services; on-line transmission of electronic publications; transmission and distribution of data or audiovisual images via a global computer network or the Internet; transmission of data, audio, video and multimedia files; transmission of data, audio, video and multimedia files, including downloadable files and files streamed over a global computer network; data transmission and data broadcasting; transmission of data or audio visual images via a global computer network or the Internet; transmission of data and information by computer and electronic communication means; transmission of information on-line; transmission of multimedia content via the Internet; transmission of sound, picture and data signals; computer-aided transmission of messages and images; exchange of messages via computer transmission; distribution of data or audio visual images via a global computer network or the Internet; streaming audio and video material on the Internet; streaming of audio, visual and audiovisual material via a global computer network; streaming of data; Internet based telecommunication services; web conferencing services; video, audio and television streaming services; access to content, websites and portals; online messaging services; broadcasting of audiovisual and multimedia content via the Internet.

41 – Gambling; services related to gambling; gaming services for entertainment purposes; casino, gaming and gambling services; training in the development of software systems; provision of gaming equipment for gambling halls; providing casino equipment [gambling]; gaming machine entertainment services; providing casino facilities [gambling]; providing halls with gaming machines; amusement arcade services; games equipment rental; rental of gaming machines;

providing amusement arcade services; rental of gaming machines with images of fruits; editing or recording of sounds and images; sound recording and video entertainment services; hire of sound reproducing apparatus; provision of gaming equipment for casinos; providing of casino facilities; online gambling services; casino, gaming and gambling services; providing amusement arcade services, online casino and betting services provided via websites; lottery services; organization of lotteries; provision of games by means of a computer based system; online interactive entertainment; on-line casino services; online game services through mobile devices; providing online entertainment in the nature of game tournaments; providing on-line information in the field of computer gaming entertainment; sports betting services; online sports betting services.

42 – Computer software technical support services; troubleshooting of computer software problems; provision of technical support in the supervision of computing networks; provision of technical support in the operation of computing networks; technical support services relating to computer software and applications; technical supervision and inspection; monitoring of computer systems by remote access; machine condition monitoring; installation, repair and maintenance of computer software; design, maintenance and updating of computer software; installation, setting up and maintenance of computer software; design, maintenance, development and updating of computer software; installation and customisation of computer applications software; technical consultancy relating to the installation and maintenance of computer software; computer system monitoring services; design of graphic software systems; development of interactive multimedia software; design and development of computer hardware; advice relating to the design of computer hardware; advisory and information services relating to the design and development of computer hardware; design, development and testing of computer software and hardware, and in particular for gambling, casino games and betting; platform as a service [PaaS]; development of computer platforms; platforms for gaming as software as a service [SaaS]; development of computer systems; computer system design and development.

(260) AM 2023 122185 A

(800) 1530242

(151) 2020 04 09

(891) 2023 03 01

(731) Artisan Spirits Box MB

Paribio g. 21B-2, LT-08129 Vilnius, Lithuania;
Sodiko N.V.

Demerstraat 9, B-3590 Diepenbeek, Belgium

(540)

The Story of Back to Black

(591) Black, white

(511)

33 – Preparations for making alcoholic beverages; cider; alcoholic beverages (except beer).

(260) AM 2023 122188 A

(800) 1559040

(151) 2020 09 24

(891) 2023 03 01

(731) Artisan Spirits Box MB

Paribio g. 21B-2, LT-08129 Vilnius, Lithuania;
Sodiko N.V.

Demerstraat 9, B-3590 Diepenbeek, Belgium

(540)

THE COLONIST

(591) Black, white

(511)

33 – Alcoholic beverages (except beer); preparations for making alcoholic beverages; cider.

(260) AM 2023 122236 A

(800) 1721108

(151) 2023 02 10

(891) 2023 02 10

(731) YANTAI DONGCHENG BIOCHEMICALS

CO., LTD.

No. 7, Changbaishan Road, Yantai

Development Zone, Yantai, 264000 Shandong,
China

(540)



(591) Black, white

(531) 26.15.01; 28.03

(511)

5 – Radiopharmaceuticals; medicines in form of tablet form; medicines for human purposes; biochemical medicines; liquid medicines; medicinal drinks; capsules for medicines; pharmaceutical preparations; radioactive substances for medical purposes; chemical preparations for medical purposes; biological preparations for medical purposes; isotopes for medical purposes; diagnostic reagents for medical purposes; diagnostic preparations for medical purposes; bulk drugs for medical purposes; injectable medicinal solutions; Chinese patent medicines; nutritional supplements.

(260) AM 2023 122237 A

(800) 1721111

(151) 2023 01 09

(891) 2023 01 09

(731) ILOVEPDF, S.L.

Sabino Arana 60, Local 2, E-08028 Barcelona,
Spain

(540)

ILOVEPDF

(591) Black, white

(511)

42 – Scientific and technological services, as well as research and design services relating thereto; industrial analysis and research services; design and development of computer hardware and software.

(260) AM 2023 122240 A

(800) 1721138

(151) 2023 01 31

(891) 2023 01 31

(731) Heidelberg Materials AG

Berliner Str. 6, 69120 Heidelberg, Germany

(540)



(591) Green and white

(531) 05.03.13; 26.04.04; 26.04.08; 27.05.01; 27.05.15; 29.01.12

(511)

35 – Retail services relating to building and construction materials; Wholesale services relating to building and construction materials; Business advisory services relating to building and construction materials.

39 – Transport and delivery of building and construction materials; Storage services; Waste collection; Removal of waste.

40 – Recycling of waste and trash; Treatment of waste and trash; Destruction of waste and trash; Incineration of waste and trash.

(260) AM 2023 122241 A

(800) 1721148

(151) 2023 02 16

(891) 2023 02 16

(731) H. Wilhelm Schaumann GmbH

An der Mühlenau 4, 25421 Pinneberg, Germany

(540)

EGGSAN

(591) Black, white

(511)

5 – Veterinary preparations; sanitary preparations for medical purposes; foodstuffs and dietetic substances for medical or veterinary purposes; dietary supplements for animals; additives to fodder for medical purposes; additives for animal foodstuffs for preventive healthcare, not for medical purposes.

31 – Animal foodstuffs; supplements for foodstuffs for animals; fortified food substances for animals; mi-

xed foodstuffs for animals; supplementary animal foodstuffs, not for medical purposes.

(260) AM 2023 122242 A

(800) 1721150

(151) 2023 02 16

(891) 2023 02 16

(731) H. Wilhelm Schaumann GmbH

An der Mühlenau 4, 25421 Pinneberg, Germany

(540)

KALBISAN

(591) Black, white

(511)

5 – Veterinary preparations; sanitary preparations for medical purposes; foodstuffs and dietetic substances for medical or veterinary purposes; dietary supplements for animals; additives to fodder for medical purposes; additives for animal foodstuffs for preventive healthcare, not for medical purposes.

31 – Animal foodstuffs; supplements for foodstuffs for animals; fortified food substances for animals; mixed foodstuffs for animals; supplementary animal foodstuffs, not for medical purposes.

(260) AM 2023 122329 A

(800) 1722680

(151) 2023 02 28

(891) 2023 02 28

(731) Limited Liability Company "LARTA GLASS RYAZAN"

Rayon Yuzhniy Promuzel, 17A, Ryazan,

RU-390011 Ryazan region, Russian Federation

(540)

LARTA

(591) Black, white

(511)

19 – Window glass for building; window glass, other than vehicle window glass; building glass; plate glass [windows] for building; insulating glass for building; enamelled glass, for building.

20 – Silvered glass [mirrors].

21 – Glass for vehicle windows [semi-finished product]; fused silica [semi-worked product], other than for building; plate glass [raw material]; opal glass; glass, unworked or semi-worked, except building glass; opaline glass; glass incorporating fine electrical conductors; enamelled glass, not for building.

35 – Retail or wholesale services for construction products.

(260) AM 2023 122330 A
 (800) 1722718
 (151) 2023 03 06
 (891) 2023 03 06
 (731) CELLTRION, INC.
 23, Academy-ro, Yeonsu-gu, Incheon 22014,
 Republic of Korea

(540)

Stoboclo

(591) Black, white

(511)

5 – Pharmaceutical preparations; pharmaceutical preparations for the treatment of osteoporosis; pharmaceutical products for the treatment of bone diseases; pharmaceutical products for the treatment of bone loss; drugs for increasing bone density.

(260) AM 2023 122331 A

(800) 1722810

(151) 2023 03 03

(891) 2023 03 03

(731) KT & G CORPORATION

71, Beotkot-gil, Daedeok-gu, Daejeon,
 Republic of Korea

(540)

iii PROUDLY SIMPLE

(591) Black, white

(511)

34 – Cigarettes; tobacco; tobacco substitutes; cigars; electronic cigarettes; liquid nicotine solutions for use in electronic cigarettes; liquid solutions for use in electronic cigarettes; flavorings, other than essential oils, for use in electronic cigarettes; humidors; cigar cutters; ashtrays for smokers; electronic cigarette cartridges; neck chains for electronic cigarettes; atomizers for electronic cigarettes; smokers' articles (including lighters for smokers); sticks for cleaning and disinfecting electronic cigarettes; cleaning brushes for electronic cigarettes; pads for cleaning electronic cigarettes; cleaners for electronic cigarettes; cleaning implements for electronic cigarettes; cleaning apparatus for electronic cigarettes; electric cleaners for electronic cigarettes; cases for electronic cigarettes; smokeless tobacco; smokeless cigarette vaporizer pipes; holders for electronic devices for the purpose of heating cigarettes or tobacco, tobacco products and tobacco substitutes; tobacco sticks for electronic cigarettes.

(260) AM 2024 122338 A

(800) 1722933

(151) 2022 09 23

(891) 2022 09 23

(731) Limited liability company "TFN"

47 km MKAD, Govorovo village, Moskovsky
 settlement, RU-108811 Moscow, Russian
 Federation

(540)



AVISPA

(591) Black, white

(531) 27.05.01; 27.05.02; 27.05.09; 27.05.10;

27.05.17; 27.05.21

(511)

7 – Machines, machine tools, power-operated tools; motors and engines, except for land vehicles; machine coupling and transmission components, except for land vehicles; agricultural implements, other than hand-operated hand tools; incubators for eggs; vending machines; 3D bioprinters; 3D printers; welding machines, electric; soldering apparatus, gas-operated; vulcanization apparatus; acetylene cleaning apparatus; high pressure washers; apparatus for drawing up beer under pressure; apparatus for aerating water; apparatus for aerating beverages; electrical apparatus for sealing plastics [packaging]; electric arc cutting apparatus; electric arc welding apparatus; electric welding apparatus; inking apparatus for printing machines; soldering apparatus, electric; fittings for engine boilers; expansion tanks [parts of machines]; drums [parts of machines]; reels, mechanical, for flexible hoses; brake shoes, other than for vehicles; concrete mixers [machines]; bioreactors for use in manufacturing biopharmaceuticals; reels [parts of machines]; bobbins for weaving looms; harrows; journal boxes [parts of machines]; bulldozers; hoppers [mechanical discharging]; mine borers; railway wagon lifts; rolling mill cylinders; crank shafts; printing rollers for machines; camshafts for vehicle engines; transmission shafts, other than for land vehicles; valves [parts of machines]; fans for motors and engines; saw benches [parts of machines]; winnowers; vibrators [machines] for industrial use; bearings [parts of machines]; water heaters being parts of machines; bellows [parts of machines]; agitators; drilling rigs, floating or non-floating; lawnmowers [machines]; card clothing [parts of carding machines]; nail extractors, electric; emergency power generators; alternators; dynamos; bicycle dynamos; current generators; electricity generators; hydraulic controls for machines, motors and engines; mufflers for motors and engines; drilling heads [parts of machines]; drilling bits [parts of machines]; cylinder heads for engines; soldering blow pipes, gas-operated; gas-operated blow torches; raking machines; stalk separators [machines]; sieves [machines or parts of machines]; mud catchers and collectors [machines]; tarring machines; rubber tracks being parts of crawlers on mining machines; rubber tracks being parts of crawlers on snow ploughs; rubber tracks being parts of crawlers on loading-unloading machines and apparatus; rubber tracks being parts of craw-

lers on agricultural machines; rubber tracks being parts of crawlers on construction machines; hydraulic engines and motors; aeronautical engines; aeroplane engines; engines for air cushion vehicles; compressed air engines; jet engines, other than for land vehicles; engines for boats; driving motors, other than for land vehicles; motors, other than for land vehicles; propulsion mechanisms, other than for land vehicles; de-aerators for feedwater; disintegrators; tympan [parts of printing presses]; holding devices for machine tools; turf removing ploughs; pump diaphragms; door closers, hydraulic; door closers, pneumatic; door closers, electric; chisels for machines; jacks [machines]; rack and pinion jacks; moving walkways; electric hand drills; crushers for kitchen use, electric; flues for engine boilers; reapers; reapers and binders; millstones; rakes for raking machines; shredders [machines] for industrial use; kitchen grinders, electric; vegetable shredders, electric; injectors for engines; tools [parts of machines]; ski edge sharpening tools, electric; hand-held tools, other than hand-operated; agricultural implements, other than hand-operated; air condensers; control cables for machines, engines or motors; capstans; calenders; rotary steam presses, portable, for fabrics; ditchers [ploughs]; carburettors; sliders for knitting machines; crankcases for machines, motors and engines; steamrollers; pressure valves [parts of machines]; clack valves [parts of machines]; pressure reducers [parts of machines]; cowlings [parts of machines]; machine wheels; freewheels, other than for land vehicles; scale collectors for machine boilers; lasts for shoes [parts of machines]; brake pads, other than for vehicles; piston segments; grease rings [parts of machines]; reapers and threshers; coal-cutting machines; compressors [machines]; air pumps [garage installations]; compressors for refrigerators; conveyors [machines]; belt conveyors; converters for steelworks; steam condensers [parts of machines]; aero-condensers; diggers [machines]; rams [machines]; thermic lances [machines]; mechanized livestock feeders; boxes for matrices [printing]; gear boxes, other than for land vehicles; grease boxes [parts of machines]; housings [parts of machines]; harvesting machines; steam engine boilers; coffee grinders, other than hand-operated; taps [parts of machines, engines or motors]; cranes [lifting and hoisting apparatus]; roller bridges; mobile cranes; water separators; spray guns for paint; cranks [parts of machines]; potters' wheels; grindstones [parts of machines]; cultivators [machines]; soldering lamps; winches; blades [parts of machines]; ploughshares; belts for conveyors; lubricators [parts of machines]; igniting magnetos; handling machines, automatic [manipulators]; churns; matrices for use in printing; machine fly-wheels; shearing machines for animals; blowing machines; knitting machines; galvanizing machines; bending machines; ironing machines; mineworking machines; blowing machines for the compression, exhaustion and transport of gases; blowing machines for the compression, sucking

and carrying of grain; net hauling machines [fishing]; electroplating machines; bottle sealing machines; sealing machines for industrial purposes; embossing machines; engraving machines; finishing machines; crushing machines; waste disposal units; blade sharpening [stropping] machines; earth moving machines; cord making machines; lace making machines; butter machines; cigarette machines for industrial purposes; sausage making machines; stereotype machines; hosiery looms; dyeing machines; bottle washing machines; dishwashers; machines for the application of sizing; bottle filling machines; cheese slicers, electric; racket stringing machines; leather-working machines; dairy machines; glass-working machines; tobacco processing machines; grain husking machines; painting machines; oil refining machines; peeling machines; machines for processing plastics; ore treating machines; printing machines for use on sheet metal; brewing machines; whitewashing machines; road sweeping machines, self-propelled; leather paring machines; machines for generating gas by electrolysis; bitumen making machines; papermaking machines; pasta making machines, electric; machines for the production of sugar; weeding machines; sifting machines; cinder sifters [machines]; puddling machines; notchers [machine tools]; bread cutting machines; road making machines; railroad constructing machines; machines for the textile industry; rammers [machines]; rail-laying machines; bottle capping machines; bottle stoppering machines; waste compacting machines; vegetable peelers, electric; die-stamping machines; stamping machines; darning machines; milking machines; drainage machines; wrapping machines; grain separators; bookbinding apparatus and machines for industrial purposes; machines and apparatus for cleaning, electric; machines and apparatus for carpet shampooing, electric; machines and apparatus for polishing [electric]; punching machines; riveting machines; kitchen machines, electric; foundry machines; smoothing presses; fleshing machines; flour mill machines; type-setting machines [printing]; hemming machines; grating machines for vegetables; braiding machines; rinsing machines; wringing machines for laundry; cutting machines; steam engines; printing machines; rotary printing presses; industrial inkjet printing machines; compressed air machines; tilling machines for agricultural purposes; trimming machines; spinning machines; filling machines; friezing machines; cutters [machines]; satinizing machines; agricultural machines; mixing machines; sorting machines for industry; stitching machines; washing machines [laundry]; coin-operated washing machines; laundry washing machines incorporating a drying tumbler; clippers [machines]; spinning frames; looms; kneading machines; typographic machines; type-setting machines [photocomposition]; beating machines; beaters, electric; packing machines; packaging machines; filtering machines; moulding machines; carding machines; sewing machines; typecasting

machines; electromechanical machines for chemical industry; labellers [machines]; mills [machines]; mills for household purposes, other than hand-operated; pepper mills, other than hand-operated; centrifugal mills; machine wheelwork; feeders [parts of machines]; transmission mechanisms, other than for land vehicles; forge blowers; mixers [machines]; blenders, electric, for household purposes; vacuum cleaner bags; threshing machines; pneumatic hammers; hammers [parts of machines]; tilt hammers; power hammers; reeling apparatus, mechanical; motorized cultivators; motors for boats; clutches, other than for land vehicles; meat choppers, electric; superchargers; brake linings, other than for vehicles; guides for machines; suction nozzles for vacuum cleaners; vacuum cleaner attachments for disseminating perfumes and disinfectants; pumps [machines]; pumps [parts of machines, engines or motors]; aerating pumps for aquaria; vacuum pumps [machines]; compressed air pumps; pumps for heating installations; beer pumps; pumps for counter-current swimming; lubricating pumps; self-regulating fuel pumps; fuel dispensing pumps for service stations; centrifugal pumps; hydrogen dispensing pumps for service stations; tin openers, electric; knives for mowing machines; chaff cutter blades; knives, electric; knives being parts of machines; shears, electric; scissors, electric; vegetable spiralizers, electric; engine mounts, other than for land vehicles; bearing brackets for machines; pulverisers [machines]; axles for machines; steam traps; chucks [parts of machines]; drill chucks [parts of machines]; exhaust manifold for engines; soldering irons, gas-operated; soldering irons, electric; superheaters; gears, other than for land vehicles; reduction gears, other than for land vehicles; drilling machines; saws [machines]; chain saws; guns [tools using explosive cartridges]; glue guns, electric; compressed air guns for the extrusion of mastics; carburettor feeders; feeding apparatus for engine boilers; loading ramps; ploughs; pneumatic transporters; pneumatic controls for machines, motors and engines; hangers [parts of machines]; anti-friction bearings for machines; roller bearings; self-oiling bearings; bearings for transmission shafts; ball-bearings; elevators [lifts]; hoists; lifts, other than ski-lifts; pulleys; saw blades [parts of machines]; pistons [parts of machines or engines]; shock absorber plungers [parts of machines]; pistons for engines; pistons for cylinders; catalytic converters; torque converters, other than for land vehicles; fuel conversion apparatus for internal combustion engines; presses [machines for industrial purposes]; wine presses; fruit presses, electric, for household purposes; fodder presses; basket presses; printing presses; typographic presses; swaging machines; pneumatic or hydraulic linear actuators, other than for land vehicles; pedal drives for sewing machines; portable laser imprinters; cleaning appliances utilizing steam; food processors, electric; springs [parts of machines]; spinning wheels; punches for punching machines; vacuum

cleaners; touchless stationary vacuums; tambours for embroidery machines; radiators [cooling] for motors and engines; sewage pulverizers; air brushes for applying colour; regulators [parts of machines]; pressure regulators [parts of machines]; speed governors for machines, engines and motors; cutting blow pipes, gas-operated; blade holders [parts of machines]; loom shafts; gears for weaving looms; belts for machines; elevator belts; fan belts for motors and engines; dynamo belts; belts for motors and engines; adhesive bands for pulleys; industrial robots; household cleaning and laundry robots with artificial intelligence; 3D printing pens; kick starters for motorcycles; joysticks being parts of machines, other than for game machines; stuffing boxes [parts of machines]; paper feeders [printing]; whisks, electric, for household purposes; sparking plugs for internal combustion engines; glow plugs for Diesel engines; brake segments, other than for vehicles; bedding machines; steam/oil separators; cream/milk separators; ball rings for bearings; sowers [machines]; exhausts for motors and engines; pigs for cleaning pipes; snow ploughs; sheaf-binding machines; shaft couplings [machines]; joints [parts of engines]; juice extractors, electric; straw [chaff] cutters; suction cups for milking machines; stands for machines; machine tools; die-cutting and tapping machines; woodworking machines; sharpening machines; bicycle assembling machines; mortising machines; stone-working machines; metalworking machines; size adjustment cutting machines for industrial purposes; threading machines; trueing machines; planing machines; lathes [machine tools]; milling machines; grinding machines; metal drawing machines; rolling mills; starters for motors and engines; stators [parts of machines]; glaziers' diamonds [parts of machines]; tables for machines; derricks; slide rests [parts of machines]; spin dryers [not heated]; couplings, other than for land vehicles; heat exchangers [parts of machines]; transmissions for machines; boiler tubes [parts of machines]; wind turbines; hydraulic turbines; turbines, other than for land vehicles; turbocompressors; central vacuum cleaning installations; suction machines for industrial purposes; machines for the mineralization of drinking water; washing installations for vehicles; degreasers [machines]; dust exhausting installations for cleaning purposes; sifting installations; pneumatic tube conveyors; dust removing installations for cleaning purposes; condensing installations; floating production, storage and offloading [FPSO] units; pneumatic waste oil drainers; lifting apparatus; air suction machines; dividing machines; igniting devices for internal combustion engines; window closers, hydraulic; window closers, pneumatic; window closers, electric; washing apparatus; binding apparatus for hay; haulage apparatus [mining]; door openers, hydraulic; door openers, pneumatic; door openers, electric; window openers, hydraulic; window openers, pneumatic; window openers, electric; curtain drawing devices, electrically opera-

ted; adhesive tape dispensers [machines]; anti-pollution devices for motors and engines; beverage preparation machines, electromechanical; food preparation machines, electromechanical; portable ultrasonic washing devices for laundry; elevator operating apparatus; control mechanisms for machines, engines or motors; shoe polishers, electric; machines and apparatus for wax-polishing, electric; air cushion devices for moving loads; handling apparatus for loading and unloading; elevating apparatus; aprons [parts of machines]; filter presses; filters for cleaning cooling air, for engines; filters being parts of machines or engines; moulds [parts of machines]; printing plates; journals [parts of machines]; centrifugal machines; elevator chains [parts of machines]; drive chains, other than for land vehicles; transmission chains, other than for land vehicles; cylinders for motors and engines; cylinders for machines; printing cylinders; pneumatic jacks; shuttles [parts of machines]; universal joints [Cardan joints]; connecting rods for machines, motors and engines; steam mops; pulleys [parts of machines]; vacuum cleaner hoses; screwdrivers, electric; brushes [parts of machines]; dynamo brushes; brushes for vacuum cleaners; brushes, electrically operated [parts of machines]; carbon brushes [electricity]; ejectors; robotic exoskeleton suits, other than for medical purposes; fuel economisers for motors and engines; excavators; shovels, mechanical; grain elevators; agricultural elevators; motors, electric, other than for land vehicles; electrodes for welding machines; electric hammers; parquet wax-polishers, electric; cartridges for filtering machines; moving staircases [escalators]; automatic grappels for marine purposes; food blenders, electric, for household purposes; window cleaning equipment, electric; replacement dust filters for vacuum cleaners; replacement bowls for blenders, grinders, meat choppers [parts of machines]; replacement attachments for blenders, grinders, meat choppers [parts of machines]; paddles for blenders, grinders, meat choppers [parts of machines]; blades for blenders, grinders, meat choppers [parts of machines].

8 – Hand tools and implements, hand-operated; cutlery, forks and spoons; side arms, other than firearms; razors; glaziers' diamonds [parts of hand tools]; apparatus for tattooing; laser hair removal apparatus, other than for medical purposes; razors, electric or non-electric; sharpening steels; scythe stones; gimlets [hand tools]; borers; augers [hand tools]; carpenters' augers; pickhammers; weeding forks [hand tools]; carving forks; table forks; agricultural forks [hand tools]; lawn clippers [hand instruments]; harpoons; harpoons for fishing; nail extractors, hand-operated; rakes [hand tools]; sand trap rakes; cutter bars [hand tools]; whetstone holders; priming irons [hand tools]; sculptors' chisels; lifting jacks, hand-operated; hand drills, hand-operated; truncheons; clamps for carpenters or coopers; spades [hand tools]; rabbeting planes; chisels; engraving needles; tattoo needles; cutlery; edge tools [hand tools]; choppers being knives; garden tools,

hand-operated; abrading instruments [hand instruments]; numbering punches; goffering irons; implements for decanting liquids [hand tools]; depilation appliances, electric and non-electric; sharpening instruments; blade sharpening instruments; livestock marking tools; nail clippers, electric or non-electric; oyster openers; polishing irons [glazing tools]; ear-piercing apparatus; tube cutting instruments; wire strippers [hand tools]; riveters [hand tools]; expanders [hand tools]; cutting tools [hand tools]; cutters; ski edge sharpening tools, hand-operated; hand tools, hand-operated; sterile body piercing instruments; stamping-out tools [hand tools]; picks [hand tools]; sharpening stones; punch rings [knuckle dusters]; trowels; centre punches [hand tools]; daggers; pickaxes; mallets [hand instruments]; pliers; punch pliers [hand tools]; blades [weapons]; annular screw plates; spanners [hand tools]; tap wrenches; ladles [hand tools]; foundry ladles [hand tools]; meat claws; breast drills; lasts [shoemakers' hand tools]; scythe rings; instruments for punching tickets; diggers [hand tools]; rams [hand tools]; scythes; hainault scythes; fire irons; emery grinding wheels; grindstones [hand tools]; sledgehammers; thistle extractors [hand tools]; nail nippers; tree pruners; nail drawers [hand tools]; ice picks; blades [hand tools]; razor blades; blades for planes; plane irons; jig-saws; spoons; table knives, forks and spoons for babies; table knives, forks and spoons of plastic; crow bars; trowels [gardening]; shovels [hand tools]; palette knives; machetes; beard clippers; hair clippers for personal use, electric and non-electric; hair clippers for animals [hand instruments]; taps [hand tools]; fireplace bellows [hand tools]; swords; hammers [hand tools]; emergency hammers; fullers [hand tools]; stone hammers; masons' hammers; riveting hammers [hand tools]; mattocks; ditchers [hand tools]; manicure sets; manicure sets, electric; pedicure sets; needle files; bits [hand tools]; files [tools]; emery files; air pumps, hand-operated; hand pumps; shaving cases; mincing knives; cheese slicers, non-electric; fruit segmenters; egg slicers, non-electric; vegetable knives; pizza cutters, non-electric; scaling knives; hobby knives [scalpels]; fruit corers; moulding irons; ceramic knives; tin openers, non-electric; farriers' knives; multi-tool knives; budding knives; hunting knives; penknives; grafting tools [hand tools]; carving knives; braiders [hand tools]; box cutters; bill-hooks; paring knives; knives; cleavers; wick trimmers [scissors]; shears; cattle shearers; border shears; pruning shears; shearers [hand instruments]; scissors; sword scabbards; kitchen mandolines; vegetable slicers, hand-operated; vegetable spiralizers, hand-operated; vegetable peelers, hand-operated; agricultural implements, hand-operated; stropping instruments; screwdrivers, non-electric; hand-operated corn cob strippers; sabres; stirring sticks for mixing paint; reamer sockets; drill holders [hand tools]; perforating tools [hand tools]; rammers [hand tools]; emery boards; nail files; nail files, electric; saws [hand

tools]; bow saws; tweezers; hair-removing tweezers; guns [hand tools]; non-electric caulking guns; guns, hand-operated, for the extrusion of mastics; dies [hand tools]; fruit pickers [hand tools]; saw blades [parts of hand tools]; shear blades; tool belts [holders]; hair braiders, electric; table cutlery [knives, forks and spoons]; crimping irons; hand implements for hair curling; vegetable choppers; money scoops; instruments and tools for skinning animals; fingernail polishers, electric or non-electric; hackles [hand tools]; pin punches; nail punches; fish tapes [hand tools]; food processors, hand-operated; punches [hand tools]; insecticide vaporizers [hand tools]; syringes for spraying insecticides; reamers; frames for handsaws; saw holders; rasps [hand tools]; paring irons [hand tools]; graving tools [hand tools]; milling cutters [hand tools]; razor strops; leather strops; planes; scythe handles; knife handles; handles for hand-operated hand tools; levers; marline spikes; bits [parts of hand tools]; hollowing bits [parts of hand tools]; pruning scissors; silver plate [knives, forks and spoons]; pruning knives; sickles; drawing knives; scrapers [hand tools]; scrapers for skis; mortise chisels; caulking irons; gouges [hand tools]; mortars for pounding [hand tools]; mitre boxes [hand tools]; branding irons; hatchets; adzes [tools]; vices; bench vices [hand implements]; hoop cutters [hand tools]; axes; holing axes; fulling tools [hand tools]; earth rammers [hand tools]; tube cutters [hand tools]; hoes [hand tools]; squares [hand tools]; extension pieces for braces for screw taps; embossers [hand tools]; apparatus for destroying plant parasites, hand-operated; metal wire stretchers [hand tools]; metal band stretchers [hand tools]; flat irons; irons [non-electric hand tools]; hand-operated fruit slicers; razor cases; ratchets [hand tools]; scraping tools [hand tools]; awls; spatulas [hand tools]; spatulas for use by artists; wine bottle foil cutters, hand-operated; bayonets; pincers; curling tongs; cuticle tweezers; eyelash curlers; flat irons, electric and non-electric; replacement parts for hair clippers; replacement blades for hair clippers.

9 – Scientific, research, navigation, surveying, photographic, cinematographic, audiovisual, optical, weighing, measuring, signalling, detecting, testing, inspecting, life-saving and teaching apparatus and instruments; apparatus and instruments for conducting, switching, transforming, accumulating, regulating or controlling the distribution or use of electricity; apparatus and instruments for recording, transmitting, reproducing or processing sound, images or data; recorded or downloadable media, computer software, blank digital or analogue recording and storage media; mechanisms for coin-operated apparatus; cash registers, calculating devices; computers and computer peripheral devices; diving suits, divers' masks, ear plugs for divers, nose clips for divers and swimmers, gloves for divers, breathing apparatus for underwater swimming; fire-extinguishing apparatus; 3D spectacles; 3D scanners; DVD players; ticket dispensers; juke boxes,

musical; fire engines; answering machines; electrical adapters; batteries for electronic cigarettes; accumulators, electric; batteries, electric, for vehicles; accelerometers; actinometers; alidades; breathalyzers; altimeters; ear pads for headphones; ammeters; apparatus for testing breast milk, other than for medical or veterinary use; nanoparticle size analysers; anemometers; anodes; aerials; anticathodes; apertometers [optics]; high-frequency apparatus; testing apparatus not for medical purposes; electro-dynamic apparatus for the remote control of railway points; electro-dynamic apparatus for the remote control of signals; monitoring apparatus, other than for medical purposes; sound recording apparatus; Global Positioning System [GPS] apparatus; remote control apparatus; distillation apparatus for scientific purposes; diffraction apparatus [microscopy]; air analysis apparatus; apparatus to check franking; sound transmitting apparatus; breathing apparatus for underwater swimming; breathing apparatus, except for artificial respiration; apparatus and installations for the production of X-rays, not for medical purposes; cash registers; electric apparatus for commutation; magnetic resonance imaging [MRI] apparatus, not for medical purposes; intercommunication apparatus; stills for laboratory experiments; projection apparatus; fire extinguishing apparatus; radiological apparatus for industrial purposes; X-ray apparatus not for medical purposes; blueprint apparatus; flashing lights [luminous signals]; stereoscopic apparatus; telephone apparatus; facsimile machines; fermentation apparatus for laboratory use; phototelegraphy apparatus; igniting apparatus, electric, for igniting at a distance; acid hydrometers; Salinometers; acidimeters for batteries; aerometers; beacons, luminous; battery jars; automated teller machines [ATM]; barometers; anode batteries; galvanic batteries; ignition batteries; solar batteries; solar panels for the production of electricity; batteries, electric; balances [steelyards]; betatrons; binoculars; bioreactors for cell culturing for scientific research; bioreactors for laboratory use; biochips; electronic tags for goods; lens hoods; magnetic tape units for computers; computer memory devices; fire hose nozzles; encoded identification bracelets, magnetic; connected bracelets [measuring instruments]; safety tarpaulins; electronic key fobs being remote control apparatus; bullet-proof clothing; signalling buoys; life buoys; marking buoys; directional compasses; vacuum gauges; variometers; internal cooling fans for computers; verniers; scales; baby scales; bathroom scales; letter scales; weighbridges; precision balances; scales with body mass analysers; levelling staffs [surveying instruments]; camcorders; video baby monitors; video cassettes; video projectors; video telephones; video screens; viewfinders, photographic; electric plugs; micrometer screws for optical instruments; viscosimeters; circuit closers; wavemeters; voltmeters; flash lamps for smartphones; mechanical signs; switchboxes [electricity]; current rectifiers; gas testing instru-

ments; gasometers [measuring instruments]; galvanometers; hands-free kits for telephones; headsets; headsets for playing video games; heliographic apparatus; apparatus for generating gas for calibration purposes; hygrometers; hydrometers; weights; peepholes [magnifying lenses] for doors; hairdressing training heads [teaching apparatus]; holograms; plotters; loudspeakers; sounding leads; plumb bobs; range finders; gauges; parking sensors for vehicles; piezoelectric sensors; densimeters; densitometers; holders adapted for mobile telephones and smartphones; detectors; smoke detectors; infrared detectors; counterfeit coin detectors; joysticks for use with computers, other than for video games; transparencies [photography]; slide projectors; diaphragms [photography]; dictating machines; thin film speakers; wearable speakers; dynamometers; light-emitting diodes [LED]; quantum dot light-emitting diodes [QLED]; organic light-emitting diodes [OLED]; floppy disks; phonograph records; disks, magnetic; optical discs; circular slide rules; disk drives for computers; juke boxes for computers; head-mounted displays; wearable video display monitors; electronic numeric displays; DNA chips; electronic interactive whiteboards; electronic notice boards; electric wire harnesses for automobiles; bullet-proof vests; life jackets; reflective safety vests; identification threads for electric wires; nose clips for divers and swimmers; biometric locks; padlocks, electronic; locks, electric; bells [warning devices]; alarm bells, electric; electric door bells; signal bells; acoustic conduits; mirrors for inspecting work; safety signs [luminous]; road signs, luminous or mechanical; warning signs [luminous]; signs, luminous; downloadable emoticons for mobile phones; marine depth finders; probes for scientific purposes; buzzers; needles for surveying compasses; needles for record players; eyewear; reflective articles for wear, for the prevention of accidents; measures; pressure measuring apparatus; simulators for the steering and control of vehicles; inverters [electricity]; pressure indicators; automatic indicators of low pressure in vehicle tyres; temperature indicators; incubators for bacteria culture; measuring instruments; cosmographic instruments; mathematical instruments; levelling instruments; instruments containing eyepieces; surveying instruments; azimuth instruments; interfaces for computers; audio interfaces; ionization apparatus not for the treatment of air or water; satellite finder meters; spark-guards; coaxial cables; fibre optic cables; cables, electric; calipers; slide calipers; screw-tapping gauges; calorimeters; calculating machines; pocket calculators; decompression chambers; rearview cameras for vehicles; cinematographic cameras; thermal imaging cameras; mouth guards for sports; life-saving capsules for natural disasters; electronic pens [visual display units]; holders for electric coils; biometric identity cards; identity cards, magnetic; video game cartridges; toner cartridges, unfilled, for printers and photocopiers; ink cartridges, unfilled, for printers and pho-

tocopiers; memory cards for video game machines; encoded magnetic cards; riding helmets; protective helmets; carriers for dark plates [photography]; cathodes; spools [photography]; choking coils [impedance]; coils, electric; electromagnetic coils; cinematographic film, exposed; computer keyboards; solenoid valves [electromagnetic switches]; wire connectors [electricity]; thin client computers; downloadable cryptographic keys for receiving and spending crypto assets; encoded key cards; electronic book readers; electronic agendas; push buttons for bells; mouse pads; dashboard mats adapted for holding mobile telephones and smartphones; magnetic encoders; visors for helmets; collectors, electric; portable speakers; calibrating rings; smart rings; mobile phone ring holders; mobile phone ring stands; ring sizers; protective suits for aviators; commutators; compact discs [audio-video]; compact discs [read-only memory]; comparators; marine compasses; computers; quantum computers; laptop computers; tablet computers; notebook computers; wearable computers; condensers [capacitors]; contacts, electric; controllers for servo motors; smart home hubs; musical instrument digital interface controllers being audio interfaces; electronic controllers for servo motors; wind socks for indicating wind direction; traffic cones; branch boxes [electricity]; distribution boxes [electricity]; junction boxes [electricity]; battery boxes; cabinets for loudspeakers; diving suits; haptic suits, other than for medical purposes; downloadable e-wallets; evacuation chairs; galena crystals [detectors]; covers for electric outlets; logs [measuring instruments]; lasers, not for medical purposes; lactodensimeters; lactometers; vacuum tubes [radio]; darkroom lamps [photography]; selfie ring lights for smartphones; thermionic valves; amplifying tubes; flashlights [photography]; head cleaning tapes [recording]; magnetic tapes; videotapes; surveying chains; fire escapes; rulers [measuring instruments]; square rulers for measuring; slide-rules; contact lenses; correcting lenses [optics]; close-up lenses; optical lenses; optical condensers; sounding lines; electricity conduits; measuring spoons; magnifying glasses [optics]; thread counters; magnets; decorative magnets; crash test dummies; resuscitation mannequins [teaching apparatus]; mouse [computer peripheral]; trackballs [computer peripherals]; pressure gauges; security tokens [encryption devices]; divers' masks; solderers' helmets; protective masks, not for medical purposes; dust masks incorporating air purification; respiratory masks, other than for artificial respiration; materials for electricity mains [wires, cables]; voting machines; money counting and sorting machines; material testing instruments and machines; furniture especially made for laboratories; megaphones; portable media players; diaphragms [acoustics]; diaphragms for scientific apparatus; metal detectors for industrial or military purposes; digital weather stations; metronomes; rules [measuring instruments]; carpenters' rules; dressmakers' measures; mechanisms for counter-

operated apparatus; coin-operated mechanisms for television sets; shutter releases [photography]; micrometers; microprocessors; microscopes; microtomes; microphones; wireless speaker microphones; audio mixers; modems; lightning conductors; monitors [computer hardware]; monitors [computer programs]; selfie sticks [hand-held monopods]; terminals [electricity]; junction sleeves for electric cables; data sets, recorded or downloadable; teeth protectors; temperature indicator labels, not for medical purposes; kneepads for workers; headphones; earpieces for remote communication; surveyors' levels; sound recording carriers; magnetic data media; optical data media; electronic sheet music, downloadable; computer game software, recorded; computer software, recorded; downloadable computer software for managing cryptocurrency transactions using blockchain technology; software as a medical device [SaMD], downloadable; sheaths for electric cables; identification sheaths for electric wires; weighing machines; computer hardware; punched card machines for offices; shoes for protection against accidents, irradiation and fire; objectives [lenses] [optics]; lenses for astrophotography; selfie lenses; egg-candlers; fire extinguishers; rescue laser signalling flares; electrified fences; limiters [electricity]; clothing for protection against accidents, irradiation and fire; clothing for protection against fire; asbestos clothing for protection against fire; clothing especially made for laboratories; survival blankets; ozonisers [ozonators]; octants; eyepieces; ohmmeters; wrist rests for use with computers; spectacle frames; oscillographs; plumb lines; mirrors [optics]; spectacles; spectacles for correcting colour blindness; sunglasses; goggles for sports; electronic collars to train animals; finger sizers; signalling panels, luminous or mechanical; biometric passports; wah-wah pedals; effects pedals for guitars; radio pagers; pince-nez; electronic pocket translators; transmitters [telecommunication]; telephone transmitters; transmitters of electronic signals; switches, electric; periscopes; data gloves; gloves for divers; gloves for protection against accidents; gloves for protection against X-rays for industrial purposes; asbestos gloves for protection against accidents; furnaces for laboratory use; droppers for measuring, other than for medical or household purposes; laboratory pipettes; pyrometers; planimeters; plane tables [surveying instruments]; plates for batteries; computer software platforms, recorded or downloadable; wafers for integrated circuits; printed circuit boards; compact disc players; cassette players; protective films adapted for computer screens; protective films adapted for smartphones; sound recording strips; mobile phone screen protectors; X-ray films, exposed; films, exposed; life-saving rafts; animal signalling rattles for directing livestock; laboratory trays; digital signs; stands adapted for laptops; in-car telephone handset cradles; cooling pads for laptop computers; airbags for safety purposes for fall protection; semiconductors; polarimeters; personal digital assistants

[PDAs]; fire pumps; measuring glassware; weight belts for divers; life belts; fuses; circuit breakers; converters, electric; telerupters; food analysis apparatus; diagnostic apparatus, not for medical purposes; distance recording apparatus; distance measuring apparatus; speed measuring apparatus [photography]; appliances for measuring the thickness of leather; apparatus for measuring the thickness of skins; speed checking apparatus for vehicles; teaching apparatus; time recording apparatus; apparatus and instruments for astronomy; surveying apparatus and instruments; weighing apparatus and instruments; nautical apparatus and instruments; navigational instruments; optical apparatus and instruments; apparatus and instruments for physics; chemistry apparatus and instruments; measuring apparatus; measuring devices, electric; boiler control instruments; meteorological instruments; naval signalling apparatus; observation instruments; navigation apparatus for vehicles [on-board computers]; satellite navigational apparatus; regulating apparatus, electric; telecommunication apparatus in the form of jewellery; precision measuring apparatus; electric actuators; electric linear actuators; audio- and video-receivers; prisms [optics]; computer software applications, downloadable; wireless portable printers for use with laptops and mobile devices; ticket printers; printers for use with computers; hemline markers; retorts' stands; apparatus for changing record player needles; drainers for use in photography; cleaning apparatus for phonograph records; fire beaters; sighting telescopes for firearms; telescopic sights for artillery; test tubes; pressure indicator plugs for valves; magnetic wires; telegraph wires; telephone wires; wires, electric; conductors, electric; copper wire, insulated; fuse wire; computer programs, recorded; computer game software, downloadable; computer programs, downloadable; computer operating programs, recorded; computer screen saver software, recorded or downloadable; record players; processors [central processing units]; rods for water diviners; electronic publications, downloadable; distribution consoles [electricity]; control panels [electricity]; radar apparatus; baby monitors; masts for wireless aerials; transmitting sets [telecommunication]; radios; vehicle radios; sprinkler systems for fire protection; frames for photographic transparencies; screens for photoengraving; flowmeters; walkie-talkies; voltage surge protectors; voltage regulators for vehicles; stage lighting regulators; light dimmers [regulators], electric; speed regulators for record players; cell switches [electricity]; washing trays [photography]; marking gauges [joinery]; T-squares for measuring; time switches, automatic; relays, electric; safety restraints, other than for vehicle seats and sports equipment; body harnesses for support when lifting loads; X-ray photographs, other than for medical purposes; rheostats; respirators for filtering air; retorts; refractometers; refractors; grids for batteries; security surveillance robots; laboratory robots; teaching robots; telepresence robots; humano-

id robots with artificial intelligence for use in scientific research; electric sockets; height measuring instruments; speaking tubes; horns for loudspeakers; subwoofers; saccharometers; optical fibres [light conducting filaments]; traffic-light apparatus [signalling devices]; dog whistles; signalling whistles; sports whistles; sextants; inductors [electricity]; safety nets; nets for protection against accidents; fire alarms; signals, luminous or mechanical; rescue flares, non-explosive and non-pyrotechnic; sirens; electronic access control systems for interlocking doors; scanners [data processing equipment]; scanners [apparatus] for performing automotive diagnostics; hand-held electronic dictionaries; smart speakers; integrated circuit cards [smart cards]; smartglasses; smartphones; foldable smartphones; smartwatches; connections for electric lines; couplings, electric; connectors [electricity]; sonars; sound locating instruments; lighting ballasts; resistances, electric; spectrograph apparatus; spectrometers; speed indicators; alcoholmeters; satellites for scientific purposes; protection devices for personal use against accidents; audiovisual teaching apparatus; charging stations for electric vehicles; radiotelegraphy sets; radiotelephony sets; spectacle lenses; anti-glare glasses; optical glass; personal stereos; stereoscopes; stands for photographic apparatus; stroboscopes; fire boats; sulfimeters; bags adapted for laptops; drying racks [photography]; spherometers; integrated circuits; printed circuits; counters; parking meters; mileage recorders for vehicles; portable ultrafine dust meters; revolution counters; abacuses; egg timers [sandglasses]; taximeters; ear plugs for divers; tachometers; television apparatus; telegraphs [apparatus]; telescopes; teleprompters; teleprinters; cordless telephones; mobile telephones; theodolites; credit card terminals; interactive touch screen terminals; thermohygrometers; thermometers, not for medical purposes; thermostats; thermostats for vehicles; climate control digital thermostats; crucibles [laboratory]; tone arms for record players; totalizers; transistors [electronic]; transponders; protractors [measuring instruments]; transformers [electricity]; step-up transformers; resuscitation training simulators; vehicle breakdown warning triangles; triodes; starter cables for motors; discharge tubes, electric, other than for lighting; capillary tubes for laboratory use; neon signs; Pitot tubes; X-ray tubes not for medical purposes; telephone receivers; headgear being protective helmets; squares for measuring; quantity indicators; petrol gauges; water level indicators; electric loss indicators; light-emitting electronic pointers; slope indicators; levels [instruments for determining the horizontal]; mercury levels; spirit levels; urinometers; amplifiers for servo motors; amplifiers; particle accelerators; electric installations for the remote control of industrial operations; steering apparatus, automatic, for vehicles; balancing apparatus; video recorders; sound reproduction apparatus; invoicing machines; tape recorders; protection devices against X-rays, not for medical

purposes; railway traffic safety appliances; data processing apparatus; oxygen transvasing apparatus; theft prevention installations, electric; devices for the projection of virtual keyboards; film cutting apparatus; drying apparatus for photographic prints; optical character readers; centering apparatus for photographic transparencies; dosage dispensers; battery chargers; mobile phone chargers; chargers for electric accumulators; chargers for electronic cigarettes; portable power chargers; acoustic alarms; sounding apparatus and machines; life-saving apparatus and equipment; apparatus for editing cinematographic film; cathodic anti-corrosion apparatus; couplers [data processing equipment]; wearable activity trackers; anti-theft warning apparatus; computer peripheral devices; anti-interference devices [electricity]; demagnetizing apparatus for magnetic tapes; acoustic couplers; alarms; fog signals, non-explosive; whistle alarms; adding machines; readers [data processing equipment]; heat regulating apparatus; photocopiers [photographic, electrostatic, thermic]; electric and electronic effects units for musical instruments; bar code readers; head-up display apparatus for vehicles; downloadable ring tones for mobile phones; downloadable image files; downloadable music files; animated cartoons; filters for respiratory masks; filters for ultraviolet rays, for photography; filters for use in photography; USB flash drives; magic lanterns; optical lanterns; signal lanterns; cameras [photography]; glazing apparatus for photographic prints; shutters [photography]; darkrooms [photography]; photometers; flash-bulbs [photography]; digital photo frames; enlarging apparatus [photography]; photovoltaic cells; containers for contact lenses; contact lens cases incorporating ultrasonic cleaning functions; spectacle cases; containers for microscope slides; cases for smartphones; cases especially made for photographic apparatus and instruments; chromatography apparatus for laboratory use; chronographs [time recording apparatus]; laboratory centrifuges; spectacle chains; cyclotrons; compasses for measuring; frequency meters; time clocks [time recording devices]; Petri dishes; sleeves for laptops; covers for personal digital assistants [PDAs]; covers for tablet computers; covers for smartphones; fire blankets; chips [integrated circuits]; jigs [measuring instruments]; pedometers; fire-extinguishing balls; meteorological balloons; electrified rails for mounting spot lights; asbestos screens for firemen; fire hose; virtual reality headsets; protective helmets for sports; neural helmets, not for medical purposes; head guards for sports; lifeboats; snorkels; cell phone straps; spectacle cords; tripods for cameras; switchboards; distribution boards [electricity]; equalizers [audio apparatus]; screens [photography]; workmen's protective face-shields; projection screens; radiology screens for industrial purposes; fluorescent screens; exposure meters [light meters]; electrolysis apparatus for laboratory use; ducts [electricity]; galvanic cells; downloadable graphics for mobile phones; epidiascopes;

ergometers; armatures [electricity]; black boxes [data recorders].

11 – Apparatus and installations for lighting, heating, cooling, steam generating, cooking, drying, ventilating, water supply and sanitary purposes; lampshades; autoclaves, electric, for cooking; steam accumulators; heat accumulators; defrosters for vehicles; adsorption apparatus for generating gas; disinfectant apparatus for medical purposes; distillation apparatus; desiccating apparatus; hydromassage bath apparatus; disinfectant apparatus; air deodorizing apparatus; ionization apparatus for the treatment of air or water; coffee roasters; beverage cooling apparatus; apparatus for fertilizer irrigation; hand drying apparatus for washrooms; fruit roasters; water purifying apparatus and machines; refrigerating apparatus and machines; under-floor heating apparatus and installations; drying apparatus and installations; membrane apparatus for generating gas; freezers; heating and cooling apparatus for dispensing hot and cold beverages; drying apparatus; fermentation apparatus for industrial purposes; coolers for furnaces; expansion tanks for central heating installations; flushing tanks; refining towers for distillation; bidets; bioreactors for use in the treatment of wastewater; bioreactors for use in the treatment of waste; boilers, other than parts of machines; bath tubs; spa baths [vessels]; bath tubs for sitz baths; waffle irons, electric; fans [air-conditioning]; fans [parts of air-conditioning installations]; electric fans for personal use; roasting spits; refrigerating display cabinets; heated display cabinets; dehumidifiers; water heaters; water flushing installations; air reheaters; extractor hoods for kitchens; gas condensers, other than parts of machines; acetylene generators; fog machines; microbubble generators for baths; hydrants; fairy lights for festive decoration; burners; acetylene burners; gas burners; burners for lamps; germicidal burners; incandescent burners; oxyhydrogen burners; laboratory burners; oil burners; alcohol burners; hot water bottles; footwarmers, electric or non-electric; bed warmers; USB-powered hand warmers; pocket warmers; warming pans; roasting apparatus; food dehydrators, electric; lampshade holders; stills; showers; refrigerating containers; gas lighters; friction lighters for igniting gas; chimney blowers; coils [parts of distilling, heating or cooling installations]; furnace ash boxes; evaporators; electric appliances for making yogurt; shower cubicles; Turkish bath cabinets, portable; heating apparatus; cool boxes, electric; refrigerating chambers; fireplaces, domestic; chimney flues; coffee capsules, empty, for electric coffee machines; structural framework for ovens; cooking pots, electric; air valves for steam heating installations; level controlling valves in tanks; thermostatic valves [parts of heating installations]; electrically heated carpets; light bulbs; light bulbs, electric; solar thermal collectors [heating]; distillation columns; furnace grates; ventilation hoods; ventilation hoods for laboratories; lamp globes; air-conditioning apparatus; air conditioners

for vehicles; gas boilers; laundry room boilers; heating boilers; coffee machines, electric; coffee machines incorporating water purifiers; taps for pipes and pipelines; taps; mixer taps for water pipes; electrically heated mugs; forges, portable; lava rocks for use in barbecue grills; couscous cookers, electric; lights, electric, for Christmas trees; acetylene flares; safety lamps; gas lamps; curling lamps; nail lamps; curing lamps, not for medical purposes; germicidal lamps for purifying air; light bulbs for directional signals for vehicles; arc lamps; laboratory lamps; oil lamps; ultraviolet ray lamps, not for medical purposes; miners' lamps; electric lamps; chandeliers; barbecues; bread baking machines; watering machines for agricultural purposes; ice-cream making machines; beer brewing machines, electric, for household purposes; soya milk making machines, electric; snow-making machines; pounded rice cake making machines, electric, for household purposes; membranes for reverse osmosis units; filters for water filtering apparatus; multicookers; footmuffs, electrically heated; heaters for baths; heaters for heating irons; immersion heaters; brackets for gas burners; anti-splash tap nozzles; heat pumps; filaments for electric lamps; magnesium filaments for lighting; heating filaments, electric; luminous house numbers; socks, electrically heated; heating apparatus for defrosting vehicle windows; hot air bath fittings; bath fittings; loading apparatus for furnaces; kiln furniture [supports]; sauna bath installations; refrigerating appliances and installations; directional lights for bicycles; running lights for vehicles; electrically heated clothing; blankets, electric, not for medical purposes; fabric steamers; lamp reflectors; vehicle reflectors; hearths; lightsticks, battery-operated; electric cooktops; food steamers, electric; steam boilers, other than parts of machines; pasteurisers; lamp mantles; sockets for electric lights; coffee percolators, electric; stoves [heating apparatus]; bakers' ovens; hot air ovens; kitchen ranges [ovens]; microwave ovens [cooking apparatus]; microwave ovens for industrial purposes; incinerators; kilns; solar furnaces; dental ovens; furnaces, other than for laboratory use; urinals being sanitary fixtures; feeding apparatus for heating boilers; heating plates; cooking stoves; hot plates; wine cellars, electric; heaters, electric, for feeding bottles; aquarium heaters; USB-powered cup heaters; aquarium lights; heating cushions, electric, not for medical purposes; clean chambers [sanitary installations]; electric vessels for making ices and ice cream; tortilla presses, electric; water intake apparatus; apparatus for dehydrating food waste; fumigation apparatus, not for medical purposes; gas scrubbing apparatus; oil-scrubbing apparatus; glue-heating appliances; drying apparatus for fodder and forage; water filtering apparatus; air purifying apparatus and machines; ice machines and apparatus; cooling appliances and installations; cooking apparatus and installations; lighting apparatus and installations; sanitary apparatus and installations; cooking rings; lighting apparatus for vehic-

les; light-emitting diodes [LED] lighting apparatus; heating apparatus for solid, liquid or gaseous fuels; heating apparatus, electric; hot air apparatus; steam facial apparatus [saunas]; safety accessories for water or gas apparatus and pipes; regulating and safety accessories for gas apparatus; regulating accessories for water or gas apparatus and pipes; regulating and safety accessories for water apparatus; regulating and safety accessories for gas pipes; roasting jacks; plate warmers; anti-glare devices for vehicles [lamp fittings]; rotisseries; radiator caps; searchlights; diving lights; light projectors; washers for water taps; heat guns; radiators [heating]; central heating radiators; radiators, electric; sinks; kitchen sinks incorporating integrated worktops; drip irrigation emitters [irrigation fittings]; light diffusers; nuclear reactors; heat regenerators; pressure water tanks; roasters; beverage urns, electric; lamps; floor lamps; ceiling lights; toilet seats; hydroponic growing systems; lighting installations for air vehicles; gas scrubbers [parts of gas installations]; tanning beds; lamp glasses; sterilizers; water sterilizers; air sterilizers; air dryers; laundry dryers, electric; hair dryers; malt roasters; tobacco roasters; tajines, electric; heat exchangers, other than parts of machines; thermo-pots, electric; standard lamps; bread toasters; discharge tubes, electric, for lighting; lamp chimneys; luminous tubes for lighting; pipes [parts of sanitary installations]; flues for heating boilers; boiler pipes [tubes] for heating installations; heat-stabilized polypropylene pipes for heating installations; toilets [water-closets]; toilets, portable; humidifiers; humidifiers for central heating radiators; membrane filtration units for water treatment apparatus; wash-hand basins [parts of sanitary installations]; toilet bowls; water conduits installations; bath installations; air-conditioning installations; desalination plants; installations for processing nuclear fuel and nuclear moderating material; watering installations, automatic; cooling installations for water; cooling installations for liquids; milk cooling installations; cooling installations for tobacco; water purification installations; purification installations for sewage; steam generating installations; water distribution installations; air filtering installations; swimming pool chlorinating apparatus; ventilation [air-conditioning] installations and apparatus; ventilation [air-conditioning] installations for vehicles; water softening apparatus and installations; cooling installations and machines; reverse osmosis units; heating installations; heaters for vehicles; heating installations [water]; polymerisation installations; water supply installations; flare stacks for use in the oil industry; disinfectant apparatus for dispensing solutions into water-pipes for sanitary installations; ash conveyor installations, automatic; deodorizing apparatus, not for personal use; whirlpool-jet apparatus; air cooling apparatus; sous-vide cookers, electric; aquarium filtration apparatus; cooking utensils, electric; flaming torches; headlights for automobiles; vehicle headlights; filters for air condi-

tioning; filters for drinking water; reverse osmosis membrane filters for water treatment; wicks specially for oil stoves; lights for automobiles; bicycle lights; motorcycle lights; lights for vehicles; electric torches; head torches; lanterns for lighting; candle lanterns; street lamps; Chinese lanterns; fountains; ornamental fountains; chocolate fountains, electric; air fryers; deep fryers, electric; fittings, shaped, for furnaces; oven fittings made of fireclay; bread-making machines; refrigerators; refrigerators, cooling apparatus and freezers for medical storage purposes; chromatography apparatus for industrial purposes; kettles, electric; dampers [heating]; book sterilization apparatus; refrigerating cabinets; carbon for arc lamps; heating elements; replacement parts for hair dryers; replacement filters for humidifiers and air purifiers; antibacterial cartridges for humidifiers and air purifiers; replacement filters for coffee makers and coffee machines; replacement carafes for coffee makers and coffee machines.

21 – Household or kitchen utensils and containers; cookware and tableware, except forks, knives and spoons; combs and sponges; brushes, except paint-brushes; brush-making materials; articles for cleaning purposes; glass, unworked or semi-worked, except building glass; glassware, porcelain and earthenware; autoclaves, non-electric, for cooking; indoor aquaria; wine aerators; buckets; automatic opening and closing trash cans; cookie jars; candle jars [holders]; china ornaments; dishes; vegetable dishes; saucers; boxes for sweets; bottles; demijohns; busts of porcelain, ceramic, earthenware, terra-cotta or glass; vases; epergnes; fruit bowls; inflatable bath tubs for babies; bird baths; baby baths, portable; plungers for clearing blocked drains; waffle irons, non-electric; diaper disposal pails; ice buckets; mop wringer buckets; buckets made of woven fabrics; whisks, non-electric, for household purposes; cooking skewers of metal; towel rails and rings; clothing stretchers; barbecue forks; serving forks; hair for brushes; horsehair for brush-making; funnels; pie funnels; candle warmers, electric and non-electric; carpet beaters [hand instruments]; signboards of porcelain or glass; candle extinguishers; heads for electric toothbrushes; flower pots; chamber pots; glue-pots; cruets; decanters; large-toothed combs for the hair; combs for animals; tea cosies; abrasive sponges for scrubbing the skin; bath sponges; make-up sponges; sponges for household purposes; sponge holders; stands for portable baby baths; toothpick holders; soap holders; table napkin holders; holders for flowers and plants [flower arranging]; tea bag rests; shaving brush stands; toilet paper holders; toilet paper dispensers; soap dispensers; plug-in diffusers for mosquito repellents; aromatic oil diffusers, other than reed diffusers, electric and non-electric; ironing boards; cutting boards for the kitchen; bread boards; washing boards; crushers for kitchen use, non-electric; strainers for household purposes; smoke absorbers for household purposes; containers for household

or kitchen use; kitchen containers; glass jars [carboys]; heat-insulated containers; heat-insulated containers for beverages; thermally insulated containers for food; glass flasks [containers]; closures for pot lids; chamois leather for cleaning; toothpicks; ceramics for household purposes; majolica; works of art of porcelain, ceramic, earthenware, terra-cotta or glass; kitchen grinders, non-electric; cleaning instruments, hand-operated; cabarets [trays]; stew-pans; couscous cooking pots, non-electric; cooking pots, non-electric; flower-pot covers, not of paper; shaving brushes; make-up brushes; basting brushes; cages for household pets; birdcages; cages for collecting insects; baking mats; ladles for serving wine; polishing leather; hot pots, not electrically heated; glass bulbs [receptacles]; shoe trees; napkin rings; poultry rings; rings for birds; disposable aluminium foil containers for household purposes; coin banks; piggy banks; bread baskets for household purposes; baskets for household purposes; waste paper baskets; feeding troughs; pet feeding bowls, automatic; mangers for animals; lunch boxes; insect collectors' boxes; tea caddies; washtubs; earthenware saucepans; mess-tins; cauldrons; coffee percolators, non-electric; coffeepots, non-electric; coffee grinders, hand-operated; mugs; beer mugs; tankards; rat traps; pot lids; aquarium hoods; butter-dish covers; dish covers; cheese-dish covers; reusable silicone food covers; buttonhooks; reusable ice cubes; jugs; perfume burners; watering cans; fly traps; insect traps; ice cream scoops; mixing spoons [kitchen utensils]; basting spoons [cooking utensils]; serving spoons; pie servers; cosmetic spatulas; spatulas for kitchen use; valet trays [receptacles for small objects] for household purposes; litter boxes for pets; butter dishes; material for brush-making; polishing materials for making shiny, except preparations, paper and stone; tablemats, not of paper or textile; noodle machines, hand-operated; lint removers, electric or non-electric; pasta makers, hand-operated; polishing apparatus and machines, for household purposes, non-electric; pepper mills, hand-operated; mills for household purposes, hand-operated; feather-dusters; brooms; isothermic bags; decorating bags for confectioners; cooking mesh bags, other than for microwaves; bowls [basins]; pet feeding bowls; soup bowls; mosaics of glass, not for building; dishcloths; saucepan scourers of metal; soap boxes; mouse traps; meat grinders, non-electric; cooking pot sets; nozzles for watering cans; pouring spouts; wine pourers; cake decorating tips and tubes; nozzles for watering hose; fitted picnic baskets, including dishes; toilet cases; floss for dental purposes; fibreglass thread, other than for textile use; cookie [biscuit] cutters; pastry cutters; sprinklers; syringes for watering flowers and plants; egg yolk separators; cotton waste for cleaning; wool waste for cleaning; cleaning tow; cold packs for chilling food and beverages; chopsticks; cocktail stirrers; food steamers, non-electric; pepper pots; abrasive mitts for scrubbing the skin; oven mitts; animal grooming gloves; gloves

for household purposes; car washing mitts; polishing gloves; gardening gloves; pestles for kitchen use; droppers for household purposes; wine-tasting pipettes; droppers for cosmetic purposes; plates for diffusing aromatic oil; plates to prevent milk boiling over; dripping pans; trays for household purposes; trays of paper, for household purposes; lazy susans; heaters for feeding bottles, non-electric; candelabra [candlesticks]; trivets [table utensils]; coasters, not of paper or textile; grill supports; menu card holders; knife rests for the table; mats, not of paper or textile, for beer glasses; flat-iron stands; egg cups; abrasive pads for kitchen purposes; scouring pads; drinking troughs; serving ladles; powdered glass for decoration; pottery; pots; vessels for making ices and ice cream, non electric; painted glassware; tableware, other than knives, forks and spoons; porcelain ware; earthenware; crystal [glassware]; cosmetic utensils; trouser presses; tortilla presses, non-electric [kitchen utensils]; tube squeezers for household purposes; fruit presses, non-electric, for household purposes; deodorizing apparatus for personal use; cruet sets for oil and vinegar; make-up removing appliances; spice sets; apparatus for wax-polishing, non-electric; bottle openers, electric and non-electric; glove stretchers; boot jacks; crumb trays; tie presses; potholders; clothes-pegs; glass stoppers; roaster pans; powder compacts, empty; perfume vaporizers; powder puffs; dusting apparatus, non-electric; foam toe separators for use in pedicures; stretchers for clothing; electric combs; combs; grills [cooking utensils]; sifters [household utensils]; drinking horns; shoe horns; candle drip rings; broom handles; salad bowls; place mats, not of paper or textile; beverage urns, non-electric; sugar bowls; beaters, non-electric; egg separators, non-electric, for household purposes; services [dishes]; coffee services [tableware]; liqueur sets; tea services [tableware]; sieves [household utensils]; cinder sifters [household utensils]; tea strainers; siphon bottles for carbonated water; rolling pins, domestic; frying pans; squeegees [cleaning instruments]; steel wool for cleaning; currycombs; smart medicine bottles, sold empty; blenders, non-electric, for household purposes; scoops for household purposes; straws for drinking; salt cellars; drinking vessels; refrigerating bottles; bulb basters; cups of paper or plastic; glasses [receptacles]; drinking glasses; statues of porcelain, ceramic, earthenware, terra-cotta or glass; figurines of porcelain, ceramic, earthenware, terra-cotta or glass; glass for vehicle windows [semi-finished product]; fused silica [semi-worked product], other than for building; plate glass [raw material]; opal glass; opaline glass; glass incorporating fine electrical conductors; enamelled glass, not for building; glass wool, other than for insulation; vitreous silica fibres, other than for textile use; fibreglass, other than for insulation or textile use; mortars for kitchen use; portable cool boxes, non-electric; soup tureens; drying racks for laundry; rotary washing lines; tajines, non-electric; basins [receptacles]; table plates; paper pla-

tes; disposable table plates; graters for kitchen use; insulating flasks; indoor terrariums [plant cultivation]; indoor terrariums [vivariums]; roller tubes for peeling garlic; cloth for washing floors; polishing cloths; cloths for cleaning; dusting cloths [rags]; furniture dusters; wax-polishing appliances, non-electric, for shoes; water apparatus for cleaning teeth and gums; electric devices for attracting and killing insects; watering devices; ultrasonic pest repellers; utensils for household purposes; kitchen utensils; cooking utensils, non-electric; figurines of porcelain, ceramic, earthenware, terra-cotta or glass for cakes; coffee filters, non-electric; flasks; water flossers; hip flasks; drinking bottles for sports; boot trees; moulds [kitchen utensils]; egg poachers; cake moulds; baking cases of paper; baking cases of silicone; ice cube moulds; cookery moulds; deep fryers, non-electric; comb cases; bread bins; fly swatters; teapots; kettles, non-electric; cups; garlic presses [kitchen utensils]; ironing board covers, shaped; tea infusers; decorative glass spheres; mop wringers; mops; cocktail shakers; cosmetic stamps, sold empty; corkscrews, electric and non-electric; animal bristles [brushware]; pig bristles for brush-making; sound wave vibration hairbrushes; dishwashing brushes; ski wax brushes; brushes for cleaning tanks and containers; lamp-glass brushes; horse brushes; scrubbing brushes; toothbrushes; toothbrushes, electric; carpet sweepers; shoe brushes; tarbrushes, long handled; toilet brushes; electric brushes, except parts of machines; brushes; eyebrow brushes; nail brushes; eyelash brushes; barbecue tongs; nutcrackers; ice tongs; salad tongs; sugar tongs; decanter tags; nest eggs, artificial; boxes for dispensing paper towels; dustbins; window-boxes; boxes of glass; food blenders non-electric, for household purposes.

34 – Tobacco and tobacco substitutes; cigarettes and cigars; electronic cigarettes and oral vaporizers for smokers; smokers' articles; matches; flavourings, other than essential oils, for tobacco; flavourings, other than essential oils, for use in electronic cigarettes; gas containers for cigar lighters; absorbent paper for tobacco pipes; cigarette paper; lighters for smokers; hookahs; tobacco pouches; books of cigarette papers; humidors; matchboxes; firestones; cigar cutters; cigar holders; cigarette holders; mouthpieces for cigarette holders; tips of yellow amber for cigar and cigarette holders; ashtrays for smokers; spittoons for tobacco users; pipe racks for tobacco pipes; pipe cleaners for tobacco pipes; liquid solutions for use in electronic cigarettes; electronic cigarettes; cigarettes; cigarettes containing tobacco substitutes, not for medical purposes; cigarillos; cigars; tobacco jars; match holders; oral vaporizers for smokers; tobacco; chewing tobacco; snuff; snuff boxes; herbs for smoking; tobacco pipes; pocket machines for rolling cigarettes; cigarette filters; wicks adapted for cigarette lighters; cigarette tips; cigar cases; cigarette cases.

(260) AM 2024 122339 A
(800) 1722995
(151) 2023 02 08
(891) 2023 02 08
(731) Limited Liability Company "ZADAR TORH"
vul. Pasichna, 171, kv. 187, Lviv 79066,
Ukraine
(540)



(591) Black, white
(531) 02.01.16; 02.01.23; 24.09.02; 24.09.05;
24.09.07; 27.03.02; 27.05.01; 27.05.09
(511)
33 – Sugarcane-based alcoholic beverages; alcoholic beverages, except beer; alcoholic beverages containing fruit; anisette [liqueur]; anise [liqueur]; aperitifs; arrack [arak]; brandy; wine; whisky; vodka; kirsch; perry; gin; digestifs [liqueurs and spirits]; cocktails; curacao; liqueurs; makkoli; hydromel [mead]; peppermint liqueurs; pre-mixed alcoholic beverages, other than beer-based; wine-based beverages; bitters; piquette; rice alcohol; rum; sake; cider; soju; spirits [beverages]; distilled beverages; grain-based distilled alcoholic beverages; alcoholic extracts; alcoholic essences; fruit extracts, alcoholic.

(260) AM 2024 122340 A
(800) 1723019
(151) 2023 03 03
(891) 2023 03 03
(731) Dmitriy Gennadyevich Loskutov
Rybatskiy pr., 43, 1, 183, RU-192076 Saint-Petersburg, Russian Federation
(540)



(591) White, blue and black
(531) 26.03.04; 27.05.01; 29.01.13
(526) LABS
(511)
25 – Bandanas [neckerchiefs]; berets; overalls; trousers; jerseys [clothing]; waistcoats; sports jerseys; ho-siery; hoods [clothing]; caps being headwear; visors being headwear; combinations [clothing]; jackets [clothing]; stuff jackets [clothing]; fishing vests; sports singlets; socks; footwear; clothing; paper clothing; outerclothing; embroidered clothing; ready-made clothing; uniforms; gloves [clothing]; fingerless gloves; headscarves; dresses; belts [clothing]; shirts; boots; sweaters; knitwear [clothing]; headwear; tee-shirts; scarves.

41 – Electronic games services provided by means of the internet; information relating to computer gaming

entertainment provided on-line from a computer database or a global communication network; arranging of games and competitions via the Internet; providing recreation facilities; organization of cosplay entertainment events; providing online videos, not downloadable; providing online music, not downloadable; providing television programmes, not downloadable, via video-on-demand services; providing films, not downloadable, via video-on-demand services; providing amusement arcade services; publication of texts, other than publicity texts; entertainment services; providing online electronic publications, not downloadable; online gambling services; providing information relating to recreational activities; providing information in the field of entertainment; game services provided online from a computer network; film production, other than advertising films.

(260) AM 2023 122369 A

(800) 1723649

(151) 2023 03 02

(891) 2023 03 02

(731) LIMITED LIABILITY COMPANY VCO

Ershovo village, 121, Odintsovo, RU-143055
Moscow Region, Russian Federation

(540)

CREAMBURG

(591) Black, white

(511)

29 – Agar-agar for culinary purposes; aloe vera prepared for human consumption; alginates for culinary purposes; andouillettes; anchovy, not live; peanuts, prepared; artichokes, preserved; white of eggs; beans, preserved; soya beans, preserved, for food; broth; ginger jam; verjuice for culinary purposes; ham; fatty substances for the manufacture of edible fats; laver, preserved; edible birds' nests; sea-cucumbers, not live; cabbage rolls stuffed with meat; peas, preserved; mushrooms, preserved; guacamole; berry-based fool; game, not live; gelatine; meat jellies; jellies for food, other than confectionery; yolk of eggs; coconut fat; bone oil for food; lard; suet for food; edible fats; fruit-based snack food; milk substitutes; soya patties; tofu patties; charcuterie; raisins; caviar; aubergine paste; vegetable marrow paste; fish roe, prepared; ginger, preserved; crystallized ginger; pickled ginger; yogurt; sauerkraut; cassoulet; quark; kephir; kimchi; isinglass for food; potato-based dumplings; klipfish [salted and dried cod]; Clams [not live]; milk shakes; black pudding; onion rings; arrangements of processed fruit; compotes; meat, tinned; vegetables, tinned; fish, tinned; fruits, tinned; duck confits; broth concentrates; vegetable-based concentrate for cooking; fruit-based concentrate for cooking; corn dogs; gherkins; shrimps, not live; prawns, not live; buttercream; croquettes; silkworm chrysalis for human consumption; sweet corn, processed; koumiss; spiny lobsters, not live; lecithin for culinary purposes; edible ant larvae,

prepared; salmon, not live; onions, preserved; margarine; marmalade; oils for food; peanut butter; cocoa butter for food; coconut oil for food; coconut butter; maize oil for food; sesame oil for food; linseed oil for food; extra virgin olive oil for food; olive oil for food; palm oil for food; palm kernel oil for food; sunflower oil for food; rape oil for food; butter; soya bean oil for food; mussels, not live; almonds, ground; animal marrow for food; shellfish, not live; molluscs, not live; milk; peanut milk; peanut milk for culinary purposes; coconut milk; coconut milk for culinary purposes; almond milk; almond milk for culinary purposes; oat milk; rice milk; rice milk for culinary purposes; albumin milk; curd; condensed milk; soured milk; soya milk; powdered milk; fermented baked milk; fish meal for human consumption; vegetable mousses; fish mousses; fruit pulp; meat; meat, preserved; freeze-dried meat; lactic acid drinks; milk beverages, milk predominating; peanut milk-based beverages; coconut milk-based beverages; almond milk-based beverages; edible insects, not live; sausage casings, natural or artificial; vegetables, preserved; freeze-dried vegetables; vegetables, processed; vegetables, dried; vegetables, cooked; hash browns; potato fritters; olives, preserved; lobsters, not live; omelettes; flavoured nuts; candied nuts; coconut, desiccated; nuts, prepared; tomato paste; pressed fruit paste; liver pâté; pectin for culinary purposes; preserved peppers; liver; pickles; vegetable-based prepared meals for toddlers; jams; powdered eggs; milk products; fish-based foodstuffs; poultry, not live; white pudding; bulgogi; pollen prepared as foodstuff; cranberry compote; tomato purée; apple purée; crayfish, not live; crustaceans, not live; ratatouille; fish, preserved; fish, not live; salted fish; vegetable salads; fruit salads; bacon; sardines, not live; satay; pork; herrings, not live; seeds, prepared; sunflower seeds, prepared; cream [dairy products]; whipped cream; vegetable-based cream; fat-based spreads for bread slices; smetana; lemon juice for culinary purposes; tomato juice for cooking; vegetable juices for cooking; salted meats; sausages; sausages in batter; hot dog sausages; preparations for making bouillon; preparations for making soup; tofu skin; vegetable-based spreads; nut-based spreads; fruit jelly spreads; tripe; berry soup; soups; vegetable soup preparations; whey; cottage cheese fritters; cheese; tajine [prepared meat, fish or vegetable dish]; tahini; cottage cheese; tofu; tempeh; truffles, preserved; tuna, not live; oysters, not live; falafel; milk ferments for culinary purposes; rennet; fish fillets; dates; crystallized fruits; frozen fruits; fruit, preserved; fruit, processed; fruit preserved in alcohol; fruit, stewed; hazelnuts, prepared; potato flakes; hummus; edible flowers, dried; fruit peel; preserved garlic; lentils, preserved; potato crisps; low-fat potato crisps; fruit chips; choucroute garnie; non-alcoholic eggnog; seaweed extracts for food; meat extracts; berries, preserved; eggs; snail eggs for consumption; yakitori.

(260) AM 2023 122370 A

(800) 1723661

(151) 2023 03 09

(891) 2023 03 09

(731) MERCK KgaA

Frankfurter Str. 250; 64293 Darmstadt,
Germany

(540)

KEEVOH

(591) Black, white

(511)

5 – Pharmaceutical products; medicines and natural remedies; diagnostic preparations and materials; hygiene preparations for medical purposes.

(260) AM 2024 122379 A

(800) 1269551

(151) 2015 06 29

(891) 2023 01 25

(731) Joint-stock company "TWINS Tec"

building 1, estate 18, Vostochnaya street,
(promzona Tekhnopark), rabochij poselok
Leninskiye Gorki, Vidnoe, RU-142712,
Russian Federation

(540)



(591) Blue, red and grey

(531) 26.11.13; 27.07.02; 28.05; 29.01.13

(511)

3 – Abrasives; abrasive cloth; glass cloth; abrasive paper; breath freshening sprays; diamantine [abrasive]; alum stones [astringents]; amber [perfume]; antistatic preparations for household purposes; cosmetic dyes; color- colour- brightening chemicals for household purposes [laundry]; bergamot oil; fragrance sachets for eye pillows; incense sticks; preparations to make the leaves of plants shiny; starch glaze for laundry purposes; abrasive preparations; badian essence; beard dyes; pastes for razor strops; shaving stones [astringents]; shaving soap; shaving preparations; eyebrow cosmetics; eyebrow pencils; petroleum jelly for cosmetic purposes; cosmetic preparations for baths; bath salts, not for medical purposes; cotton wool for cosmetic purposes; cotton sticks for cosmetic purposes; shoe black [shoe polish]; shoe cream; bleaching soda; laundry preparations; bleaching salts; dental bleaching gels; skin whitening creams; decorative transfers for cosmetic purposes; cosmetic preparations for eyelashes; false eyelashes; adhesives for affixing false eyelashes; mustache wax; creams for leather; tailors' wax; polishing wax; windshield cleaning liquids; hair dyes and bleaching products; depilatory preparations; hair lotions; hair waving lotions; volca-

nic ash for cleaning; astringents for cosmetic purposes; cloths impregnated with a detergent for cleaning; gaultheria oil; heliotropine; geraniol; javelle water; make-up; make-up removing preparations; theatrical make-up; lipsticks; disinfectant soap; deodorants for human beings or for animals; deodorant soap; depilatory creams; shampoos for pets; scented water; scented wood; extracts of flowers [perfumes]; ethereal essences; essential oils; jasmine oil; greases for cosmetic purposes; laundry bleach; flavorings [flavourings] for beverages [essential oils]; aromatics [essential oils]; cake flavorings [essential oils]; preservatives for leather [polishes]; degreasers other than for use in manufacturing processes; dentifrices; denture polishes; preparations for cleaning dentures; ionone [perfumery]; rust removing preparations; silicon carbide [abrasive]; carbides of metal [abrasives]; bases for flower perfumes; essential oils of cedarwood; adhesives for affixing false hair; adhesives for cosmetic purposes; quillaia bark for washing; corundum [abrasive]; decorative cosmetics; cosmetics for animals; cosmetic powders, creams and lotions for the face, hands and body; beauty masks; cosmetic kits; whitening; cleaning chalk; cosmetic creams; laundry glaze; laundry starch; cakes of toilet soap; lavender water; lavender oil; incense; nail polish removers; hair spray; nail polish; essential oils of lemon; polishing paper; smoothing stones; polishing preparations; polish for furniture and flooring; medicated soap; beauty lotions; tissues impregnated with cosmetic lotions; after-shave lotions; smoothing preparations [starching]; floor polish; non-slippping wax for floors; almond oil; almond soap; almond milk for cosmetic purposes; washing soda, for cleaning; detergents other than for use in manufacturing operations and for medical purposes; soap; soap for foot perspiration; antiperspirant soap; cleansing milk for toilet purposes; musk [perfumery]; fabric softeners for laundry use; mint for perfumery; mint essence [essential oil]; emery; emery cloth; emery paper; ammonia [volatile alkali] [detergent]; preparations for the permanent waving of hair; nail glitter; nail care preparations; false nails; eau de cologne; cosmetic pencils; oils for perfumes and scents; oils for cosmetic purposes; oils for toilet purposes; turpentine, for degreasing; perfumery; washing powder; pumice stone; hydrogen peroxide for cosmetic purposes; rose oil; non-medicated toiletries; toilet water; hair mascara; paint stripping preparations; refurbishing preparations; cleaning, scouring and abrasive preparations; cleaning preparations; scouring solutions; shampoos; cosmetic preparations for skin care and skin treatment; abrasive cloth; abrasive cloth and paper; smoothing stones; wallpaper cleaning preparations.

(260) AM 2024 122380 A

(800) 1519388

(151) 2020 01 30

(891) 2023 03 02

(731) Loskutov Dmitriy Gennadyevich
Rybatskiy pr., 43, 1, 183; RU-192076 Saint-
Petersburg, Russian Federation

(540)



(591) Blue, black and white

(531) 26.03.04; 26.03.05; 26.03.24; 26.04.03;
26.04.11; 27.05.01; 27.05.17; 29.01.13

(511)

25 – Bandanas [neckerchiefs]; berets; overalls; trousers; jerseys [clothing]; vests; sports jerseys; hoods [clothing]; suits; masquerade costumes; jackets [clothing]; stuff jackets [clothing]; sports singlets; hand warmers [fingerless gloves]; socks; clothing; paper clothing; outer clothing; ready-made clothing; overcoats; parkas; gloves [clothing]; scarfs; headbands [clothing]; belts [clothing]; shirts; boots; jumper dresses; sweaters; knitwear [clothing]; shoes; skull caps; headwear; tee-shirts; hats; pelisses.

41 – Videotaping; production of music; electronic games services provided by means of the Internet; information relating to computer gaming entertainment provided on-line from a computer database or a global communication network; arranging of games and competitions via the internet; publication of books; recreation information; entertainment information; movie studio services; microfilming; videotape editing; production of radio and television programmes; screenplay writing; providing; recreation facilities; arranging and conducting of colloquiums; arranging and conducting of congresses; arranging and conducting of conferences; arranging and conducting of concerts; arranging and conducting of workshops [training]; arranging and conducting of seminars; arranging and conducting of symposiums; organisation of competitions [education or entertainment]; organization of cosplay entertainment events; television entertainment; providing online videos, not downloadable; providing online music, not downloadable; presentation of live performances; film production, other than advertising films; online publication of electronic books and journals; publication of texts, other than publicity texts; radio entertainment; entertainment services; news reporters services; production of shows.

(260) AM 2024 122381 A

(800) 1572312

(151) 2020 12 04

(891) 2023 02 22

(731) SiFive, Inc.

Suite 600, 1875 South Grant Street, San Mateo
CA 94402, USA

(540)

SIFIVE

(591) Black, white

(511)

9 – Semiconductor chips; integrated circuits; microprocessors; microcontrollers; printed circuit boards; application-specific integrated circuits; system-on-chip devices; embedded systems; electronic sensors; Internet of Things (IoT) devices; electronic components and systems; semiconductor intellectual property cores; microprocessors cores; downloadable computer software; downloadable electronic publications; downloadable educational course materials in the fields of computers and electronics.

35 – Distributorship services in the field of intellectual property cores.

41 – Educational services, namely, providing on-line non downloadable instruction manuals, user guides, installation guides, product datasheets, articles, and magazines in the fields of integrated circuits, microprocessors, computer programming, Internet-of-Things (IoT), artificial intelligence, and electronics; educational services, namely, providing instruction to teachers and students in the fields of integrated circuits, microprocessors, computer programming, Internet-of-Things (IoT), artificial intelligence, and electronics; training in the fields of integrated circuits, microprocessors, computer programming, Internet-of-Things (IoT), artificial intelligence, and electronics.

42 – Software-as-a service (SaaS) services; platform as a service (PaaS) services; design services in the fields of microprocessors, integrated circuits, computer hardware, computer software, and electronics.

(260) AM 2024 122383 A

(800) 1664447

(151) 2021 12 17

(891) 2023 03 20

(731) SASUPHI S.R.L.

PIAZZA DELLA REPUBBLICA, 5, I-20121
MILANO, Italy

(540)

SA SU PHI

(591) Black, white

(511)

18 – Bags; handbags; valises; leather bags; suitcases; toiletry bags sold empty; travelling sets [leatherware]; leather cases for keys; keycases; trunks; vanity cases, not fitted; slings for carrying infants; small bags for men; purses; duffel bags; holdalls for sports clothing; hat boxes of leather; satchels; briefbags; travel cases; business card cases; leather briefcases; carrying cases for documents; luggage label holders; bumbags; clutch bags; music cases; card wallets; wallets; baby carriers worn on the body; haversacks; grocery tote bags; shoe bags for travel; pouches for holding make-up, keys and other personal items; tie cases for travel; valises; business cases; briefcases; attaché cases; backpacks.

25 – Clothing; footwear; headgear; scarves; foulards; belts for clothing; gloves.

35 – Retail and wholesale services for bags, handbags, valises, leather bags, suitcases, toiletry bags sold empty, travelling sets [leatherware], leather cases for keys, keycases, trunks, vanity cases, not fitted, slings for carrying infants, small bags for men, purses, duffel bags, holdalls for sports clothing, hat boxes of leather, satchels, briefbags, travel cases, business card cases, leather briefcases, carrying cases for documents, luggage label holders, bumbags, clutch bags, music cases, card wallets, wallets, baby carriers worn on the body, haversacks, grocery tote bags, shoe bags for travel, pouches for holding make-up, keys and other personal items, tie cases for travel, business cases, briefcases, attaché cases, backpacks; on-line wholesale and retail store services for bags, handbags, valises, leather bags, suitcases, toiletry bags sold empty, travelling sets [leatherware], leather cases for keys, keycases, trunks, vanity cases, not fitted, slings for carrying infants, small bags for men, purses, duffel bags, holdalls for sports clothing, hat boxes of leather, satchels, briefbags, travel cases, business card cases, leather briefcases, carrying cases for documents, luggage label holders, bumbags, clutch bags, music cases, card wallets, wallets, baby carriers worn on the body, haversacks, grocery tote bags, shoe bags for travel, pouches for holding make-up, keys and other personal items, tie cases for travel, business cases, briefcases, attaché cases, backpacks; retail and wholesale services for clothing, footwear, headgear, scarves, foulards, belts for clothing, gloves; on-line wholesale and retail store services for clothing, footwear, headgear, scarves, foulards, belts for clothing, gloves.

(260) AM 2024 122447 A
(800) 1724205
(151) 2023 01 05
(891) 2023 01 05
(731) WROCLAWSKIE ZAKŁADY ZIELARSKIE,
"HERBAPOL" SA
ul. św. Mikołaja 65/68, PL-50-951 Wrocław,
Poland

(540)



(591) Green
(531) 01.15.11; 26.13.25; 27.05.21; 29.01.03
(511)

3 – Cosmetics; washing and body care preparations; oral hygiene products; lotions, other than for medical

purposes; wipes soaked in cosmetic preparations; natural cosmetics; non-medicated cosmetics; ointments for cosmetic purposes; non-medicated lotions; oils for cosmetic purposes; cosmetic preparations for the face; non-medicated creams; essential oils; hair care preparations; hygienic preparations; toothpaste; bath herbs.

5 – Dental preparations and supplies and therapeutic teeth cleaners; hygiene preparations and products; dietary supplements and dietary preparations; dental preparations and products; pharmaceuticals and natural remedies; breath freshening chewing gum for medicinal purposes; pharmaceutical preparations for veterinary use; medicinal preparations for health maintenance; medical preparations; moisturisers for medical use; dietary supplements; medicinal tea; tea for asthma relief; slimming tea for medical purposes; medicinal food additives; human dietary supplements; herbal supplements; pharmaceutical products; medicines; herbal medicines; supplements; medicinal creams; medicinal gels; pharmaceutical preparations; medicinal products for internal use, in form of tablets, pastilles, liquid; preparations for hand disinfection; dietary drinks adapted for medical purposes; herbal tea [medicinal drinks]; vitaminised beverages; herbal beverages for medicinal use; syrups for pharmaceutical use; skin disinfectants; antiseptic ointments; ointments for pharmaceutical use; ointments for the treatment of sunburn; medicinal ointments; anti-inflammatory ointments; medicinal herbs; dried or preserved medicinal herbs.

(260) AM 2024 122448 A
(800) 1724222
(151) 2023 01 19
(891) 2023 01 19
(731) CHINA TOBACCO GUANGDONG
INDUSTRIAL CO., LTD.
8th-16th Floor, No. 186, Linhexiheng Road,
Tianhe, Guangzhou, Guangdong, China
(540)

Fei-Ran

(591) Black, white
(531) 27.05.01; 27.05.17
(511)

34 – Cigarettes containing tobacco substitutes, not for medical purposes; cigarettes; tobacco; cigars; tobacco powder; chewing tobacco; snuff; cigar cases; cigar cutters; cigar mouthpiece; tobacco pipes; hookahs; devices for heating tobacco for inhalation; cigarette cases; ashtrays for smokers; lighters for smokers; lighters for cigars; cigarette paper; cigarette filters; flavo-

rings, other than essential oils, for tobacco; electronic cigarettes; electronic cigars.

(260) AM 2024 122470 A
(800) 1724844
(151) 2022 10 19
(891) 2022 10 19

(731) ARI PETROL KİMYA ENDÜSTRİ VE
TİCARET ANONİM ŞİRKETİ
ORTA MAH. NUMUNEBAĞI CAD., ÖZAY
HAN 44 A Bayrampaşa, İstanbul, Türkiye

(540)



(591) Black, white
(531) 26.11.02; 26.11.06; 26.11.12; 27.05.01;
27.05.10

(511)

4 – Industrial oils and greases; cutting fluids; dust absorbing, wetting and binding compositions; solid fuels; coal, firewood; liquid and gas fuels; petrol, diesel oil, liquified petroleum gas, natural gas, fuel oil and their non-chemical additives; candles; wicks; wax [raw material]; wax and paraffin for lighting purposes.

(260) AM 2024 122609 A
(800) 1726229
(151) 2023 02 01
(891) 2023 02 01

(731) Pazu Games Ltd
1 Hatzmicha St., Yokneam Illit, Israel

(540)



(591) Black, white
(531) 02.05.03; 02.05.23
(511)

9 – Downloadable computer games; computer games software; downloadable computer games software; computer software platform for programming, design and development of computer games.

28 – Games; toys; electronic games.

41 – Online game services; online game services provided via Internet and other communication networks.

(260) AM 2023 122626 A
(800) 1726620
(151) 2022 12 05
(891) 2022 12 05

(731) Euro Games Technology Ltd.
4, "Maritsa" Str., "Vranya-Lozen-Triugulnika",
BG-1151 Sofia, Bulgaria

(540)



(591) Green, white, silver and black
(531) 27.05.01; 27.05.02; 27.05.03; 27.05.09;
27.05.10; 29.01.14

(511)

9 – Software; computer gaming software; computer software packages; computer operating system software; computer software, recorded; software drivers; virtual reality software; games software; entertainment software for computer games; computer programs for network management; operating computer software for main frame computers; monitors (computer hardware); computer hardware; apparatus for recording images; monitors (computer programs); computer game programs; computer programs for recorded games; apparatus for recording, transmission or reproduction of sound or images; communications servers [computer hardware]; electronic components for gambling machines; computer application software featuring games and gaming; computer software for the administration of on-line games and gaming; computer hardware for games and gaming; hardware and software for gambling, gambling machines, gambling games on the Internet and via telecommunication network.

28 – Gaming machines for gambling; chips for gambling; mah-jong; arcade games; gambling machines operating with coins, notes and cards; games; electronic games; parlor games; gaming chips; gaming tables; slot machines [gaming machines]; LCD game machines; slot machines and gaming devices; coin-operated amusement machines; roulette chips; poker chips; chips and dice [gaming equipment]; gaming equipment for casinos; roulette tables; gaming roulette wheels; casino games; gambling machines and amusement machines, automatic and coin-operated; coin-operated amusement machines and/or electronic coin-operated amusement machines with or without the possibility of gain; boxes for coin-operated machines, slot machines and gaming machines; electronic or electrotechnical amusement machines and apparatus, gaming machines, coin-operated entertainment machines; housings for coin-operated machines, gaming equipment, gaming machines, machines for gambling; electropneumatic and electrical gambling machines (slot machines).

41 – Gambling; entertainment services related to gambling; gaming services for entertainment purposes; ca-

sino, gaming and gambling services; training in the development of software systems; provision of gaming equipment for gambling halls; providing casino equipment [gambling]; gaming machine entertainment services; providing casino facilities [gambling]; gaming hall services; amusement arcade services; games equipment rental; rental of gaming machines; providing amusement arcade services; rental of gaming machines with images of fruits; editing or recording of sounds and images; sound recording and video entertainment services; hire of sound reproducing apparatus; provision of gaming equipment for casinos; providing of casino facilities; online gambling services; casino services; provision of gaming facilities, gaming hall facilities, Internet casinos and online gambling services.

(260) AM 2023 122627 A

(800) 1726788

(151) 2022 12 22

(891) 2022 12 22

(731) GABBA KOLTUK TEKSTİL MOBİLYA
SANAYİ VE TİCARET ANONİM ŞİRKETİ
HAMZABEY OSB MAH. 1. CAD. 17,
İNEGOL, BURSA, Türkiye

(540)

GABBA HOME

(591) Black, white

(531) 27.05.01

(511)

20 – Furniture, made of any kind of material; mattresses, pillows, air mattresses and cushions, not for medical purposes, water beds, not for medical purposes; mirrors; beehives, artificial honeycombs and sections of wood for honeycombs; bouncing chairs for babies, playpens for babies, cradles, infant walkers; display boards, frames for pictures and paintings, identification plates, not of metal; identification tags, not of metal, nameplates, not of metal; identification tags of wood or synthetic materials; packaging containers of wood or plastics, casks for use in transportation or storage, barrels, storage drums, tanks, boxes, storage containers, transportation containers, chests, loading pallets and closures for the aforementioned goods, of wood or plastics; furniture fittings, not of metal, of wood or synthetic materials; ornaments and decorative goods of wood, cork, reed, cane, wicker, horn, bone, ivory, whalebone, shell, amber, mother-of-pearl, meerschaum, beeswax, plastic or plaster, included in this class, namely figurines, holiday ornaments for walls and sculptures, all made of wood, cork, reed, cane, wicker, horn, bone, ivory, whalebone, shell, amber, mother-of-pearl, meerschaum, beeswax, plastic or plaster, baskets, not of metal, fishing baskets; kennels, nesting boxes and beds for household pets, portable ladders and mobile boarding stairs of wood or synthetic materials, bamboo curtains, roller indoor blinds

[for interiors], slatted indoor blinds, bead curtains for decoration, curtain hooks, curtain rings, curtain tie-backs, curtain rods; non-metal wheel chocks.

35 – Advertising, marketing and public relations; organization of exhibitions and trade fairs for commercial or advertising purposes; development of advertising concepts; provision of an online marketplace for buyers and sellers of goods and services; office functions; secretarial services; arranging newspaper subscriptions for others; compilation of statistics; rental of office machines; systemization of information into computer databases; telephone answering for unavailable subscribers; business management, business administration and business consultancy; accounting, commercial consultancy services, personnel recruitment, personnel placement, employment agencies, import-export agencies, temporary personnel placement services; auctioneering; the bringing together, for the benefit of others, of a variety of goods, namely, furniture, made of any kind of material, mattresses, pillows, air mattresses and cushions, not for medical purposes, water beds, not for medical purposes, mirrors, beehives, artificial honeycombs and sections of wood for honeycombs, bouncing chairs for babies, playpens for babies, cradles, infant walkers, display boards, frames for pictures and paintings, identification plates, not of metal, identification tags, not of metal, nameplates, not of metal, identification tags of wood or synthetic materials, packaging containers of wood or plastics, casks for use in transportation or storage, barrels, storage drums, tanks, boxes, storage containers, transportation containers, chests, loading pallets and closures for the aforementioned goods, of wood or plastics, small hardware goods of wood or synthetic materials, furniture fittings, of wood or synthetic materials, ornaments and decorative goods of wood, cork, reed, cane, wicker, horn, bone, ivory, whalebone, shell, amber, mother-of-pearl, meerschaum, beeswax, plastic or plaster, namely figurines, holiday ornaments for walls and sculptures, all made of wood, cork, reed, cane, wicker, horn, bone, ivory, whalebone, shell, amber, mother-of-pearl, meerschaum, beeswax, plastic or plaster, baskets, not of metal, fishing baskets, kennels, nesting boxes and beds for household pets, portable ladders and mobile boarding stairs of wood or synthetic materials, bamboo curtains, roller indoor blinds [for interiors], slatted indoor blinds, bead curtains for decoration, curtain hooks, curtain rings, curtain tie-backs, curtain rods, non-metal wheel chocks, enabling customers to conveniently view and purchase those goods, such services may be provided by retail stores, wholesale outlets, by means of electronic media or through mail order catalogues.

(260) AM 2023 122628 A

(800) 1726811

(151) 2023 03 02

(891) 2023 03 02

(731) Individual entrepreneur Adushkin Roman

Evgenievich

Verhnie polya, house 10, apt. 49, RU-109341

Moscow, Russian Federation

(540)

ASTERION
BATTERY

(591) Black, white

(531) 27.05.10; 27.05.11

(526) BATTERY

(511)

9 – Accumulators, electric; batteries, electric, for vehicles; galvanic batteries; ignition batteries; solar batteries; solar panels for the production of electricity; batteries, electric.

(260) AM 2023 122630 A

(800) 1726818

(151) 2023 02 02

(891) 2023 02 02

(731) Noscat GmbH

Wallnerstraße 44, A-1010 Wien, Austria

(540)

Benhyl

(591) Black, white

(511)

5 – Pharmaceuticals; medical and veterinary preparations; dietary supplements; pharmaceutical preparations for the treatment of disorders of the muscular system and bones; pharmaceutical and veterinary preparations for the treatment of traumatic and degenerative joint diseases and for use in orthopedic procedures; disinfectants; plasters.

10 – Surgical, medical and veterinary apparatus and instruments for the treatment of traumatic and degenerative joint diseases and for orthopedic surgery; surgical and medical devices and apparatus, syringes, cannulas, applicators, medical and surgical instruments for administering pharmaceutical and medicinal preparations.

(260) AM 2024 122710 A

(800) 1728071

(151) 2023 02 17

(891) 2023 02 17

(731) PayPal, Inc.

2211 North First Street, San Jose CA 95131,

USA

(540)

PayPal

(591) Black, white

(531) 27.05.01; 27.05.17

(511)

9 – Downloadable and recorded computer software for processing electronic payments and for transferring funds to and from others; downloadable computer software for creating, preparing, managing, sending, processing, tracking, and reconciling invoices; downloadable computer software for issuing receipts regarding mobile payment transactions; downloadable mobile application software for processing electronic payments and for transferring funds to and from others; downloadable authentication software for controlling access to and communications with computers and computer networks; computer hardware for making, authenticating, facilitating, operating, managing, and processing payment transactions with credit cards, debit cards, prepaid cards, payment cards, gift cards, and other payment forms; electronic devices, namely, point of sale terminals, chip card readers, credit card readers, payment card readers, mobile card readers, charging stands for chip card readers, credit card readers, payment card readers, and mobile card readers; magnetic encoded and coded card readers; electronic card readers for payment and credit cards; magnetically encoded credit cards; magnetically encoded payment cards being debit cards, gift cards, prepaid gift cards, prepaid cash cards, and prepaid debit cards; downloadable software for sending, receiving, accepting, buying, selling, storing, transmitting, trading and exchanging digital currency, virtual currency, cryptocurrency, stablecoins, digital and blockchain assets, digitized assets, digital tokens, crypto tokens and utility tokens; downloadable software for managing and validating digital currency, virtual currency, cryptocurrency, stablecoin, digital asset, blockchain asset, digitized asset, digital token, crypto token and utility token transactions; downloadable software for use as a digital currency, virtual currency, cryptocurrency, stablecoin, digital asset, digital token, crypto token, and utility token wallet; downloadable software for transfers of digital currency, virtual currency, cryptocurrency, stablecoins, digital and blockchain assets, digitized assets, digital tokens, crypto tokens and utility tokens between parties; downloadable computer software and downloadable mobile application software for facilitating electronic commerce transactions; downloadable computer software, namely, internet browser extensions, plug-ins, and applications for use with electronic commerce transactions and product price monitoring; downloadable computer software and downloadable mobile application software featuring offers, deals, coupons, rebates, rewards, vouchers, price tracking, price notifications, price-comparison information, links to the retail websites of others, promotional materials, and discount information; downloadable software development kits (SDK); downloadable and recorded computer software for creating and managing a business and an online store, namely, inventory management, order proces-

sing, order tracking, fulfillment of orders, sales tracking, collection of sales data, and sales analytics; downloadable and recorded computer software used for point of sale transactions; downloadable and recorded computer software used to train and manage employees, record employee hours worked, and generate payroll processing; electronic devices, namely, point of sale terminals, chip card readers, credit card readers, payment card readers, mobile card readers; charging stands adapted for use with handheld digital electronic devices, namely, cell phones, MP3 players, personal digital assistants, point of sale terminals, chip card readers, credit card readers, payment card readers, and mobile card readers.

35 – Promoting the goods of others, namely, providing information regarding discounts, coupons, rebates, vouchers and special offers for the goods of others; promoting the goods and services of others by providing hypertext links to the web sites of others; promoting the goods and services of others by providing a web site featuring links to the online retail web sites of others; business consulting services in the field of online payments; business managing and tracking credit card, debit card, ACH, prepaid cards, payment cards, and other forms of payment transactions via electronic communications networks for business purposes; business information management, namely, electronic reporting of business analytics relating to payment processing, authentication, tracking, and invoicing; business management, namely, optimization of payments for businesses; promoting the sale of goods and services of others by providing a website featuring offers, deals, coupons, rebates, rewards, vouchers, price tracking, price notifications, price-comparison information, links to the retail websites of others, promotional materials, and discount information; promoting the sale of goods and services of others by providing interactive online applications featuring offers, deals, coupons, rebates, rewards, vouchers, price tracking, price notifications, price-comparison information, links to the retail websites of others, promotional materials, and discount information; providing incentive award programs through issuance and processing of loyalty points for purchase of the goods and services of others; customer loyalty services for commercial, promotional and/or advertising purposes, namely, administration of a program that allows participants to obtain and redeem points or awards for goods and/or services; reconciling financial transactions via a global computer network and wireless networks.

36 – Financial services, namely, electronic funds transfer; clearing financial transactions via a global computer network and wireless networks; providing a wide variety of payment and financial services, namely, credit card payment processing services, issuing credit cards and providing personal and business lines of credit, electronic payment services involving elec-

tronic processing and subsequent transmission of bill payment data, bill payment services with guaranteed payment delivery, all conducted via a global communications network; credit card and debit card transaction processing services; reimbursement of payment processing for fraudulent transactions, transaction errors, and disputed transactions, namely, transactions concerning lost, damaged, misrepresented, or incorrect products or services, all in the field of electronic payment purchases; providing purchase protection services for goods and services purchased by others via a global computer network and wireless networks, namely, fraud reimbursement services in the field of credit card purchases and electronic payment purchases, secure commercial transactions for credit card purchases and electronic payment purchases, and reimbursement services for disputed transactions in the field of electronic payment purchases; credit card transaction processing services; credit services, namely, providing revolving credit account services; bill payments services; providing electronic mobile payment services for others in the nature of providing secure commercial transactions and payment options using a mobile device at a point of sale; credit card transaction processing services and payment processing services in the field of credit card payments and electronic payments; electronic foreign exchange payment processing; payment processing services, namely, providing virtual currency transaction processing services for others; financial services, namely, providing stablecoin currency, virtual currency, digital currency, digital tokens, and cryptocurrency for use by others; financial services, namely, virtual currency, digital currency, stablecoin, and cryptocurrency transfer, trading, exchange, and payment processing services; electronic transfer of cryptocurrency, digital currency, stablecoins, digital and blockchain assets, digitized assets, digital tokens, crypto tokens and utility tokens; electronic wallet services for trading, storing, sending, receiving, validating, verifying, accepting, tracking, transferring, and transmitting virtual currency, and managing virtual currency payment and exchange transactions.

42 – Providing temporary use of online non-downloadable software for processing electronic payments; providing temporary use of online non-downloadable software for creating, preparing, managing, sending, processing, tracking, and reconciling invoices; providing temporary use of online non-downloadable software for issuing receipts regarding mobile payment transactions; providing temporary use of online non-downloadable authentication software for controlling access to and communications with computers and computer networks; providing temporary use of online non-downloadable software for electronic funds transfer; providing temporary use of online non-downloadable software for sending, receiving, accepting, buying, selling, storing, transmitting, validating, verifying, tracking, transferring, trading and exchan-

ging digital currency, virtual currency, cryptocurrency, stablecoins, digital and blockchain assets, digitized assets, digital tokens, crypto tokens and utility tokens; providing temporary use of online non-downloadable software for digital currency payment and exchange transactions; providing temporary use of online non-downloadable software for use in issuing digital currency, virtual currency, cryptocurrency, stablecoins, digital and blockchain assets, digitized assets, digital tokens, crypto tokens and utility tokens; providing temporary use of online non-downloadable software for managing digital currency, virtual currency, cryptocurrency, stablecoin, digital and blockchain asset, digitized asset, digital token, crypto token and utility token payments, money transfers, and commodity transfers; providing temporary use of online non-downloadable software for use with digital currency wallet and storage services; providing temporary use of online non-downloadable software for use as an electronic wallet; providing temporary use of online non-downloadable software for facilitating electronic commerce transactions; providing temporary use of online non-downloadable software featuring offers, deals, coupons, rebates, rewards, vouchers, price tracking, price notifications, price-comparison information, links to the retail websites of others, promotional materials, and discount information; providing temporary use of online non-downloadable software for fraud detection, fraud prevention, and fraud analytics; providing temporary use of online non-downloadable computer software for tracking and analyzing payment activity; providing temporary use of online non-downloadable software to prevent fraud, facilitate integration with loyalty and reward platforms to allow tracking of purchases and accrual of rewards, and enable merchants to embed checkouts in third party sites and applications to sell and take payments on third party platforms; Application Service Provider (ASP) featuring Application Programming Interface (API) software for payment collection, payment transactions, forwarding data and information processing; data mining services; providing temporary use of online non-downloadable software for creating and managing a business and an online store, namely, inventory management, order processing, order tracking, fulfillment of orders, sales tracking, collection of sales data, and sales analytics; providing temporary use of online non-downloadable software used for point of sale transactions; providing temporary use of online non-downloadable software used to train and manage employees, record employee hours worked, and generate payroll processing.

(260) AM 2024 122711 A
 (800) 1728075
 (151) 2023 02 17
 (891) 2023 02 17
 (731) PayPal, Inc.

2211 North First Street, San Jose CA 95131,
 USA

(540)



(591) Black, white

(531) 27.05.01; 27.05.17; 27.05.19; 27.05.22

(511)

9 – Downloadable and recorded computer software for processing electronic payments and for transferring funds to and from others; downloadable computer software for creating, preparing, managing, sending, processing, tracking, and reconciling invoices; downloadable computer software for issuing receipts regarding mobile payment transactions; downloadable mobile application software for processing electronic payments and for transferring funds to and from others; downloadable authentication software for controlling access to and communications with computers and computer networks; computer hardware for making, authenticating, facilitating, operating, managing, and processing payment transactions with credit cards, debit cards, prepaid cards, payment cards, gift cards, and other payment forms; electronic devices, namely, point of sale terminals, chip card readers, credit card readers, payment card readers, mobile card readers, charging stands for chip card readers, credit card readers, payment card readers, and mobile card readers; magnetic encoded and coded card readers; electronic card readers for payment and credit cards; magnetically encoded credit cards; magnetically encoded payment cards being debit cards, gift cards, prepaid gift cards, prepaid cash cards, and prepaid debit cards; downloadable software for sending, receiving, accepting, buying, selling, storing, transmitting, trading and exchanging digital currency, virtual currency, cryptocurrency, stablecoins, digital and blockchain assets, digitized assets, digital tokens, crypto tokens and utility tokens; downloadable software for managing and validating digital currency, virtual currency, cryptocurrency, stablecoin, digital asset, blockchain asset, digitized asset, digital token, crypto token and utility token transactions; downloadable software for use as a digital currency, virtual currency, cryptocurrency, stablecoin, digital asset, digital token, crypto token, and utility token wallet; downloadable software for transfers of digital currency, virtual currency, cryptocurrency, stablecoins, digital and blockchain assets, digitized assets, digital tokens, crypto tokens and utility tokens between parties; downloadable computer software and downloadable mobile application software for facilitating electronic commerce transactions; downloadable computer software, namely, internet browser extensions, plug-ins, and applications for use with electronic commerce transactions and product price monitoring; downloadable computer

software and downloadable mobile application software featuring offers, deals, coupons, rebates, rewards, vouchers, price tracking, price notifications, price-comparison information, links to the retail websites of others, promotional materials, and discount information; downloadable software development kits (SDK); downloadable and recorded computer software for creating and managing a business and an online store, namely, inventory management, order processing, order tracking, fulfillment of orders, sales tracking, collection of sales data, and sales analytics; downloadable and recorded computer software used for point of sale transactions; downloadable and recorded computer software used to train and manage employees, record employee hours worked, and generate payroll processing; electronic devices, namely, point of sale terminals, chip card readers, credit card readers, payment card readers, mobile card readers; charging stands adapted for use with handheld digital electronic devices, namely, cell phones, MP3 players, personal digital assistants, point of sale terminals, chip card readers, credit card readers, payment card readers, and mobile card readers.

35 – Promoting the goods of others, namely, providing information regarding discounts, coupons, rebates, vouchers and special offers for the goods of others; promoting the goods and services of others by providing hypertext links to the web sites of others; promoting the goods and services of others by providing a web site featuring links to the online retail web sites of others; business consulting services in the field of online payments; business managing and tracking credit card, debit card, ACH, prepaid cards, payment cards, and other forms of payment transactions via electronic communications networks for business purposes; business information management, namely, electronic reporting of business analytics relating to payment processing, authentication, tracking, and invoicing; business management, namely, optimization of payments for businesses; promoting the sale of goods and services of others by providing a website featuring offers, deals, coupons, rebates, rewards, vouchers, price tracking, price notifications, price-comparison information, links to the retail websites of others, promotional materials, and discount information; promoting the sale of goods and services of others by providing interactive online applications featuring offers, deals, coupons, rebates, rewards, vouchers, price tracking, price notifications, price-comparison information, links to the retail websites of others, promotional materials, and discount information; providing incentive award programs through issuance and processing of loyalty points for purchase of the goods and services of others; customer loyalty services for commercial, promotional and/or advertising purposes, namely, administration of a program that allows participants to obtain and redeem points or awards for goods and/or services; reconciling financial transac-

tions via a global computer network and wireless networks.

36 – Financial services, namely, electronic funds transfer; clearing financial transactions via a global computer network and wireless networks; providing a wide variety of payment and financial services, namely, credit card payment processing services, issuing credit cards and providing personal and business lines of credit, electronic payment services involving electronic processing and subsequent transmission of bill payment data, bill payment services with guaranteed payment delivery, all conducted via a global communications network; credit card and debit card transaction processing services; reimbursement of payment processing for fraudulent transactions, transaction errors, and disputed transactions, namely, transactions concerning lost, damaged, misrepresented, or incorrect products or services, all in the field of electronic payment purchases; providing purchase protection services for goods and services purchased by others via a global computer network and wireless networks, namely, fraud reimbursement services in the field of credit card purchases and electronic payment purchases, secure commercial transactions for credit card purchases and electronic payment purchases, and reimbursement services for disputed transactions in the field of electronic payment purchases; credit card transaction processing services; credit services, namely, providing revolving credit account services; bill payments services; providing electronic mobile payment services for others in the nature of providing secure commercial transactions and payment options using a mobile device at a point of sale; credit card transaction processing services and payment processing services in the field of credit card payments and electronic payments; electronic foreign exchange payment processing; payment processing services, namely, providing virtual currency transaction processing services for others; financial services, namely, providing stablecoin currency, virtual currency, digital currency, digital tokens, and cryptocurrency for use by others; financial services, namely, virtual currency, digital currency, stablecoin, and cryptocurrency transfer, trading, exchange, and payment processing services; electronic transfer of cryptocurrency, digital currency, stablecoins, digital and blockchain assets, digitized assets, digital tokens, crypto tokens and utility tokens; electronic wallet services for trading, storing, sending, receiving, validating, verifying, accepting, tracking, transferring, and transmitting virtual currency, and managing virtual currency payment and exchange transactions.

42 – Providing temporary use of online non-downloadable software for processing electronic payments; providing temporary use of online non-downloadable software for creating, preparing, managing, sending, processing, tracking, and reconciling invoices; providing temporary use of online non-downloadable sof-

ware for issuing receipts regarding mobile payment transactions; providing temporary use of online non-downloadable authentication software for controlling access to and communications with computers and computer networks; providing temporary use of online non-downloadable software for electronic funds transfer; providing temporary use of online non-downloadable software for sending, receiving, accepting, buying, selling, storing, transmitting, validating, verifying, tracking, transferring, trading and exchanging digital currency, virtual currency, cryptocurrency, stablecoins, digital and blockchain assets, digitized assets, digital tokens, crypto tokens and utility tokens; providing temporary use of online non-downloadable software for digital currency payment and exchange transactions; providing temporary use of online non-downloadable software for use in issuing digital currency, virtual currency, cryptocurrency, stablecoins, digital and blockchain assets, digitized assets, digital tokens, crypto tokens and utility tokens; providing temporary use of online non-downloadable software for managing digital currency, virtual currency, cryptocurrency, stablecoin, digital and blockchain asset, digitized asset, digital token, crypto token and utility token payments, money transfers, and commodity transfers; providing temporary use of online non-downloadable software for use with digital currency wallet and storage services; providing temporary use of online non-downloadable software for use as an electronic wallet; providing temporary use of online non-downloadable software for facilitating electronic commerce transactions; providing temporary use of online non-downloadable software featuring offers, deals, coupons, rebates, rewards, vouchers, price tracking, price notifications, price-comparison information, links to the retail websites of others, promotional materials, and discount information; providing temporary use of online non-downloadable software for fraud detection, fraud prevention, and fraud analytics; providing temporary use of online non-downloadable computer software for tracking and analyzing payment activity; providing temporary use of online non-downloadable software to prevent fraud, facilitate integration with loyalty and reward platforms to allow tracking of purchases and accrual of rewards, and enable merchants to embed checkouts in third party sites and applications to sell and take payments on third party platforms; Application Service Provider (ASP) featuring Application Programming Interface (API) software for payment collection, payment transactions, forwarding data and information processing; data mining services; providing temporary use of online non-downloadable software for creating and managing a business and an online store, namely, inventory management, order processing, order tracking, fulfillment of orders, sales tracking, collection of sales data, and sales analytics; providing temporary use of online non-downloadable software used for point of sale transactions; providing temporary use of

online non-downloadable software used to train and manage employees, record employee hours worked, and generate payroll processing.

(260) AM 2023 122760 A

(800) 1728228

(151) 2022 08 08

(891) 2022 08 08

(731) "Agro Galaktika AE" Ltd

ul. B. Serpukhovskaya, dom 44, etazh 3, pom. I, Komn. 19 (RMYA), RU-115093 Moscow, Russian Federation

(540)



(591) Red, white, blue and dark blue

(531) 01.05.23; 26.01.18; 28.05; 29.01.13

(511)

1 – Additives, chemical, to insecticides; additives, chemical, to fungicides; plant growth regulating preparations; preparations of trace elements for plants; silicates; salts [fertilizers]; salts [chemical preparations]; fertilizers; fertilizers for agricultural use; chemicals for use in forestry, except fungicides, herbicides, insecticides and parasiticides; soil conditioning preparations.

5 – Acaricides; aconitine; algicides; antibiotics; antiseptics; germicides; biocides; fly catching paper; mothproofing paper; nutritive substances for microorganisms; hydrastine; hydrastinine; glycerophosphates; digitalin; insecticides; iodoform; calomel; carbolineum [parasiticide]; cedar wood for use as an insect repellent; curare; menthol; sulfur sticks [disinfectants]; air purifying preparations; sterilizing preparations; soil-sterilizing preparations; preparations for destroying noxious animals; herbicides; preparations for destroying dry rot fungus; larvae exterminating preparations; fly destroying preparations; preparations for destroying mice; slug exterminating preparations; preparations for destroying parasites; anticryptogamic preparations; chemical preparations for treating wheat blight; chemical preparations for treating diseases affecting vine plants; chemical preparations for treating mildew; chemical preparations for treating phylloxera; mothproofing preparations; insect repellents; insect repellent incense; fumigating sticks; parasiticides; bouillons for bacteriological cultures; steroids; strychnine; serums; fungicides; chloroform; tobacco extracts [insecticides]; rat poison; poisons; bacterial poisons.

35 – Import-export agency services; commercial information agency services; demonstration of goods; opinion polling; market studies; organization of exhi-

bitions for commercial or advertising purposes; organization of trade fairs for commercial or advertising purposes; shop window dressing; presentation of goods on communication media, for retail purposes; sales promotion for others; distribution of samples; administrative processing of purchase orders; procurement services for others [purchasing goods and services for other businesses]; providing business information; providing commercial information and advice for consumers in the choice of products and services; auctioneering.

(260) AM 2023 122761 A

(800) 1728238

(151) 2022 10 05

(891) 2022 10 05

(731) Euro Games Technology Ltd.

4, "Maritsa" Str., "Vranya-Lozen-Triugulnika",
BG-1151 Sofia, Bulgaria

(540)



(591) Green, dark green, light green, gold, black and white

(531) 05.03.06; 05.03.13; 25.01.10; 26.04.05;
26.04.15; 26.04.16; 26.04.24; 29.01.13

(511)

9 – Operating computer software for main frame computers; monitors (computer hardware); computer hardware; apparatus for recording images; monitors (computer programs); computer game programs; recorded computer game programs; apparatus for recording, transmission or reproduction of sound or images; communications servers (computer hardware); electronic components for gambling machines; computer application software featuring games and gaming; computer software for the administration of on-line games and gaming; computer hardware for games and gaming; hardware and software for gambling, gambling machines, gambling games on the Internet and via telecommunication network; computer systems; computer operating system software; computer terminals; interactive terminals; multimedia terminals; electronic terminals for generating lottery tickets; interactive touch screen terminals; computer touchscreens; electronic display panels; liquid crystal display screens; digital signage display panels; multimedia software; multimedia apparatus and instruments; interactive multimedia software for playing games; computer screens; LCD large-screen displays; liquid crystal displays [LCDs] for home theatres; media streaming software; computer application software for

streaming audio-visual media content via the Internet; software; computer gaming software; computer software packages; computer operating system software; computer software, recorded; software drivers; virtual reality software; games software; entertainment software for computer games; computer programs for network management; electronic lottery tickets; computer software platforms; operating systems; interactive computer systems; operating system programs; computer game software for use with on-line interactive games; interactive casino games provided through a computer or mobile platform; software for slot machines, betting software, software for video slot games, for casino games, for gambling and bingo games, provided online or through computer networks and that can be played on any type of computer device, including arcade games, personal computers, portable devices and mobile phones.

28 – Gaming machines for gambling; chips for gambling; mah-jong; arcade games; gambling machines operating with coins, notes and cards; games; electronic games; parlor games; gaming chips; gaming tables; slot machines [gaming machines]; LCD game machines; slot machines and gaming devices; coin-operated amusement machines; roulette chips; poker chips; chips and dice [gaming equipment]; gaming equipment for casinos; roulette tables; gaming roulette wheels; casino games; gambling machines and amusement machines, automatic and coin-operated; coin-operated amusement machines and/or electronic coin-operated amusement machines with or without the possibility of gain; boxes for coin-operated amusement machines, slot machines and gaming machines; electronic or electrotechnical amusement machines and apparatus, gaming machines, coin-operated entertainment machines; housings for coin-operated amusement machines, gaming equipment, gaming machines, machines for gambling; electropneumatic and electrical gambling machines (slot machines); lottery games; electronic targets for games and sports.

41 – Gambling services; gaming services for entertainment purposes; casino, gaming and gambling services; training in the development of software systems; provision of gaming equipment for gambling halls; providing casino equipment [gambling]; gaming machine entertainment services; providing casino facilities [gambling]; gaming hall services; games equipment rental; rental of gaming machines; providing amusement arcade services; rental of gaming machines with images of fruits; editing or recording of sounds and images; sound recording and video entertainment services; hire of sound reproducing apparatus; provision of gaming equipment for casinos; providing of gambling facilities; online gambling services; casino services; provision of gaming facilities and gaming hall facilities, Internet casinos and online gambling services; lottery services; organization of lotteries; provision of games by means of a computer

based system; online interactive entertainment; on-line casino services; online game services through mobile devices; providing online entertainment in the nature of game tournaments; providing on-line information in the field of computer gaming entertainment; sports betting services; online sports betting services; providing online games and games of chance.

(260) AM 2023 122770 A
 (800) 1728362
 (151) 2023 04 11
 (891) 2023 04 11
 (731) Aimbridge Parent, Inc.
 5301 Headquarters Drive, Plano TX 75024,
 USA
 (540)

AIMBRIDGE

(591) Black, white
 (511)
 43 – Hotel accommodation services.

(260) AM 2023 122771 A
 (800) 1728364
 (151) 2023 04 11
 (891) 2023 04 11
 (731) Aimbridge Parent, Inc.
 5301 Headquarters Drive, Plano TX 75024,
 USA
 (540)



The logo for Aimbridge features the word "Aimbridge" in a serif font. The letter "i" is stylized with a blue arc above it that extends to the left and underlines the "A".

(591) The color(s) blue, black is/are claimed as a feature of the mark.
 (531) 27.05.01; 27.05.19; 29.01.12
 (511)
 43 – Hotel accommodation services.

(260) AM 2023 122816 A
 (800) 1280002
 (151) 2015 11 24
 (891) 2023 04 25
 (731) Greubel Forsey S.A.
 Eplatures-Grise 16, CH-2301 La Chaux-de-Fonds, Switzerland
 (540)

GREUBEL FORSEY

(591) Black, white
 (511)
 14 – Precious metals and their alloys and goods made of these materials or coated therewith included in this class; jewelry, precious stones; timepieces and chronometric instruments.

(260) AM 2023 122817 A
 (800) 1550634
 (151) 2020 04 28
 (891) 2023 02 13
 (731) NANTONG START IMPORT AND EXPORT CO., LTD
 Donghuangshan village, Lvsi Town, Qidong City, Nantong, 226241 Jiangsu, China
 (540)



The logo for NEWBEAT features the word "NEWBEAT" in a bold, sans-serif font. The letter "B" is stylized with a gear-like shape inside it.

(591) Black, white
 (531) 15.07.01; 15.07.04; 27.05.08; 27.05.09; 27.05.10; 27.05.11
 (511)
 7 – Hand-held tools other than hand-operated; electric rotary hammers; electric hand-held drills; electric diamond core drills; electric marble cutters; electric angle grinders; electric disc polishers; sanders; chain saws; electric planers; electric sanders; electric wood routers; hand-held pneumatic drills; hand-held pneumatic nail guns; air compressors; spray-paint machines; woodworking machines; cutting machines; metalworking machines tools; mixing machines; electric cut-off machines; concrete vibrators (machines); electric welding apparatus; electric welding machines; generators; alternators; elevating apparatus; agricultural implements other than hand-operated; electric cleaning machines; apparatus for garbage disposal; drilling bits for machine; circular saw blades for machine; carbon brushes being parts of machines; gears other than for land vehicles; guards being parts of machines; grinding wheels for machines; electric motors other than for land vehicles; gears other than for land vehicles; bearings being parts of machines.

INTERNATIONAL TRADEMARKS PROTECTED IN GEORGIA

(260) AM 2024 119567 A
(800) 1578230
(151) 2020 09 11
(181) 2030 09 11
(891) 2022 09 02
(511) 08, 09, 14, 16, 18, 21, 24, 25, 28

(260) AM 2024 120993 A
(800) 1704472
(151) 2022 07 07
(181) 2032 07 07
(891) 2022 07 07
(511) 09

(260) AM 2024 120678 A
(800) 1700620
(151) 2022 07 19
(181) 2032 07 19
(891) 2022 07 19
(511) 06, 07, 35, 37, 42

(260) AM 2024 120994 A
(800) 1704519
(151) 2022 10 06
(181) 2032 10 06
(891) 2022 10 06
(511) 05, 35

(260) AM 2024 120869 A
(800) 1702466
(151) 2022 11 09
(181) 2032 11 09
(891) 2022 11 09
(511) 10

(260) AM 2024 120995 A
(800) 1704524
(151) 2022 10 24
(181) 2032 10 24
(891) 2022 10 24
(511) 07, 09, 11, 37, 39

(260) AM 2024 120913 A
(800) 1703550
(151) 2022 09 16
(181) 2032 09 16
(891) 2022 09 16
(511) 10, 16, 20, 21, 37, 40, 44

(260) AM 2024 120996 A
(800) 1704547
(151) 2022 11 09
(181) 2032 11 09
(891) 2022 11 09
(511) 10

(260) AM 2024 120916 A
(800) 1703565
(151) 2022 08 09
(181) 2032 08 09
(891) 2022 08 09
(511) 09, 35, 42

(260) AM 2024 120997 A
(800) 1704702
(151) 2022 11 11
(181) 2032 11 11
(891) 2022 11 11
(511) 05, 31

(260) AM 2024 120991 A
(800) 1704407
(151) 2022 04 28
(181) 2032 04 28
(891) 2022 04 28
(511) 02, 04, 05, 07, 12, 15, 34, 40, 44

(260) AM 2024 120998 A
(800) 1704703
(151) 2022 11 11
(181) 2032 11 11
(891) 2022 11 11
(511) 05, 31

(260) AM 2024 120992 A
(800) 1704435
(151) 2022 11 16
(181) 2032 11 16
(891) 2022 11 16
(511) 37

(260) AM 2024 120999 A
(800) 1704778
(151) 2022 12 01
(181) 2032 12 01
(891) 2022 12 01
(511) 05, 44

(260) AM 2024 121001 A
 (800) 1704818
 (151) 2022 09 27
 (181) 2032 09 27
 (891) 2022 09 27
 (511) 05, 16

(260) AM 2024 121086 A
 (800) 1706163
 (151) 2022 10 27
 (181) 2032 10 27
 (891) 2022 10 27
 (511) 35, 41, 42

(260) AM 2024 121002 A
 (800) 1704826
 (151) 2022 11 04
 (181) 2032 11 04
 (891) 2022 11 04
 (511) 05

(260) AM 2024 121087 A
 (800) 1706197
 (151) 2022 11 03
 (181) 2032 11 03
 (891) 2022 11 03
 (511) 09, 30, 41

(260) AM 2024 121008 A
 (800) 1705018
 (151) 2022 09 07
 (181) 2032 09 07
 (891) 2022 09 07
 (511) 09, 14, 35, 36, 38, 41, 42

(260) AM 2024 121089 A
 (800) 1706224
 (151) 2022 11 09
 (181) 2032 11 09
 (891) 2022 11 09
 (511) 05

(260) AM 2024 121024 A
 (800) 1705373
 (151) 2022 11 07
 (181) 2032 11 07
 (891) 2022 11 07
 (511) 07, 10, 14, 40, 42

(260) AM 2024 121090 A
 (800) 1706243
 (151) 2022 10 06
 (181) 2032 10 06
 (891) 2022 10 06
 (511) 09, 35, 38, 41, 42

(260) AM 2024 121027 A
 (800) 1255086
 (151) 2015 01 16
 (181) 2025 01 16
 (891) 2022 12 01
 (511) 09, 42

(260) AM 2024 121091 A
 (800) 1706269
 (151) 2022 11 25
 (181) 2032 11 25
 (891) 2022 11 25
 (511) 05

(260) AM 2024 121074 A
 (800) 1705943
 (151) 2022 11 22
 (181) 2032 11 22
 (891) 2022 11 22
 (511) 30

(260) AM 2024 121104 A
 (800) 1706759
 (151) 2022 11 18
 (181) 2032 11 18
 (891) 2022 11 18
 (511) 30

(260) AM 2024 121075 A
 (800) 1705967
 (151) 2022 07 05
 (181) 2032 07 05
 (891) 2022 07 05
 (511) 20, 35, 37, 39

(260) AM 2024 121105 A
 (800) 1706762
 (151) 2022 10 03
 (181) 2032 10 03
 (891) 2022 10 03
 (511) 09, 28, 41

(260) AM 2024 121108 A
(800) 850779
(151) 2005 04 18
(181) 2025 04 18
(891) 2022 12 17
(511) 09

(260) AM 2024 121177 A
(800) 1707207
(151) 2022 11 15
(181) 2032 11 15
(891) 2022 11 15
(511) 05

(260) AM 2024 121109 A
(800) 890472
(151) 2005 12 23
(181) 2025 12 23
(891) 2022 11 24
(511) 20, 21

(260) AM 2024 121178 A
(800) 1707208
(151) 2022 11 15
(181) 2032 11 15
(891) 2022 11 15
(511) 05

(260) AM 2024 121159 A
(800) 1706833
(151) 2022 11 10
(181) 2032 11 10
(891) 2022 11 10
(511) 03

(260) AM 2024 121181 A
(800) 1707310
(151) 2022 10 14
(181) 2032 10 14
(891) 2022 10 14
(511) 18, 25

(260) AM 2024 121173 A
(800) 1707201
(151) 2022 11 15
(181) 2032 11 15
(891) 2022 11 15
(511) 05

(260) AM 2024 121186 A
(800) 1707381
(151) 2022 11 21
(181) 2032 11 21
(891) 2022 11 21
(511) 30

(260) AM 2024 121174 A
(800) 1707202
(151) 2022 11 15
(181) 2032 11 15
(891) 2022 11 15
(511) 05

(260) AM 2024 121190 A
(800) 1707531
(151) 2022 10 21
(181) 2032 10 21
(891) 2022 10 21
(511) 42, 44

(260) AM 2024 121175 A
(800) 1707203
(151) 2022 11 15
(181) 2032 11 15
(891) 2022 11 15
(511) 05

(260) AM 2024 121191 A
(800) 1707532
(151) 2022 11 15
(181) 2032 11 15
(891) 2022 11 15
(511) 03

(260) AM 2024 121176 A
(800) 1707206
(151) 2022 11 15
(181) 2032 11 15
(891) 2022 11 15
(511) 05

(260) AM 2024 121192 A
(800) 1707554
(151) 2022 11 07
(181) 2032 11 07
(891) 2022 11 07
(511) 29

(260) AM 2024 121195 A
 (800) 1707603
 (151) 2022 10 27
 (181) 2032 10 27
 (891) 2022 10 27
 (511) 03, 04, 05, 07, 08, 09, 10, 11, 12, 13, 14, 16, 18,
 20, 21, 22, 23, 24, 25, 26, 27, 28, 29, 30, 31, 32,
 33, 34, 35, 40, 41, 43

(260) AM 2024 121196 A
 (800) 1707635
 (151) 2022 11 03
 (181) 2032 11 03
 (891) 2022 11 03
 (511) 34

(260) AM 2024 121197 A
 (800) 1707656
 (151) 2022 11 14
 (181) 2032 11 14
 (891) 2022 11 14
 (511) 03

(260) AM 2024 121198 A
 (800) 1707663
 (151) 2022 11 07
 (181) 2032 11 07
 (891) 2022 11 07
 (511) 34

(260) AM 2024 121200 A
 (800) 1707751
 (151) 2022 10 07
 (181) 2032 10 07
 (891) 2022 10 07
 (511) 41, 44

(260) AM 2024 121201 A
 (800) 1707753
 (151) 2022 10 05
 (181) 2032 10 05
 (891) 2022 10 05
 (511) 09, 28, 41

(260) AM 2024 121202 A
 (800) 1707779
 (151) 2022 10 13
 (181) 2032 10 13
 (891) 2022 10 13
 (511) 32

(260) AM 2024 121270 A
 (800) 1708180
 (151) 2022 06 06
 (181) 2032 06 06
 (891) 2022 06 06
 (511) 09, 35, 42

(260) AM 2024 121271 A
 (800) 1708208
 (151) 2022 12 02
 (181) 2032 12 02
 (891) 2022 12 02
 (511) 09

(260) AM 2024 121272 A
 (800) 1708220
 (151) 2022 11 22
 (181) 2032 11 22
 (891) 2022 11 22
 (511) 30

(260) AM 2024 121273 A
 (800) 1708254
 (151) 2022 06 09
 (181) 2032 06 09
 (891) 2022 06 09
 (511) 09, 41, 42

(260) AM 2024 121274 A
 (800) 1708284
 (151) 2022 03 05
 (181) 2032 03 05
 (891) 2022 03 05
 (511) 09, 16, 35, 38, 41, 42

(260) AM 2024 121275 A
 (800) 1708314
 (151) 2022 08 16
 (181) 2032 08 16
 (891) 2022 08 16
 (511) 09, 10, 42, 44

(260) AM 2024 121282 A
 (800) 1708465
 (151) 2022 11 25
 (181) 2032 11 25
 (891) 2022 11 25
 (511) 30

(260) AM 2024 121284 A
(800) 1708560
(151) 2022 08 23
(181) 2032 08 23
(891) 2022 08 23
(511) 01, 02, 17, 19, 35

(260) AM 2024 121296 A
(800) 1668169
(151) 2022 02 08
(181) 2032 02 08
(891) 2022 12 30
(511) 03

(260) AM 2024 121285 A
(800) 1708561
(151) 2022 09 29
(181) 2032 09 29
(891) 2022 09 29
(511) 21

(260) AM 2024 121359 A
(800) 1708631
(151) 2022 11 16
(181) 2032 11 16
(891) 2022 11 16
(511) 12

(260) AM 2024 121286 A
(800) 884148
(151) 2005 11 30
(181) 2025 11 30
(891) 2022 12 01
(511) 29, 30, 35, 43

(260) AM 2024 121360 A
(800) 1708646
(151) 2022 08 17
(181) 2032 08 17
(891) 2022 08 17
(511) 10

(260) AM 2024 121287 A
(800) 1364242
(151) 2017 02 15
(181) 2027 02 15
(891) 2022 12 30
(511) 19

(260) AM 2024 121391 A
(800) 1709636
(151) 2022 10 06
(181) 2032 10 06
(891) 2022 10 06
(511) 09, 28, 41

(260) AM 2024 121290 A
(800) 1391005
(151) 2017 12 13
(181) 2027 12 13
(891) 2022 12 30
(511) 30

(260) AM 2024 121392 A
(800) 1709637
(151) 2022 10 31
(181) 2032 10 31
(891) 2022 10 31
(511) 07

(260) AM 2024 121293 A
(800) 1531258
(151) 2020 02 21
(181) 2030 02 21
(891) 2022 12 07
(511) 05, 32

(260) AM 2024 121395 A
(800) 1709717
(151) 2022 11 25
(181) 2032 11 25
(891) 2022 11 25
(511) 14, 35

(260) AM 2024 121295 A
(800) 1627600
(151) 2021 08 03
(181) 2031 08 03
(891) 2022 12 08
(511) 29

(260) AM 2024 121396 A
(800) 1709727
(151) 2022 12 03
(181) 2032 12 03
(891) 2022 12 03
(511) 29

(260) AM 2024 121397 A
(800) 1709739
(151) 2022 12 16
(181) 2032 12 16
(891) 2022 12 16
(511) 31

(260) AM 2024 121398 A
(800) 1709741
(151) 2022 12 16
(181) 2032 12 16
(891) 2022 12 16
(511) 31

(260) AM 2024 121399 A
(800) 993183
(151) 2008 08 25
(181) 2028 08 25
(891) 2022 10 28
(511) 12

(260) AM 2024 121400 A
(800) 1127802
(151) 2012 05 30
(181) 2032 05 30
(891) 2022 12 20
(511) 19

(260) AM 2024 121401 A
(800) 1152651
(151) 2012 12 17
(181) 2032 12 17
(891) 2022 12 18
(511) 32

(260) AM 2024 121443 A
(800) 1709822
(151) 2022 10 12
(181) 2032 10 12
(891) 2022 10 12
(511) 25, 35

(260) AM 2024 121444 A
(800) 1709868
(151) 2022 08 04
(181) 2032 08 04
(891) 2022 08 04
(511) 06, 17, 19, 37

(260) AM 2024 121445 A
(800) 1709871
(151) 2022 08 04
(181) 2032 08 04
(891) 2022 08 04
(511) 06, 11, 17, 19

(260) AM 2024 121446 A
(800) 1709882
(151) 2022 08 25
(181) 2032 08 25
(891) 2022 08 25
(511) 09, 28, 41

(260) AM 2024 121447 A
(800) 1709987
(151) 2022 10 05
(181) 2032 10 05
(891) 2022 10 05
(511) 09, 28, 41

(260) AM 2024 121448 A
(800) 1709999
(151) 2022 11 09
(181) 2032 11 09
(891) 2022 11 09
(511) 36

(260) AM 2024 121488 A
(800) 1711265
(151) 2022 11 24
(181) 2032 11 24
(891) 2022 11 24
(511) 36, 43

(260) AM 2024 121489 A
(800) 1711266
(151) 2022 11 24
(181) 2032 11 24
(891) 2022 11 24
(511) 36, 43

(260) AM 2024 121490 A
(800) 1711277
(151) 2022 12 26
(181) 2032 12 26
(891) 2022 12 26
(511) 29

(260) AM 2024 121547 A
(800) 1711542
(151) 2022 12 01
(181) 2032 12 01
(891) 2022 12 01
(511) 03

(260) AM 2024 121548 A
(800) 1711572
(151) 2022 11 30
(181) 2032 11 30
(891) 2022 11 30
(511) 03

(260) AM 2024 121549 A
(800) 1711573
(151) 2022 11 28
(181) 2032 11 28
(891) 2022 11 28
(511) 03

(260) AM 2024 121550 A
(800) 1711574
(151) 2022 11 18
(181) 2032 11 18
(891) 2022 11 18
(511) 10

(260) AM 2024 121551 A
(800) 1711585
(151) 2022 12 29
(181) 2032 12 29
(891) 2022 12 29
(511) 21, 35

(260) AM 2024 121583 A
(800) 1712326
(151) 2022 12 09
(181) 2032 12 09
(891) 2022 12 09
(511) 12

(260) AM 2024 121584 A
(800) 1712327
(151) 2022 12 21
(181) 2032 12 21
(891) 2022 12 21
(511) 05

(260) AM 2024 121602 A
(800) 1712689
(151) 2023 01 04
(181) 2033 01 04

(891) 2023 01 04
(511) 09, 15, 20

(260) AM 2024 121603 A
(800) 1712797
(151) 2022 11 10
(181) 2032 11 10
(891) 2022 11 10
(511) 29, 30

(260) AM 2024 121604 A
(800) 1712799
(151) 2022 11 04
(181) 2032 11 04
(891) 2022 11 04
(511) 29, 32, 35

(260) AM 2024 121698 A
(800) 1713802
(151) 2022 07 26
(181) 2032 07 26
(891) 2022 07 26
(511) 09, 28, 41

(260) AM 2024 121799 A
(800) 1715105
(151) 2022 12 02
(181) 2032 12 02
(891) 2022 12 02
(511) 32

(260) AM 2024 121804 A
(800) 1715203
(151) 2022 07 26
(181) 2032 07 26
(891) 2022 07 26
(511) 06, 09, 11, 17, 19, 20

(260) AM 2024 121806 A
(800) 1715258
(151) 2022 11 16
(181) 2032 11 16
(891) 2022 11 16
(511) 09

(260) AM 2024 121842 A
(800) 1591925
(151) 2021 03 22
(181) 2031 03 22
(891) 2023 02 08
(511) 30

OFFICIAL NOTIFICATIONS

INVENTIONS RESTORATION OF PATENTS

(21) AP 2010 11695
(11) P 2011 5360 B
(73) Vazha Khositashvili
(54) VEGETATIVE GATHERING – ANTIOXIDANT, ANTIRADIATION AND FOR TREATMENT OF
CARDIOVASCULAR DISEASES AND MEDICAL MEANS ON ITS BASIS
DATE OF PATENT LAPSE: 2023 02 23
DATE OF PATENT RESTORATION: 2024 01 25

(21) AP 2010 11696
(11) P 2011 5361 B
(73) Vazha Khositashvili;
Levan Khositashvili;
Babri Oreni
(54) PREPARATION - ANTIOXIDANT, ANTIRADIATION, REGULATING LIPIDIC EXCHANGE AND
PREPARATION FOR TREATMENT OF CARDIOVASCULAR DISEASES
DATE OF PATENT LAPSE: 2023 02 23
DATE OF PATENT RESTORATION: 2024 01 25

(21) AP 2016 14825
(11) P 2020 7192 B
(73) Manifattura Del Seveso S.P.A.
(54) PROCESS FOR OBTAINING A CLOTH WITH HIGH PERFORMANCES FOR DIGITAL PRINTING
AND RELATIVE CLOTH
DATE OF PATENT LAPSE: 2023 12 22
DATE OF PATENT RESTORATION: 2024 01 25

(21) AP 2018 14915
(11) P 2020 7140 B
(73) Shota Gorjeladze;
Irakli Gorjeladze
(54) ROPEWAY
DATE OF PATENT LAPSE: 2023 11 02
DATE OF PATENT RESTORATION: 2024 01 25

(21) AP 2021 15814
(11) P 2023 7481 B
(73) LLC "Aquix"
(54) WATER TREATMENT METHOD AND SYSTEM
DATE OF PATENT LAPSE: 2023 11 29
DATE OF PATENT RESTORATION: 2024 01 25

(21) AP 2021 15817
(11) P 2023 7482 B
(73) LLC "Aquix"
(54) BEVERAGE (DRINK) PREPARATION MODULE

DATE OF PATENT LAPSE: 2023 12 02
DATE OF PATENT RESTORATION: 2024 01 25

LAPSE OF PATENTS WITH THE RIGHT TO RESTORE

(21) AP 2008 11415
(11) P 2012 5693 B
(73) Biogen MA Inc.
(54) SP35 ANTIBODIES AND USAGE THEREOF
DATE OF PATENT LAPSE: 2024 01 09
PATENT RESTORATION TERM: 2025 01 09

(21) AP 2010 12819
(11) P 2016 6543 B
(73) FWP IP APS
(54) PHARMACEUTICAL FORMULATION COMPRISING ONE OR MORE FUMARIC ACID ESTERS IN
EROSION MATRIX
DATE OF PATENT LAPSE: 2024 01 08
PATENT RESTORATION TERM: 2025 01 08

(21) AP 2014 13909
(11) P 2018 6817 B
(73) Greenrail S.R.L.
(54) COMPOSITE RAILWAY SLEEPER
DATE OF PATENT LAPSE: 2024 01 13
PATENT RESTORATION TERM: 2025 01 13

(21) AP 2018 15132
(11) P 2021 7227 B
(73) Rivus Pharmaceuticals Inc.
(54) NOVEL PHENYL DERIVATIVES
DATE OF PATENT LAPSE: 2024 01 05
PATENT RESTORATION TERM: 2025 01 05

(21) AP 2020 15715
(11) P 2023 7550 B
(73) Marker Holdings AG
(54) PLASMA DETOXIFICATION METHODS AND SYSTEMS
DATE OF PATENT LAPSE: 2024 01 13
PATENT RESTORATION TERM: 2025 01 13

(21) AP 2004 8568
(11) P 2006 4003 B
(73) JSC "Nizhegorodskiy Khimiko-Pharmaceuticheskiy Zavod" /JSC "NizhPharm"
(54) AGENT FOR TREATMENT OF ARTICULATION DISEASE
DATE OF PATENT LAPSE: 2023 12 29
PATENT RESTORATION TERM: 2024 12 29

EXPIRATION OF PATENTS RESTORATION TERM

(21) AP 2011 12509
(11) P 2013 5875 B
(73) LTD "A-B-C Pharmacy"
(54) METHOD OF MEDICINE PREPARATION AND APPLICATION THEREAT ADOLESCENT'S GROWTH STIMULATION
DATE OF PATENT LAPSE: 2022 12 21
DATE OF EXPIRATION OF PATENT RESTORATION TERM: 2023 12 21

(21) AP 2015 14558
(11) P 2019 7013 B
(73) Mega Industri Kontrol Sistemleri Tic. LTD STI
(54) AN ELECTRONIC SYSTEM FOR PRODUCT IDENTIFICATION AND FILLING MANAGEMENT
DATE OF PATENT LAPSE: 2022 12 31
DATE OF EXPIRATION OF PATENT RESTORATION TERM: 2023 12 31

(21) AP 2004 9503
(11) P 2011 5291 B
(73) Geox S.P.A.
(54) WATERPROOF VAPOR-PERMEABLE MULTILAYER ARTICLE
DATE OF PATENT LAPSE: 2022 12 27
DATE OF EXPIRATION OF PATENT RESTORATION TERM: 2023 12 27

(21) AP 2004 9504
(11) P 2012 5461 B
(73) Geox S.P.A.
(54) BREATHABLE WATERPROOF SOLE FOR SHOES
DATE OF PATENT LAPSE: 2022 12 27
DATE OF EXPIRATION OF PATENT RESTORATION TERM: 2023 12 27

(21) AP 2006 9773
(11) P 2009 4603 B
(73) Les Laboratoires Servier
(54) NEW ASSOCIATION OF A SINUS CURRENT INHIBITOR AND A CALCIUM INHIBITOR, AND PHARMACEUTICAL COMPOSITIONS CONTAINING THE SAME
DATE OF PATENT LAPSE: 2022 12 20
DATE OF EXPIRATION OF PATENT RESTORATION TERM: 2023 12 20

(21) AP 2006 9774
(11) P 2009 4604 B
(73) Les Laboratoires Servier
(54) NEW ASSOCIATION OF A SINUS NODE INHIBITOR AND AN ANGIOTENSIN-CONVERTING ENZYME INHIBITOR, AND A PHARMACEUTICAL COMPOSITION CONTAINING THE SAME
DATE OF PATENT LAPSE: 2022 12 20
DATE OF EXPIRATION OF PATENT RESTORATION TERM: 2023 12 20

TRANSFER OF RIGHTS

(21) AP 2014 14132

(11) P 2021 7330 B

(54) LABELED INHIBITORS OF PROSTATE SPECIFIC MEMBRANE ANTIGEN (PSMA), THEIR USE AS IMAGING AGENTS AND PHARMACEUTICAL AGENTS FOR THE TREATMENT OF PROSTATE CANCER

NAME AND ADDRESS OF NEW PATENT OWNER: Novartis AG (CH)

Lichtstrasse 35, 4056, Basel, Switzerland (CH)

NAME AND ADDRESS OF FORMER PATENT OWNER: Novartis Pharma AG (CH)

Forum 1, Novartis Campus, 4056, Basel,
Switzerland (CH)

DATE OF REGISTRATION: 2024 01 08

(21) AP 2014 15377

(11) P 2023 7479 B

(54) LABELED INHIBITORS OF PROSTATE SPECIFIC MEMBRANE ANTIGEN (PSMA), THEIR USE AS IMAGING AGENTS AND PHARMACEUTICAL AGENTS FOR THE TREATMENT OF PROSTATE CANCER

NAME AND ADDRESS OF NEW PATENT OWNER: Novartis AG (CH)

Lichtstrasse 35, 4056, Basel, Switzerland (CH)

NAME AND ADDRESS OF FORMER PATENT OWNER: Novartis Pharma AG (CH)

Forum 1, Novartis Campus, 4056, Basel,
Switzerland (CH)

DATE OF REGISTRATION: 2024 01 08

(21) AP 2014 15720

(11) P 2023 7497 B

NAME AND ADDRESS OF NEW PATENT OWNER: Novartis AG (CH)

Lichtstrasse 35, 4056, Basel, Switzerland (CH)

NAME AND ADDRESS OF FORMER PATENT OWNER: Novartis Pharma AG (CH)

Forum 1, Novartis Campus, 4056, Basel,
Switzerland (CH)

DATE OF REGISTRATION: 2024 01 08

CHANGE OF NAME AND/OR ADDRESS OF PATENT OWNER

(21) AP 2014 15719

(11) P 2023 7496 B

(54) LABELED INHIBITORS OF PROSTATE SPECIFIC MEMBRANE ANTIGEN (PSMA), THEIR USE AS IMAGING AGENTS AND PHARMACEUTICAL AGENTS FOR THE TREATMENT OF PROSTATE CANCER

NAME AND ADDRESS OF NEW PATENT OWNER: Novartis AG (CH)

Lichtstrasse 35, 4056, Basel, Switzerland (CH)

NAME AND ADDRESS OF FORMER PATENT OWNER: Novartis Pharma AG (CH)

Forum 1, Novartis Campus, 4056, Basel,
Switzerland (CH)

DATE OF REGISTRATION: 2024 01 08

UTILITY MODELS RESTORATION OF PATENT

(21) AU 2019 15177
(11) U 2021 2064 Y
(73) LTD "Geo Mulch"
(54) EXCLUSIVE TECHNOLOGY FOR ECOLOGICALLY PURE "BIOORGANIC MULCH" PRODUCTION
DATE OF PATENT LAPSE: 2023 08 26
DATE OF PATENT RESTORATION: 2024 01 25

LAPSE OF PATENTS WITH THE RIGHT TO RESTORE

(21) AU 2017 14631
(11) U 2019 1999 Y
(73) Besiki Surguladze
(54) DRUG FOR MALIGNANT TUMORS SECONDARY METASTASES TREATMENT
DATE OF PATENT LAPSE: 2023 12 28
PATENT RESTORATION TERM: 2024 12 28

(21) AU 2020 15530
(11) U 2023 2151 Y
(73) Teimuraz Ghazhonia
(54) OPTICAL TELESCOPE EQUATORIAL STAND
DATE OF PATENT LAPSE: 2023 12 30
PATENT RESTORATION TERM: 2024 12 30

EXPIRATION OF PATENT RESTORATION TERM

(21) AU 2020 15253
(11) U 2021 2075 Y
(73) Koba Kvatchantiradze;
Vakhtang Khechikashvili
(54) GAS STOVE
DATE OF PATENT LAPSE: 2023 01 09
DATE OF EXPIRATION OF PATENT RESTORATION TERM: 2024 01 09

DESIGNS

CANCELLATION OF DESIGN REGISTRATION

(11) D 2018 770 S
(73) LTD "Vaziani Company" (GE)
Peace St. 42, 2200, Telavi, Georgia (GE)
(54) WINE BOTTLE WITH LABEL
(18) 2023 07 05
(58) 2024 01 10

EXTENSION OF TERM OF INTERNATIONAL DESIGNS REGISTRATION

(11) DM/200 367
(73) HARRY WINSTON SA
Chemin Du Tourbillon 8, 1228 Plan-Les-Ouates (CH)
(15) 2018 12 18
(24) 2018 12 18
(18) 2028 12 18
(28) 5
(28') 5
(54) 1. NECKLACE, 2. EARRING, 3.-5 BRACELET

(11) DM/200 374
(73) HARRY WINSTON SA
Chemin Du Tourbillon 8, 1228 Plan-Les-Ouates (CH)
(15) 2018 12 12
(24) 2018 12 12
(18) 2028 12 12
(28) 3
(28') 3
(54) 1.-3. FINGER RING

(11) DM/200 537
(73) OMEGA SA (OMEGA AG) (OMEGA LTD.)
Jakob-Stämpfli-Strasse 96, 2502 BIEL/BIENNE (CH)
(15) 2018 12 14
(24) 2018 12 14
(18) 2028 12 14
(28) 1
(28') 1
(54) 1. WATCH

(11) DM/200 542
(73) The Swatch Group Management Services AG (The Swatch Group Management Services SA)
(The Swatch Group Management Services Ltd.)
Seevorstadt 6, 2502 Biel/Bienne (CH)
(15) 2018 12 28
(24) 2018 12 28
(18) 2028 12 28
(28) 4

(28') 4

(54) 1.-2. WATCH CASE WITH STRAP, 3. WATCH, 4. WATCH DIAL

(11) DM/200 545

(73) HARRY WINSTON SA

Chemin du Tourbillon 8, 1228 Plan-Les-Ouates (CH)

(15) 2018 12 28

(24) 2018 12 28

(18) 2028 12 28

(28) 3

(28') 3

(54) 1. DIAL, 2. WATCH CASE, 3. DIAL

(11) DM/64723

(73) SWATCH AG (SWATCH SA) (SWATCH LTD.)

94, Rue Jakob Stämpfli 2502 Bienne (CH)

(15) 2003 12 12

(24) 2003 12 12

(18) 2028 12 12

(28) 5

(28') 2

(54) WRISTWATCHES

(11) DM/64725

(73) SWATCH AG (SWATCH SA) (SWATCH LTD.)

94, Rue Jakob Stämpfli 2502 Bienne (CH)

(15) 2003 12 12

(24) 2003 12 12

(18) 2028 12 12

(28) 1

(28') 1

(54) WRISTWATCH

(11) DM/64756

(73) SWATCH AG (SWATCH SA) (SWATCH LTD.)

94, Rue Jakob Stämpfli 2502 Bienne (CH)

(15) 2003 12 17

(24) 2003 12 17

(18) 2028 12 17

(28) 6

(28') 6

(54) WRISTWATCHES

(11) DM/64822

(73) SWATCH AG (SWATCH SA) (SWATCH LTD.)

94, Rue Jakob Stämpfli 2502 Bienne (CH)

(15) 2003 12 29

(24) 2003 12 29

(18) 2028 12 29

(28) 1

(28') 1

(54) WATCH CASE

(11) DM/64863
(73) SWATCH AG (SWATCH SA) (SWATCH LTD.)
94, Rue Jakob Stämpfli 2502 Bienne (CH)
(15) 2003 12 09
(24) 2003 12 09
(18) 2028 12 09
(28) 5
(28') 5
(54) SHOP FITTING ELEMENTS AND DISPLAY CASES FOR WATCHES

(11) DM/70999
(73) SOREMARTEC S.A.
Drève de l'Arc-en-Ciel 102, B-6700 SCHOPPACH-ARLON (BE)
(15) 2008 11 26
(24) 2008 11 26
(18) 2028 11 26
(28) 22
(28') 7
(54) PACKAGINGS OR CONTAINERS FOR CONFECTIONERY PRODUCTS SUCH AS CHOCOLATES
OR PRALINES

(11) DM/71115
(73) SWATCH AG (SWATCH SA) (SWATCH LTD.)
Jakob-Stämpfli-Strasse 94, CH-2502 Biel/Bienne (CH)
(15) 2008 12 22
(24) 2008 12 22
(18) 2028 12 22
(28) 6
(28') 4
(54) WRIST-WATCHES

TRADEMARKS

EXTENSION OF TERM OF TRADEMARKS REGISTRATION

(111) M 2004 15476 R2
(151) 2004 03 15
(186) 2034 03 15
(732) Société Des Produits Nestlé S.A.
CH-1800 Vevey, Switzerland

(111) M 2003 15361 R2
(151) 2003 12 15
(186) 2033 12 15
(732) United Parcel Service of America Inc.
55 Glenlake Parkway, NE Atlanta, Georgia,
USA

(111) M 2004 15403 R2
(151) 2004 01 15
(186) 2034 01 15
(732) United Parcel Service of America Inc.
55 Glenlake Parkway, NE Atlanta, Georgia,
USA

(111) M 2004 15437 R2
(151) 2004 02 27
(186) 2034 02 27
(732) Glaxo Group Limited
GSK Medicines Research Centre, Gunnels
Wood Road, Stevenage, United Kingdom
SG1 2NY, United Kingdom

(111) M 1994 415 R3
(151) 1994 11 11
(186) 2034 11 11
(732) Exxon Mobil Corporation
a New Jersey Corporation
22777 Spingwoods Village Parkway,
Spring, TX 77389, USA

(111) M 1994 400 R3
(151) 1994 11 09
(186) 2034 11 09
(732) Exxon Mobil Corporation
a New Jersey Corporation
22777 Spingwoods Village Parkway,
Spring, TX 77389, USA

(111) M 1994 412 R3
(151) 1994 11 11
(186) 2034 11 11
(732) Exxon Mobil Corporation
a New Jersey Corporation
22777 Spingwoods Village Parkway,
Spring, TX 77389, USA

(111) M 1994 445 R3
(151) 1994 11 11
(186) 2034 11 11
(732) Exxon Mobil Corporation
a New Jersey Corporation
22777 Spingwoods Village Parkway,
Spring, TX 77389, USA

(111) M 1994 410 R3
(151) 1994 11 11
(186) 2034 11 11
(732) Exxon Mobil Corporation
a New Jersey Corporation
22777 Spingwoods Village Parkway,
Spring, TX 77389, USA

(111) M 1994 409 R3
(151) 1994 11 11
(186) 2034 11 11
(732) Exxon Mobil Corporation
a New Jersey Corporation
22777 Spingwoods Village Parkway,
Spring, TX 77389, USA

(111) M 1994 408 R3
(151) 1994 11 11
(186) 2034 11 11
(732) Exxon Mobil Corporation
a New Jersey Corporation
22777 Spingwoods Village Parkway,
Spring, TX 77389, USA

(111) M 1994 432 R3
(151) 1994 11 11
(186) 2034 11 11
(732) Exxon Mobil Corporation
a New Jersey Corporation
22777 Spingwoods Village Parkway,
Spring, TX 77389, USA

| | |
|--|--|
| (111) M 1994 433 R3 (151) 1994 11 11 (186) 2034 11 11 (732) Exxon Mobil Corporation a New Jersey Corporation 22777 Spingwoods Village Parkway, Spring, TX 77389, USA | 22777 Spingwoods Village Parkway, Spring, TX 77389, USA |
| (111) M 1994 438 R3 (151) 1994 11 11 (186) 2034 11 11 (732) Exxon Mobil Corporation a New Jersey Corporation 22777 Spingwoods Village Parkway, Spring, TX 77389, USA | (111) M 1994 373 R3 (151) 1994 11 09 (186) 2034 11 09 (732) Exxon Mobil Corporation a New Jersey Corporation 22777 Spingwoods Village Parkway, Spring, TX 77389, USA |
| (111) M 1994 216 R3 (151) 1994 11 01 (186) 2034 11 01 (732) Exxon Mobil Corporation a New Jersey Corporation 22777 Spingwoods Village Parkway, Spring, TX 77389, USA | (111) M 2014 24490 R1 (151) 2014 02 18 (186) 2034 02 18 (732) LTD "Gea" Tsereteli Av. 119, 0119, Tbilisi, Georgia |
| (111) M 1994 77 R3 (151) 1994 10 26 (186) 2034 10 26 (732) Exxon Mobil Corporation a New Jersey Corporation 22777 Spingwoods Village Parkway, Spring, TX 77389, USA | (111) M 2013 24241 R1 (151) 2013 11 04 (186) 2033 11 04 (732) Maharishi Vedic University Limited 94 Triq Il-Vanilja, MGR 2253 Mgarr, Malta |
| (111) M 1994 217 R3 (151) 1994 11 01 (186) 2034 11 01 (732) Exxon Mobil Corporation a New Jersey Corporation 22777 Spingwoods Village Parkway, Spring, TX 77389, USA | (111) M 2014 24427 R1 (151) 2014 01 21 (186) 2034 01 21 (732) FCA US LLC 1000 Chrysler Drive, City of Auburn Hills, State of Michigan 48326, USA |
| (111) M 1994 79 R3 (151) 1994 10 26 (186) 2034 10 26 (732) Exxon Mobil Corporation a New Jersey Corporation 22777 Spingwoods Village Parkway, Spring, TX 77389, USA | (111) M 2014 24553 R1 (151) 2014 03 12 (186) 2034 03 12 (732) Mitsubishi Jidosha Kogyo Kabushiki Kaisha 1-21, Shibaura 3-chome, Minato-ku, Tokyo 108-8410, Japan |
| (111) M 1994 374 R3 (151) 1994 11 09 (186) 2034 11 09 (732) Exxon Mobil Corporation a New Jersey Corporation | (111) M 2014 24554 R1 (151) 2014 03 12 (186) 2034 03 12 (732) Mitsubishi Jidosha Kogyo Kabushiki Kaisha 1-21, Shibaura 3-chome, Minato-ku, Tokyo 108-8410, Japan |
| | (111) M 2014 24556 R1 (151) 2014 03 12 (186) 2034 03 12 (732) Mitsubishi Jidosha Kogyo Kabushiki Kaisha 1-21, Shibaura 3-chome, Minato-ku, Tokyo 108-8410, Japan |

(111) M 2014 24470 R1
 (151) 2014 02 03
 (186) 2034 02 03
 (732) Société Des Produits Nestlé S.A.
 CH-1800 Vevey, Switzerland

(111) M 2014 24730 R1
 (151) 2014 05 07
 (186) 2034 05 07
 (732) Suzhou Dake Machinery Co., Ltd.
 Room 618, Building Number 1, Lucky
 City Commercial Center, Suzhou Industrial
 Park, Suzhou City, Jangsu Province, China

(111) M 2014 24437 R1
 (151) 2014 01 21
 (186) 2034 01 21
 (732) Disney Enterprises Inc.
 a Delaware Corporation
 500 South Buena Vista Street, Burbank,
 California 91521, USA

(111) M 2014 24438 R1
 (151) 2014 01 21
 (186) 2034 01 21
 (732) Western Union Holdings Inc.
 7001 East Belleview Avenue, Denver
 Colorado 80237, USA

(111) M 2014 24441 R1
 (151) 2014 01 21
 (186) 2034 01 21
 (732) Zumba Fitness LLC
 800 Silks Run, Suite 2310, Hellendale,
 Florida 33009, USA

(111) M 2014 24892 R1
 (151) 2014 06 13
 (186) 2034 06 13
 (732) Toyota Jidosha Kabushiki Kaisha (also trading
 as Toyota Motor Corporation)
 1, Toyota-Cho, Toyota-Shi, Aichi-Ken, Japan

(111) M 2014 24683 R1
 (151) 2014 04 15
 (186) 2034 04 15
 (732) ViiV Healthcare UK Limited
 980 Great West Road, Brentford, TW8 9GS
 Middlesex, United Kingdom

(111) M 2014 24684 R1
 (151) 2014 04 15
 (186) 2034 04 15
 (732) ViiV Healthcare UK Limited
 980 Great West Road, Brentford, TW8 9GS
 Middlesex, United Kingdom

(111) M 2014 24860 R1
 (151) 2014 05 30
 (186) 2034 05 30
 (732) Marriott Worldwide Corporation
 10400 Fernwood Road, Bethesda, Maryland
 20817, USA

(111) M 2013 23773 R1
 (151) 2013 06 14
 (186) 2033 06 14
 (732) LTD "Kakhetian Traditional Winemaking"
 Ksani St. 12, 0141, Tbilisi, Georgia

(111) M 2014 25318 R1
 (151) 2014 10 29
 (186) 2034 10 29
 (732) LTD "Vainmen Shps"
 Gudiashvili St. 11, 0105, Tbilisi, Georgia

(111) M 2014 25319 R1
 (151) 2014 10 29
 (186) 2034 10 29
 (732) LTD "Vainmen Shps"
 Gudiashvili St. 11, 0105, Tbilisi, Georgia

(111) M 2014 25320 R1
 (151) 2014 10 29
 (186) 2034 10 29
 (732) LTD "Vainmen Shps"
 Gudiashvili St. 11, 0105, Tbilisi, Georgia

(111) M 2014 25149 R1
 (151) 2014 09 02
 (186) 2034 09 02
 (732) LTD "Kakhuri"
 Tbilisi highway 1, 2200, Telavi, Georgia

(111) M 2014 25416 R1
 (151) 2014 11 25
 (186) 2034 11 25
 (732) JSC "Insurance Company Aldagi"
 Pushkin St. 3, Old Tbilisi District, Tbilisi,
 Georgia

(111) M 2014 25417 R1
(151) 2014 11 25
(186) 2034 11 25
(732) JSC "Insurance Company Aldagi"
Pushkin St. 3, Old Tbilisi District, Tbilisi,
Georgia

(111) M 2014 25418 R1
(151) 2014 11 25
(186) 2034 11 25
(732) JSC "Insurance Company Aldagi"
Pushkin St. 3, Old Tbilisi District, Tbilisi,
Georgia

(111) M 2014 25419 R1
(151) 2014 11 25
(186) 2034 11 25
(732) JSC "Insurance Company Aldagi"
Pushkin St. 3, Old Tbilisi District, Tbilisi,
Georgia

(111) M 2014 25247 R1
(151) 2014 09 19
(186) 2034 09 19
(732) Glaxo Group Limited
GSK Medicines Research Centre, Gunnels
Wood Road, Stevenage, United Kingdom
SG1 2NY, United Kingdom

(111) M 2013 24128 R1
(151) 2013 10 16
(186) 2033 10 16
(732) Pearson plc
80 Strand, London WC2R 0RL, United
Kingdom

(111) M 2014 25434 R1
(151) 2014 11 25
(186) 2034 11 25
(732) Exxon Mobil Corporation
a Corporation Organized and Existing Under
the Laws of the State of New Jersey
22777 Spingwoods Village Parkway, Spring,
TX 77389, USA

(111) M 2014 24407 R1
(151) 2014 01 13
(186) 2034 01 13
(732) Energo-Pro a.s.
Republic, Svitavy, Nam. miru 62/39, postal
index 56802, Czech Republic

(111) M 2014 25457 R1
(151) 2014 12 03
(186) 2034 12 03
(732) JSC "Miso Euro Credit"
Giorgi Saakadze II exit 11, Saburtalo District,
Tbilisi, Georgia

(111) M 2014 25456 R1
(151) 2014 12 02
(186) 2034 12 02
(732) JSC "Miso Euro Credit"
Giorgi Saakadze II exit 11, Saburtalo District,
Tbilisi, Georgia

(111) M 1994 127 R3
(151) 1994 10 28
(186) 2034 10 28
(732) Armacell Enterprise GmbH & Co. KG
Zeppelinstrasse 1, 12529 Schönefeld OT
Waltersdorf, Germany

COMPLETE TRANSFER OF RIGHTS

(111) M 2023 37634 R
(732) LLC "Ascaneli Brothers"
Kakheti Highway 110a, 0190, Tbilisi, Georgia
(770) LLC "Weisermark"
Mindeli St. 11, floor 14, ap. 132, 0186,
Tbilisi Georgia

(111) M 2015 25882 R
(732) Pierrel S.P.A.
Strada Statale Appia, 7/BIS 46/48, 81043
Capua (CE), Italy
(770) 3M Deutschland GmbH
a German Corporation
Carl-Schurz-Strasse 1, 41453 Neuss, Germany
(580) 2023 11 28

(111) M 1998 9623 R
(732) AstorMueller AG
Chamerstrasse 50, 6331 Hünenberg,
Switzerland
(770) Salamander GmbH
Zur Schlenkhecke 4, 40764 Langenfeld,
Germany
(580) 2023 12 23

(111) M 2019 31063 R
(732) Obshchestvo s Ogranichennoy Otvetstven-
nostyu "Masloekstraktsionniy Zavod Yug
Rusi"
Pl. Tolstogo 8, Rostov Region, Rostov-
On-Don, 344037, Russian Federation
(770) Obshchestvo s Ogranichennoy Otvetstven-
nostyu "Sistema"
Pl. Tolstogo 8, Rostov-Na-Donu 344037,
Russian Federation
(580) 2023 12 11

(111) M 2019 31064 R
(732) Obshchestvo s Ogranichennoy Otvetstven-
nostyu "Masloekstraktsionniy Zavod Yug
Rusi"
Pl. Tolstogo 8, Rostov Region, Rostov-
On-Don, 344037, Russian Federation
(770) Obshchestvo s Ogranichennoy Otvetstven-
nostyu "Sistema"
Pl. Tolstogo 8, Rostov-Na-Donu 344037,
Russian Federation
(580) 2023 12 11

CHANGES OF NAME AND/OR ADDRESS OF TRADEMARKS OWNERS

(111) M 2019 31980 R
(732) Exxon Mobil Corporation
22777 Spingwoods Village Parkway, Spring,
TX 77389, USA

(770) Exxon Mobil Corporation
5959 Las Colinas Boulevard, Irving, Texas
75039-2298, USA
(580) 2023 11 27

(111) M 2020 32672 R
(732) Exxon Mobil Corporation
22777 Spingwoods Village Parkway, Spring,
TX 77389, USA
(770) Exxon Mobil Corporation
5959 Las Colinas Boulevard, Irving, Texas
75039, USA
(580) 2023 11 27

(111) M 2021 33628 R
(732) Exxon Mobil Corporation
22777 Spingwoods Village Parkway, Spring,
TX 77389, USA
(770) Exxon Mobil Corporation
5959 Las Colinas Boulevard, Irving, Texas
75039, USA
(580) 2023 11 27

(111) M 1998 8106 R
(732) Exxon Mobil Corporation
22777 Spingwoods Village Parkway, Spring,
TX 77389, USA
(770) Exxon Mobil Corporation
5959 Las Colinas Boulevard, Irving, Texas
75039-2298, USA
(580) 2023 11 27

(111) M 2020 32754 R
(732) Marriott Worldwide Corporation
7750 Wisconsin Avenue, Bethesda, Maryland
20814, USA
(770) Marriott Worldwide Corporation
10400 Fernwood Road, Bethesda, Maryland
20817, USA
(580) 2023 12 11

(111) M 2020 32752 R
(732) Marriott Worldwide Corporation
7750 Wisconsin Avenue, Bethesda, Maryland
20814, USA

(770) Marriott Worldwide Corporation
10400 Fernwood Road, Bethesda, Maryland
20817, USA
(580) 2023 12 11

(111) M 2023 36697 R
(732) Philip Morris Global Brands Inc.
677 Washington Boulevard, Suite 1100,
Stamford, Connecticut 06901, USA
(770) Philip Morris Global Brands Inc.
120 Park Avenue, New York, New York
10017, USA
(580) 2023 11 16

(111) M 2023 37505 R
(732) Anna Davidson
Ilia Chavchavadze Av. 80, ap. 18, 0162,
Tbilisi, Georgia
(770) Anna Guzina
Ilia Chavchavadze Av. 80, ap. 18, 0162,
Tbilisi, Georgia
(580) 2023 11 28

(111) M 2023 37604 R
(732) Eqson Mobil Korporeishen
22777 Spingwoods Village Parkway, Spring,
TX 77389, USA
(770) Exxon Mobil Corporation
5959 Las Colinas Boulevard, Irving, Texas
75039-2298, USA
(580) 2023 11 27

(111) M 2023 37603 R
(732) Eqson Mobil Korporeishen
22777 Spingwoods Village Parkway, Spring,
TX 77389, USA
(770) Exxon Mobil Corporation
5959 Las Colinas Boulevard, Irving, Texas
75039-2298, USA
(580) 2023 11 27

(111) M 1998 8209 R
(732) Bayer Intellectual Property GmbH
Alfred-Nobel-Strasse 50, 40789 Monheim
am Rhein, Germany
(770) Bayer Intellectual Property GmbH
Alfred-Nobel-Strasse 10, 40789 Monheim
am Rhein, Germany
(580) 2023 11 21

(111) M 1998 8702 R
(732) Bayer Intellectual Property GmbH
Alfred-Nobel-Strasse 50, 40789 Monheim
am Rhein, Germany
(770) Bayer Intellectual Property GmbH
Alfred-Nobel-Strasse 10, 40789 Monheim
am Rhein, Germany
(580) 2023 11 21

(111) M 1998 8914 R
(732) Bayer Intellectual Property GmbH
Alfred-Nobel-Strasse 50, 40789 Monheim
am Rhein, Germany
(770) Bayer Intellectual Property GmbH
Alfred-Nobel-Strasse 10, 40789 Monheim
am Rhein, Germany
(580) 2023 11 21

(111) M 1998 10703 R
(732) Diageo Plc
16 Great Marlborough Street, London,
W1F 7HS, United Kingdom
(770) Diageo Plc
Lakeside Drive, Park Royal, London
NW10 7HQ, United Kingdom
(580) 2023 12 15

(111) M 2001 14004 R
(732) Exxon Mobil Corporation
22777 Spingwoods Village Parkway, Spring,
TX 77389, USA
(770) Exxon Mobil Corporation
5959 Las Colinas Boulevard, Irving, Texas
75039-2298, USA
(580) 2023 11 27

(111) M 2001 14126 R
(732) Exxon Mobil Corporation
22777 Spingwoods Village Parkway, Spring,
TX 77389, USA
(770) Exxon Mobil Corporation
5959 Las Colinas Boulevard, Irving, Texas
75039-2298, USA
(580) 2023 11 27

(111) M 2000 13571 R
(732) Philip Morris Global Brands Inc.
677 Washington Boulevard, Suite 1100,
Stamford, Connecticut 06901, USA
(770) Philip Morris Global Brands Inc.
120 Park Avenue, New York, New York
10017, USA
(580) 2023 11 16

(111) M 2001 14125 R
(732) Exxon Mobil Corporation
22777 Spingwoods Village Parkway, Spring,
TX 77389, USA
(770) Exxon Mobil Corporation
5959 Las Colinas Boulevard, Irving, Texas
75039-2298, USA
(580) 2023 11 27

(111) M 2001 13779 R
(732) Bayer Intellectual Property GmbH
Alfred-Nobel-Strasse 50, 40789 Monheim
am Rhein, Germany
(770) Bayer Intellectual Property GmbH
Alfred-Nobel-Strasse 10, 40789 Monheim
am Rhein, Germany
(580) 2023 11 21

(111) M 1999 11444 R
(732) Bayer Intellectual Property GmbH
Alfred-Nobel-Strasse 50, 40789 Monheim
am Rhein, Germany
(770) Bayer Intellectual Property GmbH
Alfred-Nobel-Strasse 10, 40789 Monheim
am Rhein, Germany
(580) 2023 11 21

(111) M 1999 11445 R
(732) Bayer Intellectual Property GmbH
Alfred-Nobel-Strasse 50, 40789 Monheim
am Rhein, Germany
(770) Bayer Intellectual Property GmbH
Alfred-Nobel-Strasse 10, 40789 Monheim
am Rhein, Germany
(580) 2023 11 21

(111) M 1995 958 R
(732) Bayer Intellectual Property GmbH
Alfred-Nobel-Strasse 50, 40789 Monheim
am Rhein, Germany
(770) Bayer Intellectual Property GmbH
Alfred-Nobel-Strasse 10, 40789 Monheim
am Rhein, Germany
(580) 2023 11 21

(111) M 2001 13923 R
(732) Bayer Intellectual Property GmbH
Alfred-Nobel-Strasse 50, 40789 Monheim
am Rhein, Germany
(770) Bayer Intellectual Property GmbH
Alfred-Nobel-Strasse 10, 40789 Monheim
am Rhein, Germany
(580) 2023 11 21

(111) M 1997 4762 R
(732) Exxon Mobil Corporation, a New Jersey Corporation
22777 Spingwoods Village Parkway, Spring, TX 77389, USA
(770) Exxon Mobil Corporation, a New Jersey Corporation
5959 Las Colinas Boulevard, Irving, Texas, USA
(580) 2023 11 27

(111) M 1997 4763 R
(732) Exxon Mobil Corporation, a New Jersey Corporation
22777 Spingwoods Village Parkway, Spring, TX 77389, USA
(770) Exxon Mobil Corporation, a New Jersey Corporation
5959 Las Colinas Boulevard, Irving, Texas, USA
(580) 2023 11 27

(111) M 1997 4764 R
(732) Exxon Mobil Corporation, a New Jersey Corporation
22777 Spingwoods Village Parkway, Spring, TX 77389, USA
(770) Exxon Mobil Corporation, a New Jersey Corporation
5959 Las Colinas Boulevard, Irving, Texas, USA
(580) 2023 11 27

(111) M 2004 15674 R
(732) Starwood Hotels & Resorts Worldwide, LLC
7750 Wisconsin Avenue, Bethesda, Maryland 20814, USA
(770) Starwood Hotels & Resorts Worldwide, LLC
10400 Fernwood Road, Dept. 955.23, Bethesda, Maryland 20817, USA
(580) 2023 12 20

(111) M 1995 664 R
(732) Bayer Intellectual Property GmbH
Alfred-Nobel-Strasse 50, 40789 Monheim am Rhein, Germany
(770) Bayer Intellectual Property GmbH
Alfred-Nobel-Strasse 10, 40789 Monheim am Rhein, Germany
(580) 2023 11 21

(111) M 1996 1484 R
(732) Bayer Intellectual Property GmbH
Alfred-Nobel-Strasse 50, 40789 Monheim am Rhein, Germany

(770) Bayer Intellectual Property GmbH
Alfred-Nobel-Strasse 10, 40789 Monheim am Rhein, Germany
(580) 2023 11 21

(111) M 1996 1482 R
(732) Bayer Intellectual Property GmbH
Alfred-Nobel-Strasse 50, 40789 Monheim am Rhein, Germany
(770) Bayer Intellectual Property GmbH
Alfred-Nobel-Strasse 10, 40789 Monheim am Rhein, Germany
(580) 2023 11 21

(111) M 2007 18041 R
(732) Bayer Intellectual Property GmbH
Alfred-Nobel-Strasse 50, 40789 Monheim am Rhein, Germany
(770) Bayer Intellectual Property GmbH
Alfred-Nobel-Strasse 10, 40789 Monheim am Rhein, Germany
(580) 2023 11 21

(111) M 2007 18042 R
(732) Bayer Intellectual Property GmbH
Alfred-Nobel-Strasse 50, 40789 Monheim am Rhein, Germany
(770) Bayer Intellectual Property GmbH
Alfred-Nobel-Strasse 10, 40789 Monheim am Rhein, Germany
(580) 2023 11 21

(111) M 2007 18043 R
(732) Bayer Intellectual Property GmbH
Alfred-Nobel-Strasse 50, 40789 Monheim am Rhein, Germany
(770) Bayer Intellectual Property GmbH
Alfred-Nobel-Strasse 10, 40789 Monheim am Rhein, Germany
(580) 2023 11 21

(111) M 2007 18044 R
(732) Bayer Intellectual Property GmbH
Alfred-Nobel-Strasse 50, 40789 Monheim am Rhein, Germany
(770) Bayer Intellectual Property GmbH
Alfred-Nobel-Strasse 10, 40789 Monheim am Rhein, Germany
(580) 2023 11 21

(111) M 1997 6923 R
(732) Exxon Mobil Corporation
22777 Spingwoods Village Parkway, Spring, TX 77389, USA

(770) Exxon Mobil Corporation
5959 Las Colinas Boulevard, Irving, Texas
75039-2298, USA
(580) 2023 11 27

(111) M 1997 6924 R
(732) Exxon Mobil Corporation
22777 Spingwoods Village Parkway, Spring,
TX 77389, USA
(770) Exxon Mobil Corporation
5959 Las Colinas Boulevard, Irving, Texas
75039-2298, USA
(580) 2023 11 27

(111) M 1996 2396 R
(732) Exxon Mobil Corporation
22777 Spingwoods Village Parkway, Spring,
TX 77389, USA
(770) Exxon Mobil Corporation
5959 Las Colinas Boulevard, Irving, Texas
75039-2298, USA
(580) 2023 11 27

(111) M 1996 2418 R
(732) Exxon Mobil Corporation
22777 Spingwoods Village Parkway, Spring,
TX 77389, USA
(770) Exxon Mobil Corporation
5959 Las Colinas Boulevard, Irving, Texas
75039-2298, USA
(580) 2023 11 27

(111) M 1996 2658 R
(732) Exxon Mobil Corporation
22777 Spingwoods Village Parkway, Spring,
TX 77389, USA
(770) Exxon Mobil Corporation
5959 Las Colinas Boulevard, Irving, Texas
75039-2298, USA
(580) 2023 11 28

(111) M 1996 2133 R
(732) Exxon Mobil Corporation
22777 Spingwoods Village Parkway, Spring,
TX 77389, USA
(770) Exxon Mobil Corporation
5959 Las Colinas Boulevard, Irving, Texas
75039-2298, USA
(580) 2023 11 27

(111) M 1996 2172 R
(732) Exxon Mobil Corporation
22777 Spingwoods Village Parkway, Spring,
TX 77389, USA

(770) Exxon Mobil Corporation
5959 Las Colinas Boulevard, Irving, Texas
75039-2298, USA
(580) 2023 11 27

(111) M 1996 2135 R
(732) Exxon Mobil Corporation
22777 Spingwoods Village Parkway, Spring,
TX 77389, USA
(770) Exxon Mobil Corporation
5959 Las Colinas Boulevard, Irving, Texas
75039-2298, USA
(580) 2023 11 27

(111) M 1996 2403 R
(732) Exxon Mobil Corporation
22777 Spingwoods Village Parkway, Spring,
TX 77389, USA
(770) Exxon Mobil Corporation
5959 Las Colinas Boulevard, Irving, Texas
75039-2298, USA
(580) 2023 11 27

(111) M 1996 2937 R
(732) Bayer Intellectual Property GmbH
Alfred-Nobel-Strasse 50, 40789 Monheim
am Rhein, Germany
(770) Bayer Intellectual Property GmbH
Alfred-Nobel-Strasse 10, 40789 Monheim
am Rhein, Germany
(580) 2023 11 21

(111) M 1996 1479 R
(732) Bayer Intellectual Property GmbH
Alfred-Nobel-Strasse 50, 40789 Monheim
am Rhein, Germany
(770) Bayer Intellectual Property GmbH
Alfred-Nobel-Strasse 10, 40789 Monheim
am Rhein, Germany
(580) 2023 11 21

(111) M 1994 415 R
(732) Exxon Mobil Corporation, a New Jersey
Corporation
22777 Spingwoods Village Parkway, Spring,
TX 77389, USA
(770) Exxon Mobil Corporation, a New Jersey
Corporation
5959 Las Colinas Boulevard, Irving, Texas,
USA
(580) 2023 11 27

(111) M 1994 400 R
(732) Exxon Mobil Corporation, a New Jersey Corporation
22777 Spingwoods Village Parkway, Spring, TX 77389, USA
(770) Exxon Mobil Corporation, a New Jersey Corporation
5959 Las Colinas Boulevard, Irving, Texas, USA
(580) 2023 11 27

(111) M 1994 412 R
(732) Exxon Mobil Corporation, a New Jersey Corporation
22777 Spingwoods Village Parkway, Spring, TX 77389, USA
(770) Exxon Mobil Corporation, a New Jersey Corporation
5959 Las Colinas Boulevard, Irving, Texas, USA
(580) 2023 11 27

(111) M 1994 445 R
(732) Exxon Mobil Corporation, a New Jersey Corporation
22777 Spingwoods Village Parkway, Spring, TX 77389, USA
(770) Exxon Mobil Corporation, a New Jersey Corporation
5959 Las Colinas Boulevard, Irving, Texas, USA
(580) 2023 11 27

(111) M 1994 410 R
(732) Exxon Mobil Corporation, a New Jersey Corporation
22777 Spingwoods Village Parkway, Spring, TX 77389, USA
(770) Exxon Mobil Corporation, a New Jersey Corporation
5959 Las Colinas Boulevard, Irving, Texas, USA
(580) 2023 11 27

(111) M 1994 409 R
(732) Exxon Mobil Corporation, a New Jersey Corporation
22777 Spingwoods Village Parkway, Spring, TX 77389, USA
(770) Exxon Mobil Corporation, a New Jersey Corporation
5959 Las Colinas Boulevard, Irving, Texas, USA
(580) 2023 11 27

(111) M 1994 408 R
(732) Exxon Mobil Corporation, a New Jersey Corporation
22777 Spingwoods Village Parkway, Spring, TX 77389, USA
(770) Exxon Mobil Corporation, a New Jersey Corporation
5959 Las Colinas Boulevard, Irving, Texas, USA
(580) 2023 11 27

(111) M 1994 407 R
(732) Exxon Mobil Corporation, a New Jersey Corporation
22777 Spingwoods Village Parkway, Spring, TX 77389, USA
(770) Exxon Mobil Corporation, a New Jersey Corporation
5959 Las Colinas Boulevard, Irving, Texas, USA
(580) 2023 11 27

(111) M 1994 432 R
(732) Exxon Mobil Corporation, a New Jersey Corporation
22777 Spingwoods Village Parkway, Spring, TX 77389, USA
(770) Exxon Mobil Corporation, a New Jersey Corporation
5959 Las Colinas Boulevard, Irving, Texas, USA
(580) 2023 11 27

(111) M 1994 433 R
(732) Exxon Mobil Corporation, a New Jersey Corporation
22777 Spingwoods Village Parkway, Spring, TX 77389, USA
(770) Exxon Mobil Corporation, a New Jersey Corporation
5959 Las Colinas Boulevard, Irving, Texas, USA
(580) 2023 11 27

(111) M 1994 438 R
(732) Exxon Mobil Corporation, a New Jersey Corporation
22777 Spingwoods Village Parkway, Spring, TX 77389, USA
(770) Exxon Mobil Corporation, a New Jersey Corporation
5959 Las Colinas Boulevard, Irving, Texas, USA
(580) 2023 11 27

(111) M 1994 216 R
 (732) Exxon Mobil Corporation, a New Jersey Corporation
 22777 Spingwoods Village Parkway, Spring, TX 77389, USA
 (770) Exxon Mobil Corporation, a New Jersey Corporation
 5959 Las Colinas Boulevard, Irving, Texas, USA
 (580) 2023 11 27

(111) M 1994 77 R
 (732) Exxon Mobil Corporation, a New Jersey Corporation
 22777 Spingwoods Village Parkway, Spring, TX 77389, USA
 (770) Exxon Mobil Corporation, a New Jersey Corporation
 5959 Las Colinas Boulevard, Irving, Texas, USA
 (580) 2023 11 27

(111) M 1994 217 R
 (732) Exxon Mobil Corporation, a New Jersey Corporation
 22777 Spingwoods Village Parkway, Spring, TX 77389, USA
 (770) Exxon Mobil Corporation, a New Jersey Corporation
 5959 Las Colinas Boulevard, Irving, Texas, USA
 (580) 2023 11 27

(111) M 1994 79 R
 (732) Exxon Mobil Corporation, a New Jersey Corporation
 22777 Spingwoods Village Parkway, Spring, TX 77389, USA
 (770) Exxon Mobil Corporation, a New Jersey Corporation
 5959 Las Colinas Boulevard, Irving, Texas, USA
 (580) 2023 11 27

(111) M 1994 374 R
 (732) Exxon Mobil Corporation, a New Jersey Corporation
 22777 Spingwoods Village Parkway, Spring, TX 77389, USA
 (770) Exxon Mobil Corporation, a New Jersey Corporation
 5959 Las Colinas Boulevard, Irving, Texas, USA
 (580) 2023 11 27

(111) M 1994 373 R
 (732) Exxon Mobil Corporation, a New Jersey Corporation
 22777 Spingwoods Village Parkway, Spring, TX 77389, USA
 (770) Exxon Mobil Corporation, a New Jersey Corporation
 5959 Las Colinas Boulevard, Irving, Texas, USA
 (580) 2023 11 27

(111) M 2013 24241 R
 (732) Maharishi Vedic University Limited
 94 Triq Ii-Vanilja, MGR 2253 Mgarr, Malta
 (770) Maharishi Vedic University Limited
 54 Marsamxett Road, Valeta, VLT 1853, Malta
 (580) 2023 11 06

(111) M 2014 24577 R
 (732) The Ritz-Carlton Hotel Company, L.L.C.
 7750 Wisconsin Avenue, Bethesda, Maryland 20814, USA
 (770) The Ritz-Carlton Hotel Company, L.L.C.
 10400 Fernwood Road, Bethesda, Maryland 20817, USA
 (580) 2023 12 07

(111) M 2014 24578 R
 (732) The Ritz-Carlton Hotel Company, L.L.C.
 7750 Wisconsin Avenue, Bethesda, Maryland 20814, USA
 (770) The Ritz-Carlton Hotel Company, L.L.C.
 10400 Fernwood Road, Bethesda, Maryland 20817, USA
 (580) 2023 12 07

(111) M 2014 25146 R
 (732) Super Magnificent Coffee Company Ireland Limited
 Unit 14, Gray Office Park, Galway Retail Park, Headford Road, Galway H91 C3N1, Ireland
 (770) Super Magnificent Coffee Company Ireland Limited
 Riverside One, Sir John Rogerson's Quay, Dublin 2, D02 X576, Ireland
 (580) 2023 11 24

(111) M 2014 25147 R
 (732) Super Magnificent Coffee Company Ireland Limited
 Unit 14, Gray Office Park, Galway Retail Park, Headford Road, Galway H91 C3N1, Ireland
 (770) Super Magnificent Coffee Company Ireland Limited

Riverside One, Sir John Rogerson's Quay,
Dublin 2, D02 X576, Ireland
(580) 2023 11 24

(111) M 2014 25200 R
(732) Super Magnificent Coffee Company Ireland
Limited
Unit 14, Gray Office Park, Galway Retail Park,
Headford Road, Galway H91 C3N1, Ireland
(770) Super Magnificent Coffee Company Ireland
Limited
Riverside One, Sir John Rogerson's Quay,
Dublin 2, D02 X576, Ireland
(580) 2023 11 24

(111) M 2014 25372 R
(732) Exxon Mobil Corporation, a New Jersey
Corporation
22777 Spingwoods Village Parkway, Spring,
TX 77389, USA
(770) Exxon Mobil Corporation, a Corporation
organized and existing under the laws of the
State of New Jersey
5959 Las Colinas Boulevard, Irving, Texas 7
5039-2298, USA
(580) 2023 11 27

(111) M 2014 25434 R
(732) Exxon Mobil Corporation, a Corporation
rganized and existing under the laws of the
State of New Jersey
22777 Spingwoods Village Parkway, Spring,
TX 77389, USA
(770) Exxon Mobil Corporation, a Corporation
organized and existing under the laws of the
State of New Jersey
5959 Las Colinas Boulevard, Irving, Texas
75039-2298, USA
(580) 2023 11 27

(111) M 2015 26129 R
(732) Exxon Mobil Corporation
22777 Spingwoods Village Parkway, Spring,
TX 77389, USA
(770) Exxon Mobil Corporation, 5959 Las Colinas
Boulevard, Irving, Texas 75039 – 2298, U.S.A.
USA
(580) 2023 11 27

(111) M 2015 26415 R
(732) Bayer Intellectual Property GmbH
Alfred-Nobel-Strasse 50, 40789 Monheim
am Rhein, Germany

(770) Bayer Intellectual Property GmbH
Alfred-Nobel-Str. 10, 40789 Monheim
am Rhein, Germany
(580) 2023 11 21

(111) M 2015 26536 R
(732) Bayer Intellectual Property GmbH
Alfred-Nobel-Strasse 50, 40789 Monheim
am Rhein, Germany
(770) Bayer Intellectual Property GmbH.,
Alfred-Nobel-Str. 10, 40789 Monheim am
Rhein Germany
(580) 2023 11 21

(111) M 2017 28932 R
(732) Bayer Intellectual Property GmbH
Alfred-Nobel-Strasse 50, 40789 Monheim
am Rhein, Germany
(770) Bayer Intellectual Property GmbH
Alfred-Nobel-Str. 10, 40789 Monheim
am Rhein, Germany
(580) 2023 11 21

(111) M 2019 31670 R
(732) Exxon Mobil Corporation
22777 Spingwoods Village Parkway, Spring,
TX 77389, USA
(770) Exxon Mobil Corporation
5959 Las Colinas Boulevard, Irving, Texas
75039 – 2298, USA
(580) 2023 11 27

(111) M 2019 31722 R
(732) Exxon Mobil Corporation
22777 Spingwoods Village Parkway, Spring,
TX 77389, USA
(770) Exxon Mobil Corporation
5959 Las Colinas Boulevard, Irving, Texas
75039 – 2298, USA
(580) 2023 11 27

CANCELLATION OF TRADEMARKS REGISTRATION

(111) M 2021 34612 R
(151) 2021 10 15
(732) LLC "Champions 111"
Ilia Chavchavadze Av. 29, 5th floor, 0179,
Tbilisi, Georgia
(141) 2024 01 11

(111) M 2021 34613 R
(151) 2021 10 15
(732) LLC "Champions 111"
Ilia Chavchavadze Av. 29, 5th floor, 0179,
Tbilisi, Georgia
(141) 2024 01 11

(111) M 2003 15138 R
(151) 2003 05 28
(732) Obshchestvo s Ogranichennoy Otvetstven-
nostju "Kobra International Farm"
Popov St. 2a, ap. 2,141190, Moskow Region
Fryazino, Russian Federation
(141) 2024 01 16

(111) M 2003 15139 R
(151) 2003 05 28
(732) Obshchestvo s Ogranichennoy Otvetstven-
nostju "Kobra International Farm"
Popov St. 2a, ap. 2,141190, Moskow Region
Fryazino, Russian Federation
(141) 2024 01 16

(111) M 2003 15160 R
(151) 2003 06 11
(732) Johnson & Johnson
One Johnson & Johnson Plaza, New
Brunswick, New Jersey 08933, USA
(141) 2024 01 16

(111) M 2003 15170 R
(151) 2003 06 27
(732) LLC "Heidelberg Cement Georgia"
Lermontov St. 18, 0105, Tbilisi, Georgia
(141) 2024 01 16

(111) M 2003 15162 R
(151) 2003 06 11
(732) BGI Trade Mark
30 Avenue George V, 75008 Paris, France
(141) 2024 01 16

(111) M 2003 15163 R
(151) 2003 06 11
(732) McDonald's International Property Company,
Ltd.
110 North Carpenter Street, Chicago, Illinois
60607, USA
(141) 2024 01 16

(111) M 2003 15192 R
(151) 2003 06 27
(732) Wyeth Holdings LLC
Five Giralda Farms, Madison, New Jersey
07940-0874, USA
(141) 2024 01 16

(111) M 2013 23717 R
(151) 2013 06 07
(732) The Gillette Company LLC
One Gillette Park, Boston, Massachusetts
02127, USA
(141) 2024 01 16

(111) M 2013 23786 R
(151) 2013 06 25
(732) LTD "Unimed Group Corp"
Adam Mitskevich St. 29, ap. 61, 0194,
Tbilisi, Georgia
(141) 2024 01 16

(111) M 2013 23720 R
(151) 2013 06 07
(732) General Motors LLC
300 Renaissance Center, City of Detroit,
State of Michigan 48265-3000, USA
(141) 2024 01 16

(111) M 2013 23723 R
(151) 2013 06 07
(732) Harrington Development Inc.
Arango-Orillac Bldg., East 54th street,
Republic of Panama
(141) 2024 01 16

(111) M 2013 23724 R
(151) 2013 06 07
(732) LTD "Beauty Life"
Gagarin St., Lane 2/5-4, fl. 3, office space 4,
0160, Tbilisi, Georgia
(141) 2024 01 16

(111) M 2013 23725 R
(151) 2013 06 07
(732) JSC "Management Group of Hotels and
Restaurants - EM/Group"
Marshall Gelovani Av. 2, 5th floor, 0159,
Tbilisi, Georgia
(141) 2024 01 16

(111) M 2013 23734 R
(151) 2013 06 07
(732) JSC "Georgian Beer Company"
Vill. Saguramo, 3311, Mtskheta Region,
Georgia
(141) 2024 01 16

(111) M 2013 23735 R
(151) 2013 06 07
(732) JSC "Georgian Beer Company"
Vill. Saguramo, 3311, Mtskheta Region,
Georgia
(141) 2024 01 16

(111) M 2013 23736 R
(151) 2013 06 07
(732) JSC "Georgian Beer Company"
Vill. Saguramo, 3311, Mtskheta Region,
Georgia
(141) 2024 01 16

(111) M 2013 23744 R
(151) 2013 06 07
(732) Hercules Incorporated
Hercules Plaza, 1313 North Market Street,
Wilmington, Delaware 19894-0001, USA
(141) 2024 01 16

(111) M 2013 23790 R
(151) 2013 06 25
(732) Nissan Jidosha Kabushiki Kaisha (Also
Trading as Nissan Motor Co., Ltd.)
No.2 Takaracho, Kanagawa-ku, Yokohama-
shi, Kanagawa-ken, Japan
(141) 2024 01 16

(111) M 2013 23796 R
(151) 2013 06 25
(732) Karen Vardanyan
Bairon St.3, ap. 36, Yerevan, Armenia
(141) 2024 01 16

(111) M 2013 23797 R
(151) 2013 06 25
(732) Karen Vardanyan
Bairon St. 3, ap. 36, Yerevan, Armenia
(141) 2024 01 16

(111) M 2013 23800 R
(151) 2013 06 25
(732) Abbott Healthcare Products B.V.
C.J. Van Houtenlaan 36, 1381 CP Weesp,
Netherlands
(141) 2024 01 16

(111) M 2013 23801 R
(151) 2013 06 25
(732) Abbott Healthcare Products B.V.
C.J. van Houtenlaan 36, 1381 CP Weesp,
Netherlands
(141) 2024 01 16

(111) M 2013 23754 R
(151) 2013 06 07
(732) Merck Sharp & Dohme Corp.
One Merck Drive, Whitehouse Station,
New Jersey 08889, USA
(141) 2024 01 16

(111) M 2013 23803 R
(151) 2013 06 25
(732) Sviatoslav Nechytailo
Zankovetska St.4, flat 27, Kievi, Ukraine
(141) 2024 01 16

(111) M 2013 23758 R
(151) 2013 06 07
(732) JSC "Management Group of Hotels and
Restaurants - EM/Group"
Marshall Gelovani Av. 2, 5th floor, 0159,
Tbilisi, Georgia
(141) 2024 01 16

(111) M 2013 23759 R
(151) 2013 06 07
(732) Ford Motor Company
One American Road, Dearborn, Michigan
48126, USA
(141) 2024 01 16

(111) M 2013 23805 R
(151) 2013 06 25
(732) Koba Nadareishvili
Tskvedadze st. 17, 0160, Tbilisi, Georgia
(141) 2024 01 16

(111) M 2013 23764 R
(151) 2013 06 07
(732) Pentair Technical Solutions UK Limited,
a Private limited company
3 Rutherford Road, Stephenson Industrial
Estate, Washington, Tyne And Wear,
NE37 3HX, United Kingdom
(141) 2024 01 16

(111) M 2013 23809 R
(151) 2013 06 25
(732) LTD "Chexder 22"
Merab Kostava St. 67/85, 0171, Tbilisi,
Georgia
(141) 2024 01 16

(111) M 2013 23814 R
(151) 2013 06 25
(732) Shanghai Feixun Communication Co., Ltd.
Building 20, 90, HQ Business Park, 4855
Guangfulin Road, Songjiang District,
Shanghai, China
(141) 2024 01 16

(111) M 2013 23815 R
(151) 2013 06 25
(732) JSC "Georgian Bartenders Association"
Delhi's 3rd St. 15, 0117, Tbilisi, Georgia
(141) 2024 01 16

(111) M 2013 23817 R
(151) 2013 06 25
(732) Novartis AG
4002 Basel, Switzerland
(141) 2024 01 16

(111) M 2013 23823 R
(151) 2013 06 25
(732) Philip Morris Products S.A.
Quai Jeanrenaud 3, 2000 Neuchatel,
Switzerland
(141) 2024 01 16

(111) M 2013 23824 R
(151) 2013 06 25
(732) Oncolytics Biotech Inc.
Suite 210, 1167 Kensington Crescent, N.W.,
Calgary, Alberta T2N 1X7, Canada
(141) 2024 01 16

(111) M 2013 23825 R
(151) 2013 06 25
(732) Retractable Technologies Inc.
511 Lobo Lane, Little Elm, Texas 75068, USA
(141) 2024 01 16

(111) M 2013 23836 R
(151) 2013 07 08
(732) Tinatin Apkhaidze
Ak. Tsereteli Av. 87, 0119, Tbilisi, Georgia
(141) 2024 01 12

(111) M 2013 23826 R
(151) 2013 06 26
(732) Techno Tronics Gulf
Jebel Ali Free Zone, Dubai, United Arab
Emirates
(141) 2024 01 12

(111) M 2013 23827 R
(151) 2013 06 26
(732) Techno Tronics Gulf
Jebel Ali Free Zone, Dubai, United Arab
Emirates
(141) 2024 01 12

(111) M 2013 23828 R
(151) 2013 06 26
(732) Techno Tronics Gulf
Jebel Ali Free Zone, Dubai, United Arab
Emirates
(141) 2024 01 12

(111) M 2013 23829 R
(151) 2013 06 26
(732) Teqno Troniks Galf
Jebel Ali Free Zone, Dubai, United Arab
Emirates
(141) 2024 01 12

(111) M 2013 23830 R
(151) 2013 06 26
(732) Teqno Troniks Galf
Jebel Ali Free Zone, Dubai, United Arab
Emirates
(141) 2024 01 12

(111) M 2013 23782 R
(151) 2013 06 20
(732) LTD "Geopasti"
Saburtalo St. 43, ap. 13, 0102, Tbilisi, Georgia
(141) 2024 01 12

(111) M 2013 23832 R
(151) 2013 07 02
(732) LTD "Kimerioni"
Vill. Chumlaki, 1519, Gurjaani Region,
Georgia
(141) 2024 01 12

(111) M 2013 23833 R
(151) 2013 07 02
(732) LTD "Kimerioni"
Vill. Chumlaki, 1519, Gurjaani Region,
Georgia
(141) 2024 01 12

(111) M 2013 23834 R
(151) 2013 07 02
(732) LTD "Kimerioni"
Vill. Chumlaki, 1519, Gurjaani Region,
Georgia
(141) 2024 01 12

(111) M 2013 23835 R
(151) 2013 07 02
(732) LTD "Kimerioni"
Vill. Chumlaki, 1519, Gurjaani Region,
Georgia
(141) 2024 01 12

(111) M 2013 23838 R
(151) 2013 07 08
(732) Limited Liability Company "Tekman"
Nikolay Bazhan Av. 30, 02140, Kyiv, Ukraine
(141) 2024 01 12

INTERNATIONAL LICENSE AGREEMENT

(800) 1661643

(732) Yandex LLC

Leo Tolstoy Str., 16, RU-119021 Moscow,
Russian Federation

(791) Yandex Deliveri Holding LLC

1 st Krasnogvardeisky passage, 22, building 1,
room 12-40, floor 12, 123112 Moscow,
Russian Federation

(793) №1836

Simple

From 29 05 2023- to the period of validity of
the trademark

6 – Doors of metal; jalousies of metal; outdoor blinds of metal; box fasteners of metal; locks of metal for bags; locks of metal for vehicles; locks of metal, other than electric; padlocks of metal, other than electronic; spring locks; road signs, non-luminous and non-mechanical, of metal; registration plates of metal; signs, non-luminous and non-mechanical, of metal; keys of metal; door fittings of metal; fittings of metal for windows; safes [metal or non-metal]; safes, electronic; bicycle parking installations of metal; letter boxes of metal.

7 – 3D printers; vending machines; moving walkways; coffee grinders, other than hand-operated; grinding machines; dishwashers; bottle filling machines; peeling machines; waste compacting machines; machines and apparatus for cleaning, electric; machines and apparatus for carpet shampooing, electric; kitchen machines, electric; wringing machines for laundry; washing machines [laundry]; coin-operated washing machines; spin driers [not heated]; vacuum cleaners; industrial robots; 3D printing pens; juice extractors, electric; washing installations for vehicles; washing apparatus; door openers, electric; beverage preparation machines, electromechanical; food preparation machines, electromechanical; shoe polishers, electric; electric fruit presses for household purposes; window closers, electric; window openers, electric.

9 – DVD players; ticket dispensers; coin-operated musical automata [juke boxes]; accumulators, electric, for vehicles; antennas; remote control apparatus; electro-dynamic apparatus for the remote control of signals; monitoring apparatus, other than for medical purposes; sound recording apparatus; Global Positioning System [GPS] apparatus; intercommunication apparatus; projection apparatus; telephone apparatus; solar panels for the production of electricity; electronic tags for goods; computer memory devices; encoded identification bracelets, magnetic; connected bracelets [measuring instruments]; electronic key fobs being remote control apparatus; camcorders; video baby monitors; video projectors; video telephones; video screens; mecha-

nical signs; signs, luminous; parking sensors for vehicles; joysticks for use with computers, other than for video games; floppy disks; sound recording discs; wearable video display monitors; electronic numeric displays; DNA chips; electronic interactive whiteboards; electronic notice boards; locks, electric; electric door bells; interfaces for computers; electronic pens [visual display units]; biometric identity cards; identity cards, magnetic; memory cards for video game machines; encoded magnetic cards; computer keyboards; thin client computers; downloadable cryptographic keys for receiving and spending cryptocurrency; encoded key cards; electronic book readers; electronic agendas; magnetic encoders; computers; laptop computers; tablet computers; notebook computers; wearable computers; downloadable e-wallets; vacuum tubes [radio]; darkroom lamps [photography]; thermionic tubes; amplifying tubes; flashlights [photography]; crash test dummies; resuscitation mannequins [teaching apparatus]; security tokens [encryption devices]; voting machines; money counting and sorting machines; mechanisms for coin-operated apparatus; coin-operated mechanisms for television sets; microprocessors; modems; monitors [computer hardware]; monitors [computer programs]; selfie sticks [hand-held monopods]; headphones; earpieces for remote communication; sound recording carriers; magnetic data media; optical data media; electronic sheet music, downloadable; computer software, recorded; computer hardware; selfie lenses; wrist rests for use with computers; spectacles; sunglasses; goggles for sports; electronic collars to train animals; signalling panels, luminous or mechanical; biometric passports; electronic pocket translators; transmitters [telecommunication]; telephone transmitters; transmitters of electronic signals; switches, electric; data gloves; computer software platforms, recorded or downloadable; wafers for integrated circuits; protective films adapted for computer screens; protective films adapted for smartphones; sound recording strips; digital signs; personal digital assistants [PDAs]; diagnostic apparatus, not for medical purposes; distance recording apparatus; distance measuring apparatus; speed measuring apparatus [photography]; speed checking apparatus for vehicles; teaching apparatus; time recording apparatus; apparatus and instruments for astronomy; surveying apparatus and instruments; navigational instruments; measuring apparatus; measuring devices, electric; meteorological instruments; observation instruments; navigation apparatus for vehicles [on-board computers]; satellite navigational apparatus; regulating apparatus, electric; telecommunication apparatus in the form of jewellery; precision measuring apparatus; audio- and

video-receivers; computer software applications, downloadable; ticket printers; printers for use with computers; computer programs, recorded; computer game software, downloadable; computer game software, recorded; computer programs, downloadable; computer operating programs, recorded; computer screen saver software, recorded or downloadable; record players; processors [central processing units]; electronic publications, downloadable; distribution consoles [electricity]; control panels [electricity]; radar apparatus; transmitting sets [telecommunication]; radios; vehicle radios; walkie-talkies; security surveillance robots; laboratory robots; teaching robots; telepresence robots; humanoid robots with artificial intelligence for use in scientific research; electric sockets; signals, luminous or mechanical; electronic access control systems for interlocking doors; hand-held electronic dictionaries; integrated circuit cards [smart cards]; smartglasses; smartphones; smartwatches; audiovisual teaching apparatus; charging stations for electric vehicles; bags adapted for laptops; integrated circuits; parking meters; kilometer recorders for vehicles; revolution counters; taximeters; television apparatus; teleprinters; cordless telephones; mobile telephones; credit card terminals; interactive touch screen terminals; thermostats; thermostats for vehicles; climate control digital thermostats; step-up transformers; resuscitation training simulators; vehicle breakdown warning triangles; telephone receivers; headgear being protective helmets; gauges; amplifiers; electric installations for the remote control of industrial operations; baby monitors; steering apparatus, automatic, for vehicles; video recorders; sound reproduction apparatus; invoicing machines; railway traffic safety appliances; data processing apparatus; theft prevention installations, electric; devices for the projection of virtual keyboards; optical character readers; battery chargers; chargers for electric accumulators; chargers for electronic cigarettes; acoustic alarms; apparatus for editing cinematographic film; couplers [data processing equipment]; anti-theft warning apparatus; computer peripheral devices; acoustic couplers; alarms; fog signals, non-explosive; whistle alarms; adding machines; electric and electronic effects units for musical instruments; bar code readers; downloadable image files; downloadable music files; animated cartoons; filters for use in photography; USB flash drives; cameras [photography]; digital photo frames; enlarging apparatus [photography]; containers for contact lenses; spectacle cases; cases for smartphones; cases especially made for photographic apparatus and instruments; spectacle chains; sleeves for laptops; covers for personal digital assistants [PDAs]; covers for tablet computers; covers for smartphones; chips [integrated circuits]; cell phone straps; spectacle cords; workmen's protective face-shields; downloadable graphics for mobile phones; epidiascopes; ergometers; 3D spectacles; downloa-

dable emoticons for mobile phones; mouse pads; screens [photography]; ear pads for headphones; mouse [computer peripheral]; trackballs [computer peripherals]; light dimmers [regulators], electric; safety restraints, other than for vehicle seats and sports equipment; wearable activity trackers; readers [data processing equipment]; downloadable ring tones for mobile phones; scanners [data processing equipment].

11 – Air deodorizing apparatus; hand drying apparatus for washrooms; fans [air-conditioning]; fans [parts of air-conditioning installations]; electric fans for personal use; water heaters; air-conditioning apparatus; air conditioners for vehicles; gas boilers; laundry room boilers; heating boilers; coffee machines, electric; electric lights for Christmas trees; acetylene flares; safety lamps; gas lamps; curling lamps; nail lamps; curing lamps, not for medical purposes; germicidal lamps for purifying air; light bulbs for directional signals for vehicles; ultraviolet ray lamps, not for medical purposes; electric lamps; chandeliers; multicookers; heating apparatus for defrosting vehicle windows; bread toasters; humidifiers; air-conditioning installations; kettles, electric.

12 – Motor buses; motor coaches; camping cars; driverless cars [autonomous cars]; motor racing cars; cars; robotic cars; sports cars; luggage carriers for vehicles; bumpers for automobiles; vehicle bumpers; bicycles; electric bicycles; helicopters; helicams; lorries; trucks with a crane feature incorporated; doors for vehicles; engines for land vehicles; military drones; civilian drones; delivery drones; camera drones; vehicle wheels; strollers; ships; mopeds; motor scooters; motorcycles; anti-theft devices for vehicles; push scooters [vehicles]; aeroplanes; anti-theft alarms for vehicles; reversing alarms for vehicles; safety seats for children, for vehicles; vehicle seats; snowmobiles; air vehicles; vehicles for locomotion by land, air, water or rail; ambulances; remote control vehicles, other than toys; electric vehicles; tricycles; delivery tricycles; yachts; self-balancing boards; self-balancing electric unicycles.

14 – Bracelets [jewelry]; watch bands; charms for key rings; alarm clocks; key rings [split rings with trinket or decorative fob]; retractable key rings; works of art of precious metal; jewellery; necklaces [jewelry]; split rings of precious metal for keys; rings [jewelry]; boxes of precious metal; presentation boxes for jewelry; watch cases [parts of watches]; clock cases; medals; locket [jewelry]; coins; earrings; watch chains; dials [clock- and watchmaking]; watches; sundials; clocks and watches, electric; control clocks [master clocks]; clocks; wristwatches.

16 – Fountain pens; albums; banners of paper; name badges [office requisites]; tickets; baggage claim

check tags of paper; forms, printed; announcement cards [stationery]; note books; pamphlets; booklets; newsletters; signboards of paper or cardboard; newspapers; advertisement boards of paper or cardboard; magazines [periodicals]; periodicals; printed publications; graphic representations; calendars; pencils; pictures; cards; geographical maps; catalogues; books; boxes of paper or cardboard; flyers; teaching materials [except apparatus]; packing [cushioning, stuffing] materials of paper or cardboard; stickers [stationery]; covers [stationery]; passport holders; greeting cards; postcards; conical paper bags; loose-leaf binders; stands for pens and pencils; writing cases [sets]; writing materials; writing instruments; drawing materials; school supplies [stationery]; printed matter; arithmetical tables; placards of paper or cardboard; writing or drawing books; labels of paper or cardboard; posters; folders for papers.

18 – Pocket wallets; business card cases; umbrellas; cases of leather or leatherboard; purses; travelling sets [leatherware]; vanity cases, not fitted; clothing for pets; conference folders; briefcases; rucksacks; net bags for shopping; bags; key cases; suitcases; labels of leather.

19 – Outdoor blinds, not of metal and not of textile; jalousies, not of metal.

20 – Indoor window blinds [furniture]; indoor window blinds of paper; indoor window blinds of woven wood; indoor window blinds of textile.

CLASSIFICATION INDEXES

INVENTIONS

CONCORDANCE TABLE OF INTERNATIONAL CLASSIFICATION INDEX AND PUBLICATION NUMBERS

| INTERNATIONAL CLASSIFICATION INDEXES (51) | NUMBER OF PUBLISHED APPLICATION (10) |
|--|--|
| A 61 P 25/18; A 61 P 25/22; A 61 P 25/24; A 61 P 25/28; C 07 C 235/08 | AP 2024 15862 A |
| E 02 B 9/04 | AP 2024 16087 A |
| E 04 B 2/76; E 04 B 2/74 | AP 2024 15431 A |
| F 03 B 13/16 | AP 2024 15822 A |
| G 04 B 37/18 | AP 2024 16197 A |

CONCORDANCE TABLE OF PUBLICATION NUMBERS AND INTERNATIONAL CLASSIFICATION INDEX

| NUMBER OF PUBLISHED APPLICATION (10) | INTERNATIONAL CLASSIFICATION INDEXES (51) |
|--|--|
| AP 2024 15431 A | E 04 B 2/76; E 04 B 2/74 |
| AP 2024 15822 A | F 03 B 13/16 |
| AP 2024 15862 A | A 61 P 25/18; A 61 P 25/22; A 61 P 25/24; A 61 P 25/28; C 07 C 235/08 |
| AP 2024 16087 A | E 02 B 9/04 |
| AP 2024 16197 A | G 04 B 37/18 |

CONCORDANCE TABLE OF INTERNATIONAL CLASSIFICATION INDEX, PATENT NUMBERS AND PUBLICATION NUMBERS

| INTERNATIONAL CLASSIFICATION INDEX (51) | NUMBER OF PATENT (11) | NUMBER OF PUBLISHED APPLICATION (10) |
|--|-----------------------------|---|
| A 01 G 9/029; A 01 G 31/06 | P 2024 7586 B | AP 2023 15702 A |
| A 61 K 39/395; A 61 K 39/00; A 61 K 31/7105; A 61 K 48/00; A 61 K 45/00; A 61 P 7/00 | P 2024 7587 B | AP 2023 15070 A |
| A 61 K 31/4164; A 61 P 3/10; A 61 P 11/06; A 61 P 17/06; A 61 P 19/02; C 07 D 491/048 | P 2024 7585 B | AP 2023 16005 A |
| B 01 J 23/00; F 01 N 3/00 | P 2024 7589 B | AP 2023 16037 A |
| H 04 R 9/06 | P 2024 7588 B | AP 2023 15894 A |

**CONCORDANCE TABLE OF PATENT NUMBERS,
PUBLICATION NUMBERS AND INTERNATIONAL CLASSIFICATION INDEX**

| NUMBER OF PATENT (11) | NUMBER OF PUBLISHED APPLICATION (10) | INTERNATIONAL CLASSIFICATION INDEX (51) |
|-----------------------|--------------------------------------|---|
| P 2024 7585 B | AP 2023 16005 A | A 61 K 31/4164; A 61 P 3/10; A 61 P 11/06; A 61 P 17/06; A 61 P 19/02; C 07 D 491/048 |
| P 2024 7586 B | AP 2023 15702 A | A 01 G 9/029; A 01 G 31/06 |
| P 2024 7587 B | AP 2023 15070 A | A 61 K 39/395; A 61 K 39/00; A 61 K 31/7105; A 61 K 48/00; A 61 K 45/00; A 61 P 7/00 |
| P 2024 7588 B | AP 2023 15894 A | H 04 R 9/06 |
| P 2024 7589 B | AP 2023 16037 A | B 01 J 23/00; F 01 N 3/00 |

**CONCORDANCE TABLE OF APPLICATION NUMBERS,
PUBLICATION NUMBERS AND PATENTS**

| NUMBER OF APPLICATION (21) | NUMBER OF PUBLISHED APPLICATION (10) | NUMBER OF PATENT (11) |
|----------------------------|--------------------------------------|-----------------------|
| AP 2017 15070 | AP 2023 15070 A | P 2024 7587 B |
| AP 2020 15702 | AP 2023 15702 A | P 2024 7586 B |
| AP 2022 15894 | AP 2023 15894 A | P 2024 7588 B |
| AP 2020 16005 | AP 2023 16005 A | P 2024 7585 B |
| AP 2022 16037 | AP 2023 16037 A | P 2024 7589 B |

APPLICATIONS***

**CONCORDANCE TABLE OF INTERNATIONAL CLASSIFICATION INDEX
AND PUBLICATION NUMBERS**

| INTERNATIONAL CLASSIFICATION INDEXES (51) | NUMBER OF PUBLISHED APPLICATION (10) |
|---|--------------------------------------|
| A 23 K 20/24; A 23 K 20/158; A 23 K 20/105; C 11 C 1/02 | AP 2024 16424 A |
| A 61 K 31/44; A 61 P 29/00; A 61 P 11/04; C 07 D 213/89 | AP 2024 16373 A |
| A 61 K 31/4168; A 61 P 1/16; A 61 P 3/10; A 61 P 3/06; A 61 P 3/04; A 61 P 9/00; A 61 P 9/04; A 61 P 9/10; A 61 P 9/12; A 61 P 35/00; A 61 P 3/00; A 61 P 43/00 | AP 2024 16398 A |
| A 61 K 31/095; A 61 K 8/00; A 61 K 9/00; A 61 K 33/24; A 61 K 31/194; A 61 K 31/327; A 61 P 17/00 | AP 2024 16397 A |
| A 61 K 31/437; A 61 K 31/519; A 61 K 31/5365; A 61 P 11/00; A 61 P 13/12; A 61 P 27/02; A 61 P 1/16; A 61 P 7/04; A 61 P 9/10; C 07 D 519/00 | AP 2024 16376 A |
| A 61 K 31/506; A 61 P 25/18; C 07 D 417/14 | AP 2024 16375 A |
| B 09 B 3/65; C 02 F 3/28; C 02 F 3/34 | AP 2024 16380 A |
| C 07 D 401/04; C 07 D 401/12; C 07 D 231/14 | AP 2024 16390 A |
| F 28 D 1/04; F 28 D 21/00; F 28 F 21/08; F 28 F 9/26 | AP 2024 16403 A |

**CONCORDANCE TABLE OF PUBLICATION NUMBERS
AND INTERNATIONAL CLASSIFICATION INDEX**

| NUMBER OF PUBLISHED APPLICATION (10) | INTERNATIONAL CLASSIFICATION INDEXES (51) |
|---|---|
| AP 2024 16373 A | A 61 K 31/44; A 61 P 29/00; A 61 P 11/04; C 07 D 213/89 |
| AP 2024 16375 A | A 61 K 31/506; A 61 P 25/18; C 07 D 417/14 |
| AP 2024 16376 A | A 61 K 31/437; A 61 K 31/519; A 61 K 31/5365; A 61 P 11/00; A 61 P 13/12; A 61 P 27/02; A 61 P 1/16; A 61 P 7/04; A 61 P 9/10; C 07 D 519/00 |
| AP 2024 16380 A | B 09 B 3/65; C 02 F 3/28; C 02 F 3/34 |
| AP 2024 16390 A | C 07 D 401/04; C 07 D 401/12; C 07 D 231/14 |
| AP 2024 16397 A | A 61 K 31/095; A 61 K 8/00; A 61 K 9/00; A 61 K 33/24; A 61 K 31/194; A 61 K 31/327; A 61 P 17/00 |
| AP 2024 16398 A | A 61 K 31/4168; A 61 P 1/16; A 61 P 3/10; A 61 P 3/06; A 61 P 3/04; A 61 P 9/00; A 61 P 9/04; A 61 P 9/10; A 61 P 9/12; A 61 P 35/00; A 61 P 3/00; A 61 P 43/00 |
| AP 2024 16403 A | F 28 D 1/04; F 28 D 21/00; F 28 F 21/08; F 28 F 9/26 |
| AP 2024 16424 A | A 23 K 20/24; A 23 K 20/158; A 23 K 20/105; C 11 C 1/02 |

UTILITY MODEL

**CONCORDANCE TABLE OF INTERNATIONAL CLASSIFICATION INDEX,
PATENT NUMBERS AND PUBLICATION NUMBERS**

| INTERNATIONAL CLASSIFICATION INDEX (51) | NUMBER OF PATENT (11) | NUMBER OF PUBLISHED APPLICATION (10) |
|--|--------------------------|---|
| E 02 B 3/04 | U 2024 2160 Y | AU 2023 16174 U |

**CONCORDANCE TABLE OF PATENT NUMBERS,
PUBLICATION NUMBERS AND INTERNATIONAL CLASSIFICATION INDEX**

| NUMBER OF PATENT (11) | NUMBER OF PUBLISHED APPLICATION (10) | INTERNATIONAL CLASSIFICATION INDEX (51) |
|--------------------------|---|--|
| U 2024 2160 Y | AU 2023 16174 U | E 02 B 3/04 |

**CONCORDANCE TABLE OF APPLICATION NUMBERS,
PUBLICATION NUMBERS AND PATENTS**

| NUMBER OF APPLICATION (21) | NUMBER OF PUBLISHED APPLICATION (10) | NUMBER OF PATENT (11) |
|-------------------------------|---|--------------------------|
| AU 2023 16174 | AU 2023 16174 U | U 2024 2160 Y |

DESIGNS**CONCORDANCE TABLE OF INTERNATIONAL CLASSIFICATION INDEX,
NUMBERS OF REGISTRATION AND PUBLICATION NUMBERS**

| INTERNATIONAL CLASSIFICATION INDEX (51) | NUMBER OF REGISTRATION (11) | NUMBER OF PUBLISHED APPLICATION (10) |
|--|-----------------------------------|---|
| 06-02 | D 2024 989 S | AD 2023 1306 S |
| 11-01 | D 2024 988 S | AD 2023 1302 S |
| 11-01 | D 2024 990 S | AD 2023 1303 S |

**CONCORDANCE TABLE OF NUMBERS OF REGISTRATION,
PUBLICATION NUMBERS AND INTERNATIONAL CLASSIFICATION INDEX**

| NUMBER OF REGISTRATION (11) | NUMBER OF PUBLISHED APPLICATION (10) | INTERNATIONAL CLASSIFICATION INDEX (51) |
|-----------------------------------|---|--|
| D 2024 988 S | AD 2023 1302 S | 11-01 |
| D 2024 989 S | AD 2023 1306 S | 06-02 |
| D 2024 990 S | AD 2023 1303 S | 11-01 |

**CONCORDANCE TABLE OF APPLICATION NUMBERS,
PUBLICATION NUMBERS AND NUMBERS OF REGISTRATION**

| NUMBER OF APPLICATION (21) | NUMBER OF PUBLISHED APPLICATION (10) | NUMBER OF REGISTRATION (11) |
|----------------------------------|--|--------------------------------|
| AD 2023 1302 | AD 2023 1302 S | D 2024 988 S |
| AD 2023 1303 | AD 2023 1303 S | D 2024 990 S |
| AD 2023 1306 | AD 2023 1306 S | D 2024 989 S |

DESIGNS REGISTERED ACCORDING TO THE ACCELERATED PROCEDURE

CONCORDANCE TABLE OF INTERNATIONAL CLASSIFICATION INDEX AND PUBLICATION NUMBERS

| INTERNATIONAL CLASSIFICATION INDEXES (51) | NUMBER OF REGISTRATION (11) |
|--|--------------------------------|
| 02-02 | D 2024 991 S |

CONCORDANCE TABLE OF PUBLICATION NUMBERS AND INTERNATIONAL CLASSIFICATION INDEX

| NUMBER OF REGISTRATION (11) | INTERNATIONAL CLASSIFICATION INDEXES (51) |
|--------------------------------|--|
| D 2024 991 S | 02-02 |

CONCORDANCE TABLE OF APPLICATION NUMBERS, PUBLICATION NUMBERS AND PATENTS

| NUMBER OF APPLICATION (21) | NUMBER OF REGISTRATION (11) |
|-------------------------------|--------------------------------|
| AD 2023 1354 | D 2024 991 S |

TRADEMARKS

CONCORDANCE TABLE OF REGISTRATION NUMBERS, APPLICATION NUMBERS, PUBLICATION NUMBERS AND BULLETIN NUMBERS

| NUMBER OF REGISTRATION (111) | NUMBER OF APPLICATIONS (210) | NUMBER OF PUBLISHED APPLICATIONS (260) | NUMBER OF BULLETIN |
|------------------------------------|------------------------------------|---|-----------------------|
| M 2023 37761 R | AM 126163 | – | 2(629)2023 |
| M 2024 37762 R | AM 121503 | AM 2023 121503 A | 16(619) 2023 |
| M 2024 37763 R | AM 121502 | AM 2023 121502 A | 17(620) 2023 |
| M 2024 37764 R | AM 120824 | AM 2023 120824 A | 15(618) 2023 |
| M 2024 37765 R | AM 121430 | AM 2023 121430 A | 17(620)2023 |
| M 2024 37766 R | AM 119075 | AM 2023 119075 A | 12(615)2023 |
| M 2024 37767 R | AM 120618 | AM 2023 120618 A | 14(617)2023 |
| M 2024 37768 R | AM 119353 | AM 2023 119353 A | 12(615)2023 |
| M 2024 37769 R | AM 121121 | AM 2023 121121 A | 17(620)2023 |
| M 2024 37770 R | AM 121217 | AM 2023 121217 A | 17(620)2023 |
| M 2024 37771 R | AM 121120 | AM 2023 121120 A | 17(620)2023 |
| M 2024 37772 R | AM 120700 | AM 2023 120700 A | 13(616)2023 |
| M 2024 37773 R | AM 121156 | AM 2023 121156 A | 17(620)2023 |
| M 2024 37774 R | AM 121129 | AM 2023 121129 A | 16(619)2023 |
| M 2024 37775 R | AM 120815 | AM 2023 120815 A | 15(618)2023 |
| M 2024 37776 R | AM 121127 | AM 2023 121127 A | 15(618)2023 |
| M 2024 37777 R | AM 121241 | AM 2023 121241 A | 17(620)2023 |
| M 2024 37778 R | AM 120437 | AM 2023 120437 A | 12(615)2023 |
| M 2024 37779 R | AM 119998 | AM 2023 119998 A | 12(615)2023 |
| M 2024 37780 R | AM 121636 | AM 2023 121636 A | 17(620)2023 |
| M 2024 37781 R | AM 121310 | AM 2023 121310 A | 17(620)2023 |
| M 2024 37782 R | AM 121351 | AM 2023 121351 A | 17(620)2023 |
| M 2024 37783 R | AM 121308 | AM 2023 121308 A | 17(620)2023 |
| M 2024 37784 R | AM 121309 | AM 2023 121309 A | 17(620)2023 |
| M 2024 37785 R | AM 120831 | AM 2023 120831 A | 17(620)2023 |
| M 2024 37786 R | AM 120830 | AM 2023 120830 A | 17(620)2023 |
| M 2024 37787 R | AM 126185 | – | 2(629)2023 |
| M 2024 37788 R | AM 126114 | – | 2(629)2023 |
| M 2024 37789 R | AM 126166 | – | 2(629)2023 |
| M 2024 37790 R | AM 126112 | – | 2(629)2023 |
| M 2024 37791 R | AM 120617 | AM 2023 120617 A | 13(616)2023 |
| M 2024 37792 R | AM 120935 | AM 2023 120935 A | 13(616)2023 |
| M 2024 37793 R | AM 126381 | – | 2(629)2023 |
| M 2024 37794 R | AM 126382 | – | 2(629)2023 |
| M 2024 37795 R | AM 126383 | – | 2(629)2023 |
| M 2024 37796 R | AM 126384 | – | 2(629)2023 |
| M 2024 37797 R | AM 126385 | – | 2(629)2023 |

**CONCORDANCE TABLE OF PUBLICATION NUMBERS
AND APPLICATION NUMBERS**

| NUMBER OF PUBLISHED APPLICATION (260) | NUMBER OF APPLICATION (210) |
|--|--------------------------------|
| AM 2024 122207 A | AM 122207 |

**CONCORDANCE TABLE OF INDEX OF GOODS AND/OR SERVICES
AND APPLICATION NUMBERS**

| INDEX OF GOODS AND/OR SERVICES (511) | NUMBER OF PUBLISHED APPLICATIONS (260) |
|---|--|
| 32 | AM 2024 122207 A |
| 33 | AM 2024 122207 A |
| 43 | AM 2024 122207 A |

**CONCORDANCE TABLE OF INDEX OF GOODS AND/OR SERVICES
AND NUMBERS OF TRADEMARKS REGISTERED ACCORDING
TO THE ACCELERATED PROCEDURE**

| INDEX OF GOODS AND/OR SERVICES (511) | NUMBERS OF REGISTERED ACCORDING TO THE ACCELERATED PROCEDURE (111) |
|---|--|
| 5 | M 2024 37761 R |
| 29 | M 2024 37789 R |
| 33 | M 2024 37788 R |
| 33 | M 2024 37790 R |
| 34 | M 2024 37793 R |
| 34 | M 2024 37794 R |
| 34 | M 2024 37795 R |
| 34 | M 2024 37796 R |
| 34 | M 2024 37797 R |
| 35 | M 2024 37787 R |
| 36 | M 2024 37787 R |
| 39 | M 2024 37787 R |
| 43 | M 2024 37787 R |
| 44 | M 2024 37787 R |
| 45 | M 2024 37787 R |

OFFICIAL BULLETIN OF THE INDUSTRIAL PROPERTY

INVENTIONS
UTILITY MODELS
DESIGNS
TRADEMARKS

2(629)

EDITOR-IN-CHIEF: N. Bebrishvili

EDITOR-TRANSLATOR: E. Gabunia

PROOFREADER: A. Shikhashvili

COMPUTER LAYOUT: M. Ordenidze
K. Svanidze

ISSN 2720-8486

info@sakpatenti.gov.ge
www.sakpatenti.gov.ge

**LIST OF CODES, IN ALPHABETIC SEQUENCE, AND THE CORRESPONDING (SHORT) NAMES OF STATES, OTHER ENTITIES AND INTERGOVERNMENTAL ORGANIZATIONS
(WIPO STANDARD ST.3)**

| | | | | | |
|----|--|----|---|----|--|
| AD | Andorra | | | | |
| AE | United Arab Emirates | GD | Grenada | NE | Niger |
| AF | Afghanistan | GG | Guernsey | NG | Nigeria |
| AG | Antigua and Barbuda | GH | Ghana | NI | Nicaragua |
| AI | Anguilla | GI | Gibraltar | NL | Netherlands |
| AL | Albania | GT | Guatemala | NO | Norway |
| AM | Armenia | GW | Guinea- Bissau | NP | Nepal |
| AN | Netherlands Antilles | GY | Guyana | NR | Nauru |
| AO | Angola | HK | The Hong Kong Special Administrative Region of the People's Republic of China | NZ | New Zealand |
| AP | African Regional Intellectual Property Organization (ARIPO) | HN | Honduras | OA | African Intellectual Property Organization (OAPI) |
| AR | Argentina | HR | Croatia | OM | Oman |
| AT | Austria | HT | Haiti | PA | Panama |
| AU | Australia | HU | Hungary | PE | Peru |
| AW | Aruba | IB | International Bureau of the World Intellectual Property Organization (WIPO) | PG | Papua New Guinea |
| AZ | Azerbaijan | ID | Indonesia | PH | Philippines |
| BA | Bosnia and Herzegovina | IE | Ireland | PK | Pakistan |
| BB | Barbados | IL | Israel | PL | Poland |
| BD | Bangladesh | IM | Isle of Man | PT | Portugal |
| BE | Belgium | IN | India | PW | Palau |
| BF | Burkina Faso | IQ | Iraq | PY | Paraguay |
| BG | Bulgaria | IR | Iran (Islamic Republic of) | QA | Qatar |
| BH | Bahrain | IS | Iceland | QZ | Community Plant Variety Office (European Community) (CPVO) |
| BI | Burundi | IT | Italy | RO | Romania |
| BJ | Benin | JE | Jersey | RS | Serbia |
| BM | Bermuda | JM | Jamaica | RU | Russian Federation |
| BN | Brunei Darussalam | JO | Jordan | RW | Rwanda |
| BO | Bolivia | JP | Japan | SA | Saudi Arabia |
| BR | Brazil | KE | Kenya | SB | Solomon Islands |
| BS | Bahamas | KG | Kyrgyzstan | SC | Seychelles |
| BT | Bhutan | KH | Cambodia | SD | Sudan |
| BV | Bouvet Island | KI | Kiribati | SG | Singapore |
| BW | Botswana | KM | Saint Kitts and Nevis | SH | Saint Helena |
| BX | Benelux Office for Intellectual Property (BOIP) | KP | Democratic People's Republic of Korea | SI | Slovenia |
| BY | Belarus | KR | Republic of Korea | SK | Slovakia |
| BZ | Belize | KW | Kuwait | SL | Sierra Leone |
| CA | Canada | KY | Cayman Islands | SM | San Marino |
| CD | Democratic Republic of the Congo | KZ | Kazakhstan | SN | Senegal |
| CF | Central African Republic | LA | Lao People's Democratic Republic | SO | Somalia |
| CG | Congo | LB | Lebanon | SR | Suriname |
| CH | Switzerland | LC | Saint Lucia | ST | Sao Tome and Principe |
| CI | Cote d'Ivoire | LI | Liechtenstein | SV | El Salvador |
| CK | Cook Islands | LK | Sri Lanka | SY | Syrian Arab Republic |
| CL | Chile | LR | Liberia | SZ | Swaziland |
| CM | Cameroon | LS | Lesotho | TC | Turks and Caicos Islands |
| CN | China | LT | Lithuania | TD | Chad |
| CO | Colombia | LU | Luxembourg | TG | Togo |
| CR | Costa Rica | LV | Latvia | TH | Thailand |
| CU | Cuba | LY | Libyan Arab Jamahiriya | TJ | Tajikistan |
| CV | Cape Verde | MA | Morocco | TL | Timor-Leste |
| CY | Cyprus | MC | Monaco | TM | Turkmenistan |
| CZ | Czech Republic | MD | Republic of Moldova | TN | Tunisia |
| DE | Germany | ME | Montenegro | TO | Tonga |
| DJ | Djibouti | MG | Madagascar | TR | Turkey |
| DM | Dominica | MK | The former Yugoslav Republic of Macedonia | SE | Sweden |
| DO | Dominican Republic | ML | Mali | TT | Trinidad and Tobago |
| DZ | Algeria | MM | Myanmar | TV | Tuvalu |
| EA | Eurasian Patent Organization (EAPO) | MN | Mongolia | TW | Taiwan, Province of China |
| EC | Ecuador | MO | Macao | TZ | United Republic of Tanzania |
| EE | Estonia | MP | Northern Mariana Islands | UA | Ukraine |
| EG | Egypt | MR | Mauritania | UG | Uganda |
| EH | Western Sahara | MS | Montserrat | US | United States of America |
| EM | Office for Harmonization in the Internal Market (Trademarks and Designs)(OHIM) | MT | Malta | UY | Uruguay |
| EP | European Patent Office (EPO) | MU | Mauritius | UZ | Uzbekistan |
| ER | Eritrea | MV | Maldives | VA | Holy See |
| ES | Spain | MW | Malawi | VC | Saint Vincent and the Grenadines |
| ET | Ethiopia | MX | Mexico | VE | Venezuela |
| FI | Finland | MY | Malaysia | VG | Virgin Islands (British) |
| FJ | Fiji | MZ | Mozambique | VN | Viet Nam |
| FK | Falkland Islands (Malvinas) | NA | Namibia | VU | Vanuatu |
| FO | Faroe Islands | | | WO | World Intellectual Property Organization (WIPO) |
| FR | France | | | WS | Samoa |
| GA | Gabon | | | XN | Nordic Patent Institute (NPI) |
| GB | United Kingdom | | | YE | Yemen |
| GC | Patent Office of the Cooperation Council for the Arab States of the Gulf (GCC) | | | ZA | South Africa |
| | | | | ZM | Zambia |
| | | | | ZW | Zimbabwe |